

UC Irvine

UC Irvine Previously Published Works

Title

Design and Testing of a Unique, Compact Gas Turbine Catalytic Combustor Premixer

Permalink

<https://escholarship.org/uc/item/9vq6b5p4>

Authors

Hack, RL
McDonell, VG
Samuelsen, GS
[et al.](#)

Publication Date

2003

DOI

10.1115/gt2003-38778

Copyright Information

This work is made available under the terms of a Creative Commons Attribution License, available at <https://creativecommons.org/licenses/by/4.0/>

Peer reviewed

GT2003-38778

DESIGN AND TESTING OF A UNIQUE, COMPACT GAS TURBINE CATALYTIC COMBUSTOR PREMIXER

R.L. Hack, V.G. McDonnell, , and G.S. Samuelsen¹
UCI Combustion Laboratory
University of California
Irvine, CA 92697-3550
United States of America

J. Blust, P. Dutta, K. Smith
Solar Turbines Inc.
2200 Pacific Highway
San Diego, CA 92101
United States of America

D. Yee
Catalytica Energy Systems, Inc.
430 Ferguson Drive
Mountain View, CA 94043
United States of America

ABSTRACT

Catalytic combustion systems represent a potentially significant technology development in low-NO_x gas turbine technology. The challenges associated with the implementation of catalytic combustion in a gas turbine include the need to present both a uniform fuel/air mixture as well as a uniform approach velocity to the catalyst within a minimal volume. The effort described herein addresses the design of catalytic combustor premixer for use on a small frame industrial (5 MW) stationary gas turbine.

The general requirements for the premixer were to provide velocity and fuel air mixture uniformity at the exit plane of $\pm 10\%$ of the mean and $\pm 3\%$ of the mean respectively at nominal idle and full load conditions while maintaining a pressure drop of 4% maximum. The target turbine's packaging and air-flow path presented an additional challenge requiring the flow to make a 180 degree flow reversal immediately upstream of the combustor.

Computational fluid dynamics modeling was utilized to iterate the mixer design. A unique solution was obtained utilizing an involute shaped contraction/throat/expansion scheme. The most promising design was fabricated and tested

at atmospheric conditions. As compared to a "baseline" mixer, the final involute design improved upon the flow mixing and velocity uniformity. The novel premixer design also eliminated the use of fuel injection spokes and static mixers, relying upon fuel injection from the wall and a high turbulent kinetic energy (TKE) throat section to provide the mixing, thereby simplify manufacturing.

To test both scaling issues in the mixer and to provide an opportunity to test the design at high pressure, a 25% scale (approximate) reduced size mixer was designed and fabricated. Subsequent atmospheric and elevated pressure (11 atm, 1110 kPa) testing confirmed that the mixture uniformity was maintained and the general concept was applicable at both a reduced scale and at elevated pressures. Finally the premixer was integrated with a catalyst and fueled to confirm the overall system performance. The emissions of NO_x were <1ppm .

BACKGROUND

Catalytic combustion systems represent a potentially significant technology development in low-NO_x gas turbine technology (e.g., Fant, et al., 2000; Cutrone, et al., 1999). This is especially important in urban air sheds where (1) a reduction in NO_x is vital to the air quality of the region, and (2) the

1. corresponding author, gss@uci.edu
949 824-5950 x120, 949 824-7423 FAX

application of the gas turbine is expanding rapidly due to the advance of;

- Combined cycle and co-generation systems,
- Distributed power generation,
- Future application of ultra high efficiency combined fuel cell/gas turbine systems,
- Future applications of gas turbine to rail locomotives and
- Future application of gas turbines to hybrid automobiles

A typical catalytic combustion system schematic is shown in Figure 1. In this system, compressor discharge air is first pre-heated through a small lean, pre-mixed burner or recuperator. This is necessary to bring the air to a temperature at which the catalyst can activate. Then, fuel for engine operation is introduced and pre-mixed with the heated air in a pre-mixer. Pre-mixed fuel and air pass through the catalyst bed where the surface reactions occur. This process rapidly heats the reactants so that when they exit the catalyst bed they ignite. The burn-out zone is an advanced backside cooled liner in which the reactants burn and consume excess fuel and CO. Note that the part load injection of fuel, which bypasses the catalyst bed, is intended to provide combustion stability at off peak conditions through the establishment of a separate flame in the burn-out zone.

Technological challenges remain, however, for the successful application of catalysts to gas turbine engines. A paramount challenge is to obtain, with minimum pressure drop, the best possible mixing between the fuel and the air prior to its introduction to the catalytic reactor. The success and durability of this system is largely dependent upon the quality of fuel-air pre-mixing provided by the pre-mixer. Exceptionally good mixing is needed to (1) minimize NO_x, and (2) minimize hot spots and thermal stresses within the catalyst bed.

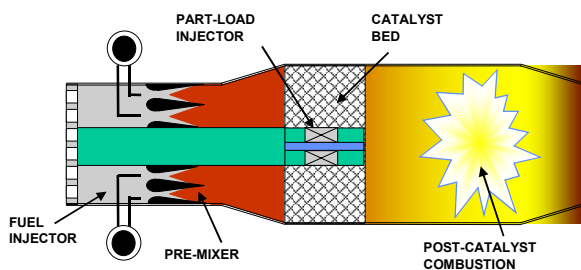

Figure 1. Typical Catalytic Combustor System.

An ideal pre-mixer would provide a $\pm 3\%$ concentration uniformity (from the mean) and $\pm 10\%$ velocity uniformity (from the mean) to the catalyst bed with a pressure drop of less than 4%. The concentration and velocity uniformity specifications were established by Catalytica based upon their

experience with catalyst life and performance while the pressure drop consideration was established by Solar Turbines based upon typical gas turbine engine operating parameters.

BASELINE MIXER DESIGN AND CHARACTERIZATION

To form a basis for design iteration and comparison, a “baseline” mixer was designed and fabricated. While not an exact duplicate of a proposed, proprietary premixer, it did incorporate many of the “current thinking, common practices” on mixing technology and fuel injection as well as faithfully mimicked the geometric packaging constraints of the target engine. The most distinguishing characteristic of the premixer packaging, as mandated by the target engine, is the 180-degree flow reversal section, henceforth referred to as the “horseshoe bend”. Fuel is introduced through a spoke fuel injection scheme comprised of twelve, 4.78 mm OD fuel injection spokes, each with six, 1.37 mm dia holes arranged in 2 sets of 3 equally spaced along the length of the spoke and oriented at 90-deg to the bulk air flow. Fuel and air mixing is further enhanced in the baseline design through the implementation of 3 static mixers downstream of the fuel injection that utilizes shear layer interaction to promote mixing. Figure 2 shows a cross

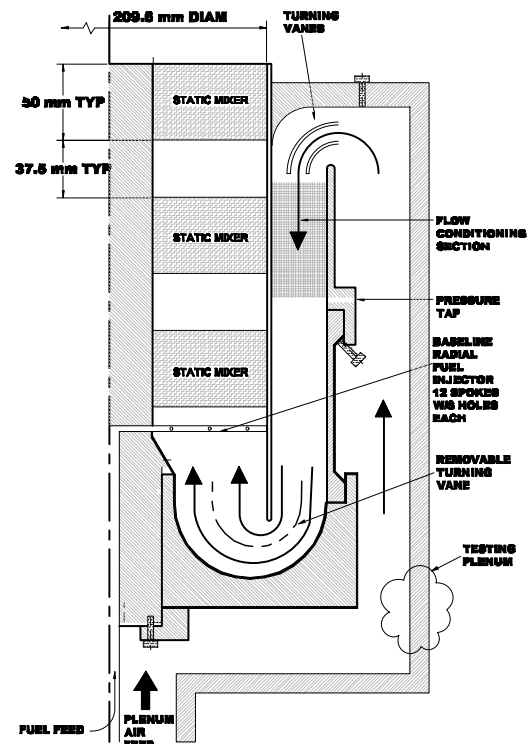

Figure 2: Baseline Premixer Cross Section section of the premixer installed in the test plenum. The flow conditioning section is a unique artifact of the plenum fed air supply configuration used for testing and is intended to flattened the air flow prior to entering the premixer itself; in the

target engine, the flow would have a long, co-axial entry to the premixer (as opposed to the turning vane as shown) and would have a relatively flat profile. Note the location of the pressure tap downstream of the flow condition section used to measure the pressure drop across the both the baseline and novel premixers (the flow conditioner was common to both the baseline and novel configurations). Figure 3 shows the actual premixer. The static mixers are evident in the component on the right as is the bottom of the horseshoe bend. The cylinder on the left slips over the static mixers and provides the dividing wall for the flow reversal. For a sense of scale, the exit plane diameter is 209.6 mm.

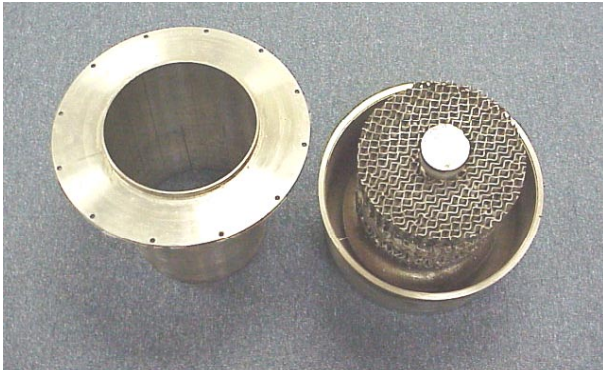

Figure 3: Baseline Premixer Hardware

Atmospheric pressure tests were made on the baseline premixer to characterize the “as designed” catalyst entrance velocity and mixture uniformity. The measurement plane for both velocity and concentrations measurements were made at 30.5 mm downstream of the exit plane, representative of the entrance to the catalyst section. After the exit plane of the premixer was a 12.7 mm open space, then a 12.7 mm thick honeycomb (nominally 6.35 mm hexagonal cell; 0.13 mm thick wall) and then 5.08 mm of open space before the measurement plane.

Velocity measurements were made using a two-component laser anemometry (LA) system. A 30-degree forward scattering configuration was utilized. The airflow was seeded with 3-micron alumina. The football shaped sample volume generated by the intersecting laser beams is approximately 1 mm long x 0.45 mm dia. A spatial filter in the receiver establishes the effective sample volume dimensions of 0.20 mm x 0.45mm. A sampling grid on rectilinear 12.7 mm x 12.7 mm pattern provided over 200+ sample points at the 209.6 mm dia exit plane of the baseline premixer. However a shadowing effect from various fixturing hardware components reduced the number of sample points to 146 across the exit plane. Sampling at each location was for a period of 2 minutes or until 4000 valid samples were obtained, whichever occurred first.

Concentration measurements were made with natural gas flowing as the fuel. Utilizing a 3.3 mm OD, 1.6 mm ID uncooled stainless steel extractive probe, a real time continuous gas sample was extracted and directed to a flame ionization

detector to measure the exit plane concentration. The same sampling grid utilized for the LA measurements was used for the concentration measurements. However, no “shadowing” effect limited the extractive probe and as such, 217 sample locations were obtained over the sample plane. Sampling time at each location was defined as the point at which a stable reading was achieved for a minimum of 10 seconds. The recorded value was the average of the final 10-second period (as determined by the data acquisition system)

The tests were conducted at atmospheric conditions due to the simplicity of the set-up and the relative ease of screening various designs. (Elevated pressure tests were ultimately conducted on the final design). For the atmospheric test, the mass flow was scaled so that the velocity at the measurement plane (i.e. the entrance to the catalyst section) matched the target engine application. Specifically, an “idle” state of 0.46 kg/sec = 22.6 std cubic meters/min air, 3% by volume fuel and “full load” state of 0.68 kg/sec = 34 std cubic meters/min air, 4% by volume fuel, were established as the two atmospheric test conditions.

Data analysis was comprised of determining three statistical parameters:

- Standard Deviation
- Pattern Factor (PF) = $\frac{[MaxValue - MeanValue]}{MeanValue}$
- Modified Pattern Factor = $\frac{[MaxValue - MinValue]}{MeanValue}$

Perfectly uniform conditions would result in “zero” for all of these statistics; the lower the value, the better the uniformity. To meet the desired goals of $\pm 3\%$ concentration and $\pm 10\%$ velocity from the mean value of each, modified pattern factors of 0.06 and 0.2 respectively would be achieved {e.g. $[1.03 - 0.97]/1 = 0.06$, $[1.1 - 0.9]/1 = 0.2$ } In addition to the statistical analysis, contours of the measured quantities are presented to provide a qualitative visual assessment of uniformity. The individual point measurements were normalized with respect to the mean of all the measurements in the plane for a give operating condition. A Kriging algorithm was used to generate the contour map the measurements onto a Cartesian grid. Boundary conditions of zero velocity and zero radial concentration gradient were applied. Finally, a color of “yellow” was assigned to contours that were within the desired uniformity windows.

Figures 4 and 5 show the normalized fuel concentration and axial velocity for the baseline premixer at the idle condition.

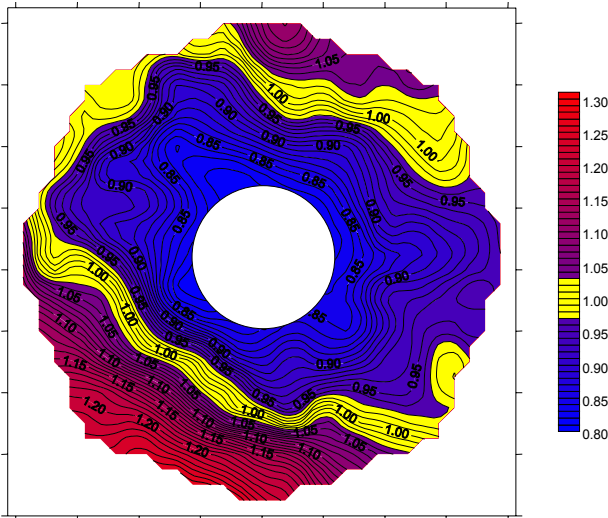

Figure 4: Baseline Premixer Normalized Fuel Concentration: Idle Condition

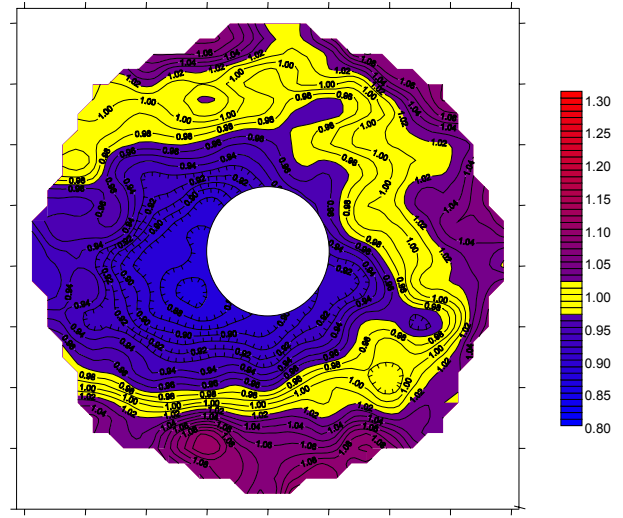

Figure 6: Baseline Premixer Normalized Fuel Concentration with Horseshoe Turning Vane and Injector Modifications: Idle Condition

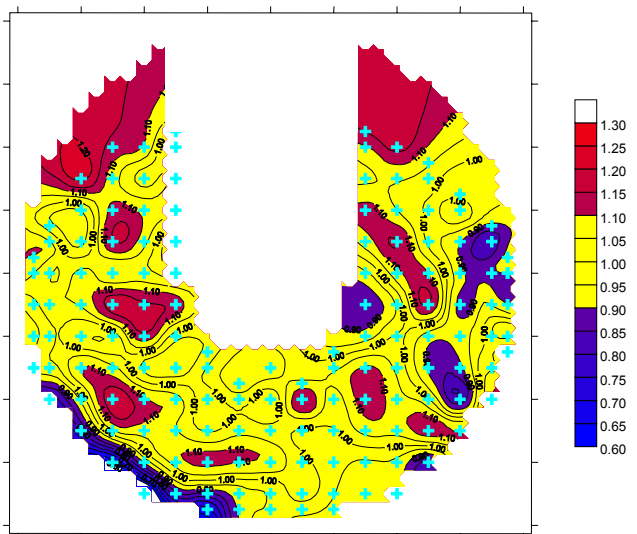

Figure 5: Baseline Premixer Normalized Velocity: Idle Condition

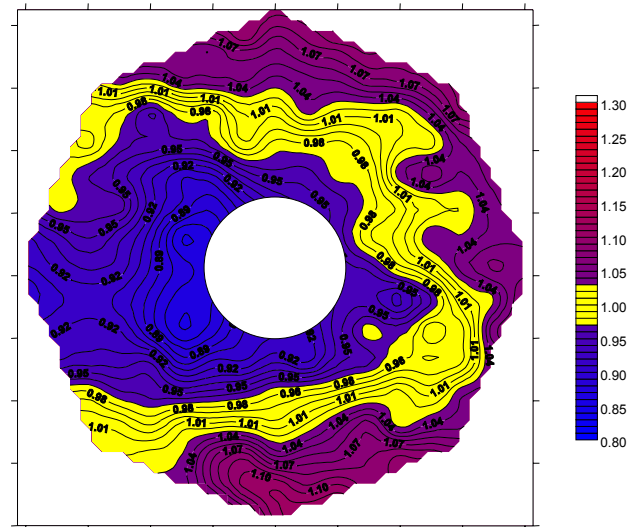

Figure 7: Baseline Premixer Normalized Fuel Concentration with Horseshoe Turning Vane and Injector Modification: Full Power Condition.

While the velocity uniformity in the baseline condition was not unreasonable, with only a few islands of velocity out of the desired range, the fuel concentration uniformity was quite poor. It was suspected that flow mal-distribution around the horseshoe bend as well as fuel injection radial mal-distribution through the spokes lead to the poor concentration results. Figures 6 and 7 shows the results of adding a turning vane to the horseshoe bend and the elimination of the outer two-injector holes on each spoke. The improvement in the concentration was encouraging and suggested that relatively simple control of both the fuel injection and the flow profile around the horseshoe bend could produce the desired results.

NOVEL PREMIXER DESIGN

To address the goals of improved mixing and velocity uniformity in a premixer that would ostensibly be easier to fabricate, a novel approach to mixing was sought. Specifically, a flow contraction to a throat section followed by a controlled expansion was the system of choice. In the concept, fuel would be injected upstream of the throat section; mixing would occur through the throat section as a result of the high level of turbulent kinetic energy generated. The level of throat contraction (inlet area to throat area ratio) and mixing would be mitigated by the desire to keep the premixer pressure drop less than 4%. The controlled expansion would be necessary to prevent flow separation that could result in both higher-pressure

drops and, more importantly, regions susceptible to auto-ignition and flame stabilization upstream of the catalyst. The 180-deg horseshoe bend provided the opportunity to utilize an involute design as a means of controlling the contraction. Flow around a bend poses special problems specifically with flow separation (e.g. Berger et al , 1983) but there is equal potential for advantageous mixing through the generation of turbulent mixing eddies (e.g. Bradshaw, P., 1987, Yaras, M. I: 1996). An involute is a “nautilus” shell configuration and is the loci of points of increasing radius as the angle of rotation increases about an origin (i.e. a string unwrapping from a spindle). The expansion section also utilized an involute configuration.

A number of different designs were investigated and evaluated through the use of computational fluid dynamics (CFD—Fluent version 5.4). The myriad of designs included large inlet to throat area ratios, multiple throat sections, fuel injection location and strategies upstream of the throat section, and different exit section configurations. The goals were:

- Maximum exit plane uniformity
- < 4% pressure drop
- No recirculation zones
- Maintain target engine configuration limitations

An extensive campaign of configuration iteration and 2-D axi-symmetric modeling resulted in a near optimal design, the results of which are shown in Figure 8. Despite numerous iterations on the expansion section curvature, the modeling suggested that potential for separation (indicated by the “red” region on the concave surface) existed although the size of the recirculation zone had been greatly reduced. The design does show good exit plane concentration uniformity. In addition, the configuration resulted in a pressure drop of roughly 3% as a result of an inlet area-to-throat ratio of 4:1 (while a 4% maximum pressure drop was the initial design goal, further discussions with Solar Turbines suggested that a 3% pressure drop as desirable). Note that the CFD modeling is based upon injection from either the inner or outer surface of the involute bend. The 2-D axi-symmetric model renders this injection as an annular slot, not as a discrete circular injection hole. To assess the actual mixing of a single fuel injection port, a 3-D CFD model of a single fuel injection port and the surrounding flow was constructed. The results are shown in Figure 9.

The modeling suggested that this pre-mixer configuration, while not optimal, appeared to be the “best” candidate to pursue additional testing. A full size pre-mixer based upon this configuration detail was fabricated to confirm the results through physical measurements.

GENERATION 1 NOVEL PREMIXER

Figure 10 shows cross section of the Generation 1 novel pre-mixer including the involute section and fuel injection specifics. Figure 11 shows the actual Generation 1 pre-mixer

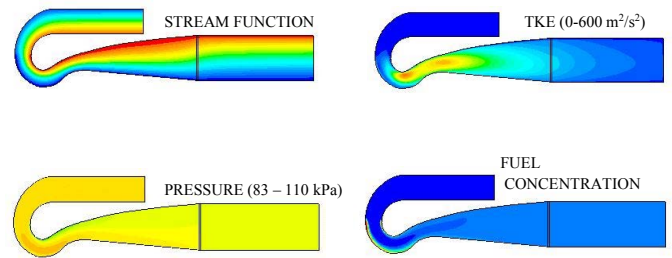

Figure 8: 2-D Axisymmetric CFD Modeling Results for Involute Premixer Design.

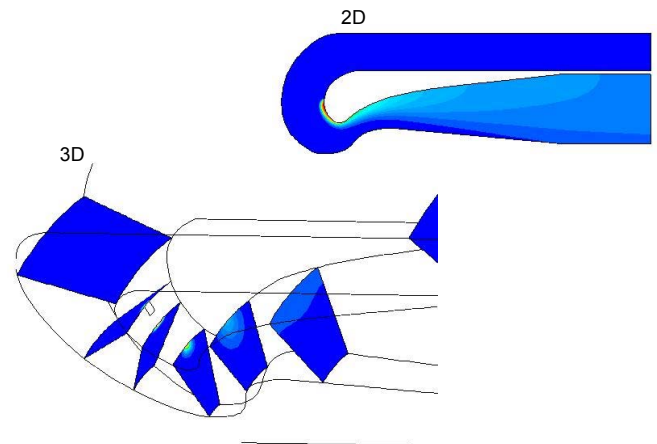

Figure 9: Fuel Concentration contour; comparison of 2-D axisymmetric and 3-D, 15-deg sector modeling.

components separated and assembled. The physical envelope of the pre-mixer is identical to the baseline pre-mixer (as dictated by the target engine). Again, for a sense of scale, the exit plane diameter is 209.6 mm. Note the elimination of the static mixers employed in the baseline mixer that would have been affixed to the central core of component and the absence of the static mixer at the exit plane of the assembled pre-mixer; compare the build up presented in figure 11 with the baseline build-up shown in Figure 3. The Generation 1 pre-mixer also eliminated the use of the individual fuel injection spokes utilized in the baseline mixer configuration. Rather, the Generation 1 novel pre-mixer was constructed with a series of five sets of 36 circumferentially arranged wall based fuel injection ports positioned on the outer (two sets) and inner (three sets) wall surfaces as shown in Figures 10b. Figures 12 and 13 show the inner and outer sections of the actual Generation 1 pre-mixer and the injection holes. The multiple injection locations allowed several different configurations to be tested and evaluated. Finally note in Figures 12 and 13 the compound curvature of the involute design used on both the outer and inner surfaces of the horseshoe bend.

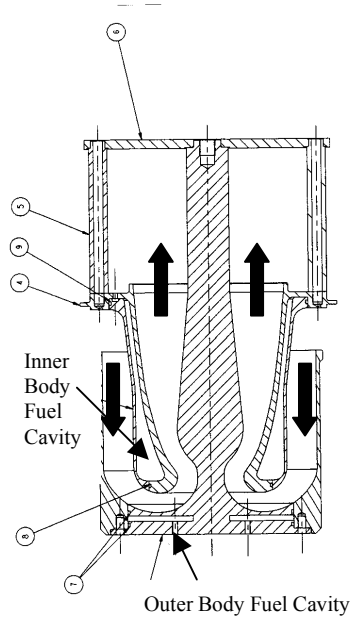

Figure 10a: Cross section of Generation 1 Novel Premixer

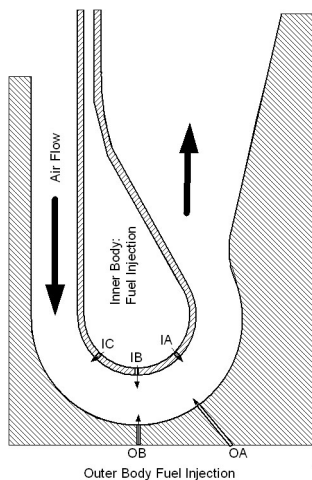

Figure 10b: Detail of Generation 1 Involute Horseshoe Bend illustrating multiple fuel injection locations.

Utilizing the same measurement plane, techniques, equipment, and protocol established for the baseline premixer, the generation 1 novel premixer was tested to assess premixer pressure drop, mixture uniformity and velocity.

The measured pressure drop results for the atmospheric tests are presented in Table 1 for both the idle and full power conditions. For comparison, the measured values for the baseline premixer are also presented. The values shown correspond well with the CFD modeling results.



Figure 11a: Generation 1 Novel Premixer components (Plenum removed for clarity)

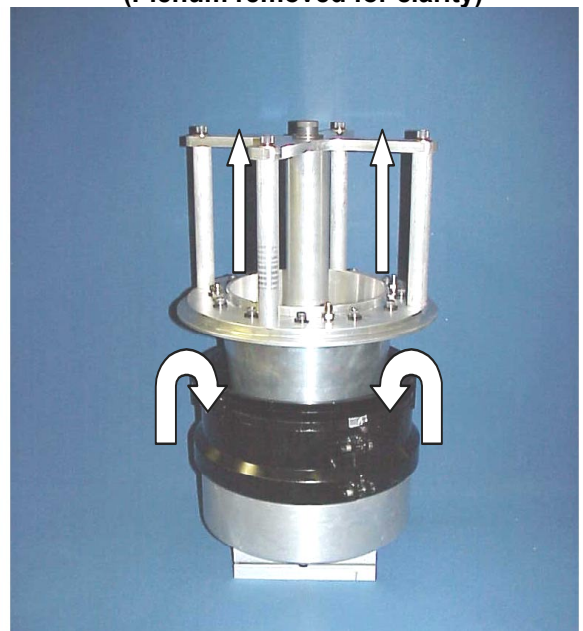

Figure 11b: Generation 1 Novel Premixer; Assembled (Plenum removed for clarity- air flow in and out shown)

The measured axial velocity, normalized with respect to the mean velocity, utilizing the LA system is presented in Figure 14. Note that data were obtained only along the diameter of the premixer. The axial symmetric nature of the novel premixer (with the elimination of the static mixers) and the limited access across the face of the premixer owing to the centerbody and other shadowing effects lead to measurement of the velocity across only the diameter of the premixer. Figure 14 shows a radial variation of the velocity with higher velocity at the centerline. While the velocity is not necessarily as “flat” as the baseline mixer as a result of the elimination of the static mixer, the moderately axial symmetry was encouraging as was the fact that only the inner most sections (smallest radius) fall outside of the tolerance band. In fact roughly approx 75% of the exit plane area falls within the tolerance band.

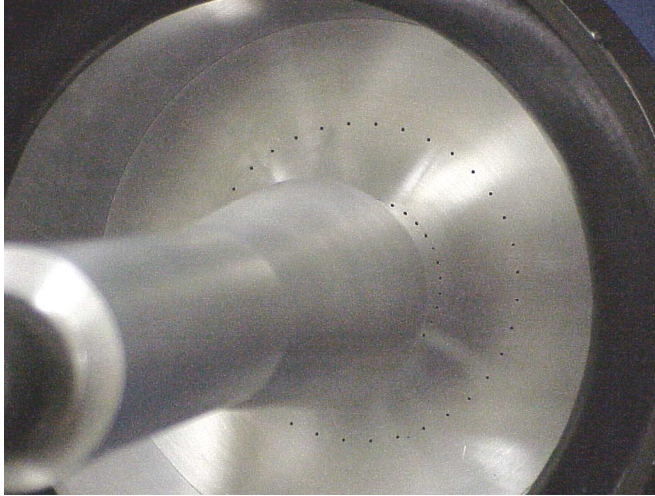

Figure 12: Outer Body Detail; Fuel Injection Points

condition. Both conditions show a tendency for slightly under penetrating fuel injection (with the higher normalized concentration as indicated by the purple contours near the center body). Nevertheless, the uniformity is improved compared to the baseline premixer.

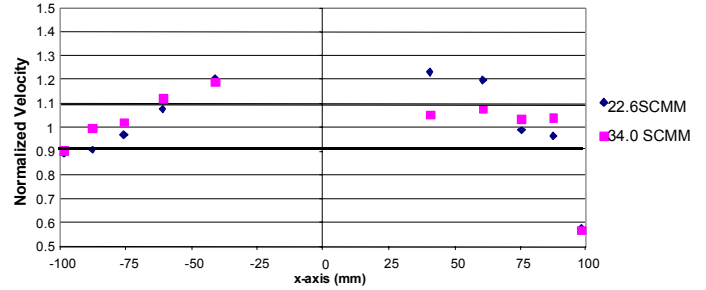

Figure 14: Novel Premixer Normalized Axial Velocity; Full Load and Idle Condition along diameter.

The question of separation was assessed with an indicating fluid painted on the surface of the inner and outer body. Non-separated flow would result in the fluid streaking in the direction of the flow, following the boundary layer velocity, while separation would result in “a line” representative of “zero” flow velocity of the boundary layer as it reverses direction. Figure 18 shows the indicating fluid traces for the outer body, the concave section being the most susceptible to separation. The results of the testing indicated that, at atmospheric conditions, no separation occurred.

The results for the Generation 1 novel premixer were considered a success and suggested that a scaled-down version of the premixer, Generation 2, be developed to both assess the scale-ability of the results and theory as well as permit pressurized rig testing at Solar Turbine’s test facility.

GENERATION 2 PREMIXER

A geometrically scaled premixer was designed with approximately 12% of the exit plane area as the Generation 1 premixer (the Generation 2 premixer exit plane diameter was 73.1 mm). Figure 19 shows the Generation 2 premixer hardware. Based upon the poor results seen with inner body fuel injection on the Generation 1 premixer, the fuel injection strategy was changed to two circumferential sets of 12 holes each located on the outer body surface only. One set of holes is offset 15-deg to form a “nesting” between the two. Full 3-D CFD modeling investigated 4 operating scenarios, idle and full load conditions at atmospheric and 11 atmosphere (1110 kPa) elevated pressure operating conditions. The results of the effort indicated that the mixing and velocity would be acceptable and would improve at elevated pressure.



Figure 13: Inner body detail: fuel injection points

Table 1: Pressure Drop Measurements

	22.6 std cu-m/min @ 101 kPa	34.0 std cu-m/min @ 101 kPa
Baseline Premixer	1.0 kPa	1.88 kPa
Novel Premixer	1.88 kPa (1.8%)	3.38 kPa (3.2%)

Recall the variety of injection locations provided by the novel premixer design. Test results showed that, in general, fuel injection from the inner body did not provide as uniform a mixing as fuel injected from the outer body. Figure 15 shows the results of one typical inner body injection. The measured concentration was not symmetrical. In contrast, Figure 16 shows the result of a typical injection scenario at idle condition for the outer body only injection. The results appear much more symmetrical relative to the center axis. Figure 17 shows the results of the concentration measurements (for one quadrant) with outer body fuel injection at the full load

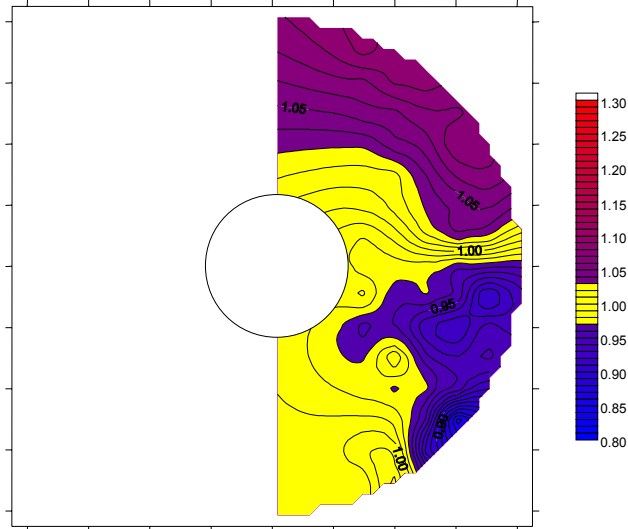

Figure 15: Novel Premixer Normalized Concentration; Idle Condition; Inner body fuel injection

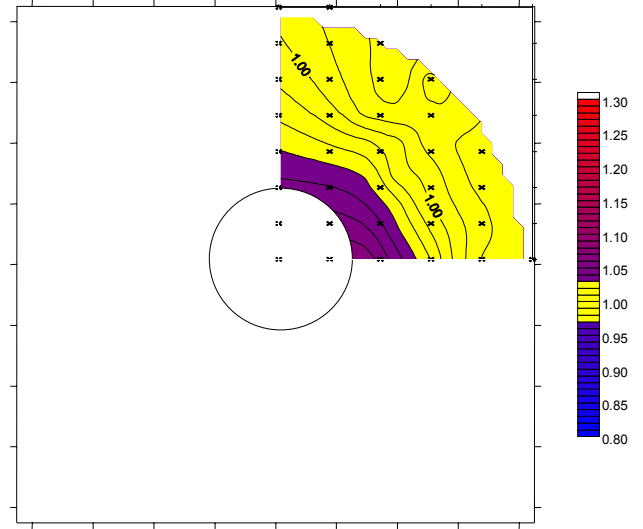

Figure 17: Novel Premixer Normalized Concentration; Full Power Condition; Outer Body Injection

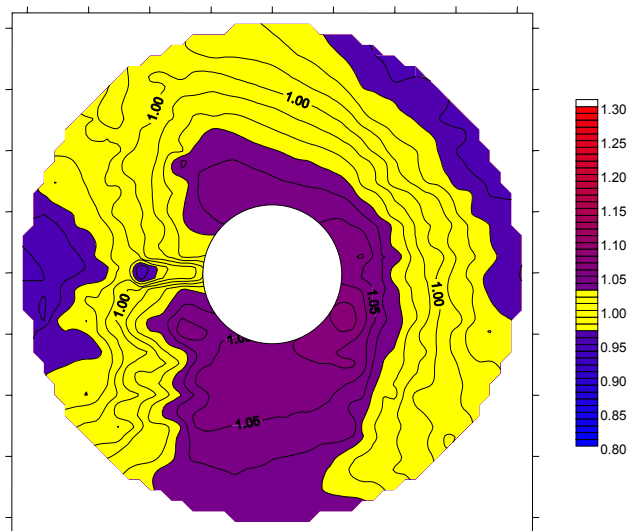

Figure 16: Novel Premixer Normalized Concentration; Idle Condition; Outer Body fuel Injection



Figure 18: Surface Flow Indicating Fluid traces; Generation 1 Novel Premixer Outer Body.

The Generation 2 premixer was fabricated and tested at UCI utilizing the same measurement techniques described for the baseline and Generation 1 premixer. One change was the relocation of the sample plane to 17.8 mm (vs. 30.5 mm) downstream of the premixer exit plane to match the target engine application. Volumetric airflow was scaled to produce equivalent exit plane velocities of 13 m/s and 19.5 m/s at idle and full power conditions. Figure 20 shows the measured exit plane velocity at idle condition.

For concentration evaluation, the premixer was tested at both nominal idle and full load conditions and with three

different fuel injection configurations. The results are presented in Table 2. The configuration that produced the best statistical performance was fuel injected through both sets of injection holes (i.e. total of 24 injection holes). Figures 21 and 22 show the extractive concentration contours for the “row 1 and row 2” injection scheme at the scaled idle and full power conditions.

With the encouraging results from the atmospheric tests, the Generation 2 premixer was transitioned to a high pressure test rig at Solar Turbines to verify both mixing uniformity (in a non-reacting mode) at elevated pressure and to provide a premixer for a reacting catalyst tests. The premixer was assembled with an extractive sample array between the premixer and catalyst entrance and a two-stage catalyst element

section with thermocouples at the entrance, between the stages and at the exit plane of the catalyst section.

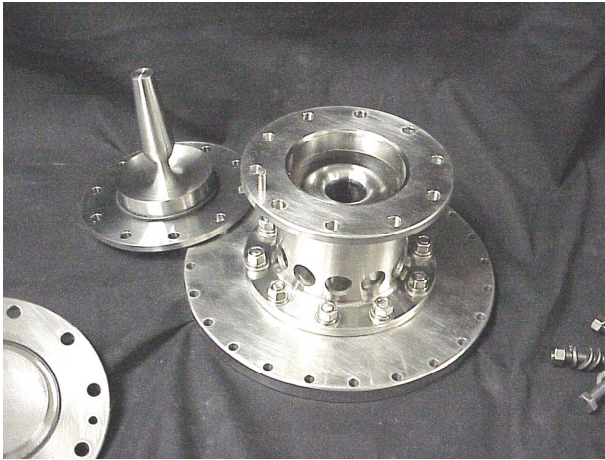

Figure 19: Generation 2 Premixer

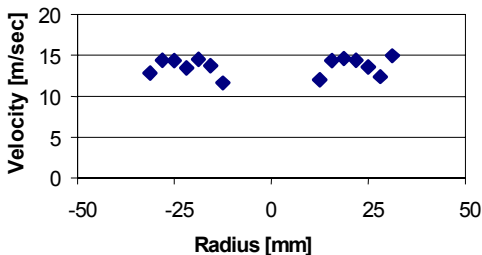

Figure 20: Generation 2 Premixer: Axial Velocity Distribution; Idle Condition (nominally 13 m/s)

Table 2 : Generation 2 Premixer: Atmospheric Fuel Concentration Measurement Results

Test #	1	2	3	4	5	6
Injection Scheme	Outer Holes	Outer Holes	Inner Holes	Inner Holes	Inner & Outer	Inner & Outer
Flow Vel. [m/sec]	13	19	13	19	13	19
Avg. Fuel Conc.-v/v [%]	3.18	3.97	3.37	4.36	3.41	4.32
Std. Dev.	0.0774	0.106	0.220	0.213	0.0845	0.0642
Pattern Factor(PF)	0.0554	0.0497	0.105	0.0876	0.0494	0.0300
Mod. PF	0.103	0.108	0.219	0.173	0.095	0.515

For the mixture uniformity tests, Figure 23 shows the sampling locations at the exit of the premixer (entrance of the catalyst) and the results. Test conditions were: Air=0.5 kg/sec, air/fuel mass ratio = 54, 150 C preheat, 11 atm (1110 kPa). The results with the two rows of fuel injection holes open met the

desired $\pm 3\%$ mixture uniformity, validating both the atmospheric testing and CFD modeling evaluations.

As a final assessment of the design, reacting tests with the premixer upstream of the catalyst were conducted. This was accomplished by maintaining the same air and fuel flow established in the mixture uniformity tests above but increasing the inlet air preheat until a reaction was established (as indicated by a rise in temperature at the exit plane). In as much as the rig testing was conducted on the scaled Generation 2 premixer, there was no baseline premixer configuration performance data for comparison. Rather, the primary goal was simply to demonstrate that the mixer in fact did provide satisfactory mixing to permit a reaction to be established while preventing the formation of recirculation zones upstream of the catalyst section.

The elevated pressure reacting tests show that the novel premixer worked at least as well as, if not better than, predicted by the modeling. Figure 24 shows the steady state temperatures at the catalyst inlet, mid section between the two stages for sequential data capture events (the x-axis is essentially time; interval between data capture events was on the order of minutes but there is no attempt to capture at consistent intervals). The steadiness of the inlet air temperature confirms the absence of any unwanted upstream reactions/flame stabilization. The mid-section temperatures were nearly equal while the catalyst exit temperatures showed only a slightly wider but acceptable variation. The relative uniformity in the measured temperatures is clearly indicative of the uniformity of the entering the fuel-air mixture provided by the premixer.

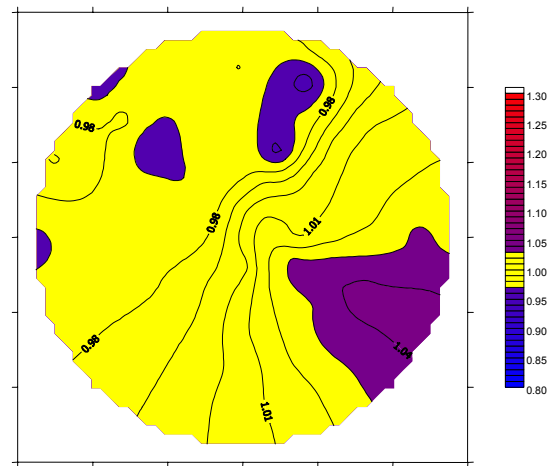

Figure 21: Generation 2 Premixer; Fuel Concentration Results; Idle condition

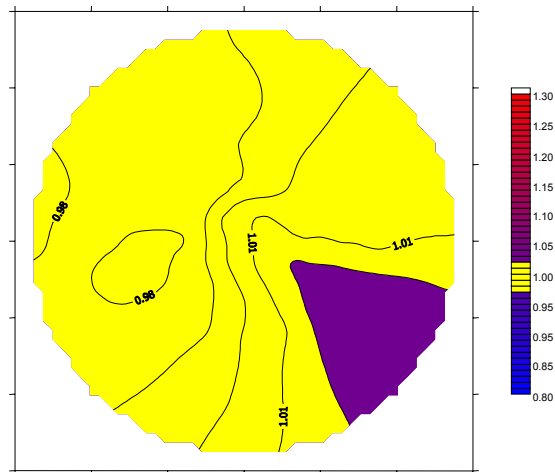
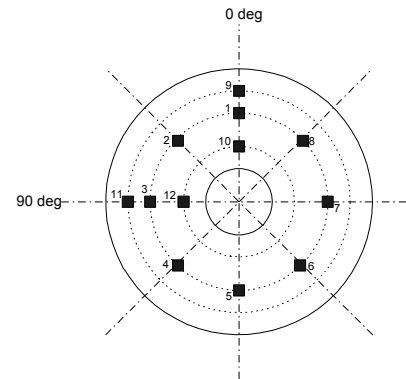

Figure 22: Generation 2 Premixer: Fuel Concentration Results; Full Power Condition

Figures 25 and 26 show the NO_x emissions and the HC/CO emissions respectively. A single stainless steel water-cooled probe at the exit of the homogenous burn out section was used to measure the concentration of the products. The NO_x emissions were quite low (< 1 ppmvd @ 15% O₂) but the CO and HC were much greater than expected. Upon further consideration, the high CO and HC emissions were deemed attributable to inadequate post catalyst homogenous combustion burn-out zone residence time.

The flow requirements for testing of the Generation 2 premixer represented the low limits of operation of the test rig. The operating parameters could not be varied with the required precision/resolution to permit more extensive testing to further quantify the premixer performance. Improvements to the facility control issues would be necessary to carry on the testing. In addition, a redesigned post catalyst homogenous burn-out zone would need to be designed and integrated to eliminate the high HC and CO emissions. Nevertheless, there is consensus amongst the parties involved that the premixer:

- Provided a well mixed gas to the catalyst entrance
- Did not permit the formation of upstream recirculation zones and subsequent upstream reaction zones
- Was not the root cause of the abnormal emissions behavior.



Performance of Novel Premixer Gen II in Solar Rig Tests:

Point	Measured Methane Concentration	Normalized Concentration (wrt mean)
1	5.3%	0.98
2	5.4%	1.00
3	5.45% (alternating between 5.4 and 5.5)	1.01
4	5.55% (alternating between 5.5 and 5.6)	1.03
5	5.5%	1.02
6	5.4%	1.00
7	5.35% (alternating between 5.3 and 5.4)	0.99
8	5.3%	0.98
9	5.3%	0.98
10	5.4%	1.00
11	5.4%	1.00
12	5.45% (alternating between 5.4 and 5.5)	1.01

Average: 5.4%
 Std Dev: 0.079%
 Maximum/Minimum deviation from Mean: 3% / 2%
 Pattern Factor [(max-mean)/mean]: 0.027
 Modified Pattern Factor [(max-min)/mean]: 0.046

Figure 23: Generation 2 Premixer; Elevated Pressure Catalyst Entrance Fuel Concentration Measurements

CONCLUSIONS

A novel catalytic premixer has been designed and demonstrated. The novel premixer eliminates static mixers and fuel injection spokes, meets the desired mixture uniformity of ± 3 variation from the mean and a velocity uniformity of $\pm 10\%$ from the mean, scales over a wide size range, and promises to be easier to fabricate than premixers of the base line design. CFD modeling was successfully incorporated in the design process and resulted in rapid design evaluation and proved to be a reliable predictive tool. A rig test at elevated pressures and temperatures confirmed the premixer performance as predicted through the CFD modeling and atmospheric testing. An integrated catalyst reacting test resulted in anomalous emissions results but confirmed the performance of the premixer.

ACKNOWLEDGEMENTS

The authors acknowledge the support of the South Carolina Institute for Energy Studies (SCIES) program director Dr. Larry Golan. Additionally, the efforts of UCI Technician Mr. Colin Andrews and students Mr. Vu Phi and Mr. Viken Jermakian in the collection of data are gratefully appreciated.

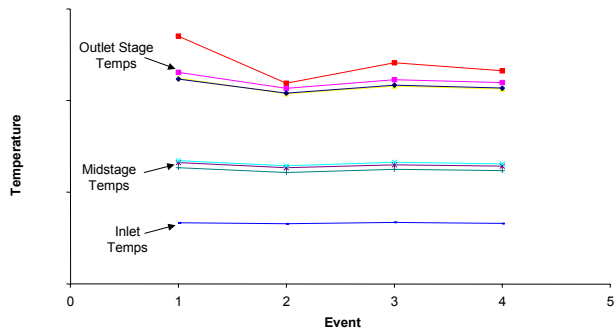

Figure 24: Reacting Tests, Steady State Temperature Profiles

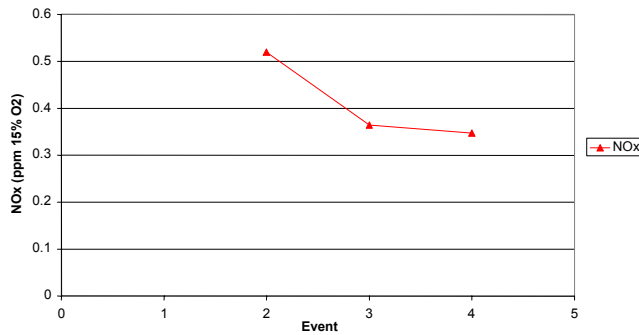

Figure 25: Reacting Tests; NOx emissions

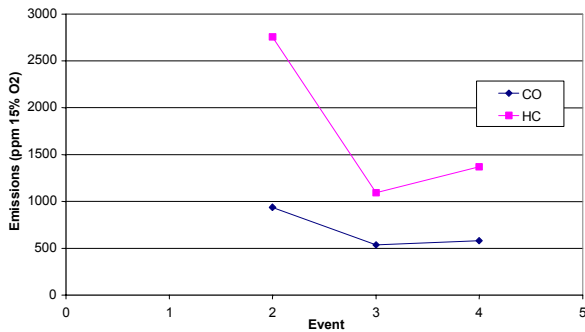

Figure 26: Reacting Tests; CO and Hydrocarbon Emissions

REFERENCES

Fant, DB; Jackson, GS; Karim, H; Newbury, DM; Dutta, P; Smith, KO; Dibble, RW. (2000). Status of Catalytic Combustion R+D for the Department of Energy Advanced Turbine Systems Program. *Journal Of Engineering For Gas Turbines And Power*, V122(N2): 293-300

Cutrone MB. Beebe KW. Dalla Betta RA. Schlatter JC. Nickolas SG. Tsuchiya T. (1999). Development of a Catalytic Combustor for a Heavy-duty Utility Gas Turbine. *Catalysis Today*. 47(1-4):391-398.

Berger, R. L., Talbot, L., and Yao, L. S., 1983, "Flow in Curved Pipes," *Annual Review of Fluid Mechanics*, Vol. 15, pp. 461-512

Bradshaw, P., 1987, "Turbulent Secondary Flows," *Annual Review of Fluid Mechanics*, Vol. 19, pp. 53-74.

Yaras, M. I.; 1996, "Effects of Inlet Conditions on the Flow in a Fishtail Curved Diffuser with Strong Curvature," *ASME Journal of Fluids Engineering*, Vol. 118, pp. 772-778.