

Lawrence Berkeley National Laboratory

Lawrence Berkeley National Laboratory

Title

Storage Viability and Optimization Web Service

Permalink

<https://escholarship.org/uc/item/9tn4m21w>

Author

Stadler, Michael

Publication Date

2010-10-15



ERNEST ORLANDO LAWRENCE BERKELEY NATIONAL LABORATORY

Storage Viability and Optimization Web Service

Michael Stadler, Chris Marnay, Judy Lai, Afzal Siddiqui, Tanachai Limpaitoon, Trucy Phan, Olivier Megel, Jessica Chang, Nicholas DeForest

**Environmental Energy
Technologies Division**

<http://eetd.lbl.gov/EA/EMP/emp-pubs.html>

This work was funded by the Public Interest Energy Research (PIER) program of the California Energy Commission under California Interagency Agreement 500-02-004 to the California Institute for Energy and the Environment (CIEE) and Memorandum Agreement POM081-L01 between The Regents of the University of California and Lawrence Berkeley National Laboratory. The Berkeley Lab is managed and operated by the University of California for the U.S. Department of Energy under contract DE-AC02-05CH11231.

Disclaimer

This document was prepared as an account of work sponsored by the United States Government. While this document is believed to contain correct information, neither the United States Government nor any agency thereof, nor The Regents of the University of California, nor any of their employees, makes any warranty, express or implied, or assumes any legal responsibility for the accuracy, completeness, or usefulness of any information, apparatus, product, or process disclosed, or represents that its use would not infringe privately owned rights. Reference herein to any specific commercial product, process, or service by its trade name, trademark, manufacturer, or otherwise, does not necessarily constitute or imply its endorsement, recommendation, or favoring by the United States Government or any agency thereof, or The Regents of the University of California. The views and opinions of authors expressed herein do not necessarily state or reflect those of the United States Government or any agency thereof, or The Regents of the University of California.

Ernest Orlando Lawrence Berkeley National Laboratory is an equal opportunity employer.

Public Interest Energy Research (PIER) Program FINAL PROJECT REPORT

Storage Viability and Optimization Web Service

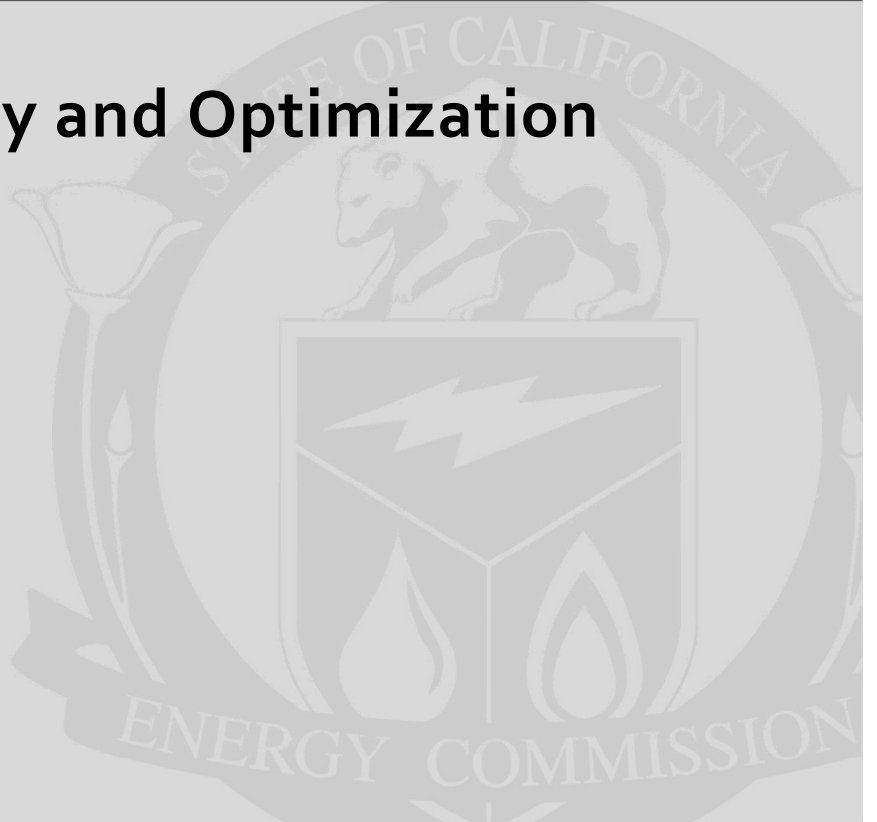

Prepared for: California Energy Commission

Prepared by: Lawrence Berkeley National Laboratory



OCTOBER 2010
CEC-500-02-004

Prepared by:

Lawrence Berkeley National Laboratory

Primary Author(s):

Michael Stadler
Chris Marnay
Judy Lai
Afzal Siddiqui
Tanachai Limpaitoon
Trucy Phan
Olivier Megel
Jessica Chang
Nicholas DeForest



<http://der.lbl.gov>

Contract Number: 500-02-004

Industrial, Agricultural, and Water Storage Viability and Optimization Web Service (SVOW); a project financed by the California Energy Commission (CEC), Public Interest Energy Research (PIER).

Prepared for:

California Energy Commission

Pramod Kulkarni
Contract Manager

Anish Gautam
Project Manager

Ken Krich
Office Manager
CIEE

Thom Kelly, Ph.D.
Deputy Director
Energy Research & Development Division

Melissa Jones
Executive Director

DISCLAIMER

This report was prepared as the result of work sponsored by the California Energy Commission. It does not necessarily represent the views of the Energy Commission, its employees or the State of California. The Energy Commission, the State of California, its employees, contractors and subcontractors make no warrant, express or implied, and assume no legal liability for the information in this report; nor does any party represent that the uses of this information will not infringe upon privately owned rights. This report has not been approved or disapproved by the California Energy Commission nor has the California Energy Commission passed upon the accuracy or adequacy of the information in this report.

ACKNOWLEDGEMENTS

This work was funded by the Public Interest Energy Research (PIER) program of the California Energy Commission under California Interagency Agreement 500-02-004 to the California Institute for Energy and the Environment (CIEE) and Memorandum Agreement POM081-L01 between The Regents of the University of California and Lawrence Berkeley National Laboratory. The Berkeley Lab is managed and operated by the University of California for the U.S. Department of Energy under contract DE-AC02-05CH11231.

We are very appreciative of the Commission's timely support for this project. We particularly thank Pramod Kulkarni and Anish Gautam for their guidance and assistance through all phases of the project.

Of course, the authors alone are responsible for the contents of this report.

PREFACE

The California Energy Commission Public Interest Energy Research (PIER) Program supports public interest energy research and development that will help improve the quality of life in California by bringing environmentally safe, affordable, and reliable energy services and products to the marketplace.

The PIER Program conducts public interest research, development, and demonstration (RD&D) projects to benefit California.

The PIER Program strives to conduct the most promising public interest energy research by partnering with RD&D entities, including individuals, businesses, utilities, and public or private research institutions.

PIER funding efforts are focused on the following RD&D program areas:

- Buildings End-Use Energy Efficiency
- Energy Innovations Small Grants
- Energy-Related Environmental Research
- Energy Systems Integration
- Environmentally Preferred Advanced Generation
- Industrial/Agricultural/Water End-Use Energy Efficiency
- Renewable Energy Technologies
- Transportation

Storage Viability and Optimization Web Service is the final report for the Electricity Storage Viability and Optimization Website project (contract number 500-02-004, work authorization number MR-523) conducted by Lawrence Berkeley National Laboratory. The information from this project contributes to PIER's Energy-Related Environmental Research Program.

For more information about the PIER Program, please visit the Energy Commission's website at www.energy.ca.gov/research/ or contact the Energy Commission at 916-654-4878.

ABSTRACT

Non-residential sectors offer many promising applications for electrical storage (batteries) and photovoltaics (PVs). However, choosing and operating storage under complex tariff structures poses a daunting technical and economic problem that may discourage potential customers and result in lost carbon and economic savings. Equipment vendors are unlikely to provide adequate environmental analysis or unbiased economic results to potential clients, and are even less likely to completely describe the robustness of choices in the face of changing fuel prices and tariffs. Given these considerations, researchers at Lawrence Berkeley National Laboratory (LBNL) have designed the Storage Viability and Optimization Web Service (SVOW): a tool that helps building owners, operators and managers to decide if storage technologies and PVs merit deeper analysis.

SVOW is an open access, web-based energy storage and PV analysis calculator, accessible by secure remote login. Upon first login, the user sees an overview of the parameters: load profile, tariff, technologies, and solar radiation location. Each parameter has a pull-down list of possible predefined inputs and users may upload their own as necessary. Since the non-residential sectors encompass a broad range of facilities with fundamentally different characteristics, the tool starts by asking the users to select a load profile from a limited cohort group of example facilities. The example facilities are categorized according to their North American Industry Classification System (NAICS) code. After the load profile selection, users select a predefined tariff or use the widget to create their own. The technologies and solar radiation menus operate in a similar fashion. After these four parameters have been inputted, the users have to select an optimization setting as well as an optimization objective.

The analytic engine of SVOW is LBNL's Distributed Energy Resources Customer Adoption Model (DER-CAM), which is a mixed-integer linear program (MILP) written and executed in the General Algebraic Modeling System (GAMS) optimization software.

LBNL has released version 1.2.0.11 of SVOW. Information can be found at <http://der.lbl.gov/microgrids-lbnl/current-project-storage-viability-website>.

Keywords: Energy storage, photovoltaics, optimization, distributed energy resources, DER-CAM

Please use the following citation for this report:

Stadler, Michael, Chris Marnay, Judy Lai, Afzal Siddiqui, Tanachai Limpaitoon, Trucy Phan, Olivier Megel, Jessica Chang, Nicholas DeForest.. (Lawrence Berkeley National Laboratory). 2010. *Storage Viability and Optimization Website*. California Energy Commission. Publication number: CEC-XXX-2010-XXX (*forthcoming*).

TABLE OF CONTENTS

EXECUTIVE SUMMARY	1
Introduction	1
Background and Overview.....	1
Project Features	1
CHAPTER 1: Distributed Energy Resources Customer Adoption Model (DER-CAM).....	3
CHAPTER 2: Standard Data used for SVOW.....	5
Load Profiles	5
Storage and PV Data.....	5
Electric Rates.....	5
Solar Radiation Data.....	9
Marginal CO ₂ Emissions Rates.....	9
CHAPTER 3: User Manual	10
<i>Step 1: Overview/Optimization Settings.....</i>	<i>10</i>
<i>Step 2: Normalized Load Profile Details</i>	<i>17</i>
<i>Step 3: Utility Tariff Details.....</i>	<i>18</i>
<i>Step 4: Technology Details</i>	<i>19</i>
<i>Step 5: Solar Radiation Details.....</i>	<i>20</i>
Running the Optimization.....	21
Results.....	21
Tips and Helps.....	22
CHAPTER 4: Conclusions	23
CHAPTER 5: References.....	24
APPENDIX A: SVOW License Agreement	26
APPENDIX B: Previously Released Reports	28
Storage Viability and Optimization Website Interim Report I.....	28
Storage Viability and Optimization Website Interim Report II.....	49

EXECUTIVE SUMMARY

Introduction

The non-residential sectors offer many promising applications for electrical storage. However, choosing and operating storage under complex tariff regimes poses a daunting technical and economic problem that is likely to discourage potential customers, potentially resulting in lost carbon and economic savings. Vendors offering limited equipment lines are unlikely to provide adequate environmental analysis or unbiased economic results to potential clients, and are even less likely to completely describe the robustness of choices in the face of changing fuel prices and tariffs. Given these considerations, site managers need a place to start in their quest for independent technical and economic guidance on whether storage is even worth the considerable analytic effort. Therefore, an open access, web-based electrical storage and photovoltaic (PV) analysis calculator has been designed and developed to provide economically sound and technology-neutral guidance.

Background and Overview

The Storage Viability and Optimization Website (SVOW) aims to provide basic guidance on whether available storage technologies, PV or combinations of these technologies merit deeper analysis. Since the non-residential sectors encompass a broad range of facilities with fundamentally different characteristics, the tool first asks the user to select a load profile from a limited cohort group of example facilities. These examples may be modified by the user to better fit a site's unique circumstances. After the load profile selection, the user will be prompted to select a tariff, the cost option, and so on, until all of the parameters are specified. Based on the user selections, the solution set will be adjusted to provide ballpark results to the user (see Figure ES1 and ES2).

Project Features

SVOW

- ✓ is a free service that does not require users to install any programs
- ✓ includes 20 standard load profiles for non-residential energy users. These data can be used to perform fast and easy investigations (<1 min)
- ✓ contains technology parameters for the batteries and PV
- ✓ holds tariffs for medium and large commercial/industrial customers in PG&E, SCE, and SDGE territories
- ✓ parameter may be over-written by the users
- ✓ delivers an initial optimal investment solution and an optimal operating schedule
- ✓ demonstrates economic and/or environmental benefits compared to the status quo.

The SVOW service works on WinXP (at least Service Pack 3), Windows VISTA, and Windows 7, and is accessed via the Remote Desktop Connection (Terminal Services Client 6.0). It also can be accessed on a MAC by using Windows Parallels(TM) or a similar emulator.

LBNL has released version 1.2.0.11 of SVOW. Information can be found at <http://der.lbl.gov/microgrids-lbnl/current-project-storage-viability-website>.

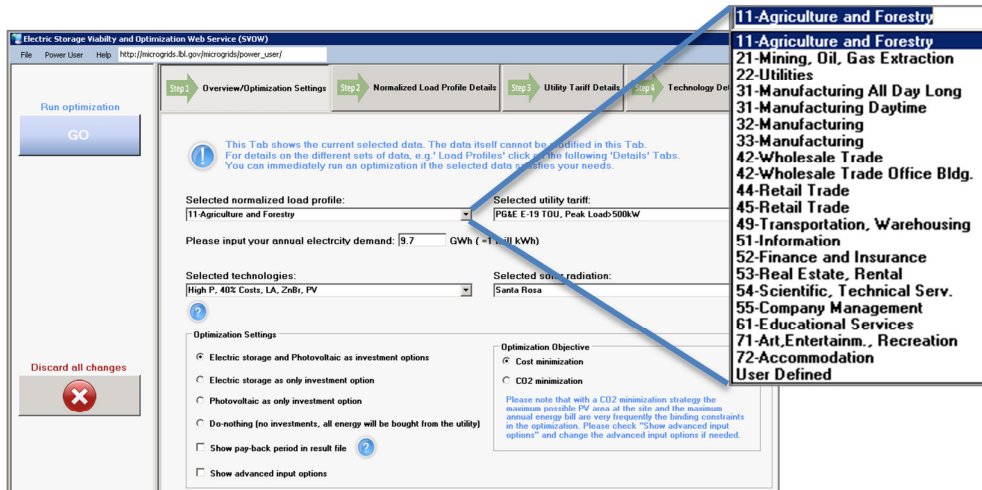

Figure ES1. Screen Shot of SVOW Start Up Page; User Sees Overview of Options; Settings and View of Load Profiles Pull-Down Menu

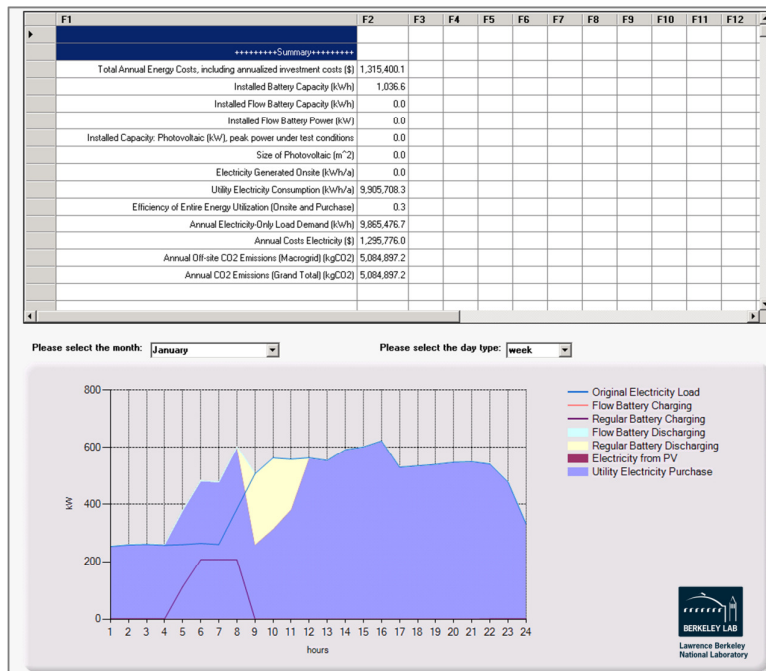

Figure ES2. Sample Results of Optimization

CHAPTER 1:

Distributed Energy Resources Customer Adoption Model (DER-CAM)

The Distributed Energy Resources Customer Adoption Model (DER-CAM) (Stadler et al. 2008) is a mixed-integer linear program (MILP) written and executed in the General Algebraic Modeling System (GAMS), which is not suitable for wide-spread commercial usage due to high software license costs and lack of a user-friendly interface. The major objective of this project is to make some of the DER-CAM capabilities accessible through the web and to provide a user-friendly web-interface for SVOW, as well as to provide the standard data for loads, tariffs, technologies, and solar radiation. SVOW uses a Remote Desktop Connection to provide the user with the DER-CAM storage and PV optimization. It works on WinXP (at least Service Pack 3), Windows VISTA, and Windows 7. At this point, we are not able to provide a full MAC version due to a major bug in the Remote Desktop Connection for MAC. However, MAC users can use Windows Parallels(TM) or a similar emulator to run the SVOW service.

DER-CAM's objective is to minimize the annual costs or CO₂ emissions of providing energy services to the modeled building site, including utility electricity and natural gas purchases, plus amortized capital and maintenance costs for any distributed generation (DG) investments.

Figure 1 shows a high-level schematic of some of the building energy flows that can be modeled in DER-CAM. Please note that not all energy flows are currently implemented in DER-CAM, e.g. passive building measures are limited. Available energy inputs to the site might include solar radiation, utility electricity, utility natural gas, biofuels, and geothermal heat. For a given site, DER-CAM selects the economically optimal or lowest CO₂ emission combination of utility electricity purchase, on-site generation, storage and cooling equipment required to meet the site's end-use loads at each time step.

The outputs of DER-CAM include the optimal technology adoption, the resulting costs, fuel consumption, and CO₂ emissions (Figure 2), as well as an hourly operating schedule. Optimal combinations of equipment can be identified in a way that would be intractable by trial-and-error enumeration of possible combinations. The economics of storage are particularly complex, both because they require optimization across multiple time steps and because of the influence/role of complex tariff structures featuring fixed charges, on-peak, off-peak, and shoulder energy prices, and demand or power charges.

One major feature still missing in DER-CAM, which is planned to be added to SVOW, is a comprehensive efficiency investment and demand response formulation. As can be seen from Figure 1, the end-uses could be directly influenced by efficiency measures and demand reduction measures. This features needs to be designed within DER-CAM to create a holistic optimization approach for a building or microgrid. Definitions of a microgrid can be found at Microgrid Symposium 2005-2010, and Hatziaargyriou et al. 2007.

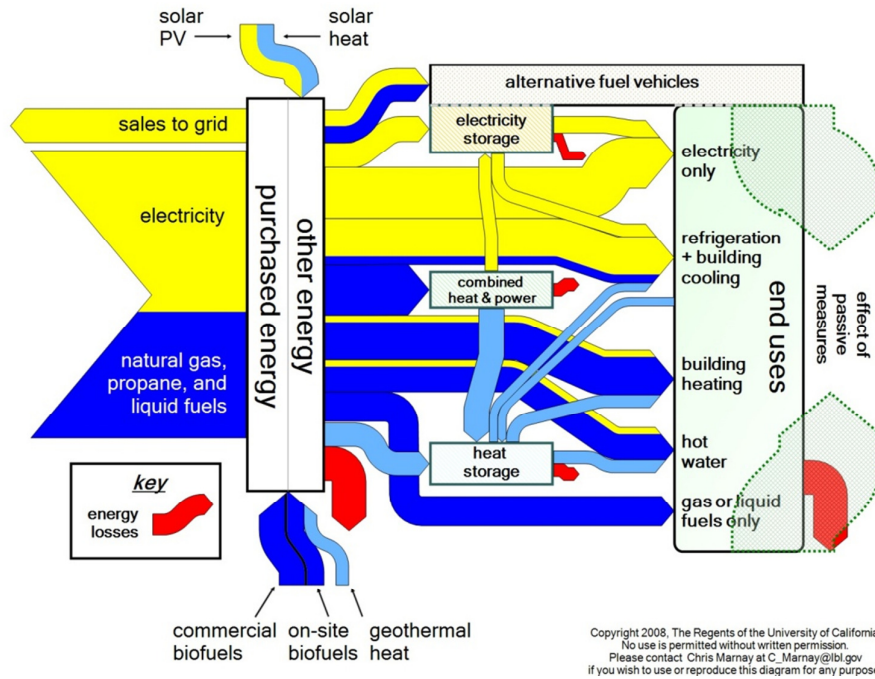

Figure 1. Schematic of Energy Flows Represented in DER-CAM

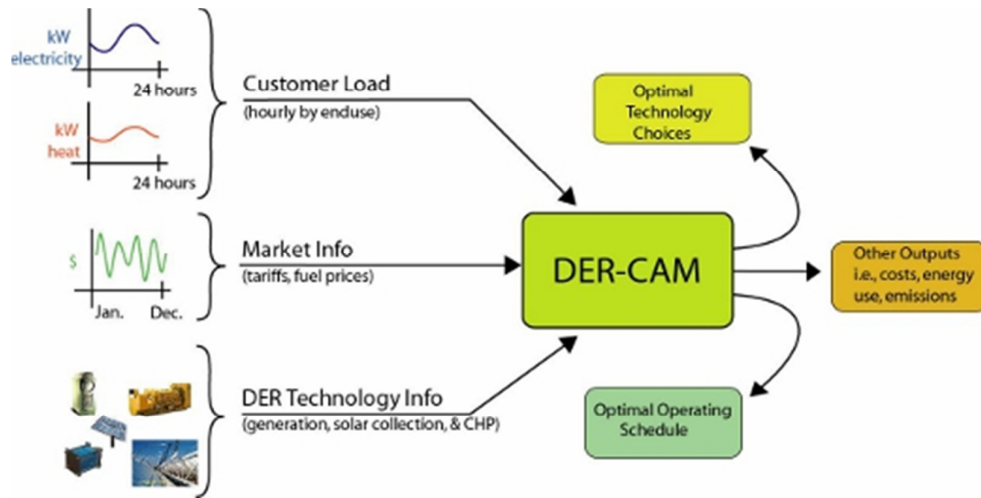

Figure 2. Schematic of Information Flow in DER-CAM

For more information on DER-CAM please see Stadler et al. 2008 and Stadler et al. 2009.

CHAPTER 2: Standard Data used for SVOW

Load Profiles

The load profiles are based on likely commercial and industrial customers usage patterns using the 2009 calendar and normalized to 1 GWh (annual electricity consumption) within the PG&E service territory and their identities are kept confidential. Users can choose a suitable load shape for initial screening and upload their own for more refined analysis.

Storage and PV Data

SVOW provides economic and technical parameters for eight commonly available battery technologies, as well as for a Zinc-Bromide (ZnBr) flow battery and PV. Current technology costs are based on EPRI-DOE, Schoenung et al. 2003, SGIP 2008, and Stadler et al. 2009. More information on the technology assumptions, costs, parameters, and how to use them in SVOW can be found in chapter 3.

Electric Rates

Commercial and industrial time-of-use (TOU) pricing for both energy and power (demand charge) is very common in California; and therefore, a brief description of TOU tariff structures is given. Demand charges are proportional to the maximum rate of electricity consumption (kW), regardless of the duration or frequency of such consumption over the billing period. Demand charges may be assessed daily (e.g. for some New York DG customers) or monthly (more common) and may be for all hours of the month or only certain periods (e.g. on, mid, or off peak), or hit just at the hour of peak system-wide consumption.

There are five demand types in DER-CAM applicable to daily or monthly demand charges:

- Non-coincident: incurred by the maximum consumption in any hour.
- On-peak: based only on on-peak hours.
- Mid-peak: based only on mid-peak hours.
- Off-peak: based only on off-peak hours.
- Coincident: based only on the time of peak system-wide consumption.

Pacific Gas & Electricity (PG&E) Electricity Rates

For the PG&E service territory, three different tariffs were used (see also PG&E A-1, PG&E A-10, and PG&E E-19). Please note that the SVOW project started late 2008, prior to the Peak Day Pricing (PDP) roll out in May 2010, therefore the rates shown are the otherwise applicable tariff without taking into account the effects of PDP.

- for buildings with electric peak load up to 199 kW: flat tariff A-1, no demand charge, seasonal difference between winter and summer months is a factor of 1.45, "PG&E A-1 Flat Rate, Peak<200kW" in SVOW

Table 1. PG&E Commercial Sector Electricity Prices, Electric Peak Load < 200 kW

Electricity	Summer (May – Oct.)		Winter (Nov. – Apr.)	
	electricity (US\$/kWh)	demand (US\$/kW)	electricity (US\$/kWh)	demand (US\$/kW)
Variable	0.20		0.14	
Fixed (US\$/month)	13.31			

Source: PG&E A-1

- for buildings with electric peak load 200 kW – 499 kW: TOU tariff A-10, seasonal demand charge, “PG&E A-10 TOU, 200-500kW” in SVOW

Table 2. PG&E Commercial Sector Electricity Prices, Electric Peak Load from 200 kW to 499 kW

Electricity	Summer (May – Oct.)		Winter (Nov. – Apr.)	
	electricity (US\$/kWh)	demand (US\$/kW)	electricity (US\$/kWh)	demand (US\$/kW)
non-coincident	na	10.27	na	5.76
on-peak	0.16			
mid-peak	0.14		0.11	
off-peak	0.13		0.10	
Fixed (US\$/month)	118.28			

Source: PG&E A-10

- for buildings with electric peak load 500 kW and above: TOU tariff E-19, seasonal demand charge, “PG&E E-19 TOU, Peak Load>500kW” in SVOW

Table 3. PG&E Commercial Sector Electricity Prices, Electric Peak Load 500 kW and above

Electricity	Summer (May – Oct.)		Winter (Nov. – Apr.)	
	electricity (US\$/kWh)	demand (US\$/kW)	electricity (US\$/kWh)	demand (US\$/kW)
non-coincident	na	7.70	na	7.70
on-peak	0.16	13.51		
mid-peak	0.11	3.07	0.09	1.04
off-peak	0.09		0.08	
Fixed (US\$/month)	406.57			

Source: PG&E E-19 and own calculations

The time periods for A-10 and E-19 are defined below.

summer on-peak: 12:00 – 18:00 during weekdays

summer mid-peak: 08:00 – 12:00 and 18:00 – 21:00 during weekdays

summer off-peak: 21:00 – 08:00 during weekdays and all weekends and holidays

winter mid-peak: 08:00 – 21:00 during weekdays

winter off-peak: 21:00 – 08:00 during weekdays and all weekends and holidays

Southern California Edison (SCE) Electric Rates

For SCE service territory three different tariffs were used (see also SCE GS-2, SCE TOU-GS-3, SCE TOU-8):

- for buildings with electric peak load 20 – 200 kW: flat tariff GS-2, seasonal difference between winter and summer months is a factor of 1.1 (energy) and 2.83 (demand charge), “SCE GS-2 Flat Rate, 20-200kW” in SVOW

Table 4. SCE Commercial Sector Electricity Prices, Electric Peak Load between 20 kW and 200 kW

Electricity	Summer (June – Sept.)		Winter (Oct. – May.)	
	electricity (US\$/kWh)	demand (US\$/kW)	electricity (US\$/kWh)	demand (US\$/kW)
non-coincident	na	28.76	na	10.16
Variable	0.08		0.07	
Fixed (US\$/month)	92.34			

Source: SCE GS-2

- for buildings with electric peak load 200 kW – 499 kW: tariff TOU-GS-3, seasonal demand charge, “SCE GS-3 TOU, 200-500kW” in SVOW

Table 5. SCE Commercial Sector Electricity Prices, Electric Peak Load from 200 kW to 499 kW

Electricity	Summer (June – Sept.)		Winter (Oct. – Apr.)	
	electricity (US\$/kWh)	demand (US\$/kW)	electricity (US\$/kWh)	demand (US\$/kW)
non-coincident	na	10.47	na	10.47
on-peak	0.11	16.35		
mid-peak	0.09	5.61	0.09	
off-peak	0.06		0.06	
Fixed (US\$/month)	358.05			

Source: SCE TOU-GS-3 and own calculations

- for buildings with electric peak load 500 kW and above: tariff TOU-8, seasonal demand charge, “SCE TOU-8, Peak Load>500kW” in SVOW

Table 6. SCE Commercial Sector Electricity Prices, Electric Peak Load 500 kW and above

Electricity	Summer (June – Sept.)		Winter (Oct. – Apr.)	
	electricity (US\$/kWh)	demand (US\$/kW)	electricity (US\$/kWh)	demand (US\$/kW)
non-coincident	na	11.54	na	11.54
on-peak	0.11	15.22		
mid-peak	0.09	5.14	0.09	
off-peak	0.06		0.06	
Fixed (US\$/month)	446.85			

Source: SCE TOU-8 and own calculations

The time periods for TOU-GS-3 and TOU-8 are defined below.

summer on-peak: 12:00 – 18:00 during weekdays

summer mid-peak: 08:00 – 12:00 and 18:00 – 23:00 during weekdays

summer off-peak: 23:00 – 08:00 during weekdays and all weekends and holidays

winter mid-peak: 08:00 – 21:00 during weekdays

winter off-peak: 21:00 – 08:00 during weekdays and all weekends and holidays

San Diego Gas & Electric (SDG&E) Electric Rates

The SDG&E tariffs for medium and large time-of-use customers are only distinguished by the monthly fixed costs. They are “SDGE AL-TOU, 20-500kW”, “SDGE AL-TOU, Peak Load>500kW” in SVOW

Table 7. SDG&E Commercial Sector Electricity Prices

Electricity	Summer (May – Sep.)		Winter (Oct. – Apr.)	
	electricity (US\$/kWh)	demand (US\$/kW)	electricity (US\$/kWh)	demand (US\$/kW)
non-coincident	na	12.80	na	12.80
on-peak	0.13	13.30	0.13	4.72
mid-peak	0.11		0.12	
off-peak	0.08		0.09	
Fixed (US\$/month)	58.22 for 20-500kW peak, 232.87 for 500kW peak			

Source: SDG&E Tariffs

The time periods for SDG&E are defined below.

summer on-peak: 11:00 – 18:00 during weekdays

summer mid-peak: 06:00 – 11:00 and 18:00 – 22:00 during weekdays

summer off-peak: 22:00 – 06:00 during weekdays and all weekends and holidays

winter on-peak: 17:00 to 20:00 during weekdays

winter mid-peak: 06:00 – 17:00 and 20:00 – 22:00 during weekdays

winter off-peak: 22:00 – 06:00 during weekdays and all weekends and holidays

Solar Radiation Data

The solar data necessary for PV and solar thermal simulation were gathered from NREL's PVWATTS database.

Marginal CO₂ Emissions Rates

In the present version of SVOW, the marginal CO₂ emissions rates are based on Mahone et al. 2008 and fixed. In future versions of SVOW, it may be possible for the user to input specific marginal CO₂ emissions rates data.

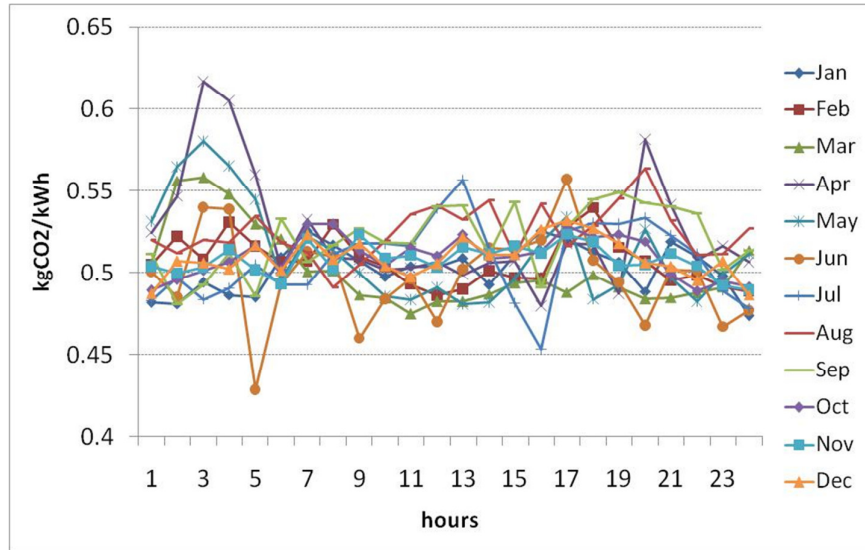

Figure 3. Marginal CO₂ Emissions Rates

CHAPTER 3: User Manual

This chapter introduces all of SVOW's features in detail and provides the user with the tools and knowledge needed to resolve most technical difficulties.

Step 1: Overview/Optimization Settings

In *step 1*, the user can personalize his/her settings to begin the analysis. The four drop-down menus for load profiles, technologies, tariffs, and solar radiation, as well as and the optimization options/settings are described below.

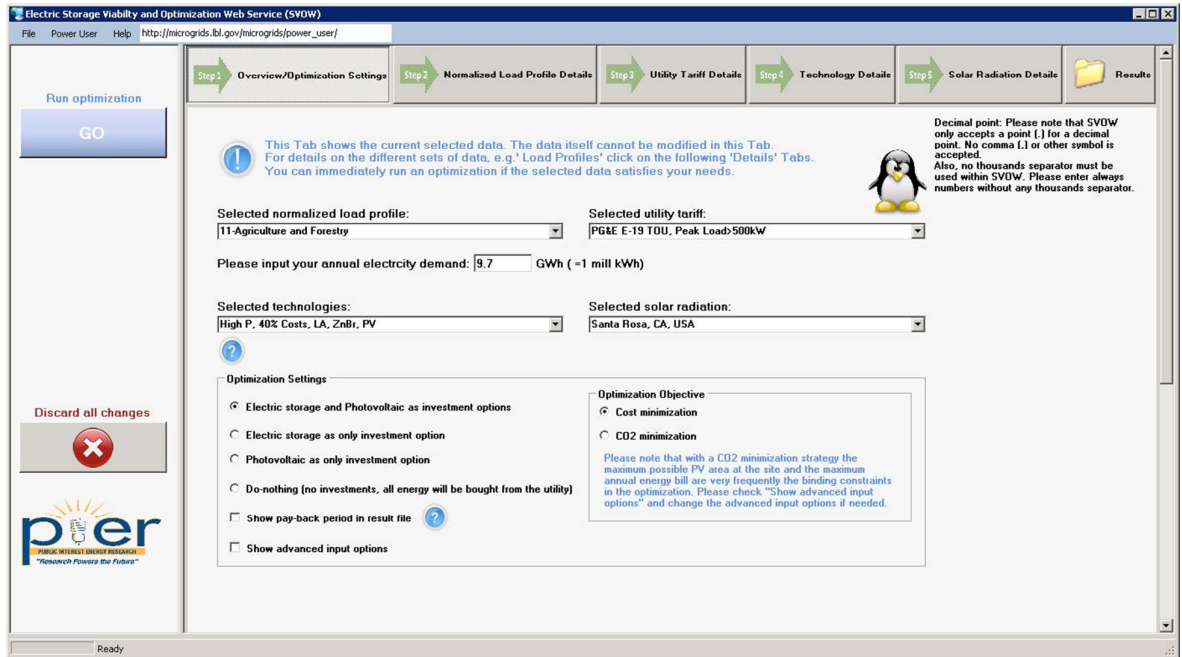

Figure 4. Step 1, Overview/Optimization Settings

Selected Normalized Load Profile

The user can either select one of the 20 standard load profiles by business types or input user specific load profiles. The standard load profiles are normalized to 1GWh (=1 mill kWh) annual electricity consumption. The *annual electricity demand* should also be provided to allow SVOW to scale the problem accordingly. The predefined load profiles can be used to perform fast and easy investigations to get a first estimate. If the user selects the “User Defined” load profile, he/she will have to enter the data in step 2.

Following standard load profiles are included in SVOW, prefaced by their North American Industry Classification System (NAICS) 2 digit code:

- 11-Agriculture and Forestry
- 21-Mining, Oil, Gas Extraction
- 22-Utilities
- 31-Manufacturing¹ All Day Long
- 31-Manufacturing Daytime
- 32-Industrial Manufacturing (wood/paper, petroleum/chemical, and plastics/rubber)
- 33-Primary Metal Manufacturing

¹ The manufacturing sector encompasses a wide range of businesses with wildly different load profiles. For the purposes of SVOW, we have made a distinction between those that operate all day without much variation in load, referred to as “31-Manufacturing All Day Long” (machinery oriented, ~24/7 operation) and those that follow a diurnal pattern “31-Manufacturing Daytime” (workers go home and machines shut down daily).

- 42-Wholesale Trade
- 42-Wholesale Trade Office Bldg.
- 44-Retail Trade²
- 45-Retail Trade
- 49-Transportation, Warehousing
- 51-Information
- 52-Finance and Insurance
- 53-Real Estate, Rental
- 54-Scientific, Technical Serv.
- 55-Company Management
- 61-Educational Services
- 71-Art,Entertainm., Recreation
- 72-Accommodation

For more information on the NAICS categories, please visit <http://www.naics.com>.

These predefined load profiles can be visualized in *step 2* (see green arrows in Figure 4)

Selected Technologies

SVOW provides economic and technical parameters for eight commonly available battery technologies, as well as for ZnBr flow battery and PV. ZnBr flow battery and PV are always part of the available technologies, and one other type of battery, so called regular batteries, can be selected. The costs are based on EPRI-DOE, Schoenung et al. 2003, SGIP 2008, and Stadler et al. 2009. To show the impact of battery and PV adoption 40% costs are introduced as standard data. These sets of parameters may be modified later, or manually specified if the user select the “*User Defined*” option (see *step 4*).

The following standard technologies are available in SVOW:

- High P, 40% Costs, LA, ZnBr, PV
 - Lead-Acid (LA) battery with higher than realistic performance (charging and discharging efficiencies), used for sensitivity analysis only
 - ZnBr flow battery and PV
 - 60% cost reduction for LA battery, ZnBr flow battery and PV, the prices are only 40% of the currently observed costs
- 40% Costs, LA, ZnBr, PV
 - Lead-Acid (LA) battery, ZnBr flow battery and PV

² The breakdown between the retail categories (44 and 45) can be seen at <http://www.census.gov/cgi-bin/sssd/naics/naicsrch?chart=2007a>

- 60% cost reduction for LA battery, ZnBr flow battery and PV
- 100% Costs, LA, ZnBr, PV
 - Same as above with actual³ observed costs
- 40% Costs, VRLA, ZnBr, PV
 - Valve-Regulated Lead-Acid (VRLA) battery, ZnBr flow battery and PV
 - 60% cost reduction for VRLA battery, ZnBr flow battery and PV
- 100% Costs, VRLA, ZnBr, PV
 - Same as above with actual observed costs
- 40% Costs, NiCd-fc, ZnBr, PV
 - Nickel-Cadmium fast-charging (NiCd-fc) battery, higher costs due to power electronics for fast charging/discharging, ZnBr flow battery and PV
 - 60% cost reduction for NiCd-fc battery, ZnBr flow battery and PV
- 100% Costs, NiCd-fc, ZnBr, PV
 - Same as above with actual observed costs
- 40% Costs, NiCd-sc, ZnBr, PV
 - Nickel-Cadmium slow-charging (NiCd-sc) battery, lower costs due to cheaper electronics for charging/discharging, ZnBr flow battery and PV
 - 60% cost reduction for NiCd-sc battery, ZnBr flow battery and PV
- 100% Costs, NiCd-sc, ZnBr, PV
 - Same as above with actual observed costs
- 40% Costs, NaS-fc, ZnBr, PV
 - Sodium-Sulfur fast-charging (NaS-fc) battery, higher costs due to power electronics for fast charging/discharging, ZnBr flow battery and PV
 - 60% cost reduction for NaS-fc battery, ZnBr flow battery and PV
- 100% Costs, NaS-fc, ZnBr, PV
 - Same as above with actual observed costs
- 40% Costs, NaS-sc, ZnBr, PV
 - Sodium-Sulfur slow-charging (NaS-sc) battery, lower costs due to cheaper electronics for charging/discharging, ZnBr flow battery and PV
 - 60% cost reduction for NaS-sc battery, ZnBr flow battery and PV

³ Year 2009

- 100% Costs, NaS-sc, ZnBr, PV
 - Same as above with actual observed costs
- 40% Costs, Li-Ion-fc, ZnBr, PV
 - Lithium-Ion fast-charging (Li-Ion-fc) battery, higher costs due to power electronics for fast charging/discharging, ZnBr flow battery and PV
 - 60% cost reduction for Li-Ion-fc battery, ZnBr flow battery and PV
- 100% Costs, Li-Ion-fc, ZnBr, PV
 - Same as above with actual observed costs
- 40% Costs, Li-Ion-sc, ZnBr, PV
 - Lithium-Ion slow-charging (Li-Ion-sc) battery, lower costs due to cheaper electronics for charging/discharging. ZnBr flow battery and PV
 - 60% cost reduction for Li-Ion-sc battery, ZnBr flow battery and PV
- 100% Costs, Li-Ion-sc, ZnBr, PV
 - Same as above with actual observed costs

Selected Utility Tariff

The user can either select one of the default tariffs listed in Table 8, or create his/her own one by selecting “*UserDefined*” tariff. Please note that we only provide California tariffs at this point, and the new Peak Day Pricing (PDP) tariff for California will be implemented in future SVOW versions. If the user chooses to define the utility tariff, the *Electric Tariff Wizard* will pop up (Figure 5).

The Electric Tariff Wizard allows building tariffs of increasing complexity. By default, with all the boxes unchecked, the user can only input a single value for electricity price, resulting in a flat tariff year round. By checking the “*seasonal difference*” box, a differentiation is created between summer and winter tariffs and the user can select which months belong to which season. By checking the “*Time-of-use weekdays*” (TOU) box, a differentiation is created between on, mid and off-peak hours during weekdays. The user can specify which time of the day falls in which time of use period. Thus, by selecting seasonal and TOU options the user can create a tariff composed of up to 6 different price levels.

By clicking the “*Demand pricing / demand charges*” box, a demand charge component will be added to the tariff. As for the energy pricing, the demand charge can be composed of 1, 2, 3 or 6 values, depending on if seasonal and TOU options are selected or not. The definitions of summer, winter, on, mid and off-peak hours apply to energy pricing and demand charges.

Finally, the user can choose to add a monthly fixed cost by checking the corresponding box. In case the user wants to input a more complex tariff, he/she is advised to contact the SVOW team directly by email since the SVOW team can add new tariffs to the tariff database. The tariffs (built-in as well as user defined) can be visualized in *step 3*.

Electric Tariff Wizard

Please note that this Tariff Wizard is under construction and that we will add more tariff options over time. Complex tariffs can be added to the database by the SVOW team. Please feel free to send us an email.

Season

Seasonal difference

Summer months:

Jan April July Oct
 Feb May Aug Nov
 March June Sept Dec

TOU

Time-of-use week days SVOW will determine off peak hours based on your input. All weekend days are assumed to be off peak.

on peak summer hours: mid peak summer hours: on peak winter hours: mid peak winter hours:

00:00-01:00 00:00-01:00 00:00-01:00 00:00-01:00
 01:00-02:00 01:00-02:00 01:00-02:00 01:00-02:00
 02:00-03:00 02:00-03:00 02:00-03:00 02:00-03:00
 03:00-04:00 03:00-04:00 03:00-04:00 03:00-04:00
 04:00-05:00 04:00-05:00 04:00-05:00 04:00-05:00
 05:00-06:00 05:00-06:00 05:00-06:00 05:00-06:00
 06:00-07:00 06:00-07:00 06:00-07:00 06:00-07:00
 07:00-08:00 07:00-08:00 07:00-08:00 07:00-08:00
 08:00-09:00 08:00-09:00 08:00-09:00 08:00-09:00
 09:00-10:00 09:00-10:00 09:00-10:00 09:00-10:00

Energy Part of Electric Tariff

Energy pricing (\$/kWh)

off peak summer price: mid peak summer price: on peak summer price:

off peak winter price: mid peak winter price: on peak winter price:

Demand Part of Electric Tariff

Demand pricing / demand charges (\$/kW)

off peak summer price: mid peak summer price: on peak summer price:

off peak winter price: mid peak winter price: on peak winter price:

Monthly Fixed Part of Electric Tariff

Monthly fixed costs (\$/month)

Cancel

Accept

Figure 5. Electric Tariff Wizard

Table 8. Predefined Utility Tariffs

Utility	Name	Peak load range	Description
Pacific Gas and Electric (PG&E)	E-19 TOU	>500kW	Time-Of-Use (TOU) tariff. Demand charge and energy price have 3 different values during winter and 2 during summer, depending of the time (on, mid or off-peak, and weekday or weekend)
	A-10 TOU	200-500kW	TOU tariff for energy price, flatter than above. Demand charge only depends on the season (winter or summer), not on the time of the day
	A-1 Flat Rate	<200kW	Flat rate for energy price, no demand charge.
Southern California Edison (SCE)	TOU-8	>500kW	Similar to PG&E E-19 TOU, except that winter demand charge is constant throughout the day
	GS-3 TOU	200-500kW	Similar to SCE TOU-8
	GS-2 Flat Rate	20-200kW	Flat rates for energy price and demand charge, different values for winter and summer
San Diego Gas and Electric (SDGE)	AL-TOU	>500kW	TOU tariff for energy and demand charges. 3 different levels for energy, 2 for demand charge, tariff pattern change between summer and winter
	AL-TOU	20-500kW	Same as above, but with different monthly fixed costs

Selected Solar Radiation

For quick estimates, the user can select predefined solar radiation data for the locations listed below. For more accurate results, the user can input his/her own solar data by selecting “*User Defined*” in the drop-down menu, and then manually input it in *step 5*.

Predefined solar radiation locations are:

- Santa Rosa
- Sacramento
- Fresno
- San Jose
- San Francisco
- Long Beach
- Burbank
- Riverside
- Los Angeles
- San Diego

Optimization Settings

Different settings are available to evaluate a project. First, the user can choose which technologies to model:

- *Electric storage and photovoltaic as investment options:*
 - The solver will be allowed to select and size battery technologies (of the type specified above), flow battery and PV in order to minimize its goal (either cost or CO₂).
- *Electric storage as only investment option:*
 - Same as above but without PV.
- *Photovoltaic as only investment option:*
 - The solver can only select and size PV to minimize its goal (either cost or CO₂).
- *Do-nothing (no investments, all electricity will be bought from the utility):*
 - The solver has no degree of freedom as all electricity has to be bought from the utility. This option should be used only to estimate the energy bill in the absence of batteries or PV.

Two optional settings can further help the user with analysis:

- *Show pay-back period in result file:*

If checked, SVOW will only consider solutions that reduce energy bill below their estimated initial levels. Two runs will be performed automatically. First a base case (do-nothing) run will be performed and then the selected investment case. Please note that this feature overwrites the *Max. allowed annual energy costs (including annualized capital costs)* from *Show advanced input options* by the base case (do-nothing) costs from the first run. Thus, if no investments are observed with this setting checked, the user may uncheck *Show pay-back period in result file* and redo the run with higher *Max. allowed annual energy costs (including annualized capital costs)* from *Show advanced input options*.

- *Show advanced input options:*

If the objective is to minimize costs, the initial investment costs for batteries and PV will be annualized using the *interest rate* that can be specified by checking the *Show advanced input options* box. This annualized investment cost is added to the energy bill. The *maximum pay-back period for the initial investment* can also be specified in the *advanced input options*.

If *Show pay-back period in result file* is unchecked, SVOW will use the *Maximum allowed energy costs (including annualized capital costs)* as an upper boundary for the cost. This maximum total cost is also part of the *Advanced input options*.

Unchecking the “*Show pay-back period in result file*” box and increasing the *maximum allowed energy costs* is useful if the user wants to assess scenarios with higher costs than the base case (do-nothing).

On top of the above-mentioned *Interest rate*, *Maximum costs* and *Maximum pay-back period*, one more advanced option is available. The *Maximum available space for PV system at site* specifies an upper boundary for PV installation. The available space on the rooftop may be a good estimate of this figure.

Finally, the user can specify whether he/she wants to *minimize cost* or *CO₂ emissions*.

Step 2: Normalized Load Profile Details

If the user selected a user defined load profile in *step 1*, he/she should use this tab to input his/her load profile. This can be done simply by copying and pasting from an external spreadsheet into SVOW.

The data is organized in a 24-column by 36-row block of data. Each of the columns refers to one hour of the day, using 24 hour notation system. The first column refers to the 00h 00min – 00h 59min period (12:00 a.m. – 12:59 a.m.), and the last column to 23h 00min – 23h 59m (11:00 p.m. – 11:59 p.m.).

The upper third of the data (first 12 rows) refers to the weekday load profiles for each month, the middle refers to peak days for each month and the lower third refers to weekend load profiles for each month. The peak days refer to the 3 days of the month with the highest demand.

The user can also manually type in values in any of the cells. Since the timestamp is one hour, the load profiles unit can be consider either as kW or as kWh.

As indicated, if the user provides the load profiles without normalizing them to 1 GWh of annual electricity consumption, then he/she should input "1" as the annual electricity demand in *step 1*.

If data are provided without distinction between weekdays, peakdays and weekends, then the user should simply enter the same load profiles for weekdays, peakdays and weekends.

The graph on the lower part of the tab allows visualizing the monthly load profile, either for weekdays, peakdays or weekends. This feature can be used for both predefined and user defined load profiles.

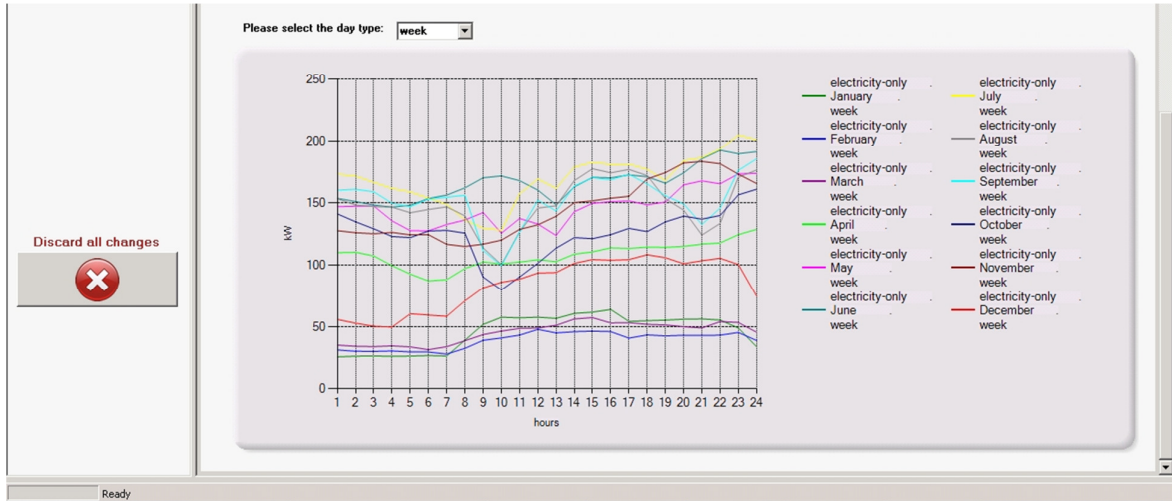

Figure 6. Lower Part of the *Step 2* Tab Displaying Load Profiles

Step 3: Utility Tariff Details

This tab can be used to visualize both predefined and user defined tariffs.

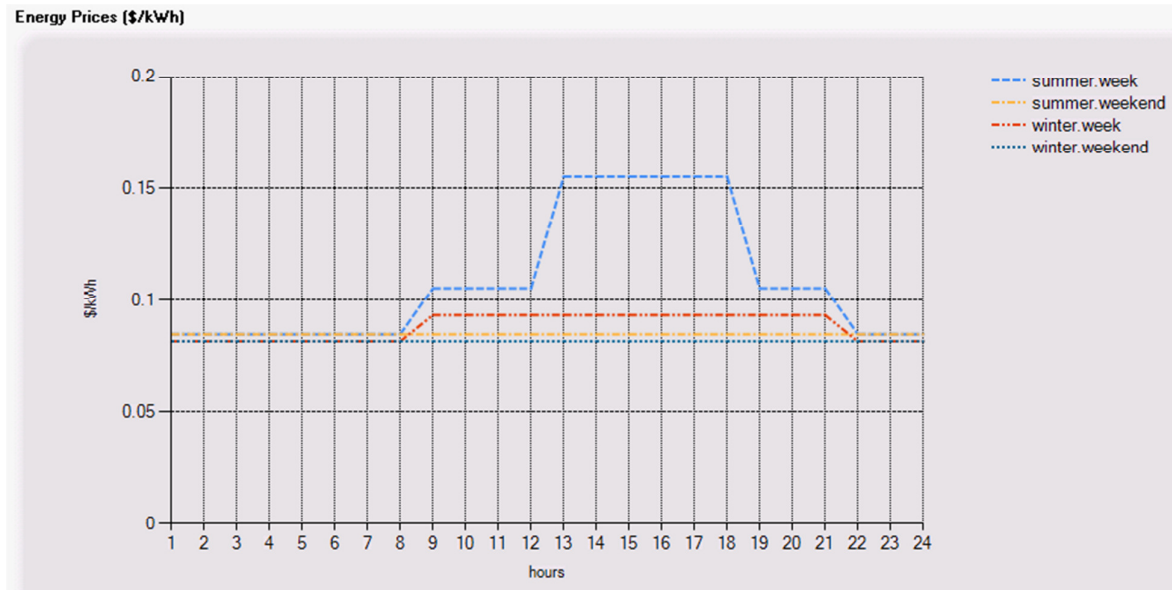

Figure 7. Energy Prices as Displayed in *Step 3*

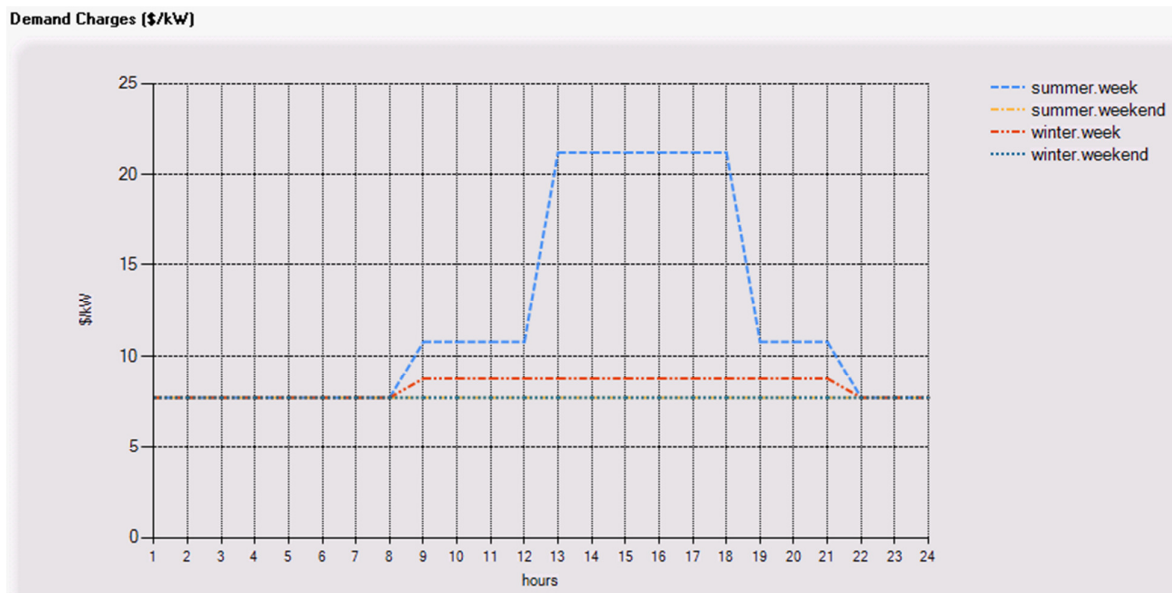

Figure 8. Demand Charges as Displayed in Step 3

Step 4: Technology Details

This tab can be used to view or edit the economic and technical parameters of regular batteries, flow batteries and PV. Please note that it is possible to edit a predefined set of technologies, and that SVOW will detect the modification and display “User Defined” instead of the name of the standard set. In other words, the user does not have to specify all the parameters of a set from scratch, as he/she can simply use a predefined set as a starting point and modify the parameters he/she wants to focus on. To edit any cell, the user simply has to click on it and type in a new value.

Economic parameters⁴

- *Fixed cost*: in \$, applied as soon as the technology is selected, regardless of the size.
- *Variable cost*: in \$/kW for PV and the power part of the flow battery and in \$/kWh for the regular battery and the energy part of the flow battery. Please note that this parameter also includes costs for power electronics necessary for charging and discharging. High charging and discharging rates require more expensive power electronics, and therefore, increase the variable cost. To account for this fact, SVOW offers different technology set with fast or slow charging and discharging rates.

The SVOW team realizes that this reduces the flexibility of the model, and therefore, future versions of SVOW will also select the optimal size of power electronics.

- *Lifetime*: in years.
- *Fixed maintenance*: expressed in the same units as the variable costs.

Regular Battery Parameters

- *Efficiency of charge*: fraction of the electricity sent to the battery that is effectively stored in the battery.

⁴Here, electric storage means regular battery (not flow battery).

- *Efficiency of discharge*: fraction of the electricity discharged from the battery that is effectively available.
- *Decay*: fraction of the energy stored in the battery that is lost by decay in one hour.
- *Maximum charging rate*: maximum fraction of the battery capacity that can be charged up in one hour.
- *Maximum discharging rate*: maximum fraction of the battery capacity that can be discharged in one hour.
- *Minimum state of charge*: minimum level of charge to avoid damaging the battery.

Flow Battery Parameters

The parameters of the flow battery are the same as for the regular battery but without the maximum charge and discharge rate, as flow batteries are not limited in this regard.

High P, 40% Costs, LA, ZnBr, PV

Economic Parameters

	Technologies	FixedCost	VariableCost	Lifetime	FixedMaintenance
▶	ElectricStorage	0.0	88.0	6.0	0.0
	FlowBatteryEnergy	0.0	88.0	10.0	0.1
	FlowBatteryPower	0.0	850.0	10.0	0.0
	PV	0.0	3,320.0	20.0	0.3

Regular Battery Parameters		Flow Battery Parameters	
	Item	(unitless)	(unitless)
▶	EfficiencyCharge	0.950	0.840
	EfficiencyDischarge	0.950	0.840
	Decay	0.004	0.000
	MaxChargeRate	0.200	
	MaxDischargeRate	0.250	
	MinStateOfCharge	0.300	0.250

Figure 9. Technology Parameters for High P, 40% Costs, LA, ZnBr, PV, Step 4

Step 5: Solar Radiation Details

This tab can be used to view or edit the solar radiation data. If the user selected a predefined location in *step 1*, it is not possible to modify the data; this can be done only if the “User Defined” solar data has been selected in *step 1, Overview/Optimization Settings*.

The table on the upper part of *step 5* can be edited in the same way as the tables in *step 2* and *4* by copying-pasting data from an external spreadsheet or directly typing in the values. The unit of each cell is kW/m², where “1.0” is considered to be the maximum solar radiation on an optimally tilted PV panel.

As indicated in SVOW, the solar radiation data is assumed to represent the solar radiation on a fixed PV panel having the same tilt as the latitude of the selected location. If the user wishes to input his/her own data, he/she should be sure that this assumption is considered.

The lower part of the tab allows the user to visualize the solar radiation for each hour and each month.

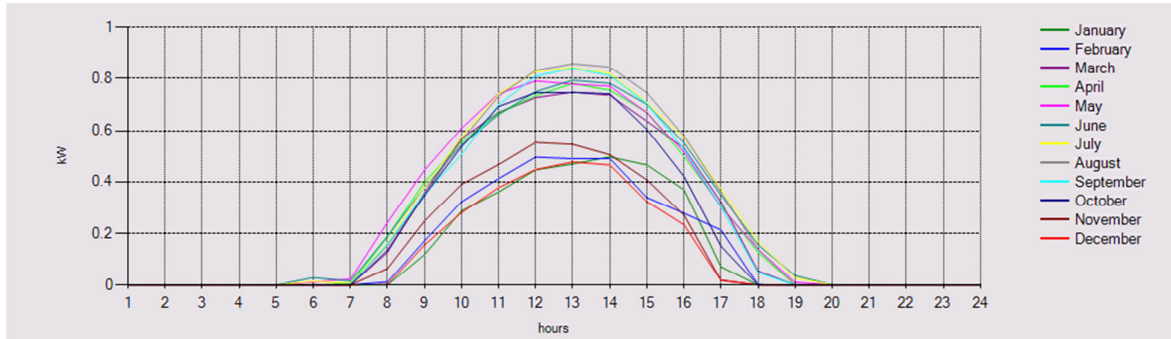

Figure 10. Example Solar Radiation, Step 5

Running the Optimization

Once the user has input all the required information in *steps 1* through *5*, he/she is ready to launch the optimization. To do so, simply hit the “GO” button on the upper left part of the window. After a few seconds, the *Results* tab will be shown.

Results

The result tab provides summarized result as well as detailed hourly schedule and information.

The top part of the table provides the user with the following information (see Figure above):

- *Total Annual Energy Costs, including annualized investment costs (\$)*
- *Payback period of investments (years), if it has been selected*
- *Installed Battery Capacity (kWh)*
- *Installed Flow Battery Capacity (kWh)*
- *Installed Flow Battery Power (kW)*
- *Installed Capacity: Photovoltaic (kW), peak power under test conditions*
- *Size of Photovoltaic (m²)*
- *Electricity Generated Onsite (kWh/a), amount of electricity generated by PV*
- *Utility Electricity Consumption (kWh/a)*
- *Efficiency of Entire Energy Utilization (Onsite and Purchase)*
- *Annual Electricity-Only Load Demand (kWh), input data*
- *Annual Costs Electricity (\$)*
- *Annual Off-site CO₂ Emissions (Macrogrid) (kgCO₂), CO₂ from utility*

- *Annual CO₂ Emissions (Grand Total) (kgCO₂)*, equal to the line above, since there is no CO₂ emitting technology in SVOW

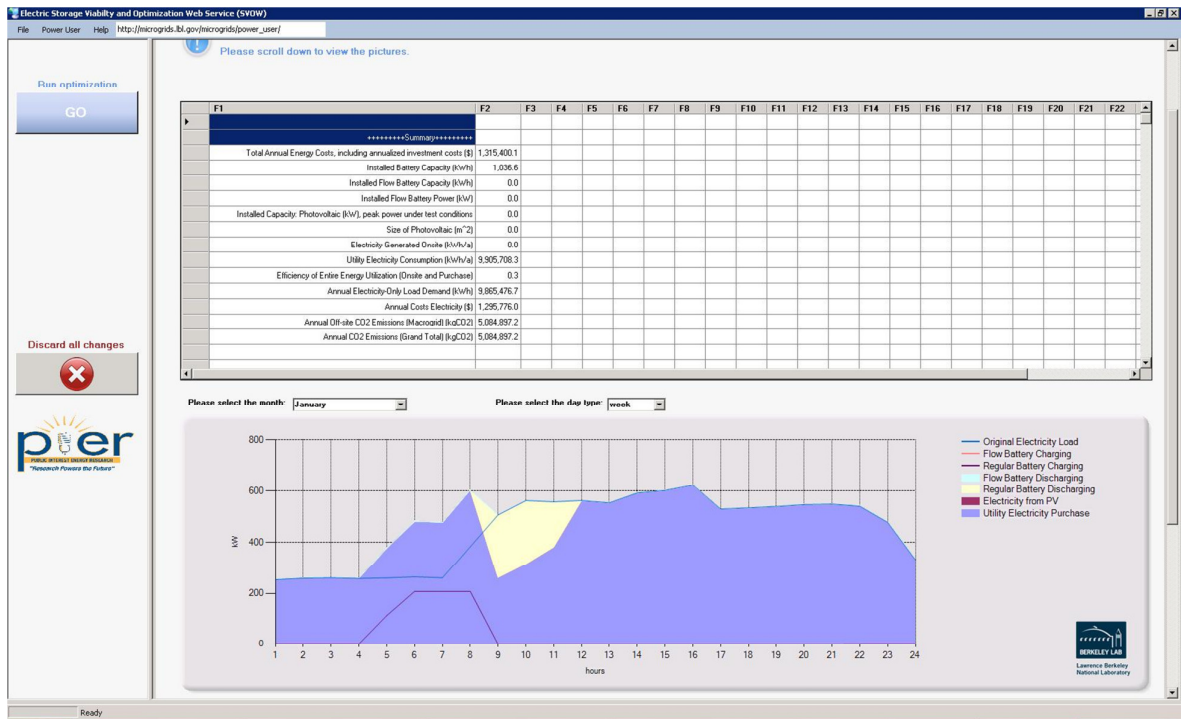

Figure 11. Example Result Tab of SVOW

If the user scrolls down the table, he/she will see the detailed hourly optimal schedule for week-, peak-, and weekend days. The following components are provided:

- *Utility electricity consumption (kW)*
- *Electricity Generation from Photovoltaics (kW)*
- *(Stationary) Battery*: electricity input, output and decay losses, refers to regular (non flow) battery
- *Flow Battery*: electricity input, output and decay losses
- *Electricity Load (kW)*: building electricity load profile

The lower part of the *result* tab displays a graph based on these optimal schedules. The user can select which month and type of day he/she wishes to visualize in the chart area.

Tips and Helps

Although SVOW has been designed to be intuitive and user-friendly, confusion and misunderstandings can and do happen. In order to offer the user the best experience, tips are available throughout the web service wherever something needs to be clarified. Please click on the blue question mark and a penguin will provide tips and help messages. In any case please feel free to send an email to Michael Stadler at mstadler@lbl.gov.



Figure 12. Tips and Helps in SVOW

CHAPTER 4: Conclusions

Originally designed for analyses in California, the SVOW service has since then attracted attention from all over the world. Version 1.2.0.11, which provides the Tariff Wizard option, was released shortly after version 1.1. and gives the user the possibility to define his/her own electric tariffs and to overwrite California solar radiation data.

Within the first three months of the SVOW release, 90 users have been registered to use the online service. The Remote Desktop Connection approach was proven very successful. No single user⁵ observed any stability or login problem. Also, Remote Desktop Connection requires less maintenance as an individual programmed website and handles user management on the web server automatically.

Following number of users from different countries / states registered for the SVOW service:

- *California: 17*
- *Other US states: 32*
- *Austria: 4*
- *Canada: 4*
- *Germany: 2*
- *Australia, Belgium, China, Denmark, Ireland, Italy, New Zealand, Poland, Portugal, Spain, Taiwan: 1 each*
- *Other countries (unknown/unresolved IP addresses): 20*

To increase the number of users, an additional emailing list at Lawrence Berkeley National Laboratory together with the LBNL communications office is planned for October 2010.

Finally, the most common feedback from the users have been requests about extending the tool by other distributed energy resource (DER) technologies, e.g. wind, and therefore, we are planning on extending SVOW by combined heat and power (CHP), storage technologies as well as demand response and efficiency measures.

Information on how to access SVOW can be found at <http://der.lbl.gov/microgrids-lbnl/current-project-storage-viability-website>.

⁵ More precisely, no single user who registered online. There has been a problem with California Energy Commission (CEC) test users due to outdated WinXP Service Packs.

CHAPTER 5: References

- Stadler, M., C. Marnay, A.S. Siddiqui, J. Lai, B. Coffey, and H. Aki (2008), "Effect of Heat and Electricity Storage and Reliability on Microgrid Viability: A Study of Commercial Buildings in California and New York States," LBNL-1334E, Berkeley Lab, Berkeley, CA, USA
- Microgrid Symposium. Held at Berkeley, CA, USA in June 2005, near Montréal, Canada in June 2006, in Nagoya, Japan in April 2007, Kythnos, Greece in May 2008, San Diego in September 2009, and Vancouver, Canada, in July 2010 (materials available at <http://der.lbl.gov>)
- Hatziargyriou, N. et al., (2007), "Microgrids, An Overview of Ongoing Research, Development, and Demonstration Projects," IEEE Power & Energy magazine, July/August 2007
- Stadler, M., C. Marnay, G. Cardoso, T. Lipman, O. Mégel, S. Ganguly, A Siddiqui, and J. Lai (2010),. "The Carbon Dioxide Abatement Potential of California's Mid-Sized Commercial Buildings," California Energy Commission, PIER Program, CEC-500-07-043, 500-99-013, LBNL-3024E, December 2009.
- EPRI-DOE Handbook of Energy Storage for Transmission and Distribution Applications, EPRI, Palo Alto, CA, and the U.S. Department of Energy, Washington, DC: 2003. 1001834
- Schoenung S. M. and W. V. Hassenzahl (2003), "Long- vs. Short-Term Energy Storage Technologies Analysis, A Life-Cycle Cost Study, "Sandia Report SAND2003-2783 Unlimited Release, August 2003.
- SGIP (2008), Statewide Self-Generation Incentive Program Statistics, California Center for Sustainable Energy, <http://www.sdenergy.org/ContentPage.asp?ContentID=279&SectionID=276&SectionTarget=35>, updated December 2008
- PG&E A-1, http://pge.com/tariffs/tm2/pdf/ELEC_SCHEDS_A-1.pdf
- PG&E A-10, http://www.pge.com/tariffs/tm2/pdf/ELEC_SCHEDS_A-10.pdf
- PG&E E-19, http://www.pge.com/tariffs/tm2/pdf/ELEC_SCHEDS_E-19.pdf
- SCE GS-2, <http://www.sce.com/NR/sc3/tm2/pdf/ce30-12.pdf>
- SCE TOU-GS-3, <http://www.sce.com/NR/sc3/tm2/pdf/CE281.pdf>
- SCE TOU-8, <http://www.sce.com/NR/sc3/tm2/pdf/ce54-12.pdf>
- SDG&E Tariffs (2009), http://www.sdge.com/tm2/pdf/ELEC_ELEC-SCHEDS_AL-TOU.pdf
- Mahone, A., S. Price, W. Morrow (2008), "Developing a Greenhouse Gas Tool for Buildings in California: Methodology and Use," Energy and Environmental Economics, Inc., September 10, 2008 and PLEXOS Production Simulation Dispatch Model

NREL PVWATTS, <http://rredc.nrel.gov/solar/calculators/PVWATTS/version1/>

APPENDIX A: SVOW License Agreement

1. **LICENSE GRANT.** Berkeley Lab grants you, and you hereby accept, a non-exclusive, non-transferable, royalty-free perpetual license to use the Industrial, Agricultural, and Water Storage Viability and Optimization Website Service - SVOW (hereafter the "Software"), subject to the following terms and conditions:

- (a) You may use the Software solely for your own internal non-commercial use;
- (b) You may not reverse engineer, disassemble, decompile, or otherwise attempt to derive the source code of the Software. You may not modify, alter, or create derivative works of the Software in any manner;
- (c) You agree not to extract information from the microgrids.lbl.gov server and its directories and databases, distribute or provide others with your personal user account data, or any information available on, derived or extracted from the microgrids.lbl.gov directories and databases or any part thereof. You also agree not to store any non-SVOW related data and files on microgrids.lbl.gov server and its directories and databases; and
- (d) You may not rent, lease, loan, sublicense, distribute or transfer the Software to any third party, nor use it for commercial time-sharing or service bureau use.

2. **COPYRIGHT; RETENTION OF RIGHTS.** (i) you hereby acknowledge that the Software is protected by United States copyright law and international treaty provisions; (ii) Berkeley Lab, and its licensors (if any), hereby reserve all rights, title and interest in and to the Software which are not explicitly granted to you herein; and (iii) without limiting the generality of the foregoing, Berkeley Lab and its licensors (if any) retain all title, copyright, and other proprietary interests in the Software and any copies thereof, and you do not acquire any rights, express or implied, in the Software, other than those specifically set forth in this Agreement.

3. **NO MAINTENANCE OR SUPPORT.** Berkeley Lab shall be under no obligation whatsoever to: (i) provide maintenance or support for the Software; or (ii) to notify you of bug fixes, patches, or updates (collectively, "Update") to the Software (if any). If, in its sole discretion, Berkeley Lab makes an Update available to you and Berkeley Lab does not separately enter into a written license agreement with you relating to such Update, then it shall be deemed incorporated into the Software and subject to this Agreement.

5. **WARRANTY DISCLAIMER.** The software is supplied "as is" without warranty of any kind. Berkeley Lab, its licensors, the United States Department of Energy, and their employees: (1) disclaim any warranties, express or implied, including but not limited to any implied warranties of merchantability, fitness for a particular purpose, title or non-infringement, (2) do not assume any legal liability or responsibility for the accuracy, completeness, or usefulness of the software, (3) do not represent that use of the software would not infringe privately owned rights, (4) do not warrant that the software will function uninterrupted, that it is error-free or that any errors will be corrected.

6. LIMITATION OF LIABILITY. In no event will Berkeley Lab or its licensors be liable for any indirect, incidental, consequential, special or punitive damages of any kind or nature, including but not limited to loss of profits or loss of data, for any reason whatsoever, whether such liability is asserted on the basis of contract, tort (including negligence or strict liability), or otherwise, even if Berkeley Lab has been warned of the possibility of such loss or damages. In no event shall Berkeley Lab's liability for damages arising from or in connection with this agreement exceed the amount paid by you for the software.

7. INDEMNITY. You shall indemnify, defend, and hold harmless Berkeley Lab, the U.S. Government, the Software developers, the Software sponsors, and their agents, officers, and employees, against any and all claims, suits, losses, damage, costs, fees, and expenses arising out of or in connection with this Agreement. You shall pay all costs incurred by Berkeley Lab in enforcing this provision, including reasonable attorney fees.

APPENDIX B: Previously Released Reports

Storage Viability and Optimization Website Interim Report I

Storage Viability and Optimization Website

Tanachai Limpaitoon, Michael Stadler, Judy Lai, and Chris Marnay

28 December 2009

1.0 Review of Public Access Screening Tools

As background for designing the Storage Viability and Optimization Website (SVOW), this review focuses on public access software tools with storage capabilities. The tools reviewed are HOMER, RETScreen, and CogenPro. Details on the selection of initial test sites are also included.

1.1. HOMER

HOMER is a standalone program that finds the least cost combination of components that meets electrical and thermal loads for smaller scale distributed and renewable power projects. Users download the software and run it on their own computer. Contrary to our Distributed Energy Resources Customer Adoption Model (DER-CAM), HOMER may not be used to directly find optimal system configurations. It simulates different system configurations with pre-selected components, optimizes for lifecycle cost, and generates results of sensitivity analyses. Sample files are provided on the website to illustrate how the program works, but no database of electric load shapes is available.

1.1.1. Inputs

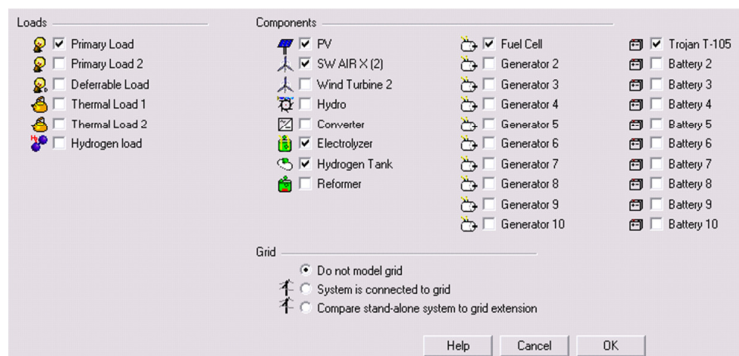

Figure B1. HOMER Components

Users manually enter daily load profiles or import a text file containing hourly load data for a single year. The text file must be properly formatted, and it must contain 8,760 lines, each containing the average load (in kW) over a single hour. HOMER defines a component as a

piece of machinery that is part of a power system. Users can easily add components⁶ by ticking checkboxes, as seen in Figure B1. Once components are added, buttons corresponding to the components will appear in a schematic diagram (see Figure B2).

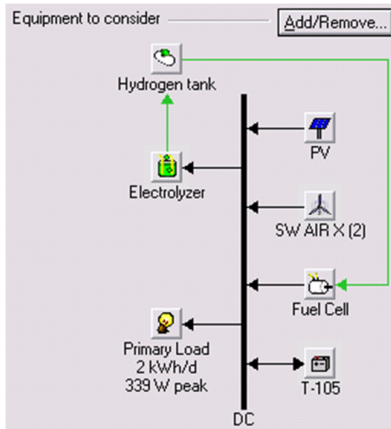

Figure B2. HOMER Schematic Diagram

Users may select from components stored in a library. As an example, Figure B3 shows a drop-down box containing available battery types. Once a battery type is selected, users can modify its properties. In addition, users may wish to create a completely new battery type with specific properties.

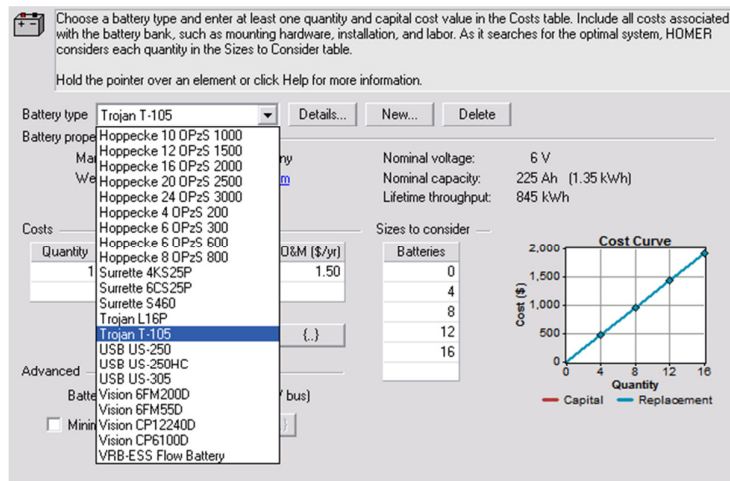

Figure B3. The Drop-Down List of Battery Types

1.1.2. Simulation

HOMER can simulate a variety of micropower system configurations, comprising any combination of loads and components (Figure B1). Operation is simulated by making energy balance calculations for each hour in a year to minimize total lifecycle cost. Dispatch

⁶ Note that absorption chiller is not available in HOMER.

decisions consider operating reserve, charging strategy⁷, and load priority. In other words, for systems that include batteries and generators, HOMER decides hourly how to operate the generators. Charging or discharging the batteries requires a dispatch strategy, as explored through a case study in the next section.

If the system meets the loads for the entire year, HOMER estimates the lifecycle cost of the system, accounting for capital, replacement, operation and maintenance, fuel and interest costs, using the total net present cost to represent the lifecycle cost. This value includes all costs and revenues that occur within the project lifetime, with future cash flows discounted to the present.

1.1.3. Optimization

Decision variables include: the size of components such as any PV array, generators, AC-DC converters, hydrogen storage tanks, and numbers of wind turbines and batteries. HOMER allows the modeler to enter multiple values for each decision variable. As an example, Figure B4 shows there are 6 components, each of which is assigned with a range of values, comprising a search space. HOMER finds the optimal lifecycle cost by comparing all possible configurations in the search space. Also, a list of feasible systems is displayed, as seen in Figure B5.

	PV Array (kW)	AIR (Quantity)	FC (kW)	T-105 (Quantity)	Electrolyzer (kW)	H2 Tank (kg)
1	0.000	0	0.00	0	0.00	0.00
2	0.400	1	0.40		0.40	2.00
3	0.600	2		8	0.60	3.00
4	0.800	3		12	0.80	4.00
5	1.000			16		6.00
6	1.500					8.00
7						12.00
8						16.00
9						20.00
10						24.00

Figure B4. Search Space

	PV (kW)	AIR	FC (kW)	T-105	Elec (kW)	H2 Tank (kg)	Disp. Strgy	Initial Capital	Operating Cost (\$/yr)	Total NPC	COE (\$/kWh)	Ren. Frac.	Capa. Short
1	0.8			12			CC	\$ 10,210	396	\$ 15,269	1.640	1.00	0
2	0.8	1		8			CC	\$ 11,230	421	\$ 16,612	1.783	1.00	0
3	0.8	0.4	0.4	12	0.4		CC	\$ 12,210	389	\$ 17,178	1.845	1.00	0
4	0.8	1	0.4	8	0.4		CC	\$ 13,230	414	\$ 18,520	1.988	1.00	0
5	1.5		0.4		0.6	2	LF	\$ 17,970	507	\$ 24,446	2.630	0.83	0
6	1.0	1	0.4		0.6	3	LF	\$ 17,770	550	\$ 24,796	2.657	0.79	0
7		3	0.4	4	0.6	20	LF	\$ 37,350	789	\$ 47,431	5.119	0.57	0
8		3	0.4		0.4	28	LF	\$ 46,870	949	\$ 59,006	6.323	0.48	0

Figure B5. A List of Feasible Systems, Sorted By Lifecycle Cost

1.1.4. Sensitivity Analysis

Users may use sensitivity analysis to deal with uncertainty in key parameters. A sensitivity analysis on inputs can be performed by assigning more than one value to each input of interest, and HOMER repeats the simulation for each one. Users can specify as many sensitivity parameters as they want, and analyze the results using HOMER's graphing

⁷ a set of rules governing how the system charges the battery bank

capabilities, e.g. Optimal System Type graphs (Figure B6). Figure B6 shows the results of a sensitivity analysis over a range of fuel-cell capital multipliers and wind speeds. The user specified six values for the wind speed and six values of the capital multiplier. The two values can be different. At each of the 36 sensitivity cases, HOMER performed its algorithm over the search space. The diamonds in the graph indicate these sensitivity cases, and the color of each neighborhood indicates the optimal system type for that sensitivity case. For example, at a wind speed of 6 m/s and a Fuel Cell (FC) capital multiplier of 0.5, the optimal system type was the blue Wind-PV-Battery, i.e. a power system consisting of wind turbines, PV, and batteries. Note that at low wind speeds and multipliers, FCs dominate, but at higher multipliers and wind speeds wind becomes increasingly dominant, as one would expect.

HOMER can also do sensitivity analyses on hourly data sets such as the primary electric load or some resources. HOMER’s use of scaling variables enables such sensitivity analyses. Since each hourly data set comprises of 8760 values that have a certain average value, the modeler can scale the averages of the entire data set up or down without affecting the load shape, and analyze the effects through the Optimal System Type graph.

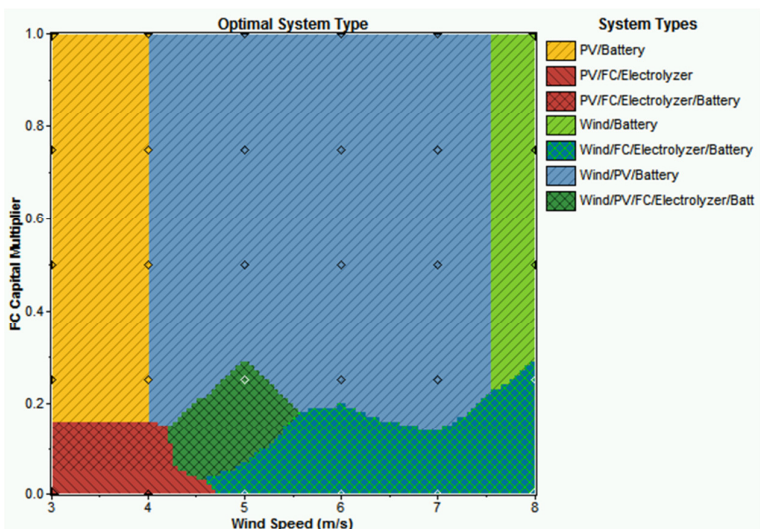

Figure B6. Optimal System Type Graph

1.2. RETScreen

RETScreen provides evaluation of energy production, life-cycle costs, and greenhouse gas emission reductions for various types of proposed energy efficient and renewable energy technologies. The software’s analysis task is to determine whether or not the balance of costs and savings over the life of the project make for a financially attractive proposition; however, RETScreen is designed to focus on incremental changes of a proposed case when compared to a base case.

RETScreen is developed in Microsoft® Excel, shown in Figure B7. Users need to specify project information and site-reference conditions. In specifying project information, users may start with a template (see Figure B8), or they can choose from a list of case studies in a database (See Figure B9). Climate data location can also be selected from a list (see Figure B10).

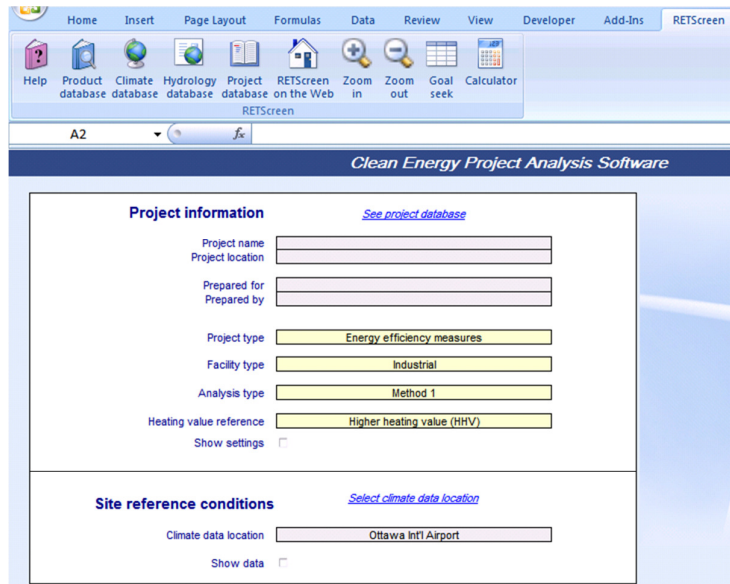

Figure B7. RETScreen Start Page

Project type	Type	Project name
Energy efficiency measures	Industrial	Heat recovery - Pulp and paper
Energy efficiency measures	Industrial	Heat recovery - Petrochemical
Energy efficiency measures	Industrial	Steam losses
Energy efficiency measures	Industrial	Process heat
Energy efficiency measures	Industrial	Other
Energy efficiency measures	Industrial	Refrigeration
Power	Ocean current power	1,200 kW
Power	Photovoltaic	100 kW
Power	Photovoltaic	0.4 kW - Off-grid
Power	Reciprocating engine	6,000 kW - Landfill gas
Power	Reciprocating engine	100 kW - Biogas
Energy efficiency measures	Residential	Building envelope - Apartment building
Energy efficiency measures	Residential	Model National Energy Code for Buildings (MNECB)
Energy efficiency measures	Residential	Hot water - Apartment building
Heating	Solar air heater	Process - Crop drying
Heating	Solar air heater	Industrial - Transpired-plate

Figure B8. Templates Database

Project type	Type	Project location	Climate data location	Project name
Combined heating & power	Reciprocating engine	Canada	Ottawa Intl Airport	50 kW - Biogas
Combined heating & power	Reciprocating engine	Canada	Peterborough	65 kW - Biogas
Power	Photovoltaic	Canada	Toronto	80 kW
Power	Photovoltaic	Canada	Iqaluit Airport	3.2 kW - Isolated-grid
Power	Photovoltaic	Canada	Goose A	Industrial - 3.1 kW - Off-grd
Power	Photovoltaic	Canada	Muskoka Airport	Residential - 0.3 kW - Off-g
Power	Photovoltaic	Canada	Whitehorse Airport	Industrial - 0.2 kW - Off-grd
Power	Photovoltaic	Canada	Toronto Intl Airport	Water pumping - 0.05 kW -
Power	Photovoltaic	Syrian Arab Republic	Aleppo/Messelmieh	Community - 3.6 kW - Off-g
Power	Photovoltaic	Morocco	El Kelaâ Des Sraghna	Water pumping - 1.9 kW - C
Power	Photovoltaic	Argentina	Neuquen Airport	School - 0.4 kW - Off-grid
Power	Photovoltaic	Germany	Kassel	1,000 kW
Power	Photovoltaic	Canada	Kingston	Water pumping - 0.123 kW
Energy efficiency measures	Other - Agricultural	Canada	Mount Forest (MARS)	Lights - Fluorescent T8 - el

Figure B9. Case Studies Database

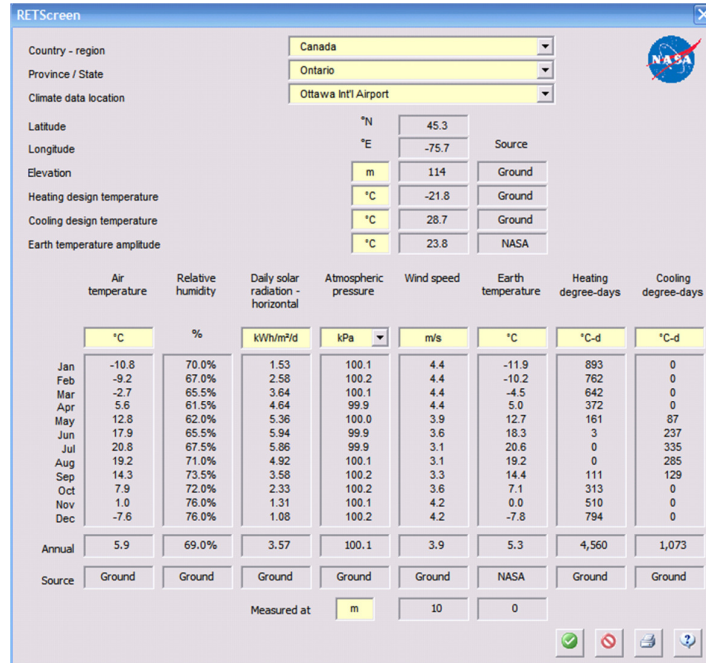

FigureB10. Select Climate Data Location Window

In analyzing projects, users perform a five-step-analysis procedure, some of which are optional to the users. The five steps are: energy model, cost analysis, greenhouse gas analysis, financial summary, and sensitivity & risk analysis.

There is no explicit storage analysis in RETScreen. As an example, the so-called Photovoltaic Project Analysis model will be presented in this review, having been selected mainly because of its closest relevance to electrical storage. There are three basic applications that can be evaluated with the PV model: on-grid applications⁸, off-grid applications⁹, and water pumping applications¹⁰. An off-grid application is taken as an example simply because it includes a battery.

1.2.1. Step 1 – Energy Model

The type of system used in the base case and the technology for the proposed case must be specified. RETScreen calculates the energy production and savings. Figure B11 shows the parameters that users need to specify for the base case in the Photovoltaic Project Analysis model.

⁸ On-grid applications cover both central-grid and isolated-grid systems

⁹ Off-grid applications include both stand-alone (PV-battery) systems and hybrid (PV-battery-genset) systems

¹⁰ Water pumping applications include PV-pump systems

Power project			
Base case power system			
Grid type	Off-grid		
Technology	Reciprocating engine		
Fuel type	Diesel (#2 oil) - L		
Fuel rate	\$/L	1.000	
Capacity	kW	1.50	
Heat rate	kJ/kWh	21,396	
Annual O&M cost	\$	0	
Electricity rate - base case	\$/kWh	0.558	
Total electricity cost	\$	4,200	
Load characteristics			
<input type="radio"/> Method 1 <input type="radio"/> Method 2			
Percent of month used			
Electricity - daily - DC	Unit	Base case	Proposed case
Electricity - daily - AC	kWh	20,640	20,640
Intermittent resource-load correlation	kWh	0.000	0.000
			Zero
Electricity - annual - DC	MWh	7.534	7.534
Electricity - annual - AC	MWh	0.000	0.000
Peak load - annual	kW		1.50
			Energy saved
			0%
			Incremental initial costs
			\$ -
			\$ -

Figure B11. Energy Model – Base Case

1.2.2. Step 2 – Cost Analysis

A user specifies the initial, annual, and periodic costs for the proposed case as well as credits for any base case costs that are avoided. As an example, Figure B12 shows the input of initial costs.

Initial costs (credits)	Unit	Quantity	Unit cost	Amount	Relative costs
Feasibility study					
Feasibility study	cost	1	\$ 2,470	\$ 2,470	
Sub-total:				\$ 2,470	4.5%
Development					
Development	cost	1	\$ 1,560	\$ 1,560	
Sub-total:				\$ 1,560	2.9%
Engineering					
Engineering	cost	1	\$ 6,065	\$ 6,065	
Sub-total:				\$ 6,065	11.2%
Power system					
Base load - Photovoltaic	kW	3.08	\$ 7,000	\$ 21,560	
Peak load - Reciprocating engine	kW	1.50		\$ -	
Road construction	km			\$ -	
Transmission line	km			\$ -	
Substation	project			\$ -	
Energy efficiency measures	project			\$ -	
Collector support structure	cost	1	\$ 4,102	\$ 4,102	
Installation	cost	1	\$ 6,160	\$ 6,160	
Sub-total:				\$ 31,882	58.7%
Balance of system & miscellaneous					
Spare parts	%			\$ -	
Transportation	project	1	\$ 5,000	\$ 5,000	
Training & commissioning	p-d			\$ -	
Electrical equipment	cost	1	\$ 4,774	\$ 4,774	
Contingencies	%	5.0%	\$ 51,751	\$ 2,588	
Interest during construction		6 month(s)	\$ 54,339	\$ -	
Sub-total:				\$ 12,362	22.7%
Total initial costs				\$ 54,339	100.0%

Figure B12. Cost Analysis – Initial Costs

1.2.3. Step 3 – Greenhouse Gas Analysis

This analysis step determines the annual reduction in the emission of greenhouse gases when comparing the proposed technology with the base case (see Figure B13).

Base case system GHG summary (Baseline)				
Fuel type	Fuel mix %	Fuel consumption	GHG emission factor	GHG emission
		MWh	tCO ₂ /MWh	tCO ₂
Diesel (#2 oil)	100.0%	45	0.252	11.3
Total	100.0%	45	0.252	11.3

Proposed case system GHG summary (Power project)				
Fuel type	Fuel mix %	Fuel consumption	GHG emission factor	GHG emission
		MWh	tCO ₂ /MWh	tCO ₂
Diesel (#2 oil)	86.3%	23	0.252	5.8
Solar	13.7%	4	0.000	0.0
Total	100.0%	27	0.217	5.8

GHG emission reduction summary					
	Base case GHG emission tCO ₂	Proposed case GHG emission tCO ₂	Gross annual GHG emission reduction tCO ₂	GHG credits transaction fee %	Net annual GHG emission reduction tCO ₂
Power project	11.3	5.8	5.5	0%	5.5
Net annual GHG emission reduction	5.5	tCO ₂	is equivalent to	1.1	Cars & light trucks not used

Figure B13. Greenhouse Gas Analysis

1.2.4. Step 4 – Financial Summary

In this step, users enter financial parameters, e.g., inflation rate, debt ratio, debt term, and taxes. Table B1 shows which technical and financial parameters RETScreen considers, and which financial indicators. Then, RETScreen calculates project costs and savings, and the viability of the project. The required parameters are shown in detail in the left column of Figure B14, while the right column of Figure 14 displays the financial summary. The viability of the project includes internal rate of return, paybacks, net present values, and savings (see Figure B15).

Table B1. Input parameters and output indicators

Technical and Financial Parameters (Input Parameters)	Financial Indicators (Output Indicators)
<ul style="list-style-type: none"> • Avoided cost of energy • Fuel cost – proposed case • Fuel cost – base case • Renewable energy (RE) delivered • Initial costs • Annual costs (Operating & Maintenance) • Debt ratio • Debt interest rate • Debt term • GHG emission reduction credit • Net GHG reduction – credit duration • RE production credit • Customer premium income – rebate • Electricity export rate 	<ul style="list-style-type: none"> • After-tax internal rate of return (IRR) and return on investment (ROI) • After-tax IRR – equity • After-tax IRR – assets • Year-to-positive cash flow (equity payback) • Net present values (NPV)

Financial parameters	Project costs and savings/income summary
General Fuel cost escalation rate % 5.0% Inflation rate % 2.5% Discount rate % 9.0% Project life yr 25	Initial costs Feasibility study 4.5% \$ 2,470 Development 2.9% \$ 1,560 Engineering 11.2% \$ 6,065 Power system 58.7% \$ 31,882
Finance Incentives and grants \$ Debt ratio % 60.0% Debt \$ 32,603 Equity \$ 21,735 Debt interest rate % 8.50% Debt term yr 10 Debt payments \$/yr 4,969	Balance of system & misc. 22.7% \$ 12,362 Total initial costs 100.0% \$ 54,339
Income tax analysis Effective income tax rate % 42.6% Loss carryforward? <input checked="" type="checkbox"/> Flow-through Depreciation method Declining balance Half-year rule - year 1 yes/no No Depreciation tax basis % 85.0% Depreciation rate % 30.0% Tax holiday available? yes/no No	Annual costs and debt payments O&M \$ -27,742 Fuel cost - proposed case \$ 2,158 Debt payments - 10 yrs \$ 4,969 Total annual costs \$ -20,615
Annual income Electricity export income	Periodic costs (credits) Annual savings and income Fuel cost - base case \$ 4,200 Total annual savings and income \$ 4,200

Figure B14. Financial Analysis – Financial Parameters and Summary

Financial viability		
Pre-tax IRR - equity	%	121.0%
Pre-tax IRR - assets	%	50.4%
After-tax IRR - equity	%	102.5%
After-tax IRR - assets	%	31.8%
Simple payback	yr	1.8
Equity payback	yr	0.9
Net Present Value (NPV)	\$	185,958
Annual life cycle savings	\$/yr	18,932
Benefit-Cost (B-C) ratio		9.56
Debt service coverage		6.15
GHG reduction cost	\$/CO2	(3,453)

Figure B15. Financial Analysis – Financial Viability

1.2.5. Step 5 – Sensitivity & Risk Analysis

Users can determine how uncertainty in the estimates of various key parameters affects the financial viability of the project. This analysis is partitioned into two portions: sensitivity and risk.

1.2.6. Sensitivity Analysis

This portion shows the effect of varying a pair of input parameters on the financial indicators (See Figure B16). For example, users can perform sensitivity analysis on net present values, while the pair of debt interest rate and base-case fuel cost is varying.

Sensitivity analysis						
Perform analysis on		Net Present Value (NPV)				
Sensitivity range		5%				
Threshold		\$				
		Debt interest rate				%
Fuel cost - base case		8.08%	8.29%	8.50%	8.71%	8.93%
\$		-5%	-3%	0%	3%	5%
3,990	-5%	184,358	184,198	184,036	183,874	183,711
4,095	-3%	185,319	185,158	184,997	184,835	184,672
4,200	0%	186,280	186,119	185,958	185,796	185,633
4,305	3%	187,240	187,080	186,919	186,756	186,594
4,410	5%	188,201	188,041	187,879	187,717	187,554
		Debt term				yr
Debt interest rate		10	10	10	10	11
%		-5%	-3%	0%	3%	5%
8.08%	-5%	187,109	187,707	186,280	186,865	187,420
8.29%	-3%	186,963	187,563	186,119	186,706	187,263
8.50%	0%	186,817	187,418	185,958	186,546	187,105
8.71%	3%	186,670	187,272	185,796	186,386	186,946
8.93%	5%	186,522	187,125	185,633	186,224	186,786
		Initial costs				\$
Fuel cost - proposed case		51,622	52,980	54,339	55,697	57,055
\$		-5%	-3%	0%	3%	5%
2,050	-5%	188,438	187,691	186,945	186,199	185,453
2,104	-3%	187,944	187,198	186,452	185,705	184,959
2,158	0%	187,450	186,704	185,958	185,212	184,466
2,212	3%	186,956	186,210	185,464	184,718	183,972
2,266	5%	186,463	185,717	184,970	184,224	183,478

Figure B16. Sensitivity Analysis

1.2.7. Risk Analysis

RETScreen uses Monte Carlo simulation for its risk analysis. By providing a range of values, users can investigate the effect of changes of several pre-selected technical and financial parameters on key financial indicators. Figure B17 shows the median and confidence interval of results.

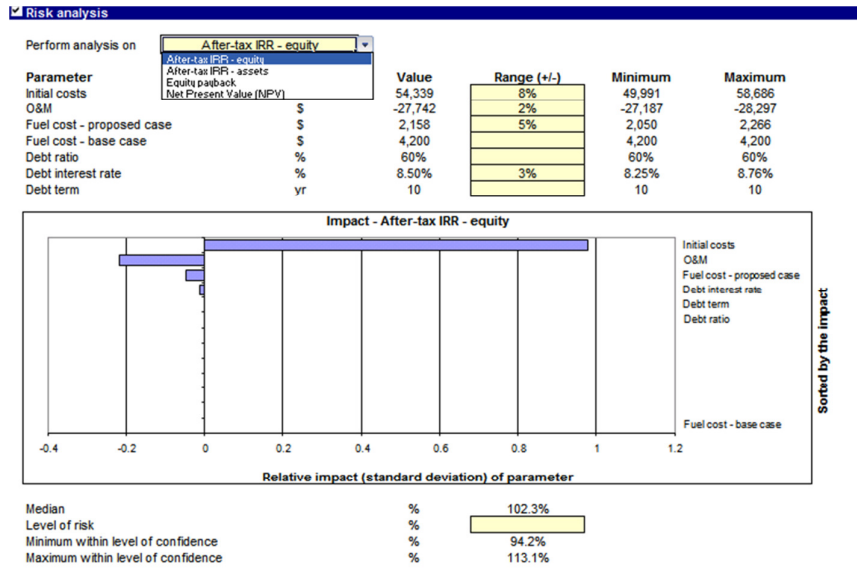

Figure B17. Median & Confidence Intervals

1.3. CogenPro

CogenPro is a web-based Java-applet Combined Heat and Power (CHP) simulation and selection software. The software poses a series of questions, with some guideline answers, to determine what system is of interest to users. Based on the answers, CogenPro generates a different sequence of questions to find a match with users' systems.

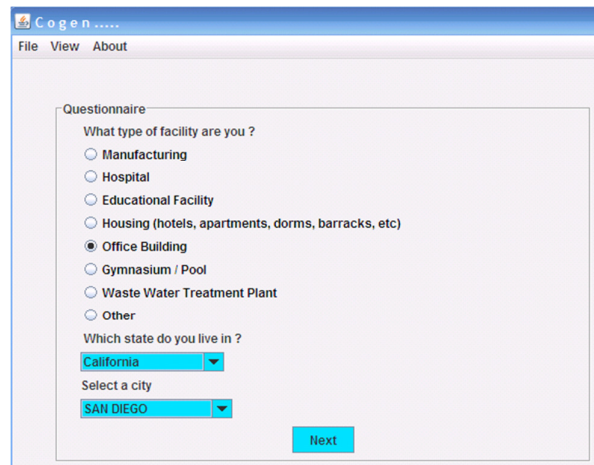

Figure B18. The First Question

An example of a series of questions and answers is as follows:

- What type of facility are you? *Office Building*
- What kind of cogeneration system would you like to install? *Fuel Cell*
- How many would you like to install? *Best system picked by computer*
- What will the waste heat off the cogeneration system be used for? *Producing hot water*

- What will the waste heat off the cogeneration system be used for? *Heating hot water*

Once the software figures out what the system is like, it will ask for parameters of the system. For example, users need to enter the temperature of hot water required and how much is needed. Information about estimated demands and expenses is also required. Ultimately, CogenPro calculates a summary of energy production, savings, and emissions, which users can view with different preferences (see Figure B19).



Figure B19. Summary Page of CogenPro

2.0 Summary of Public Access Screening Tools

Based on this brief survey, HOMER is probably the only public-access program that has any storage optimization capability. HOMER provides a model to minimize the NPV of energy costs by choosing technologies and scheduling their operations. Using a schematic diagram screen, the tool makes it easy for users to construct an analysis of their systems. Although the tool applies a detailed representation of battery characteristics, its optimizing algorithm does not effectively take into account tariffs when charging battery bank, which critically determines scheduling.

RETScreen is a decision support tool that evaluates the energy production and savings, costs, emission reductions, financial viability, and risk for various types of renewable-energy technologies. The software also provides sample energy projects and climate databases. RETScreen is primarily aimed to reduce the cost of pre-feasibility studies and analyze technical and financial viability. Given this focus, none of the RETScreen models considers the optimal scheduling of storage technologies.

While both HOMER and RETScreen are standalone programs, the web-based Java-applet simulation, CogenPro, does not require users to download the tool. By posing a series of questions, it provides a summary of energy production, savings, and emissions to users. Nonetheless, CogenPro does not provide any analysis of operations of storage technologies.

Since both RETScreen and CogenPro do not address the issue of optimally scheduling the operation of storage technologies, only the performance of HOMER and DER-CAM can be

directly compared. Under a complex tariff¹¹ scenario, the same power system was simulated in both DER-CAM and HOMER and results compared.

2.1.1. Comparison Study of HOMER and DER-CAM

Firstly, a grid-connected power system is constructed in DER-CAM. The system has a primary load¹², batteries, and a DC-AC converter. The same power system is then constructed in HOMER, as depicted in Figure B20.

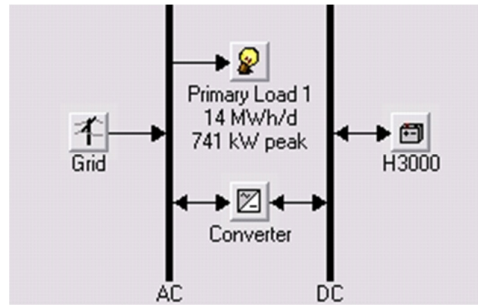

Figure B20. Test System

The properties of each component are configured to be the same, except for the battery. There are some inconsistencies between DER-CAM and HOMER in how a battery is represented. HOMER's battery representation takes into account a much richer set of physical properties: nominal voltage, capacity curve, lifetime curve, minimum state of charge, and round-trip efficiency. On the other hand, DER-CAM captures only the basic properties of batteries. For this analysis, HOMER's battery representation is simplified to achieve a similar battery specification. HOMER does not use a stochastic approach to determine the optimal battery-charging strategy. Users choose between two simple charging strategies: load-following and cycle-charging. Under the load-following strategy, a generator produces only sufficient power to supply the load. Only renewable power sources charge the battery, generators do not. Under the cycle-charging strategy, an operating generator runs at its maximum rated capacity and charges the battery bank with any excess energy. In other words, whenever the generators operate and produce more power than required to serve the load, the surplus electricity charges the battery bank.

Clearly, HOMER's charging strategies do NOT capture the effects of complex tariffs which is a serious limitation. This consequence can be seen in the operating cost results in Figure B21. By exploiting complex tariffs, DER-CAM can optimally schedule the charge/discharge of battery. The annual operating costs obtained from DER-CAM optimal system is only \$587,063 versus \$648,382 from HOMER, i.e. comparing the operating costs DER-CAM yields about 9% lower costs.

¹¹ Tariff data are from Pacific Gas and Electric Company (PG&E).

¹² The data for primary load is based on a nursing home in Oakland.

H3000	Conv. (kW)	Grid (kW)	Initial Capital	Operating Cost (\$/yr)	Total NPC	COE (\$/kWh)	Ren. Frac.	Batt. Lf. (yr)
1	1	20000	\$ 0	648,382	\$ 7,436,889	0.129	0.00	
2	1	20000	\$ 280	648,361	\$ 7,436,926	0.129	0.00	5.0

Figure B21. HOMER Results

This example demonstrates that DER-CAM's optimization finds lower cost solutions. Further, the simple search algorithm of HOMER would become increasingly time-consuming for complex problems. In other words, DER-CAM both directly finds optimal solutions and is less vulnerable to the curse of dimensionality. Nonetheless, the battery representation of HOMER is more sophisticated than currently available in DER-CAM, and this limitation must be addressed.

3.0 Initial Commercial-Industrial Sites

It has taken a great deal of effort to establish default load shapes for the SVOW project. Ultimately, 20 test sites were derived such that: they are large energy users; they are drawn from various industry sectors; they are located in different climate zones; and they experience varied tariffs. In this way, our initial test website can potentially draw interest from a variety of users. The 20 sites selected are from the following industries: construction, packaging, mining, oil, software, gases, materials, bottling, winemaking, and cement.

Table B2 shows more information about the sites. All selected sites have maximum demands larger than 1 MW. Due to seasonality, some of the sites may have higher maximum demand but lower average demand. For example, the winery has a higher maximum demand for electricity than packaging; however, the winery consumes less electricity on average. With different characteristics of operations of each industry, load shapes for each industry can be different. Their load duration curves are shown in Figure B22 to illustrate the relationship between load requirements and capacity utilization. The software site has a high load factor with a flatter curve compared to a steep curve with lower load factor for construction. This implies that software has a less volatile demand for electricity than construction. In any case, after some difficulty we now have an excellent data in house and ready for use in the development of the SVOW algorithms.

Table B2. Site Information

Industry	Rate	Load Factor	Max Demand (kW)	Avg Demand (kW)	Climate Zone
Construction	E20T	0.1938	1794	348	S
Packaging	E20T	0.6715	12069	8105	S
Mining	E20T	0.5408	12717	6877	X
Oil	SE20P	0.6134	3550	2178	X
Winery	E20T	0.3108	14413	4480	R
Software	E20P	0.6678	4935	3295	X
Gases	E20T	0.1938	19968	15734	S

Materials	E20T	0.1261	12180	1536	T
Bottling	E20T	0.5313	2735	1453	T
Cement	E20T	0.4343	11345	4927	R

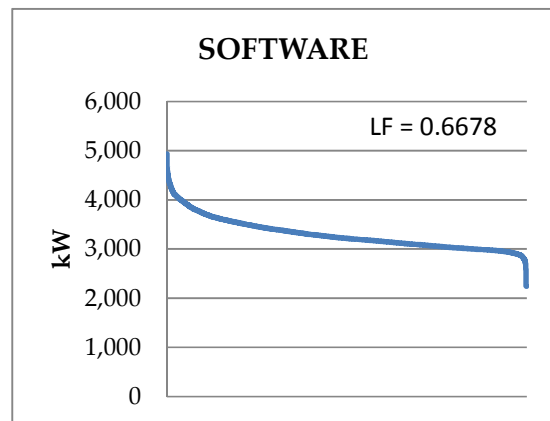
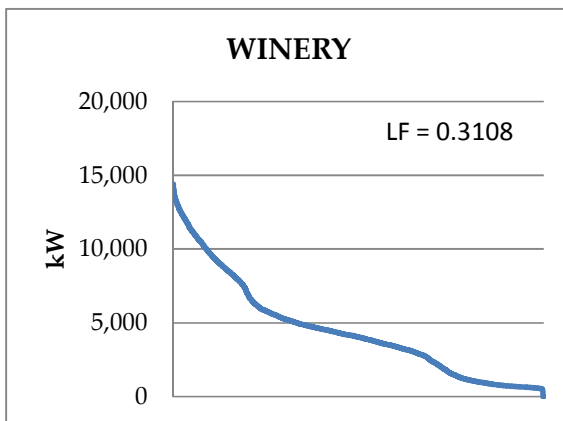
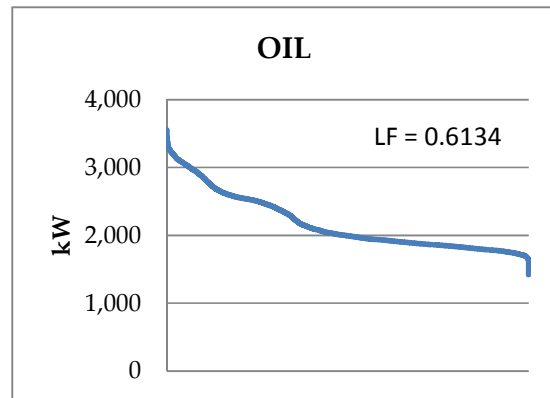
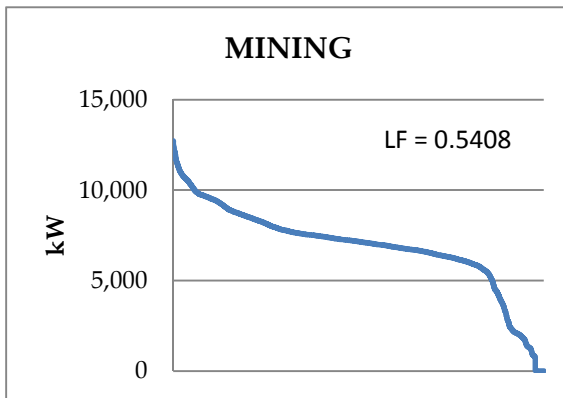
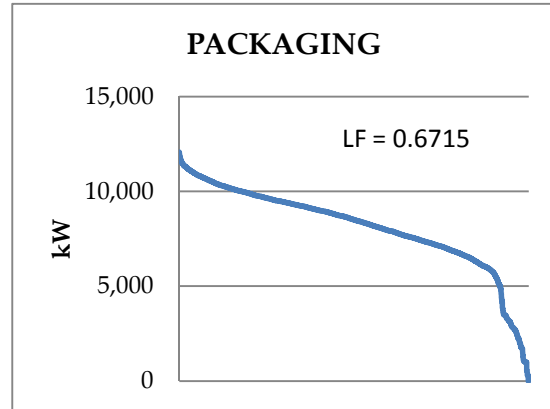
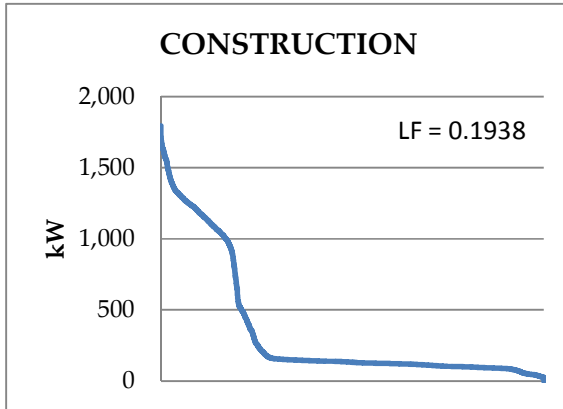

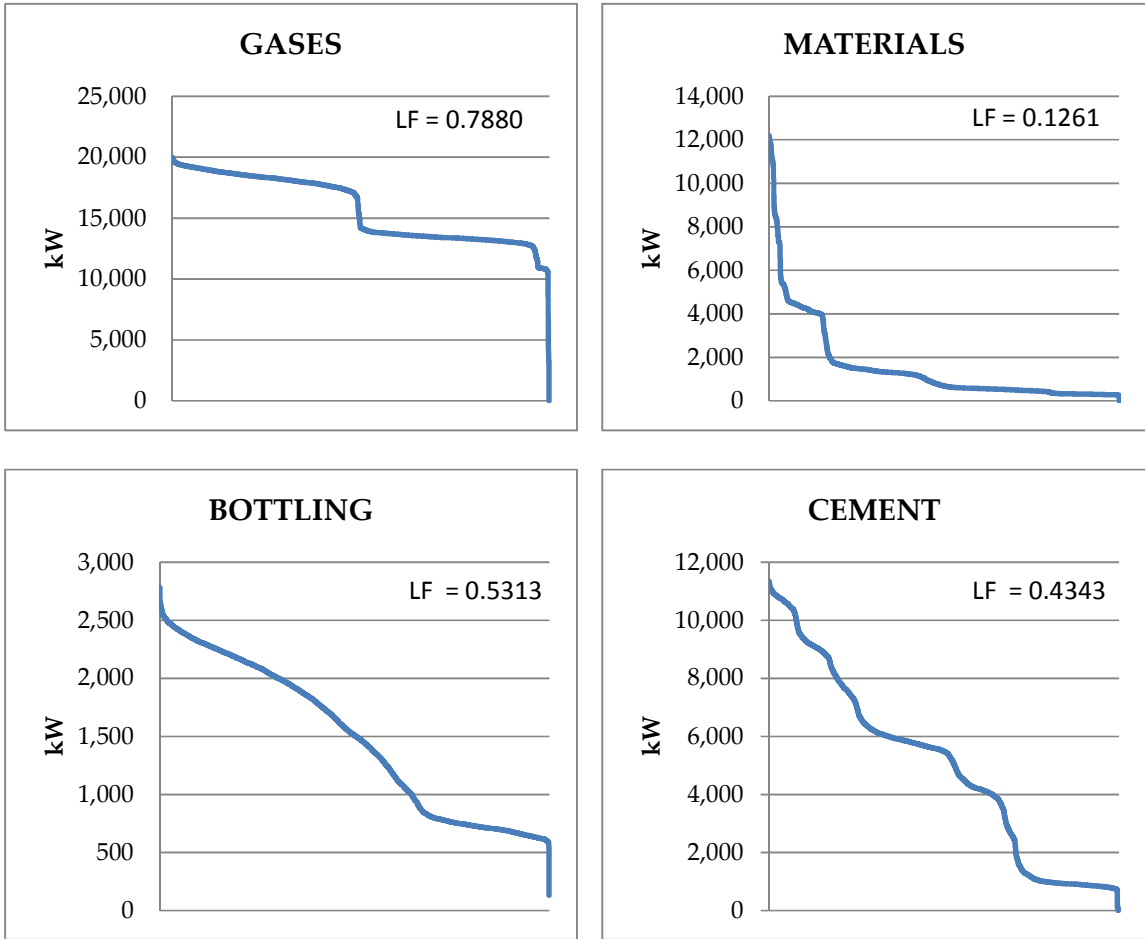

Figure B22. Load Duration Curves

4.0 Web Page Approach and Mock-Up

Berkeley Lab has prepared a structure and mock-up for the proposed web site.

4.1. Structure

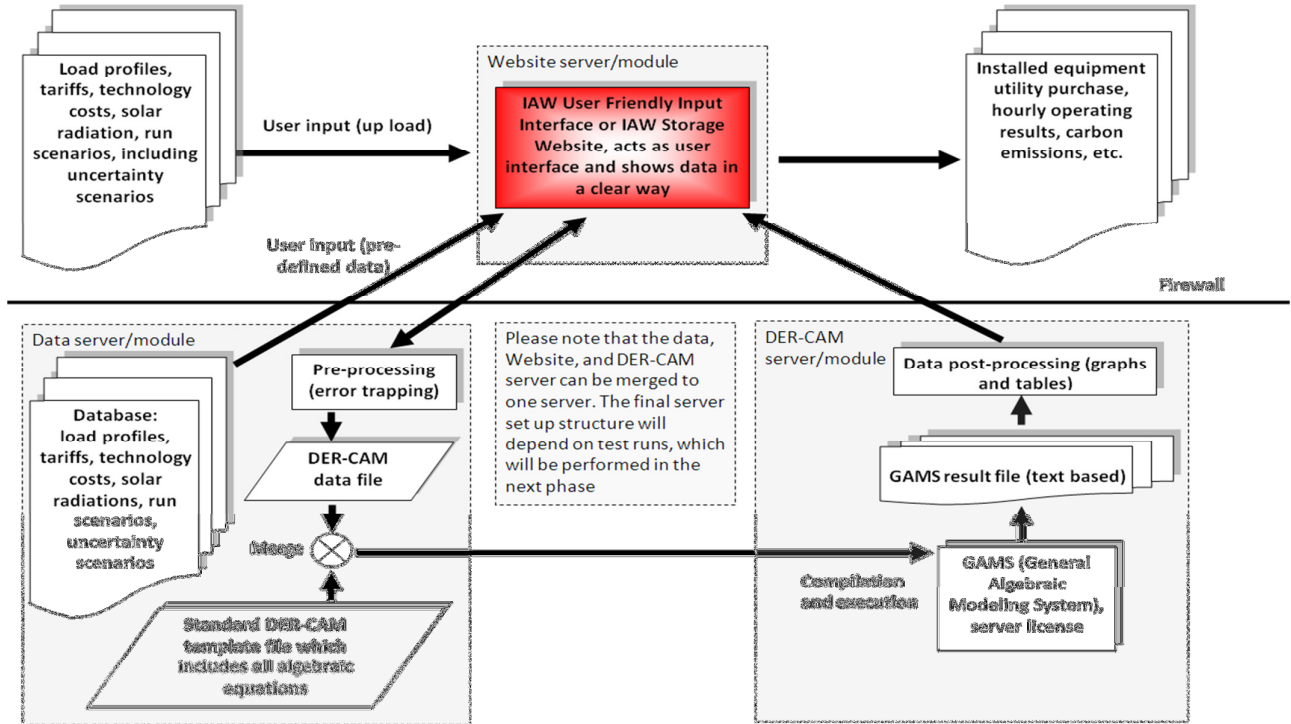

Figure B23. Proposed Structure for Web Site Hosting

Figure B23 shows the proposed structure for hosting the SVOW. The intention is to establish an open access server running a version of DER-CAM that can receive requests from the web page itself for optimization jobs. The attraction of this approach is that it strikes a compromise between the desire to have a full optimization that takes maximum advantage of the highly developed capabilities of DER-CAM and the licensing complications of code written in the proprietary GAMS® language and using a commercial solver. Licensing is available that permits open access execution that enables provision of an open access server. As shown in the figure, the structure has 3 modules. The first is the *Website Module* that users actually access, receiving input data and returning error messages and results to users. The second is the *Data Module*, where the necessary background information needed to execute optimizations is stored. This data has two parts. The first is the default data necessary to supplement the user provided inputs. This data set includes default load profiles, tariffs, technology costs, etc., and uncertainty bounds on key inputs for uncertainty analysis of outcomes. The second part of the background data is the GAMS code necessary to build a DER-CAM run. A DER-CAM run consists of a package of instructions and the necessary data to execute them. The Data Module will prepare this package and dispatch it the third *DER-CAM Module*. GAMS automatically compiles and executes the package and returns the results to the Website Module which presents to the user in a comprehensible format.

These modules will initially reside together on one dedicated server. The longer run goal will be separate the Data and DER-CAM Modules on an isolated server that would be constructed to provide a bullet-proof host.

4.2. Screen Mock-Ups

The SVOW website mockup can be found at http://der.lbl.gov/new_site/SVOW/, and a screen shots of it appears as Figures B24 – B26.

It can also be accessed by going to “Current Projects” at http://der.lbl.gov/new_site/.

The site leads users through the 5 steps necessary to execute an optimization. Graphics show the user the assumptions that are entering the simulation. The website navigation is meant to be self-explanatory, with the user going through five steps (marked by red dotted circle in Figure B24) to characterize the building(s) and then clicking on the *run optimization* button (circled in blue) to see the results. In step 1, the user selects a load profile from the pull-down menu. There are currently only two load profiles possible in the mockup: a winery and a cement plant. Once a load profile is selected, a corresponding load duration curve thumbnail will appear below it. The user can click on the thumbnail to bring up a detailed window with more information for the selected load shape, see Figure B25. The user then proceeds to step 2, selecting a tariff. Similar to step 1, after a tariff is selected, the corresponding graphic below updates and more detail on the chosen tariff can be brought up when the user clicks on the thumbnail. Similarly, the user steps through the selection of technology costs, solar radiation, and scenario choice.

When the user executes the optimization by clicking the button on the left, in the blue circle, a result window as shown in Figure B26 appears.

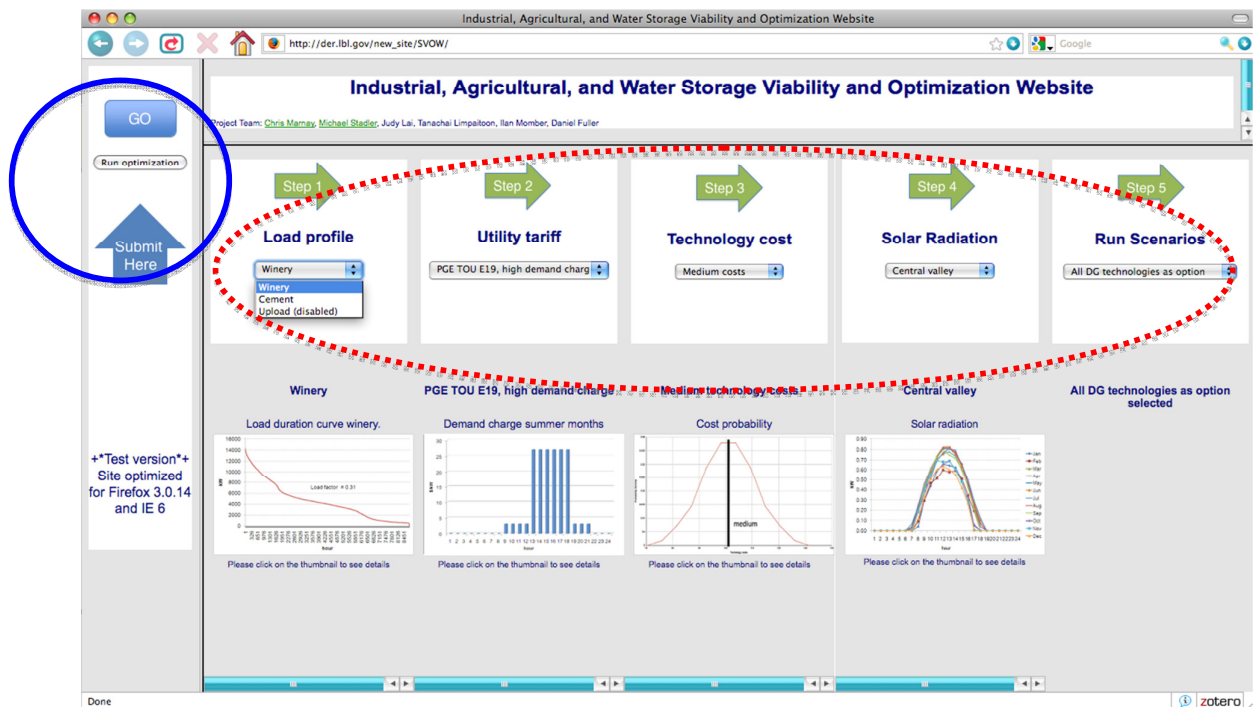

Figure B24. Web Site Home Screen

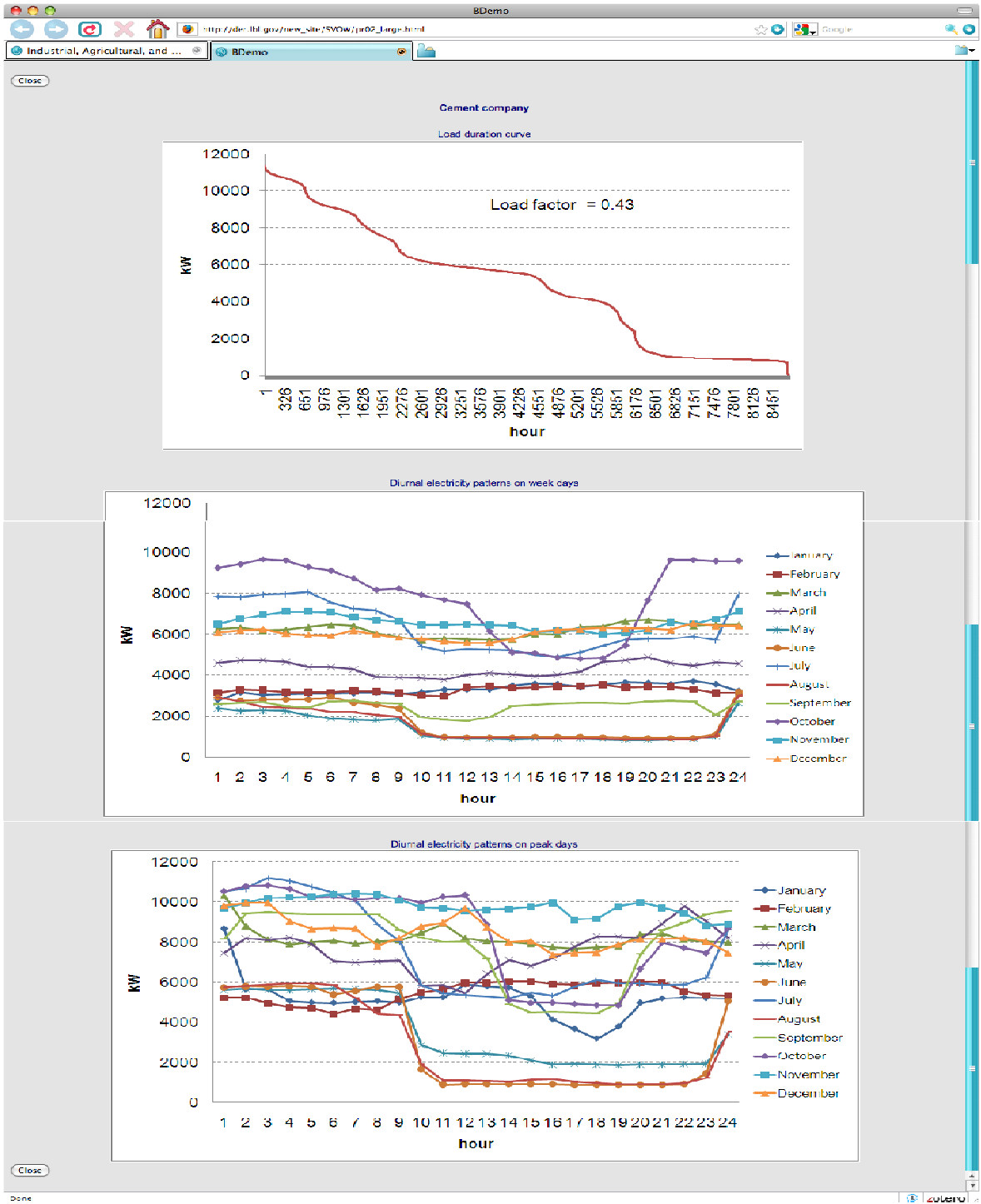

Figure B25. Input Detail Screen

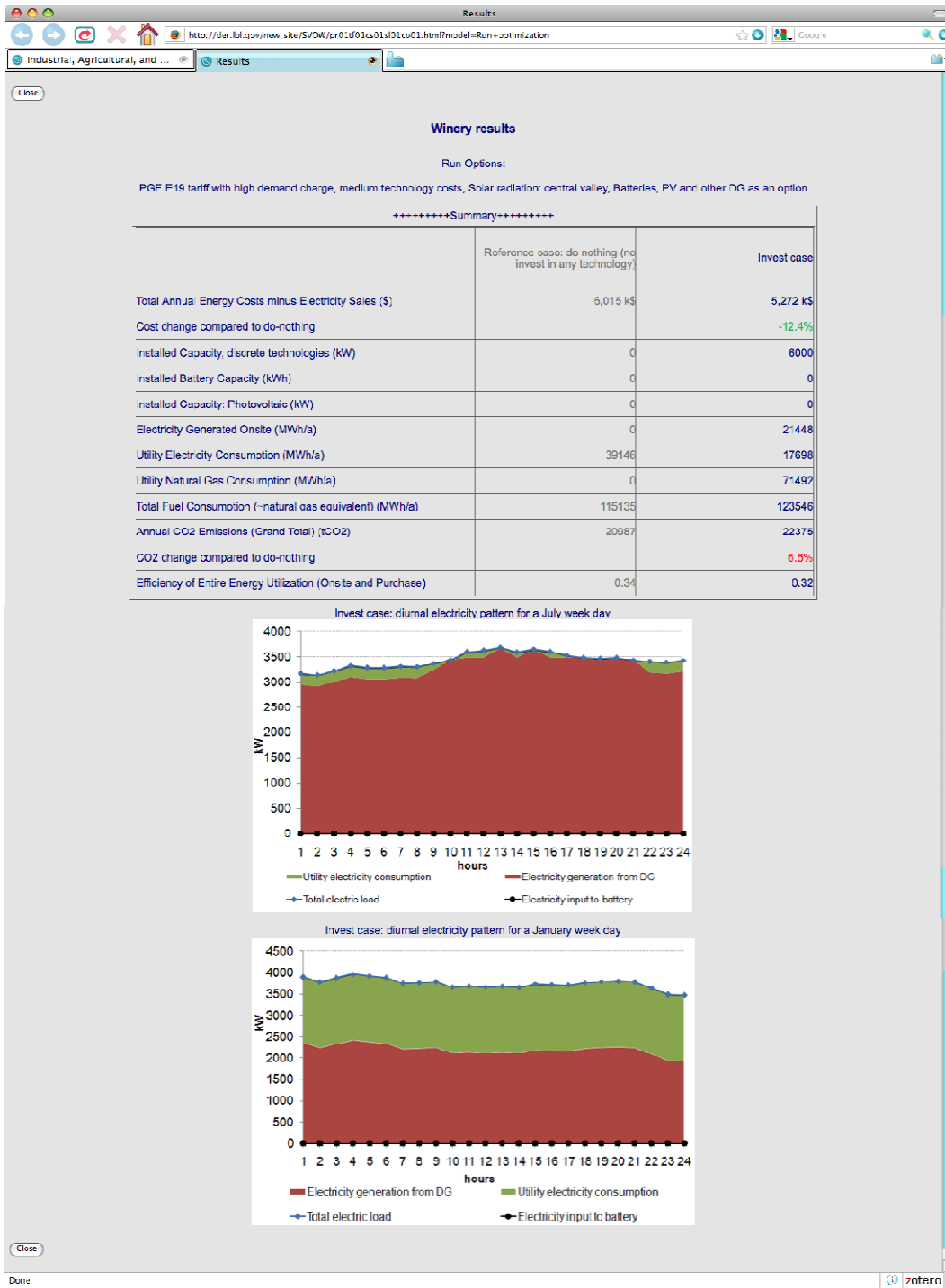

Figure B26. Result Screen

Bibliography

Lambert, T., Gilman, P., & Lilienthal, P. (2006). Micropower System Modeling with HOMER. In F. A. Ferret, & M. G. Simoes, *Integration of Alternative Sources of Energy* (pp. 379-418). John Wiley & Sons, Inc.

RETScreen International. (2005). *Clean Energy Project Analysis*. Natural Resources Canada.

San Diego State University's Industrial Assessment Center. (n.d.). Retrieved October 30, 2009, from CogenPro: <http://www-rohan.sdsu.edu/~eadc/cogenH.html>

http://der.lbl.gov/new_site/SVOW/

Storage Viability and Optimization Website Interim Report II

Storage Viability and Optimization Website

Chris Marnay, Michael Stadler, Afzal Siddiqui, Judy Lai, Jessica Chang, and Trucy Phan

15 March 2010

1.0 Overview of Analysis and Implementation Approach

This memo serves as the second deliverable on the Storage Viability and Optimization Website (SVOW) project. The purpose is to briefly describe the chosen approach to implementing the analytic tool developed in the last phase together with available data to provide the SVOW. The approach adopted is similar in structure to initial thinking, but quite different in implementation. The central change in implementation is that rather than relying on user interface via an HTML web page, the user will have direct access to run simulations on the server using the RemoteApp capability of recent Windows server operating systems. This approach overcomes some of the security and programming problems that a html approach would entail, but it will require an unlimited user license for GAMS and CPLEX, which constitute the platform on which the analysis engine runs. Efforts to reprogram funds for this purpose are already under way. The approach will also require somewhat more rigorous testing than a simple web site, particularly to overcome, or at least anticipate, firewall problems that some users will experience. Security of the SVOW server itself does not appear to be a problem.

The schematic below, which was presented to CEC staff earlier, shows the basic structure of the SVOW. The user can input full data describing hir operations, or just basic parameters that the analysis engine will couple to generic data to provide an approximate initial result. The most likely scenario is that the user will input a few basic characteristics and run a simulation or two, but only follow-up with detailed data if initial results are promising. Whatever data the user provides is merged with default data and an input file to GAMS is constructed. GAMS requires an input package consisting of the job commands and input data consolidated in a simple script file. The job is executed and results returned to the user. As shown in the diagram, this procedure involves 3 modules that could reside on one or multiple machines. Security and reliability suggest multiple machines, but cost may preclude such an approach.

Unfortunately, the key input, the interval site load data represents a major data input, typically 8760 hourly values or 8760×4 15-min values. A key programming task for the next phase is to develop an approach for receiving these data sets in a simple automated manner. This will likely be accomplished by allowing the interested users to become power users by signing up and getting a login to a controlled part of the server. The power users can then upload their own data and run more complex cases.

2.0 Summary of Public Access Screening Tools

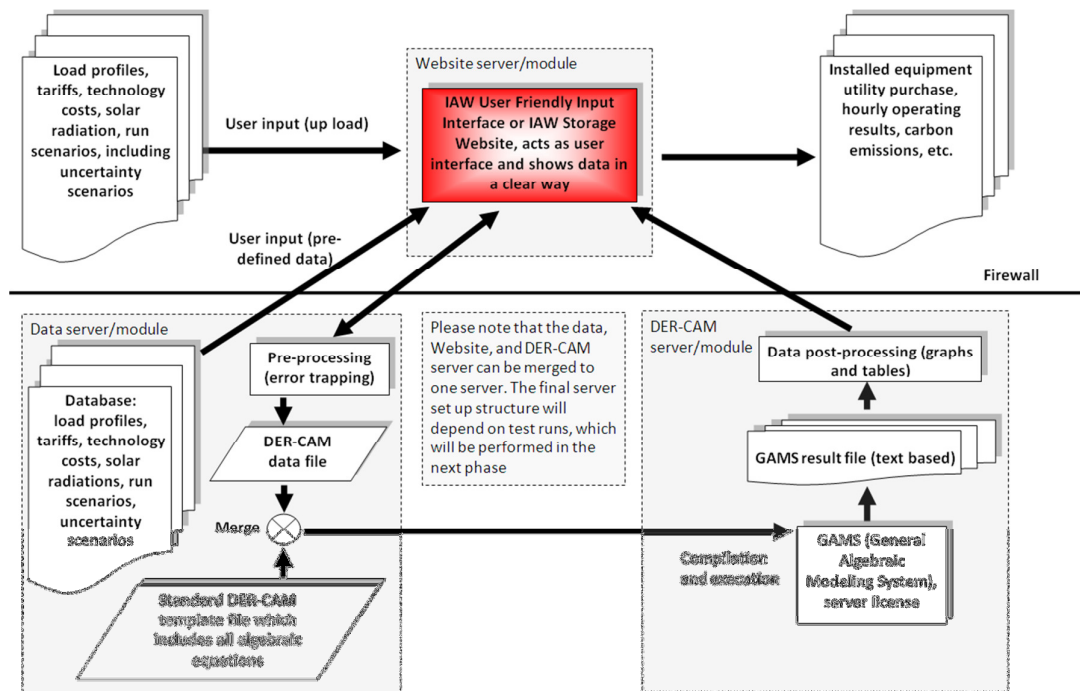

Schematic of the SVOW Structure

3.0 Initial Commercial-Industrial Sites

As reported earlier, we are committed to providing at least 10 loadshapes initially. From the data previously collected, we have selected ≈ 14 sites' 2009 loads to provide initially. We will adopt 2009 as our standard calendar. Three are manufacturing sites, and the remainder are a variety of large customers including entertainment, mining, warehousing, wholesale, and retail. The sites were chosen the basis of the most complete data, particularly clear evidence of the North American Industry Classification System (NAICS) code of the site. This will be a big help to users trying to identify which default best matches their own businesses. The most detailed that a category can be identified as is 6 digits, the least detailed is by 2, and all steps between are defined. The actual codes get very complicated, as the following example for code 21 shows:

- 21 = Mining, Quarrying, and Oil and Gas Extraction
- 212 = Mining (except Oil and Gas)
- 2123 = Nonmetallic Mineral Mining and Quarrying
- 21231 = Stone Mining and Quarrying
- 212312 = Crushed and Broken Limestone Mining and Quarrying

Note that not every number is used, and modifications every 5-10 years. It clearly will not be possible to precisely maintain accurate NAICS numbering of our default loadshapes, but we hope to provide at least rough numbering.

4.0 Conclusion

The major analytic work for the project is now complete. The implementation approach has been selected, the load data collected and archived, and the analysis engine built. The user interface is implemented using the RemoteApp capability of the Windows Server. This provides the user's desktop with a window in which s/he can run the analysis directly. This approach simplifies programming and provides a simple path to allowing visitors to the site to become power users with greater privileges to upload data and refine optimizations. It will require an unlimited user license and will likely create some firewall problems, but the approach will be simpler, more robust, and more powerful.