

UC Berkeley

Research Reports

Title

Early Opportunities to Apply Automation in California Managed Lanes

Permalink

<https://escholarship.org/uc/item/9qh3w4hx>

Authors

Liu, Hao

McKeever, Benjamin

Lu, Xiao-Yun

et al.

Publication Date

2019-08-31

CALIFORNIA PATH PROGRAM
INSTITUTE OF TRANSPORTATION STUDIES
UNIVERSITY OF CALIFORNIA, BERKELEY

Early Opportunities to Apply Automation in California Managed Lanes

Hao Liu, UC Berkeley PATH Program
Benjamin McKeever, UC Berkeley PATH Program
Xiao-Yun Lu, UC Berkeley PATH Program
Steven Shladover, UC Berkeley PATH Program

California PATH Research Report
UCB-ITS-PRR-2018-02

Final Report for Agreement 65A0595

August 2018

DISCLAIMER STATEMENT

This document is disseminated in the interest of information exchange. The contents of this report reflect the views of the authors who are responsible for the facts and accuracy of the data presented herein. The contents do not necessarily reflect the official views or policies of the State of California or the Federal Highway Administration. This publication does not constitute a standard, specification or regulation. This report does not constitute an endorsement by the Department of Transportation of any product described herein.

ABSTRACT

Connected and automated vehicles hold the potential for substantial improvements to traffic safety, travel time reliability, roadway capacity, and environmental impacts and managed lanes have the potential to be ideal testbeds for CAV technologies. The purpose of this report is to identify specific opportunities to leverage California's managed lane network as early experimental and pilot deployment sites for CAVs. To this end, we have conducted a detailed inventory of the managed lane facilities in California and applied evaluation criteria to identify two promising sites for future CAV tests and initial deployments. Our study recommends the I-15 Express Lanes in San Diego and the I-10 Express Lanes in Los Angeles for future CAV tests.

In this report, we have also documented the major CAV applications that are being considered by USDOT for near-term deployment. After assessing which of the CAV applications are best suited for deployment in managed lanes, we selected the following five applications to be considered for testing in the two California sites: highway CACC, V2I speed harmonization, freeway merge coordination, automated bus rapid transit, and automated barrier mover vehicle.

Next, we presented conceptual test and deployment plans for those five CAV applications along with various testing scenarios. We then presented an analysis of the likely timeline for testing and pilot deployment and related vehicle and infrastructure requirements of those applications. For most of the applications, there will be at least two years of preparation required before testing or initial deployment can occur. Finally, our report describes the expected benefits of deploying the selected CAV applications at the proposed sites including increased capacity, reduced congestion and smoother traffic flow in managed lanes and some related improvements to safety.

Table of Contents

1. Introduction.....	1
2. Assessment of California Managed Lane Facilities.....	2
2.1 I-80 HOV Lanes between Bay Bridge and Carquinez Bridge.....	2
2.2 I-680 Express Lanes between SR-24 and I-580.....	4
2.3 I-580 Express Lanes between I-680 and Greenville.....	6
2.4 I-210 HOV Lanes from SR-134 to I-605.....	8
2.5 I-10 Express Lanes from US-101 to SR-605.....	9
2.6 I-110 Express Lanes from I-10 to I-105.....	11
2.7 SR-91 Express Lanes from SR-55 to I-15.....	12
2.8 I-15 Express Lanes from SR-163 to SR-78.....	14
2.9 SR-125 (Southbound Expressway) from SR-52 to SR-78.....	18
2.10 Recommended Sites for CAV Testing and Early Deployment.....	19
3. Assessment of CAV Applications for Managed Lanes.....	21
3.1 Highway Cooperative Adaptive Cruise Control (CACC) for light-duty vehicles.....	21
3.2 Freeway speed harmonization/variable speed limits utilizing V2I communications.....	22
3.3 Eco-traffic signal control using V2I communications.....	22
3.4 Eco-cooperative ACC adjusting arterial speed profiles based on SPaT data.....	23
3.5 Heavy truck CACC/platooning for highway driving.....	23
3.6 Highway merge coordination (V2V and V2I).....	24
3.7 Low-speed “driverless” urban shuttle vehicles for first-mile/ last-mile access to line-haul transit.....	24
3.8 Automated bus rapid transit on busways.....	25
3.9 Low-speed urban TNC services (Uber/Lyft) using highly automated vehicles.....	25
3.10 Automated small package delivery.....	26
3.11 Automated barrier mover vehicle.....	26
3.12 Recommended CAV Applications.....	27
4. Testing and Deployment Concepts for California Managed Lanes.....	28
4.1 Overview of the Testing and Deployment Concepts.....	28
4.2 Detailed Descriptions of Testing and Deployment Concepts.....	30

4.2.1 Highway CACC Application	30
4.2.2 V2I Speed Harmonization.....	32
4.2.3 Highway Merge Coordination	34
4.2.4 Automated Bus Rapid Transit.....	36
4.2.5 Automated Barrier Mover Vehicle	37
4.3 Deployment Readiness Assessment.....	37
4.3.1 Time Needed for Development, Testing and Initial Deployment.....	37
4.3.2 Test Vehicles, Fleets and Drivers	39
4.3.3 Infrastructure Requirements.....	40
4.3.4 Expected Benefits	41
5. Conclusion	43
5.1 Summary	43
5.2 Next Steps	43

1. Introduction

In recent years the automotive industry has been making significant progress in developing the technologies for automating portions of the dynamic driving task, and a wide range of products have been introduced to provide “Level 1” automation (adaptive cruise control or lane keeping assistance). A few manufacturers have introduced “Level 2” automation providing simultaneous adaptive cruise control and lane keeping, and most other manufacturers will be introducing similar products on their top-of-the-line vehicles within the next year or two. Although these systems provide improvements in driving comfort and convenience, they are not likely to have appreciable impacts on system-level measures of transportation system performance (safety, efficiency, sustainability). Achieving those more significant benefits is going to require combinations of the in-vehicle technologies with infrastructure support and connected vehicle capabilities including both vehicle-to-vehicle (V2V) and vehicle-to-infrastructure (V2I) communications.

The opportunities for transportation system improvements will become more significant as higher levels of automation and connectivity are developed in the coming years. Several other states have already seen this as an opportunity to encourage local industrial development while enhancing their transportation systems and have invested in the development of testbed facilities and early deployment incentives for automated systems. California has an opportunity to play a stronger role in this domain because of a unique combination of attributes. First, one of the largest network of managed lanes in the country, which has advantages when testing new connected automated vehicle (CAV) concepts. Second, it has one of the largest concentrations of automotive Research & Development facilities in the country, between its academic research institutions and Silicon Valley industrial labs.

This project is being conducted by California Partners for Advanced Transportation Technology (PATH) under the direction of Caltrans. The primary goal of the project is to identify specific opportunities to capitalize on the state’s managed lane network as early experimental and deployment sites for CAVs. The managed lanes are important in this context because they provide a means of concentrating equipped vehicles near each other, with some degree of separation from other traffic, so that they can interact with each other as if they represented a larger fraction of the vehicle population than they really do. Examples of managed lanes include high occupancy vehicle (HOV) lanes, high occupancy toll (HOT) lanes and Express Lanes, which typically require a toll payment or HOV status to use the lane.

The remainder of this report is organized as follows. Chapter 2 describes the candidate managed lane facilities in California that could be used for CAV tests and early deployment. The most promising sites are recommended in the end of this chapter. Chapter 3 assesses the state of the art CAV applications that may be deployed in managed lane facilities. In Chapter 4, we define the CAV deployment concepts that are feasible to test and deploy in the recommended managed lane sites. Detailed descriptions of the applications, test and deployment concepts, and expected benefits are provided in this chapter. The concluding remarks are provided in Chapter 5.

2. Assessment of California Managed Lane Facilities

The first step of this project was to identify the facilities that would provide the best opportunity to capitalize on California's managed lane network as early experimental and deployment sites for CAV. The sites considered were in the San Francisco Bay Area, greater Los Angeles Area, and San Diego since those regions are home to all the managed lanes in California. The following criteria were used to identify which facilities should be considered as the most promising for CAV deployment:

- (1) Should be at least 10 miles of continuous lane to represent a critical mass and provide opportunities for sustained driving using CAV technology to identify a measurable level of benefits.
- (2) Should be in heavily traveled locations, with heavy enough congestion in the general-purpose lanes to provide incentives for users to switch.
- (3) Should at least be active during both morning and evening peak hours in both directions.
- (4) Should be in existence already, under construction, or expected to be available for public use no later than 2020. Facilities that will come online later than that are probably not going to be useful for relatively near-term field operational tests.
- (5) The collection of such facilities should include some diversity of physical configurations, at least including physically segregated lanes, lanes with discrete access points and lanes with continuous access.

After applying these criteria, the PATH team selected nine sites for further consideration and site visits. The sites included:

1. I-80 HOV lanes near San Francisco
2. I-680 Express lanes near San Francisco
3. I-580 Express lanes near San Francisco
4. I-210 HOV lanes near Los Angeles
5. I-10 Express Lanes near Los Angeles
6. I-110 Express Lanes near Los Angeles
7. SR-91 Express Lanes near Los Angeles
8. I-15 Express Lanes near San Diego
9. SR-125 (Southbound) Expressway near San Diego

Detailed descriptions of the 9 managed lane sites that were visited by PATH are given below.

2.1 I-80 HOV Lanes between Bay Bridge and Carquinez Bridge

Physical Configurations:

- *Length of corridor:* 18 miles
- *Number of managed lanes:* 2 (1 in each direction)
- *Type of managed lane(s):* carpool lane

- Activation time: 5-10 AM, 3-7 PM, Monday to Friday
- Access type: continuous
- Segregation: none
- User requirements: vehicles with 3 people or more
- Location: San Francisco Bay Area (see Fig 1)



Fig 1. Location of the I-80 HOV Lane Facility.

Advantages:

- The I-80 Smart Corridor Project has been implemented for this site. The project includes the deployment of traffic adaptive ramp metering, which is active during 5 AM to 8 PM, Monday to Friday, or on weekends when the traffic is heavy. It also applies overhead message signs to show lane closure information and advisory speeds in the westbound direction when severe incidents occur. The traffic information boards on the roadside and local street signs are utilized to show the travel times and detour guidance. Detailed information can be found at <http://www.dot.ca.gov/80smartcorridor/>.
- There are two left HOV lane entrances at this site. The Cutting Blvd entrance on I-80 EB aims to serve the nearby El Cerrito Del Norte BART station, whereas the Richmond Parkway entrance on I-80 WB serves a nearby park and ride facility.
- A microscopic simulation model has been built for this site in VISSIM.

Disadvantages:

- The HOV lane does not have a left shoulder (Fig 2).



Fig 2. Left Shoulder of the I-80 HOV Lane.

- The HOV lane is congested during the peak hours.
- There is a plan to implement express lane operation at this site but it won't be deployed in the next 5 years.

2.2 I-680 Express Lanes between SR-24 and I-580

Physical Configurations:

- Length of corridor: 12 miles southbound from Rudgear Road to Alcosta Blvd.; 11 miles northbound from Alcosta Blvd. to Livorna Road
- Number of managed lanes: 2 (1 in each direction)
- Type of managed lane(s): express lane
- Activation time: 5 AM – 8 PM, Monday through Friday
- Access type: continuous
- Segregation: none
- User requirements: vehicles with FasTrak or vehicles with 2 people or more
- Location: San Francisco Bay Area (see Fig 3)

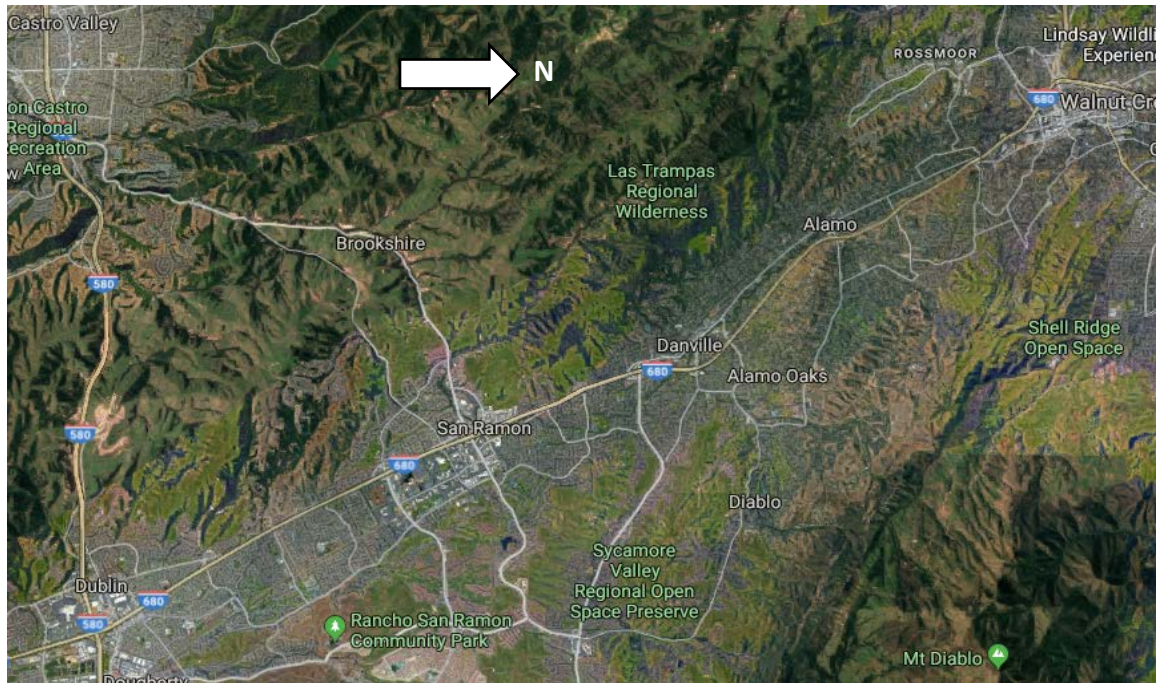

Fig 3. Location of the I-680 Express Lane Facility.

Advantages:

- This is a new express lane facility. Vehicles equipped with FasTrak can use the express lane during the hours of operation.
- Since it is a new facility, all the signage and pavement markings are very clear and easy for machine vision to recognize.

Disadvantages:

- A segment of the express lane does not have any left shoulder (Fig 4). This results in a very narrow lane which could be challenging for testing automated vehicles.



Fig 4. Left Shoulder of the I-680 Express Lane.

- The express lane is congested during the peak hours.
- The facility does not have physical segregation from the general-purpose lanes. All that separates the lanes is a single white line.

2.3 I-580 Express Lanes between I-680 and Greenville

Physical Configurations:

- Length of corridor: 11 miles eastbound from Hacienda to Greenville; 14 miles westbound from Greenville to San Ramon
- Number of managed lanes: 3 (2 in eastbound direction, 1 in westbound direction)
- Type of managed lane(s): express lane
- Activation time: 5 AM-8 PM, Monday to Friday
- Access type: limited access
- Segregation: double white lanes for a portion and single white lines for the rest
- User requirements: vehicles with FasTrak or vehicles with 2 people or more
- Location: San Francisco Bay Area (see Fig 5)



Fig 5. Location of the I-580 Express Lane Facility.

Advantages:

- This is an express lane facility. Vehicles equipped with FasTrak can use the express lane during the hours of operation.
- The eastbound facility has two express lanes (Fig 6).



Fig 6. The two-lane facility of the I-580 Express Lane.

Disadvantages:

- The express lane does not have physical segregation from the general-purpose lanes (Fig 6). It also only has single white lines separating express and general-purpose lanes for a portion.
- The facility is congested during the peak hours.

2.4 I-210 HOV Lanes from SR-134 to I-605**Physical Configurations:**

- Length of corridor: 12 miles
- Number of managed lanes: 2 (1 in each direction)
- Type of managed lane(s): carpool lane
- Activation time: 7/24
- Access type: limited access
- Segregation: double yellow (white) line
- User requirements: vehicles with 2 people or more
- Location: Los Angeles (see Fig 7)

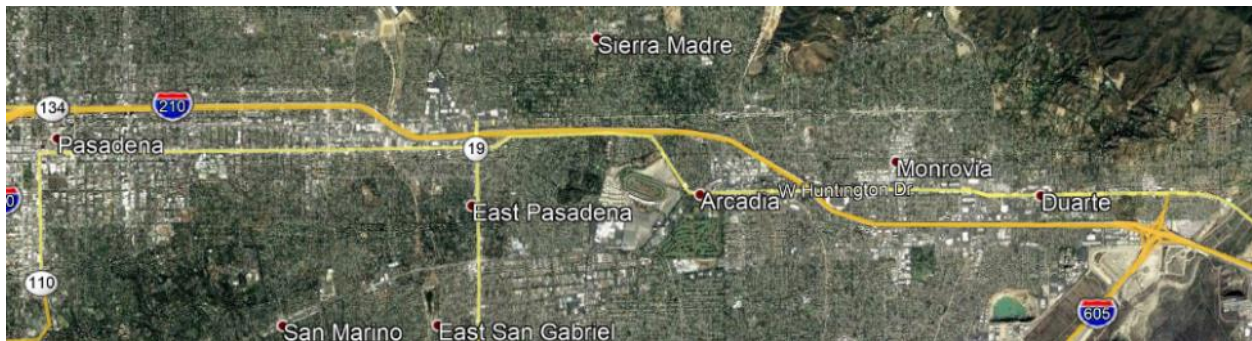

Fig 7. Location of the I-210 HOV Lane Facility.

Advantages:

- The PATH Connected Corridor team has built a microscopic simulation model for this site in Aimsun. In addition to the freeway segment, the model also covers the adjacent arterials with more than 1,000 signalized intersections. The model adopts a mesoscopic plus microscopic simulation scheme. The default Aimsun microscopic car following and lane changing models and mesoscopic models are used. Traffic management strategies such as ramp metering and demand management have been established in the Aimsun model as well.

Disadvantages:

- The HOV lane does not have left shoulder (Fig 8).



Fig 8. No Left Shoulder along the I-210 HOV Lane.

- The HOV lane is congested during the peak hours.

2.5 I-10 Express Lanes from US-101 to SR-605

Physical Configurations:

- Length of corridor: 13 miles
- Number of managed lanes: 4 (2 in each direction)
- Type of managed lane(s): express lane
- Activation time: 7/24
- Access type: limited access
- Segregation: double white line and physical segregation
- User requirements: vehicles equipped with FasTrak transponder, vehicles with 2 people or 3+ people get different levels of discount
- Location: Los Angeles (see Fig 9)

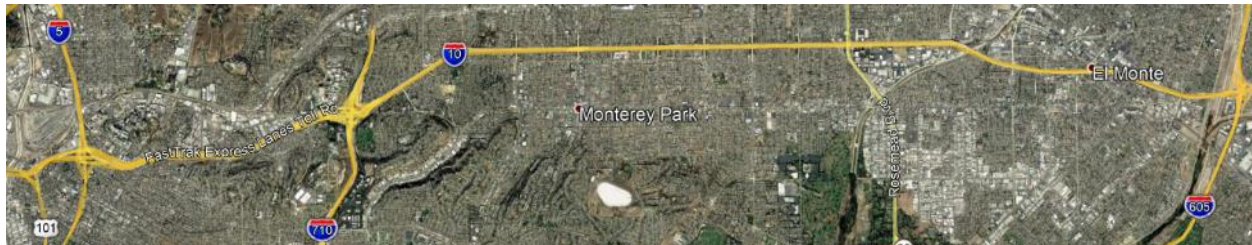

Fig 9. Location of the I-10 Express Lane Facility.

Advantages:

- This site has a combination of the geometry features. At the beginning of the section (close to the I-605 end, Fig 10), the express way has 1 lane with a wide shoulder. It eventually becomes a two-lane managed lane operation (Fig 11). After I-710, the express lane is operated alongside a dedicated bus lane and is physically separated from the general-purpose lane.



Fig 10. Beginning of the I-10 Express Lane.



Fig 11. Two-Lane Segment of the I-10 Express Lane Facility.

- A rapid bus line is currently operating along the corridor and the bus stops are integrated with the express lane facility. The bus stops are in the median of the freeway (Fig 12). This can offer an opportunity to test the applications of CAV technology for public transit.



Fig 12. Bus Station at the I-10 Express Lane Facility.

Disadvantages:

- The site has a very complicated interchange (I-10 with I-710). It might pose geometry constraints for the CAV test.

2.6 I-110 Express Lanes from I-10 to I-105

Physical Configurations:

- Length of corridor: 9 miles
- Number of managed lanes: 4 (2 in each direction)
- Type of managed lane(s): express lane
- Activation time: 7/24
- Access type: limited access
- Segregation: double yellow (white) line and physical separation
- User requirements: vehicles must be equipped with FasTrak transponder, vehicles with 2 people or 3+ people get different levels of discount based on time of day
- Location: Los Angeles (see Fig 13)

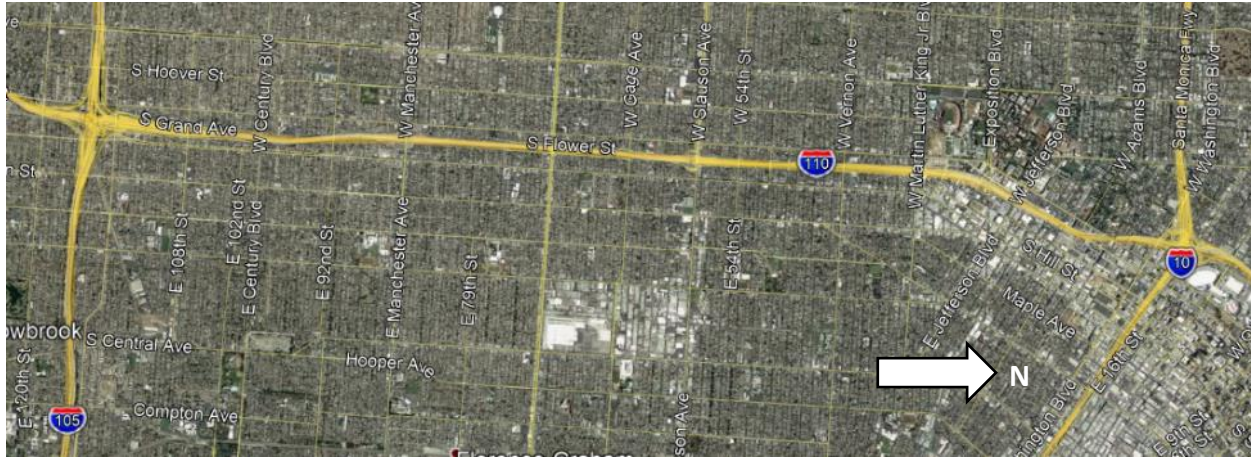

Fig 13. Location of the I-110 Express Lane Facility.

Advantages:

- A portion of this segment is elevated express way, completely separated from the general-purpose lanes (Fig 14).



Fig 14. Elevated Express Lane Facility on I-110.

Disadvantages:

- Only a portion of this facility is physically separated from the general-purpose lanes. The rest is segregated by double-yellow lines.
- The length of the express lane is less than 10 miles.

2.7 SR-91 Express Lanes from SR-55 to I-15

Physical Configurations:

- *Length of corridor:* 18 miles
- *Number of managed lanes:* 4 (2 in each direction)
- *Type of managed lane(s):* express lane

- Activation time: 7/24
- Access type: limited access
- Segregation: double white line and physical segregation
- User requirements: vehicles must be equipped with FasTrak transponder
- Location: Los Angeles (see Fig 15)



Fig 15. Location of the SR-91 Express Lane Facility.

Advantages:

- This corridor serves heavy commute traffic between Orange County and the Inland Empire.
- The removable delineators are used to segregate the express lane (Fig 16).



Fig 16. Removable Segregation for SR-91 Express Lane.

- The ingresses and egresses are well designed. It has an approximately 1-mile exit segment, followed by a 1-mile weaving segment, and lastly a 1-mile entry segment (Fig 17).



Fig 17. Ingress/Egress Section of SR-91 Express Lane Facility.

Disadvantages:

- The entrance of the facility could become very congested during the peak hours. The delay induced by the congestion can greatly offset the time savings of the facility.
- There are only a few entrance points available along the 20-mile segment.

2.8 I-15 Express Lanes from SR-163 to SR-78

Physical Configurations:

- Length of corridor: 20 miles
- Number of managed lanes: 4 (configurable to 1, 2 or 3 per direction)
- Type of managed lane(s): express lane
- Activation time: 7/24
- Access type: limited access
- Segregation: double white line (4 miles), physical barrier and grade segregation (16 miles)
- User requirements: HOV or single-occupied vehicles with FasTrak transponder
- Location: San Diego (see Fig 18)



Fig 18. Location of the I-15 Express Lane Facility.

Advantages:

- Moderate congestion that is controlled by dynamic pricing during peak hours. The maximum toll is \$8.00 to travel the entire length of the corridor, after which point the lanes become HOV-only.
- Restricted accesses to enter and exit from the express lane. The facility has 12 distinct ingress/egress sections in each direction (Fig 19).



Fig 19. Ingress/Egress Section of I-15 Express Lane Facility.

- The facility has 5 direct access ramps in each direction that allow traffic to exit or enter the express way directly to or from the local road. The direct access is especially useful to serve the public transit park & ride facilities located near each direct access ramp (Fig 20).





Fig 20. Direct Access Ramps on I-15 for Public Transit.

- Physical barriers and grade separation between express lanes and general traffic for most of the corridor (16 miles). The 4-mile segment on the northern end is separated by double white lines.
- Express lanes are 14 feet wide with a wide shoulder providing additional space for CAV testing.
- Movable barriers to account for the directional traffic. The freeway has movable barriers for the 16-mile segment on the southern end (Fig 21). For the remaining 4 miles of the road, the directional traffic is segregated by permanent barriers (Fig 22). The facility provides 3 express lanes for the southbound traffic and 1 lane for the northbound traffic between 5 to 9 AM through Monday to Thursday. It resumes to the 2-lane northbound and 2-lane southbound configuration for the rest of the day. In addition to the daily schedule to rearrange the barrier, the Caltrans operation center can temporarily shift the barrier due to traffic incidents. It takes 2 hours to completely move the barrier for the entire 16-mile segment.



Fig 21. Movable Barriers along I-15 Express Lane (on left side).



Fig 22. Permanent Barriers along I-15 Express Lane.

- Good inter-agency collaboration. The toll collection is operated by SANDAG and the traffic management is handled by Caltrans. The two agencies jointly update the Changeable Message Signs to inform the road users (Fig 23).



Fig 23. Changeable Message Signs on I-15 Express Lane.

- The facility has very sophisticated intelligent transportation system (ITS) infrastructure including an integrated corridor management (ICM) system and ramp meters that are coordinated with the arterial signals.
- No trucks can enter the express lane.
- There is an extensive coverage of data collection sensors such as radar, video cameras and loop detectors.
- The facility has already been named an official CAV proving ground by the United States Department of Transportation (USDOT). The local management agency has an established protocol for the users to apply for on-road CAV testing.
- The South Control Yard on the southern end of the corridor can be used as a staging area during testing or to store and work on automated vehicles (Fig 24).



Fig 24. South Control Yard on the Southern End of I-15 Express Lane.

Disadvantages:

- This is an ideal facility for testing CAVs but it might not be representative of typical managed lanes in the U.S. What is learned here might not be entirely transferable to the rest of the U.S.

2.9 SR-125 (Southbound Expressway) from SR-52 to SR-78

Physical Configurations:

- Length of corridor: 4 miles
- Number of managed lanes: N/A
- Type of managed lane(s): general purpose toll road
- Activation time: 24/7
- Access type: toll booths and gantries at each exit and on the southern end of the facility
- Segregation: N/A
- User requirements: N/A
- Location: San Diego (see Fig 25)



Fig 25. Location of the SR-125 Expressway.

Advantages:

- Located in the City of Chula Vista. The city is active in promoting CAV tests.
- The facility has already been named an official CAV proving ground by USDOT. The local management agency has an established protocol for the users to apply for on-road AV testing.
- New pavement markings are being installed with 6-inch stripes to support AV operations.

Disadvantages:

- Short distance (only 4 miles).
- Not a managed lane facility. No HOV considerations.
- Very light traffic in rural area.

2.10 Recommended Sites for CAV Testing and Early Deployment

Based on the information obtained from the site visits, we recommend the I-15 Express Lane Facility in San Diego and the I-10 Express Lane Facility in Los Angeles as the potential managed lane sites for future CAV tests.

The I-15 site is identified because it fits all the site selection criteria listed in Section 1. In addition, it offers an exclusive and controllable traffic environment for the CAV tests. Most of the facility is physically segregated from the general-purpose lanes. The interaction between the traffic stream of the express lane and the general traffic is limited to the ingress/egress areas. The operation agencies also offer the opportunity to close some entrances and/or exits during tests. This configuration gives the testing team a leverage to actively control the test traffic conditions,

thus allowing the subject vehicles to be evaluated in different levels of traffic complexity. Moreover, the facility has an extensive coverage of the traffic monitoring system. The system can be used to collect real-time data during the tests. The operation agencies (i.e., Caltrans and SANDAG) are active in promoting the testing of CAVs at the facilities. They have streamlined the test permitting process and are willing to open the right-of-way for installing additional road-side infrastructure, which might be an essential component of the CAV tests. In addition, I-15 has already been named an official CAV proving ground by USDOT. For the above reasons, we would first recommend this site for evaluating the early development of the CAV technologies.

The I-10 Express Lane Facility is selected as an alternative site. The major advantage of this site is that it contains various physical configurations (e.g., 1-lane vs. 2-lane facility, physical segregation vs. double white line segregation, and wide shoulder vs. narrow shoulder). It provides a 'one-stop' test ground for the examination of the CAV performances. In addition, a rapid bus line is currently operating along the corridor and the bus stops are integrated with the express lane facility. This can further offer an opportunity to test the applications of the CAV technology for public transit.

3. Assessment of CAV Applications for Managed Lanes

To identify and assess the most promising CAV applications for early field testing and deployment at these sites, the PATH team considered a broad range of CAV applications having varying degrees of connectivity (V2V, V2I and/or neither) and varying degrees of automation (Level 0 to Level 4 with respect to the SAE Levels of Automation). The criteria that we used to assess the applications included:

- Technological readiness of the application,
- Suitability for operating in Managed Lanes environment,
- Likelihood of having significant early impact,
- Importance to stakeholders,
- Availability of enabling ITS infrastructure and data, and
- Availability of equipped test vehicles.

In total we considered 11 CAV applications for early testing and deployment in California Managed Lanes. Most of these applications are being considered by USDOT as likely candidates for early deployment. The results of our assessment are provided below.

3.1 Highway Cooperative Adaptive Cruise Control (CACC) for light-duty vehicles

Cooperative Adaptive Cruise Control (CACC) is a Level 1 vehicle automation system that performs automated speed control based on real-time vehicle operation information shared among vehicles with wireless connectivity. This allows vehicles to safely travel in closely coupled strings with high speeds. This CAV application has been receiving considerable research attention within the academic community and the industry as well, in terms of both technology development and impact assessment using models. It also has the potential to produce large impacts on highway capacity and traffic dynamics when it achieves a significant market penetration within a highway lane. By concentrating CACC-equipped vehicles in one of the recommended managed lane facilities, there is greater opportunity to realize these benefits sooner. The technology is sufficiently mature such that there are no significant technological impediments to deployment. The only potential barriers are uncertainty regarding the messaging standards and its ability to recognize sufficient market pull to motivate serious product development. Since this is primarily a V2V application it doesn't require the ability to communicate with existing ITS infrastructure.

CRITERIA	YES/NO
Technological readiness:	Yes
Suitability for operating in managed lanes environment:	Yes
Likelihood of having significant early impact:	Yes
Importance to stakeholders:	Yes
Availability of enabling ITS infrastructure and data:	N/A
Availability of equipped test vehicles:	Yes
Overall Recommendation	Yes

3.2 Freeway speed harmonization/variable speed limits utilizing V2I communications

Freeway speed harmonization is a method to reduce congestion and improve traffic performance by gradually lowering speeds before a heavily congested area to reduce the stop-and-go disturbances. A traffic management center (TMC) calculates optimal speeds for vehicles approaching the congestion and broadcasts the speed values to connected vehicles on the road via V2I communications. This application can be implemented at Level 0 (with speed advisories to drivers) or Level 1 (with V2I commands of set speeds to ACC systems on the vehicles), so it does not face technological impediments. It has the potential to mitigate highway traffic bottlenecks and reduce secondary crashes upstream of incidents, but the net transportation system impacts are likely to be relatively subtle rather than dramatic. Implementation depends on public agency implementation of the traffic management functionality and V2I communication systems and availability of sufficiently comprehensive real-time traffic data to enable the TMC to make wise selections of the speed limit values. Both the I-15 and I-10 Express Lanes have significant ITS infrastructure, traffic data and existing traffic models that could be leveraged to support this application. In addition, traffic management agencies in San Diego and Los Angeles have shown a willingness to experiment with innovative traffic control strategies such as ICM and variable speed limits. Since vehicles would not necessarily need to be automated, it would be easy to equip a fleet. One consideration for testing speed harmonization in Managed Lanes is that federal policy encourages operators to maintain the average speed of Managed Lanes at no less than 45 mph.

CRITERIA	YES/NO
Technological readiness:	Yes
Suitability for operating in managed lanes environment:	Yes
Likelihood of having significant early impact:	Yes
Importance to stakeholders:	Yes
Availability of enabling ITS infrastructure and data:	Yes
Availability of equipped test vehicles:	Yes
Overall Recommendation	Yes

3.3 Eco-traffic signal control using V2I communications

This is an arterial application that does not involve any vehicle automation, but only involves use of connected vehicle technology to communicate between vehicles and the traffic signal controllers, primarily by enabling the signal control system to obtain comprehensive real-time traffic condition data from the vehicles serving as traffic data probes so that it can make more intelligent allocations of green time to minimize vehicle energy consumption and emissions. The traffic signal phase and timing (SPaT) information can be communicated directly to the drivers of the vehicles (V2I) to augment their ability to see the traffic signal heads, but that is likely to have only a relatively minor effect. Since this CAV application operates on signalized arterials rather than freeways it is not suitable for operating in Managed Lanes.

CRITERIA	YES/NO
Technological readiness:	Yes
Suitability for operating in managed lanes environment:	No
Likelihood of having significant early impact:	No
Importance to stakeholders:	Yes
Availability of enabling ITS infrastructure and data:	No
Availability of equipped test vehicles:	Yes
Overall Recommendation	No

3.4 Eco-cooperative ACC adjusting arterial speed profiles based on SPaT data

This is an extension of the preceding application, with the addition of Level 1 automation of the speed profiles of the approaching vehicles based on their ability to receive V2I communication of the traffic signal phase and timing information. It has been successfully tested at isolated intersections in controlled environments. This application should have a larger impact by making it possible for the vehicles to automatically follow speed profiles that minimize a combination of energy consumption and emissions without requiring additional driver workload, but its success depends on growing market penetration of ACC vehicles and of the communication technology on both the infrastructure and vehicle sides. Also, since this application operates on signalized arterials rather than freeways it is not suitable for operating in Managed Lanes.

CRITERIA	YES/NO
Technological readiness:	Yes
Suitability for operating in managed lanes environment:	No
Likelihood of having significant early impact:	Yes
Importance to stakeholders:	Yes
Availability of enabling ITS infrastructure and data:	No
Availability of equipped test vehicles:	Yes
Overall Recommendation	No

3.5 Heavy truck CACC/platooning for highway driving

Although heavy trucks represent only a modest fraction of the vehicle population, they account for a significant fraction of vehicle energy usage, so technologies such as this that improve the energy efficiency of heavy trucks can make a significant impact over long distances. Because the economic returns to the truck fleet operators from the fuel savings look significant, this is likely to be one of the earliest CAV applications to be widely deployed. This technology can also relieve traffic bottlenecks in corridors with high volumes of heavy truck traffic. However, semi-trailer trucks are not permitted to operate in either the I-15 or I-10 Express Lanes. Further, both I-15 and I-10 Managed Lanes are relatively short segments (under 20 miles) so the energy savings from platooning would barely be noticeable. In summary, this application is not suitable for these express lane facilities.

CRITERIA	YES/NO
Technological readiness:	Yes
Suitability for operating in managed lanes environment:	No

Likelihood of having significant early impact:	Yes
Importance to stakeholders:	Yes
Availability of enabling ITS infrastructure and data:	N/A
Availability of equipped test vehicles:	No
Overall Recommendation	No

3.6 Highway merge coordination (V2V and V2I)

In freeway ramp areas, frequent lane-changing, merging, and yielding maneuvers can cause severe traffic congestion and jeopardize traffic safety. This is also a problem at the ingress/egress points of managed lanes where the speed differential between the general-purpose lane and the managed lane can make merging dangerous. In a connected vehicle environment, vehicles can communicate and exchange detailed information such as speed, acceleration, and position in real time. Such information exchange is important for improving traffic safety and mobility, especially in highway merge areas. This application can be implemented at several different levels of automation, ranging from Level 0 (merge advisory assistance to drivers), to Level 1 (automatic speed control to facilitate merging) or Level 2 (automatic speed coordination combined with automatic lane changing). Because merging is one of the main causes of highway congestion, this has the potential for significant relief of highway congestion, especially as the level of automation increases, but advancing to those higher levels of automation may take many years to be realized so this CAV application is not likely to be implemented as soon as others. If deployed on the I-10 and I-15 Express Lanes this application has potential to improve safety and operations at the ingress/egress points. Finally, stakeholders in the San Diego and Los Angeles regions have expressed interest in testing this CAV application.

CRITERIA	YES/NO
Technological readiness:	Yes (at Levels 0 and 1)
Suitability for operating in managed lanes environment:	Yes
Likelihood of having significant early impact:	Yes
Importance to stakeholders:	Yes
Availability of enabling ITS infrastructure and data:	Yes
Availability of equipped test vehicles:	Yes (at Levels 0 and 1)
Overall Recommendation	Yes

3.7 Low-speed “driverless” urban shuttle vehicles for first-mile/ last-mile access to line-haul transit

The low-speed urban shuttles are likely to be the first Level 4 automation systems to be implemented, based on use at very low speeds and in protected environments. These shuttles have already been tested in some cities on a very limited scale. They can help solve the first-mile/last-mile access problems of conventional line-haul transit systems, making those transit systems more attractive to potential users. However, because they will only be applicable within limited geographical areas and the public transit systems only carry a small fraction of the travelers in most urban regions, their overall transportation impacts are not likely to be very large, even when they are more widely deployed. And since they typically operate at low speeds in protected environments, they are not suitable for operating in managed lanes.

CRITERIA	YES/NO
Technological readiness:	Yes
Suitability for operating in managed lanes environment:	No
Likelihood of having significant early impact:	No
Importance to stakeholders:	Yes
Availability of enabling ITS infrastructure and data:	N/A
Availability of equipped test vehicles:	Yes
Overall Recommendation	No

3.8 Automated bus rapid transit on busways

Busways are attractive early deployment environments for the higher levels of automation because they provide some segregation from other road users, simplifying the driving environment for the automation technology. Automated bus rapid transit can provide cost savings for the public transit operator, but the net impacts on regional transportation are usually limited because busway infrastructure is expensive and typically available only in very limited scale networks. However, the I-15 and the I-10 Express Lanes are both good candidates for automated bus operations since they have physical separation from other lanes and they both have existing rapid transit service. In fact, a major section of the I-10 Express Lane was originally built as the El Monte Busway with express transit service in mind. Although partially automated buses have been tested on a limited scale in operational environments, highly automated buses have not yet been implemented in an operational environment (except for the low-speed shuttles described in the previous section). Therefore, any early testing of this application would need to be done with a driver behind the wheel. Transit stakeholders in the area of these facilities such as San Diego Metropolitan Transit System are very forward thinking and have already tested innovative solutions such as hard shoulder running so they may be amenable to testing this application. Another option for finding vehicle fleets would be to equip one of more of the many van pools that operate on these corridors.

CRITERIA	YES/NO
Technological readiness:	Yes (at levels 1 and 2)
Suitability for operating in managed lanes environment:	Yes
Likelihood of having significant early impact:	Yes
Importance to stakeholders:	Yes
Availability of enabling ITS infrastructure and data:	N/A
Availability of equipped test vehicles:	Yes (only need 1 or 2 buses)
Overall Recommendation	Yes

3.9 Low-speed urban TNC services (Uber/Lyft) using highly automated vehicles

This CAV application has been receiving extensive media attention through the promotional efforts of the companies and interest groups active in promoting it. Within the next decade or two it will probably only be technically feasible to provide TNC services using highly automated vehicles (with no onboard drivers, but with remotely located humans supervising the operations of the vehicles) within limited urban neighborhoods and within limited speed ranges and weather

conditions. These systems could have significant transportation system impacts within the zones where they are capable of operating, but it is highly uncertain how extensive those zones are going to be, so the net transportation system impacts remain highly uncertain. At the current time, this application does not seem ready or suitable for operation in managed lanes.

CRITERIA	YES/NO
Technological readiness:	No
Suitability for operating in managed lanes environment:	No
Likelihood of having significant early impact:	No
Importance to stakeholders:	Yes
Availability of enabling ITS infrastructure and data:	N/A
Availability of equipped test vehicles:	No
Overall Recommendation	No

3.10 Automated small package delivery

Interest has been growing in the use of small automated vehicles (sometimes described as “beer coolers on wheels”) for local package deliveries in urban areas. These may operate on pedestrian paths or sidewalks rather than on the public roads so that they would not necessarily need to interact with full-size vehicles except in pedestrian crossings, but pedestrian and bicyclist advocates have expressed concerns about their interactions with these vehicles. If online shopping continues to grow at the expense of traditional brick-and-mortar retail, small package delivery applications could become an increasingly important element in transportation operations, although many practical considerations remain to be resolved for this class of highly automated vehicle. At the current time, this application does not seem ready or suitable for operation in managed lanes.

CRITERIA	YES/NO
Technological readiness:	No
Suitability for operating in managed lanes environment:	No
Likelihood of having significant early impact:	Yes
Importance to stakeholders:	Yes
Availability of enabling ITS infrastructure and data:	N/A
Availability of equipped test vehicles:	No
Overall Recommendation	No

3.11 Automated barrier mover vehicle

The I-15 managed lane facility has a 4-lane express way that is configurable to 1, 2 or 3 lanes per direction. The movable barriers are used to configure the lane settings. Under normal traffic operation, the facility provides 3 express lanes for the southbound traffic and 1 lane for the northbound traffic between 5 to 9 AM through Monday to Thursday. It resumes to the 2-lane northbound and 2-lane southbound configuration for the rest of the time. In addition to the daily schedule to rearrange the barrier, the Caltrans operation center can temporarily shift the barrier due to traffic incidents. A manually driven barrier mover vehicle is used to rearrange the movable barriers each day. It takes 2 hours to completely move the barrier for the entire 16-mile

segment and there is additional time required for response when the barrier needs to be moved off schedule. An automated barrier mover vehicle is expected to reduce the response time needed to change the lane configuration. It should be especially helpful when the lane configuration needs to be switched temporarily, outside of normal hours to address the non-recurrent congestions. Equipping the barrier mover vehicle to operate in fully automated mode is made easier because it operates on a predefined track and there is no turning involved. While this application has limited applicability to other agencies in the United States (unless they operate a manual barrier mover vehicle), it does show how CAV technologies may be used to meet the specific requirements of a local managed lane operation agency.

CRITERIA	YES/NO
Technological readiness:	Needs investigation
Suitability for operating in managed lanes environment:	Yes
Likelihood of having significant early impact:	Yes
Importance to stakeholders:	Yes
Availability of enabling ITS infrastructure and data:	N/A
Availability of equipped vehicles:	Needs investigation
Overall Recommendation	Yes

3.12 Recommended CAV Applications

The PATH team recommends the following five CAV applications to be considered for testing at the two identified managed lane sites (I-15 in San Diego and I-10 in Los Angeles):

- Highway CACC for light-duty vehicles
- V2I freeway speed harmonization/variable speed limit
- Highway merge coordination (V2V and V2I)
- Automated bus rapid transit on busways
- Automated barrier mover vehicle for I-15 Express Lane

Previous simulation studies or small-scale field tests indicate that the first four applications have potential to greatly shift traffic flow patterns within the existing highway facilities. This would result in significant improvement of traffic mobility and safety, and vehicle fuel economy without massive investment on infrastructure expansion. The supporting technologies of those applications are readily available or will be available soon. We expect that those four applications represent the very first CAV systems to be implemented in the highway facilities. The last application listed above fits the specific need of the I-15 site. The test of this application can demonstrate how CAV technologies may be used to meet the specific requirements of a local managed lane operation agency.

4. Testing and Deployment Concepts for California Managed Lanes

As described in Section 3, the PATH team recommends considering the following five CAV applications for testing and possible deployment at the two identified managed lane sites (I-15 Express Lanes in San Diego and I-10 Express in Los Angeles):

- Highway CACC for light-duty vehicles
- V2I freeway speed harmonization/variable speed limit
- Highway merge coordination (V2V and V2I)
- Automated bus rapid transit on busways
- Automated barrier mover vehicle for I-15 Express Lane

Future tests or early pilot deployments of these CAV applications will aim to explore the readiness of the applications and quantify their potential traffic, safety, and/or environmental impacts. The results of future tests can help the State of California (as well as other states) determine the feasibility of long-term deployment and develop large-scale implementation protocols for CAV systems at other managed lane facilities in the future.

In the remainder of this chapter, we provide further details of how the identified CAV applications could be tested at the two sites, and the expected benefits of the deployment of those applications.

4.1 Overview of the Testing and Deployment Concepts

The highway CACC application enables vehicles equipped with CACC to operate in CACC strings. Such an operation allows vehicles to safely travel at very short gaps under high speed conditions. This can greatly improve the traffic flow stability, efficiency and safety. At early CACC deployment stages, the market penetration of CACC is low. It could be difficult for CACC vehicles randomly scattered in the traffic stream to form strings. The I-15 and I-10 sites offer an express way facility that is physically segregated from the general-purpose lanes with dedicated on and off ramps. It is possible to make a CACC managed lane within each facility by allowing each CACC vehicle special access to enter the lane through the express way ingresses or dedicated on-ramps without paying a fee. In this case, the market penetration of the CACC managed lane can be increased locally, leading to a potential capacity increase of the managed lane. In addition, as CACC traffic is attracted from the general-purpose lanes to the managed lane, the performance of the general-purpose lanes is expected to improve as well.

The V2I speed harmonization application aims to smooth the traffic flow over a congested corridor. When the traffic of a bottleneck is about to become congested, this speed harmonization system will send advisory speeds to vehicles upstream from the bottleneck via V2I communications. After adopting the advisory speed, the upstream vehicles will gradually decrease their speeds before entering the bottleneck area. As a result, the input flow to the

bottleneck area will decrease, leading to the delay or elimination of traffic breakdown and the capacity drop associated with the traffic breakdown. In addition, since the vehicles have already slowed down upstream from a congested bottleneck area, they can enter the bottleneck smoothly without rear-end conflicts with vehicles in the congestion region. This can result in safety improvement of the freeway. This application can be tested in two stages. In the first stage, we can test the effectiveness of the speed harmonization if the cellular wireless network is used to send an advisory speed to all vehicles equipped with connectivity. In the next stage, we can test the effect of a centralized control strategy where the roadside units will use dedicated short-range communications (DSRC) to send customized speed command to individual vehicles. Both identified sites have an advanced ITS traffic monitoring and management systems. The existing ITS can be either utilized directly, repurposed, or leveraged to incorporate the V2I communication system and central control system needed to send the advisory speed to vehicles equipped with connectivity.

The highway merge coordination application can streamline the freeway merging process. It identifies the gaps in the freeway mainline for the merging vehicles. If there are no gaps, it can ask the mainline vehicles to create gaps before entering the merging area. In the meantime, it leads the on-ramp vehicles to merge into those identified or created gaps by providing them with speed commands. The dedicated on-ramps of the two managed lane facilities make them good sites to test the merge coordination application. Those on-ramps offer direct access to the express lane facility. If the merge coordination is used at those on-ramps, we can directly measure its effectiveness from the managed lane traffic, without the need to consider the influence of the complex traffic in the general-purpose lane. This application requires some form of V2I communication to collect data from mainline vehicles and on-ramp vehicles and send speed commands to those vehicles for achieving smooth merging maneuvers. We will need to install V2I communications devices and a centralized controller at the site to test this application.

The automated bus rapid transit application could be tested at both the I-10 and I-15 sites. The test could be implemented in two stages. In the first stage, the automated bus could be tested at the I-10 site, which has a dedicated bus lane for a portion of the I-10 Express Lane. In the dedicated bus lane segment, the bus stops are built at the median of the freeway facility. It offers an exclusive and simple traffic environment to test the operation of automated buses. In the next stage, the automated bus testing could take place at the I-15 site. At the I-15 site, the automated buses will operate in mixed traffic. Those buses will use the transit facilities that are connected to the managed lane via dedicated on/off ramps. Testing results obtained at this site will demonstrate the readiness of implementing the automated bus in a more complicated traffic environment. For both sites, the automated bus will operate as a level 1 or 2 system and thus require a driver behind the wheel. Nevertheless, such a deployment would still showcase partial bus automation in an operational setting and demonstrate the safety and operational benefits of such a system.

The automated barrier mover vehicle application is specific to the needs of the I-15 site. The lane configuration of the site can be changed by readjusting the movable barriers with the barrier

mover vehicle. If this process can be automated, it may speed up the lane reconfiguration, providing better chance for the facility to respond quickly to various types of traffic incidents.

4.2 Detailed Descriptions of Testing and Deployment Concepts

Since one of the primary goals of the testing and early deployment stage is to estimate potential impacts of the CAV applications, it will be critical to compare the performance of each facility both with and without CAV applications. This section describes the base case, performance metrics, and testing scenarios of each individual CAV application. Note that these applications could be deployed independently or together but they are discussed as independent pilot deployments below. Also, CAV deployment considerations are assumed to be the same for both the I-15 and the I-10 sites unless stated otherwise.

4.2.1 Highway CACC Application

Base Case

For the highway CACC application, the base case represents the existing traffic conditions prior to CAV deployment under the peak and non-peak hour demand. The performance of the base case can be measured over the entire corridor, or at areas of interest such as on/off ramp regions and recurrent bottlenecks.

Performance Metrics

The traffic performance can be measured by throughput at individual bottlenecks, average speed of concerned locations, travel time over the corridor, and time-space diagram that visualizes shockwaves. In addition, we can collect detailed car following and lane changing datasets from individual CACC vehicles. Those datasets can be used to develop CACC car following and lane changing models.

The effectiveness of the highway CACC application depends on how many vehicles can operate in CACC strings. Once in string, the vehicles can safely follow preceding vehicles with high speeds and short gaps. This car following behavior can save great time-space resource of the freeway and stabilize the traffic flow. To describe the performance of CACC strings, we will use the following metrics: percentage of time a CACC vehicle operates in string, average length of string, and frequency of turning off CACC. The first two metrics are expected to be improved as the CACC vehicles can easily identify and join CACC strings. The last metric depends on the intensity of the traffic disturbances in the traffic stream. If there are repeated shockwaves or lane changes, the drivers will need to frequently turn off the CACC controller and deal with the unstable traffic condition manually. This will decrease the effectiveness of the highway CACC application.

Testing Scenarios

To conduct meaningful field tests of CACC, there will need to be a minimum number of CACC-equipped vehicles. Some tests can be conducted with just a few CACC vehicles but most require higher numbers. Depending on how many CACC vehicles are involved in the tests, we define the following testing scenarios:

Scenario 1: performance of individual CACC strings under realistic traffic conditions of the express lane. This scenario requires at least three CACC vehicles that form a string before entering the managed lane. Once those vehicles merge into the managed lane, they will be instructed to maintain the CACC operation whenever possible. We will measure the string operation metrics of the tested string under a range of CACC gap settings. The testing results will reveal how well a CACC string can operate in the existing mixed traffic stream and how much of the time it can remain together (after subtracting the times when it is interrupted by other vehicles cutting in). This scenario is illustrated by Fig 26 (green vehicles are CACC-equipped).

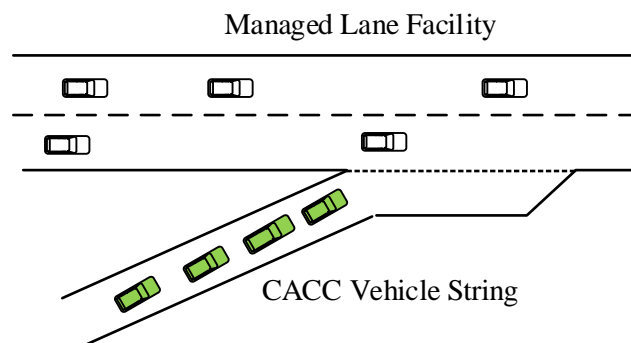

Fig 26. Scenario 1 of Highway CACC Application.

Scenario 2: performance of the corridor under various CACC market penetrations and traffic demands. This scenario should be performed when the CACC fleet size is sufficiently large (e.g., several hundred). We can ask those testing vehicles to enter the managed lane facility within an hour. This would make the CACC market penetration reach 10% to 20% during the testing period (e.g., 200 CACC vehicles in a facility with a volume of 1,000 to 2,000 vehicles per hour). We can ask some of the vehicles to turn on or off the CACC system during the test. In this case, the CACC market penetration rate becomes a controllable variable. The tests will be performed during both peak and non-peak hours. The test results will indicate the effect of CACC under different traffic congestion levels and market penetrations. This scenario is illustrated by Fig 27 (green vehicles are CAVs).

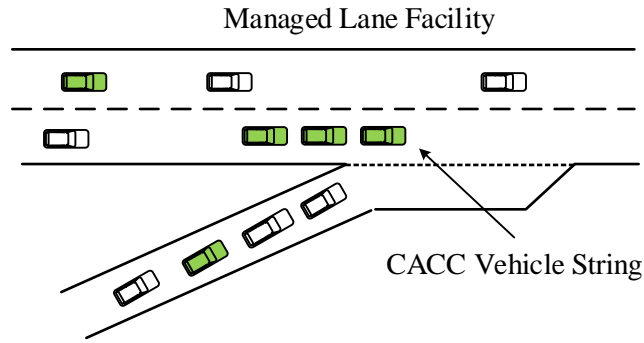

Fig 27. Scenario 2 of Highway CACC Application.

Scenario 3: impacts of CACC lane configurations. This scenario should be performed when the CACC fleet size is sufficiently large (e.g., several hundred). In this scenario, we will test three different lane configurations for CACC vehicles: 1) CACC vehicles can enter any lane of the I-10 or I-15 Express Lane facility; 2) CACC vehicles can travel only in a designated lane in each direction; and 3) one lane in each direction is used as the CACC only lane. We will investigate which lane configuration can better facilitate the CACC string operation and brings about larger traffic performance improvement. This scenario is illustrated by Fig 28 (green vehicles are CAVs).

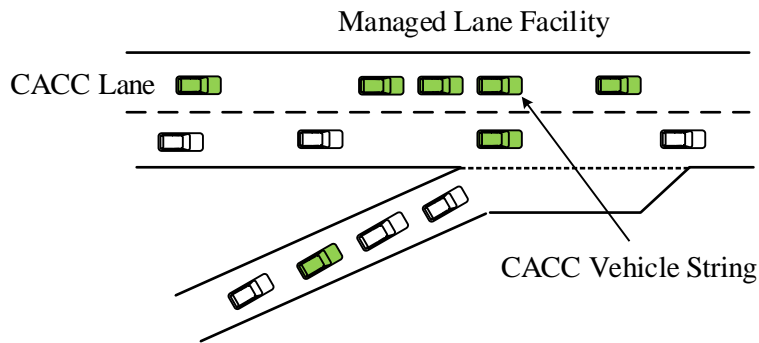

Fig 28. Scenario 3 of Highway CACC Application.

4.2.2 V2I Speed Harmonization

Base Case

For V2I speed harmonization, the base case represents the existing traffic conditions prior to CAV deployment under the peak and non-peak hour demand. The performance of the base case can be measured over the entire corridor, or at areas of interests such as on/off ramp regions and recurrent bottlenecks.

Performance Metrics

The traffic performance can be measured by throughput at individual bottlenecks, average speed of concerned locations, travel time over the corridor, and time-space diagram that visualizes shockwaves. We can also measure safety impacts by looking at safety surrogate measures such as the number of rear-end conflicts and time to collision.

Testing Scenarios

Scenario 1: performance of the application when the cellular network and universal speed advisories are used. In this scenario, we will test the effects of the speed harmonization application when its centralized controller (e.g., controller at the Traffic Management Center) adopts the cellular network to send an advisory speed to the drivers of all connected vehicles within the freeway segment to be managed. The scenario can be performed under various connected vehicle market penetrations and with no automation (level 0) or partial automation (level 1) but partial automation would be more complicated. The tests will be conducted during both peak and non-peak hours. The test results will indicate the effect of the speed harmonization under different traffic congestion levels and connected vehicle market penetrations. This scenario is illustrated by Fig 29 (green vehicles are CAVs).

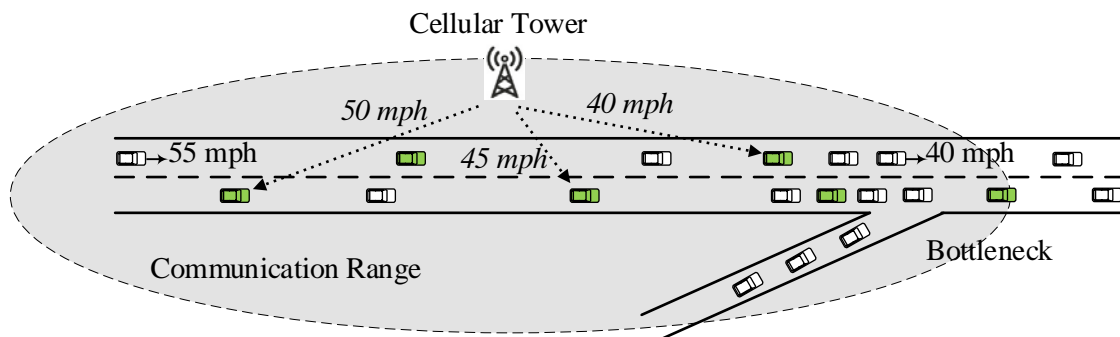

Fig 29. Scenario 1 of I2V Speed Harmonization Application.

Scenario 2: performance of the application when DSRC and customized speed control are used. In this scenario, we will test the effects of the speed harmonization application when it uses a centralized controller to send customized speed commands to vehicles equipped with wireless communication devices and level 1 longitudinal automation. The scenario can be performed under various CAV market penetrations. The tests will be conducted during both peak and non-peak hours. The test results will indicate the effect of the application under different traffic congestion levels and CAV market penetrations. This scenario is illustrated by Fig 30 (green vehicles are CAVs).

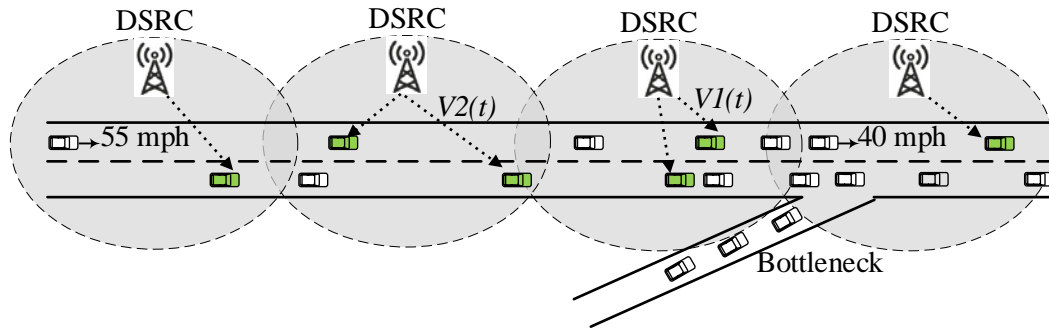

Fig 30. Scenario 2 of I2V Speed Harmonization Application.

4.2.3 Highway Merge Coordination

Base Case

For highway merge coordination, the base case represents the existing traffic conditions prior to CAV deployment under peak and non-peak hour demand at merge bottlenecks of concern.

Performance Metrics

The traffic performance can be measured by throughput at individual bottlenecks, average speed of the bottlenecks, and time-space diagram that visualizes shockwaves caused by traffic disturbances in the bottleneck area. We can also measure safety impacts by looking at safety surrogate measures such as the number of side-swipe conflicts and time to collision.

Testing Scenarios

Scenario 1: performance of concerned bottlenecks using level 0 connected vehicles under various traffic demands. In this scenario, we will test the effects of the merge assistance application to the connected manually driven vehicles. In this case, the roadside unit will send speed commands to both on-ramp and mainline vehicles equipped with connectivity. The drivers of those vehicles will try to follow the speed commands as closely as possible. The scenario can be performed under various connected vehicle market penetrations during both peak and non-peak hours. The test results will indicate the effect of the application under different traffic congestion levels. This scenario is illustrated by Fig 31 (green vehicles are CAVs).

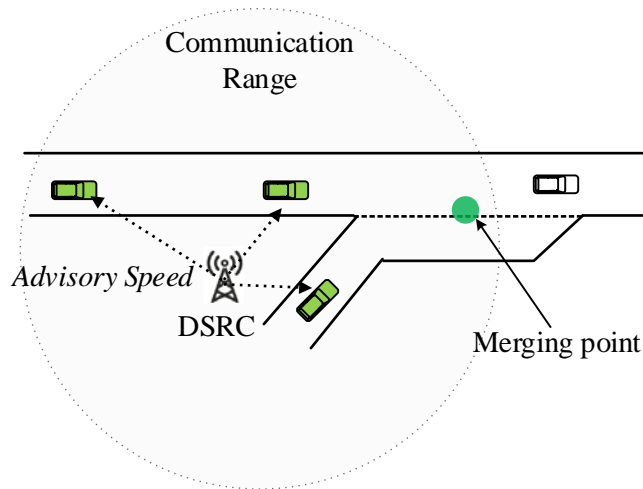

Fig 31. Scenario 1 of Highway Merge Coordination Application.

Scenario 2: performance of concerned bottlenecks using level 1 CAVs under various traffic demands. In this scenario, we will test the effects of the merge assistance application to the connected automated vehicles. In this case, the roadside unit will broadcast speed commands to both the freeway mainline and on-ramp vehicles via V2I wireless communications. The automated speed controllers of those vehicles will follow the speed commands as closely as possible. The scenario can be performed under various connected vehicle market penetrations during both peak and non-peak hours. The test results will indicate the effect of the application under different traffic congestion levels. This scenario is illustrated by Fig 32 (green vehicles are CAVs).

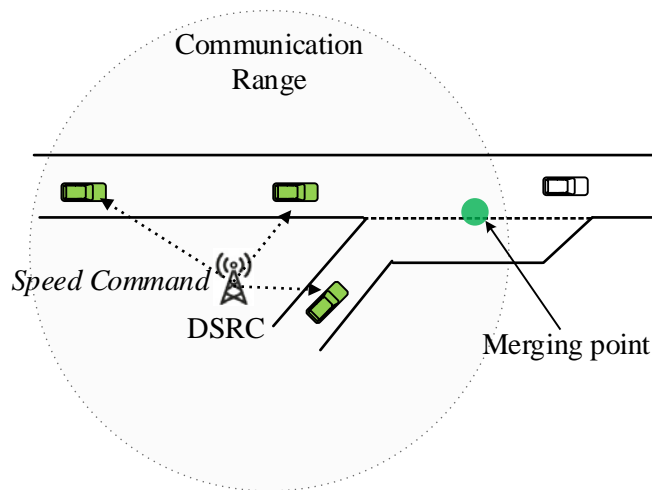

Fig 32. Scenario 2 of Highway Merge Coordination Application.

4.2.4 Automated Bus Rapid Transit

Base Case

For automated bus rapid transit, the base case represents the existing bus service where the manually driven buses are operated in the I-10 bus lane and the I-15 managed lanes.

Performance Metrics

The efficiency of the bus service can be measured with the travel time of each bus, frequency of the bus service, number of the ridership, and average dwell time at the bus stops. Since even a level 1 or 2 automated system can reduce the workload of bus drivers, the drivers are expected to operate the buses more safely than drivers without the automation systems. The safety benefits can be measured by safety surrogate measures such as the number of rear-end conflicts and time to collision.

Testing Scenarios

Scenario 1: performance of automated buses in the dedicated bus lane. In this scenario, we will test the impacts of level 1 or 2 automated bus rapid transit on bus service at the I-10 site. This site offers a dedicated bus lane facility in a portion of the I-10 Express Lanes. We will test the system performance of the managed lane corridor with and without the automated buses. This scenario is illustrated by Fig 33.

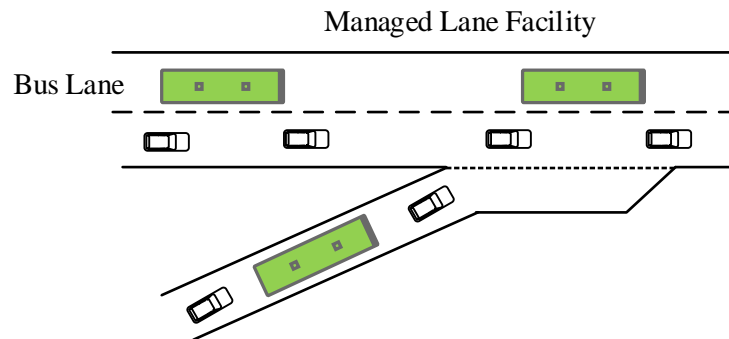

Fig 33. Scenario 1 of Automated Bus Application.

Scenario 2: performance of automated buses in mixed traffic. In this scenario, we will test the impacts of level 1 or 2 automated bus rapid transit on bus service at the I-15 site. In this site, the automated buses will operate with other traffic in the managed lanes. We will test the system performance of the managed lane corridor with and without the automated buses. This scenario is illustrated by Fig 34.

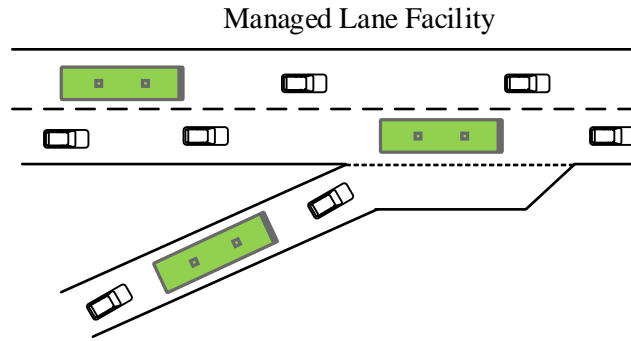

Fig 34. Scenario 2 of Automated Bus Application.

4.2.5 Automated Barrier Mover Vehicle

Base Case

Here, the base case represents the existing situation where the movable barriers of the site are adjusted by a manually driven barrier mover vehicle.

Performance Metrics

The performance metrics for this application are time needed to respond to an incident and completely adjust the position of the movable barriers and the resulting impact that has on traffic flow in the I-15 Express Lanes.

Testing Scenarios

Scenario 1: We will test the system performance of the I-15 Express Lanes with and without the automated barrier mover vehicle to determine the time savings resulting from automating the barrier move vehicle.

4.3 Deployment Readiness Assessment

4.3.1 Time Needed for Development, Testing and Initial Deployment

For Scenario 1 of the highway CACC application, the initial testing can be performed once at least three CACC vehicles are available. The PATH team has performed multiple CACC tests involving 6 passenger cars and 3 trucks on freeway general-purpose lanes^{1, 2}. Similar tests can be easily performed within a year on the I-15 and I-10 managed lane facility using an existing

¹ Milanés, V., Shladover, S.E., 2014. Modeling cooperative and autonomous adaptive cruise control dynamic responses using experimental data. *Transportation Research Part C: Emerging Technologies* 48, 285-300.

² Ramezani H., S.E. Shladover, X. Y. Lu and O.D. Altan, "Micro-Simulation of Truck Platooning with Cooperative Adaptive Cruise Control: Model Development and a Case Study", *Transportation Research Record*, 2018.

CACC fleet, either from PATH or perhaps provided by USDOT. Scenario 2 and 3 require larger CACC vehicle fleet size of at least several hundred. The Connected Vehicle Safety Pilot program sponsored by FHWA recruited several thousand connected vehicles over a small city³. We expect that we will need a smaller fleet size for testing those two scenarios. The recruitment of additional vehicles and drivers could be enhanced if incentives are provided such as free access to the express lanes. Depending on the level of support of the local transportation agencies and the acceptance of the facility users, it may take 2 to 5 years before there are sufficient CACC vehicles for the tests and initial deployment following Scenario 2 and 3.

The V2I speed harmonization application will require the development of a V2I communications system (either cellular or DSRC based) and the deployment of a centralized traffic management system at the Traffic Management Center (TMC) that could take anywhere from 1 to 3 years. The first scenario of the V2I speed harmonization application can take advantage of existing cellular networks. It only requires the installation of the centralized controller at the TMC and the recruitment of several testing vehicles and their drivers with wireless communication devices. This scenario should be ready to test in the next 1 or 2 years. The second scenario of the application needs V2I transponders along the managed lane facility with the spacing of several hundred meters. Since this scenario requires real-time speed control by the roadside units, the centralized controllers need to be built into individual roadside units as well. The requirement of the infrastructure support is more intense than the first scenario. For this reason, the initial testing and deployment of the second scenario may need a substantially longer time than the first one.

The freeway merge coordination application relies on infrastructure support including the development of a V2I communications system (DSRC based) and the deployment of a centralized traffic control system. The effectiveness of the merge coordination application can be tested once the infrastructure and control system are ready at one merging area. The initial tests can be performed if there are at least two testing vehicles equipped with the connected system and/or the automated speed controller (see study in ⁴ for an example). Such a test may be conducted within the next 1 or 2 years. The test of the systematic influence of the application requires roadside units to be installed at several consecutive on-ramp locations. This will take much longer time.

The automated bus applications both require development of specialized automated vehicles. The PATH team has implemented a Level 1 automated bus in Oregon to improve the Bus Rapid Transit service⁵. The PATH automated bus system adopts a magnetic referencing system to help the buses perform automated lateral control. The human drivers are only responsible for the longitudinal control. This technology is ready for the testing and initial deployment at the managed lane facilities if the magnetic referencing system is installed. PATH estimates that it

³ https://www.its.dot.gov/research_archives/safety/cv_safetypilot.htm

⁴ Scarinci, R., Hegyi, A., & Heydecker, B. (2017). Definition of a merging assistant strategy using intelligent vehicles. *Transportation research part C: emerging technologies*, 82, 161-179.

⁵ Tan, H. S., Huang, J., Bu, F., Dicky, S., Nelson, D., Liang, T., ... & Zhang, W. B. (2017). *Vehicle Assist and Automation Demonstration Report* (No. FTA Report No. 0113).

will take about half a year to install the magnets along a 10-kilometer automated bus route planned for Shanghai, China. With respect to the I-10 and I-15 Express Lanes, it would take anywhere from 6 months to a year to upgrade the infrastructure if the PATH Level 1 automated bus is to be used for testing. The PATH team is also developing Level 2 systems that will utilize on-board radar and LIDAR sensors for lane keeping, and ACC/CACC system for car following. This new technology development might take 3 to 5 years before it is ready to test at a managed lane site. Level 4 automated bus systems that operate at highway speeds have not been tested yet so it will be at least 5 years before they are ready for testing and early deployment on California Managed Lanes.

The automated barrier mover vehicles have relatively small demand since there are so few in operation in the United States. The manufacturers may not have a big incentive to develop fully automated vehicles soon. If this application is to be seriously considered for testing at the I-15 site, we need to work closely with the manufacturer to explore the possibility of automating the vehicle.

4.3.2 Test Vehicles, Fleets and Drivers

The highway CACC application requires that the test vehicles are equipped with the CACC system. The PATH team has developed and tested CACC systems for passenger cars and trucks. The technology is ready for small-scale tests of several CACC vehicles at the two recommended sites, which should be sufficient for scenario 1. However, scenarios 2 and 3 require a higher CACC market penetration (e.g., more than 10%) before we can evaluate the impacts of the CACC vehicles on the corridor level traffic performance⁶. Also, increasing the fleet size and user acceptance of the system may take many years and need close collaboration between the public and private stakeholders.

The V2I speed harmonization and merge assistance application can be deployed using vehicles with Level 0 automation if the drivers can receive information wirelessly from the centralized controller. Since the drivers will have a choice whether or not to follow the speed instructions from the roadside units, the driver compliance level should be considered in the tests. As vehicles transition from level 0 to level 1 automation, the two applications can take advantage of the new technology by sending those vehicles customized speed commands. Recent studies (e.g., see ^{7, 8}) reported that the traffic stream performance can be substantially improved if a few vehicles follow the advisory speed of the speed harmonization algorithm. In this case, we may only need a small fleet (e.g., 20 – 50 vehicles) to start the testing and initial deployment of the

⁶ Liu, H., Kan, D., Shladover, S.E., Lu, X.Y., Ferlis, R. (2018). Impact of Cooperative Adaptive Cruise Control (CACC) on Multilane Freeway Merge Capacity. *Journal of Intelligent Transportation Systems*, VOL. 22, NO. 2, 1–13.

⁷Ghiasi, A., Ma, J., Zhou, F., & Li, X. (2017). Speed Harmonization Algorithm Using Connected Autonomous Vehicles. In *96th Annual Meeting of the Transportation Research Board, Washington, DC*.

⁸ Yang, H., & Rakha, H. (2017). Feedback control speed harmonization algorithm: Methodology and preliminary testing. *Transportation Research Part C: Emerging Technologies*, 81, 209-226.

two applications. We can measure how the impact changes with market penetration as more vehicles are equipped with the required CAV systems.

The successful testing and pilot deployment of the automated bus rapid transit application heavily relies on the availability of the test vehicles. An automated bus like the one developed by PATH could be made available for testing at sites that have the magnetic referencing system. If such an infrastructure support is not available at the testing and deployment sites, we will need to use automated buses that are equipped with automated lane keeping and/or ACC/CACC systems. The Federal Transit Administration (FTA) has proposed a 5-year strategic transit automation research plan⁹. The plan promotes the development of Level 1 to Level 2 transit buses that can perform tasks such as precision docking, platooning, and smooth acceleration and deceleration. The Level 4 automated bus rapid transit is also considered in the plan. The plan also presents a good funding opportunity for California if they wish to test automated BRT at the two recommended managed lane sites.

Development of an automated barrier mover vehicle will need close involvement and support from the vehicle manufacturer. If this application is to be seriously considered for testing at the I-15 site, we need to work closely with the manufacturer to explore the possibility of automating the vehicle.

4.3.3 Infrastructure Requirements

The highway CACC application does not need any infrastructure modifications since it only relies on V2V communications. It can be tested within the existing managed lane facilities.

The V2I speed harmonization and freeway merge coordination need to use centralized traffic controllers at the TMC or on the roadside and some type of wireless communication system. Those systems may not be readily available and thus require new infrastructure construction or upgrades. Existing systems and models should be leveraged whenever possible. For the V2I speed harmonization application, initial testing and deployment can utilize the existing cellular network. In this case, only the centralized controller needs to be implemented at the TMC and existing systems such as the I-15 ICM system can be leveraged to develop the central control algorithms. When more advanced algorithms are used for sending customized speed to individual vehicles, the V2I communication devices should be built along the freeway such that they can provide continuous coverage of the wireless communication over the concerned corridor. This demands more intensive infrastructure adjustment and more sophisticated central control scheme. The V2I merge coordination may require less infrastructure support than the V2I speed harmonization application since it only requires roadside infrastructure at merge points rather than along the entire corridor.

⁹ <https://www.transit.dot.gov/automation-research>

The automated bus application may need infrastructure adjustment if the magnetic referencing system is used. In this case, the magnets should be planted along the bus route at 1-meter intervals. Alternatively, if the automated bus uses on-board sensors and on-board processing to perform automated lane keeping and car following, the system constraints on infrastructure can be relaxed.

The automated barrier mover vehicle application may need some infrastructure enhancements such as the addition of reference markings to help guide the vehicle. It can be tested within the existing I-15 Express Lanes.

4.3.4 Expected Benefits

The highway CACC application is expected to improve the capacity of the managed lane by allowing the operation of CACC strings. The effectiveness of the string operation can be further improved if a dedicated CACC lane is used within the managed lane facility. In addition to the capacity improvement, this application can also stabilize the traffic flow because vehicles in the strings can react almost simultaneously to the traffic disturbances. Since the CACC controller has a shorter perception-reaction time than human drivers, the application may also reduce the rear-end collisions frequently caused by drivers' distraction and drowsiness.

The V2I speed harmonization can delay or eliminate the traffic breakdown at bottleneck areas by asking the traffic upstream from a bottleneck area to travel at a speed lower than the free flow speed. This application causes a minor and artificial congestion region upstream from the bottleneck, thereby reducing input flow to the bottleneck area. As a result, the bottleneck area can always operate at capacity during the peak hours, without suffering the capacity drop observed in congested freeway segments. This application also reduces the likelihood of rear-end collisions in bottleneck areas since drivers will be slowing down prior to reaching the congestion.

The freeway merge coordination can smooth the merging behavior of the on-ramp vehicles. This reduces the traffic disturbances caused by the merging traffic, resulting in the delay or elimination of the traffic breakdown at the merge bottlenecks. Similar to the speed harmonization, this application can also help avoid freeway capacity drop due to the traffic breakdown. Also, this application should improve safety by making it easier for vehicles to merge safely into mainline traffic.

The automated bus application may reduce the cost of operating the bus services. It may also enable the transportation agencies to offer more frequent bus services with higher operation efficiency of the bus lane. Additionally, the application may bring about safety benefits as the driving tasks for bus drivers become less after the implementation of the automated bus systems.

The automated barrier mover vehicle application is expected to reduce the time needed to adjust the lane configuration of the I-15 express lane facility. This is expected to reduce the traffic

delays caused by unexpected incidents in the express lane. The automated barrier mover vehicle application may also reduce operational costs.

5. Conclusion

To conclude this report, we provide a summary of major findings and present recommended next steps below.

5.1 Summary

Connected and automated vehicles hold the potential for substantial improvements to traffic safety, travel time reliability, roadway capacity, and environmental impacts and managed lanes have the potential to be ideal testbeds for CAV technologies. The purpose of this report is to identify specific opportunities to leverage California's managed lane network as early experimental and pilot deployment sites for CAVs. To this end, we have conducted a detailed inventory of the managed lane facilities in California and applied evaluation criteria to identify two promising sites for future CAV tests and initial deployments. Our study recommends the I-15 Express Lanes in San Diego and the I-10 Express Lanes in Los Angeles for future CAV tests.

In this report, we have also documented the major CAV applications that are being considered by USDOT for near-term deployment. After assessing which of the CAV applications are best suited for deployment in managed lanes, we selected the following five applications to be considered for testing in the two California sites: highway CACC, V2I speed harmonization, freeway merge coordination, automated bus rapid transit, and automated barrier mover vehicle.

Next, we presented conceptual test and deployment plans for those five CAV applications along with various testing scenarios. We then presented an analysis of the likely timeline for testing and pilot deployment and related vehicle and infrastructure requirements of those applications. For most of the applications, there will be at least two years of preparation required before testing or initial deployment can occur. Finally, our report describes the expected benefits of deploying the selected CAV applications at the proposed sites including increased capacity, reduced congestion and smoother traffic flow in managed lanes and some related improvements to safety.

5.2 Next Steps

We anticipate that the results of this study will generate greater interest in CAV testing and deployment in managed lanes in California. The I-15 Express Lanes in San Diego and the I-10 Express Lanes in Los Angeles should be considered as prime candidates for near-term CAV testing and the five applications that we have identified should be considered as logical candidates for initial deployment. After a period of initial testing and pilot deployments, California could decide which CAV applications are ready for wider deployment in managed lanes throughout the state. With this in mind, the PATH study team recommends the following next steps for Caltrans to move this concept forward:

- Explore opportunities to fund CAV field tests at the I-15 and I-10 Express Lane sites and promote these sites as prime candidates for early CAV testing. There are many federal funding programs that could support this type of project including the USDOT's ongoing Advanced Transportation and Congestion Management Technologies Deployment (ATCMTD) grant program, the Federal Transit Administration (FTA) transit automation grant programs and the recent Federal Motor Carrier Safety Administration (FMCSA) Automate Vehicle grant program. These programs often require a local match so Caltrans would need to identify matching funds or bring in local partners with matching funds.
- Build partnerships with local stakeholders to get buy-in and support for the CAV testing and pilot deployment concepts. For the I-15 site this would include Caltrans District 11, SANDAG and a transit agency such as San Diego Metropolitan Transit System. For the I-10 site this would include Caltrans District 7, LA Metro and possibly another transit agency.
- Explore and promote opportunities to combine the CAV testing concepts for the I-15 and I-10 sites with a possible CAV demonstration at the ITS World Congress in Los Angeles in 2020. Both sites are in southern California and many of the applications could be deployed within a two-year period. Since this event is only a little over two years away, these discussions would need to begin as soon as possible and should involve a broad group of stakeholders including local agencies in Southern California, USDOT, ITS America and the 2020 ITS World Congress Planning Committee.
- Develop more detailed plans for CAV testing and early deployment at the I-15 and I-10 sites. These more detailed plans should consider the possible synergies and issues associated with bundling various CAV applications. Also, the different testing scenarios should be fleshed out in greater detail, taking into account the specific geometry and traffic patterns of each site and the scenarios should be tested in microscopic simulations before being deployed in the field.
- Once specific CAV applications are selected for actual testing and pilot deployment, the CAVs will need to be developed in partnership with a vehicle manufacturer and tested on a test track prior to being deployed in the field.