

# UC San Diego

## San Diego Linguistic Papers, Issue 3

### Title

Aspectual Verbs and the Aspect Phrase Hypothesis

### Permalink

<https://escholarship.org/uc/item/9pj2s50f>

### Author

Fukuda, Shin

### Publication Date

2008-05-29

## Aspectual Verbs and the Aspect Phrase Hypothesis\*

Shin Fukuda

University of California, San Diego

Since influential work by Perlmutter (1968, 1970), the standard analysis of English aspectual verbs (EAVs) is that they are ambiguous between control and raising verbs. In this paper, I first argue against the control/raising analysis of EAVs by showing that: (i) there is no clear evidence that any EAV is thematic and (ii) there is no clear evidence that EAVs form bi-clausal sentences. As an alternative, I propose that EAVs are functional heads projecting their own phrases, or *aspect phrases* (Travis 1991), in two different positions in a clause: inside the verbal projection (between *v* and VP) or outside it (immediately above *vP*). The difference in the position of an EAV is spelled out as two different forms of their complements. When an EAV is between *v* and VP, it is realized as a gerundive. When an EAV is above *vP*, it is realized as an infinitive. I argue that the analysis accounts for the evidence used to motivate the control/raising analysis as well as previously overlooked differences among EAVs. Further arguments for the proposed analysis of EAVs are provided by data from aspectual verbs in other languages.

### 1. The control/raising analysis of English Aspectual Verbs

#### 1.1. Arguments for the Control/raising Analysis

Since Perlmutter (1968, 1970), the standard assumption has been that English Aspectual Verbs (EAVs) are ambiguous between control and raising predicates.<sup>1</sup>

The arguments for the raising analysis come from the fact that English aspectual verbs can have non-thematic subjects. They allow for expletive subjects (1a-b), exhibit active/passive synonymy (2), and permit idiom chunks to maintain their idiomatic meanings (3).

- |     |    |   |                              |
|-----|----|---|------------------------------|
| (1) | a. | There began to be commotion.                | (Perlmutter 1970: 108, (6))  |
|     | b. | It began to rain.                           | (Perlmutter 1970: 109, (7))  |
| (2) | a. | The noise began to annoy Joe.               |                              |
|     | b. | Joe began to be annoyed by the noise.       | (Perlmutter 1970: 109, (9))  |
| (3) | a. | Heed began to be paid to urban problems.    | (Perlmutter 1970: 110, (12)) |
|     | b. | Headway began to be made toward a solution. | (Perlmutter 1970: 110, (13)) |

---

\* This paper is a revised and extended version of a paper presented at WCCFL 26 at UC Berkeley. I would like to thank Henry Beecher, Ivano Caponigro, Mark Gawron, George Gibbard, Alex del Giudice, Grant Goodall, Peter Jenks, Laura Kertz, Cynthia Kilpatrick, Dan Michel, John Moore, Masha Polinsky, Hannah Rohde, Barbara Stiebels, and the audience at WCCFL 26 for their helpful comments and suggestions. Needless to say, all the remaining errors are my own. This work was supported in part by NSF grant BCS-0131946.

<sup>1</sup> In the terminology used in Perlmutter (1968, 1970), a raising verb is an intransitive verb that takes a clausal complement and a control verb is a transitive verb which requires identity between its own subject and the subject of the complement, triggering Equi(valent)-NP deletion.

The arguments for the control analysis come from the fact that there seem to be cases where the subjects of aspectual verbs must be thematic. First, aspectual verbs can be embedded under a subject or object control verb (4a and 4b). Second, aspectual verbs are compatible with the imperative (5).

- (4) a. I tried to begin to work. (Perlmutter 1970: 111, (20))  
 b. I forced Tom to begin to work. (Perlmutter 1970: 112, (23))
- (5) Begin to work. (Perlmutter 1970: 113, (25))

In the transformational grammar framework, (4) was taken to show that aspectual verbs select an animate subject in order for ‘Equi-NP deletion’ to take place. Likewise, (5) suggests that aspectual verbs can select a second person subject (5). Ross (1972) provides further support for the control/raising analysis of English aspectual verbs, arguing that only control verbs allow for what he calls Anaphoric Complement Deletion (ACD) (6):

- (6) a. Max suggested writing to Santa Claus, and Teddy agreed/began/approved ~~to write~~  
~~him~~. (Ross 1972: 576, (8))  
 b. \*It’s supposed to be muggy tonight, but it hasn’t begun yet ~~to be muggy~~.  
 (Ross 1972: 576, (9a))

Using ACD as a diagnostic test, Ross argues that *cease* can only be a raising verb, unlike *stop*:

- (7) I suggested that they not shriek anymore, so they stopped/\*ceased.  
 (Ross 1972: 576, (11a))

Ross also claims that *finish* can only be a control verb, since it is incompatible with the weather *it* (8). In contrast, *stop* can be either a control or a raising verb, given (7) and (8):

- (8) It stopped/\*finished being muggy. (Ross 1972: 576, (10a))

## 1.2. Problems for the Control/raising Analysis

Although the arguments for the raising analysis of English aspectual verbs remain virtually unchallenged, the arguments for the control analysis are not as decisive and they have been challenged by a number of subsequent studies (Fischer and Marshal 1969, Givón 1973, Newmeyer 1975, Freed 1979, Brinton 1988, Rochette 1999). First, as for the arguments presented in Ross (1970), ACD in (6) does not seem to be a syntactic process, since it does not require syntactic identity between the deleted element and its antecedent (i.e. 6a). The claim that *finish* is incompatible with the weather *it* (8) is not supported by empirical evidence, as naturally occurring examples of ‘finish’ with the weather *it* such as (9) are not difficult to find.

- (9) a. The best part is that when *it*’s finished raining, all the plants and trees have suddenly...<sup>2</sup>  
 b. After *it* finished raining we went down to Divi Village’s new pool.<sup>3</sup>

<sup>2</sup> <http://andrasue.blogspot.com/>

<sup>3</sup> <http://tripreports.visitaruba.com/>

Moreover, both Newmeyer and Brinton argue that aspectual verbs are transparent with respect to selectional restrictions, even when they are embedded under a control verb, as in (4). Their argument is based on examples such as (10) (Newmeyer 1975: 33-34, Brinton 1988: 65).

- (10) a. John asked him to listen/#hear.  
b. John began to listen/hear.  
c. John asked him to begin.  
d. John asked him to begin to listen/#hear.

(10a) shows that *hear* cannot be embedded under *ask* while *listen* can. (10b) shows that *begin* does not impose such selectional restrictions and (10c) shows that *begin* can also be embedded under *ask*. Assuming that selectional restrictions are local, one would expect that *begin to hear* should embed under *ask*, given (10b) and (10c). Instead, (10d) shows that the selectional restriction conflict between *ask* and *hear* in (10a) still has its effects in (10d). Thus, Newmeyer and Brinton argue that aspectual verbs are transparent with respect to selectional restrictions and cannot be control verbs. These counterarguments leave the imperative evidence in (5) as the only valid argument for the control analysis of aspectual verbs.<sup>4, 5</sup>

On the other hand, assuming that aspectual verbs are pure raising verbs raises additional problems. First, this leaves the imperative evidence in (5) unaccounted for. Second, under a raising analysis, sentences with English aspectual verbs must be bi-clausal, following the standard assumption that the complement of a raising verb is a TP. However, evidence discussed in the literature suggests that complements of English aspectual verbs are smaller than a TP. English infinitives have been analyzed as consisting of their own tense, based on the fact that infinitives can have a time adverbial that is in conflict with another time adverbial modifying the matrix event, as shown in (11a-b) (Bresnan 1972, Stowell 1982, Pesetsky 1991, Bošković 1997, Landau 2000, Martin 2001).

- (11) a. Yesterday, John decided to leave tomorrow.  
b. Today, John hopes to win someday.

Since the infinitival complement in these cases denotes a yet-to-be-realized event, the tense specification of such complements has been called the ‘unrealized future tense’. Aspectual verbs, however, are known to disallow the ‘unrealized future’ interpretation.

- (12) a. ??Yesterday, John began to leave tomorrow.  
b. ??Today, the law ceased to have its effect tomorrow.

---

<sup>4</sup> Another argument that Perlmutter presents is the distribution of *do so* anaphora. Perlmutter claims that a *do so* anaphor can replace an aspectual verb when it is a control verb (ia) but cannot when it is a raising verb (ib).

- (i) a. Warren tried to begin to work and Jerry tried to do so too.  
b. \*Oil began to gush from the well and water did so too.

However, Newmeyer argues that the unacceptability of (ib) has to do with the definiteness of the arguments, given that (ii) is acceptable (Newmeyer 1975: 31, fn. 7).

- (ii) *The* oil stopped gushing from the well and *the* water did so too.

<sup>5</sup> Perlmutter (1970) also points out that aspectual verbs take an NP complement, unlike typical raising verbs. However, I focus only on cases with clausal complements in this paper. For recent discussion of aspectual verbs with NP complements, see Thompson (2005) and Pykkänen and McElree (2006).

Nonetheless, lack of an independent time specification in the infinitive complements of aspectual verbs does not necessarily mean that these complements lack tense. For instance, Landau (2000) claims that the tense of infinitive complements that cannot have their own time specification is anaphoric with the matrix tense. Nevertheless, there is evidence that the complements of aspectual verbs lack projections of grammatical aspect, which has been argued to be lower than TP. Akmajian, Steele, and Wasow (1979) show that the complements of aspectual verbs cannot encode grammatical aspect, neither progressive nor perfective (13). This is in contrast with other verbs that also take nonfinite complements but allow for both (14).

- (13) a. \*He began [<sub>Progressive</sub> being running down the road].  
 b. \*He began [<sub>Perfective</sub> to have finished his homework].  
 (Akmajian et al. 1979: 40, (112))
- (14) a. We'll try to make him [<sub>Progressive</sub> be singing "Coming through the Rye"] when....  
 (Akmajian et al. 1979: 40, (115a))  
 b. I will try [<sub>Perfective</sub> to have finished the work] by the time...  
 (Akmajian et al. 1979: 43, (125))

Given the hierarchical order of tense and the grammatical aspect markers such as 'be' and 'have' in English, (13) requires one of the following two options to be true: (i) the complements of aspectual verbs lack the tense projection and grammatical aspect projection altogether; or (ii) they do have the tense projection (anaphoric with the matrix tense) but lack the grammatical aspect projection. Due to lack of independent support for (ii), I assume (13) shows that complements of aspectual verbs do not contain a tense projection or grammatical aspect projection.<sup>6</sup> Thus, English aspectual verbs cannot be raising verbs, given the standard assumption that sentences with raising predicates are bi-clausal.

In sum, the control/raising analysis of English aspectual verbs appears untenable given the evidence that aspectual verbs fail to behave as control or raising verbs. An analysis of English aspectual verbs, therefore, must account for the fact that they are non-thematic without assuming that they are raising verbs. At the same time, it must also account for the fact that English aspectual verbs are compatible with the imperative without assuming that they are control verbs.

## 2. Proposal: EAVs as Heads of Aspect Phrases

In order to account for the problematic behavior of English aspectual verbs, I propose that they are functional heads which appear in two positions in a clause: between  $\nu$  and VP and immediately above  $\nu$ P. The hypothesis that there is a functional projection within the verbal projection (VP or  $\nu$ P) has been proposed in many studies, such as Sportiche (1990, 1998), Travis (1991), Koizumi (1994), Collins and Thráinsson (1996) and Hallman (2004). Given that EAVs encode aspectual information about events, I call their projections *aspect phrases*, following Travis (1991). Moreover, the projection of aspect above  $\nu$ P is called *H(igh)-Asp(ect)* and the one that is between  $\nu$  and VP is called *L(ow)-Asp(ect)*. Finally, I argue that the difference in the position of EAVs is visible in syntax: the complement of H-Asp ( $\nu$ P) is realized as an *infinitival complement* (15a) and the complement of L-Asp (VP) is realized as a *gerundive complement* (15b).

<sup>6</sup> See also Wurmbrand (2006, 2007) for arguments that English infinitives do not have tense even when they have the 'unrealized future' reading.

(15) a. Bill started to run.

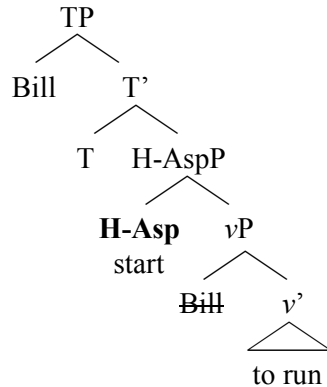

b. Bill started running.

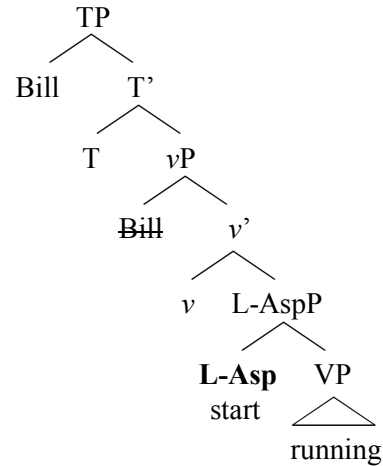

The proposed analysis is different from the control/raising analysis of aspectual verbs in several important ways. First, the control/raising analysis assumes a bi-clausal structure whereas sentences with aspectual verbs are mono-clausal in the proposed analysis. Second, the control/raising analysis assumes that aspectual verbs assign a theta role to their subjects when they are control verbs. In the proposed analysis aspectual verbs are functional heads and never bear theta roles. Third, the control/raising analysis has very little to say about the two different complement types, infinitive and gerundive. In the proposed analysis, the difference in selection of two complement types is a consequence of the two possible positions for aspectual verbs in the proposed analysis. Crucially, aspectual verbs which take either type of clausal complement (e.g. *begin*, *start*, *continue* or *cease*) can appear either as H-Asp or L-Asp, whereas aspectual verbs that take only a gerundive complement (e.g. *stop* and *finish*) can only be L-Asp. In the remainder of this paper, I motivate the proposed analysis for EAVs with both language-specific and cross-linguistic arguments.

### 3. Arguments for the Aspect Phrase Analysis

#### 3.1. The Size of Infinitives and Gerundives

Immediate consequences of analyzing infinitives and gerundives under EAVs as vPs and VPs is that such an analysis accounts for both (i) the lack of evidence for a tense projection (12) and (ii) the evidence for the lack of the grammatical aspect projection (13) in the complements of aspectual verbs. If infinitives and gerundives under aspectual verbs are vPs and VPs, respectively, neither tense nor grammatical aspect can be present in these complements.

There is also evidence that infinitives under aspectual verbs are structurally larger than gerundives in the same environment. The evidence comes from the interpretation of certain adverbs. English has adverbs such as *stupidly* that can be ambiguous between a speaker-oriented reading, which is generally associated with a relatively high syntactic position, and a manner reading, which is generally associated with a relatively low syntactic position. Interestingly, when such an ambiguous adverb occurs within the clausal complement of an aspectual verb, its possible interpretations differ according to the nature of the complement. Four native speakers that I consulted interpreted *stupidly* as either a speaker-oriented adverb only or as ambiguous between the two possible readings when it immediately preceded an infinitive (16a), whereas the

same adverb was only interpreted as a manner adverb when it immediately preceded a gerundive (16b).

- (16) a. ...found everyone around me grew quiet as I began *stupidly to say* what I really think.<sup>7</sup>  
 b. ...found everyone around me grew quiet as I began *stupidly saying* what I really think.

First, the observation that the speaker-oriented reading of *stupidly* is only available with an infinitive supports the claim that infinitives are structurally larger than gerundives. Speaker-oriented adverbs are generally associated with the CP domain (Alexiadou 1997, Cinque 1999). However, the evidence presented earlier ((12) and (13)) strongly suggests that infinitives under EAVs are unlikely to be even TPs, much less CPs. Given the grammaticality of (16a), I argue that an infinitive under EAVs is a *vP*, based on assumptions that speaker-oriented adverbs minimally require a proposition as their complement and a *vP* is a smallest syntactic unit with which a complete proposition can be syntactically represented (see Bale 2007 for a relevant discussion). Second, the observation that the same adverb *stupidly* can only be interpreted as a manner adverb with a gerundive (16b) suggests that a gerundive cannot be a *vP* under the adopted assumptions. A reasonable analysis appears to be that a gerundive under EAVs is a VP, given that manner adverbs are generally associated with VPs. Finally, the availability of the manner reading of *stupidly* with the infinitive is consistent with the analysis that an infinitive is a *vP*, since a *vP* embeds a VP.

Further support for the claim that infinitives under EAVs are larger than gerundives in the same environment comes from differences in their selectional restrictions (Bolinger 1968, Freed 1979, and Brinton 1988). The examples in (17) below show that gerundives under aspectual verbs force a single event interpretation of the embedded verb, making these sentences very awkward. In contrast, infinitives in the same environment do not impose such an interpretation and allow for a reading in which the same event is repeated multiple times.

- (17) a. That never ceases to amaze/??amazing me.  
 b. That student continued to fall asleep/??falling asleep in my class.

A sharper contrast can be seen with embedded statives. Gerundives under aspectual verbs simply cannot have a stative verb, unlike infinitives.

- (18) a. The problem ceased to exist/\*existing.  
 b. Nora began to know/\*knowing right from wrong.

Thus, the evidence suggests that infinitives under aspectual verbs are larger than gerundives in the same environment. Specifically, the possible interpretations of the adverb *stupidly* suggest that infinitives are *vPs*, while gerundives are VPs.

### 3.2. Quantifier Scope

The second argument for the proposed analysis is the ambiguity resulting from the interaction between a quantifier in subject position and aspectual verbs. May (1985) points out that raising predicates interact with a quantifier in subject position and create ambiguity. In (19) below, a

<sup>7</sup> <http://www.bat-girl.com/archives/000528.php>

quantifier *someone* is ambiguous between a specific reading (19a) and an existential reading (19b).

- (19) Someone from NY is likely to win the lottery.  
a. There is a person from NY who is likely to win the lottery. (specific)  
b. It is likely that a person from NY will win the lottery. (existential)

Under the raising analysis, the quantifier in subject position, *someone*, is base-generated as the embedded subject and undergoes A movement to become the matrix subject. The existential interpretation of *someone* obtains because *someone* is under the scope of *be likely* in its base-generated position, and the specific interpretation of *someone* obtains because *someone* ends up taking scope over ‘be likely’ after moving to the matrix subject position.

The proposed analysis predicts that a similar ambiguity should obtain with an aspectual verb in H-Asp, since the subject is under the scope of H-Asp in its base-generated position (Spec of *vP*), but it ends up taking scope over H-Asp once it moves to Spec of TP. On the other hand, such an ambiguity is not expected with L-Asp, which is lower than *vP*. This prediction is borne out. According to four native speakers consulted, ‘someone’ is ambiguous between the existential and specific reading with an infinitive complement under an aspectual verb in H-Asp (20a), whereas no ambiguity is found with a gerundive complement under an aspectual verb in L-Asp (20b).<sup>8</sup>

- (20) a. Someone from NY started to win the lottery. (infinitive = H-Asp)  
i) someone > start (specific)  
ii) start > someone (existential)  
b. Someone from NY started winning the lottery. (gerundive = L-Asp)  
i) someone > start (specific)  
ii) ??start > someone (existential)

Therefore, the contrast in the possible scope interactions between (20a) and (20b) supports the proposed analysis of EAVs.

### 3.3 Quantifier Float

Cable (2004) argues that certain English predicates, such as *try*, instantiate restructuring when they take a gerundive complement. One of his arguments for the restructuring analysis of predicates such as *try*, as opposed to non-restructuring predicates such as *prefer*, is distribution of floating quantifiers. Under the bare VP complement analysis of restructuring (See Wurmbrand 2001 for references and a comprehensive discussion of the VP complement analysis of restructuring), a gerundive complement of a restructuring predicate is subject-less. Assuming that a floating quantifier *all* must be in a local and c-commanding relation with the NP with which it is associated, *all* is predicted to be not licensed with a bare VP complement under a restructuring predicate.<sup>9</sup> Cable shows that the prediction is borne out, based on the contrast in the

<sup>8</sup> The scenario given to the native speakers for (20) is the following. The state of NY established a lottery ten years ago. In the first few years, people from other states kept winning the lottery. Five years ago, someone from NY finally won the lottery, and since then, the lottery has always been won by someone from NY.

<sup>9</sup> This prediction is based on the distribution of ‘all’ and it holds whether one assumes the stranding analysis or the adverbial analysis of floating quantifiers. See Bobaljik (1998, 2003) and Fitzpatrick (2006) for recent discussions of the different approaches to floating quantifiers.



grammaticality of *all* immediately preceding the gerundive complement of *prefer* (21a) and *try* (21b):

- (21) a. We would prefer *all* riding the train together.  
 b. \*We tried *all* riding the train together.

The proposed aspect phrase analysis of EAVs also predicts that a floating *all* would be ungrammatical with a gerundive complement of EAVs, which is a subject-less VP, while a floating *all* would be grammatical with an infinitive complement of EAVs, which is a vP. This prediction is borne out with the results of online searches for naturally occurring examples of floating *all* in the complement of EAVs. Using the search engine Google, naturally occurring examples of *all* adjoined to an infinitive or gerundive complement of EAVs were searched for. In order to find relevant examples, two strings, *aspectual verb+to+all* and *aspectual verb+all+verb*, with an EAV in either present tense or past tense were searched for, using three EAVs that take either infinitive or gerundive complement: *begin*, *continue* and *start*. The first two hundred hits of each of the four strings for three EAVs (a total of 2400 hits) were manually examined to look for the relevant examples. Table 1 below summarizes the results:

Table 1: Results of On-line Search for ‘floating *all*’ embedded under aspectual verbs

	present+to+all+ verb (token/type)	past+to+all+ verb (token/type)	present+all+ verb-ing (token/type)	past+all+ verb-ing (token/type)
<i>begin</i>	100/44	83/43	0/0	1/1
<i>continue</i>	21/13	4/4	0/0	0/0
<i>start</i>	19/12	101/44	0/0	0/0
total	140/69	188/91	0/0	1/1

The results show a clear difference between infinitive and gerundive with respect to their compatibility with *all*. While naturally occurring examples of *all* adjoining to an infinitive complement under an aspectual verb are abundant (total 328), there is only one naturally occurring example of *all* adjoining to a gerundive complement under an aspectual verb.<sup>10</sup> (22a) to (22d) are some of the examples of ‘all’ with an infinitive complement. (23) is the only example of *all* with a gerundive that was found:

- (22) a. ..and in the end get into a huge fight where they begin to *all* kill each other.<sup>11</sup>  
 b. we can continue to *all* work together to recognise the challenge and build on.....<sup>12</sup>  
 c. The possible knock against this album is that the songs start to *all* sound the same.<sup>13</sup>  
 d. The stories stand on their own, sharing some characters, but as the movie progresses they start to *all* knit together for the big finale.<sup>14</sup>

<sup>10</sup> Although the contrast is clear in the results of the online search, native speakers’ judgments suggest that the difference is subtle. Among the four native speakers to which I asked their judgments on sentences with ‘all’ adjoined to an infinitive and a gerundive under an aspectual verb, one speaker found no significant difference, another speaker mentioned that the gerundive examples are only slightly more unusual, while two other speakers reported the gerundive examples are clearly less acceptable.

<sup>11</sup> <http://en.wikipedia.org/>

<sup>12</sup> <http://www.naturebase.net/>

<sup>13</sup> <http://www.amazon.com/>

<sup>14</sup> <http://www.cinegeek.com/>

- (23) ...around the same time as when we blue kids began *all* sitting on the same side of the room so we could all be together for our morning ...<sup>15</sup>

Thus, the distribution of floating *all* under EAVs provides another supporting argument for the proposed analysis of EAVs.

### 3.4. Long Passive

Further support for the proposed analysis of English aspectual verbs is provided from phenomena commonly called long passive. Long passive is passivization of an embedded object with the passive morpheme appearing only on the matrix predicate. Long passive has been observed with aspectual verbs and other restructuring verbs in languages as different as Spanish (Aissen and Perlmutter 1976, 1983), German (Wurmbrand 2001), Japanese (Shibatani 1973, Nishigauchi 1993, Matsumoto 1996), Chamorro (Chung 2004) and Kannada (Agbayani and Shekar, to appear).

In Japanese, aspectual verbs can be classified into three groups based on their behavior with respect to passive. The aspectual verb *owar* ‘finish<sub>1</sub>’ only allows an embedded passive (24a); another aspectual verb, *oe* ‘finish<sub>2</sub>’, only allows long passive (24b), while two other aspectual verbs, *hajime* ‘begin’ and *tsuzuke* ‘continue’, allow both options (25) (Shibatani 1973, Nishigauchi 1993, Matsumoto 1996).<sup>16</sup>

- (24) a. Rombun-ga [t<sub>i</sub> kak -are] -owar (\*-are) -ta  
 paper-NOM [t<sub>i</sub> write -PASS] -finish<sub>1</sub> (\*-PASS) -PERF  
 ‘That paper finished being written.’ (embedded passive only)
- b. Rombun<sub>i</sub>-ga[t<sub>i</sub> kaki (\*-are) oe] -rare -ta  
 paper<sub>i</sub>-NOM [t<sub>i</sub> write (\*-PASS) finish<sub>2</sub>] -PASS -PERF  
 ‘That paper finished being written.’ (long passive only)
- (25) a. Rombun-ga [t<sub>i</sub> kak -are] -hajime/tsuzuke -ta  
 paper-NOM [t<sub>i</sub> write -PASS] -begin/continue -PERF  
 ‘That paper began/continued to be written.’ (embedded passive)
- b. Rombun<sub>i</sub>-ga[t<sub>i</sub> kaki hajime/tsuzuke] -rare -ta  
 paper<sub>i</sub>-NOM [t<sub>i</sub> write begin/continue] -PASS -PERF  
 ‘That paper began/continued to be written.’ (long passive)

While previous analyses attempted to account for the pattern in (24) and (25) based on the assumption that Japanese aspectual verbs are either control or raising verbs that may involve restructuring or reduced complements (Nishigauchi 1993, Kageyama 1993, 1999, Matsumoto 1996, Koizumi 1998), I proposed in Fukuda (2006, 2007) that these aspectual verbs are heads of functional projections which can appear in two different positions: L-Asp (below *v*P) and H-Asp (above *v*P). Under such an analysis, the regular embedded passive is the only option with an aspectual verb in H-Asp, since the passive morpheme must precede the aspectual verb, assuming that the passive morpheme occupies the *v* position (Krazter 1994, 1996, Chomsky 1995 among

<sup>15</sup> <http://uncpress.unc.edu/>

<sup>16</sup> Abbreviations: NOM = nominative, ACC = accusative, PASS = passive, PERF = perfective.

others) (26a). In contrast, long passive is the only option with an aspectual verb in L-Asp, since the passive morpheme is above the position of the aspectual verb and must follow it (26b).

- (26) a. H-Asp = only embedded passive      b. L-Asp = only long passive

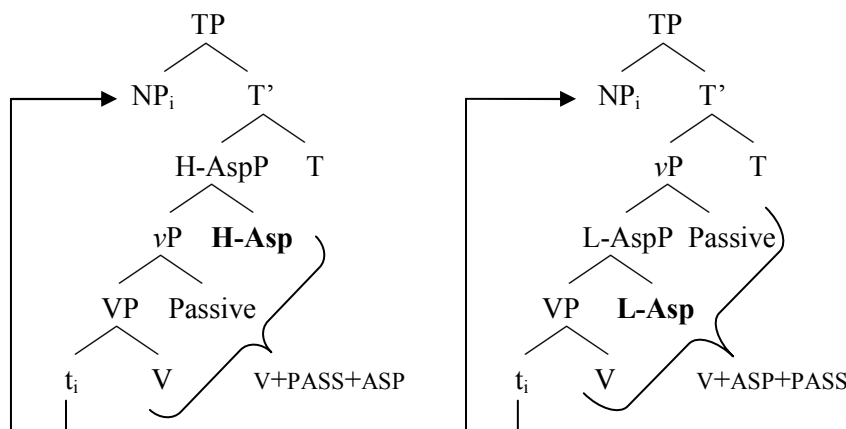

Both Wurmbrand (2001) and Cinque (2003) independently proposed similar analyses for long passive in German and in Romance languages, respectively.<sup>17</sup>

If the proposed aspect phrase analysis of EAVs is on the right track, the cross-linguistic data just discussed suggest that the long passive should also be grammatical with EAVs in L-Asp. In fact, one does not have to try too hard to find examples of apparent long passives in English:

- (27) a. When the pies and cakes were finished baking, it was about...<sup>18</sup>  
 b. Defendant waited until the sheets were finished washing and...<sup>19</sup>  
 c. The RV-9A was finished painting last Sunday.<sup>20</sup>

It appears that there are two restrictions to the apparent cases of long passive in English. First, long passive is grammatical only with *finish*, and not with other L-Asp verbs (28).

- (28) These cakes were finished/\*were continued/\*were began/\*were stopped baking.

Second, not all transitive verbs form a grammatical long passive sentence under *finish*. (29a) shows that long passive is ungrammatical with certain activity predicates, such as *watch*, while it is grammatical with another activity predicate, *bake* (29b):

- (29) a. ??These movies were finished watching.  
 b. These cakes were finished baking.

It turned out that similar observations have been made with long passive with aspectual verbs in other languages. The first restriction, that long passive is restricted to *finish*, finds its

<sup>17</sup> An important difference between Wurmbrand (2001) and Cinque (2003) is that all ‘restructuring verbs’ (which include aspectual verbs that allow for long passive) are functional heads in Cinque, whereas Wurmbrand makes a distinction between functional and lexical restructuring verbs.

<sup>18</sup> <http://www.allairevillage.org>

<sup>19</sup> <http://www.sconet.state.oh.us>

<sup>20</sup> <http://www.avsim.com>

equivalent in long passive in Spanish. Aissen and Perlmutter (1983) note that long passive is grammatical in Spanish only with completive aspect verbs, such as *terminar* ‘finish’ and *acabar de* ‘finish’:

- (30) a. Estas paredes están siendo terminadas de pintar (por los obreros)  
 these walls are being finished to paint (by the workers)  
 ‘These walls were finished being painted (by the workers),’
- b. Las casas fueron acabadas de pintar (por los obreros)  
 the houses were finished to paint (by the workers)  
 ‘The houses were finished being painted (by the workers).’  
 (Aissen and Perlmutter 1983; 390-391, (P33b) and (P34b))

Other restructuring predicates in Spanish, which otherwise show mono-clausal behavior, do not allow long passive. Moreover, in Japanese, one of the completive aspect verbs, *oe* ‘finish<sub>2</sub>’ is the only one among the four aspectual verbs discussed earlier that is restricted with long passive as seen in (24b). These observations suggest that something about aspectual verbs with completive aspect makes them particularly suitable for long passive. Thus, the fact that only ‘finish’ allows the apparent long passive in English is probably not a coincidence.

The second observation suggests that English long passive requires certain semantic types of objects. While both *watch* and *bake* are activity predicates, one way in which these verbs differ is that only an object of ‘bake’ undergoes a change of state. Whereas cakes come into their existence in baking events, movies do not change their status in watching events. In fact, the grammatical examples of long passive that I found all involve transitive verbs whose objects undergo a change of state, such as sheets that were washed (27b) and an airplane being painted (27c).

Why does long passive require an object that undergoes a change of state? I suggest that the relevant feature of the passivized object in long passive is its ability to delimit events and long passive is grammatical only with objects that delimit events. Objects of transitive verbs that undergo a change of state delimit events embedded under an aspectual verb. Thus, they make grammatical long passive sentences. On the other hand, objects of transitive verbs that do not undergo a change of state do not delimit events embedded under an aspectual verb. Therefore, they fail to make grammatical long passive.

Data from Italian discussed in Cinque (2003) appear to support this hypothesis. Cinque shows that, in Italian, long passive is grammatical with inceptive aspectual verbs (i.e. ‘begin’) and completive aspect verbs (i.e. ‘finish’) but only marginally acceptable with continuative aspect verbs (i.e. ‘continue’). With those aspectual verbs that are compatible with long passive, Cinque shows that there is an additional constraint on grammatical long passive: the passivized object must be quantized. With the same aspectual verbs, long passive is grammatical with a quantized object *due case* ‘two houses’ (32a) but ungrammatical with a bare plural object *case* ‘houses’ (32b):

- (32) a. Furuno inziare/?cominciare a costruire solo due case  
 were begun<sub>1</sub>/begun<sub>2</sub> to build only two houses  
 ‘Only two houses were begun to be built.’
- b. \*furuno inziare/comninciare a costruire case  
 were begun<sub>1</sub>/begun<sub>2</sub> to build houses  
 ‘Houses were begun to be built,’ (Cinque 2003; 56, (10))

With a quantized object, *due case* ‘two houses’, the building event in (32a) has a clear end point. In other words, the event embedded under the aspectual verb is delimited. On the other hand, the bare plural object *case* ‘houses’ does not delimit the embedded event in (32b). Thus, it appears that, in both English and Italian, the passivized object in long passive must be capable of delimiting an event embedded under a passivized aspectual verb.

Therefore, the two restrictions observed with the apparent long passive in English, (i) that only *finish* allows for long passive and (ii) that only certain transitive verbs form grammatical long passive sentences, turned out to show that English long passive shares similarities with long passive in other languages such as Japanese, Spanish, and Italian. While a careful and fully-developed analysis of English long passive is clearly necessary, the initial observations about the apparent long passive in English provide additional support for the proposed analysis of EAVs, according to which EAVs appear in two different positions in a clause, one of which is below *v*.

#### 4. Imperative Revisited

So far, I have presented several arguments for the aspect phrase analysis of English aspectual verbs. There is an important question that has been left unanswered: if, as I have argued, aspectual verbs are functional heads with no theta role, how are they compatible with the imperative?

I suggest that an explanation can be found in the two positions available to aspectual verbs. With L-Asp, an aspectual verb is first combined with VP, forming an aspect phrase (33b). This aspectual phrase is then combined with *v* (33c), which introduces the subject as its specifier (33d).

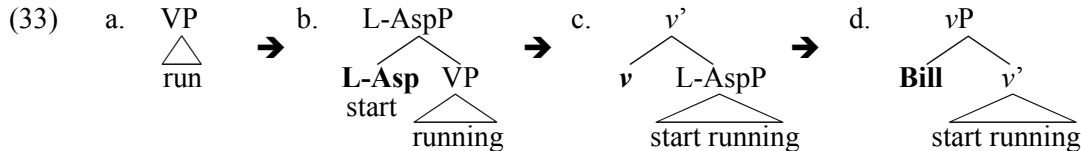

With H-Asp, on the other hand, a  $v'$  is first formed with *v* and its complement, VP (34b), and the subject is then merged to this structure,  $vP$  (34c), before an aspectual verb is introduced (34d).

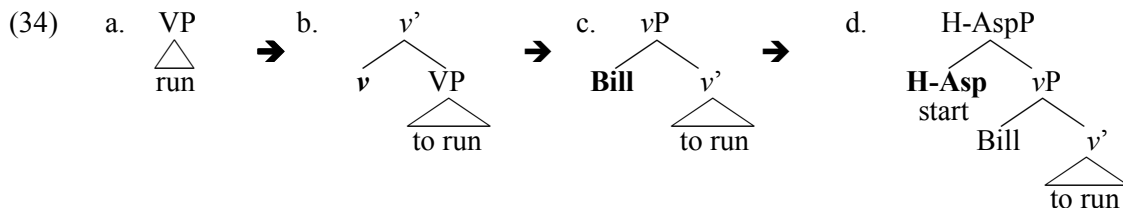

Following Kratzer (1994, 1996), I assume that *v* (*Voice* in Kratzer) creates a predication relation between the external argument in Spec of  $vP$  and its complement. Thus, only with L-Asp is the subject predicated of the aspect phrase. In other words, ‘Bill’ is the subject of ‘started running’ in (33), but in (34) it is the subject only of ‘to run’. Thus, only L-Asp in (33) has the ‘thematic’ interpretation, which inspired the original control analysis of aspectual verbs.

Now, the imperative requires an appropriate external argument (e.g. agent). Given the assumption that  $vP$  is where the external argument is introduced, I propose that the imperative formation targets  $vP$ .<sup>21</sup> Under such an analysis, the current proposal predicts that only an aspectual verb in L-Asp with a gerundive complement should be compatible with the imperative, since L-Asp is part of  $vP$ . An aspectual verb in H-Asp with an infinitival complement is not

<sup>21</sup> Unless negation is involved (see Potsdam, in press, for a recent analysis of English negative imperatives).

expected to be felicitous with the imperative, since H-Asp is above vP. Elicitations with fifteen native speakers show that this is indeed the case. They were first given a situation which can be followed by an imperative sentence, such as (35), and asked to choose between an imperative sentence with a gerundive (35a) and with an infinitive (35b). 93% or fourteen out of the fifteen native speakers chose the example with a gerundive as the more natural option.

- (35) Situation: after giving directions to a group of students who are about to write an in-class essay, the proctor says:
- a. Begin writing!! (93.3% or 14/15)
  - b. Begin to write!! (6.7% or 1/15)

Therefore, the proposed analysis makes the right prediction about imperative formation with EAVs. In contrast, the traditional control/raising analysis of EAVs does not seem to offer an account for the contrast with two different forms of the complement of EAVs with respect to imperative.

## 5. Further Arguments from Other Languages

In this section, I present further arguments for the aspect phrase analysis of EAVs from data concerning aspectual verbs in two other languages: German and Basque. German data are discussed in Wurmbrand (2001), in which the control and raising interpretations of an aspectual verb *beginnen* ‘begin’ are argued to correspond to two different syntactic positions, based on distribution of neighboring elements, such as modals. Basque data come from Arregi and Molina-Azaola (2004), in which two aspectual verbs, *hasi* ‘begin’ and *amaitu* ‘finish’, are argued to occupy two different syntactic positions, based on long-distance agreement phenomena.

### 5.1. German (Wurmbrand 2001)

Wurmbrand (2001) argues that control and raising verbs in German occupy different positions in a clause. While German raising verbs occupy the position where auxiliary verbs are found, German control verbs are found as the head of VP (Wurmbrand 2001: 206).

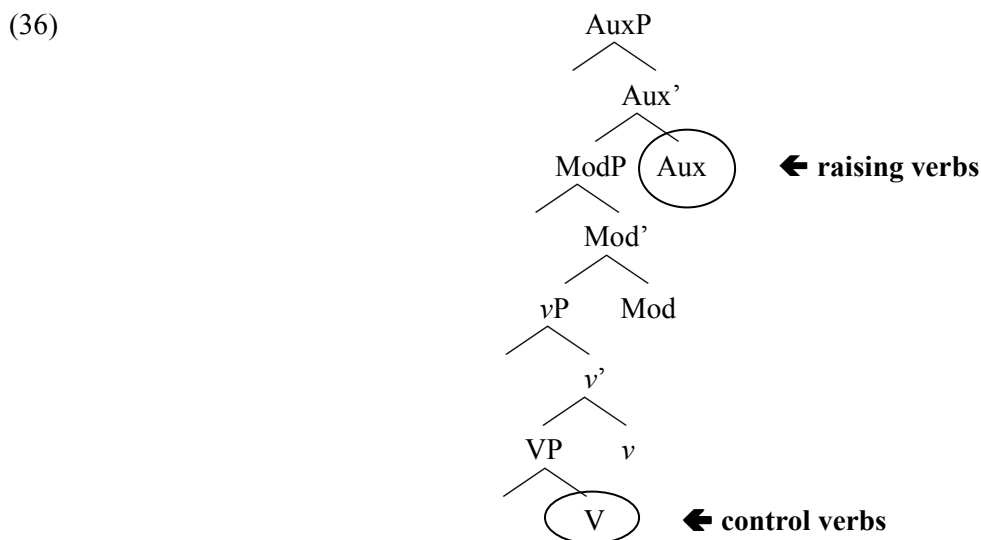

Under this analysis, aspectual verbs that have been argued to be ambiguous between control and raising are analyzed to appear in either of these two positions (either as the head of AuxP or VP), while unambiguous control and raising verbs are restricted to occur as the head of VP and the head of AuxP, respectively.

In order to show differences in the structural position of control and raising verbs, Wurmbrand contrasts the distribution of unambiguous raising verbs, such as *scheinen* ‘seem’ and *pflügen* ‘be use to’, and ambiguous verbs, such as *versprechen* ‘promise’, *drohen* ‘threaten’ and an aspectual verb, *beginnen* ‘begin’. First, Wurmbrand shows that the unambiguous raising verbs cannot be embedded *under* a modal, although they can embed a modal.<sup>22</sup>

- (37) a. \*Morgan **wird/dürfte** er di Stadt zu verlassen *scheinen*  
 Tomorrow will/might he the town to leave seem  
 ‘He might seem to be leaving the town tomorrow.’  
 (Wurmbrand 2001: 207, (168a, 168c))
- b. Sie *schien* zu Hause arbeiten zu **müssen/können**  
 she seemed at home work to must/can  
 ‘She seemed to have to/be able to work at home.’  
 (Wurmbrand 2001: 207, (169d, 169e))

In contrast, ambiguous verbs can be embedded under a modal verb. However, when they are, they can only be interpreted as control verbs (i.e. the epistemic interpretation of ‘promise’ and ‘threaten’ are not available).

- (38) Er **muß** ein guter Vater zu warden versprechen/drohen  
 He must a good father to become promise/threaten  
 ‘He must promise/threaten to become a good father.’  
 (Wurmbrand 2001: 209, (172c, 172d))

Second, both the unambiguous raising verbs and the ambiguous verbs allow passive in the embedded clause ((39a) and (39b)). However, once an ambiguous verb is embedded under a modal, embedded passive becomes ungrammatical (39c).

- (39) a. ?Die Stadt **began** zerstört zu werden  
 the town began destroyed to AUX<sub>Pass</sub>  
 ‘The town began to get destroyed.’ (Wurmbrand 2001: 211, (174c))
- b. Der Kaviar *schien* gegessen worden zu sien  
 the caviar seemed eaten been to be  
 ‘The caviar seemed to have been eaten.’ (Wurmbrand 2001: 208, (170c))
- c. \*Die Stadt **muss/kann** zerstört zu werden beginnen  
 the town must/can destroyed to AUX<sub>Pass</sub> begin  
 ‘The town must/can/may begin to get destroyed.’  
 (Wurmbrand 2001: 211, (176a, 176b))

<sup>22</sup> According to Wurmbrand, only deontic modals can be embedded under *scheinen* ‘seem’, which, under her analysis, occupies the position where auxiliary verbs and epistemic modals occupy.

Third, while the unambiguous raising verbs do not passivize (40a), the ambiguous aspectual verb *beginnen* ‘begin’ can passivize, which can be impersonal passive (40b) or long passive (40c).

- (40) a. \*Der Kaviar wurde zu essen geschient/geschienen  
the caviar was to eat seem-PART<sub>a</sub>/seem-PART<sub>b</sub>  
‘It seemed that somebody ate the caviar.’ (Wurmbrand 2001: 208, (170a, 170b))
- b. Es wurde begonnen den Wagen zu reparieren  
it was began-PART the car-ACC to repair  
‘They began to repair the car.’ (*impersonal passive*) (Wurmbrand 2001: 212, (178b))
- c. Der Wagen wurde zu reparieren begonnen  
the car was to repair begun-PART  
‘They began to repair the car.’ (*long passive*) (Wurmbrand 2001: 213, (180a))

Here, *beginnen* ‘begin’ differs from two other ambiguous verbs that Wurmbrand discusses, *versprechen* ‘promise’ and *drohen* ‘threaten’, as only *beginnen* ‘begin’ allows for long passive. With the two other ambiguous verbs, only impersonal passive is grammatical (Wurmbrand 2001, 213). Finally, an impersonal passive sentence with an ambiguous verb, as in (40b), can be embedded under a modal (41). However, in this particular environment, the ambiguous verb can only be interpreted as a control verb, as was the case with the ‘disambiguated’ instances of the ambiguous verbs, seen in (38) above.

- (41) Es **muss** sofort begonnen warden den Wagen zu  
It must immediately begin Aux<sub>Pass</sub> the car-ACC to  
reparieren  
repair  
‘They must begin immediately to repair the car.’ (Wurmbrand 2001: 213, (179b))

Wurmbrand argues that all of the above observations show that control and raising verbs occupy two different structural positions, as illustrated in (36). The *unambiguous* raising verbs can embed a modal but cannot be embedded under a modal, as in (37), because raising verbs occupy a position as high as or higher than where modals appear. When an ambiguous verb is embedded under a modal, as in (38), the verb can only be in the lower position, where it is interpreted as a control verb. Moreover, both the unambiguous raising verbs and the ambiguous verbs are expected to have embedded a passive complement ((39a) and (39b)), since raising verbs occupy the position higher than *vP*, where the passive morpheme is assumed to occupy. Yet once an ambiguous verb is embedded under a modal, as in (39c), it can only be in the lower position, where it is interpreted as a control verb. When an ambiguous verb is in the lower position, there is no *vP* projection below it. Thus, it follows that an ambiguous verb cannot embed a passive complement in (39c). Moreover, while the unambiguous raising verbs are above *vP* and therefore they do not passivize (40a), the ambiguous verbs are below *vP* and therefore they are expected to passivize ((40b) and (40c)). Finally, since only an ambiguous verb in the lower position is expected to passivize, the ‘passivized’ aspectual verb is expected to embed under a modal (41).

On the other hand, if we were to maintain the assumption that control and raising verbs appear in the same position, i.e. the head of VP, the above observations would be problematic. One would have to assume, for instance, that these differences derive from differences in each verb’s compatibility with modals and passives. However, such an approach would have to be quite



complex, since, under such a scenario, the ambiguous verbs' compatibility with passive would have to change, depending on the presence/absence of a modal.

Thus, Wurmbrand convincingly shows that the same predicates are interpreted as control and raising verbs depending on their syntactic positions in German. As such, the German data discussed by Wurmbrand support the proposed analysis of EAVs, according to which the control/raising ambiguity with EAVs is argued to be due to two positions in a clause where EAVs may occur.

Moreover, Wurmbrand's data also suggest that *beginnen* 'begin' may occupy a position that is lower than one that two ambiguous verbs, *versprechen* 'promise' and *drohen* 'threaten' may occupy. Recall that *beginnen* 'begin' is the only verbs which allows for both impersonal passive and long passive. The two other ambiguous verbs, *versprechen* 'promise' and *drohen* 'threaten', only allow for impersonal passive. In impersonal passive, the embedded object is licensed with accusative case despite the fact that the matrix verb is passivized. Under the assumption that it is *v* that provides accusative case, this means that the ambiguous verbs embed a *vP* in impersonal passive, as in (42).

- (42)      Es wurde begonnen      [<sub>vP</sub>    den    Wagen      zu    reparieren]  
           it was    began-PART      [<sub>vP</sub>    the    car-ACC      to    repair]

One way to account for the structure in (42) is to analyze impersonal passive as involving a clausal complementation (i.e. a bi-clausal structure) in which *versprechen* 'promise' and *drohen* 'threaten' occupy the position for lexical verbs, V, and take a *vP* complement. On the other hand, in long passive, the embedded object moves to the matrix subject position, presumably because accusative case is not available in a long passive sentence. Under the same assumption about accusative case mentioned above, this means that the complement of *beginnen* 'begin' in long passive must not contain *v*, i.e. it is a VP.

- (43)      Der            Wagen            wurde            [<sub>VP</sub> zu    reparieren]      begonnen  
           the            car                was                [<sub>VP</sub> to    repair]            begun-PART

There are at least two possible analyses of long passive in (43). One is to assume that long passive results when *beginnen* 'begin' takes a VP complement. Under such an analysis, *beginnen* 'begin' occupies V just like it is assumed to do in (42) and the structure is still bi-clausal. The difference between *beginnen* 'begin' on one hand and *versprechen* 'promise' and *drohen* 'threaten' on the other is a matter of selectional restrictions. While *beginnen* 'begin' can take either a *vP* or VP, *versprechen* 'promise' and *drohen* 'threaten' can only take a *vP*. Alternatively, one may analyze (43) as having a mono-clausal structure, in which *beginnen* 'begin' occupies a position between the passive *v* and V, i.e. L-Asp under the proposed analysis of EAVs. In this analysis, *beginnen* 'begin' is the only ambiguous verb that allows for long passive because it is the only one that can head an L-Asp phrase. While I am not aware of any further evidence that would tease apart these two possible analyses of long passive, it seems safe to say that the aspect phrase analysis proposed in this study is a promising approach to accounting for the unique distribution of *beginnen* 'begin' in German.<sup>23</sup>

<sup>23</sup> Wurmbrand in fact suggests the possibility that *beginnen* 'begin' is a functional head (aspectual head), although she does not pursue this possibility (Wurmbrand 2001; fn. 76).

4.2. Basque (Arregi and Molina-Azaola 2004)

Basque offers support for the proposed analysis of aspectual verbs, for a very different reason from the evidence presented so far. Arregi and Molina-Azaola (A&M) (2004) discuss two aspectual verbs, *hasi* ‘begin’ and *amaitu* ‘finish’, which show different agreement patterns. While both aspectual verbs are analyzed as restructuring verbs, since the matrix auxiliary can agree with embedded arguments with both of these verbs<sup>24</sup>, only *amaitu* ‘finish’ allows the matrix auxiliary to agree with both the embedded dative and absolutive argument (44a). As can be seen in (44b) and (44c), *hasi* ‘begin’ allows the matrix auxiliary to agree only with the embedded dative argument.

- (44) a. Berak [zuri babak egiten] amaitu dautsuz  
 he-ERG [you-DAT beans-ABS do-NF] finished AGR<sub>A</sub>AGR<sub>D</sub>AGR<sub>E</sub>  
  
 ‘He finished cooking the beans for you.’ (A&M 2004; 101, (1))

- b. Bera [zuri babak egiten] hasi jatzu  
 he-ABS [you-DAT beans-ABS do-NF] began AGR<sub>D</sub>AGR<sub>A</sub>  
  
 ‘He began cooking the beans for you.’ (A&M 2004; 101, (2))

- c. \*Bera [zuri babak egiten] hasi jatzuz  
 he-ABS [you-DAT beans-ABS do-NF] began AGR<sub>A</sub>AGR<sub>D</sub>  
  
 ‘He began cooking the beans for you.’ (A&M 2004; 102, (3))

A&M attempt to associate the difference in agreement patterns and the fact that these two aspectual verbs have different case on their subjects. As can be seen above, *amaitu* ‘finish’ has an ergative subject (44a), while *hasi* ‘begin’ has an absolutive subject (44b). Descriptively, therefore, it appears that the matrix auxiliary cannot agree with an embedded argument with a particular case, if it has already formed an agreement relation with a matrix argument of the same case. In (44c), the matrix auxiliary cannot form an agreement relation with the embedded absolutive argument, since it is already in an agreement relation with the matrix absolutive subject. Based on this observation, A&M hypothesize that locality in agreement is relativized to case (A&M 2004: 108).

In order to account for the different agreement patterns of the two aspectual verbs, A&M propose that these two aspectual verbs are functional heads that assign absolutive case, which occupy two different positions in a clause. Specifically, A&M argue that while *amaitu* ‘finish’

<sup>24</sup> It is not clear whether these verbs are control or raising. From what I have found in the literature, however, these aspectual verbs appear to be closer, in their structural characteristics, to the verbs that are considered as control in Basque, than to the verbs that are considered as raising in Basque, as raising verbs in Basque generally require finite complement (Hualde and Ortiz de Urbina 2003: 653-56).

occupies the position immediately below *vP*, *hasi* ‘begin’ occupies the position immediately above *vP* (A&M 2004: 109, (17), (18)).

(45) a. *amaitu* ‘finish’

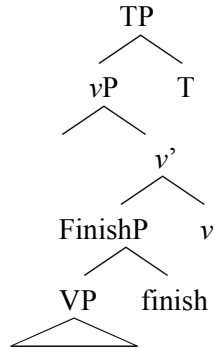

b. *hasi* ‘begin’

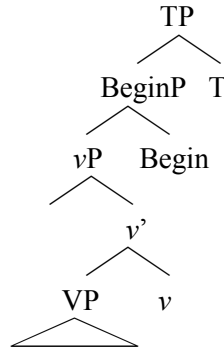

Their analysis accounts for the two agreement patterns as follows. One of the aspectual verbs, *amaitu* ‘finish’ provides absolutive case to the embedded verb’s direct object, since it is closer to the direct object than *v*, the other functional head which potentially assigns absolutive case (46a). In contrast, with *hasi* ‘begin’ *v* is closer to the direct object. Thus, it is *v* that provides absolutive case to the direct object, and *hasi* ‘begin’ ends up providing its absolutive case to the subject.<sup>25</sup> This accounts for the observation that only with *hasi* ‘begin’ is the subject marked with absolutive (46b).

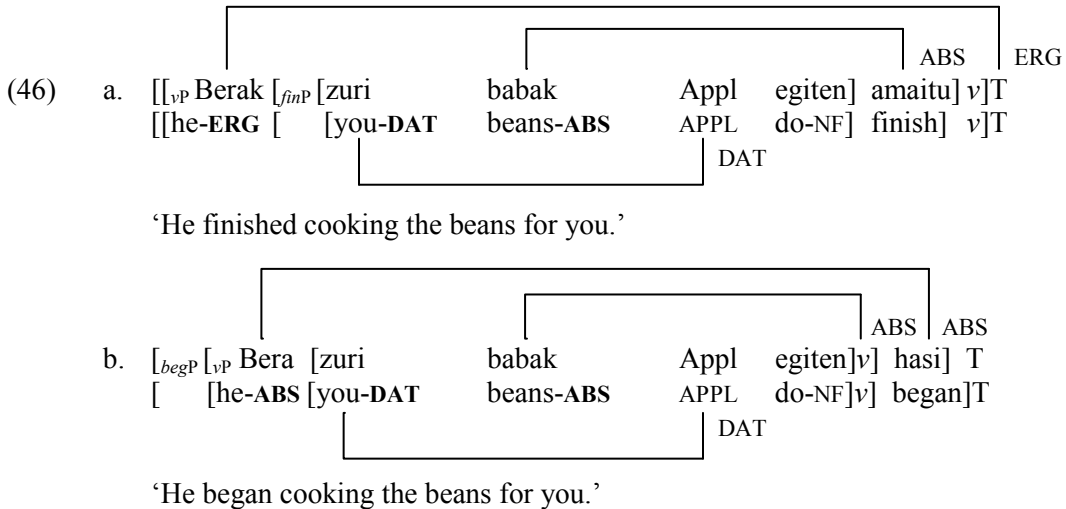

Assuming the relativized locality of agreement that they propose, this case assignment configuration accounts for the ungrammaticality of the long distance absolutive agreement with *hasi* ‘begin’ in (44c). With *amaitu* ‘finish’, the matrix T can agree with three arguments, the matrix ergative, the embedded dative, and the embedded absolutive, as seen in (44a), since there are no two arguments that bear the same case in this configuration. In contrast, with *hasi* ‘begin’,

<sup>25</sup> In both configurations, A&M assume that applicative head is responsible for assigning dative case to the indirect object.

long distance agreement between the matrix T and the embedded absolute argument is blocked by the matrix subject, which also bears absolutive case *and* is structurally higher than the embedded absolute argument.

(47)

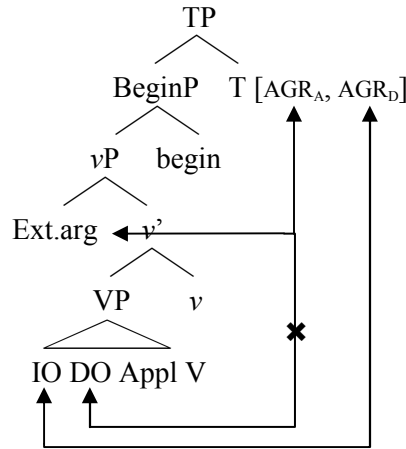

What is interesting about A&M's analysis of Basque aspectual verbs for our purposes is that they reach a very similar conclusion to the proposed analysis of EAVs about the syntactic positions of the two aspectual verbs in Basque. There are two positions for aspectual verbs in Basque, immediately below and above vP, with one of the aspectual verbs, *finish*, occupying the lower position and the other aspectual verb, *begin*, the higher position. Importantly, their conclusion is reached based on a very different set of data concerning a very different mechanism of grammar than what we have examined, namely, agreement.

## 5. Conclusion

In this paper, I argued against the control/raising analysis of English aspectual verbs (EAVs) and proposed an alternative analysis, in which EAVs project their own functional projections, aspect phrases, in two different positions in a clause: between *v* and VP (L-Asp) and above vP (H-Asp). I argued that the difference in the position of EAVs manifests as the two different forms of their complements, gerundive and infinitive, and motivated the proposed analysis based on language-specific data and cross-linguistic data concerning syntactic distribution of aspectual verbs.

While I hope to have shown that the proposed analysis of EAVs is a promising approach to analyzing aspectual verbs, the proposed analysis also raises a number of questions that this paper did not address. For instance, how are the differences among aspectual verbs across languages handled under the proposed analysis? While the proposed analysis captures the similarities among aspectual verbs in different languages, they also have differences. Another question that the proposed analysis raises is whether the proposed analysis can be extended to other predicates with similar syntactic behavior. For instance, modals and semi-modal like predicates, such as 'want' and 'tend', have also been claimed to exhibit the ambiguity between a thematic and non-thematic interpretation as well as mono-clausal behavior in many languages. Could these predicates also be analyzed as functional heads within the verbal projection? If so, do they occupy different positions from the positions for aspectual verbs or do they appear in the same syntactic positions? I hope that this study opens the door to investigations into these questions and leads us to a better understanding of the syntax of the predicates that share similar characteristics with aspectual verbs.

To the extent it is successful, the proposed analysis provides further support for the hypothesis that the functional projection inside the verbal projection encodes grammatical aspect, as originally proposed in Travis (1991). It also enables us to establish a connection between the hypothesis that there is a functional projection within the verbal projection and the well-known syntactic peculiarity of aspectual verbs and potentially other classes of semi-modal like predicates. Finally, the approach to the syntax of aspectual verbs advanced in this study suggests a particular view on non-finite clausal complementation in general. Constructions that have been analyzed as instances of non-finite clausal complementation may in fact be analyzed as simple clauses, with predicates that ‘select’ non-finite clausal complement being analyzed as functional heads that are parts of the phrase structure of simple clauses. Under such a view, what has been analyzed as non-finite clausal complementation does not involve embedding of clausal complements in the traditional sense after all.

## References

- Agbayani, Brian & Chandra Shekar. (to appear). Restructuring and clausal architecture in Kannada. To appear in *Clever and Right: Papers in Honor of Joseph Emonds*.
- Aissen, Judith & David M. Perlmutter (1976). Clause reduction in Spanish. *BLS* 2. 1-30.
- Aissen, Judith & David M. Perlmutter (1983). Clause reduction in Spanish. In David M. Perlmutter (ed.), *Studies in Relational Grammar* 1. 360-403. Chicago: The University of Chicago Press.
- Akmajian, Adrian, Susan M. Steele & Thomas Wasow. (1979). The category AUX in Universal Grammar. *Linguistic Inquiry* 10: 1-64.
- Alexiadou, Artemis. (1997). *Adverb Placement: A Case Study of Antisymetric Syntax*. Amsterdam: John Benjamins.
- Arregi, Karlos & Gainko Molina-Azaola. (2004). Restructuring in Basque and the theory of agreement. *WCCFL* 23, 101-114.
- Bobaljik, Jonathan. (1998). Floating quantifiers: Handle with care [State of the Article]. *Glott International* 3.6: 3-10.
- Bobaljik, Jonathan. (2003). Floating Quantifiers: Handle with care. In Lisa Cheng and Rint Sybesma, (eds.), *The Second Glot International State-of-the-Article Book*. Mouton de Gruyter, 107-148.
- Bale, Alan. C. (2007). Quantifiers and verb phrases: An exploration of propositional complexity. *Natural Languages and Linguistic Theory* 25: 447-483.
- Bolinger, Dwight. (1968). Entailment and the meaning of structures. *Glossa* 2: 119-127.
- Bošković, Željko. (1997). *The Syntax of Nonfinite Complementation: An Economy Approach*. Cambridge, MA: MIT Press.
- Bresnan, Joan. (1972). *Theory of Complementation in English Syntax*. PhD dissertation. MIT.
- Brinton, Laurel, L. (1988). *The Development of English Aspectual Systems*. New York: Cambridge University Press.
- Cable, Seth. (2004). *Restructuring in English*. Ms., MIT.
- Chomsky, Noam. (1995). *The Minimalist Program*. Cambridge, MA: MIT Press.
- Chung, Sandra. 2004. Restructuring and verb-initial order in Chamorro. *Syntax* 7: 199-233.
- Cinque, Guglielmo. (1999). *Adverbs and Functional Heads: A Cross-linguistic Perspective*. Oxford: Oxford University Press.
- Cinque, Guglielmo. (2003). The interaction of passive, causative, and ‘restructuring’ in Romance. In Christina Tortora (ed.), *The Syntax of Italian Dialects*. Oxford: Oxford University Press.
- Collins, Chris. & Höskuldur Thráisson. (1996). VP-internal structure and object shift in Icelandic. *Linguistic Inquiry* 27, 391-444.
- Fischer, Susan & Byron A. Marshall. (1968). *The Examination and Abandonment of the Theory of Begin by D.M. Perlmutter as...* Bloomington, IN: Indiana Linguistic Circle.
- Fitzpatrick, Justin. (2006). *The Syntactic and Semantic Roots of Floating Quantification*. PhD dissertation. MIT.
- Freed, Alice F. (1979). *The Semantics of English Aspectual Complementation*. London: Reidel.
- Fukuda, Shin. (2006). The syntax of Japanese aspectual verbs. A paper presented at the 3<sup>rd</sup> Workshop on Altaic in Formal Linguistics.
- Fukuda, Shin (2007). Projections of aspect in Japanese. In Yoichi Miyamoto and Masao Ochi (eds.), *Formal Approaches to Japanese Linguistics: Proceedings of FAJLA*. MIT Working Papers in Linguistics 55. 37-48.
- Givón, Talmay. (1973). The time-axis phenomenon. *Language* 49: 890-925.
- Hallman, Peter. (2004). NP-interpretation and the structure of predicates. *Language* 80. 707-747.

## *Aspectual Verbs and the Aspect Phrase Hypothesis*

- Huarde, José Ignacio & Jon Oirtiz de Urbina. (2003). *A Grammar of Basque*. Berlin: Mouton de Gruyter.
- Kageyama, Taro. (1993). *Bumpo to gokeisei* [Grammar and word formation]. Tokyo: Hitsuji shoboo.
- Kageyama, Taro. (1999). Word formation. In Natsuko Tsujimura (ed.), *The Handbook of Japanese Linguistics*. Oxford: Blackwell, 297-325.
- Koizumi, Masatoshi. (1994). Object agreement phrases and the split VP hypothesis. In Jonathan Bobaljik and Colin Phillips (eds.), *Papers on Case and Agreement I*. MIT Working Papers in Linguistics 18, 99-148.
- Koizumi, Masatoshi. (1995). *Phrase Structure in Minimalist Syntax*. PhD dissertation, MIT.
- Koizumi, Masatoshi. (1998). Invisible agree in Japanese. *The Linguistic Review* 15: 1-39.
- Kratzer, Angelika. (1994). On external arguments. In Elena Benedicto & Jeffery Runner (eds.), *Functional Projections: University of Massachusetts Occasional Papers 17*, 103-130.
- Kratzer, Angelika. (1996). Severing the external argument from the verb. In Johan Rooryck & Laurie Zaring (eds.), *Phrase Structure and the Lexicon*. Dordrecht: Kluwer.
- Landau, Idan. (2000). *Elements of Control: Structure and Meaning in Infinitival Constructions*. Dordrecht: Kluwer.
- Martin, Roger. (2001). Null case and the distribution of PRO. *Linguistic Inquiry* 32: 141-166.
- Matsumoto, Yo. (1996). *Complex Predicates in Japanese: A Syntactic and Semantic Study of the Notion 'word'*. Tokyo and Stanford: Kuroshio and CSLI.
- May, Robert. (1985). *Logical Form: Its Structure and Derivation*. Cambridge, MA: MIT Press.
- Newmeyer, Frederic J. (1975). *English Aspectual Verbs*. Paris: Mouton.
- Nishigauchi, Taisuke. (1993). Long distance passive. In Nobuko Hasegawa (ed.), *Japanese Syntax in Comparative Grammar*. Tokyo: Kuroshio, 79-114.
- Perlmutter, David M. (1968). *Deep and Surface Structure Constraints in Syntax*. Doctoral dissertation. MIT.
- Perlmutter, David M. (1970). The two verbs *begin*. In Roderick A. Jacobs & Peter S. Rosenbaum (eds.), *Readings in English Transformational Grammar*. Waltham, MA: Blaisdell, 107-19.
- Pesetsky, David. (1991). *Zero Syntax II: An Essay on Infinitives*. Ms., MIT.
- Potsdam, Eric. (in press). Analysing word order in the English imperative. In Wim van der Wurff (ed.), *Imperative Clauses in Generative Grammar: Studies Offered to Frits Beukema*. Amsterdam: John Benjamins, 111-128.
- Pylkkänen, Liina & Brian McElree. (2006). The syntax-semantic interface: on-line composition of sentence meaning. In Matthew Traxler & Ann Gernsbacher Morton (eds.), *Handbook of Psycholinguistics* (2nd Ed.). New York: Elsevier, 537-577.
- Rochette, Anne. (1999). The selection properties of aspectual verbs. In Kyle Johnson & Ian Roberts (eds.), *Beyond Principles and Parameters: Essays in Memory of Osvaldo Jaeggli*. Dordrecht: Kluwer.
- Ross, John R. (1972). More on *begin*. *Foundations of Language* 8: 574-577.
- Shibatani, Masayoshi. (1973). Where morphology and syntax clash: a case in Japanese aspectual verbs. *Gengo Kenkyu* 64: 65-96.
- Sportiche, Dominique. 1990. *Movement, Case and Agreement*. Ms., UCLA.
- Sportiche, Dominique. 1998. *Partition and Atoms of Clause Structure*. London: Routledge.
- Stowell, Tim. (1982). The tense of infinitives. *Linguistic Inquiry* 13: 561-570.
- Thompson, Ellen. (2005). *Time in Natural Language: Syntactic Interfaces with Semantics and Discourse*. Berlin: Mouton de Gruyter.
- Travis, Lisa M. (1991). *Derived object, inner aspect, and structure of VP*. Paper presented at NELS 22.
- Wurmbrand, Susi. (2001). *Infinitives: Restructuring and Clause Structure*. Berlin: Mouton de Gruyter.
- Wurmbrand, Susi. (2006). *wolP: where syntax and semantics meet*. Paper presented at NELS 37.
- Wurmbrand, Susi. (2007). Infinitives are tenseless. To appear in *UPenn Working Papers in Linguistics* 13.1.

Shin Fukuda  
Department of Linguistics  
University of California, San Diego  
fukuda@ling.ucsd.edu