

UCLA

UCLA Electronic Theses and Dissertations

Title

On the nature of "say" complementation

Permalink

<https://escholarship.org/uc/item/9101w860>

Author

Major, Travis

Publication Date

2021

Peer reviewed|Thesis/dissertation

UNIVERSITY OF CALIFORNIA
Los Angeles

On the nature of “say” complementation

A dissertation submitted in partial satisfaction
of the requirements for the degree
Doctor of Philosophy in Linguistics

by

Travis Major

2021

© Copyright by
Travis Major
2021

ABSTRACT OF THE DISSERTATION

On the nature of “say” complementation

by

Travis Major

Doctor of Philosophy in Linguistics

University of California, Los Angeles, 2021

Professor Dominique Sportiche, Co-Chair

Professor Harold Torrence, Co-Chair

This dissertation investigates the syntax and semantics of the verb “say” and clausal complementation involving the verb “say”. Clausal complementation involving the verb “say” is among the most common strategies implemented across the world’s languages and they exhibit morpho-syntactic, semantic, and pragmatic properties that differ from other types of clausal complementation. The goal of this dissertation is to offer a syntactic analysis that offers an explanation for these differences. Each language that has “say” complementation also has a grammatical mechanism whose responsibility is to link verbs to form complex predicates. The null hypothesis in this dissertation is that “say” complementation does not involve a “complementizer”, but instead involves a clause containing the verb “say” that adjoins to the matrix clause. The three questions taken up are as follows: (i) What are the morpho-syntactic and semantic properties of the verb “say”?, (ii) What are the morpho-syntactic and semantic properties of the clause-linking mechanism, and (iii) Do “say” complementation structures exhibit the properties of “say” in a serialization structure? These questions are answered based primarily on data from Uyghur, English, and Avatime.

Chapter One introduces discussion of the main puzzles, introduces background information about Uyghur and Avatime, and introduces a brief literature review that this dissertation builds on. Methodological information is also provided within the discussion of each

language.

Chapter Two introduces in-depth discussion of the verb “say” in English. Building upon intuitions presented in Grimshaw (2015), a morpho-syntactic analysis of the verb “say” as the overt realization of an abstract “Light Verb” SAY is provided. It is shown that “say” alternates between being stative and dynamic, which has effects on argument structure. More specifically, only dynamic “say” is capable of licensing a Goal argument and an Agent, while stative “say” introduces only Linguistic Material (what was said) and its source. It is further shown that “say” is unique with respect to the range of internal arguments that it can take relative to other predicates. Based on a “Flavours of little *v*” analysis (Folli and Harley, 2005), it is argued that stative “say” involves a truncated structure embedded under v_{be} , which lacks all syntactic structure responsible for eventive/agentive semantics, while dynamic/eventive “say” involves a non-truncated structure. It is finally argued that certain predicates, such as “scream” manner adjoins to v_{do} , which prevents the predicate SAY from getting pronounced. The Chapter ends with discussion of the stative/eventive alternation in Avatime, which is reflected by the presence/absence of agreement morphology in the language.

Chapter Three demonstrates that Uyghur shows the same stative versus eventive alternation observed for English, but further demonstrates that Uyghur “say” is unique in many ways that are distinct from English. Building upon Sudo (2012) and Shklovsky and Sudo (2014) it is argued that “say” is uniquely able to introduce a nominalized complement clause or a tensed complement clause, the latter of which resembles a finite (root) clause. It is proposed that the seemingly finite CPs vary in size. The larger CPs host monstrous or quotative operators that trigger Indexical Shift, which enable full feature transmission from C-to-T, yielding what looks like a root clause as it relates to case and agreement. “Say” additionally introduces a defective (reduced) CP, which does not allow full transmission of features, forcing the embedded subject to raise for case and resulting in default agreement on the embedded verb.

Chapter Four offers an analysis of converbial constructions in Uyghur, which is the suf-

fix found on the “say” element in Uyghur “say” complementation structures. It is shown that the converbial suffix has two adjunction sites: VP and TP, which has interpretive consequences. Novel data demonstrates that the distribution of converbial clauses in general account for the distribution of “say” complementation structures, followed by demonstrating that the properties of “say” illustrated in Chapter Three are similarly observed in “say” complementation structures, offering a syntactic account for observations made in Messick (2017) and explaining various unexplained issues described in Sudo (2012) and Shklovsky and Sudo (2014). The chapter concludes by offering brief discussion of the equivalent structures in Avatime, demonstrating that its “say” complementation structures are built upon Nuclear Serial Verb Constructions in the language, which is functionally similar to converbial constructions in Uyghur. For both languages, I conclude that “say” complementation structures are truly adjunction structures where “say” introduces a clausal complement, not classical CPs.

Chapter Five offers discussion of Case Theory on the basis of the analysis in Chapter 4. Baker and Vinokurova (2010) and Baker (2015) introduce discussion of Sakha (Turkic) which has “say” complementation structures that are nearly identical to Uyghur. They argue in favor of Dependent Case Theory to account for the distribution of accusative case, on the basis of accusative case showing up in environments that seem to lack a verb capable of licensing accusative case. I demonstrate that in most environments, the verb “say” is present and capable of licensing accusative case. I conclude that the analysis of complementation in Chapter Four resurrects the debate between Dependent Case Theory and classical theories of case assignment, but suggest that even if we adopt Dependent Case Theory, the analysis in Chapter Four improves its explanatory power.

The dissertation of Travis Major is approved.

Hilda Koopman

Satoshi Tomioka

Dominique Sportiche, Committee Co-Chair

Harold Torrence, Committee Co-Chair

University of California, Los Angeles

2021

For Kim

TABLE OF CONTENTS

List of Figures	xii
List of Tables	xiii
Acknowledgments	xiv
Vita	xvii
1 Introduction	1
1.1 Overview	1
1.1.1 Preview of this dissertation	3
1.1.2 Broad Conclusions	8
1.2 Methodology	9
1.2.1 Uyghur	9
1.2.2 Avatime	10
1.3 Uyghur	11
1.3.1 General Background	11
1.3.2 Basic grammar	12
1.3.3 Accusative case	13
1.3.4 Tense, Aspect, and Embedded Clauses	16
1.3.5 Null Arguments	19
1.4 Avatime	21
1.4.1 General background	21
1.4.2 Basic language properties	22

1.5	“Say” literature	24
1.5.1	“Say” as a Light Verb (Grimshaw, 2015)	24
1.5.2	Anand et al. (2017): Subjects of “saying”	27
1.5.3	Major & Stockwell (2021)	28
1.5.4	Flavours of little <i>v</i> and the syntax of event structure	30
1.5.5	Notes on semantics of “say”	35
1.5.6	Silent Modal SAY and Saturation	36
2	The verb “say” in English	39
2.1	Expanding the Empirical Landscape of “say”	42
2.1.1	Grammaticality judgments, tense, eventivity, and “say”	42
2.1.2	Argument structure	46
2.2	Analysis	52
2.2.1	Analyzing stative “say”	53
2.2.2	Analyzing Eventive “say”	54
2.2.3	Accounting for SAY	55
2.2.4	More on Linguistic Material	58
2.2.5	Final notes on LM	61
2.3	Extending the analysis to Avatime	62
2.4	SAY in Non-Standard English	66
2.5	Conclusions	68
3	Properties of “say” in Uyghur	70
3.1	Tense, argument structure, and event structure of Uyghur “say”	74
3.1.1	Tense	74

3.1.2	Argument Structure	76
3.2	Linguistic Material Arguments	80
3.2.1	NP/DP complements to “say”	80
3.2.2	Clausal LM arguments	82
3.2.3	Accusative subjects externally merge within the TEC	86
3.2.4	Accusative subjects raise	87
3.2.5	Locus of accusative case	90
3.2.6	Interpretation of accusative subjects	91
3.2.7	Analyzing internal arguments of “say”	93
3.3	Tensed embedded clauses, Finiteness, and Indexical Shift	95
3.3.1	Introducing and re-analyzing monsters	99
3.3.2	Monsters and accusative subjects	101
3.3.3	Agreement on embedded verbs	103
3.3.4	Agreement correlates with clause size	107
3.3.5	Analysis	108
3.3.6	Accusative subjects and the lexical status of monsters	112
3.3.7	Implications for the typology of indexical shift	114
3.4	More on NECs and TECs	115
3.5	Conclusions	117
4	Converbial “say” clauses in Uyghur	119
4.1	Introduction	119
4.1.1	Preliminary reasons that <i>dep</i> is not “that”	120
4.1.2	What is <i>-(I)p</i> ?	121
4.1.3	Events, <i>-(I)p</i> , and discourse coherence	122

4.1.4	Discourse Coherence	123
4.1.5	Discourse coherence and $-(I)p$	124
4.1.6	Preview of Analysis	127
4.1.7	Roadmap	129
4.2	The syntax of VP $-(I)p$ modifiers	130
4.2.1	Sugar 2019: Inner Aspect Serial Verb Constructions	130
4.2.2	Building upon Sugar’s analysis	134
4.3	TP modifying $-(I)p$ constructions	138
4.3.1	Overview	138
4.3.2	Revisiting Sugar’s Event SVCs	139
4.3.3	Analyzing TP $-(I)p$	141
4.4	Final notes on $-(I)p$	144
4.5	The distribution of <i>dep</i> and $-(I)p$	146
4.5.1	Notes on Transitivity, <i>v</i> , and <i>dep</i>	147
4.5.2	VP-modifying <i>dep</i> Constructions	150
4.5.3	<i>Dep</i> and attitude verbs	161
4.6	Evidence for “say” in <i>dep</i>	164
4.6.1	Indexical Shift	165
4.6.2	Raising-to-Object	166
4.6.3	Direct Quotation	168
4.6.4	Factivity and <i>dep</i>	170
4.7	Recap	175
4.8	About <i>si</i> “say” in Avatime	176
4.9	Conclusions	182

5	Uyghur Dependent Case Theory	184
5.1	Introduction	184
5.2	Case theory and language background	186
5.2.1	Background on Case Theory	186
5.2.2	Accusative case in (di)transitive constructions	189
5.2.3	Passives and unaccusatives	190
5.2.4	Predicting movement	192
5.3	Accounting for accusative subjects	193
5.3.1	Accusative Subject TECs	193
5.3.2	Accusative subjects merge inside the embedded TP	195
5.3.3	Accusative subjects raise	196
5.3.4	Finiteness, A-movement, and Agreement	197
5.3.5	DCT and Case in Sakha	202
5.4	Analysis	206
5.4.1	The role of <i>de-</i> “say” in accusative assignment	209
5.4.2	<i>Dep</i> does not always license accusative case	210
5.4.3	Dative arguments	219
5.5	Conclusions	220
6	Concluding Remarks	222

LIST OF FIGURES

1.1	The Xinjiang Uyghur Autonomous Region (from https://upload.wikimedia.org/wikipedia/commons/9/95/Xinjiang_map.png)	11
1.2	Avatime Map (from https://joshuaproject.net/people_groups/10496/GH)	22

LIST OF TABLES

1.1	Uyghur case system	12
1.2	<i>Three level tones in Avatime</i>	23
1.3	<i>A subset of Avatime noun classes</i>	23
2.1	Argument structure and temporal properties of “saying”	53
3.1	Non-past paradigm for ‘leave’	104

ACKNOWLEDGMENTS

Writing a dissertation based on fieldwork comes with many challenges. Writing a dissertation is a similarly challenging experience. Writing a dissertation based on fieldwork during a global pandemic is an experience I would not wish upon anyone. If anyone else has this experience moving forward, I hope they, too, are surrounded by a supporting cast willing to join them in a Zoom window on a moment's notice.

First, I would like to thank my committee members, beginning with my chair, Harold Torrence. I joined Harold at the University of Kansas and joined him on the trek to UCLA. We have done fieldwork in Ghana and Nigeria, co-authored presentations and papers, and he has offered advice and feedback at every turn throughout my career to this point. His abilities as a formal syntactician and as a fieldworker have helped me develop my own views on what it means to do good research: the analysis is only as good as the data that supports it. On a personal level, there are few people I'd rather encounter when I'm having a bad day (or a pandemic year).

Dominique Sportiche, my co-chair, is one of the most thoughtful linguists that I have met. Any time I have approach him with a proposal, the response is the same: a moment of silence, followed by pointing out five potential holes, followed by offering suggestions for addressing these holes. Broadly speaking, his ability to help me take my big picture intuitions and focus in on the details has been invaluable.

Hilda Koopman has been invaluable to my development as a fieldworker and syntactician during my time at UCLA. I cannot count the number of times that I have shared an idea with her about some obscure fact, to have her respond with, "That's just like X's analysis of Y in language Z!" The time that we have spent brainstorming ideas, talking through puzzles, and discussing the big picture, has been a real pleasure, which I will truly miss. She has played a critical role in helping me realize the importance of making sure that every claim has empirical backing and how important it is to develop diagnostics for each language and to avoid making assumptions. If there are any unmotivated claims in this dissertation, it is

likely due to me not seeing/remembering her comment!

Finally, it has been great having Satoshi Tomioka on my committee as an external member. I saw him give a talk on “purpose questions” in Japanese as a plenary speaker, which played a role in helping me realize that syntacticians could care about pragmatics. In the end, my own research ended up overlapping with his and he fortunately agreed to be my external member. Every conversation that we have had has been enlightening, and I am grateful that he was willing to share his time and knowledge with me.

Next I must thank the Uyghurs who have played a critical role in both my academic career and life in general. First, I have to thank Mahire Yakup, who taught me three years of Uyghur as a second language, has collaborated with me on a few different projects, and hosted me in Kazakhstan for fieldwork. She was the first to teach me that no matter time I dropped her off at home, she was contractually obligated by Uyghur law to invite me in for food and tea. I also would like to thank Gülnar Eziz, who I met at the beginning of my time at the University of Kansas. Without Gülnar, this dissertation simply would not exist. She has played an important role for me as a consultant, linguist, chef, and friend. Finally, I would like to thank Ziba Ablet, Mustafa Aksu, Akbar Amat, Ablikim Emet, Abduqyum Mamat, Nashtarr, Memetjan Semet, and the students and teachers at School 153 in Almaty, Kazakhstan, Ruslan Arziyov, Shawket Omerov, and Narzigam Makhmudova, for sharing their language and culture with me.

I also would like to thank everyone who welcomed us into Amedzofe. In particular, I would like to thank Vincent Azafokpe, Divine Agyepong, Gifty Amu, Peace Awunyama, Wisdom Ekissi, Philomena Ewoenam Kumatse, Jones Kwame, Paul Kwawu, Akos Mawulorm, and Agbenya Wisdom for sharing their language, culture, and countless hours with us. Also many thanks to Dr. Kofi Dorvlo for helping us get started. My intial intention was to write substantially more on Avatime, but my return trip made it difficult to confirm critical data. I especially wish to thank Vincent Azafokpe and Divine Agyepong for countless complicated whatsapp calls, as we tried to make long distance fieldwork possible over the pandemic.

I would like to thank Sun-Ah Jun for helping me gain expertise in doing Intonational

Fieldwork, Pam Munro and the AIS crew for constant valuable feedback and friendship, and also Tim Stowell, Yael Sharvit, Tim Hunter, Jessica Rett, Dylan Bumford, Stefan Keine, Ethan Poole, and Michael Diercks for many invaluable conversations, helping me see things through a different light, and offering great advice or insights. I thank Andrew McKenzie for helping me realize the importance of doing semantic fieldwork, even as a syntactician, and for being so liberal with his time. I would like to also thank Bruce Hayes for general guidance and Megha Sundara for teaching me that humans are faster than buses, at least during rush hour. Finally, I would like to thank Sara Hosegara, Jackie Perez, and Nancy Gutierrez for being a constant positive presence in the department.

Connor Mayer has been a great friend, office mate, and collaborator. We have worked on projects ranging from Formal Grammar to the intonation of indexical shift and speech reports in Uyghur. We are quickly running out of subfields to expand into. I would also like to thank Blake Lehman for being an amazing friend, collaborator, and fieldwork companion. I thank Deniz Özyıld, Sözen Özkan, Richard Stockwell, Margit Bowler, and John Gluckman for being great friends and collaborators. I thank Colin Brown for being an outstanding friend and making the pandemic year much more pleasant, Nicoletta Loccioni, Nikos Angelopolous, Zhuo Chen, Canaan Breiss, Beth Sturman, Adam Royer, Maura O'leary, Rachel Jacobson, Viiu Wichman, Deb Wong, Jesse Zymet, ZL, Maayan Abenina-Adar, Phil Barnett, Kerri Devlin, and many others for both academic insights and friendship.

I thank my family for being so supportive over the years. In particular, I thank Kim, for joining me through all of this.

Finally, to the Uyghur people: *Méning qelbim her zaman siler bilen bille. Men hemme Uyghurlarning parlaq kélechigi bolushini chin dilimdin ümid qilimen.*

VITA

2014	MA in Linguistics, University of Kansas
2011	BA in Linguistics, University of Wisconsin-Milwaukee
2011	BA English, University of Wisconsin-Milwaukee
2011	Certificate in Teaching English to Speakers of Other Languages, University of Wisconsin-Milwaukee

PUBLICATIONS

Major, T. (accepted). Major, T. Revisiting the syntax of monsters in Uyghur. *Linguistic Inquiry*.

Major, T., & Stockwell, R. (accepted) “Say”-ing without a Voice. *Proceedings of NELS 51*. UQAM, Montreal, CA.

Major, T., & Torrence, H. (accepted). “Say”-chains, not “say”-complementation. *Proceedings of WCCFL 38*. UBC, BC.

Major, T., & Mayer, C. (2019). What indexical shift sounds like: Uyghur intonation and interpreting speech reports. In M. Baird and J. Pesetsky (Eds). *NELS 49: Proceedings of the Forty-Ninth Annual Meeting of the North East Linguistic Society, 2*, 255-264.

Özyildiz, D., Major, T., Maier, E. (2019). Communicative Reception Reports as Hear-say: Evidence from Indexical Shift in Turkish. *Proceedings of West Coast Conference on Formal*

Linguistics 36, 296-306. UCLA, California.

Mayer, C., & Major, T. (2018). A challenge for tier-based strict locality from Uyghur backness harmony. In Foret, A., Kobele, G., Pogodalla, S. (Eds). *Formal Grammar 2018. FG 2018. Lecture Notes in Computer Science, vol 10950*. Springer, Berlin, Heidelberg. doi: 10.1007/978-3-662-57784-4_4

McKenzie, A., Eziz, G., Major, T. (2018). Latent homomorphism and content satisfaction: The double life of Turkic auxiliary -(I)p bol-. *Glossa: a journal of general linguistics* 3 (1), 47.

CHAPTER 1

Introduction

1.1 Overview

Since the inception of generative syntax, issues related to clausal complementation have played a critical role in advancing the theory. Complement clauses are embedded clauses that behave like arguments to verbs. Research in this domain seeks to connect (lexical) properties of verbs that combine with complement clauses and the shape of the clausal complement with which they occur (Rosenbaum, 1967; Kiparsky, 1970; Bresnan, 1972). The distribution of labor between the clause-selecting predicate and embedded clauses themselves remains an active debate, even in English.

The goal of this dissertation is to add to the discussion of complement clauses as it relates to a common cross-linguistic strategy involving a special form of the verb “say”. An example is shown in, such as those shown in (1) from the Kwa language: Twi.

- (1) a. o-n-**se** biribi.
 he-NEG-say something
 “He said nothing.” (Lord, 1993:p. 176, ex: 304a)
- b. ko ka-kyerre no **se** ommere.
 go speak-show him say he-shall.come
 literally: “Go, tell him, say, he shall come.” (Lord, 1993:p. 178, ex: 310)

Notice in (1a) that *se* is the sole predicate, glossed as “say”. Notice that the same element co-occurs with the predicate *ka-kyerre* “tell” in (1b). Lord (1993) describes this as a diachronic development by which the verb “say” doubles as a main predicate and a complementizer within the language. Lord introduces an alternative analysis, indicated by

the translation in (1b), by which “say” is the final verb in a serial verb construction (Riis, 1854) or a quotative (Christaller, 1875). Of course, the position of *se* “say” in (1b) is the same position where “that” occurs in the English equivalent, but this on its own should not lead us to assume they are isomorphic structures.

In this dissertation, I argue that Riis (1854) was on the right track treating (1b) as a serial verb construction involving the verb “say”, as opposed to a complementizer that is equivalent to “that”. As part of this investigation, I ask three rather straightforward questions:

- (i) What are the morpho-syntactic and semantic properties of the verb “say”?
- (ii) What are the morpho-syntactic and semantic properties of multiple verb constructions (e.g. serial verb constructions, converbial constructions)?
- (iii) Do “say” complementation structures exhibit the properties of “say” in a serialization structure?

I demonstrate that (i)-(iii) show variation cross-linguistically, which suggests that the general properties discussed in this dissertation need to be investigated for each language that has “say” clauses, but the similarities between the unrelated languages discussed here strongly suggest that there is something fundamental about “say” constructions more broadly that differs from clausal complementation structures in e.g. Romance or Germanic, which have received more attention in the literature.

Whereas Lord (1976, 1993) argues that serial verb constructions involving “say” develop into complementizers, I suggest a slight reframing. More specifically, unlike complementation structures involving complementizers derived from relative pronouns, *wh*-expressions, and demonstratives, which exhibit many nominal characteristics, “say” clauses remain complex predicates formed via serialization. That is that “say” clauses form complex predicates with whichever predicate they co-occur with (e.g. “tell”, “know”, or “scream”). I demonstrate this via in-depth discussion of “say” and complex predicate formation in three languages: English, Uyghur (Turkic), and Avatime (Kwa).

1.1.1 Preview of this dissertation

One primary and overarching goal of this dissertation is to introduce novel description and theoretical analysis of Uyghur, while also introducing my preliminary findings in Avatime. Both languages are understudied to varying degrees, and to the extent possible, I seek to introduce my findings, both empirical and analytical to the best of my abilities. In addition to presenting my fieldwork, I additionally present some interesting discoveries in English.

In Chapter 2, I begin by discussing the English verb “say”, where I make two main points. First, I argue that there is a contrast between uses of “say” related to whether it is used to introduce some “linguistic content” and the source of that content (stative), as in (2a), or to report a communicative act, in which the subject is an agent who physically produces speech (2b).

- (2) a. Yesterday I saw Kayla. {She} (#enthusiastically) says (#to me) that she is coming tonight!
- b. Yesterday I saw Kayla. {She} (enthusiastically) said (to me) that she is coming tonight!

I argue that the structure of the the “say” clause in (2a) is truncated, introduces a source, not an agent, and is interpreted as stative. I suggest that sources are introduced VP-internally, and no higher Voice projection is introduced into the structure, similar to common assumptions regarding unaccusative predicates. In (2b), on the other hand, “say” functions as an activity verb, which involves an agent, linguistic content, and because it is interpreted as an activity predicate, is compatible with manner modification and a Goal argument. In this way, I assume the differences between events and states to be represented in the syntax (e.g. Borer, 1994, 2003; Rosen, 1999; Ramchand, 2008, 2018; Travis, 2010).

In this way, I assume that both (2a) and (2b) share the same core structure, as illustrated in (3).

(3)

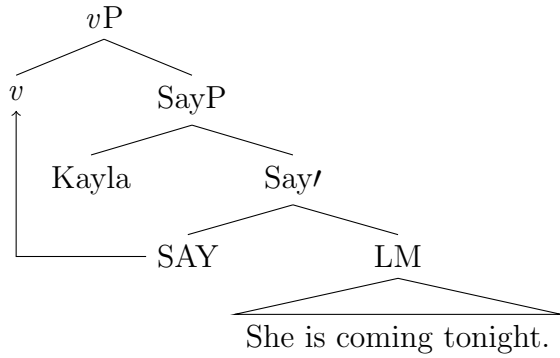

I assume in following with Folli and Harley (2005); Pylkkänen (2008); Key (2013); Harley (2017); Folli and Harley (2020) that there are different types of v , that determine whether “say” is interpreted as a stative predicate or an activity predicate (i.e. “say” describes the physical production of speech, not just the communicated content). More specifically, if vP is headed by v_{BE} , “Kayla” raises to spec, TP to satisfy the EPP, but the structure lacks agentive semantics, event modifiers are banned, and Goal arguments are prohibited. However, if v is headed by v_{DO} , “Kayla” is introduced as an Agent, which is compatible with a Goal argument and event/agent modifiers.

(4)

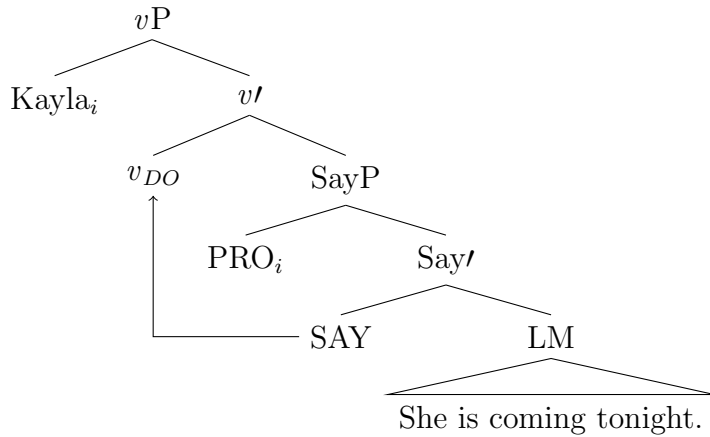

I represent the subject of SAY as PRO, which is controlled by Kayla. It is equally possible to assume that the subject of SAY is the lower copy left behind by “Kayla” assuming a movement theory of control (Boeckx et al., 2010), but this choice does not impact the present analysis. In Chapter 2, I also build an argument inspired by Grimshaw (2015) that “say” is the overt realization of an abstract light verb SAY. Grimshaw argues that when a

predicate like “scream” occurs with a clausal complement, the clausal complement is actually introduced by SAY (the same would be true of “mutter”, “tell”, “ask”, etc.).

- (5) Mary screamed SAY (that) Bill left.

I argue in favor of Grimshaw’s analysis, but offer a slightly more precise formalization of it. More specifically, I assume that “say” is pronounced as a last resort, when no other predicate adjoins to *v*. For instance I suggest that predicates like “scream” adjoin to the *v* region, in which case *v*_{DO} is realized as “scream”. In this way, “say” is realized only when a more specific root does not merge.

In Chapter 3, I turn to Uyghur. I first establish that Uyghur exhibits the same stative versus eventive contrast found in English, which I attribute to the same structural distinction discussed above. Uyghur differs from English as it relates to properties of clauses that it introduces. I argue that Uyghur “say” selects for clauses of different sizes, which gives rise to distinct syntactic effects. More specifically, I demonstrate that *de-* “say” is the only verb in Uyghur that can introduce a tensed embedded clause. I show that this clause can be defective, in which case, the embedded verb does not agree with the embedded subject, which subsequently raises out of the embedded TP and gets accusative case (6a). Alternatively, “say” can introduce a full CP that hosts a monstrous operator $\hat{\omega}$ (Anand and Nevins, 2004) or a quotative operator (6c). When the monstrous or quotative operator is introduced, the embedded subject must be in the nominative and the embedded verb must agree, as is the case in root clauses (6b)-(6c). In (6b) and (6c), indexicals (e.g. “I” or “You”) are interpreted relative to the reported context, as opposed to the present discourse context. As a result, “I” in both cases is interpreted as “Mahinur”, not the speaker, unlike (6a). This process is known as “Indexical Shift”.

- (6) a. Mahinur [méni [t_i ut-t-i] dé]-d-i.
 Mahinur 1SG.ACC leave-PST-3 say-PST-3
 “Mahinur said I_{Speaker}/*Mahinur won.”

- b. Mahinur [☞ men ut-t-um] dé-d-i.
 Mahinur 1SG win-PST-1SG say-PST-3
 “Mahinur said I_{Mahinur/*Speaker} won.”
- c. Mahinur [QUOT men ut-t-um] dé-d-i.
 Mahinur 1SG win-PST-1SG say-PST-3
 “Mahinur said, “I_{Mahinur/*Speaker} won”.”

In this discussion, I argue for three main points: i) T inherits case/phi features from C (Chomsky, 2004, 2008), ii) ☞ and QUOT require full CPs - when either is present, T is not deficient, resulting in full agreement and nominative case assignment, and iii) In the absence of an operator, the CP is defective, T does not inherit case/phi-features, which results in the Raising-to-Object (6a). This offers support for analyses building from George and Kornfilt (1981), that suggest Agreement, not Tense are responsible for effects attributed to finiteness.

In Chapter 4, I turn to “say” complementation in Uyghur. This chapter begins by discussing the distribution and properties of converbial *-(I)p* constructions, largely building on Sugar (2019). I demonstrate that *-(I)p* introduces a VoiceP that can merge in the VP region, modifying the main VP or at TP, where it modifies the entire clause. For instance, in (7a) *-(I)p* is used to introduce a predicate “pound” that modifies the manner of “flattening”. Furthermore, *-(I)p* can be used to establish other coherence relations between events, such as causality in cases like (7b), where a sequence of events takes place: “putting on makeup” and subsequent “reddening of the cheeks”.

- (7) a. Ahmat métal-ni ur-up tüzli-wet-t-i.
 Ahmat metal-ACC pound-CNV flatten-COMPL-PST-3
 “Ahmat pounded the metal flat (flattened by pounding).” (Sugar, 2019:14, ex: 1)
- b. U-ning mengz-i girim qil-ip qizir-ip ket-t-i.
 s/he-GEN cheek-3POSS makeup do-CNV redden-CNV leave-PST-3
 “Their/her/his cheeks turned red by makeup.” (Sugar, 2019:100, ex: 212a)

I then suggest that *dep* (= say complement) clauses occur in precisely these two environments and combine via the same process. I show that cases like (7a) involve the same syntax

as cases like (8a). More specifically, I suggest that the $-(I)p$ clauses function as adverbial modifiers that adjoin to VP in such cases. In such cases, the $-(I)p$ clause is interpreted as a manner modifier. I suggest that cases like (7b) involve the same structure as (8b), both of which involve TP adjunction. I argue that $-(I)p$ is an underspecified linking morpheme. The meaning of the $-(I)p$ clause is determined by pragmatics, but the height of merge plays an important role in restricting the possible interpretations.

- (8) a. Mahinur [Tursun ket-t-i *(**de**-*p*)] warqiri-d-i.
 Mahinur Tursun leave-PST-3 say-CNV scream-PST-3
 “Mahinur screamed, saying ‘Tursun left’.”
- b. [Mahinur Tursun ket-t-i *(**de**-*p*)] ket-t-i.
 Mahinur Tursun leave-PST-3 say-CNV leave-PST-3
 “Mahinur said Tursun left and (thus) left.”

I then demonstrate that all instances of *de*- “say”, including *dep* environments exhibit properties that are unique to main verb “say”. More specifically, all *de*- “say” environments are able to trigger raising to object, license indexical shift, introduce direct quotation, assign accusative case, and are obligatorily non-factive. On this basis, I conclude that *dep* is not a complementizer, but instead an instance of the converbial form of “say”. It is the fact that “say” is an extremely abstract verb in general that gives the impression that it is functional, but I conclude that *dep* is not a grammaticalized fossil, but instead is synchronically best understood as a combination of the verb “say” and the converbial suffix $-(I)p$.

Chapter 5 focuses on the implications the analysis presented in Chapter 4 has for case theory. Baker and Vinokurova (2010) argue that accusative embedded subjects cannot be accounted for on the basis of traditional theories of case, such as those involving Agree, based on data from Sakha that largely runs parallel to Uyghur. The primary reason that they de-link accusative assignment from the presence of an active *v* is because of cases like (8b), where there does not appear to be a transitive (accusative-assigning) verb in the utterance, if we assume *dep* (or *dien* in Sakha) to be a vacuous complementizer, as opposed to a verbal element. I demonstrate that once we adopt the analysis of “say” complementation in Chapter 4, an Agree-based analysis is resurrected. I suggest that Case-by-Agree is preferable for

reasons of parsimony, but further demonstrate that my analysis of complementation sharpens a Dependent Case Theoretic analysis if we decide to maintain it for e.g. typological purposes.

1.1.2 Broad Conclusions

From a theoretical perspective, I show that the verb “say” exhibits an eventive (dynamic) versus stative alternation across languages, which corresponds to distinct syntactic structures. “Say” clauses in languages that use them in clausal complementation structures are a type of clausal adjunct that contains the verb “say”. I show that properties unique to “say” as a main verb tend to surface in all “say” clauses. This includes phenomena, such as: Raising-to-Object, Indexical Shift, Logophoricity, and direct quotation. Furthermore, the distribution of “say” clauses is generally distinct from standard clausal complements, patterning like serialization structures, which varies from language to language. The particular serialization structure within the language is the mechanism responsible for linking “say” clauses with the main clause. These findings are important, because of how widespread “say” complementation is cross-linguistically. In other words, the discoveries made for Uyghur, Avatime, and English open up new questions for other languages with verbal clausal complementation structures.

From a fieldwork perspective, this dissertation highlights the importance of looking beyond translational equivalence. In the domain of clausal complementation, it is often the case that some clauses look nominal in nature, while others look verbal (e.g. “say”). These differences in morphology, even if provided the same translation, often have very different properties. This dissertation discusses these differences at length. Almost all of the data from this dissertation involved a combination of data-collection techniques, including traditional translation tasks and grammaticality judgments, context-based elicitation and other semantic/pragmatic methods, discourse construction tasks, and corpus data. Each technique offers different insights into the grammar, which I hope this dissertation is a testament to. The event versus state alternation was initially observed in conversation with Professor Justine Sikuku in a conversation about complementation structures in Bukusu. This conversation

turned into a chapter on English that was not initially planned. This involved none of the techniques above; instead, it simply involved listening to descriptions of his intuitions.

1.2 Methodology

1.2.1 Uyghur

Uyghur has a large diaspora population, a long written tradition, and many available texts, which has made it possible to collect data in many different ways.

1.2.1.1 Elicitation

Much of the data in this thesis was collected via various forms of elicitation with individuals and small groups. This took place both in the United States and in Kazakhstan. These sessions included standard grammaticality and truth value judgment tasks. To the extent possible, I had at least five speakers judge every sentence, and indicate disagreements when necessary.

Some of the data in this dissertation was collected in the process of developing a model of Uyghur Intonation. One task involved meeting with pairs of speakers and asking them to speak about a particular issue or topic that was intended to elicit particular constructions. Other tasks involved collaborating with speakers to embed target sentences into naturalistic discourse contexts (I refer to this as *scriptwriting*, see Major and Mayer (2018)). This task was extremely useful for developing a deeper understanding of how the surrounding discourse interacts with target sentences, making anaphoric dependencies transparent, while also ensuring that target sentences were truly acceptable. This has benefits for elicitation of syntactic, semantic, pragmatic, and intonation data.

I additionally used various semantics-based elicitation techniques (Matthewson, 2004; Bochnak and Matthewson, 2015). Almost every complex example involved grammaticality judgment tasks, followed by context-based elicitation. Throughout the dissertation, I have

attempted to differentiate between grammaticality and felicity, although there are some contexts where this issue is unclear.

1.2.1.2 Naturalistic Data

Much of the data in this thesis is informed by naturalistic data, but simplified for expository purposes. Most of the naturalistic data was obtained via corpora, then simplified with the assistance of native speakers of Uyghur. The most frequently used corpora were generated using web scrapers, which is software that is able to download content from individual pages at a given URL. There are separate web scrapers for Uyghur Awazi and Radio Free Asia archives.¹

One anonymous Uyghur speaker shared naturalistic recordings with me, but requested that their identity and the identity of the speakers be withheld. These recordings mostly consisted of narratives, which granted access to naturalistic speech and dialogues, which was extremely useful for the topic of this dissertation.

1.2.2 Avatime

For Avatime, much of our data was collected via elicitation with individuals or small groups in Amedzofe, Ghana. The same elicitation methods described for Uyghur were also used for Avatime. Other elicitation sessions were carried out by telephone. We additionally used data from texts collected by ourselves from 2017-2020, corpora created by Defina and Van Putten.², and from the New Testament.

¹These web scrapers were developed by Connor Mayer, Daniela Zokaeim, Tyler Carson, and the author. They are freely available for use in research. For more information, see: https://github.com/connormayer/uyghur_tools/tree/master/uyghur_awazi_scraper and <https://github.com/yzgncx/RFA-Scraper>.

²Link to corpus: https://www.elararchive.org/uncategorized/SO_fdf2968a-7769-4dcd-931a-18c5d873bbd2/

1.3 Uyghur

1.3.1 General Background

Uyghur (ISO 639-3: uig) is a Southeastern Turkic language spoken by roughly 12 million people. Its speakers are located primarily in the Xinjiang Uyghur Autonomous Region in the People’s Republic of China, but also in neighboring Kazakhstan, Kyrgyzstan, Uzbekistan, and in diasporic communities in Turkey, the United States, Canada, Australia, Russia, Saudi Arabia, Afghanistan, Pakistan, India, and across Europe.



Figure 1.1: The Xinjiang Uyghur Autonomous Region

(from https://upload.wikimedia.org/wikipedia/commons/9/95/Xinjiang_map.png)

Uyghur has been written in numerous orthographies throughout time (see Dwyer, 2005), but is most commonly written in a Perso-Arabic based script today. A standardized Latin-based Uyghur orthography as developed for transliteration purposes in Engesæth et al. (2009/2010), which I use throughout this thesis. This system overlaps almost entirely with English with the following exceptions: ⟨è, e, zh, gh⟩ correspond to [e, æ, ʒ, ɣ/ʁ] respectively.

All glosses taken from other sources have been modified to match my glossing conventions.

1.3.2 Basic grammar

Uyghur is an SOV language. Verbs canonically agree with the subject in person and number (9).

- (9) a. Mahinur Tursun-ni kör-d-i.
 Mahinur Tursun-ACC see-PST-3
 “Mahinur saw Tursun.”
- b. Biz Tursun-ni kör-d-uq.
 1PL Tursun-ACC see-PST-1PL
 “We saw Tursun.”

Uyghur has a rich case system, which includes: nominative, accusative, dative, ablative, and genitive, as shown in Table (1.1).

Case	Case Marker	Example 1	Example 2
Nominative	∅	somka-∅ “bag”	xet-∅ “letter”
Accusative	-ni	somki-ni “bag-ACC”	xet-ni “letter-ACC”
Dative	-GA	somki-gha “bag-DAT”	xet-ke “letter-DAT”
Ablative	-Din	somki-din “bag-ABL”	xet-tin “letter-ABL”
genitive	-ning	somki-ning “bag-GEN”	xet-ning “letter-GEN”

Table 1.1: Uyghur case system

First, notice that the stem *somka* “bag” is realized as *somki-* when it takes a suffix. This is a common process traditionally known as *vowel reduction*, by which *a/e* raise to *i* in medial open syllables. In other words, suffixation feeds application of *vowel reduction*.³

There is a second raising process from *a/e* to *é* in initial open syllables when the following vowel is [i] (or sometimes [é]), as illustrated in (10).

- (10) a. tash “stone”
 b. tésh-i “head-3POSS”

³These symbols correspond to orthographic representations, not IPA.

These raising processes play no role in this dissertation, but forms for the same words do change throughout without explanation, as a result of these processes.⁴

Furthermore, notice in the “Case Marker” column in Table (1.1), that some characters are capitalized. This is in following with Turkic tradition, where capital letters indicate underspecification (thus, allomorphy). For instance, notice that dative is represented as -GA. This is because, the initial consonant changes on the basis of voicing and consonant harmony (backness - velar (front) versus uvular (back)), while the vowel changes based on backness harmony. For this reason, there are four distinct realizations of the dative suffix, as shown in (11).

- (11) a. adem-ge “man-DAT”
 b. xet-ke “letter-DAT”
 c. almi-gha “apple-DAT”
 d. put-qa “foot-DAT”

1.3.3 Accusative case

Accusative case receives considerable attention in this dissertation, for which reason I discuss it at greater length than other case-markers in the language. In Uyghur, Accusative case functions as differential object marking (henceforth DOM), a term originally coined by Bossong (1985). In Uyghur, DOM is used to indicate specificity, as illustrated in (12).

- (12) a. Mahinur alma yé-di
 Mahinur apple eat-PST.3
 “Mahinur ate an apple.”
 b. Mahinur almi-ni yé-di
 Mahinur apple-ACC eat-PST.3
 “Mahinur ate the/aforementioned apple.”

Broadly speaking, the felicity conditions for (12b) are based on whether the word *alma-*

⁴See Mayer (2021) for in-depth discussion of vowel harmony and raising in Uyghur.

“apple” has been uttered earlier in the discourse or whether a particular apple exists in the common ground. Bare objects, on the other hand, are typically discourse-new.⁵

To offer additional detail, Uyghur accusative shows roughly the same distribution as Turkish with respect to the referentiality scale discussed in von Heusinger and Kornfilt (2017) (13).

- (13) a. sız-*(ni) kör-d-üm
 you-ACC see-PST-1SG
 “I saw you.”
- b. Tursun-*(ni) kör-d-üm
 Tursun-ACC see-PST-1SG
 “I saw Tursun.”
- c. ani-si-*(ni) kör-d-üm
 mother-3POSS-ACC see-PST-1SG
 “I saw his mother.”
- d. qız-ni kör-d-üm
 girl-ACC see-PST-1SG
 “I saw the (contextually salient) girl.”
- e. bir qız-ni kör-d-üm
 a girl-ACC see-PST-1SG
 “I saw a contextually salient/specific girl.”

When the direct object is inherently referential, as is the case with pronouns (13a), proper names (13b), accusative case is obligatory. This is also true of possessive DPs, where accusative case is similarly obligatory (13c). For other NP/DPs, accusative is necessary only when the argument is discourse salient in some capacity (13d)-(13e).

On the basis of evidence that has been used a wide range of languages, I assume that accusative objects get case by raising out of VP, while bare objects remain in their VP-internal merge positions (Massam, 2001; Kornfilt, 1997; Öztürk, 2005; Baker, 2014). As is

⁵Despite the fact that Uyghur DOM has received little attention in the literature, the basic properties are strikingly similar to Turkish. See Enç (1991); Kornfilt (1997); Öztürk (2005); Predolac (2017); von Heusinger and Kornfilt (2017); Kornfilt (2020) for detailed discussion of Turkish DOM.

true of bare objects in many other languages, these arguments are full NPs, as they are able to be modified by numerals and adjectives (14). For this reason, these are clearly not instances of head incorporation because they are clearly phrasal.

- (14) U [Bir qizil alma] yé-d-i.
 s/he one red apple eat-PST-3
 ‘‘S/he ate a red apple.’’

In following with Baker (2014)’s analysis of Sakha and Tamil, I take these NPs to be psuedo-incorporated into the verb. I assume that there is a direct correlation between this raising and the Mapping Hypothesis (Diesing, 1992), which is argued to be the case for other Turkic languages (Sugar, 2019; Major, To Appear; Predolac, 2017; Baker and Vinokurova, 2010). That is to say, that it is the object’s escaping the nuclear scope of the quantificational structure of the clause that causes it to be interpreted as specific (i.e. it evades existential closure).

One piece of evidence for raising comes from the relationship between manner adverbs and bare versus accusative-marked objects. Specifically, accusative-marked objects have to raise to the left of manner adverbs like *quickly* (15a), while indefinite objects are obligatorily unmarked and remain within the VP (15b).

- (15) a. Almi-*(ni) téz yé-d-i.
 apple-ACC quickly eat-PST-3
 ‘‘S/he quickly ate the apple.’’
 b. téz alma-(*ni) yé-d-i.
 quickly apple-ACC eat-PST-3
 ‘‘S/he quickly ate an apple.’’

Furthermore, only accusative-marked objects are able to undergo scrambling (16).

- (16) Almi-*(ni) Mahinur yé-di
 apple-ACC Mahinur eat-PST.3
 ‘‘Mahinur ate the apple.’’

I assume that scrambling requires accusative case, because in order to scramble out of *vP*, the object must transit through the edge of *vP* to access the higher phase (Chomsky, 2000, 2001).

1.3.4 Tense, Aspect, and Embedded Clauses

Uyghur has a rich inventory of tense and aspect markers. For present purposes, I introduce only those markers that will be seen throughout this dissertation. The first contrast is between the simple past, the indirect past, and the past participial.

- (17) a. Mahinur Tursun-ni kör-d-i.
 Mahinur Tursun-ACC see-PST-3
 “Mahinur (definitely) saw Tursun.”
- b. Mahinur Tursun-ni kör-üptu.
 Mahinur Tursun-ACC see-PST.INDIR.3
 “Mahinur (reportedly) saw Tursun.”
- c. Mahinur Tursun-ni kör-gen.
 Mahinur Tursun-ACC see-PTPL.PST
 “Mahinur saw Tursun.”

If the speaker was present or is fully confident that what they are reporting is true, the simple past is used (17a). When the speaker wants to indicate that the utterance is based on hearsay or reported information, the indirect past is used (17b). When something is reported as a general truth, the past participial is generally used with no overt tense-marker (17c).

A similar alternation is found in the non-past between a vocalic tense-marker (*i/y*) in (18a), which alternates with a participial *-idighan* that gives rise to roughly the same meaning (18b).

- (18) a. Mahinur Tursun-ni kör-i-du.
 Mahinur Tursun-ACC see-NONPST-3
 “Mahinur will see Tursun.”

- b. Mahinur Tursun-ni kör-idighan.
 Mahinur Tursun-ACC see-PTPL.IMPF
 “Mahinur will see Tursun.”

Tense itself does not play a critical role in this dissertation, but there are some points worth making. The Uyghur chapters of this dissertation focus heavily on clausal embedding, which is an area where the tense distinction plays a more important role. More specifically, there are two types of embedded clauses: tensed embedded clauses (TECs), such as (19a), and nominalized embedded clauses (NECs), (19b).

- (19) a. Mahinur [Tursun-(ni) naxsha éyt-ti/iptu de-p] angli-d-i.
 Mahinur Tursun-ACC song sing-PST-3 say-CNV hear-PST-3
 “Mahinur heard that Tursun sang a song.”
- b. Mahinur [Tursun-ning naxsha éyt-qan-liq-i-ni] angli-d-i.
 Mahinur Tursun-GEN song sing-PTPL.PST-COMP-3POSS-ACC hear-PST-3
 “Mahinur heard that Tursun sang a song.”

Tensed embedded clauses are always embedded by *de-* and resemble root clauses, allowing for the same tense-marking and agreement (19a). NECs, such as (19b) are built from participials and host the same kind of agreement found on the possessum in genitive constructions. Furthermore, an NEC cannot host root tense/evidentiality (20).

- (20) a. * Mahinur Tursun-ing ket-t-i/iptu-(lik)-i-ni
 Mahinur Tursun-GEN leave-PST-3/PST.INDIR.3-COMP-3POSS-ACC
 dé-d-i.
 say-PST-3
 Intended: “Mahinur said that Tursun left/left supposedly.”
- b. * Mahinur Tursun-ing ket-i-du-(lik)-i-ni dé-d-i.
 Mahinur Tursun-GEN leave-NONPST-3-COMP-3-ACC say-PST-3
 Intended: “Mahinur said that Tursun leaves/will leave.”

In addition to tense-marking/agreement, TECs allow for left-peripheral elements, such as the question particle =*mu* in (21a), while NECs are unable to host any morphology higher than Asp (between Asp and Comp) (21b). It is for this reason that I assume TECs to be CPs, as opposed to TPs.

- (21) a. Mahinur [Tursun-ni naxsha éyt-t-i=mu de-p] sori-d-i.
 Mahinur Tursun-ACC song sing-PST-3=Q say-CNV ask-PST-3
 “Mahinur asked (something), saying, ‘Will Tursun sing a song?’”
- b. Mahinur [Tursun-ning naxsha éyt-qan
 Mahinur Tursun-GEN song sing-PTPL-PST
 éyt-mi-ghan-liq-i-ni] sori-d-i.
 sing-NEG-PTPL.PST-COMP-3POSS-ACC ask-PST-3
 “Mahinur asked whether Tursun sang a song or not.”

I assume Asarina (2011)’s analysis of NECs, who argues that there is a (usually null) nominal that hosts case and agreement morphology in NECs like (19b). This N Agrees with the embedded subject, which results in it showing matching agreement. Like relative clauses in the language⁶, clausal complements to nouns are AspPs, not full TPs. This is shown in (22).

(22)

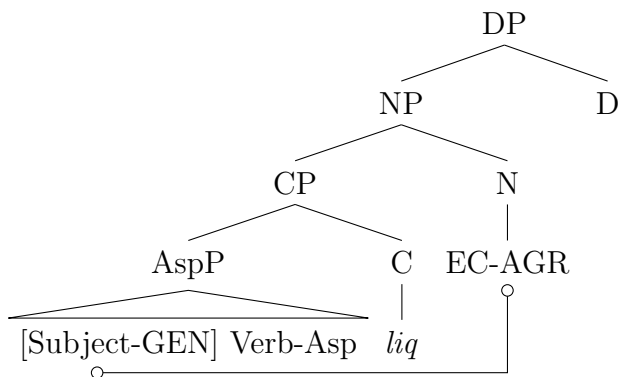

The particular case-marker is determined by the embedding verb. Most verbs select accusative-marked NECs, as shown for “say”, “hear”, and “know” in (23a). Other predicates have idiosyncratic case-assignment properties, such as the dative assigning predicates “believe”, “regret” and “resent” in (23b).

⁶Participial clauses exhibit many behaviors similar to relative clauses, as well as nearly identical morphology. This is compatible with a growing number of proposals that clausal embedding involves relativization (Aboh, 2010; Caponigro and Polinsky, 2011; Kayne, 2014). This does not apply to “say” complementation structures.

- (23) a. Mahinur [Tursun-ning ket-ken-lik-Ø-i-ni/*ge]
 Mahinur Tursun-GEN leave-PERF-COMP-NOUN-3-ACC/*DAT
 dédi/anglidi/bilidu.
 said/heard/knows
 “Mahinur said/heard/knows that Tursun left.”
- b. Mahinur [Tursun-ning ket-ken-lik-Ø-i-ge/*ni]
 Mahinur Tursun-GEN leave-PERF-COMP-NOUN-3POSS-DAT/*ACC
 ishinidu/pushayman#qildi/nepretlendi.
 believes/regretted/resented
 “Mahinur believes/regretted/resented that Tursun left.”

Dep clauses are unaffected by the embedding verb as it relates to case-marking, as shown in (24a) and (24b).

- (24) a. Mahinur [Tursun-(ni) ket-t-i de-p] anglidi/bilidu.
 Mahinur Tursun-ACC leave-PST-3 say-CNV heard/knows
 “Mahinur said/heard/knows that Tursun left.”
- b. Mahinur [Tursun-(ni) ket-t-i de-p]
 Mahinur Tursun-ACC leave-PST-3 say-CNV
 ishinidu/pushayman#qildi/nepretlendi.
 believes/regretted/resented
 “Mahinur believes/regretted/resented that Tursun left.”

In Chapter 4, I argue that *dep* clauses are not selected, while NECs are. As a result, only the latter behave like standard, DP arguments. I spend the second half of Chapter 3 discussing the structure of TECs.

1.3.5 Null Arguments

Uyghur is a discourse *pro*-drop language, like Japanese, Chinese, and Turkish (Huang, 1982, 1984; Hasegawa, 1984/1985). Notice that when the topic in a question (25a) functions as the internal argument of the the answer (25b), the object is naturally unpronounced.

(25) a. Question:

Bu métal-gha néme bol-d-i?
this metal-DAT what become-PST-3

“What happened to this metal?”

b. Answer:

Ahmat (u-ni) ur-up tüzli-wet-t-i.
Ahmat it-ACC pound-CNV flatten-COMPL-PST-3

“Ahmat flattened it by pounding (it).”

This is common behavior for a *pro*-drop language. Given that arguments are freely dropped across the language, I do not adopt Sugar’s PRO analysis of internal arguments to V1; instead suggesting that argument sharing is simply a result of argument drop. More specifically, in a case like (25b) the internal argument need not be pronounced at all when it is salient in the discourse. However, argument drop is complicated by several factors, which make it difficult to determine the status of a null argument without a full-scale independent study.

In some cases, the empty category is entirely identical to its antecedent, as was the case in (25b). There can be a case mismatch between a dropped argument and its antecedent. Notice that the unergative subject “Mahinur” in (26) is in the nominative case, while the empty category that is co-referenced with Mahinur would carry the dative case (when pronounced).

(26) Mahinur öy-ge kir-d-i, emma Tursun (uning-gha)
Mahinur home-DAT enter-PST-3 but Tursun 3SG.GEN-DAT
pisent.qil-mi-d-i.
ignore.do-NEG-PST-3
“Mahinur came home, but Tursun ignored (her).”

In these cases, it is natural to interpret the null argument as *pro*, which is co-indexed with “Mahinur”. There is thus no requirement that the antecedent and empty category be morpho-syntactically identical.

Perhaps even more importantly, not all empty categories are interpreted as identical to their antecedent. As discussed in Tomioka (2014) for Mandarin and Japanese, there are

cases like (27) in Uyghur, where the empty category is interpreted as “whichever person is chosen”.

- (27) Tursun Mahinur yaki Aynur-ni öy-i-ge appir-i-du. U-ning
 Tursun Mahinur or Aynur-ACC home-3POSS-DAT bring-NONPST-3. 3SG-GEN
 ata-ani-si xoshalliq bilen (u-ni) küt-iwal-i-du.
 father-mother-3POSS happiness with 3SG-ACC welcome-CMPL-NONPST-3SG
 “Tursun will bring either Mahinur or Aynur to his home. His parents will welcome
 her_{EC} with joy.”

Furthermore, if an intervening sentence picks out one of the two alternatives, that individual functions as the antecedent for the empty category, as shown in (28).

- (28) Tursun Mahinur yaki Aynur-ni öy-i-ge appir-i-du. U-ning
 Tursun Mahinur or Aynur-ACC home-3POSS-DAT bring-NONPST-3. 3SG-GEN
 ata-anisi ikki-si-din Mahinur-ni yaxshi.kör-i-du. (Ular)
 father-mother-3POSS two-3POSS-ABL Mahinur-ACC good.see-NONPST-3. 3SG.PL
 xoshalliq bilen (u-ni) küt-iwal-i-du.
 happiness with 3SG-ACC welcome-CMPL-NONPST-3SG
 “Tursun will bring either Mahinur or Aynur to his home. His parents like Mahinur
 of the two. His parents will welcome her_{EC} with joy.”

The discussion above is important, because null arguments are licensed in a great many contexts in Uyghur. This is especially important in the context of Chapter 4 on converbial constructions, but plays an active role everywhere in the language.

1.4 Avatime

1.4.1 General background

Avatime (ISO 639-3: avn) is an endangered Kwa language spoken in the Volta Region of Ghana, with approximately 24,000 speakers (Ethnologue). The language is also known as *Siya* or *Sideme*. The majority of speakers are situated east of Lake Volta near the regional capital of Ho. Most of our consultants are from Amedzofe and Gbadzeme. It is classified

as a member of the Ghana-Togo Mountain language group (also “Central Togo” or “Togo Remnant” languages), which consists of about 15 languages. Avatime is in the *Ka-Togo* branch.

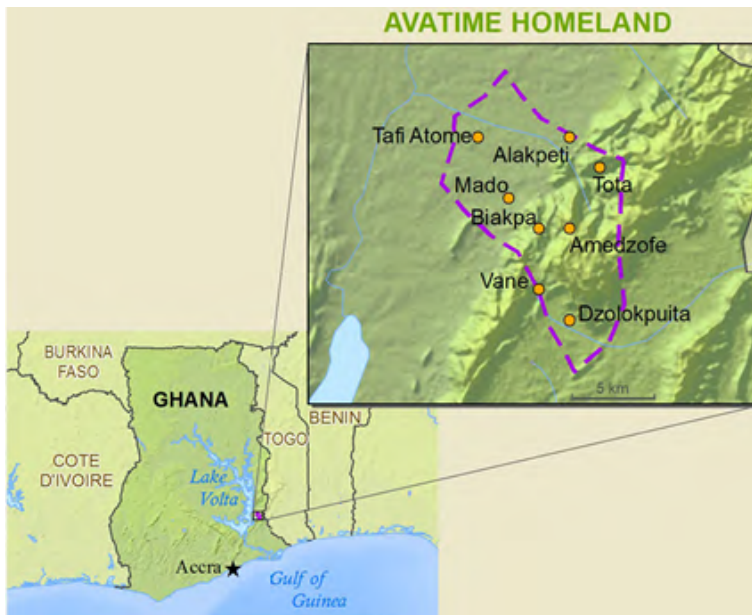

Figure 1.2: Avatime Map

(from <https://joshuaproject.net/people-groups/10496/GH>)

1.4.2 Basic language properties

Avatime has basic S(T)VO order. The first verb displays a subject marker, which agrees with the subject in person and number.

- (29) Ayape a-kla ke-plekpà
 Ayape 3SG-read CL-book
 “Ayape read the book.”

Avatime is a tone language, but there is considerable disagreement with respect to the tone system. It is unclear whether there are 3 or 4 level tones (see Ford, 1971; Schuh, 1995; Defina, 2016; Van Putten, 2014). There have also been proposed to be as many as 17 tone classes (Ford, 1971), which correlates with Tense, Aspect, and Mood. I do not make any strong claims with respect to the tone system, but do represent surface tones. I assume three

level tones, as represented in (1.2).

Superhigh	á
High	a
Low	à

Table 1.2: *Three level tones in Avatime*

Due to the Covid 19 pandemic, not all of my files were able to clearly be analyzed for tone and I was unable to make a return trip. I intend to offer a more precise description of the tones once I am able to make a return trip to Ghana, but in the meantime, I have represented tones to the best of my ability.

As is typical of Ghana-Togo Mountain languages, Avatime has a rich noun class system (and noun class concord) (1.3). These noun class markers occur on the left of almost all nouns in the language (e.g. *ke-* on “book”). In this dissertation, I gloss all classifiers as CL as a simplification for expository purposes (Van Putten, 2014:c.f.).

ó-dzε	“woman”
bá-dzε	“women”
ò-hà	“pig”
ì-hà	“pigs”
ki-kù	“yam”
bi-kù	“yams”
ku-de	“road”
be-de	“roads”
ke-plekpa	“book”
kù-plekpa	“books”

Table 1.3: *A subset of Avatime noun classes*

Tense, aspect, mood, and person/number are marked indicated with portmanteau prefixes on the verb. The unmarked tense in cases like (30a)-(31a) is generally interpreted like the simple past, but is also compatible with present and future contexts in some cases, being referred to as perfective or aorist in some sources (see Van Putten, 2014). Due to the complexity of the system, I mark only the phi-features for present purposes.⁷

⁷The distribution and semantic contribution of the “DEF”(inite) suffixes is not clear.

- (30) a. ma-tà kɪ-mimi-è
 1SG-eat CL-rice-DEF
 ‘I ate rice’
- b. mǝ-tà kɪ-mimi-è
 1SG.PROG-eat CL-rice-DEF
 ‘I am eating rice.’
- (31) a. a-tà kɪ-mimi-è
 3SG-eat CL-rice-DEF
 ‘S/he ate rice.’
- b. ǎ:-tà kɪ-mimi-è
 3SG.FUT-eat CL-rice-DEF
 ‘S/he will eat rice.’

All Avatime glosses from other sources have been changed to be consistent with my glossing conventions.

1.5 “Say” literature

As mentioned in the introduction, there is some pre-existing discussion of the properties of the verb “say” in the literature. The next chapter expands the empirical landscape related to the verb “say”, but it is necessary to first introduce what we already know about “say” from recent literature.

1.5.1 “Say” as a Light Verb (Grimshaw, 2015)

Grimshaw (2015) argues for the existence of an abstract light verb SAY in English. The general idea is that predicates derive from a set of universal semantic components combined with principles that govern their realization, which are syntactically represented. Under this proposal, SAY is one of these abstract universal semantic components akin to e.g., BE, DO, GO, CAUSE and HAVE (Dowty, 1979; Talmy, 1985; Jackendoff, 1992; Hale and Keyser, 1993; Folli and Harley, 2004: a.o.). Like these other light verbs, “say” is often present in the

syntax, although it is often unpronounced.

Grimshaw argues that the main verb “say” is the overt realization of the abstract light verb SAY, which is a silent component of communicative predicates more broadly (e.g. SAY + *ask* = [æsk], SAY + *scream* = [skɹɪm]). Grimshaw suggests that there could be incorporation of SAY into “scream” or some other process, but the precise mechanics are left open. What is clearly argued for is that the combination of “scream” and SAY introduces an Agent and so-called “Linguistic Material” (henceforth LM), despite the fact that SAY is not overtly realized in the utterance. This is demonstrated for “Mary screamed (that) Bill left” in (32).

(32) Mary screamed [SAY Bill left].

For Grimshaw, the say schema involves an Agent, Goal, and LM. All predicates that combine with SAY are said to involve the SAY schema. (33) is a case where all three are overtly represented.

(33) The teacher said to the students that the exam was easy. (Grimshaw, 2015:80:2)

In this sentence the verb “say” is the overt expression of SAY, which introduces the teacher as its agent and the students as a goal argument. The LM argument is “that the exam is easy”. The ability to introduce a goal argument and the form that it takes independent on the properties of the SAY schema predicate that SAY combines with. For instance, “tell” and “ask” can occur with a DP goal argument, whereas “say” or “scream” require the Goal to be expressed as a PP (34), which are adapted from Grimshaw (2015: ex. 56-57).

- (34) a. She muttered/screamed *(to/at) the teacher that the exam was too difficult.
b. She asked/told (*to/at) the teacher that the exam was too difficult.

One issue worth discussing more is the status of LM arguments. For Grimshaw, LM arguments can only be introduced by SAY. The primary diagnostic developed for LM is based on whether or not a direct quotation is acceptable as an argument of the predicate. The cases in (35)-(37) are modeled from Grimshaw (2015: pp. 82-84). In some cases, direct

quotes are introduced in complement position (35), other times in inversion constructions (36), and other times combines with a copula in a pseudo-cleft (37) construction.

- (35) a. “Our exam was easy,” the students said/remarked/*believed/*felt.
b. The students asked/wondered/*knew/*found out “Will our exam be easy?”
- (36) a. “Our exam was easy,” the students said/remarked/*believed/*felt.
b. “Will our exam be easy?” the students asked/wondered/*knew/*found out.
- (37) a. What the students said/announced/*believed/*felt was “Our exam was easy.”
b. What the students asked/wondered/*knew/*found out was “Will our exam be easy?”

The direct quotation test is a valuable way of differentiating predicates from the SAY schema from those that are not. Whereas some predicates are always ruled out as SAY predicates, such as “believe/know/find out/feel”, others are ruled in, such as “think” (38) (Adapted from Grimshaw, 2015:pp 84, ex: 20).

- (38) a. The students thought “This exam is easy.”
b. “This exam is easy,” the students thought.
c. What the students thought was, “This exam was easy.”

The verb “think” is an interesting test case, because it is an attitude verb that does not intuitively share the same properties as many other predicates that realize the SAY schema. Grimshaw suggests that these are instances where the LM is presented internally, which holds of other predicates such as “wonder” and “want to know”.

I continue to use LM to refer to the arguments of “say”/SAY throughout the rest of this dissertation.

- (39) *Linguistic Material*: Direct quotation or any argument that can be substituted with direct quotation.

Based on the definition above, in following with Grimshaw, I assume that SAY is the only predicate capable of introducing LM.

Grimshaw further demonstrates that subjects of “saying” can also be Locations, as opposed to Agents, giving rise to a stative interpretation.

(40) The sign said that the park was closed.

Grimshaw does not discuss syntactic differences between the SAY schema with agents and those with locations, but does provide evidence that the latter are stative. Evidence for stativity comes from the fact that they cannot occur in the progressive (41a) or introduce a Goal argument (41b).

- (41) a. ?? The sign/poster/book/article
was saying that the park was closed. (Grimshaw, 2015:87: ex 30)
- b. ?? The sign/poster/book/article
said to the tourists that the park was closed.(Grimshaw, 2015:87: ex 30)

This is important because it illustrates that “say” alternates between states and events in English. Thus argument structure, theta roles assignment, event structure, and more are contingent upon which “say” structure is used.

1.5.2 Anand et al. (2017): Subjects of “saying”

Anand et al. (2017) argue for a different typology of external arguments of a wide range of speech/communication predicates. Their inventory of external arguments is provided below:

- Sentient beings, which can be experiencers (John)
- Agentive repositories of information: R-of-Is which can be discourse agents (book, article, review)
- Non-agentive repositories of information: R-of-Is which cannot be discourse agents (data, transcript)

- Inanimates: Inanimate objects that lack propositional constant (plate, time of death)

For my purposes here, the main point is that there are useful characterizations of inanimate subjects that explain their ability to function as agents or external arguments of certain speech/attitude verbs.

For instance, what Grimshaw (2015) refers to as “locations” (e.g. “signs”, “posters”, or “notes”), Anand et al. (2017) refers to as Agentive R-of-Is. They classify “say” and “claim” as communicative predicates. I provide examples based on (Anand et al., 2017:2) in (42).

- (42) a. The critic **claims/says** that the food is good here.
b. The (critic’s) review **claims/says** that the food is good here.
c. # The (critic’s) empty plate **claims** that the food is good here.
d. The (critic’s) empty plate **says** that the food is good here.

With a sentient agent (42a), both predicates are acceptable. The same can be said for “the review”, which they characterize as an agentive R-of-I. An inanimate like “plate” cannot function as the subject of claim (42c), but it is acceptable with “say” (42d). I maintain this general contrast, but suggest that the verb “say” remains stable across uses. In other words, (42d) simply involves stative “say”, although there is an inference made on behalf of the speaker.

1.5.3 Major & Stockwell (2021)

Building upon Grimshaw (2015) and Anand et al. (2017), Major and Stockwell (2021) argue that the interpretation of “say” is dependent on the structure that dominates the VP that “say” heads. More specifically, we argue that at least the Agent versus “Location” distinction needs to be made with respect to “say”. The cases in (43) illustrate the range of external and internal arguments of “say”.

- (43) a. John said { “I like cheese” / that he likes cheese / something about cheese }.
 b. The sign said { “Quite please!” / to shut up / something rude } (on it).
 c. It says { “Wash with like colours” / that you should wash it with like colours / only one thing } on the label.

The data in (43) demonstrate that there are cases where “say” takes either an agentive (sentient) external argument (43a), an inanimate, such as “sign” (43b), or an expletive “it” subject (43c). We showed that (43b) is ambiguous between an Agentive R-of-I and a Holder (roughly equivalent to Grimshaw’s “Location”), however the presence of the locative PP “on it” disambiguates the structure, forcing the “Holder” interpretation. Furthermore, we argued that the expletive subject can only have a stative interpretation.

We further suggest that there are not separate lexical entries for “say”, but rather, there are syntactic/semantic distinctions between each of the structures introduced by SAY. More specifically, the only structure shared across all instances of “say” is a VP headed by “say” and a LM internal argument (44).

- (44) *VP-internal syntax of “say”*

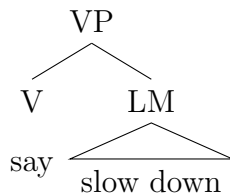

The difference between “say” with an agent and a Holder is linked to the head that introduces the external argument. We adopt a version of the proposal in Kratzer (1996), by which distinct Voice heads have different properties. More specifically, If Voice is headed by Agent, it introduces an Agent as the external argument and its complement is interpreted as a dynamic event (45a). On the other hand, if Voice is headed by Holder, the external argument is the Holder of a state, and its complement is stative (45b).

- (45) a. Mittie [Agent [fed the dog]].
 b. Mittie [Holder [owns the dog]].

Applying this to “say”, when the external argument is an agent and the “saying” is dynamic, the structure is as shown in (46a). Holder Voice, on the other hand, introduces a Holder as the external argument of “say”, which lacks agentive semantics yielding a stative interpretation (46b). Finally, in structures with expletive subjects, we argue that there is no Voice layer in the structure at all, which forces expletive insertion (46c) and a stative interpretation.

- (46) a. Mittie [_{Voice/} [Agent] [said slow down]]]
 b. The sign [_{Voice/} [Holder] [says slow down (on it)]]]
 c. It [says slow down (on the sign)]

I build upon the overall findings in Major and Stockwell (2021), but transition away from the Voice-based theory above to a so-called “Flavours of little *v*” analysis (Folli and Harley, 2005). Under this theory, *v*P is able to be headed by a range of little *v* heads, e.g.: *v_{cause}*, *v_{be}*, *v_{become}*, etc. Each of these heads gives rise to different properties related to argument structure, event structure, and semantic interpretation.

1.5.4 Flavours of little *v* and the syntax of event structure

Since at least Hale and Keyser (1993) (henceforth HK), many syntacticians have argued for a more articulated VP-internal structure. This work involves an L-syntax that occurs in the lexicon, closely mirroring operations in the “Deep Structure”. A fundamental property of this group of proposals is that there is a class of abstract light verbs that merge with some other element that results in a “verb” that we see on the surface. For instance, the verb “laugh” is actually composed of the light verb “DO”, which selects “laugh” as its internal argument, which subsequently incorporates into the light verb and is realized on the surface as “laugh”.

Building on HK, others have arrived at similar conclusions with slightly distinct technical applications. Cuervo (2003), for instance, assumes that roots are able to license internal arguments (or not). In (47), it is the light verb DO that is responsible for licensing the

agent and the root is responsible for determining what type of internal argument, if any, is permitted. When DO combines with a resultative small clause, it is interpreted as a causative, as in (47b). However, “laugh” does not license an internal argument (47c) or an adjectival predicate (47d) directly. It does determine that a small clause is permitted, which allows the SC subject “himself” and “silly” into the structure.

- (47) a. Sean laughed. (Cuervo, 2003:p.23, ex: 21a-d)
 b. Sean laughed himself silly.
 c. *Sean laughed himself.
 d. *Sean laughed silly.

Cuervo assumes three different light verbs: *vDO* (creates activity verbs), *vGO* (indicating motion or direction), *vBE* (creates stative verbs). In Cuervo’s system, the root itself is responsible for determining whether an internal argument can be licensed. For a root like “dance”, an internal argument is optional, as shown in (48).

- (48) a. Vicki bailó (un tango). (Adapted from Cuervo, 2003:p.24, ex: 23a-b)
 Vicki danced a tango
 “Vicki danced a tango.”

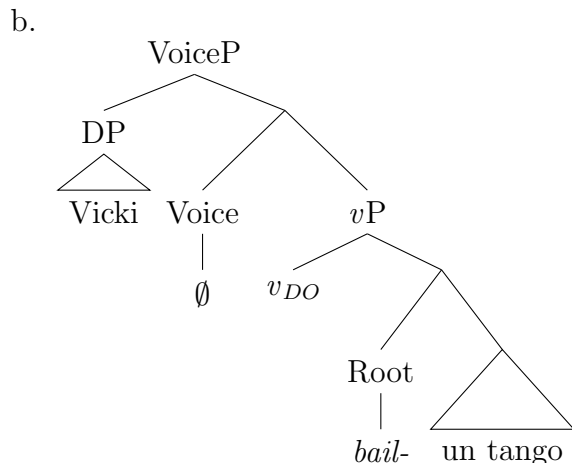

In Folli and Harley (2004), it is argued that there is a single *v*, which can be headed by DO, CAUSE, or BECOME, each of which places different restrictions on the external argument and its complement. In particular, they demonstrate an important contrast between DO

and CAUSE. For instance, they demonstrate that a consumption verb like “eat” requires an agent (i.e. v is headed by DO). On the other hand, “eat away” is a cause + result construction, where an inanimate can cause the eating away of something. Thus (49a) is acceptable, because John can function as an agent, while without “away”, the sea is teleologically incapable of functioning as an agent, ruling out (49b). However, the presence of “away” enforces a cause + result structure. The sea is capable of causing the eating away of the beach, as shown in (49c).

- (49) a. John ate the apple.
 b. *The sea ate the beach.
 c. The sea ate the beach away

Grammaticality is thus determined by whether the external argument is compatible with the particular light verb that heads v .⁸

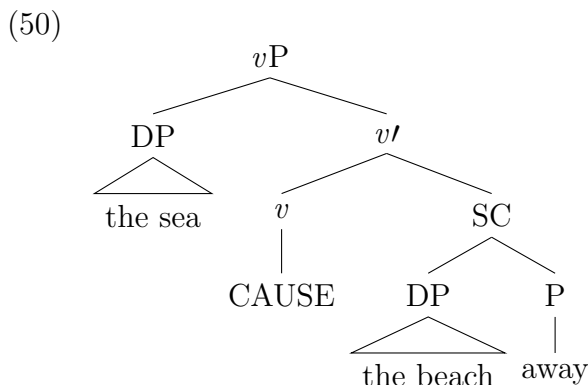

The precise mechanism by which the root is introduced into the structure has varied in the literature and I am not concerned about which mechanism we adopt for the present. It is possible that the root incorporates into the light verb (Hale and Keyser, 1993; Cuervo, 2003), that the root is inserted late via “Manner Incorporation” (Mateu, 2002; Harley, 2005:a.o.), or that it is the head of a Process Phrase that intervenes between the two VP shells (e.g.

⁸In Larson (1988), v represents the upper VP shell and SC represents the predicative VP shell.

between *v*P and SC).⁹

Turning briefly to event/aspectual structure, Ramchand (2008, 2018) offers a synthesis of a number of proposals grounded in both the syntactic and semantic literatures. The hierarchy proposed by Ramchand is shown in (51).

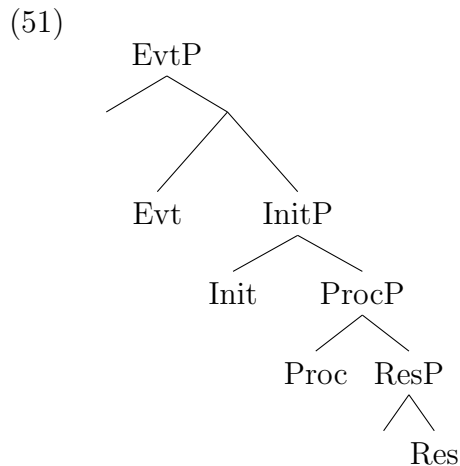

The function of each of these projections is defined below:

- EvtP: Locus of external argument
- InitP: Causation subevent
- ProcP: Dynamic/Change subevent
- ResP: Result subevent

Thus for an utterance like “Katherine broke the stick”, Katherine is the initiator of a process by which the stick breaks, resulting in the stick being broken (52) (Ramchand, 2008:75, ex: 29):

⁹These proposals are built upon lexical-conceptual structures proposed by Jackendoff (1990); Levin and Rappaport Hovav (1998).

(52)

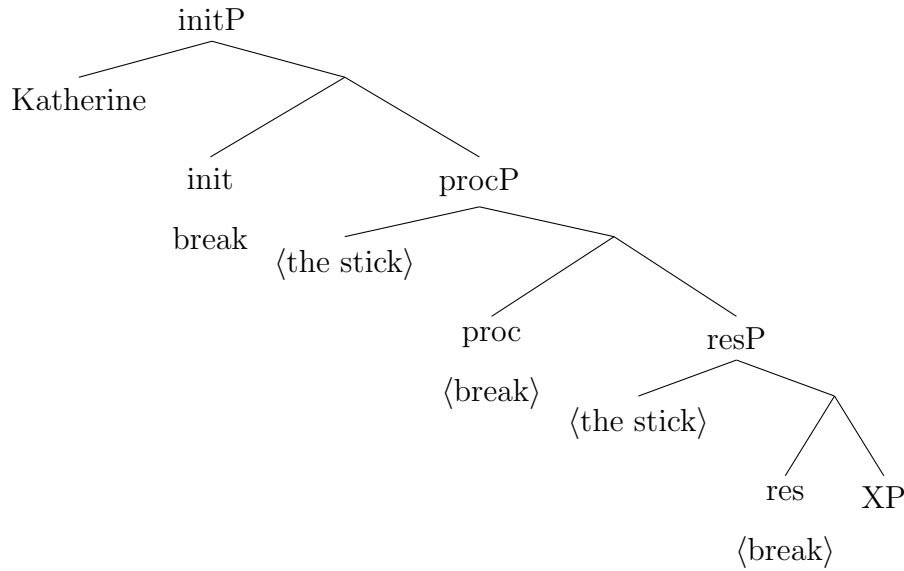

As far as I am aware, the analyses of “say” structures put forth in this dissertation are compatible with Ramchand’s approach, a Voice-based approach, or a “Flavours of little *v*” analysis. The implementation of these structures in this dissertation is most similar to Folli and Harley (2020), who introduces the lowest VP shell, ResultP, as the complement to *v*, as shown in (53) below:

(53)

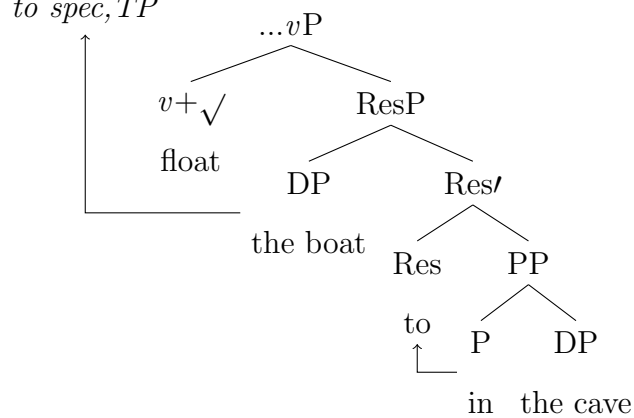

As shown in the introduction for “say” structures, (3) and (4), I assume the basic proproperties of *ResP* to be equivalent to what I call “SayP”, which can describe the result of communication.

1.5.5 Notes on semantics of “say”

One final issue related to “say” that is important to the discussions throughout this dissertation has to do with the overall bleached or variable semantics of “say”. To briefly demonstrate some of the relevant types of variability, consider Moltmann (2017)’s discussion of communicative predicates, which can all be represented with distinct syntactic structures and illustrate some of the variability we find with respect to the semantics of “say” and the various realizations of LM.

Moltmann (2017) draws from Austin (1975), suggesting that speaking events should be decomposed into illocutionary acts (e.g. assertion, interrogation, ordering) and locutionary acts, which are interpreted “below” the level of illocution. Locutionary acts are described as rhetic acts (i.e. the act of uttering words or a sentence with a specific meaning and reference) and a phatic act (the act of uttering words) and the phonetic act of producing sounds.

The verb “say” is able to represent any of the following layers of a communication act:

- Illocutionary act: “Kayla said to shut Alex up.”
- Locutionary act
 - Rhetic act: “Kayla said Alex is being loud/.”
 - Phatic act: “Kayla said (in a whisper), “Alex needs to shut up”.”
 - Phonetic act: “Kayla said “shhhhh”.”

I do not attempt to formalize all of these distinctions, but simply wish to point out that LM is diverse in how it can be represented. More specifically, “saying” events can be described in many different ways.

One other issue covered by Moltmann that is relevant to the present involves another realization of the LM argument, which she refers to as *words*-NPs. These are plural NPs, such as (54).

(54) John said a few words / those words.

Importantly, as noted by Moltmann, this particular set of NPs are not actually plural forms of the singular “word”, but instead are used as a *plurale tantum*. Rather than standing for a plurality of individual expressions, these NPs represent pluralities of words with specific meanings in a meaningful configuration. Moltmann further shows that in addition to *words*-NPs, that certain quantifiers and pronouns are similarly able to stand in for clausal complements: *something*, *everything*, *that*, and *what*. I will refer to these elements as “Linguistic Material Nominals”, defined as (55).

- (55) *Linguistic Material Nominals*: The set of nominals that can stand in for LM arguments.

Given that these stand in for LM, they can be diagnosed by replacing the the LMN with a direct quotation, as in (56b).

- (56) a. John said something.
 b. John said, “I am tired”.

I return to this issue in depth for English, Avatime, and Uyghur throughout this dissertation, suggesting that the set of nominal expressions that can be introduced by “say” is unique, especially relative to the types of arguments permitted by other communication/attitude verbs.

1.5.6 Silent Modal SAY and Saturation

Kratzer (2016) offers a proposal that is rather similar to the proposal argued for in this dissertation, by which English has a silent SAY modal. Kratzer suggests that clausal complements are predicates that modify either nominals, along lines similar to Kratzer (2006) and Moulton (2009). More specifically, Kratzer suggests that the LF for cases like (57) is as shown in (58).

(57) Ralph sighed that Ortcutt was a spy.

(58) [Ralph [[sighed] [_{CP} [say] [_{MoodP} “thing” [that Ortcutt was a spy]]]]].

Kratzer is inspired to posit the presence of SAY on the basis of languages that explicitly use the *verba dicendi* in clausal complementation contexts. It is argued that all finite complement clauses are either modifiers of nouns (e.g. “the rumor that”) or verbs, of the variety above. In (58), the abstract nominal “thing” combines with the predicate “that Ortcutt was a spy”. That entire constituent combines with “say” forming a CP, which combines with the verb “sigh” via “event identification”. The overarching idea is compatible with the discussion in this dissertation, but I suggest that SAY, which is treated as a left peripheral element in (58) is actually a verb (cross-linguistically). I also demonstrate that “say” as a main verb exhibits exceptional behavior that is further observed for SAY (building on Grimshaw’s ideas).

Turning to Moulton (2015), it is argued that in English, when complement clauses combine with verbs, there is a short A-movement step that leaves behind a trace of type *e*, which is able to saturate the internal argument requirement of the embedding predicate. However, Moulton (2016) describes the status of *in-situ* saturators, which is similar to Kratzer’s analysis of SAY modals. Moulton treats these SAY elements as C elements, which provides quantification over possible worlds. This forms a CP composed of a head “SAY” and a TP complement that composes *in situ*. Many aspects of this proposal are compatible with the analysis in this dissertation, but I suggest that these elements are actually verbs.

In particular, one aspect of Grimshaw’s proposal that is not discussed in Kratzer or Moulton is the fact that SAY uniquely introduces LM and that “say” is the overt realization of SAY. The patterns mentioned by Moulton for Bengali, Japanese, Korean, and Zulu with respect to what is introduced by that SAY elements also hold of “say”. For instance, “say” is unique in that it can introduce a finite clause, but cannot occur with a content nominal. For example, the types of DPs that “say” can combine with are only those that stand in for LM, not those that are able to combine with CPs.

- (59) a. Ralph believes the rumor/story/myth/claim that Ortcutt is a spy.
b. *Ralph said the rumor/story/myth/claim that Ortcutt is a spy.
c. Ralph said something interesting/a few words (*that Ortcutt is a spy).

In many ways I offer case studies that support aspects of Kratzer and Moulton’s proposals, but deviate in some non-trivial ways. For instance, I show that the properties of “say” are observed in all SAY contexts, that is made transparent in other languages. I demonstrate that a language’s complex predicate formation strategy plays a critical role in determining the distribution of SAY clauses. Finally, I suggest that these elements are truly verbal in a way that remains compatible with using event identification to merge “say p” and e.g. “sigh”. Finally, “say” is one of the only predicates that allows *in situ* saturation, which is further interesting because all possible realizations of LM arguments are capable of saturating the internal argument requirement of “say”. On the other hand, predicates that combine with “say” have their own subcategorization frames, which determine whether internal arguments, modifiers, are allowed in addition to SAY+LM. The syntax offered in this dissertation presents a more elaborate syntax that incorporates insights from Koopman (1984); Grimshaw (2015); Kratzer (2016); Moulton (2016).

CHAPTER 2

The verb “say” in English

As discussed at the end of Chapter 1, the verb “say” is typologically unique, especially when compared to other speech and attitude verbs. “Say” shows signs of being both transitive and intransitive both within and across languages (Munro, 1982), often appears with clause-embedding predicates (Lord, 1993), occurs with subjects of various types (Grimshaw, 2015; Anand et al., 2017; Major and Stockwell, 2021), and shows variation as it relates to its status as an activity versus stative predicate (Grimshaw, 2015; Major and Stockwell, 2021). The goal of this chapter is to offer a syntactic account of these phenomena based on English.

The first goal of this chapter is to establish a new empirical landscape for the verb “say” in English as it relates to event and argument structure. Recall that both Grimshaw (2015) and Major and Stockwell (2021) discussed a range of inanimates that function as Locations or Holders of LM in cases like (60a), which are stative constructions. This chapter argues that the eventive versus stative contrast exists independent of animacy distinctions. In other words, I demonstrate that (60a) and (60b) involve stative, truncated structures. On the other hand, more canonical uses of “say”, where the utterance is interpreted as an agent physically producing speech, as in (60c) involve the full clause structure observed for any other activity predicate. Moving forward, I refer to “stative” uses of “say” as *say_{Source}* and eventive uses of “say” as *say_{Agent}*.

- (60) a. {The sign/poster/book/article} says, “The park is closed.” *Say_{Source}*
(Grimshaw, 2015:87, ex: 32)
- b. {Suspect #2’s sweating/Suspect #2} says that he is guilty. *Say_{Source}*
- c. Suspect #2 said that he is guilty. *Say_{Agent}*

“Sources” contrast with “Agents” in that *say_{Source}* constructions do not describe the external argument physically producing sound. Instead, these indicate that the subject is the source of some LM, compatible with the subject having done nothing, at least with volition.

As mentioned in Chapter 1, I argue that each of the cases in (60a)-(60c) share the core structure in (61).

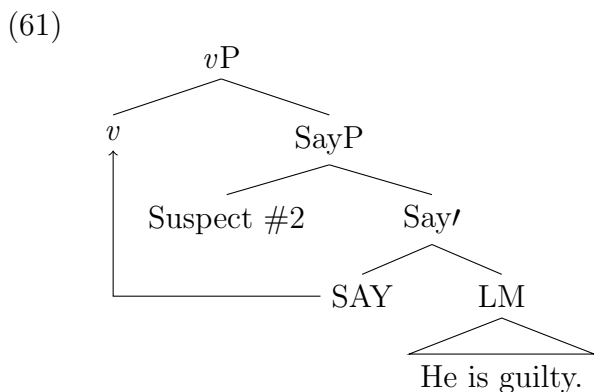

If *vP* in (61) is headed by *v_{be}*, the sentence is interpreted as stative, no Voice layer is merged, agentive/eventive modifiers are prohibited, and the subject of *SayP* raises to spec, TP to satisfy the Extended Projection Principle (Chomsky, 1981), which requires that spec, TP be filled.

Furthermore, if *v_{do}* merges into the structure, an agentive external argument is introduced (following Koopman and Sportiche, 1991; Chomsky, 1995; Hale and Keyser, 1993; Kratzer, 1996), which further enables the introduction of a Goal argument, event/manner modifiers, agent modifiers, and also the ability to passivize, as shown in (62). Furthermore, I assume these to be control constructions, where the subject of *SayP* is PRO, controlled by the external argument introduced in spec, VoiceP.¹

¹The structure in (62) involves split *vP* and VoiceP projections, which is somewhat controversial. It is possible that VoiceP and *vP* are actually bundled into a single projection (Pylkkänen, 2002, 2008; Harley, 2017), but this choice does not have any bearing on the analysis.

(62)

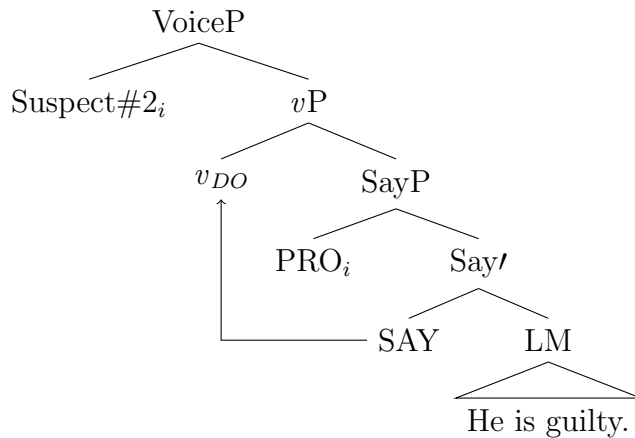

This analysis offers an explanation for the syntactic differences between the two SAY schemas (agents versus locations) described in Grimshaw (2015). I further argue that “say” is realized in all contexts where a root (e.g. “scream” or “mumble”) does not modify *v_{do}*.

In addition to the two structures that contrast with respect to event structure above, I additionally expand upon what types of arguments qualify as LM arguments in English. As mentioned in Chapter 1, I assume following Grimshaw that direct quotation is the clearest diagnostic that a given argument is a LM argument. In this chapter, I introduce in some detail the relationship between the two “say” structures and the ways in which LM arguments can be realized.

- (63) a. Kayla said (that) she got a promotion.
b. Kayla said (*that), “I got a promotion!”
c. Kayla said something amazing (*that she got a promotion)!

Kratzer (2006); Moulton (2009); Kratzer (2016) discuss the existence of content nominals, such as “rumors” and “ideas”, which often occur with attitude verbs (e.g. John heard the rumor that...). I demonstrate that the set of nominal elements that are compatible with “say” overlap with, but are distinct from the set of content nouns, in that they stand in for the argument and cannot co-occur with propositional content, as shown in (63c).

2.1 Expanding the Empirical Landscape of “say”

The goal of this section is to systematically differentiate between say_{Agent} and say_{Source} constructions. I begin by introducing relevant discussion of tense/aspect, which often results in one of the two uses of “say” being favored. I then show that

2.1.1 Grammaticality judgments, tense, eventivity, and “say”

Many verbs have eventive and stative readings, which are disambiguated based on discourse context, tense, and aspect. Özyıldız (2021) shows that “think” in the simple present is most naturally interpreted as stative (64a), while in the progressive (64b) or as part of a wh-cleft (64c), it is interpreted as eventive.

- (64) a. John thinks that the sky is blue. (stative)
b. John is thinking about Mary. (eventive)
c. What John did was think about Mary. (eventive)

“Say” shows a similar alternation, but more naturally alternates between eventive and stative readings without coercion. However, the preference varies with properties of the subject and tense. The remainder of this section is primarily intended to assist the reader with the relevant judgments, as I do not offer a formal analysis of SAY and Tense in this dissertation.

Consider (65), for instance, which illustrates that whereas “says” cannot occur with the subject-oriented adverb “excitedly” or a goal argument (65a), “said” is compatible with both (65b). I return to the discussion of argument/event structure later, but for the present, it is important to note that tense plays a disambiguating role between uses of “say”.

- (65) a. I ran into Katie yesterday and she gave me some excellent news! She (#excitedly) says (#to me) that she’s coming tonight!
b. I ran into Katie yesterday and she gave me some excellent news! She (excitedly) said (to me) that she’s coming tonight!

At first glance, these sentences seem to be almost identical. In both cases, the interpretation is such that Katie and I spoke yesterday and that Katie uttered something, communicating the LM “that she’s coming tonight”. Notice, however, that a subject oriented adverb and a goal argument is possible in (65b), but not in (65a). As with “think”, it is often the case that the simple present gives rise to a stative interpretation, while the past or future give rise to eventive readings. This is simply a tendency and not a grammatical requirement, which I show in the proceeding sections.

Let’s begin with an inanimate like “sign”, which was argued to be stative (Grimshaw, 2015; Major and Stockwell, 2021). In (66a), the most natural interpretation is that the sign was seen at some point in the past and the speaker reports the contents of the sign (which is assumed to hold at the present time). In the past (66b), a stative interpretation is still preferred, but carries an implicature that the contents of the sign have since changed. This is simply intended to show that inanimates like “sign” favor a stative reading regardless of tense. For this reason, these types of subjects are useful as control cases.

- (66) a. The sign says “slow down” on it.
b. The sign said “slow down” on it.

With animate subjects, the ambiguity is more complex. For instance, (67a) is most naturally interpreted as stative, meaning that the LM introduced by Kayla, which holds present relevance, is that we should slow down. In (67b), the more natural interpretation is that the actual communicative event is reported, which is situated at some point in the past.

- (67) a. Kayla says that we should slow down.
b. Kayla said that we should slow down.

I often use the simple present with animate subjects when discussing stative constructions and the simple past with eventive constructions to assist with judgments. However, it is often possible to coerce an eventive reading for the simple present or a stative reading with the simple past.

For instance, if additional context is introduced, it is possible to reverse the preferences. When “every time” is introduced into the structure, a habitual interpretation involving a set of communicative events is most natural (68a). Similarly, with a modifier such as “up until last week”, the simple past is much easier to interpret as a state that held “until last week” (68b).

- (68) a. Every time I see Kayla, she says (to us) that we should slow down.
b. Up until last week, Kayla said that we should slow down when biking.

One way to differentiate between readings is by using temporal adverbs. For instance, the most natural reading of (69) is that at some point in the past, she mentioned that she would be “coming to conference tonight”, which holds at the present and is relevant to the present discourse in some way.

- (69) Kayla says that Katie is coming to the conference tonight.

One way to strengthen the contrast in acceptability between stative and eventive is to insert a temporal adverb into the “say” utterance. For instance, despite the fact that the LM was communicated to the speaker in the past, whether they report it using the eventive or stative construction, only the eventive construction is compatible with “yesterday”. Notice in (70a), that the temporal adverb “yesterday” fixes the time of the communicative act when the LM was introduced. In (70b), “yesterday” renders the sentence ungrammatical, despite the fact that the implied communicative act, whose source was “Kayla” or “The look on Kayla’s face” likely took place in the past.

- (70) a. Yesterday, Kayla said that Katie is coming to the conference tonight.
b. *Yesterday, {Kayla/the look on Kayla’s face} says that she is coming to the conference tonight.

The temporal properties of the source event can be established in the context. For instance, in (71), it is clear that the communicative act took place yesterday given the

lead-in sentence. However, the target sentence only indicates that the state still holds at present.

(71) I ran into Kayla yesterday. She says that she is coming to the conference tonight.

One other issue related to tense that one should keep in mind while considering the grammaticality judgments that follow is the so-called “narrative present” in English. An example from Schlenker (2004) is provided in (72), where the simple present is interpreted in the past as part of a narrative.

(72) Fifty eight years ago to this day, on January 22, 1944, just as the Americans *are* about to invade Europe, the Germans *attack* Vercors. (Schlenker, 2004:(2))

In this sentence, the context clearly indicates that the present tense is interpreted relative to the narrative time, not the utterance time. Schlenker argues that this is the result of bi-contextual valuation. That is to say that both the speech and narrative times are available for evaluating tense and adverbs in (72).

The purpose of this section is to illustrate that ordinary uses of “says” do not involve the narrative present. For instance, the narrative present is generally infelicitous out of the blue. In response to a neutral question, (73a) is infelicitous, while *Say_{Source}* constructions are perfectly acceptable under the same conditions (73b). In this way,

(73) *What’s new?*

a. # My boss gives me a promotion.

b. My boss says she’s giving me a promotion.

The narrative present is thus a natural way to achieve an eventive interpretation in the simple present. The main point of this section is that there are many factors in play that affect judgments with respect to event structure with a verb like “say”. To the extent possible, I offer lead-in sentences in the sections that follow on the basis of the information above, to help disambiguate between eventive and stative structures.

2.1.2 Argument structure

This section shows that say_{Agent} constructions require an agent and are able to occur with a Goal argument. Say_{Source} constructions introduce only the source of LM, not an agent. Both say_{Agent} and say_{Source} constructions obligatorily introduce a LM argument.

Beginning with eventive “say”, the subject is always an agent. For instance, subject-oriented adverbs are allowed, as is passivization. This is suggestive that the structure involves a Voice layer allowing for passive and further allowing the introduction of an Agent.

- (74) I visited the suspects in the detention center yesterday.
- a. Suspect #2 enthusiastically said that he is guilty.
 - b. It was enthusiastically said (by suspect #2) that he is guilty.
 - c. ? That he is guilty was enthusiastically said (by suspect #2).

If we assume that there is a direct relationship between v_{DO} , the presence of Voice, and the introduction of an Agent, it follows that passivization should be possible only in say_{Agent} constructions. Furthermore, these same environments should allow an agent-oriented adverb. Given that say_{Agent} constructions most naturally involve the physical production of speech, they are further able to introduce a Goal argument.

- (75) We had an encounter with suspect #2 yesterday. He said to us that he is the culprit.

I assume that the syntax is responsible for this. In other words, v_{do} is responsible for eventive semantics and is required to license an Applicative Phrase (ApplP), which is compatible with the proposals in Pyllkänen (2002, 2008).

In say_{Source} constructions with inanimate subjects like “signs”, as shown in (76a). Furthermore, passivization is prohibited, as shown in (76b) and (76c).

- (76) a. The sign (#convincingly) says “slow down” on it.
b. * It is (convincingly) said “slow down” {on it/the sign}.

- c. * “Slow down” is (convincingly) said on the sign.

The same facts hold for *say_{Source}* constructions that do not encode the location of LM, as shown in (77). A subject-oriented adverb is prohibited (77a), as is passivization in all cases and passivization is prohibited (77b)-(77c).²

- (77) I visited the suspects in the detention center yesterday.
- a. Suspect #2’s sweating/Suspect#2 (#hesitantly) says that he is guilty.
- b. # It is/was (hesitantly) said (by suspect #2’s sweating/Suspect #2) that he is guilty.
- c. # That he is guilty was (hesitantly) said (by suspect #2’s sweating/Suspect #2).

I take this as evidence that the *say_{Source}* constructions lack Agents and Voice Projections altogether. One could claim that Sources are introduced by a different Voice head and passivization is blocked via some other process, but this would not change the main empirical point made here.

Furthermore, *say_{Source}* constructions are incompatible with Goal arguments. Notice for *say_{Source}* constructions with inanimate subjects like “the sign”, as discussed in Grimshaw (2015); Major and Stockwell (2021), a goal argument is not permitted (78). The same is true for inanimate sources of LM (79).

- (78) The sign says “slow down” (#to us) on it.
- (79) We had an encounter with suspect #2 yesterday. {The fact that he was sweating/he} says (#to us) that he is the culprit.”

Again, if we relate the selection of Applicatives to v_{DO} , either directly or indirectly, the fact that vP is headed by v_{BE} is incompatible with a Goal argument.

²With Suspect #2 as the subject, the sentence is acceptable, but it forces the subject to be interpreted as an Agent.

Finally, LM arguments are required by both say_{Agent} and say_{Source} constructions, as shown in (80).

- (80) I spoke with suspect #2 yesterday.
- a. He said *(that he is guilty). say_{Agent}
 - b. He says *(that he is guilty). say_{Source}

LMNs, such as *Words*-NPs, are generally prohibited, or at least marginal in say_{Source} constructions -, while they are perfectly acceptable in say_{Agent} constructions .

- (81) a. ??/# The sign says a few words (on it). say_{Source} (*loc*)
- b. */# I ran into Kayla yesterday. She says a few words. say_{Source}
 - c. I ran into Kayla yesterday. She said a few words. say_{Agent}

However, with other types of LMNs, such as “something important”, the situation is slightly more complex. Notice that (82a) is compatible, an animate subject is not (82b), and (82c) is not. This may be reason to maintain a distinction between animate subjects of say_{Source} constructions and those inanimates that locate LM, like “signs”, but I leave this question to future research.

- (82) a. The sign says something important (on it). say_{Source} (*loc*)
- b. */# I ran into Kayla yesterday. She says something important. say_{Source}
 - c. I ran into Kayla yesterday. She said something important. say_{Agent}

It is unclear whether the markedness of *words*-NPs in these contexts is syntactic or pragmatic. It is reasonable that an LMN is marked in say_{Source} constructions, because the function of an LMN is to saturate the internal argument slot of “say” without introducing the actual content, which places emphasis on the communciative act itself. However, attributing “a few words” to a source is not particularly informative.

The conclusions from this section are as follows:

- Say_{Agent} constructions contain v_{DO} and involve Agents, Voice, (optional) Goals, and are compatible with all types of LM.
- Say_{Source} constructions involve Sources, lack a Voice layer, are incompatible with Goals, and allow a limited set of possible LM arguments.

2.1.2.1 Event Structure

Event structure has been alluded to throughout this section. This section demonstrates that only say_{Agent} constructions are interpreted as events, while say_{Source} constructions are obligatorily interpreted as states. In order to demonstrate this I systematically apply diagnostics for eventhood/statehood drawn from the literature (e.g., Rothmayr, 2009; Alexiadou, 2014; Angelopoulos, 2019).³

First, manner adverbs are only permitted with eventive predicates. They are thus compatible with say_{Agent} constructions (83a), but not say_{Source} constructions (83b). However, if the manner modifier is inserted into the discourse prior to the target sentence, manner can be conveyed, but this is not indicated by the say_{Source} clause itself (83c).

- (83) a. I ran into Kayla yesterday in the library. She excitedly said that Katie is coming to the conference tonight.
- b. # I ran into Kayla yesterday in the library. She excitedly says that Katie is coming to the conference tonight.
- c. I ran into Kayla yesterday at the library and she quietly whispered some great news to me. She says that Katie is coming to the conference tonight!

Similar to manner modification, the progressive is only compatible with events. The same behavior is observed. In say_{Agent} constructions, the progressive is perfectly acceptable.

³I provide both an animate and inanimate say_{Source} constructions for each test, since in some cases the judgments are less controversial for say_{Source} constructions with inanimate subjects, because there is no way of coercing an agentive say_{Agent} reading.

In *say_{Source}* constructions (84b), the progressive is not permitted.⁴

- (84) I ran into Kayla yesterday.
- a. She was saying that Katie is coming to the conference tonight.
 - b. # She's saying that Katie is coming to the conference tonight.

So-called “Anaphoric follow-ups” are also restricted to contexts involving dynamic events and are incompatible with states as antecedents. For this reason, *say_{Agent}* constructions, such as (85a) are capable to function as antecedents for “this”. However, *say_{Source}* constructions are not eventive, thus there is no event capable of functioning as the antecedent in cases like (85b).

- (85) a. Kayla said that Katie is coming to the conference tonight. This happened yesterday.
- b. # Kayla says that Katie is coming to the conference tonight. This happened yesterday.

One test used for speech reports is the “What Happened Next” test (Bary and Maier, ms.). This is quite similar to the anaphor follow-up test, in the sense that for something to “happen” is must be an event. Notice that the same pattern holds, where *say_{Agent}* is fine as a follow-up (86a), but both *say_{Source}* constructions are infelicitous in the is context (86b)-(86c).

- (86) So you called Suspect #2 to the stand. What happened next?
- a. He said that he is guilty.
 - b. # He says that he is guilty.
 - c. # His sweating says that he is guilty.

⁴There is a reading of (84b) that means something like “She has been going around and saying..”, but this seems to have a different meaning. Under that construal, manner modification and Goals are also permitted, suggesting that this reading is not a *say_{Source}* construction.

One final note on the structure of “say” relates to negation. When there is a communicative act, as is the case in say_{Agent} constructions (87a), negation of the communicative act itself is possible. If the primary function of say_{Source} constructions are to introduce contextually relevant LM into the discourse, negation would not involve a meaningful discourse move.

- (87) a. I ran into Kayla yesterday. She didn’t say that Katie is coming to the conference tonight.
- b. # I ran into Kayla yesterday. She doesn’t say that Katie is coming to the conference tonight.
- c. # I ran into Kayla yesterday. Her reaction doesn’t say that Katie is coming to the conference tonight.

Again, this seems to be an issue related to felicity, not grammaticality. In other words, it is hard to imagine a context where introducing a source and the LM that they did not convey would be felicitous within a discourse.

Finally, there are a number of idiomatic expressions that are similarly compatible with only say_{Source} , as illustrated in (88). In these cases, “say” is unambiguously interpreted as say_{Source} .⁵

- (88) a. A: Writing a dissertation is easy! B: Says YOU.
- b. But what say you, General Hospital fans? Would you like to see Cyrus return and perhaps get a shot at genuinely bonding with Laura? (<https://soaps.sheknows.com/general-hospital/news/602514/general-hospital-cyrus-return-jeff-kober-emmy-interview/>)
- c. What sayst thou? Hast thou not a word of joy? (Romeo and Juliet, A3,S5,P9)
- d. So say we all. (a common interjection in *Battlestar Gallactica*)

In (88a), the communicative act and source is already salient in the discourse. Clearly, Speaker B is not reporting what their interlocutor said, but is instead challenging the extent

⁵I would like to thank Pamela Munro for drawing my attention to examples of the first type.

to which they believe the LM to be true. Similarly, (88b) is not asking readers what words will come out of their mouth, it is asking how they will react. In (88c), the request is asking about how the interlocutor feels, not what they will “say”. Finally, (88d) is said in unison to say that all involved are committed to or stand by the same LM, which is salient in the discourse.

2.2 Analysis

Now that the empirical picture has been established, I move on to the analysis of “say” in English. The task in the present is to explain the alternations between *say_{Source}* and *say_{Agent}* constructions. As mentioned in Chapter 1, I assume that properties of event structure are represented in the syntax (e.g. Borer, 1994, 2003; Rosen, 1999; Ramchand, 2008, 2018; Travis, 2010). Furthermore, I assume that external arguments are introduced VP-externally (e.g. Chomsky, 1995; Hale and Keyser, 1993; Kratzer, 1996), and that there are certain abstract “light verbs” that determine properties related to causation, agentivity, stativity, and directionality Hale and Keyser (1993); Cuervo (2003); Folli and Harley (2004, 2020). On the basis of this syntax, I build upon Anand et al. (2017); Grimshaw (2015); Major and Stockwell (2021) to argue that “say” exhibits alternations that are rarely (if ever) discussed for communication or attitude verbs.⁶

⁶The data in this paper could be analyzed using a system where rather than different “flavours of little *v*”, differences in event/argument structure correlate strictly with particular Voice heads, such as Marantz (2013); Alexiadou et al. (2015); Wood (2015); Kastner (2016).

For ease of exposition, I summarize the previous sections in (2.1).

	Say _{Agent}	Say _{Source}
Subject	Agent	Source
Goal?	Yes	No
Passive?	Yes	No
Subject-oriented adverb?	Yes	No
Manner adverbs	Yes	No
Progressive	Yes	No
Anaphoric follow	Yes	No
What Next?	Yes	No
Event/State?	Event	State

Table 2.1: Argument structure and temporal properties of “saying”

As mentioned at the beginning of this chapter, I argue that all “say” constructions minimally contain the structure in (89).

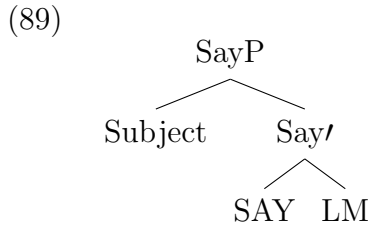

Thus all other differences discussed in this chapter are determined by the structure that dominates SayP. SayP is always the lowest VP shell, similar to ResP in Ramchand (2008, 2018); Folli and Harley (2020) or Small Clause Results in the sense of (Hoekstra, 1988).

2.2.1 Analyzing stative “say”

To account for say_{Source} constructions like (90), I suggest that SayP is selected by v_{be} , which is incapable of occurring with an agent. I propose the structure in (91).

(90) Suspect #2 says he is the culprit.

(91)

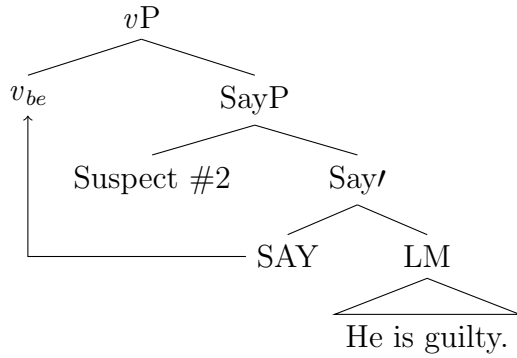

Given that these constructions cannot be passivized and are incompatible with subject-oriented adverbs, I conclude that there is no Voice projection merged. If we further assume that v_{be} is unable to select an ApplP as its complement, we are also able to explain the prohibition on the Goal. Finally, given the very fact that v_{be} introduces stative semantics, event modifiers, manner adverbs, progressive aspect, and anaphoric follow-ups are all predicted to be unacceptable. This all follows from (91).

2.2.2 Analyzing Eventive “say”

Moving to say_{Agent} constructions, the most critical difference is that SayP is selected by v_{do} . As a result, a Goal is optionally permitted and “say” is interpreted as an activity verb. Moreover, passivization is possible and subject-oriented adverbs are permitted, suggesting the presence of a VoiceP projection. Given the presence of v_{do} and Voice, we should expect the cluster of properties that are allowed in say_{Agent} constructions are ruled in, while say_{Source} constructions are far more restricted. My analysis is provided in (92).

(92)

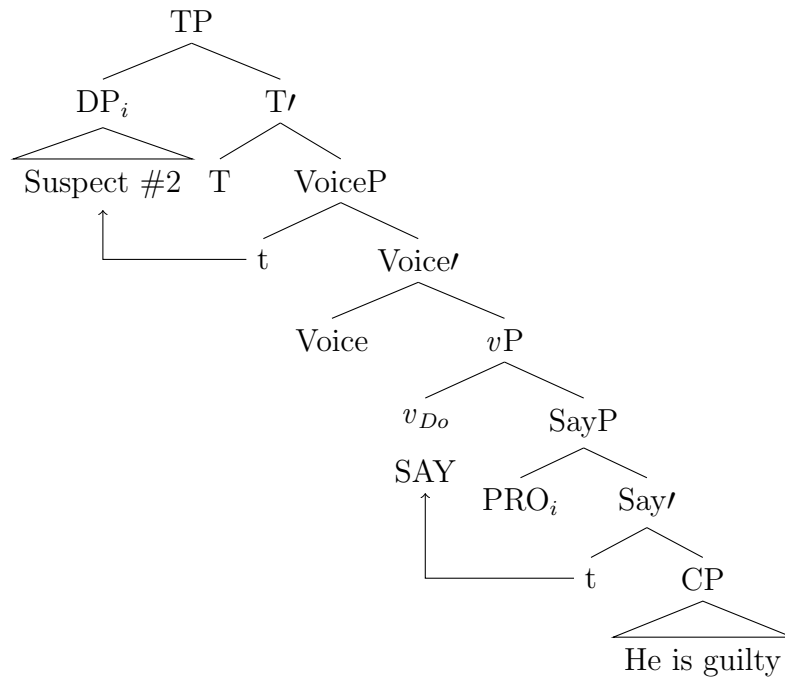

I assume for reasons of parsimony that there is still a subject generated in spec, SayP, represented here as PRO. Because the agent is always the source of LM, and also the agent of the speech act, I assume the subject of SayP to be PRO, which is obligatorily controlled by the agent. One could alternatively assume the “Movement Theory of Control”, in which case the subject A-moves from one theta position (spec, SayP) into a second theta position (spec, VoiceP), in line with Boeckx et al. (2010). Because these are cases of obligatory control, I believe either analysis is able to account for the facts.⁷

2.2.3 Accounting for say

Now that analyses have been provided for both *say_{Source}* and *say_{Agent}* constructions, let’s consider other predicates that are part of the SAY schema. Recall that Grimshaw (2015) argues that SAY is present, but goes unpronounced when a verb like “scream” introduces LM, as presented in (93).

⁷I represent lower copies as t(races) for notational purposes alone. I assume the copy theory of movement (Chomsky, 1995).

(93) Suspect #2 screamed SAY that he is guilty.

I assume that “scream” externally merges into the structure in the same way as other manner modifiers. Originating with (Hale and Keyser, 1993), it was argued that manner modifiers merge as internal arguments to light verbs via head movement in the lexicon. Cuervo (2003) argues that the root merges into the structure below *v* and subsequently raises, which determines the realization of the root. Other analyses assume that there are other morphological processes involved (e.g. Embick and Noyer, 2001; Folli and Harley, 2020). I remain agnostic as to which of these processes is involved, but suggest that manner of speech predicates involve the same process. My proposal for simple cases lacking SayP is provided in (94) for sentences like “Suspect #2 screamed”.

(94)

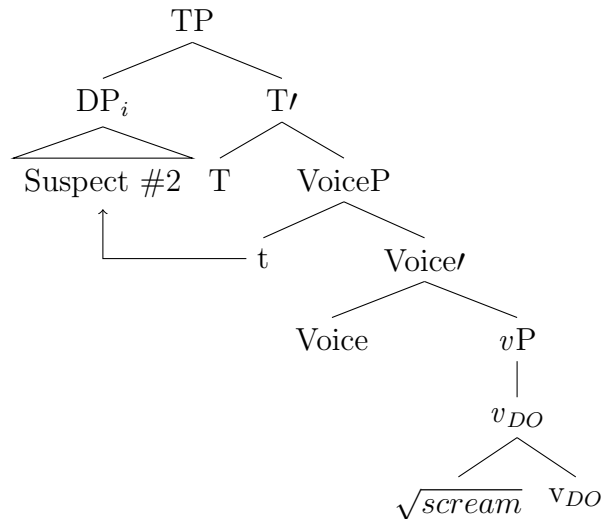

In this structure, Suspect #2 is the agent of “scream”, which cannot take an internal argument. This contrasts with “say”, as shown in (95).

- (95) a. Suspect #2 screamed (loudly).
 b. *Suspect #2 said (loudly).

Both “scream” and “say” are able to occur with *words*-NPs as internal arguments or direct quotation, as illustrated in (96):

- (96) a. Suspect #2 screamed {something/“I am guilty”}.
- b. Suspect #2 said {something/“I am guilty”}.

“Scream” cannot generally take an internal argument that describes screaming (97).

- (97) * Suspect #2 screamed {a loud noise/a rumor}

Following Grimshaw, and considering the fact that “scream” is unergative, we can conclude that the LM is introduced as complement to SAY, not “scream” directly. However, despite the fact that v + “scream” does not take a DP complement, but it can take a SayP complement. In this way, unergatives like “scream” are able to occur with LM arguments, as shown in (98).

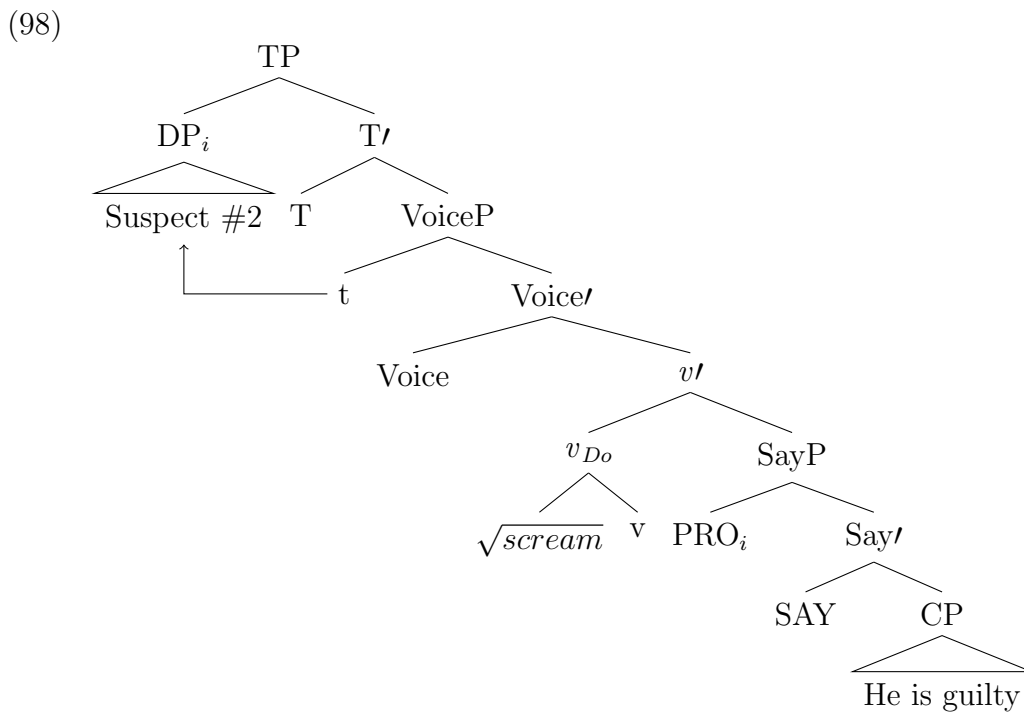

Under this analysis, the result of Suspect #2’s “screaming” is the communication or “saying” of the LM “He is guilty”. This structure is essentially equivalent to (92) with the exception that “say” is not pronounced. Given that “screaming” is more informative than “saying” as it relates to manner, much like “floating” is more informative than “going”. I suggest that SAY is not pronounced in these environments because the merger of the

root blocks movement. Furthermore, for predicates like “scream”, which do not introduce arguments, make it possible for SAY to be inferred from the structure, leading it to go unpronounced. This is similar to the line of reasoning taken up by e.g. Zubizarreta and Oh (2007) for “CAUSE”, which they similarly suggest that the learner can infer its presence, therefore making it unnecessary to syntactically encode it.

2.2.4 More on Linguistic Material

The final issue I wish to address in this chapter is related to LMNs and demonstrate that these elements are distinct from so-called “content nouns”, as described in Kratzer (2006); Moulton (2009). Content nouns are nouns like *idea*, *rumor*, *story*, and *myth*, which are often selected by attitude verbs (see Moulton, 2009). Consider the case in (99).

(99) Mary heard the story that Edna was stealing.

Moulton (2009), following Kratzer (2006), argues that the CP “that Edna was stealing” is a predicate of story, not an argument. In this way, the “that” clause introduces the unique content of nouns like stories. Kratzer (2016) suggests the presence of a silent modal SAY that is reminiscent of Grimshaw’s proposal. Kratzer suggests that the sentence in (100) has the LF in (101), where the “that” clause is a predicate of the noun “thing”.

(100) Ralph sighed that Ortcutt was a spy.

(101) [Ralph [[sighed] [_{CP} [say] [_{MoodP} “thing” [that Ortcutt was a spy]]]]].

As mentioned in Chapter 1, there are some modifications necessary. In particular, “say” cannot occur with content nouns; instead they occur with LMNs, which exhibit different properties. Furthermore, the analysis put forth in this chapter predicts that “scream” and “say” should occur with the same set of LM arguments, which holds.

First, notice in (102a), that “say” and “scream” are able to occur with LMNs (e.g. “a few words”), but these LMNs are not able to combine with CPs. Moulton argues that finite

complement clauses, such as “that he is guilty” are predicates, not arguments. The fact that the set of LMNs are not able to combine with finite complement clauses, suggests that LMNs need separate treatment from Content nouns. Furthermore, notice that “say” and “scream” are incompatible with the standard set of “content nouns” (102b).

- (102) a. Suspect #2 said/screamed {a few words/those words/something shocking} (*that he is guilty).
b. *Suspect #2 said/screamed {the news/the rumor/the myth/the truth} (that he is guilty).

This contrasts with predicates like “believe” or “know”, which are unable to combine with LMNs (103a), at least with the same meaning as (102a), but do occur with content nouns (103b).

- (103) a. *Suspect #2 believes/knows {a few words/those words} that he will be let off on a technicality.
b. Suspect #2 believes/knows {the news/the rumor/the myth} that he will be let off on a technicality.

Unlike content nouns, which can be modified by a CP that specifies the content hosted by nominals like “the news”, LMNs are in complementary distribution with CPs that specify the contents of the LM. The only exception that I am aware of are direct quotations, which require a large prosodic break and must be a direct quotation, as shown by the grammaticality of (104a) and the ungrammaticality of (104b).

- (104) a. Suspect #2 shouted/said the words: “I am innocent!”
b. *Suspect #2 shouted/said the words that he is innocent.

Notice that in (104a), that “the words:” does not really convey the meaning discussed by Moltmann for *Words*-NPs. In other words, these constructions do not seem to convey the meaning that involves a “plurality of words with specific meanings in a meaningful

configuration”, but rather that there were particular words uttered. For instance, (105) is perfectly acceptable and does not convey the same meaning as “Mary said a few words”, where “a few words” stands in for some propositional content.

(105) Mary shouted/said the words: “Turtle”, “Cat”, and “Octopus”.

The specification of “the words” is obligatory in (105). I suggest that this is because the definite “the words” does not function as LM on its own and cannot stand in for a direct quotation, which introduces the requirement that the LM be specified in addition to the definite object. This is not true of content nouns, whose contents need not be specified.

(106) Mary knows/heard/believes the rumor/myth/story.

I conclude that SAY generally resists definite DP internal arguments, because they are unable to stand in for LM arguments in any context other than those that involve a sequence of uttered words, such as (105). These must be direct quotations. Definitionally, LM is always able to occur with any type of direct quotation, which makes this less surprising, perhaps.

I suggest that what makes “say” unique is that it is able to license any form of a LM argument in-situ. In this way, “that clauses”, direct quotations, etc., are able to saturate the internal argument requirement of “say” in-situ. If this is on the right track, English “say” and SAY are able to license finite clausal complements in-situ (c.f. Moulton, 2009, 2016). However, this suggests that the *in-situ* saturators discussed in Moulton (2016), mostly derived from *verba dicendi* in other languages, are a fundamental property of “say”, even in English.

One final issue discussed in Kratzer (2016) discusses extraction properties initially discussed in Erteschik-Shir (1973) with respect to manner of speech predicates and islandhood.

- (107) a. * Who did Ralph sigh that he saw at the beach?
b. Who did Ralph say that he saw at the beach?

The analysis in (98) offers an explanation for why (107a) is an island for extraction, if we adopt some version of *Phase Extension* (den Dikken, 2006:pp. 1):

- (108) Phase Extension: Syntactic movement of the head H of a phase α up to the head X of the node β dominating α extends the phase up from α to β ; α loses its phasehood in the process, and any constituent on the edge of α ends up in the domain of the derived phase β as a result of Phase extension.

If we assume that merging a manner root, such as “scream” or “sigh” with v , prohibits or renders movement of SAY-to- v optional, we have a potential explanation for the weak island behavior of manner of speech verbs. If we assume that SAY-to- v is responsible for phase extension and thus determines extractability, any environment where SAY does not raise would be function as an island.

One speculative possibility is that predicates more closely linked to speech, such as Discourse Role predicates (e.g. “tell”, “report”, and “announce”), which are not islands force SAY raising, while those predicates that are able to be coerced into SAY verbs are more resistant to occurring with SAY and thus more resistant to allowing SAY to raise. If this were on the right track, there would need to be a sense in which questionable verbs (Erteschik-Shir, 1973:pp. 83), such as “grunt”, “holler”, “mumble”, etc., are more natural with SAY than e.g. “purr”, “snarl”, “editorialize”. This seems to be on the right track, at least intuitively, but further investigation is necessary.

2.2.5 Final notes on LM

Another way of probing the status of LM arguments is to look at answers to questions. In response to the question “What did Kayla do?”, one can respond with (109a), (109b), or (109c). A LM is required for “say”, but optional for scream.

- (109) What did Kayla do?
- a. She screamed/made a loud scream.
 - b. She screamed some surprising words.
 - c. She said *(some surprising words).

If we consider a question that targets the internal argument, such as “What did Kayla scream?” (110), the possibilities change. Scream is an unergative verb. If we assume that it cannot directly take a DP/CP internal argument, but can select SayP. Because SAY requires a LM argument and is silent in the context of scream, it gives the illusion that “scream” has a transitive variant. Under the present proposal, it is actually the LM argument introduced by SAY that is actually the target of the wh-question in (110).

- (110) What did Kayla scream?
- a. #(She screamed/made) a loud scream.
 - b. (She screamed) some surprising words.
 - c. (She screamed) that she was leaving.

I suggest that in (110) that the question underlyingly contains SayP and the internal argument being questioned is that of SAY, not the internal argument of “scream”.

2.3 Extending the analysis to Avatime

Avatime exhibits a morphological contrast between stative uses of “say” and eventive uses. Notice that *si* “say” in (111a) lacks a subject marker, while (111b) has one.

- (111) a. Kofí **sì** Ayape a-sè.
 Kofi 3SG.PFV-say Ayape 3SG.PFV-leave
 “Kofi said that Ayape left.”
- b. Kofí **a-sì** Ayape a-sè.
 Kofi 3SG.PFV-say Ayape 3SG.PFV-leave
 “Kofi said that Ayape left.”

I show that non-agreeing *si* introduces only a source and LM (=say_{Source}), while agreeing *si* is always eventive (=say_{Agent}) represents is obligatorily eventive and it is often preferred that there be a Goal argument.

Agreement is required in all environments where a Goal is introduced. Interestingly, *si* is doubled in each of these contexts, as shown in (112).

- (112) a. Kofi *(a)-si mɛ *(sì) Ayape a-sè.
 Kofi 3SG-say me say Ayape 3SG.PFV-leave
 “Kofi told me Ayape left.”
- b. Kofi e-do *(si) mɛ *(sì) Ayape a-sè.
 Kofi 3SG.PFV-tell say me SAY Ayape 3SG.PFV-leave
 “Kofi told me Ayape left.”

This offers further support that Agreement correlates with the structure that allows an Agent to be introduced, presumably *v_{do}* and Voice.

Even in the absence of a clausal LM argument, the fact that LM was communicated as opposed to random noise is indicated by the presence of *si* “say”. A predicate like “yell” can occur with a Goal in two different constructions. LM is entailed in (113a) when *si* is present, while the postposition *va* simply indicates that loud noises were directed at “me” (113b).

- (113) a. kofi a-kpe o-zi-lo si mɛ .
 Kofi 3SG.PFV-make CL-yell-DEF 1SG
 “Kofi yelled, saying something to me.”
- b. kofi a-kpe o-zi-lo mɛ va.
 Kofi 3SG.PFV-make CL-yell-DEF 1SG on
 “Kofi yelled at me.”

In this way, I conclude that the SM is introduced within the *vP/VoiceP* region, which is absent in truncated, non-agreeing *si* constructions.

To introduce progressive aspect, a common diagnostic for (dynamic) events, agreement is required on *si* (114), which follows if the Agreement Marker requires structure not present in *say_{Source}* constructions.

- (114) Kofi *(a)-zě-sì mé sì Ayape a-se.
 Kofi 3SG.PFV-PROG-say me say Ayape 3SG.PFV-leave
 “Kofi was saying to me that Ayape left.”

Similarly, agreeing *si* is required to introduce a manner adverbial, such as *nì ɔna-yɔ*

“with softness” (115a). This is also compatible with other communication predicates, such as “say/tell”, which always agrees (115b).

- (115) a. Kofi *(a)-sì mɛ nì ɔna-yɔ̀ sì Ayape a-sɛ̀.
 Kofi 3SG.PFV-say me with softness SAY Ayape 3SG.PFV-leave
 “Kofi said with softness Ayape left.”
- b. Kofi *(e)-do mɛ nì ɔna-yɔ̀ sì Ayape a-sɛ̀.
 Kofi 3SG.PFV-tell me with softness SAY Ayape 3SG.PFV-leave
 “Kofi said with softness Ayape left.”

Analytically, both of the facts above suggest that there is a relationship between the projection where the subject marker is introduced and the ability to insert manner modification or aspect.

Furthermore, I previously noted that an anaphoric follow-up is compatible with events, but not states (Alexiadou, 2014). Notice that the anaphoric follow-up “he said it yesterday” is not permitted following non-agreeing *si* (116a), but is allowed following agreeing *si* (116b). The complement to *si* in the follow-up is represented by a null morpheme that stands in for inanimate 3rd person objects.

- (116) a. Kofi **sì** Ayape a-sɛ̀. #Kivoe (a)-sì.
 Kofi say Ayape 3SG.PFV-leave. yesterday 3SG--say
 “Kofi said that Ayape left. #He said it yesterday.”
- b. Kofi **a-sì** (mɛ sì) Ayape a-sɛ̀. Kivoe (a)-sì.
 Kofi 3SG.PFV-say 1SG.OBJ SAY Ayape 3SG.PFV-leave yesterday 3SG--say
 “Kofi said (to me) that Ayape left. He said it yesterday.”

The verb *si* is unable to be negated without agreement, as shown in (117a), while agreeing *si* is negatable (117b). Other communicative predicates are similarly able to be negated, as shown in (117c).

- (117) a. *Kofi ɔ-si Ayape a-sɛ̀.
 Kofi 3SG.NEG-say Ayape 3SG-leave
 Intended: “Kofi didn’t say Ayape left.”

- b. Kofi ɔ-si me sɪ Ayape a-sɛ̀.
 Kofi 3SG.NEG-say 1SG SAY Ayape 3SG-leave
 “Kofi didn’t say to me that Ayape left.”
- c. Kofi o-dó sɪ Ayape a-sɛ̀.
 Kofi 3SG.NEG-tell SAY Ayape 3SG-leave
 “Kofi didn’t say to me that Ayape left.”

In addition to Agreement indicating the contrast between *say_{Source}* and *say_{Agent}*, there is a similar correlation with overt Tense. More specifically, agreement is required to introduce tense-marking, as shown in (118).

- (118) Kofí *(a)-tá sɪ me sɪ Ayape a-sɛ̀.
 Kofi 3SG-FUT say 1SG SAY Ayape 3SG.PFV-leave.
 “Kofi will say to me that Ayape left. ”

However, both agreeing and non-agreeing *si* can occur with a past tense adverb, as shown in (119a)-(119b).

- (119) a. Kivoe Kofí sɪ Ayape a-sɛ̀.
 yesterday Kofi say Ayape 3SG.PFV-leave.
 “Yesterday Kofi says that Ayape left. ”
- b. Kivoe Kofí a-sɪ Ayape a-sɛ̀.
 yesterday Kofi 3SG-say Ayape 3SG.PFV-leave.
 “Yesterday Kofi said that Ayape left. ”

In this way, Avatime is extremely interesting, in that it allows a truncated SAY structure that corresponds to the minimal SayP structure analyzed for English. In other words, Avatime morphologically allows SayP to be uttered explicitly, as shown in (120).

(120)

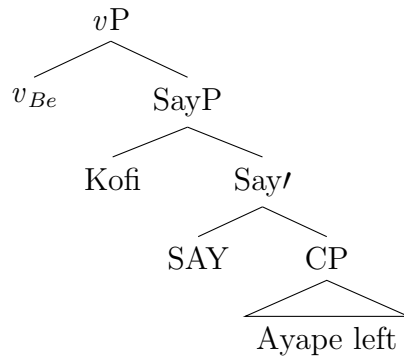

I assume there is an obligatorily null tense that attracts the subject upward and that SAY raises, as was the case in English. Also like English, the absence of v_{DO} and VoiceP, it is unsurprising that negation, manner/event modification, Goal arguments, etc., would be prohibited. Avatime makes this transparent by the presence/absence of an Agreement marker.⁸

2.4 SAY in Non-Standard English

Based on ongoing research, I suggest that many varieties of English, including the variety I am a native speaker of, do in fact, allow pronunciation of the lower “say” shell in certain environments. Consider, for instance the cases in (121).⁹

- (121) a. 'N I told'em I said, “It’s time to let the dog off the leash and he loose!” -Jalen Hurts
- b. So anyway, I says to Mabel, I says... -Bart Simpson

⁸The empirical facts in Avatime are almost identical to those described for Ewe (Clements, 1975) and Tigrinya (Spadine, 2020). It seems plausible that the same stative/eventive alternation could be responsible for the modificational restrictions on the equivalent elements in these languages as well. However, this would require additional fieldwork and further investigation.

⁹The cases above are the result of searching Google, Twitter, and observation. Each is entirely natural to me, and have very specific intonational, syntactic/semantic, and discourse-related properties. These constructions are highly unnatural with a “that” complementizer, they most naturally introduce direct quotation, and often occur in narrative contexts, but this is not an absolute requirement. My native dialect is spoken in Northeastern WI, but this construction is quite widespread across dialects.

- c. And she said to me, she said, “Tell him, because his father said it was time to go.” - Theresa Caputo
- d. She said to me, she said, “Why you singing their music?” -Charlie Pride
- e. I told'em I said, we had to focus on 270... -Karl Rove
- f. I told him, I says, “I’ll do it, but you better be on time.” -Jack Major
- g. I had asked him a question, I said, ‘Bill, is all my money gone?’, and he didn’t even give me a forthright answer.

Notice in each of the cases above, that the second instance of “say” introduces the LM argument, while the other predicate indicates e.g. discourse role or manner. Despite the fact that these SAY constructions are far more restricted with respect to the range of predicates that they can compose with than other languages, I suggest that they provide evidence that the lower SAY shell does exist and sometimes can be overtly realized, even in English. In many ways, this construction aligns perfectly with what we find in languages like Avatime and Uyghur.

Furthermore, with respect to the *si* doubling observed in Avatime with Goal arguments, the same thing naturally happens in colloquial English. The Goal is always introduced in the first clause that precedes the final “say” that introduces LM.

- (122) a. So he says to me, he says, “You might be the luckiest person I’ve ever met.”
(overheard)
- b. So he says to me, he says, “I work down at the university of Science there”.
-Norm MacDonald

Very similar structures occur in at least some varieties of African American Vernacular English, as shown in (123), from (Martin and Wolfram, 1998).

- (123) a. They tell him say, “you better not go there”.
- b. They told him, they said, You’d better not go there”.
- c. She tell him (*and) say, go get your mail.

As far as I'm aware, these constructions are identical to those spoken in my dialect, with the exception that “say” is invariably uninflected. Furthermore, the predicates in both AAVE and my dialect seem to restrict these “say” constructions to a limited set of predicates, whereas languages like Avatime and Uyghur allow them with many communication and attitude verbs.

However, in Nigerian Pidgin English, the range of predicates is far less restricted. “Say” is able to occur with a wide range of predicates, such as “know” and “tell”, as shown in (124) (from Mfon Udoinyang, p.c.).

- (124) a. Dem sabi sey I (don) waka - “They know I left.”
b. I tell dem sey I no fit come - “I told them that I can't come.”

My interpretation of all of these results are that there truly is a lower SAY structure that introduces LM. In Standard American English, SAY is only pronounced when it is the main predicate. However, the data above suggests that the entire SayP can be overtly realized in non-standard varieties of English, which is highly reminiscent of what we find in “say” complementation structures cross-linguistically.

2.5 Conclusions

In conclusion, I have shown that “say” alternates between being a stative verb and an eventive/activity verb. I have argued that the former involves a truncated structure containing v_{be} , which lacks a Voice Projection, while the latter contains v_{do} , which is able to introduce a Goal argument and further makes passivization possible.

I have also offered a syntactic explanation of what makes “say” a light verb, which was influenced by Grimshaw (2015). In other words, the lowest shell, SayP introduces linguistic material, and “say” is realized iff no other root (e.g. “scream”) incorporates into v .

Finally, I have argued that the set of content nouns are unique from the set of content nouns discussed in the literature. More specifically, I have argued that there are a unique

set of nominals that can be selected by say, which I assume to represent a natural class of LM arguments, in line with Grimshaw's proposal. This same set of facts is shown to hold for "say" in Uyghur and Avatime in subsequent chapters.

CHAPTER 3

Properties of “say” in Uyghur

This chapter is an in-depth case study of *de-* “say” in Uyghur across multiple dimensions. First, I demonstrate that “say” exhibits the same argument/event structural contrasts discussed for English and Avatime in Chapter 2. I argue for essentially the same analysis to account for this contrast, except I assume a head-final structure. Similar to English, Uyghur has *say_{Source}* constructions like (125), which I analyze as (126). These contain *v_{be}*, which selects a stative SayP complement, which entirely lacks eventive agentive syntax/semantics.

- (125) Uyghur-lar Mahmud al-Qeshqiri Uyghur de-y-du.
 Uyghur-PL Mahmud al-Qeshqiri Uyghur say-NONPST-3
 “Uyghurs say that Mahmud al-Qeshqiri is Uyghur.”

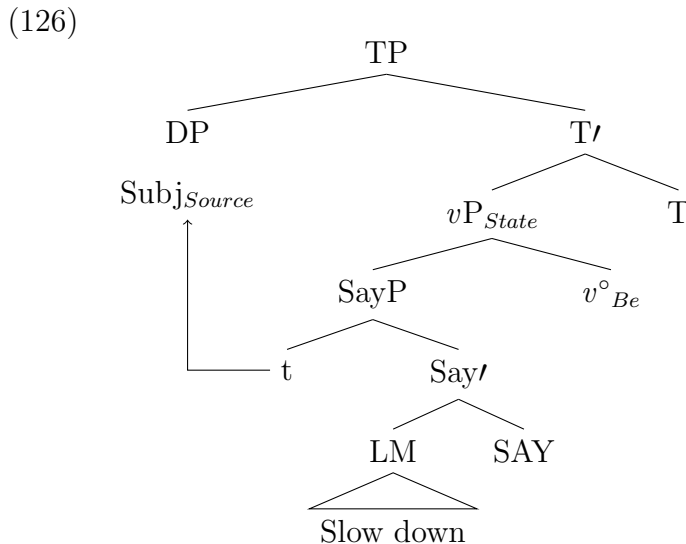

As for English, I suggest that when *v_{do}* is head of *vP*, a Voice projection is merged above *vP*, and the complement of *v* is dynamic, which permits manner/event modifiers, accusative

case-assignment, and (optionally), an ApplP/goal argument. An Uyghur *say_{Agent}* sentence is provided in (127), which I analyze as (209).

- (127) Bir Uyghur adem (manga) Mahmud al-Qeshqiri Uyghur de-y-du.
 an Uyghur man 1SG.DAT Mahmud al-Qeshqiri Uyghur say-NONPST-3
 “An Uyghur man told me that Mahmud al-Qeshqiri is Uyghur.”

(128)

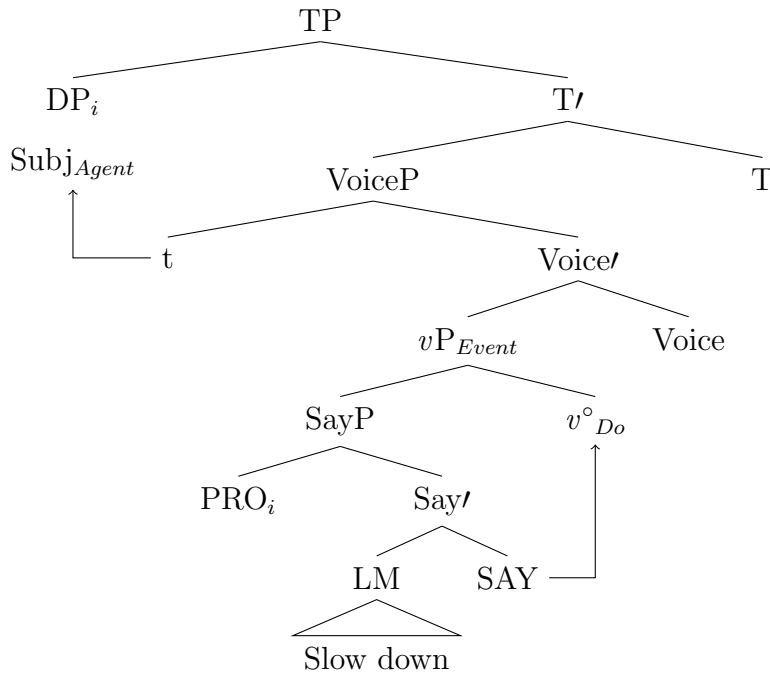

I then turn to a series of Uyghur-specific properties involving the range of complements that can be selected by “say” (i.e. the ways in which LM arguments can be realized). First, *de-* “say” is the only verb that can select both Nominalized Embedded Clauses (NEC) and Tensed Embedded Clauses (TEC) as its complement, as shown in (129a) and (129c) respectively.

- (129) a. Mahinur **Tursun-ning ket-ken-lik-i-ni** dé-d-i.
 Mahinur Tursun-GEN leave-PTPL.PST-3POSS-ACC say-PST-3
 “Mahinur said the Tursun left.”
- b. Mahinur **bir.némi-ler-ni** dé-d-i.
 Mahinur one.what-PL-ACC say-PST-3
 “Mahinur said a few things.”

- c. Mahinur **Tursun-(ni)** ket-t-i dé-d-i.
 Mahinur Tursun-ACC leave-PST-3 say-PST-3
 “Mahinur said Tursun left.”

Despite the apparent differences with respect to tense-marking/finiteness, notice that there is an accusative-marked argument in each of the cases in (129a)-(129c). I argue that all instances of accusative marking are correlated with agents, thus require v_{do} , which I assume to arise via Agreement between v and the closest NP in its c-command domain (Chomsky, 2000, 2001). In each of the cases above, the relevant v is within the extended projection of the verb *de-* “say”.

I then move the discussion to TECs that bear no sign of accusative case-marking. It is in these environments that the LM argument bears a strong resemblance to root clauses. Interestingly, these clauses, which are shown in (130a), involve “Indexical Shift”, a process by which indexicals (e.g. “I” and “You”) are interpreted relative to a reported discourse context, as opposed to the present discourse context. As a result, “I” in (130a) is interpreted as the matrix subject “Mahinur”, not the present speaker. This alternates with constructions that host an accusative-marked subject, like (130b), in which case the accusative subject “I” is interpreted as the present speaker, the embedded verb does not agree in phi-features with the embedded subject (it obligatorily bears 3rd person marking).

- (130) a. Mahinur (**men**) hér-ip ket-t-**im** dé-d-i.
 Mahinur 1SG tired-CNV KET-PST-1SG say-PST-3
 “Mahinur said $I_{Mahinur/*speaker}$ got tired.”
- b. Mahinur **méni** hér-ip ket-t-**i** dé-d-i.
 Mahinur 1SG.ACC tired-CNV KET-PST-3 say-PST-3
 “Mahinur said $I_{Speaker/*Mahinur}$ got tired.”

Building upon prior research by Shklovsky and Sudo (2014) (henceforth S&S) I argue that this difference arises from two different realizations of the LM argument. More specifically, in following with (Sudo, 2012) and S&S, I assume that indexical shift arises from a monstrous operator (represented as $\hat{\omega}$) that causes indexicals in its scope to shift. I argue in these cases that $\hat{\omega}$ requires a full CP. I adopt Chomsky (2004, 2008)’s analysis that T inherits

its features of C. I suggest that the full CP allows the same feature-transmission process observed in root clauses, resulting in full agreement between the embedded subject and object and nominative case on the subject. I further argue that the absence of agreement correlates with a defective CP (see George and Kornfilt, 1981), which results in a defective T. For this reason, the embedded verb does not agree with the embedded subject, and the embedded subject must raise for case. I propose that the former, cases like (130a), involve the structure in (131). Cases like (130b), on the other hand, should be analyzed as (132).

(131) *Indexical Shift*

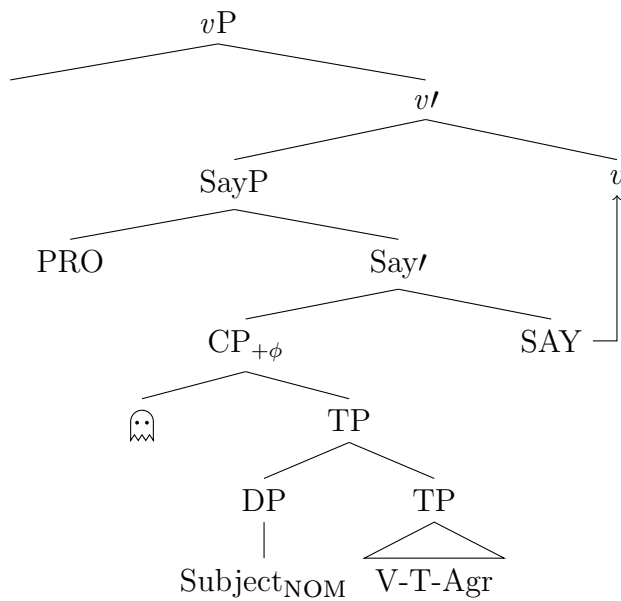

(132) *No Indexical Shift*

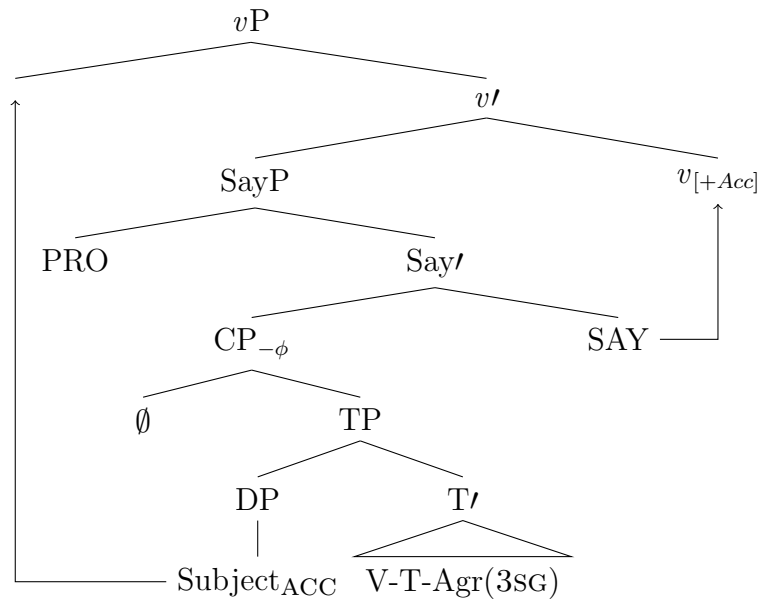

The results of this chapter have implications for analyses of Raising-to-Object, Indexical Shift, and new insights into the typology of “say”. Of importance to this dissertation, each of the results of this chapter, serve as diagnostics for the presence of “say” in Chapter 4, which argues that *de-* “say” is active in *dep* constructions. More specifically, I show that all possible realizations of the LM in this chapter are possible realizations of the complement to *de-* “say” in *dep* clauses in the next chapter.

3.1 Tense, argument structure, and event structure of Uyghur “say”

The purpose of this section is to demonstrate that “say” occurs in two different structures: *say*_{Source} and *say*_{Agent}, the former being stative, and the latter, eventive.

3.1.1 Tense

Generally speaking, stative predicates in Uyghur occur in the non-past and receive an interpretation like the English simple present, as shown for “know” in (133), which describes

Mahinur’s knowledge state in the present, not something she will come to know.

- (133) Mahinur [Tursun-ning ket-ken-lik-i-ni] bil-i-du.
Mahinur Tursun-GEN leave-PTPL.PST-COMP-3POSS-ACC know-NONPST-3
“Mahinur knows that Tursun left.”

Activity verbs in the non-past ordinarily get a future or imperfective interpretation in Uyghur. As is the case for English, the durative/progressive is generally used to describe things happening in the present.

- (134) a. Mahinur polu-ni ye-y-du.
Mahinur pilaf-ACC eat-NONPST-3
“Mahinur will eat pilaf.”
b. Mahinur polu-ni ye-wat-i-du.
Mahinur pilaf-ACC eat-DUR-NONPST-3
“Mahinur is eating pilaf.”

Moving to “say”, Uyghur exhibits an alternation similar to English as it relates to tense, as shown in (135).

- (135) a. Mahinur Tursun бүгүн axsham yighin-gha kél-i-du
Mahinur Tursun today evening conference-DAT come-NONPST-3
de-y-du.
say-NONPST-3
“Mahinur says that Tursun is coming to the conference tonight.”
b. Mahinur Tursun бүгүн axsham yighin-gha kél-i-du dé-d-i.
Mahinur Tursun today evening conference-DAT come-NONPST-3 say-PST-3
“Mahinur said that Tursun is coming to the conference tonight.”

Both cases in (135) involve involve speech reports, based on a communicative acts that took place in the past. (135a) is a *say_{Source}* construction, which introduces the source of LM “Mahinur” and the contents of the LM. (135b), on the other hand, is a *say_{Agent}* construction, which involves an agent, (Mahinur), who carried out a speech act conveying the same LM.

As was the case in English, “yesterday” is not compatible with “say” in the present (136a), but is permitted in the past (136b).

- (136) a. *Tünügün Mahinur Tursun bugün axsham yighin-gha kél-i-du
 Yesterday Mahinur Tursun today evening conference-DAT come-NONPST-3
 de-y-du.
 say-NONPST-3
 Intended: “Yesterday Mahinur says that Tursun is coming to the conference
 tonight.”
- b. Tünügün Mahinur Tursun bugün axsham yighin-gha kél-i-du
 yesterday Mahinur Tursun today evening conference-DAT come-NONPST-3
 dé-d-i.
 say-PST-3
 “Yesterday, Mahinur said that Tursun is coming to the conference tonight.”

Furthermore, in cases that are clearly stative (e.g. locations), the present tense (137a) is strongly preferred, while the past tense is marked (assuming there was not a change of state) (137b).

- (137) a. Taxi-da astalang de-y-du.
 sign-LOC slow.down say-NONPST-3
 “On the sign, it says slow down.”
- b. # Taxi-da astalang dé-d-i.
 sign-LOC slow.down say-NONPST-3
 “On the sign, it says slow down.”

This is precisely the preference noted for English.

3.1.2 Argument Structure

This section walks addresses the same set of diagnostics provided for English that demonstrates that essentially the same alternations shown for English apply to Uyghur. In order to make judgments clearer, because the non-past is ambiguous between a stative reading and a future reading, I introduced each target sentence as the follow-up to (138), which makes a future agentive reading infelicitous.

- (138) Tünügün Mahinur bilen parangla-sh-t-im.
 yesterday Mahinur with converse-RECP-PST-1SG
 “Yesterday I spoke with Mahinur.”

First, as was the case for English, there is (at least) a three way distinction between subjects of “say”, agents (139a), sources (139b), and holders/locations (139c)-(139d).

- (139) a. Mahinur astala-ng dé-di. Say_{Agent}
 Mahinur slow.down-2SG.IMP say-PST-3
 “Mahinur said to slow down.”
- b. Mahinur astala-ng de-y-du. Say_{Source}
 Mahinur slow.down-2SG.IMP say-NONPST-3
 “Mahinur says to slow down.”
- c. Taxta astala-ng de-y-du. Say_{Source}
 sign-LOC slow.down-2SG.IMP say-NONPST-3
 “On the sign, it says slow down.”
- d. Taxti-da astala-ng de-y-du. Say_{Loc}
 sign-LOC slow.down-2SG.IMP say-NONPST-3
 “On the sign, it says slow down.”

The difference between agents and sources is essentially the same as English: sources identify the source of LM and the content of the LM. Say_{Source} constructions do not make reference to the actual communicative act, instead, focusing exclusively on the result. Agents, on the other hand, indicate the individual who carried out the speech act. One difference between Uyghur and English is related to holders/locations, where two options are available: in Uyghur, the holder/location is the subject of “say” (139c) or an impersonal construction where “the sign” is in the locative and the subject of “say” is likely *pro*.¹ For present purposes, I make the assumption that the syntax between these constructions differs only in whether the subject is *pro* or an overt inanimate DP.

In say_{Agent} constructions, goals are permitted (143a), while in say_{Source} constructions, goals are prohibited (143b)-(143c).

¹All 8 speakers that I consulted have a preference for the locative construction with inanimate “sayers”.

- (140) a. Mahinur manga astala-ng dé-di.
 Mahinur 1SG.DAT slow.down-2SG.IMP say-PST-3
 “Mahinur said to me to slow down.”
- b. *Mahinur manga astala-ng de-y-du.
 Mahinur 1SG.DAT slow.down-2SG.IMP say-NONPST-3
 Intended: “Mahinur says to me to slow down.”
- c. *Taxti-da manga astalang de-y-du.
 sign-LOC 1SG.DAT slow.down say-NONPST-3
 Intended: “On the sign, it says to me slow down.”

Furthermore, the ability to introduce an LMN correlates with the the eventive/stative contrast. More specifically, LMNs occur in *say_{Agent}* contexts (141a), while *say_{Source}* (141b) and *say_{Holder}* (141c) constructions are incompatible with LMNs.

- (141) a. Mahinur birnémi-ler-*(ni) dé-di. *Say_{Agent}*
 Mahinur one.what-PL-ACC say-PST-3
 “Mahinur said a few things.”
- b. *Mahinur birnémi-ler-(ni) de-y-du. *Say_{Source}*
 Mahinur one.what-PL-ACC say-NONPST-3
 Intended: “Mahinur says a few things.”
- c. *Taxti-da birnémi-ler-(ni) de-y-du. *Say_{Loc}*
 sign-LOC one.what-PL-ACC say-NONPST-3
 Intended: “On the sign it says a few things.”

In Uyghur, *birnémi-ler-*(ni)* is the most natural DP used to stand in for LM. Recall that English “a few words” performs the same function. In Uyghur, an Agent is necessary to license an NP/DP object (i.e. *v_{do}*). This condition is met in (141a), where there is an agent. However, both (141b) and (141c) lack an Agent and thus are unable to license a *words*-NP as an internal argument.

Finally, the availability of a volitional adverb such as *meqsetlik halda* “intentionally” is similarly indicative of whether or not there is an agent. There is a volitional agent in (142a), making the adverb acceptable. However, the cases in (142b)-(142c) are both stative and

incompatible with a the volitional adverb.²

- (142) a. Mahinur meqsetlik hal-da astala-ng dé-di.
 Mahinur deliberate way-LOC slow.down-2SG.IMP say-PST-3
 “Mahinur deliberately said to slow down.”
- b. # Mahinur meqsetlik hal-da astala-ng de-y-du.
 Mahinur deliberate way-LOC slow.down-2SG.IMP say-NONPST-3
 Intended: “Mahinur deliberately says to slow down.”
- c. # Taxti-da meqsetlik hal-da astalang de-y-du.
 sign-LOC deliberate way-LOC slow.down say-NONPST-3
 Intended: “On the sign, it deliberately says slow down.”

There are many light verb constructions that encode the intentions of the subject, such as *-(I)p baq-* “try”, which requires an agent (see Bridges, 2008).³ This construction is compatible with the *say_{Agent}* construction in (143a), but infelicitous in (143b)-(143c).

- (143) a. Mahinur astala-ng de-p baq-t-i.
 Mahinur slow.down-2SG.IMP say-CNV BAQ-PST-3
 “Mahinur tried to say slow down.”
- b. * Mahinur astala-ng de-p baq-i-du.
 Mahinur slow.down-2SG.IMP say-CNV BAQ-NONPST-3
 Intended: “Mahinur tries to say slow down.”
- c. * Taxti-da astalang de-p baq-i-du.
 sign-LOC slow.down say-CNV BAQ-NONPST-3
 Intended: “On the sign, it deliberately says slow down.”

With respect to subjects, English and Uyghur both allow agents and holders/sources to be subjects of “saying”. I assume that sources/holders are generated internally, while agents/causers are base-generated external to SayP. In all cases, I assume the

²There is a speaker-oriented reading available in (142b) and (142c), that does not express the deliberacy of the communicative act, but rather the speaker’s evaluation. In (142b), it is possible to interpret the non-past as a future event, in which case it is again infelicitous.

³In English, “try” is ambiguous between “attempt to do” and “do and see what happens”. In Uyghur, *-(I)p baq-* corresponds to the “do and see what the outcome is or what happens” interpretation.

lowest VP shell, SayP, to obligatorily introduce a LM argument. As mentioned in the intro, I assume the structure in (126) for $\text{say}_{\text{Source}}$ constructions and (128) for $\text{say}_{\text{Agent}}$ constructions.

3.2 Linguistic Material Arguments

Now that I have motivated the $\text{say}_{\text{Source}}$ versus $\text{say}_{\text{Agent}}$ distinction, I move onto LM arguments in Uyghur. I begin by discussing simple DP objects and then move on to clausal complements. For purposes of this section, I ignore indexical shift and the alternations that occur within TECs related to finiteness, clause size, and case/agreement, but return to these issues in the final sections of this chapter. In this section, I focus more broadly on the different realizations of LM arguments in Uyghur.

3.2.1 NP/DP complements to “say”

As mentioned in Chapter 1.2, accusative case functions as DOM in Uyghur. For this reason, accusative marking is restricted to specific internal arguments. This is shown for the verb “say” in (144) below.

- (144) a. Mahinur ikki söz dé-d-i.
Mahinur two word say-PST-3
“Mahinur said two words.”
- b. Mahinur ikki söz-ni dé-d-i.
Mahinur two word-ACC say-PST-3
“Mahinur said (the two salient/known) words.”

Notice in (144a) that “two” words is non-specific, while the presence of accusative case in (144b) indicates that there are two salient words in the discourse. In other words, for (144b) to be uttered, both discourse participants are aware of which two words Mahinur uttered.

By inserting a manner adverbial, it is apparent in (145a) that “two words” remains low in the structure. When the internal argument gets accusative case, it raises higher than the manner adverb (145b).

- (145) a. Mahinur {ünlük} ikki söz {*ünlük} dé-d-i.
 Mahinur loudly two word loudly say-PST-3
 “Mahinur said two words.”
- b. Mahinur {*ünlük} ikki söz-ni {ünlük} dé-d-i.
 Mahinur loudly two word-ACC loudly say-PST-3
 “Mahinur said (the two salient/known) words.”

For Uyghur, I assume that the derivation for (145) is as shown in (146), where both bare and accusative objects merge as sisters to Say^o, but accusative derives from raising into spec, *v*P.

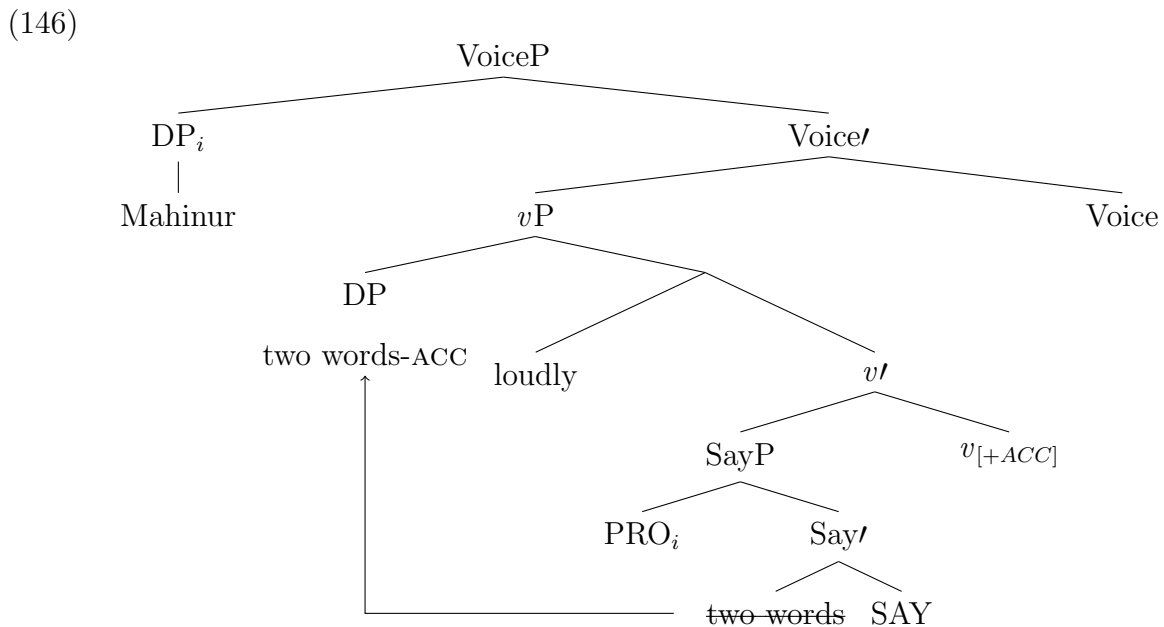

I assume manner adverbs to merge in the *v* domain in a position that intervenes between the base position of the internal argument and the position where it gets accusative. Furthermore, I assume that *v* optionally bears an accusative/specific feature, which results in it assigning accusative case to the closest NP in its c-command domain (Chomsky, 2000, 2001). I further assume that this Agree relation results in attraction of the internal argument into the specifier position of *v*, as shown in (146). I assume the absence of this feature to result in the NP pseudo-incorporating into the verb, as mentioned in Chapter 1.2, where it is interpreted as non-specific.

These simple DP arguments behave like canonical direct objects in the language. For instance, when “say” is passivized, accusative case on “two words” is barred, and it is promoted to subject position (147).

- (147) Ikki söz-(*ni) ünlük dé-yil-d-i.
 two word-ACC loudly say-PASS-PST-3
 “Mahinur said two words.”

The data above with simple NP/DP direct objects is intended to serve as a point of comparison as I turn to clausal complements in the next section.

3.2.2 Clausal LM arguments

Moving to more complex cases, “say” is compatible with internal arguments of multiple syntactic types, which exhibit distinct behaviors with respect to case-marking and passivization. As a reminder, “say” can select a TEC that closely resembles a root clause (148a), but optionally allows the subject to receive accusative case (148b). “Say” can also select an NEC, which has a genitive subject and nominal morphology (case and agreement) on the right edge (148c). Finally, (148d) involves an indefinite DP object that stands in for LM (148d).

- (148) a. Mahinur [Tursun ket-t-i] dé-d-i.
 Mahinur Tursun leave-PST-3 say-PST-3
 “Mahinur said that Tursun left.”
- b. Mahinur [Tursun-ni ket-t-i] dé-d-i.
 Mahinur Tursun-ACC leave-PST-3 say-PST-3
 “Mahinur said that Tursun left.”
- c. Mahinur [Tursun-ning két-idighan-liq-i-ni] dé-d-i.
 Mahinur Tursun-GEN leave-PTPL.IMPF-COMP-3POSS-ACC say-PST-3
 “Mahinur said Tursun left.”
- d. Mahinur birnémi-ler-*(ni) dé-d-i.
 Mahinur one.what-PL-ACC say-PST-3
 “Mahinur said a few things.”

I argue that the derivation of accusative case in (146) applies to all instances of accusative case in (148), which includes: the accusative subject in (148b), the entire nominalized embedded clause in (148c), and the indefinite object in (148d).

Beginning with the position of TECs, notice that the manner adverb “loudly” is unnatural with “say” + TEC constructions in general. This is because this construction most naturally does not encode “speaking out loud”, but instead indicates who the agent was and the LM that they introduced. For this reason, both orders are ungrammatical in (149).

- (149) a. Mahinur {??/*ünlük} [Tursun ket-t-i] {*ünlük} dé-d-i.
 Mahinur loudly Tursun-ACC leave-PST-3 loudly say-PST-3
 “Mahinur said that Tursun left.”
- b. Mahinur {??/*ünlük} [Tursun-ni ket-t-i] {*ünlük} dé-d-i.
 Mahinur loudly Tursun-ACC leave-PST-3 loudly say-PST-3
 “Mahinur said that Tursun left.”

However, turning toward an adverbial modifier, such as “three times”, we see that it similarly must occur to the left of the TEC and is acceptable (150).

- (150) a. Mahinur üç qétim (manga) [Tursun-(ni) ket-t-i] dé-d-i.
 Mahinur three times 1SG.DAT Tursun-ACC leave-PST-3 say-PST-3
 “Mahinur said three times (to me) that Tursun left.”
- b. *Mahinur (manga) [Tursun-(ni) ket-t-i] üç qétim dé-d-i.
 Mahinur 1SG.DAT Tursun-ACC leave-PST-3 three times say-PST-3
 Intended: Mahinur said three times (to me) that Tursun left.”

(150) is naturally interpreted such that Mahinur said something on three occasions, each transmitting the same content: “Tursun left”. This is suggestive that the TEC remains in its VP-internal merge position, since it patterns like a bare object more generally.

In addition to the manner adverb facts, further insights about these structures come from passivization. First, notice that when “give” is passivized, the direct object “book” obligatorily loses accusative case, while the indirect object is unaffected (151b). Furthermore, both DO-IO and IO-DO orders are permitted under passivization (151b)-(151c).

- (151) a. Mahinur Tursun-gha kitab-(ni) ber-d-i.
 Mahinur Tursun-DAT book-ACC give-PST-3
 “Mahinur gave the book to Tursun.”
- b. Kitab-(*ni) Tursun-gha bér-il-d-i.
 book-ACC Tursun-DAT give-PASS-PST-3
 “A book was given to Tursun.”
- c. Tursun-gha Kitab-(*ni) bér-il-d-i.
 Tursun-DAT book-ACC give-PASS-PST-3
 “A book was given to Tursun.”

Turning back to TECs, I insert Goal arguments because they mark the edge of the matrix clause. Notice that TECs do not exhibit expected behavior as it relates to internal arguments under passivization. They are able to occur to the right of the goal argument (152b), but are unable to raise into subject position (over the goal) (152c). Finally, despite the fact that TECs are unable to raise, subjects of TECs are able to raise, losing accusative case in the process (152d).

- (152) a. Mahinur manga Tursun-(ni) kél-i-du dé-d-i.
 Mahinur 1SG.DAT Tursun-ACC come-NONPST-3 say-PST-3
 “Mahinur said to me that Tursun will come.”
- b. janga Tursun-(*ni) kél-i-du dé-yil-d-i.
 1SG.DAT Tursun-ACC come-NONPST-3 say-PASS-PST-3
 “It was said to me that Tursun will come.”
- c. *Tursun-(*ni) kél-i-du manga dé-yil-d-i.
 Tursun-ACC come-NONPST-3 1SG.DAT say-PASS-PST-3
 “It was said to me that Tursun will come.”
- d. Tursun-(*ni) manga kél-i-du dé-yil-d-i.
 Tursun-ACC 1SG.DAT come-NONPST-3 say-PASS-PST-3
 “It was said to me that Tursun will come.”

Multiple conclusions can be drawn from this data. The fact that both passive and a goal argument are permitted in this construction are indicative that both *v* and Voice are projected (i.e. these are *say_{Agent}* constructions). Second, accusative case-marking is

prohibited on the subject of the TEC, which suggests that its licensing is contingent upon an active Voice head in the matrix clause. Most importantly, however, we can conclude that TECs are unable to raise out of VP (i.e. they must remain adjacent to *de-* “say”). Despite this, TEC subjects exhibit similar behavior to other accusative-marked objects, such as NECS and indefinite LM arguments, which I turn to now.

Returning to NECs and LMNs, which are both obligatorily accusative-marked, we find the same behavior as other accusative-marked arguments in the language. Notice that the manner adverb obligatorily occurs to the right of the NEC in (153a) or the indefinite LM argument in (153b).

- (153) a. Mahinur {*ünlük} [Tursun-ning két-idighan-liq-i-ni] {ünlük}
 Mahinur loudly Tursun-GEN leave-PTPL.IMPF-COMP-3POSS-ACC loudly
 dé-d-i.
 say-PST-3
 “Mahinur loudly said Tursun left.”
- b. Mahinur {*ünlük} birnémi-ler-ni {ünlük} dé-d-i.
 Mahinur loudly one.what-PL-ACC loudly say-PST-3
 “Mahinur loudly said a few things.”

Similarly, both of these internal arguments behave the same under passivization as any other internal argument. They obligatorily raise over manner adverbials under passivization (154a)-(154b), unlike TECs.

- (154) a. {*ünlük} [Tursun-ning két-idighan-liq-i] {ünlük} dé-yil-d-i.
 loudly Tursun-GEN leave-PTPL.IMPF-COMP-3POSS loudly say-PST-3
 “That Tursun left was loudly said.”
- b. {*ünlük} birnémi-ler {ünlük} dé-yil-d-i.
 loudly one.what-PL loudly say-PST-3
 “A few things were loudly said.”

As mentioned at the outset of this section, all of the cases discussed here are *say_{Agent}* constructions. However, the data in this section demonstrates that TECs and bare NPs merge (and remain) low in the structure as complement to SAY. All accusative marked arguments: NECs, DPs, and subjects of TECs raise into spec, *vP*.

(155)

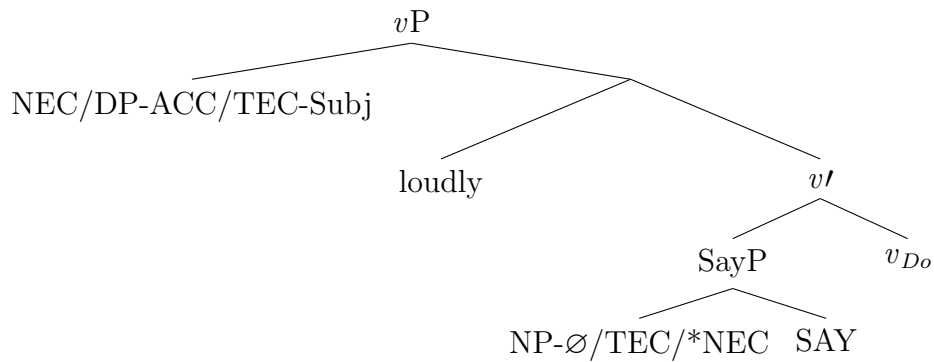

This section has shown that all accusative-marked arguments raise into a position higher than manner adverbs and behave the same under passivization. However, further discussion is necessary with respect to accusative subjects. For instance, it remains possible that accusative subjects are base-generated VP-externally and are resumed by an empty category within the TEC. I show that this is not the case in the next section.

3.2.3 Accusative subjects externally merge within the TEC

This section briefly demonstrates that accusative subjects originate within the TEC and raise out, by ruling out a so-called *prolepsis* analysis, by which accusative subjects merge as an argument in the matrix clause and control a null pronoun in the embedded clause.⁴ I provide three pieces of evidence that accusative subjects originate within the TEC: Negative Concord Items and idioms, both of which were first discussed in Shklovsky and Sudo (2014) (henceforth S&S). Beginning with the former, the negative quantifier *héch* requires clausemate negation (Sudo, 2012), which is illustrated by the fact that *héchkim* “nobody” is only permitted if the clause is negated (353).

- (156) **Héch-kim** ket-*(mi)-d-i.
no-who leave-NEG-PST-3
“Nobody left.”

Importantly, *héchkim-ni* “nobody-ACC” can be licensed by embedded negation, as shown

⁴See Salzmann (2017) for an overview of prolepsis and prior analyses of prolepsis.

in (354), which entails that it originates within the embedded clause, since the matrix clause is affirmative.

- (157) Mahinur **héchkim-ni** ket-mi-d-i dé-d-i.
 Mahinur nobody-ACC leave-NEG-PST-3 say-PST-3SG
 ‘Mahinur said that nobody left.’

A second piece of evidence involves idiom chunks. Subjects of sentential idioms must merge as the subject within the idiom in order to receive an idiomatic interpretation. The idiom is provided in (158a), which is embedded under ‘say’ in (158b).

- (158) a. **Burut-ung-(*ni)** xet tart-iptu.
 mustache-2SG.POSS-ACC letter pull-PST.INDIR.3
 ‘You’ve become a man.’ (lit. Your mustache pulled a letter)
- b. Mahinur **burut-ung-ni** xet tart-iptu dé-d-i.
 Mahinur mustache-2SG.POSS-ACC letter pull-PST.INDIR.3 say-PST-3
 Mahinur said you’ve become a man.’ (lit. your mustache pulled a letter.)

Despite receiving accusative case in (158b), the idiomatic interpretation remains. This is strongly suggestive that the accusative subject originates downstairs, otherwise we would expect the idiomatic interpretation to be lost.

3.2.4 Accusative subjects raise

Evidence that accusative subjects do, in fact, raise into a higher position comes from reciprocals and passivization. Starting with the former, reciprocals are subject to Condition A of Binding Theory. The reciprocal in (159), which is formed from the numeral *bir* ‘one’, must be locally bound by a plural antecedent.

- (159) Tursun bilen Ali bir-bir-i-*(**ni**) kör-(üşh)-ti.
 Tursun with Ali one-one-3POSS-ACC see-RECP-PST.3
 ‘Tursun and Ali saw each other.’

The locality constraints are demonstrated by the differences between (160a) and (160b), where (160a) shows that accusative case is required on the reciprocal embedded subject. If

we take the position of accusatives to be in the same binding domain as its antecedent for Condition A, while nominatives are not, this is predicted. (160b) demonstrates that the antecedent for reciprocals must be local and cannot bind across a singular subject.

- (160) a. Tursun bilen Ali **bir-bir-i-*(ni)** ut-i-du de-p
 Tursun with Ali one-one-3POSS-ACC win-NONPST-3 say-CNV
 oyla-y-du/oyli-sh-i-du.
 think-NONPST-3/think-RECP-NONPST-3
 “Tursun and Ali think eachother will win.”
- b. *Tursun bilen Ali Mahinur-(ni) bir-bir-i-ni kör-(üşh)-ti
 Tursun with Ali Mahinur-ACC one-one-3POSS-ACC see-RECP-PST.3
 de-p oyla-y-du/oyli-sh-i-du.
 say-CNV think-NONPST-3/think-RECP-NONPST-3
 Intended: “Tursun and Ali think that Mahinur saw each of them.”

Given that word order is very flexible in Uyghur, it is difficult to pinpoint exactly where the lowest accusative position is, but I assume it to be in the spec, *vP* associated with *de-* “say”.⁵

Another piece of evidence for raising comes from passivization. (161a) again illustrates that accusative case is lost under passivization in Uyghur. However, passivization of the embedded verb does not lead to prohibition of accusative case on the promoted internal argument in (161b). Because passivization blocks accusative assignment within the same clause, the acceptability of (161b) is an argument in favor of the embedded subject raising to a higher position where it gets accusative case.

- (161) a. Istakan-(*ni) buz-ul-d-i.
 glass-ACC break-PASS-PST-3
 “The glass was broken.” (S&S, 392:28a)
- b. Ahmet [istakan(-ni) buz-ul-d-i] dé-d-i.
 Ahmet glass-ACC break-PASS-PST-3 say-PAST-3
 “Ahmet said that the glass was broken.” (S&S, 392:28b)

⁵See Major and Mayer (2018) for a prosody-based analysis that suggests the accusative subject is situated in the matrix clause, as opposed to the left periphery of the embedded clause.

Despite the fact that it is clear that accusative subjects raise, it is difficult to determine their precise landing site. Consider (162) with an addressee and a matrix adverb.

- (162) a. Mahinur Tursun-ni Alim-gha ket-t-i dé-d-i.
 Mahinur Tursun-ACC Alim-DAT leave-PST-3 say-PST-3
 “Mahinur said to Alim that Tursun left.”
- b. Mahinur Tursun-ni tünügün két-i-du dé-d-i.
 Mahinur Tursun-ACC yesterday leave-NON.PST-3 say-PST-3
 “Mahinur said yesterday that Tursun will leave.”

The fact that the accusative subject “Tursun” can occur to the left of of the addressee “Alim ” in (162a) or to the left of a matrix temporal adverb, as in (162b) is clear evidence that accusative subjects are able to occur in the matrix clause.

Perhaps the clearest evidence that Accusative subjects raise comes from the the test shown earlier that subjects of TECs are able to be promoted to subject position under passivization, unlike the rest of the TEC, repeated in (163).

- (163) Tursun-(*ni) manga kél-i-du dé-yil-d-i.
 Tursun-ACC 1SG.DAT come-NONPST-3 say-PASS-PST-3
 “It was said to me that Tursun will come.”

The simplest interpretation of this data is that accusative case is acquired via A-movement into the matrix clause, followed by subsequent A-movement to the subject position as a result of passivization, similar to arguments for Japanese (Tanaka, 2002)

This is similarly supported by the requirement that subjects of TECs must have accusative case in order to scramble. If we make the assumption that raising for accusative allows the TEC subject to land at the edge of matrix *v*P, it follows that subsequent movement (e.g. Topicalization or scrambling) should be possible, which is what we see in (164).

- (164) {Tursun-*(ni)} Mahinur {Tursun-*(ni)} manga {Tursun-(ni)} ket-t-i
 Tursun-ACC Mahinur Tursun-ACC 1SG.DAT Tursun-ACC leave-PST-3
 dé-d-i.
 say-PST-3
 “Mahinur said to me that Tursun left.”

3.2.5 Locus of accusative case

Before moving into a detailed analysis of the two types of TECs (nominative versus accusative subject) and a re-analysis of finiteness in the language, I first address a couple of arguments that suggest accusative subjects are licensed within the embedded clause. The first has to do with the locus of accusative case. Shklovsky and Sudo (2014) argue that accusative subjects remain within the embedded CP due to an apparent constraint against more than one accusative appearing in the same clause. More specifically, they suggest that sentences like (165) are ungrammatical because both the subject and object are competing for a single instance of accusative case.⁶

- (165) Tursun *méni nan-(?ni) yaq-t-i dé-d-i.*
Tursun I.ACC bread-(ACC) bake-PST-3 say-PST-3
“Tursun said that I baked bread.”

The absence of a true double accusative constraint is most clearly illustrated by looking at constructions where accusative is not optional on either the subject or the object, such as cases where where the object is a pronoun (166a), where the object precedes a manner adverb (166b), or all cases where the object is scrambled (166c).

- (166) a. Tursun **méni siz-*(ni)** *kör-d-i dé-d-i.*
Tursun I.ACC you-(ACC) see-PST-3 say-PST-3
“Tursun said that I saw you.”
- b. Tursun **méni nan-*(ni) asta** *yaq-t-i dé-d-i.*
Tursun I.ACC bread-(ACC) slowly bake-PST-3 say-PST-3
“Tursun said that I baked bread.”
- c. **Nan-*(ni)** Tursun **méni** *yaq-t-i dé-d-i.*
bread-(ACC) Tursun I.ACC bake-PST-3 say-PST-3
“Tursun said that I baked bread.”

A detailed (morpho-)syntactic analysis of the cases in (166) is not necessary for present purposes. The critical property that falls out from the data above is that the object is not

⁶Speakers agree that there is a general preference for only one instance of accusative in (165), but this is treated as a preference as opposed to a inviolable grammatical constraint.

in competition with the subject for accusative case within the embedded clause. In other words, subjects and objects seem to get accusative case in different positions. If the “double accusative constraint” is operative, it suggests that both causativized ditransitives and tensed embedded clauses consist of more than one clause. If the constraint is not operative, it no longer serves as a relevant diagnostic and thus no longer needs to be addressed.⁷ Regardless, either interpretation is compatible with the analysis that accusative subjects are derived by raising from the embedded clause into the matrix clause, as supported by reciprocal binding, passivization, and prosodic phrasing.

3.2.6 Interpretation of accusative subjects

If we adopt the idea that accusative subjects are derived in the same way as accusative objects, we should also find parallel interpretive effects. This is precisely what we find in (167)-(168), where discourse salience determines whether accusative is necessary.⁸

- (167) Context: Alim and I (the speaker) are roommates and have been talking about a suspicious man who has been wandering the street by our house for months. Alim returns home to find the garden destroyed. Our neighbor, Tursun describes the suspicious man as the culprit. I return home and ask Alim what happened, and he reports what the neighbor said:

Tursun **kishi-*(ni)** mén-ing güllük-üm-ni weyran qil-iptu
Tursun person-ACC I-GEN garden-1SG.POSS-ACC destruction do-PST.INDIR.3
dé-di.
say-PST.3

“Tursun said that that (specific) person destroyed my garden.”

⁷The Uyghur data runs contrary to the double accusative constraint, which does hold in languages like Japanese (Hiraiwa, 2010).

⁸Predolac (2017) provides for similar constructions in Turkish, which exhibit many of the same properties.

(168) Context: Alim and I are roommates. He returns home and sees that the garden has been destroyed. He asks our neighbor, Tursun, who tells him that some person he didn't recognize was the culprit. Alim has no idea who Tursun is referring to. I return home, notice the garden, ask Alim, and he reports:

Tursun (bir) **kishi-(*ni)** mén-ing güllük-üm-ni weyran
 Tursun some person-ACC I-GEN garden-1SG.POSS-ACC destruction
 qil-iptu dé-di.
 do-PST.INDIR.3 say-PST.3

“Tursun said that some person destroyed my garden.”

The first context involves an entity that already exists in the common ground, which leads to obligatory accusative marking on the subject (167). In a similar context where the embedded subject is neither part of the common ground nor discourse-salient, an accusative subject is banned (168).⁹

One additional interpretive property noted in Shklovsky and Sudo (2014) is shown in (169). In this case, a *de dicto* reading of the accusative subject is available, which suggests that they are interpreted below the attitude verb (169).

(169) Tursun [tulpar-ni kel-d-i] dé-d-i, ema tulpar yoq.
 Tursun [winged.horse-ACC arrive-PST-3] say-PST-3 but winged.horse not.exist
 “Tursun said that a winged horse arrived, but winged horses do not exist.” (S&S, 392:29)

First, as with the previous examples, *tulpar* “winged horse” can only be accusative-marked if the *tulpar* has been mentioned earlier in the discourse or if it is otherwise already in the common ground. This is consistent with the previous data, where despite the fact that there is no commitment that winged horses exist, there is a specificity requirement. The fact that this sentence is possible without requiring a commitment to the existence of winged

⁹Pronouns must receive accusative case (when no shift occurs), as they do in mono-clausal transitive constructions. On the other hand, proper names optionally receive accusative case in subject position, but must get accusative case when they are direct objects in simple transitive contexts. Native speakers recognize a difference, but find it difficult to articulate.

horses suggests that reconstruction back into the embedded clause is possible; however, this is hardly surprising given that reconstruction is in principle, always an option.

The data above suggest that there is a reasonable parallel between direct objects of simple transitives and subjects of TECs. When they are specific, each raises to spec, v P and receives accusative case, while when non-specific, they remain in their initial merge position.

3.2.7 Analyzing internal arguments of “say”

Now that we have established that accusative subjects raise into spec, v P of the matrix clause, like all other accusative arguments, it is worth taking a moment to formalize the findings to this point. First, I begin by assuming Chomsky (2000, 2001), where accusative case is established via Agreement between a probing v and the closest nominal that it c-commands, via the process specified in (338).

- (170) If a functional head $F \in \{ T, D \}$ has unvalued phi-features and an NP, X, has an unvalued case feature [and certain locality conditions hold], then agreement happens between F and X, resulting in the phi-features of X being assigned to F and the case associated with F being assigned to X. (Baker and Vinokurova, 2010:p. 596)

We assume v to be a probe that is optionally endowed with an “accusative/specificity” feature, and that v searches into its c-command domain for an NP that has not already entered into an Agree relationship. It Agrees with the closest NP in its c-command domain, assigns it accusative case and attracts it into its specifier.

Following Asarina’s analysis of NECs, such as (171), there is a null N that embeds a CP in NECs. In this way, v agrees with that NP attracts it into its specifier, and assigns it accusative case, as shown in (172).¹⁰

¹⁰I assume that whatever property is responsible for PRO resisting case in general is the reason that it cannot agree with v .

- (171) Mahinur Tursun-ning ket-ken-lik-(xewir)-i-ni angli-d-i.
 Mahinur Tursun-GEN leave-PTPLPST-COMP-NEWS-3POSS-ACC hear-PST-3
 “Mahinur heard that Tursun left.”

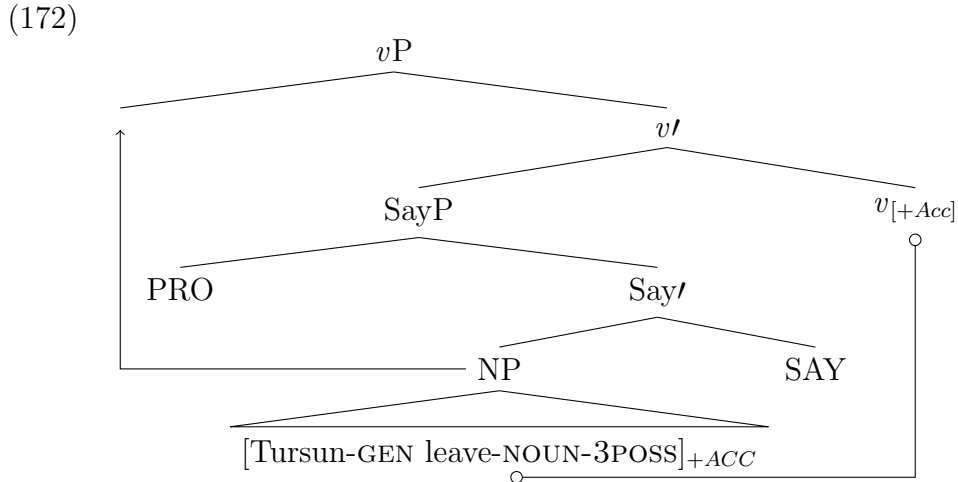

Turning to TECs, when v bears an accusative feature, the LM complement to SAY is not itself an NP, but is instead a CP. In this case, the closest NP in its c-command domain is the subject, which it Agrees with, attracts it into its specifier, and assigns it accusative case. The derivation for the familiar case in (173) is provided in (174).

- (173) Mahinur Tursun-ni ket-t-i dé-d-i.
 Mahinur Tursun-ACC leave-PST-3 say-PST-3
 “Mahinur said Tursun left.”

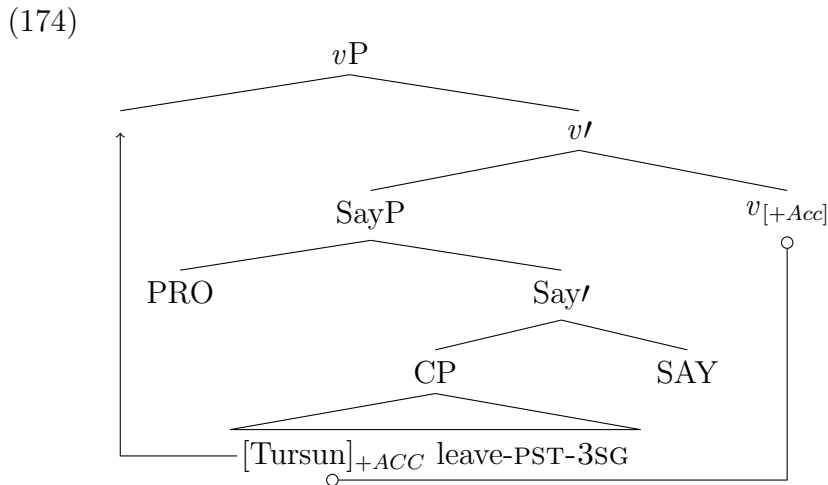

CPs resist case (Stowell, 1981), making it unsurprising that a TEC cannot check the accusative feature on *v*. The problem here is that this requires that TECs be (at least sometimes) transparent for Agree. Given that TECs appear to be finite clauses, this is problematic for an analysis that assumes that Agreement for A-processes is phase bound (see Halpert, 2012). I return to this issue in the next section.

Before moving on, however, I assume that TECs are able to pseudo-incorporate into the matrix verb, or get licensed VP-internally via some other mechanism, just like bare NPs, making (175) a licit structure.

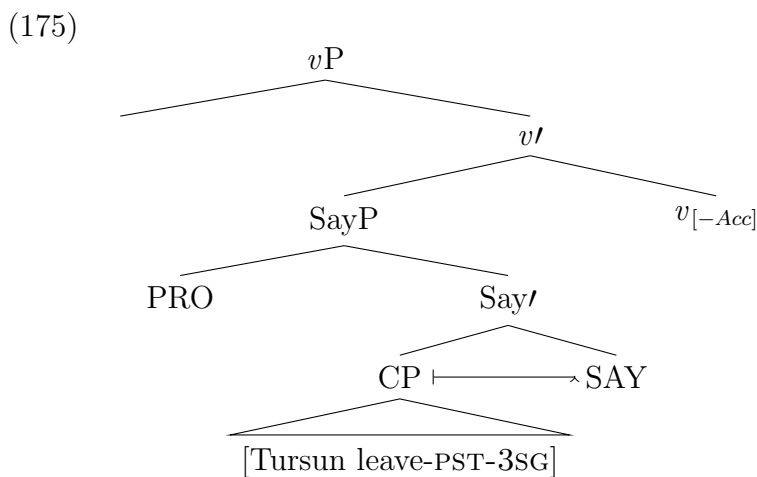

Related to the issue with Agreement across a finite clause boundary, there is a question as to why nominative case is an option. I suggest that there are differences in clause size that translate to differences in transparency for Agreement. In the next section I demonstrate based on Indexical shift that clause size correlates with its presence, which indicates whether the CP will be transparent or not for Agree. In the end, I suggest in following with George and Kornfilt (1981) that properties of Agreement in Uyghur are reminiscent of the finiteness contrast in English.

3.3 Tensed embedded clauses, Finiteness, and Indexical Shift

This section serves two distinct purposes: (i) to introduce novel data and analysis of Uyghur indexical shift; and (ii) argue that finiteness in Uyghur does not correlate with tense, offering

an explanation for why subjects can raise out of finite clauses as shown in (174) in the process.

In recent years, there has been considerable discussion of counterexamples to Kaplan (1977)’s claim that indexicals like “I” and “you” be interpreted relative to the utterance discourse context. These counterexamples, which involve indexicals being interpreted relative to a reported context, is known as *indexical shift*. This section builds upon Sudo (2012); Shklovsky and Sudo (2014) (henceforth S and S&S respectively), which has implications for indexical shift and finiteness as it relates to the verb “say”.

To this point in this chapter, I have exclusively shown TECs with proper names as subjects to avoid indexical shift. When an indexical like “I” is the subject of a TEC, the relevant contrast arises (176).

- (176) a. Ahmet [men ket-t-im] dé-d-i.
 Ahmet [1SG.NOM leave-PAST-1SG] say-PST-3
 “Ahmet said that I_{Ahmet/*Speaker} left.” (S&S, 386)
- b. Ahmet [méni ket-t-i] dé-d-i.
 Ahmet [1SG.ACC leave-PAST-3] say-PST-3
 “Ahmet said that I_{Speaker/*Ahmet} left.” (S&S, 386)

Notice that the 1st person pronoun in (176a) is interpreted as the matrix subject *Ahmet*, has nominative case, and triggers phi-agreement on the embedded verb. The 1st person pronoun in (176b) is obligatorily interpreted as the current speaker, bears accusative case, and does not show expected 1st person, singular agreement on the embedded verb. S&S argue that both cases in (176) contain an (monstrous) operator, represented by $\hat{\omega}$ (Anand and Nevins, 2004), which shifts indexicals in its scope by overwriting the context parameter that the indexicals are interpreted against (i.e. the context of the current speech act versus the reported speech act). S&S argue for the structure in (177).

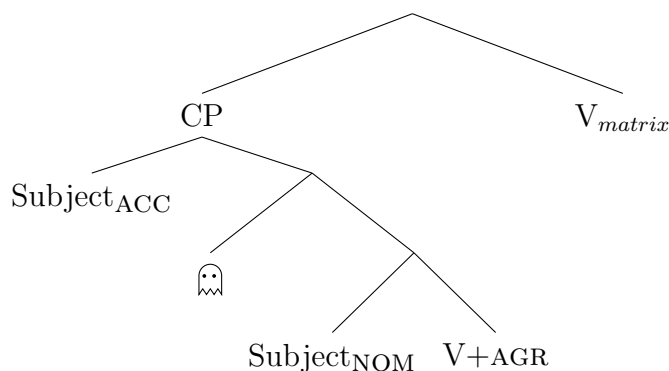

Under this analysis, accusative subjects are situated in a position higher than $\hat{\omega}$, and thus are interpreted relative to the current speech context (1sg = current speaker). Nominative subjects, however, remain within the scope of the operator and are thus interpreted relative to the reported context (1sg = matrix subject), which bears resemblance to direct quotation in English. Arguably the most substantial implication of this analysis is that it provides syntactic support in favor of $\hat{\omega}$ as an independent lexical item, offering support for Anand and Nevins (2004) over Schlenker (2003), who argues that attitude verbs involve quantification over contexts, where indexical shift is the result of the embedded context variable getting bound by a quantifier distinct from the matrix clause. The syntactic structure that intervenes between the attitude verb and the position where shift takes place, namely the landing site of accusative subjects, requires an analysis that allows indexical shift to be introduced in a structurally lower position than the attitude verb. This would require non-trivial modification to Schlenker (2003) to account for the empirical facts, but is captured straightforwardly by the operator analysis.

In (174), it was argued that accusative subjects raise into spec, *vP*, which already differs from (177) above. In this section, I argue in favor of a new landing site for accusative subjects, but also that S&S's analysis needs to be split into two distinct structures: one which contains the monstrous operator (176a) and one that does not (176b). These two constructions differ in size (i.e. contain different functional heads), which are responsible for the interpretive differences. Moreover, accusative subjects are licensed only when the embedded clause is

reduced or truncated, does not host the operator, and does not trigger expected agreement on the embedded verb (similar to non-finite embedded clauses in English), as in (178). When the operator is merged, on the other hand, the structure is large enough to enable feature transmission from C° to T° (Chomsky, 2004, 2008), which is necessary to license nominative case on the subject and the expected ϕ -agreement on T° (179).

(178) *No Indexical Shift*

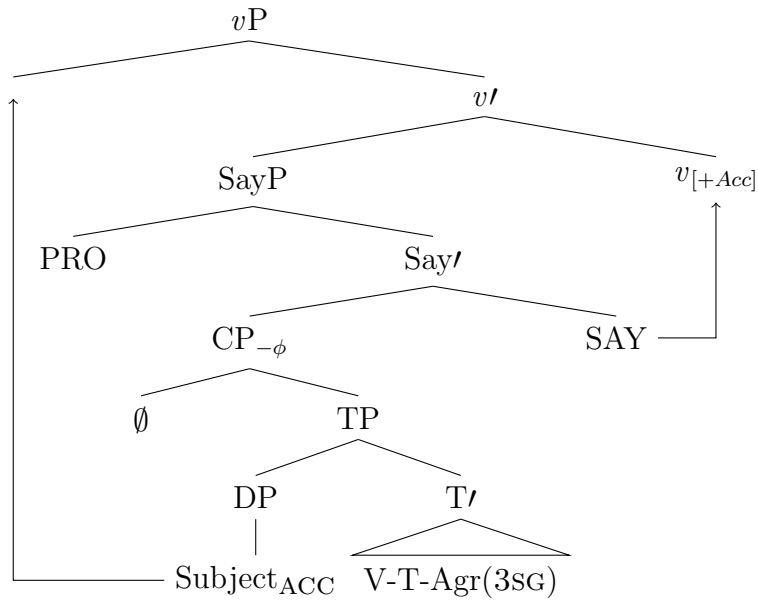

(179) *Indexical Shift*

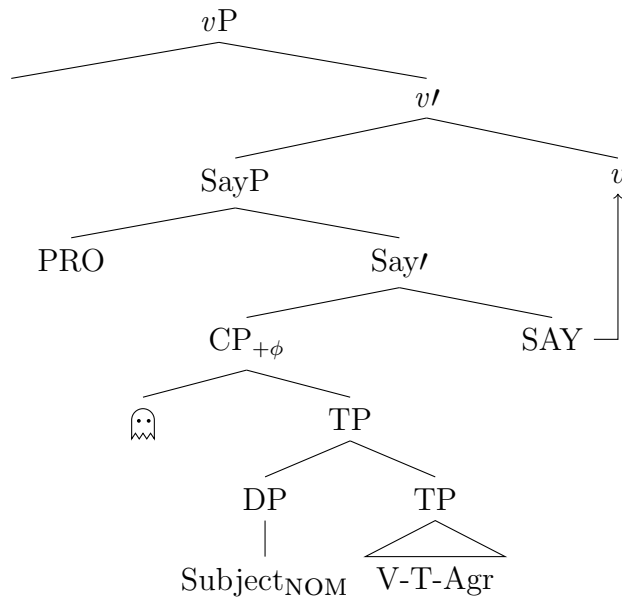

One implication of the analyses in (178) and (179) is that the monstrous operator and accusative subjects are in complementary distribution, which eliminates the possibility of using the position of accusative subjects to pinpoint the position of the monster, contra S&S's proposal. However, I assume that indexical shift does function exactly as suggested by S&S in (179). A second implication is that under the present proposal, the structural differences are directly linked to C-selectional properties of SAY. In (178), SAY selects for a defective CP that is incapable of transmitting features to T. As a result, the embedded verb does not agree and the embedded subject cannot get nominative case. On the other hand, in (179), SAY selects a CP large enough to host the monstrous operator. This full CP allows transmission of the relevant phi-features from C to T. As a result, T exhibits the same agreement behavior as matrix clauses.

3.3.1 Introducing and re-analyzing monsters

For present purposes, I follow the proposal in S&S to account for indexical shift in Uyghur. More specifically, I assume that all 1st and 2nd person pronouns in the scope of the monstrous operator shift to the reported speech context. Unlike S&S, however, I argue that the monster

is in complementary distribution with accusative TECs. In this chapter, I do not suggest any changes to the analysis of indexical shift in Uyghur outlined in Sudo (2012) when indexical shift does occur; therefore, I refer the reader to this work for the formal semantic details.

The embedded clause in (180), based on the italicized speech below, is ambiguous between a direct quotation and an indirect speech report that contains shifted indexicals, although both interpretations correspond to entirely different prosodic structures (Major and Mayer, 2018).

(180) Reported speech act - Tursun says: “*men oyun-ni ut-tu-m* (I won)”.

Tursun [(men) oyun-ni ut-t-um] dé-d-i.
 Tursun I game-ACC win-PST-1SG say-PST-3

‘Tursun said, “I won the game”.

“Tursun said that I_{Tursun} won the game.”

That the indirect speech report is in fact indirect comes from applying the same set of diagnostics introduced by S&S and Sudo (2012). First, quantification out of quotation is not possible, but this restriction does not hold of non-quotative clauses. The fact that the *wh*-expression *qachan* is able to take matrix scope from within the clause illustrates that it is not direct quotation (181).

(181) Tursun [oyun-ni **qachan** ut-t-um] dé-d-i.
 Tursun game-ACC when win-PST-1SG say-PST.-
 “When did Tursun say he won the game?”

The fact that (181) can be interpreted as a matrix scope question indicates that it is not a case of direct quotation. If it were direct quotation it would be interpreted as equivalent to ‘Tursun said, “When did I win the game?”’. Another test involves negative concord item licensing, for which the logic is similar. Negative concord items like *héchqachan* require negation for licensing (182a). When these items are embedded, it is predicted that if they reside inside a direct quotation, the licensing negation would have to occur within the quote, otherwise the quoted utterance would be ungrammatical. However, matrix negation can

license them, which would not have been present for the quoted utterance, which strongly supports an analysis by which (182b) is actually an indirect speech report with a shifted indexical.

- (182) a. Tursun **héçqachan** ut-*(mi)-d-i.
 Tursun never win-NEG-PST-3
 “Tursun never won.”
- b. Tursun oyun-ni **héçqachan** ut-t-um dé-mi-d-i.
 Tursun game-ACC never win-PST-1SG say-NEG-PST-3
 “Tursun didn’t say that he never won the game.”

In summary, facts related to interpretation, wh-questions, and negative concord item licensing serve as strong support that these are indirect speech reports that contain shifted 1st person indexicals (i.e. interpreted as the matrix subject as opposed to the speaker).

3.3.2 Monsters and accusative subjects

The present proposal diverges from S&S with regard to the relationship between monsters and accusative subjects. More specifically, whereas S&S propose that the monster is present even in constructions with accusative subjects (177), the present analysis shows that monsters and accusative subjects are in complementary distribution.

S&S’s analysis predicts that all indexicals that are interpreted within the scope of the monster should shift. As a result, any 1st or 2nd person direct object should shift regardless of whether the subject shifts. This does not happen, as shown for 2nd person in (183a) and 1st person in (183b).

- (183) a. Ali méni_k (* $\overset{\circ}{\omega}$) [t_k siz-ni kör-d-i] dé-d-i.
 Ali I.ACC Op. you-ACC see-PST-3 say-PST-3
 “Ali said that I saw you_{hearer_{current}/*hearer_{original}’}
- b. Ali siz-ni_k (* $\overset{\circ}{\omega}$) [t_k mén-i kör-d-i] dé-d-i.
 Ali you-ACC Op. I-ACC see-PST-3 say-PST-3
 “Ali said that you saw me_{speaker_{current}/*speaker_{original}’}

Assuming the analysis in S&S, the embedded subject raises over the monster in both (183a) and (183b); however, there is still a context-sensitive indexical within the scope of the monster. Thus, we should find a mismatch between subjects and objects and the context parameters they are interpreted against (i.e. the object should shift, while the subject does not), contrary to fact. As a matter of fact, there is no evidence that shift is ever compatible with accusative subjects. The same pattern holds for 1st/2nd person datives embedded under accusative subjects, as demonstrated in (184).

- (184) Ali méni_k (*_{κλ}) [t_k siz-ge gül ber-d-i] dé-d-i.
 Ali I.ACC Op. you-DAT flower give-PST-3 say-PST-3
 ‘Ali said that I_{Speaker} gave you_{current-addressee} a flower.’

In addition to cases like (184), where a dative does not shift, it is also unclear why accusative subjects cannot reconstruct within the scope of the monster under S&S. In other words, even in cases like (185), the fact that reconstruction is optional, should mean that shift is also optional, contrary to fact.

- (185) Ali méni_k (*_{κλ}) [t_k ket-t-i] dé-d-i.
 Ali I.ACC Op. leave-PST-3 say-PST-3
 “Ali said that I_{speaker}/*Ali left.”

In other words, given that NCIs, subjects of idioms, and de dicto readings all demonstrate that reconstruction is possible (or obligatory), it is unclear what prevents *meni* in cases like (185) from reconstructing below the monster and thus shifting to the matrix subject *Ali*. The present analysis makes this prediction straightforwardly.

To make this point even clearer, notice that even when indexicals are embedded within an NCI subject, they exhibit the same indexical shift patterns as simple 1st and 2nd person pronouns, as shown in (186).

- (186) a. Mahinur [mén-ing héchqaysi dost-um kel-me-y-du] dé-d-i.
 Mahinur I-GEN no.which friend-1SG.POSS come-NEG-NONPST-3 say-PST-3
 “Mahinur said none of my_{Mahinur's}/*Speaker's friends will come.”

- b. Mahinur [[mén-ing héchqaysi dost-um-ni]_k [t_k kel-me-y-du]]
 Mahinur I-GEN no.which friend-1SG.POSS-ACC come-NEG-NONPST-3
 dé-d-i.
 say-PST-3
 “Mahinur said none of my_{Speaker's}/**Mahinur's* friends will come.”

(186) offers indisputable evidence for complementary distribution between accusative subjects and monstrous operators. Both the present analysis and S&S predict that (186a) should shift, given that the subject is nominative (unraised). However, (186b), is entirely incompatible with S&S, as the accusative subject raises, obligatorily reconstructs for NCI licensing, yet the indexical does not and cannot shift.¹¹ This is suggestive that the embedding verb can introduce an accusative subject or the monster, but critically not both.

3.3.3 Agreement on embedded verbs

The embedded verb invariably exhibits 3rd person agreement when the subject is accusative, regardless of the subject's ϕ -features. In other words, the embedded verb does not show co-varying agreement, even when the accusative subject is 1st or 2nd person, as illustrated in (187a) and (187b) respectively.

- (187) a. Ahmet [méni ket-t-i/*im] dé-d-i.
 Ahmet [1SG.ACC leave-PAST-3/*1SG] say-PST-3
 “Ahmet said that I_{speaker} left.”
- b. Ahmet [siz-ni ket-t-i/*ingiz] dé-d-i.
 Ahmet [2SG-ACC leave-PAST-3/2SG] say-PST-3
 “Ahmet said that you_{current-addressee} left.”

¹¹In addition to the verb *de-* “say”, shift is also acceptable in all *dep* environments. This suggests a tight relationship between *de-* “say” and the monster.

- (1) a. Tursun [ḡ qiz-im aghrip.qal-d-i de-p] ket-t-i.
 Tursun Op. daughter-1SG.POSS get.sick-PST-3 say-IP leave-PST-3
 “Tursun mentioned my_{Tursun's}/**Speaker's* daughter got sick and left.”
- b. Tursun [qiz-im-ni (*ḡ) aghrip.qal-d-i de-p] ket-t-i.
 Tursun daughter-1SG.POSS-ACC Op. get.sick-PST-3 say-IP leave-PST-3
 “Tursun mentioned that my_{Speaker's}/**Tursun's* daughter got sick and left.”

This observation regarding the agreement mismatch was noted in S&S, but was left as an open question. Given that monsters and accusative subjects are in complementary distribution, the analysis of accusative subjects no longer need to have any direct relationship to constructions that contain monsters. In following with the Raising to Object/ECM literature on Turkish (George and Kornfilt, 1981; Zidani-Eroğlu, 1997), I argue that the absence of expected agreement is correlated with non-finite clauses, while full agreement is correlated with finite clauses (i.e. tense is not a reliable indicator of finiteness). One crucial difference between Uyghur and Turkish, however, is that the Turkish literature suggests that there is no agreement (3rd person agreement is unmarked in Turkish), whereas Uyghur shows us that the lack of agreement is actually default 3rd person agreement, as shown in Table (3.1).

(188)

	Uyghur	Turkish	Translation
1sg	két-i- men	gid-iyor- um	‘I leave’
2sg	két-i- siz	gid-iyor- sun	‘You leave’
3	két-i- du	gid-iyor	‘S/he leaves’

Table 3.1: Non-past paradigm for ‘leave’

The 3rd person in Uyghur has a unique morphological exponent, while in Turkish it is impossible to differentiate between 3rd person agreement and no agreement. Turning back to the construction at hand, it is clear that there is, in fact, agreement triggered (189).

(189) Tursun méni két-i-du/*men dé-d-i.
 Tursun I.ACC leave-NONPST-3/*1SG say-PST-3
 “Tursun said that I will leave.”

Because the 3rd person form is triggered, the crucial modification needed for Uyghur is that finiteness correlates with successful/full agreement (i.e. matching ϕ -features between the embedded subject and the embedded verb).¹² The absence of expected case and agreement in Uyghur is thus indicative that the clause is non-finite.

¹²There are other language-internal reasons to assume that 3rd person agreement is a default marker. One such example comes from so-called *izafet* constructions, where the *-i* marker appears unexpectedly on

Before getting back to the implications of the finiteness distinction discussed above, there are a set of apparent counterexamples introduced by S&S in their closing pages (364). These cases appear to be problematic because there happens to be non-default agreement in addition to an accusative-marked argument. At first glance, these data seem inconsistent with the claim that raising for accusative is explicitly correlated with default agreement. However, after some scrutiny, these accusative elements can clearly be shown to be proleptic, and thus the generalization that raising for accusative is strictly correlated with default agreement or “non-finite clauses”.¹³

(190) (Adapted from S&S, 399:51)

- a. Ahmet Aygül-ni [(siz) nan ye-p-siz] dé-d-i.
 Ahmet Aygül-ACC you bread eat-PST.INDIR-2SG say-PST-3
 “Ahmet said of Aygul, you ate bread.”
- b. Ahmet méni [(siz) nan ye-p-siz] dé-d-i.
 Ahmet I.ACC you bread eat-PST.INDIR-2 say-PST-3
 “Ahmet said of me, you ate bread.”
- c. Men [peqet öz-em-ni-la (men) nan ye-y-men]
 I only self-1SG.POSS-ACC-ONLY I bread eat-NONPST-1SG
 dé-d-im.
 say-PST-1SG
 “I said only of myself, I will eat bread.”

I introduce a detailed breakdown of why the cases in (364) are actually instances of prolepsis below, but for the present wish to point to a few important issues. First, in these examples, the accusative element does not actually control agreement. These examples

nominals in Noun-Noun constructions (e.g. *eptiday-i jemiyat* ‘origin-3 society’), which happens to be homophonous with the 3rd person form.

One potential solution to this puzzle would be to assume Moore (1998)’s analysis of Turkish, which argues that the tail of the chain created by raising is *pro*. An additional stipulation would be necessary; namely, that *pro* bears 3rd person features, despite the fact that the raised subject bears distinct phi-features. An alternative would be to treat the default, 3rd person morpheme as a morphological requirement as opposed to a syntactic object. A claim of this sort would essentially look like the mirror image of L-insertion in Arregi and Nevins (2012), where a default morpheme is inserted to prevent T^o occurring initially. Thinking in these terms, the Uyghur 3rd person agreement marker would essentially result in preventing T-finality.

¹³I changed the embedded tense, the translation, and inserted the optional nominal pronominal subject. The tense was changed strictly because it is more natural for speakers.

show a 3rd person subject (190a) and 1st person (190b) accusative argument controlling 2nd person agreement on the embedded verb. The third example uninterestingly shows a 1st person accusative element occurring with 1st person agreement, but the availability of a nominative pronoun suggests this case, in addition to the other examples are instances of (resumptive) prolepsis.

Given that Uyghur exhibits both raising and prolepsis as options, it is necessary that the relevant controls be applied to each new construction - either the NCI licensing or idiom test. The cases in (191) involve prolepsis.

- (191) a. Mahinur héchqaysi-miz-ni (siz) nan ye-p-siz
 Mahinur no.which-1PL.POSS-ACC you bread eat-PST.INDIR
 dé-mi-d-i.
 say-NEG-PST-3
 “Mahinur didn’t say of any of us, you ate bread.”
- b. * Mahinur héchqaysi-miz-ni nan y’e-me-p-siz dé-d-i.
 Mahinur no.which-1PL.POSS-ACC bread eat-NEG-PST.INDIR-2SG say-PST-3
 Intended: “Mahinur said of none of us, you ate bread.”

The NCI in this construction can be licensed by negation of the matrix verb (366a), but not the embedded verb (366b). Notice that the NCI subject in (191a) occurs with 2SG agreement on the embedded verb. In this case, the NCI subject is licensed by negation on the matrix verb. The fact that the NCI subject is not licensed by embedded negation in (191b) suggests that this argument is proleptic (i.e. merged outside the embedded clause). This is likely due to *pro* shifting to meet the aboutness requirements of prolepsis (i.e. proleptic objects must correspond to a resumptive element in the embedded clause).

This contrasts with (192), which illustrates that the this NCI is licensed by embedded negation as long as the embedded verb bears 3rd person agreement.

- (192) Mahinur héchqaysi-miz-ni nan yé-me-p-tu dé-d-i.
 Mahinur no.which-1PL-ACC bread eat-NEG-PST.INDIR-3SG say-PST-3
 “Mahinur said none of us ate ate bread.”

3.3.4 Agreement correlates with clause size

The central aspect of the finiteness distinction discussed throughout this section is critical moving forward. I make the assumption that T° inherits its features from C° (Chomsky, 2004, 2008). Given this assumption, it comes as no surprise that a structural reduction in the C-domain could be responsible for default (or defective) agreement, as we find with accusative subjects, while a full left periphery could give rise to full agreement. Thus, even though we see tense and evidentiality in these clauses, suggesting they are rather large, it is the dominating C-domain that determines the case/agreement facts, as shown in (193).¹⁴

- (193) a. Tursun méni ket-t-i/két-ip-tu dé-d-i.
Tursun I.ACC leave-PST-3/PST.INDIR-3 say-PST.3
“Tursun said that $I_{Speaker}$ left.”
- b. Tursun men ket-t-im/két-ipti-men dé-d-i.
Tursun I.NOM leave-PST-1SG/PST.INDIR-1SG say-PST-3
“Tursun said that I_{Tursun} left.”

Assuming the presence of a monstrous operator as evidence for a full C-domain in cases like (193b), it is unsurprising that we find full agreement on/in the T domain in conjunction with indexical shift. Similarly, if the absence of the monster (and thus lack of shift) is evidence for a reduced clause, we can reasonably explain the unavailability of nominative case and the lack of full agreement.¹⁵ In following with the raising literature in better studied languages, the status of these clauses as being non-finite and structurally reduced, has the unsurprising effect of exceptional case being licensed and raising permitted.

¹⁴See Korotkova (2021) for relevant discussion of clause size and evidentiality in Turkish.

¹⁵It is possible that the C-layer is entirely absent, but because the clause hosts tense, evidentiality, and agreement, it seems less controversial to treat this structure as a CP without an overt complementizer. Nothing hinges on this choice, as assuming the absence of the C-domain equally correlates with non-finiteness based on the logic presented here. Furthermore, an anonymous reviewer compares this data to Sakha, where it is argued that the accusative never escapes the embedded CP. If this were in fact proven for Uyghur (there is no evidence currently), the present analysis as it relates to indexical shift could simply be recast as a ban on raising over the context-shifting operator.

3.3.5 Analysis

At this point, I have illustrated the following: i) monsters and accusative embedded subjects are in complementary distribution (i.e. indexical shift and accusative subjects are in complementary distribution), ii) accusative embedded subjects only raise out of clauses with default agreement, and iii) accusative embedded subjects are more local to matrix subjects than nominative embedded subjects. Having identified these properties, this raises the question of how or if they can be accounted for under a unified analysis. Throughout the rest of this section, I discuss some analytical directions that account for the full range of data. Regardless of the analysis we adopt moving forward, the one fact that indisputably needs to be accounted for is that the “monstrous” operator and accusative subjects are in complementary distribution.

3.3.5.1 “Finiteness” and Raising

One option involves linking these phenomena directly to finiteness/non-finiteness and Subject to Object raising in languages like English. Under this analysis, T° inherits features from C° , meaning that a defective C° is incapable of transferring features to T° (Chomsky, 2004, 2008). Thus if we make the assumption that case, person/number, and EPP features in tensed embedded clauses are dependent on a full CP, the lack of nominative case and prohibition on movement and defective (default, 3rd person) agreement are predicted. Although the option of an overt complementizer is not available, we can still point to the presence of the monstrous operator (diagnosable by indexical shift) as evidence for a full C(P). Therefore, it is only in environments where the monster merges into the structure that T° inherits case, EPP, and ϕ features (i.e. allows for a nominative subject and triggers full agreement on the embedded verb), which is precisely what the facts show.

(194) *No indexical shift*

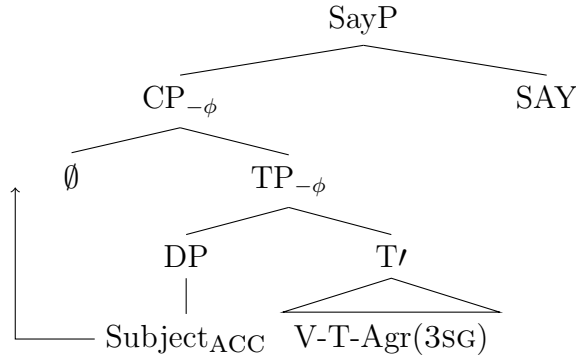

The proposal in (194) suggests the absence of the monster leads to obligatory raising of the embedded subject, accusative case, and default agreement on the embedded verb. I maintain that this finiteness distinction, however we formally account for it, should be maintained to explain the (in)ability to raise.

By this logic, we should expect to find structures where the matrix clause lacks a *v* phase, in which case T is able to agree with the embedded subject without violating the PIC. If we assume passivization eliminates the *v* phase boundary in the matrix clause, it would follow that a defective clause should be accessible to T. This is precisely what we find in (195)

- (195) a. Sen manga kél-i-du dé-yil-d-ing.
 2SG 1SG.DAT come-NONPST-3 say-PASS-PST-2SG
 “It was said to me that you would leave.”
- b. *Sen manga kél-i-du dé-yil-d-i.
 2SG 1SG.DAT come-NONPST-3 say-PASS-PST-3
 “It was said to me that you would leave.”

When the embedded verb shows default agreement and the matrix verb is passivized, the embedded subject can be promoted to subject and obligatorily triggers agreement on T, as shown in (195a)-(195b). This is strongly suggestive that the ability for a matrix head to Agree with an element in the embedded clause is directly correlated with the ability for the embedded verb to show agreement.

3.3.5.2 Case-driven movement

The finiteness distinction discussed above predicts that raising should be possible iff the monster does not merge. However, movement is obligatory and this needs to be formally motivated. If we make the assumption that accusative case licensing is mediated by an Agree and attract relationship between a probe v° and the closest active NP in its c-command domain, it would follow that the embedded subject would raise into Spec, vP as the result of an EPP feature on v° . This is represented in (196).¹⁶

(196) *No indexical shift*

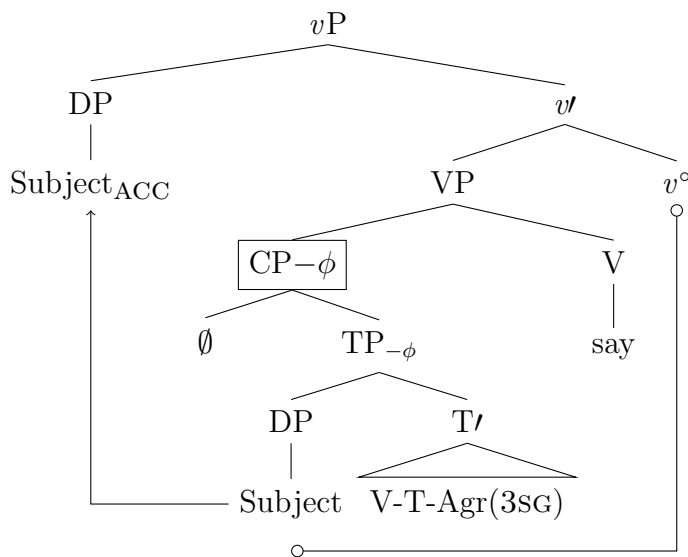

Given the reduced size of the embedded clause (lack of monster), T° is unable to assign nominative case and is defective for agreement. As a result, the subject remains without case. For this reason, the embedded subject remains active for Agree, enters into an Agree relation with the matrix v° , from which it gets accusative case and raises into the specifier position.

Furthermore, we must also block Agreement between v° and the embedded subject when

¹⁶The extent to which the ban against raising out of finite clauses is illicit is questionable given recent work on so-called *hyperraising*, where a number of languages allow raising out of finite clauses. A number of analyses unrelated to indexical shift have been proposed to account for these scenarios, but a deeper discussion is outside the scope of this paper. For more details, see Martins and Nunes (2005, 2010); Ferreira (2009); Zeller (2006); Carstens (2010, 2011); Deal (2017); Diercks (2012); Halpert (2012); Zyman (2017).

the monster is merged into the left periphery of the embedded clause. One way of accomplishing this would be to resort to the Activity Condition Chomsky (2001), as defined in (197).

- (197) **Activity Condition:** A goal must be active (i.e. bear some unvalued feature, e.g. Case) to be a valid target for Agree. (Asarina, 2011:17)

If we adopt the Activity Condition, we can argue that when the monster is present and C° is not defective, T° inherits the relevant features and assigns nominative case to the embedded subject. As a result of nominative assignment, the subject is no longer active for further Agree (at least as it relates to case), and thus Agreement with v° and subsequent raising and accusative assignment are prohibited.

However, there are reasons that we may not want to take this route. In particular, Asarina (2011) provides convincing argumentation that the Activity Condition is insufficient to account for a range of constructions in Uyghur (and beyond). Focusing more on genitive constructions and raising, Asarina manages to account for raising (and lack of raising) with the Phase Impenetrability Condition, as opposed to the Activity Condition, which is defined in (198).

- (198) **Chomsky's (2001) Phase Impenetrability Condition (PIC_{weak}):** In phase α with head H, the domain of H is accessible to operations outside α only until the next (strong) phase head is merged.

If we assume the monstrous operator to be a strong phase head, while the complementizer in accusative constructions is either non-existent or weak, we can account for the ban on raising, as it renders the clause embedded under it inaccessible. When the monster is not merged, it signifies that the clause is truncated (i.e. there is no strong phase head merged), which leads to default agreement and eliminates the ability for nominative case to be assigned. As a result, v° probes into its complement and finds the closest DP (the subject), which it attracts into its specifier, assigning it accusative case in the process, which is fully

in line with Chomsky (2000)'s analysis of accusative assignment. This gives rise to the same effect, by which raising and accusative licensing are banned when the monster is merged into the structure.

3.3.6 Accusative subjects and the lexical status of monsters

One final discussion is in order related to one of the main contributions of S&S's analysis, which is whether Uyghur provides syntactic evidence for the presence and position of a monster in the first place. Under S&S, it is obligatory that the monster be an independent lexical item (Anand and Nevins, 2004), because the landing site for accusative subjects intervenes between the attitude verb and the position where the monster takes scope. For this reason, they reject the possibility that indexical shift is a property of the attitude verb, which is directly responsible for quantifying over contexts, as argued for in Schlenker (1999, 2003). I have demonstrated that the monster and accusative subjects are in complementary distribution, which at first glance reopens the possibility that the mechanism responsible for indexical shift is built into the attitude verb itself; however, there are numerous reasons to maintain the presence of an operator present in the syntax, as I outline below.

The generalization that was motivated in this paper is that monsters and accusative subjects never co-occur. Given that accusative subjects seem to involve A-movement that cannot occur across monsters, it follows that a syntactic explanation is in order. Given the correlation between the monster and clause size, it follows that additional functional structure is present when shift takes place, as schematized in (199).

- (199) a. Tursun [méni_i [_{CP- ϕ} \emptyset [_{TP} ~~men~~_i ket-ti]]] dé-d-i.
 b. * Tursun [méni_i [_{CP+ ϕ} $\hat{\omega}$ [_{TP} ~~men~~_i ket-ti-m]]] dé-d-i.

The operator approach involves a syntactic element that when merged gives rise to additional functional structure and yields various morpho-syntactic consequences (case and agreement effects). If we consider the difference between shift/no-shift without an operator, the differences arise from the properties of the binder of the context variable associated with

the attitude verb.

- (200) a. λc Tursun say [c ...]
b. λc Tursun say $\lambda c'$ [c' ...]

Although Schlenker does not use lambda notation in his initial proposal, the gist of his analysis is outlined in (200), where indexical shift is conditioned by whether the context variable in the embedded clause is bound by the matrix clause (200a) or the embedded clause (200b). It seems more likely that clause size and A-dependencies would be conditioned by the presence or absence of an operator in the left periphery than whether the binder of the embedded context variable is identical to the matrix binder.¹⁷ However, under the operator approach, the presence of an independent lexical operator (the monster in this case) requires more left peripheral structure, which is directly in parallel with the role of the complementizer in finite versus non-finite clauses in English.

Another reason to assume that the monster is an independent lexical item is that it appears that indexical shift or its absence involves selection. In other words, either an accusative argument or the monster is selected, but never both. Recall that I argue that all accusative arguments get case in the same position. Notice in (201) that the nominalized embedded clause does not allow indexical shift (the structure is adapted from Asarina (2011)).

- (201) Tursun [_{CP} [_{AspP} mén-ing ket-ken]-lik]- \emptyset -im-ni dé-di.
Tursun I-GEN leave-PERF-COMP-NOUN-1SG.POSS-ACC say-PST.3
“Tursun said that I_{Speaker}/*Tursun left.”

Asarina argues that Uyghur nominalizations are essentially noun complement constructions, which can, but generally do not contain overt nouns. The crucial point here is that the CP is selected by a noun that is generally null, not by the attitude verb itself. Verbs

¹⁷Technically speaking, one could make the argument that the embedded clause in (200b) is larger, given the presence of the local binder, giving rise to a similar finiteness/clause size distinction discussed throughout this paper, but I am unaware of any parallels with e.g. worlds that would give rise to meaningful case/movement distinctions in the syntax.

that take clausal complements select for nominalizations that bear particular case-marking, such as (202), where *ishin-* selects a dative complement.

- (202) Tursun Ali-ning ket-ken-lik-i-ge/*ni ishin-i-du.
 Tursun Ali-GEN leave-PERF-COMP-3-DAT/ACC believe-NONPST-3
 “Tursun believes that Ali left”

Now let’s consider the main verb *de-* “say” with a nominalized complement clause. If indexical shift were triggered inside the speech verb *de-* “say”, there is no reason that the 1st person subject in the embedded clause in (203) should not shift, contrary to fact.

- (203) Tursun (* $\overset{\circ}{\underset{\circ}{\text{w}}}$) [_{CP} mén-ing ket-ken-lik]- \emptyset -im-*(ni) dé-d-i.
 Tursun Op I-GEN leave-PART-COMP-NOUN-1SG.POSS-ACC say-PST-3
 Intended: “Tursun said that I_{Tursun} left.”

If we take the clausal accusative case marker to be licensed by the same source as accusative subjects, it would then follow that the monster cannot be selected if an accusative nominalization is selected. This is precisely what we see in (203). If it were simply an issue of binding, there is no straightforward semantic reason why there would be no context variable in the embedded clause that would show the same optionality as with tensed embedded clauses. Under this analysis, it is the operator that is only compatible with a tensed embedded clause, which is the only environment where indexical shift can take place.

3.3.7 Implications for the typology of indexical shift

This section has shown that the alternation between indexical shift and raising-to-object is not accidental. In other words, “say” can select a full CP (containing the monster) or a reduced CP (forces raising-to-object), which explains the resulting interpretation, in addition to case/agreement.

These findings are entirely in line with the discussion in Deal (2020) who establishes a link between indexical shift and clause size. An important next step is to determine the extent to which the present analysis of Uyghur informs analyses of related languages, such as: Mishar

Tatar (Podobryaev, 2014), Kazan Tatar (personal fieldwork) and Turkish (Şener and Şener, 2011; Özyıldız, 2012), in addition to all of the other languages discussed in Deal (2020). In Turkish, for instance, nominative subjects with agreeing embedded verbs do not obligatorily trigger indexical shift. This means that Turkish has a non-defective embedded clause type that is not dominated by the monster (unlike Uyghur), which definitely requires further research. However, it should be noted that all of these languages have raising constructions with accusative embedded subjects¹⁸ that strictly do not allow indexical shift. For instance, shift is banned for Turkish in (204a).

- (204) a. Ali beni git-ti/m de-di.
 Ali I.ACC leave-PST.3/1SG say-PST.3
 “Ali said that I_{Speaker/*Ali} left.”
- b. Ali ben git-ti-m de-di.
 Ali I leave-PST-1SG say-PST.3
 “Ali said that I_{Speaker/Ali} left.” (Özyıldız, p.c.)

The analysis in this paper applies straightforwardly to account for the ban on shifting with accusative subjects in (204a) and the option of indexical shift in (204b). The difference between Uyghur and Turkish is that Turkish allows a full CP to be embedded under “say” without an operator in the left periphery, making shift optional, despite the subject receiving nominative case and triggering agreement on the embedded verb.

3.4 More on NECs and TECs

There are two final issues I discuss here. The first has to do with the relationship between NECs and TECs. Notice that the simple copular construction provided in (205a) can be embedded under “say”. Like subjects of all TECs, the subject of the TEC can raise and get accusative case (205b). The nominal predicate remains in its base position adjacent to the verb.

¹⁸ECM constructions also exist in Sakha (Baker and Vinokurova, 2010), another Turkic language, but indexical shift is not discussed.

- (205) a. Éghwa xewer (idi).
 rumor news AUX.PST
 “The rumor is/was news.”
- b. Mahinur éghwa-(ni) xewer (idi) dé-d-i.
 Mahinur rumor-ACC news AUX.PST say-PST-3
 “Mahinur said (the salient) rumor is/was news.”

In a similar vein, there are environments where an NEC and a TEC can co-occur (205b).¹⁹

- (206) Mahinur manga [Hesen-ning ket-ken-lik-i-ni] Hüsen-(*ni)
 Mahinur 1SG.DAT Hesen-GEN leave-PTPL.PST-COMP-3-ACC
 ket-t-i dé-d-i.
 Hüsen-ACC leave-PST-3 say-PST-3
 “Mahinur said (of) Hesen’s leaving that Hüsen left.”

In this case, it is clear that the NEC fills the accusative position, which prohibits the subject of the TEC from raising - this follows naturally from the fact that the nominalization is the closest NP to *v*.²⁰

Similar to standard NEC constructions under passivization, when these constructions are passivized, the NEC is promoted to subject and loses accusative case, while the TEC remains in its base position.

- (207) Hesen-ning ket-ken-lik-i-(*ni) manga Hüsen-(*ni) ket-t-i
 Hesen-GEN leave-PTPL.PST-COMP-3-ACC 1SG.DAT Hüsen-ACC leave-PST-3
 dé-yil-d-i.
 say-PST-3
 “It was said (of) Hesen leaving that Husen left.”

As was the case for subjects of TECs, under passivization, the NEC is promoted to subject. This would be compatible with an analysis by which the NEC is the subject of a

¹⁹Similar data has been reported in Buryat (Bondarenko, 2019) and Turkish (Özyıldız, 2017). See these papers for a semantic analysis of these constructions.

²⁰Hesen and Hüsen are common names for twins among Uyghurs. This makes the sentence natural without any further context, because the possibility of the agent’s identity being mistaken is inherently natural.

small clause in (206) and (207), whose predicate is the TEC “Husen left”, similar to the relationship between the subject and predicate in (205b).

If this were the case, it seems plausible or at least worth exploring whether NECs always occur with a (usually silent predicate). In the same vein, it would be interesting whether there is an implied nominal when there is a TEC without an accusative argument in the structure. Furthermore, it’s possible that these constructions are actually proleptic, in which case they would be uninformative as it relates to the derivation of NECs.

3.5 Conclusions

This chapter has argued that Uyghur “say” exhibits a stativity/eventivity alternation that is highly reminiscent of English. This contrast arises not from “say” being lexically ambiguous, but instead from VP-external structure.

I assume the base structure for all *de-* “say” constructions to be minimally a source/holder and a LM argument, as shown in (208). The subject of SAY is interpreted as a source/holder only when SayP is complement to v_{Be} . These constructions do not allow a nominal internal argument, a Goal, manner modification, or agent modifiers.

(208)

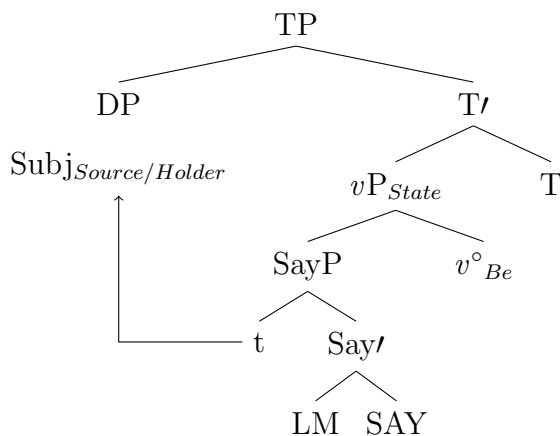

Say_{Agent} constructions share the same base structure, but involve an agentive *v* and a Voice projection. These constructions are interpreted as activity predicates with an agent, which can include a Goal, manner/event modification, and are compatible with a DP internal

argument, which can receive accusative case (209).

(209)

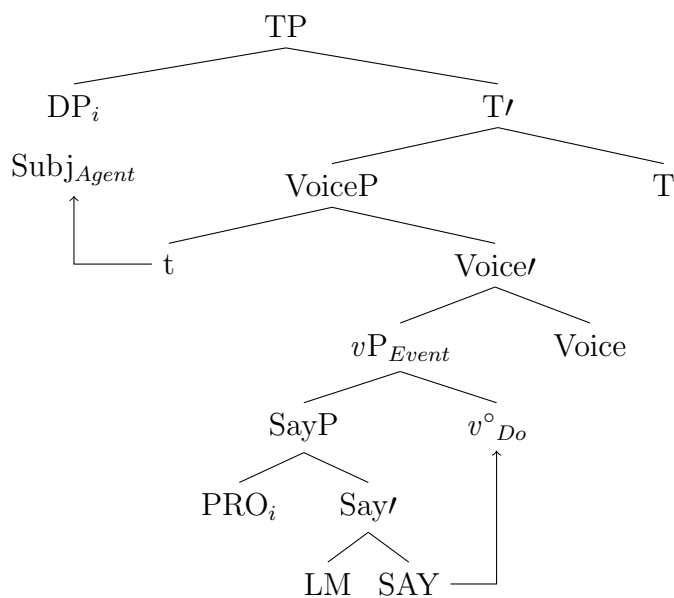

Within the class of *say_{Agent}* constructions, the LM argument can be expressed in many different ways. If it is an NP or a TEC, it can pseudo-incorporate into the verb and remain in its merge position. If it is an NEC or a specific NP, it is attracted into spec *vP*, where it gets accusative case.

Again, if we assume that “say” uniquely introduces LM arguments, Uyghur offers us important insights into what is possible within a LM. More specifically, in addition to allowing direct quotation, the initial diagnostic for LM-hood, Uyghur allows indexical shift in precisely the same environments. In this way, Uyghur allows “say” to introduce LMNs, defective clauses that trigger Raising-to-Object (accusative subjects), Full CPs that behave like root clauses, which host an operator (indexical shift or direct quotation). Furthermore, like with English, the main verb “say” is able to license its LM argument in-situ, as was suggested for English.

CHAPTER 4

Converbial “say” clauses in Uyghur

4.1 Introduction

The previous chapter offered an in-depth look into the argument and event structure of *de*-“say”, with considerable emphasis on the types of LM arguments and their properties. This chapter offers an analysis of *dep* clauses. First, all properties discussed in the Chapter 3 now serve as diagnostics with respect to whether *de*-“say” is present in *dep*. This is because we have now answered research question (i) from the introduction. We are now able to move on to questions (ii)-(iii):

- (i) What are the morpho-syntactic and semantic properties of the verb “say”?
- (ii) What are the morpho-syntactic and semantic properties of multiple verb constructions (e.g. serial verb constructions, converbial constructions)?
- (iii) Do “say” complementation structures exhibit the properties of “say” in a serialization structure?

This chapter first addresses question (ii) and then moves on to question (iii). If we are to take the morphology of *dep* seriously, we should find that the syntax of *-(I)p* offers more insight into the distribution of *dep* clauses than treating *dep* clauses as equivalent to “that clauses”.

4.1.1 Preliminary reasons that *dep* is not “that”

Based on translations and simple examples, it is unsurprising that one would conclude that *dep* is equivalent to “that”. For instance, one could assume that the primary difference between (210a) and (210b) is simply related to word order (i.e. Uyghur being head-final).

- (210) a. Kayla [thinks [**that** Alex left]].
b. Mahinur Tursun-(ni) ket-t-i **de-p** oyla-y-du.
Mahinur Tursun-ACC leave-PST-3 say-CNV think-NONPST-3
“Mahinur thinks Tursun left.”

However, there are many reasons to go beyond translational equivalence. The first is that *dep* appears in many environments, where “that” clauses do not occur in English. For instance, *dep* is used in sequential constructions to mean “say, and then/while” (211a), in constructions resembling reason clauses (211b)-(211c), and naming constructions (211d).

- (211) a. Mahinur Tursun-gha yaxshimusiz de-p ket-t-i.
Mahinur Tursun-DAT hello say-CNV leave-PST-3
“Mahinur said, ‘hello’ to Tursun and left/while leaving.”
b. Mahinur Tursun-ni kél-i-du **de-p** ket-t-i.
Mahinur Tursun-ACC come-NONPST-3 say-CNV leave-PST-3
“Mahinur said Tursun will come and left.”
“Mahinur left, saying that Tursun will come.”
c. Mahinur Tursun-ni **de-p** ket-t-i.
Mahinur Tursun-ACC say-CNV leave-PST-3
“Mahinur left, having mentioned Tursun.”
d. Mahinur oghl-i-gha Tursun **de-p** isim qoy-d-i.
Mahinur son-3POSS-DAT Tursun say-CNV name put-PST-3
“Mahinur gave her son the name Tursun.”

Each of the cases above lack a “that” clause equivalent in English. Distributionally speaking, “say” clauses have been shown to pattern differently from simple “that” CPs across many typologically unrelated languages (e.g. Lord, 1976; Munro, 1982; Lord, 1993;

Bayer, 1999; Chappell, 2008; Güldemann, 2008; Balusu, 2020). Every language that I have investigated has “say” clauses, also has a designated grammatical strategy for constructing complex predicates. Given that we cannot simply apply our analysis of English “that” CPs to account for the distribution above, my null hypothesis is that the distributional properties in (211) above are conditioned by converbial *-(I)p*. Much of this chapter builds upon Sugar (2019), who offers the most expansive description and analysis of *-(I)p* constructions to date.

4.1.2 What is *-(I)p*?

Sugar (2019) introduces four distinct “types” of *-(I)p* construction, each of which are argued to involve slightly different syntactic structures, provided in (212).

- (212) a. Ahmat métal-ni ur-up tüzli-wet-t-i.
 Ahmat metal-ACC pound-CNV flatten-COMPL-PST-3
 “Ahmat pounded the metal flat (flattened by pounding).”
 (Sugar, 2019:14, ex: 1)
- b. Ular meydan-da putbol oyna-p yataq-qa qayt-t-i.
 they field-LOC soccer play-CNV dorm-DAT return-PST-3
 “They played soccer on the field, and came back to the dorm.”
 (Sugar, 2019:14, ex: 2)
- c. Qar yégh-ip shamal chiq-ip jahan muzli-d-i.
 snow precipitate-CNV wind rise-CNV world freeze-PST-3
 “The snow fell, the wind picked up, and the world froze.”
 (Sugar, 2019:15, ex: 3)
- d. Tursun öy-i-ge pat-pat xet yéz-ip tur-i-du.
 Tursun home-3POSS-DAT often letter send-CNV stand-NPST-3
 “Tursun often write letters home.”
 (Sugar, 2019:15, ex: 4)

Sugar argues that each of the cases above involves a slightly different syntactic structure, which vary in terms of clause size, height of merge, and event structure. I incorporate many of Sugar’s intuitions into the present analysis, but propose a number of non-trivial

modifications.

In cases like (212a), I follow Sugar in assuming that the merge site of the $-(I)p$ clause is at VP/ v P level, while the cases in (212b)-(212c) involve $-(I)p$ merging higher in the structure. However, I suggest that both of these cases involve the same general syntax (c.f. Sugar, 2019). In other words, I suggest that $-(I)p$ clauses are adverbial modifiers that can merge into two distinct places: VP and TP. I suggest that a combination of the height at which $-(I)p$ merges and various pragmatic factors; namely, discourse coherence, play a crucial role in determining felicity or grammaticality.

For purposes of this chapter, I set aside verbal light verb constructions, such as (212d) - I refer the reader to Bridges (2008) and Sugar (2019) for further discussion.

4.1.3 Events, $-(I)p$, and discourse coherence

For expository purposes, I first establish some basic assumptions and terminology related to events before I move into the analysis. My focus in this chapter is not so much on the status of events themselves, but describing particular kinds of relations between events is part of the present goal. As described in Chapter 1, I assume a direct relationship between the syntax and event structure (e.g. Borer, 1994, 2003; Rosen, 1999; Ramchand, 2008; Travis, 2010).

In this chapter, I discuss complex predicates that are composed of at least two subevents. For the sake of comparison, consider causative constructions, for instance. Causatives involve a causative subevent and a stative subevent. In (213), there is a “pumping up the boat” subevent that causes the result state of “the boat is inflated”..

(213) Katie pumped up the boat.

Turning to Uyghur, causatives like (213) are formed via a causative morpheme ($-(I)t$ below), which indicates that the relationship between the the event whose agent is Mahinur, and the result state of “I am angry” is one of causation (214).

- (214) Mahinur méni renj-**it**-t-i.
 Mahinur 1SG.ACC angry-CAUSE-PST-3
 “Mahinur made me angry.”

There are many morphological structures that directly encode unambiguously what the event structure is, like the case of causatives above. However, I argue that there are also morphemes that are underspecified with respect to the how they relate to event structure. The primary focus of this chapter, *-(I)p*, is one such case..

This suffix plays a crucial role in linking events (and sometimes propositions), but does not encode explicitly which relationship holds of the constituents it links. Instead, it is compatible with a wide range of relationships, which I suggest are determined by pragmatics. However, the syntax and LF play an important role in constraining the types of relationships established by *-(I)p* in each relevant environment.

4.1.4 Discourse Coherence

For present purpose, I find the set of discourse coherence relations described in Kehler (2002) to function as a valuable starting point for understanding what kinds of relations we find between constituents linked by *-(I)p*. The set of coherence relations include: *Resemblance*, *Cause-effect*, and *Contiguity*. I do not offer the formalizations introduced by Kehler here; instead, I introduce some examples of each to establish the general intuitions behind *-(I)p* and what it does.¹ Furthermore, within the categories mentioned above, I describe only those most directly relevant to *-(I)p* constructions.

First, Kehler states that the canonical instance of a Resemblance relation is *Parallel*, an example of which is shown in (215):

- (215) Dick Gephardt organized rallies for Gore, and Tom Daschle distributed pamphlets
 for him. (Kehler, 2002:p 16, ex: (21))

¹For those interested in the formalizations, I direct the reader to Kehler’s work directly.

The parallel arguments in these two clauses include “organized rallies for” and “distributed pamphlets for”, in which case the relation between might be understood as “do something to support”.

Another possible relation is a *Contrast* relation, as exemplified in (216), which is intuitively a situation where the contrasting relation can be construed as “the candidate each entity supports”.

(216) Gephardt supported Gore, but Arney supported Bush.(Kehler, 2002:p 16, ex: (22))

Moving on to *Cause-Effect* Relations, the most common is *Result*, as exemplified in (217).

(217) George is a politician, and therefore he’s dishonest.(Kehler, 2002:p 20, ex: (32))

The relevant relationship here is related to the association between “politician” and “being dishonest”, where the latter is interpreted as the result of the former.

The final relationship is *Contiguity*, for which only one type, *Occasion*, is provided. This is exemplified in (218a).

- (218) a. George picked up the speech. He began to read.
b. A flashy-looking campaign bus arrived in Iowa. Soon afterward, George W. Bush gave his first speech of the primary season.

Occasions are introduced less formally than the other relations, because they are the trickiest to define or narrow down.

4.1.5 Discourse coherence and *-(I)p*

Turning to Uyghur *-(I)p*, it is worth briefly demonstrating what the discourse coherence relations introduced above actually accomplishes for us. Consider the case in (219), for instance. There are three clauses with a shared subject, which include: “going to school”, “attending class”, and “returning”.

- (219) Mahinur mektep-ke bér-ip, ders-ke qatnish-ip, qayt-t-i.
 Mahinur school-DAT go-CNV class-DAT attend-CNV return-PST-3
 “Mahinur went to school, attended class, and returned.”

If we assume for a moment that each $-(I)p$ enforces that there be a discourse link between the clauses, we can evaluate each juncture through the lens of discourse coherence. For instance, Mahinur “going to school” makes it possible for her to attend class, which bears the hallmarks of a *Cause-Result* relationship. Furthermore, the combination of “going to school” and “attending class” make it possible for Mahinur to “return”, which is indicative of the same type of relationship.

Let’s turn to a case where the subevents are a bit more tightly linked, such as (220).

- (220) Abliz su-ni qayni-t-ip tash-tur-iwet-t-i.
 Abliz water-ACC boil-CAUS-IP overflow-CAUS-COMPL-PST-3
 “Abliz made the water overflow, by boiling it.” (Adapted from Sugar, 2019: p. 105, ex:224)

Notice in (220), that there are two events associated with Abliz: “he boiled the water” and “he caused the water to overflow”. At first glance, this looks like a clear causative construction, but notice that “overflow” does not bear stative morphology. Both “boil” and “overflow” are transitive verbs, capable of independently introducing an Agent (“Abliz”) and a Theme (“water”) in (221).

- (221) a. Abliz su-ni qayna-t-t-i.
 Abliz water-ACC boil-CAUS-PST-3
 “Abliz boiled the water.”
 b. Abliz su-ni tash-tur-iwet-t-i.
 Abliz water-ACC overflow-CAUS-COMPL-PST-3
 “Abliz made the water overflow.”

Thus when these two events combine in (220), I suggest there is no element enforcing the *Cause-Result* relationship, unlike the case for morphological causatives like (214). Instead, I suggest that any of the discourse coherence relations discussed above are possible, but

the two predicates and syntactic position are likely to favor a particular relationship. As mentioned above, the most natural reading for (220) is that the boiling caused the overflow, but this utterance is also compatible with a scenario where Abliz dropped something into the water he was boiling, which is responsible for the overflow. The point being that the relationship indicated by $-(I)p$ is not fixed, but rather variable depending on context. The non-causal reading mentioned above is likely best construed as the *Contiguity* relationship described by Kehler.

To offer a case where the relationship between the clauses is most naturally the *Occasion* reading, consider (222).

- (222) Mahinur kitab oqu-p polu yé-d-i.
 Mahinur book read-CNV pilaf eat-PST-3
 “Mahinur read a book and ate pilaf.”

With enough creativity, one could come to a causal relationship between “reading a book” and “eating pilaf”, but under normal circumstances this is impossible. Thus to the extent possible, speakers accommodate this by assuming an the *Occasion* reading. This relation is largely spatio-temporal in nature, but further could be described as “things Mahinur did at a particular time in a particular place”. A general rule of thumb is that speakers generally try to establish the strongest possible relationship.

One final note before moving on, it is worth introducing an explicit contrast between an “infelicitous” $-(I)p$ construction and a correction to drive this point home. Consider the infelicitous case in (223a) and its felicitous counterpart in (223b).

- (223) a. # Mahinur nan yéq-ip, Tursun polu et-t-i.
 Mahinur bread bake-CNV Tursun pilaf make-PST-3
 “Mahinur baked bread and Tursun made pilaf.”
- b. Mahinur nan yéq-ip, Tursun polu ét-ip, ular yé-d-i.
 Mahinur bread bake-CNV Tursun pilaf make-CNV, they eat-PST-3
 “Mahinur baked bread, Tursun made pilaf, and they ate it.”

In weird cooking, “Mahinur made bread” and “Tursun made pilaf” are linked together

with $-(I)p$, which is almost universally rejected out of the blue. Speaker intuitions reflect that these two events are hard to relate to one another. However, by adding the 3rd clause, “they ate (it)”, speakers universally accept it out of the blue. I suggest the reason is that the third offers a clear link between the first two clauses, which could either be construed as a *Cause-Result* relationship, or a *Contiguity* relation. ²

4.1.6 Preview of Analysis

The first goal of this chapter is to discuss the morpho-syntactic and semantic properties of $-(I)p$ across two of its uses. For the two merge sites of $-(I)p$, I propose that there is a corresponding *dep* construction. More specifically, I show that $-(I)p$ can merge at either VP or TP and suggest the same is true for *dep*.

When $-(I)p$ merges at the VP level, it takes a VoiceP as its complement and merges as an adverbial modifier. The main verb is always the one that bears Voice, TAM, and agreement morphology. I propose that the analysis for both cases in (224) involve the same syntactic structure, as illustrated in (225)

- (224) a. Ahmat métal-ni ur-up tüzli-wet-t-i.
 Ahmat metal-ACC pound-CNV flatten-COMPL-PST-3
 “Ahmat pounded and flattened the metal.”
- b. Ahmat Tursun-(ni) ket-t-i de-p warqiri-d-i.
 Ahmat Tursun-ACC leave-PST-3 say-CNV scream-PST-3
 “Yesterday Ahmat screamed, saying Tursun left.”

²These intuitions largely overlap with Barany and Nikolaeva (To Appear)’s analysis of Turkic converbial constructions, where they assume that the relevant restriction is that clauses linked by $-(I)p$ identify the same Topic situation, building upon McKenzie (2012)’s analysis of Switch Reference constructions. This could potentially work, but they do not introduce a detailed formal analysis.

(225)

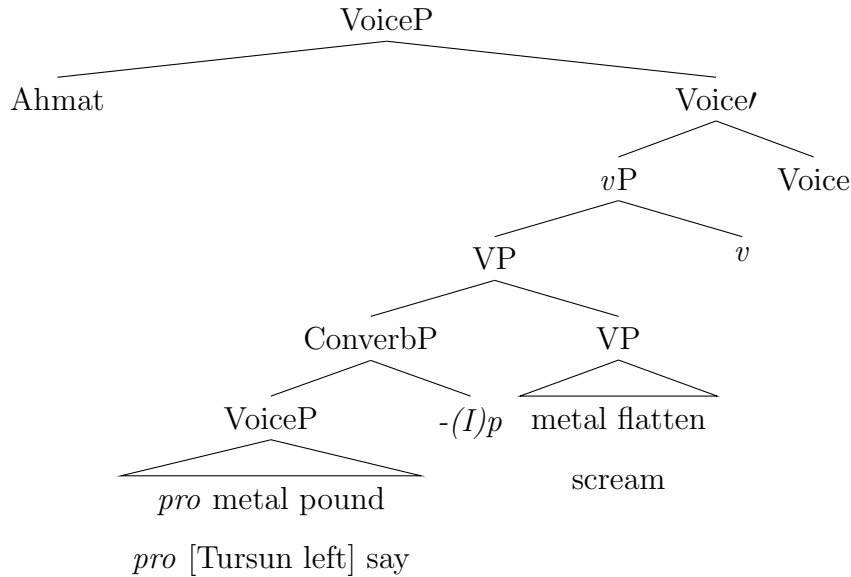

In (225), the $-(I)p$ clause functions as a VP modifier in the same region of the clause as manner adverbs and directed motion modifiers. For this reason, $-(I)p$ clauses that merge in this region must be construable as modifiers of these types. Further restriction comes from the fact that the entire verbal complex is embedded under the same TAM morphology; in other words, the modifier is subject to the same spatio-temporal and aspectual specifications as the main VP that it modifies. In this way, I suggest that “pounding” is the manner in which the “flattening” was done in (224a), “saying Tursun left” is the way that Ahmat “screamed” in (224b).

The other relevant $-(I)p$ construction merges at the TP level, which generally relates clauses. There is only a single inflection for Tense in these constructions, which forces the modifier to be related spatio-temporally to the main clause. However, because a spatio-temporal and topical link is sufficient, much looser relationships are observed in these contexts. An example of this is shown in (226a), which involves two events: “Mahinur doing makeup” and “her cheeks reddening”. I suggest that this same structure is involved in “reason” *dep* clauses (226b), in which case there is an event of “Mahinur saying Tursun is coming” and a “leaving” event. I intentionally avoid using “because” or “as a result” to indicate that this relationship is a preference and not enforced by the syntax, similar to the English translation, where the Cause-Result relation is implied, not forced.

- (226) a. Mahinur girim qil-ip u-ning mengz-i qizir-ip ket-t-i.
 Mahinur makeup do-CNV s/he-GEN cheek-3POSS redden-CNV KET-PST-3
 “Mahinur did makeup and her cheeks reddened.”
- b. Mahinur Tursun-ni kél-i-du **de-p** ket-t-i.
 Mahinur Tursun-ACC come-NONPST-3 say-CNV leave-PST-3
 “Mahinur said Tursun will come and left.”

In cases like (226a), the most natural interpretation is one in which the makeup is red, and after applying it, Mahinur’s cheeks became red. This is also compatible with a scenario where Mahinur made a mistake applying her makeup and blushed upon realizing it. Similarly, the most natural way of linking the *dep* clause to “leaving” in cases like (226b) is with a reason interpretation, where what Mahinur communicates is her reason for leaving, but this need not be the case. I motivate the structure in (227).

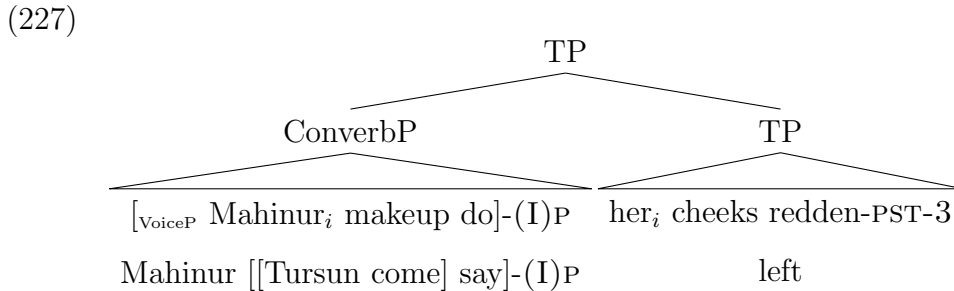

I discuss only two structures, which differ only with respect to the height at which they merge. In other words, the range of interpretations is far more restricted when the modification is at the VP level, in which case both clauses are interpreted such that they occur at the same time (i.e. they are embedded under a single T and Aspect. When *-(I)p* adjoins at the TP level, a sequential/simultaneous relationship, culminating in the final (inflected) predicate is sufficient.

4.1.7 Roadmap

Section 4.2 offers discussion and analysis of VP-modifying *-(I)p* constructions. In Section 4.3, I analyze TP-modifying *-(I)p* constructions. In Section 4.4, I demonstrate that the distribution of *dep* clauses are best understood based on the distribution of *-(I)p* more

generally. In section 4.5, I show that properties of “say” arise in all *dep* environments. To show this, I demonstrate that the following are possible in every *de*- “say” environment, including *dep*: Indexical Shift, Raising-to-Object, direct quotation, and resistant to factivity. I then conclude.

4.2 The syntax of VP $-(I)p$ modifiers

Moving forward, I refer to VP-modifying $-(I)p$ as VP- $-(I)p$, which closely aligns with what Sugar calls “Inner-Aspect Serial Verb Constructions”, based on Travis (2010). In Sugar’s description, $-(I)p$ takes a *vP* complement. This clause merges at *vP* of the matrix clause and indicates direct motion or manner of the main clause event. He further claims that all arguments are shared. I argue that $-(I)p$ can introduce minimally VP and maximally VoiceP in these structures, where felicity is based on whether the modifier is compatible with the main VP (c.f. Sugar, 2019). I first introduce some of the data used by Sugar to argue that these constructions are maximally *vPs*, and then show that certain contexts allow this constituent to be as large as VoiceP.

4.2.1 Sugar 2019: Inner Aspect Serial Verb Constructions

Sugar provides various forms of evidence that $-(I)p$ merges low, at the *vP* level in some contexts. Under his analysis, the complement of $-(I)p$ is the same size (*vP*). He additionally suggests that $-(I)p$ heads an InnerAspP in such cases, which leads him to adopt the term “Inner Aspect Serial Verb Constructions”.³ Sugar discusses two distinct functions that $-(I)p$ clauses have as *vP* modifiers: resultatives (228a) and directionals (228b).

³Part of the motivation for this term comes from the Serial Verb Construction literature, where argument sharing has been a central focus (e.g. Baker, 1989; Collins, 1997)

- (228) a. Ahmat métal-ni ur-up tüzli-wet-t-i.
 Ahmat metal-ACC pound-CNV flatten-COMPL-PST-3
 “Ahmat pounded the metal flat (flattened by pounding).”
 (Sugar, 2019:14, ex: 1)
- b. Abliz méng-ip kel-d-i.
 Abliz walk-CNV come-PST-3
 “Abliz walked here (came by walking).”

In both constructions, the $-(I)p$ clause behaves like a manner modifier. Consider the following question-answer pairs for the sentences introduced in (228) in (229) and (230). Notice that the manner wh-question in both cases is answered by inserting an $-(I)p$, which provides a sufficient answer.

- (229) a. A: Ahmat métal-ni qandaq tüzli-wet-t-i?
 Ahmat metal-ACC how flatten-COMPL-PST-3
 “How did Ahmat flatten the metal?”
- b. B: (U-ni) ur-up tüzli-wet-t-i.
 it-ACC pound-CNV flatten-COMPL-PST-3
 “He flattened it by pounding it.” (Sugar, 2019: p. 76, ex: 150a-b)
- (230) a. A: Abliz qandaq kel-d-i?
 Abliz how come-PST-3
 “How did Abliz come (here)?”
- b. B: (U) méng-ip kel-d-i.
 he walk-CNV come-PST-3
 “He came by walking.” (Sugar, 2019: p. 77, ex: 151a-b)

In both cases above, the $-(I)p$ clause is introduced as an answer to the manner or directional wh-question. In this way, $-(I)p$ clauses behave much like manner modifiers, which are generally considered to merge at roughly the edge of VP (Cinque, 1999). We can thus hypothesize that these attach similarly to manner adverbs.

To demonstrate that these structures are spatio-temporally restricted, a consecutive adverbial, such as *andin* “then” triggers a reading where the “flattening” was not done via “pounding” (231).

- (231) Ahmat métal-ni ur-up andin tüzli-wet-t-i.
 Ahmat metal-ACC pound-CNV and.then flatten-COMPL-PST-3
 “Ahmat pounded the metal and then flattened it.”

(231) is incompatible with the interpretation that corresponds to (228a). The former obligatorily involves two consecutive events, while the latter is simultaneous. Given that VP-*(I)p* shares all tense and aspectual specifications with the main verb, the relationship between events is obligatorily “tighter” and is incompatible with an adverb such as *andin*. However, this adverb can be accommodated by merging the *-(I)p* clause higher (at TP), in which case the two events are construed as temporally related “things” that Ahmat did.

Sugar also demonstrates that progressive aspect is possible on the second verb, as shown in (232a), but cannot appear on both, as shown in (232b). This is suggestive that the *-(I)p* clause lacks the necessary structure to host the progressive (i.e. lacks AspP).

- (232) a. Ahmat métal-ni ur-up tüzle-wat-i-du.
 Ahmat metal-ACC hit-CNV flatten-PROG-NONPST-3
 “Ahmet is flattening the metal by pounding it.”
- b. * Ahmat métal-ni ur-iwét-ip tüzle-wat-i-du.
 Ahmat metal-ACC hit-PROG-CNV flatten-PROG-NONPST-3
 Intended: “Ahmat is hitting and flattening the metal.”

The same holds for the lower, completive aspect. This appears on only the second verb, but is prohibited on the verb embedded under *-(I)p*.

- (233) * Ahmat métal-ni ur-iwét-ip tüzli-wet-t-i.
 Ahmat metal-ACC pound-COMPL-CNV flatten-COMPL-PST-3
 “Ahmat pounded the metal and then flattened it.”

On this basis, it is reasonable to at least conclude that *-(I)p* clauses do not introduce an AspP of their own, but are interpreted with respect to the Aspect of the main clause.⁴

⁴The completive and progressive are syncretic preceding *-(I)p* due to vowel raising. (233) is ungrammatical under either reading.

Sugar further demonstrates that a Negative Concord Item, such as *héchnerse* “anything” can be licensed by negation on the main verb. As mentioned in the previous chapter, *héch*-verbs require clausemate negation. Because this element is licensed by negation on only the main verb, it suggests that it is within the same clause in (234). We may thus conclude that negation scopes over both the main VP and the *-(I)p* clause.

- (234) Ahmat héchnersi-ni ur-up tüzli-wet-*(mi)-d-i.
 Ahmat no.what-ACC pound-CNV flatten-COMPL-NEG-PST-3
 “Ahmet didn’t flatten anything by pounding.(Sugar, 2019:p. 83, ex: 167)

Similarly, passivization of only the main verb results in the *-(I)p* clause maintaining its manner interpretation (235a), while passivizing both verbs, albeit possible, forces a temporal interpretation, in which the “pounding” and “flattening” events are unrelated (235b). In other words, (235b) cannot be accommodated as a VP-*(I)p* construction, but it is compatible with a TP-modifier reading. Sugar interprets this as evidence that VP-*(I)p* constructions are compatible with only a single Voice head.

- (235) a. Métal ur-up tüzli-wét-il-d-i.
 metal pound-CNV flatten-COMPL-PASS-PST-3
 “The metal was pounded flat.”
- b. Métal ur-ul-up tüzli-wét-il-d-i.
 metal pound-PASS-CNV flatten-COMPL-PASS-PST-3
 “The metal was pounded and flattened (by some other means).”
 (Sugar, 2019: p. 80, ex: 160a-b)

Finally, Sugar provides (236) as an argument that *pro* is not the empty category that saturates the internal argument position of “pound”. He suggests that the presence of the pronoun *u-ni* “it-ACC” forces the two separate (temporally-related) events reading. On these grounds, Sugar suggests that these are control structures, by which the *-(I)p* clause contains a PRO theme argument that is controlled by the matrix theme.

- (236) Ahmat métal-ni ur-up u-ni tüzli-wet-t-i.
 Ahmat metal-ACC pound-CNV it-ACC flatten-COMPL-PST-3
 “Ahmat pounded the metal and flattened it.” (Sugar, 2019:94, ex: 198)

Now I turn to novel evidence that VP-*(I)p* constructions are VoicePs that merge at the VP level.

4.2.2 Building upon Sugar’s analysis

In this section, I adopt Sugar’s analysis that these *-(I)p* clauses merge at *vP*, but suggest that size of the *-(I)p* clause can be as large as VoiceP, although as indicated above, Aspect, Negation, and Tense are all prohibited.

Beginning with the status of argument sharing, I show that this is not actually an absolute requirement, but is instead a preference in most manner-modifying contexts. Because the language is extremely permissive as it relates to argument drop (See Chapter 1) and often exhibits a strong preference for argument drop when the antecedent is salient, it is generally the case that arguments are dropped when they are able. Introducing theme arguments that form a part-whole relation is an easy way to ensure that the theme is shared, but that different information is introduced by virtue of introducing the theme in both clauses. This is shown in (237).

- (237) Ahmat métal-ni ur-up yérim-i-ni tüzli-d-i.
 Ahmat metal-ACC pound-CNV half-POSS3-ACC flatten-PST-3
 “Ahmet flattened half of it by pounding the metal.”

(237) is interpreted such that the *-(I)p* clause describes the manner in which the “flattening” has occurred, but also requires the realization of both internal arguments because each provides different information. If we assume a relationship between *v* and accusative case, we can further conclude that the *-(I)p* clause is able to introduce at least *vP*.

Furthermore, manner adverbs are revealing as it relates to the size of the *-(I)p* clause. For instance, (238) is ambiguous as to whether the adverb scopes over “pound” or over the entire complex VP.

- (238) Ahmat métal-ni téz ur-up tüzli-wet-t-i.
 Ahmat metal-ACC quickly pound-CNV flatten-COMPL-PST-3
 “Ahmat flattened the metal by quickly pounding it”
 “Ahmat quickly flattened the metal by pounding it.”

Perhaps offering even clearer evidence as to the size of these constructions, there are *vip* constructions that are able to host an independent external. For instance, (239a) involves a case where the “winning” is accomplished by “cheating”, which is the same type of manner modification discussed in the previous section. However, it is plausible that not every winner cheated, which allows the *-(I)p* clause to host a subject that differs from the main clause (239b).

- (239) a. Biz bu musabiqi-de aldamchiliq qil-ip ut-t-uq.
 1PL this game-LOC cheating do-CNV win-PST-1PL
 “We won this game by cheating.”
 b. Biz bu musabiqi-de [Tursun=(1a) aldamchiliq qil-ip] ut-t-uq.
 1PL this game-LOC Tursun=only cheating do-CNV win-PST-1PL
 “We won this game by Tursun cheating.”

According to speaker intuitions, the same factor that licensed a second theme argument in (237) is at work here. If the external argument is shared between the main clause and the *-(I)p* clause, it is unnatural to pronounce it a second time. However, in a case like (239b), speakers are able to naturally accommodate this construction as a part whole relationship, where “we” won and only Tursun cheated. I take this as evidence that VP-*-(I)p* constructions are able to embed *vP/VoiceP*.⁵

However, this VP-*-(I)p* construction is not able to host a speaker-oriented adverb. It is possible for a subject oriented adverb to modify the complex VP (240a), but it is not licensed within the *-(I)p* clause itself (240b).

⁵The fact that *qil-* “do”, a light verb, is able to occur within the *-(I)p* clause serves as evidence for the presence of a *v* element, assuming Folli and Harley (2005)’s analysis of its Persian equivalent that these elements are over realizations of *v*.

- (240) a. Biz bu musabiqi-de qiziqarliq [Tursun=(la) aldamchiliq qil-ip]
 1PL this game-LOC interestingly Tursun=only cheating do-CNV
 ut-t-uq.
 win-PST-1PL
 “We interestingly won this game by Tursun cheating.”
- b. *Biz bu musabiqi-de [Tursun qiziqarliq aldamchiliq qil-ip]
 1PL this game-LOC Tursun interestingly cheating do-CNV
 ut-t-uq.
 win-PST-1PL
 Intended: “We won this game by Tursun interestingly cheating.”

My results confirm Sugar’s finding that aspectual marking is not permitted within VP-*(I)p* constructions, as shown in (241).

- (241) *Biz bu musabiqi-de [Tursun aldamchiliq qil-iwét-ip] ut-t-uq.
 1PL this game-LOC Tursun cheating do-PROG/COMPL-CNV win-PST-1PL
 Intended: “We won this game by Tursun cheating/having cheated.”

In this particular environment, both the completive and progressive aspects are homophonous, realized as *iwét*. Neither is permitted into this construction, however.

Applying the NCI test again, it turns out that only elements in the matrix clause meet the clausemate requirement for NCI licensing. More specifically, the subject of the *-(I)p* clause cannot be an NCI licensed by negation on the matrix verb (242a). However, material introduced in the matrix clause meets the clausemate condition, making it possible for negation on the matrix verb to license an NCI that stands in for “in the game” (242b).

- (242) a. *Biz bu musabiqi-de [héchkim aldamchiliq qil-ip] ut-mi-d-uq.
 1PL this game-LOC no.who-ACC cheating do-CNV win-NEG-PST-1PL
 Intended: “We won this game by nobody cheating.”
- b. Biz héchnersi-de aldamchiliq qil-ip ut-mi-d-uq.
 1PL no.what-LOC cheating do-CNV win-NEG-PST-1PL
 “We didn’t win in anything by cheating (we won fairly).”

This data is suggestive that the clause embedded under *-(I)p* does not bear clausemate status with respect to negation on the matrix verb, but this does not prevent the NCI licensed

in the matrix clause from functioning as the antecedent for an empty category housed within the $-(I)p$ clause. This is what I suggest is happening in cases like (234).

To demonstrate that this is a property related to the NCI being encapsulated inside another constituent, an NCI can be licensed inside of a PP in cases like (243).

- (243) Mahinur héchkim bilen kel-mi-d-i.
Mahinur nobody with come-NEG-PST-3
“Mahinur didn’t come with anybody.”

Based on the data above, I assume that $-(I)p$ merges at the VP level, which is fully compatible with Sugar’s analysis. However, I have shown that the constituent embedded by $-(I)p$ is large enough to host a subject (c.f. Sugar, 2019). I thus make the assumption that it always introduces a *pro* subject when there is not an identity mismatch, as indicated in (244). It could be argued that the constituent is variable in size, ranging from a VP to VoiceP, but given the pervasiveness of argument drop, I will assume the former. Furthermore, in following with Sugar, I conclude that these utterances contain only a single instance of negation, tense, aspect, mood, etc.

(244)

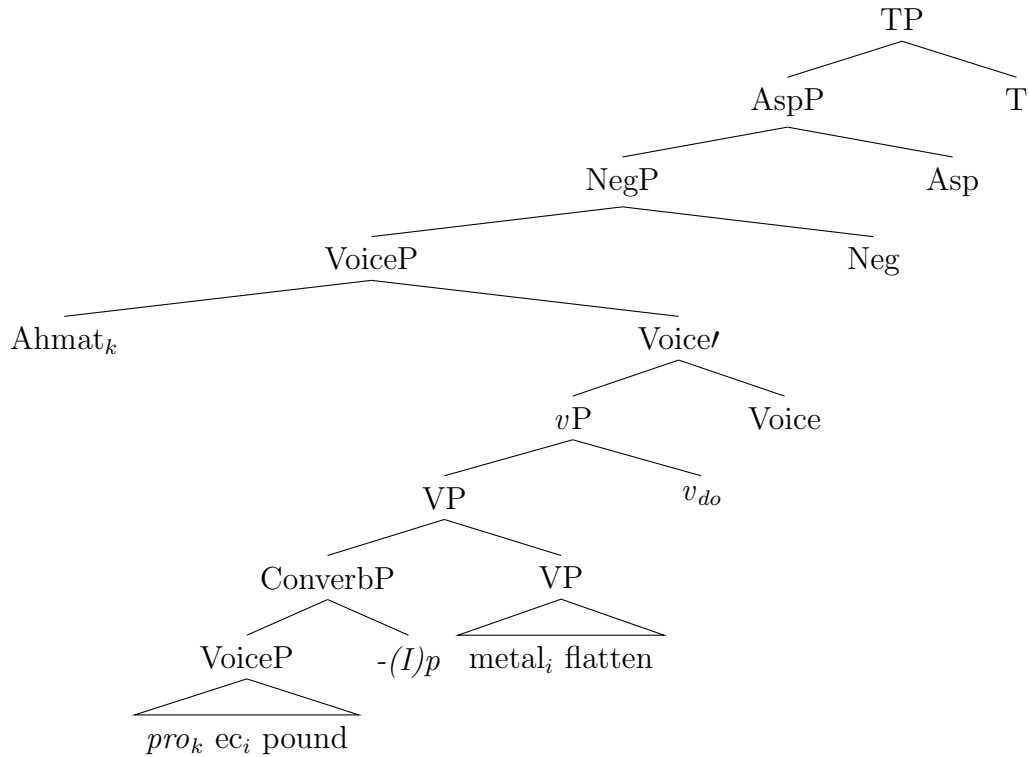

4.3 TP modifying $-(I)p$ constructions

4.3.1 Overview

Throughout the previous section, I alluded to TP modifying $-(I)p$ constructions, henceforth TP- $(I)p$. These constructions are far less restricted than VP- $(I)p$ constructions, which I assume to be based on properties of the syntax. More specifically, whereas *vip* modifies the core event represented by the main clause, I argue that TP- $(I)p$ constructions are TP adjuncts, which modify the same clause. I assume that discourse coherence is the primary factor in determining whether a TP- $(I)p$ is a suitable modifier for the TP it merges with. Furthermore, I have no evidence that these $-(I)p$ clauses are any larger than VoiceP.

Arguably the most common function of TP- $(I)p$ constructions is to chain together clauses that are sequentially related. When the clauses all share the same subject, an infinite number of clauses can be linked together on the basis that they are all events that were carried out by the same subject. In other words, the clauses in (245) are related by the fact that they

are spatio-temporally related to the same subject.

- (245) Mahinur mektep-ke bér-ip, ders-ke qatnish-ip, qayt-t-i.
Mahinur school-DAT go-CNV class-DAT attend-CNV return-PST-3
“Mahinur went to school, attended class, and returned.”

In the case of (246), on the other hand, each clause has a different subject. However, these distinct subjects are sufficiently related for discourse coherence on the basis that they naturally describe the weather at a particular place at a particular time.

- (246) Qar yégh-ip shamal chiq-ip jahan muzli-d-i.
snow precipitate-CNV wind rise-CNV world freeze-PST-3
“The snow fell, the wind picked up, and the world froze.” (Sugar, 2019:15, ex: 3)

Whereas Sugar (2019) assumes cases like (245) and (246) to involve distinct syntactic structures, I assume them to be the same. However, I assume cases like (245) to simply be easier for speakers to accommodate on the basis that a sequence of events with the same subject is sufficient to use $-(I)p$ as a linker, while the presence of different subjects makes it more difficult for the speakers to determine how exactly the TP- $(I)p$ construction modifies the matrix TP. I first revisit Sugar’s work, and then motivate a new proposal.

4.3.2 Revisiting Sugar’s Event SVCs

The purpose of this section is to demonstrate that the cases in (245) and (246) involve the same general syntax as Sugar’s “Event SVC”. In order to do this, I begin by demonstrating that Sugar’s analysis of cases like (247) need some modification. Sugar argues suggests that in (247), the subject *uning mengzi* “his/her/their cheeks” raises from its position as the subject associated with the unaccusative predicate “redden” into spec, TP of the matrix clause, where it controls the internal argument of “do makeup”.

- (247) U-ning mengz-i girim qil-ip qizir-ip ket-t-i.
s/he-GEN cheek-3POSS makeup do-CNV redden-CNV leave-PST-3
“Their/her/his cheeks turned red by makeup.” (Sugar, 2019:100, ex: 212a)
“Someone applied makeup and their/her/his cheeks turned red (TM)”

First, it should be noted that the construction above has two subjects: *pro* and “his/her/their cheeks”. For instance, (248) is equivalent, which leaves the subject of *red* in its base position.

- (248) *Girim qil-ip U-ning mengz-i qizir-ip ket-t-i.*
 makeup do-CNV s/he-GEN cheek-3POSS *red*-CNV leave-PST-3
 “Someone applied makeup and their/her/his cheeks turned red.”

“Their/her/his cheeks” is permitted as the subject of the unaccusative predicate “*red*” in a root clause (249).

- (249) *U-ning mengz-i qizir-ip ket-t-i.*
 s/he-GEN cheek-3POSS *red*-CNV KET-PST-3
 “Their/her/his cheeks turned red.”

The subject of *qil*- “do/make” is an agent and its internal argument is *girim* “makeup”. Notice in (250a) that *girim* can optionally bear accusative marking if there is contextually salient makeup in the discourse. If one wishes to describe the location where makeup was applied, it is obligatorily introduced as a dative-marked oblique (250b).

- (250) a. *Mahinur girim-(ni) qil-d-i.*
 Mahinur makeup-ACC do-PST-3
 “Mahinur did (the contextually salient) makeup.”
 b. *Men (u-ning mengz-i-ge/*ni) girim qil-d-im.*
 I s/he-GEN cheek-3POSS-DAT/ACC makeup do-PST-3
 “I applied makeup (to his/her/their cheek).”

Furthermore, under passivization, *girim* “makeup” is promoted to subject, while the goal can optionally remain in the structure unchanged (251).

- (251) *Girim (u-ning mengzi-ge) qil-in-d-i.*
 makeup s/he-GEN face-DAT do-PASS-PST-3
 “Makeup was applied (to his/her/their cheek).”

Finally, an overt subject is able to be inserted into the structure, as shown in (252).

- (252) Mahinur girim qil-ip u-ning mengz-i qizir-ip ket-t-i.
 Mahinur makeup do-CNV s/he-GEN cheek-3POSS redden-CNV KET-PST-3
 “Mahinur did makeup and her cheeks reddened.”

(252) makes it clear that *girim qil-* “do makeup” takes an agent as its subject, while the second clause is an unaccusative utterance, whose subject is “her cheeks”.

I conclude that these *-(I)p* constructions are TP adjuncts, which explains the independence of the two clauses, in addition to the basic word order facts. Recall from the previous section that all VP-*(I)p* constructions involve the matrix subject occurring at the left edge of the sentence, while the subject of the *-(I)p* clause occurs at the edge of the *-(I)p* clause. In cases like (245), (246), and (252), the entire *-(I)p* clause precedes the matrix TP.

The behavior of passivization supports this hypothesis, as well. When *qil* “do” undergoes passivization, *girim* “makeup” raises to subject, while the matrix clause is unchanged (253).

- (253) [Girim qil-in-ip] u-ning mengz-i qizir-ip ket-t-i.
 makeup do-CNV s/he-GEN cheek-3POSS redden-CNV KET-PST-3
 “Makeup was done and her cheeks reddened.”

This follows if the *-(I)p* construction is a TP adjunct, in which case it would not have any effect on the matrix clause, which it doesn’t. The one consequence it does have is that the antecedent of *uning* “his/her/their” is no longer present in the structure, but the implied agent is still interpreted as the binder.

4.3.3 Analyzing TP *-(I)p*

All TP-*(I)p* constructions are obligatorily compatible with the tense inflected on the main verb. For instance, although temporal adverbs are permitted in each clause, they must all be compatible with the matrix tense. For this reason, “yesterday” and “today” are compatible with the past tense (254a). However, “yesterday” and “tomorrow”, although sequential, cannot occur with the future (254b).

- (254) a. Men tünügün mektep-ke bér-ip, bugün bazar-gha bar-d-im.
 1SG yesterday school-DAT go-CNV today bazaar-DAT go-NONPST-1SG
 “Yesterday I went to school and today I went to the bazaar.”
- b. *Men tünügün mektep-ke bér-ip, ete bazar-gha bar-i-men.
 1SG yesterday school-DAT go-CNV tomorrow bazaar-DAT go-NONPST-1SG
 Intended: “Yesterday I went to school and tomorrow I will go to the bazaar.”

Because *(I)p* clauses lack tense themselves, their temporal reference comes from the discourse. Because the inflected verb indicates the culmination of the sequence of clauses, each *-(I)p* clause must precede the inflected verb. This is similar to the analysis in Pancheva and Zubizarreta (2020), which suggests that in the narrative present in English or in Guarani (a tenseless language), sequentiality is required unless the temporal reference is updated. I suggest the same is happening here, where the tense of each clause must be simultaneous or sequential, unless a new Tense head is introduced.

I propose the structure in (227) for these constructions, where the ConverbP modifies the matrix TP, as shown in (255).

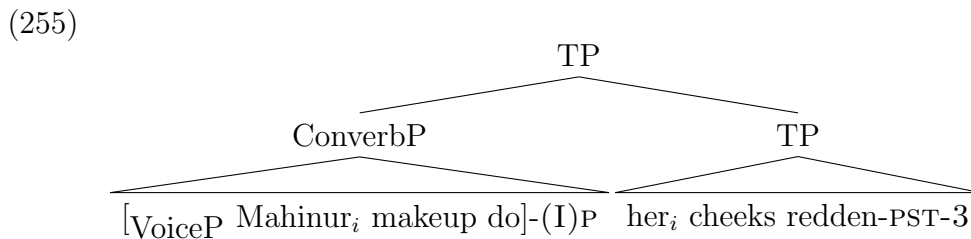

This analysis predicts that any number of clauses can precede the matrix clause, because each is a TP adjunct, that minimally requires a sequential relationship. Thus this construction would be compatible with describing everything that has taken place in the universe, as long as the proper sequential order is maintained. Furthermore, there are pragmatic factors at play related to discourse coherence. These clauses can be interpreted as having an e.g. Cause-Result relationship, but this is dependent on the speaker and the particular clauses that are linked.

Returning to the cases in (256), speakers can use *-(I)p* to reflect a wide range of coherence relations. In the case of (256a), there is clearly a sequential relationship between the clauses,

and leaving makes it at least possible to return, which could be construed as causality. (256b) offers a more natural *Cause-Effect* interpretation, where jumping off the bed naturally could lead one to fall and break their foot. Relationships of each of these varieties is permissible with $-(I)p$.

- (256) a. Mahinur mektep-ke bér-ip, *pro* ders-ke qatnish-ip, *pro* qayt-t-i.
 Mahinur school-DAT go-CNV class-DAT attend-CNV return-PST-3
 “Mahinur went to school, attended class, and returned.”
- b. Men karwat-tin sekre-p *pro* chüsh-üp *pro* put-um-ni
 1SG bed-ABL jump-CNV fall-CNV foot-1SG.POSS-ACC
 sundur-iwal-d-im.
 break-CAUS-COMPL-PST.DIR-1SG
 “I jumped off the bed, fell, and broke my foot.”

Finally, returning to the contrast between multi-subject chains that are generally considered infelicitous out of the blue, such as (257a), the two clauses are syntactically unproblematic, but there is not a clear enough link between the clauses from the perspective of discourse coherence. (257b) is much more clearly acceptable, because the matrix subject is plural, the predicate has to do with “eating”, and the first two clauses involve two individuals (Mahinur and Tursun) cooking food. This is easy to accommodate, because the two TP- $(I)p$ constructions coherently modify the matrix clause.

- (257) a. # Mahinur nan yéq-ip, Tursun polu et-t-i.
 Mahinur bread bake-CNV Tursun pilaf make-PST-3
 “Mahinur baked bread and Tursun made pilaf.”
- b. Mahinur nan yéq-ip, Tursun polu ét-ip, *(ular) yé-d-i.
 Mahinur bread bake-CNV Tursun pilaf make-CNV, they eat-PST-3
 “Mahinur baked bread, Tursun made pilaf, and they ate it.”

Also important here, is that the 3PL pronoun is obligatorily pronounced. This suggests that *pro*-drop is only possible when the same subject is shared across constructions. In other words, *pro* drop across TP- $(I)p$ constructions, behaves the same way that *pro* drop works across sentences within a discourse.

4.4 Final notes on $-(I)p$

There are reasons to think that $-(I)p$ is the so-called elsewhere morpheme for verbs. Furthermore, all verbs marked with $-(I)p$ are followed by a fully inflected verb. I suggest that only the final verb raises, while all other verbs are marked with $-(I)p$ in constructions involving more than one verb.

In head-final languages, it is often difficult to determine whether the verb raises, picking up morphology, or if this process is purely a PF phenomenon. In Major (2017), I argue in favor of a syntactic analysis, by which the verb undergoes head movement, picking up each functional head along the way. The clearest evidence comes from so-called “Contrastive Polarity Questions”, which are argued to involve verb-stranding TP-ellipsis (258).

- (258) Sen mektep-ke téz bar-d-ing=mu (*sen mektep-ke téz)
2SG school-DAT quickly go-PST-2SG=Q 2SG school-DAT quickly
bar-mi-d-ing=mu?
go-NEG-PST-2SG=Q
“Did you quickly go to school or not?”

This argument assumes Max Elide (Merchant, 2008), which informally requires that ellipsis must target the largest possible constituent. In this way, the entire VoiceP introduced in the first clause (“you”, “to school”, and “quickly”) is omitted in the second clause. The fact that the verb survives such ellipsis, along with negation, is suggestive that it must have raised out of its merge position.

Furthermore, only one verb can raise when there is an auxiliary (“light verb”) - the auxiliary, as shown in (259).

- (259) Sen mektep-ke téz bér-ip baq-t-ing=mu (*bér-ip) baq-mi-d-ing=mu?
2SG school-DAT quickly go-CNV try-PST-2SG=Q go-CNV NEG-PST-2SG=Q
“Did you try to quickly go to school or not?”

In this way, only the final verb raises to the matrix C (or possibly ForceP, assuming Rizzi (1997)). The main lexical verb remains downstairs and is marked with $-(I)p$.

There is another more restricted converb, *-GACH*, which strictly encodes a simultaneous relationship between two separate events (260a), which is distinct from *-(I)p*(260b).

- (260) a. Mahinur polu yé-gech kitab oqu-d-i.
 Mahinur pilaf eat-SIM book read-PST-3
 “Mahinur read a book, while eating pilaf.”
- b. Mahinur polu ye-p kitab oqu-d-i.
 Mahinur pilaf eat-CNV book read-PST-3
 “Mahinur ate pilaf and (then) read a book.”

Whereas (260a) is fixed in its interpretation - it strictly requires that the “reading” and “eating” events were simultaneous. In the case of (260b), it is possible that the events were sequential or simultaneous.

Furthermore, *-GACH* is unable to link clauses with distinct subjects, while *-(I)p* is able (261b).

- (261) a. * Mahinur polu yé-gech Tursun kitab oqu-d-i.
 Mahinur pilaf eat-SIM book read-PST-3
 Intended: “Tursun read a book, while Mahinur ate pilaf.”
- b. Mahinur polu ye-p Tursun kitab oqu-d-i.
 Mahinur pilaf eat-CNV Tursun book read-PST-3
 “Mahinur ate pilaf and Tursun read a book.”

Offering a full analysis of *-GACH* constructions is outside the scope of this dissertation, but I introduce this data to make two points. All unraised (non-final) verbs (excluding root imperatives) require morphology. There are highly specified/restricted morphemes, such as *-GACH*, which satisfy this requirement and impose strict requirements between the VPs that it links. *-(I)p* on the other hand is the elsewhere morpheme, that meets this requirement, but is far less restrictive in terms of how it relates the clause(s) embedded under *-(I)p* with the inflected verb, requiring what seems to be some basic coherence relationship.

Before moving on to *dep*, I consider why *-(I)p* clauses are not “standard” coordination structures. This chapter has suggested that *-(I)p* maximally introduces VoiceP as its complement. Furthermore, *-(I)p* is restricted to verbs. First, recall (257a), which treats “baking

bread” as an insufficient modifier of “Tursun made pilaf”. Speakers almost universally suggested using a standard conjunction in that case, as shown in (262). In this case, the two clauses are equal in the sense that neither is dependent on the other.

- (262) Mahinur nan yaq-t-i we Tursun polu et-t-i.
 Mahinur bread bake-PST-3 and Tursun pilaf make-PST-3
 Mahinur baked bread and Tursun made pilaf.”

In cases of true coordination, both conjoined clauses behave as independent root clauses. Similarly conjunctions like *we* “and” are able to link constituents of all types. Whereas, aspect is specified in the main clause, where it is “inherited” by the $-(I)p$ clause. This follows from the truncated VoiceP structure functioning as a modifier. In the case of true coordination, all of these restrictions are lifted, as shown in (263).

- (263) Mahinur nan yéq-iwat-i-du we Tursun ötken hepte polu et-t-i.
 Mahinur bread bake-PROG-NONPST-3 and Tursun last week pilaf make-PST-3
 Mahinur is baking bread and Tursun made pilaf last week.”

4.5 The distribution of *dep* and $-(I)p$

The previous section argued for two distinct converbial $-(I)p$ constructions, which differ with respect to their syntactic height and the size of the $-(I)p$ clause itself. In one configuration, $-(I)p$ clauses function as VP modifiers (VP- $-(I)p$), which establishes a tight relationship between clauses (they are embedded under the same TAM marking). In the other configuration, $-(I)p$ links a VoiceP with a TP, and the two clauses are minimally spatio-temporally related (TP- $-(I)p$). I suggest that all *dep* constructions fit into one of these two configurations, beginning with Complex Single Event *dep* constructions, and then discuss Multiple Event *dep* constructions.

4.5.1 Notes on Transitivity, *v*, and *dep*

There has been considerable discussion regarding the role of light verbs and the syntax/semantics of “say” throughout this dissertation thus far. It should be noted that there are a great many predicates that explicitly display a light verb, which has further implications for argument structure. For instance, the difference between “do/make” and “be/become” differentiates between states and events explicitly, as illustrated by (264).

- (264) a. Mahinur bu xewer-(ni) éniq qil-d-i.
Mahinur this news-ACC clear do/make-PST-3
“Mahinur made this news clear.”
- b. Bu xewer éniq bol-d-i.
this news clear be/become-PST-3
“This news became clear.”

In line with Folli et al. (2005) for Persian. I assume verbs like *qil-* “do/make” and *bol-* “be” to be overt realizations of *v*, which are responsible for a transitivity alternation.

The former case in (264a) is transitive, while (264b) is unaccusative. There are similar alternations that involve predicates of nominals related to speech that combine with these same light verbs, which exhibit the same transitivity alternation, such as (265).

- (265) a. Yighin-ning axir-i-da Mahinur tilshunasliq toghrisida söz
meeting-GEN end-3POSS-LOC Mahinur linguistics about word
qil-d-i.
make-PST-3
“At the end of the meeting, Mahinur said words (spoke) about linguistics.”
- b. Yighin-ning axir-i-da tilshunasliq toghrisida söz bol-d-i.
meeting-GEN end-3POSS-LOC linguistics about word be-PST-3
“At the end of the meeting, the words (topic) were about linguistics.”

In (265a), the verb *qil-* “do/make” takes “word” as its internal argument, which can be modified by an adjunct PP, such as “about linguistics”. (265b) on the other hand is an unaccusative, whose subject is “word”, which also is able to be modified by “about linguistics”.

Importantly, regardless of the transitivity of the predicate or which light verb is present, both are compatible with *dep* clauses (266).

- (266) a. Yighin-ning axir-i-da Mahinur [Tursun-ning maqali-si yaxshi
meeting-GEN end-3POSS-LOC Mahinur Tursun-GEN article-3POSS good
de-p] tilshunasliq toghrisida söz qil-d-i.
say-CNV linguistics about word make-PST-3
“At the end of the meeting, Mahinur said words (spoke) about linguistics,
saying Tursun’s article is good.”
- b. Yighin-ning axir-i-da [Tursun-ning maqali-si yaxshi de-p]
meeting-GEN end-3POSS-LOC Tursun-GEN article-3POSS good say-CNV
tilshunasliq toghrisida söz bol-d-i.
linguistics about word become-PST-3
“At the end of the meeting, the words (topic) were about linguistics, saying
Tursun’s article is good.”

(266) offers important distributional insights into the status of *dep* clauses. In these cases it is clear that *dep* is not functioning as an argument of the verb, because otherwise we would expect interactions between the *dep* clause and the little *v* associated with the second predicate. Across the rest of the language, “do” is systematically transitive, while “be” is systematically intransitive, yet *dep* clauses are permitted in either case, as shown in (266a) or intransitive “be” in (266b).

As the predicate that *dep* combines with can involve a stative or eventive *v*, recall from Chapter 3, that *de-* “say” itself shows alternations with respect to *v* the types of arguments it assigns. For instance, a clausal argument is acceptable in (267a), but a DP argument is not (267b).

- (267) a. Xewer-de astalang de-y-du.
sign-LOC slow.down say-NONPST-3
“On the sign, it says slow down.”
- b. *Xewer-de ikki söz-(ni) de-y-du.
sign-LOC two word-ACC say-NONPST-3
“On the sign, it says two words.”

I attribute this to the absence of v_{do} when the location of LM is being described, which is purely stative (introduced by v_{be}).

Now if we take a simple unaccusative, such as (268a), notice that it can combine with a *dep* clause (268b).

- (268) a. Bu xewer éniq bol-d-i.
 this news clear be/become-PST-3
 “This news became clear.”
- b. Bu xewer Milwaukee-(*ni) ut-ti de-p éniq bol-d-i.
 this news Milwaukee-ACC win-PST-3 say-CNV clear be/become-PST-3
 “This news saying Milwaukee won, became clear.”

The absence of accusative case within the *dep* clause follows from the fact that two clauses are both unaccusative.

This alternates with “make clear”, which requires an agent and involves the transmission of LM, which is agentive.

- (269) a. Mahinur bu xewer-ni éniq qil-d-i.
 Mahinur this news-ACC clear do/make-PST-3
 “Mahinur made this news clear.”
- b. Mahinur bu xewer Milwaukee-(*ni) ut-t-i de-p éniq
 Mahinur this news Milwaukee-ACC win-PST-3 say-CNV clear
 qil-d-i.
 do/make-PST-3
 “Mahinur made the news clear saying Milwaukee won.”

In this way, the number of internal arguments licensed is conditioned by the number of v Ps headed by v_{do} in the structure. This further determines the number of instances of accusative case that are possible. Given that *dep* clauses can occur with unaccusative predicates, can be stative themselves, and can occur with transitive predicates, there are multiple possibilities with respect to case-assignment and argument structure, as schematized in (270).

(270)

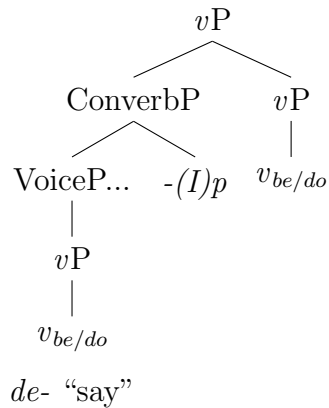

Moving forward, there are four possible combinations as it relates to *v* specifications. I now demonstrate that VP-*(I)p* and TP-*(I)p* are sufficient to explain the distribution of *dep* clauses.

4.5.2 VP-modifying *dep* Constructions

4.5.2.1 “Say” doubling

Recall from Chapter 3, that “say” often does not involve the physical production of sound, instead describing an internal state of “saying”. In other cases, “say” is used in the more canonical sense of describing an event of speech transmission. These two uses were argued to be disambiguated by the syntax. Also recall that manner modification is strongly dispreferred when *de*- “say” is used as a main verb, as repeated in (271a)-(271b).

- (271) a. Mahinur {??/*ünlük} [Tursun ket-t-i] {*ünlük} dé-d-i.
Mahinur loudly Tursun-ACC leave-PST-3 loudly say-PST-3
“Mahinur said that Tursun left.”
- b. Mahinur {??/*ünlük} [Tursun-ni ket-t-i] {*ünlük} dé-d-i.
Mahinur loudly Tursun-ACC leave-PST-3 loudly say-PST-3
“Mahinur said that Tursun left.”

Furthermore, notice below that *de*- “say” as a main verb cannot occur with a *dep* clause (272a).

- (272) a. * Mahinur Tursun-(ni) ket-t-i de-p dé-d-i.
 Mahinur Tursun-ACC leave-PST-3 say-CNV say-PST-3
 Intended: “Mahinur said that Tursun left.”

I suggest that this ban is not due to haplology, which is commonly suggested in the literature, but because it induces redundancy in these cases. The choice of using *dep* as opposed to a more descriptive verb, already favors the stative verb, because a manner of speech verb or a discourse role verb is more informative. However, if one wants to indicate manner using *de-* “say” and the communicative content, *dep* can co-occur with *de-* “say” in such contexts, as shown in (273).

- (273) Mahinur Tursun-(ni) ket-t-i de-p ünlük dé-d-i.
 Mahinur Tursun-ACC leave-PST-3 say-CNV loudly say-PST-3
 “Mahinur loudly said Tursun left.”

In this case, the inflected “say” is interpreted as *say_{Agent}*, introducing information about the communicative act itself; namely, that it was loud and that Mahinur was the agent. *Dep*, on the other hand, plays the role of *say_{Source}* in this context: introducing LM and a source. For this reason, it is possible to use a VP-(*I*)*p* structure to combine the “loud saying” and “saying Tursun left” clauses, in which the adverbial that modifies *de-* eliminates the redundancy in (272a).

Evidence that the inflected “say” in these contexts is *say_{Agent}* and also that it does not take the *dep* clause as its complement comes from the fact that it can introduce an accusative-marked LM argument, as shown in (274).

- (274) a. Mahinur [Tursun-(ni) ket-t-i de-p] birnémi-ler-ni ünlük
 Mahinur Tursun-ACC leave-PST-3 say-CNV one.what-PL-ACC loudly
 dé-d-i.
 say-PST-3
 “Mahinur loudly said a few things, saying Tursun left.”
- b. Mahinur birnémi-ler-ni [Tursun-(ni) ket-t-i de-p] ünlük
 Mahinur one.what-PL-ACC Tursun-ACC leave-PST-3 say-CNV loudly
 dé-d-i.
 say-PST-3

“Mahinur loudly said a few things, saying Tursun left.”

In this case, it is clear that there is a single event that is composed of two parts: “say_{Agent} something loudly” and “say_{Source} Tursun left”. This can be accounted for via the same analysis proposed for Complex Single Event Constructions earlier, as represented in (275).

(275)

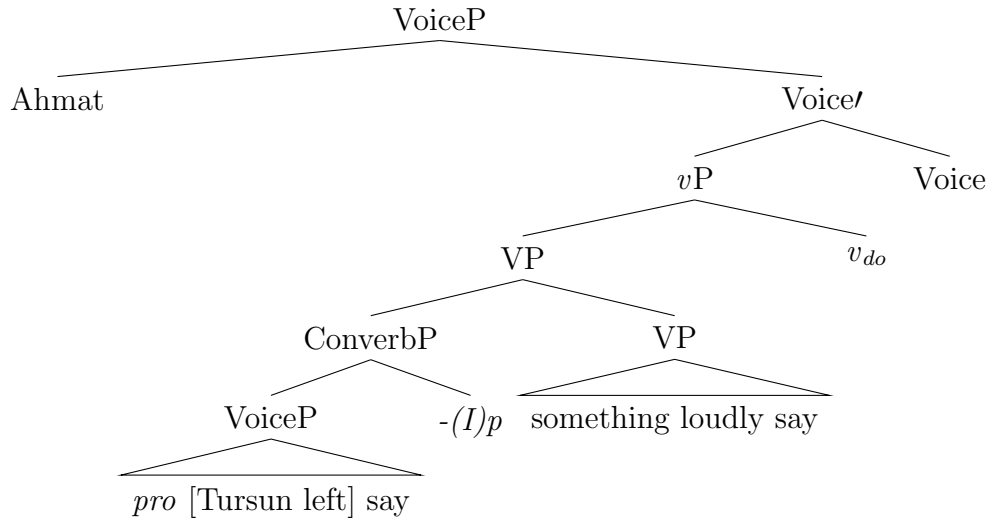

By this logic, whenever there is a predicate that describes the manner of a communicative act or a discourse role, the second clause will play a critical role in how “say” is interpreted. For instance, if the clause contains “scream”, “say” will introduce LM that can be screamed. If the second predicate is *de-* “say”, as above, it indicates that the actual transmission of LM was either done in a generic way.

4.5.2.2 Manner predicates

As was the case in English, the verb “scream” is able to function as an independent, unergative verb, while “say” requires a LM argument, as shown in (276a) and (276b) respectively.⁶

- (276) a. Mahinur warqiri-d-i.
Mahinur scream-PST-3
“Mahinur screamed.”
- b. *Mahinur dé-d-i.
Mahinur say-PST-3
“Mahinur said.”

Furthermore, “scream” does not select for an internal argument of any type .

- (277) a. *Mahinur birnémi-ler-ni warqiri-d-i.
Mahinur one.what-PL-ACC scream-PST-3
Intended: “Mahinur screamed something.”
- b. *Mahinur Tursun-(ni) ket-t-i warqiri-d-i.
Mahinur Tursun-ACC leave-PST-3 scream-PST-3
Intended: “Mahinur screamed that Tursun left.”
- c. *Mahinur Tursun-ning ket-ken-lik-i-ni warqiri-d-i.
Mahinur Tursun-GEN leave-PTPL.PST-COMP-3POSS-ACC scream-PST-3
Intended: “Mahinur screamed that Tursun left.”

However, *dep* can introduce an LMN (278a) or a TEC (278b) as its internal argument and the *dep* clause itself can modify the VP containing “scream”. In (278a), it is clear that LM was screamed, as opposed to (276a), which simply indicates that a loud noise was made. The same holds for (278b), where the LM is made transparent. In (278c), it is shown that *dep* cannot introduce an NEC in this case.

⁶(276b) is possible in contexts that would similarly allow a null argument; namely, if the complement to “say” is salient in the discourse, licensing a so-called “Null Complement Anaphor (Hankamer and Sag, 1976).

- (278) a. Mahinur birnémi-ler-ni de-p warqiri-d-i.
 Mahinur one.what-PL-ACC SAY-CNV scream-PST-3
 “Mahinur screamed something.”
- b. Mahinur Tursun-(ni) ket-t-i de-p warqiri-d-i.
 Mahinur one.what-PL-ACC say-CNV scream-PST-3
 “Mahinur screamed something.”
- c. * Mahinur Tursun-ning ket-ken-lik-i-ni de-p
 Mahinur Tursun-GEN leave-PTPL.PST-COMP-3POSS-ACC say-CNV
 warqiri-d-i.
 scream-PST-3
 Intended: “Mahinur screamed that Tursun left.”

Unlike “say”, which can select a DP internal argument, “scream” cannot, which results in only a single internal argument being introduced, as shown in (279). The fact that *dep* cannot introduce an NEC (278c) requires further research, but it is the case that VP-(I)p require the converbial clause to be associated with the matrix subject. If we assume NECs to be speaker oriented, which is compatible with what Özyıldız (2017) found for related facts related to factivity in Turkish, it would follow that an NEC would not be an accurate representation of what was actually screamed, because the NEC represents the speakers evaluation (i.e. NECs are interpreted *de re*). I save these details for future research.

In other words, “scream” only indicates manner, while the “say” clause introduces the LM argument. These two clauses form a Complex Single Event of “screaming and “saying”.

(279)

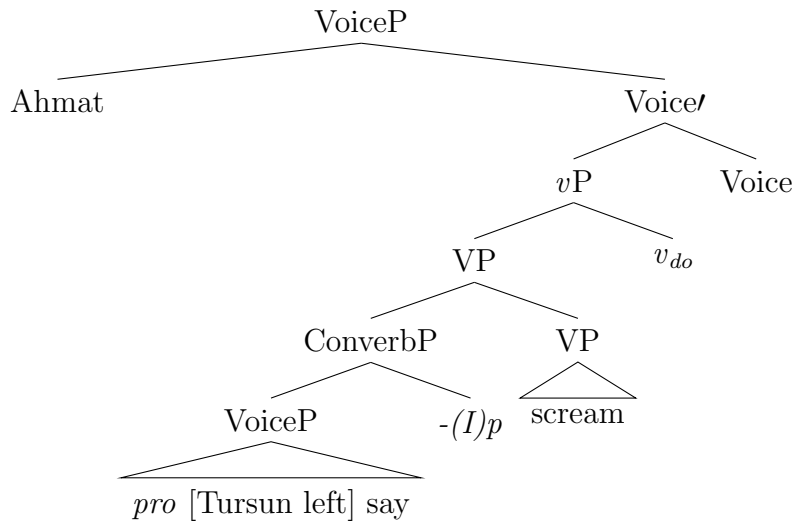

This differs from the case with *dep* + *de-* in (275), in which case both predicates can introduce LM arguments of different types, because “say” is transitive.

4.5.2.3 Discourse Role Predicates

I suggest that discourse role predicates involve the same structure as manner of speech predicates. The primary differences are related to the internal structure of the matrix clause. Grimshaw (2015) classifies discourse role verbs as predicates that encode aspects of the discourse role of the events they report: asserting, ordering, questioning, and commenting, among others.

Notice that “tell” can directly introduce an internal argument like “the news” or it can combine with a *dep* clause. Again, at first glance, one may assume that the DP internal argument (280a) and the clausal complement (280b) are serving the same function, saturating the internal argument requirement of the predicate “tell”.

- (280) a. Mahinur manga bu xewer-(ni) éyt-t-i.
 Mahinur 1SG.DAT this news-ACC tell-PST-3
 “Mahinur told me the news.”
- b. Mahinur manga Tursun-(ni) ket-t-i *(de-p) éyt-t-i.
 Mahinur 1SG.DAT Tursun-ACC leave-PST-3 say-CNV tell-PST-3
 “Mahinur told me that Tursun left.”

However, this is not the case, because they are not in complementary distribution - i.e. they can co-occur (281). Furthermore, the internal argument of “tell”, “news”, interacts with the *dep* clause as though it were any other modifier. For instance, “news” is obligatorily bare when it is adjacent to the verb (281a), but can occur in any position higher in the structure, as long as it is accusative marked (281b)-(281c).

- (281) a. Mahinur manga Tursun-(ni) ket-t-i *(de-p) ünlük bu xewer-(*ni)
 Mahinur 1SG.DAT Tursun-ACC leave-PST-3 say-CNV loudly this news-ACC
 éyt-t-i.
 tell-PST-3
 “Mahinur told me news that Tursun left.”
- b. Mahinur manga Tursun-(ni) ket-t-i *(de-p) bu xewer-*(ni) ünlük
 Mahinur 1SG.DAT Tursun-ACC leave-PST-3 say-CNV this news-ACC loudly
 éyt-t-i.
 tell-PST-3
 “Mahinur told me this news, saying Tursun left.”
- c. Mahinur manga bu xewer-*(ni) Tursun-(ni) ket-t-i *(de-p) ünlük
 Mahinur 1SG.DAT this news-ACC Tursun-ACC leave-PST-3 say-CNV loudly
 éyt-t-i.
 tell-PST-3
 “Mahinur told me this news, saying Tursun left.”

One could suggest that these are N-comp constructions, or essentially equivalent to content nominals in the sense of Kratzer (2006) and Moulton (2009). To derive the structures above, one would need to allow the content noun to scramble independent of the clause that modifies it, otherwise e.g. (281c) would be ungrammatical. However, there is a construction that I take to be more like N-comp constructions or Content Noun + modifier constructions, which involve NECs, as shown in (282)

- (282) a. Mahinur manga Tursun-ning ket-ken-lik xewir-i-ni
 Mahinur 1SG.DAT Tursun-GEN leave-PTPL.PST-COMP news-3POSS-ACC
 éyt-t-i.
 tell-PST-3
 “Mahinur told me the news that Tursun left.”

- b. Tursun-ning ket-ken-lik xewir-i-ni Mahinur manga
Tursun-GEN leave-PTPL.PST-COMP news-3POSS-ACC Mahinur 1SG.DAT
éyt-t-i.
tell-PST-3
“Mahinur told me the news that Tursun left.”
- c. *Tursun-ning ket-ken-lik Mahinur manga xewir-i-ni
Tursun-GEN leave-PTPL.PST-COMP Mahinur 1SG.DAT news-3POSS-ACC
éyt-t-i.
tell-PST-3
Intended: “Mahinur told me the news that Tursun left.”

Notice that the entire NEC, headed by the overt noun “news” is able to scramble left of the subject in (282b), but the clause modifying news is unable to scramble independent of the head noun (282c).

Furthermore, *dep* cannot be used to combine a clause with a noun in general. For instance, relative clauses are formed from the same participial used to construct NECs, as shown in (283a).⁷ However, *dep* is unable to introduce a relative clause (283b).⁸

- (283) a. Men [Tursun oghrili-ghan almi-ni] yé-d-im.
1SG Tursun steal-PTPL.PST apple-ACC eat-PST-3
“I ate the apple that Tursun stole.”
- b. *Men [Tursun oghrili-d-i de-p almi-ni] yé-d-im.
1SG Tursun steal-PST-3 say-CNV apple-ACC eat-PST-1SG
Intended: “I ate the apple that Tursun stole.”

As was the case for NECs, the entire RC can scramble (284b), but it is impossible to scramble only the head noun, independent of the rest of RC (284c).

- (284) a. Men Tursun oghrili-ghan almi-ni yé-d-im.
1SG Tursun steal-PTPL.PST apple-ACC eat-PST-3
“I ate the apple that Tursun stole.”

⁷Asarina (2011) argues that NECs and RCs involve almost identical structures in Uyghur.

⁸(283b) is acceptable under the reading “I ate the apple, saying Tursun stole it.”

- b. Tursun oghrili-ghan almi-ni men yé-d-im.
 Tursun steal-PTPL.PST apple-ACC 1SG eat-PST.1SG
 “I ate the apple that Tursun stole.”
- c. *Almi-ni Men [Tursun oghrili-ghan] yé-d-im.
 apple-ACC 1SG Tursun steal-PTPL.PST eat-PST-1SG
 Intended: I ate the apple that Tursun stole.”

Further evidence against an N-Comp analysis of *dep* clauses comes from the fact that the *dep* clause does not raise with “the news” under passivization in (285).

- (285) Bu xewer manga [Tursun-(ni) ket-t-i *(de-p)] ünlük éyt-il-d-i.
 this news 1SG.DAT Tursun-ACC leave-PST-3 say-CNV loudly tell-PASS-PST-3
 “The news was told to me saying Tursun left.”

As mentioned for English in Chapter 2 and Uyghur in Chapter 3 with respect to Moulton (2016), the verb “say” is capable of licensing its LM argument in-situ, no raising is necessary. In this way, *dep* is able to license its complement internal to the *dep* clause, which is a fundamental property of “say”. Participial clauses, on the other hand, are able to directly function as modifiers of content nouns, which “say” is incapable of selecting. In this way, *dep* clauses do not directly combine with nouns, although they can be part of the same complex predicate with a predicate that introduces a content noun.

For discourse role verbs, I propose the structure in (286).

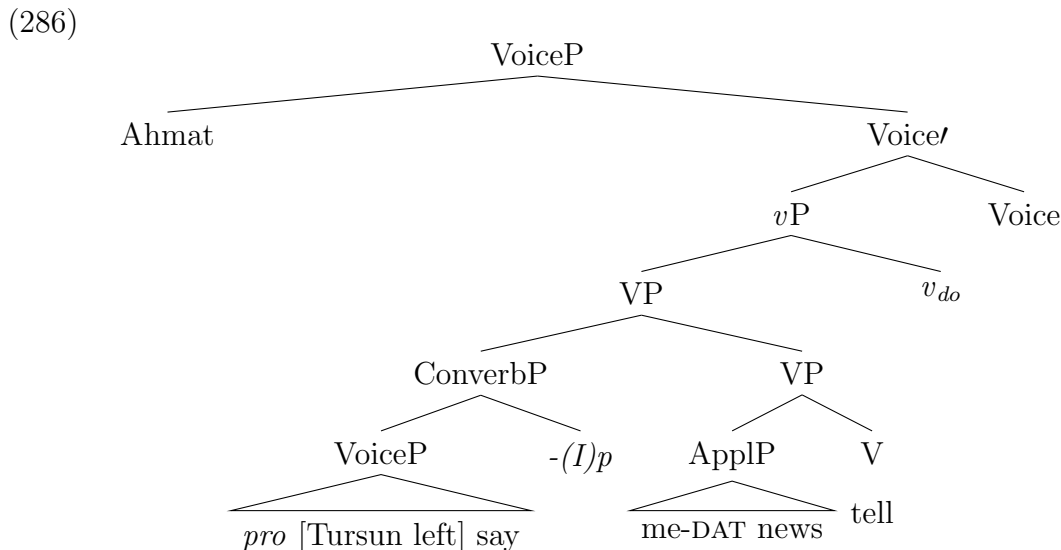

This structure allows for the independence we observe of the nominal element “news” in this construction. It is the internal argument of “tell” in the main clause, which has no selectional relationship to ConverbP. The main VP introduces a description of the communicative act and discourse role, including a Goal or optional nominal element, while the *dep* clause strictly indicates the LM that was communicated.

I have provided evidence that nominals like “news” do not select *dep* clauses. One prediction made in (286) is that the Goal argument is also incapable of c-commanding into the *dep* clause. This is borne out based on evidence from reciprocal binding. Notice that the reciprocal in (287b) can be bound by the matrix subject, but not the Goal.

- (287) a. Oghul-lir- i_k {ular-gha $_i$ } birbir-i-ni $_k$ / * i ut-t-i de-p
 son-PL-3POSS 3PL-DAT one.one-3POSS-ACC win-PST-3 say-CNV
 {ular-gha $_i$ } éyt-t-i.
 tell-PST-3
 “His/her/their sons $_k$ told them $_i$ that each other $_k$ / * i won.”
- b. * Oghul-lir- i_k {ular-gha $_i$ } birbir-i-ni $_k$ / * i ut-t-i de-p
 son-PL-3POSS 3PL-DAT one.one-3POSS-ACC win-PST-3 say-CNV
 {ular-gha $_i$ } éyt-t-i.
 tell-PST-3
 “His/her/their sons $_k$ told them $_i$ that each other $_k$ / * i won.”

This follows from an analysis in which the Indirect Object and Direct Object are embedded under the main VP, which is lower than the position where the *dep* clause merges, as indicated in (286).

As we turn to other discourse role predicates, such as “ask” (288) or “order” (289), we find the same general behavior, where a nominal is introduced independent of the *dep* clause. The difference between “ask question” and “tell news” is linked to the possible realizations of the LM argument of *dep*, which must be a question, as in (288a), not propositional (288b).

- (288) a. Mahinur men-din {so'al-*(ni)} [Tursun kél-em-du de-p]
 Mahinur 1SG-ABL question-ACC Tursun come-NONPST.Q-3 say-CNV
 {so'al-*(ni)} sori-d-i.
 question-ACC ask-PST-3
 “Mahinur asked me a/the question, saying, “Will Tursun come?”
- b. # Mahinur men-din {so'al-*(ni)} [Tursun kél-i-du de-p]
 Mahinur 1SG-ABL question-ACC Tursun come-NONPST-3 say-CNV
 {so'al-*(ni)} sori-d-i.
 question-ACC ask-PST-3
 “Mahinur asked me a/the question, saying, “Tursun will come”.

The same flexibility found for DP internal arguments of verbs like “tell”, such as “the news” applies to interrogative internal arguments like “question”, which can freely follow or precede the *dep* clause.

The same is true for “give order” in (289), where *dep* can introduce an imperative (289a), but not a proposition (289b).

- (289) a. Men Tursun-gha {boyruq-*(ni)} öy-üing-ni tazla de-p
 1SG Tursun-DAT order-ACC room-2SG.POSS-ACC clean say-CNV
 {boyruq-*(ni)} ber-d-im.
 order-ACC give-PST-1SG
 “I gave a/the order to Tursun, saying “Clean your room!”
- b. # Men Tursun-gha {boyruq-*(ni)} öy-üing-ni tazla-y-du
 1SG Tursun-DAT order-ACC room-2SG.POSS-ACC clean-NONPST-3
 de-p {boyruq-*(ni)} ber-d-im.
 say-CNV order-ACC give-PST-1SG
 “I gave a/the order to Tursun, saying “He will clean his room.”

It may be unsurprising that “ask” occurs with questions, while “order” occurs with orders/imperatives, but it is worth noting that this need not be the result of C-selection as commonly assumed for languages like English. In at least *dep* constructions, I suggest that these are instances of semantic selection, in line with (Grimshaw, 1979), where the utterance will be felicitous only if the clauses form a satisfiable event description. This explains why “say” elements like *dep* do not vary with the selecting predicate, but remain subject to felicity conditions on what is introduced by *dep*.

By the same logic, turning back to manner of speech predicates like “scream”, we should find that they are compatible with *dep* clauses containing questions, commands, or propositions, because “scream” only indicates the manner of “saying”. For this reason, anything compatible with *de-* “say” should be compatible with “scream”. This is precisely what we find in (290).

- (290) Mahinur [{Tursun ketti/Tursun ketti-mu?/Ahhhhhh!} de-p] warqiri-d-i.
 Mahinur Tursun left/Tursun left-Q/ahhhhh! say-CNV scream-PST-3
 “Mahinur screamed Tursun left/Did Tursun leave?/Ahhhh!”

4.5.3 *Dep* and attitude verbs

Grimshaw (2015) recognizes that verbs like “think” are able to introduce quotations in English, which qualifies them as SAY predicates in her system. In Uyghur, verbs like “think” are able to combine with *dep* clauses (291).

- (291) Mahinur [Tursun-(ni) ket-t-i de-p] oyla-y-du.
 Mahinur [Tursun-ACC] leave-PST-3 say-CNV think-NONPST-3
 “Mahinur thinks Tursun left.”

Following Grimshaw, I assume that attitude verbs are obligatorily interpreted as internal “saying”. However, there are differences with respect to event structure and the types of complements that can be introduced under “say”. For instance, the stative use of “think” in (292a) is incompatible with an interrogative LM argument under *dep*, while eventive “think” in the progressive is (292b).⁹

- (292) a. * Mahinur [Tursun-(ni) ket-t-i=mu de-p] oyla-y-du.
 Mahinur [Tursun-ACC] leave-PST-3=Q say-CNV think-NONPST-3
 “Mahinur thinks Tursun left.”
- b. Mahinur [Tursun-(ni) ket-t-i=mu de-p] oyla-wat-i-du.
 Mahinur [Tursun-ACC] leave-PST-3=Q say-CNV think-PROG-NONPST-3
 “Mahinur thinks Tursun left.”

⁹I thank Deniz Özyıldız for drawing my attention to this distinction in Turkish. This is further reminiscent of what Özyıldız (2021) finds in English, with respect to interrogative clauses combining with “think”.

Intuitively, I assume that “think” in the progressive offers a deliberatory interpretation, by which the question is being pondered, while the simple present does not. I assume that this is settled by the speaker, as they evaluate whether the LM + *de-* “say” is capable of modifying the main clause VP. This shows that the type of LM argument is impacted not only by the predicate, but also by aspectual information encoded on the predicate.

One piece of evidence that *dep* is not the internal argument of “think” comes from the fact that the *dep* clause can occur in addition to the clausal anaphor *shundaq*, as shown in (293b), which would be unexpected if the *dep* clause itself were to saturate the internal argument slot of “think”.

- (293) a. Tursun shundaq oyla-y-du.
 Tursun so think-NONPST-3
 “Tursun thinks so.”
- b. ?Tursun [Mahinur-ni ket-t-i de-p] [shundaq oyla-y-du].
 Tursun Mahinur-ACC leave-PST-3 say-CNV so think-NONPST-3
 “Tursun thinks Mahinur left.”
- lit. “Tursun says Mahinur left and thinks (it) so.”

I assume these structures to similarly involve VP-*(I)p* constructions, which are interpreted as internal “saying”, because verbs like “think” or “know” do not encode the transmission of speech. In this way, a *dep* clause can only modify an attitudinal VP if it describes the thoughts held by the matrix subject. This seems to be the case, as even factive verbs are not interpreted as factive when they combine with *dep*, an issue that I return to later.

4.5.3.1 TP-modifying *dep* Constructions

The final type of *dep* construction that I discuss are those that do not involve modification of VP, but instead TP. In some cases, *dep* is interpreted as a single verb in a series of clauses, in which case it is a simple TP adjunct that involves an agent saying some LM, as in (294). These are straightforwardly like any other sequential *-(I)p* chain.

- (294) Tursun kél-ip, (andin) *pro* yaxshimusiz *de-p*, (andin) *pro* ket-t-i.
 Tursun come-CNV then hello say-CNV then leave-PST-3
 “Tursun came, said “hello”, and left.”

Where things get a bit more complex, are cases where there are multiple possible relationships, such as the “reason” interpretation corresponding to some *dep* clauses. Take for instance (295a) and (295b). Both are segmentally the same, but the adjunction site determines the interpretation. In (295a) it is possible that what is being reported is that there was a communicative act, followed by returning home. In (295b), the returning home is happening simultaneously with the (likely internal) “saying” event.

- (295) a. [[Mahinur_k Yakup-(ni) soqmaq yasa-y-du de-p] *pro*_k öy-ge
 Mahinur Yakup-ACC bars make-NONPST-3 say-CNV home-DAT
 qayt-t-i.]
 return-PST-3
 “Mahinur said Yakup would make soqmaq bars and returned home.”
- b. [Mahinur_k [*pro*_k Yakup-(ni) soqmaq yasa-y-du de-p] öy-ge
 Mahinur Yakup-ACC bars make-NONPST-3 say-CNV home-DAT
 qayt-t-i.]
 return-PST-3
 “Mahinur returned home saying that Yakup would make soqmaq bars.”

The analysis for (295a) is provided in (296), while (295b) involves the same VP-adjunction structure discussed throughout the previous section.

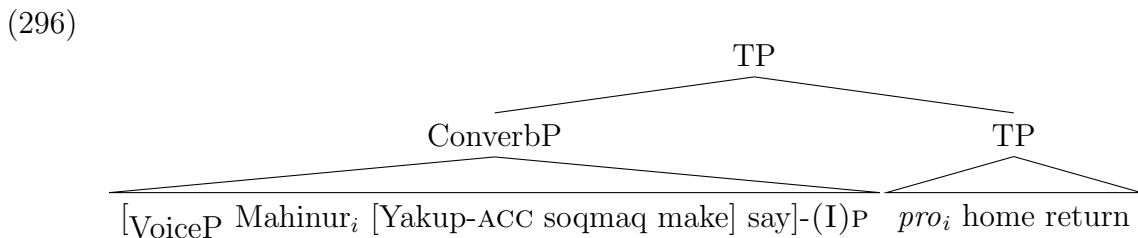

In this way, it is up to the speaker to determine what the most natural link between these clauses, which is likely a reason interpretation. This offers a potential explanation for cases like (297), which does not include a full clause as its complement, instead introducing only “Yakup”. If the link between clauses is pragmatic, it follows that speakers would associate

Mahinur ‘mentioning’ Yakup, and then leaving, as indicating that something related to Yakup is the reason that Mahinur left.

- (297) Mahinur [Yakup-ni de-p] (andin) *pro* öy-ge qayt-t-i.
 Mahinur Yakup-ACC say-CNV then home-DAT return-PST-3
 “Mahinur returned home having mentioned Yakup.”

We find parallel behavior in English in cases like (298a) and (298b), where there are multiple ways of interpreting the relationship between events.

- (298) a. Kayla said Jacob was making bars and went home.
 b. Kayla went home, saying that Jacob was making bars.

For instance, (298a) naturally involves the “saying” event, which is followed by “going home”, which is naturally interpreted as Cause-Result, but this is not required. (298b) shows the same optionality, again with a strong preference that “say” introduces a reason.¹⁰

In this way, I suggest that just as $-(I)p$ is sometimes ambiguous between VP- $(I)p$ and TP- $(I)p$, the same applies to *dep* constructions. In some cases, one is strongly preferred over the other, such as a VP headed by “scream” or “think” being modified directly by *dep*.

4.6 Evidence for “say” in *dep*

The previous section argued that the distribution and behavior of *dep* clauses is best understood on the basis of a decompositional analysis, by which general properties of “say” and converbial $-(I)p$ are taken into consideration. This section demonstrates that the properties of “say” discussed in Chapter 3 are possible in all environments involving *de*- “say”, including *dep*, including: Indexical shift, Raising-to-Object (accusative subjects), Direct Quotation, and some notes regarding factivity.

¹⁰A theory such as Discourse Coherence Theory (Kehler, 2002) might be better equipped to capture these distinctions than a purely syntactic account, at least if we want to understand felicity in these contexts.

4.6.1 Indexical Shift

It was argued in Chapter 3 that indexical shift arises from “say” introducing a monstrous operator $\llbracket \text{say} \rrbracket$. I further suggested that “say” is the only verb capable of doing so. A simple example involving “say” as a main verb is provided in (299).

- (299) Mahinur $\llbracket \text{say} \rrbracket$ men qachan ut-i-men] dé-d-i?
 Mahinur I when win-NONPST-1SG say-PST-3
 “When did Mahinur say $I_{Mahinur}$ will win?”

Recall that TECs are only able to be introduced by *de-* across all environments. In all *de-* environments, indexical shift is possible. This is shown in (300a)-(300d) for “scream”, “tell”, “hear”, and “win” respectively., which is not possible in any other environment. This is shown for

- (300) a. Mahinur $\llbracket \text{say} \rrbracket$ men qachan ut-i-men] dep warqiri-d-i.
 Mahinur I when win-NONPST-1SG say-CNV scream-PST-3
 “When did Mahinur scream $I_{Mahinur}$ will win?”
- b. Mahinur $\llbracket \text{say} \rrbracket$ men qachan ut-i-men] dep éyt-t-i.
 Mahinur I when win-NONPST-1SG say-CNV tell-PST-3
 “When did Mahinur tell $I_{Mahinur}$ will win?”
- c. Mahinur $\llbracket \text{say} \rrbracket$ men qachan ut-i-men] dep angli-d-i.
 Mahinur I when win-NONPST-1SG say-CNV hear-PST-3
 “When did Mahinur hear $I_{Mahinur}$ will win?”
- d. Mahinur $\llbracket \text{say} \rrbracket$ men qachan ut-i-men] dep oyun-da oyni-d-i.
 Mahinur I when win-NONPST-1SG say-CNV game-LOC play-PST-3
 “When did Mahinur play in a game, saying $I_{Mahinur}$ will win?”

Messick (2017) recognizes the tendency for indexical shift to occur only under complementizers derived from “say”. The present analysis suggests that these are not complementizers at all, but instead contain the verb “say”. In this way, it follows that “say” is always responsible for triggering indexical shift. This predicts that indexical shift should be possible in all contexts where “say” introduces a TEC, as shown in (301).

- (301) a. Tursun [مەن دەملە-ي-مەن دە-گەن قەھۋە-نى] مەنگە
 Tursun 1SG make-NONPST-1SG say-PTPL.PST coffee-ACC 1SG.DAT
 ber-d-i.
 give-PST-3
 “Tursun gave me the coffee he said I_{Tursun} made.”
- b. Tursun [مەن ھەر-ىپ كەت-ت-ىم دە-گەچ قەھۋە دەملى-د-ى.
 Tursun tired-CNV KET-PST-1SG say-SIM coffee make-PST-3
 “Tursun made coffee while saying I_{Tursun} am tired.”
- c. Tursun [مەن ھەر-ىپ كەت-ت-ىم دە-گەن-دىن كەيىن مەھىنۇر قەھۋە
 Tursun tired-CNV KET-PST-1SG say-PTPL.PST-ABL after Mahinur coffee
 demli-d-i.
 make-PST-3
 “After Tursun said I_{Tursun} am tired, Mahinur made coffee.”

The fact that accusative subjects are licensed when “say” is a main verb, in all *dep* contexts, and also when “say” is used in relative clauses (301a), simultaneous adverbial clauses headed by “say” (301b), and inside participial temporal adjuncts involving “say” (301c) serves as strong evidence that this is truly a property of *de-* “say”. I take this as solid evidence that “say” is present in *dep*, as opposed to a diachronic coincidence.

4.6.2 Raising-to-Object

Chapter 3 also showed that “say” is the only predicate that licenses accusative subjects in Uyghur. Following the same logic as for indexical shift in the previous section, if *dep* contains “say”, we should find that accusative subjects should be possible in all “say” environments. This is shown again for “say” as a main verb in (302).

- (302) Mahinur مەنى ۈت-ت-ى دە-د-ى.
 Mahinur 1SG.ACC win-PST-3 say-PST-3
 “Mahinur said I won.”

Just as *dep* can introduce indexical shift in all environments that it occurs, it shows a raising-to-object alternation in the same set of environments. This is shown with “scream” (303a), “tell” (303b), “hear” (303c), and “leave” (303d).

- (303) a. Mahinur méni ut-t-i de-p warqiri-d-i.
 Mahinur 1SG.ACC win-PST-3 say-CNV scream-PST-3
 “Mahinur screamed that I won.”
- b. Mahinur méni ut-t-i de-p éyt-t-i.
 Mahinur 1SG.ACC win-PST-3 say-CNV tell-PST-3
 “Mahinur told that I won.”
- c. Mahinur méni ut-t-i de-p angli-d-i.
 Mahinur 1SG.ACC win-PST-3 say-CNV hear-PST-3
 “Mahinur heard that I won.”
- d. Mahinur méni ut-t-i de-p ket-t-i.
 Mahinur 1SG.ACC win-PST-3 say-CNV leave-PST-3
 “Mahinur said I won and left.”

It is also possible to use *dep* to report the subject’s excuse for doing something. For instance, in (304), Mahinur cited “me” as the reason for leaving and this DP similarly requires accusative case.

- (304) Mahinur méni de-p ket-t-i.
 Mahinur 1SG.ACC say-CNV leave-PST-3
 “Mahinur mentioned me and left.”

Again, the licensing of an accusative subject is found in all “say” environments. Notice that an accusative subject is possible in the same set of environments as indexical shift, as shown in (305).

- (305) a. Tursun-ni kél-i-du dé-gen u adem kel-d-i.
 Tursun-ACC come-NONPST-3 say-PTPL.PST that man come-PST-3
 “That man who said that Tursun is coming came.”
- b. Tursun Mahinur-ni hér-ip ket-t-i dé-gech qehwe demli-d-i.
 Tursun Mahinur-ACC tired-CNV KET-PST-3 say-SIM coffee make-PST-3
 “Tursun made coffee while saying Mahinur is tired.”

- c. Tursun Mahinur-ni hér-ip ket-t-i dé-gen-din kéyin
 Tursun Mahinur-ACC tired-CNV KET-PST-3 say-PTPL.PST-ABL after
 öz-i qehwe demli-d-i.
 self-3POSS coffee make-PST-3
 “Tursun made coffee after saying Mahinur was tired.”

Again, the fact that accusative subjects are generally prohibited in the language except in TECs introduced by the verb “say” is strongly suggestive that *de*- “say” is directly correlated with accusative subjects. This is also suggestive that the same “finiteness” alternation discussed in Chapter 3 is active in all “say” environments. It can introduce a nominative subject that undergoes indexical shift or introduce an accusative subject that does not trigger expected phi-agreement on the predicate within the embedded clause. In Chapter 5, I argue that this is because accusative subjects are licensed within the extended projection of *de*- “say” in all contexts.

4.6.3 Direct Quotation

Similar to indexical shift, “say” is present in all instances of direct quotation and can introduce a direct quotation regardless of the predicate it occurs with. An example involving “say” as a main verb is provided in (306).

- (306) Mahinur “Oh- Men ut-t-um!” dé-d-i.
 Mahinur wow 1SG win-PST-1SG say-PST-3
 “Mahinur said, “Wow - I won!””

In addition to “say”, direct quotation is possible in all of the same *dep* environments discussed for indexical shift and raising to object, as shown in (307).

- (307) a. Mahinur “Oh- Men ut-t-um!” de-p warqiri-d-i.
 Mahinur wow 1SG win-PST-1SG say-CNV scream-PST-3
 “Mahinur screamed, “Wow - I won!””
 b. Mahinur “Oh- Men ut-t-um!” de-p éyt-t-i.
 Mahinur wow 1SG win-PST-1SG say-CNV tell-PST-3
 “Mahinur told, “Wow - I won!””

- c. Mahinur “Oh- Men ut-t-um!” de-p angli-d-i.
 Mahinur wow 1SG win-PST-1SG say-CNV hear-PST-3
 “Mahinur heard, “Wow - I won!””
- d. Mahinur “Oh- Men ut-t-um!” de-p ket-t-i.
 Mahinur wow 1SG win-PST-1SG say-CNV leave-PST-3
 “Mahinur left after saying, “Wow - I won!””

The same is true for direct quotation, which is able to be introduced regardless of the construction in which *de-* “say” occurs (308).

- (308) a. “Oh- Men ut-t-um!” dé-gen u adem kel-d-i.
 wow 1SG win-PST-1SG say-PTPL.PST that man come-PST-3
 “That man who said, “Wow - I won!” came.”
- b. Mahinur “Oh- Men ut-t-um!” dé-gech ussul oyni-d-i.
 Mahinur wow 1SG win-PST-1SG say-SIM dance play-PST-3
 “Mahinur danced while saying, “Wow - I won!””
- c. Mahinur “Oh- Men ut-t-um!” dé-gen-din kéyin ket-t-i.
 Mahinur wow 1SG win-PST-1SG say-PTPL.PST-ABL after leave-PST-3
 “Mahinur left after saying “Wow - I won!””

Recall that direct quotation is the diagnostic used in Grimshaw (2015) for SAY predicates in general. If we assume SAY in English to occur in the same environments as *dep* in Uyghur, we may expect that predicates that do not introduce direct quotations in English to be incompatible with *dep* in Uyghur. However, this does not seem to be the case, as even verbs like “know” and “remember” are capable of occurring with direct quotes introduced by *dep*.

- (309) a. * Mahinur knows/remembered “I won!”
- b. Mahinur “Men ut-t-um!” de-p bilidu/eslidi.
 Mahinur 1SG win-PST-1SG say-CNV knows/remembered
 “Mahinur knows, “I won!””

I conclude that it is “say” in these constructions that allows direct quotation involving internal thoughts, despite the fact that the main predicate is incapable of introducing direct quotes. In other words, it is the absence of “say” in these constructions that prohibits direct quotation in English, and its presence, that allows it across environments in Uyghur.

4.6.4 Factivity and *dep*

One interesting aspect of *dep* clauses is that the content they introduce is never interpreted as factive. This is true of all of the environments discussed in the previous section. In recent literature, it has been shown that a wide variety of languages exhibit a factivity alternation based on the status of the complement of the embedding predicate (Moulton, 2009; Hanink and Bochnak, 2017; Özyıldız, 2017; Bondarenko, 2020). A similar alternation exists in Uyghur (310).

- (310) a. Mahinur Tursun-ning ket-ken-lik-i-ni bil-i-du, #biraq
 Mahinur Tursun-GEN leave-PTPL-COMP-3POSS-ACC know-NONPST-3 but
 u ket-mi-d-i.
 he leave-NEG-PST-3
 “Mahinur knows that Tursun left, but he didn’t leave.”
- b. Mahinur Tursun-(ni) ket-t-i de-p bil-i-du, biraq u
 Mahinur Tursun-ACC leave-PST-3 say-CNV know-NONPST-3 but he
 ket-mi-d-i.
 leave-NEG-PST-3
 “Mahinur knows something, saying that Tursun left, but he didn’t leave.”

The “but” continuation would be infelicitous due to contradiction if the complement of “know” were factive (i.e. the speaker is committed to the truth of the complement of “know”). This is what we find in (310a), where the NEC complement to “know” exhibits a factive presupposition. However, the contradiction vanishes when “know” combines with a *dep* clause in (310b). In other words, the speaker is only committed to Tursun’s having left as a fact when the complement is a NEC, not a TEC.

Sudo (2012) treats the alternation in (310) as involving two distinct predicates, one that means “believe” and the other that means “know”. The present analysis offers a different perspective on this issue. More specifically, TECs are not introduced by any predicate other than “say” or *dep* and “know” does not select *dep* clauses - they combine via complex predicate formation. For this reason, because the TEC is introduced by *dep*, the complement to *dep* should only be factive if “say” is factive. In both cases in (311), it is shown that

regardless of whether “say” introduces an NEC (311a) or a TEC (311b), the continuation does not force a contradiction, suggesting it is not factive.

- (311) a. Mahinur Tursun-ning ket-ken-lik-i-ni dé-d-i, biraq u
 Mahinur Tursun-GEN leave-PTPL.PST-COMP-3POSS-ACC say-PST-3, but he
 ket-mi-d-i.
 leave-NEG-PST-3
 “Mahinur said Tursun left, but he didn’t leave.”
- b. Mahinur Tursun-(ni) ket-t-i dé-d-i, biraq u ket-mi-d-i.
 Mahinur Tursun-ACC leave-PST-3 say-PST-3 but he leave-NEG-PST-3
 “Mahinur said Tursun left, but he didn’t leave.”

However, a DP complement to “know” such as “news” is presuppositional in sentences like (312a). The same holds for “news” when introduced under “know” in a *dep* construction (312b). The existence of the news is presupposed, but the complement of *dep* is non-presuppositional.

- (312) a. Mahinur u xewer-ni bil-i-du, #biraq xewer yoq.
 Mahinur that news-ACC know-NONPST-3, but news NEG.EXIST
 “Mahinur knows the news, #but the news does not exist.”
- b. Mahinur {u xewer-ni} [Tursun-(ni) ket-t-i de-p] {u xewer-ni}
 Mahinur that news-ACC Tursun-ACC leave-PST-3 say-CNV that news-ACC
 bil-i-du, #biraq xewer yoq.
 know-NONPST-3, but news NEG.EXIST
 “Mahinur knows the news saying that Tursun left, #but the news does not exist.”

If we take this to be a complex event composed of “knowing news” and “saying Tursun left”, it follows that the existence of news be presupposed, because it is the complement of “know”, while “Tursun left” is not factive because it is the complement of *dep*. However, it is possible for a content noun like “news” to select a nominalization, in which case it behaves like English content nominals (see Moulton, 2009).

- (313) Mahinur Tursun-ning ket-ken-lik xewir-i-ni bil-i-du,
 Mahinur Tursun-GEN leave-PTPL.PST-COMP news-3POSS-ACC know-NON.PST-3
 #biraq u ket-mi-d-i.
 but he leave-NEG-PST-3
 “Mahinur knows the news that Tursun left, but he didn’t leave.”

Asarina (2011) argues that there is always a nominal that hosts possessive agreement and case in NECs. In other words, when there is no overt noun like “news” above, there is a null noun that merges into the same position. It then follows that the entire complement to “know” would behave as a unit as it relates to what is presupposed and what is not.

If we take the availability of overt nominals like “news” as evidence for the presence of a nominal argument more generally, as Asarina does, we can apply the same logic to *dep* constructions. When the main verb is transitive, like “know” it always introduces an argument, which can optionally be pronounced, as shown in (314).

- (314) Mahinur [[Tursun-(ni) ket-t-i de-p] [bu xewer-ni/*ec* bil-i-du]].
 Mahinur Tursun-ACC leave-PST-3 say-CNV this news-ACC know-NONPST-3
 “Mahinur says Tursun left and knows this as news.”

There is not sufficient space to offer a complete analysis of what exactly the EC is in cases like (314), but it is important to recall the discussion of null arguments in Uyghur more broadly. It is possible for null arguments to behave like standard *pro* or like e-type pronouns. If we assume the structure from (286) here, the result is as shown in (315).

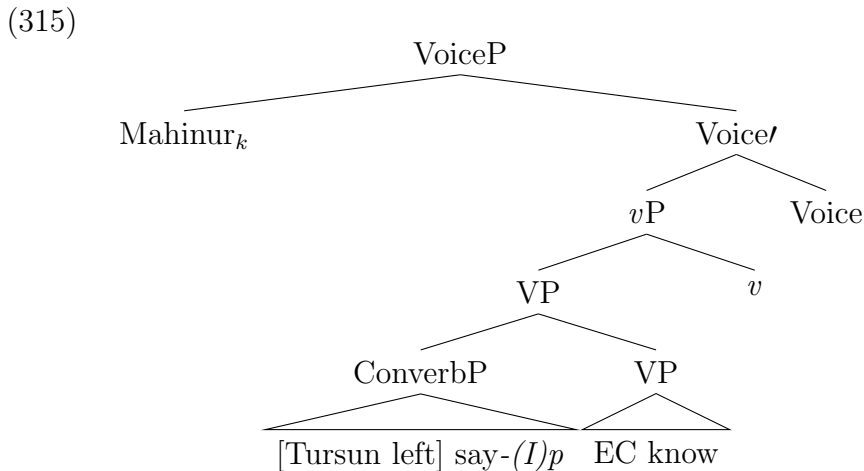

The exact status of the EC remains unclear in these constructions, but under the present analysis, the EC would be presupposed (i.e. that Mahinur knows something). However, the *dep* clause functions as a standard *say_{Source}* construction that indicates that Mahinur was the source of the LM and that the LM was that Tursun left. I leave the precise identity of the EC to future research, but as long as it is not identical to the proposition introduced by *dep*, it would not be construed as factive. Perhaps one of the most unclear remaining puzzles is what “knowing” means in Uyghur.

One important fact to note is that Uyghur “know” has a different range of meanings from English. For instance, it is able to naturally occur in the progressive (316).

- (316) Mahinur Tursun-(ning) ket-ken-lik-i-ni bil-iwat-i-du,
 Mahinur Tursun-GEN leave-PTPL-PST-COMP-3POSS-ACC know-DUR-NONPST-3
 #biraq u ket-mi-d-i.
 but he leave-NEG-PST-3
 “Mahinur is coming to know that Tursun left, #but he did not leave.”

In (316), “know” describes a process of developing knowledge. Perhaps this sheds light on how to understand (314). In this way, perhaps the two clauses represented in (315) should be intuitively thought of as “Mahinur is coming to know something, saying Tursun left.” The *dep* clause functions as a normal *say_{Source}* construction (i.e. Mahinur is the source of the LM: “Tursun left”), and the speaker is reporting that Mahinur is in the process of treating this as knowledge (a fact).

It should be noted that this is not an isolated property of “know”, which would be more amenable to a lexical ambiguity analysis. However, the data in (317) strongly suggests that the pattern is quite regular. First, all accusative-marked NECs (317a) and dative-marked NECs (317b) introduced by factive verbs are interpreted as factive in Uyghur. However, *dep* can occur with all of them, rendering them non-factive (317c).

- (317) a. Mahinur [Tursun-ning ket-ken-lik-i-ni]
 Mahinur Tursun-GEN leave-PTPL.PST-COMP-3POSS-ACC
 bilidu/eslidi/kördi, #biraq u ket-mi-d-i.
 knows/recalled/saw, but he leave-NEG-PST-3
 “Tursun knows/recalled/saw that Tursun left, #but he didn’t leave.”
- b. Mahinur [Tursun-ning ket-ken-lik-i-ge]
 Mahinur Tursun-GEN leave-PTPL.PST-COMP-3POSS-DAT
 ökündi/gumanlandi/nepretlendi, #biraq u ket-mi-d-i.
 regret/doubt/resent, but he leave-NEG-PST-3
 “Mahinur regrets/doubts/resents that Tursun left, #but he didn’t leave.”
- c. Mahinur [Tursun-(ni) ket-t-i de-p]
 Mahinur Tursun-ACC leave-PST-3 say-CNV
 [bilidu/eslidi/kördi/ökündi/gumanlandi/nepretlendi], biraq u
 knows/recalled/saw/regretted/doubted/resented but he
 ket-mi-d-i.
 leave-NEG-PST-3
 “Mahinur knows/recalled/saw/regretted/doubted/resented (something), say-
 ing Tursun left, but he didn’t leave.”

The fact that the whole range of factive predicates in (317c) are non-factive when they occur with *dep* suggests we should not analyze the factivity alternation via lexical ambiguities. If we assume that “say” is present in these structures and responsible for introducing TECs, it follows naturally that the lack of factivity is a result of “say” being present in the structure and non-factive.

There are some predicates that shed some light on the properties at work with respect to *dep* clauses and factivity. For instance, “forget” selects NECs and is interpreted as factive (318a). However, it cannot get the same event construal as the predicates above, for what I take to me pragmatic reasons, as shown in (318b).

- (318) a. Mahinur Tursun-ning ket-ken-lik-i-ni unut-t-i,
 Mahinur Tursun-GEN leave-PTPL.PST-COMP-3POSS-ACC forget-PST-3
 #biraq u ket-mi-d-i.
 but he leave-NEG-PST-3
 “Mahinur forgot that Tursun left, #but he did not leave.”

- b. Mahinur Tursun-(ni) ket-t-i de-p unut-t-i, biraq u
 Mahinur Tursun-ACC leave-PST-3 say-CNV forget-PST-3 but he
 ket-mi-d-i..
 leave-NEG-PST-3
 #“Mahinur forgot something, saying that Tursun left, but he didn’t leave.
 “Mahinur said Tursun left and then forgot, but he didn’t leave.

Mahinur is unable to simultaneously have communicated and forgot something. As a result, speakers cannot accommodate *dep* + forget with this meaning. However, speakers can accommodate (318b) as a sequential construction meaning “Mahinur said Tursun left and then forgot (that she said Tursun left).” This is exactly the behavior found for *-(I)p* constructions more broadly, where the same event construction is far more restrictive than any of the other uses of *-(I)p*.

4.7 Recap

Chapters 3 and 4 analyze *dep* as the sum of its parts: *de-* “say” and converbial *-(I)p*. The results explain different realizations of LM, new insights into finiteness, and the distribution of indexical shift. This discussion of Uyghur has implications for a wide range of questions/phenomena in the syntax and semantics literature.

For instance, Deal (2020) offers a broad typology of indexical shift, describing the predicates that are capable of licensing indexical shift. Furthermore, Messick (2017) mentions that indexical shift is correlated with special complementizers cross-linguistically. The present analysis suggests we may reduce the number of predicates capable of licensing indexical shift (in at least some of these languages) to one: “say”.¹¹ More specifically, this reduces whether “say” selects a monstrous operator or not. The same is true of quotative operators.

Related to indexical shift and quotation, this proposal offers new questions to investigate in other languages, that exhibit so-called “quotative markers”, which show distributional and semantic/pragmatic properties similar to *dep* clauses. For instance, Japanese *to* (see

¹¹Balusu (2020) makes similar observations for Dravidian.

Shimamura, 2018) and Korean *ko* (see Kim, 2018) share many, but not all properties linked to *dep*. It seems reasonable that these elements could represent the lower shell of “say”, lacking a *v*, but projecting the rest of the SayP structure.

Furthermore, this chapter introduces a new line of inquiry for languages that exhibit hyper-raising and exceptionally case-marked embedded subjects. Wurmbrand (2019) discusses raising out of finite clauses in Turkish, Buryat (Mongolic), and Zulu (Bantu), all of which exhibit “say”, or at least verbal, complementation structures. The analysis put forth here suggests that associating finiteness with the precise nature of what “say” selects determines case, agreement, and raising, as opposed to the presence/absence of tense, largely in following with George and Kornfilt (1981). I suspect that a new notion of finiteness may allow us to maintain traditional analyses of cross-clausal A-dependencies. Issues related to case theory are discussed at length in the next chapter.

4.8 About *si* “say” in Avatime

Additional support for the analysis in Uyghur comes from Avatime. Recall from the discussion in Chapter 2, that Avatime morphologically distinguishes between eventive and stative “say”. Avatime also shows the same general properties as Uyghur as it relates to complex “say” constructions. More specifically, there is a specific type of Serial Verb construction in the language that involves verbal sequences where the Subject Marker occurs on only the first verb.

As was the case in Uyghur, such examples are reminiscent of resultative constructions. However, also in alignment with the Uyghur facts, these constructions involve two transitive verbs, e.g. “shoot” and “kill” (319a), not a transitive “kill” followed by an unaccusative “die” (319a).

- (319) a. a-ta ɔ-ga=ɛ ye.
 3SG-shoot CL-goat=DEF kill
 “He shot the goat dead.” (Defina, 2016:662, ex: 37)

- b. * a-ta ɔ-ga=ε tse.
 3SG-shoot CL-goat=DEF die
 Intended: “He shot the goat dead.” (Defina, 2016:662, ex: 37)

Based on my fieldwork, the only SVCs that require that non-initial subject markers on verbs are what Defina refers to as “Nuclear” SVCs, based on Van Valin (2005). This is exemplified by (319a) above. Nuclear SVCs are the most restrictive and require the tightest connection between their verbs, exhibiting the following modificational functions: Posture, Manner+path, Complex path, and Manner+activity. Crucially, nuclear SVCs allow modification of the entire series, but not only a single clause, as shown for the “Itive” marker in (320).

- (320) a. Komla a-zε-tà ɔ-gà=ε ye.
 Komla 3SG-ANDATIVE-shoot CL-goat=DEF kill
 “Komla went and shot and killed the goat.” (Defina, 2016:669, ex: 60a)
- b. * Komla a-tà ɔ-gà=ε zε-ye.
 Komla 3SG-shoot CL-goat=DEF ANDATIVE-kill
 “Komla went and shot and killed the goat.” (Defina, 2016:669, ex: 60b)

Nuclear SVCs do not allow manner adverbs, which generally occur clause finally, to modify only VP in these constructions. The manner adverb must occur after the second verb and similarly must modify the entire complex predicate (321a) and cannot modify just a single VP (321b).

- (321) a. Kofi a-ta ɔ-ga=ε ye ziazia.
 Kofi 3SG-shoot CL-goat=DEF kill quickly
 “Kofi quickly shot the goat dead.”
- b. * Kofi a-ta {ziazia} ɔ-ga=ε {ziazia} ye .
 Kofi 3SG-shoot quickly CL-goat=DEF quickly kill
 Intended: “Kofi quickly shot the goat dead.”

With regard to negation, the entire complex predicate can be negated, but the second

VP cannot be negated independently, nor can both verbs host negative marking.¹²

- (322) a. Kofi ó-tá ɔ-ga=ε ye.
 Kofi 3SG.NEG-shoot CL-goat-DEF kill
 “Kofi didn’t shoot the goat.”
- b. *Kofi ó-tá ɔ-ga=ε ó-ye.
 Kofi 3SG.NEG-shoot CL-goat-DEF 3SG.NEG-kill
 Intended: “Kofi didn’t shoot the goat.”
- c. *Kofi a-ta ɔ-ga=ε ó-ye.
 Kofi 3SG-shoot CL-goat-DEF 3SG.NEG-kill
 Intended: “Kofi shot the goat and didn’t kill it.”

It is only possible for a single tense marker to occur, which must precede the initial predicate, as shown in (323).

- (323) a. Kofi a-tá-ta ɔ-ga=ε ye.
 Kofi 3SG-FUT-shoot CL-goat-DEF kill
 “Kofi will shoot and kill the goat.”
- b. *Kofi a-tá-ta ɔ-ga=ε a-tá-ye.
 Kofi 3SG-FUT-shoot CL-goat-DEF 3SG-FUT-kill
 Intended: “Kofi will shoot and will kill the goat.”
- c. *Kofi a-ta ɔ-ga=ε a-tá-ye.
 Kofi 3SG-shoot CL-goat-DEF 3SG-FUT-kill
 Intended: “Kofi shot and will kill the goat.”

Finally, aspect markers, such as *zě* (progressive) are able to occur only to the left of the initial predicate (324).

- (324) a. Kofi a-zě-ta ɔ-ga=ε ye.
 Kofi 3SG-IT-shoot CL-goat-DEF kill
 “Kofi is shooting and killing the goat.”

¹²Cases where only one VP is negated must be expressed with an overt conjunction or with a large pause, in which case the second clause requires a resumptive pronoun. This is incompatible with the SVC structure.

- b. * Kofi a-zě-ta ɔ-ga=ε a-zě-ye.
 Kofi 3SG-IT-shoot CL-goat-DEF 3SG-IT-kill
 Intended: “Kofi is shooting and killing the goat.”
- c. * Kofi a-ta ɔ-ga=ε a-zě-ye.
 Kofi 3SG-shoot CL-goat-DEF 3SG-IT-kill
 Intended: “Kofi shot and is killing the goat.”

Nuclear SVCs are reflected by the morphology of “say” complementation structures. These structures involve an inflected first predicate, followed by a second predicate, which it is closely related to. In the case of (325), it looks like the mirror image of Uyghur, where the first predicate, “scream” indicates manner, and the second introduces LM.

- (325) kofi a-[[kpe o-zi-lo] [sì Ayápe a-sè]].
 Kofi 3SG.PFV-put CL-yell-DEF SAY Ayape 3SG-leave
 “Kofi yelled that Ayape left.”

Si cannot bear any inflection in these constructions, cannot take event/manner modification, or introduce a goal, which is a general property of Nuclear SVCs, as shown above. If we apply the same logic as Uyghur, the result is that the main predicate indicates the manner/what was done, while *si* introduces the LM (the result of the screaming).

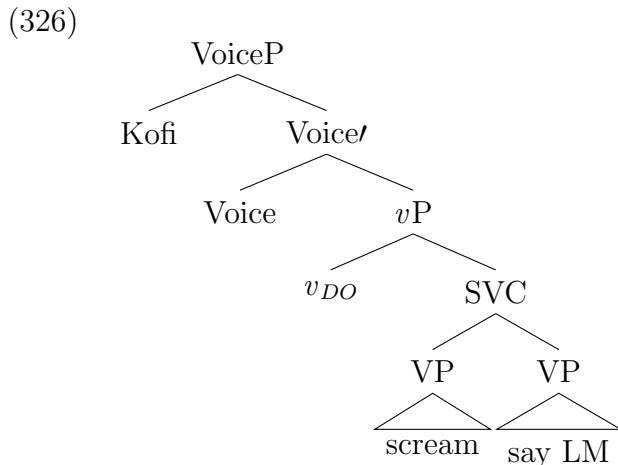

Also like Uyghur, it can be illustrated that *si* clauses are not necessarily selected by V or N. First, it occurs in clearly unselected environments, such as (327), where it functions as a purpose clause.

- (327) Kofí e-dzi li-gbo-lè [sì yi-zè].
 Kofi 3SG-buy CL-chair-DEF say LOG-SBJ-sit
 “Kofi bought the chair saying he would sit (on it).”

I assume this to be analogous to what happens in Uyghur, where *si* clauses can combine with any predicate that is able to combine with it to form a coherent relationship.

If we compare this with (328), notice that the two events are related as sequential, but cannot be construed as a single event. To link these events, despite the fact that they have the same subject, the clausal conjunction *lě* is preferred and a subject marker is required on both “buy” and “sit”. This is suggestive that Avatime *si* constructions are restricted to the lower attachment site, unlike Uyghur.

- (328) Kofí e-dzi li-gbo-lè [(le) *(e)-zè.]
 Kofi 3SG-buy CL-chair-DEF and.then 3SG-sit
 “Kofi bought the chair and sat on it.”

Furthermore, like Uyghur, it is possible for the main verb to introduce certain types of DP arguments that *si* “say” cannot. For instance, the type of indefinite DP selected by *si* “say” is different from the type of indefinite selected by *do* “say/tell”

- (329) a. Kofí (a)-sì ki-dí-tɔ/*li-boé-tɔ.
 Kofi -m3sg-say CL-THING-INDEF/CL-thing-INDEF
 “Kofi said something (i.e. some words).”
 b. Kofí (e)-do li-boé-tɔ/*ki-dí-tɔ.
 Kofi -m3sg-say CL-thing-INDEF/CL-THING-INDEF
 “Kofi said something (i.e. some words).”

Interestingly, *si* can introduce *ki-dí-tɔ* and combine with *do* (330).

- (330) Kofí (e)-do si ki-dí-tɔ.
 Kofi -m3sg-say SAY CL-THING-INDEF
 “Kofi said something (i.e. some words).”

First, if an anaphoric DP is inserted as the complement to a verb, it would generally stand in for the entire clause, including the complementizer, as shown in (331).

- (331) a. Mary knows something.
 b. *Mary knows that something.

The fact that *si* not only avoids substitution in cases like (330), but also introduces the type of indefinite that is unique to “say” among speech/attitude verbs is solid evidence that this is not a typical clausal complementation structure. However, it is compatible with the Nuclear Serial Verb Construction analysis provided here, because each verb, *do* and *si* has a different function in this construction. More specifically if we assume *ki-dí-to* to stand in for a LM argument and that *si* obligatorily introduces a LM argument, it follows that when *si* is present, it will always introduce a LM argument, regardless of the predicate it combines with.

Similar facts obtain from looking at different predicates that select for complements with distinct Force specifications. For instance, consider both the proposition-selecting predicates in (332a) and interrogative-selecting predicates in (332b). Each of these predicates is able to occur with a DP internal argument and a *si* clause. The *si* clause must introduce LM with matching force, but there is not a different element that introduces the LM in each case.

- (332) a. Kofi e-**do**/fami/bu li-boé-to/li-gabwe. sì Ayape
 Kofi 3SG-told/screamed/thought CL-thing-INDEF/CL-nonsense say Ayape
 a-sè.
 3SG.PFV-leave
 “Kofi told/said/screamed/thought something/the nonsense, saying: ‘Ayape left’.”
- b. Kofi e-**vi** li-boé-to/kù-vi-vi sì Ayape
 Kofi 3SG-ask CL-SOMETHING-INDEF/CL-question-NZLR say Ayape
 a-sè nà.
 3SG.PFV-leave Q
 “Kofi asked something/the question, saying: ‘Did Ayape leave?’.”

When the first predicate does not match the Force associated with the LM introduced by *si*, the sentences become infelicitous (333).

- (333) a. # Kofi e-**do**/fami/bu li-boé-tɔ/li-gabwe sì Ayape
 Kofi 3SG-told/screamed/thought CL-thing-INDEF/CL-nonsense say Ayape
 a-sè nà.
 3SG.PFV-leave Q
 Intended: “Kofi told/said/screamed/thought something/the nonsense, saying: “Did Ayape leave?.”
- b. # Kofi e-**vi** li-boé-tɔ/kù-vi-vi sì Ayape
 Kofi 3SG-ask CL-SOMETHING-INDEF/CL-question-NZLR say Ayape
 a-sè.
 3SG.PFV-leave
 Intended: “Kofi asked something/the question, saying: ‘Ayape left’.”

In this way, the type of content nominal is determined locally based on selection by V, but *si* can occur with any of these predicates as long as the LM it introduces is compatible with the Force specifications of the initial predicate. This is likely the same reason that two predicates, such as “eat” and “drink” are unable to occur in Nuclear SVC configurations. Their internal arguments are incompatible (one solid and one liquid) and they cannot happen simultaneously. I assume the same for a proposition selecting predicate and a *si* clause that introduces interrogative LM.

Avatime requires further investigation, but the preliminary discussion here, in addition to Major and Torrence (To Appear), provide clear evidence that *si* clauses are highly reminiscent of their Uyghur converbial counterparts. In this way, I again stress that it is not a coincidence that verbs with “say” complementation structures (always?) have an additional mechanism reserved for forming complex predicates.

4.9 Conclusions

The analysis in this chapter suggests that understanding “say” complementation structures require a detailed understanding of the linking mechanism involved, such as converbial constructions in Uyghur, in addition to an analysis of the verb “say”. I have argued that the distribution of *dep* clauses is best understood based on the distributional properties of con-

verbs more generally. Furthermore, I have shown that all of the properties unique to “say” as a main verb apply to constructions involving *dep*: indexical shift, raising to object, direct quotation, factivity (or lack thereof) and more. Finally, I have argued that there is a pragmatic component involved in determining which predicates can combine with *dep* and how they will be construed.

CHAPTER 5

Uyghur Dependent Case Theory

5.1 Introduction

Chapters 3-4 both offered in-depth discussion of *dep* clauses, demonstrating that they are best analyzed as the sum of their parts “say” + converbial *-(I)p*. One issue that was discussed in both chapters involves the status of accusative subjects of TECs. Baker and Vinokurova (2010) (henceforth B&V) discuss similar data in Sakha (Northeastern Turkic) as having implications for Case Theory. The purpose of this chapter is to revisit B&V’s work through the lens of the analysis of *dep* constructions proposed in Chapters 3-4.

B&V revitalized debate with respect to the role and assignment of Case in generative grammar. In the Government and Binding/Principles and Parameters era, Burzio (1986) proposed a positive correlation between the introduction of an agent and the assignment of accusative case, encapsulated as “Burzio’s Generalization”. Since Chomsky (2000), one prominent proposal that establishes a direct correlation between an external argument and accusative case on direct objects involves an Agree(ment) relation between a probe, *v* (or Voice), and a goal, which is the internal argument of the verb.¹ Assuming that *v* is responsible for introducing an external argument and also accusative case, Burzio’s generalization is straightforwardly captured by this theory (henceforth Case-by-Agree).²

¹Kratzer (1996) argues that Voice is responsible for introducing the external argument. I remain agnostic as to whether the same head is responsible for introducing the external argument and assigning accusative case.

²Throughout this paper, I frame the theoretical discussion as a competition between Case-by-Agree versus Dependent Case Theory, although other analyses associated accusative case with a functional head would suffice, such as spec-head agreement (Chomsky, 1986; Kayne, 1989; Koopman and Sportiche, 1989) or a combination of spec-head agreement and government (Koopman and Sportiche, 1991).

B&V point to cases like (334) as evidence against Case-by-Agree.³ This structure appears to lack a transitive verb altogether, thus lacks *v*, and should be incapable of licensing accusative case. However, the subject of the *dien* clause, *Misha* gets accusative marking in spite of this fact. Based on data like this, B&V argue in favor of *Dependent Case Theory* (DCT), a configurational theory of case based on Marantz (1991). Further, Burzio’s Generalization results from a c-command relation between two arguments within the same local domain (the same phase). Under this theory, *Misha* raises into the same domain as the matrix subject *Masha*, which c-commands it, as the result of a DCT rule, gets accusative case because it is the lower of two NPs within the matrix CP phase.

- (334) Masha [Misha-**ny** [yaldj-ya **dien**]] tönün-ne.
 Masha Misha-ACC fall.sick-FUT.3SS that return-PST.3SS
 “Masha returned (for fear) that Misha would fall sick.” (B&V, 617:44)

The important question is whether (334) truly lacks a *v* capable of licensing accusative case on the subject, *Misha*. The element translated as “that” above is equivalent to Uyghur *dep*. It too consists of the verb *die-* “say” and the converbial suffix *-(E)n*.⁴ Throughout this chapter, I argue that the decompositional analysis of these complementation structures reopens the possibility that Case-by-Agree is responsible for accusative assignment, while simultaneously improving the predictive power of DCT if we choose to maintain it.

This chapter primarily focuses on data from Uyghur, which is for the most part identical

³I use the glosses offered by B&V for all Sakha data. I assume that upon further scrutiny, the glosses that are offered for the Uyghur equivalent data are likely more accurate, however.

⁴Sakha *dien* is composed of the same morphological pieces as Uyghur *dep*. In Sakha, the converbial suffix is *-(A)n* as exemplified in (1):

- (1) o-nu me:kkele:-n leppieske oŋor-on hi:-r e-ti-bit
 that.OBL-ACC grind-PF.CVB flatbread make-PF.CVB eat-PRSP AUX-PST-1PL
 “We ground that and made flatbread and ate that.” (Pakendorf et al., 2007:144:28e)

Similarly, there is evidence that *dien* at least sometimes behaves like a full lexical verb, as in (2).

- (2) je hirit-tin törö-büt doydu-tugar di-en
 well walk.IMP.3SG be.born-PSTPT land-DAT.3SG say-PF.CVB
 “Saying: ‘well, let him walk around in his home country.’” (Pakendorf et al., 2007:209:64a)

to Sakha; enough so that a similar analysis is preferable for both languages. This chapter is structured as follows. In section 2, I provide relevant background on case theory, introduce the basic Uyghur facts, highlight a few minor differences between Uyghur and Sakha, and demonstrates that the data in Uyghur and Sakha are nearly identical.

Section 3 provides an overview of embedded accusative subjects, illustrating that they are Raising-to-Object constructions, and a brief comparison between them and prolepsis constructions. Section 4 begins by illustrating that DCT does not adequately account for either the Sakha or Uyghur data as laid out by B&V. I subsequently broaden the empirical picture, offer argumentation for the decompositional analysis of the complementizer-like element into its component parts: “say” and the converbial linker $-(I)p$. I then show that the distribution of accusative case, in addition to environments where accusative is not licensed, fall out from general properties of “say” and converbs. In section 5 I conclude that Case-by-Agree is sufficient to account for the distribution of accusative case, and because it is more restrictive, thus making stronger predictions, is preferable to DCT.

5.2 Case theory and language background

The empirical landscape for accusative case is essentially the same for Uyghur and Sakha in monoclausal utterances. The goal of this section is to introduce both theories of case as laid out in B&V and then show how the mechanics work based on these simple monoclausal structures, before moving into more complex structures.

5.2.1 Background on Case Theory

The formal principles of case assignment presented in (Baker and Vinokurova, 2010:595:4a-b) for DCT are shown in (335).⁵

⁵B&V argue that nominative and genitive case require an Agree-based system, while accusative and dative require DCT. In subsequent research to B&V, Levin and Preminger (2015) argue that it is possible to account for nominative and genitive case using a configurational method of case calculus. This paper does the inverse, meaning that when combined with B&V, the entire case system can be accounted for using an Agree-based system.

- (335) a. If there are two distinct argumental NPs in the same VP-phase such that NP1 c-commands NP2, then value the case feature of NP1 as dative unless NP2 has already been marked for case.
- b. If there are two distinct argumental NPs in the same phase such that NP1 c-commands NP2, then value the case feature of NP2 as accusative unless NP1 has already been marked for case.

In DCT, case is determined by a confluence of factors: i) the c-command relationship between two DPs both in the same local domain (i.e. phase), ii) which phase the c-command relation occurs in, and iii) whether either of the NPs has already been assigned case. It is well-known across Turkic that accusative direct objects derive from raising into a higher position (B&V for Sakha, Kornfilt (1997); Öztürk (2013) for Turkish, also discussed at length in the previous two chapters of this dissertation for Uyghur. For B&V, the position where accusative is assigned is at the edge of VP, which they argue to be a phase edge. As a consequence of the object raising into the edge, it becomes accessible to the higher phase for case calculus. The raised object, being the lower of two NPs within the higher phase, gets accusative case, as schematized in (336). Objects that do not raise, on the other hand, are inaccessible to the higher phase, and remain unmarked. In Baker (2015), a minor modification is made; namely, the internal object raises into the specifier of *v* (337). This option is more in following with standard assumptions regarding phasehood, because *v* is treated as the phase head. As far as I am aware, both (336) and (337) make the same prediction: whenever the internal argument raises into a position accessible to the higher phase, it will receive accusative case as long as there is a c-commanding NP argument in the higher phase.

$$(336) \quad [[_{vP} \underbrace{SUBJ [_{VP} OBJ - ACC]_k}_{CPPhase} [[_{VP} t_k V] v] T]$$

$$(337) \quad [_{vP} \underbrace{SUBJ [[OBJ - ACC]_k}_{CPPhase} [_{VP} t_k V] v] T]$$

Deriving accusative case with Case-by-Agree is hardly distinct from (337). The only

substantive difference is that an active v is responsible for accusative-assignment under Case-by-Agree (based on Chomsky, 2000, 2001), as spelled out in (338).

- (338) If a functional head $F \in \{ T, D \}$ has unvalued phi-features and an NP, X, has an unvalued case feature [and certain locality conditions hold], then agreement happens between F and X, resulting in the phi-features of X being assigned to F and the case associated with F being assigned to X. (B&V, 596)

Given that this chapter is focused on accusative case, I assume the relevant probing head to be v , which is generally assumed to correlate with transitive and unergative verbs. B&V argue that (338) is untenable, because accusative case occurs in environments that appear to lack an overt v . I argue that no such cases exist, which makes (338) sufficient to account for almost the entire distribution of accusative case. As mentioned in Chapter 3, I assume the analysis in (339) for accusative case.

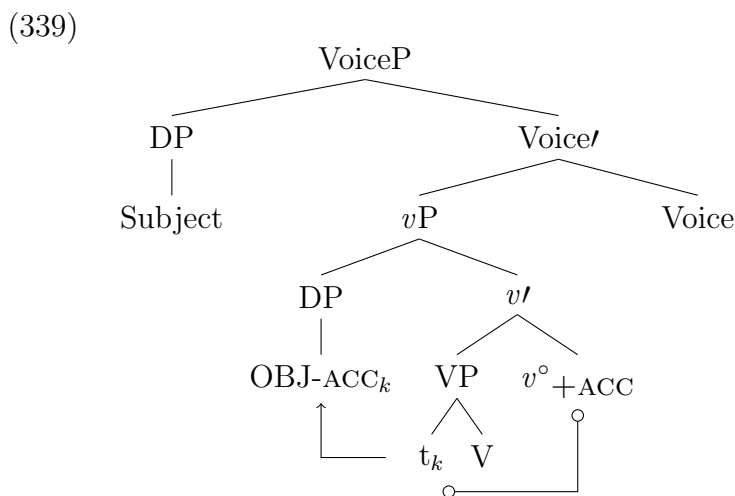

This analysis assumes the landing site of accusative elements to be the specifier of v . The analysis above shares one crucial property with the DCT analysis: accusative objects are obligatorily derived by raising. The difference is that DCT does not assume that the movement step and accusative case are achieved via Agreement with v , but rather is epiphenomenal, being made possible by the movement step. This is fully compatible with the updated DCT analysis introduced in Baker (2015) for Sakha.

5.2.2 Accusative case in (di)transitive constructions

The previous section introduced the technical details of case theory. This section offers a quick recapitulation of the basic facts introduced in the preceding chapters. Recall that there are both syntactic and semantic properties associated with accusative case in Uyghur. With respect to a manner adverbial, internal arguments that remain in their merge position (to the right of the adverb) are obligatorily bare, while those that raise higher than the manner adverb (to the left of it) are obligatorily accusative marked:

- (340) a. Mahinur *téz* **polu-*(ni)** *yé-d-i*.
Mahinur quickly pilaf-ACC eat-PST-3
“Mahinur quickly ate pilaf.”
- b. Mahinur **polu-*(ni)** *téz* *yé-d-i*.
Mahinur pilaf-ACC quickly eat-PST-3
“Mahinur quickly ate the pilaf.”

Expanding this discussion to include dative arguments, Uyghur exhibits the same behavior as Sakha. When the direct object linearly follows the indirect object and is adjacent to the verb, it cannot be accusative-marked (in neutral contexts) (341a). When the direct object precedes the indirect object, it must bear accusative marking and is interpreted as specific, as shown in (341b).

- (341) a. Mahinur *manga* **polu** *ber-d-i*.
Mahinur 1SG.DAT pilaf give-PST-3
“Mahinur gave me pilaf.”
- b. Mahinur **polu-*(ni)** *manga* *ber-d-i*.
Mahinur pilaf-ACC 1SG.DAT give-PST-3
“Mahinur gave me the pilaf.”

From the perspective of Case-by-Agree, the dative argument is introduced by some (perhaps Applicative) head associated with ditransitive verbs, while accusative is directly linked to the *v* responsible for introducing the Agent. Under DCT, B&V argue that VP-internally (i.e. within the lower, VP phase), the higher of two unmarked NPs gets dative case. It

is the subsequent raising of the object to the edge of the lower phase that allows it go get accusative case, as schematized in (342).

- (342) a. [[**vP** Mahinur [_{Phase 1} VP *me.DAT pilaf ate*] **v**] _{Phase 2} **T**]
 b. [[**vP** Mahinur [_{Phase 2} VP **pilaf-ACC_k**] [_{Phase 1} VP *me.DAT t_k ate*]] **v**] **T**]

The structures in (342) illustrate how both dative and accusative rules apply based on the DCT rules proposed by B&V. Dative is assigned VP-internally. If the direct object remains in its merge position, it remains bare (342a), and if it raises to the edge of VP, it becomes accessible to the higher phase, resulting in it getting accusative case. It should be emphasized here, that there are not any differences between Uyghur and Sakha (at least related to case) up to this point.

5.2.3 Passives and unaccusatives

One area where the languages diverge relates to the relationship between an active *v* and accusative case. In Uyghur, accusative case is banned on subjects of passives, as shown in (343).⁶

- (343) a. Mahinur polu-ni yé-d-i.
 Mahinur pilaf-ACC eat-PST-3
 “Mahinur ate the pilaf.”
 b. Polu-(*ni) yé-yil-d-i.
 pilaf-ACC eat-PASS-PST-3
 “The pilaf was eaten.”

Surprisingly, Sakha passivization does not block accusative case assignment to promoted objects, as shown in (344).

⁶There are attested varieties of Uyghur that behave more like Sakha, in that the accusative-marker can occur in passive constructions Öztürk (2013), although this does not hold of any of the speakers that I have worked with. The speakers I work with are from Urumchi, Korla, Kashgar, and Hoten. In Uzbek, Uyghurs closest relative, accusative case is permitted on subjects of passives in most varieties. The extent to which these are true passives as opposed to e.g. impersonals is unclear.

- (344) a. Caakky/caakky-ny aldjat-ylyn-na.
 cup/cup-ACC break-PASS-PST-3SS
 “The cup was broken.” (B&V, 608:26a)
- b. Kinige/kinige-ni aaq-ylyn-na.
 book/book-ACC read-PASS-PST-3SS
 “The/a book was read.” (B&V, 608:26b)

B&V argue following Collins (2005) that an external argument can still be generated in passive constructions. They propose that the external argument is a silent PRO that enters into the case competition. Therefore, when PRO is merged into the structure, it is able to assign accusative case via the same process described for simple transitives. The analysis of these facts offered by B&V is provided in (345).

- (345) a. [TP [vP - - (*intentionally) [VP cup [VP t break]] PASS] past] (B&V, 609:28a)
- b. [TP [vP PRO (intentionally) [VP cup-ACC [VP t break]] PASS] past] (B&V, 609:28b)

When the agent is not introduced into the structure, there is no higher NP to license accusative case on the internal argument of the passive verb, which results in a bare (i.e. nominative) subject of the passive (345a). When there is a null agent introduced into the structure, the volitional adverb ‘intentionally’ is possible and accusative case is licensed despite passivization (345b). One potential way of differentiating between Uyghur and Sakha might be to assume that Uyghur passives simply do not allow an agent, null or otherwise, to merge into passive structures, but I leave this question to future research.

In neither Uyghur nor Sakha are accusative arguments licensed by unaccusative verbs. The Uyghur data in (346) show that *qayna-* ‘boil’ can license accusative case and occur with a volitional adverb when causativized (346a), but cannot when not causativized (346b). When a causative is passivized, as in (346c), a volitional adverb is permitted, but accusative case remains illicit. The distribution of volitional adverbs suggest that Uyghur has an implicit agent in passives, although this is not sufficient to license accusative case.

- (346) a. Tursun su-**ni** (meqsetlik) qayna-*t-t-i*.
 Tursun water-ACC intentionally boil-CAUS-PST-3
 “Tursun boiled the water on purpose.”
- b. Su(***-ni**) (*meqsetlik) qayni-d-i.
 water-ACC intentionally boil-PST-3
 “The water boiled (*intentionally).”
- c. Su(***-ni**) (meqsetlik) qayni-*t-il-d-i*.
 water-ACC intentionally boil-CAUS-PASS-PST-3
 “The water was boiled (intentionally).”

Uyghur and Sakha differ only as it relates to the passive form. Despite the fact that volitional adverbs are possible in both languages, only Sakha allows accusative case in passives.

5.2.4 Predicting movement

One final note before moving on is related to when movement is predicted to occur in general. Regardless of the case-assignment mechanism involved, we need to ban movement in cases like (347). These predicate nominals are intentionally both specific, referential and are incompatible with accusative case.

- (347) a. Mahinur Ziba(***-ni**) bol-d-i.
 Mahinur Ziba-ACC become-PST-3
 “Mahinur became Ziba.”
- b. Mahinur [herkim-ning dost-i](***-ni**) bol-d-i.
 Mahinur everybody-GEN friend-3POSS-ACC become-PST-3
 “Mahinur became everybody’s friend.”

If we minimally make the assumption that raising is triggered by Agreement, both theories make essentially the same predictions (in most cases). If we make the assumption that there is no probe with a strong EPP feature, the predicate nominal remains downstairs. Both theories are compatible with, or even predict, that predicate nominals will not raise and will not receive accusative case.

5.3 Accounting for accusative subjects

Recall from Chapters 2 and 3 that only “say” can license accusative subjects in Uyghur. This is true of environments where “say” is the main verb (348a) and in *dep* constructions (348b).⁷

- (348) a. Mahinur [**Tursun-ni ket-t-i** **dé**]-d-i.
Mahinur Tursun-ACC leave-PST-3 say-PST-3
“Mahinur said Tursun left.”
- b. Mahinur [**Tursun-ni ket-t-i** **de-p**] éyt-t-i.
Mahinur Tursun-ACC leave-PST-3 say-CNV tell-PST-3
“Mahinur said Tursun left.”

Moving forward, I argue that the bolded parts of (348a) and (348b) are identical and that the accusative-assignment mechanism is the same. I argue that accusatives are always licensed within the extended projection of *de*- “say”.

5.3.1 Accusative Subject TECs

Recall that accusative subject TECs obligatorily trigger default, 3rd person agreement on the embedded verb, regardless of the phi-features of the accusative subject. (349) illustrates this for a 2SG, accusative subject.

- (349) Men **siz-*(ni)** bugün ut-t-i/***ingiz/uptu** de-p ümid.qil-d-im
I you-ACC today win-PST.3/*2SG/PST.INDIR.3 say-CNV hope-PST-1SG
“I hoped that you won today.”

The range of inflection on the verb “win” illustrate two points: these clauses can host the full range of tense/evidentiality contrasts found in root clauses, and only 3rd person forms are possible.

⁷The difference in vowel quality between (348a) and (348b) is entirely predictable and is purely phonological. Vowel raising is regular and occurs on the final syllable of verb stems that end in *a* or *e*.

Accusative subjects further exhibit the same general properties as accusative objects. First, only accusative subjects are able to scramble, shown in (350), where “Mahinur” can scramble only when accusative-marked.⁸

- (350) {Mahinur-*(**ni**)} men {Mahinur-*(**ni**)} bugün {Mahinur-(**ni**)}
 Mahinur-ACC I Mahinur-ACC today Mahinur-ACC
 ut-ti/uptu de-p ümid.qil-d-im
 win-PST.3/PST.INDIR.3 say-CNV hope-PST-1SG
 “I hoped that Mahinur won today.”

This fact runs completely in parallel with direct objects, where it was shown that bare objects must occur adjacent to the verb, while accusative objects are free to scramble.

Second, accusative subjects are obligatorily interpreted as specifics, which was also shown for direct objects in Chapter 2. Notice in (351), that there is no particular dog in the common ground, while there is in (352). For this reason, the former does not allow accusative case, while the latter requires it.

- (351) Mahinur is sad about social isolation. She really likes dogs and mentioned to me on Zoom that she misses spending time with dogs and that she wishes one would show up at her house. I tell you later:

Mahinur it-*(**ni**) kél-i-du de-p ümid.qil-i-du.
 Mahinur dog-ACC return-NONPST-3 say-CNV hope-NONPST-3
 “Mahinur hopes a dog will come.”

- (352) Our group of friends knows that there is a particular dog that spends time around Mahinur’s house. It has not shown up in quite some time and Mahinur tells me she would like it to return. I tell you later:

Mahinur it-*(**ni**) kél-i-du de-p ümid.qil-i-du.
 Mahinur dog-ACC return-NONPST-3 say-CNV hope-NONPST-3
 “Mahinur hopes the dog will come.”

⁸The fact that proper names, which are inherently referential, do not require accusative case, while (unshifted) pronouns do, is left as an open question. Similarly, why proper names require accusative case when they are objects of simple transitive verbs remains an open question.

Given the shared properties in both cases above, I conclude that it is to our benefit to analyze the relationship between accusative case on objects and subjects in the same manner.

5.3.2 Accusative subjects merge inside the embedded TP

One important aspect of the discussion that follows is that subjects merge within the TEC and raise into a higher position, where they get accusative case. Recall that the negative quantifier *héch* requires clausemate negation (Sudo, 2012). This is shown for *héchkim* “nobody” in (353).

- (353) **Héch-kim** ket-*(mi)-d-i.
 no-who leave-NEG-PST-3
 “Nobody left.”

The accusative subject *héchkim-ni* “nobody-ACC” can be licensed by embedded negation, as shown in (354), which entails that it originates within the TEC, since the matrix clause is affirmative.

- (354) Men **héchkim-ni** ket-**mi**-d-i de-p ümid.qil-i-men.
 1SG nobody-ACC leave-NEG-PST-3 say-CNV hope-NONPST-1SG
 “I hope that nobody left.”

This serves as one piece of evidence against a *prolepsis* analysis, by which accusative subjects merge as an argument in the matrix clause and control a null pronoun in the embedded clause.⁹

A second piece of evidence involves idiom chunks. Subjects of sentential idioms must merge as the subject within the idiom in order to receive an idiomatic interpretation. The idiom is provided in (355a), which is embedded under “say” in (355b).

- (355) a. **Burut-ung-(*ni)** xet tart-iptu.
 mustache-2SG.POSS-ACC letter pull-PST.INDIR.3
 “You’ve become a man.” (lit. Your mustache pulled a letter)

⁹See Salzmann (2017) for an overview of prolepsis and prior analyses of prolepsis.

- b. Mahinur **burut-ung-ni** **xet tart-iptu** dé-d-i.
 Mahinur mustache-2SG.POSS-ACC letter pull-PST.INDIR.3 say-PST-3
 Mahinur said you've become a man." (lit. your mustache pulled a letter.)

Despite getting accusative case in (355b), the idiomatic interpretation remains. This is strong evidence that the accusative subject originates downstairs since the idiomatic interpretation holds.

5.3.3 Accusative subjects raise

Evidence that accusative subjects do, in fact, raise into a higher position comes from reciprocals, which are subject to Condition A of Binding Theory. The reciprocal in (356), which is formed from the numeral *bir* "one", must be locally bound by a plural antecedent.

- (356) Tursun bilen Ali **bir-bir-i-(ni)** kör-(üşh)-ti.
 Tursun with Ali one-one-3POSS-ACC see-RECP-PST.3
 'Tursun and Ali saw each other.'

The locality constraints are demonstrated by the differences between (357a) and (357b), where (357a) shows that accusative case is required on the reciprocal embedded subject. If we take the position of accusatives to be in the same binding domain as its antecedent for Condition A, while nominatives are not, this is predicted. (357b) demonstrates that the antecedent for reciprocals must be local and cannot bind across a singular subject.

- (357) a. Tursun bilen Ali **bir-bir-i-(ni)** ut-i-du de-p
 Tursun with Ali one-one-3POSS-ACC win-NONPST-3 say-CNV
 oyla-y-du/oyli-sh-i-du.
 think-NONPST-3/think-RECP-NONPST-3
 "Tursun and Ali think eachother will win."
- b. *Tursun bilen Ali Mahinur-(ni) **bir-bir-i-ni** kör-(üşh)-ti
 Tursun with Ali Mahinur-ACC one-one-3POSS-ACC see-RECP-PST.3
 de-p oyla-y-du/oyli-sh-i-du.
 say-CNV think-NONPST-3/think-RECP-NONPST-3
 Intended: "Tursun and Ali think that Mahinur saw each of them."

Given that word order is quite flexible in Uyghur, it is difficult to pinpoint exactly where the lowest accusative position is, but I assume it to be in the spec, *v*P associated with *de*-“say”.¹⁰

5.3.4 Finiteness, A-movement, and Agreement

Recall from the discussion in Chapter 3 that “say” selects TECs of different sizes. In cases like (358), the 2SG.ACC subject cannot trigger 2SG agreement on the embedded verb; instead, it has default 3rd person agreement.

- (358) Ahmet [siz-ni_k [t_k nan yé-d-i] dé]-d-i.
Ahmet 2SG-ACC bread eat-PST-3 say-PST-3
“Ahmet said you ate bread.”

These structures are reduced, lack a C or evidence for a left-peripheral operator. It was argued that as long as we adopt the weak PIC, this reduced left periphery makes it possible for the *v* associated with “say” to probe into the embedded clause, where it Agrees and attracts the embedded subject into its specifier position. This is repeated in (359).

¹⁰See Major and Mayer (2018) for a prosody-based analysis that suggests the accusative subject is situated in the matrix clause, as opposed to the left periphery of the embedded clause.

(359) *No Indexical Shift*

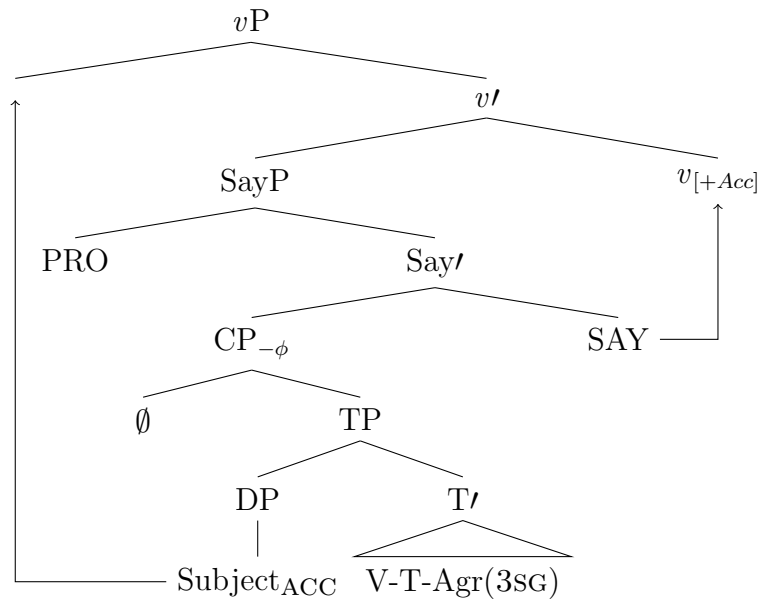

This alternates with structures that involve full CPs. The clearest cases involving a full CP are those that trigger indexical shift with a left peripheral monstrous operator. In these cases, the embedded subject is able to get nominative case, which fully agrees with the embedded verb. This is exemplified by (360).

- (360) Ahmet [siz nan yé-d-ingiz] dé-d-i.
 Ahmet 2SG bread eat-PST-2SG say-PST-3
 “Ahmet said you_{Reported-Addressee} ate bread.”

These CPs are opaque to syntactic operations, as Agreement is banned across a strong phase boundary. This analysis is repeated in (361).

(361) *Indexical Shift*

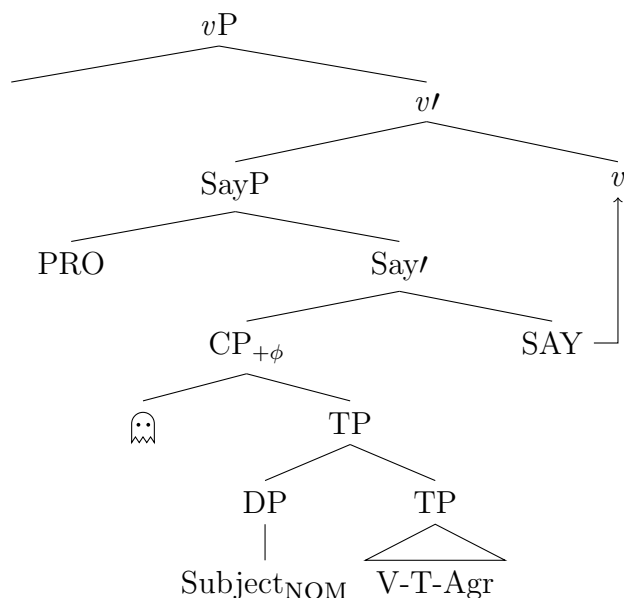

According to my proposal, the derivation of accusative subjects is essentially equivalent to standard Raising-to-Object configurations. This is precisely what I argue happens internal to “say” clauses.

One related issue worth mentioning has to do with an apparent difference between Uyghur and Sakha. Sakha appears to allow agreement with accusative subjects (362).¹¹

- (362) Min ehigi/ehigi-ni bugün kyaj-yax-xyt dien erem-mit-im. *Sakha*
 I 2SG/2SG-ACC today win-FUT-2PS that hope-PTPL-1SS
 “I hoped that you would win today.” (B&V 615:39a)

At first glance, it appears that (362) allows the embedded subject to receive accusative or nominative case with no other differences. However, Uyghur allows the equivalent to (362), but crucially it is not a raising-to-object construction. The Negative Concord Item data

¹¹Notice that there is no indexical shift in (362). Baker (2011) suggests that there is no truth conditional difference between agreeing and non-agreeing embedded clauses. Indexical shift is possible in Sakha in these environments, even if not obligatory (Vinokurova, 2011). This is similar to Turkish, for which indexical shift is optional for nominatives in finite tensed embedded clauses. However, Turkish accusative subjects can never shift (Özyıldız, p.c.), as is true in Uyghur, Kazan Tatar (personal fieldwork), and Mishar Tatar Podobryaev (2014). This suggests that unlike Uyghur, Sakha allows for a full CP to be introduced that does not contain the operator responsible for indexical shift. In Uyghur, this full CP option is available only when the subject is a non-pronominal, full DP.

in both Uyghur and Sakha demonstrate that there are instances of raising-to-object, but both languages similarly allow prolepsis. In Sakha, all diagnostics against prolepsis involve 3rd person negative quantifiers. Recall the data involving agreeing negative quantifiers from Chapter 2. Uyghur allows us to investigate the relationship between the accusative subject and agreement more directly, as shown in (363). It appears that the 2sg accusative subject triggers agreement on the embedded verb, as a consequence of the language being *pro-drop*. The fact that an overt nominative pronoun is possible in this environment is highly suggestive that these are instances of prolepsis, where there is co-reference between the 2nd person accusative argument and the optionally overt (nominative) 2sg pronoun.

- (363) Ahmet **siz-ni** [(?*siz*) nan ye-p-**siz**] dé-d-i.
 Ahmet 2SG-ACC 1SG bread eat-PST.INDIR-2SG say-PST-3
 “Ahmet said of you, you ate bread.”

A prolepsis analysis is further strengthened by cases where it can be shown that the accusative argument can co-occur with agreement on the embedded verb that does not share the same phi-features as the accusative argument. This is shown for “Aygul” and “I” in (364), which are both able to occur with an embedded clause bearing 2nd person singular agreement. This is an absolute mystery if these are raising constructions, but follows straightforwardly from a prolepsis analysis. Proleptic arguments are generally treated as aboutness topics. In (364), the only way for the proleptic argument to be resumed in the embedded clause is if the 2nd person subject shifts, which is precisely what we see.

- (364) Ahmet **Aygül-ni/méni** [(*siz*) nan ye-p-*siz*] dé-d-i.
 Ahmet Aygül-ACC/1SG.ACC 2SG bread eat-PST.INDIR-2 say-PST-3
 “Ahmet said of Aygul/me, you ate bread.”

Furthermore, we can explicitly investigate whether a given construction is proleptic or raising using the same method discussed in Chapter 3, by using a Negative Concord Item that triggers non-3rd person agreement. *héchqaysi-miz* “none of us” requires clausemate negation for licensing and triggers 1PL agreement, as shown in (365).

- (365) **Héčqaysi-miz** yé-*(**mi**)-d-uq/*i.
 no.which-1PL.POSS eat-NEG-PST-1PL/*3
 “None of us ate.”

If we embed “none of us” as the subject of an embedded clause, we can manipulate both the position of negation, which it requires for licensing, and whether the embedded verb has default (3rd person) agreement or 1PL agreement. (366a) shows that accusative-marked “none of us” can be licensed by matrix negation with matching embedded 1PL agreement, but also allows an (optionally) overt nominative 1PL pronoun, which is suggestive of prolepsis. (366b) demonstrates that if negation is moved into the embedded clause, “none of us” cannot be accusative-marked..

- (366) a. Mahinur héčqaysi-miz-ni (biz) nan ye-d-uq dé-**mi**-d-i.
 Mahinur no.which-1PL.POSS-ACC 1PL bread eat-PST-1PL say-PST-3
 “Mahinur didn’t say of any of us, we ate bread.”
- b. * Mahinur héčqaysi-miz-ni (biz) nan ye-**mi**-d-uq dé-d-i.
 Mahinur no.which-1PL.POSS-ACC 1PL bread eat-NEG-PST-1PL say-PST-3
 Intended: “Mahinur said of none of us, we ate bread.”

Crucially, when the embedded verb bears default, 3rd person agreement, embedded negation is again able to license accusative-marked *héčqaysimiz* “none of us”, as shown in (367).

- (367) Mahinur **héčqaysi-miz-ni** nan yé-**mi**-d-i dé-d-i.
 Mahinur no.which-1PL.POSS-ACC bread eat-NEG-PST-3 say-PST-3
 “Mahinur said of none of us, we ate bread.”

This data suggests that it might be useful to recheck Sakha to ensure that raising has occurred in constructions involving accusative subjects with matching agreement. If the results match Uyghur, one construction is prolepsis and the other involves raising-to-subject, which allows us to account for the patterns using the analyses in (??) and (361).

5.3.5 DCT and Case in Sakha

There are non-trivial problems related to B&V's analysis of DCT that are worth introducing before transitioning to the novel discussion in the next section. For ease of exposition, I repeat the DCT rules as introduced by B&V below in (368).

- (368) a. If there are two distinct argumental NPs in the same VP-phase such that NP1 c-commands NP2, then value the case feature of NP1 as dative unless NP2 has already been marked for case.
- b. If there are two distinct argumental NPs in the same phase such that NP1 c-commands NP2, then value the case feature of NP2 as accusative unless NP1 has already been marked for case.

For B&V, accusative-marked objects are derived by raising to the edge of the *v*P phase. A slightly modified version of the analysis from (Baker, 2015) is presented in (369).¹²

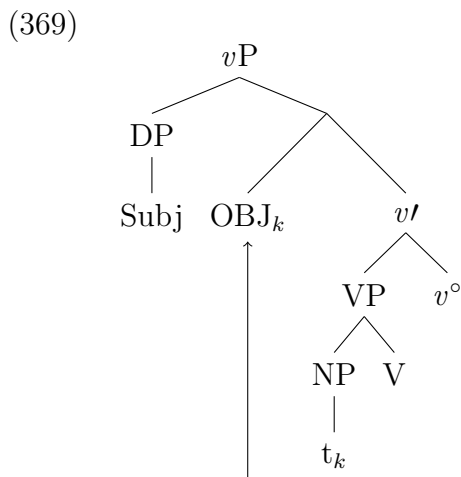

The object raises from VP into the higher phase, where it enters into a case competition with the subject in the CP phase. Because the subject c-commands the raised object, the object gets accusative case.

¹²The trees in this section are my own. These structures are not provided in B&V or Baker (2015). This is what I assume their structures look like based on the descriptions..

They argue that accusative subjects in cases like (370) are derived via essentially the same process.

- (370) Min ehigi-ni bögün kyaj-yax-xyt dien erem-mit-im.
 I 2SG-ACC today win-FUT-2PS that hope-PTPL-1SS
 “I hoped that you would win today.” (Adapted from B&V 615:39a)

In their analysis, The embedded subject raises into Spec, CP as shown in (371).

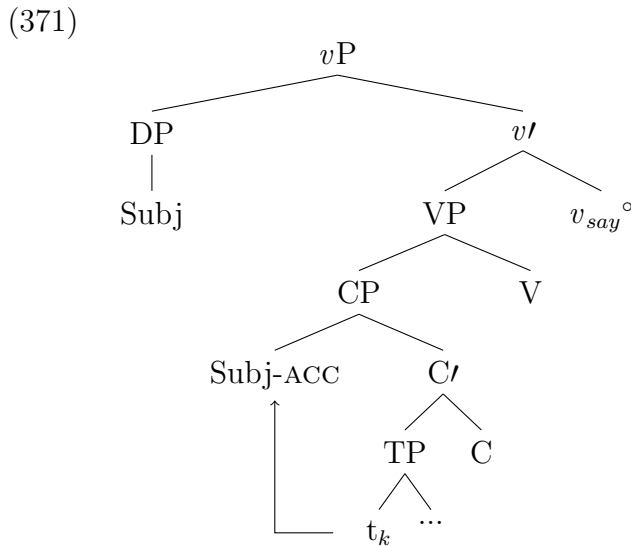

B&V recognize that if the landing site for accusative subjects is spec, CP, that it would not technically be accessible to the matrix subject in the matrix CP phase. They provide the following explanation in a footnote:

“To be precise, putting NP at the edge of CP makes it visible in the matrix VP phase, but not the matrix CP phase, where the matrix subject is. We assume, though, that complement CPs always shift out of the VP (cf Stowell (1981))” (B&V, 617).

If we assume Uyghur and Sakha to be identical, there are reasons to assume that this leftward movement does not happen. The clearest evidence comes from passivization. Recall that TECs cannot raise to subject under passivization (repeated in (372b) and (372c)). Even under passivization, the TEC remains in its base position.

- (372) a. Mahinur manga Tursun-(ni) kél-i-du dé-d-i.
 Mahinur 1SG.DAT Tursun-ACC come-NONPST-3 say-PST-3
 “Mahinur said to me that Tursun will come.”
- b. manga Tursun-(*ni) kél-i-du dé-yil-d-i.
 1SG.DAT Tursun-ACC come-NONPST-3 say-PASS-PST-3
 “It was said to me that Tursun will come.”
- c. *Tursun-(*ni) kél-i-du manga dé-yil-d-i.
 Tursun-ACC come-NONPST-3 1SG.DAT say-PASS-PST-3
 “It was said to me that Tursun will come.”

However, the embedded subject can be promoted to subject under passivization to the exclusion of the rest of the TEC (373).¹³

- (373) Tursun-(*ni) manga kél-i-du dé-yil-d-i.
 Tursun-ACC 1SG.DAT come-NONPST-3 say-PASS-PST-3
 “It was said to me that Tursun will come.”

Similarly, TECs cannot scramble (374a), but subjects can (374b).

- (374) a. *Mahinur Tursun-(ni) kél-i-du manga dé-d-i.
 Mahinur Tursun-ACC come-NONPST-3 1SG.DAT say-PST-3
 “Mahinur said to me that Tursun will come.”
- b. Mahinur Tursun-ni manga kél-i-du dé-d-i.
 Mahinur Tursun-ACC 1SG.DAT come-NONPST-3 say-PST-3
 “Mahinur said to me that Tursun will come.”

As noted, TECs behave like bare objects, in that they must remain low in the structure, adjacent to the verb. Subjects of TECs can remain low where they get nominative case (remain bare) or they can raise, where they behave like accusative-marked objects more broadly.

Finally, even if we accept that CP extraposition does take place, problems arise once we insert intervening material between the matrix subject and the embedded subject. In cases

¹³This same pattern is found in Turkish (Betül Erbası, personal communication).

like (375), the accusative-marking on the embedded subject, the dative on the goal/addressee, and the fact that the matrix subject gets nominative case all require explanation.

- (375) Sargy Keskil-ge/*i [kim-i daqany [kel-im-ie dien]]
 Sargy Keskil-DAT/*ACC who-ACC PRT come-NEG-FUT that
 erenner-de.
 promise-PAST
 “Sargy promised Keskil that nobody will come.”

A schematic representation of (375) based on B&V’s analysis is provided in (376).

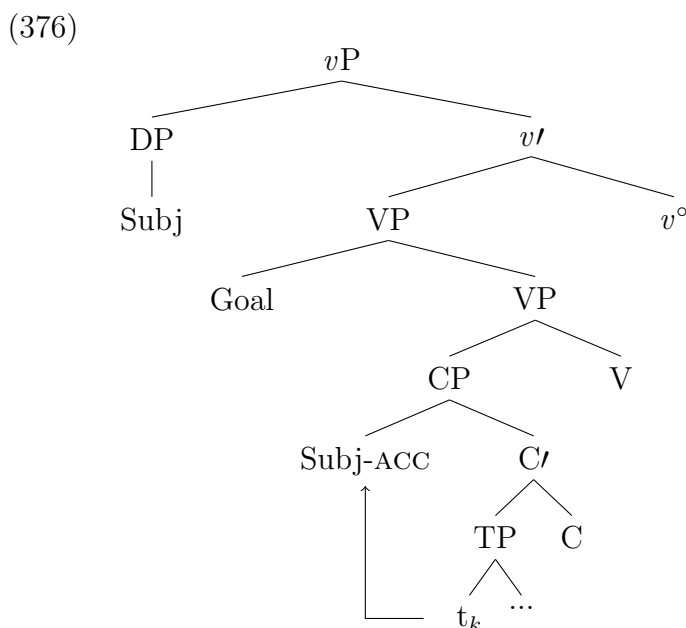

B&V correctly predict that the Goal argument will receive accusative case. However, if the embedded subject raises to the edge of the embedded CP, it becomes accessible to the VP phase, where it is in a local configuration with the Goal argument. By the DCT rules, the higher of these two constituents gets dative, which is precisely what we find in (375). However, they do not explain how the embedded subject gets accusative case. In this case, CP extraposition would lead to the embedded clause preceding the goal argument. One could claim that this involves PF reconstruction or obligatory double scrambling, but I am unaware of any evidence of this being an obligatory process in Turkic or beyond.

However, by adopting the analysis of complementation presented in Chapter 4, DCT is able to account for the distribution of accusative case, as is Case-by-Agree. More specifically, the fact that there is a verbal element and subject within the “say” clause itself offers a solution. For both theories, the *v* associated with “say” Agrees with the subject and attracts it into its specifier. Under Case-by-Agree, this process alone results in accusative assignment. Under DCT, this raising feeds application of the accusative DCT rule, resulting in its getting accusative case based on its relation to the subject off “say”. The next section spells this out more explicitly.

5.4 Analysis

Let us now consider the analysis of Uyghur *de-* “say” and *dep* introduced in Chapters 3 and 4 respectively. I suggest that this analysis contributes explanations for the domain for case-assignment, the distribution of case, and also the distribution of *dep* clauses more broadly. Moving forward I show that this analysis is compatible with either Case-by-Agree or DCT, but further suggest that both approaches are sharpened by my analysis of complementation.

First, recall the proposal from Chapter 3 regarding the assignment of accusative subjects, provided in (377).

(377)

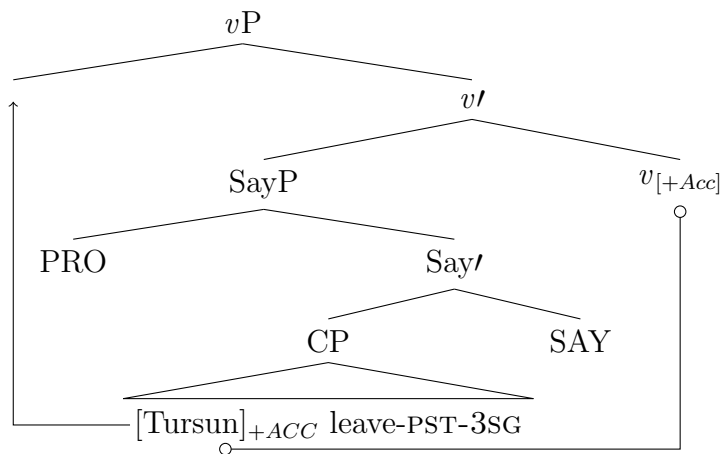

Based on this analysis, it is always spec, *vP* within the extended projection of “say” that hosts accusative subjects. For Case-by-Agree, *v* agrees with the closest NP in its c-command

domain (the TEC subject), assigns it accusative case, and attracts it into its specifier, which results in a specific interpretation. This is further compatible with a DCT analysis with one small change. One could maintain that *v* bears a strong [+specific] feature that is responsible for the specific interpretation and triggering movement. After this movement step has taken place, the TEC subject is at the edge of the *v*P, which is accessible to the matrix CP phase. At this point, the lower of these two NPs gets accusative case via the second Dependent Case rule. Both of these options make similar predictions, but there are potential ways of differentiating between these options. For instance, if there is an environment that clearly lacks *v*, where accusative is still assigned, DCT would be better suited to account for such data.

Recall that there is also a stative structure associated with “say”, shown in (378).

(378)

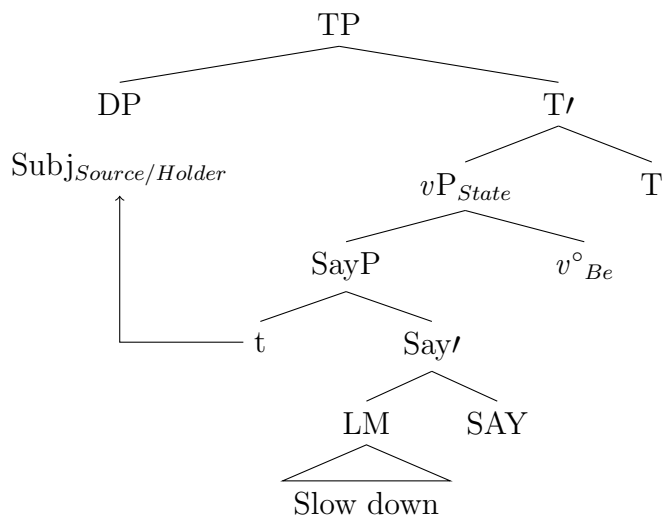

Recall that the stative structure can introduce a LM argument, but it is incapable of licensing a DP. In these cases, the external argument is the source/location of LM, not an agent. In these structures, primarily with inanimate subjects, accusative cannot be licensed.

Then recall the two structures associated with converbial constructions. In both structures, there are two subjects: one in the matrix clause, and one internal to the converbial clause. In some subject configurations, this involves co-indexation between the matrix subject and *pro*, as shown for (379a) in (379b). In this case, the internal argument merges as

the complement to the inflected verb and raises over the converbial adjunct clause.

- (379) a. Mahinur birnémiler-ni [Tursun-(ni) ket-t-i de-p] ünlük
 Mahinur one.what-PL-ACC Tursun-ACC leave-PST-3 say-CNV loudly
 dé-d-i.
 say-PST-3
 “Mahinur loudly said a few things, saying Tursun left.”

b.

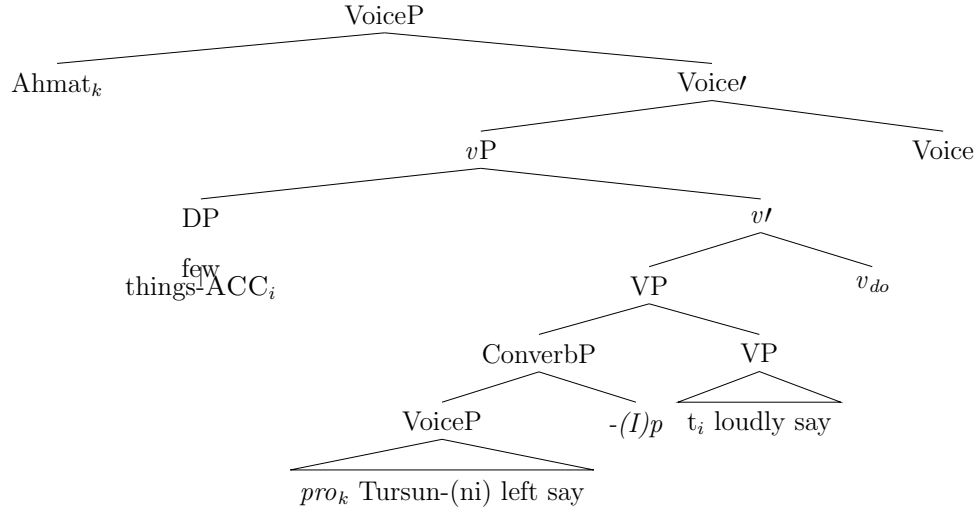

The other structure involves the converb $-(I)p$ adjoining to TP. As mentioned in Chapter 4, cases like (380a) are compatible with either the VP-adjunction structure or the TP-adjunction structure, which correspond to slightly different interpretations. The first translation in (380a) corresponds to the structure in (380b), while the second translation involves the same structure as (379b) above.¹⁴

- (380) a. Mahinur Yakup-(ni) soqmaq ét-t-i de-p öy-ge qayt-t-i.
 Mahinur Jacob-ACC bar make-PST-3 say-CNV home-DAT return-PST-3
 “Mahinur said Jacob made fruit and nut bars and returned home.”
 “Mahinur returned home saying Yakup made fruit and nut bars.”

¹⁴These structures are able to be disambiguated by insertion of *andin* “and then” to the right of *dep*.

b.

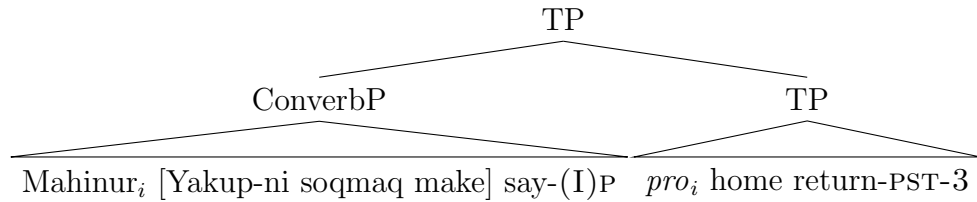

The structure in (380b) is the same structure that I assume for sequential *-(I)p* constructions in general. The differences are mostly correlated with the precise meaning of “say” in a given environment.

In this section I analyze the complex distribution of accusative case, described in Section 3. In section 5.4.2, I illustrate that the verb *de-* “say” is always responsible for licensing accusative subjects. 5.4.3 addresses environments where *dep* is present, but accusative subjects are not licensed, and section 5.5 briefly discusses dative arguments.

5.4.1 The role of *de-* “say” in accusative assignment

Perhaps the clearest argument in favor of accusative case coming from *de-* “say” as opposed to the predicate that *dep* combines with is related to passivization. Recall that passivization of main verb “say” blocks accusative assignment to the subject of the TEC, as shown in (381).

- (381) Tursun-(*ni) ket-t-i dé-yil-d-i
 Tursun-ACC leave-PST-3 say-PASS-PAST-3
 “Tursun was said to have left.”

The present proposal predicts that as long as *de-* “say” is eventive, it should be able to license an accusative subject. When *dep* combines with a verb like “tell”, as in (382), both “say” and “tell” can assign accusative case. When “tell” is passivized, its internal argument “news” is promoted to subject and cannot receive accusative case. However, the TEC subject introduced by *dep* is still able to receive accusative case (382b).

- (382) a. Mahinur [Tursun-(ni) ket-t-i de-p] xewer-(ni) éyt-t-i.
 Mahinur Tursun-ACC leave-PST-3 say-CNV news-ACC tell-PST-3
 “Mahinur told the news, saying Tursun left.”
- b. Xewer-(*ni) [*pro* Tursun-(ni) ket-t-i de-p] éyt-il-d-i.
 news-ACC Tursun-ACC leave-PST-3 say-CNV tell-PASS-PST-3
 “The news was told, saying Tursun left.”

Given that this is an eventive construction, even if the agent of “telling” is suppressed due to passivization, *dep* remains active and able to license an accusative subject. This follows passivized “tell”. If we maintain that Agree is responsible for triggering movement, accusative assignment is predicted to be possible because there is an eventive *v* in the structure that is able to Agree with the subject embedded under “say” and attract it into its specifier. Case-by-Agree assumes that accusative case is licensed as part of the Agreement process, while DCT predicts that this feeds accusative assignment, because the landing site of the raised subject is within the same phase as *pro*.

Turning to environments that B&V suggested lack a transitive verb, like (383), there is now an active verb “say” in the structure. The *v* within the extended projection of “say” agrees with the embedded subject and attracts it into its specifier. The present analysis offers an explanation for the accusative-marking on the embedded subject and explains where the modality or reason interpretation come from.

- (383) [Mahinur_k [Tursun-ni_i [t_i aghrip.qal-i-du] de]-p] *pro*_k kel-d-i.
 Mahinur Tursun-ACC get.sick-NONPST-3 say-CNV come-PST-3
 “Mahinur *said* Tursun got sick and (thus) returned.”

5.4.2 *Dep* does not always license accusative case

B&V acknowledge that *dien* is diachronically related to the verb “say” combined with the converbial suffix, but dismiss this option in a single footnote (Baker and Vinokurova, 2010:619, fn. 20)). Having demonstrated the explanatory power that comes along with the “say” + converb analysis as it relates to configurations where accusative case is assigned, it is also necessary to explain why there are *dep* environments where accusative case is not

permitted. I begin by discussing impersonal constructions, followed by genitive constructions and participial clauses, which introduce two types of puzzles: i) environments where *dien/dep* is present, but an accusative subject is prohibited, ii) environments in Sakha where accusative embedded subjects are licensed in the absence of *dien*.

5.4.2.1 Impersonal constructions

B&V point to impersonal constructions, as a type of construction that contains *dien*, yet is incompatible with accusative subjects, such as (384). In this particular example, there is no overt matrix subject and *Masha* must be bare.

(384) *Sakha*

Bügün munnjax-xa [Masha-(*ny) [ehiil Moskva-qa bar-ya dien]]
 Today meeting-DAT Masha-ACC next.year Moscow-DAT go-FUT.3SS that
 cuolkaydan-na
 become.certain-PST.3SS

“It became clear at the meeting that Masha would go to Moscow next year.”

(Baker and Vinokurova, 2010:619: 47a)

B&V rule out accusative-marking in (384) on the grounds that *cuolkaydan-* “become certain” is an impersonal predicate. They suggest that regardless of whether there is an expletive *pro* or not, that NP would not be an argument, which is prerequisite for entering into a case competition.

Turning back to Uyghur, the equivalent to the Sakha construction in (384) exhibits the same properties, as shown in (385). There is no overt matrix subject, the predicate is unaccusative, and the subject of the *dep* clause, *Mahinur*, cannot get accusative case.

(385) *Uyghur*

[[*pro*_k Bügün yighin-da Mahinur-(*ni) kéler yil-i Qeshqer-ge
today meeting-LOC Mahinur-ACC coming year-3POSS Kashgar-DAT
bar-i-du de-p] *pro*_k éniq bol-d-i.]
go-NONPST-3 say-CNV clear become-PST-3

“It became clear at the meeting that Mahinur would go to Kashgar next year.”

However, full DP subjects, such as “the news”, are permitted in this construction (386).

(386) *Uyghur*

[[Bu xewer_k bügün yighin-da Mahinur-(*ni) kéler yil Qeshqer-ge
this news today meeting-LOC Mahinur-ACC coming year Kashgar-DAT
bar-i-du de-p] *pro*_k éniq bol-d-i.]
go-NONPST-3 say-CNV clear become-PST-3

“The news became clear at the meeting today, saying that Mahinur would go to Kashgar next year.”

Despite the fact that “the news” is an argument (i.e. the subject of the unaccusative predicate “become clear”), “Mahinur” is unable to receive accusative case. It would seem at first glance that DCT should apply here given that there is an overt subject and there is nothing restricting “Mahinur” from raising. Notice that the source of LM in (386) is “the news”, which is also the source of “saying”. Maintaining that only an eventive *v* is capable of entering into an Agree relationship and attracting the embedded subject, it is predicted that if “say” is stative, accusative case will not be permitted.

Beginning with the main clause, the predicate “become clear” is unaccusative and the subject of the unaccusative “the news” is clearly not an agent (387).

(387) *Uyghur*

Bu xewer éniq bol-d-i.
this news clear become-PST-3

“The news became clear.”

Given that this is a same subject construction and the two clauses are incompatible with an interpretation where the state of “saying Mahinur would go to Kashgar next year” is not temporally distinct from the news becoming clear, this is likely VP-adjoining *dep*. With this said, the subject of the *dep* clause is “the news”, which is the holder LM, not an agent. For this reason, “say” is embedded under v_{be} which is not an accusative licenser. Given that the predicate that *dep* combines with is also unaccusative, there are no accusative licensers in the structure, as indicated in (388).

(388)

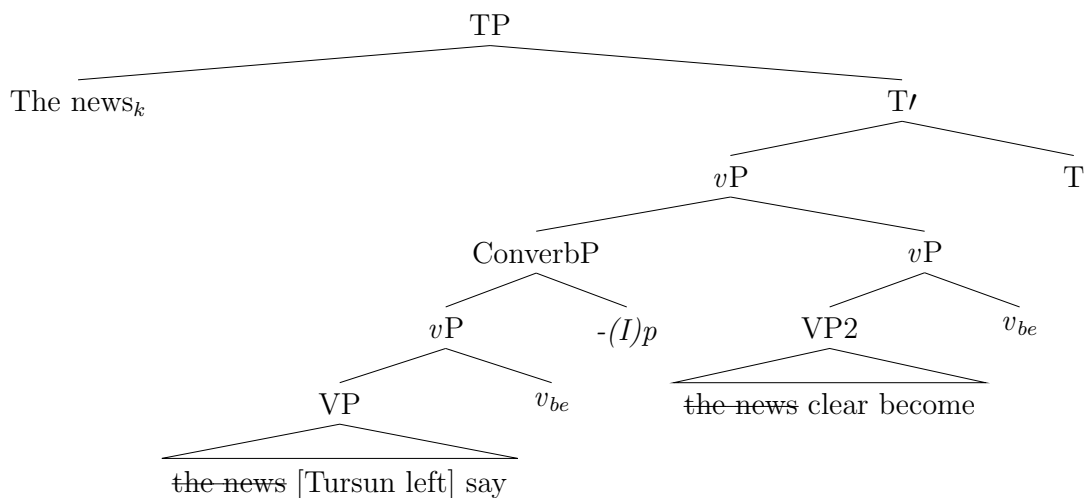

It is unclear whether this structure involves Across the Board Movement (Ross, 1967), where two identical instance of “the news” raise to spec, TP, in unison, or if the subject of *dep* is *pro*, but the result remains the same, both v ’s are stative.

There is a clear prediction that follows from this. If we transitivize the main predicate “become clear”, forming “make clear”, an agent-introducing v is required. As a result, we should find that “make clear” obligatorily involves v_{do} , which enables the vP associated with *dep* to naturally be construed as either the eventive or stative version of “say”. As a result, accusative case again becomes possible in (389). The Agent *bashliqi* “her boss” is both responsible for the communication of the LM and making the news clear, thus allowing accusative-marking on both the TEC subject and the news.

(389) *Uyghur*

[[Bashliq- i_k bugün yighin-da Mahinur-(ni) kéler yil Qeshqer-ge
boss-3SG.POSS today meeting-LOC Mahinur-ACC coming year Kashgar-DAT
bar-i-du de-p] pro_k bu xewer-(ni) éniq qil-d-i.]]
go-NONPST-3 say-CNV this news-ACC clear make-PST-3

“Her boss made the news clear at the meeting today that Mahinur would go to Kashgar next year.”

As mentioned earlier, when “make clear” is passivized, the suppressed external argument is still interpreted as the communicator of the LM introduced by the *dep* clause. For this reason, “the news” is promoted to subject position and cannot get accusative case, while *dep* remains active, as shown in (390).

(390) [[Bu xewer-(*ni) meqsetlik bugün yighin-da [pro Mahinur-(ni) kéler yil
this news-ACC intentionally today meeting-LOC Mahinur-ACC coming year
Qeshqer-ge bar-i-du de-p] éniq qil-in-d-i.
Kashgar-DAT go-NONPST-3 say-CNV clear make-PASS-PST-3

“The news was intentionally made clear at the meeting today that Mahinur would go to Kashgar next year.”

If we assume that the [+specific] feature is not available in the unaccusative structure, Agreement with “the news” would not be possible in (386), but would be possible in (389) and (390). If an unaccusative *v* does not agree, it cannot trigger movement, which would lead to the absence of accusative case under both Case-by-Agree and DCT.

5.4.2.2 Genitive constructions

The remaining issues raised by B&V involve two different genitive constructions. Before addressing these issues directly, it should be noted that there is a difference between genitive case in Uyghur and Sakha. Uyghur requires the possessor to bear genitive-marking, while Sakha possessors are unmarked (391). However, both languages require genitive agreement on the possessum, whose phi-features match those of the possessor. This is illustrated by the subject in (391), where the possessor, *Masha*, is bare, but the possessum “father” bears

3rd person agreement. In Uyghur (391b), the genitive case marker *ning* appears on the possessor, *Mahinur* and “father”, the possessum, hosts a 3rd person agreement marker.

- (391) a. Masha aqa-ta yt-y kör-dö. *Sakha*
 Masha.GEN father-3SP dog-ACC see-PAST.3SS
 “Masha’s father saw the dog.”
- b. Mahinur-*(ning) ati-si it-ni kör-d-i. *Uyghur*
 Mahinur-GEN father-3POSS dog-ACC see-PST-3
 “Mahinur’s father saw the dog .”

B&V introduce cases like (392) as a problem for an analysis where *dien* is the case assigner.¹⁵ Similar to impersonals, the subject of the *dien* clause, *tağara*, cannot be marked with accusative case. Furthermore, the noun *iteqel* “belief” bears genitive agreement, which B&V treat as a N-Comp construction, where presumably the noun *iteqel* takes the *dien* clause as its complement.¹⁶

- (392) Kini tağara-(*ny) baar dien iteqel-e küühür-de. *Sakha*
 He god-ACC exist.copula DIEN belief-3SP strengthen-PST.3
 “His belief that God exists strengthened.” (Vinokurova, 2005:365:113)

I suggest that this construction is more complex than a run-of-the-mill N-Comp construction, which is made even clearer in Uyghur. The translation of (392) (Sakha) into Uyghur, is provided in (393). Under the present analysis, it is crucial that *iteqel* “belief” bears genitive agreement that covaries with that of the genitive-marked DP, which suggests that Sakha *kini* in (392) is actually genitive. This is made transparent in Uyghur, which requires genitive case on the 3rd person pronoun, *u*, as shown in (393).

¹⁵The example introduced in B&V is a sentence fragment based on (392), but does not constitute a complete sentence (c.f. (Baker and Vinokurova, 2010:619)). I thus use (392) because the complete sentence is necessary for present purposes.

¹⁶One interesting question that does not arise in B&V is whether a sentence like (392) can be accounted for using DCT. More specifically, *kini* is bare and assuming there is nothing independently preventing the embedded subject to raise to the edge of the clause, we might expect accusative case to be licensed.

- (393) U-*(ning) Tengri-(*ni) bar de-p étiqad-i-(*ni)
 s/he-GEN god-ACC EXIST say-CNV belief-3SG.POSS-ACC
 küchey-d-i.
 become.stronger-PST-3
 “His/her belief that God exists got stronger”

If *dep* were actually selected as a complement to *étiqad* “belief”, it would be unexpected to be able to extract the nominal to the exclusion of the *dep* clause, which is acceptable, as shown in (394).

- (394) U-*(ning) étiqad-i-(*ni) Tengri-(*ni) bar de-p
 s/he-GEN belief-3SG.POSS-ACC god-ACC EXIST say-CNV
 küchey-d-i.
 become.stronger-PST-3
 “His/her belief that God exists got stronger”

Deriving both structures above is outside the scope of this paper, but for the present, we can minimally conclude that the construction above lacks an agent. The subject, “his belief” introduced by the unaccusative predicate “become stronger”, results in the same configuration as (389), where the controller of *pro* is the subject of an unaccusative, which leads to *pro* being interpreted as a holder. As a result, neither predicate licenses accusative case. Similarly, as was shown for impersonals, if the verb in (393) is causativized, two instances of accusative case are again licensed, as shown in (395).

- (395) Tursun [Tengri-(ni) bar de-p] (öz-i-ning) étiqad-i-(ni)
 Tursun god-ACC EXIST say-CNV self-3POSS-GEN belief-3POSS-ACC
 küchey-t-t-i.
 become.strong-CAUS-PST-3
 “Tursun strengthened his belief that god exists.”

I thus conclude that we can predict the interpretation of *de-* “say” based on the predicate it combines with and the external argument associated with it. When the external argument associated with the final verb is agentive, the *pro* it controls is similarly agentive. Because both clauses contain agents, they each have the structure necessary to license accusative case, as observed above.

5.4.2.3 Participial clauses

The final objection offered by B&V against *dien* being the accusative licenser, comes from participial embedded clauses that allow accusative subjects. This particular issue applies only to Sakha, which I assume is fundamentally linked to the absence of an overt genitive case-marker. The comparison between languages in (396) demonstrates two crucial facts: i) Sakha shows no case-marking on the participial subject in (396a), ii) Uyghur allows genitive case on the participial subject, which indicates specificity (not unlike accusative on objects).¹⁷ Sakha, on the other hand, does not have any marking on “dog”, but both languages show agreement that co-varies with the embedded subject immediately preceding the case-marker on the right edge of the participial clause.

- (396) a. [[it üüt-ü ih-iex-teeq-i]-n] bil-e-bin. *Sakha*
dog milk-ACC drink-FUT-MOOD-3SG-ACC know-AOR-1SG
“I know the dog should drink the milk.” (Kornfilt, 2005:521:13)
- b. [[it-(ning) két-idighan-liq-i]-ni] bil-i-men. *Uyghur*
dog-GEN leave-PTPL.IMPF-3POSS-ACC know-NONPST-1SG
“I know a/(the) dog will leave.”

Before getting into the crucial Sakha data, I first discuss the analysis of the Uyghur data in (396b), which is slightly modified from Asarina (2011) and presented in (397). The crucial aspect of this analysis is that participial clauses involve Agreement between a null nominal and the participial subject, which results in genitive case assignment. This further results in a specific interpretation of genitive subjects.

¹⁷It is unclear whether the same holds for Sakha, but it is the case in Turkish. See Kornfilt (2020) for related discussion in Turkish.

(397)

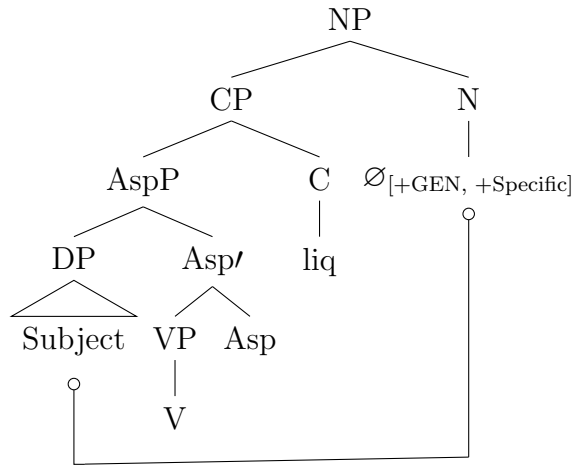

Turning back to Sakha, the question is now to explain how *ehighi* “you” is able to receive accusative case in (398), a participial clause.

- (398) Min ehigi-ni bügün kyaj-byk-kyt-yn ihit-ti-m.
 I you-ACC today win-PTPL-2PP-ACC hear-PST-1SG
 “I heard you won today.”

Similar to accusative NPI subjects of *dien* clauses, it is also demonstrated that accusative NPI subjects can be licensed by embedded negation in participial clauses (399). This at least requires that the NPI originate within the participial clause, otherwise the NPI would not be licensed.

- (399) Min kim-i daqany kyaj-bataq-yn ihit-ti-m.
 I who-ACC PRT win-NEG.PTPL-3SP.ACC hear-PAST-1SS
 “I heard that nobody won (the lottery).” (B&V, 617: 42b)

Further research is needed to explain the presence of accusative case on subjects in Sakha participial clauses, but I offer a potential explanation here. Given that the result of a participial subject in Uyghur agreeing with the N in participial constructions yields genitive case and a specific interpretation, it could reasonably follow that the same process in Sakha could yield accusative. If the (often) null N is capable of hosting a [+specific], as *v* does, we could attribute the presence of accusative in Sakha to underspecification theory. Because Sakha does not have an overt genitive in these environments, it defaults to accusative as a

result of agreement. It would further be possible that Agreement with N results in the subject of the participial construction raising, which prompts it to enter into a case competition with the matrix subject, resulting in it being assigned accusative case. I leave these questions to future research¹⁸ I leave these questions to future research.

5.4.3 Dative arguments

B&V and Baker (2015) argue that dative case is also a dependent case, but offer far less evidence in support of this claim than they do for the accusative. They are required to limit DCT assignment of dative to only arguments. Given the updated empirical landscape, it is unclear whether dative should be treated as a Dependent Case or not.

For instance, recall that the verb “say” allows both agentive and non-agentive subjects depending on context. Notice that only the “say” construction with an agent is compatible with the addressee *bizge* “to us” in (400). In other words, the addressee can be introduced when Mahinur is the external argument (400a), while the impersonal with the locative *taxtida* “on the sign” is incompatible with an addressee (400b).

- (400) a. Mahinur (biz-ge) astalang de-y-du.
 Mahinur 1PL-DAT slow.down say-NONPST-3
 “Mahinur said (to us) slow down.”
- b. Taxti-da (*biz-ge) astalang de-y-du.
 sign-LOC 1PL-DAT slow.down say-NONPST-3
 “It said (*to us) slow down on the sign.”

This seems to suggest that even dative arguments show sensitivity to properties of Voice or *v*. Furthermore, there is no NP argument in (400a). The contrast in (401) illustrates that the LM argument “astalang” remains low in the structure.

¹⁸B&V demonstrate that accusative subjects are derived by raising for *dien* clauses, but not participial clauses (see B&V: 616, 41).

- (401) a. Biz-ge astalang dé-yil-i-du.
 1PL-DAT slow.down say-PASS-NONPST-3
 “It is said to us to slow down.”
- b. *Astalang biz-ge dé-yil-i-du.
 slow.down 1PL-DAT say-PASS-NONPST-3
 Intended: “It is said to us to slow down.”

In the grammatical case, there is no NP argument, only an LM (CP) argument. For this reason, it seems the fact that “say” is agentive is what matters here, not that it is the higher argument within the VP. If both accusative and the ability to license a dative Goal are contingent upon properties of Voice or *v*, we may choose to abandon dative (and even accusative) as dependent cases.

5.5 Conclusions

This chapter has offered an analysis of complementation and case-assignment on the basis of novel empirical data from Uyghur, which I argue further extends to Sakha, and has implications for the debate in the literature regarding Case Theory. More specifically, I argue that most environments where accusative arguments emerge are only unexpected if we treat the elements *dep* (Uyghur) and *dien* (Sakha) as simple (vacuous) C elements, as opposed to decomposing them into the verb “say” and the converbial suffix. The presence of *de-* “say” allows us to associate these instances of accusative case with a transitive verb, which allows us to maintain Burzio’s Generalization when capturing accusative case in Uyghur and Sakha.

There are several implications that the results of this paper have for Case theory and complementation. It resurrects the possibility that we can maintain traditional theories of case assignment, such as Case-by-Agree, on the grounds that there is almost always a verb in the structure. Preminger (2017) suggests that Case-by-Agree is more restrictive than DCT. If we take this to be true, Case-by-Agree would be favored for reasons of parsimony, in which case this would be a welcomed result. Of course this requires an explanation for

Sakha participial constructions. If we decide to maintain DCT, we can treat Agree to be the movement trigger, and the DCT rules to apply as formulated by B&V and Baker (2015). In this way, the new analysis of complementation offers a clearer explanation for the distribution of *dep* clauses, allows DCT to operate within *dep* clauses, offering an explanation for case assignment that does not require CP extraposition or double scrambling.

CHAPTER 6

Concluding Remarks

This dissertation provides new perspectives on “say” and “say” complementation, one of the most widespread clausal complementation structures observed in the world’s languages. It leads to novel insights that have made it possible to connect seemingly unrelated phenomena: serialization/converbs, Indexical Shift, Raising-to-Object, factivity, unselected (e.g. “reason”) clauses, and beyond. I have drawn connections with respect to “say” and “say” complementation between typologically unrelated, understudied languages, like Uyghur and Sakha with both standard and non-standard varieties of English. Given how widespread “say” complementation is, the insights found in this dissertation open a research program that extends across the world’s languages. Furthermore, I have shown that the best way of understanding the internal structure of “say” complementation is to first develop an understanding of “say” and how complex predicates are formed within a particular language.

There were multiple findings regarding “say” as a main verb.

- (i) I have shown in English, Uyghur, and Avatime, it alternates between being eventive (dynamic) or stative.
- (ii) It selects a special set of nominal arguments (LMNs) that differ from the set of nominals compatible with other communicative and attitude verbs.
- (iii) It cross-linguistically is able to introduce a wider range of clausal arguments than other predicates (it is the only predicate capable of introducing direct quotation or tensed clauses in Avatime/Uyghur).
- (iv) It is at least capable of licensing LM arguments in-situ (they do not raise), offering

insights into the observations made in Kratzer (2016); Moulton (2016).

- (v) Chapter 1 introduced an analysis that captures the intuitions in Grimshaw (2015) that “say” is a light verb.

With respect to “say” complementation structures, I have offered a series of novel analytical insights and methodological approaches for probing deeper into “say” complementation structures.

- (i) Dating back to at least Lord (1976), a link between “say” complementation and serial verb constructions have been established.
- (ii) I have shown that “say” complementation literally is serialization.
- (iii) Properties unique to “say” as a main verb, tend to apply internally to “say” complementation structures (e.g. Indexical Shift and Raising-to-Object in Uyghur).
- (iv) “Say” complementation structures are observed in some varieties of English!

For Uyghur, I have demonstrated that many seemingly unrelated phenomena related to *dep* follow from treating it as “say” + the converbial suffix $-(I)p$.

- (i) *De-* “say” introduces a CP containing the monstrous operator $\hat{\omega}$, responsible for indexical shift.
- (ii) It can introduce a defective CP that results in Raising-to-Object (into the extended projection of the verb “say”), which results in accusative case-assignment.
- (iii) The alternation between stative and eventive structures impacts its ability to license accusative case (e.g. stative “say” cannot license accusative).
- (iv) The distribution of *dep* clauses corresponds to the distribution of $-(I)p$ structures.
- (v) I have shown that the same general analysis applies to Avatime, *si* “say”, as well.

One might conclude a strong claim, that all “say” elements are equal, and thus what I have shown in Uyghur should extend to all “say” complementizers. It has been shown, especially in Bantu (e.g. Halpert, 2019) that the role, distribution, morphological makeup, and function of “say” elements varies across languages. I hypothesize that in some languages, this element may be so semantically bleached, that the “say” component makes minimal semantic contribution, but this does not mean that the syntactic linking mechanism is different. In other words, it seems reasonable that a Turkic language, for instance, could maintain a converbial “say” complementation structure, where the converbial component has remained observable, while the “say” component is bleached or opaque. This should not necessarily be interpreted as grammaticalization from V to C, as it is possible that the morpho-syntactic structure remains stable, but the semantics of V are simply bleached. This is quite possibly the situation across Sinitic, discussed in Chappell (2008), for instance.

The methodology and findings within this dissertation open up many new questions that are relevant to different areas in contemporary syntax and semantics. One particular area of interest is related to hyper-raising or raising out of what appear to be finite clauses more generally. Wurmbrand (2019) discusses cases in Turkish, Buryat (Mongolian), and Bantu that suggest that the finiteness versus non-finiteness distinction in English is insufficient to account for the types of cross-clausal dependencies observed in these languages. More specifically, these structures involve raising out of finite embedded clauses, sometimes resulting in accusative case-assignment. Halpert (2019) discusses the fact that the environment for hyperraising correlates with only the “say” complementation structures in two Bantu languages. Bondarenko (2020) mentions in a footnote that the relevant complementation structure involving accusative subjects involves the converbial form of the verb “say” in Buryat. The same is true for Bukusu, based on recent research Major et al. (ms). In Turkish, the distribution of accusative subjects is different than in Uyghur or Tatar (personal fieldwork), but Turkish is also more permissive in allowing certain predicates select finite clauses directly, many speakers disprefer accusative subjects under “say”, and the “say” element *diye* does not include the converbial marker, but instead a suffix whose fundamental

selection of particular types of D elements. There are a number of Uyghur verbs (e.g. regret, remember, be surprised/sad/happy) that are factive when they occur with a nominalization and non-factive when they occur with *dep*. Similar behaviors have been noted in Turkish (Özyıldız, 2017), Mongolic (Bondarenko, 2020), Washo (Hanink and Bochnak, 2017), in Tatar (personal fieldwork), Avatime (personal fieldwork), where factivity seems to correlate with N/D properties, which are absent in verbal complementation structures.

The present dissertation also serves as a jumping off point for investigation of other verbal “complementizers” found in the world’s languages. For instance, Lord (1993) notes “be like” complementizers, which have similarly been found in the Grassfields Bantu language, Dschang (Hilda Koopman, p.c.). Furthermore, there have been more abstract verbs, such as “say+think” described for languages like Laz (Demirok et al., 2019) and Ewe (Clements, 1975), which may reduce down to the different realizations of “say” described in this dissertation. It also seems plausible that each of these could involve the serialization mechanism used within the given language, in which case the contribution of the semantically bleached V element could vary, while the adjunction or linking structure could remain stable.

BIBLIOGRAPHY

- Aboh, Enoch Oladé. 2010. Event operator movement in factives: Some facts from Gungbe. *Theoretical Linguistics* 36:153–162.
- Alexiadou, Artemis. 2014. The problem with internally caused change-of-state verbs. *Linguistics* 52:870–910.
- Alexiadou, Artemis, Elena Anagnostopoulou, and Florian Schäfer. 2015. *External Arguments in Transitivity Alternations: A layering approach*, vol. 55 of *Oxford Studies in Theoretical Linguistics*. Oxford University Press.
- Anand, Pranav, Jane Grimshaw, and Valentine Hacquard. 2017. Sentence embedding predicates, factivity and subjects. In *Lauri Karttunen Festschrift*, edited by Cleo Condoravdi, 1–29. CSLI.
- Anand, Pranav and Andrew Nevins. 2004. Shifty Operators in Changing Contexts. In *Proceedings of SALT XIV*, edited by Robert B. Young, 20–37. Cornell University, Ithaca, NY: CLC Publications.
- Angelopoulos, Nikolaos. 2019. Complementizers and prepositions as probes: Insights from greek. Ph.D. thesis, UCLA.
- Arregi, Karlos and Andrew Nevins. 2012. *Morphotactics: Basque auxiliaries and the structure of spellout*, vol. 86. Springer.
- Asarina, Alya. 2011. Case in Uyghur and beyond. PhD Thesis, MIT, Cambridge, MA.
- Austin, John Langshaw. 1975. *How to do things with words*, vol. 88. Oxford university press.
- Baker, Mark. 1989. Object sharing in serial verb constructions. *Linguistic Inquiry* 20:513–533.

- Baker, Mark. 2014. Pseudo Noun Incorporation as covert incorporation: linearization and crosslinguistic variation: linearization and crosslinguistic variation. *Language and Linguistics* 15:5–46.
- Baker, Mark. 2015. *Case: its principles and its parameters*. No. 146. Cambridge University Press.
- Baker, Mark and Nadya Vinokurova. 2010. Two modalities of Case assignment: case in Sakha. *Natural Language and Linguistic Theory* 28:593–642.
- Baker, Mark C. 2011. When agreement is for number and gender but not person. *Natural Language & Linguistic Theory* 29(4):875–915.
- Balusu, Rahul. 2020. The quotative complementizer says “I’m too Baroque for that.”. In *Proceedings of Formal Approaches to South Asian Languages (FASAL) 8*, edited by Bhamati Dash and Gurmeet Kaur, vol. 3.
- Barany, Andras and Irina Nikolaeva. To Appear. Possessive and non-identity relations in turkic switch-reference. *Studies in Language* .
- Bary, Corien and Emar Maier. ms. The landscape of speech reporting. *Unpublished Manuscript* URL <https://ling.auf.net/lingbuzz/003526>.
- Bayer, Josef. 1999. Final complementizers in hybrid languages. *Journal of Linguistics* 35(2):233–271. Publisher: Cambridge University Press.
- Bochnak, Ryan and Lisa Matthewson. 2015. *Methodologies in semantic fieldwork*. Oxford University Press.
- Boeckx, Cedric, Norbert Hornstein, and Jairo Nunes. 2010. *Control as Movement*. Cambridge Studies in Linguistics. Cambridge University Press.
- Bondarenko, Tatiana. 2019. From think to remember: how CPs and NPs combine with attitudes in Buryat. In *Semantics and Linguistic Theory*, vol. 29, 509–528.

- Bondarenko, Tatiana. 2020. Factivity from pre-existence: Evidence from Barguzin Buryat. *Glossa: a journal of general linguistics* 5, 1:1–35.
- Borer, Hagit. 1994. On the Projection of Arguments. In *Functional Projections*, 19–48. Amherst: GRADUATE LINGUISTIC STUDENT ASSOCIATION.
- Borer, Hagit. 2003. Exo-skeletal vs. endo-skeletal explanations: Syntactic projections and the lexicon. In *The nature of explanation in linguistic theory*, edited by John Moore and Maria Polinsky, 31–67. Oxford: Oxford University Press.
- Bossong, Georg. 1985. *Differentielle Objektmarkierung in den Neuiranischen Sprachen*. Gunter Narr Verlag, Tübingen.
- Bresnan, Joan. 1972. Theory of complementation in English syntax. PhD Thesis, Massachusetts Institute of Technology.
- Bridges, Michelle. 2008. Uyghur auxiliary verbs.
- Burzio, Luigi. 1986. *Italian syntax: A government-binding approach*, vol. 1. Springer Science & Business Media.
- Caponigro, Ivano and Maria Polinsky. 2011. Relative embeddings: a circassian puzzle for the syntax/semantics interface. *Natural Language and Linguistic Theory* 29:71–122.
- Carstens, Vicki. 2010. Implications of grammatical gender for the theory of uninterpretable features. In *Exploring Crash-Proof Grammars*, edited by Michael T. Putnam, 31–57. John Benjamins.
- Carstens, Vicki. 2011. Hyperactivity and hyperagreement in Bantu. *Lingua* 121(721-741).
- Chappell, Hilary. 2008. Variation in the grammaticalization of complementizers from *verba dicendi* in Sinitic languages. *Linguistic Typology* Publisher: Walter de Gruyter.
- Chomsky, Noam. 1981. *Lectures on government and binding*. Dordrecht: Foris Publications.
- Chomsky, Noam. 1986. *Barriers*. Linguistic Inquiry Monograph. MIT Press.

- Chomsky, Noam. 1995. *The Minimalist Program*. Cambridge, Massachusetts: MIT Press.
- Chomsky, Noam. 2000. Minimalist Inquiries: The Framework. In *Step by step: Essays on Minimalist syntax in honor of Howard Lasnik*, edited by Roger Martin, David Michaels, and Juan Uriagereka, 89–156. Cambridge: MIT Press.
- Chomsky, Noam. 2001. Derivation by Phase. In *Ken Hale: A Life in Linguistics*, edited by Michael Kenstowicz, 1–52. Cambridge: MIT Press.
- Chomsky, Noam. 2004. Beyond Explanatory Adequacy. In *Structures and Beyond: The Cartography of Syntactic Structures*, edited by Adriana Belletti, vol. 3, 104–131. Oxford: Oxford University Press.
- Chomsky, Noam. 2008. On Phases. In *Foundational Issues in Linguistic Theory*, edited by Robert Freidin, Carlos Otero, and Maria Luisa Zubizarreta, 133–166. Cambridge, MA: MIT Press.
- Christaller, J. G. 1875. *A Grammar of the Asante and Fante Language called Tshi (Chwee, Twi)*. Gold Coast: Basel German Evangelical Mission. Reprinted 1964, Ridgewood, New Jersey: Gregg Press.
- Cinque, Guglielmo. 1999. *Adverbs and functional heads: a cross-linguistic perspective*. New York: Oxford University Press.
- Clements, George N. 1975. The logophoric pronoun in ewe: its role in discourse. *Journal of West African Languages* 10(2):141–177.
- Collins, Chris. 1997. Argument sharing in serial verb constructions. *Linguistic Inquiry* 28(3):461–497.
- Collins, Chris. 2005. A Smuggling Approach to the Passive in English. *Syntax* 8(2):81–120.
- Cuervo, María Cristina. 2003. Datives at large. PhD Thesis, MIT.

- Deal, Amy Rose. 2017. Covert hyperraising to object. In *Proceedings of NELS*, vol. 47, 257–270.
- Deal, Amy Rose. 2020. *A theory of indexical shift: meaning, grammar, and crosslinguistic variation*, vol. 82. MIT Press.
- Defina, Rebecca. 2016. Events in Language and Thought: The Case of Serial Verb Constructions in Avatime. PhD Thesis, sn: sl.
- Demirok, Omer, Deniz Ozyıldız, and Balkız Oztürk. 2019. Complementizers with attitude. *Proceedings of NELS49* .
- Diercks, Michael. 2012. Parameterizing Case: Evidence from Bantu. *Syntax* 15(3).
- Diesing, Molly. 1992. Bare Plural Subjects and the Derivation of Logical Representations. *Linguistic Inquiry* 23(3):353–380.
- den Dikken, Marcel. 2006. *Relators and Linkers*. MIT Press.
- Dowty, David R. 1979. *Word meaning and Montague grammar*, vol. 7. Dordrecht, The Netherlands: Kluwer Academic Publishers.
- Dwyer, Arienne M. 2005. *The Xinjiang conflict: Uyghur identity, language policy, and political discourse*. East-West Center Washington.
- Embick, David and Rolf Noyer. 2001. Movement operations after syntax. *Linguistic Inquiry* 32(4):555–595.
- Engesæth, Tarjei, Mahire Yakup, and Arienne Dwyer. 2009/2010. *Teklimakandin Salam: hazirqi zaman Uyghur tili qollanmisi / Greetings from the Teklimakan: a handbook of Modern Uyghur*. Lawrence: University of Kansas Scholarworks.
- Enç, Mürvet. 1991. The Semantics of Specificity. *Linguistic Inquiry* 22(1):1–27.
- Erteschik-Shir, Nomi. 1973. On the nature of island constraints. Ph.D. thesis, Massachusetts Institute of Technology.

- Ferreira, Marcelo. 2009. Null subjects and finite control in Brazilian Portuguese. In *Minimalist Essays on Brazilian Portuguese Syntax*, edited by Jairo Nunes, 17–50. John Benjamins.
- Folli, Raffaella and Heidi Harley. 2020. A head-movement approach to Talmy’s typology. *Linguistic Inquiry* 51:425–470.
- Folli, Raffaella and Heidi Harley. 2004. Flavors of \$v\$. In *Aspectual Inquiries*, 95–120. Springer.
- Folli, Raffaella and Heidi Harley. 2005. Flavors of *v*. In *Aspectual Inquiries*, 95–120. Springer.
- Folli, Raffaella, Heidi Harley, and Simin Karimi. 2005. Determinants of event type in persian complex predicates. *Lingua* 115(10):1365–1401.
- Ford, Kevin C. 1971. Aspects of Avatime syntax. PhD Thesis, Legon: University of Ghana.
- George, Leland and Jaklin Kornfilt. 1981. Finiteness and boundedness in Turkish. *Binding and filtering* 105:127. Publisher: Croom Helm/MIT Press London/Cambridge, MA.
- Grimshaw, Jane. 1979. Complement Selection and the Lexicon. *Linguistic Inquiry* 10:279–326.
- Grimshaw, Jane. 2015. The light verbs say and SAY. *Structures in the Mind: Essays on Language, Music, and Cognition in Honor of Ray Jackendoff* 79. Publisher: MIT Press.
- Güldemann, Tom. 2008. *Quotative Indexes in African Languages: A Synchronic and Diachronic Survey*, vol. 34 of *Empirical Approaches to Language Typology*. Mouton de Gruyter.
- Hale, Kenneth and Samuel Jay Keyser. 1993. *The view from building 20*. Cambridge, Massachusetts: MIT Press.
- Halpert, Claire. 2012. Argument licensing and agreement in Zulu. PhD Thesis, MIT.
- Halpert, Claire. 2019. How to be an embedded clause: say-complementizers in Bantu. In *Proceedings of TripleA 5: Fieldwork perspectives on the semantics of African, Asian, and*

- Austronesian languages*, edited by Ryan Bochnak, Miriam Butt, Erlinde Meertens, and Mark-Matthias Zymla, 31–46. Universitätsbibliothek Tübingen, Publikationssystem.
- Hanink, Emily and Ryan Bochnak. 2017. Factivity and two types of embedded clauses in Washo. In *Proceedings of NELS 47*, edited by Andrew Lamont and Katerina Tetzloff. GLSA.
- Hankamer, Jorge and Ivan Sag. 1976. Deep and surface anaphora. *Linguistic Inquiry* 7(3):391–428.
- Harley, Heidi. 2005. How do verbs get their names? Denominal verbs, manner incorporation, and the ontology of verb roots in English. In *The syntax of aspect*, edited by Nomi Erteschik-Shir and Tova Rapoport, 42–64. Oxford: Oxford University Press.
- Harley, Heidi. 2017. The “bundling” hypothesis and the disparate functions of little v. In *The Verbal Domain*, 3–28. New York: Oxford University Press.
- Hasegawa, Nobuko. 1984/1985. On the so-called “zero pronouns” in Japanese. *The Linguistic Review* 4:289–341.
- von Heusinger, Klaus and Jaklin Kornfilt. 2017. Partitivity and case marking in Turkish and related languages. *Glossa* 2(1):1. Publisher: Ubiquity Press.
- Hiraiwa, Ken. 2010. Spelling out the double-o constraint. *NLLT* 28:723–770.
- Hoekstra, Teun. 1988. Small Clause Results. *Lingua* 74:101–139.
- Huang, C.-T. James. 1982. Logical relations in Chinese and the theory of grammar. PhD Thesis, Massachusetts Institute of Technology.
- Huang, C.-T. James. 1984. On the Distribution and Reference of Empty Pronouns. *Linguistic Inquiry* 15:531–574.
- Jackendoff, Ray. 1990. On Larson’s Treatment of the Double Object Construction. *Linguistic Inquiry* 21(3):427–455.

- Jackendoff, Ray. 1992. Mme. Tussaud meets the Binding Theory. *Natural Language and Linguistic Theory* 10(1):1–32.
- Kaplan, David. 1977. Demonstratives: An essay on the semantics, logic, metaphysics, and epistemology of demonstratives and other indexicals. *Themes from Kaplan* 565–614.
- Kastner, Itamar. 2015. Factivity mirrors interpretation: The selectional requirements of presuppositional verbs. *Lingua* 164:156–188. Publisher: Elsevier.
- Kastner, Itamar. 2016. Form and meaning in the hebrew verb. PhD Thesis, New York University.
- Kayne, Richard. 2014. Why isn't this a complementizer? In *Functional structure from top to toe: The cartography of syntactic structures*, edited by Peter Svenonius. Oxford University Press.
- Kayne, Richard S. 1989. Null subjects and clitic climbing. In *The null subject parameter*, 239–261. Springer.
- Kehler, Andrew. 2002. *Coherence, Reference, and the Theory of Grammar*. CSLI Publications.
- Key, Gregory. 2013. The morphosyntax of the Turkish causative construction. Ph.D. thesis, The University of Arizona.
- Kim, Jooyoung. 2018. Embedding without a license?: Typology of unselected embedded clauses. PhD Thesis, University of Delaware.
- Kiparsky, Paul. 1970. Fact. *Progress in linguistics* 143–147.
- Koopman, Hilda. 1984. *The Syntax of Verbs*. Dordrecht, The Netherlands: Foris Publications.
- Koopman, Hilda and Dominique Sportiche. 1989. Pronouns, Logical Variables, and Logophoricity in Abe. *Linguistic Inquiry* 20(4):555–588.

- Koopman, Hilda and Dominique Sportiche. 1991. The position of subjects. *Lingua* 85(2-3):211–258.
- Kornfilt, Jaklin. 1997. *Turkish*. London: Routledge.
- Kornfilt, Jaklin. 2005. Agreement and its placement in turkic nonsubject relative clauses. *The Oxford Handbook of Comparative Syntax* .
- Kornfilt, Jaklin. 2020. Dom and dsm in turkish: Not only dependent case, but also dependent agree. In *Case, agreement, and their interactions: New perspectives on differential object marking*, 127–174. De Gruyter.
- Korotkova, Natasha. 2021. The embedding puzzle: Constraints on evidentials in complement clauses. *Linguistic Inquiry* 52(1):210–226.
- Kratzer, Angelika. 1996. Severing the external argument from its verb. In *Phrase Structure and the Lexicon*, edited by Johan Rooryck and Laurie Zaring, 109–137. Dordrecht, The Netherlands: Kluwer Academic Publishers.
- Kratzer, Angelika. 2006. Decomposing Attitude Verbs. Talk given at The Hebrew University of Jerusalem.
- Kratzer, Angelika. 2016. Evidential Moods in Attitude & Speech Reports (unpublished slides). Slides from talk at UConn, Sept 9.
- Larson, Richard. 1988. On the double object construction. *Linguistic Inquiry* 19(3):335–392.
- Levin, Beth and Malka Rappaport Hovav. 1998. Morphology and lexical semantics. In *Handbook of Morphology*, edited by Arnold Zwicky and Andrew Spencer. Oxford: Blackwell.
- Levin, Theodore and Omer Preminger. 2015. Case in sakha: are two modalities really necessary? *Natural Language & Linguistic Theory* 33(1):231–250.
- Lord, Carol. 1976. Evidence for syntactic reanalysis: from verb to complementizer in Kwa. *Papers from the parasession on diachronic syntax* 179–191.

- Lord, Carol. 1993. *Historical change in serial verb constructions*, vol. 26. John Benjamins Publishing.
- Major, Travis. 2017. Uyghur contrastive polarity questions: A case of verb-stranding “tp-ellipsis”. In *Proceedings of the 12th Workshop on Altaic Formal Linguistics*, edited by L. Zidani-Eroglu, M. Ciscel, and E. Koulidobrova.
- Major, Travis. To Appear. Revisiting the syntax of monsters in Uyghur. *Linguistic Inquiry* .
- Major, Travis and Connor Mayer. 2018. What indexical shift sounds like: Uyghur intonation and interpreting speech reports. In *Proceedings of NELS 49*.
- Major, Travis, Justine Sikuku, and Michael Diercks. ms. Reanalyzing bukusu complementizer agreement. To be submitted to NLLT.
- Major, Travis and Richard Stockwell. 2021. “Say”-ing without a Voice. *Proceedings of NELS 51* Place: UQAM.
- Major, Travis and Harold Torrence. To Appear. “Say”-chains, not “say”-complementation. In *The Proceedings of WCCFL 38*. UBC.
- Marantz, Alec. 1991. Case and Licensing. *ESCOL* 234–253.
- Marantz, Alec. 2013. Verbal argument structure: Events and participants. *Lingua* 4(2):152–168.
- Martin, Stefan and Walt Wolfram. 1998. The sentence in african-american vernacular english. In *African American English: structure, history, and use*, edited by John R. Rickford Mufwene, Salikoko, Guy Bailey, and John Baugh, 11–36. Routledge New York, NY.
- Martins, Ana Maria and Jairo Nunes. 2005. Raising issues in Brazilian and European Portuguese. *Journal of Portuguese Linguistics* 4(2):53–77.

- Martins, Ana-Maria and Jairo Nunes. 2010. The Complementizer Phase: Subjects and Operators. 143–166. Oxford: Oxford University Press. Section: Apparent Hyper-raising in Brazilian Portuguese: Agreement with Topics across a Finite CP.
- Massam, Diane. 2001. Pseudo noun incorporation in Niuean. *Natural Language and Linguistic Theory* 19(1):153–197.
- Mateu, Jaume. 2002. Argument structure: Relational construal at the syntax-semantics interface. PhD Thesis, Universitat Autònoma de Barcelona.
- Matthewson, Lisa. 2004. On the methodology of semantic fieldwork. *International Journal of American Linguistics* 70(4):369–415.
- Mayer, Connor. 2021. Issues in Uyghur backness harmony: Corpus, experimental, and computational studies. Ph.D. thesis, UCLA.
- McKenzie, Andrew. 2012. The role of contextual restriction in reference-tracking. Ph.D. thesis, University of Massachusetts Amherst.
- Merchant, Jason. 2008. Variable island repair under ellipsis. In *Topics in Ellipsis*, edited by Kyle Johnson, 132–153. Cambridge, United Kingdom: Cambridge University Press.
- Messick, Troy. 2017. The morphosyntax of self-ascription: A cross-linguistic study. Ph.D. thesis, University of Connecticut.
- Moltmann, Frederike. 2017. Levels of linguistic acts and the semantics of saying and quoting. In *Interpreting Austin: Critical Essays*, 34–59. Cambridge.
- Moore, John. 1998. Turkish Copy-Raising and A-Chain Locality. *Natural Language and Linguistic Theory* 16(1):149–189.
- Moulton, Keir. 2009. Natural selection and the syntax of clausal complementation. PhD Thesis, University of Massachusetts-Amherst, Amherst, MA.
- Moulton, Keir. 2015. CPs: Copies and Compositionality. *Linguistic Inquiry* 46(2):305–342.

- Moulton, Keir. 2016. Ingredients of embedding. Lecture notes, Göttingen Summer School, August 2016.
- Munro, Pamela. 1982. On the Transitivity of Say Verbs. In *Studies in Transitivity*, vol. 15 of *Syntax and Semantics*, 301–318. Brill.
- Öztürk, Balkız. 2005. *Case, referentiality, and phrase structure*. John Benjamins Publishing Company.
- Öztürk, Balkız. 2013. Postverbal constituents in sov languages. *Theoretical approaches to disharmonic word orders* 270–305.
- Özyıldız, Deniz. 2012. When I is not me: A preliminary case study of shifted indexicals in Turkish. *Ms, École Normale Supérieure* .
- Özyıldız, Deniz. 2017. Attitude reports with and without true belief. In *Semantics and Linguistic Theory* 27, 397–417.
- Özyıldız, Deniz. 2021. The event structure of attitudes. PhD Thesis, UMASS Amherst.
- Özyıldız, Deniz, Travis Major, and Emar Maier. 2018. Communicative reception reports as hear-say: Evidence from indexical shift in Turkish. In *Proceedings of WCCFL36*, vol. 36, 296–305.
- Pakendorf, Brigitte et al. 2007. *Contact in the prehistory of the Sakha (Yakuts): Linguistic and genetic perspectives*. Netherlands Graduate School of Linguistics,(LOT) Utrecht.
- Pancheva, Roumyana and Maria Luisa Zubizarreta. 2020. Temporal reference in the absence of tense in Paraguayan Guarani. *Proceedings of NELS50* .
- Podobryaev, Alexander. 2014. Persons, imposters, and monsters. Ph.D. thesis, MIT.
- Predolac, Esra. 2017. The syntax of sentential complementation in turkish. Ph.D. thesis, Cornell University.

- Preminger, Omer. 2017. No case for agreement (as a causer of case). Talk presented at the 48th Northeast Linguistics Society Conference (NELS 48) in Reykjavic, Iceland.
- Pylkkänen, Liina. 2002. *Introducing Arguments*. PhD Thesis, Massachusetts Institute of Technology.
- Pylkkänen, Liina. 2008. *Introducing Arguments*. Linguistic Inquiry Monograph. Cambridge, MA: MIT Press.
- Ramchand, Gillian. 2008. *Verb Meaning and the Lexicon: A First-Phase Syntax*. Cambridge: Cambridge University Press.
- Ramchand, Gillian. 2018. *Situations and Syntactic Structures Rethinking Auxiliaries and Order in English*. Cambridge, MA: MIT Press.
- Riis, H. N. 1854. *Grammatical Outline and Vocabulary of the Oji-Language, With Especial Reference to the Akwapim-Dialect, Together With a Collection of Proverbs of the Natives*. Bahnmaier, Basel.
- Rizzi, Luigi. 1997. The fine structure of the left periphery. In *Elements of grammar*, 281–337. Springer.
- Rosen, Sarah T. 1999. The syntactic representation of linguistic events. *Glott International* 4.2:3–11.
- Rosenbaum, Peter S. 1967. *The grammar of English predicate complement constructions*. Cambridge, MA: MIT Press.
- Ross, John. 1967. Constraints on variables in syntax. PhD Thesis, Massachusetts Institute of Technology.
- Rothmayr, Antonia. 2009. *The structure of stative verbs*, vol. 143. John Benjamins Publishing.

- Salzmann, Martin. 2017. Prolepsis. In *The Wiley Blackwell Companion to Syntax*, 1–42. Wiley-Blackwell, second edn.
- Schlenker, Philippe. 1999. Propositional attitudes and indexicality. Ph.D. thesis, Massachusetts Institute of Technology.
- Schlenker, Philippe. 2003. A Plea for Monsters. *Linguistics and Philosophy* 26:29–120.
- Schlenker, Philippe. 2004. Context of thought and context of utterance: A note on free indirect discourse and the historical present. *Mind and Language* 19:279–304.
- Schuh, Russell G. 1995. Avatime noun classes and concord. *Studies in African Linguistics* 24(2):123.
- Şener, Nilüfer Gültekin and Serkan Şener. 2011. Null subjects and indexicality in Turkish and Uyghur. In *Proceedings of the 7th Workshop on Altaic Formal Linguistics (WAFLL7)*, 269–284.
- Shimamura, Koji. 2018. The theory of quotative complementation in Japanese semantico-syntax. PhD Thesis, University of Connecticut.
- Shklovsky, Kirill and Yasutada Sudo. 2014. The Syntax of Monsters. *Linguistic Inquiry* 45:381–402.
- Spadine, Carolyn. 2020. The Structure of Attitude Reports: Representing Context in Grammar. PhD Thesis, Massachusetts Institute of Technology.
- Stowell, Timothy Angus. 1981. Origins of phrase structure. Ph.D. thesis, Massachusetts Institute of Technology.
- Sudo, Yasutada. 2012. On the semantics of phi features on pronouns. PhD Thesis, Massachusetts Institute of Technology.
- Sugar, Alexander. 2019. Verb-linking and Events in Syntax: The Case of Uyghur -(i)p Constructions. PhD Thesis, University of Washington.

- Talmy, Leonard. 1985. Lexicalization patterns: Semantic structure in lexical forms. *Language Typology and Syntactic Description* 3(99):36–149.
- Tanaka, Hidekazu. 2002. Raising to object out of cp. *Linguistic Inquiry* 33(4):637–652.
- Tomioka, Satoshi. 2014. Micro-parameters in discourse pro-drop languages: Comments on 'born empty' by yen-hui audrey li. *Lingua* 151:69–77.
- Travis, Lisa. 2010. *Inner aspect: The articulation of VP*. Dordrecht: Springer.
- Van Putten, Saskia. 2014. Information structure in Avatime. PhD Thesis, Radboud University.
- Van Valin, R. 2005. *Exploring the syntax-semantics interface*. Cambridge: Cambridge University Press.
- Vinokurova, Nadezhda. 2005. Lexical categories and argument structure: a study with reference to sakha. Ph.D. thesis, University of Utrecht.
- Vinokurova, Nadezhda. 2011. Shifting indexicals in sakha. In *In Proceedings of the 10th Seoul International Altaistic Conference*, 239–262. Seoul: Altaic Society of Korea.
- Wood, Jim. 2015. *Icelandic morphosyntax and argument structure*, vol. 90. Dordrecht: Springer.
- Wurmbrand, Susi. 2019. Cross-clausal a-dependencies. In *Proceedings of the Chicago Linguistic Society*, edited by Laura Stigliano & Yenan Sun Eszter Ronai, vol. 54, 585–604.
- Zeller, Jochen. 2006. Raising out of finite CP in Nguni: the case of *fanele*. *Southern African Linguistics and Applied Language Studies* 24(3):255–275.
- Zidani-Eroğlu, Leyla. 1997. Indefinite NPs in Turkish. PhD Thesis, University of Wisconsin, Madison.
- Zubizarreta, Maria Luisa and Eunjeong Oh. 2007. *On the syntactic composition of manner and motion*. Cambridge, MA: MIT Press.

Zyman, Erik. 2017. P'urhepecha hyperraising to object: An argument for purely altruistic movement. *Proceedings of the Linguistic Society of America* 2:53:1–15.