

Lawrence Berkeley National Laboratory

Lawrence Berkeley National Laboratory

Title

PRELIMINARY THERMAL AND THERMOMECH-ANICAL MODELING FOR THE NEAR SURFACE TEST FACILITY HEATER EXPERIMANTS AT HANFORD: Appendix D

Permalink

<https://escholarship.org/uc/item/8qw4v9q5>

Author

Chan, T.

Publication Date

1978-12-01

CK
OK

RECEIVED
LAWRENCE
BERKELEY LABORATORY

MAY 31 1979

LIBRARY AND
DOCUMENTS SECTION

LBL-7069 v. 2, p. 1
UC-70

Preliminary Thermal and Thermomechanical Modeling for the Near Surface Test Facility Heater Experiments at Hanford

VOLUME II (Appendix D)

Tin Chan and Janet S. Remer
Earth Sciences Division

December 1978

TWO-WEEK LOAN COPY

This is a Library Circulating Copy
which may be borrowed for two weeks.
For a personal retention copy, call
Tech. Info. Division, Ext. 6782

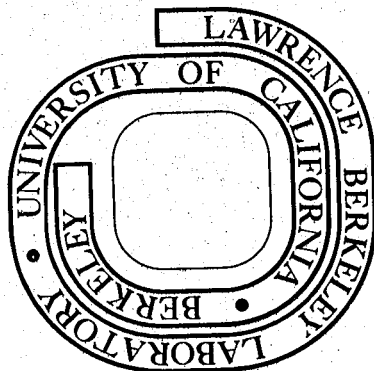

Prepared for the U. S. Department of Energy
under Contract W-7405-ENG-48
and for Rockwell Hanford Operations —
a Department of Energy Prime Contractor —
under Memorandum Order No. W8A-SBB-51760

LBL-7069 v. 2, p. 1

LBL-7069

PRELIMINARY THERMAL AND THERMOMECHANICAL MODELING FOR
THE NEAR SURFACE TEST FACILITY HEATER EXPERIMENTS AT HANFORD

Volume 2 (Appendix D)

Tin Chan and Janet S. Remer

Earth Sciences Division
Lawrence Berkeley Laboratory
University of California
Berkeley, California 94720

December 1978

Prepared for the U.S. Department of Energy
under Contract No. W-7405-ENG-48
and for Rockwell Hanford Operations
-A Department of Energy Prime Contractor-
under Memorandum Order No. W8A-SBB-51760

— LEGAL NOTICE —

This report was prepared as an account of work sponsored by the United States Government. Neither the United States nor the Department of Energy, nor any of their employees, nor any of their contractors, subcontractors, or their employees, makes any warranty, express or implied, or assumes any legal liability or responsibility for the accuracy, completeness or usefulness of any information, apparatus, product or process disclosed, or represents that its use would not infringe privately owned rights.

CONTENTS: Volume 2 (Appendix D)

	<u>Page</u>
Preface	xi
Contents, Volume 1	1
Table D1: Summary of Figures Representing Models Studied	3
Table D2: Correspondence Between Figures in Volume 1 and Appendix D, Volume 2	4
 <u>Figures</u>	
Figure D1 Hanford Full-Scale Experiment Heater Array	5
Figure D2 Hanford Full-Scale Experiment Power Schedules	
(a) Power Schedule 1a	6
(b) Power Schedule 1b	7
(c) Power Schedule 1c	8
(d) Power Schedule 2a	9
(e) Power Schedule 2b	10
(f) Power Schedule 2c	11
Figure D3 Hanford Time-Scaled Experiment Heater Array	12
Figure D4 Hanford Time-Scaled Experiment Power Schedule 3	13
Figure D5 Finite Element Mesh and Boundary Conditions for Full-Scale Heater Experiment	
(a) View of entire finite element mesh	14
(b) Details of area "B" in "A"	15
(c) Details of area "C" in "B"	16
Figure D6 Temperature Profiles for Hanford Full-Scale Experiment: $z = 0.0$ m, $\theta = 0.0^\circ$, $r = 0.203$ to 0.881 m	
(a) Power Schedule 1a	17
(b) Power Schedule 1b	18
(c) Power Schedule 1c	19
(d) Power Schedule 2a	20
(e) Power Schedule 2b	21
(f) Power Schedule 2c	22

Figure D7 Temperature Profiles for Hanford Full-Scale
 Experiment: $z = 0.0$ m, $\theta = 0.00^\circ$,
 $r = 0.919$ to 5.0 m

(a)	Power Schedule 1a	23
(b)	Power Schedule 1b	24
(c)	Power Schedule 1c	25
(d)	Power Schedule 2a	26
(e)	Power Schedule 2b	27
(f)	Power Schedule 2c	28

Figure D8 Isotherms in Vertical Plane, Hanford Full-Scale
 Experiment: Infinite Medium Model, Main Heater
 = 5kW

(a)	7 days	29
(b)	30 days	30
(c)	90 days	31
(d)	180 days	32
(e)	365 days	33
(f)	372 days	34
(g)	395 days	35
(h)	455 days	36
(i)	730 days	37
(j)	737 days	38
(k)	760 days	39
(l)	790 days	40
(m)	1095 days	41

Figure D9 Isotherms in Vertical Plane, Hanford Full-Scale
 Experiment: Isothermal Boundary Model,
 Main Heater = 5 kW

(a)	7 days	42
(b)	30 days	43
(c)	90 days	44
(d)	180 days	45
(e)	365 days	46
(f)	372 days	47
(g)	395 days	48
(h)	455 days	49
(i)	730 days	50
(j)	737 days	51
(k)	760 days	52
(l)	790 days	53
(m)	1095 days	54

Figure D10 Isotherms in Vertical Plane, Hanford Full-Scale Experiment: Infinite Medium Model, Main Heater = 2 kW

(a)	7 days	55
(b)	30 days	56
(c)	90 days	57
(d)	180 days	58
(e)	365 days	59
(f)	372 days	60
(g)	395 days	61
(h)	455 days	62
(i)	730 days	63
(j)	737 days	64
(k)	760 days	65
(l)	790 days	66
(m)	1095 days	67

Figure D11 Isotherms in Vertical Plane, Hanford Full-Scale Experiment: Isothermal Boundary Model, Main Heater = 2 kW

(a)	7 days	68
(b)	30 days	69
(c)	90 days	70
(d)	180 days	71
(e)	365 days	72
(f)	372 days	73
(g)	395 days	74
(h)	455 days	75
(i)	730 days	76
(j)	737 days	77
(k)	760 days	78
(l)	790 days	79
(m)	1095 days	80

Figure D12 Deformation of Heater Drift and Borehole under Power Schedule 1a, Hanford Full-Scale Experiment.

(a)	730 days	81
(b)	1095 days	82

Figure D13 Deformation of Heater Drift and Borehole under Power Schedule 2a, Hanford Full-Scale Experiment.

(a)	730 days	83
(b)	1095 days	84

	<u>Page</u>
Figure D14 Hanford Full-Scale Experiment, Displacement Profiles (u_z) at $r = 0.45$ m, $\theta = 0^\circ$, Mesh 1.	
(a) 730 days	85
(b) 1095 days	86
Figure D15 Hanford Full-Scale Experiment, Displacement Profiles (u_z) at $r = 1.875$ m, $\theta = 0^\circ$, Mesh 1.	
(a) 730 days	87
(b) 1095 days	88
Figure D16 Hanford Full-Scale Experiment, Displacement Profiles (u_z) at $r = 10.5$ m, $\theta = 0^\circ$, Mesh 1.	
(a) 730 days	89
(b) 1095 days	90
Figure D17 Hanford Full-Scale Experiment, Displacement Profiles (u_z) at $r = 0.45$ m, $\theta = 0^\circ$, Mesh 7.	
(a) 730 days	91
(b) 1095 days	92
Figure D18 Hanford Full-Scale Experiment, Displacement Profiles (u_z) at $r = 1.875$ m, $\theta = 0^\circ$, Mesh 7.	
(a) 730 days	93
(b) 1095 days	94
Figure D19 Hanford Full-Scale Experiments, Displacement Profiles (u_z) at $r = 10.5$ m, $\theta = 0^\circ$, Mesh 7.	
(a) 730 days	95
(b) 1095 days	96
Figure D20 Hanford Full-Scale Experiment, Displacement Profile (u_r) for Mesh 1. Main Heater = 5 kW, $z = 0.0$ m, $\theta = 0^\circ$.	
(a) 7 days	97
(b) 30 days	98
(c) 90 days	99
(d) 180 days	100
(e) 365 days	101
(f) 371 days	102
(g) 390 days	103
(h) 450 days	104
(i) 730 days	105

	<u>Page</u>
(j) 760 days	106
(k) 790 days	107
(l) 1095 days	108
Figure D21 Hanford Full-Scale Experiment, Displacement Profile (u_r) for Mesh 1. Main Heater = 2 kW, $z = 0.0$ m, $\theta = 0^\circ$.	
(a) 7 days	109
(b) 30 days	110
(c) 90 days	111
(d) 180 days	112
(e) 365 days	113
(f) 371 days	114
(g) 390 days	115
(h) 450 days	116
(i) 730 days	117
(j) 760 days	118
(k) 790 days	119
(l) 1095 days	120
Figure D22 Hanford Full-Scale Experiment, Displacement Profile (u_r) for Mesh 7. Main Heater = 5 kW, $z = 0.0$ m, $\theta = 0^\circ$.	
(a) 730 days	121
(b) 1095 days	122
Figure D23 Hanford Full-Scale Experiment, Displacement Profile (u_r) for Mesh 7. Main Heater = 2 kW, $z = 0.0$ m, $\theta = 0^\circ$.	
(a) 730 days	123
(b) 1095 days	124
Figure D24 Hanford Full-Scale Experiment, Stress Profiles for Mesh 1. $z = 0.0$ m, $\theta = 0^\circ$.	
(a) 1 day	125
(b) 7 days	126
(c) 30 days	127
(d) 90 days	128
(e) 180 days	129
(f) 365 days	130
(g) 371 days	131
(h) 390 days	132
(i) 450 days	133

	<u>Page</u>
(j) 730 days	134
(k) 760 days	135
(l) 790 days	136
(m) 1095 days	137
Figure D25 Hanford Full-Scale Experiment, Stress Profiles for Mesh 1. Main Heater = 2 kW, $z = 0.0$ m, $\theta = 0^\circ$.	
(a) 1 day	138
(b) 7 days	139
(c) 30 days	140
(d) 90 days	141
(e) 180 days	142
(f) 365 days	143
(g) 371 days	144
(h) 390 days	145
(i) 450 days	146
(j) 730 days	147
(k) 760 days	148
(l) 790 days	149
(m) 1095 days	150
Figure D26 Hanford Full-Scale Experiment, Tangential Stress Along Floor of Heater Drift ($z = 3.875$ m), Mesh 7.	
(a) 730 days	151
(b) 1095 days	152
Figure D27 Hanford Full-Scale Experiment, Radial Stress Along Floor of Heater Drift ($z = 3.875$ m), Mesh 7.	
(a) 730 days	153
(b) 1095 days	154
Figure D28 Interference Between the Two Full-Scale Experiments: Combined Temperature Profile at $z = 0$ m, $\theta = 0^\circ$; Infinite Medium Model.	
(a) 730 days	155
(b) 1095 days	156
Figure D29 Interference Between the Two Full-Scale Experiments: Stress (σ_r) Profiles at $z = 0$ m, $\theta = 0^\circ$; Mesh 1.	
(a) 730 days	157
(b) 1095 days	158

Figure D30	Interference Between the Two Full-Scale Experiments: Displacement (u_r) Profiles at $z = 0$ m, $\theta = 0^\circ$; Mesh 1.	
	(a) 730 days	159
	(b) 1095 days	160
Figure D31	Temperature Profiles for Hanford Time-Scaled Experiment.	
	(a) Diagram showing locations at which temperature profiles were made	161
	(b) $x = 8.75$ to 14 m, $y = 0$ m, $z = 0$ m	162
	(c) $x = 5.25$ to 7.064 m, $y = 0$ m, $z = 0$ m	163
	(d) $x = 0.064$ to 3.5 m, $y = 0$ m, $z = 0$ m	164
	(e) $x = 0$ m, $y = 3.064$ to 6 m, $z = 0$ m	165
	(f) $x = 0$ m, $y = 0.064$ to 2.937 m, $z = 0$ m	166
	(g) $x = 7.045$ to 10.5 m, $y = 3.545$ to 3.455 m, $z = 0$ m	167
	(h) $x = 3.545$ to 6.955 m, $y = 1.545$ to 3.455 m, $z = 0$ m	168
	(i) $x = 0.045$ to 3.455 m, $y = 0.045$ to 1.455 m, $z = 0$ m	169
Figure D32	Isotherms in Horizontal Plane, Hanford Time-Scaled Experiment.	
	(a) 7 days	170
	(b) 30 days	171
	(c) 90 days	172
	(d) 180 days	173
	(e) 365 days	174
	(f) 730 days	175
	(g) 737 days	176
	(h) 760 days	177
	(i) 820 days	178
	(j) 910 days	179
	(k) 1095 days	180
Figure D33	Migration of 5° Isotherm in Horizontal Plane, Hanford Time-Scaled Experiment.	181

PREFACE

Appendix D is a complete set of figures illustrating the detailed calculations necessary for designing the heater experiments at the Near Surface Test Facility (NSTF) at Hanford, Washington. The discussion of the thermal and thermomechanical modeling that yielded these calculations is presented in Volume 1. A summary of the figures and the models they illustrate is given in Table D1. The most important figures have also been included in the discussion in Volume 1, and Table D2 lists the figure numbers in this volume that correspond to figure numbers used there.

Contents: Volume 1

Preface	v
List of Figures	vi
List of Tables	xi
Acknowledgments	xiii
Abstract	xv
1.0 Introduction	1
1.1 Background and objectives	1
1.2 Scope of present work	2
2.0 Physical Systems to be Modeled	4
2.1 Full-scale heater experiments	5
2.2 Time-scaled heater experiment	9
3.0 Thermal and Thermo-Mechanical Models Used	15
3.1 Closed form integral solutions for thermal analysis	15
3.2 Finite element thermo-mechanical models	18
4.0 Results and Discussion	22
4.1 Full-scale experiments	22
4.1.1 Temperatures	24
4.1.2 Displacements	38
4.1.3 Stresses	49
4.1.4 Interference of the two full-scale experiments	58
4.2 Time-scaled experiment	65
5.0 Summary, Conclusions and Recommendations	73
References	79
Appendix A: Closed Form Integral Solutions for Temperature Distribution Due to a Finite Cylinder and a Disc Source with Arbitrary Time Dependence	83
Appendix B: Generalization to an Anisotropic Medium	87
Appendix C: Consideration of Temperature Rise as a Function of the Group Parameter t/r^2 ; Comparison of Finite Line and Infinite Line Sources	89

Appendix D tables: Table D1, Summary of Figures Representing
Models Studied
Table D2, Correspondence between Figures in
Volume 1 and Appendix D, Volume 2. 93

Appendix D

Table D1. Summary of figures representing models studied.

Power Schedule	(a) Full-Scale Experiments					
	Temperature Calculations		Displacement Calculations		Stress Calculations	
	Infinite Medium	Isothermal Boundary	Mesh 1	Mesh 7	Mesh 1	Mesh 7
1a (Fig. 2a)	D6a, D7a D8a-D8m	D9a-D9m	D12a, D12b D14a, D14b D15a, D15b D16a, D16b D20a-D20l	D12a, D12b D17a, D17b D18a, D18b D19a, D19b D22a, D22b	D24a-D24m	D26a, D26b, D27a, D27b
1b (Fig. 2b)	D6b, D7b					
1c (Fig. 2c)	D6c, D7c					
2a (Fig. 2d)	D6d, D7d D10a-D10m	D11a-D11m	D13a, D13b D14a, D14b D15a, D15b D16a, D16b D21a-D21l	D13a, D13b D17a, D17b D18a, D18b D19a, D19b D23a, D23b	D25a-D25m	D26a, D26b, D27a, D27b
2b (Fig. 2e)	D6e, D7e					
2c (Fig. 2f)	D6f, D7f					
Interference between Experiments with 1a (Fig. 2a) and 2a (Fig. 2d)	D28a, D28b		D30a, D30b		D29a, D29b	
(b) Time-Scaled Experiment						
3 (Fig. 4)	D31a-D31h D32a-D32k D33					

Table D2. Correspondence between figures in Volume 1 and Appendix D, Volume 2.

Figure Number in Volume 1	Figure Number in Appendix D, Volume 2
1	D1
2a-2f	D2a-D2f
3	D3
4	D4
5a-5c	D5a-D5c
6a-6c	D6a,D6d,D6f
7a-7c	D7a,D7d,D7f
8a,8b	D8e,D8i
9a-9c	D9b,D9e,D9i
10a,10b	D10e,D10i
11a-11c	D11b,D11e,D11i
12a,12b	D12a,D12b
13a-13c	D17a,D18a,D19a
14a-14f	D20b-D20f,D20i
15	D22a
16a-16e	D24a-D24c,D24f,D24g
17	D26a
18	D27a
19	D28a
20	D29a
21	D30a
22	D31a
23a,23b	D31b,D31i
24a,24h	D32a,D32c-D32g,D32j,D32k
25	D33

HANFORD FULL-SCALE EXPERIMENT

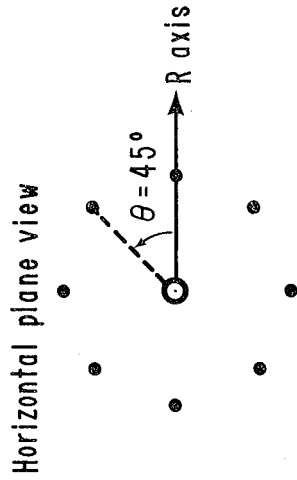
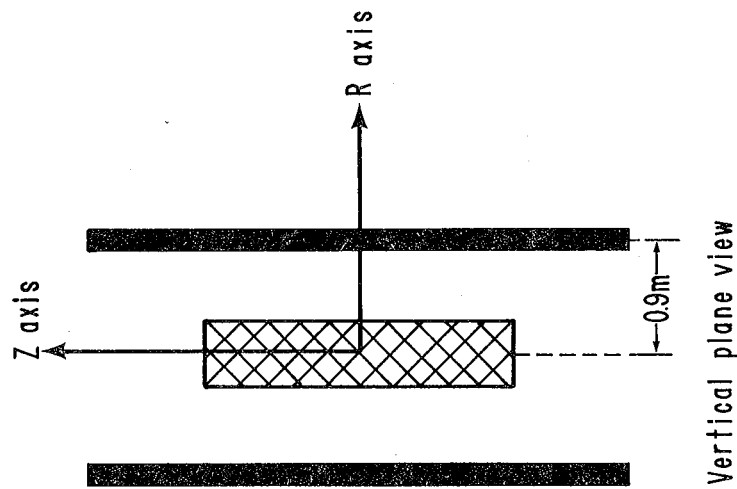

Central (main) heater:
length = 2.4384 m (8 ft.), radius = 0.2286 m (9 in)
energized at start of experiment.

Peripheral heaters:
length = 4.2672 m (14 ft), radius = 0.0191 m (0.75 in);
energized 365 days after start of experiment

Axes represented are those used in numerical modeling.
Diameters of heaters in diagram are greatly exaggerated.

Figure DT
XBL 787-1993

HANFORD FULL-SCALE EXPERIMENT
POWER SCHEDULE 1A

1 - CENTRAL HEATER

2 - PERIPHERAL HEATERS (8)

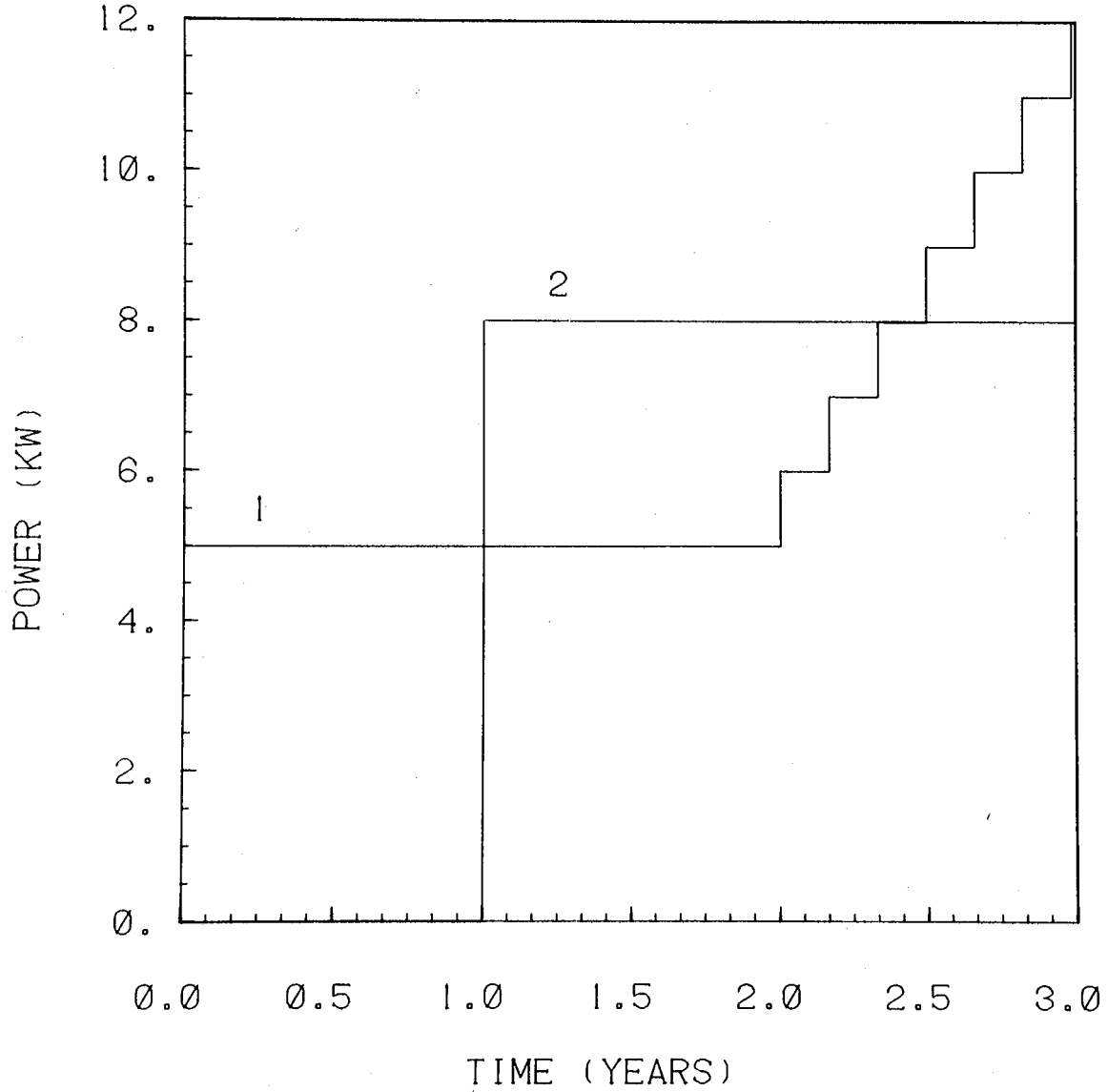

XBL 787-9729

Figure D2a

HANFORD FULL-SCALE EXPERIMENT

POWER SCHEDULE 1B

1 - CENTRAL HEATER

2 - PERIPHERAL HEATERS (8)

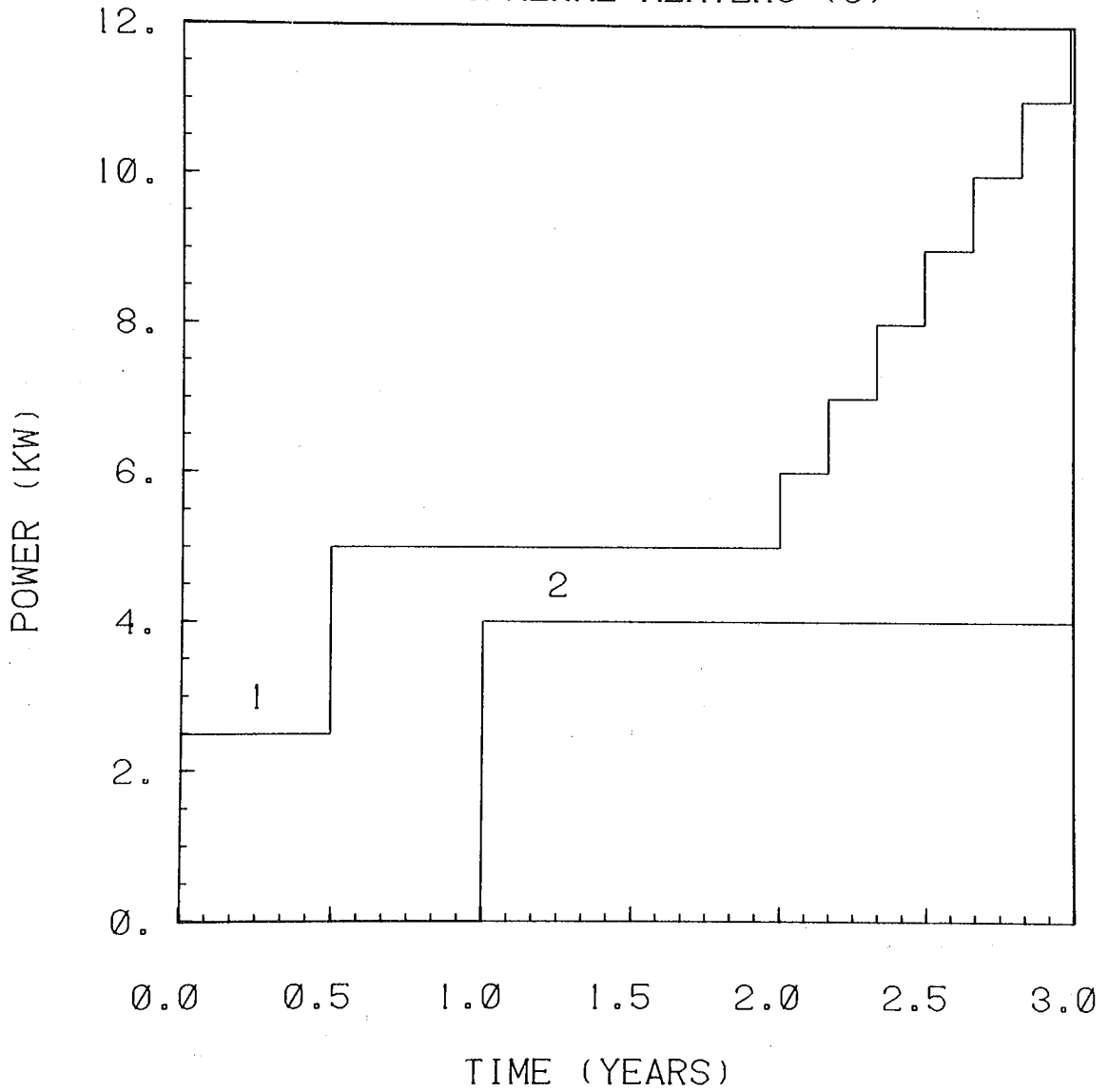

XBL 787-9733

Figure D2b

HANFORD FULL-SCALE EXPERIMENT
POWER SCHEDULE 1C
1 - CENTRAL HEATER
2 - PERIPHERAL HEATERS (8)

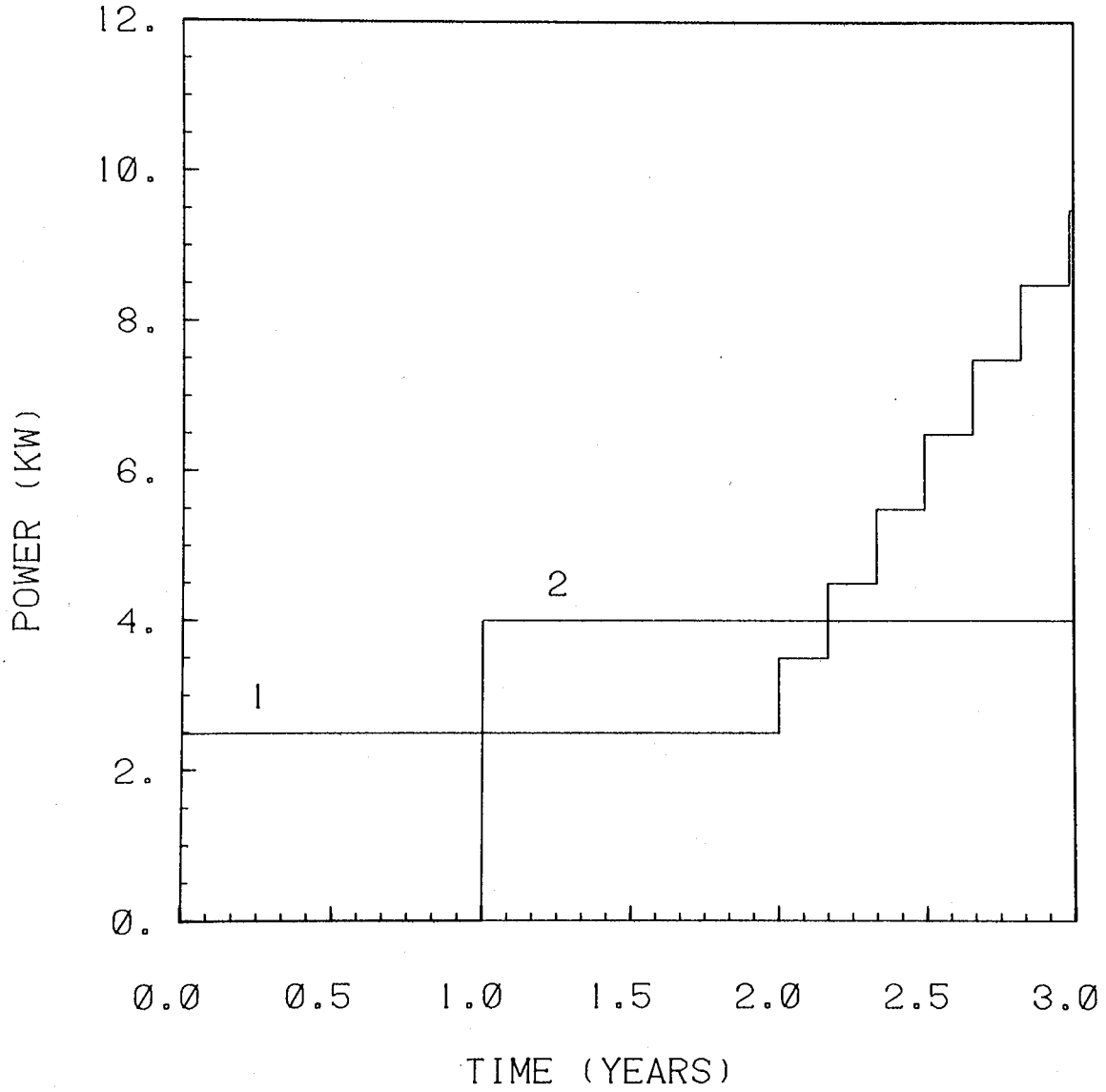

XBL 787-9732

Figure D2c

HANFORD FULL-SCALE EXPERIMENT
POWER SCHEDULE 2A

1 - CENTRAL HEATER

2 - PERIPHERAL HEATERS (8)

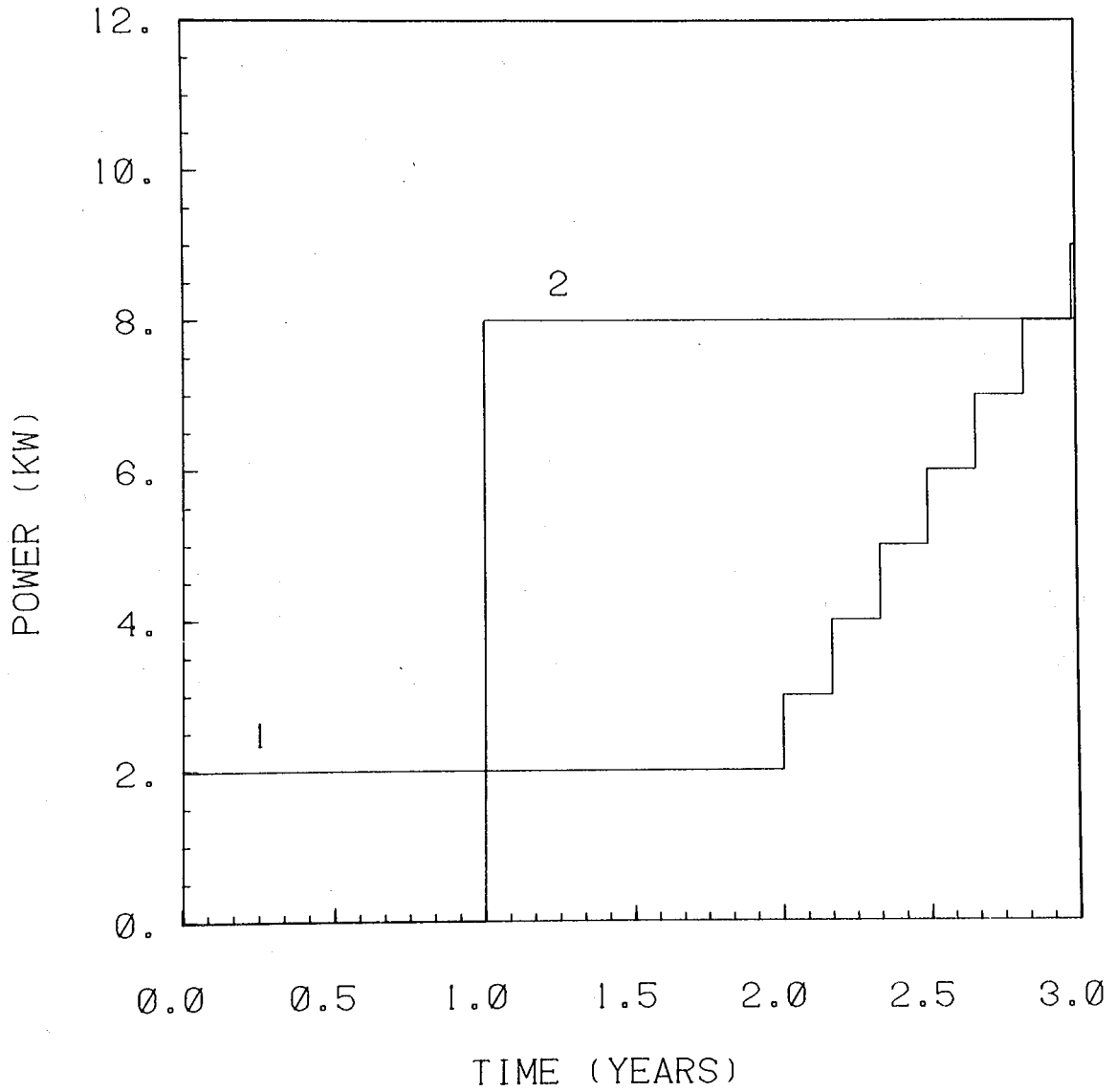

XBL 787-9730

Figure D2d

HANFORD FULL-SCALE EXPERIMENT
POWER SCHEDULE 2B

1 - CENTRAL HEATER

2 - PERIPHERAL HEATERS (8)

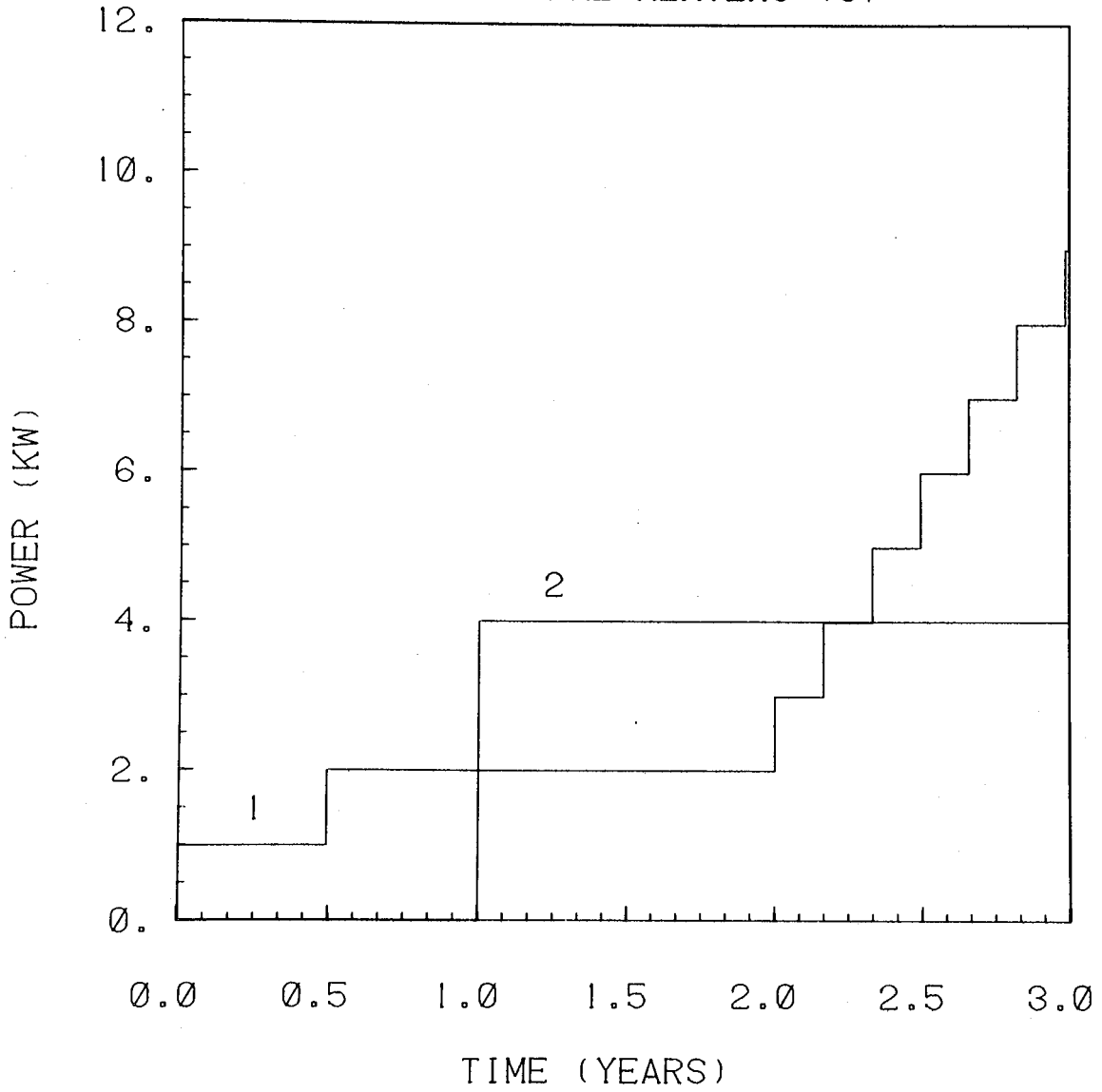

XBL 787-9731

Figure D2e

HANFORD FULL-SCALE EXPERIMENT

POWER SCHEDULE 2C

1 - CENTRAL HEATER

2 - PERIPHERAL HEATERS (8)

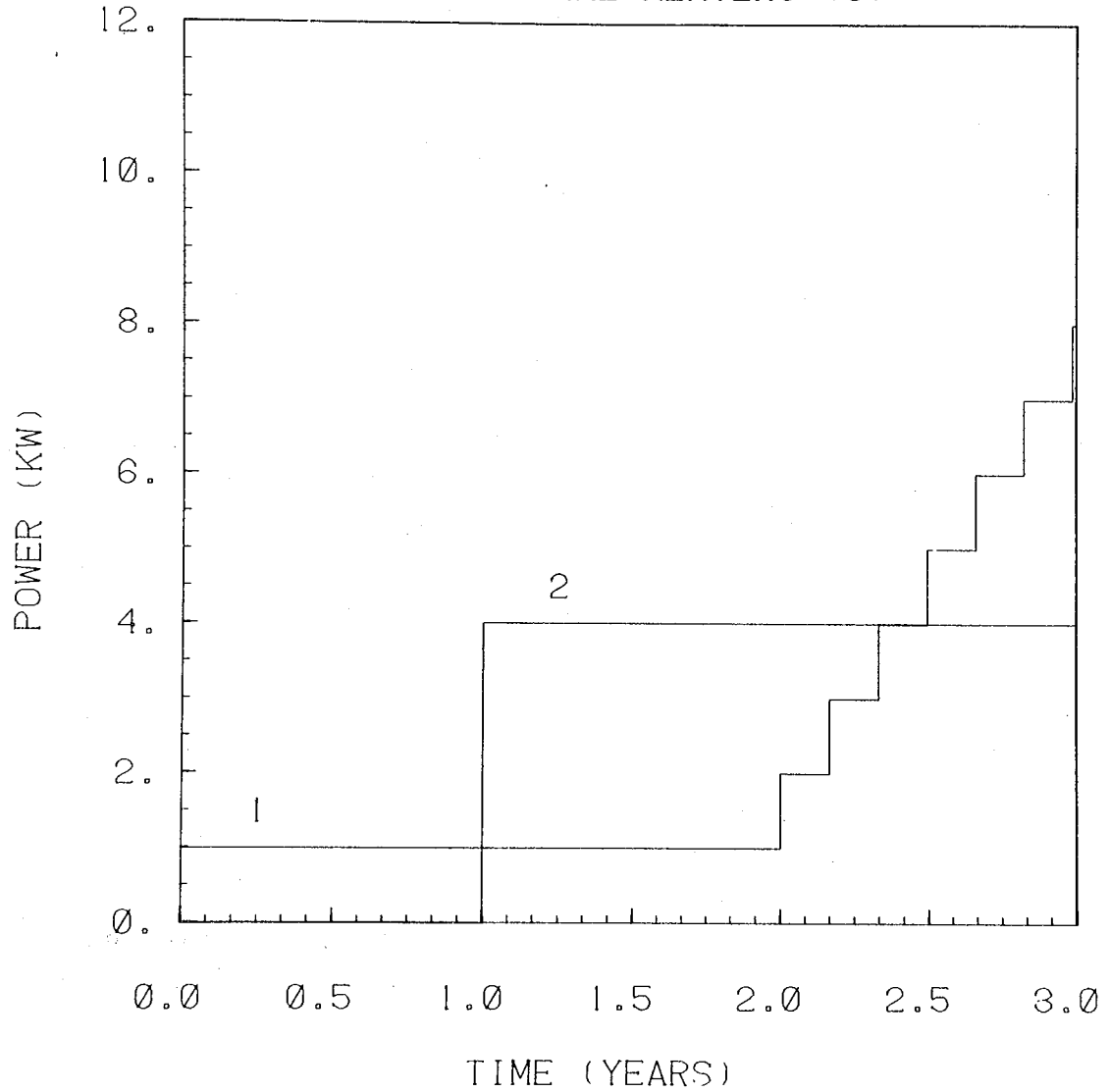

XBL 787-9750

Figure D2f

HANFORD TIME - SCALE EXPERIMENT

Horizontal plane view of arrangement of heaters.

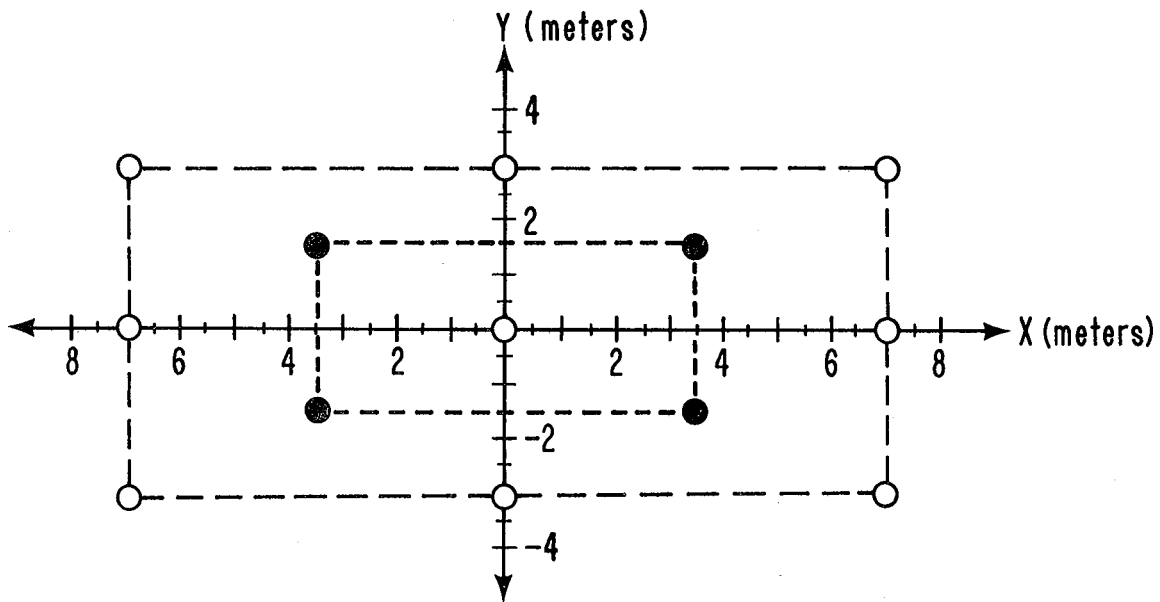

- Primary heaters : length = 0.81 m ; radius = 0.0635 m ; energized at start of experiment.
 - Secondary heaters : length = 0.81 m ; radius = 0.0635 m ; energized 730 days after start of experiment.
- Axes represented are those used in numerical modeling.
Diameter of heaters in diagram is greatly exaggerated.

XBL 787-1994

Figure D3

HANFORD TIME-SCALED EXPERIMENT Power Schedule 3

* Primary heaters (9)

- Secondary heaters (4)

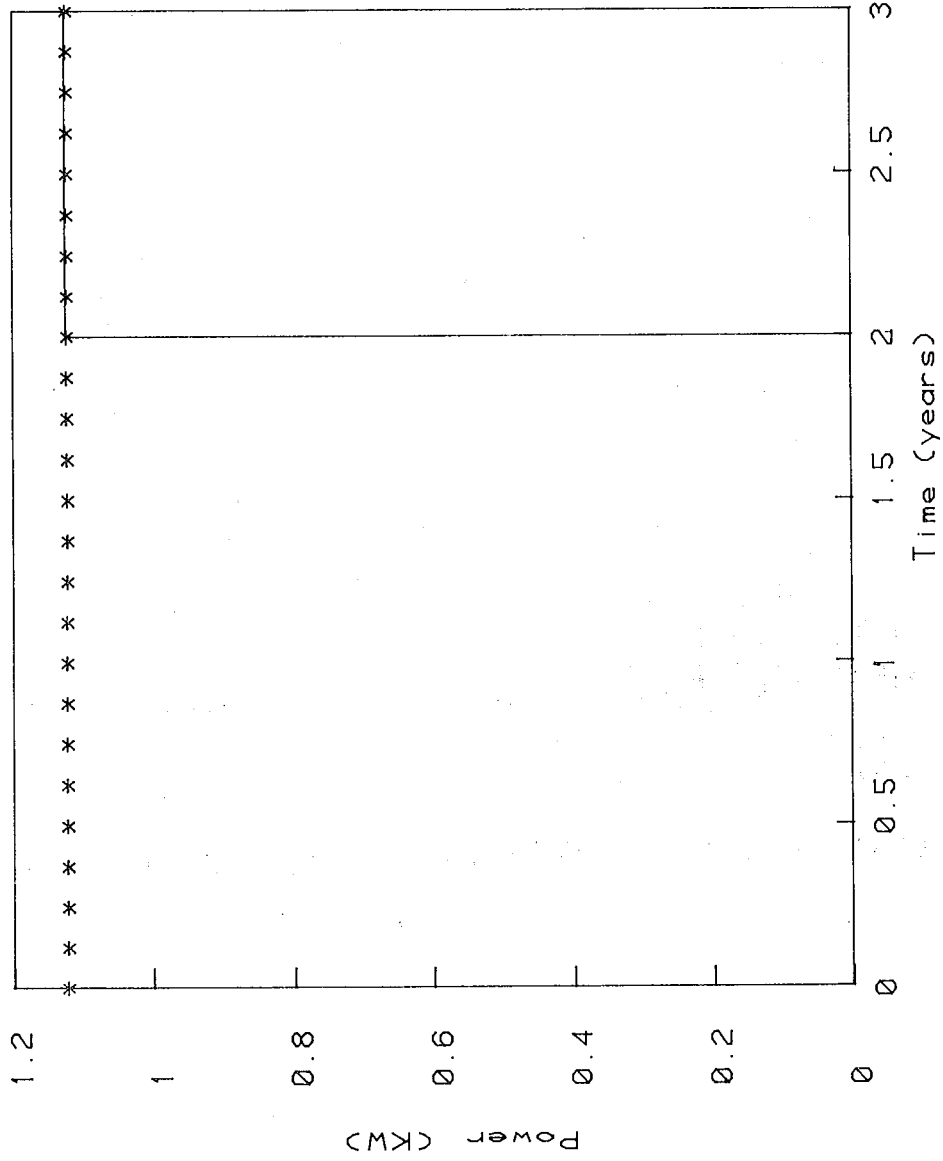

XBL 7810-11827

Figure D4

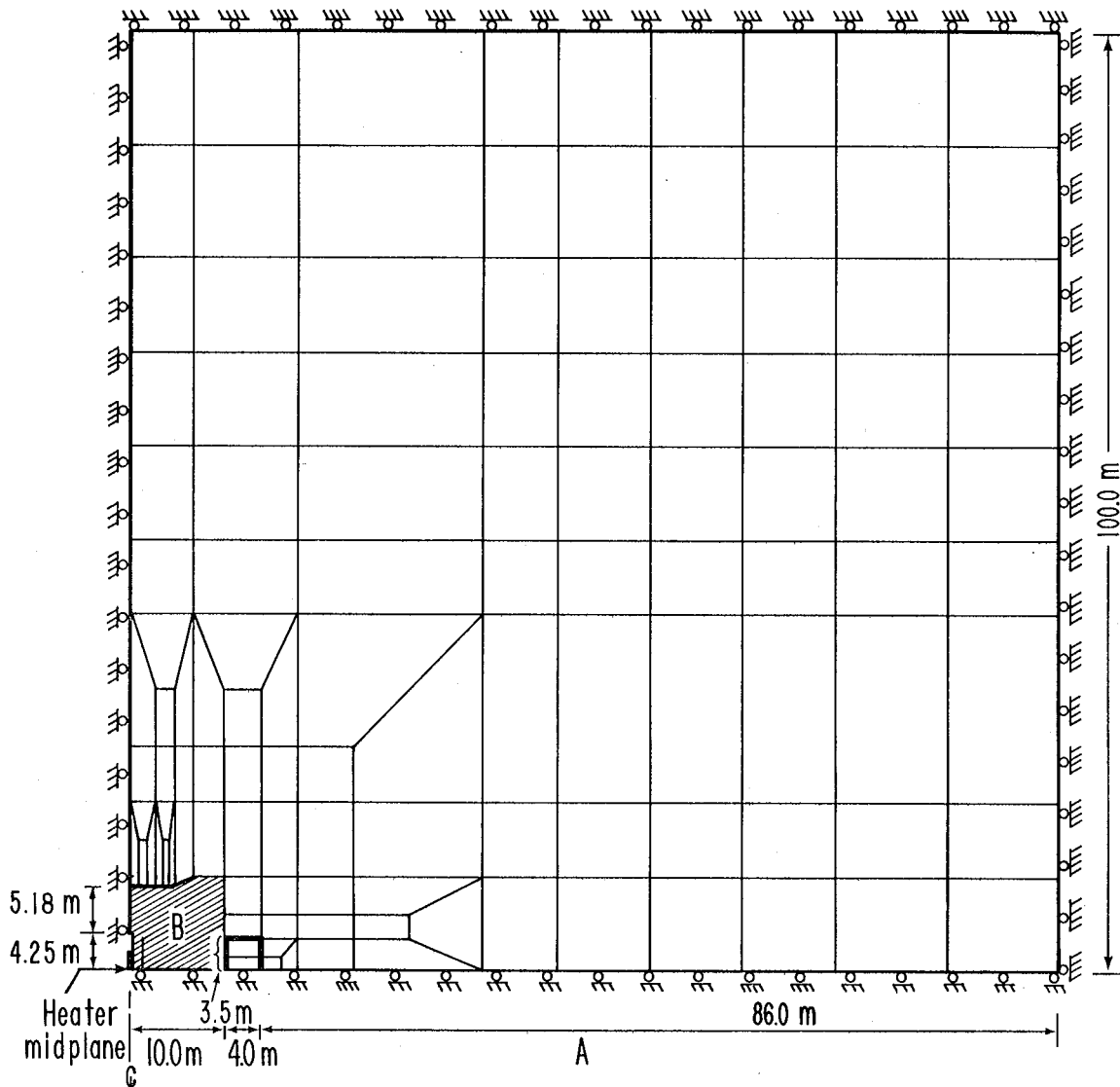

FINITE ELEMENT MESH AND BOUNDARY CONDITIONS FOR FULL SCALE HEATER
EXPERIMENT 2.

XBL 786 - 1962 A/B

Figure D5a

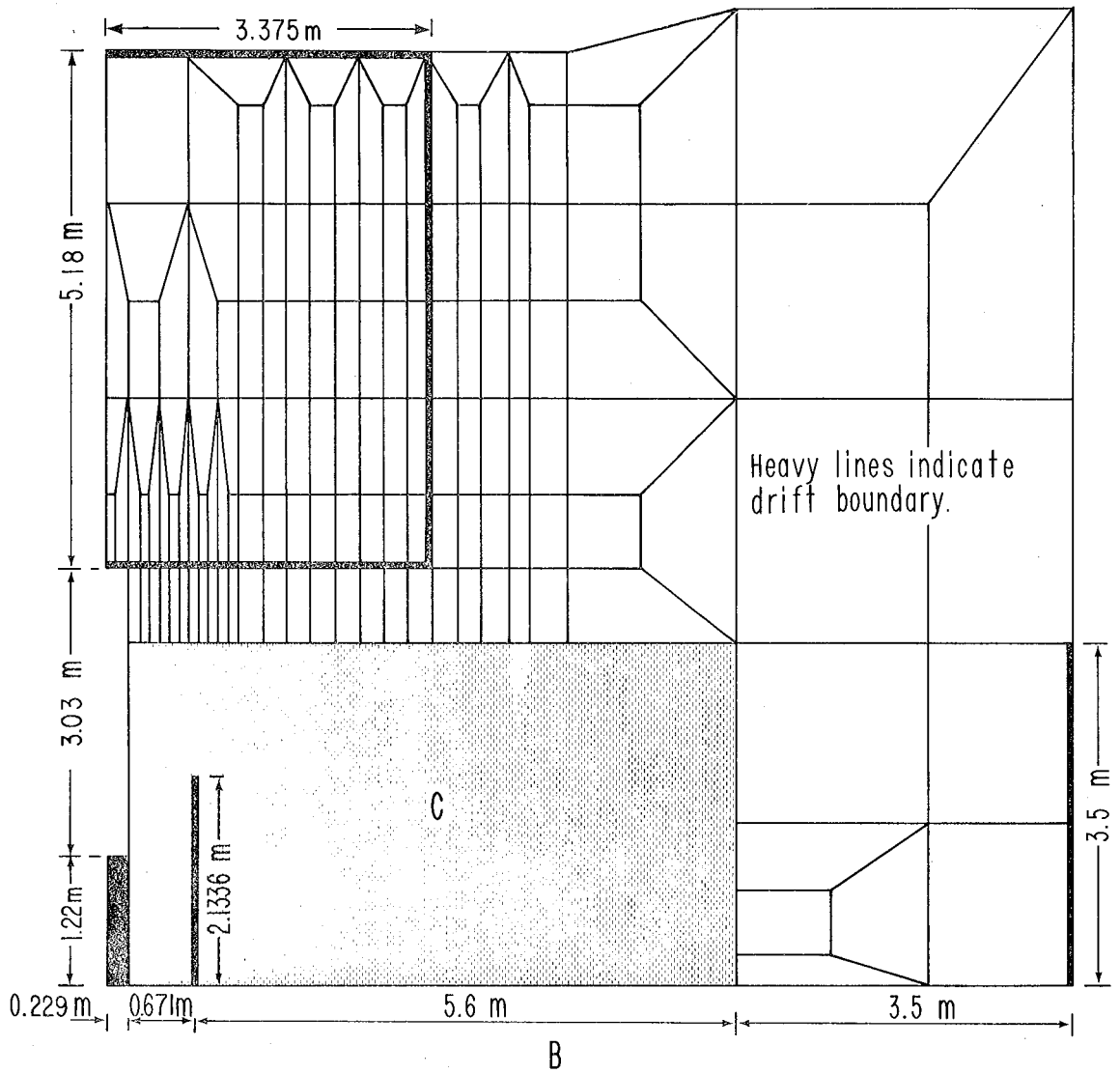

DETAILS OF AREA "B" IN "A".

XBL 786-1964/B

Figure D5b

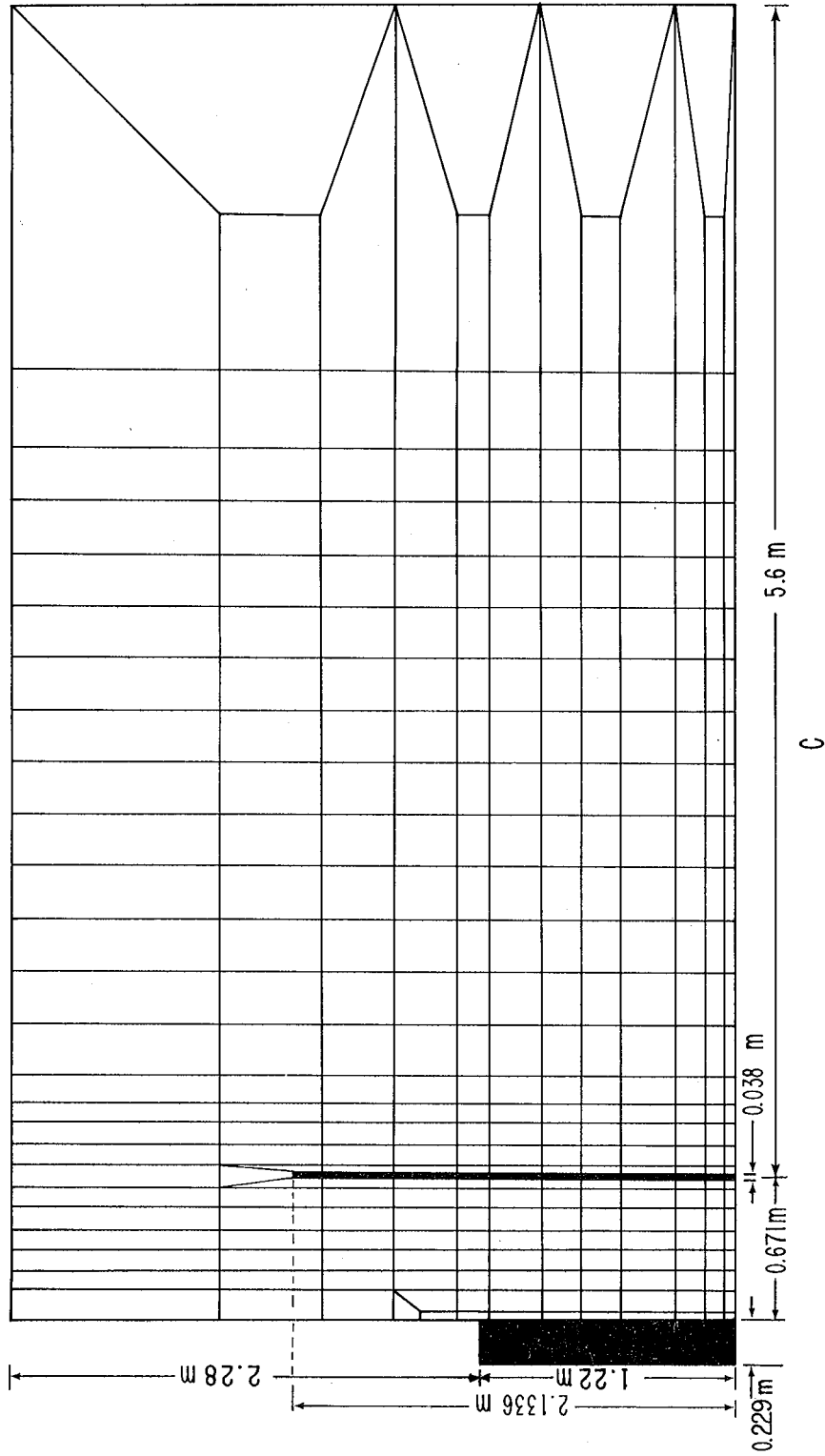

DETAILS OF AREA "C" IN "B":

Figure D5c

XBL 786-1965A/B

TEMPERATURE PROFILES FOR
HANFORD FULL-SCALE EXPERIMENT
POWER SCHEDULE 1A
Z = 0.0 M, THETA = 0.0 DEG.
R = 0.203 TO 0.881 M

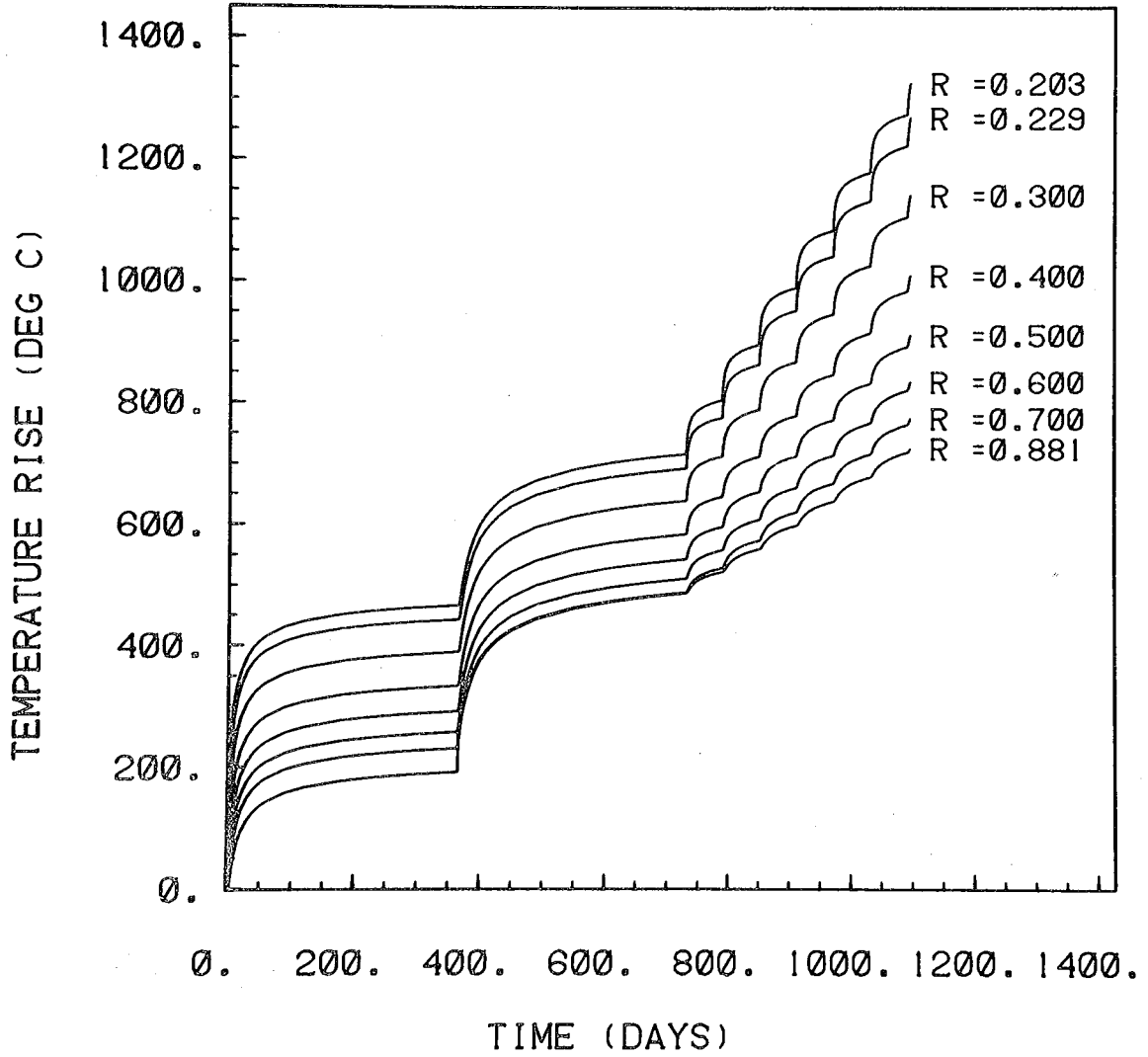

XBL 787-9847

Figure D6a

TEMPERATURE PROFILES FOR
HANFORD FULL-SCALE EXPERIMENT
POWER SCHEDULE 1B
Z = 0.0 M, THETA = 0.0 DEG.
R = 0.203 TO 0.881 M

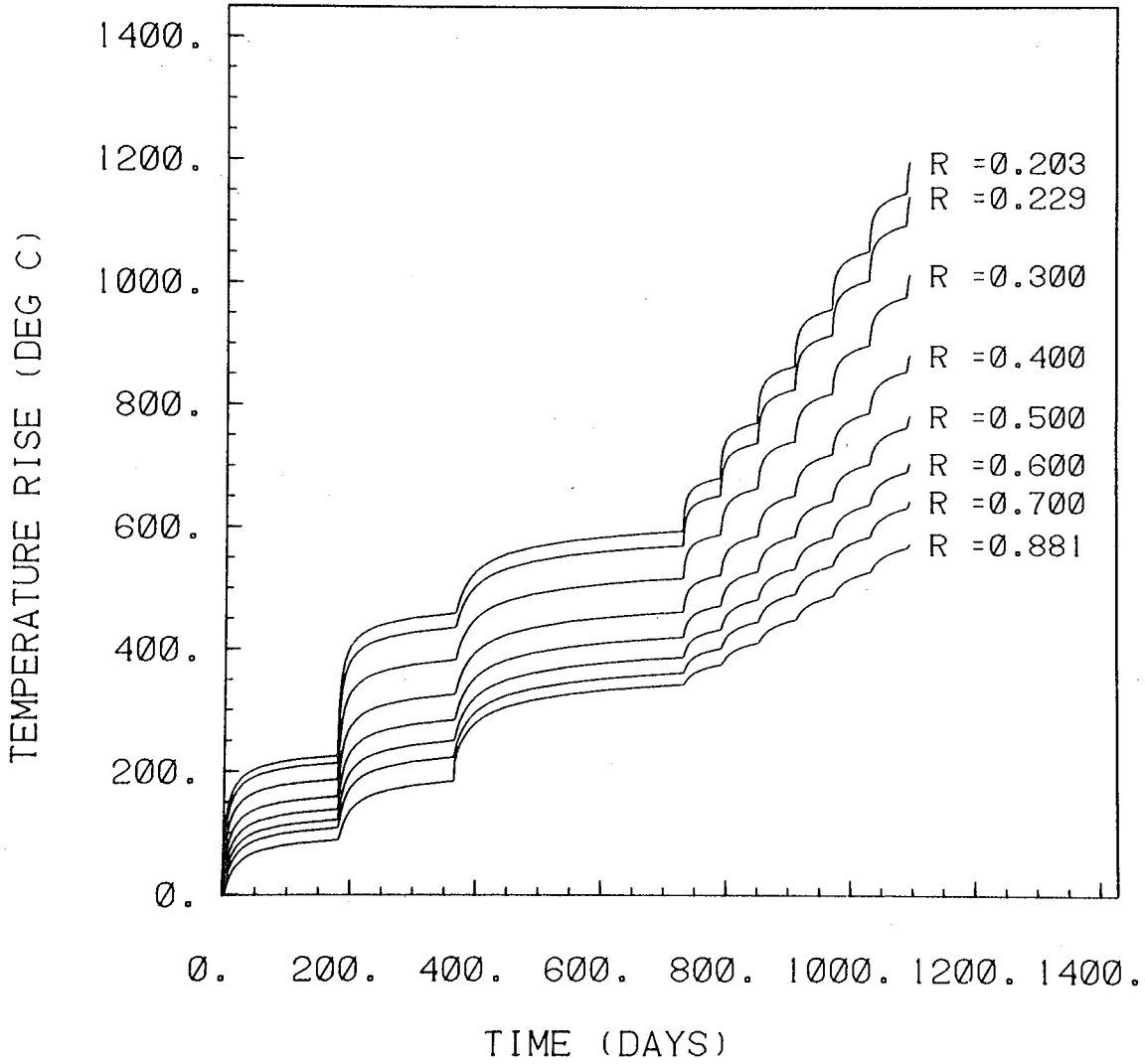

XBL 787-9843

Figure D6b

TEMPERATURE PROFILES FOR
HANFORD FULL-SCALE EXPERIMENT
POWER SCHEDULE 1C
Z = 0.0 M, THETA = 0.0 DEG.
R = 0.203 TO 0.881 M

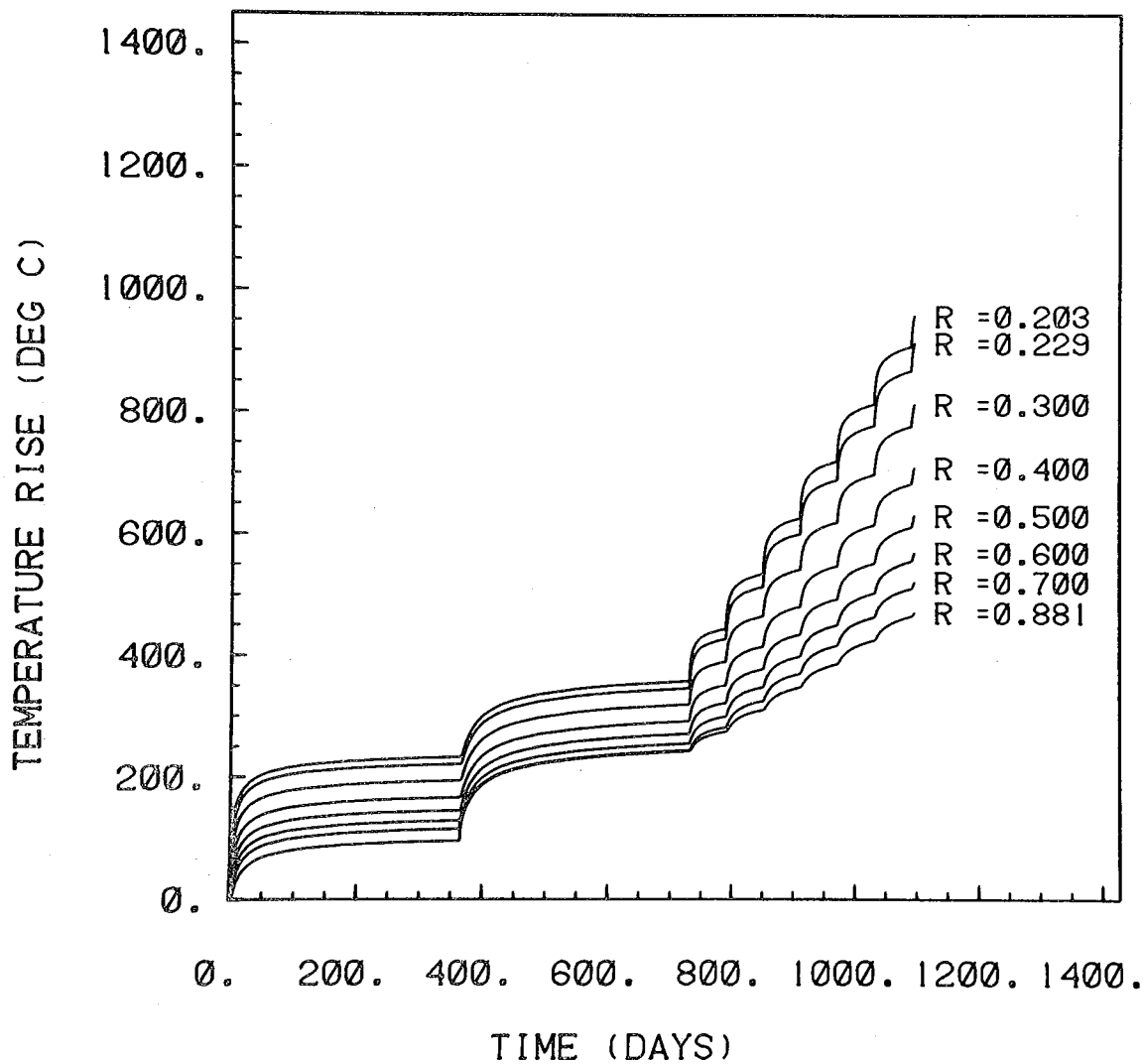

XBL 787-9845

Figure D6c

TEMPERATURE PROFILES FOR
HANFORD FULL-SCALE EXPERIMENT
POWER SCHEDULE 2A
Z = 0.0 M, THETA = 0.0 DEG.
R = 0.203 TO 0.881 M

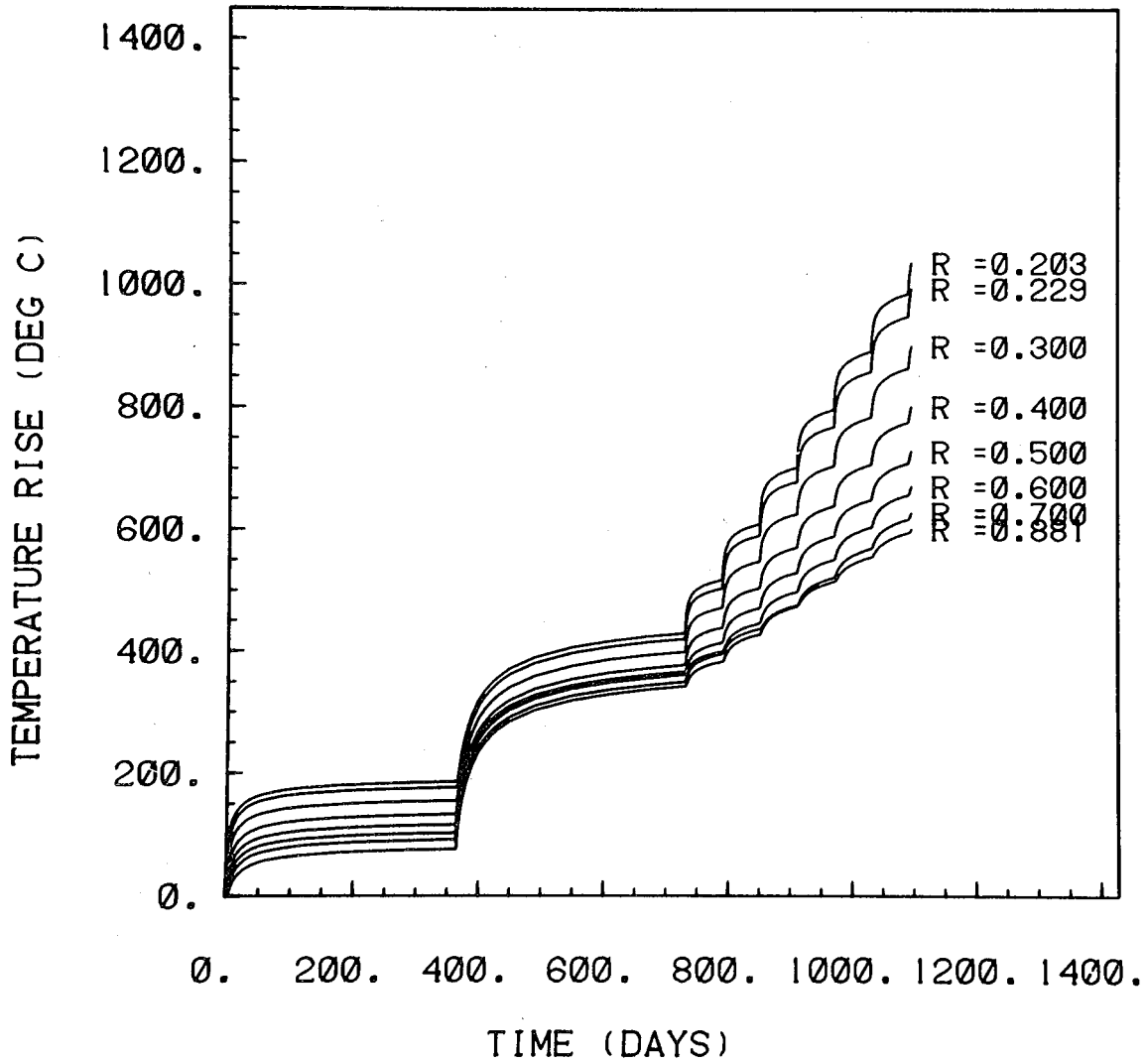

XBL 787-9846

Figure D6d

TEMPERATURE PROFILES FOR
HANFORD FULL-SCALE EXPERIMENT
POWER SCHEDULE 2B
Z = 0.0 M, THETA = 0.0 DEG.
R = 0.203 TO 0.881 M

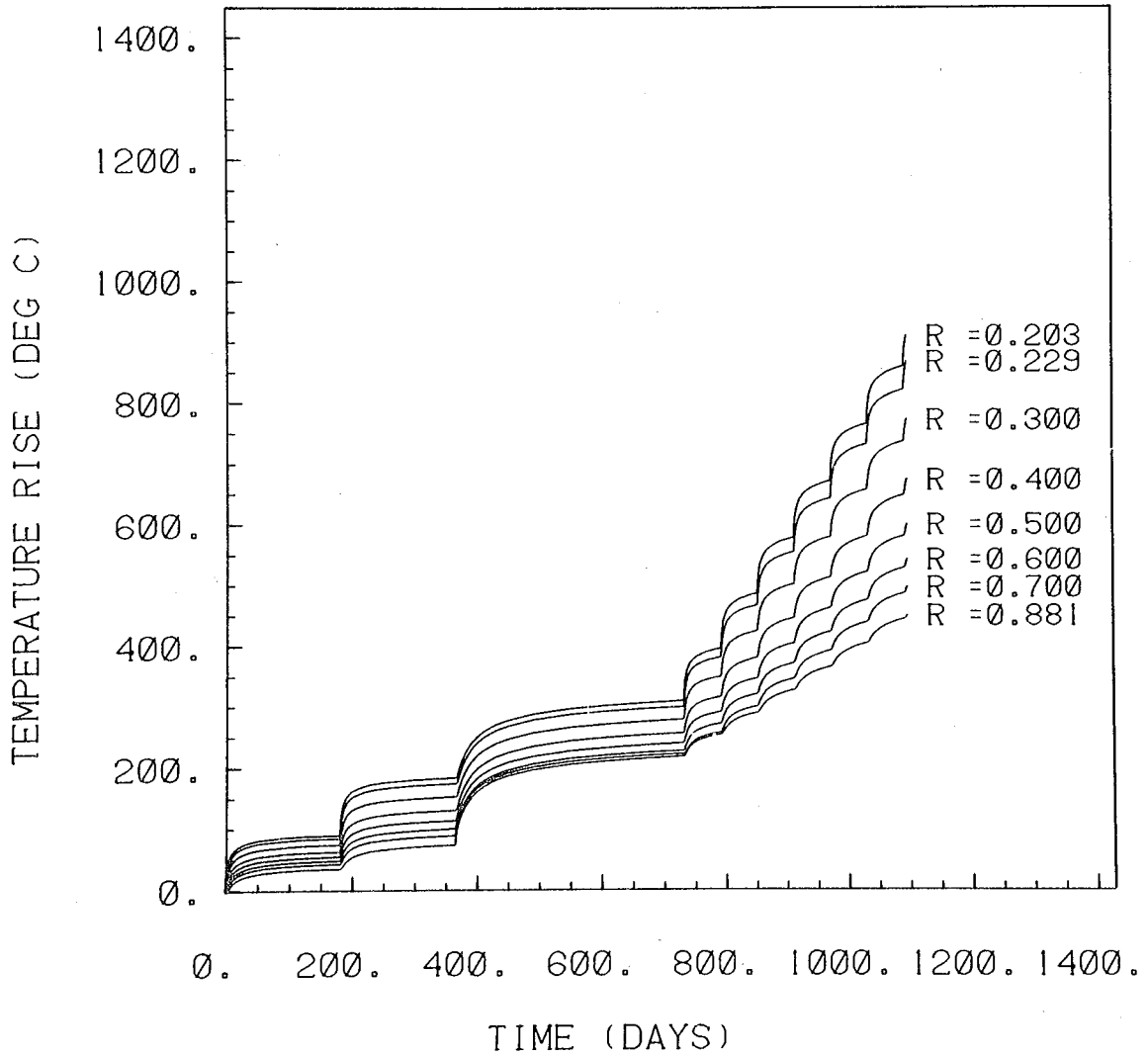

XBL 787-9842

Figure D6e

TEMPERATURE PROFILES FOR
HANFORD FULL-SCALE EXPERIMENT
POWER SCHEDULE 2C
Z = 0.0 M, THETA = 0.0 DEG.
R = 0.203 TO 0.881 M

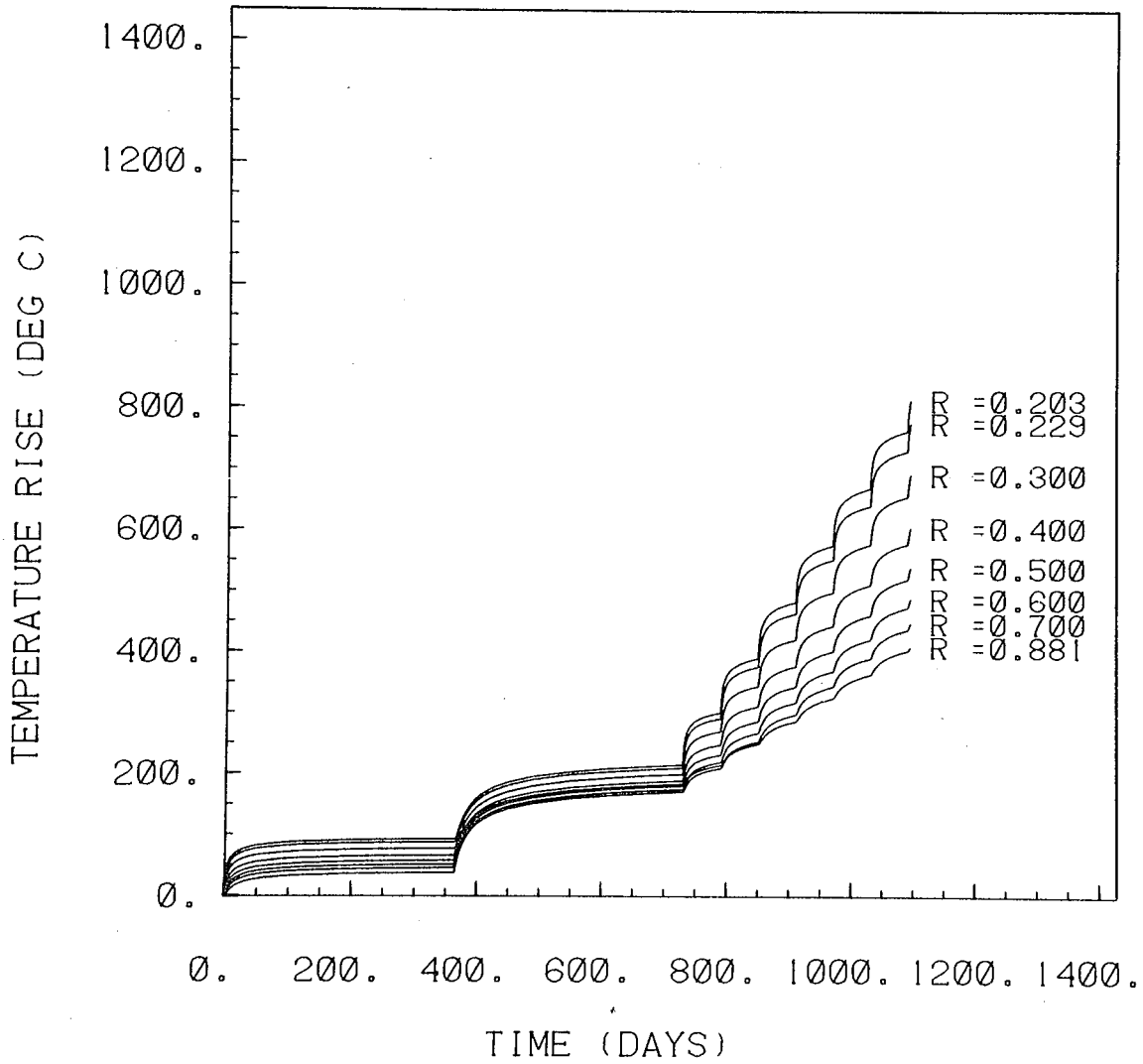

XBL 787-9844

Figure D6f

TEMPERATURE PROFILES FOR
HANFORD FULL-SCALE EXPERIMENT
POWER SCHEDULE 1A
Z = 0.0 M, THETA = 0.0 DEG.
R = 0.919 TO 5.0 M

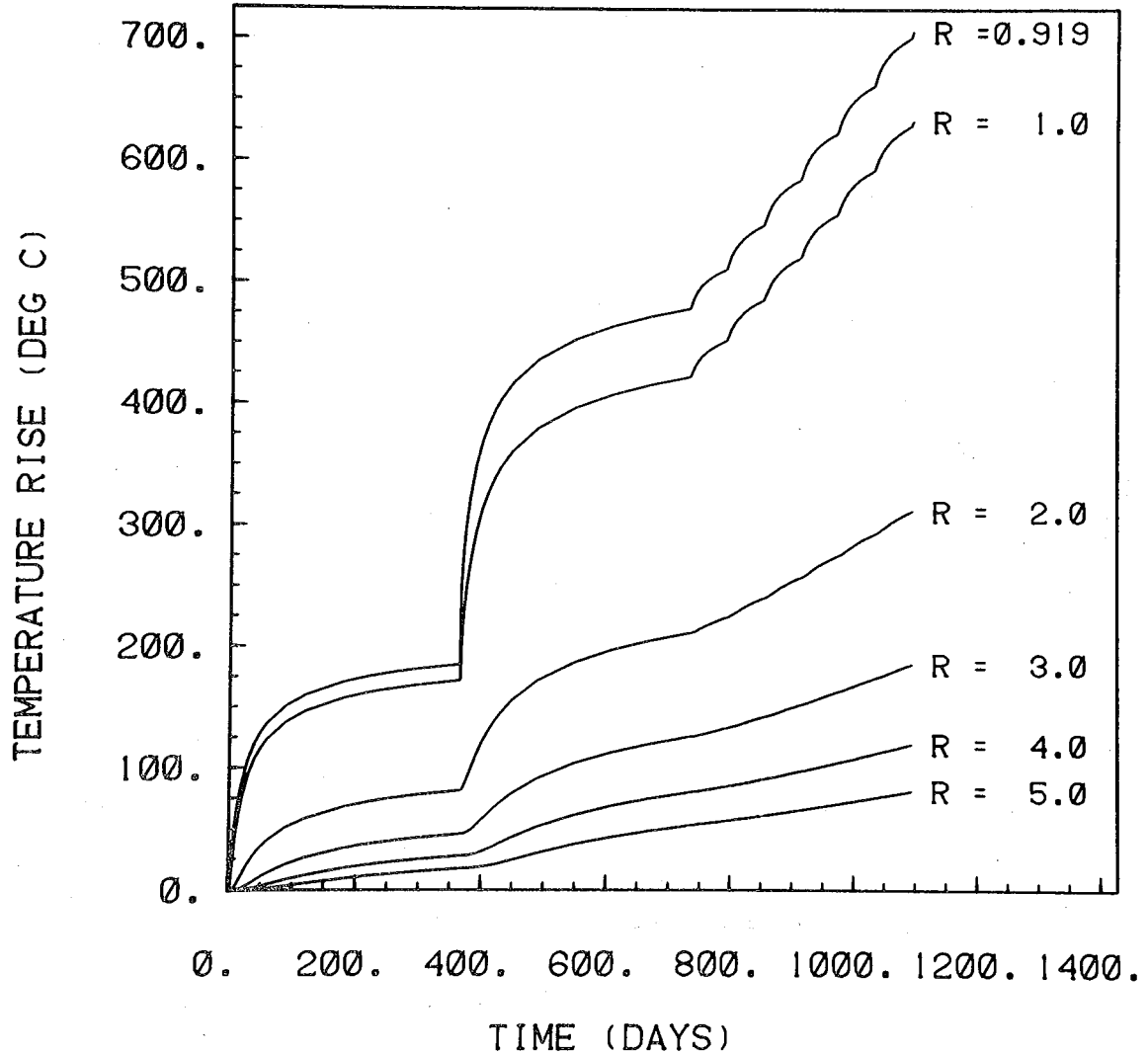

XBL 787-9852

Figure D7a

TEMPERATURE PROFILES FOR
HANFORD FULL-SCALE EXPERIMENT
POWER SCHEDULE 1B
Z = 0.0 M, THETA = 0.0 DEG.
R = 0.919 TO 5.0 M

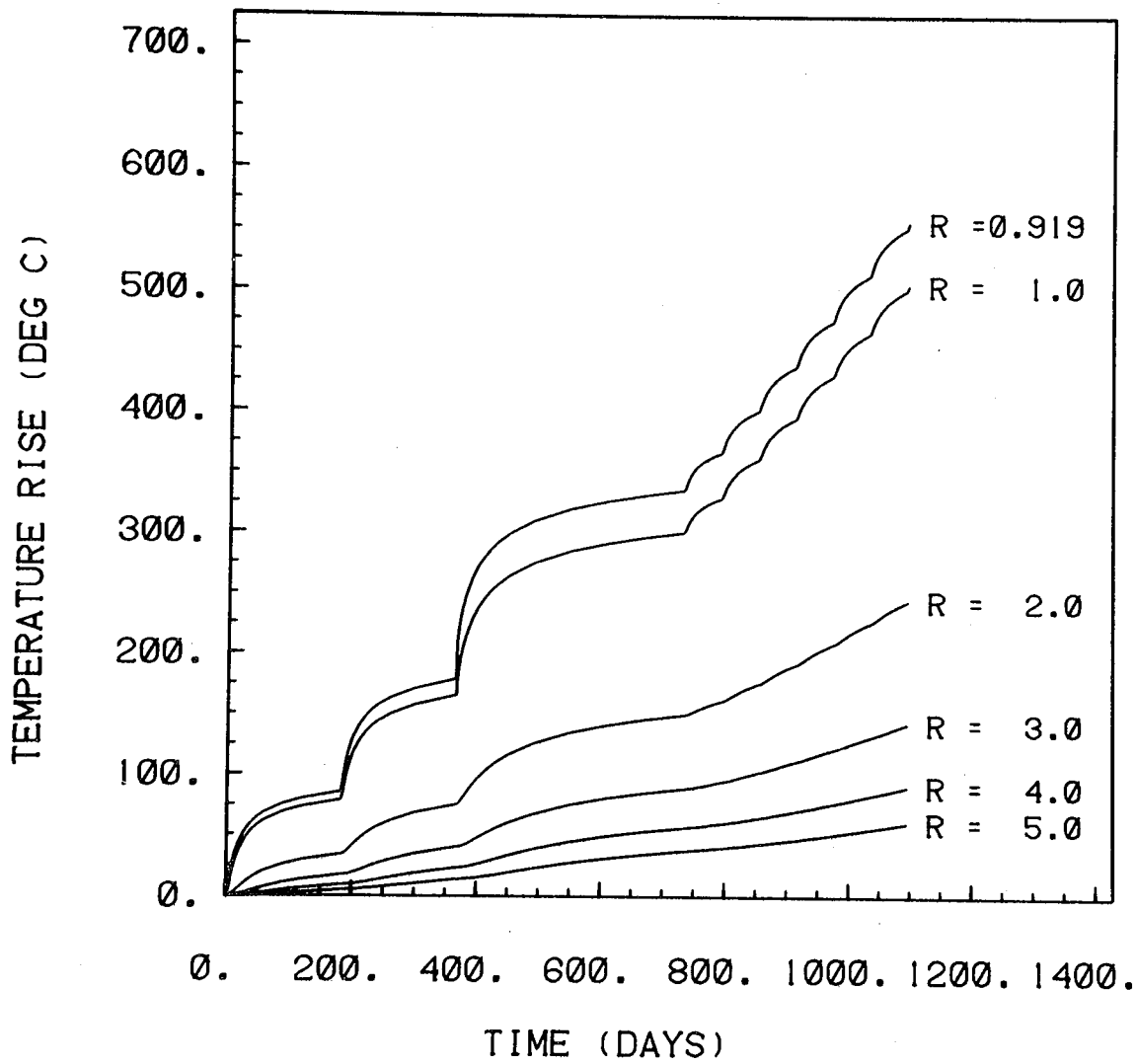

XBL 787-9849

Figure D7b

TEMPERATURE PROFILES FOR
HANFORD FULL-SCALE EXPERIMENT
POWER SCHEDULE 1C
Z = 0.0 M, THETA = 0.0 DEG.
R = 0.919 TO 5.0 M

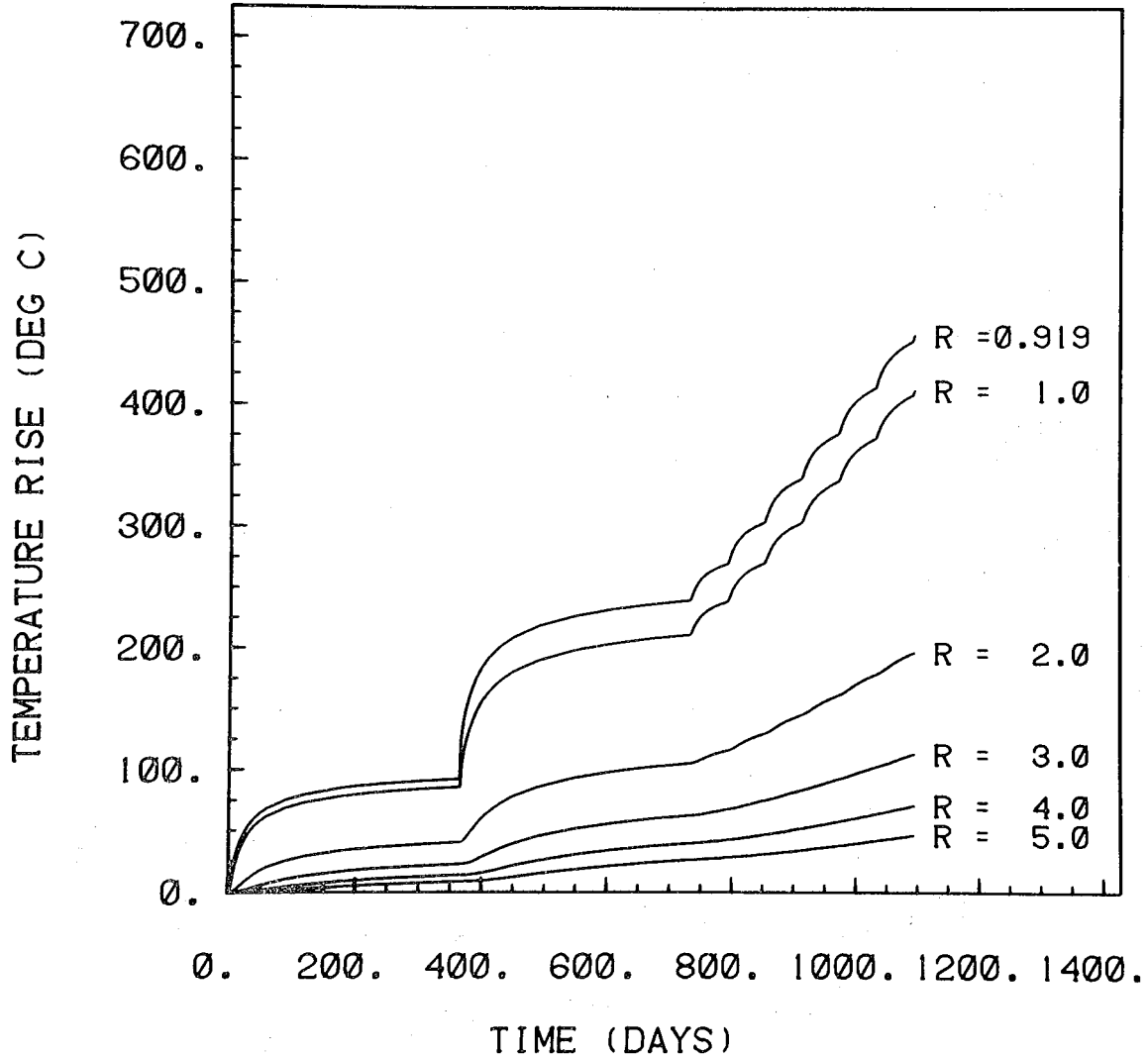

XBL 787-9850

Figure D7c

TEMPERATURE PROFILES FOR
HANFORD FULL-SCALE EXPERIMENT
POWER SCHEDULE 2A
Z = 0.0 M, THETA = 0.0 DEG.
R = 0.919 TO 5.0 M

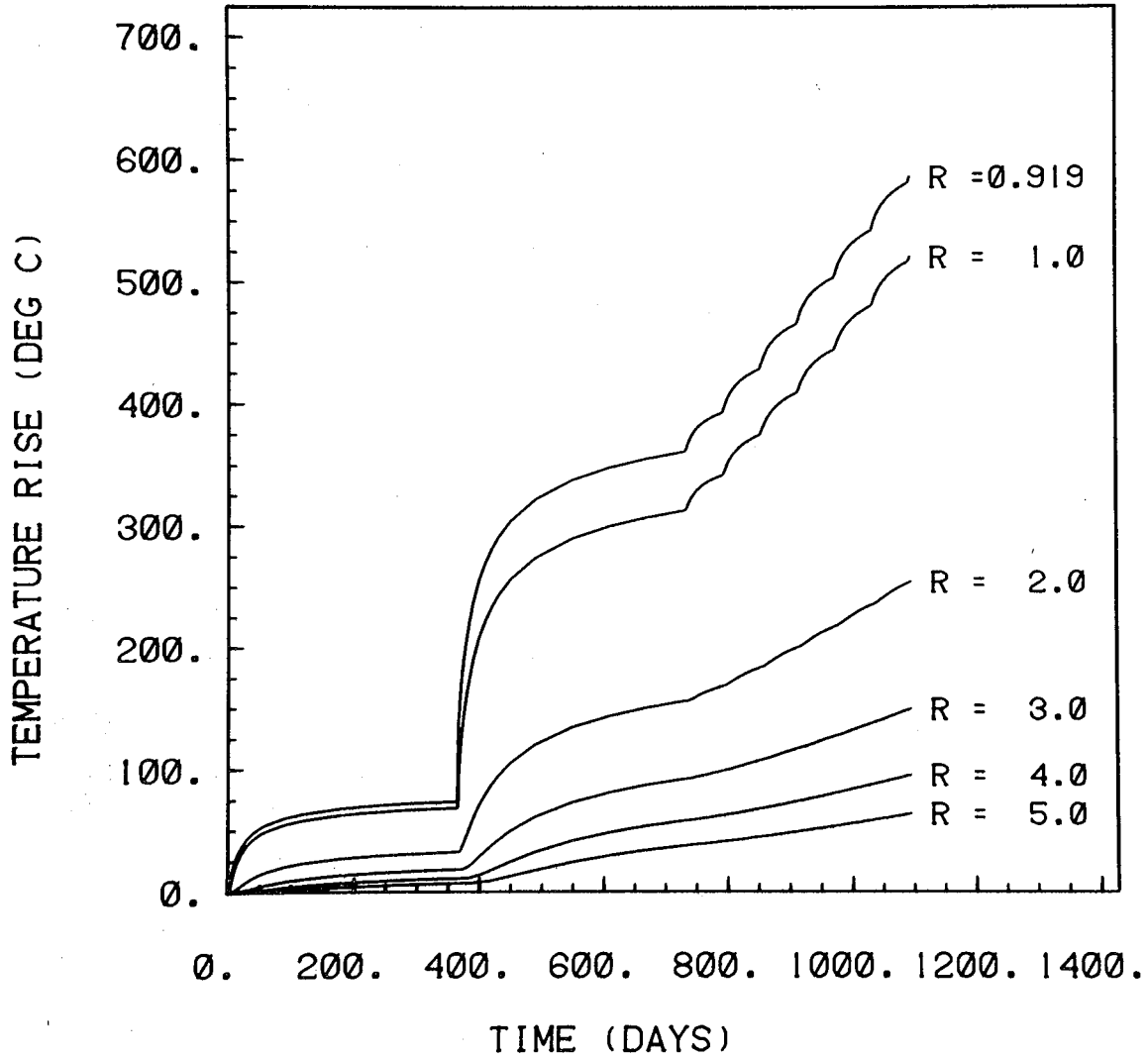

XBL 787-9853

Figure D7d

TEMPERATURE PROFILES FOR
HANFORD FULL-SCALE EXPERIMENT
POWER SCHEDULE 2B

Z = 0.0 M, THETA = 0.0 DEG.

R = 0.919 TO 5.0 M

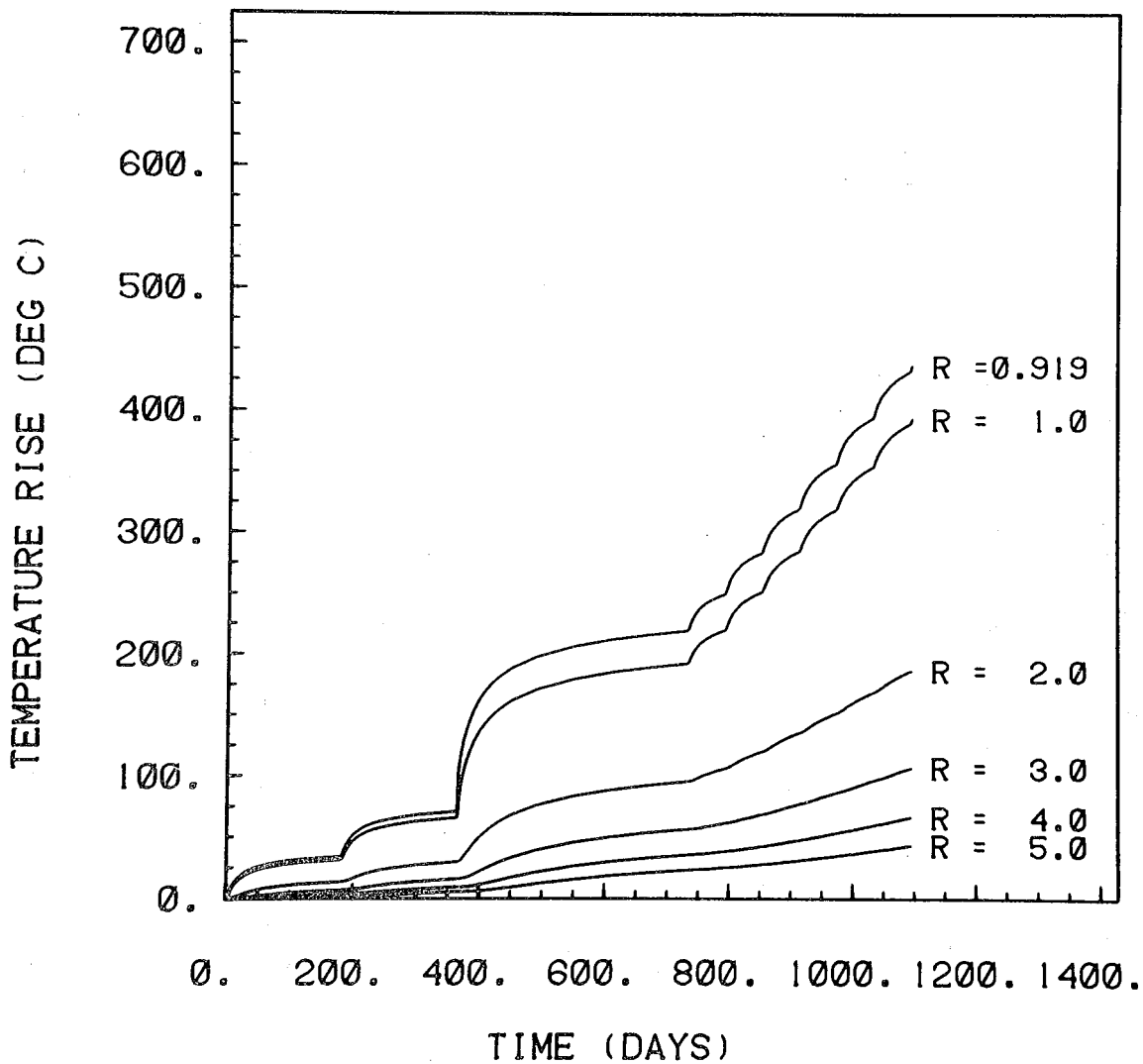

XBL 787-9848

Figure D7e

TEMPERATURE PROFILES FOR
HANFORD FULL-SCALE EXPERIMENT
POWER SCHEDULE 2C
Z = 0.0 M, THETA = 0.0 DEG.
R = 0.919 TO 5.0 M

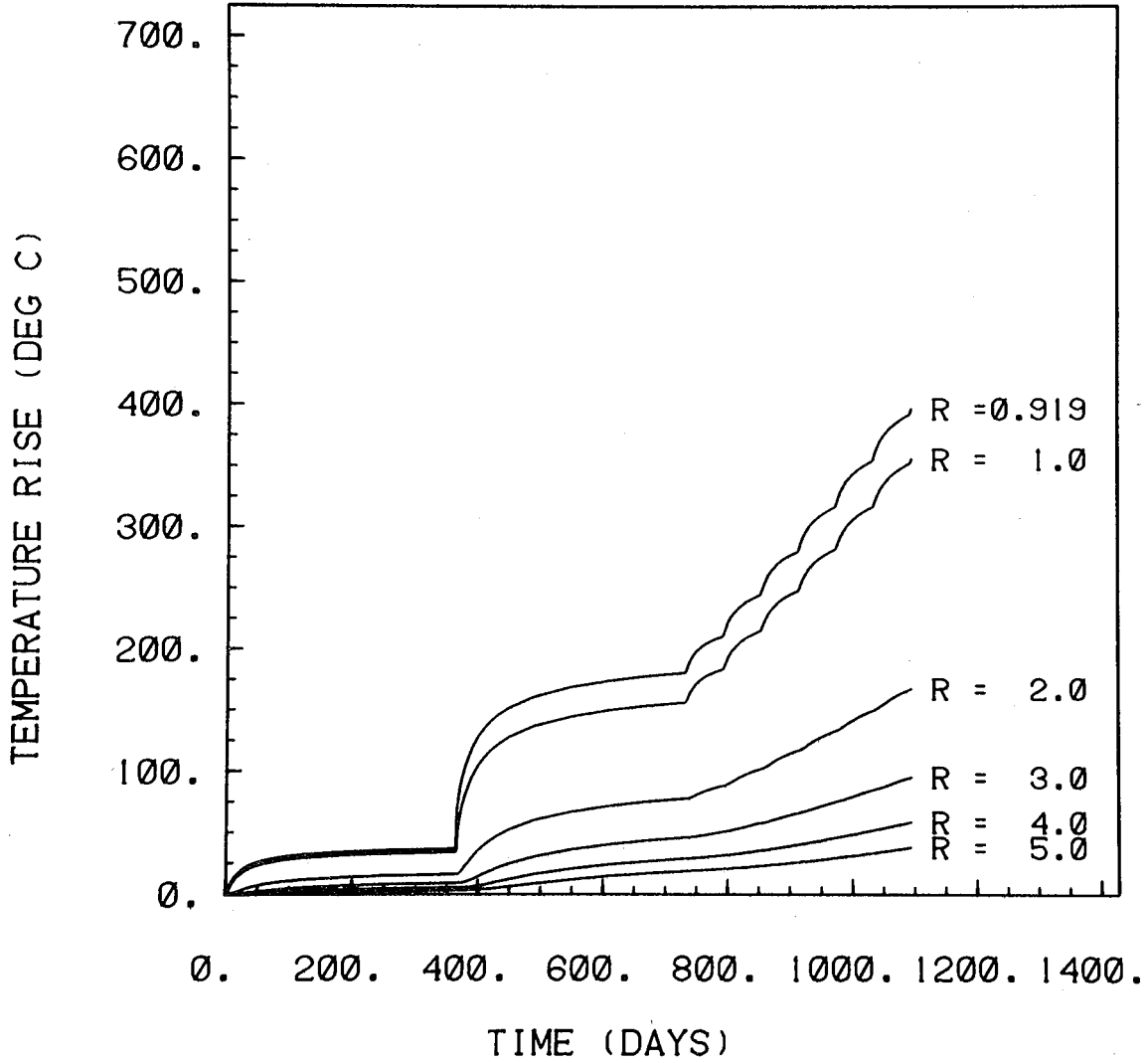

XBL 787-9851

Figure D7f

ISOTHERMS IN VERTICAL PLANE
HANFORD FULL-SCALE EXPERIMENT

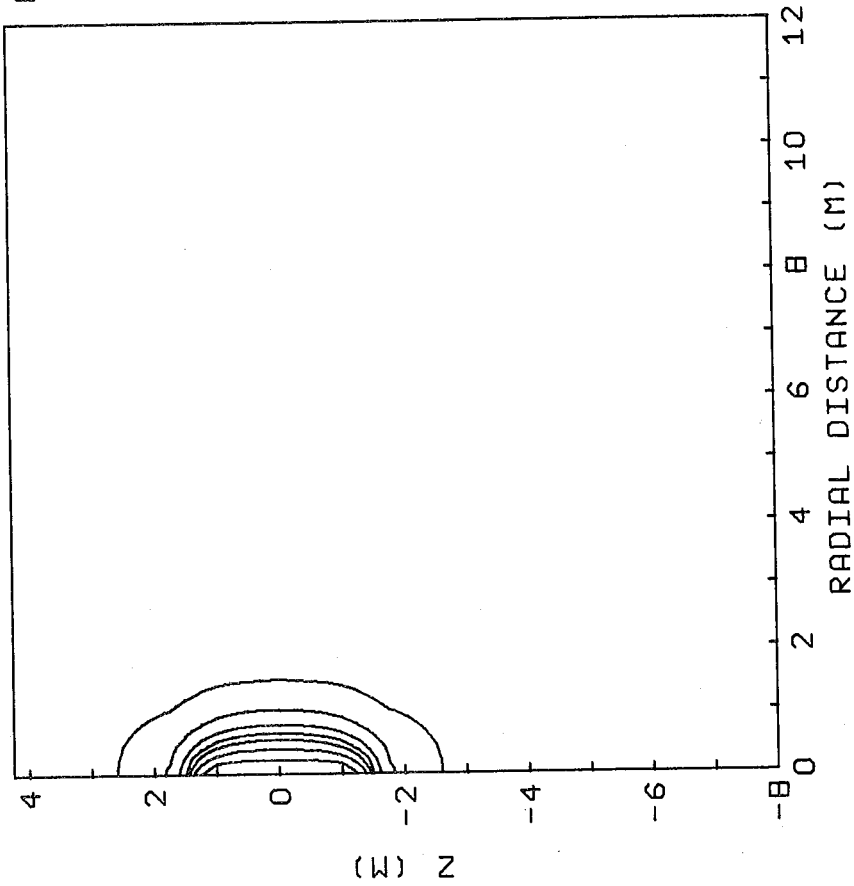

PLOT INFORMATION

TIME = 7. DAYS

THETA = 0.0 DEG.

INFINITE MEDIUM MODEL

MAIN HTR = 5.00 KW

PERIPHERAL HTR = 1.00 KW

CONTOURS (DEG.C.) PLOTTED -

255. 150. 100. 75.

50. 25. 5.

XBL 787-9498

Figure D8a

ISOTHERMS IN VERTICAL PLANE
HANFORD FULL-SCALE EXPERIMENT

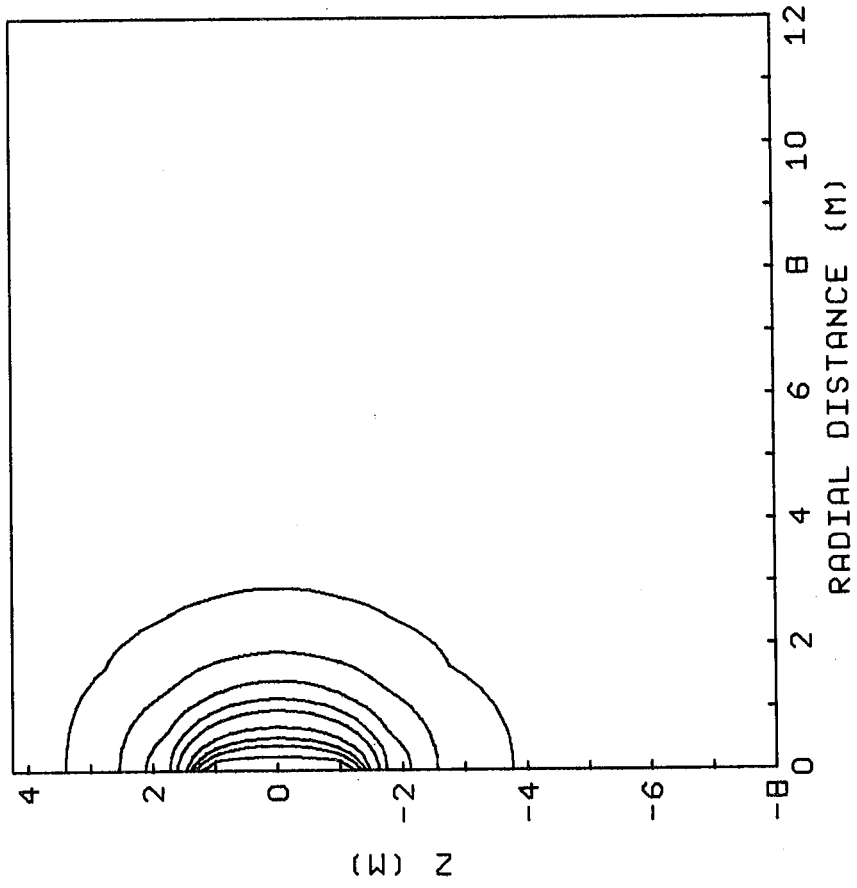

PLOT INFORMATION

TIME = 30. DAYS
THETA = 0.0 DEG.
INFINITE MEDIUM MODEL
MAIN HTR = 5.00 KW
PERIPHERAL HTR = 1.00 KW
CONTOURS (DEG.C.) PLOTTED -
360. 250. 200. 150.
100. 75. 50. 25.
5.

Figure D8b

ISOTHERMS IN VERTICAL PLANE
HANFORD FULL-SCALE EXPERIMENT

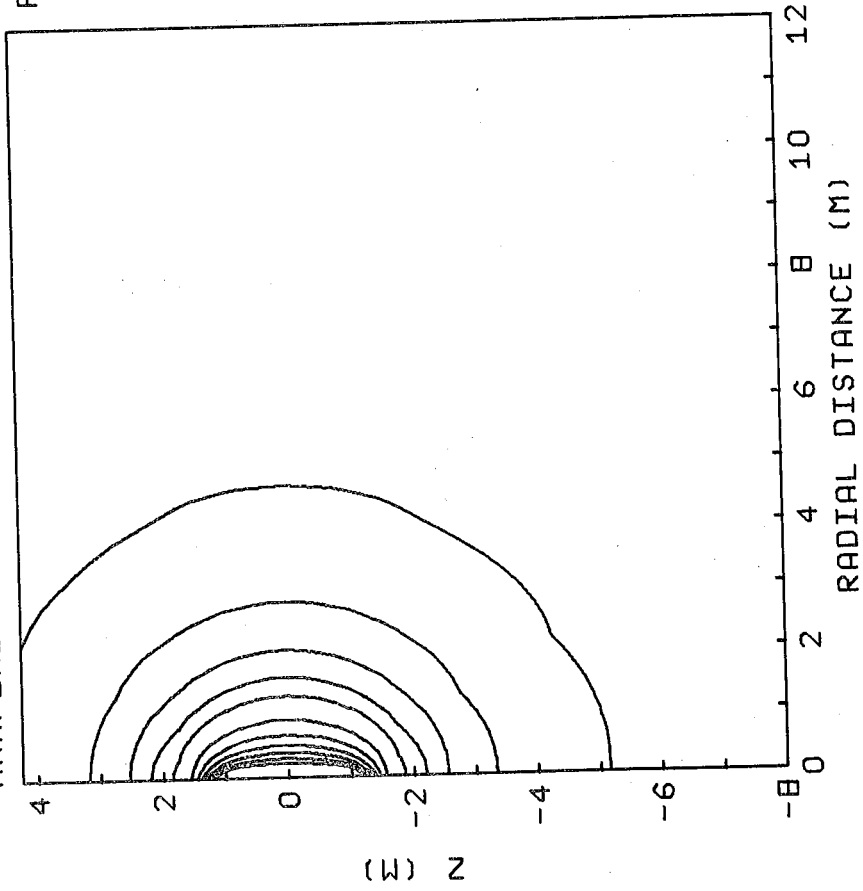

PLOT INFORMATION

TIME = 90. DAYS

THETA = 0.0 DEG.

INFINITE MEDIUM MODEL

MAIN HTR = 5.00 KW

PERIPHERAL HTR = 1.00 KW

CONTOURS (DEG.C.) PLOTTED -

408. 350. 300. 250.

200. 150. 100. 75.

50. 25. 5.

Figure D8c

ISOTHERMS IN VERTICAL PLANE
HANFORD FULL-SCALE EXPERIMENT

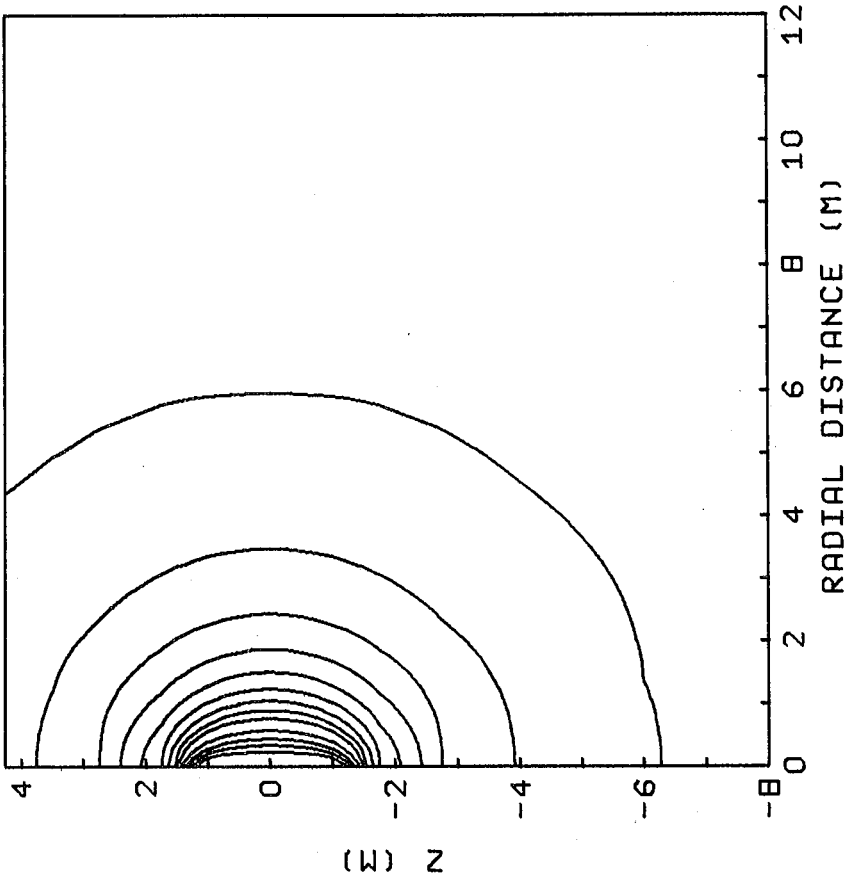

PLOT INFORMATION

TIME = 180. DAYS

THETA = 0.0 DEG.

INFINITE MEDIUM MODEL

MAIN HTR = 5.00 KW

PERIPHERAL HTR = 1.00 KW

CONTOURS (DEG.C.) PLOTTED -

428. 350. 300. 250.

200. 175. 150. 125.

100. 75. 50. 25.

5.

XBL 787-9502

Figure D8d

ISOTHERMS IN VERTICAL PLANE
HANFORD FULL-SCALE EXPERIMENT

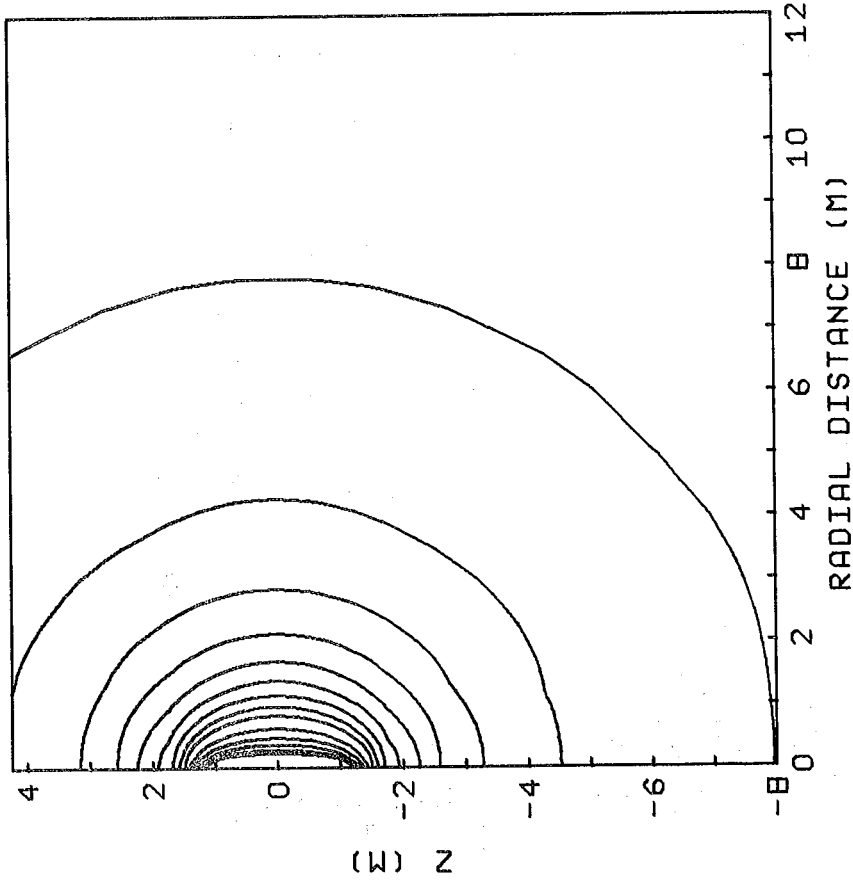

PLOT INFORMATION

TIME = 365. DAYS

THETA = 0.0 DEG.

INFINITE MEDIUM MODEL

MAIN HTR = 5.00 KW

PERIPHERAL HTR = 1.00 KW

CONTOURS (DEG.C.) PLOTTED -

443. 400. 350. 300.
250. 200. 175. 150.
125. 100. 75. 50.
25. 5.

Figure D8e

ISOTHERMS IN VERTICAL PLANE
HANFORD FULL-SCALE EXPERIMENT

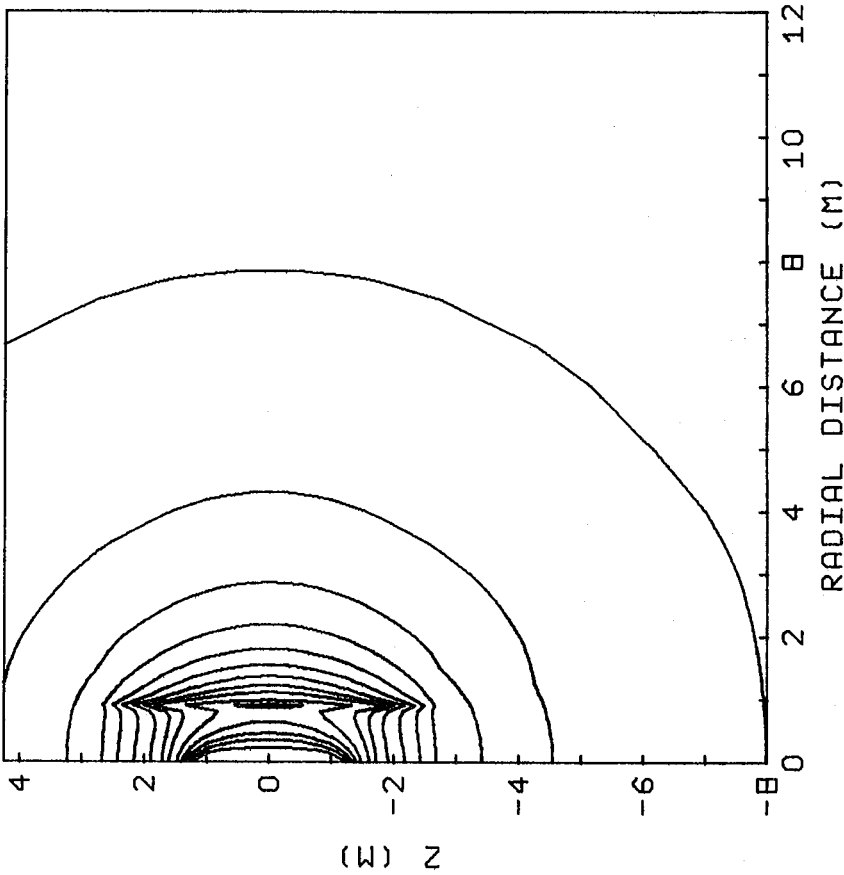

PLOT INFORMATION

TIME = 372. DAYS

THETA = 0.0 DEG.

INFINITE MEDIUM MODEL

MAIN HTR = 5.00 KW

PERIPHERAL HTR = 1.00 KW

CONTOURS (DEG.C.) PLOTTED -

481. 400. 350. 300.

250. 200. 175. 150.

125. 100. 75. 50.

25. 5.

XBL 787-9510

Figure D8f

ISOTHERMS IN VERTICAL PLANE
HANFORD FULL-SCALE EXPERIMENT

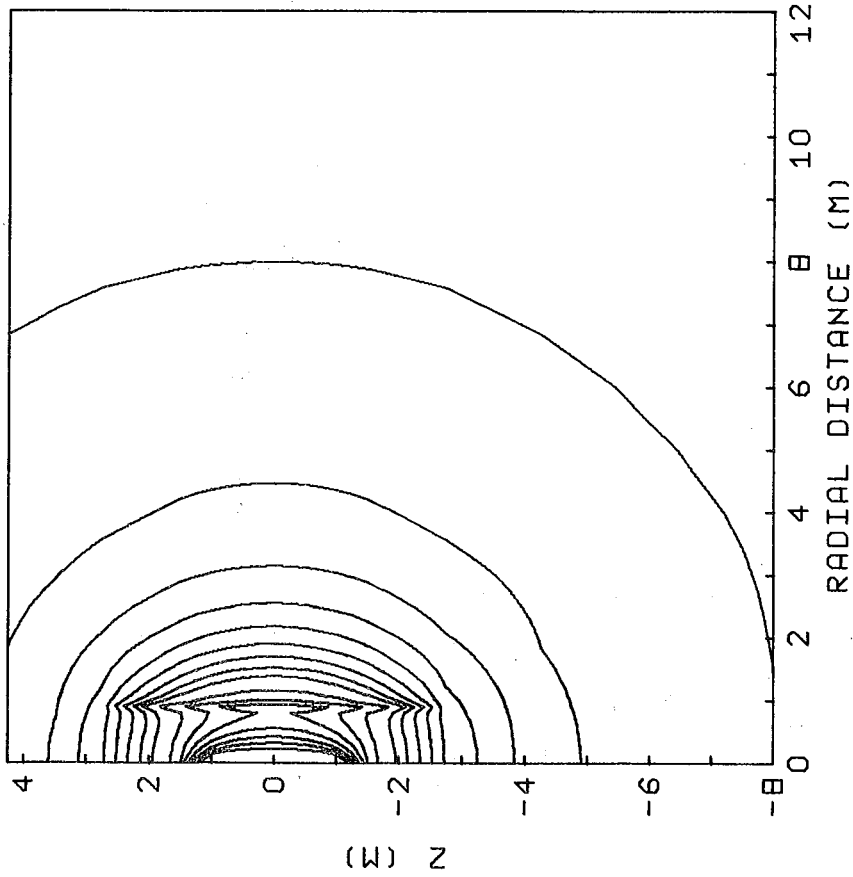

PLOT INFORMATION

TIME = 395. DAYS

THETA = 0.0 DEG.

INFINITE MEDIUM MODEL

MAIN HTR = 5.00 KW

PERIPHERAL HTR = 1.00 KW

CONTOURS (DEG.C.) PLOTTED -
568. 500. 450. 400.
350. 300. 250. 200.
175. 150. 125. 100.
75. 50. 25. 5.

XBL 787-9509

Figure D8g

ISOTHERMS IN VERTICAL PLANE
HANFORD FULL-SCALE EXPERIMENT

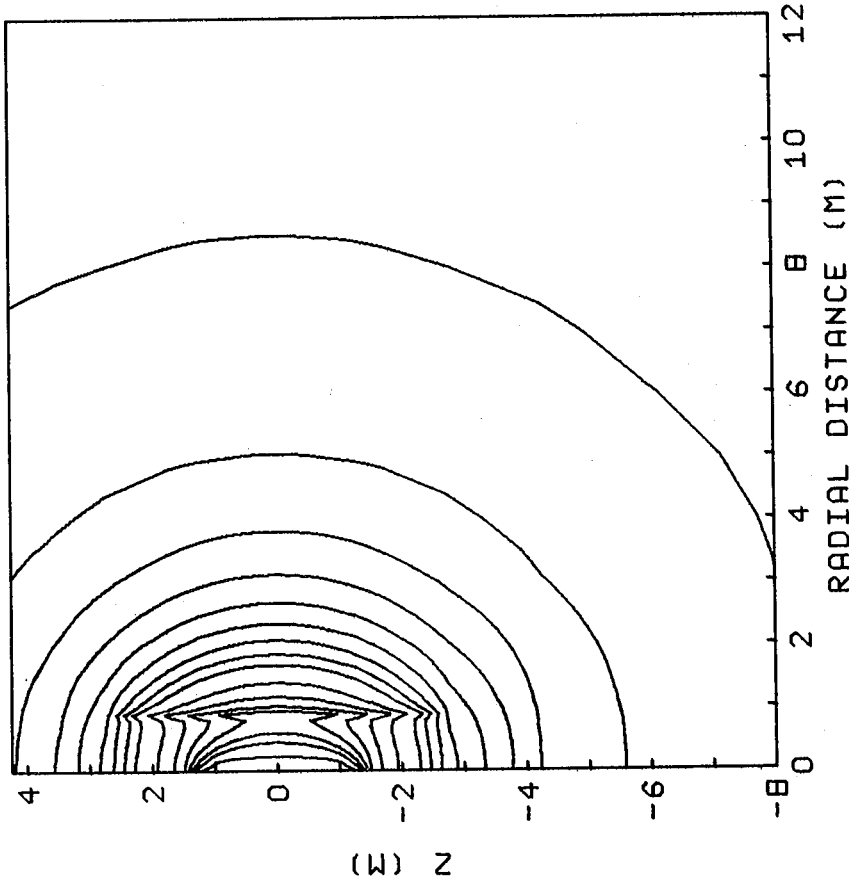

PLOT INFORMATION

TIME = 455. DAYS

THETA = 0.0 DEG.

INFINITE MEDIUM MODEL

MAIN HTR = 5.00 KW

PERIPHERAL HTR = 1.00 KW

CONTOURS (DEG.C.) PLOTTED -

- 633. 500. 450. 400.
- 350. 300. 250. 200.
- 175. 150. 125. 100.
- 75. 50. 25. 5.

XBL 787-9508

Figure D8h

ISOTHERMS IN VERTICAL PLANE
HANFORD FULL-SCALE EXPERIMENT

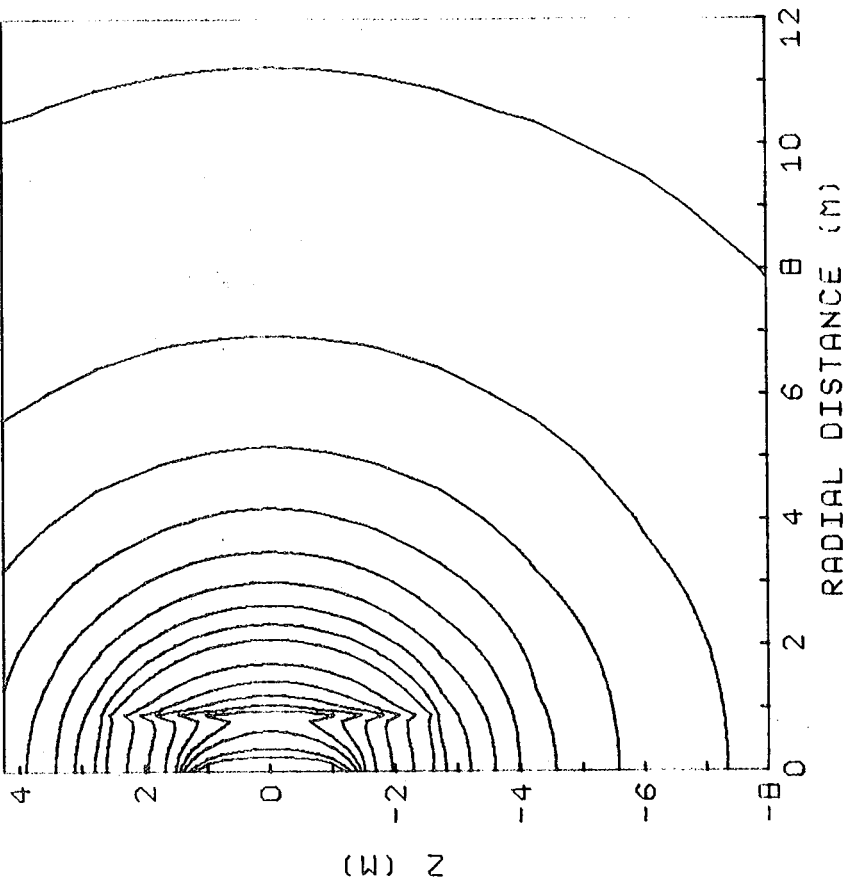

PLOT INFORMATION

TIME = 730. DAYS

THETA = 0.0 DEG.

INFINITE MEDIUM MODEL

MAIN HTR = 5.00 KW

PERIPHERAL HTR = 1.00 KW

CONTOURS (DEG.C.) PLOTTED -

692.	600.	500.	450.
400.	350.	300.	250.
200.	175.	150.	125.
100.	75.	50.	25.
			5.

XBL 787-9507

Figure D8i

ISOTHERMS IN VERTICAL PLANE
HANFORD FULL-SCALE EXPERIMENT

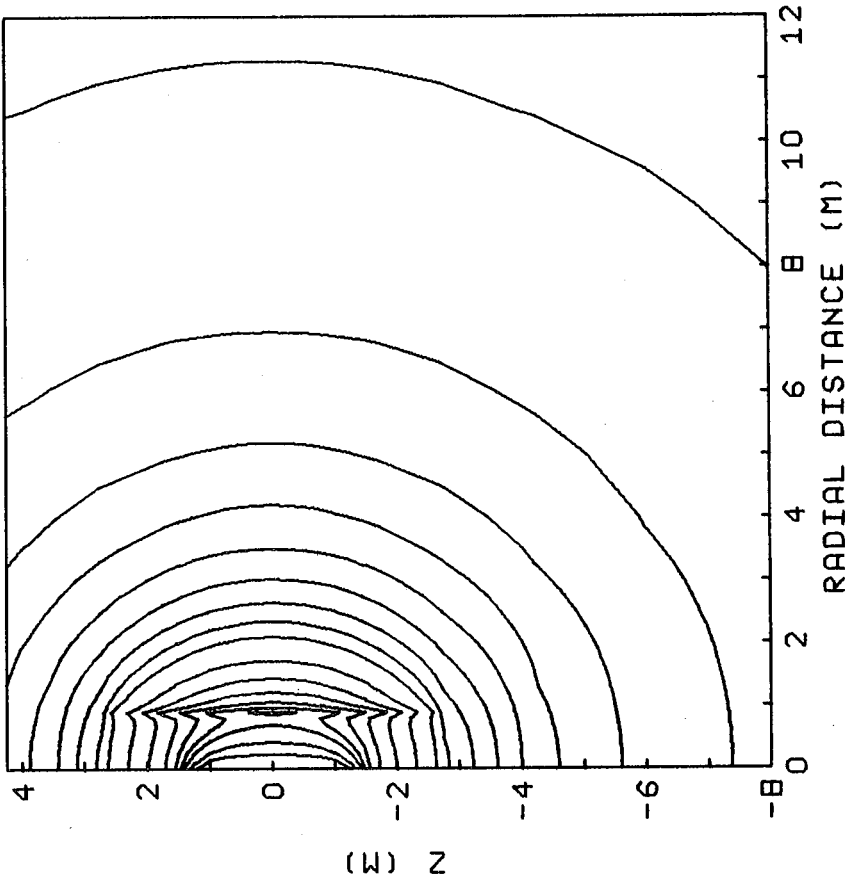

PLOT INFORMATION

TIME = 737. DAYS

THETA = 0.0 DEG.

INFINITE MEDIUM MODEL

MAIN HTR = 5.00 KW

PERIPHERAL HTR = 1.00 KW

CONTOURS (DEG.C.) PLOTTED -
744. 600. 500. 450.
400. 350. 300. 250.
200. 175. 150. 125.
100. 75. 50. 25.
5.

Figure D8j

ISOTHERMS IN VERTICAL PLANE
HANFORD FULL-SCALE EXPERIMENT

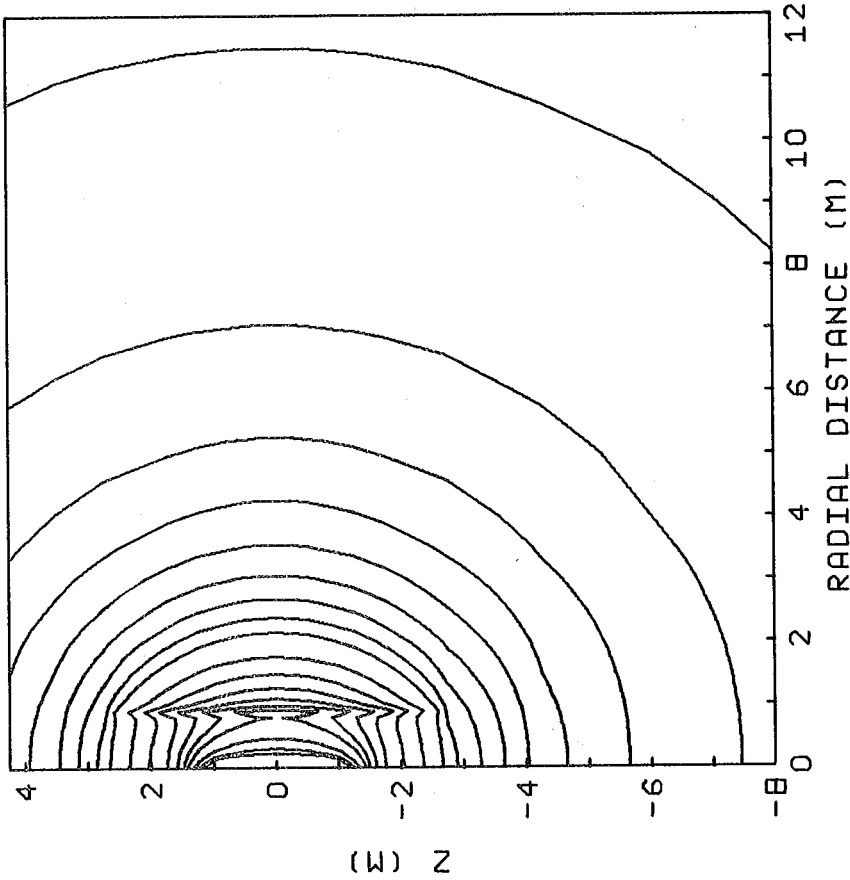

PLOT INFORMATION

TIME = 760. DAYS

THETA = 0.0 DEG.

INFINITE MEDIUM MODEL

MAIN HTR = 5.00 KW

PERIPHERAL HTR = 1.00 KW

CONTOURS (DEG.C.) PLOTTED -
766. 700. 600. 500.
450. 400. 350. 300.
250. 200. 175. 150.
125. 100. 75. 50.
25. 5.

XBL 787-9505

Figure D8k

ISOTHERMS IN VERTICAL PLANE
HANFORD FULL-SCALE EXPERIMENT

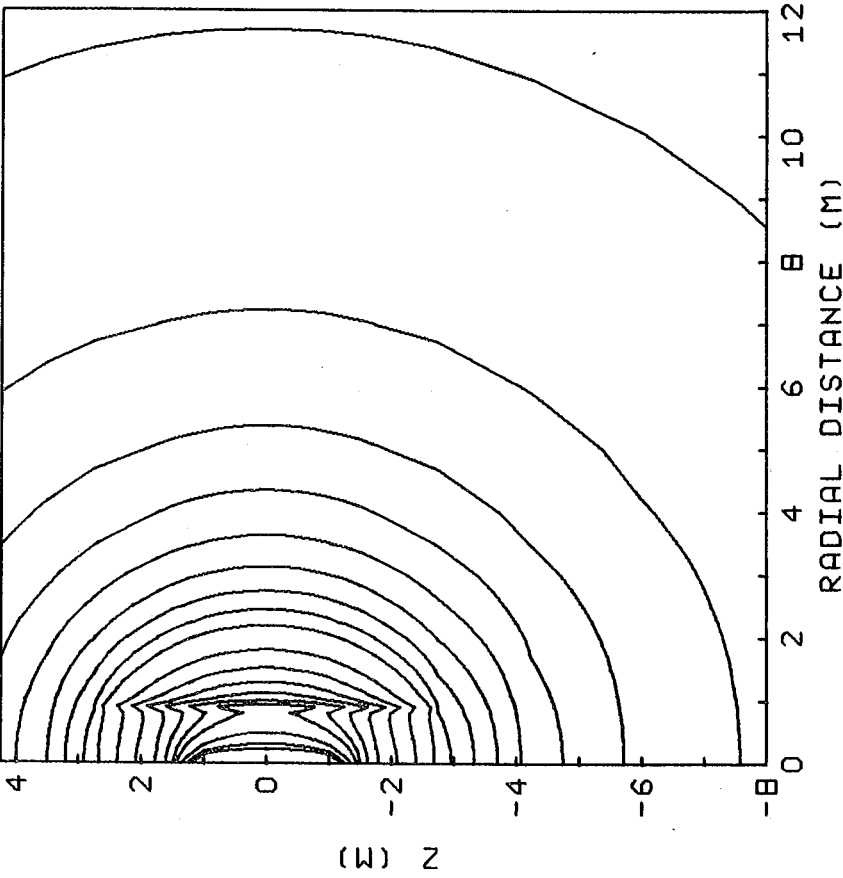

PLOT INFORMATION

TIME = 790. DAYS

THETA = 0.0 DEG.

INFINITE MEDIUM MODEL

MAIN HTR = 5.00 KW

PERIPHERAL HTR = 1.00 KW

CONTOURS (DEG.C.) PLOTTED -
775. 700. 600. 500.
450. 400. 350. 300.
250. 200. 175. 150.
125. 100. 75. 50.
25. 5.

XBL 787-9504

Figure D81

ISOTHERMS IN VERTICAL PLANE
HANFORD FULL-SCALE EXPERIMENT

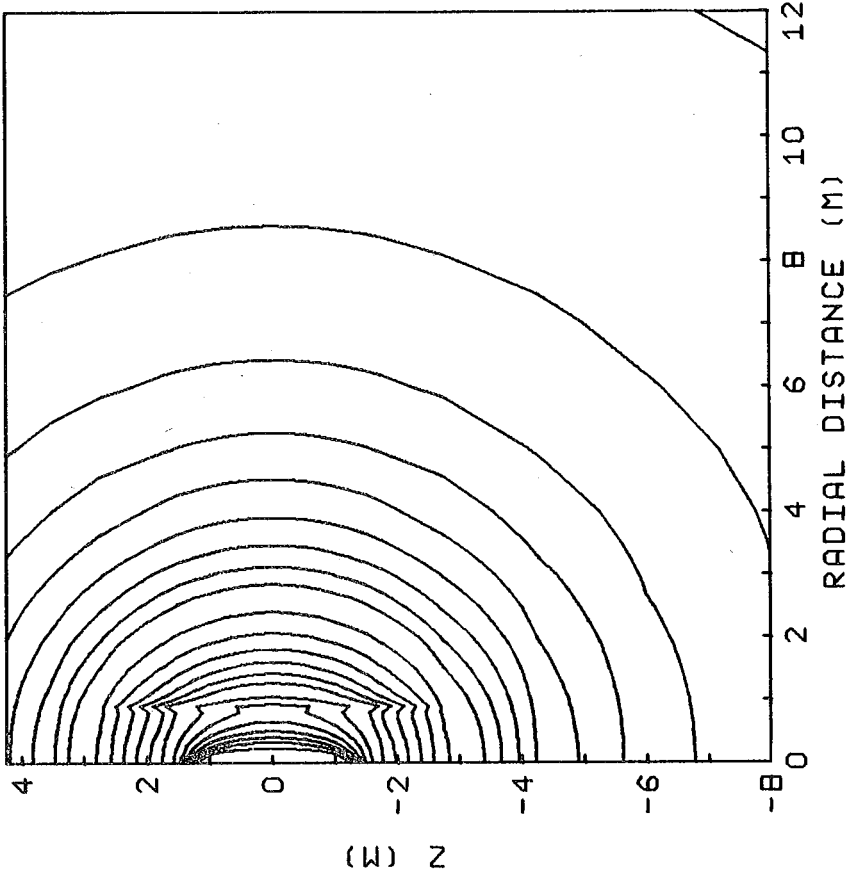

PLOT INFORMATION

TIME = 1095. DAYS

THETA = 0.0 DEG.

INFINITE MEDIUM MODEL

MAIN HTR = 5.00 KW

PERIPHERAL HTR = 1.00 KW

CONTOURS (DEG. C.) PLOTTED -

1269.	1100.	1000.	900.
800.	700.	600.	500.
450.	400.	350.	300.
250.	200.	175.	150.
125.	100.	75.	50.
25.		5.	

XBL 787-9503

Figure D8m

ISOTHERMS IN VERTICAL PLANE
HANFORD FULL-SCALE EXPERIMENT

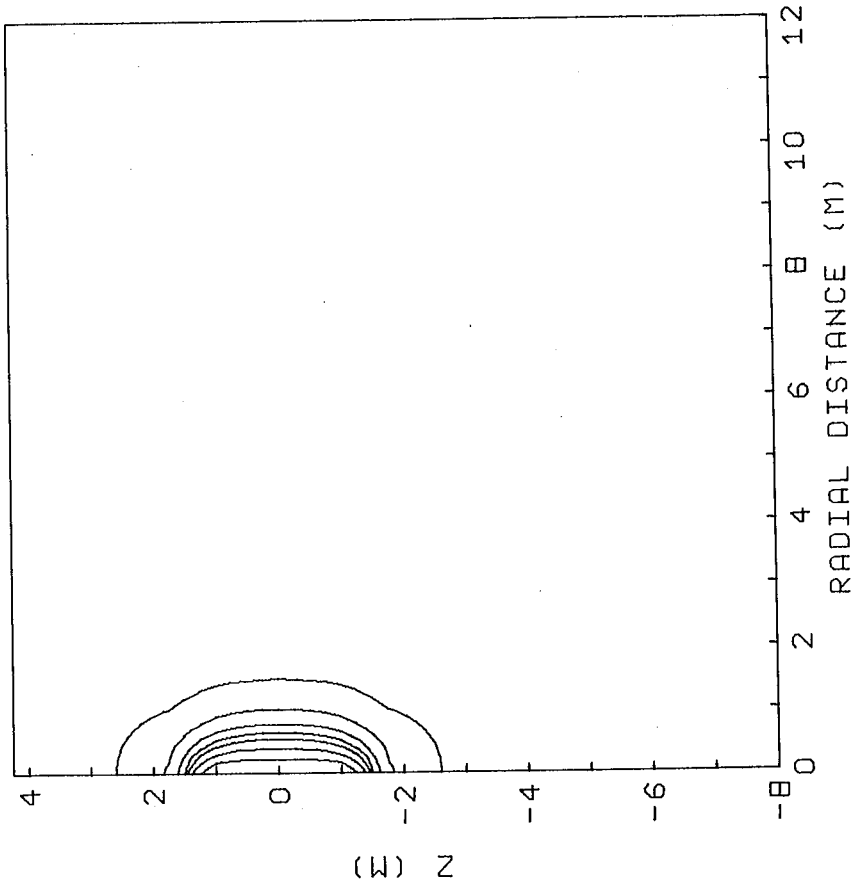

PLOT INFORMATION

TIME = 7. DAYS

THETA = 0.0 DEG.

ISOTHERMAL BOUNDARY MODEL

MAIN HTR = 5.00 KW

PERIPHERAL HTR = 1.00 KW

CONTOURS (DEG.C.) PLOTTED -

255. 150. 100. 75.

50. 25. 5.

Figure D9a

ISOTHERMS IN VERTICAL PLANE
HANFORD FULL-SCALE EXPERIMENT

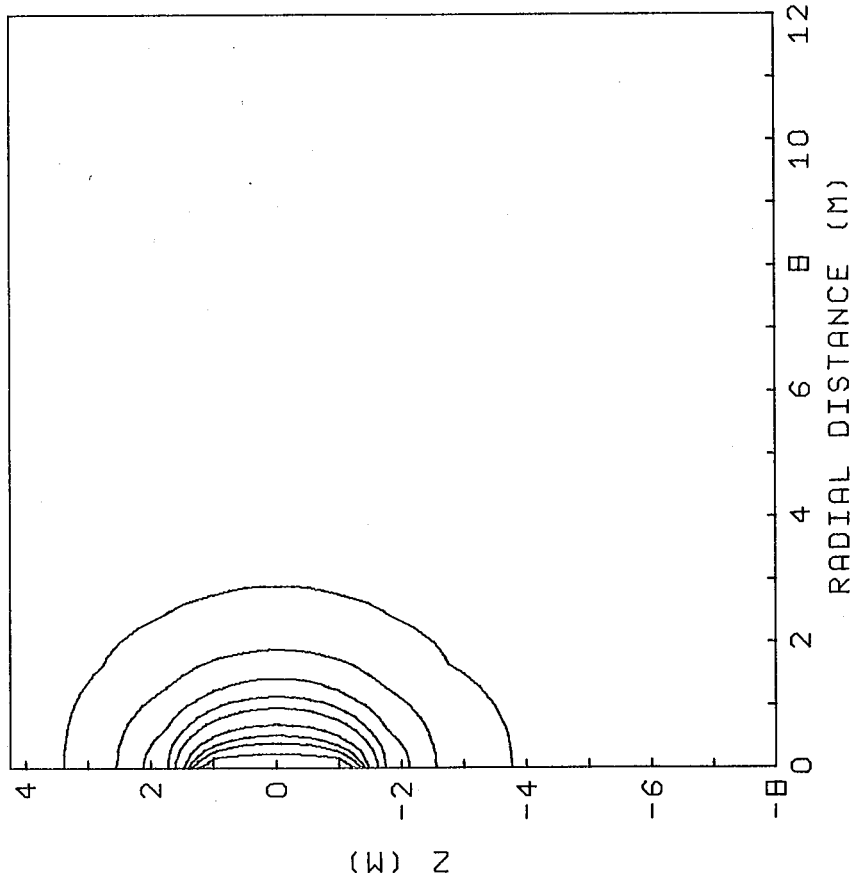

PLOT INFORMATION

TIME = 30. DAYS

THETA = 0.0 DEG.

ISOTHERMAL BOUNDARY MODEL

MAIN HTR = 5.00 KW

PERIPHERAL HTR = 1.00 KW

CONTOURS (DEG.C.) PLOTTED -

360. 250. 200. 150.

100. 75. 50. 25.

5.

Figure D9b

ISOTHERMS IN VERTICAL PLANE
HANFORD FULL-SCALE EXPERIMENT

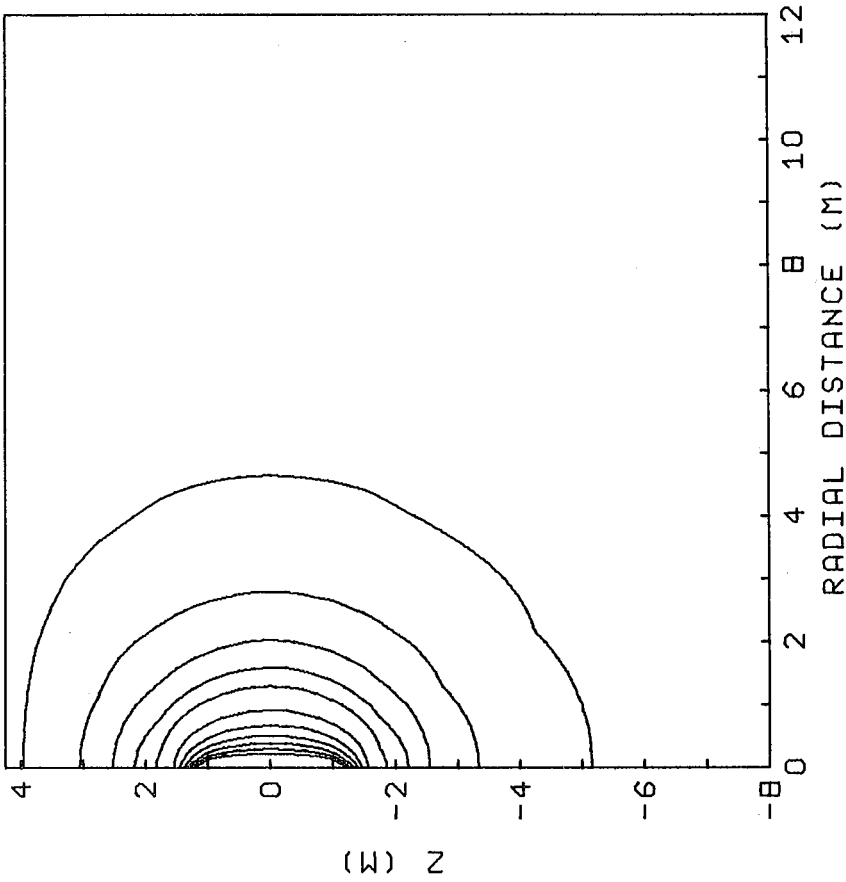

PLOT INFORMATION

TIME = 90. DAYS

THETA = 0.0 DEG.

ISOTHERMAL BOUNDARY MODEL

MAIN HTR = 5.00 KW

PERIPHERAL HTR = 1.00 KW

CONTOURS (DEG.C.) PLOTTED -

408. 350. 300. 250.

200. 150. 100. 75.

50. 25. 5.

Figure D9c

ISOTHERMS IN VERTICAL PLANE
HANFORD FULL-SCALE EXPERIMENT

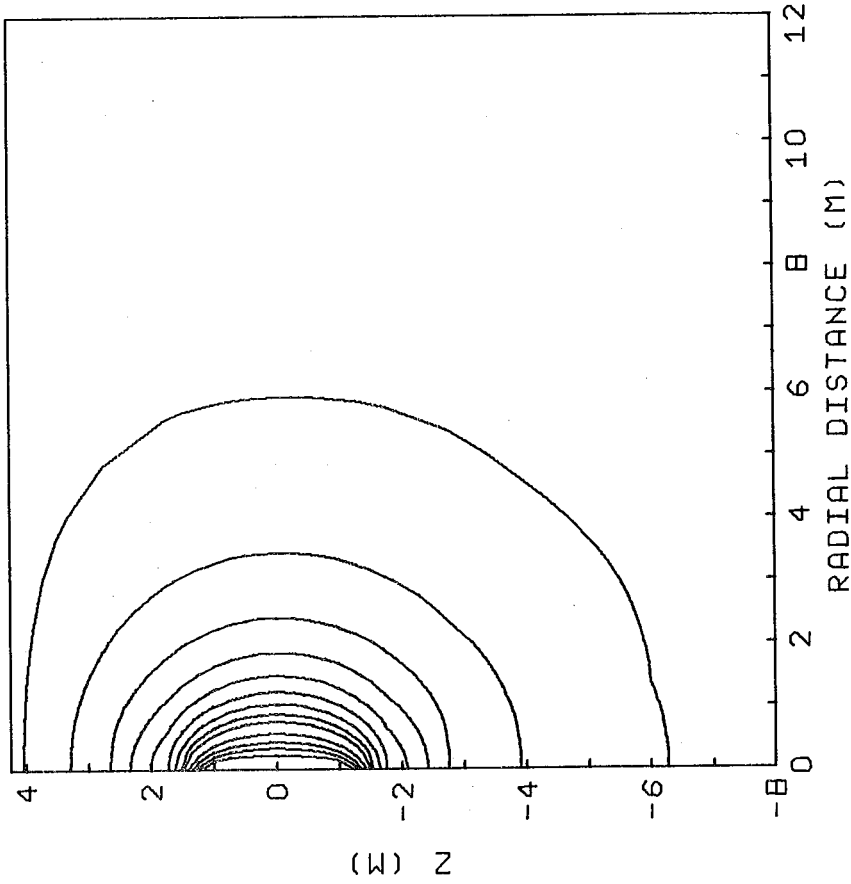

PLOT INFORMATION

TIME = 180. DAYS

THETA = 0.0 DEG.

ISOTHERMAL BOUNDARY MODEL

MAIN HTR = 5.00 KW

PERIPHERAL HTR = 1.00 KW

CONTOURS (DEG.C.) PLOTTED -

427. 350. 300. 250.

200. 175. 150. 125.

100. 75. 50. 25.

5.

Figure D9d

ISOTHERMS IN VERTICAL PLANE
HANFORD FULL-SCALE EXPERIMENT

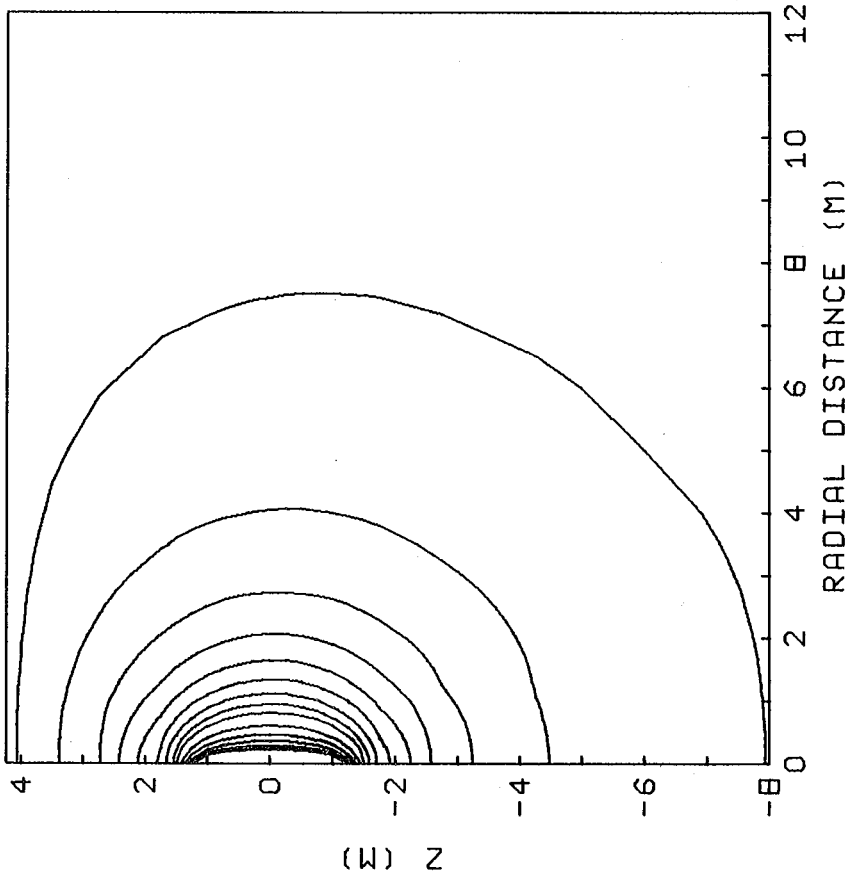

PLOT INFORMATION

TIME = 365. DAYS

THETA = 0.0 DEG.

ISOTHERMAL BOUNDARY MODEL

MAIN HTR = 5.00 KW

PERIPHERAL HTR = 1.00 KW

CONTOURS (DEG.C.) PLOTTED -

440.	400.	350.	300.
250.	200.	175.	150.
125.	100.	75.	50.
25.			

Figure D9e

ISOTHERMS IN VERTICAL PLANE
HANFORD FULL-SCALE EXPERIMENT

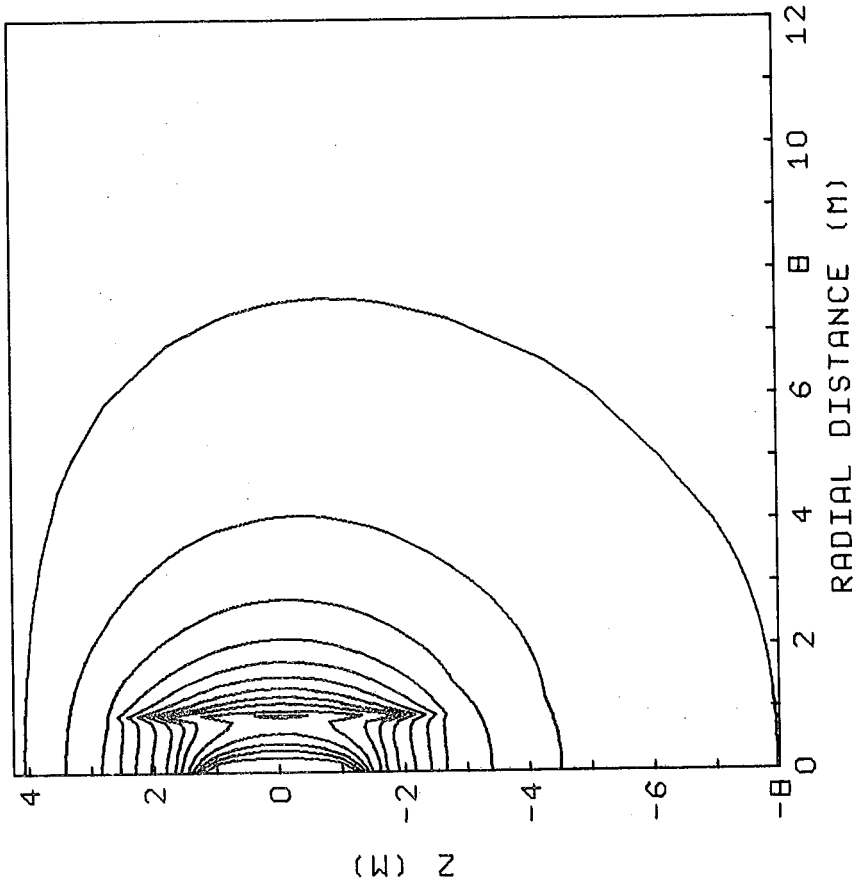

PLOT INFORMATION

TIME = 372. DAYS

THETA = 0.0 DEG.

ISOTHERMAL BOUNDARY MODEL

MAIN HTR = 5.00 KW

PERIPHERAL HTR = 1.00 KW

CONTOURS (DEG.C.) PLOTTED -

477.	400.	350.	300.
250.	200.	175.	150.
125.	100.	75.	50.
25.			5.

Figure D9f

ISOTHERMS IN VERTICAL PLANE
HANFORD FULL-SCALE EXPERIMENT

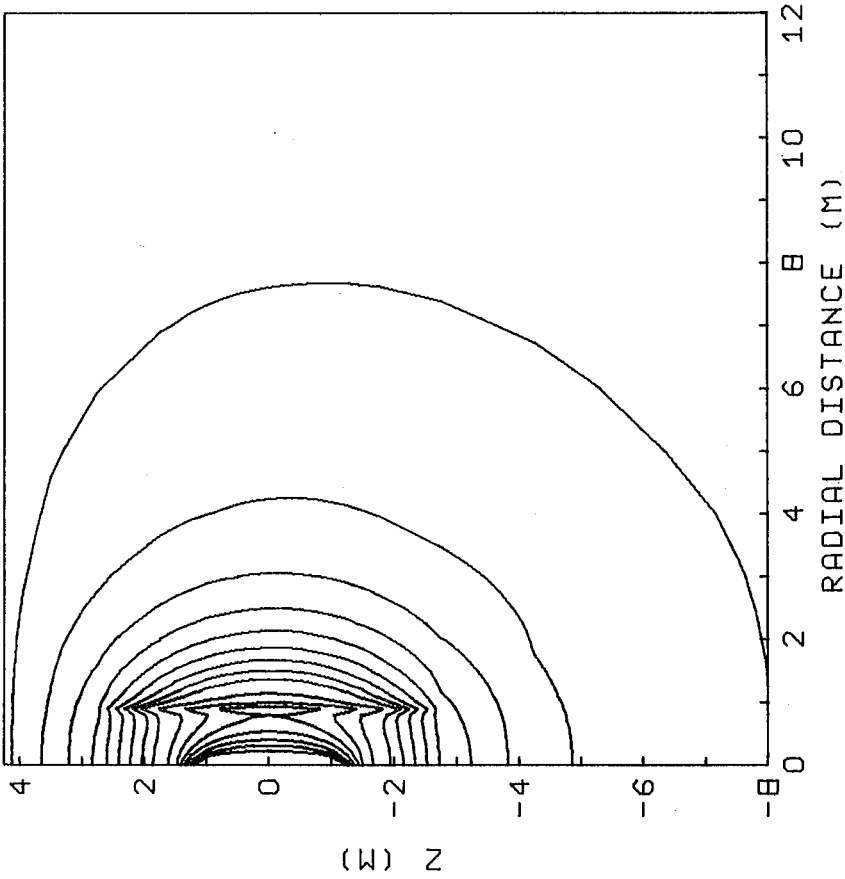

PLOT INFORMATION

TIME = 395. DAYS

THETA = 0.0 DEG.

ISOTHERMAL BOUNDARY MODEL

MAIN HTR = 5.00 KW

PERIPHERAL HTR = 1.00 KW

CONTOURS (DEG.C.) PLOTTED -

563.	500.	450.	400.
350.	300.	250.	200.
175.	150.	125.	100.
75.	50.	25.	5.

Figure D9g

ISOTHERMS IN VERTICAL PLANE
HANFORD FULL-SCALE EXPERIMENT

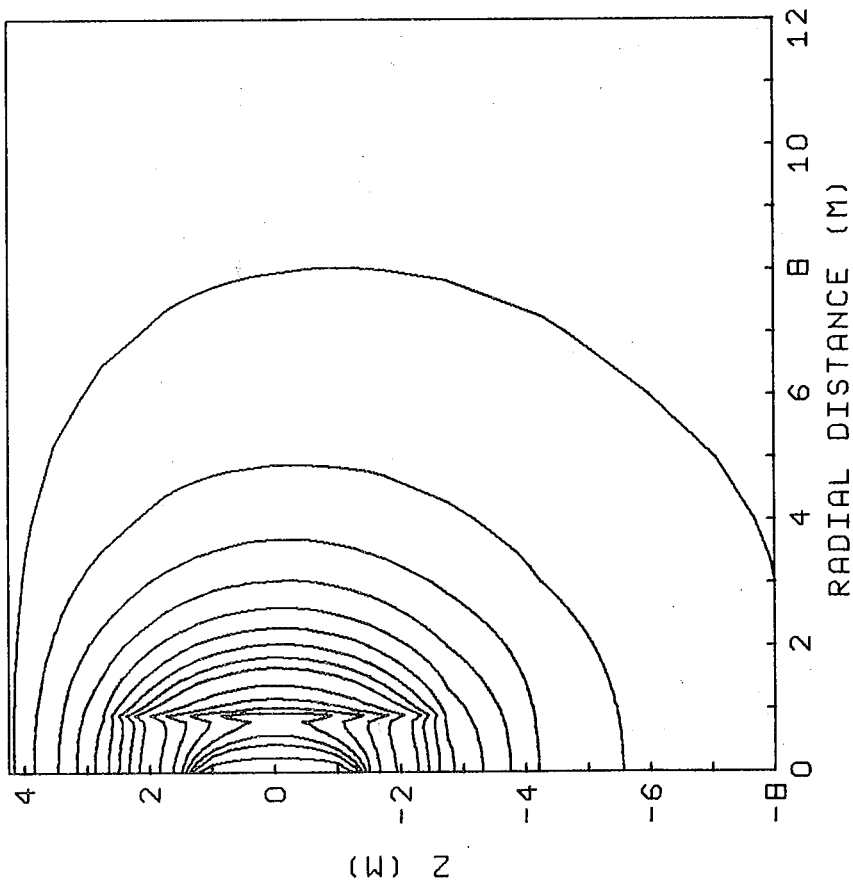

PLOT INFORMATION

TIME = 455. DAYS

THETA = 0.0 DEG.

ISOTHERMAL BOUNDARY MODEL

MAIN HTR = 5.00 KW

PERIPHERAL HTR = 1.00 KW

CONTOURS (DEG.C.) PLOTTED -

628. 500. 450. 400.
350. 300. 250. 200.
175. 150. 125. 100.
75. 50. 25. 5.

XBL 787-9476

Figure D9h

ISOTHERMS IN VERTICAL PLANE
HANFORD FULL-SCALE EXPERIMENT

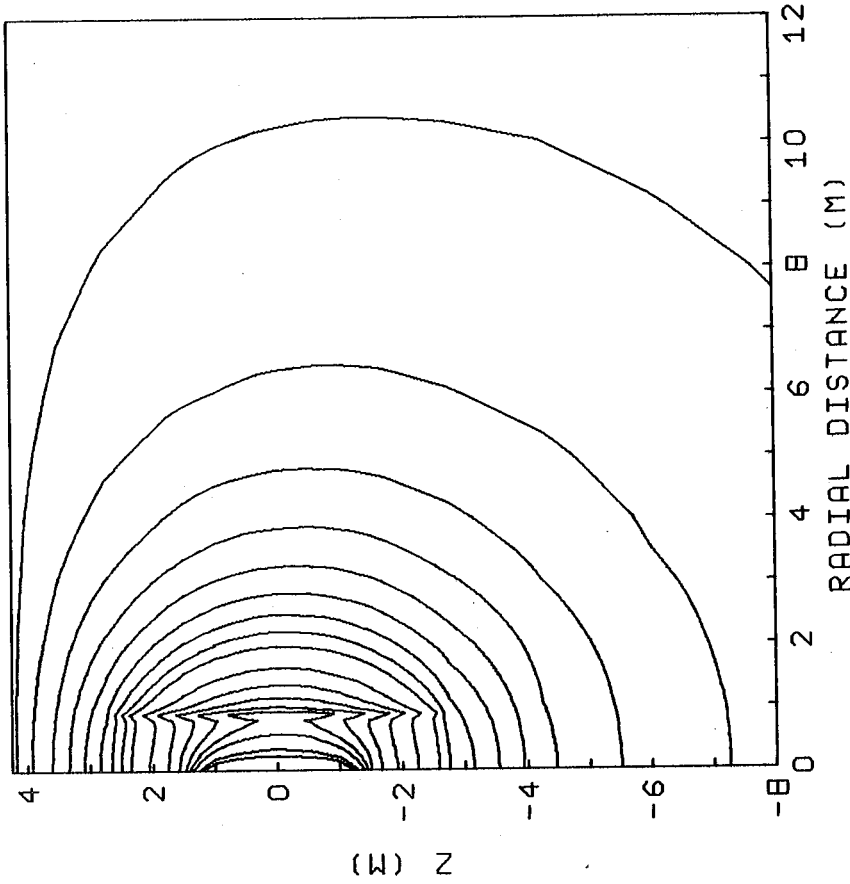

PLOT INFORMATION

TIME = 730. DAYS

THETA = 0.0 DEG.

ISOTHERMAL BOUNDARY MODEL

MAIN HTR = 5.00 KW

PERIPHERAL HTR = 1.00 KW

CONTOURS (DEG.C.) PLOTTED -

- 677. 600. 500. 450.
- 400. 350. 300. 250.
- 200. 175. 150. 125.
- 100. 75. 50. 25.

XBL 787-9472

Figure D9i

ISOTHERMS IN VERTICAL PLANE
HANFORD FULL-SCALE EXPERIMENT

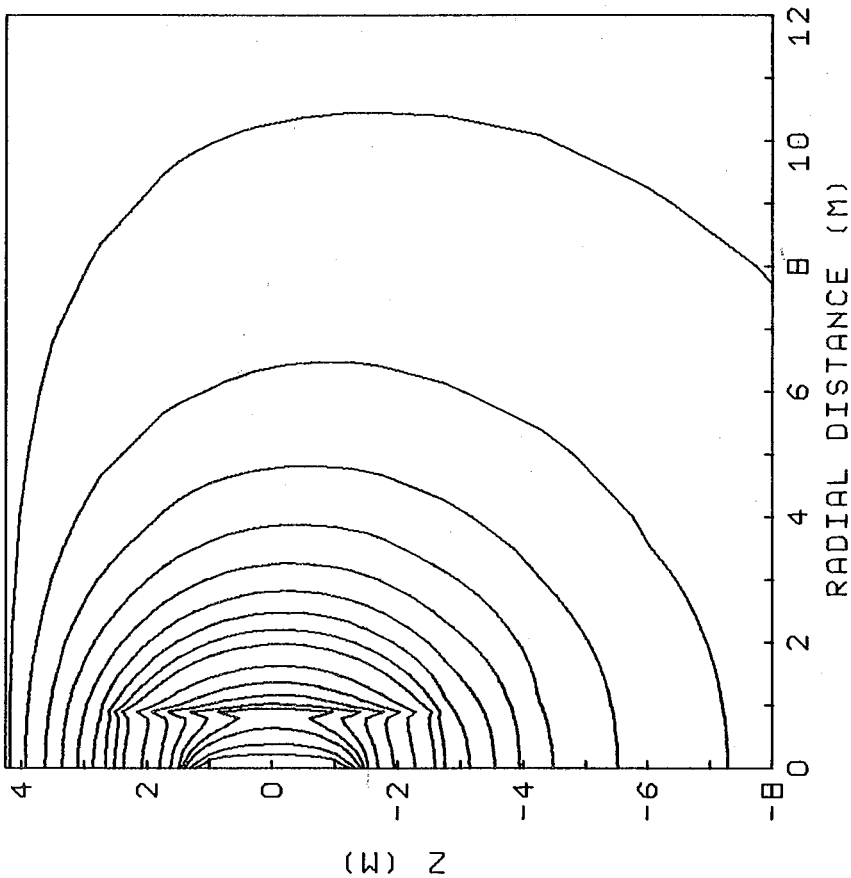

PLOT INFORMATION

TIME = 737. DAYS

THETA = 0.0 DEG.

ISOTHERMAL BOUNDARY MODEL

MAIN HTR = 5.00 KW

PERIPHERAL HTR = 1.00 KW

CONTOURS (DEG.C.) PLOTTED -
729. 600. 500. 450.
400. 350. 300. 250.
200. 175. 150. 125.
100. 75. 50. 25.
5.

XBL 787-9468

Figure D9j

ISOTHERMS IN VERTICAL PLANE
HANFORD FULL-SCALE EXPERIMENT

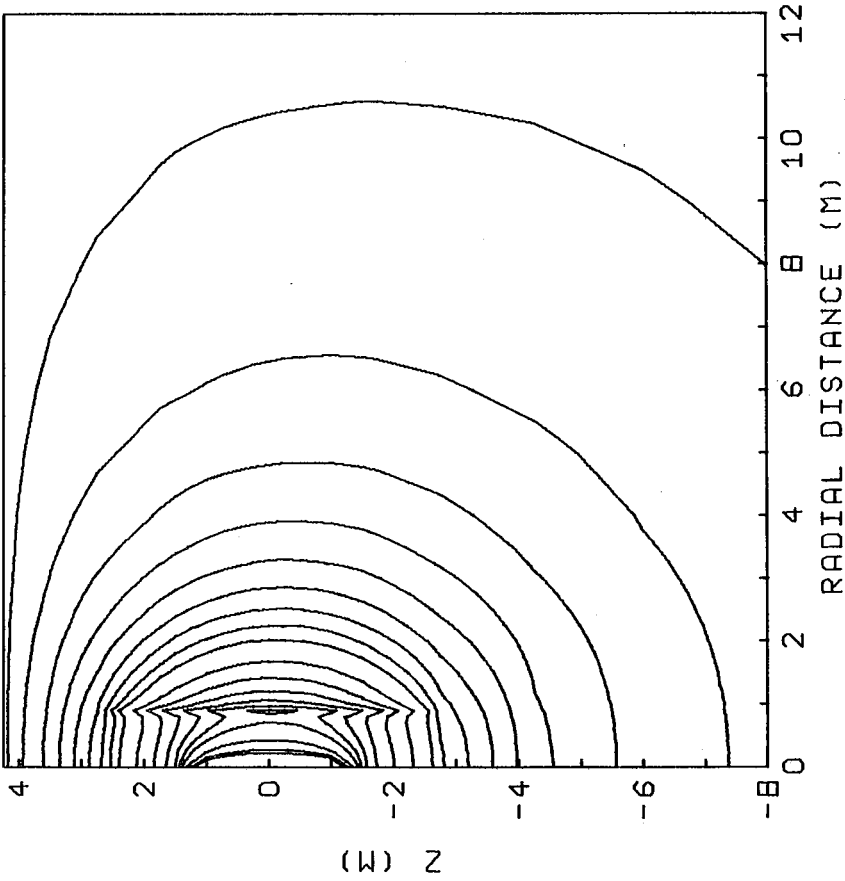

PLOT INFORMATION

TIME = 760. DAYS

THETA = 0.0 DEG.

ISOTHERMAL BOUNDARY MODEL

MAIN HTR = 5.00 KW

PERIPHERAL HTR = 1.00 KW

CONTOURS (DEG.C.) PLOTTED -
751. 700. 600. 500.
450. 400. 350. 300.
250. 200. 175. 150.
125. 100. 75. 50.
25. 5.

XBL 787-9467

Figure D9k

ISOTHERMS IN VERTICAL PLANE
HANFORD FULL-SCALE EXPERIMENT

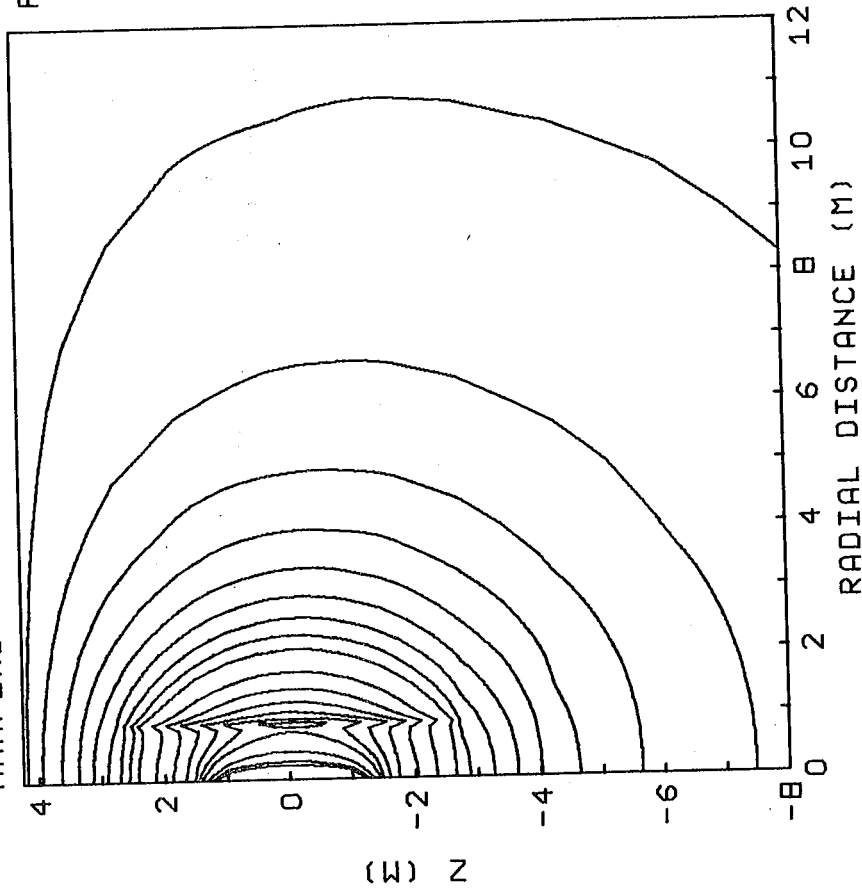

PLOT INFORMATION

TIME = 790. DAYS

THETA = 0.0 DEG.

ISOTHERMAL BOUNDARY MODEL

MAIN HTR = 5.00 KW

PERIPHERAL HTR = 1.00 KW

CONTOURS (DEG.C.) PLOTTED -

- 759. 700. 600. 500.
- 450. 400. 350. 300.
- 250. 200. 175. 150.
- 125. 100. 75. 50.
- 25. 5.

XBL 787-9466

Figure D9I

ISOTHERMS IN VERTICAL PLANE
HANFORD FULL-SCALE EXPERIMENT

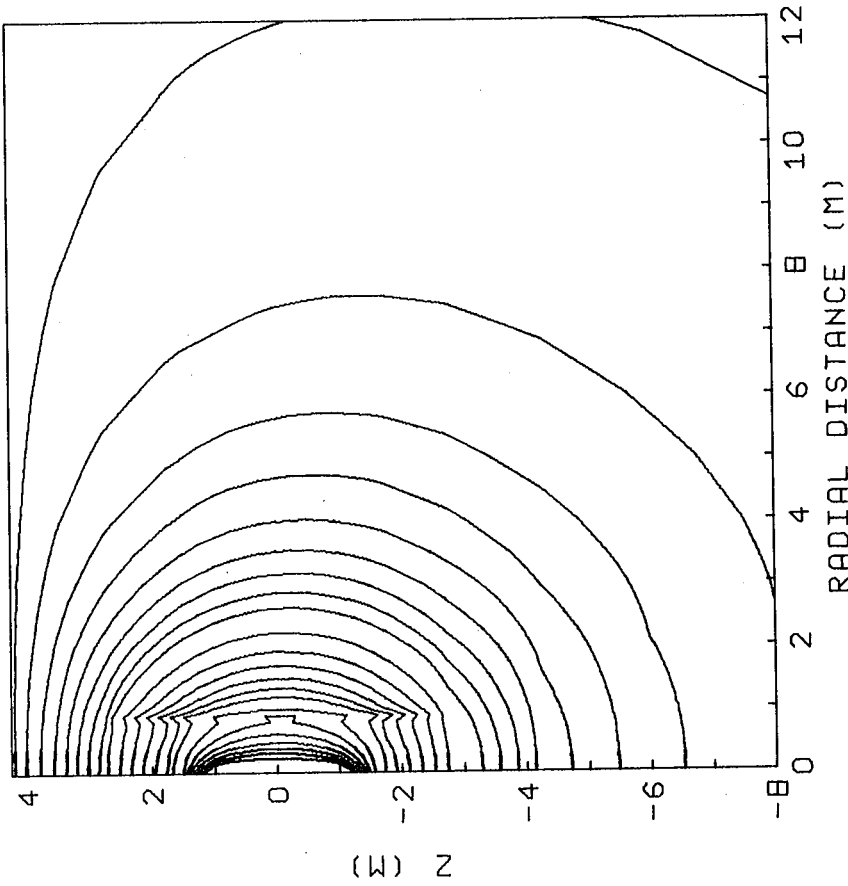

PLOT INFORMATION

TIME = 1095. DAYS

THETA = 0.0 DEG.

ISOTHERMAL BOUNDARY MODEL

MAIN HTR = 5.00 KW

PERIPHERAL HTR = 1.00 KW

CONTOURS (DEG.C.) PLOTTED -

- 1242. 1100. 1000. 900.
- 800. 700. 600. 500.
- 450. 400. 350. 300.
- 250. 200. 175. 150.
- 125. 100. 75. 50.
- 25. 5.

XBL 787-9465

Figure D9m

ISOTHERMS IN VERTICAL PLANE
HANFORD FULL-SCALE EXPERIMENT

PLOT INFORMATION
TIME = 7. DAYS
THETA = 0.0 DEG.
INFINITE MEDIUM MODEL
MAIN HTR = 2.00 KW
PERIPHERAL HTR = 1.00 KW
CONTOURS (DEG.C.) PLOTTED -
102. 75. 50. 25.
5.

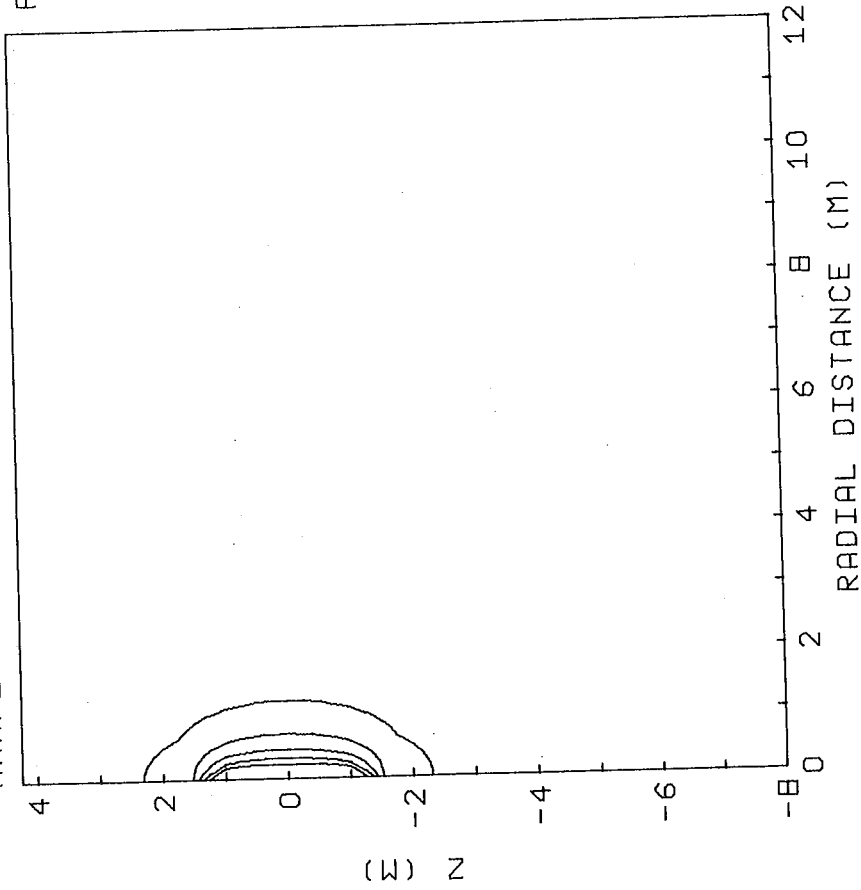

XBL 786-9452

Figure D10a

ISOTHERMS IN VERTICAL PLANE
HANFORD FULL-SCALE EXPERIMENT

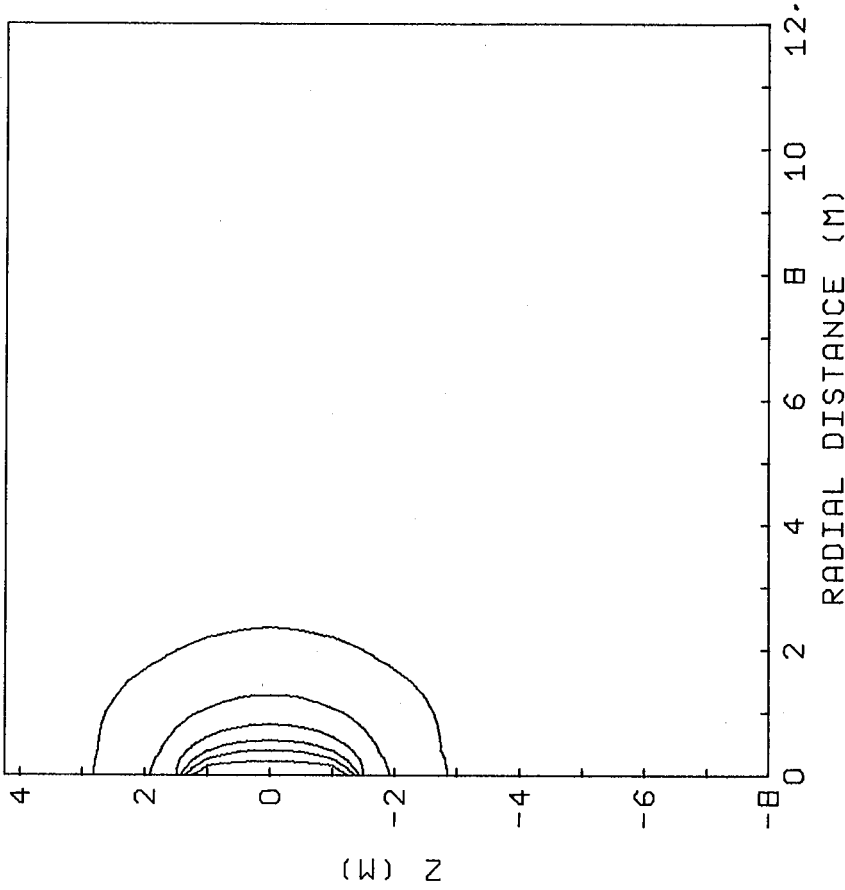

PLOT INFORMATION

TIME = 30. DAYS

THETA = 0.0 DEG.

INFINITE MEDIUM MODEL

MAIN HTR = 2.00 KW

PERIPHERAL HTR = 1.00 KW

CONTOURS (DEG.C.) PLOTTED -

144. 100. 75. 50.

25. 5.

XBL 787-9456

Figure D10b

ISOTHERMS IN VERTICAL PLANE
HANFORD FULL-SCALE EXPERIMENT

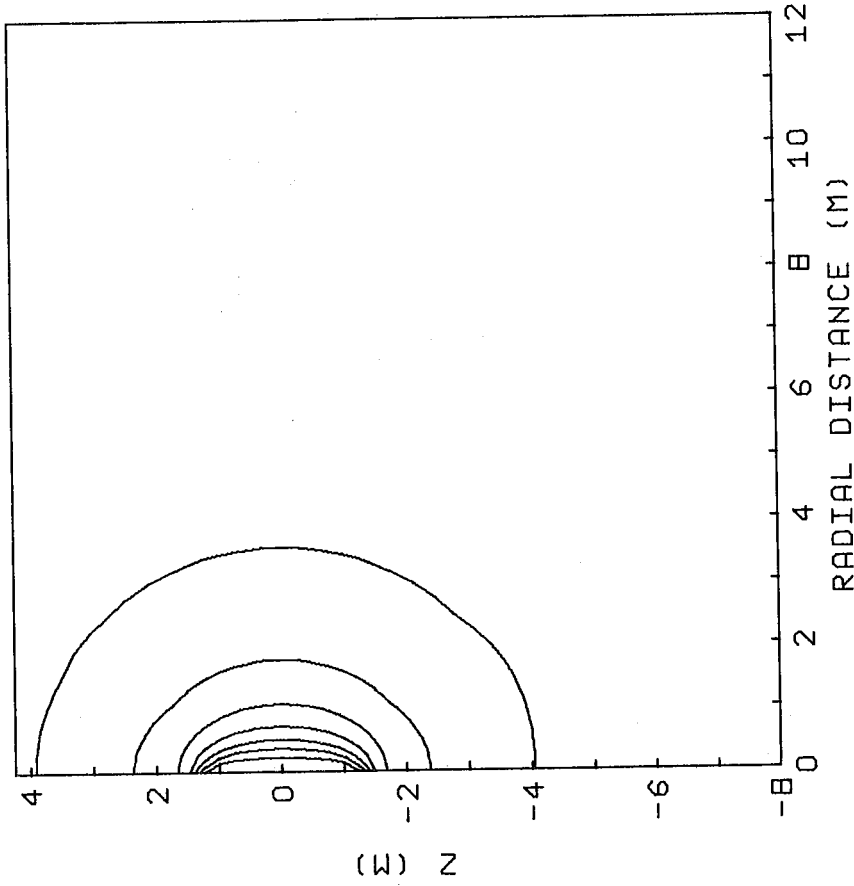

PLOT INFORMATION

TIME = 90. DAYS

THETA = 0.0 DEG.

INFINITE MEDIUM MODEL

MAIN HTR = 2.00 KW

PERIPHERAL HTR = 1.00 KW

CONTOURS (DEG.C.) PLOTTED -

163. 125. 100. 75.

50. 25. 5.

Figure D10c

ISOTHERMS IN VERTICAL PLANE
HANFORD FULL-SCALE EXPERIMENT

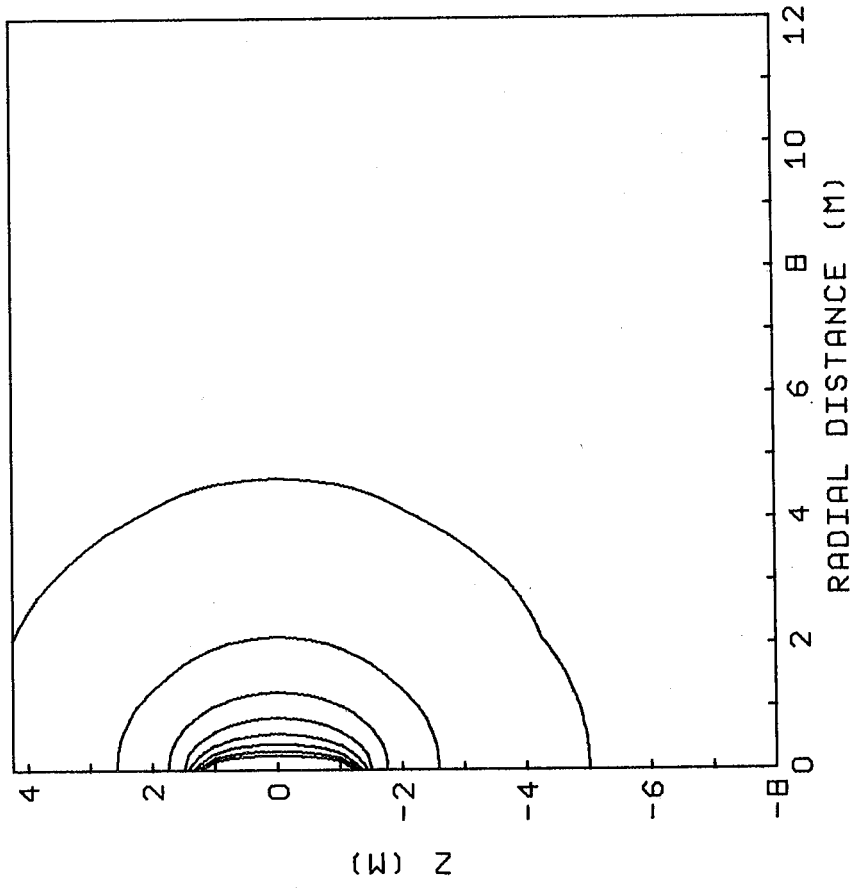

PLOT INFORMATION

TIME = 180. DAYS

THETA = 0.0 DEG.

INFINITE MEDIUM MODEL

MAIN HTR = 2.00 KW

PERIPHERAL HTR = 1.00 KW

CONTOURS (DEG.C.) PLOTTED -

171. 150. 125. 100.

75. 50. 25. 5.

Figure D10d

ISOTHERMS IN VERTICAL PLANE
HANFORD FULL-SCALE EXPERIMENT

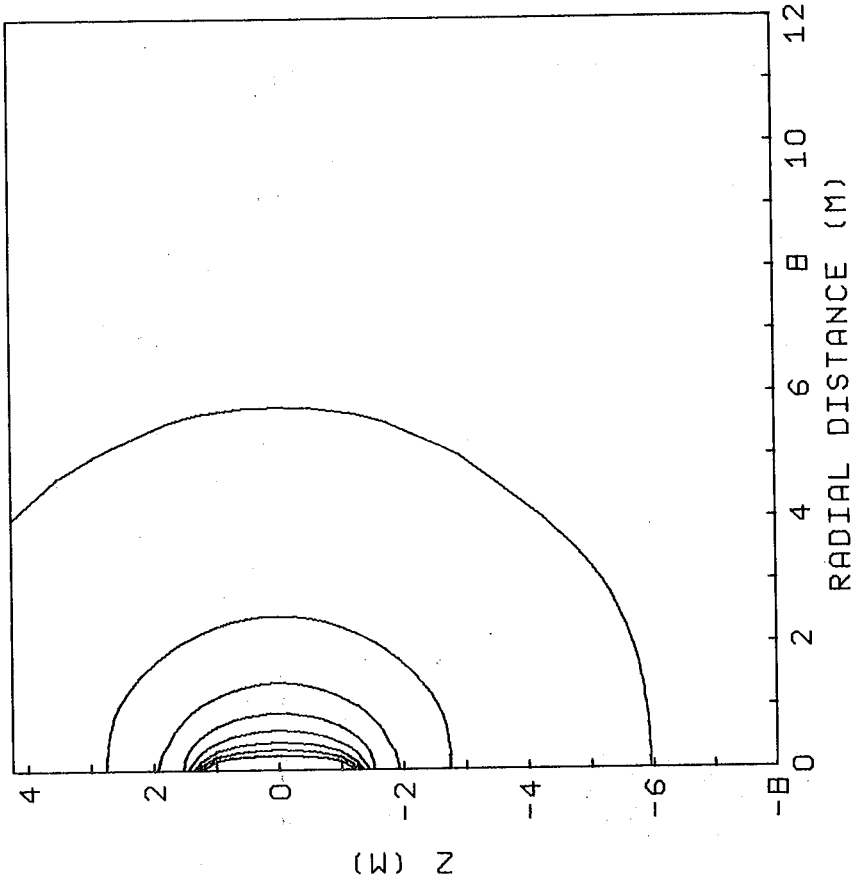

PLOT INFORMATION

TIME = 365. DAYS

THETA = 0.0 DEG.

INFINITE MEDIUM MODEL

MAIN HTR = 2.00 KW

PERIPHERAL HTR = 1.00 KW

CONTOURS (DEG.C.) PLOTTED -

177. 150. 125. 100.

75. 50. 25. 5.

XBL 787-9461

Figure D10e

ISOTHERMS IN VERTICAL PLANE
HANFORD FULL-SCALE EXPERIMENT

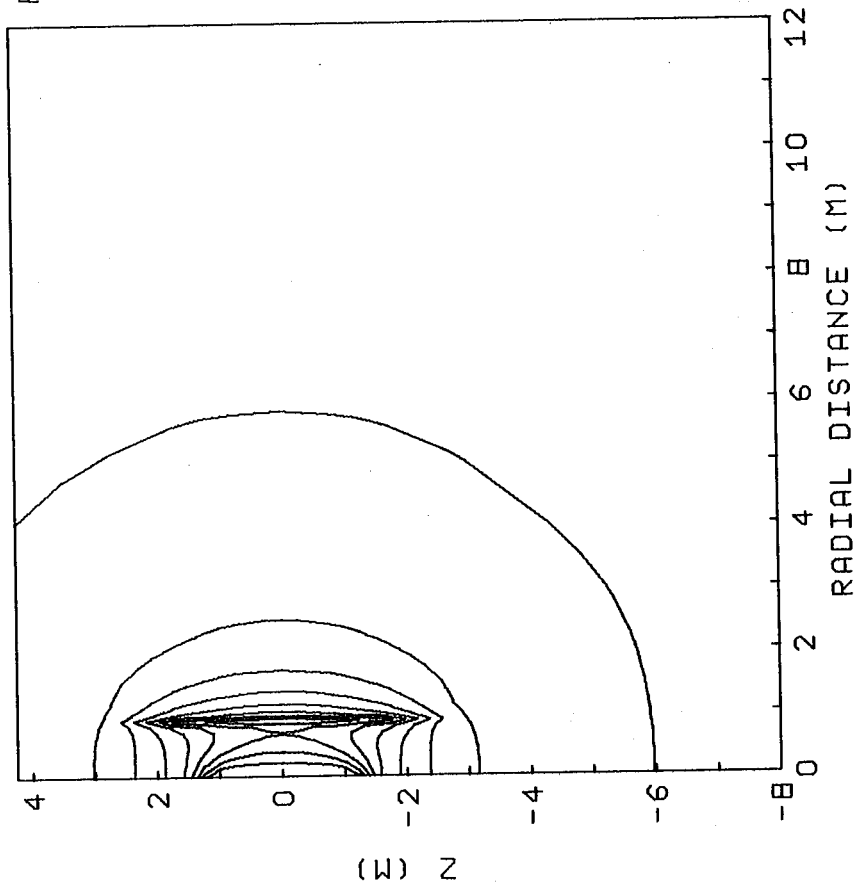

PLOT INFORMATION

TIME = 372. DAYS

THETA = 0.0 DEG.

INFINITE MEDIUM MODEL

MAIN HTR = 2.00 KW

PERIPHERAL HTR = 1.00 KW

CONTOURS (DEG.C.) PLOTTED -

215. 175. 150. 125.

100. 75. 50. 25.

5.

Figure D10f

ISOTHERMS IN VERTICAL PLANE
HANFORD FULL-SCALE EXPERIMENT

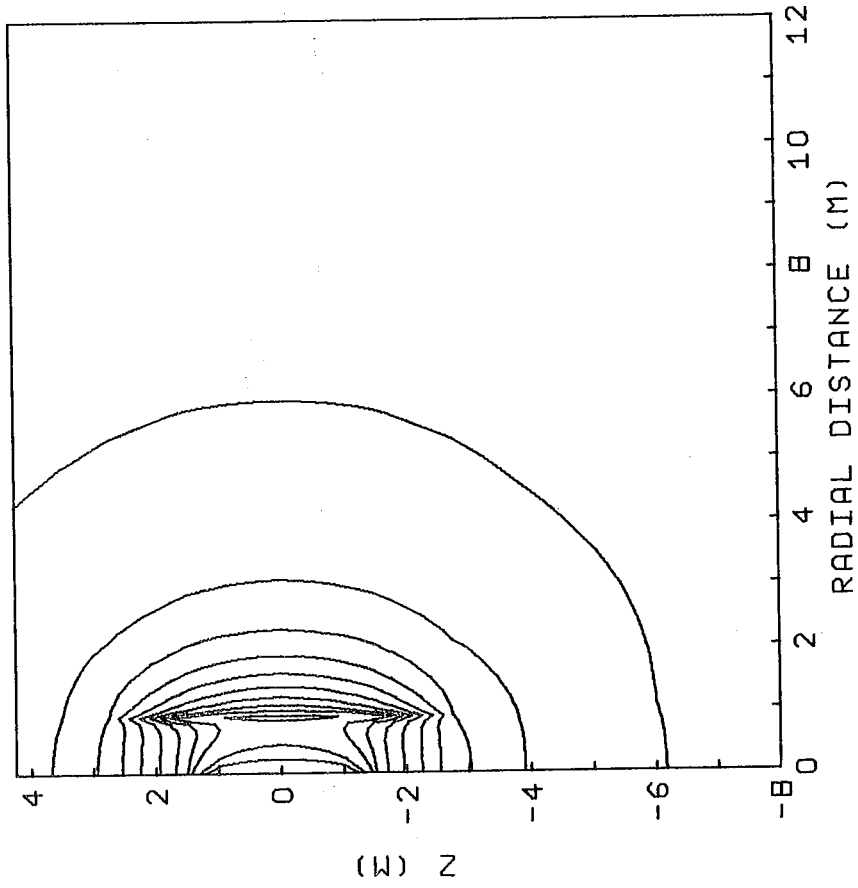

PLOT INFORMATION

TIME = 395. DAYS

THETA = 0.0 DEG.

INFINITE MEDIUM MODEL

MAIN HTR = 2.00 KW

PERIPHERAL HTR = 1.00 KW

CONTOURS (DEG.C.) PLOTTED -

301: 250: 200: 175:

150: 125: 100: 75:

50: 25: 5:

XBL 787-9464

Figure D10g

ISOTHERMS IN VERTICAL PLANE
HANFORD FULL-SCALE EXPERIMENT

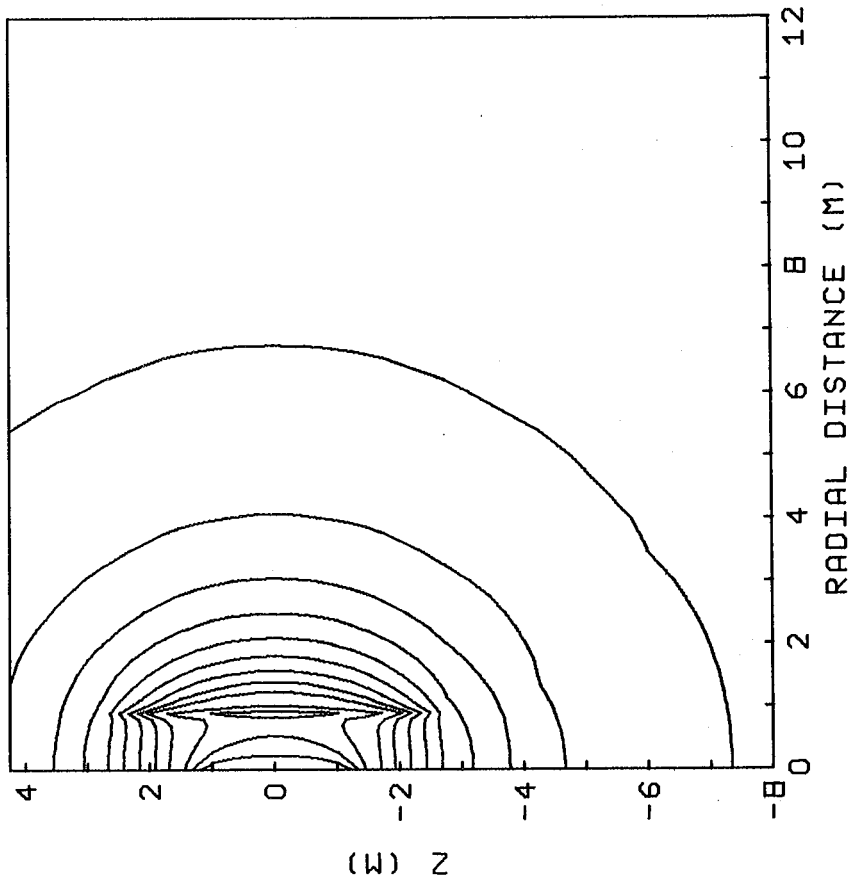

PLOT INFORMATION

TIME = 455. DAYS

THETA = 0.0 DEG.

INFINITE MEDIUM MODEL

MAIN HTR = 2.00 KW

PERIPHERAL HTR = 1.00 KW

CONTOURS (DEG.C.) PLOTTED -

365. 300. 250. 200.

175. 150. 125. 100.

75. 50. 25. 5.

Figure D10h

ISOTHERMS IN VERTICAL PLANE
HANFORD FULL-SCALE EXPERIMENT

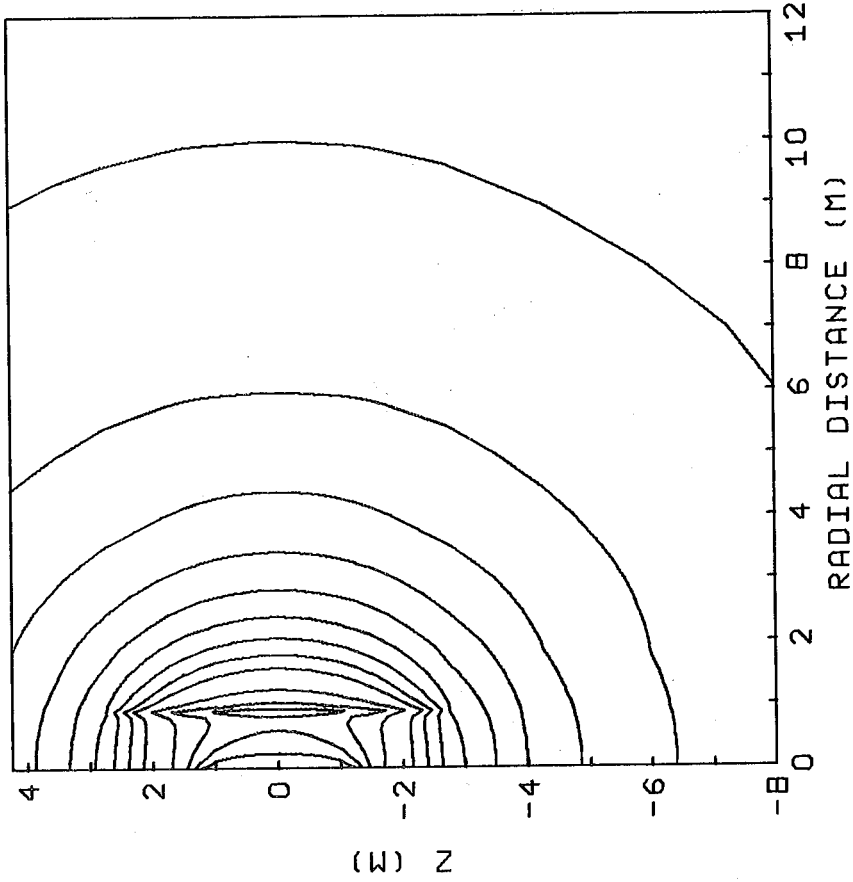

PLOT INFORMATION

TIME = 730. DAYS

THETA = 0.0 DEG.

INFINITE MEDIUM MODEL

MAIN HTR = 2.00 KW

PERIPHERAL HTR = 1.00 KW

CONTOURS (DEG.C.) PLOTTED -

420.	350.	300.	250.
200.	175.	150.	125.
100.	75.	50.	25.
			5.

Figure D10i

ISOTHERMS IN VERTICAL PLANE
HANFORD FULL-SCALE EXPERIMENT

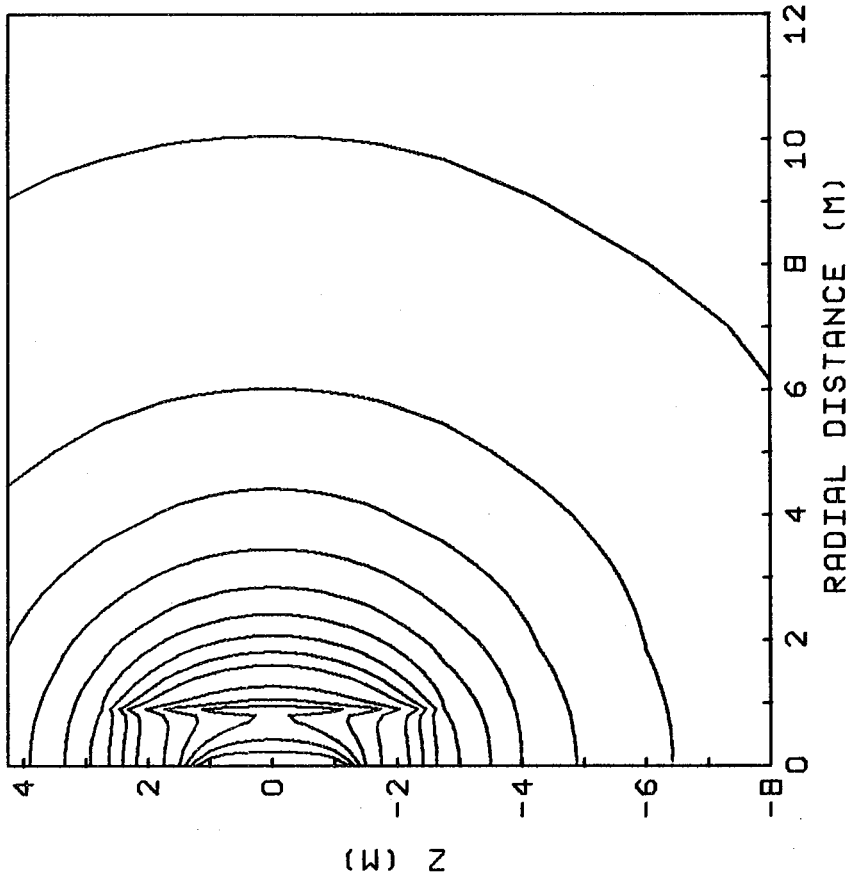

PLOT INFORMATION

TIME = 737. DAYS

THETA = 0.0 DEG.

INFINITE MEDIUM MODEL

MAIN HTR = 2.00 KW

PERIPHERAL HTR = 1.00 KW

CONTOURS (DEG.C.) PLOTTED -

472. 400. 350. 300.
250. 200. 175. 150.
125. 100. 75. 50.
25. 5.

XBL 787-9459

Figure D10j

ISOTHERMS IN VERTICAL PLANE
HANFORD FULL-SCALE EXPERIMENT

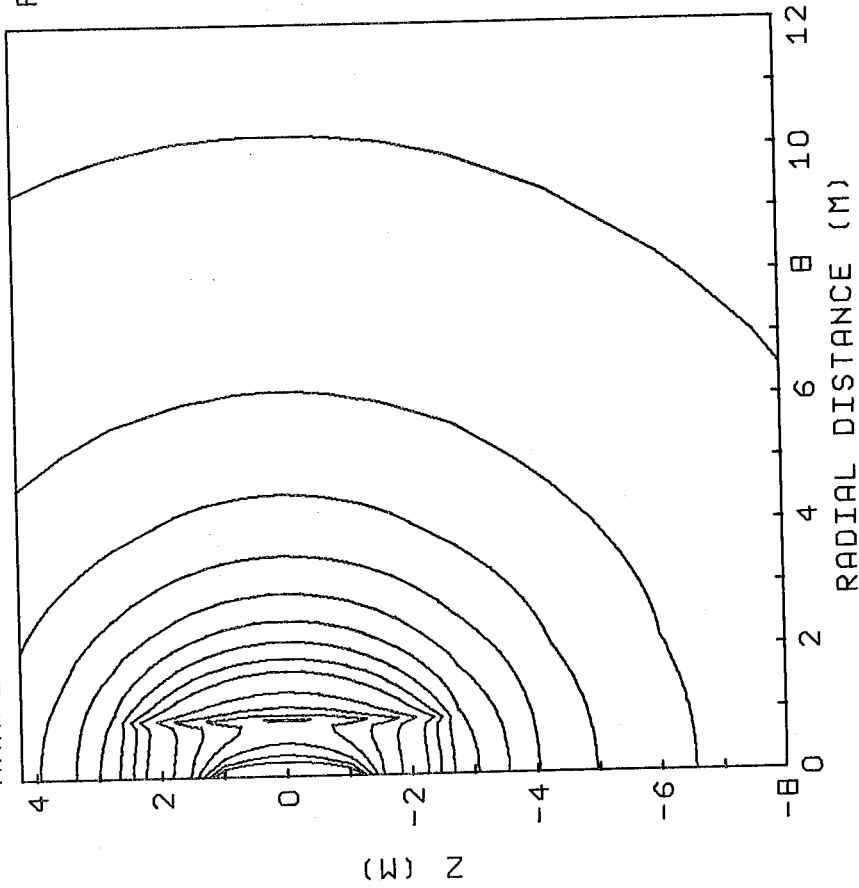

PLOT INFORMATION

TIME = 760. DAYS

THETA = 0.0 DEG.

INFINITE MEDIUM MODEL

MAIN HTR = 2.00 KW

PERIPHERAL HTR = 1.00 KW

CONTOURS (DEG.C.) PLOTTED -

- 494. 450. 400. 350.
- 300. 250. 200. 175.
- 150. 125. 100. 75.
- 50. 25. 5.

XBL 787-9455

Figure D10k

ISOTHERMS IN VERTICAL PLANE
HANFORD FULL-SCALE EXPERIMENT

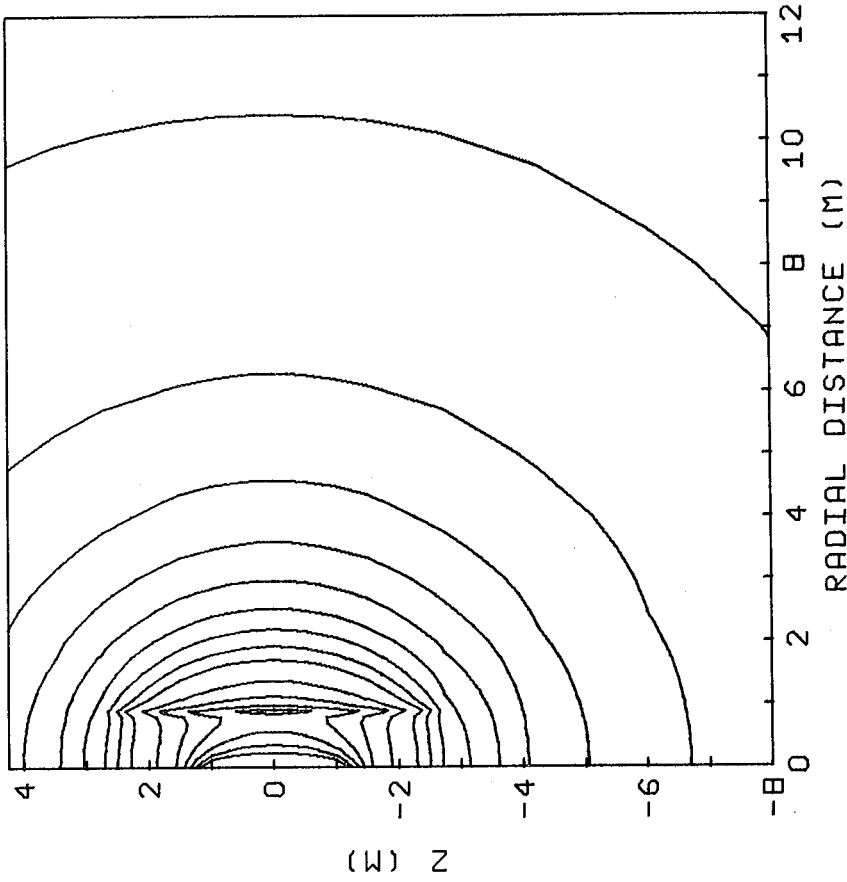

PLOT INFORMATION

TIME = 790. DAYS

THETA = 0.0 DEG.

INFINITE MEDIUM MODEL

MAIN HTR = 2.00 KW

PERIPHERAL HTR = 1.00 KW

CONTOURS (DEG.C.) PLOTTED -
503. 450. 400. 350.
300. 250. 200. 175.
150. 125. 100. 75.
50. 25. 5.

XBL 787-9454

Figure D101

ISOTHERMS IN VERTICAL PLANE
HANFORD FULL-SCALE EXPERIMENT

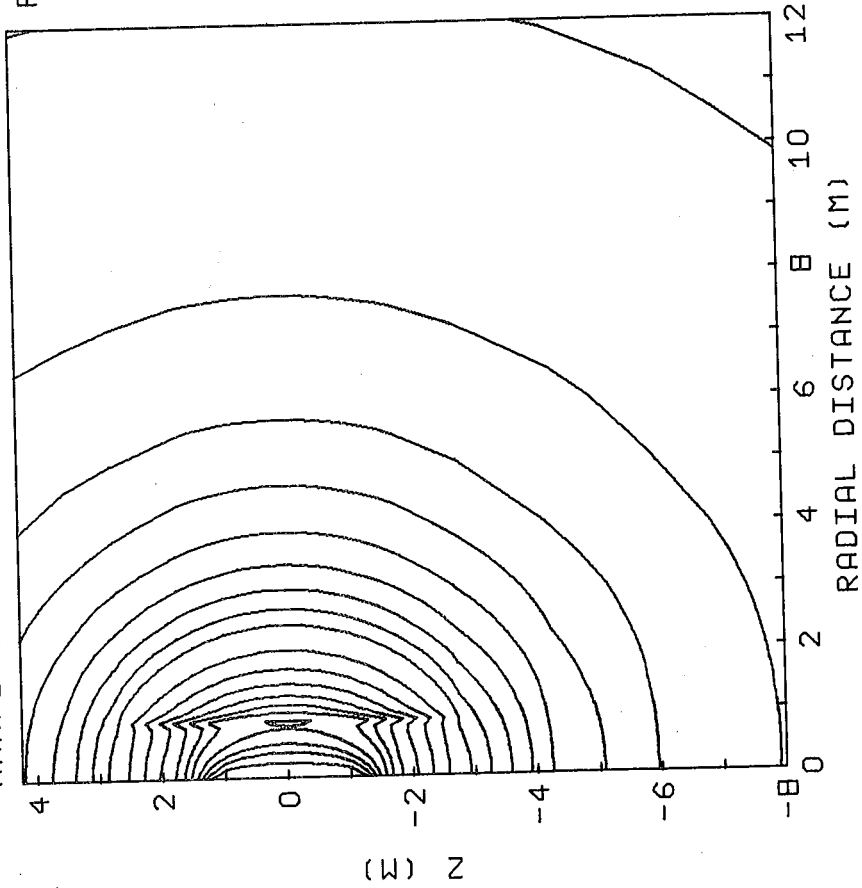

PLOT INFORMATION

TIME = 1095. DAYS

THETA = 0.0 DEG.

INFINITE MEDIUM MODEL

MAIN HTR = 2.00 KW

PERIPHERAL HTR = 1.00 KW

CONTOURS (DEG.C.) PLOTTED -

- 994. 800. 700. 600.
- 500. 450. 400. 350.
- 300. 250. 200. 175.
- 150. 125. 100. 75.
- 50. 25. 5.

XBL 786-9453

Figure D10m

ISOTHERMS IN VERTICAL PLANE
HANFORD FULL-SCALE EXPERIMENT

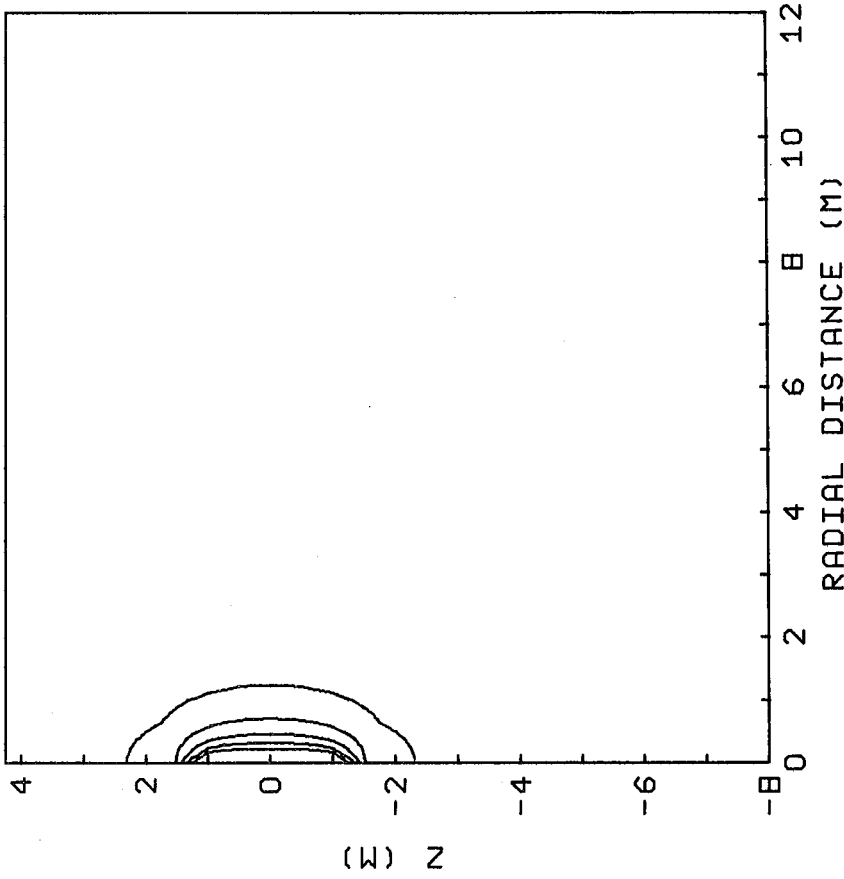

PLOT INFORMATION

TIME = 7. DAYS

THETA = 0.0 DEG.

ISOTHERMAL BOUNDARY MODEL

MAIN HTR = 2.00 KW

PERIPHERAL HTR = 1.00 KW

CONTOURS (DEG.C.) PLOTTED -
102. 75. 50. 25.
5.

Figure D11a

ISOTHERMS IN VERTICAL PLANE
HANFORD FULL-SCALE EXPERIMENT

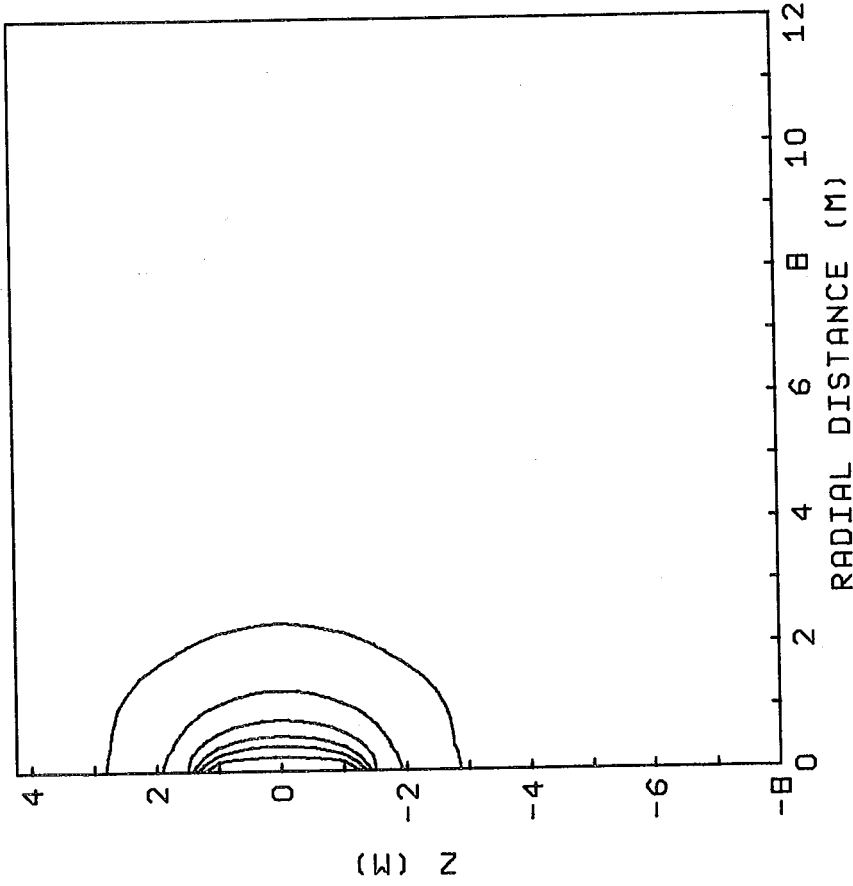

PLOT INFORMATION

TIME = 30. DAYS

THETA = 0.0 DEG.

ISOTHERMAL BOUNDARY MODEL

MAIN HTR = 2.00 KW

PERIPHERAL HTR = 1.00 KW

CONTOURS (DEG.C.) PLOTTED -
143. 100. 75. 50.
25. 5.

XBL 787-9490

Figure D11b

ISOTHERMS IN VERTICAL PLANE
HANFORD FULL-SCALE EXPERIMENT

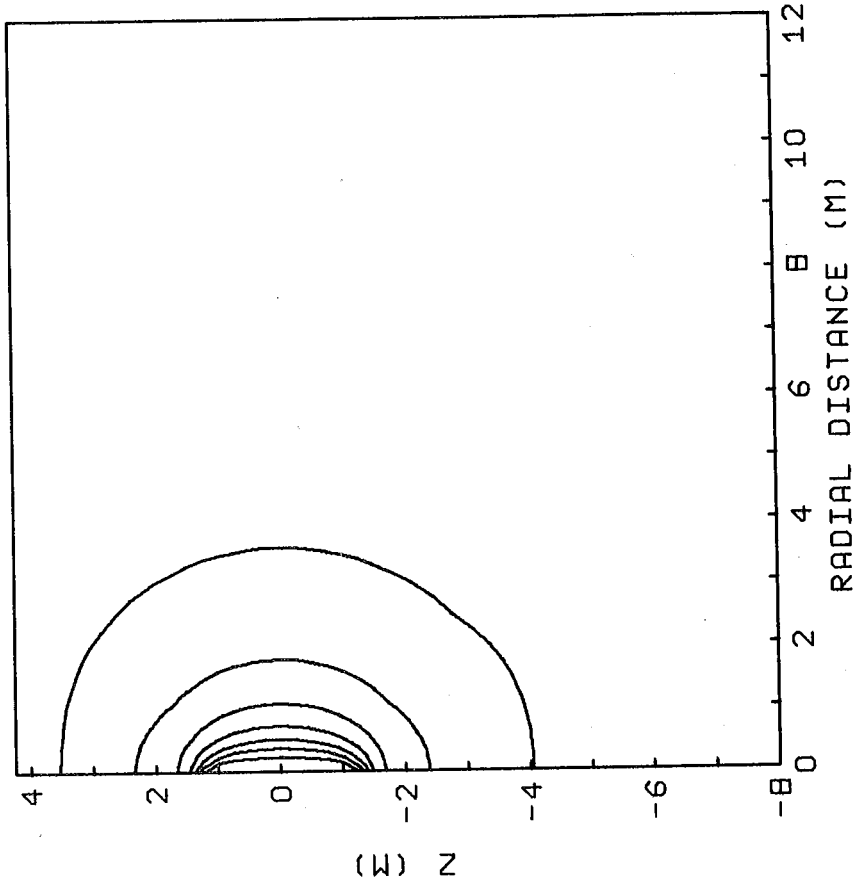

PLOT INFORMATION

TIME = 90. DAYS

THETA = 0.0 DEG.

ISOTHERMAL BOUNDARY MODEL

MAIN HTR = 2.00 KW

PERIPHERAL HTR = 1.00 KW

CONTOURS (DEG.C.) PLOTTED -

163. 125. 100. 75.

50. 25. 5.

XBL 787-9491

Figure D11c

ISOTHERMS IN VERTICAL PLANE
HANFORD FULL-SCALE EXPERIMENT

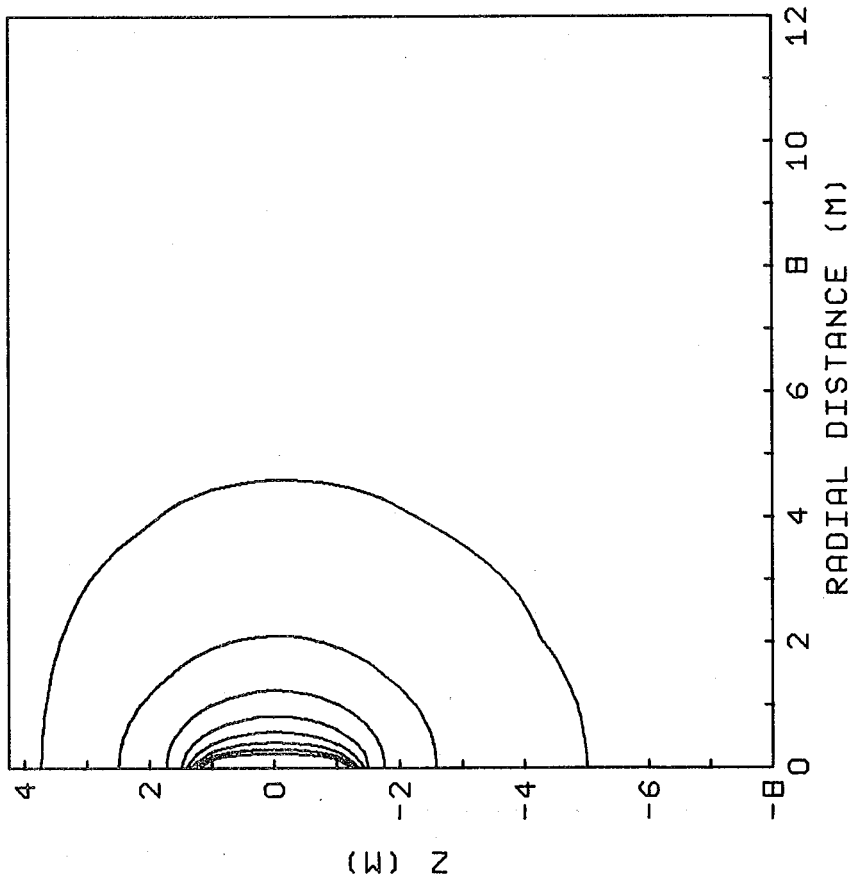

PLOT INFORMATION

TIME = 180. DAYS

THETA = 0.0 DEG.

ISOTHERMAL BOUNDARY MODEL

MAIN HTR = 2.00 KW

PERIPHERAL HTR = 1.00 KW

CONTOURS (DEG.C.) PLOTTED -

171. 150. 125. 100.

75. 50. 25. 5.

Figure D11d

ISOTHERMS IN VERTICAL PLANE
HANFORD FULL-SCALE EXPERIMENT

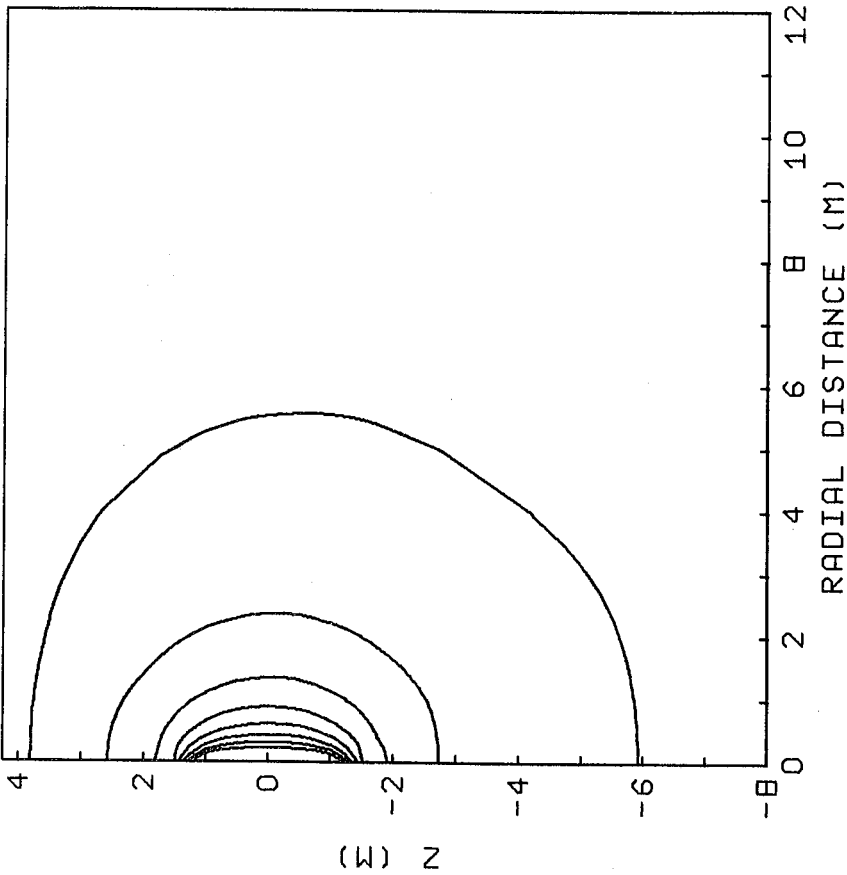

PLOT INFORMATION

TIME = 365. DAYS

THETA = 0.0 DEG.

ISOTHERMAL BOUNDARY MODEL

MAIN HTR = 2.00 KW

PERIPHERAL HTR = 1.00 KW

CONTOURS (DEG.C.) PLOTTED -

176. 150. 125. 100.

75. 50. 25. 5.

XBL 787-9487

Figure D11e

ISOTHERMS IN VERTICAL PLANE
HANFORD FULL-SCALE EXPERIMENT

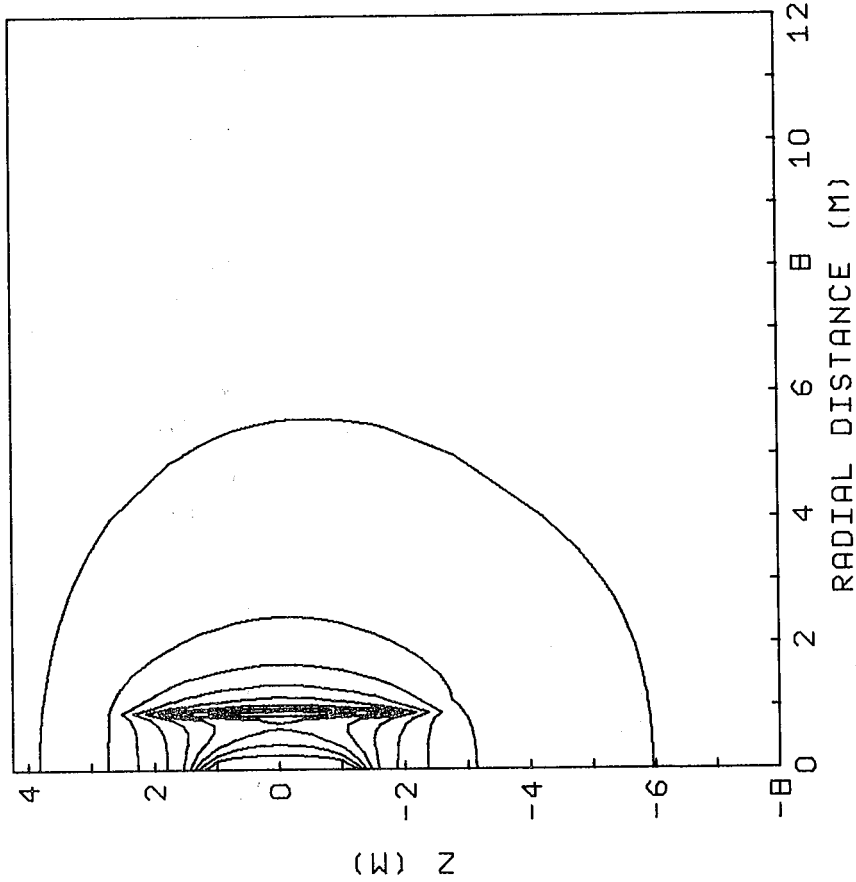

PLOT INFORMATION

TIME = 372. DAYS

THETA = 0.0 DEG.

ISOTHERMAL BOUNDARY MODEL

MAIN HTR = 2.00 KW

PERIPHERAL HTR = 1.00 KW

CONTOURS (DEG.C.) PLOTTED -

213. 175. 150. 125.

100. 75. 50. 25.

5.

XBL 787-9486

Figure D11f

ISOTHERMS IN VERTICAL PLANE
HANFORD FULL-SCALE EXPERIMENT

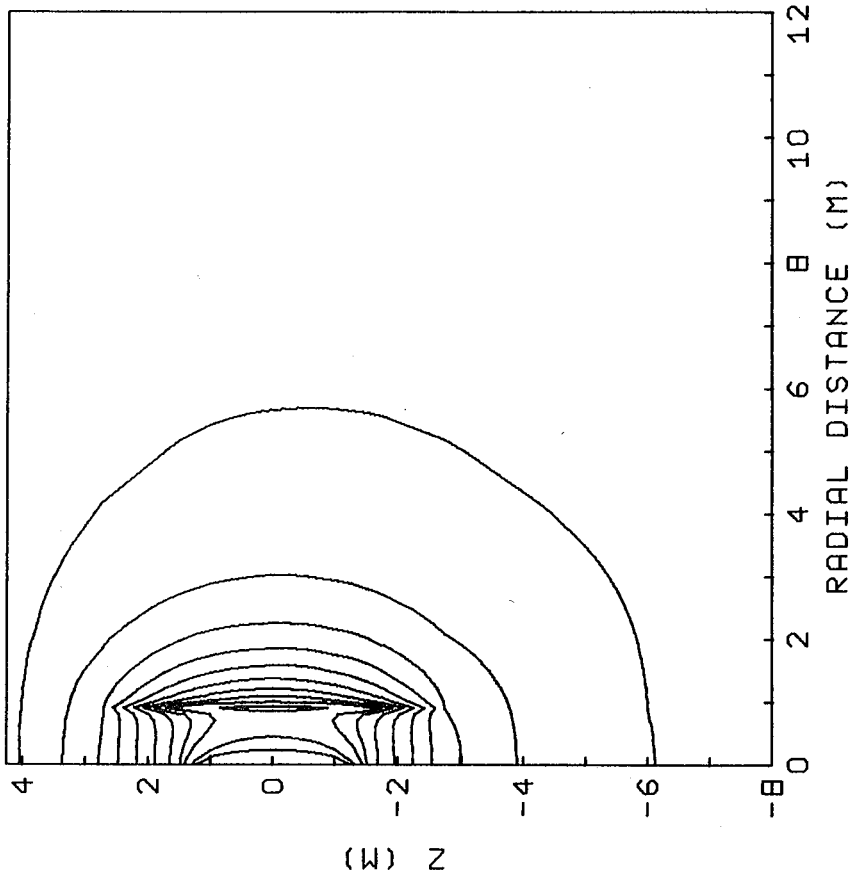

PLOT INFORMATION

TIME = 395. DAYS

THETA = 0.0 DEG.

ISOTHERMAL BOUNDARY MODEL

MAIN HTR = 2.00 KW

PERIPHERAL HTR = 1.00 KW

CONTOURS (DEG.C.) PLOTTED -

299. 250. 200. 175.

150. 125. 100. 75.

50. 25. 5.

Figure D11g

ISOTHERMS IN VERTICAL PLANE
HANFORD FULL-SCALE EXPERIMENT

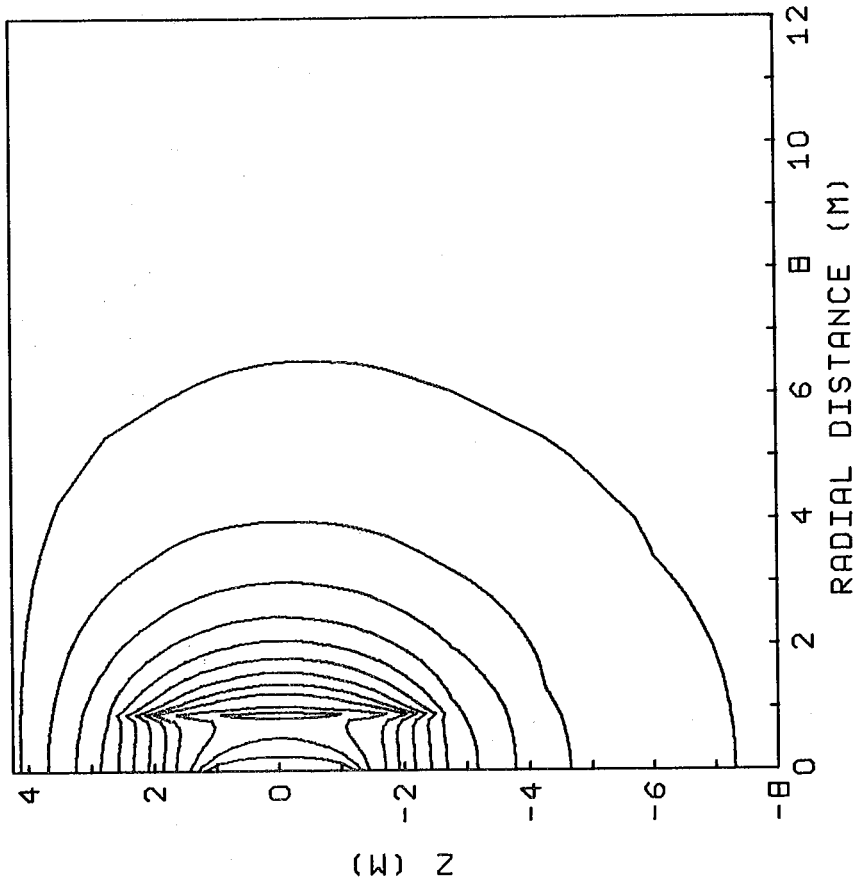

PLOT INFORMATION

TIME = 455. DAYS

THETA = 0.0 DEG.

ISOTHERMAL BOUNDARY MODEL

MAIN HTR = 2.00 KW

PERIPHERAL HTR = 1.00 KW

CONTOURS (DEG.C.) PLOTTED -
363. 300. 250. 200.
175. 150. 125. 100.
75. 50. 25. 5.

XBL 787-9484

Figure D11h

ISOTHERMS IN VERTICAL PLANE
HANFORD FULL-SCALE EXPERIMENT

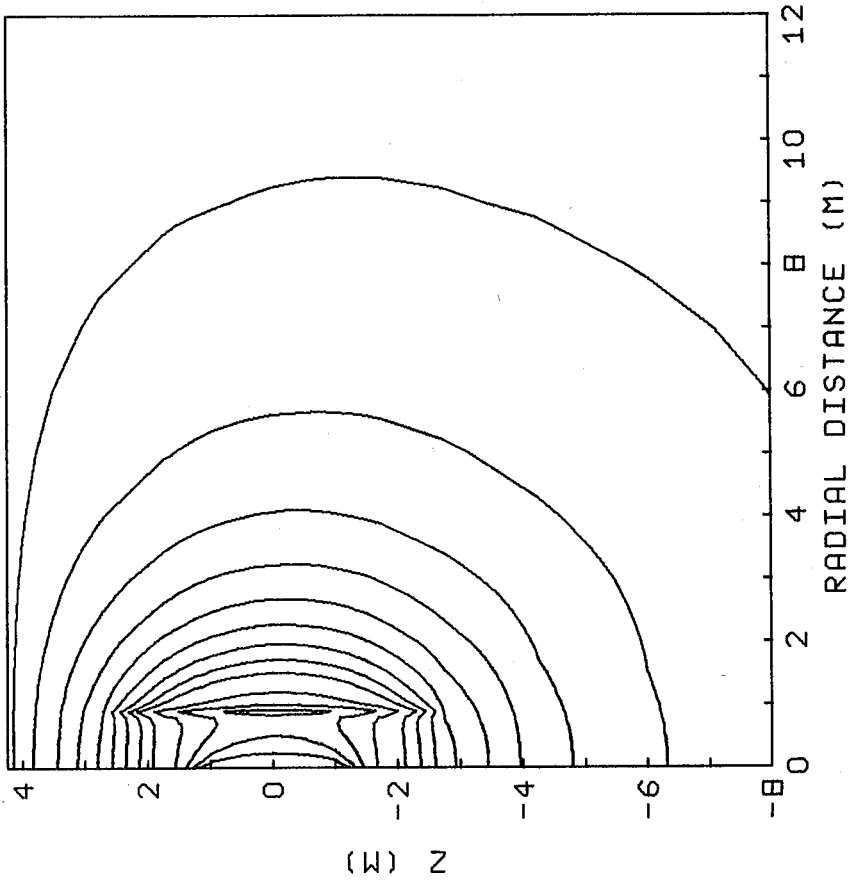

PLOT INFORMATION

TIME = 730. DAYS

THETA = 0.0 DEG.

ISOTHERMAL BOUNDARY MODEL

MAIN HTR = 2.00 KW

PERIPHERAL HTR = 1.00 KW

CONTOURS (DEG.C.) PLOTTED -

410. 350. 300. 250.

200. 175. 150. 125.

100. 75. 50. 25.

5.

XBL 787-9483

Figure D11i

ISOTHERMS IN VERTICAL PLANE
HANFORD FULL-SCALE EXPERIMENT

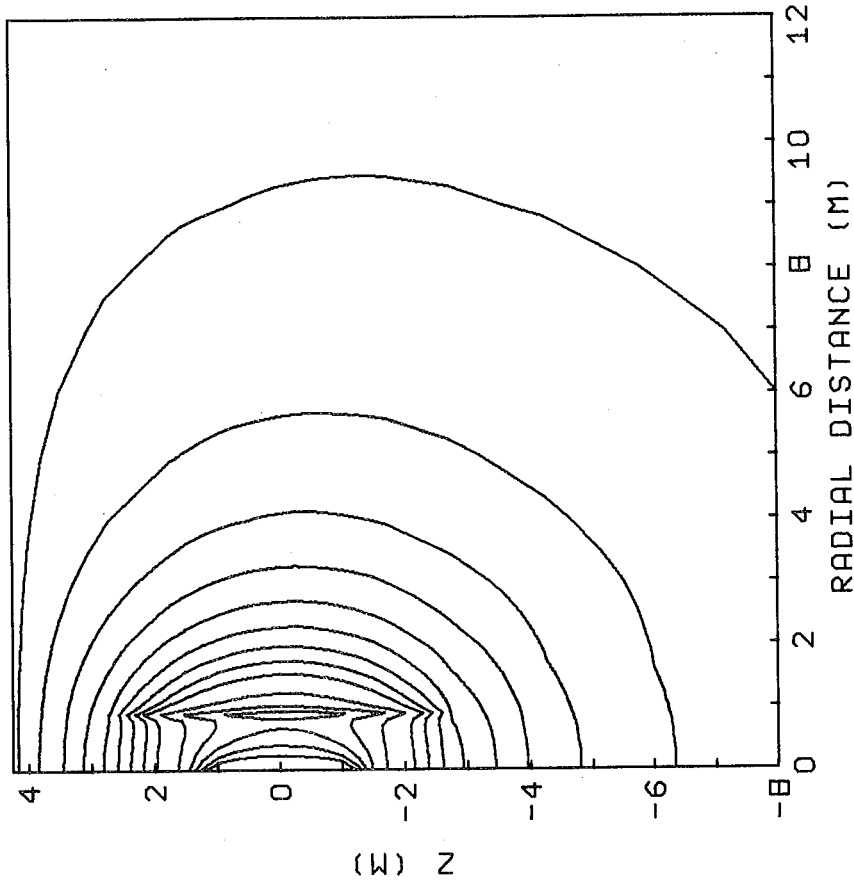

PLOT INFORMATION

TIME = 737. DAYS

THETA = 0.0 DEG.

ISOTHERMAL BOUNDARY MODEL

MAIN HTR = 2.00 KW

PERIPHERAL HTR = 1.00 KW

CONTOURS (DEG.C.) PLOTTED -

461. 400. 350. 300.
250. 200. 175. 150.
125. 100. 75. 50.
25. 5.

Figure D11j

ISOTHERMS IN VERTICAL PLANE
HANFORD FULL-SCALE EXPERIMENT

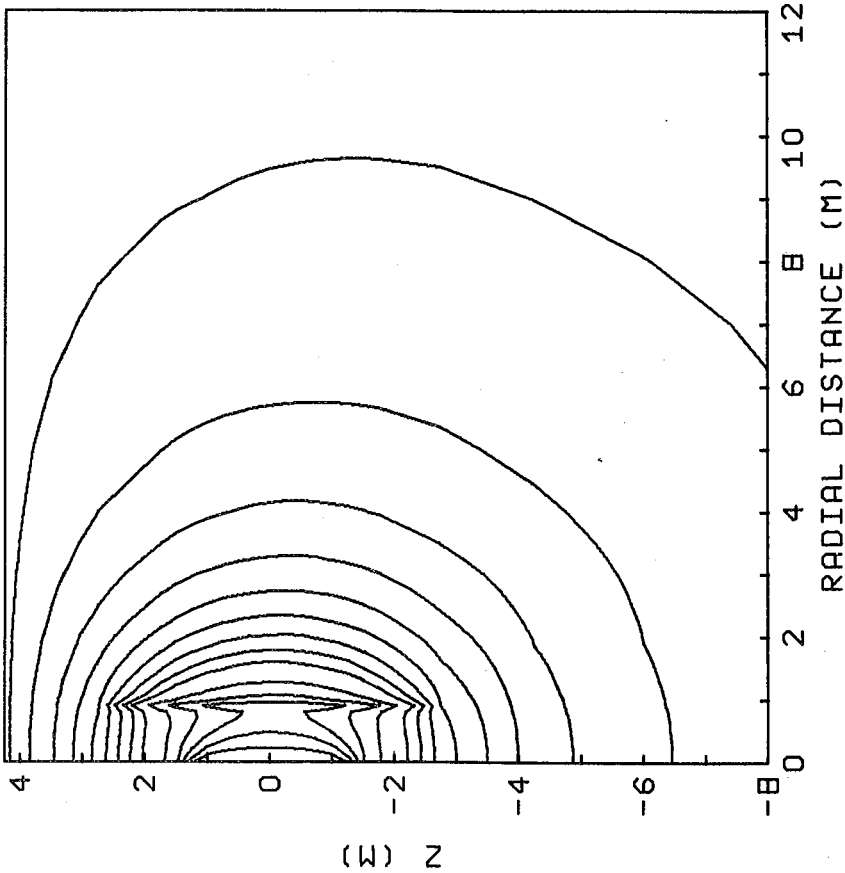

PLOT INFORMATION

TIME = 760. DAYS

THETA = 0.0 DEG.

ISOTHERMAL BOUNDARY MODEL

MAIN HTR = 2.00 KW

PERIPHERAL HTR = 1.00 KW

CONTOURS (DEG.C.) PLOTTED -

484. 400. 350. 300.

250. 200. 175. 150.

125. 100. 75. 50.

25. 5.

XBL 787-9481

Figure D11k

ISOTHERMS IN VERTICAL PLANE
HANFORD FULL-SCALE EXPERIMENT

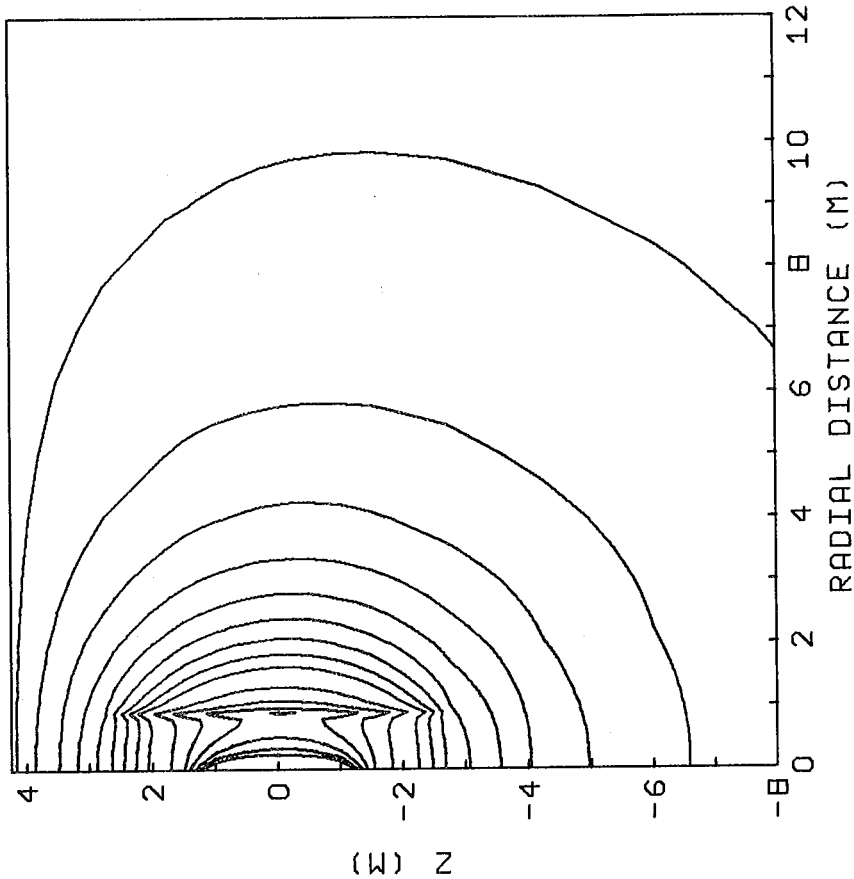

PLOT INFORMATION

TIME = 790. DAYS

THETA = 0.0 DEG.

ISOTHERMAL BOUNDARY MODEL

MAIN HTR = 2.00 KW

PERIPHERAL HTR = 1.00 KW

CONTOURS (DEG.C.) PLOTTED -

- 491. 450. 400. 350.
- 300. 250. 200. 175.
- 150. 125. 100. 75.
- 50. 25. 5.

XBL 787-9480

Figure D111

ISOTHERMS IN VERTICAL PLANE
HANFORD FULL-SCALE EXPERIMENT

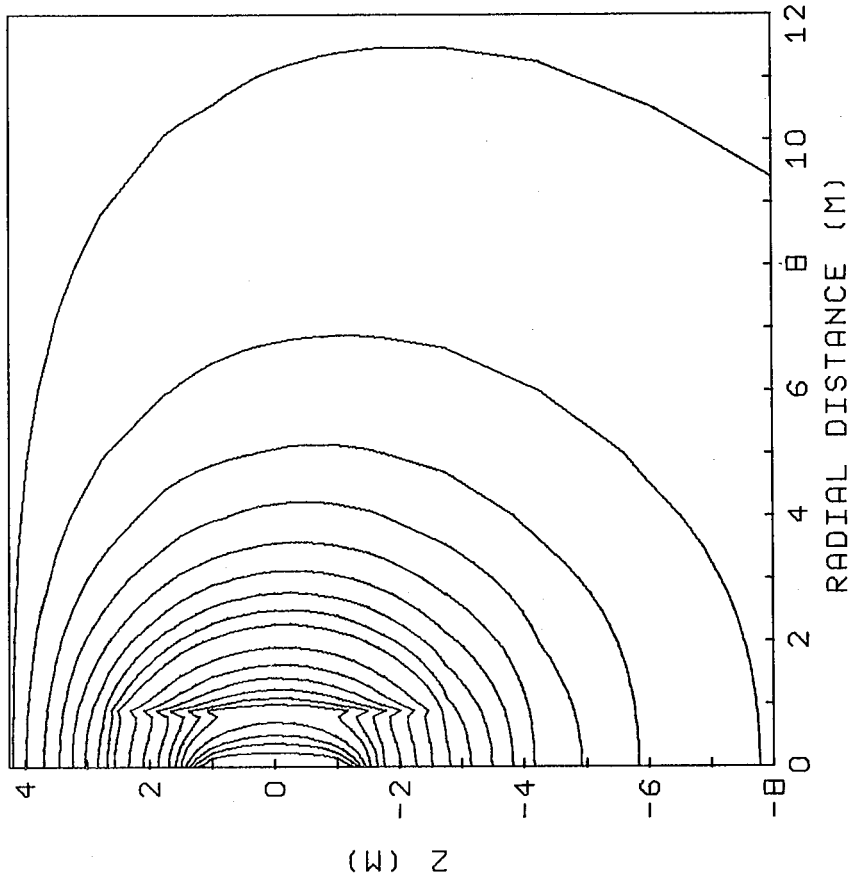

PLOT INFORMATION

TIME = 1095. DAYS

THETA = 0.0 DEG.

ISOTHERMAL BOUNDARY MODEL

MAIN HTR = 2.00 KW

PERIPHERAL HTR = 1.00 KW

CONTOURS (DEG.C.) PLOTTED -

974.	800.	700.	600.
500.	450.	400.	350.
300.	250.	200.	175.
150.	125.	100.	75.
50.	25.	5.	

Figure D11m

HANFORD FULL-SCALE EXPERIMENT
Power schedule 1A
Deformation drift and borehole
730 days

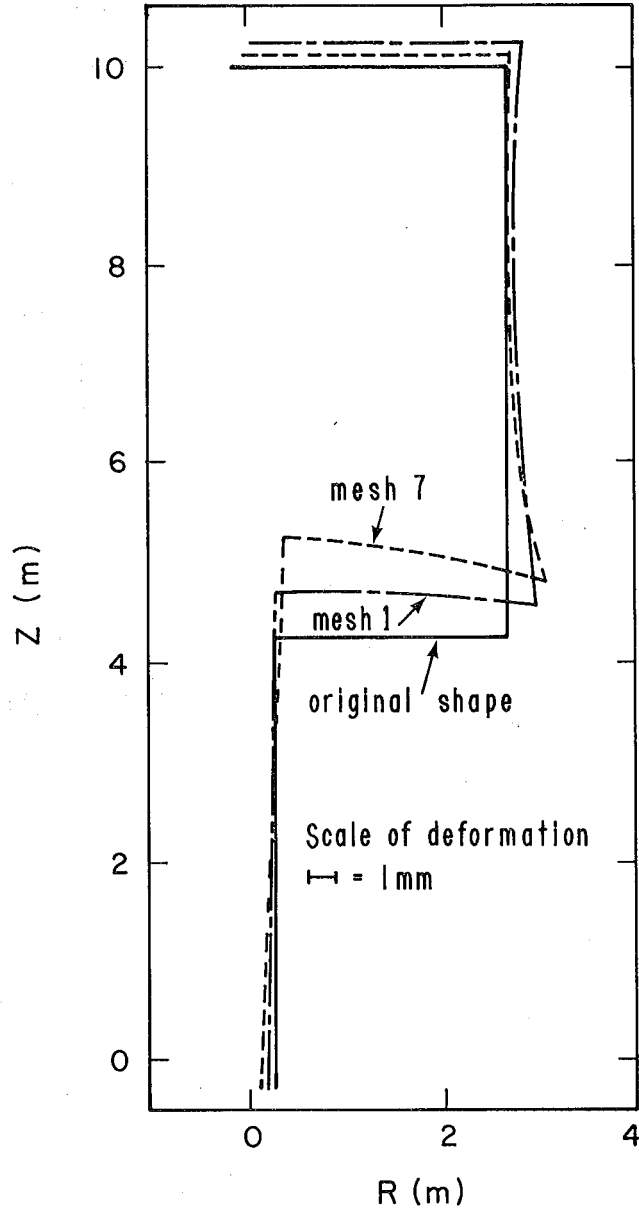

XBL 787-1989 A

Figure D12a

HANFORD FULL-SCALE EXPERIMENT

Power schedule 1A

Deformation of heater drift and
borehole 1095 days

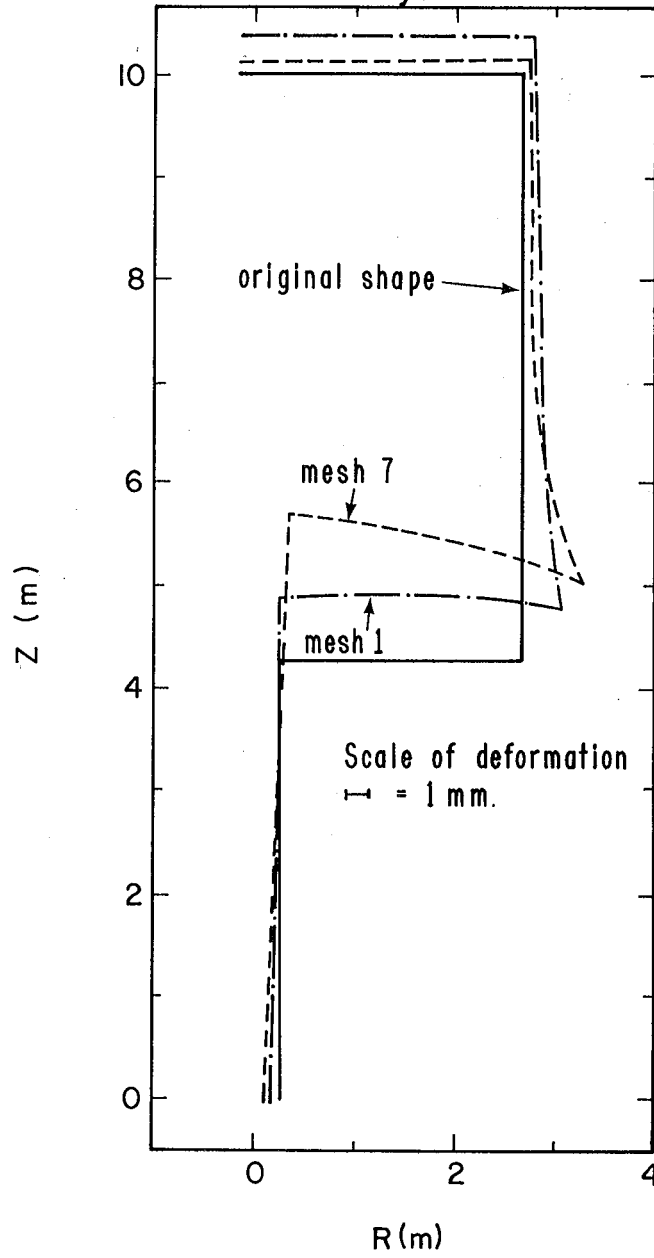

XBL 787-1990 A

Figure D12b

HANFORD FULL-SCALE EXPERIMENT
POWER SCHEDULE 2A
Deformation of heater drift and
borehole 730 days

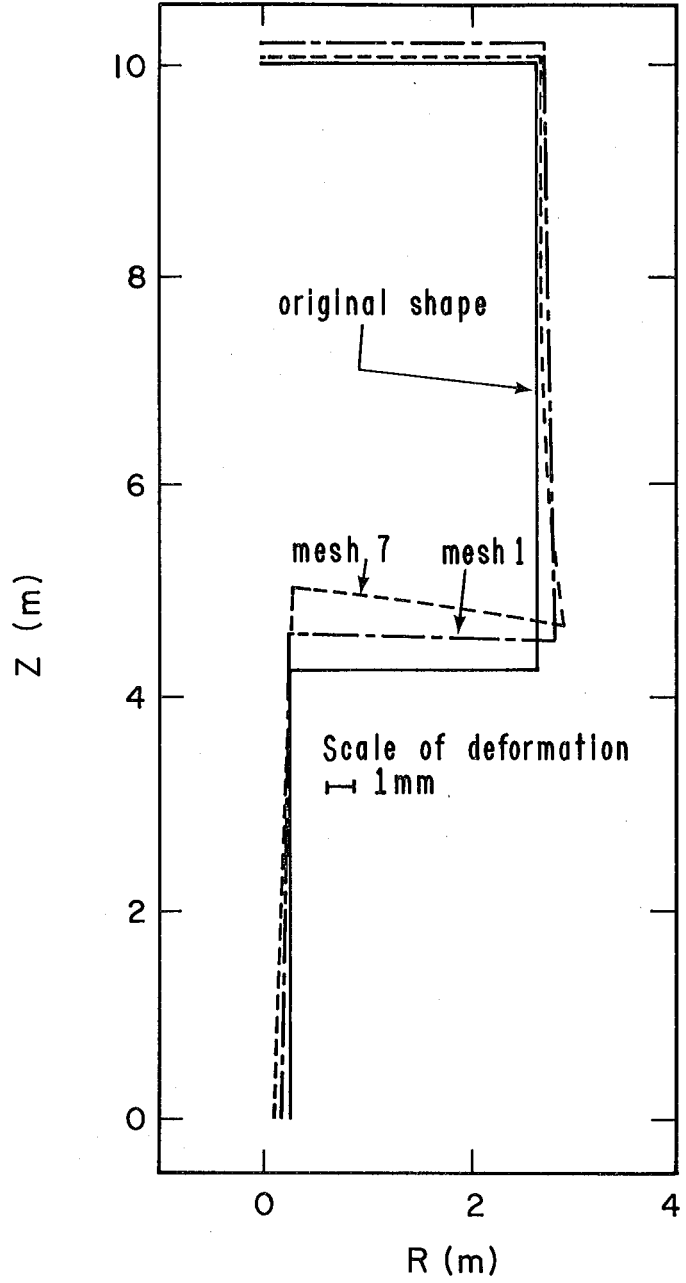

XBL 787-1991 A

Figure D13a

HANFORD FULL-SCALE EXPERIMENT
Power schedule 2A
Deformation of heater drift and
borehole 1095 days

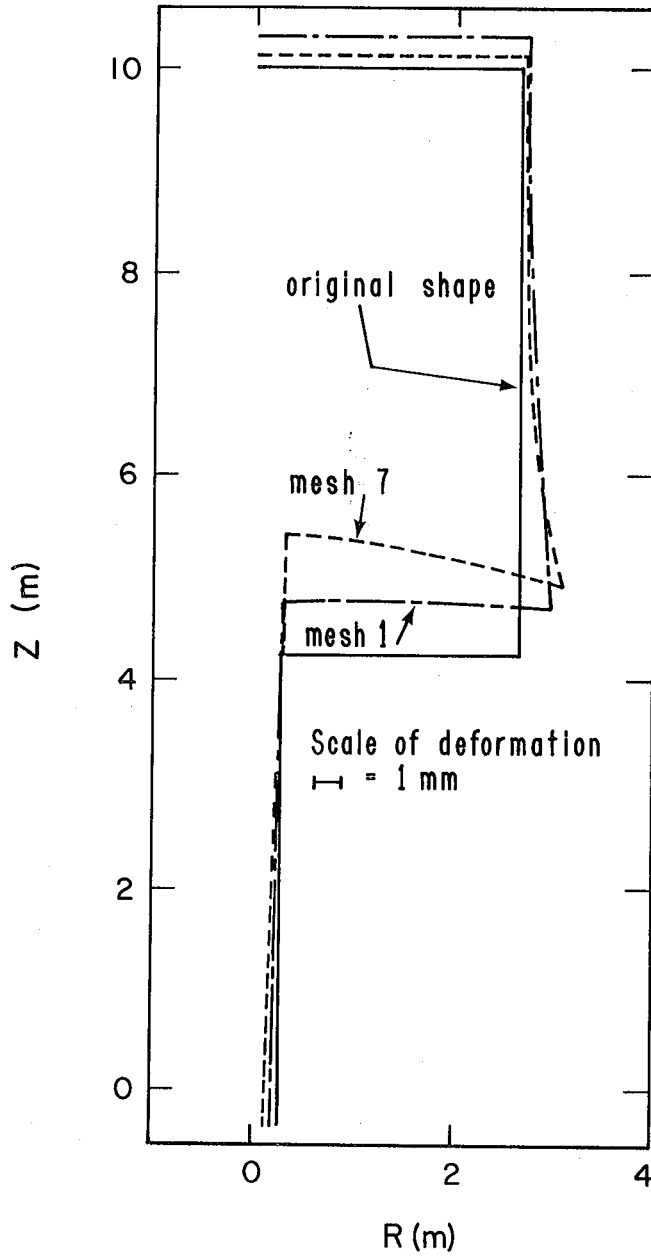

XBL 789-1992 A

Figure D13b

HANFORD FULL-SCALE EXPERIMENT
Displacement(U_z) profiles at $R=0.45m$, $\theta=0$ deg.
Mesh 1, 730 days

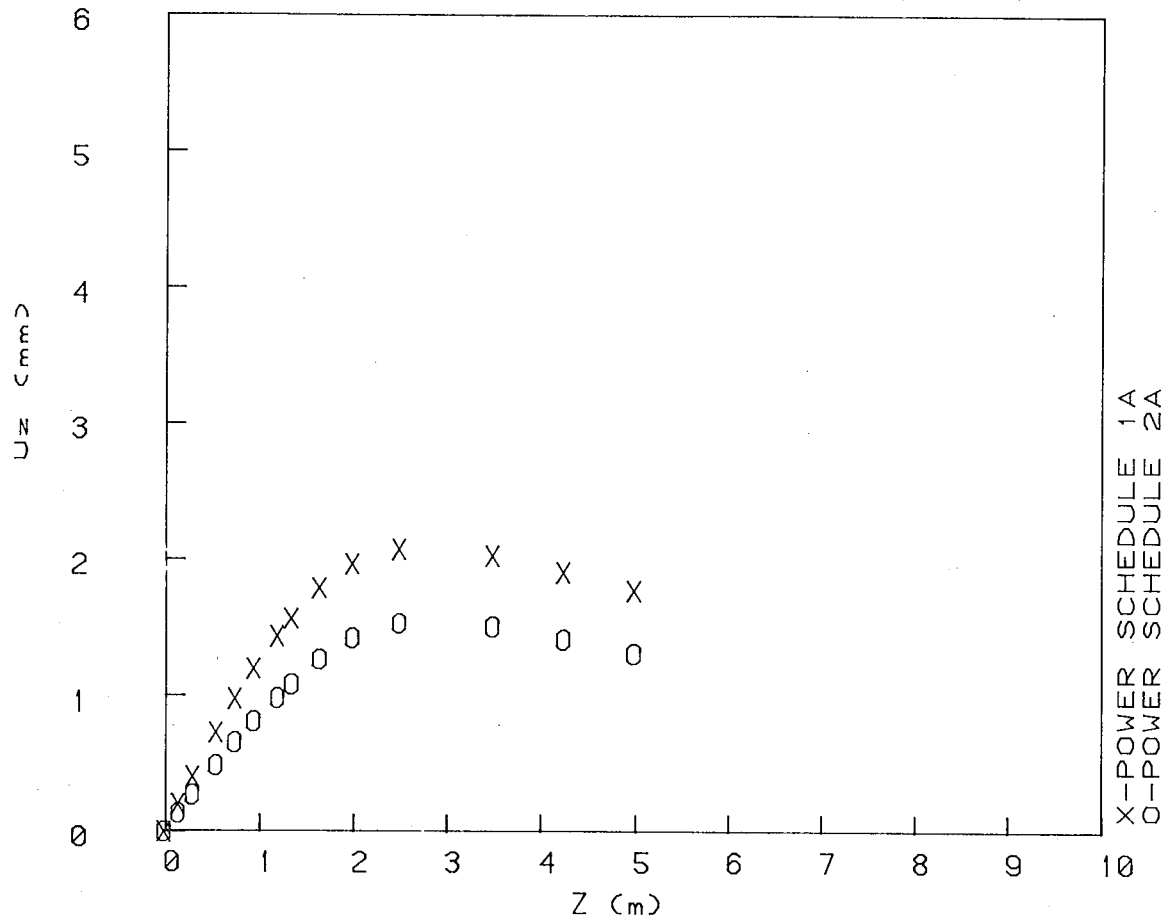

XBL 788-10441

Figure D14a

HANFORD FULL-SCALE EXPERIMENT
Displacement (Uz) profiles at R=0.45m, THETA=0 deg.
Mesh 1, 1095 days

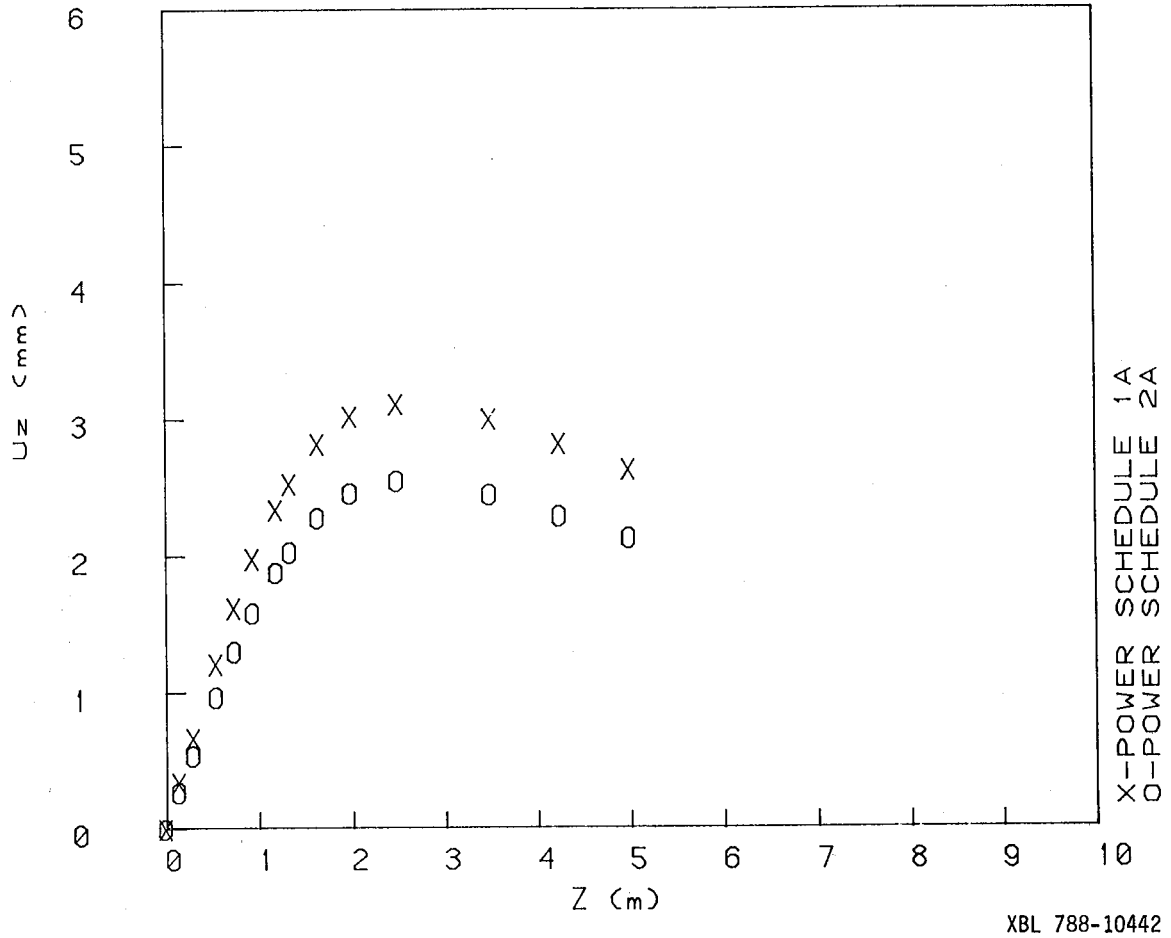
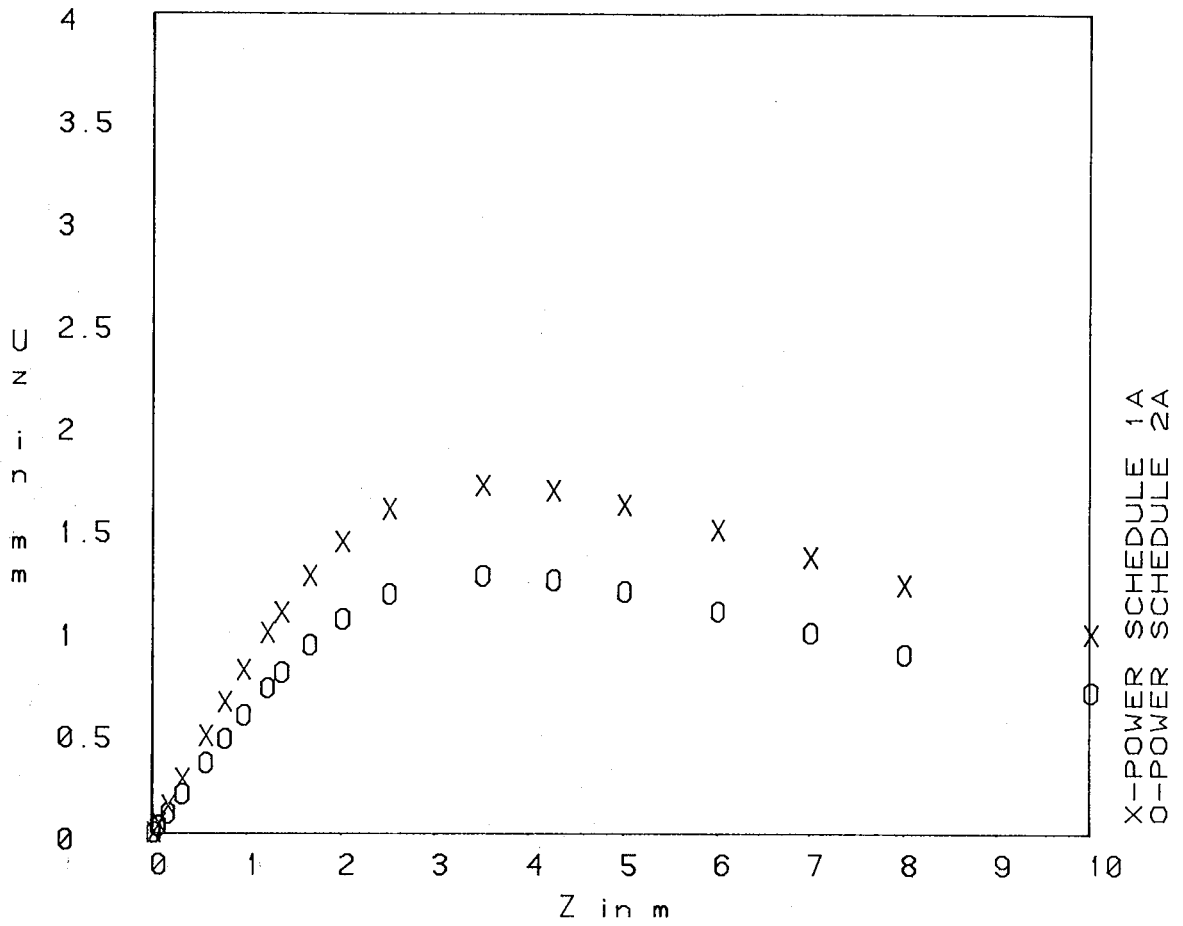

Figure D14b

HANFORD FULL-SCALE EXPERIMENT
Displacement(U_z) profiles at $R=1.875m$, $\theta=0$ deg.
Mesh1, 730 days



XBL 788-10443

Figure D15a

HANFORD FULL-SCALE EXPERIMENT
Displacement (U_z) profiles at $R=1.875m$, $\theta=0$ deg.
Mesh 1, 1095 days

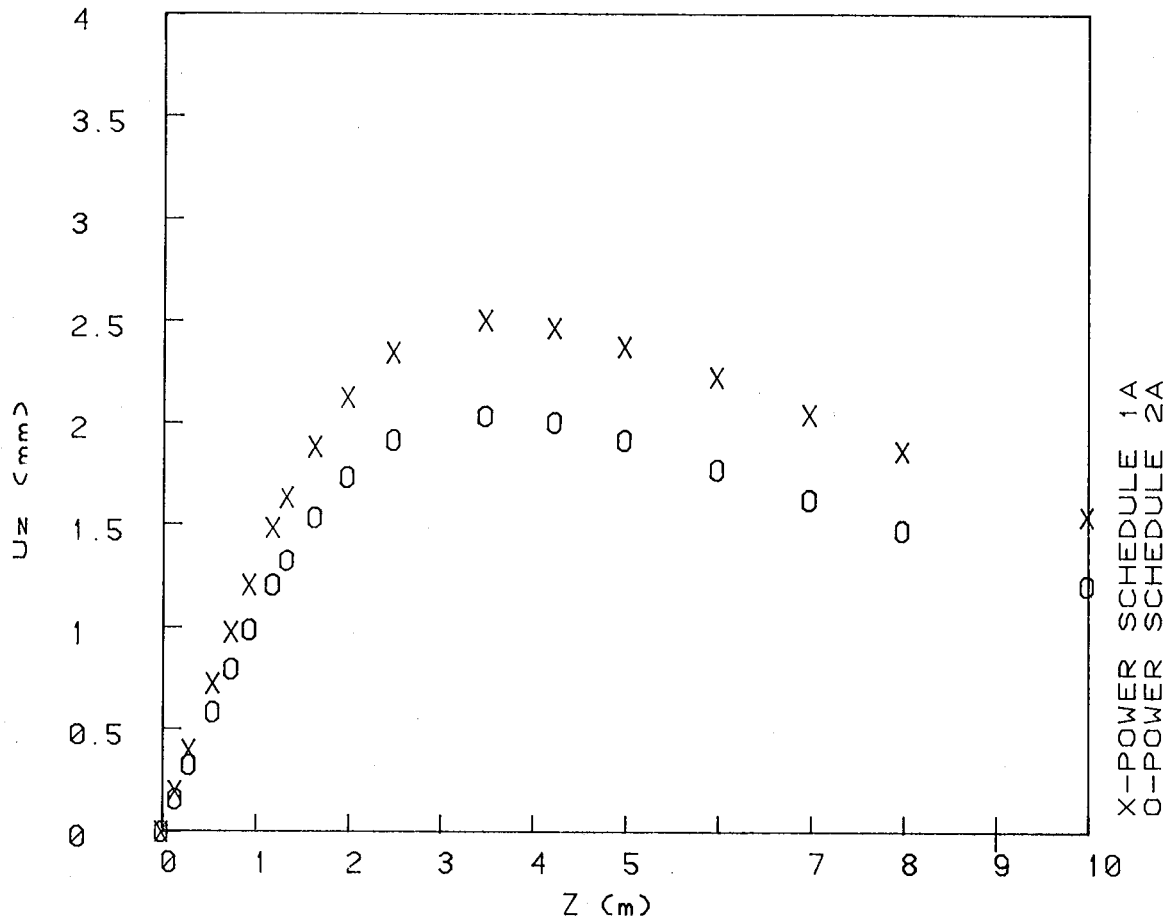

XBL 788-10444

Figure D15b

HANFORD FULL-SCALE EXPERIMENT
Displacement(U_z) profiles at $R=10.5m$, $\theta=0$ deg.
Mesh1, 730 days

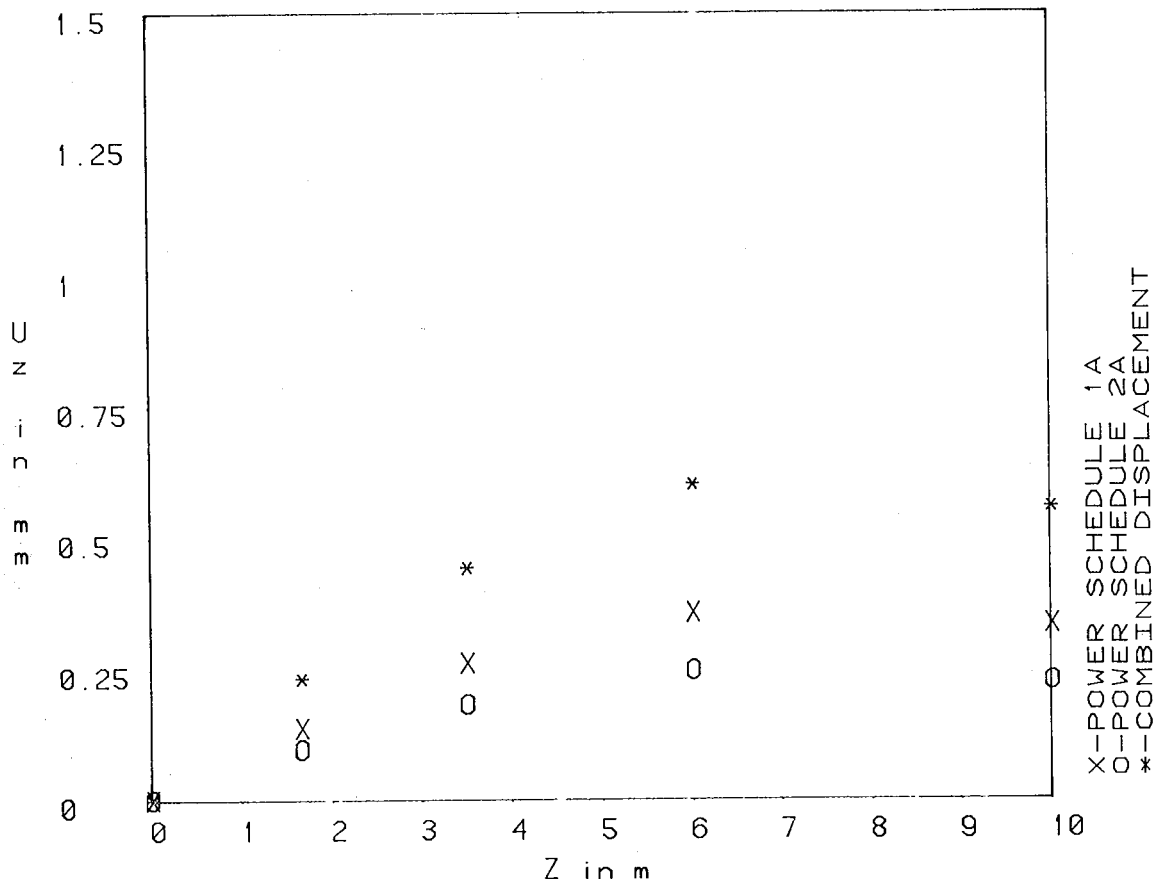

XBL 788-10445

Figure D16a

HANFORD FULL-SCALE EXPERIMENT
Displacement (Uz) profiles at R=10.5m, THETA=0 deg.
Mesh 1, 1095 days

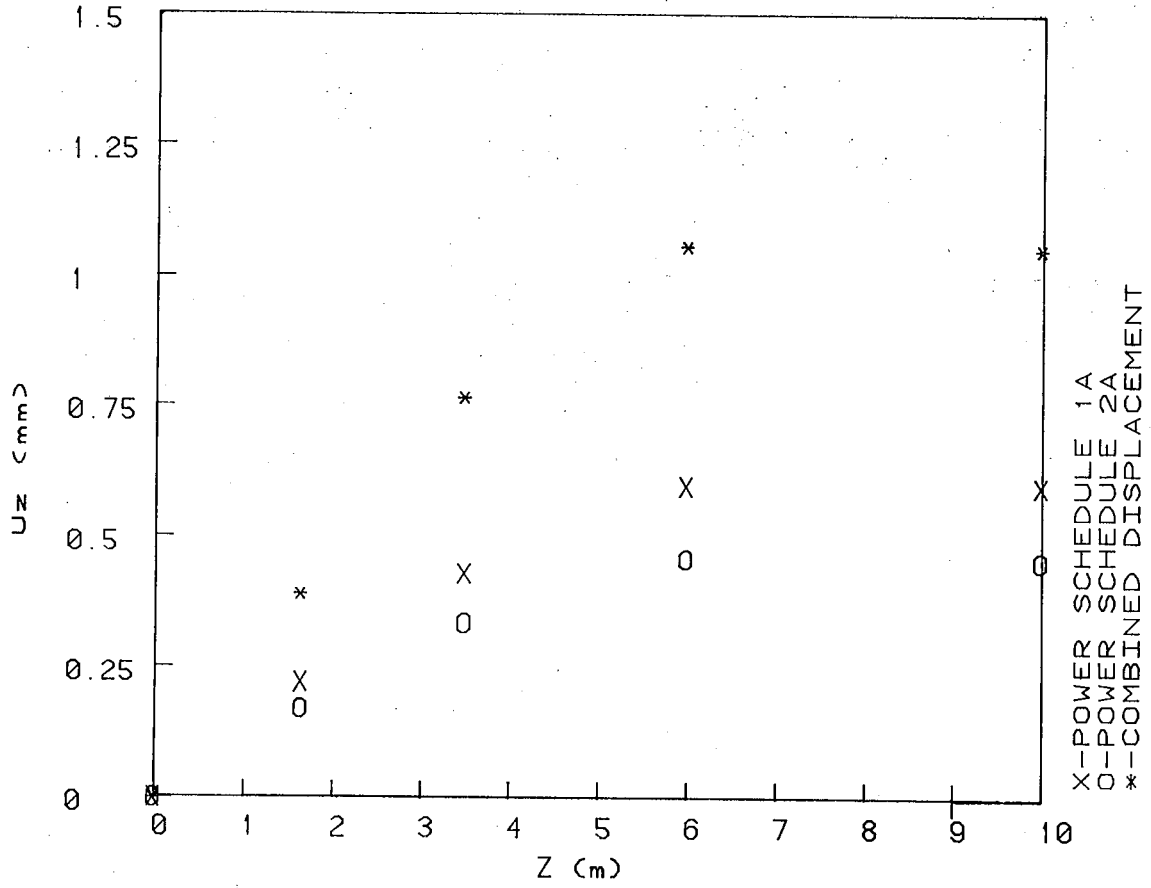

XBL 788-10446

Figure D16b

HANFORD FULL-SCALE EXPERIMENT

Displacement (U_z) profiles at $R = 0.45$ m., $\text{THETA} = 0$ deg.
Mesh 7, 730 days

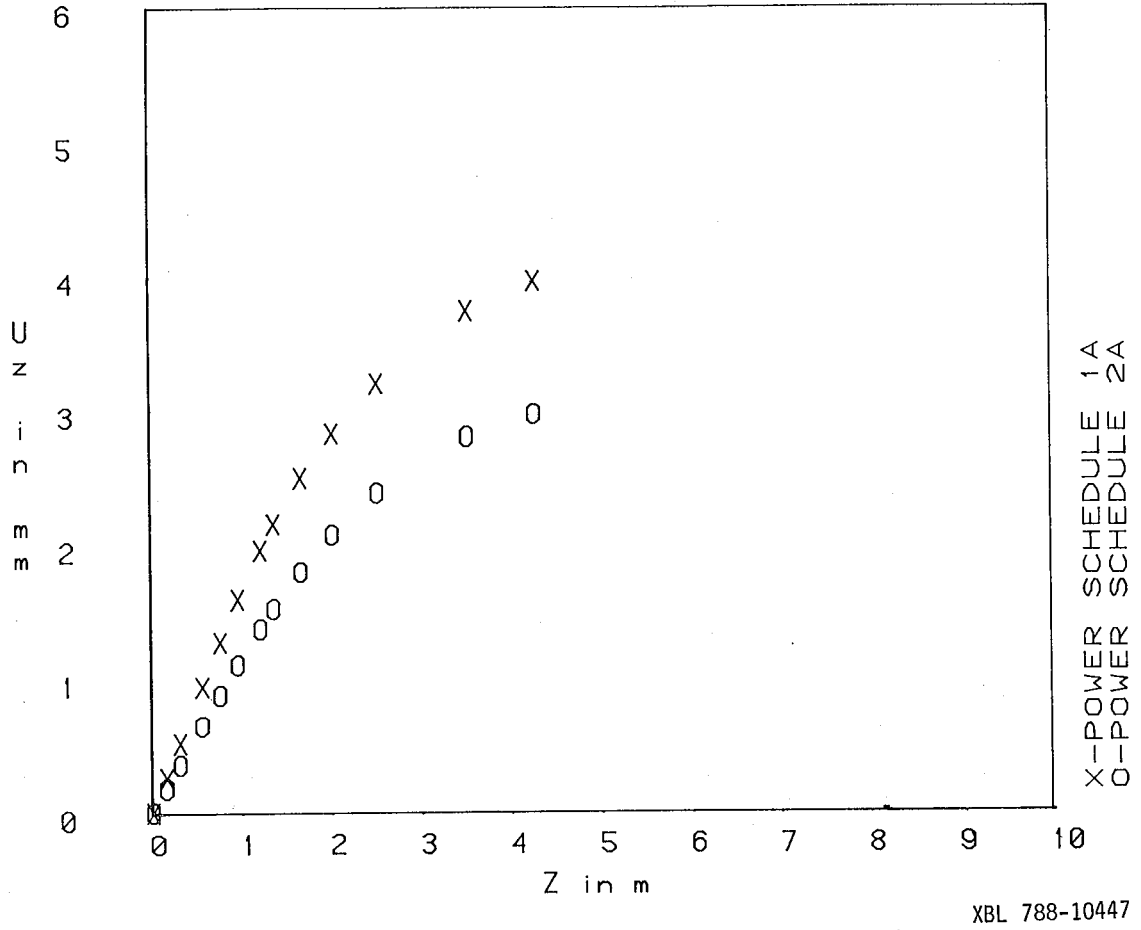
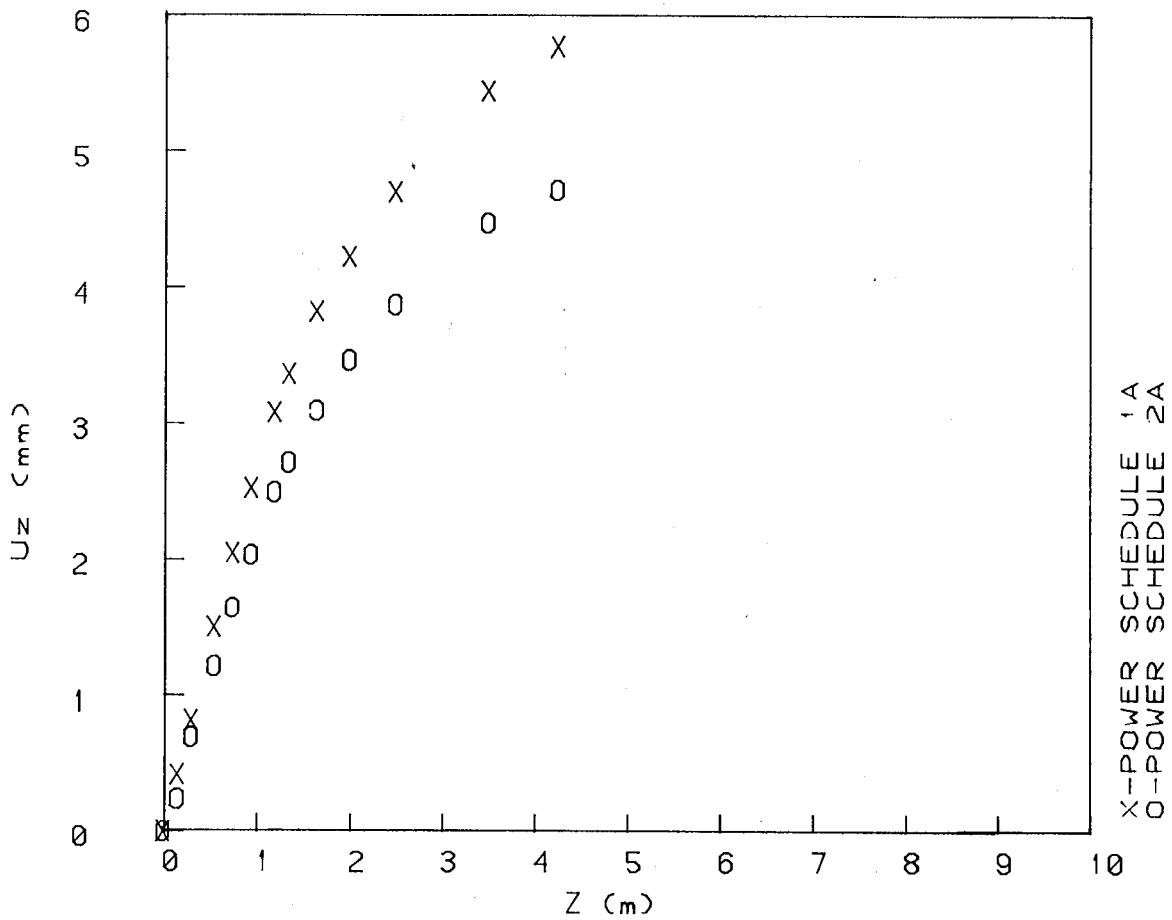

Figure D17a

HANFORD FULL-SCALE EXPERIMENT
Displacement (U_z) profiles at $R=0.15m$, $\theta=0$ deg.
Mesh 7, 1095 days



XBL 788-10448

Figure D17b

HANFORD FULL-SCALE EXPERIMENT
Displacement(U_z) profiles at $R=1.875m$, $\theta=0$ deg.
Mesh7, 730 days

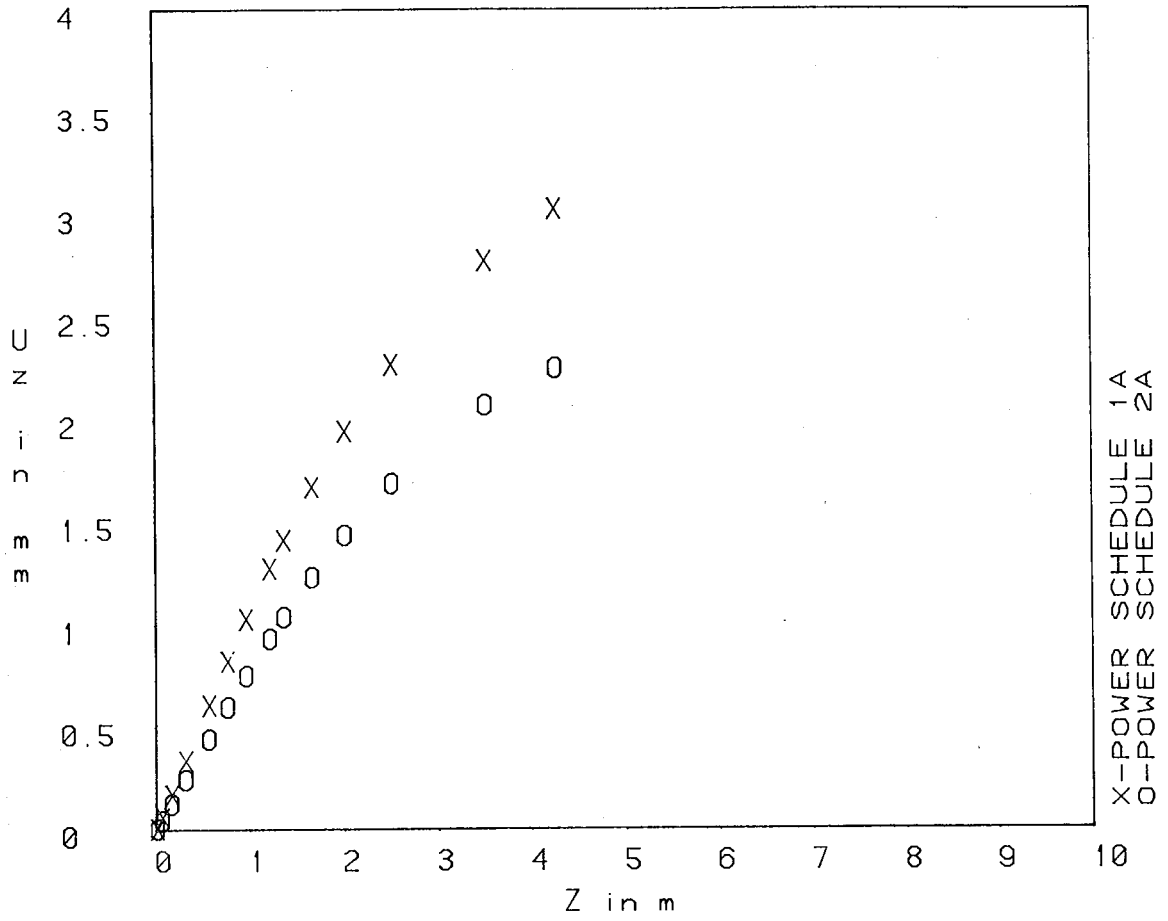

XBL 788-10449

Figure D18a

HANFORD FULL-SCALE EXPERIMENT
Displacement (U_z) profiles at $R=1.875m$, $\theta=0$ deg.
Mesh 7, 1095 days

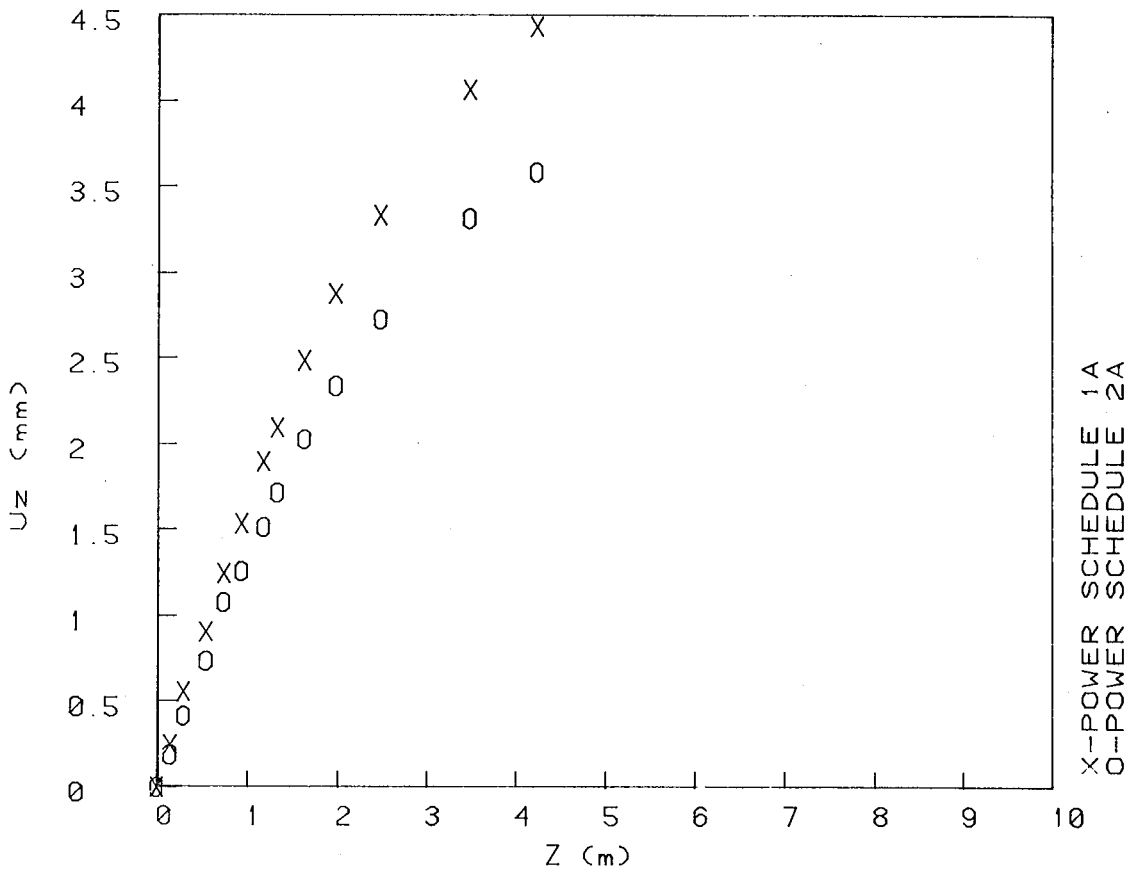

XBL 788-10450

Figure D18b

HANFORD FULL-SCALE EXPERIMENT
Displacement (Uz) profiles at R=10.5m, THETA=0 deg.
Mesh 7, 730 days

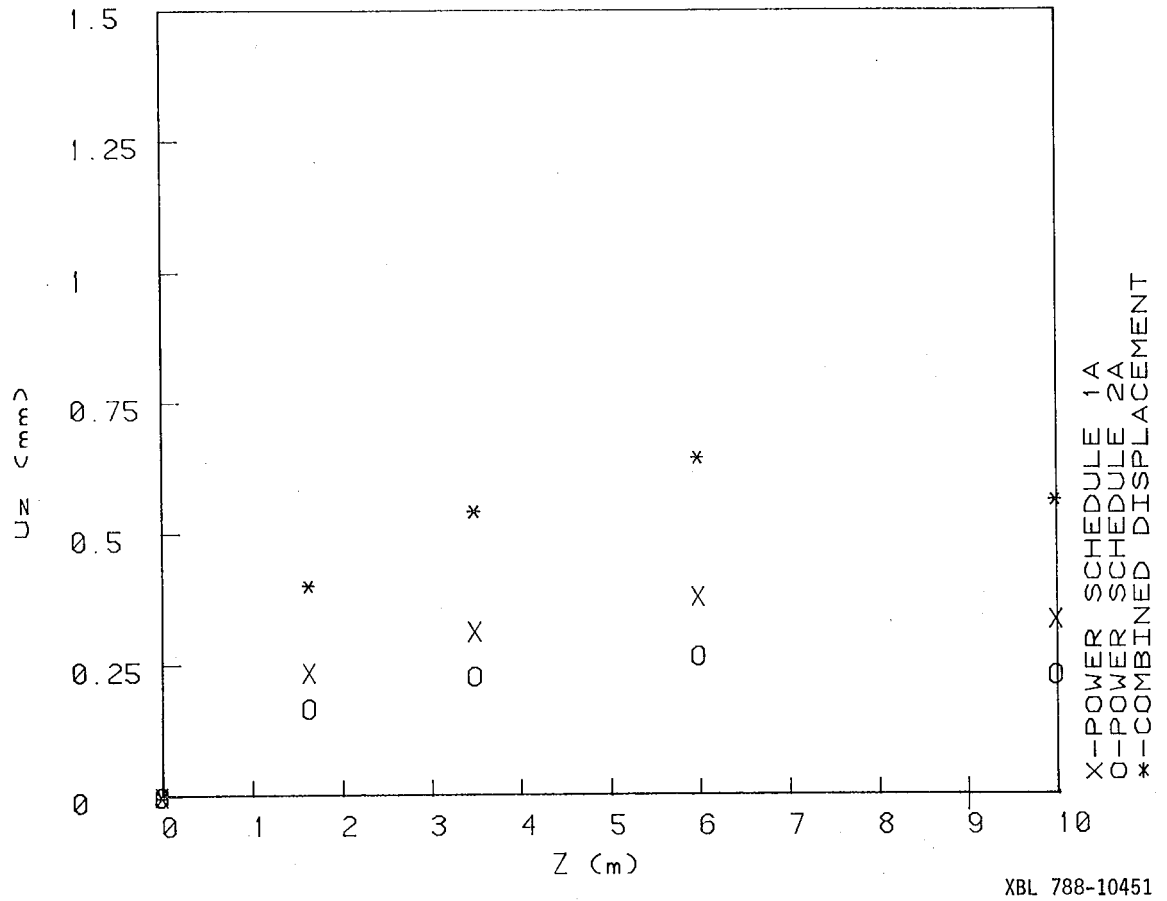

Figure D19a

HANFORD FULL-SCALE EXPERIMENT
Displacement (U_z) profiles at $R=10.5m$, $\theta=0$ deg.
Mesh 7, 1095 days

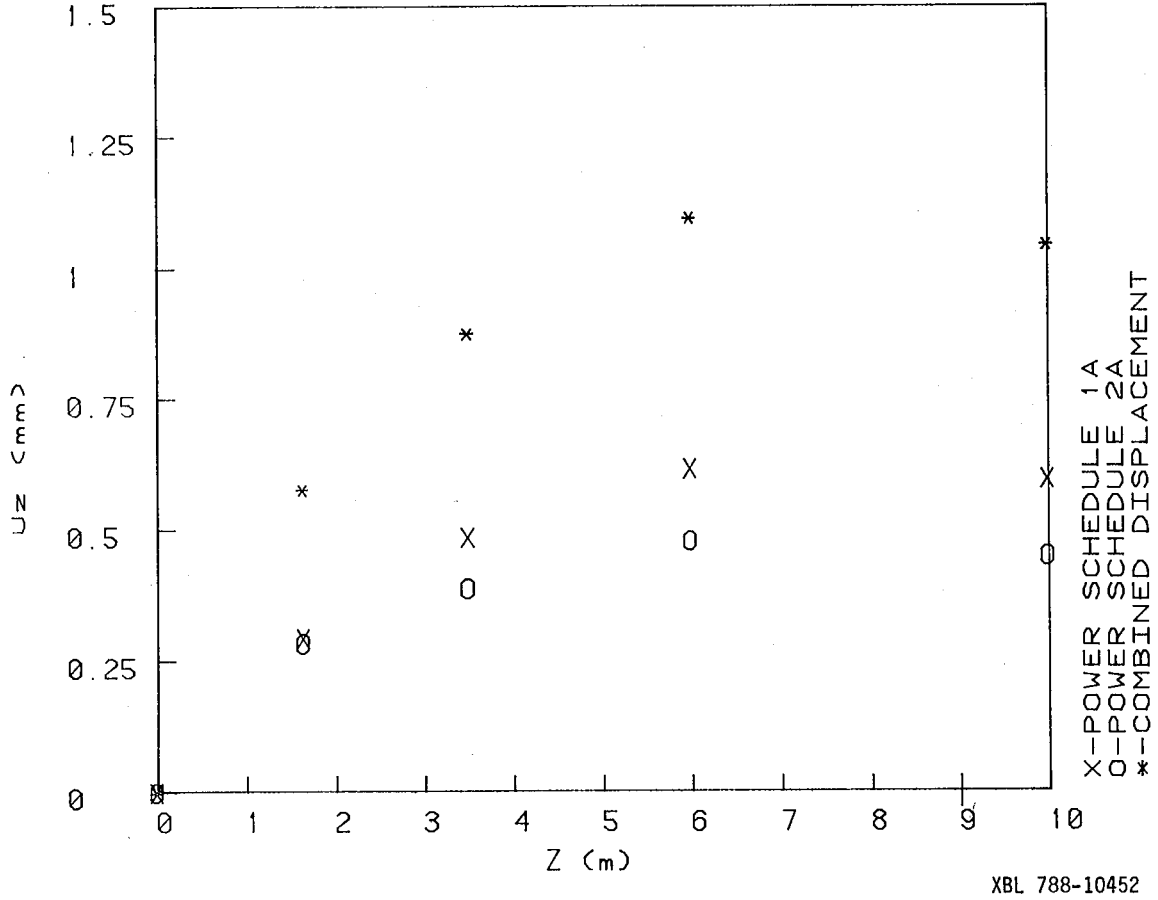
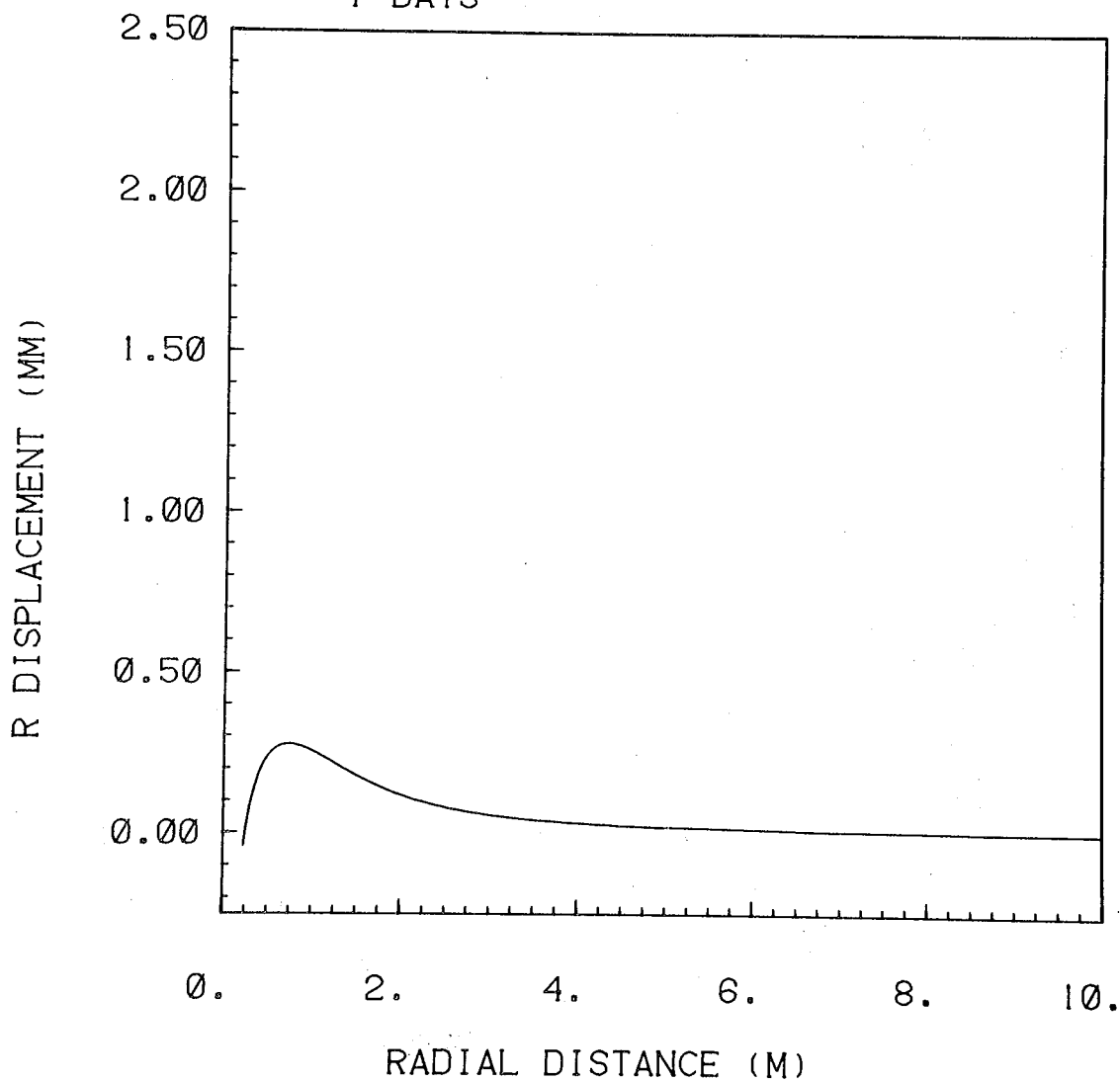

Figure D19b

DISPLACEMENT PROFILE FOR MESH 1
HANFORD FULL-SCALE EXPERIMENT
MAIN HEATER = 5 KW
PERIPHERAL HEATER = 1 KW
Z = 0.0 M, THETA = 0.0 DEG.
7 DAYS



XBL 787-9748

Figure D20a

DISPLACEMENT PROFILE FOR MESH 1
HANFORD FULL-SCALE EXPERIMENT
MAIN HEATER = 5 KW
PERIPHERAL HEATER = 1 KW
Z = 0.0 M, THETA = 0.0 DEG.
30 DAYS

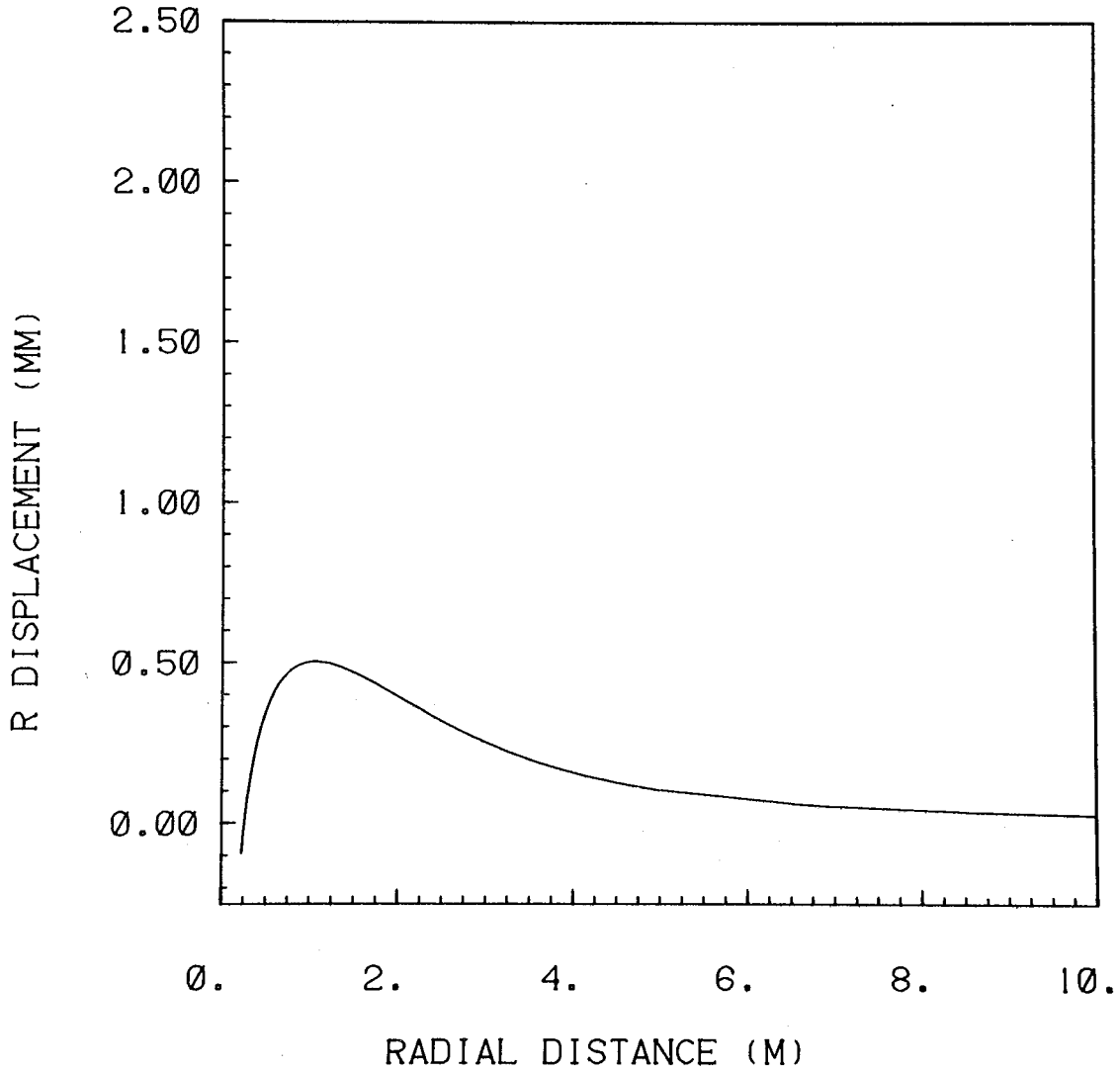

XBL 787-9749

Figure D20b

DISPLACEMENT PROFILE FOR MESH 1
HANFORD FULL-SCALE EXPERIMENT
MAIN HEATER = 5 KW
PERIPHERAL HEATER = 1 KW
Z = 0.0 M, THETA = 0.0 DEG.
90 DAYS

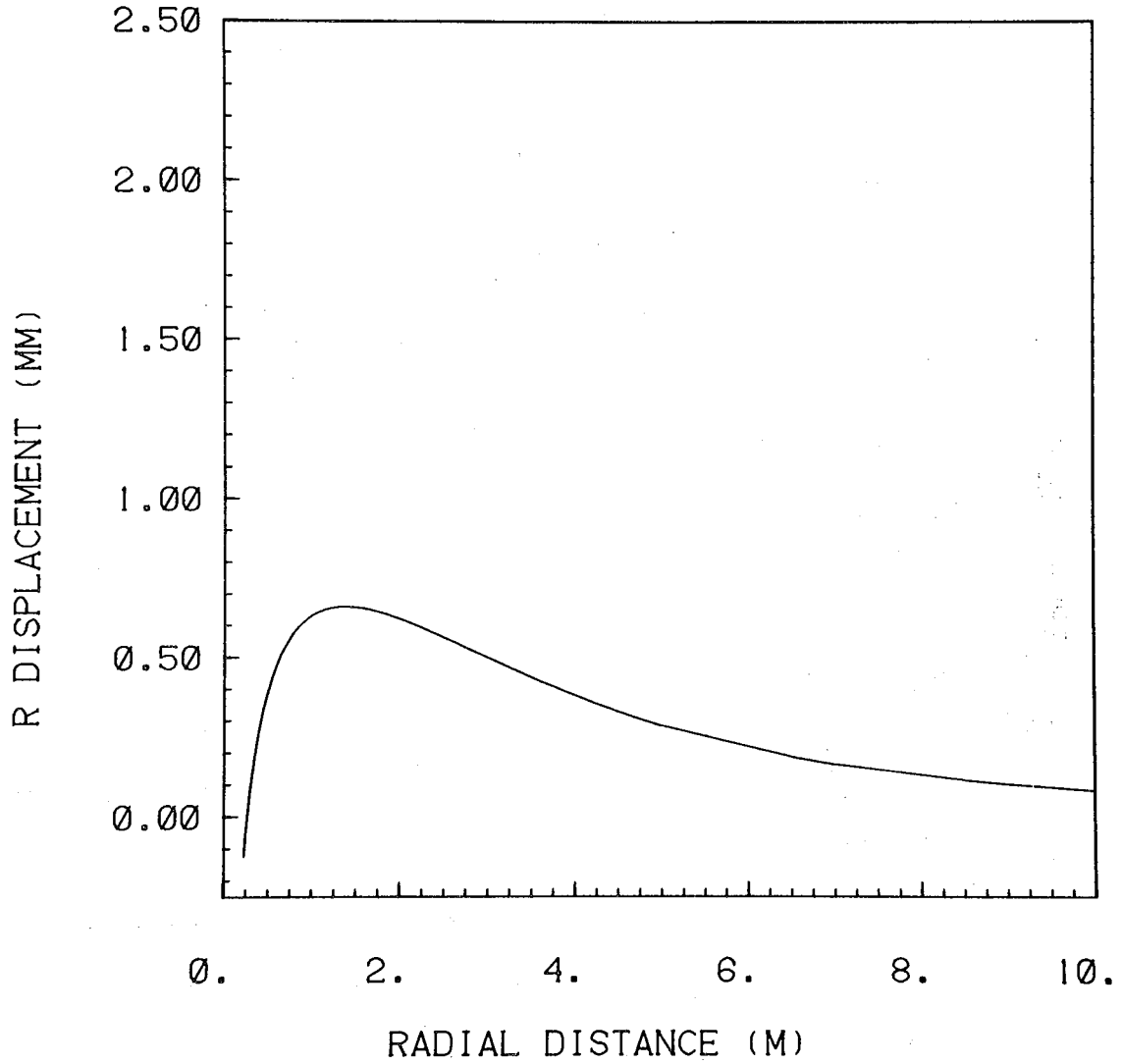

XBL 787-9747

Figure D20c

DISPLACEMENT PROFILE FOR MESH 1
HANFORD FULL-SCALE EXPERIMENT
MAIN HEATER = 5 KW
PERIPHERAL HEATER = 1 KW
Z = 0.0 M, THETA = 0.0 DEG.
180 DAYS

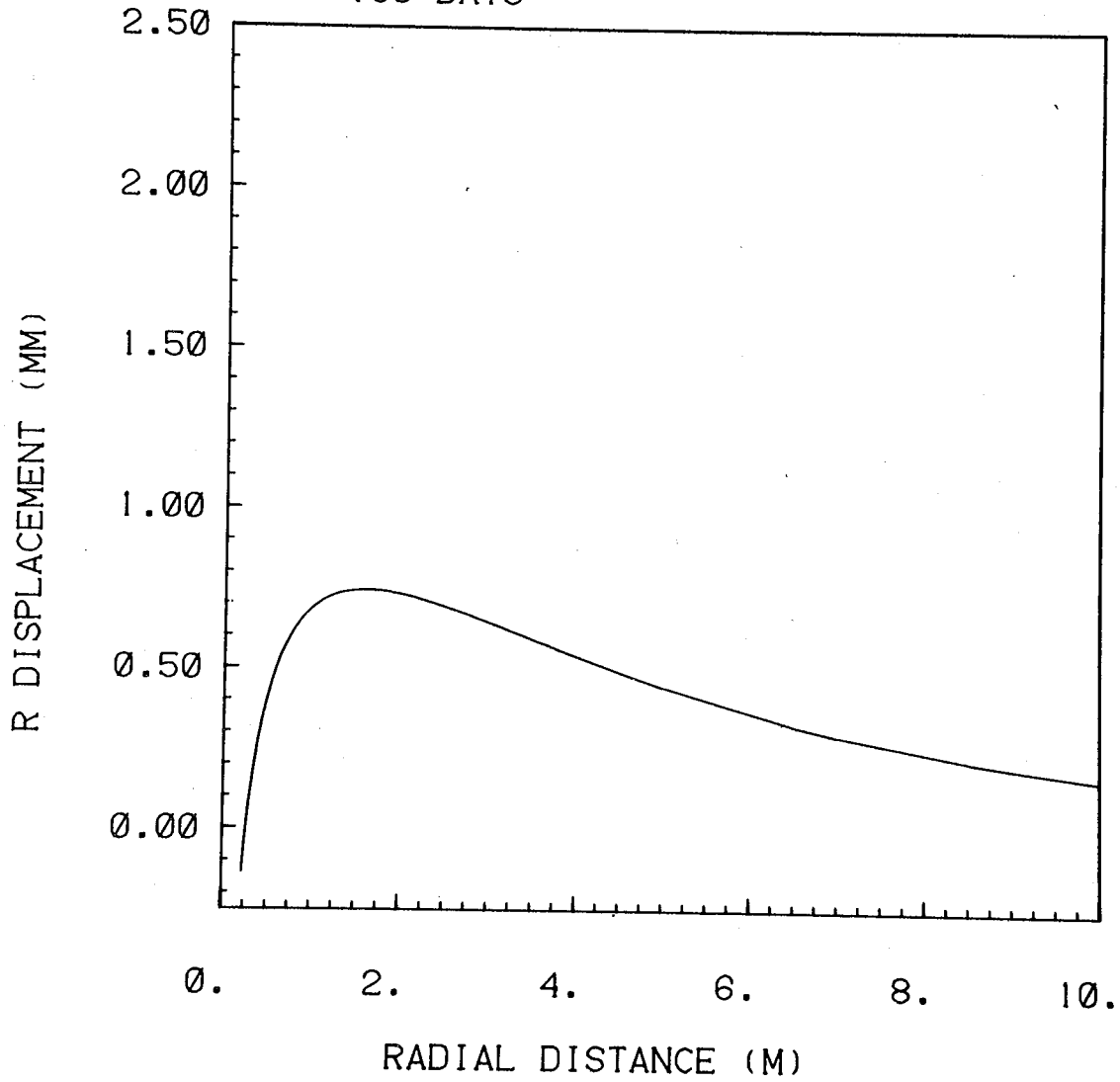

XBL 787-9746

Figure D20d

DISPLACEMENT PROFILE FOR MESH 1
HANFORD FULL-SCALE EXPERIMENT
MAIN HEATER = 5 KW
PERIPHERAL HEATER = 1 KW
Z = 0.0 M, THETA = 0.0 DEG.
365 DAYS

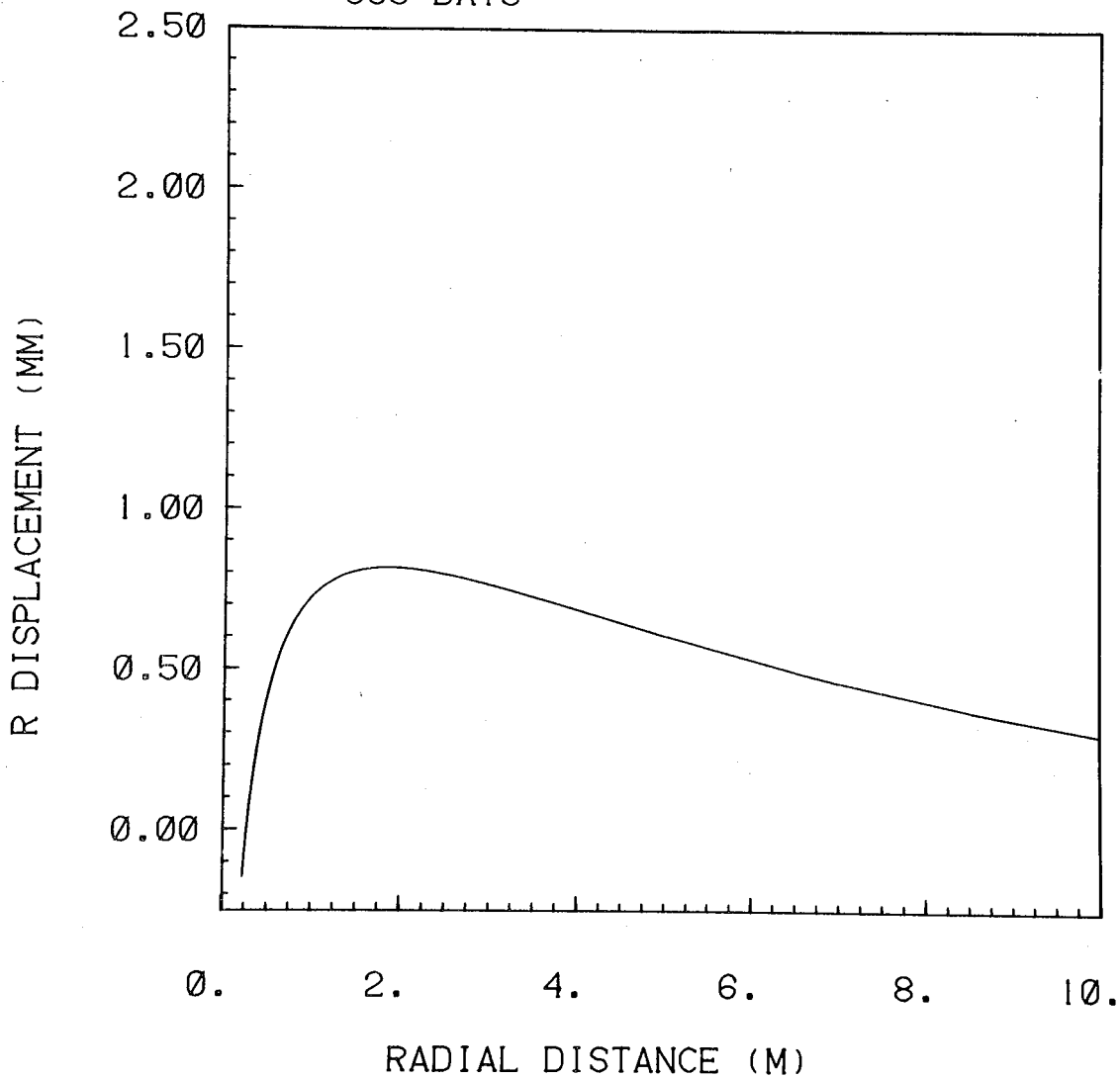

XBL 787-9745

Figure D20e

DISPLACEMENT PROFILE FOR MESH 1
HANFORD FULL-SCALE EXPERIMENT
MAIN HEATER = 5 KW
PERIPHERAL HEATER = 1 KW
Z = 0.0 M, THETA = 0.0 DEG.
371 DAYS

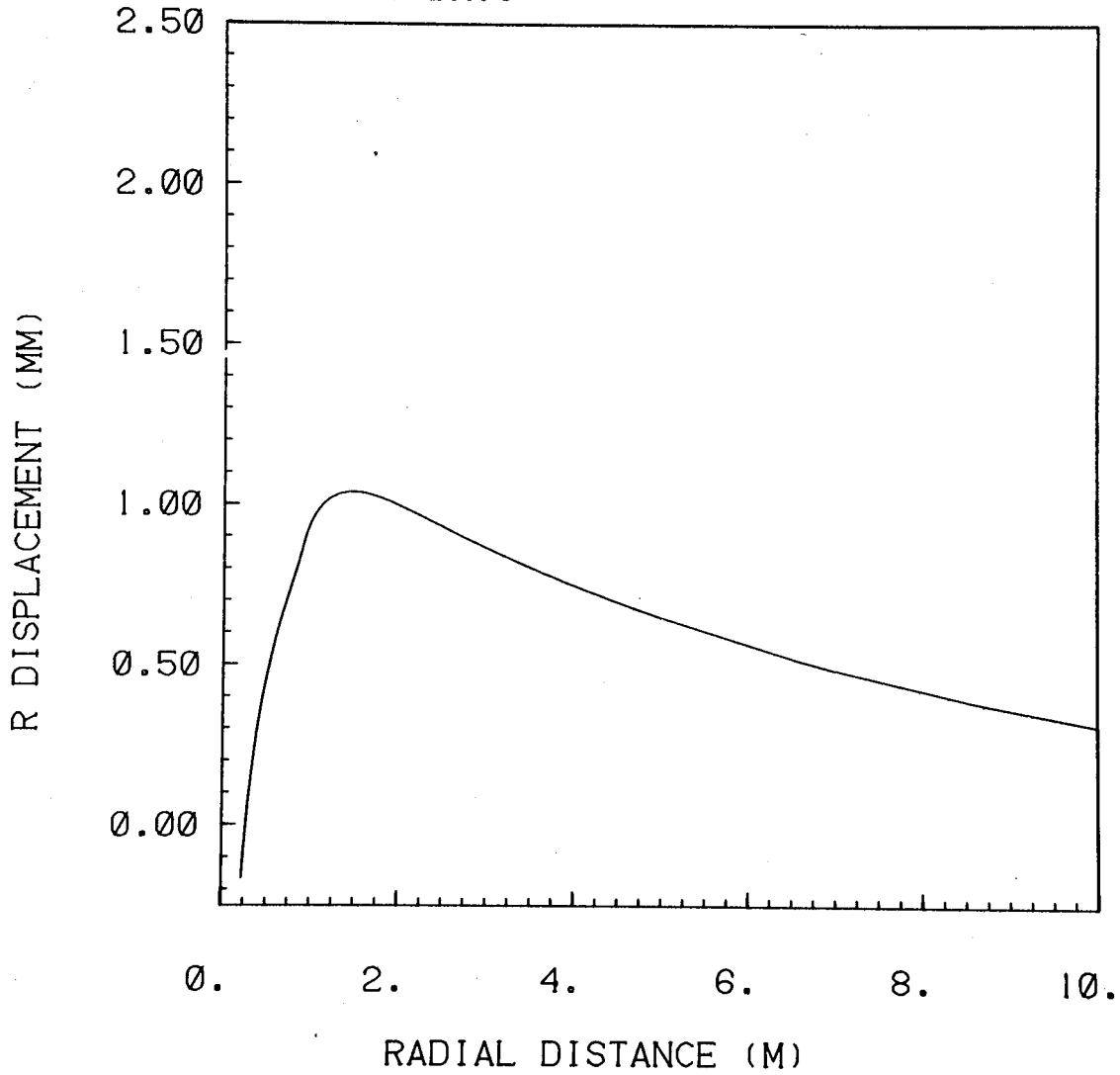

XBL 787-9744

Figure D20f

DISPLACEMENT PROFILE FOR MESH 1
HANFORD FULL-SCALE EXPERIMENT
MAIN HEATER = 5 KW
PERIPHERAL HEATER = 1 KW
Z = 0.0 M, THETA = 0.0 DEG.
390 DAYS

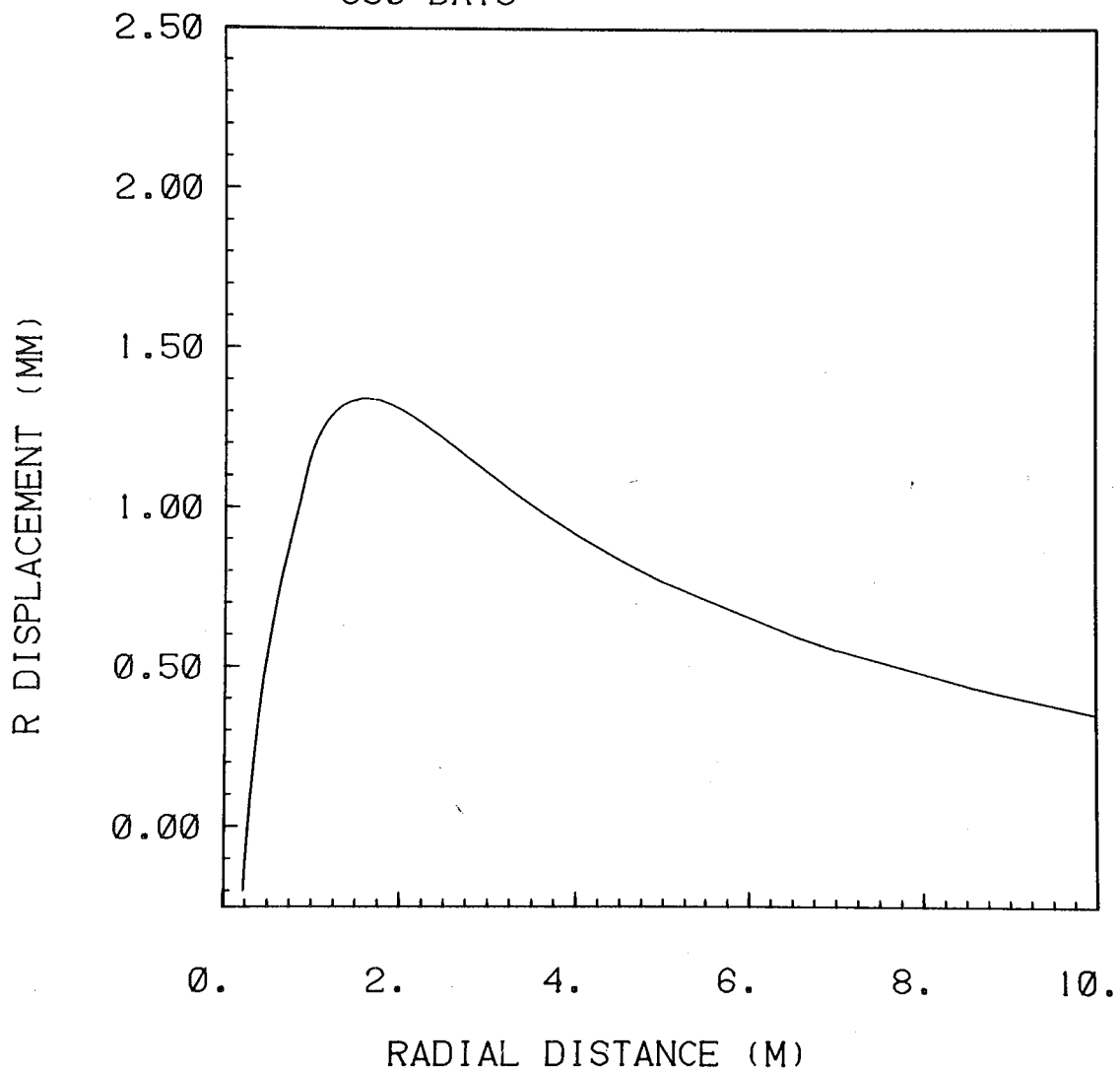

XBL 787-9743

Figure D20g

DISPLACEMENT PROFILE FOR MESH 1
HANFORD FULL-SCALE EXPERIMENT
MAIN HEATER = 5 KW
PERIPHERAL HEATER = 1 KW
Z = 0.0 M, THETA = 0.0 DEG.
450 DAYS

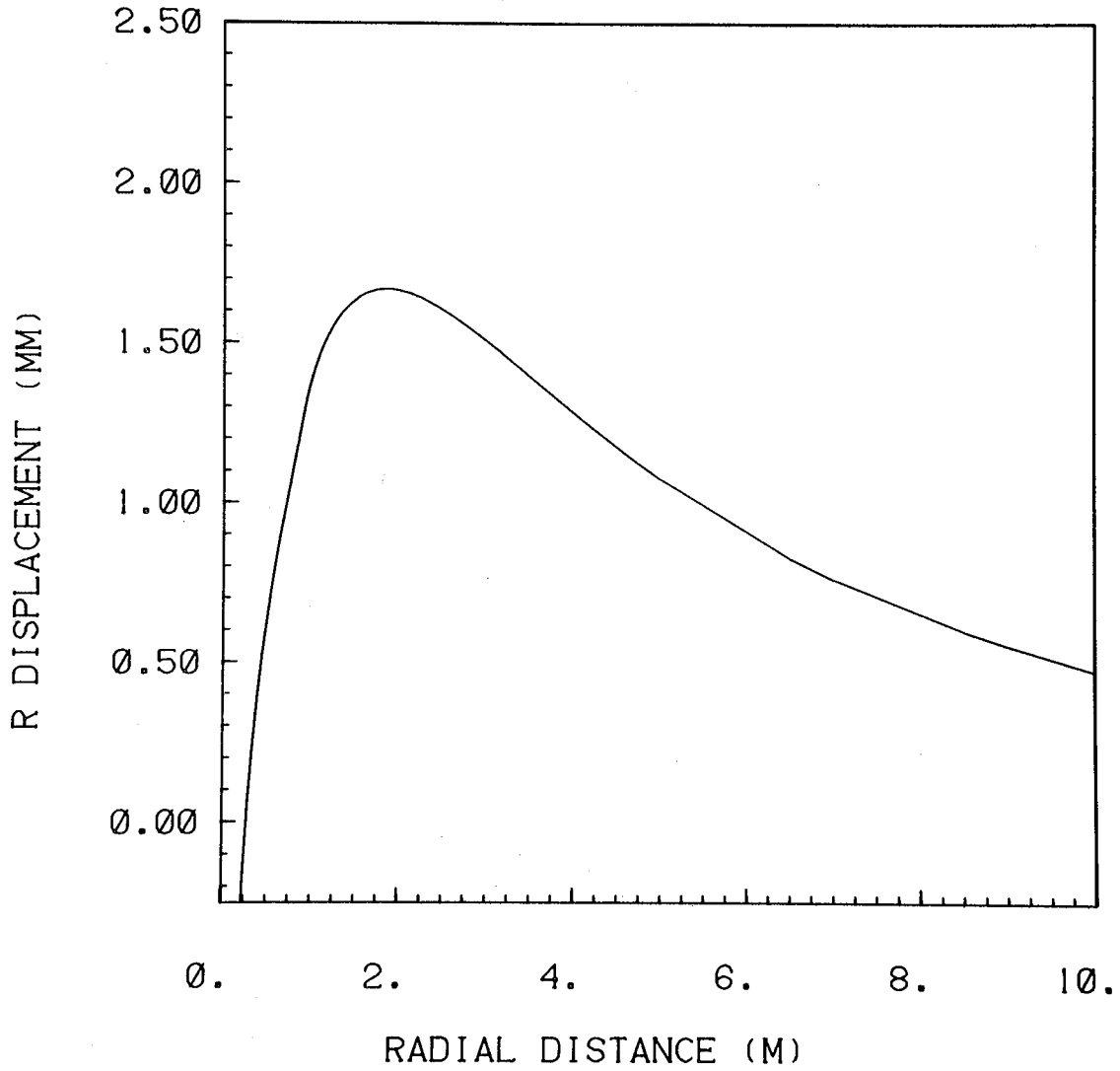

XBL 787-9742

Figure D20h

DISPLACEMENT PROFILE FOR MESH 1
HANFORD FULL-SCALE EXPERIMENT
MAIN HEATER = 5 KW
PERIPHERAL HEATER = 1 KW
Z = 0.0 M, THETA = 0.0 DEG.
730 DAYS

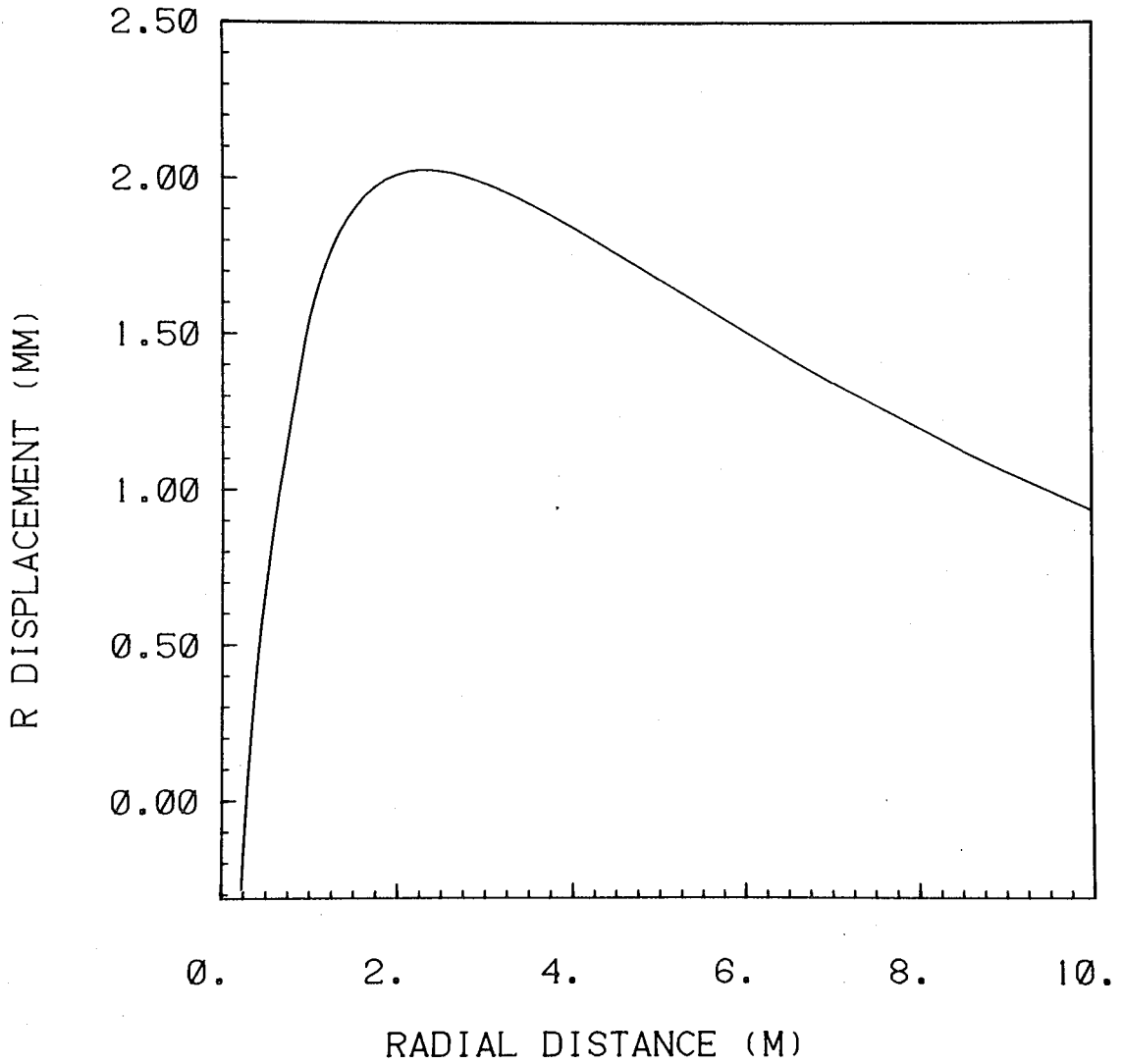

XBL 787-9741

Figure D20i

DISPLACEMENT PROFILE FOR MESH 1
HANFORD FULL-SCALE EXPERIMENT
MAIN HEATER = 5 KW
PERIPHERAL HEATER = 1 KW
Z = 0.0 M, THETA = 0.0 DEG.
760 DAYS

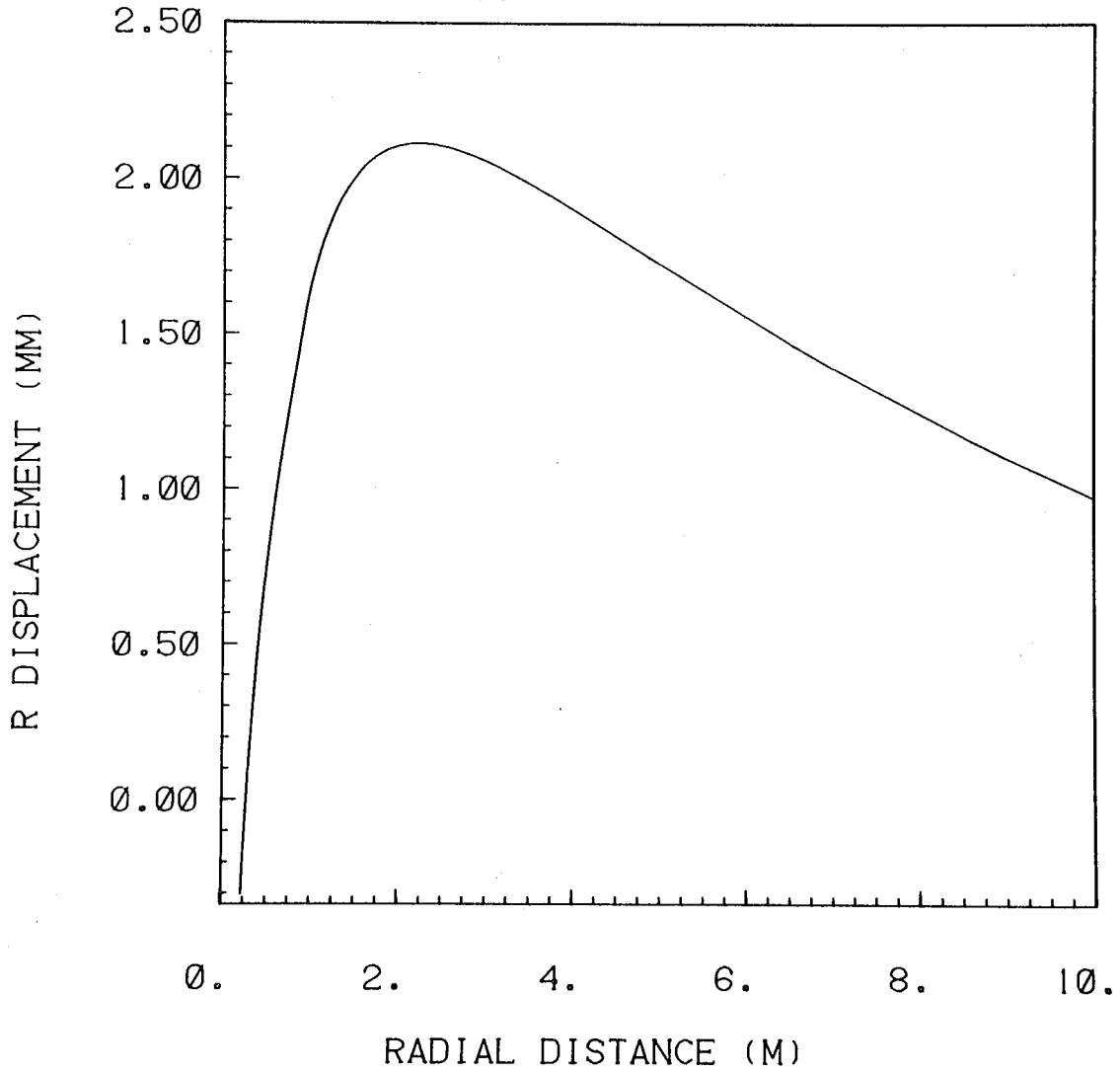

XBL 787-9740

Figure D20j

DISPLACEMENT PROFILE FOR MESH 1
HANFORD FULL-SCALE EXPERIMENT
MAIN HEATER = 5 KW
PERIPHERAL HEATER = 1 KW
Z = 0.0 M, THETA = 0.0 DEG.
790 DAYS

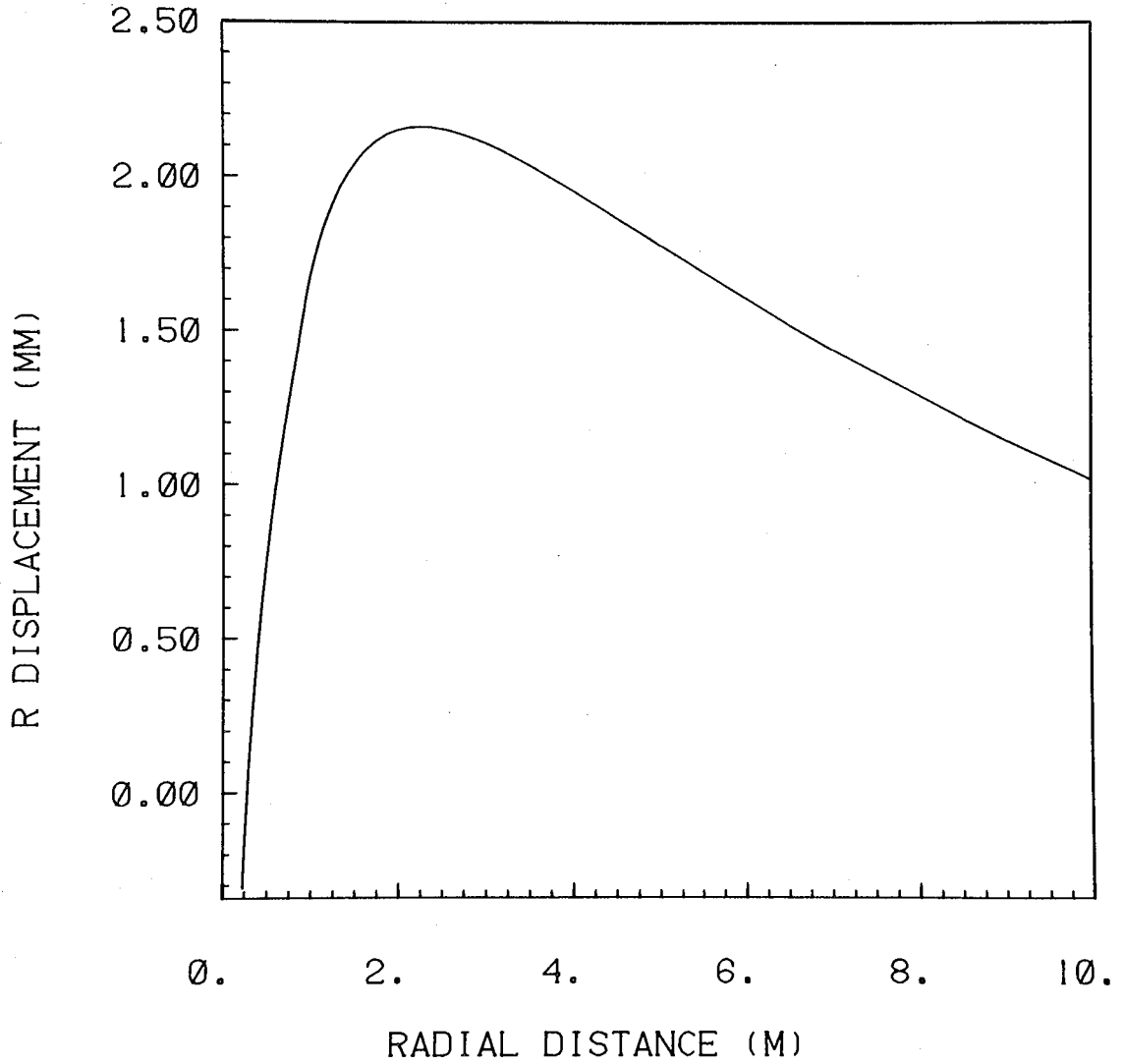

XBL 787-9739

Figure D20k

DISPLACEMENT PROFILE FOR MESH 1
HANFORD FULL-SCALE EXPERIMENT
MAIN HEATER = 5 KW
PERIPHERAL HEATER = 1 KW
Z = 0.0 M, THETA = 0.0 DEG.
1095 DAYS

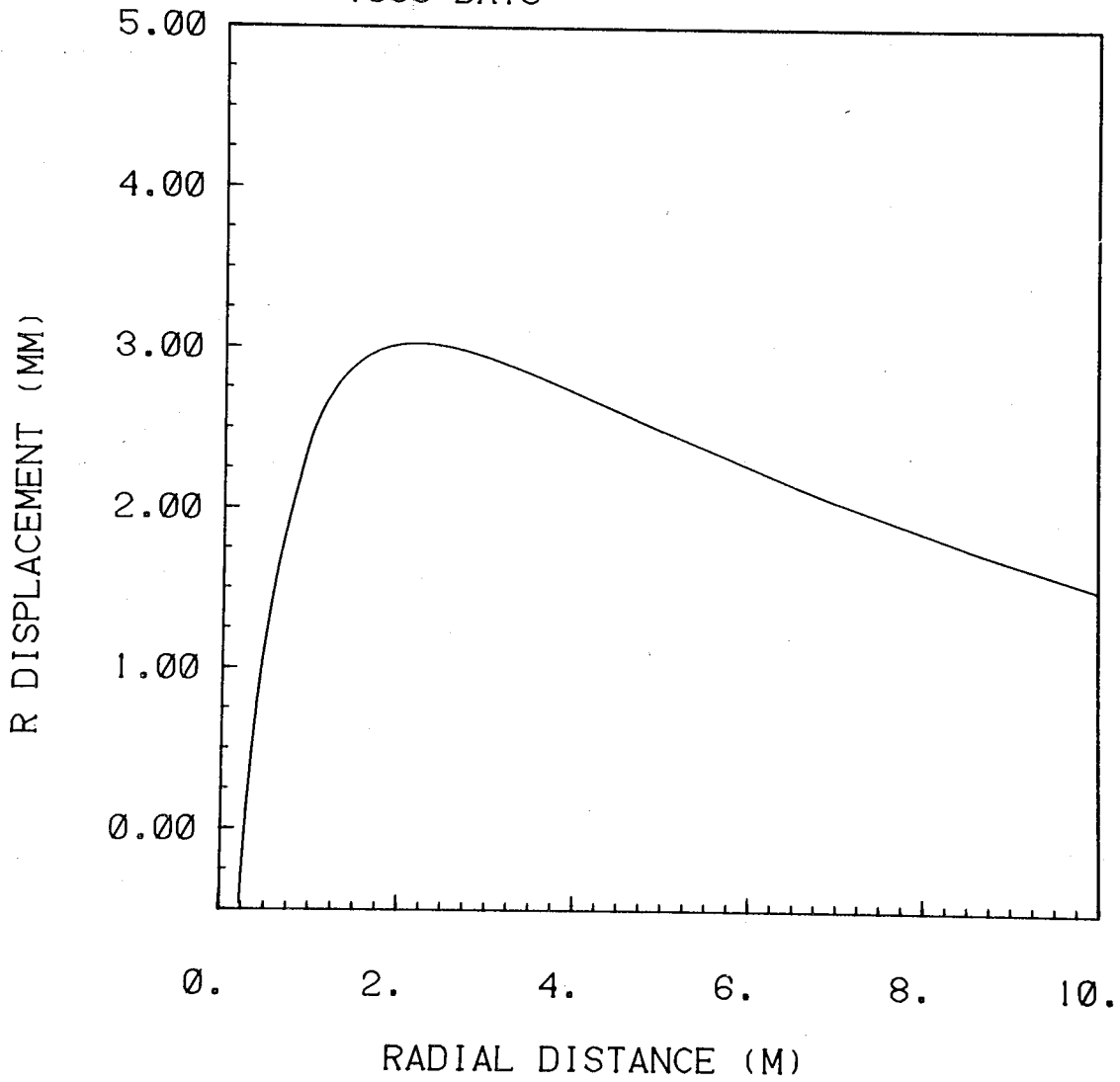

XBL 787-9738

Figure D201

DISPLACEMENT PROFILE FOR MESH 1
HANFORD FULL-SCALE EXPERIMENT
MAIN HEATER = 2 KW
PERIPHERAL HEATER = 1 KW
Z = 0.0 M, THETA = 0.0 DEG.
7 DAYS

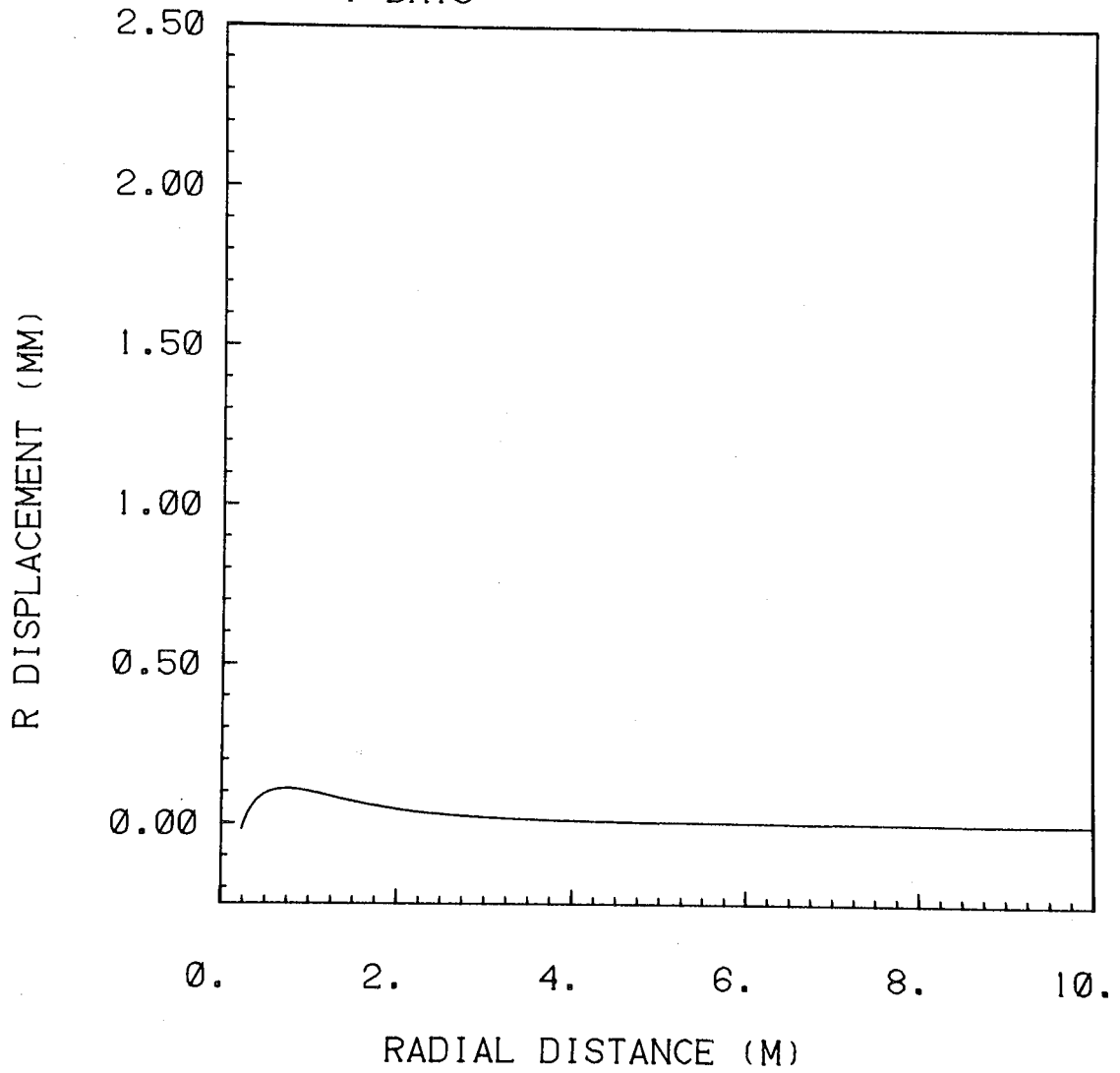

XBL 787-9716

Figure D21a

DISPLACEMENT PROFILE FOR MESH 1
HANFORD FULL-SCALE EXPERIMENT
MAIN HEATER = 2 KW
PERIPHERAL HEATER = 1 KW
Z = 0.0 M, THETA = 0.0 DEG.
30 DAYS

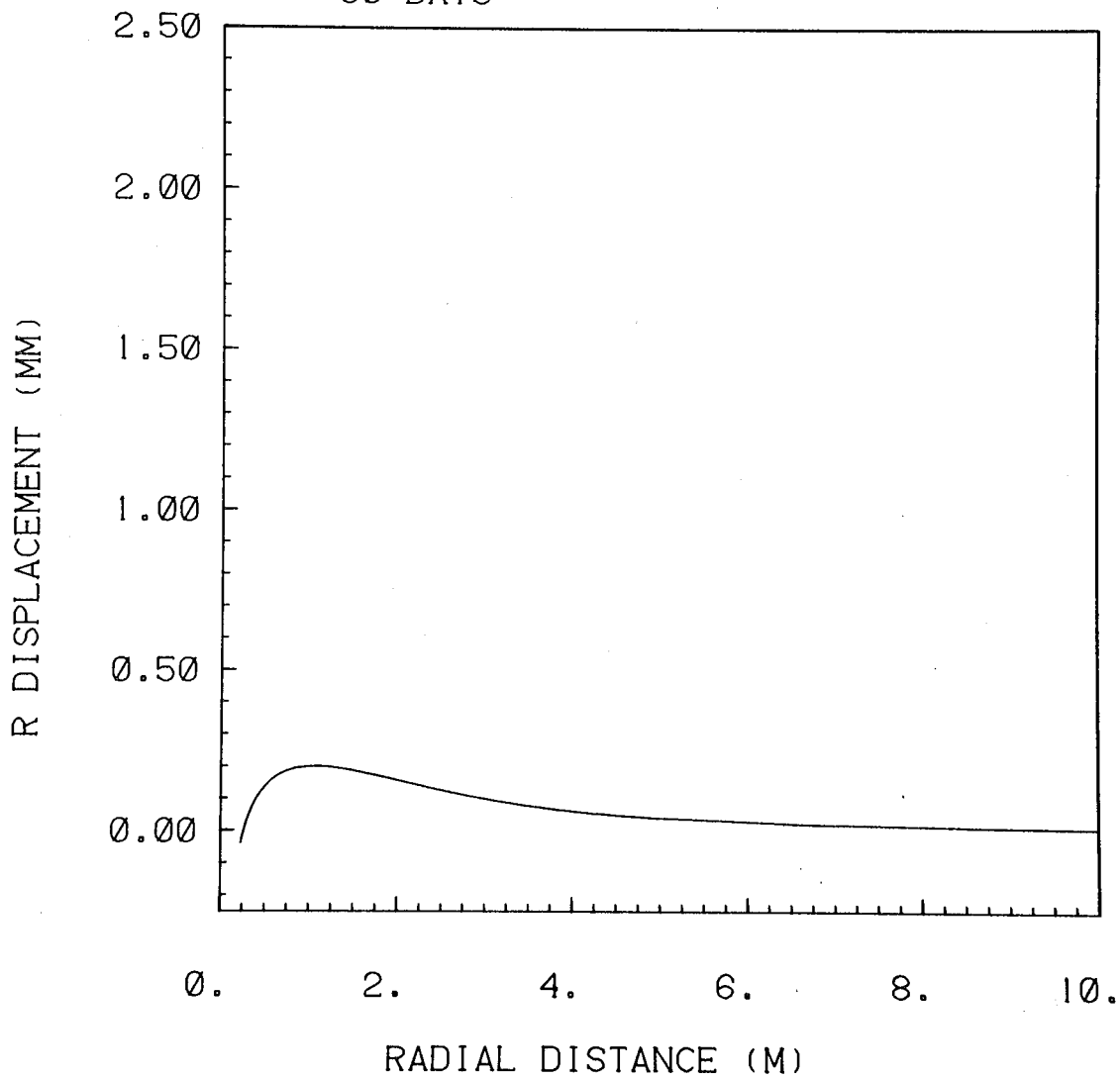

XBL 787-9715

Figure D21b

DISPLACEMENT PROFILE FOR MESH 1
HANFORD FULL-SCALE EXPERIMENT
MAIN HEATER = 2 KW
PERIPHERAL HEATER = 1 KW
Z = 0.0 M, THETA = 0.0 DEG.
90 DAYS

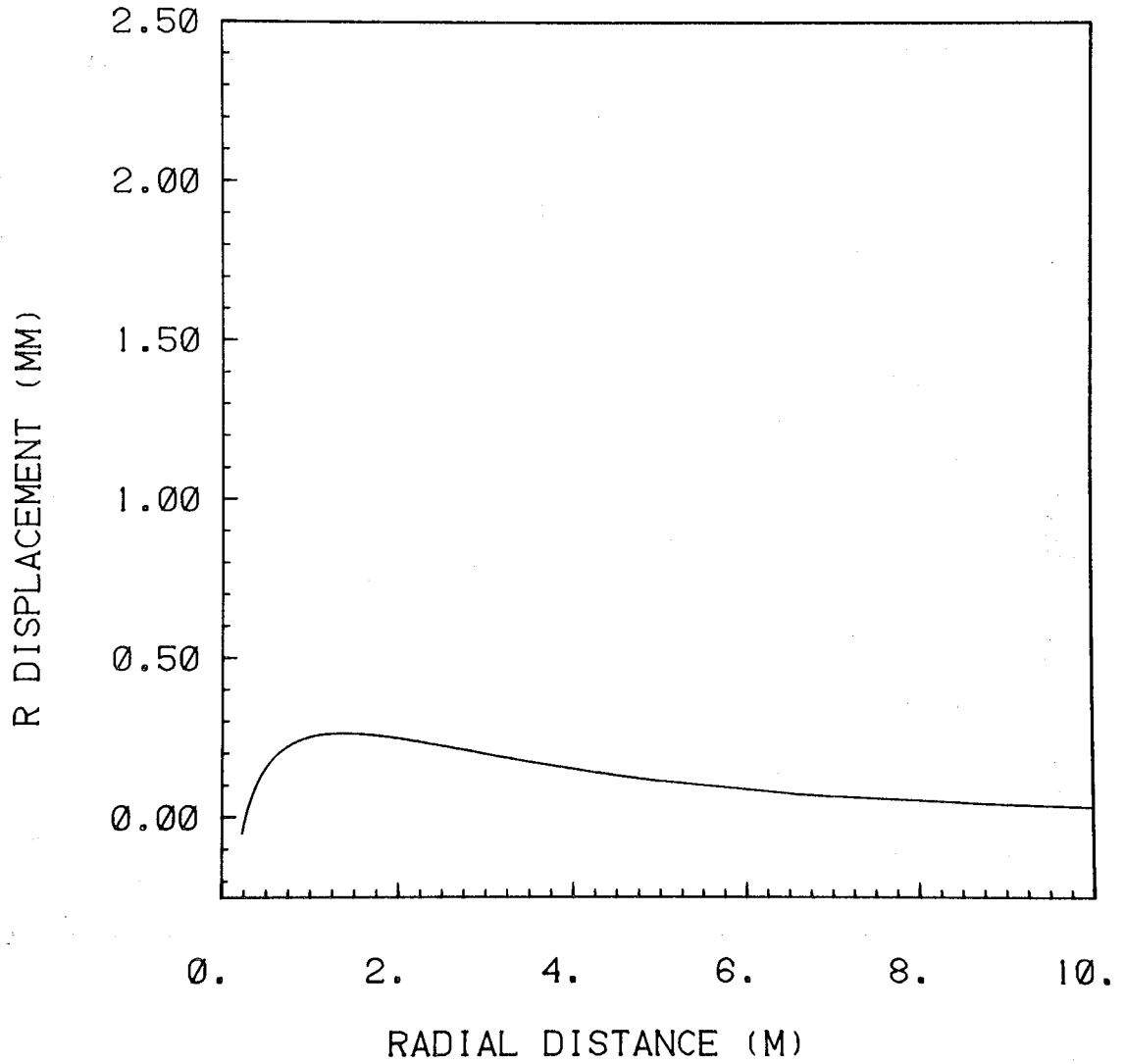

XBL 787-9714

Figure D21c

DISPLACEMENT PROFILE FOR MESH 1
HANFORD FULL-SCALE EXPERIMENT
MAIN HEATER = 2 KW
PERIPHERAL HEATER = 1 KW
Z = 0.0 M, THETA = 0.0 DEG.
180 DAYS

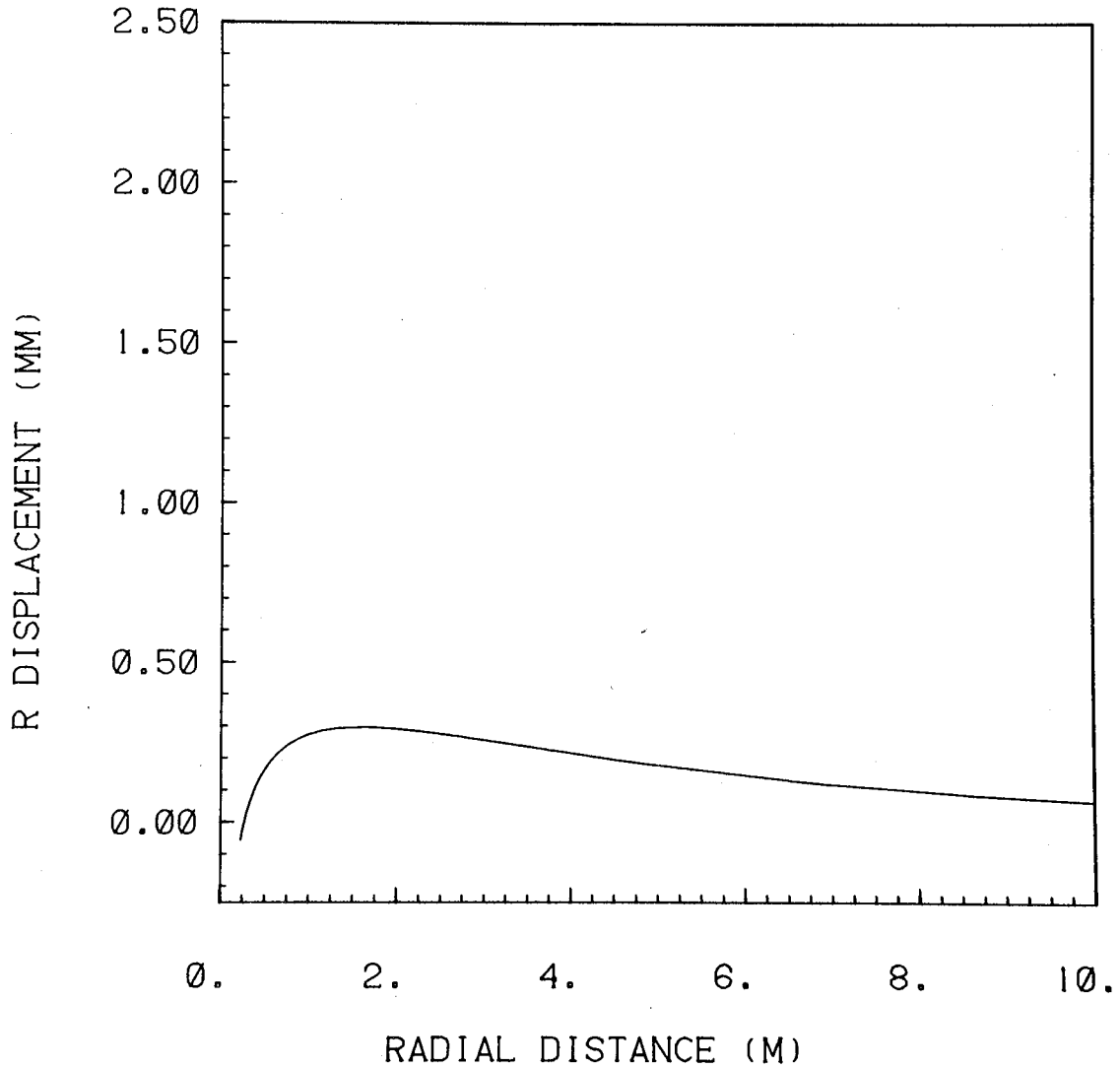

XBL 787-9713

Figure D21d

DISPLACEMENT PROFILE FOR MESH 1
HANFORD FULL-SCALE EXPERIMENT
MAIN HEATER = 2 KW
PERIPHERAL HEATER = 1 KW
Z = 0.0 M, THETA = 0.0 DEG.
365 DAYS

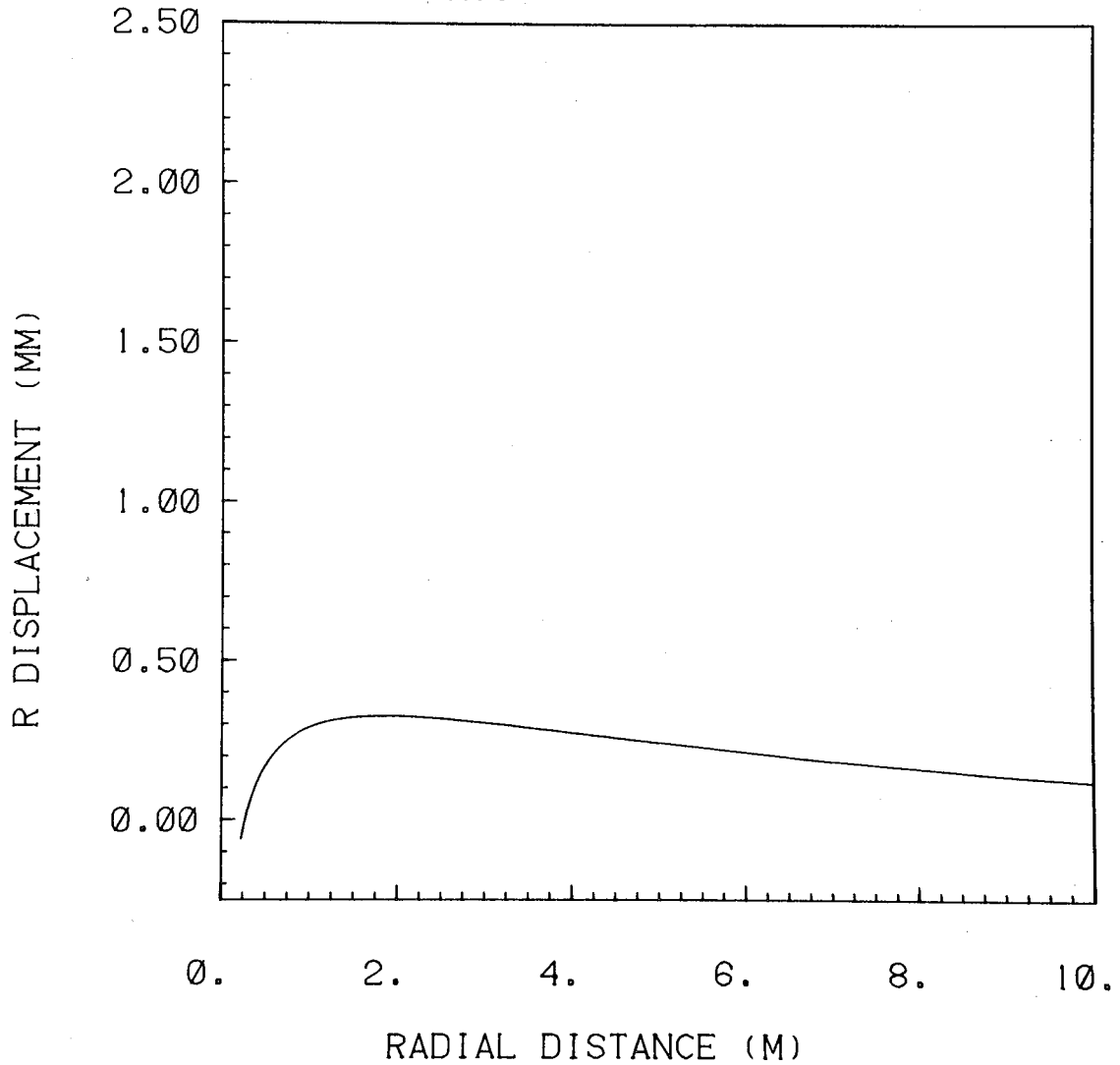

XBL 787-9712

Figure D21e

DISPLACEMENT PROFILE FOR MESH 1
HANFORD FULL-SCALE EXPERIMENT
MAIN HEATER = 2 KW
PERIPHERAL HEATER = 1 KW
Z = 0.0 M, THETA = 0.0 DEG.
371 DAYS

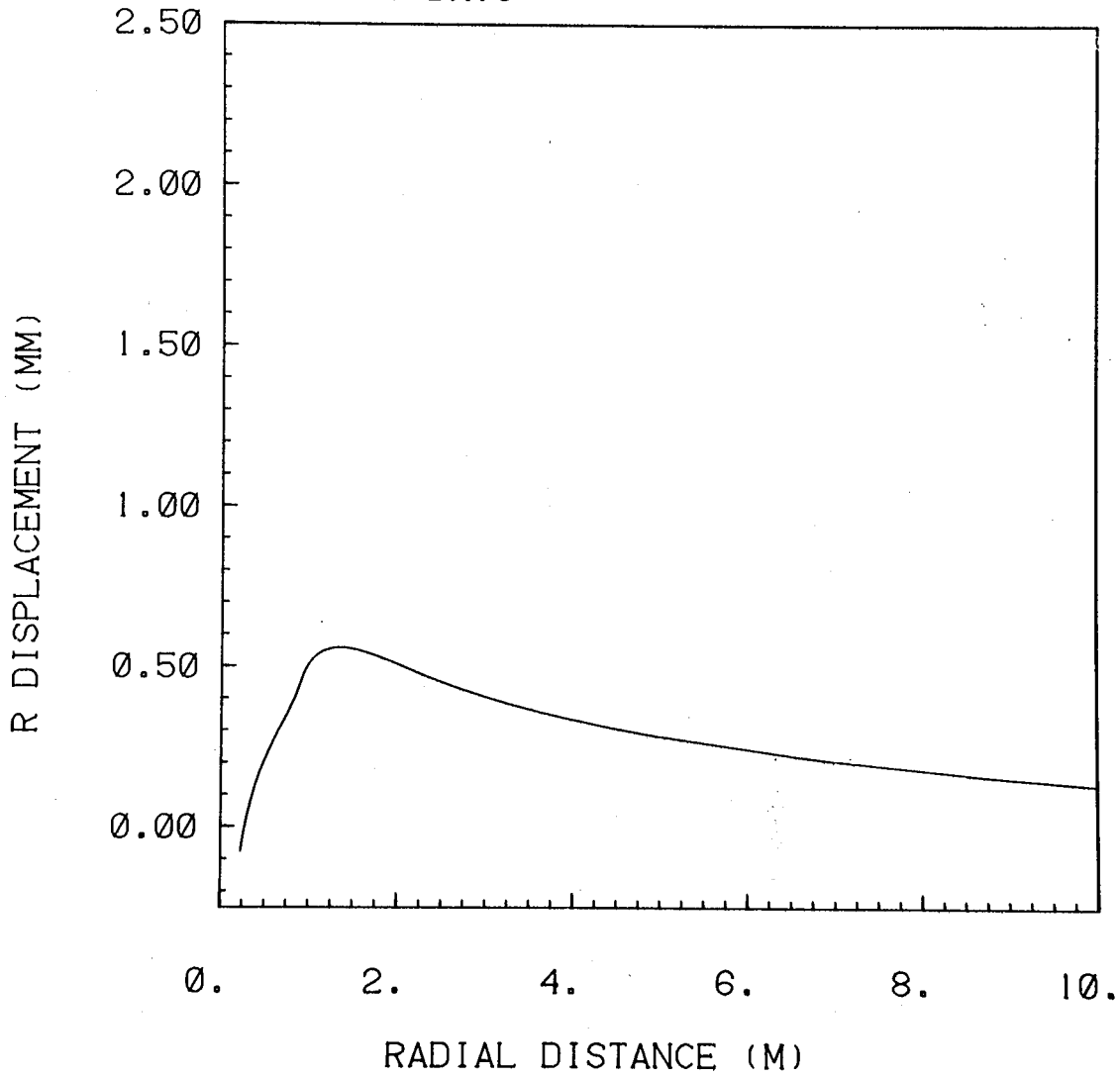

XBL 787-9711

Figure D21f

DISPLACEMENT PROFILE FOR MESH 1
HANFORD FULL-SCALE EXPERIMENT
MAIN HEATER = 2 KW
PERIPHERAL HEATER = 1 KW
Z = 0.0 M, THETA = 0.0 DEG.
390 DAYS

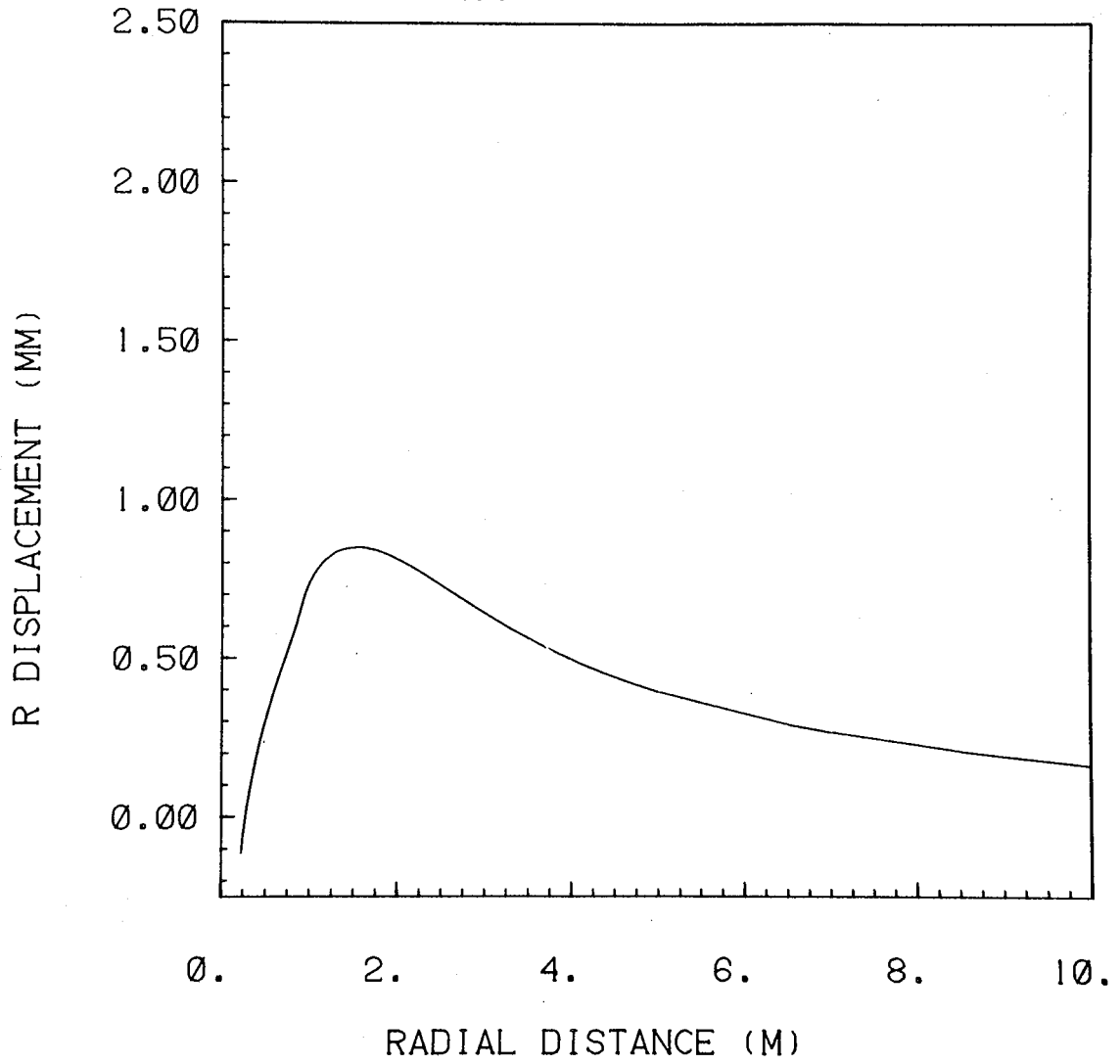

XBL 787-9710

Figure D21g

DISPLACEMENT PROFILE FOR MESH 1
HANFORD FULL-SCALE EXPERIMENT
MAIN HEATER = 2 KW
PERIPHERAL HEATER = 1 KW
Z = 0.0 M, THETA = 0.0 DEG.
450 DAYS

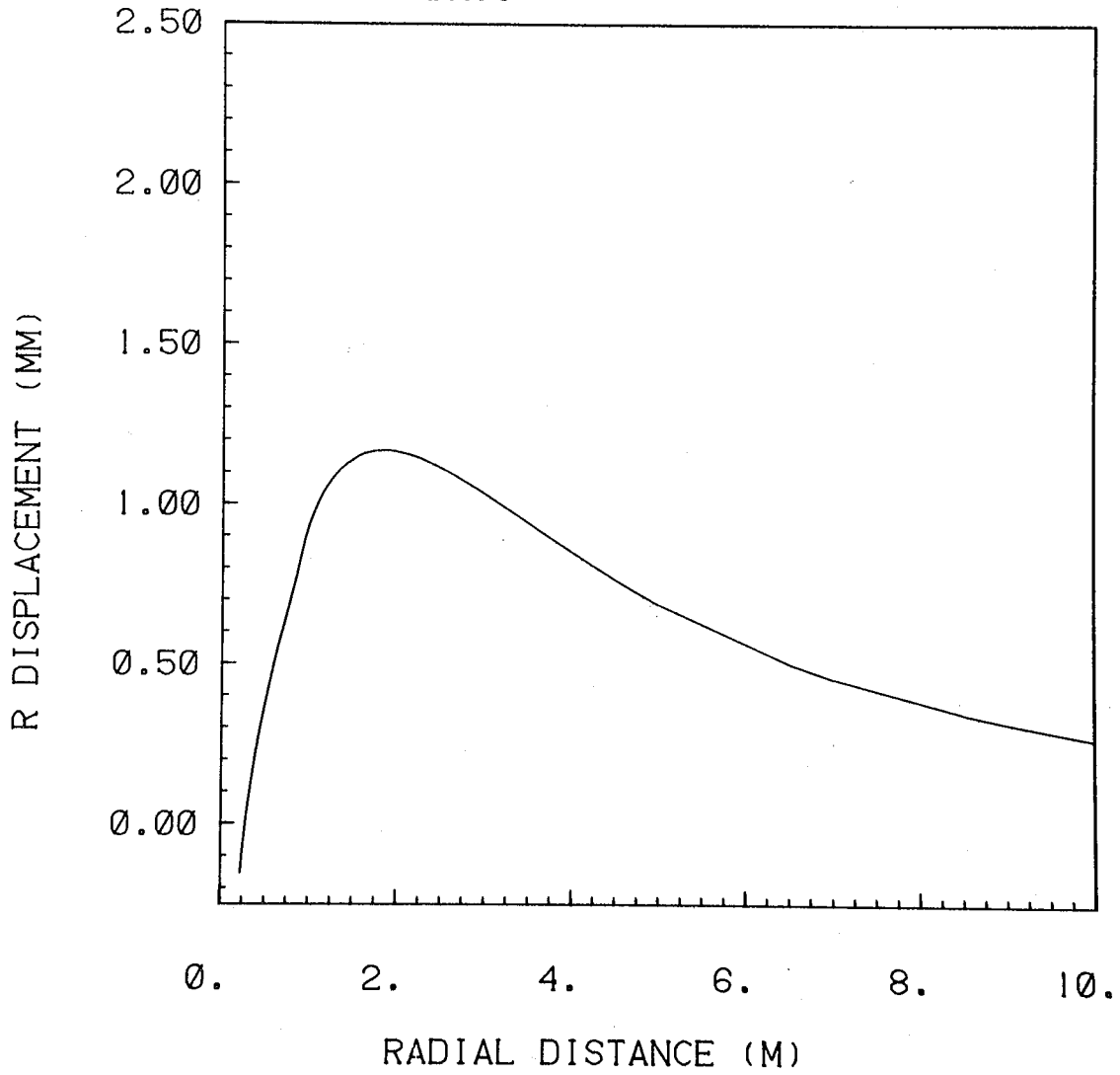

XBL 787-9709

Figure D21h

DISPLACEMENT PROFILE FOR MESH 1
HANFORD FULL-SCALE EXPERIMENT
MAIN HEATER = 2 KW
PERIPHERAL HEATER = 1 KW
Z = 0.0 M, THETA = 0.0 DEG.
730 DAYS

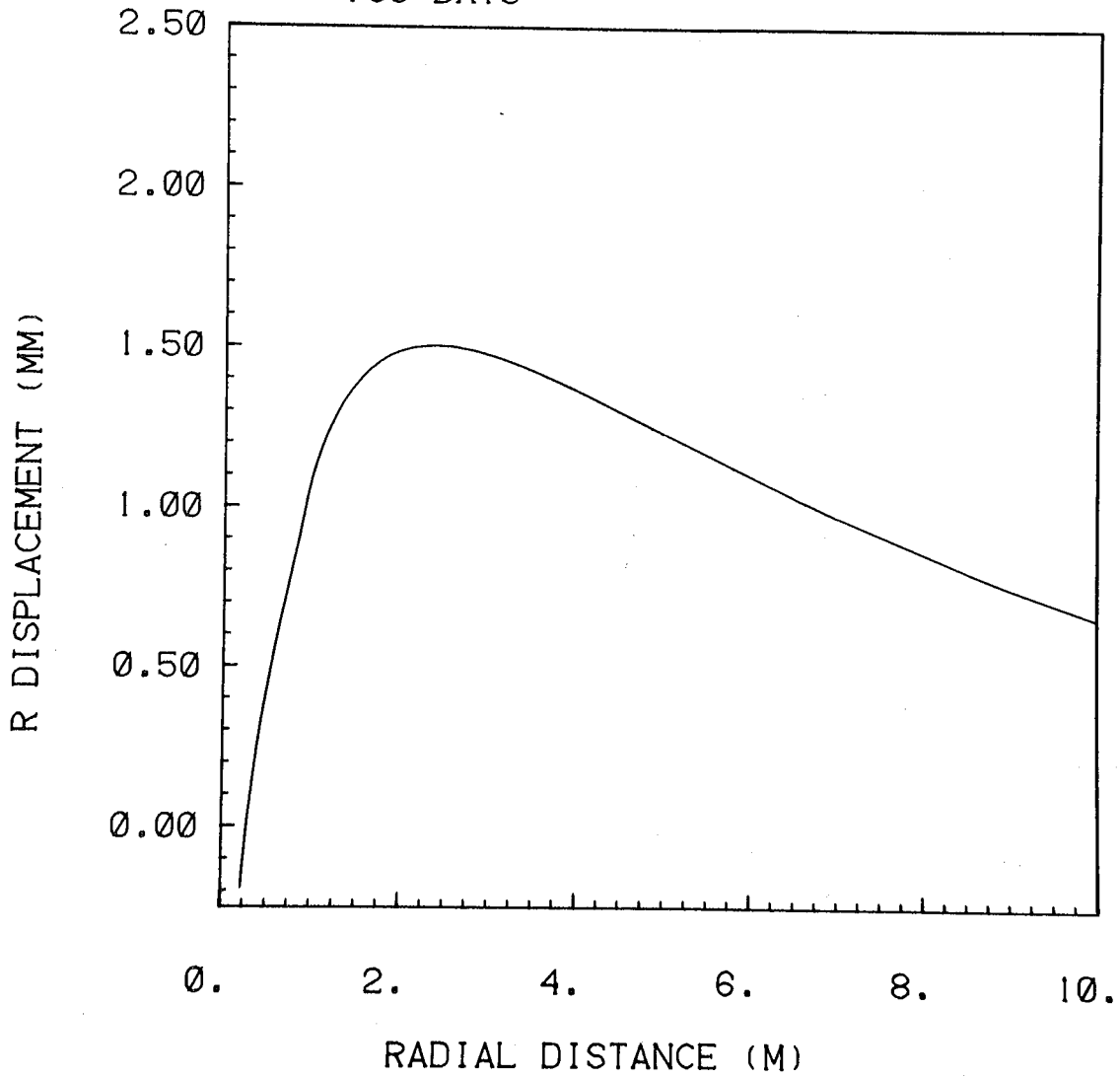

XBL 787-9708

Figure D21i

DISPLACEMENT PROFILE FOR MESH 1
HANFORD FULL-SCALE EXPERIMENT
MAIN HEATER = 2 KW
PERIPHERAL HEATER = 1 KW
Z = 0.0 M, THETA = 0.0 DEG.
760 DAYS

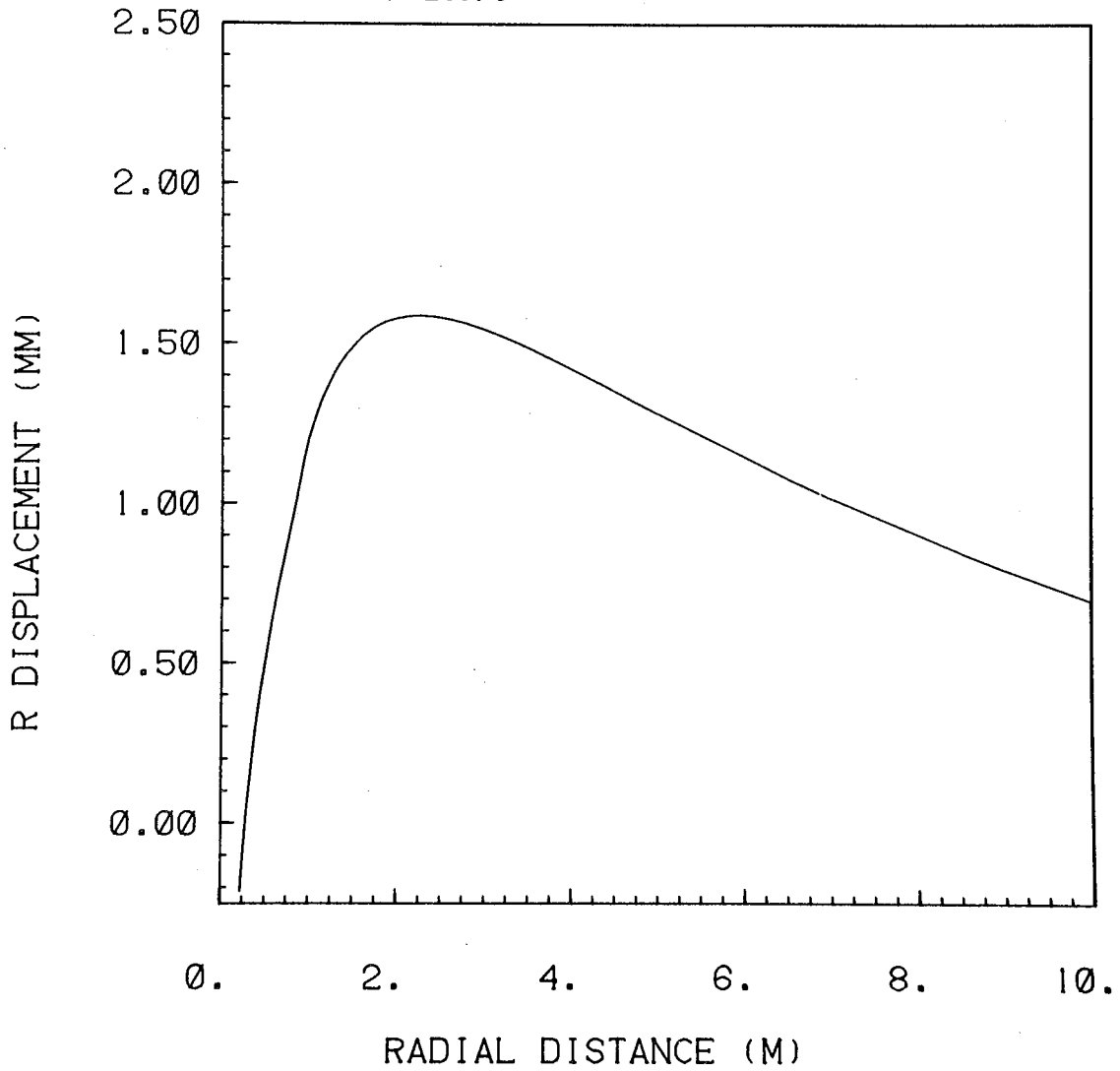

XBL 787-9707

Figure D21j

DISPLACEMENT PROFILE FOR MESH 1
HANFORD FULL-SCALE EXPERIMENT
MAIN HEATER = 2 KW
PERIPHERAL HEATER = 1 KW
Z = 0.0 M, THETA = 0.0 DEG.
790 DAYS

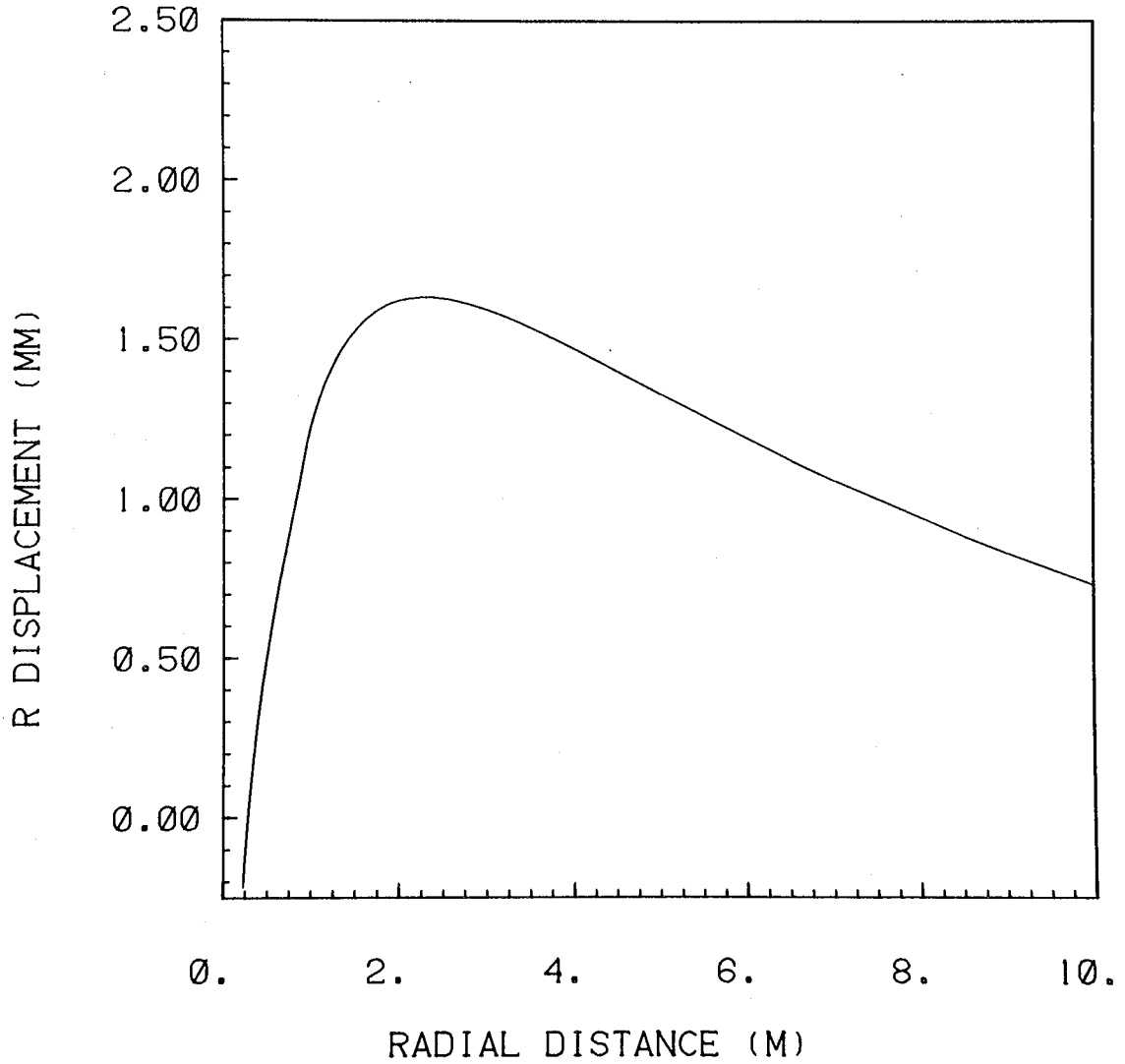

XBL 787-9706

Figure D21k

DISPLACEMENT PROFILE FOR MESH 1
HANFORD FULL-SCALE EXPERIMENT
MAIN HEATER = 2 KW
PERIPHERAL HEATER = 1 KW
Z = 0.0 M, THETA = 0.0 DEG.
1095 DAYS

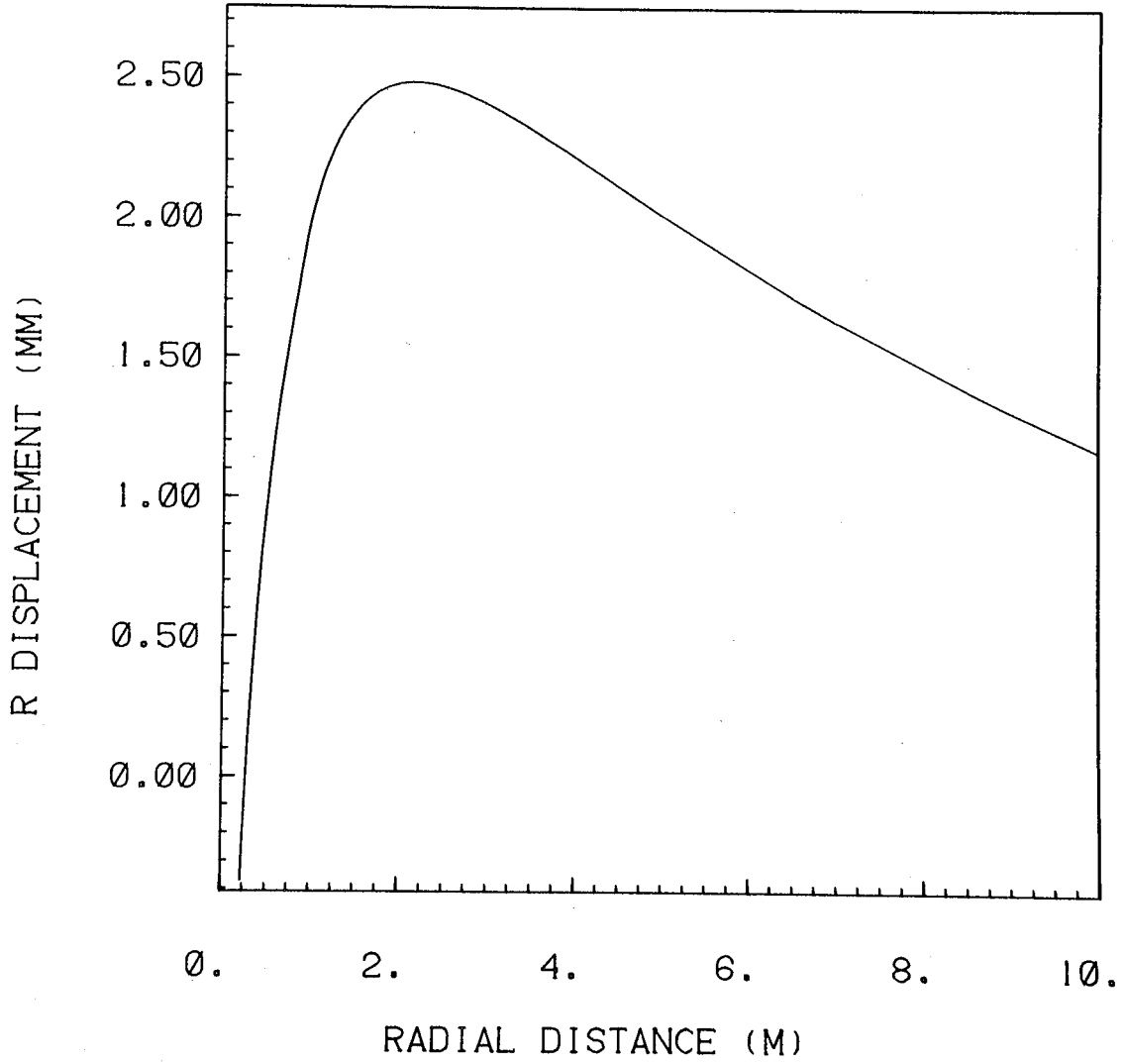

XBL 787-9705

Figure D211

DISPLACEMENT PROFILE FOR MESH 7
HANFORD FULL-SCALE EXPERIMENT
MAIN HEATER = 5 KW
PERIPHERAL HEATER = 1 KW
Z = 0.0 M, THETA = 0.0 DEG.
730 DAYS

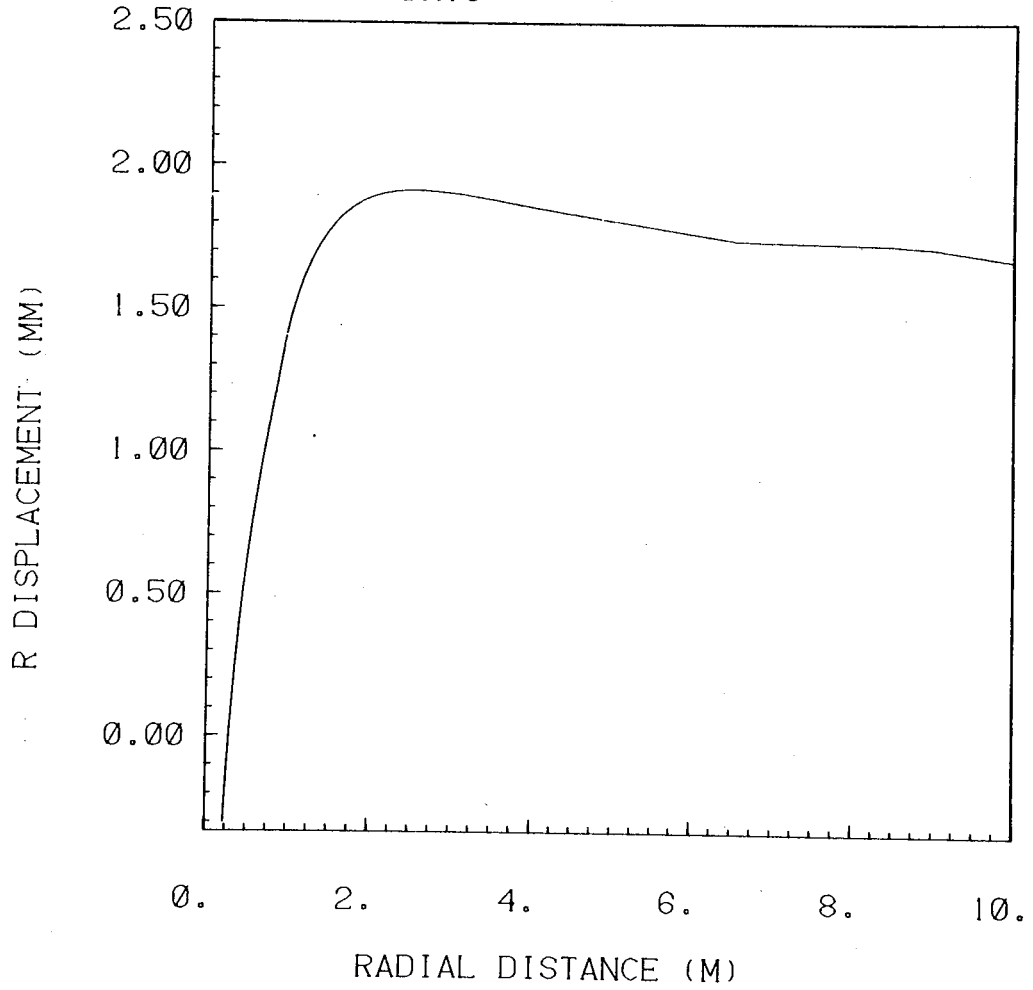

XBL 788-10467

Figure D22a

DISPLACEMENT PROFILE FOR MESH 7
HANFORD FULL-SCALE EXPERIMENT
MAIN HEATER = 5 KW
PERIPHERAL HEATER = 1 KW
Z = 0.0 M, THETA = 0.0 DEG.
1095 DAYS

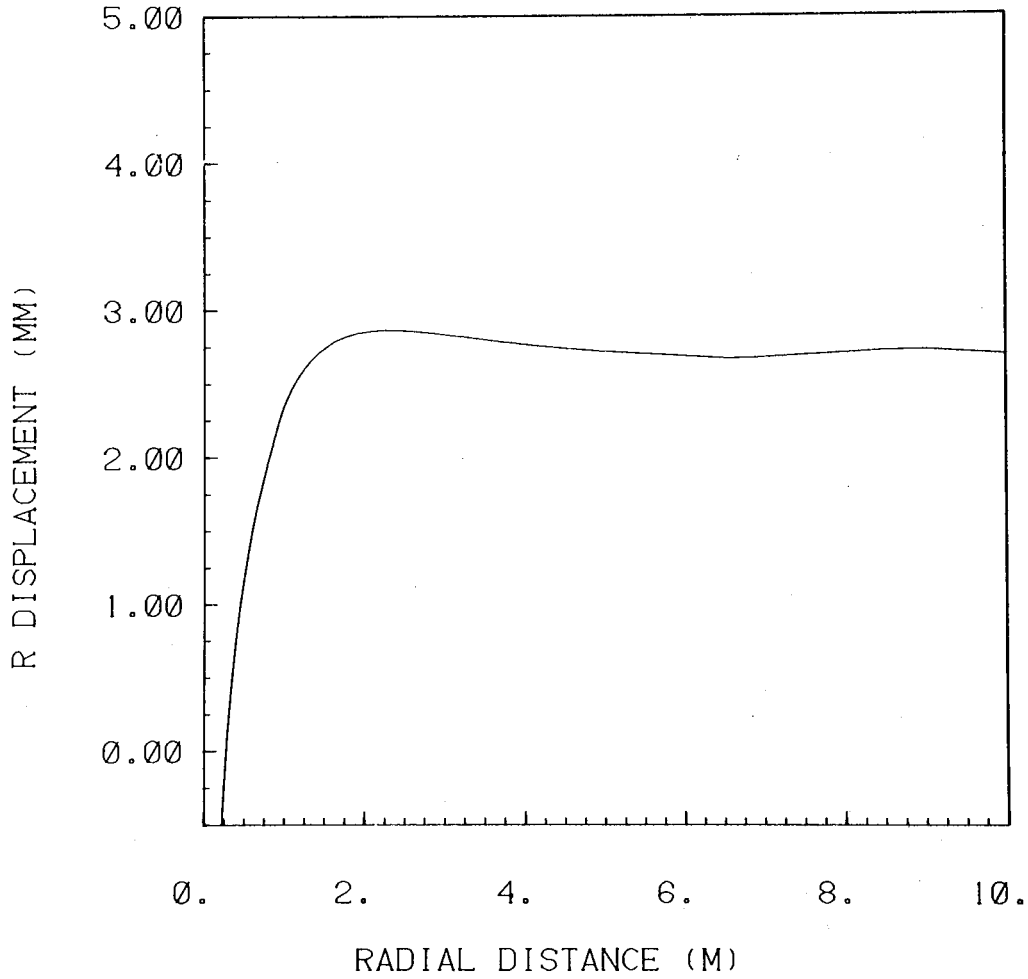

XBL 788-10468

Figure D22b

DISPLACEMENT PROFILE FOR MESH 7
HANFORD FULL-SCALE EXPERIMENT
MAIN HEATER = 2 KW
PERIPHERAL HEATER = 1 KW
Z = 0.0 M, THETA = 0.0 DEG.
730 DAYS

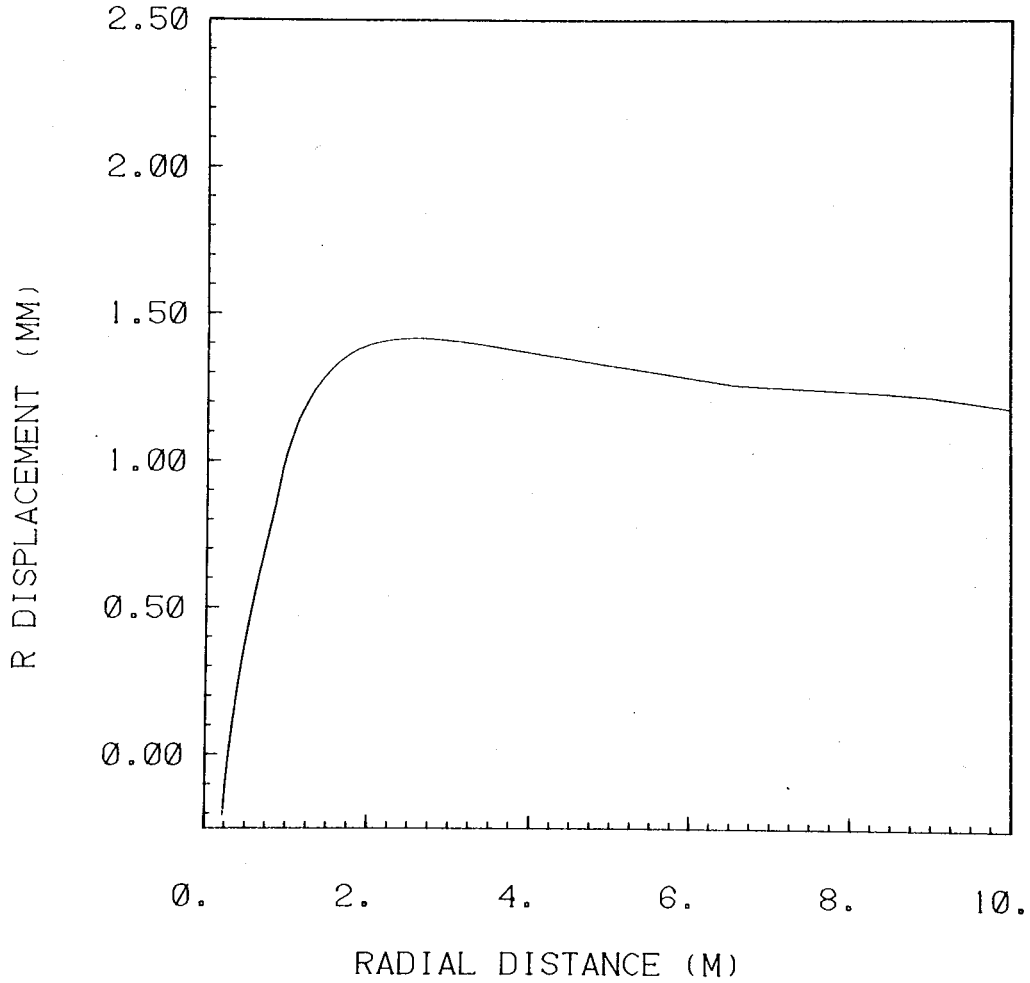

XBL 788-10470

Figure D23a

DISPLACEMENT PROFILE FOR MESH 7
HANFORD FULL-SCALE EXPERIMENT
MAIN HEATER = 2 KW
PERIPHERAL HEATER = 1 KW
Z = 0.0 M, THETA = 0.0 DEG.
1095 DAYS

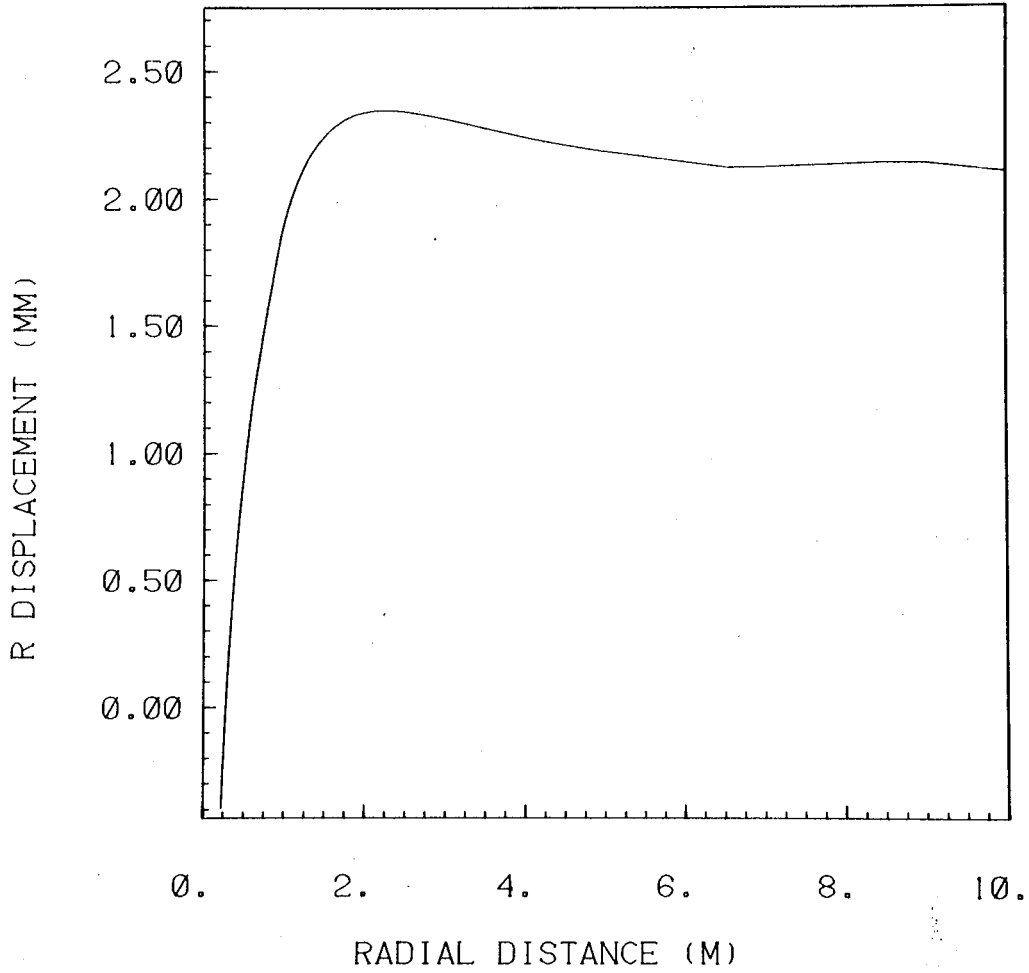

XBL 788-10469

Figure D23b

STRESS PROFILES FOR MESH 1
HANFORD FULL-SCALE EXPERIMENT
MAIN HEATER = 5 KW
PERIPHERAL HEATER = 1 KW
Z = 0.0 M, THETA = 0.0 DEG.
1 DAY

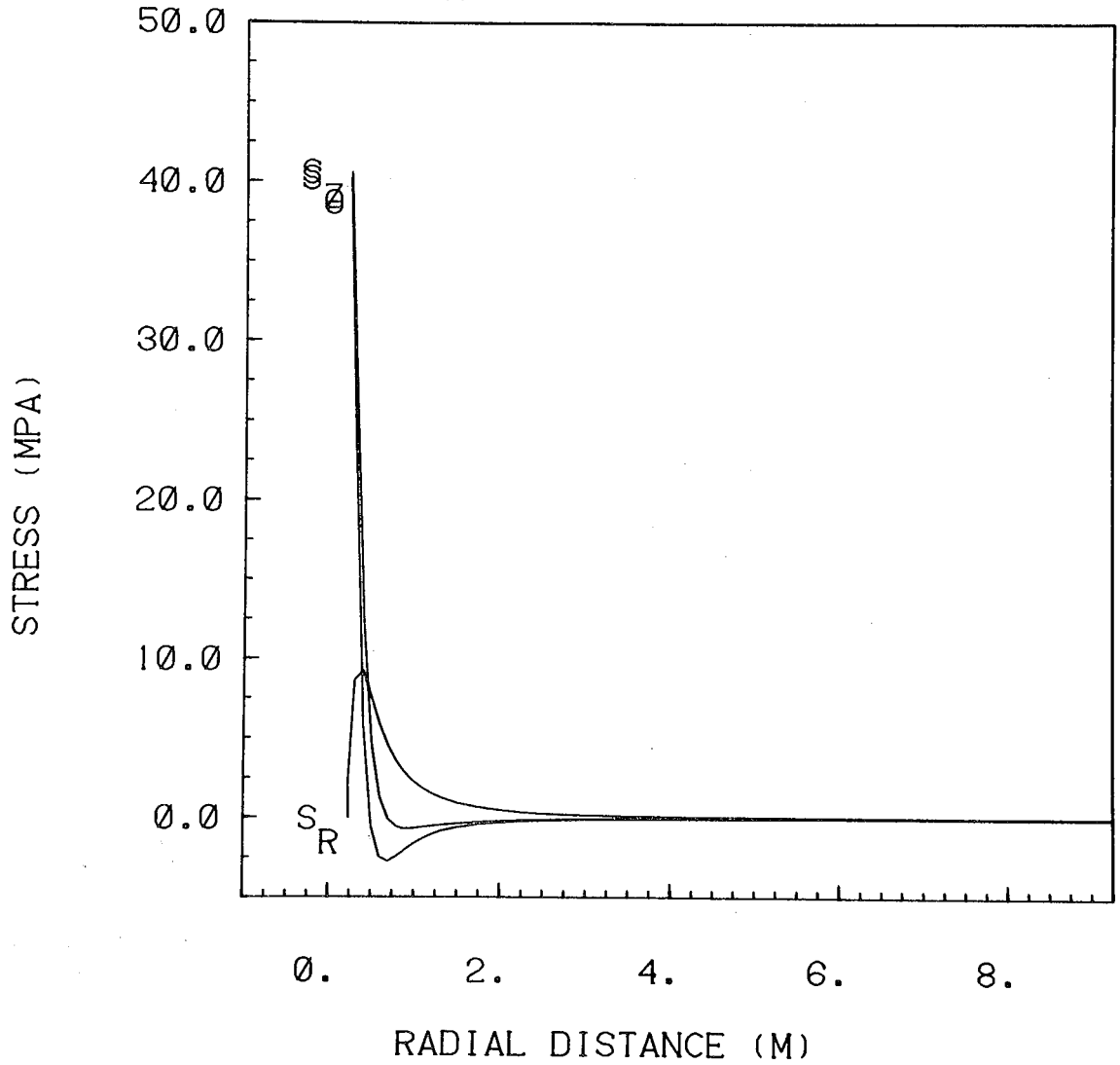

XBL 788-9862

Figure D24a

STRESS PROFILES FOR MESH 1
HANFORD FULL-SCALE EXPERIMENT
MAIN HEATER = 5 KW
PERIPHERAL HEATER = 1 KW
Z = 0.0 M, THETA = 0.0 DEG.
7 DAYS

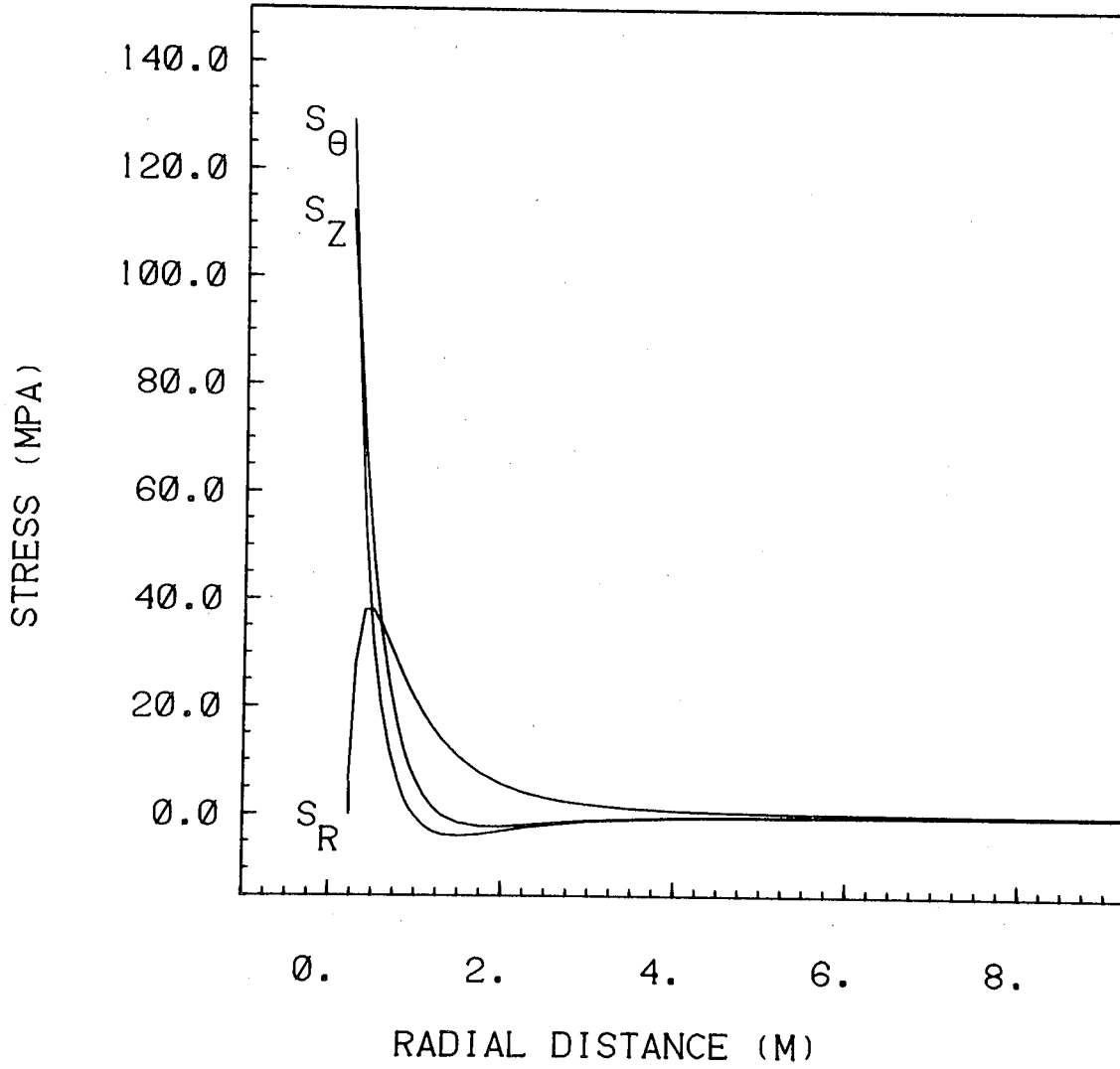

XBL 787-9737

Figure D24b

STRESS PROFILES FOR MESH 1
HANFORD FULL-SCALE EXPERIMENT
MAIN HEATER = 5 KW
PERIPHERAL HEATER = 1 KW
Z = 0.0 M, THETA = 0.0 DEG.
30 DAYS

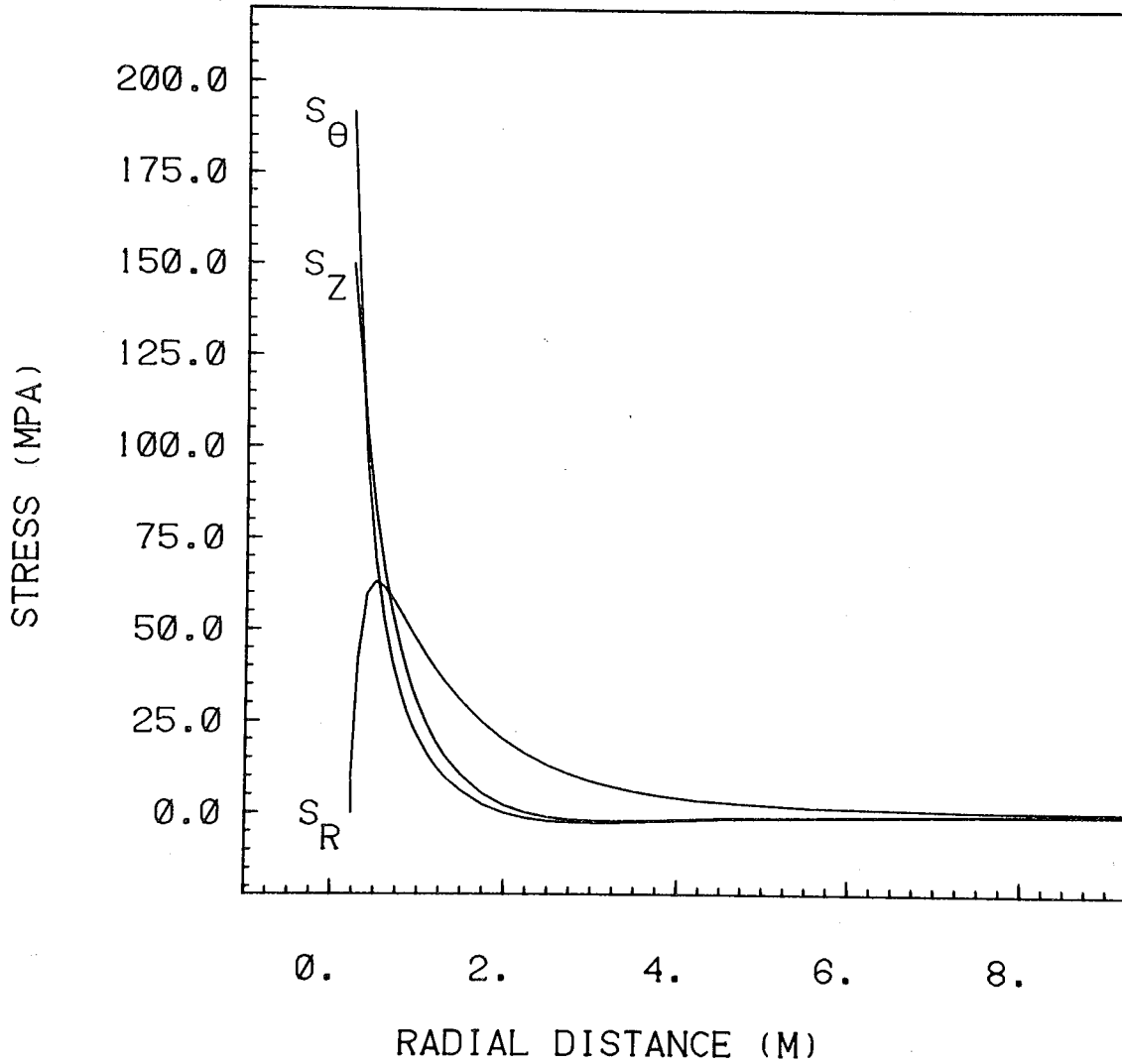

XBL 787-9736

Figure D24c

STRESS PROFILES FOR MESH 1
HANFORD FULL-SCALE EXPERIMENT
MAIN HEATER = 5 KW
PERIPHERAL HEATER = 1 KW
Z = 0.0 M, THETA = 0.0 DEG.
90 = DAYS

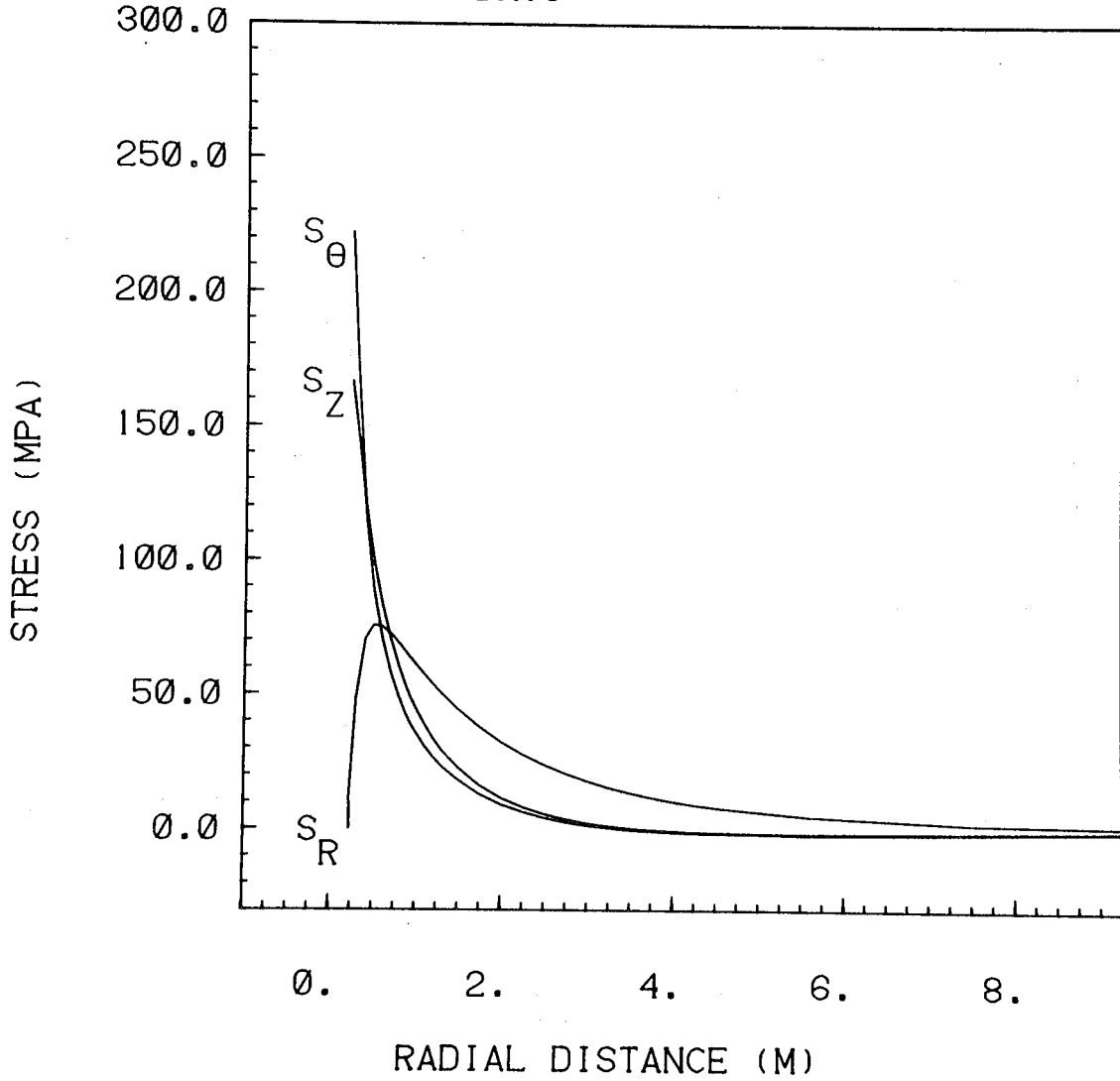

XBL 787-9735

Figure D24d

STRESS PROFILES FOR MESH 1
HANFORD FULL-SCALE EXPERIMENT
MAIN HEATER = 5 KW
PERIPHERAL HEATER = 1 KW
Z = 0.0 M, THETA = 0.0 DEG.
180 DAYS

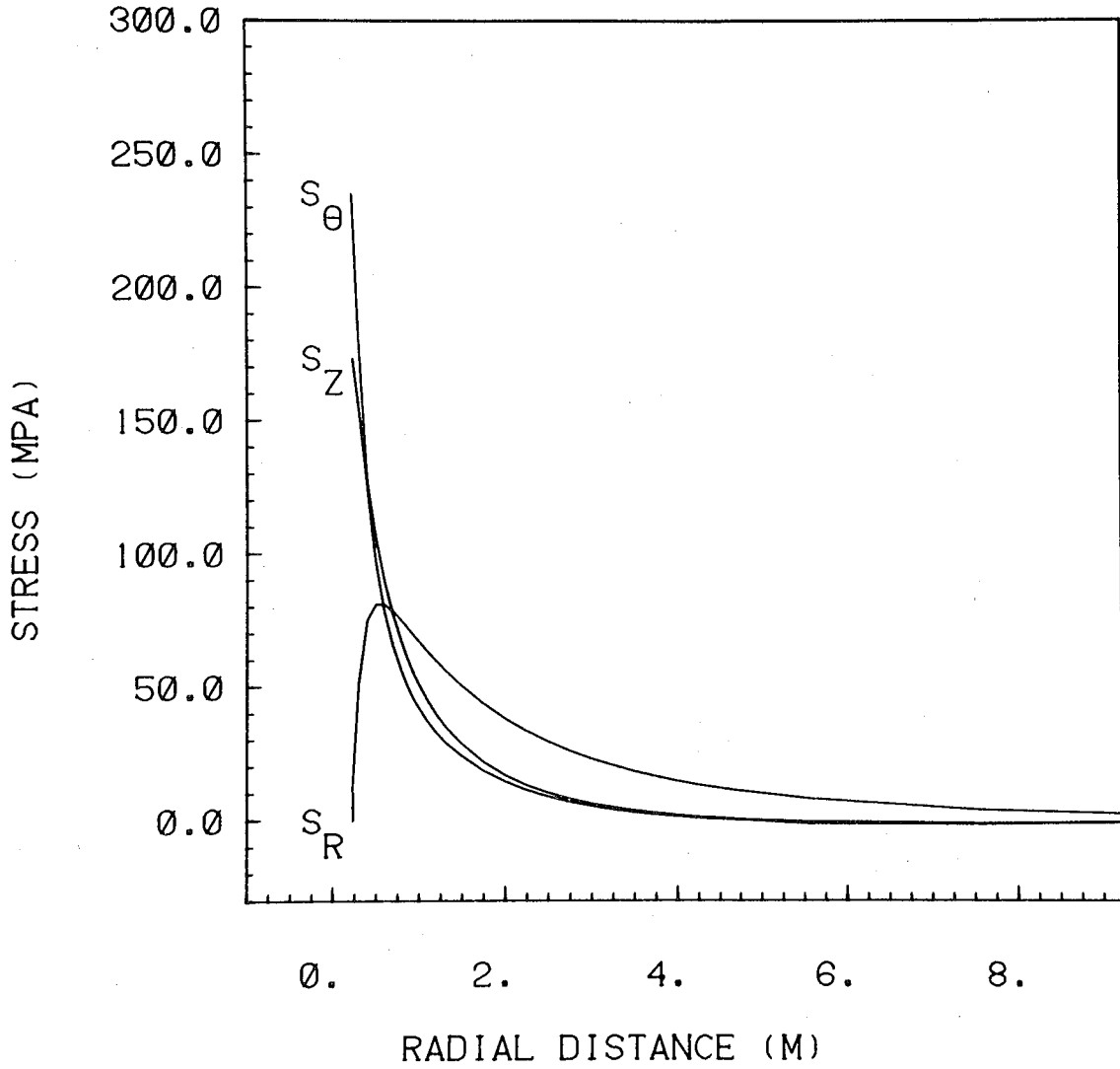

XBL 787-9734

Figure D24e

STRESS PROFILES FOR MESH 1
HANFORD FULL-SCALE EXPERIMENT
MAIN HEATER = 5 KW
PERIPHERAL HEATER = 1 KW
Z = 0.0 M, THETA = 0.0 DEG.
365 DAYS

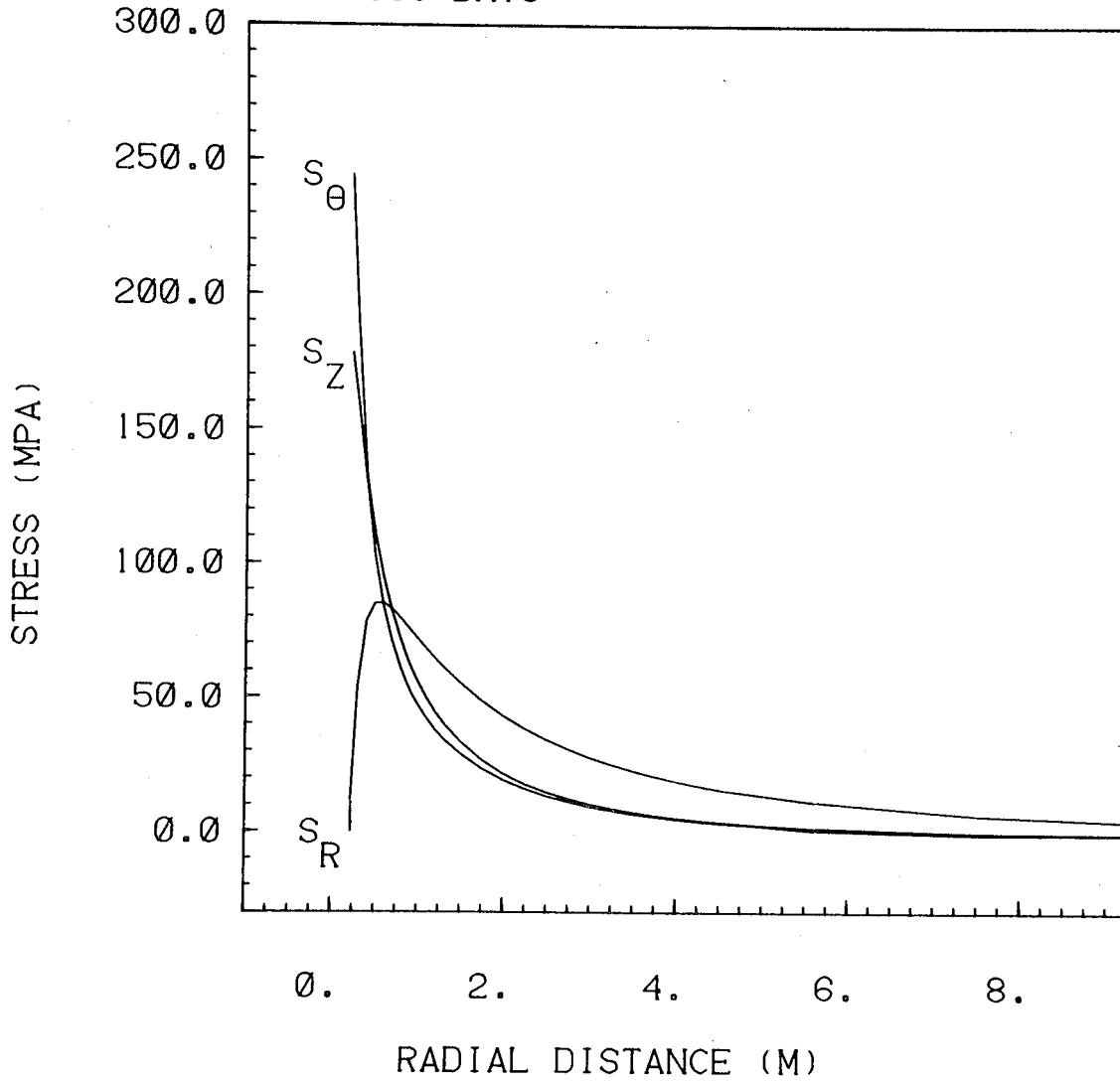

XBL 787-9697

Figure D24f

STRESS PROFILES FOR MESH 1
HANFORD FULL-SCALE EXPERIMENT
MAIN HEATER = 5 KW
PERIPHERAL HEATER = 1 KW
Z = 0.0 M, THETA = 0.0 DEG.
371 DAYS

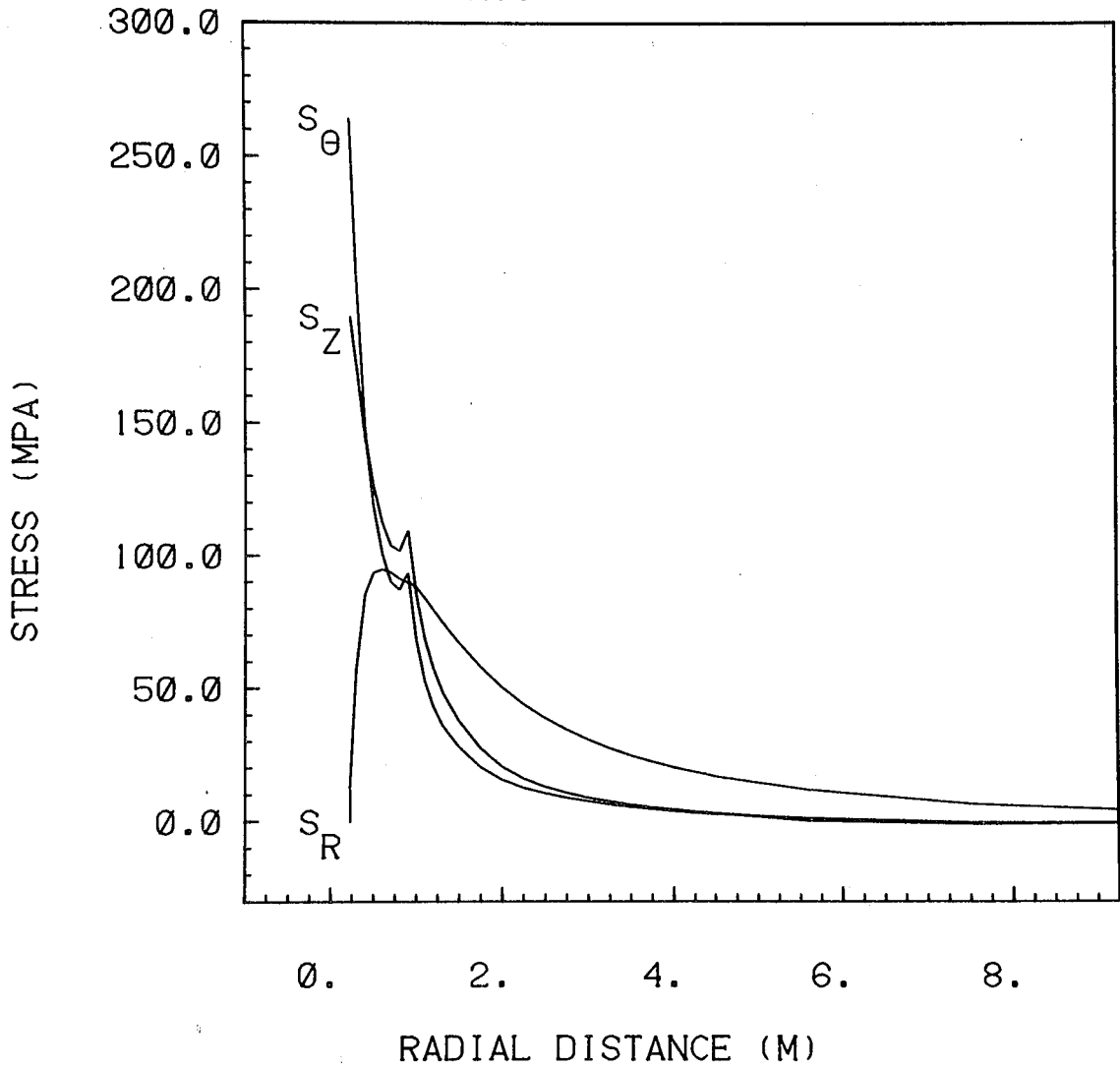

XBL 787-9698

Figure D24g

STRESS PROFILES FOR MESH 1
HANFORD FULL-SCALE EXPERIMENT
MAIN HEATER = 5 KW
PERIPHERAL HEATER = 1 KW
Z = 0.0 M, THETA = 0.0 DEG.
390 DAYS

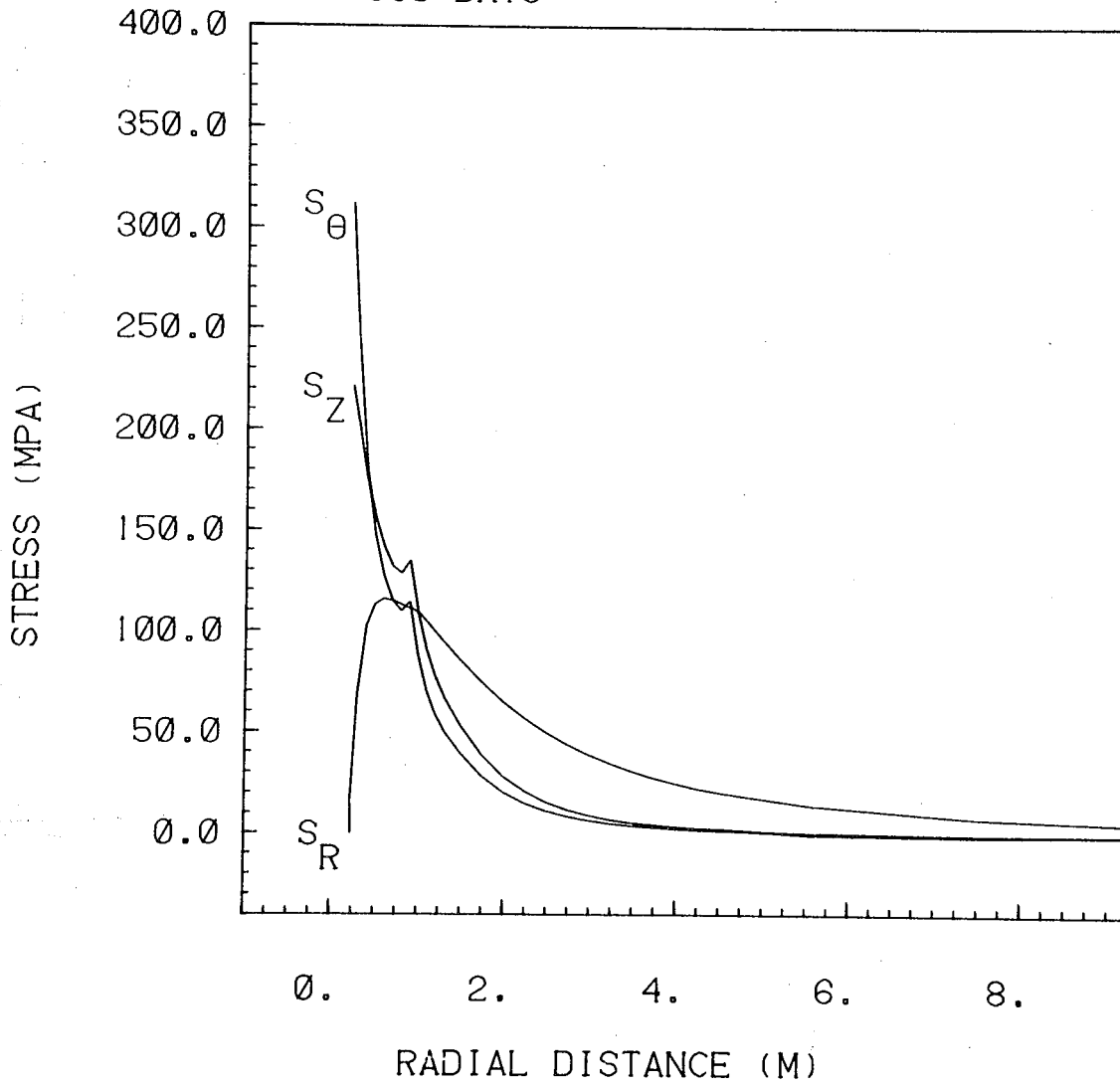

XBL 787-9699

Figure D24h

STRESS PROFILES FOR MESH 1
HANFORD FULL-SCALE EXPERIMENT
MAIN HEATER = 5 KW
PERIPHERAL HEATER = 1 KW
Z = 0.0 M, THETA = 0.0 DEG.
450 DAYS

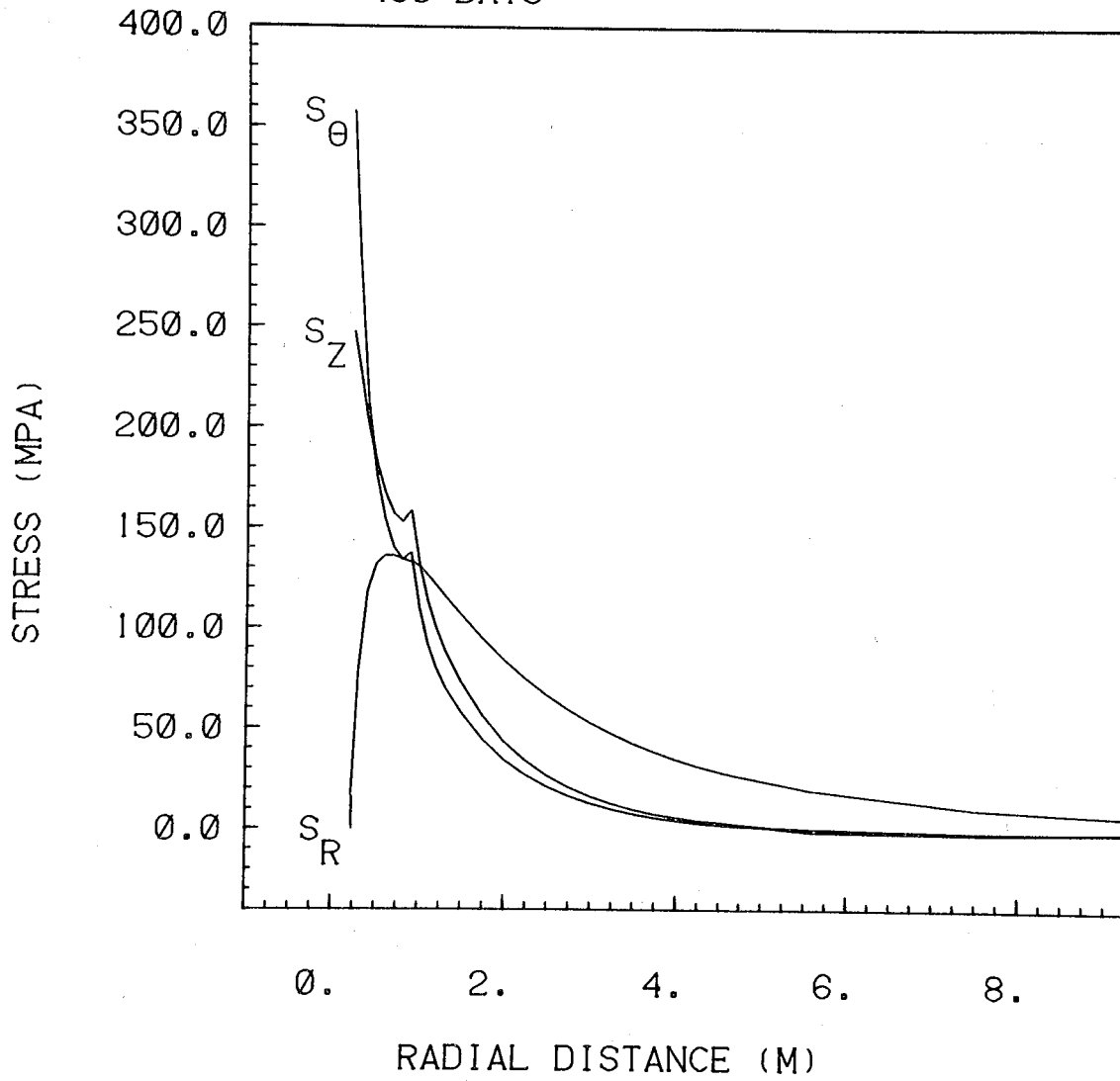

XBL 787-9700

Figure D24i

STRESS PROFILES FOR MESH 1
HANFORD FULL-SCALE EXPERIMENT
MAIN HEATER = 5 KW
PERIPHERAL HEATER = 1 KW
Z = 0.0 M, THETA = 0.0 DEG.
730 DAYS

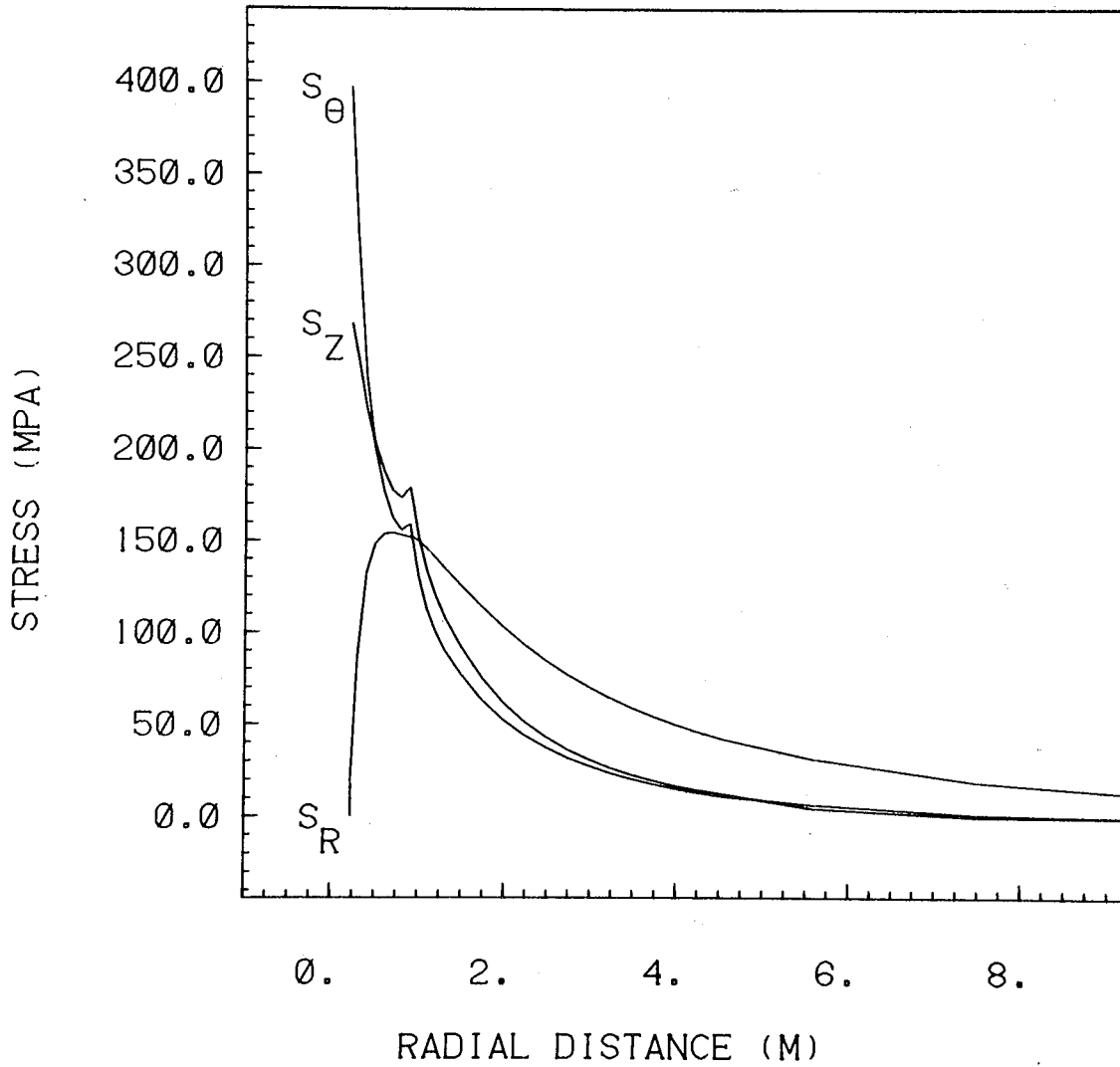

XBL 787-9701

Figure D24j

STRESS PROFILES FOR MESH 1
HANFORD FULL-SCALE EXPERIMENT
MAIN HEATER = 5 KW
PERIPHERAL HEATER = 1 KW
Z = 0.0 M, THETA = 0.0 DEG.
760 DAYS

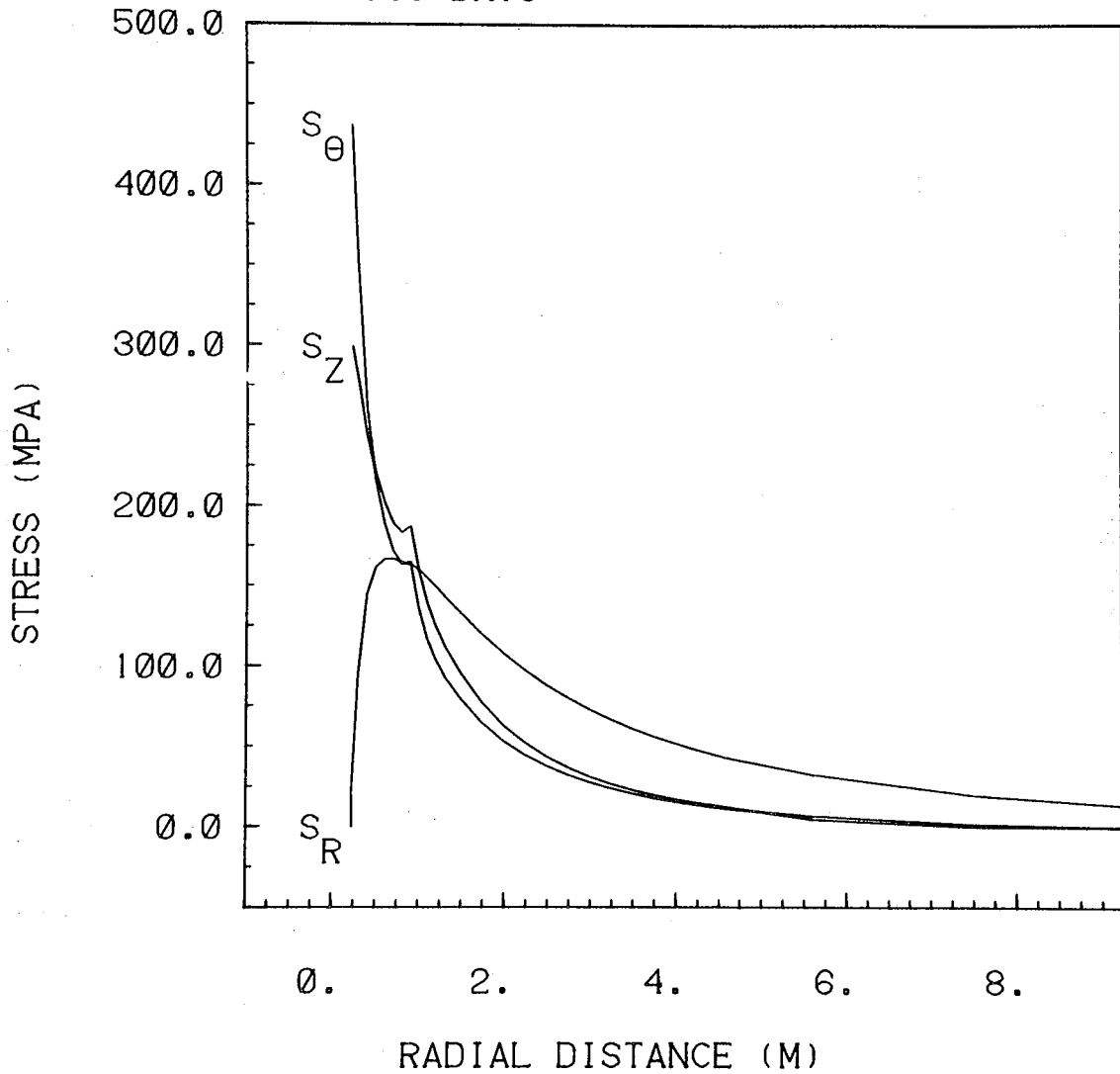

XBL 787-9702

Figure D24k

STRESS PROFILES FOR MESH 1
HANFORD FULL-SCALE EXPERIMENT
MAIN HEATER = 5 KW
PERIPHERAL HEATER = 1 KW
Z = 0.0 M, THETA = 0.0 DEG.
790 DAYS

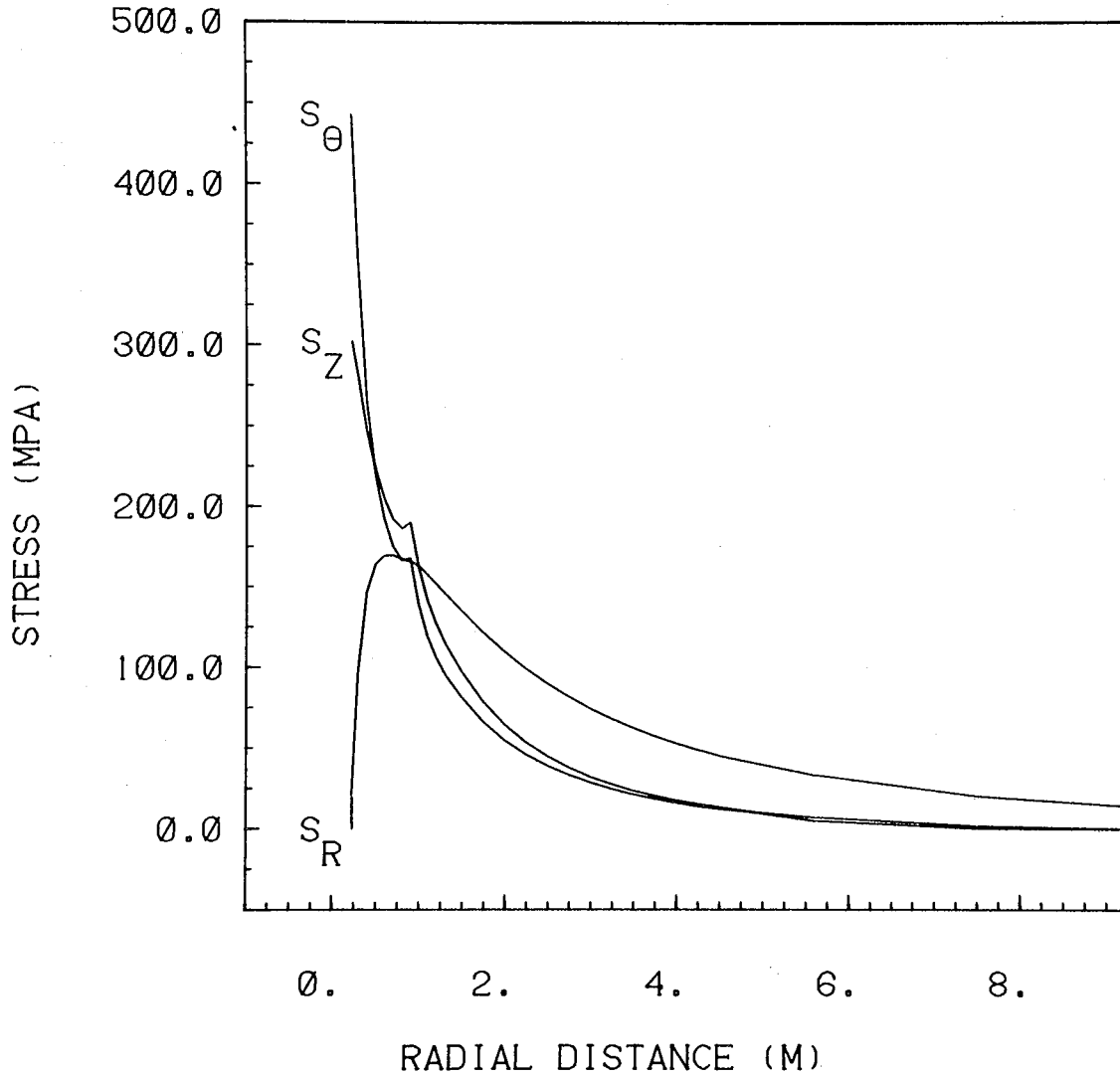

XBL 787-9703

Figure D241

STRESS PROFILES FOR MESH 1
HANFORD FULL-SCALE EXPERIMENT
MAIN HEATER = 5 KW
PERIPHERAL HEATER = 1 KW
Z = 0.0 M, THETA = 0.0 DEG.
1095 DAYS

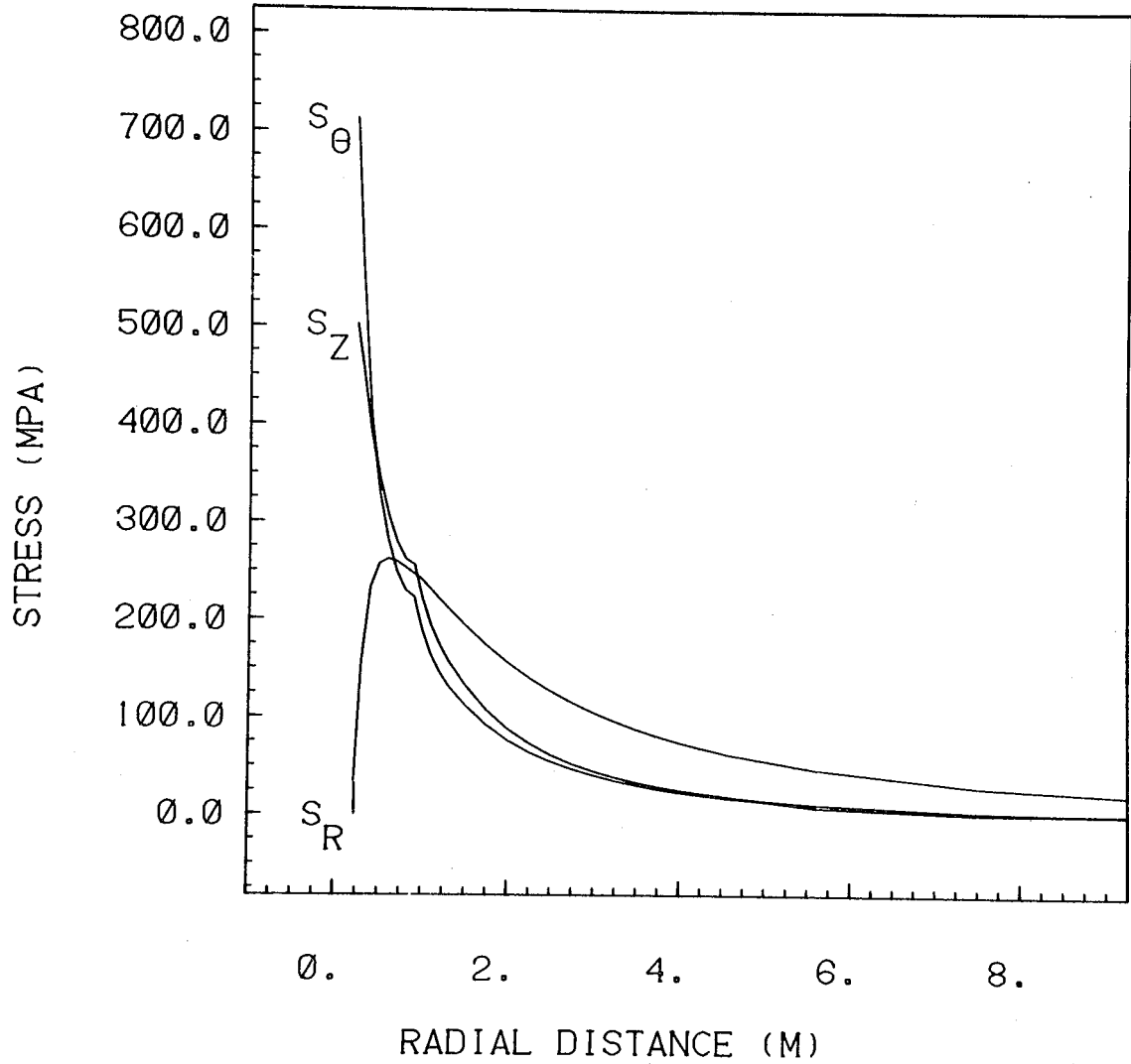

XBL 787-9704

Figure D24m

STRESS PROFILES FOR MESH 1
HANFORD FULL-SCALE EXPERIMENT
MAIN HEATER = 2 KW
PERIPHERAL HEATER = 1 KW
Z = 0.0 M, THETA = 0.0 DEG.
1 DAY

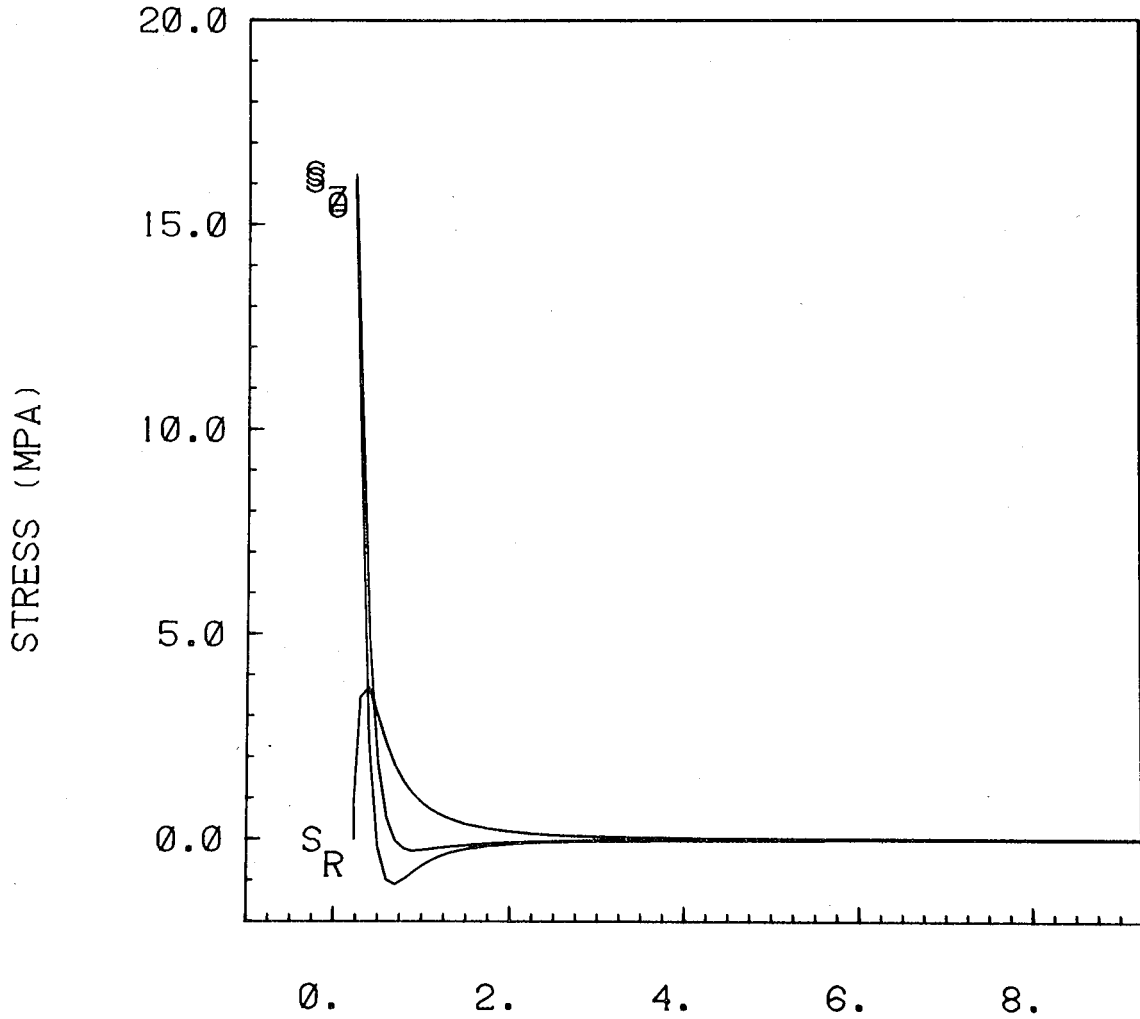

XBL 788-9864

Figure D25a

STRESS PROFILES FOR MESH 1
HANFORD FULL-SCALE EXPERIMENT
MAIN HEATER = 2 KW
PERIPHERAL HEATER = 1 KW
Z = 0.0 M, THETA = 0.0 DEG.
7 DAYS

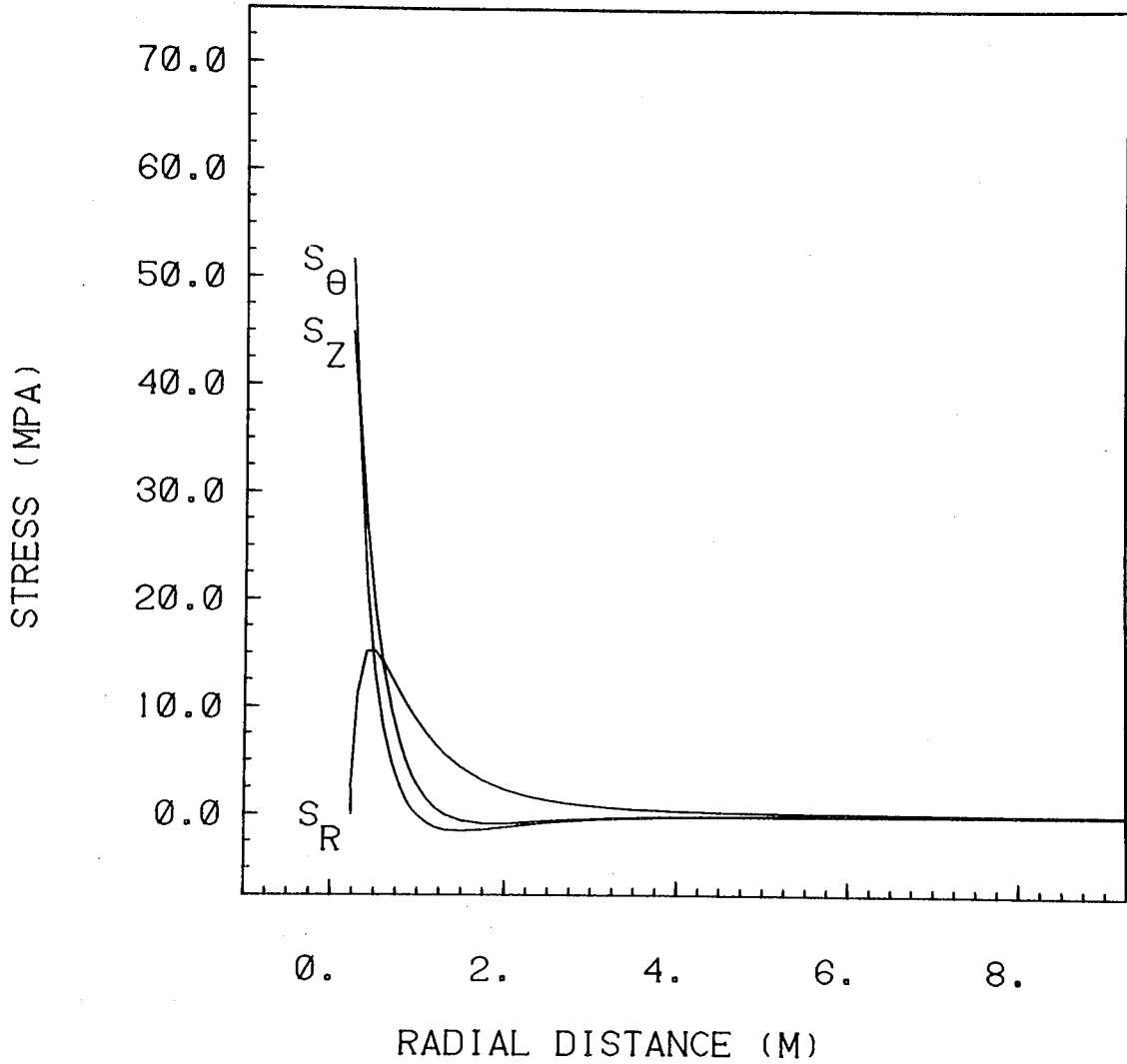

XBL 787-9717

Figure D25b

STRESS PROFILES FOR MESH 1
HANFORD FULL-SCALE EXPERIMENT
MAIN HEATER = 2 KW
PERIPHERAL HEATER = 1 KW
Z = 0.0 M, THETA = 0.0 DEG.
30 DAYS

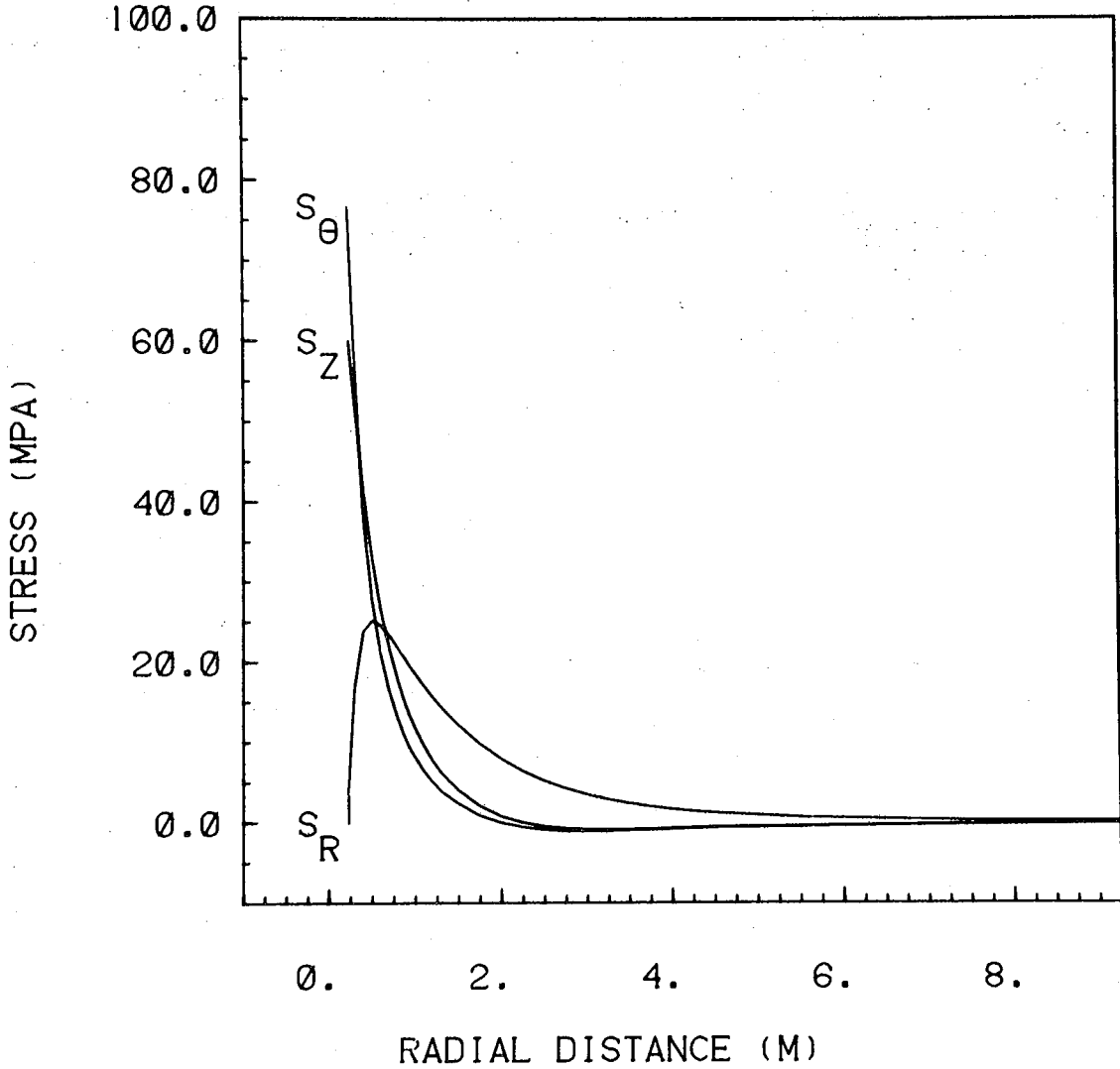

XBL 787-9718

Figure D25c

STRESS PROFILES FOR MESH 1
HANFORD FULL-SCALE EXPERIMENT
MAIN HEATER = 2 KW
PERIPHERAL HEATER = 1 KW
Z = 0.0 M, THETA = 0.0 DEG.
90 = DAYS

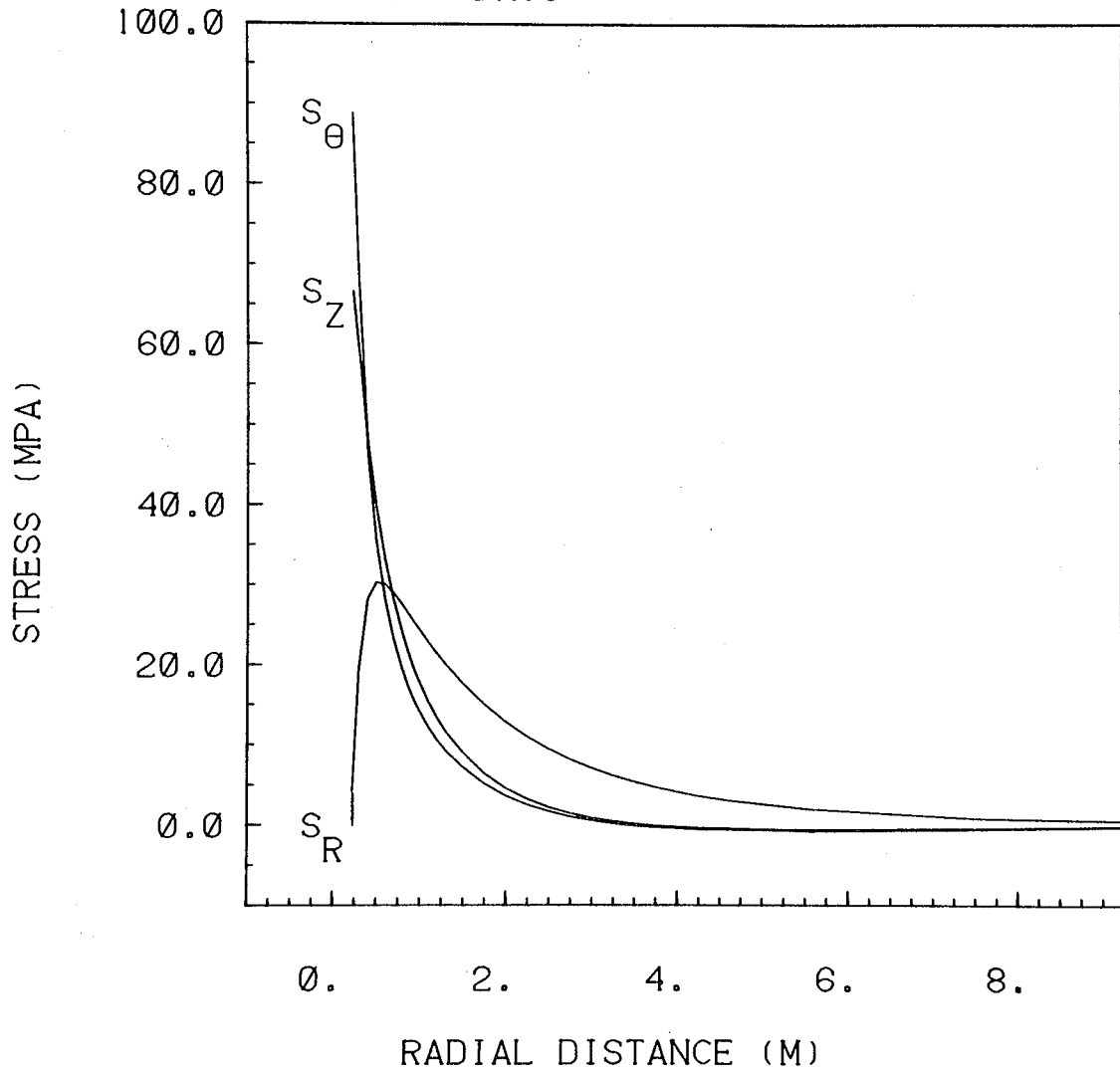

XBL 787-9719

Figure D25d

STRESS PROFILES FOR MESH 1
HANFORD FULL-SCALE EXPERIMENT
MAIN HEATER = 2 KW
PERIPHERAL HEATER = 1 KW
Z = 0.0 M, THETA = 0.0 DEG.
180 DAYS

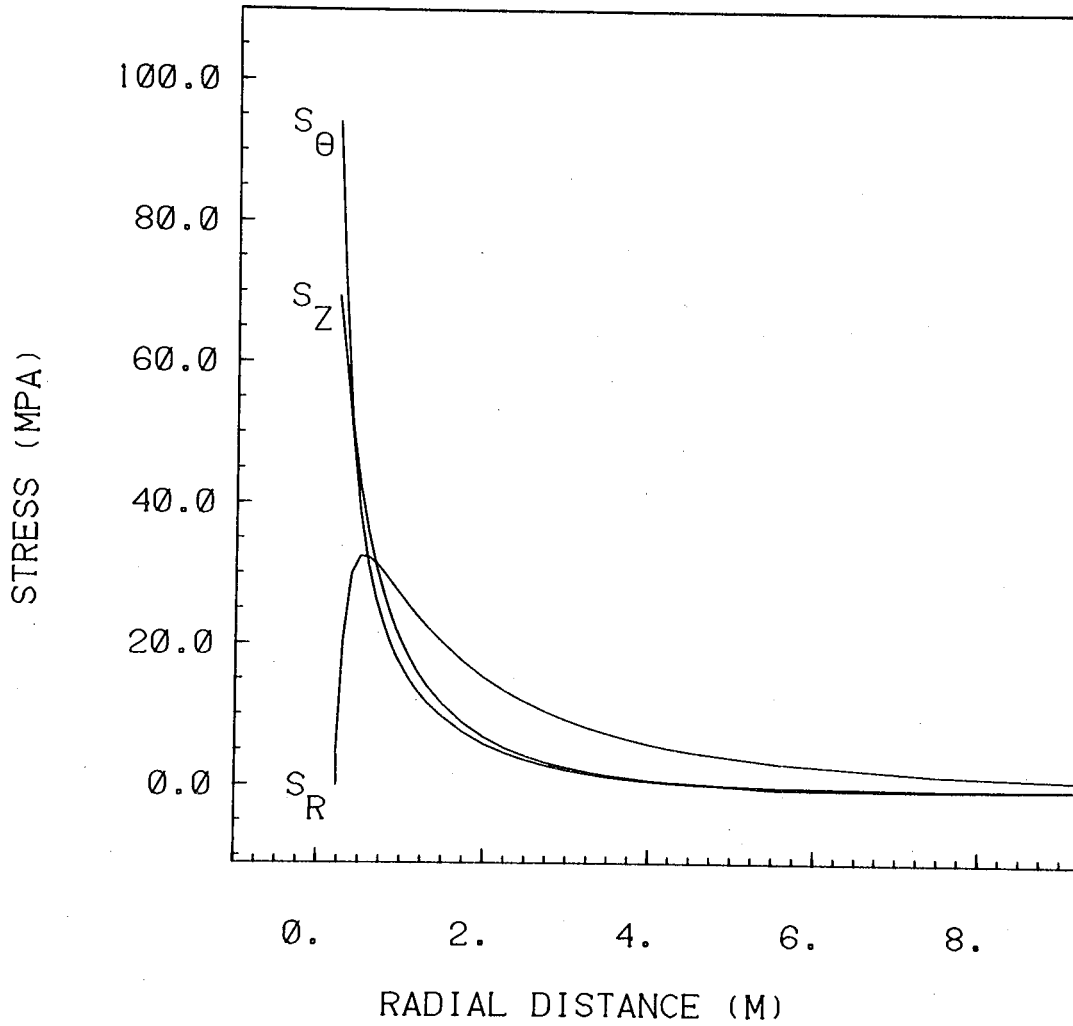

XBL 787-9720

Figure D25e

STRESS PROFILES FOR MESH 1
HANFORD FULL-SCALE EXPERIMENT
MAIN HEATER = 2 KW
PERIPHERAL HEATER = 1 KW
Z = 0.0 M, THETA = 0.0 DEG.
365 DAYS

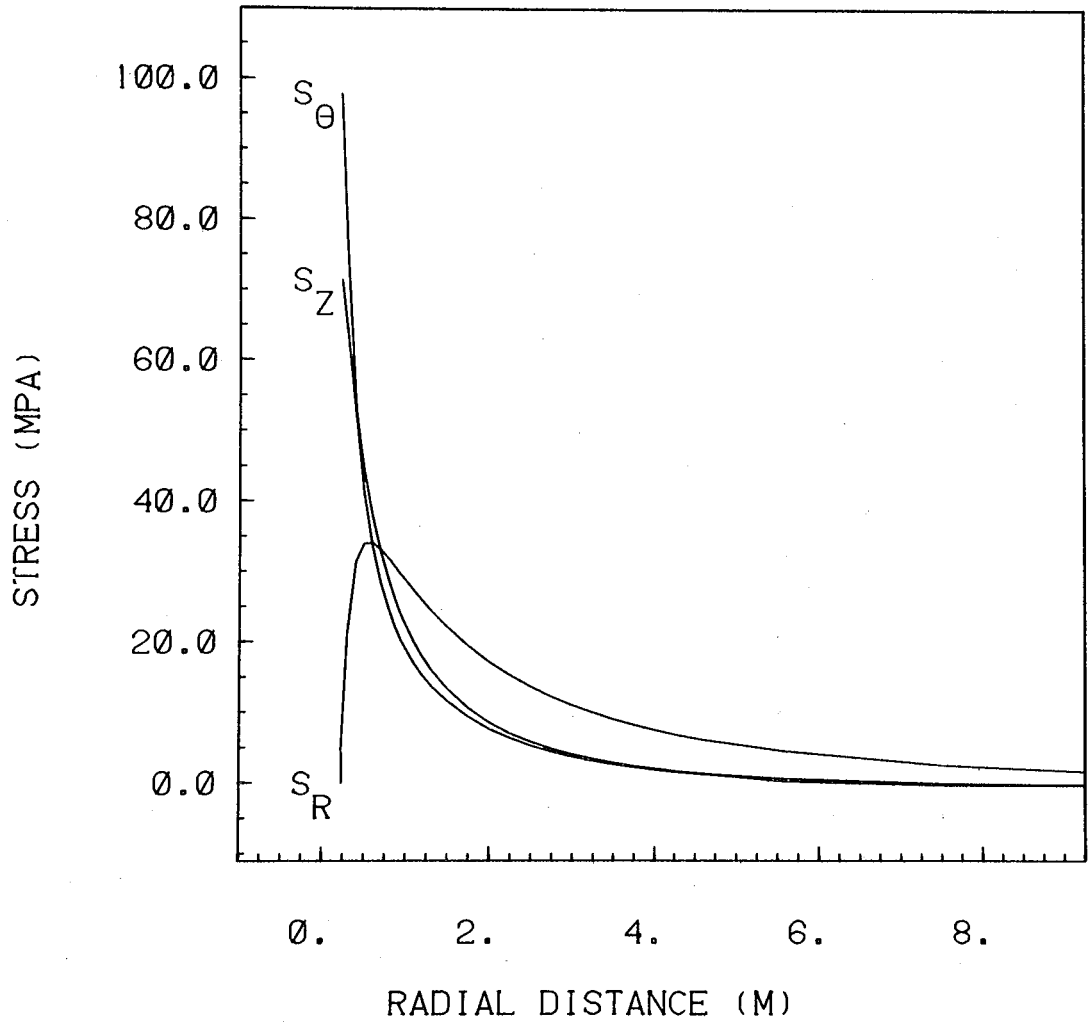

XBL 787-9721

Figure D25f

STRESS PROFILES FOR MESH 1
HANFORD FULL-SCALE EXPERIMENT
MAIN HEATER = 2 KW
PERIPHERAL HEATER = 1 KW
Z = 0.0 M, THETA = 0.0 DEG.
371 DAYS

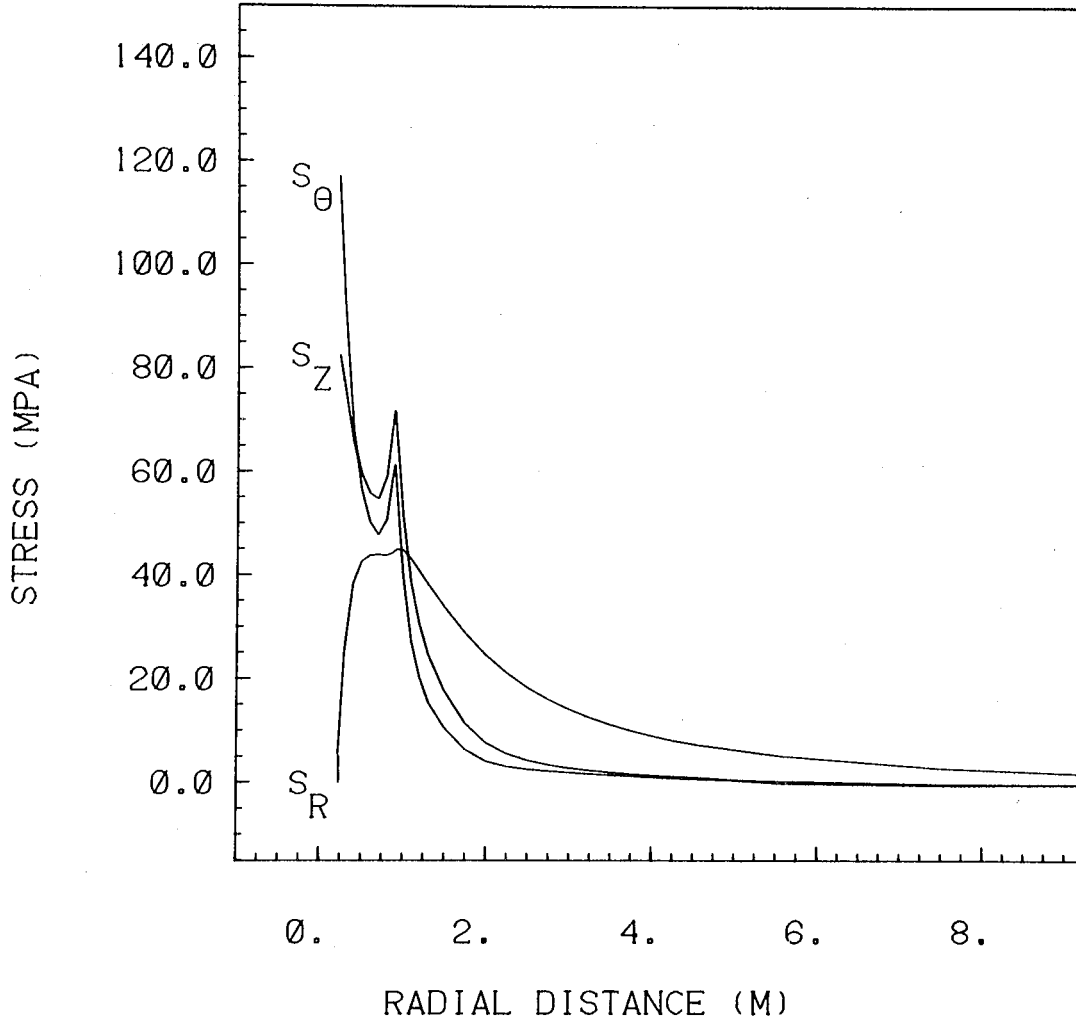

XBL 787-9722

Figure D25g

STRESS PROFILES FOR MESH 1
HANFORD FULL-SCALE EXPERIMENT
MAIN HEATER = 2 KW
PERIPHERAL HEATER = 1 KW
Z = 0.0 M, THETA = 0.0 DEG.
390 DAYS

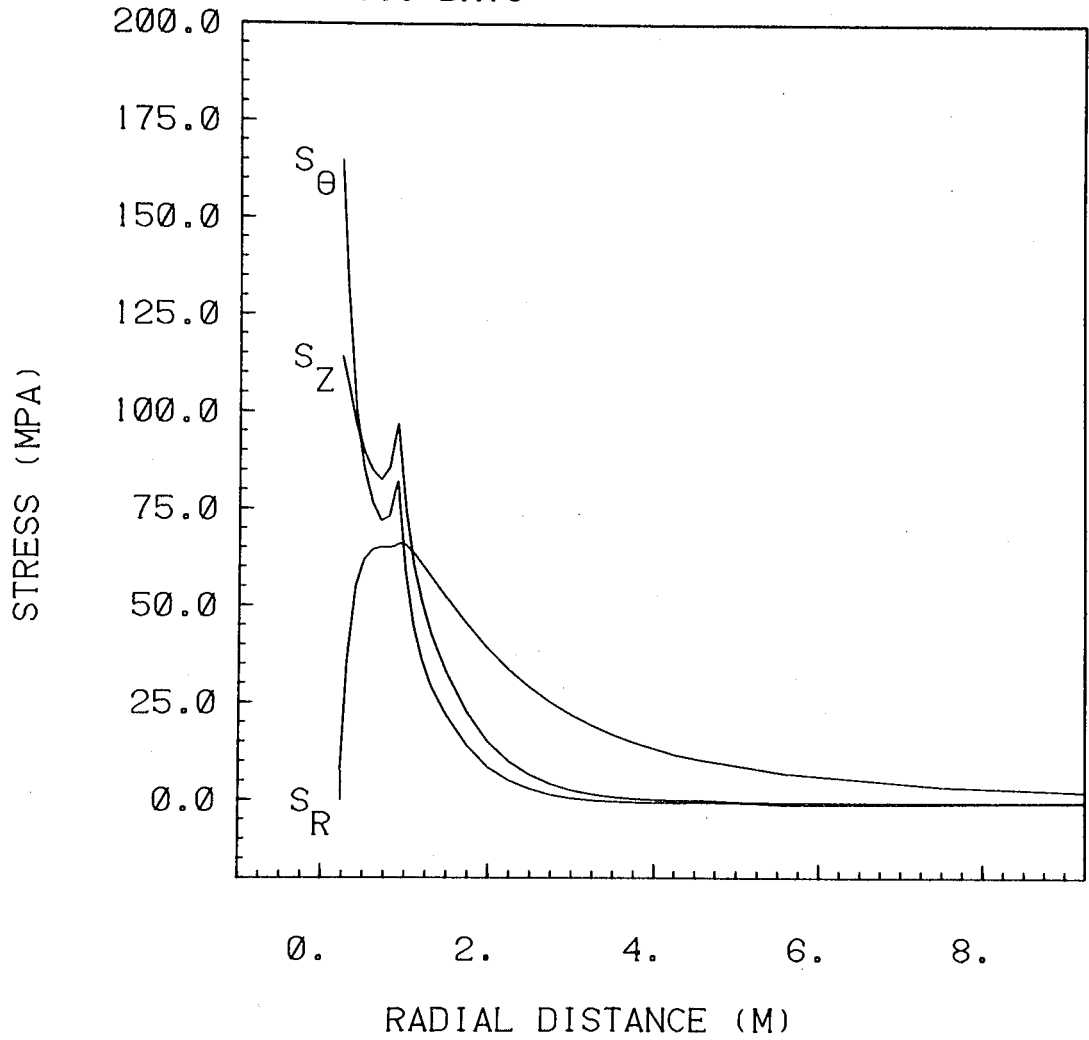

XBL 787-9723

Figure D25h

STRESS PROFILES FOR MESH 1
HANFORD FULL-SCALE EXPERIMENT
MAIN HEATER = 2 KW
PERIPHERAL HEATER = 1 KW
Z = 0.0 M, THETA = 0.0 DEG.
450 DAYS

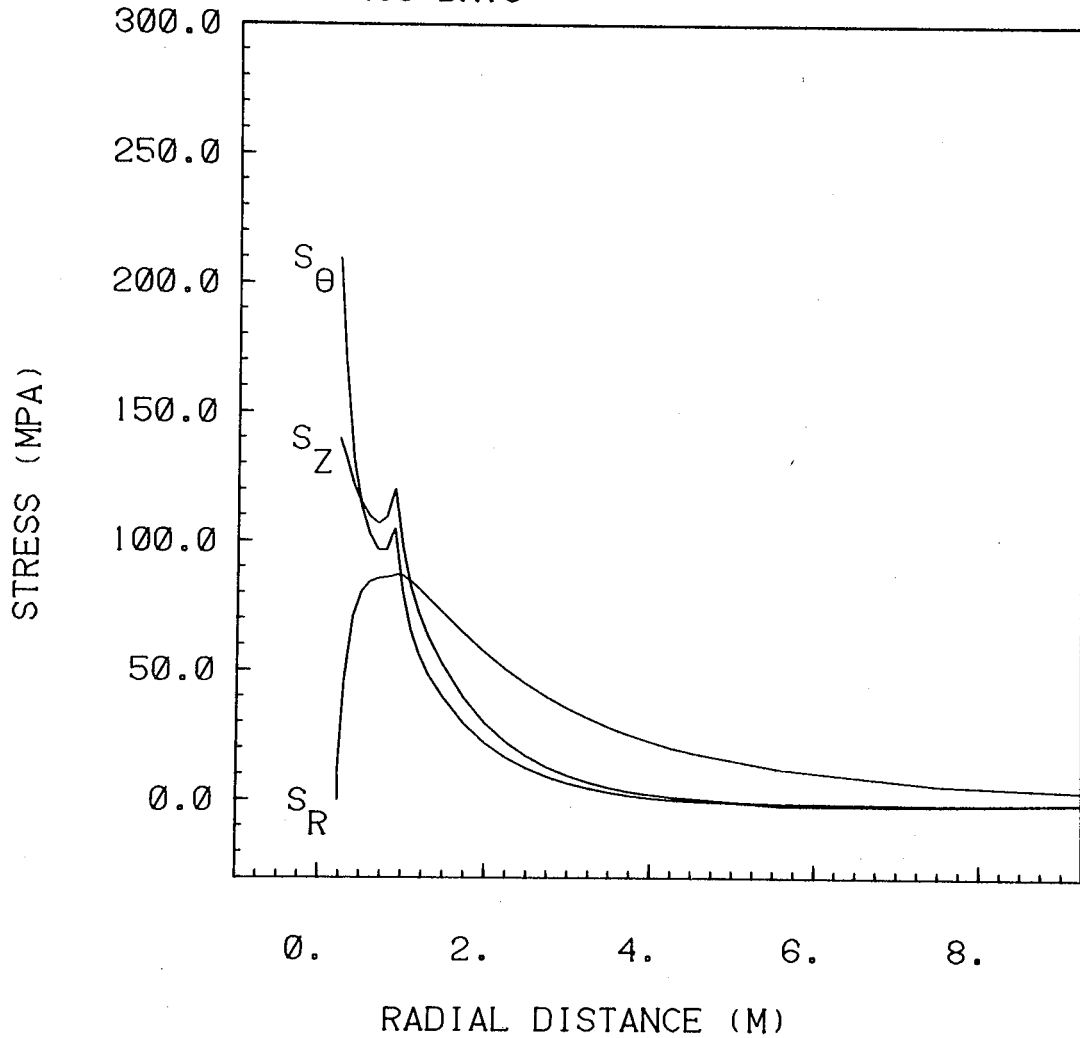

XBL 787-9724

Figure D25i

STRESS PROFILES FOR MESH 1
HANFORD FULL-SCALE EXPERIMENT
MAIN HEATER = 2 KW
PERIPHERAL HEATER = 1 KW
Z = 0.0 M, THETA = 0.0 DEG.
730 DAYS

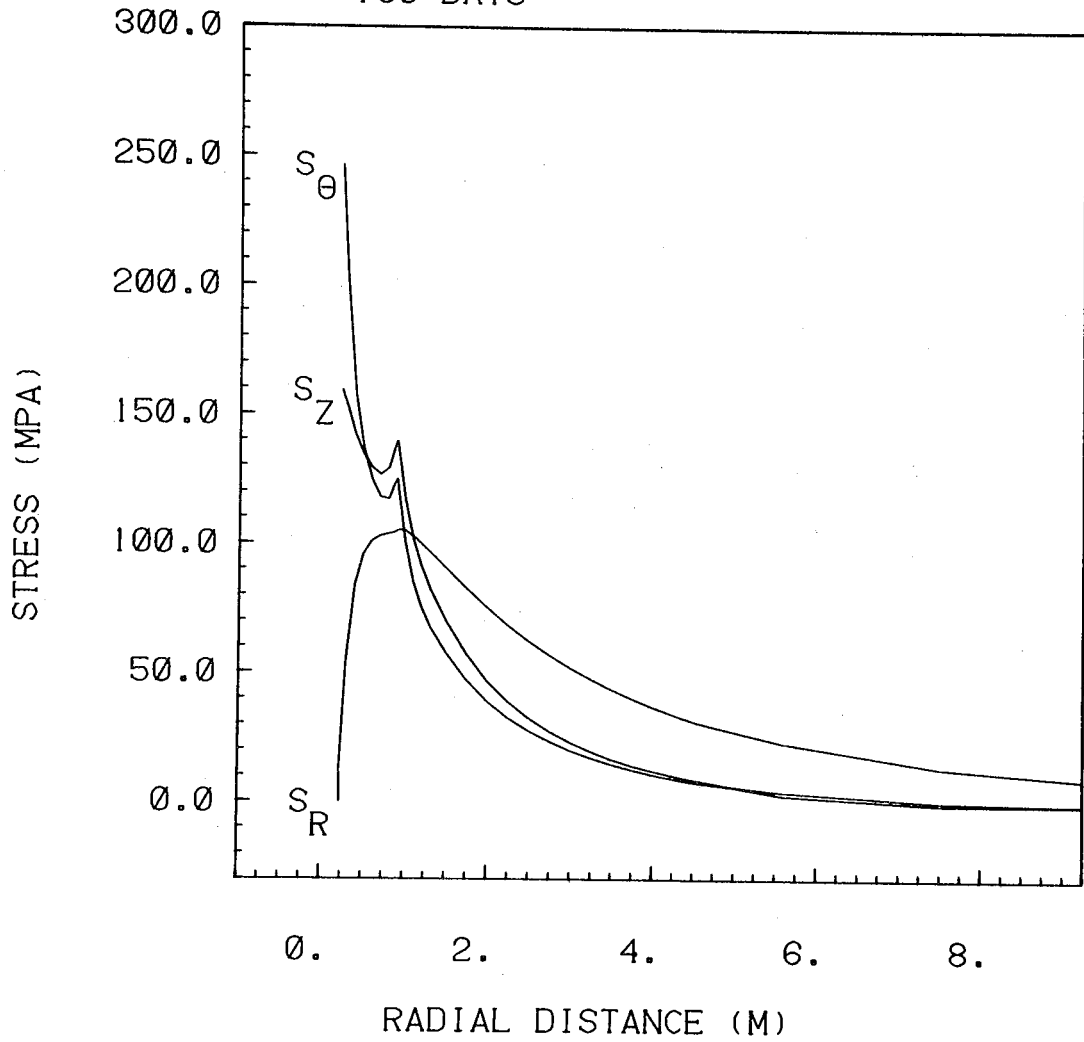

XBL 787-9725

Figure D25j

STRESS PROFILES FOR MESH 1
HANFORD FULL-SCALE EXPERIMENT
MAIN HEATER = 2 KW
PERIPHERAL HEATER = 1 KW
Z = 0.0 M, THETA = 0.0 DEG.
760 DAYS

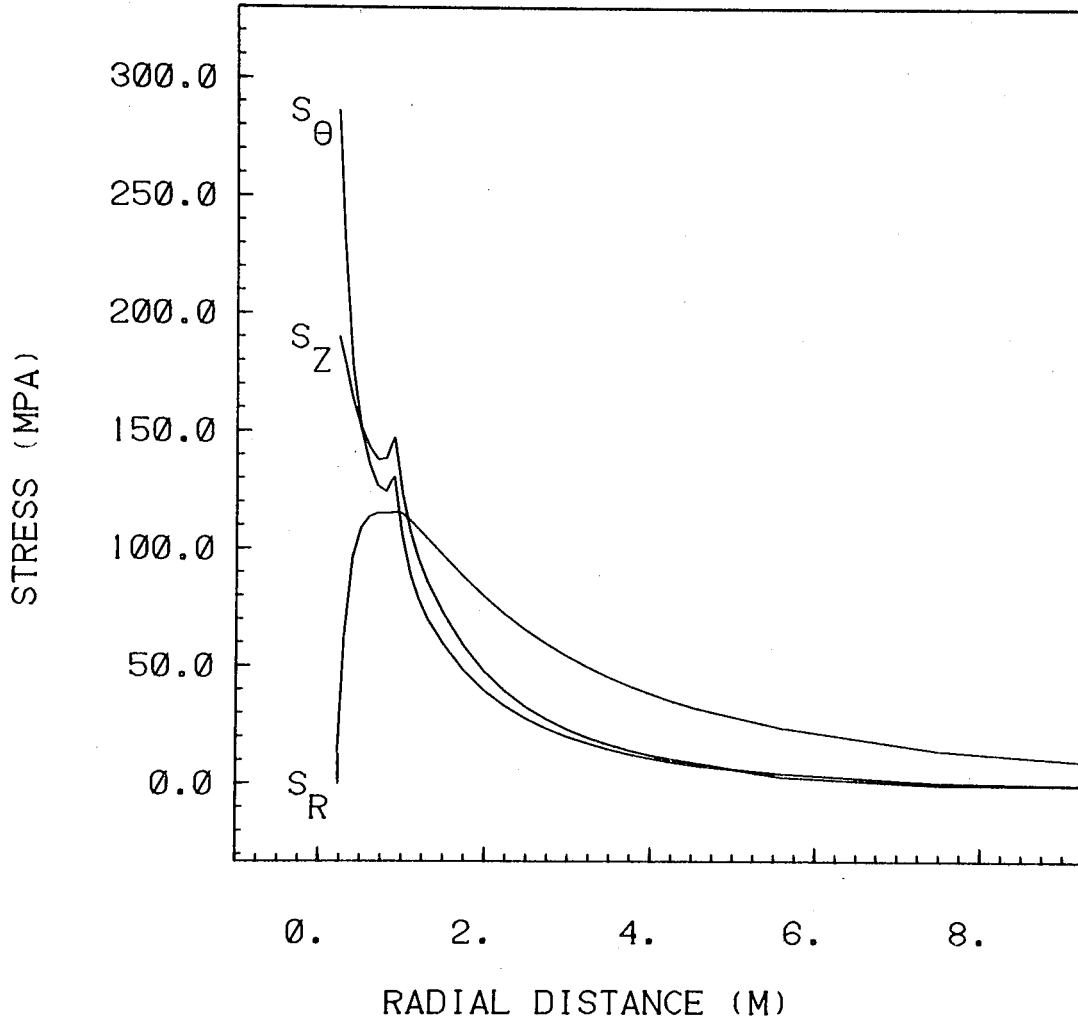

XBL 787-9726

Figure D25k

STRESS PROFILES FOR MESH 1
HANFORD FULL-SCALE EXPERIMENT
MAIN HEATER = 2 KW
PERIPHERAL HEATER = 1 KW
Z = 0.0 M, THETA = 0.0 DEG.
790 DAYS

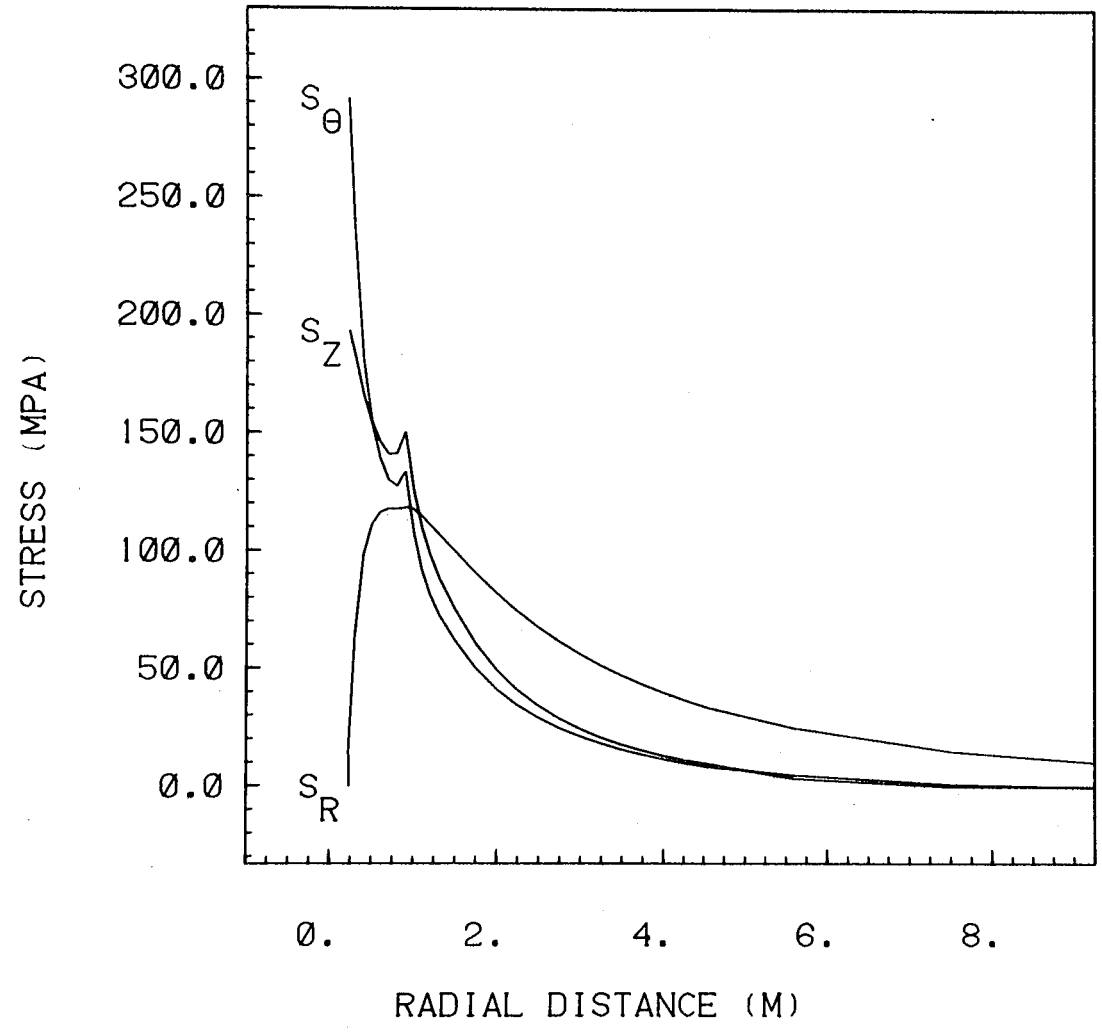

XBL 787-9727

Figure D251

STRESS PROFILES FOR MESH 1
HANFORD FULL-SCALE EXPERIMENT
MAIN HEATER = 2 KW
PERIPHERAL HEATER = 1 KW
Z = 0.0 M, THETA = 0.0 DEG.
1095 DAYS

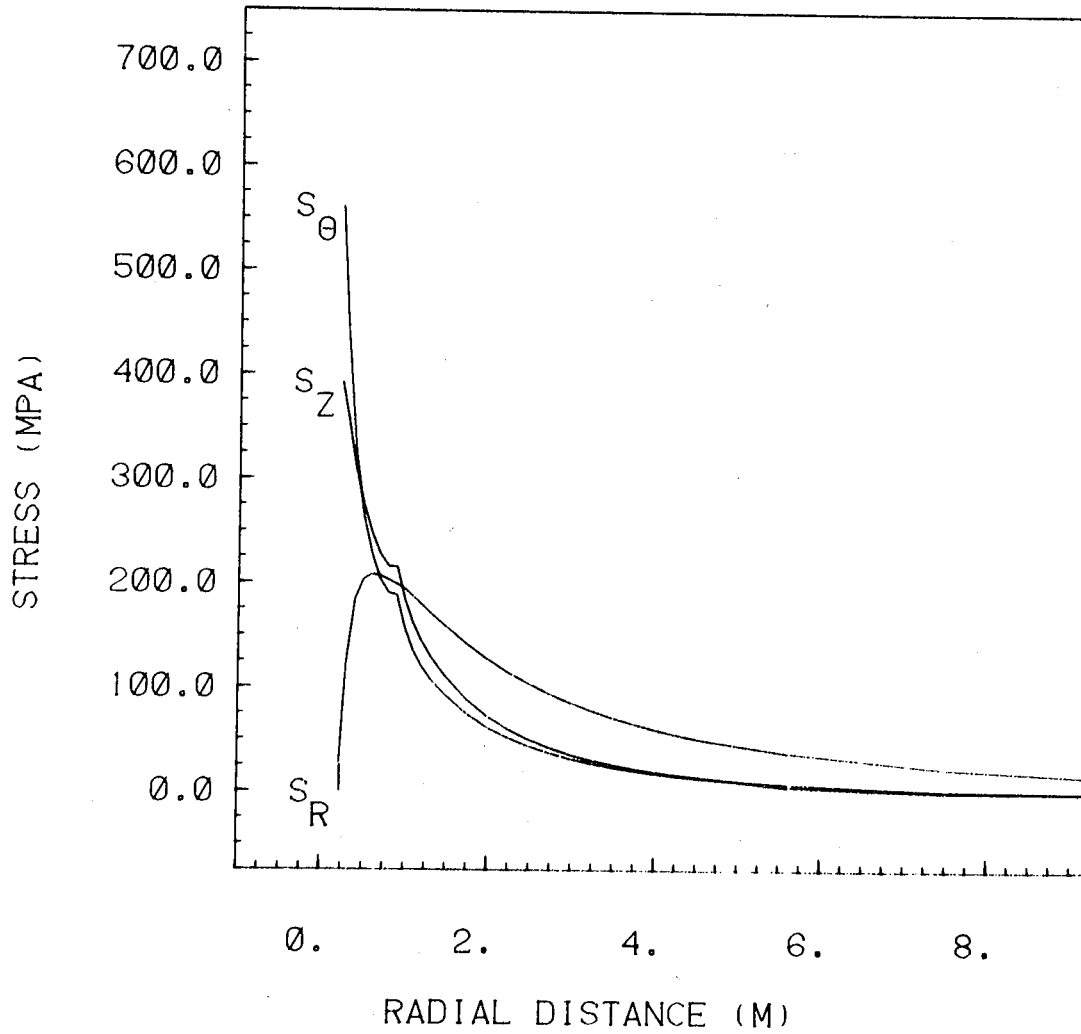

XBL 787-9728

Figure D25m

HANFORD FULL-SCALE EXPERIMENT
Stress-THETA along floor of drift, Z=3.875 m
Mesh 7, 730 days

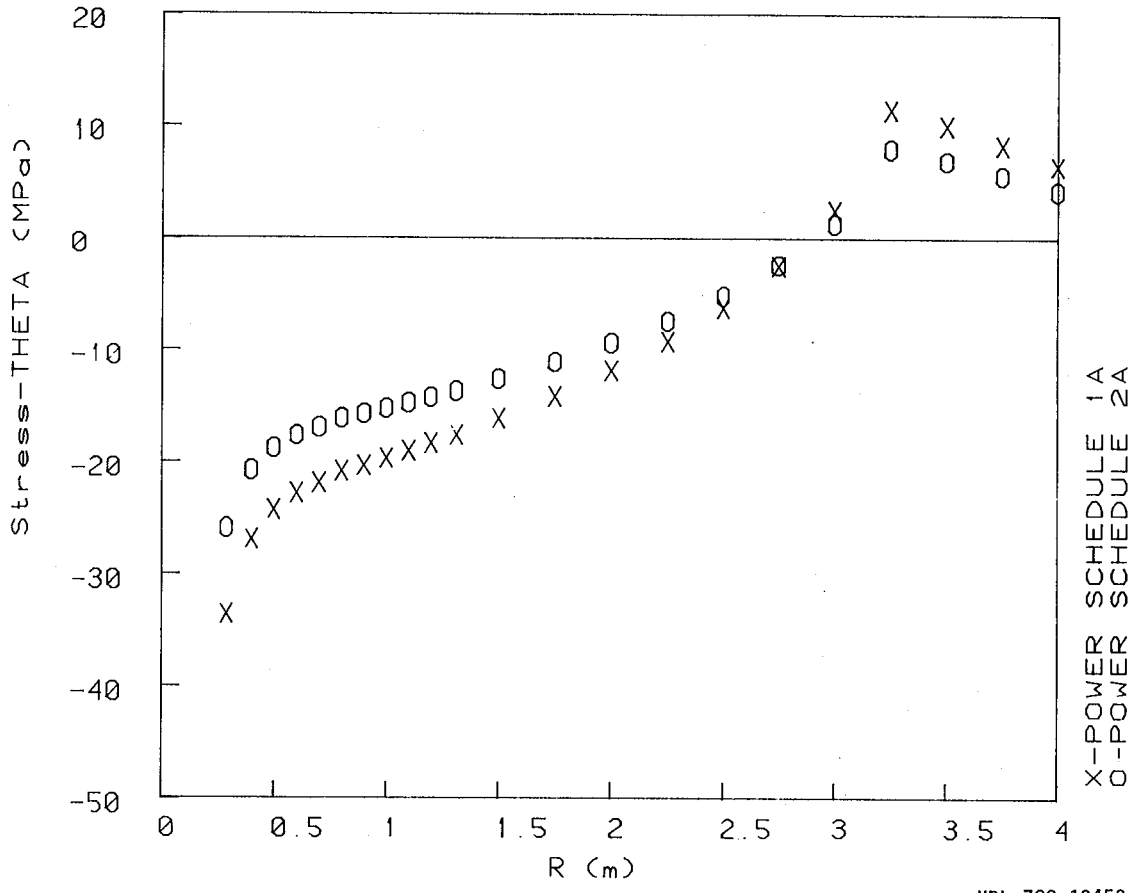

XBL 788-10453

Figure D26a

HANFORD FULL-SCALE EXPERIMENT
Stress-THETA along floor of drift, Z=3.875m
Mesh 7, 1095 days

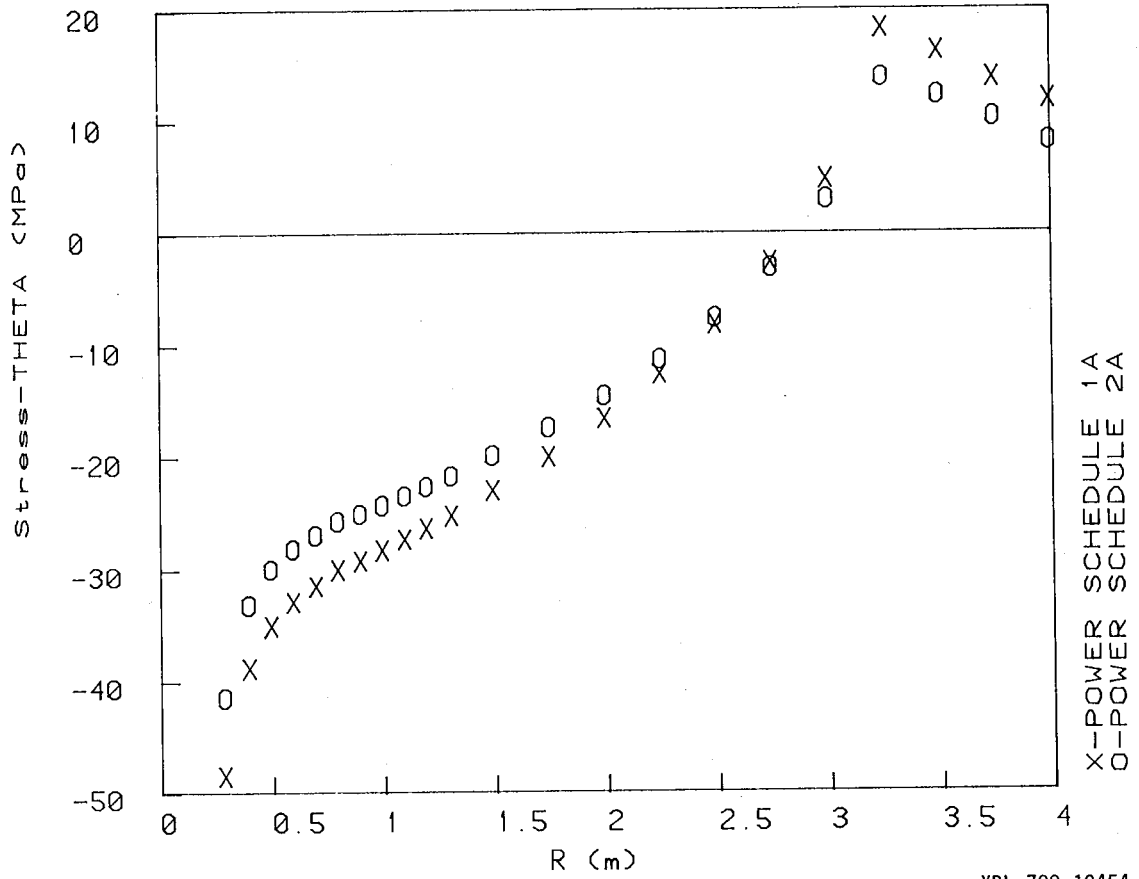
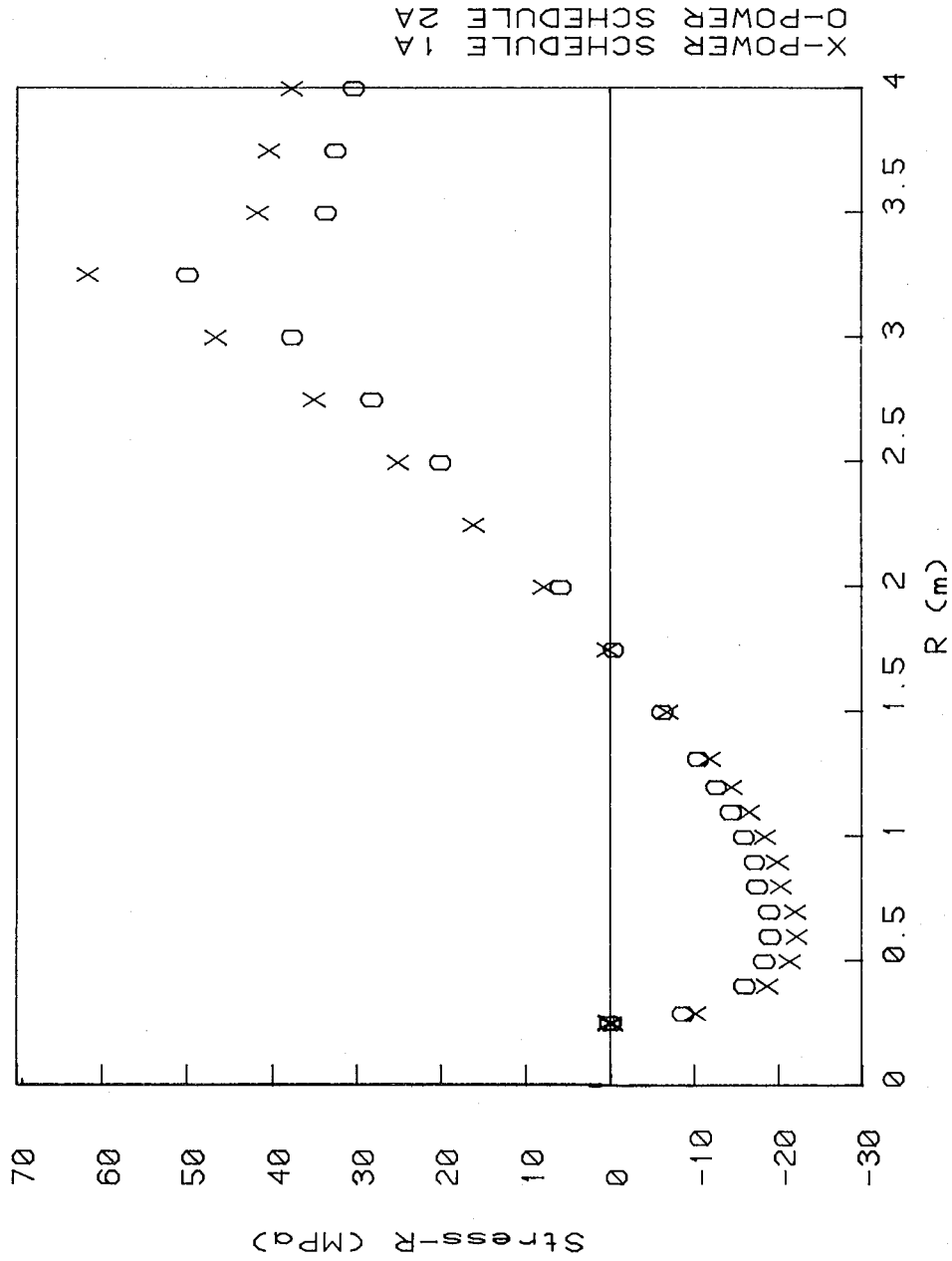

Figure D26b

HANFORD FULL-SCALE EXPERIMENT
Stress-R along floor of heater drift, Z=3.875m
Mesh 7, 1095 days



XBL 7810-11829

Figure D27a

HANFORD FULL-SCALE EXPERIMENT
Stress-R along floor of heater drift, Z=3.875m
Mesh 7, 730 days

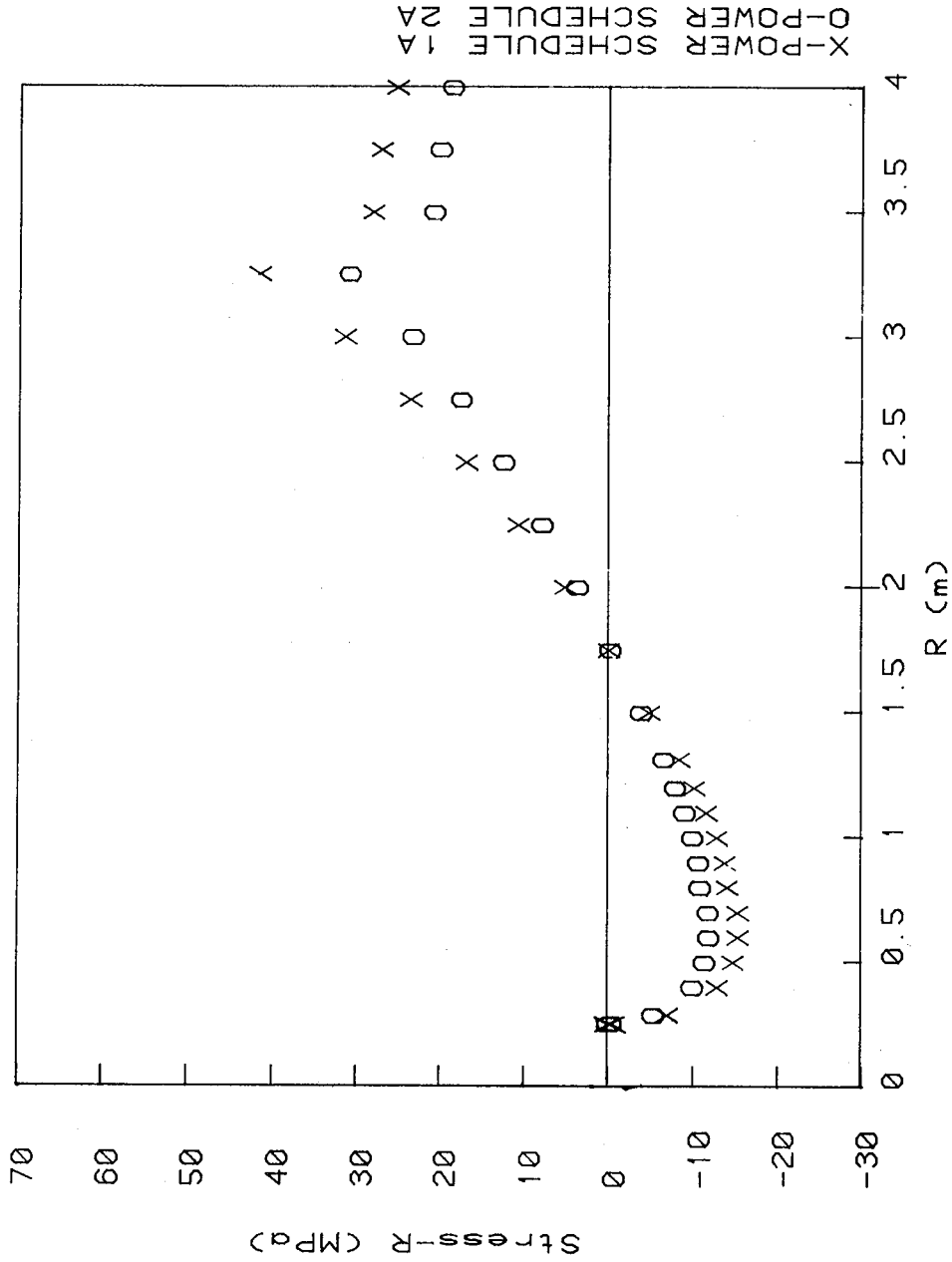

XBL 7810-11828

Figure D27b

INTERFERENCE BETWEEN THE TWO FULL-SCALE EXPERIMENTS
Combined temperature profile at $Z=0$ m, $\text{THETA}=0$ deg.
Infinite Medium Model, 730 days

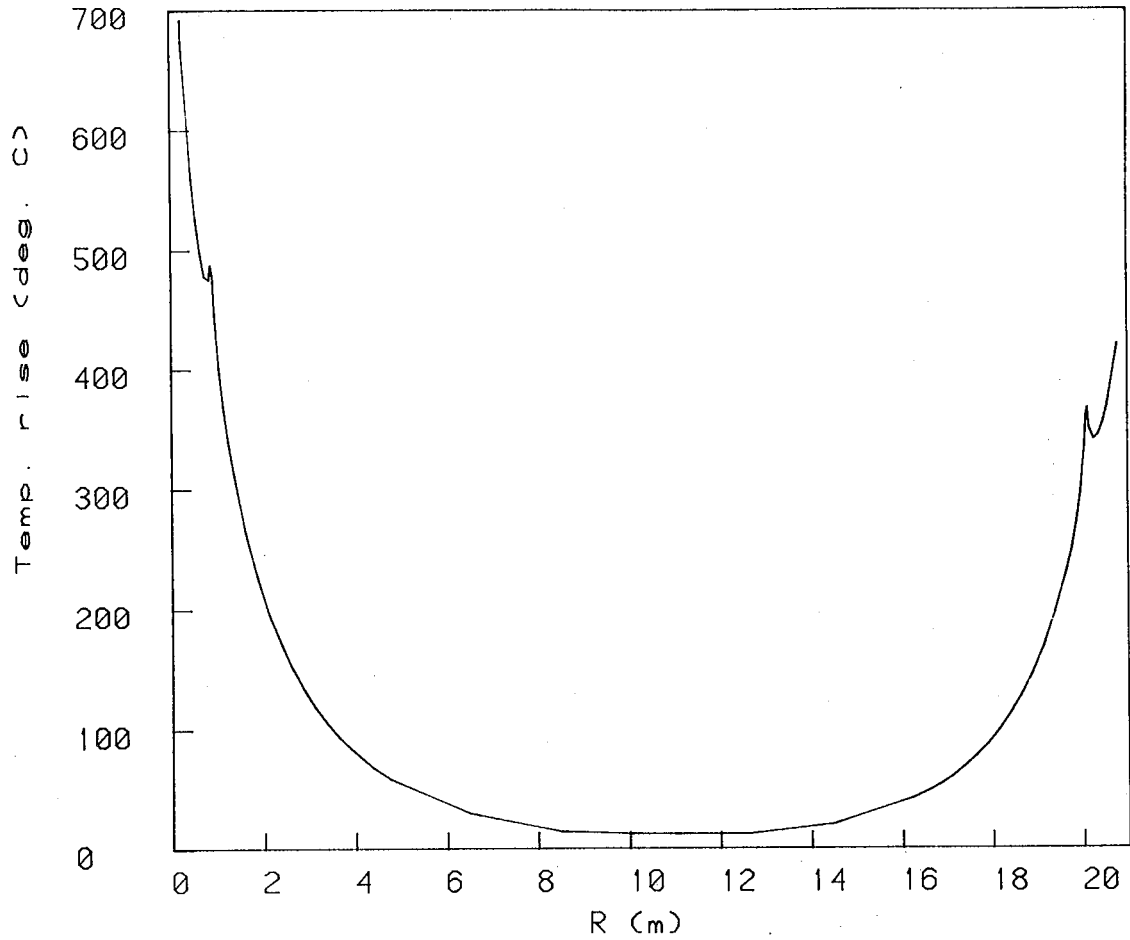

XBL 788-10457

Figure D28a

INTERFERENCE BETWEEN THE TWO FULL-SCALE EXPERIMENTS
Combined temperature profile at $Z=0$ m, $\text{THETA}=0$ deg.
Infinite Medium Model, 1095 days

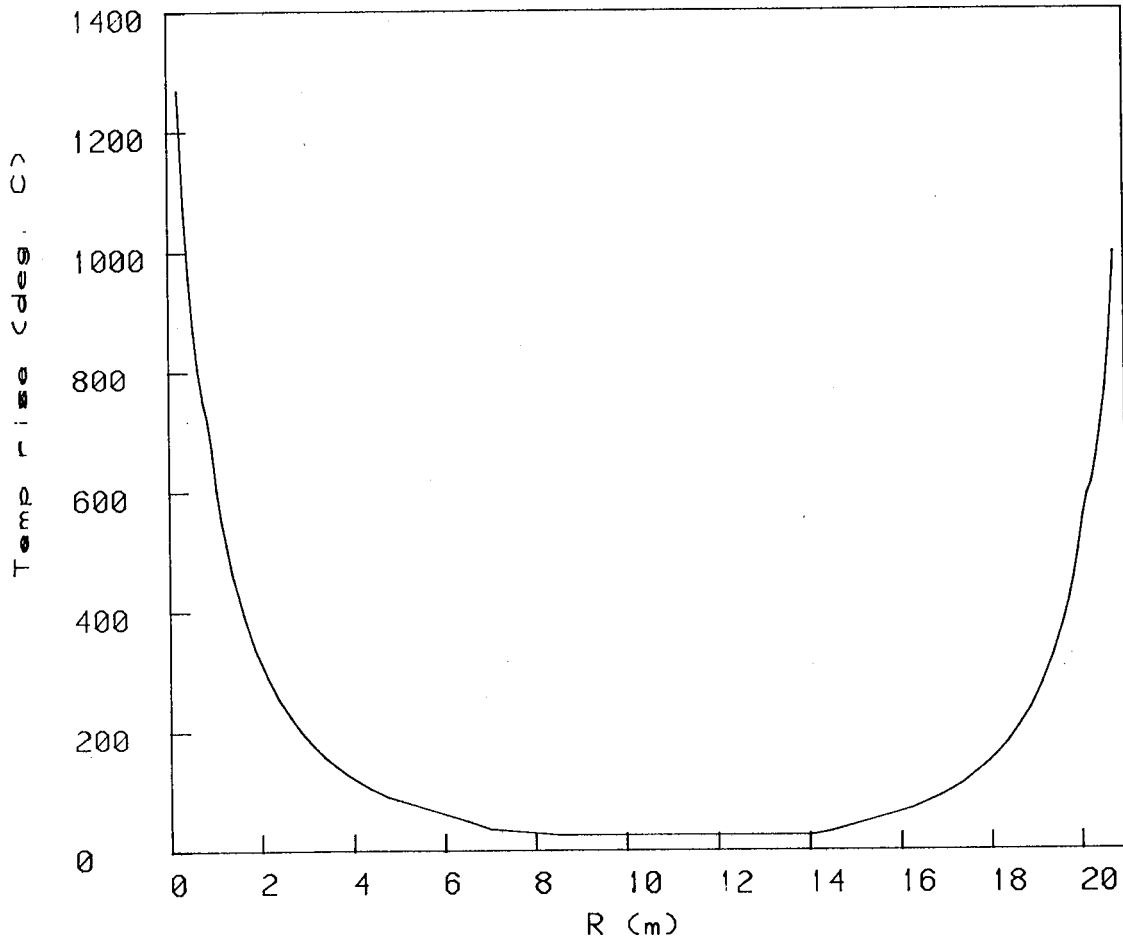

XBL 788-10458

Figure D28b

INTERFERENCE BETWEEN TWO FULL-SCALE EXPERIMENTS
Stress-R profiles at Z=0.0m, THETA=0 deg.
Mesh 1, 730 days

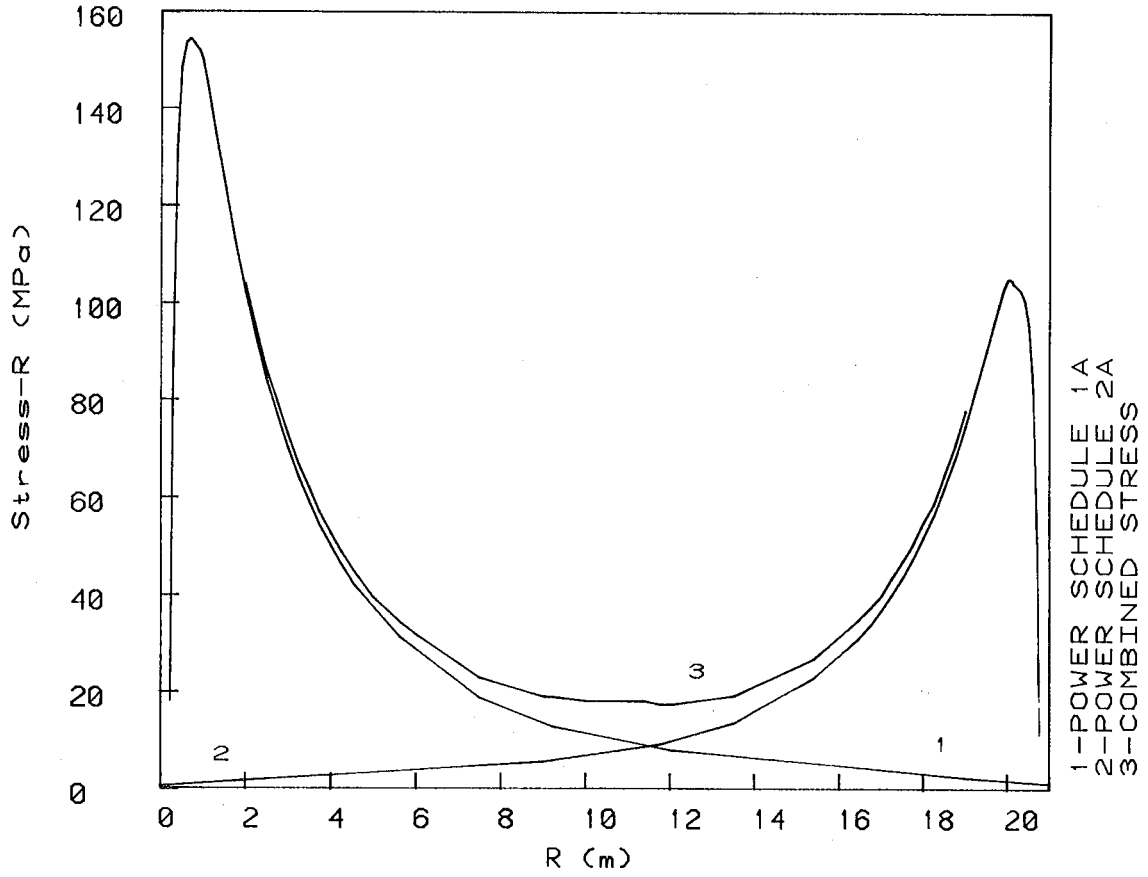

XBL 788-10461

Figure D29a

INTERFERENCE BETWEEN TWO FULL-SCALE EXPERIMENTS
Stress-R profiles at Z=0.0m, THETA=0 deg.
Mesh 1, 1095 days

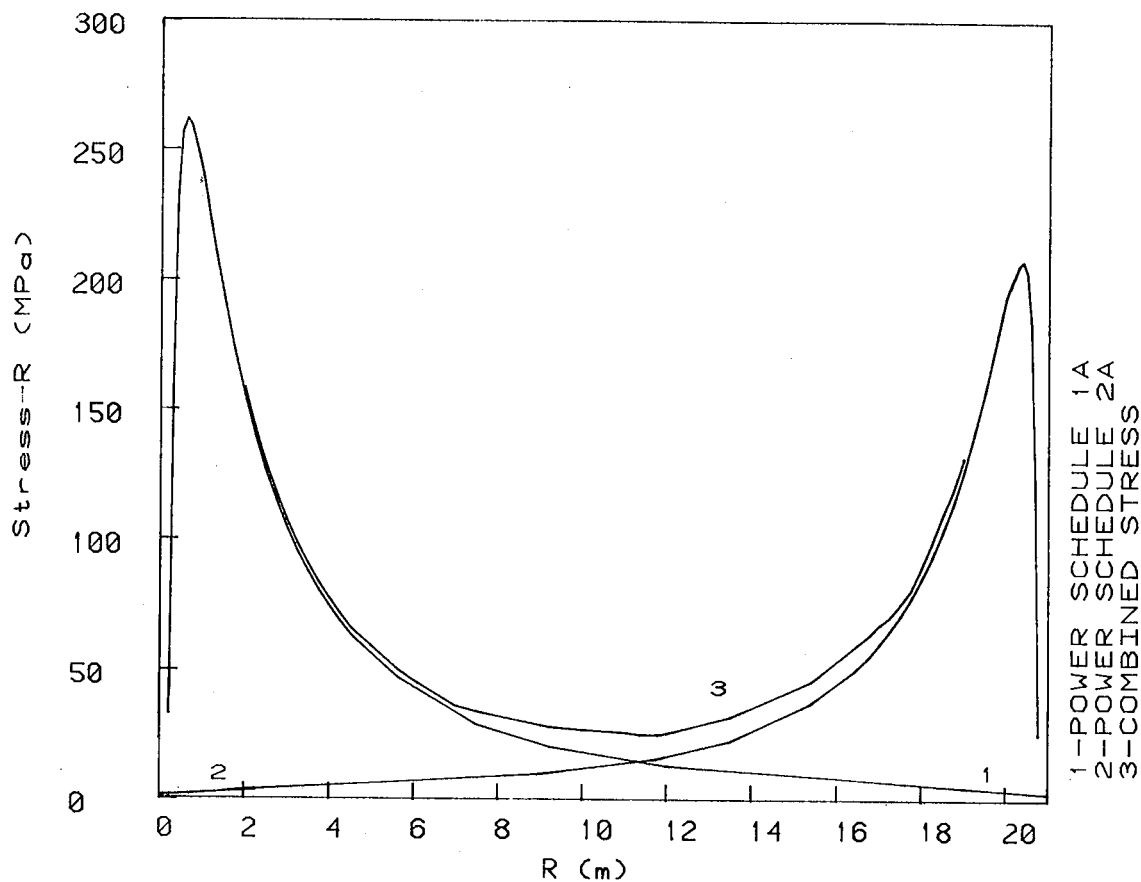

XBL 788-10462

Figure D29b

INTERFERENCE BETWEEN TWO FULL-SCALE EXPERIMENTS
Displacement (U_r) profiles at $Z=0.0m$, $\theta=0$ deg.
Mesh 1, 730 days

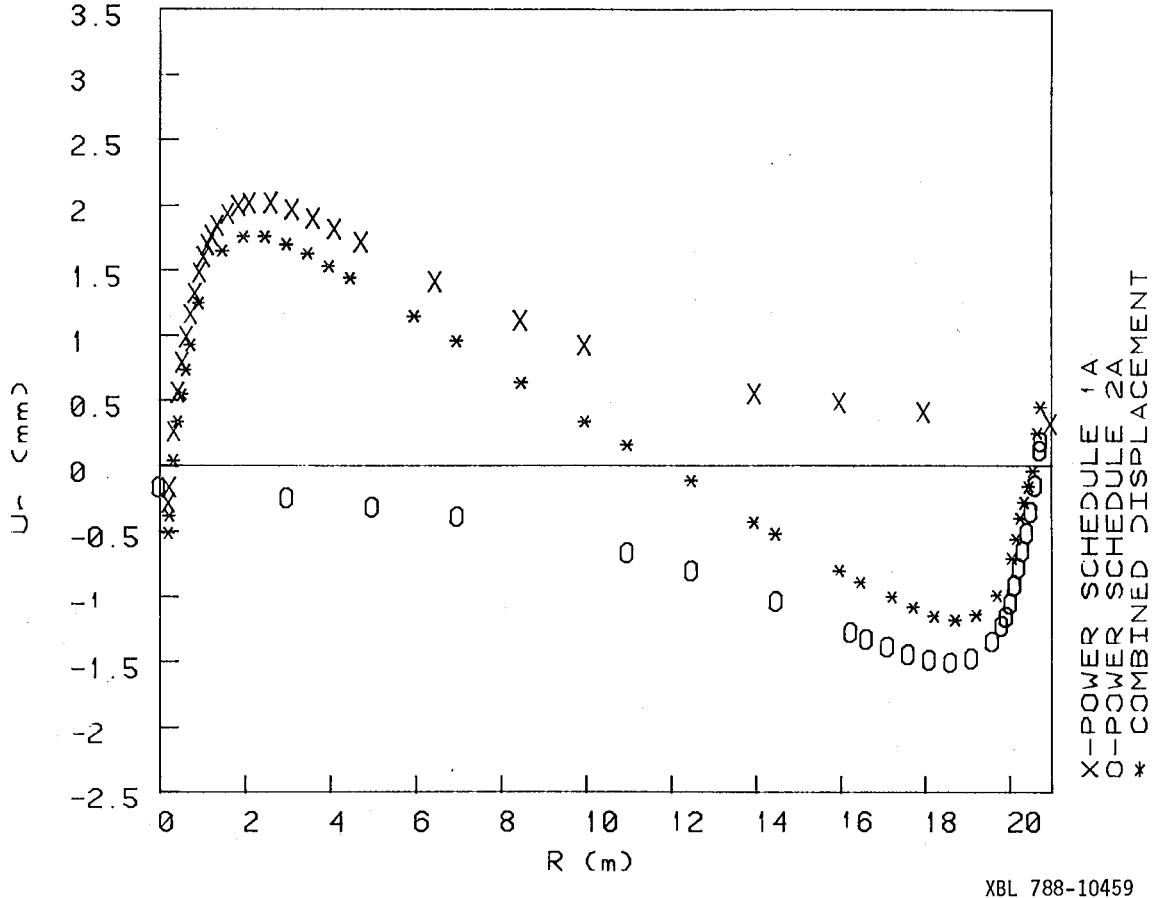

Figure D30a

INTERFERENCE BETWEEN TWO FULL-SCALE EXPERIMENTS
Displacement (U_r) profiles at $Z=0m$, $\theta=0$ deg.
Mesh 1, 1095 days

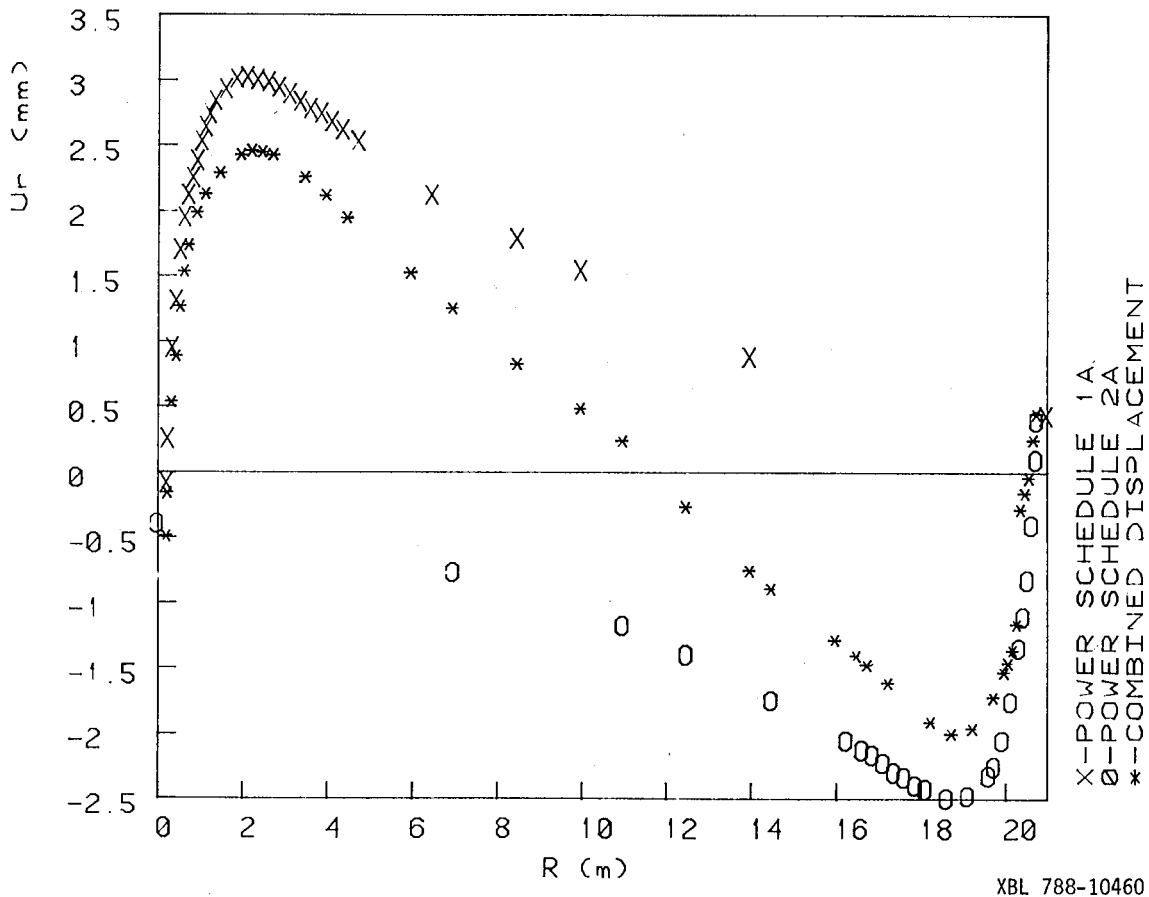
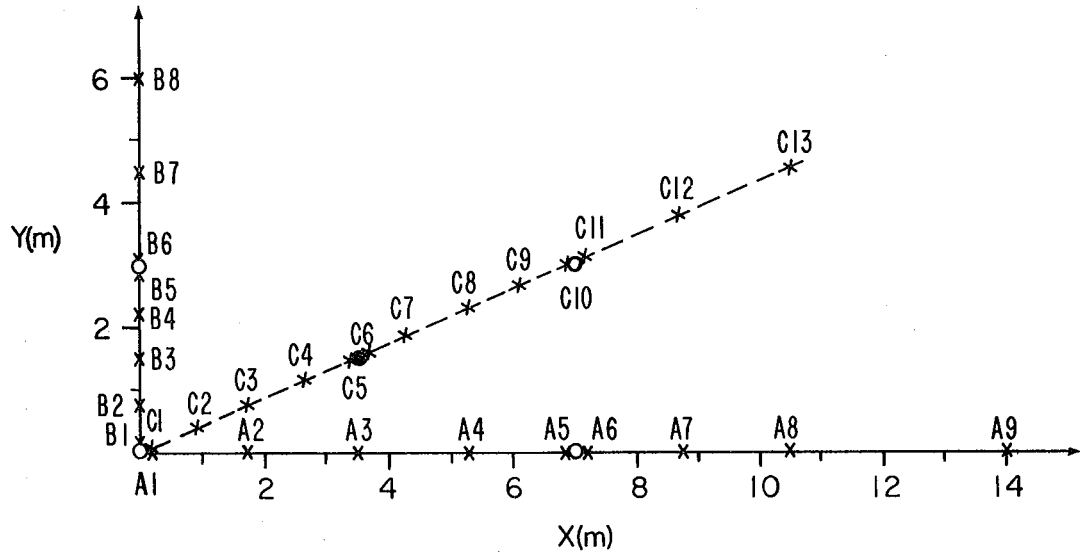

Figure D30b

QUARTER PLANE SHOWING LOCATIONS AT WHICH TEMPERATURE PROFILES WERE MADE

Hanford time-scaled experiment



- PRIMARY HEATERS, ENERGIZED AT THE START OF EXPERIMENT.
- SECONDARY HEATERS, ENERGIZED TWO YEARS AFTER THE START OF EXPERIMENT.
(Heaters not drawn to scale).

XBL 788-2014

Figure D31a

HANFORD TIME-SCALE EXPERIMENT
POWER SCHEDULE 3

LABEL	X	Y	Z
A 9	14.0000	0.0000	0.0000
A 8	10.5000	0.0000	0.0000
A 7	8.7500	0.0000	0.0000

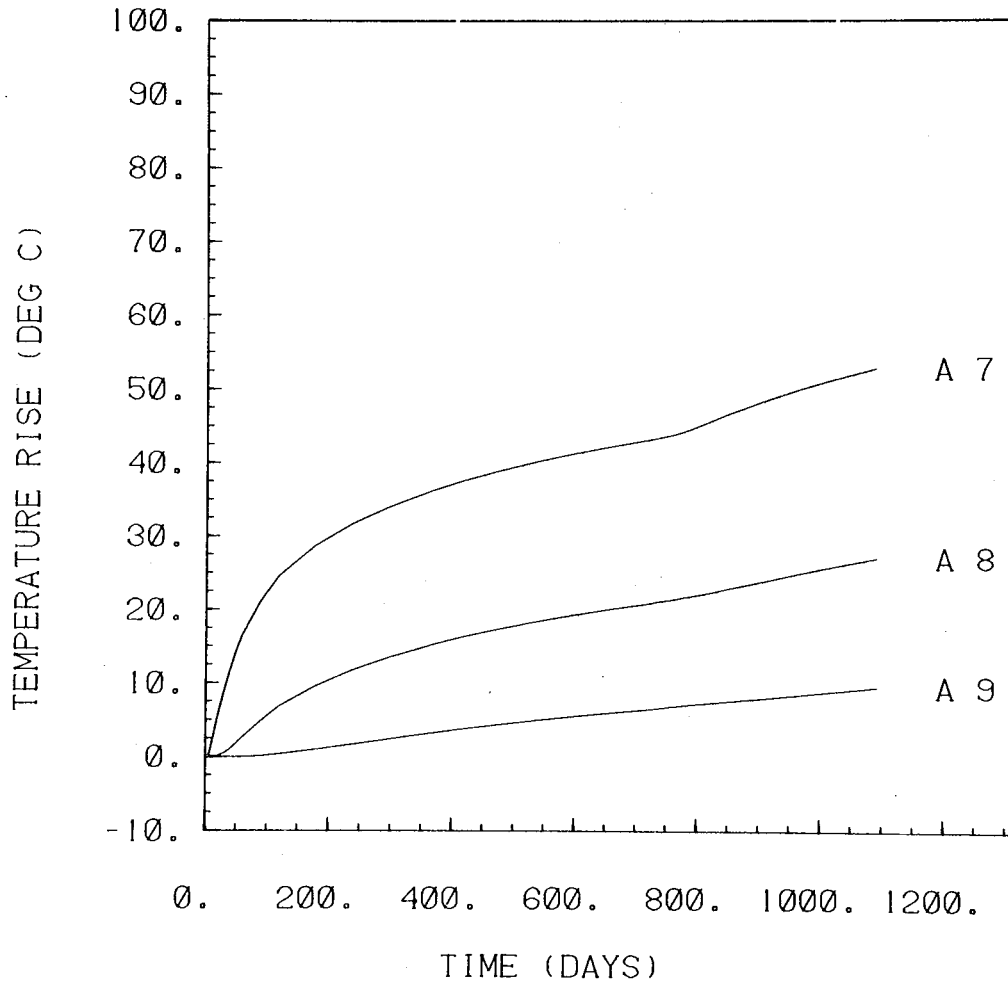

XBL 788-10464

Figure D31b

HANFORD TIME-SCALE EXPERIMENT
POWER SCHEDULE 3

LABEL	X	Y	Z
A 6	7.0640	0.0000	0.0000
A 5	6.9370	0.0000	0.0000
A 4	5.2500	0.0000	0.0000

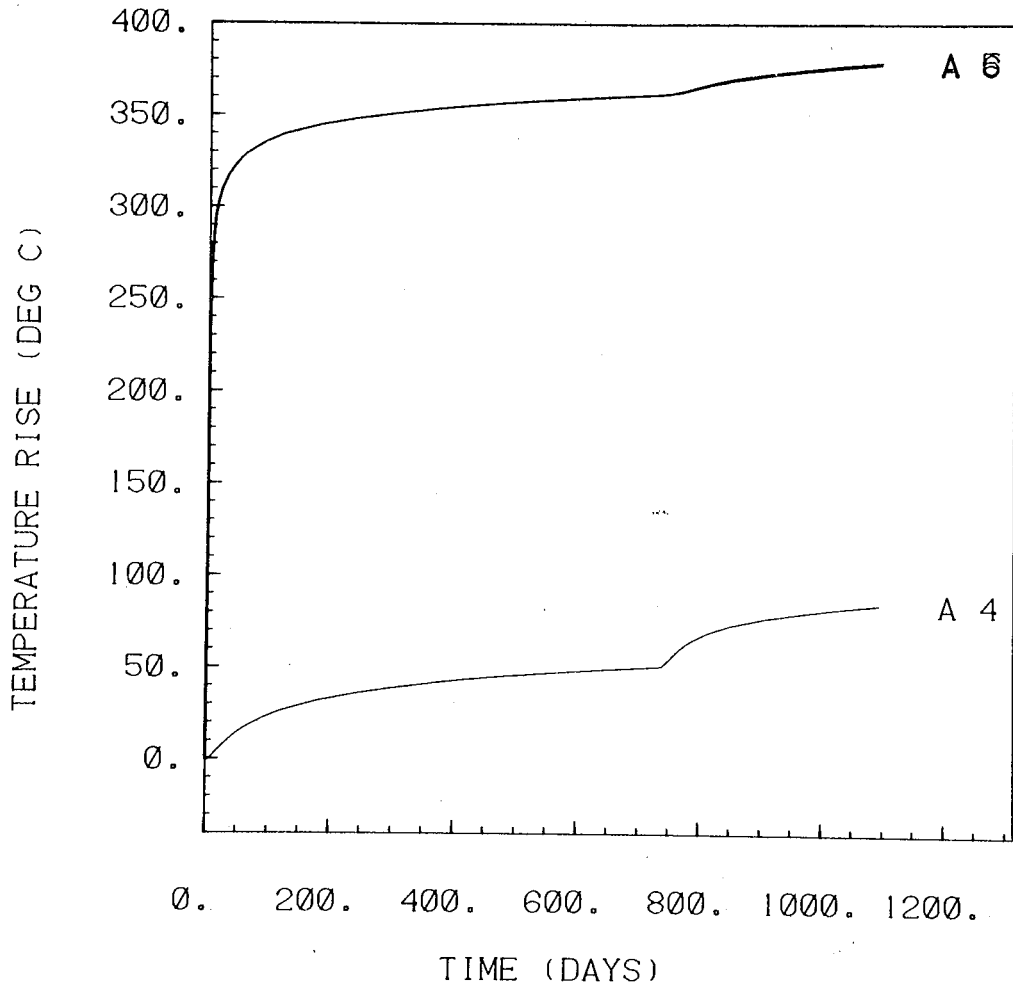

XBL 788-10463

Figure D31c

HANFORD TIME-SCALE EXPERIMENT
POWER SCHEDULE 3

LABEL	X	Y	Z
A 3	3.5000	0.0000	0.0000
A 2	1.7500	0.0000	0.0000
A 1	0.0640	0.0000	0.0000

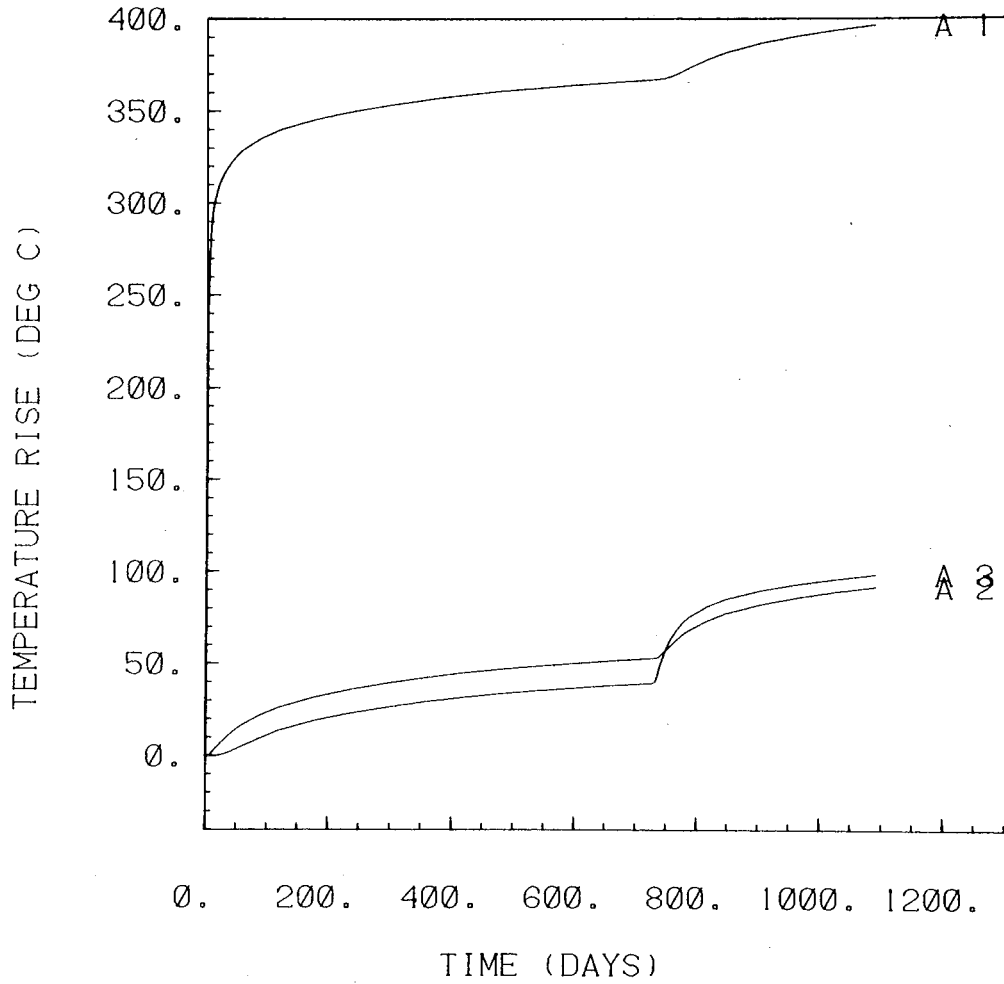

XBL 788-10471

Figure D31d

HANFORD TIME-SCALE EXPERIMENT
POWER SCHEDULE 3

LABEL	X	Y	Z
B 8	0.0000	6.0000	0.0000
B 7	0.0000	4.5000	0.0000
B 6	0.0000	3.0640	0.0000

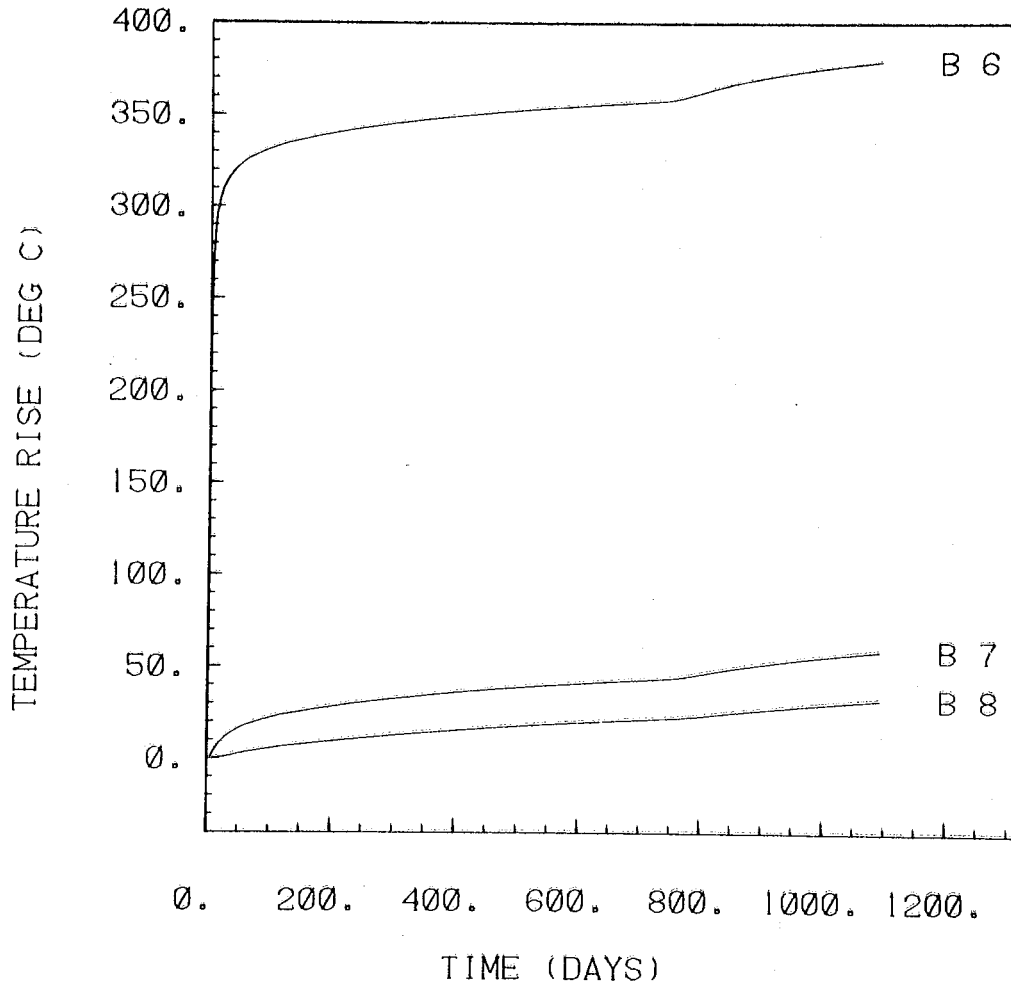

XBL 788-10466

Figure D31e

STANFORD TIME SCALE EXPERIMENT
POWER SCHEDULES

	S LABEL	X	Y	Z
0000.0	B 5	0.0000	2.9870	0.0000
0000.0	B 4	0.0000	2.2500	0.0000
0000.0	B 3	0.0000	1.5000	0.0000
	B 2	0.0000	0.7500	0.0000
	B 1	0.0000	0.0640	0.0000

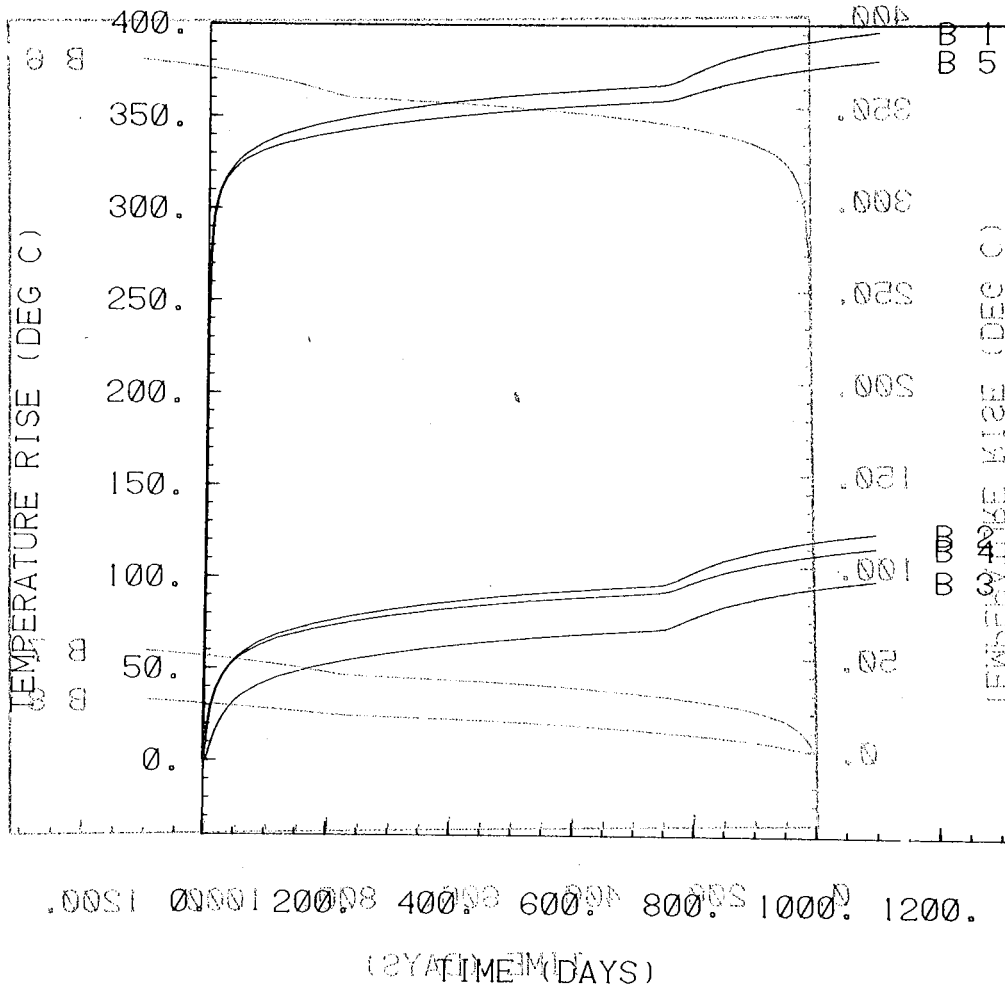

XBL 788-10473

XBL 788-10473

Figure D31f

HANFORD TIME-SCALE EXPERIMENT
POWER SCHEDULE 3

LABEL	X	Y	Z
C13	10.5000	4.5000	0.0000
C12	8.7500	3.7500	0.0000
C11	7.0450	3.5450	0.0000

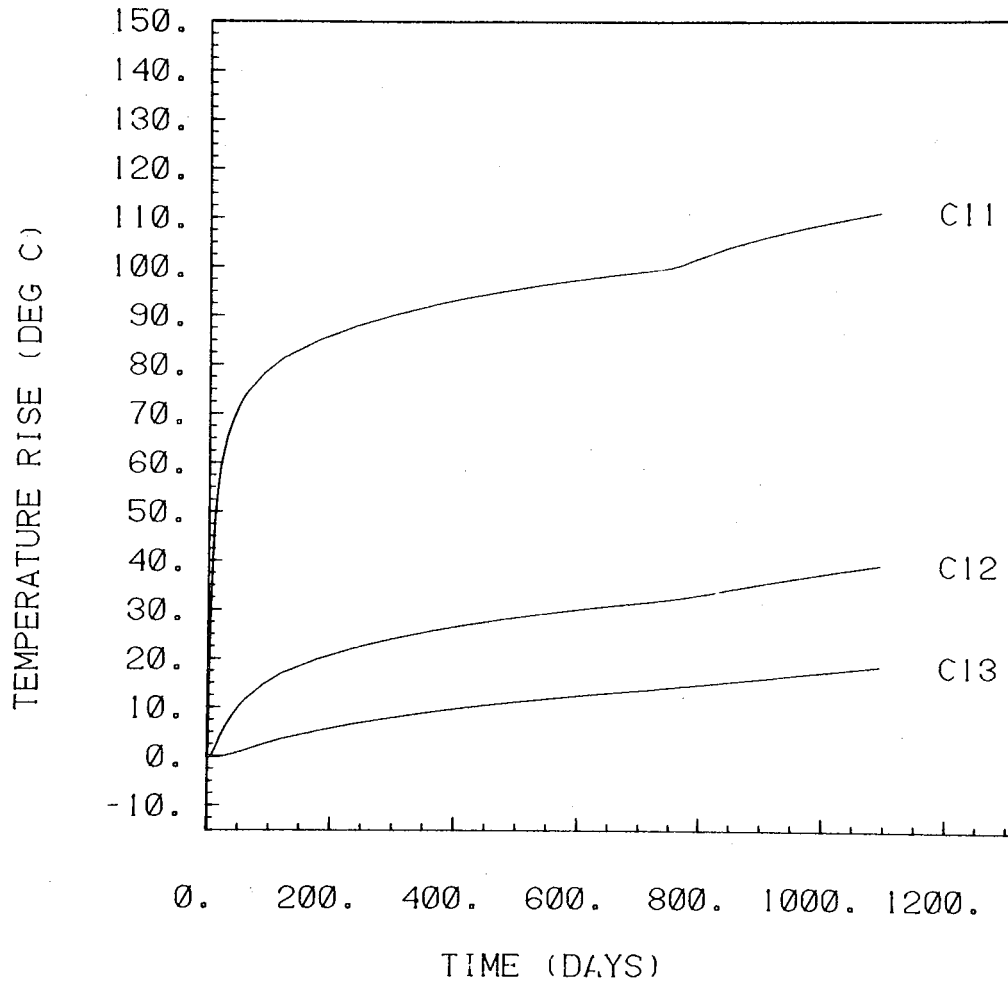

XBL 788-10465

Figure D31g

HANFORD TIME-SCALE EXPERIMENT
POWER SCHEDULE 3

LABEL	X	Y	Z
C 10	6.9550	3.4550	0.0000
C 9	6.1250	2.6250	0.0000
C 8	5.2500	2.2500	0.0000
C 7	4.3750	1.8750	0.0000
C 6	3.5450	1.5450	0.0000

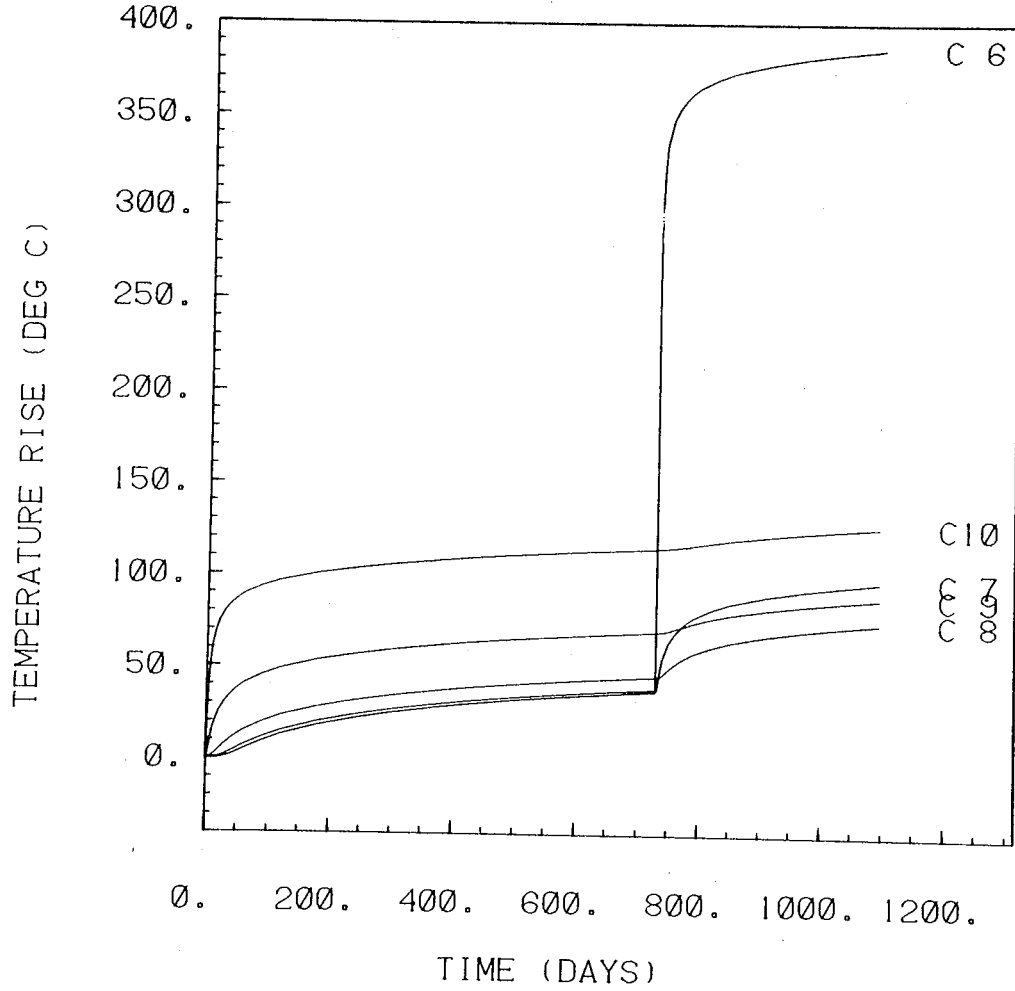

XBL 788-10474

Figure D31h

HANFORD TIME-SCALE EXPERIMENT
POWER SCHEDULE 3

LABEL	X	Y	Z
C 5	3.4550	1.4550	0.0000
C 4	2.6250	1.1250	0.0000
C 3	1.7500	0.7500	0.0000
C 2	0.8750	0.3750	0.0000
C 1	0.0450	0.0450	0.0000

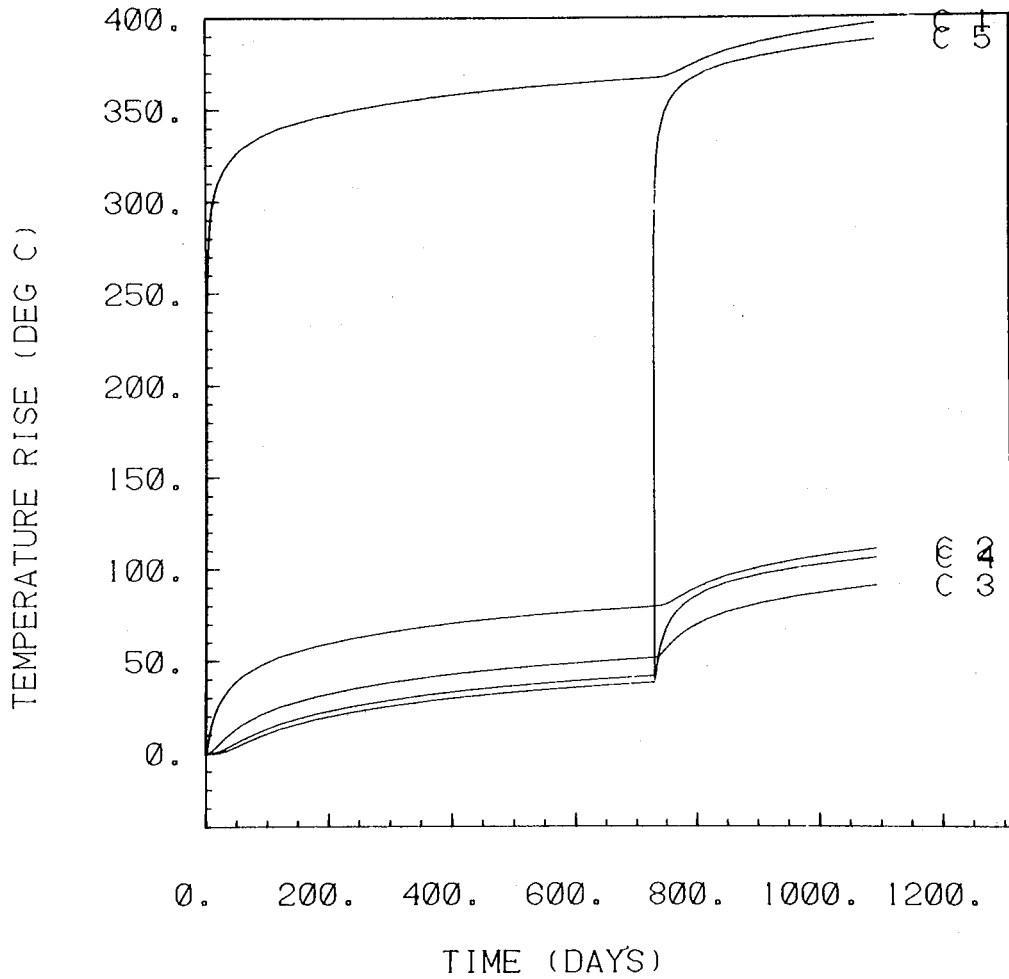

XBL 788-10472

Figure D31i

ISOTHERMS IN HORIZONTAL PLANE
HANFORD TIME-SCALE EXPERIMENT

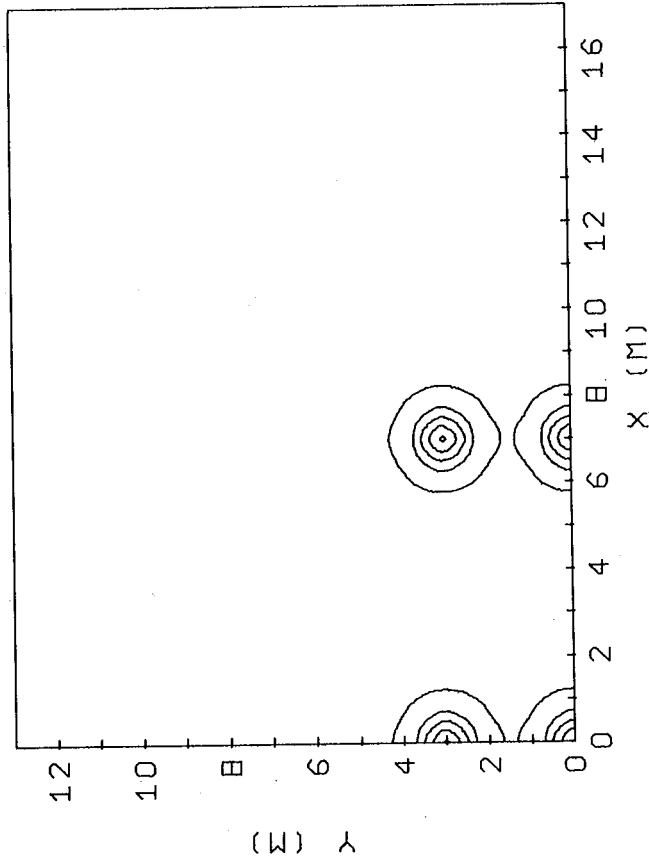

PLOT INFORMATION

TIME = 7. DAYS

Z = 0.00 M

POWER OF HEATERS = 1.125 KW
SECONDARY HEATERS ENERGIZED
AFTER 730. DAYS

CONTOURS (DEG.C.) PLOTTED -
300.100.50.25. 5.

XBL 786-9308

Figure D32a

ISOTHERMS IN HORIZONTAL PLANE
HANFORD TIME-SCALE EXPERIMENT

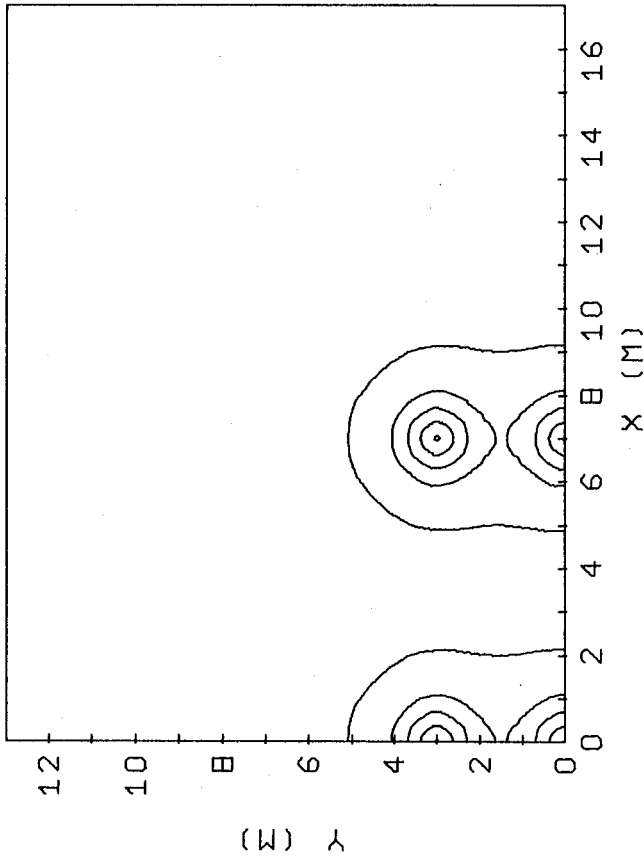

PLOT INFORMATION

TIME = 30. DAYS

Z = 0.00 M

POWER OF HEATERS = 1.125 KW
SECONDARY HEATERS ENERGIZED
AFTER 730. DAYS

CONTOURS (DEG.C.) PLOTTED -
325.100. 50. 25. 5.

XBL 786-9309

Figure D32b

ISOTHERMS IN HORIZONTAL PLANE
HANFORD TIME-SCALE EXPERIMENT

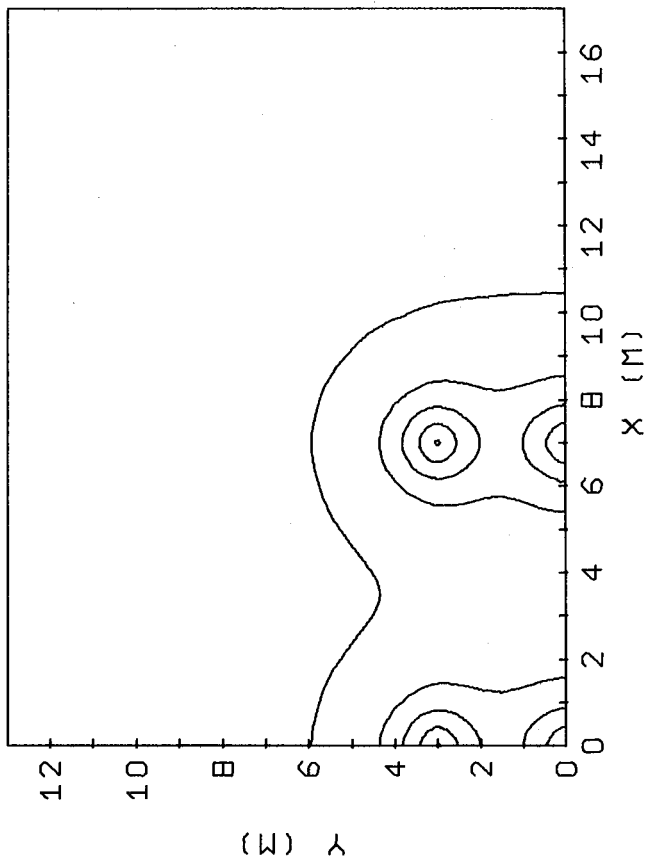

PLOT INFORMATION

TIME = 90. DAYS

Z = 0.00 M

POWER OF HEATERS = 1.125 KW
SECONDARY HEATERS ENERGIZED
AFTER 730. DAYS

CONTOURS (DEG.C.) PLOTTED -
350.100. 50. 25. 5.

XBL 786-9307

Figure D32c

ISOTHERMS IN HORIZONTAL PLANE
HANFORD TIME-SCALE EXPERIMENT

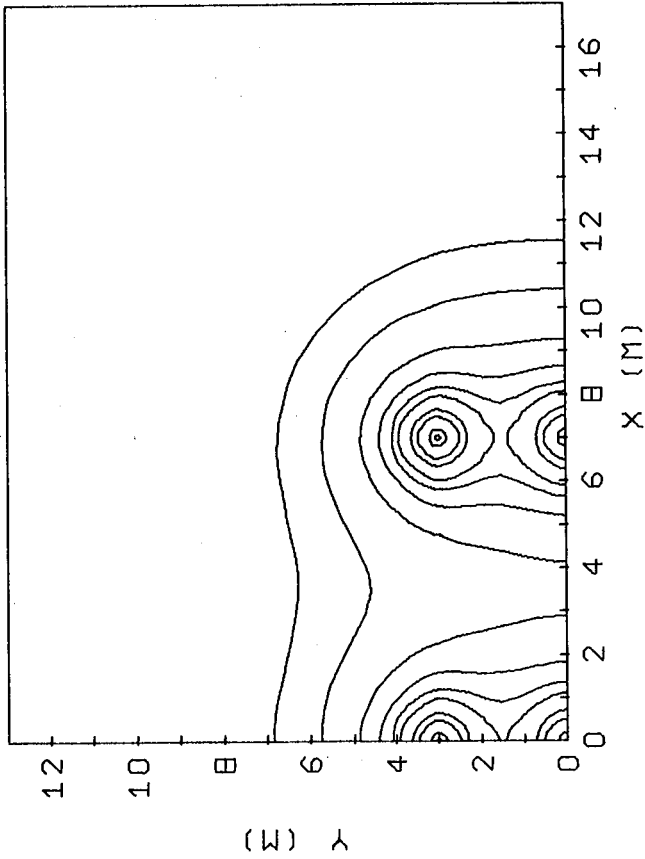

PLOT INFORMATION

TIME = 180. DAYS

Z = 0.00 M

POWER OF HEATERS = 1.125 KW
SECONDARY HEATERS ENERGIZED
AFTER 730. DAYS

CONTOURS (DEG.C.) PLOTTED -
350.200.100.75.50.
40.30.20.10.5.

XBL 786-9302

Figure D32d

ISOTHERMS IN HORIZONTAL PLANE
HANFORD TIME-SCALE EXPERIMENT

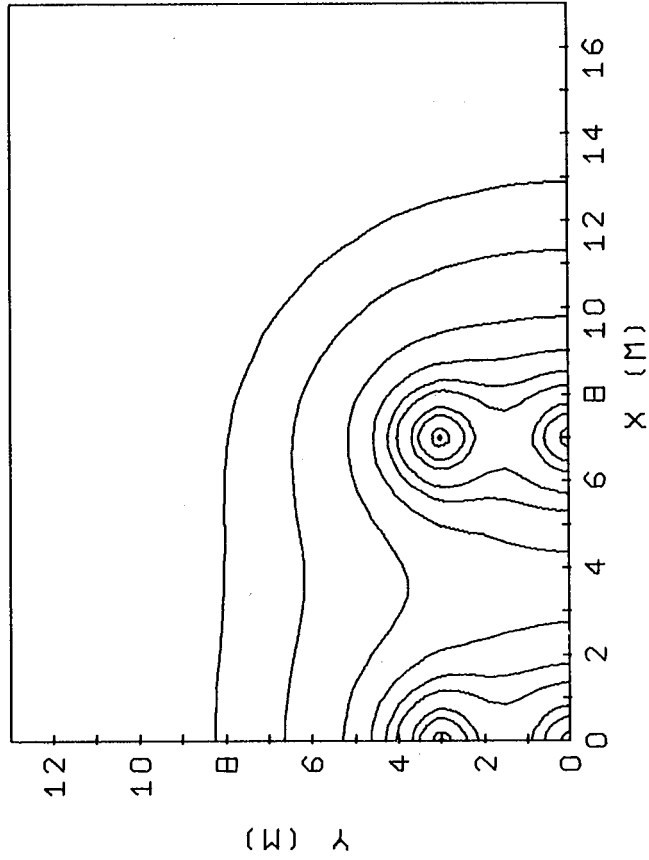

PLOT INFORMATION

TIME = 365. DAYS

Z = 0.00 M

POWER OF HEATERS = 1.125 KW
SECONDARY HEATERS ENERGIZED
AFTER 730. DAYS

CONTOURS (DEG.C.) PLOTTED -
375.200.100. 75. 50.
40. 30. 20. 10. 5.

XBL 786-9306

Figure D32e

ISOTHERMS IN HORIZONTAL PLANE
HANFORD TIME-SCALE EXPERIMENT

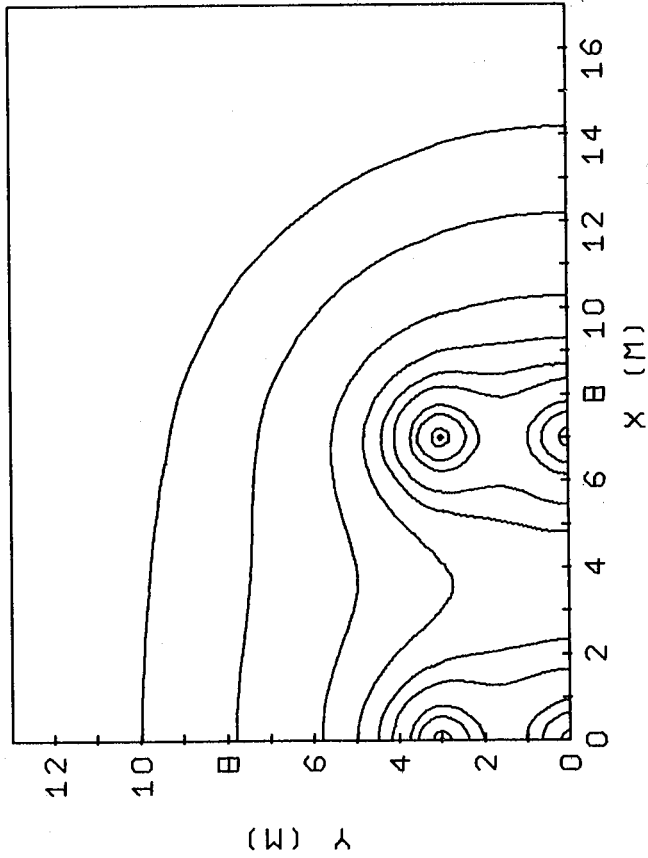

PLOT INFORMATION

TIME = 730. DAYS

Z = 0.00 M

POWER OF HEATERS = 1.125 KW
SECONDARY HEATERS ENERGIZED
AFTER 730. DAYS

CONTOURS (DEG.C.) PLOTTED -
375.200.100.75.50.
40.30.20.10.5.

XBL 786-9304

Figure D32f

ISOTHERMS IN HORIZONTAL PLANE
HANFORD TIME-SCALE EXPERIMENT

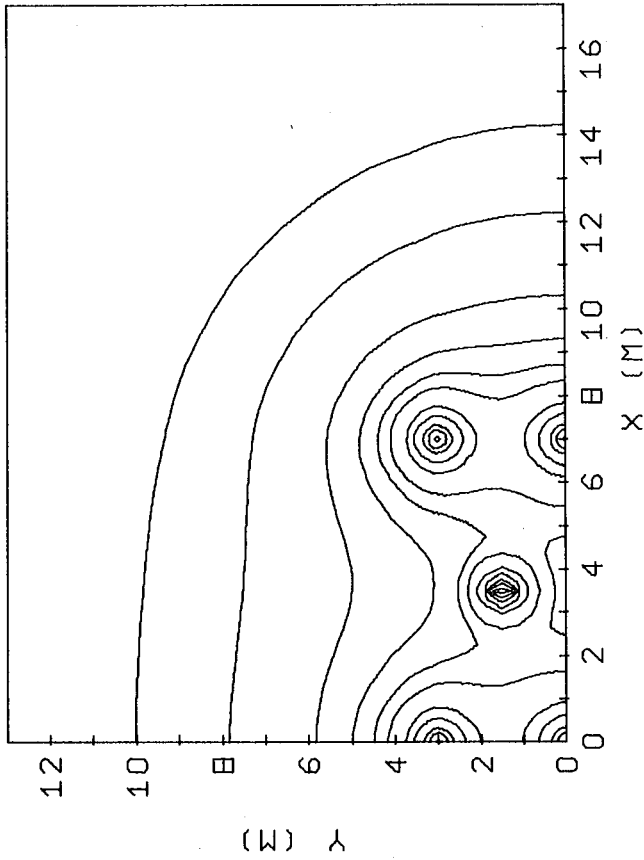

PLOT INFORMATION

TIME = 737. DAYS

Z = 0.00 M

POWER OF HEATERS = 1.125 KW
SECONDARY HEATERS ENERGIZED
AFTER 730. DAYS

CONTOURS (DEG.C.) PLOTTED -
375.200.150.100.75.
50. 40. 30. 20. 10.
5.

XBL 786-9305

Figure D32g

ISOTHERMS IN HORIZONTAL PLANE
HANFORD TIME-SCALE EXPERIMENT

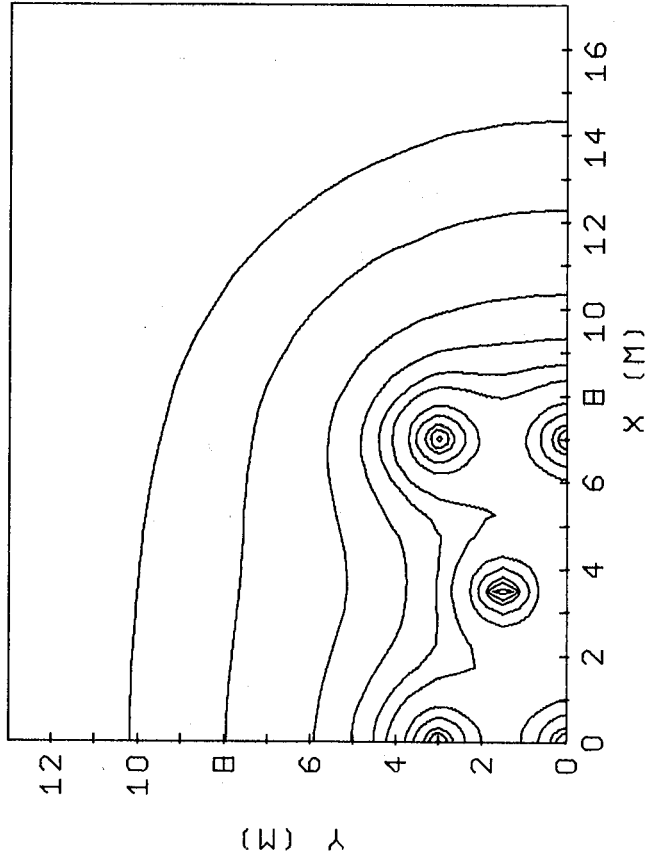

PLOT INFORMATION

TIME = 760. DAYS

Z = 0.00 M

POWER OF HEATERS = 1.125 KW
SECONDARY HEATERS ENERGIZED
AFTER 730. DAYS

CONTOURS (DEG.C.) PLOTTED -
375.200.150.100.75.
50.40.30.20.10.
5.

XBL 786-9303

Figure D32h

ISOTHERMS IN HORIZONTAL PLANE
HANFORD TIME-SCALE EXPERIMENT

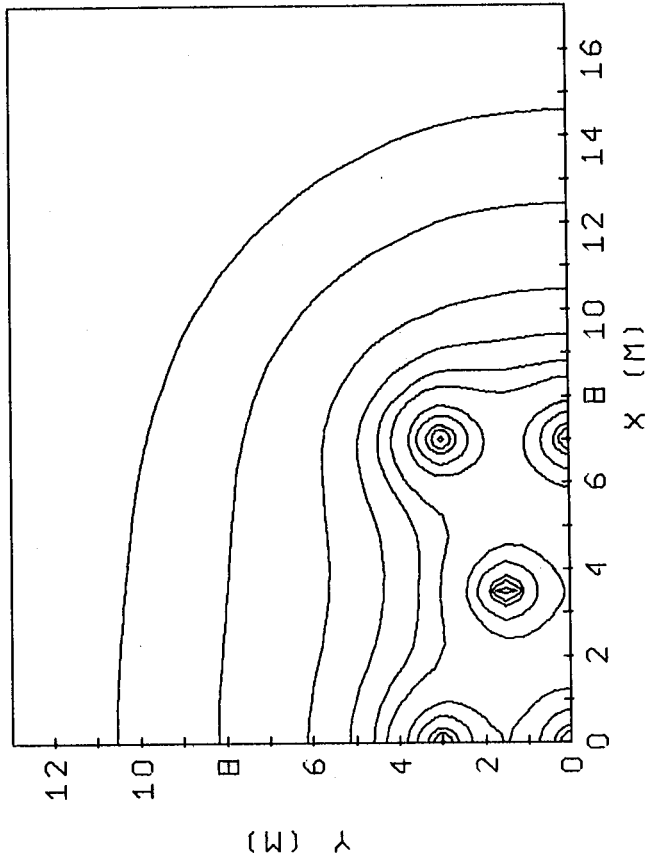

PLOT INFORMATION

TIME = 820. DAYS

Z = 0.00 M

POWER OF HEATERS = 1.125 KW
SECONDARY HEATERS ENERGIZED
AFTER 730. DAYS

CONTOURS (DEG.C.) PLOTTED -
375.200.150.100. 75.
50. 40. 30. 20. 10.
5.

XBL 786-9301

Figure D32j

ISOTHERMS IN HORIZONTAL PLANE
HANFORD TIME-SCALE EXPERIMENT

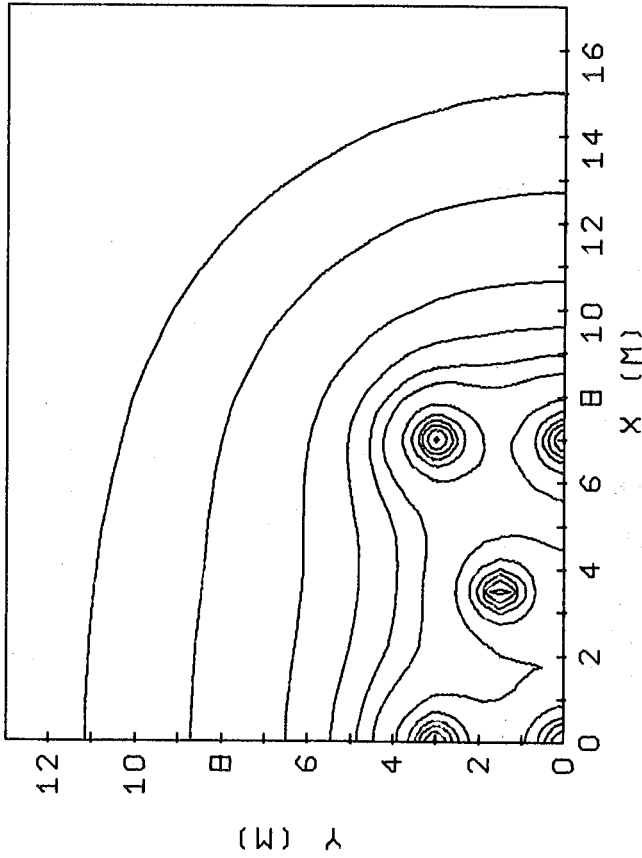

PLOT INFORMATION

TIME = 910. DAYS

Z = 0.00 M

POWER OF HEATERS = 1.125 KW
SECONDARY HEATERS ENERGIZED
AFTER 730. DAYS

CONTOURS (DEG.C.) PLOTTED -
400.200.150.125.100.
75. 50. 40. 30. 20.
10. 5.

XBL 786-9310

Figure D32j

ISOTHERMS IN HORIZONTAL PLANE
HANFORD TIME-SCALE EXPERIMENT

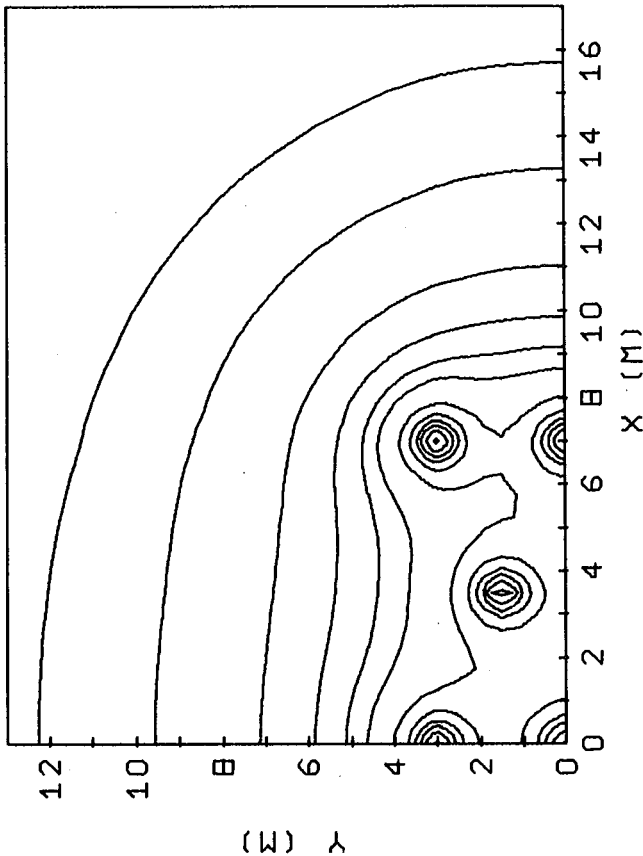

PLOT INFORMATION

TIME = 1095. DAYS

Z = 0.00 M

POWER OF HEATERS = 1.125 KW
SECONDARY HEATERS ENERGIZED
AFTER 730. DAYS

CONTOURS (DEG.C.) PLOTTED -
400.200.150.125.100.
75. 50. 40. 30. 20.
10. 5.

XBL 786-9311

Figure D32k

MIGRATION OF 5° ISOTHERM HANFORD TIME-SCALE EXPERIMENT

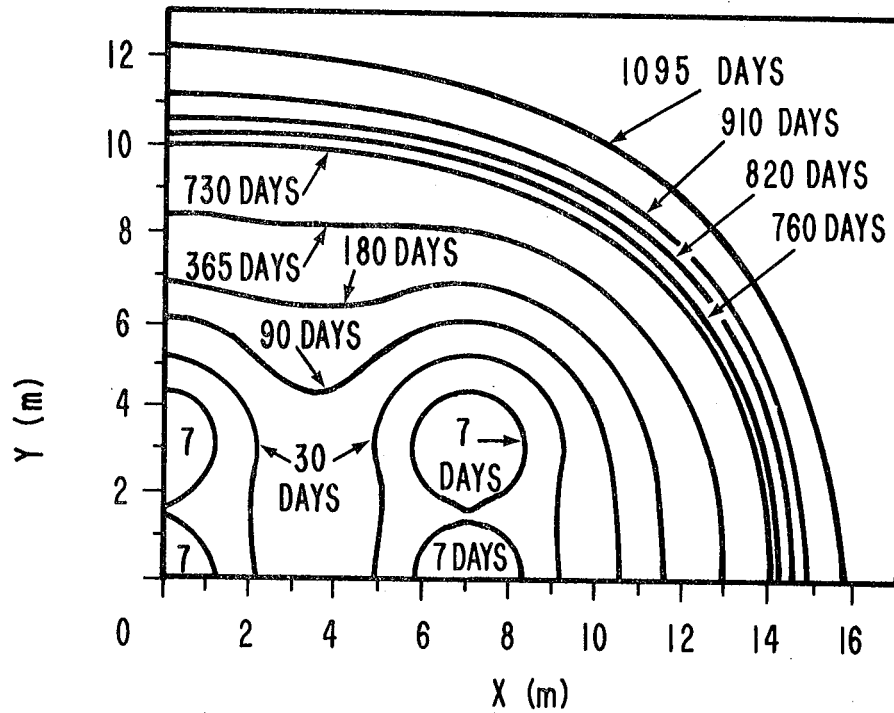

PLOT INFORMATION

Z = 0(m)

Power of heaters = 1.125 kW

Secondary heaters energized
after 730 days. (Contours (days) shown).

XBL 788-2014A

Figure D33

This report was done with support from the Department of Energy. Any conclusions or opinions expressed in this report represent solely those of the author(s) and not necessarily those of The Regents of the University of California, the Lawrence Berkeley Laboratory or the Department of Energy.

Reference to a company or product name does not imply approval or recommendation of the product by the University of California or the U.S. Department of Energy to the exclusion of others that may be suitable.