

UCLA

UCLA Previously Published Works

Title

Gene delivery in malignant B cells using the combination of lentiviruses conjugated to anti-transferrin receptor antibodies and an immunoglobulin promoter

Permalink

<https://escholarship.org/uc/item/8nk5w9c4>

Journal

The Journal of Gene Medicine, 16(1-2)

ISSN

1099-498X

Authors

Leoh, Lai Sum
Morizono, Kouki
Kershaw, Kathleen M
[et al.](#)

Publication Date

2014

DOI

10.1002/jgm.2754

Peer reviewed



Published in final edited form as:

J Gene Med. 2014 ; 16(0): 11–27. doi:10.1002/jgm.2754.

Gene delivery in malignant B cells using the combination of lentiviruses conjugated to anti-transferrin receptor antibodies and an immunoglobulin promoter

Lai Sum Leoh¹, Kouki Morizono^{3,4}, Kathleen M. Kershaw¹, Irvin S. Y. Chen^{2,3,4}, Manuel L. Penichet^{1,2,3,5,6}, and Tracy R. Daniels-Wells¹

¹Division of Surgical Oncology, Department of Surgery, David Geffen School of Medicine, University of California, Los Angeles, CA, USA

²Department of Microbiology, Immunology, and Molecular Genetics, University of California, Los Angeles, CA, USA

³UCLA AIDS Institute, University of California, Los Angeles, CA, USA

⁴Department of Medicine, University of California, Los Angeles, CA, USA

⁵Jonsson Comprehensive Cancer Center, University of California, Los Angeles, CA, USA

⁶The Molecular Biology Institute, University of California, Los Angeles, CA, USA

Abstract

Background—We previously developed an antibody-avidin fusion protein (ch128.1Av) specific for the human transferrin receptor 1 (TfR1; CD71) to be used as a delivery vector for cancer therapy and showed that ch128.1Av delivers the biotinylated plant toxin saporin-6 into malignant B cells. However, due to widespread expression of TfR1, delivery of the toxin to normal cells is a concern. Therefore, we explored the potential of dual targeted lentiviral-mediated gene therapy approaches to restrict gene expression to malignant B cells. Targeting occurs through the use of ch128.1Av or its parental antibody without avidin (ch128.1) and through transcriptional regulation using an immunoglobulin promoter.

Methods—Flow cytometry was used to detect the expression of enhanced green fluorescent protein (EGFP) in a panel of cell lines. Cell viability after specific delivery of the therapeutic gene *FCUI*, a chimeric enzyme consisting of cytosine deaminase genetically fused to uracil phosphoribosyltransferase that converts the 5-fluorocytosine (5-FC) prodrug into toxic metabolites, was monitored by an MTS assay.

Results—We found that EGFP was specifically expressed in a panel of human malignant B cells, but not in human T cell lines. EGFP expression was observed in all cell lines when a ubiquitous promoter was used. Furthermore, we show the decrease of cell viability in malignant plasma cells in the presence of 5-FC.

Correspondence: Tracy R. Daniels-Wells, Ph.D., Division of Surgical Oncology, Department of Surgery, UCLA, 10833 Le Conte Avenue, CHS 54-140, Box 951782, Los Angeles, CA 90095-1782; Phone: 310 825-0457; Fax: 310 825-7575; tdaniels@mednet.ucla.edu.

Conflicts of Interest: The authors have no conflicts to disclose.

Conclusions—These studies demonstrate that gene expression can be restricted to malignant B cells and suggest that this dual targeted gene therapy strategy may help to circumvent the potential side effects of certain TfR1-targeted protein delivery approaches.

Keywords

transferrin receptor; antibody; lentivirus; gene therapy; prodrug therapy; malignant B cells

Introduction

The multiple, complicated steps involved in B cell differentiation and activation make these cells especially susceptible to oncogenic mutations, resulting in a variety of malignancies originating from B cells at various stages of differentiation [1]. Multiple myeloma (MM) is derived from terminally differentiated B cells (plasma cells) and is the second most common hematologic malignancy [2, 3]. In 2013, there is an estimated 22,350 new cases diagnosed and 10,710 MM-associated deaths in the United States [2]. Approval of the immunomodulatory agents thalidomide, lenalidomide, and pomalidomide, along with the proteasome inhibitors bortezomib and carfilzomib, in combination with doxorubicin and dexamethasone have significantly improved the overall outcome of MM [3–5]. Despite these advances, MM remains incurable [3, 6]. Non-Hodgkin lymphoma (NHL) is a term covering a heterogeneous group of lymphoproliferative malignancies. NHL is the most common hematologic malignancy in the United States, with an estimated 69,740 new cases in year 2013 and 19,020 NHL-associated deaths in 2013 [2]. Approximately 80% of NHL are B cell malignancies and the majority of these express surface CD20, a transmembrane protein expressed on the membrane of all B cells starting at the pro-B phase that is involved in B-cell signaling, proliferation and differentiation [7–9]. Rituximab, a mouse/human chimeric anti-CD20 IgG1, is widely used with standard chemotherapy regimens, resulting in higher response rates and improved survival in a subset of NHL patients [10–12]. Unfortunately, some patients do not initially respond to these treatments and relapse is common among those that do [13–15]. Mantle cell lymphoma (MCL) is a type of NHL that has particularly poor prognosis and is considered incurable [16–18]. The genetic hallmark of MCL is the translocation t(11;14)(q13;q32), which leads to aberrant expression of the cell cycle regulator cyclin D1 and the increased proliferation of mature B lymphocytes. MCL responds poorly to conventional therapies (including rituximab), with a relatively short median survival of 3–5 years [17–19]. Therefore, there is an urgent need for innovative approaches for the treatment of several types of B cell malignancies.

Iron is a cofactor of heme and non-heme proteins important for many cellular processes, including metabolism, respiration, and DNA synthesis [20–22]. Transportation of iron into cells occurs through binding of iron-loaded transferrin to the transferrin receptor 1 (TfR1, also known as CD71) on the cell surface. The receptor is constitutively internalized into cells in clathrin-coated pits through receptor-mediated endocytosis and is recycled back to the cell surface. The TfR1 is ubiquitously expressed at low levels on normal cells and is expressed at greater levels on cells with a high proliferation rate or an increased need for iron. Elevated levels of TfR1 expression have been observed in cancer cells, including hematopoietic cancers [20–22]. Correlation of increased TfR1 expression with tumor stage

or prognosis has been observed in chronic lymphocytic leukemia and NHL [23]. Due to all of these properties, the TfR1 has been extensively used as a therapeutic target for cancer therapy [20, 22, 24]. DNA delivery mediated by TfR targeting, a process known as *transferrinfection* [25], has been reported and used to deliver polymers/polyplexes, liposomes, or viral vectors into cancer cells [22, 24].

In order to target cancer cells overexpressing the TfR1, our group previously developed an antibody fusion protein that consists of a mouse/human chimeric antibody with human IgG3 constant regions and the variable regions of the 128.1 murine monoclonal antibody specific for human TfR1 genetically fused to chicken avidin at its carboxy terminus (ch128.1Av; previously known as anti-hTfR IgG3-Av) [26–28]. ch128.1Av was developed as a universal delivery system to transport biotinylated anti-cancer agents into cells [26, 27]. ch128.1Av, and its parental antibody ch128.1 (previously known as anti-hTfR1 IgG3) to a lesser extent, was also shown to exhibit intrinsic cytotoxic activity against certain malignant B-cell lines due to induction of TfR1 degradation and lethal iron deprivation [26, 29, 30]. ch128.1Av alone was able to block Akt and NF- κ B survival pathways [31], which are important for myeloma development and progression [32]. Importantly, both ch128.1 and ch128.1Av show significant anti-tumor activity in two *in vivo* models of MM [33]. Conjugation of ch128.1Av with biotinylated saporin 6, a plant ribosomal inactivating toxin, overcame resistance of malignant B-cells to the treatment of ch128.1Av [34]. The mechanism of cell death induced by ch128.1Av conjugated to this toxin was shown to be due to the effects of the toxin and not iron starvation [35], suggesting the ability of ch128.1Av to deliver active anti-cancer agents into TfR1 overexpressing malignant cells. ch128.1Av alone is not toxic to normal hematopoietic stem/early progenitor cells [33] or late progenitors [34]. However, conjugation of ch128.1Av with biotinylated saporin was highly toxic to late progenitor cells of both the erythroid and myeloid lineages [34]. Importantly, no toxicity to hematopoietic stem/early progenitor cells was observed upon treatment with the ch128.1Av complexed with biotinylated saporin [35], which is consistent with the lack of TfR1 expression on these cells [36–38].

To overcome the potential side effects of the delivery of toxic proteins into normal cells expressing the TfR1, we have developed a new gene therapy strategy. We have previously shown targeted delivery of enhanced green fluorescent protein (EGFP) into Jurkat T cell leukemia cells using biotinylated lentiviral vectors conjugated to ch128.1Av [39]. Lentiviruses were chosen since they can transduce non-dividing cells and are less immunogenic than their adenoviral counterparts [40]. The goal of the current study was to expand that approach and develop dual targeted strategies using targeted lentiviral-mediated gene delivery for the treatment of B cell malignancies. Since the TfR1 is overexpressed on the surface of cancer cells and in order to enhance the therapeutic window, the first level of targeting occurs through the use of our antibodies specific for the TfR1 in two different strategies: 1) lentiviral vectors pseudotyped with a modified chimeric Sindbis virus envelope encoding the Fc-binding region (ZZ domain) of protein A (2.2 SINDBIS) conjugated to ch128.1, and 2) pseudotyped virus containing the biotin adaptor peptide (BAP SINDBIS) instead of the ZZ domain, which results in biotinylation of the surface of the virus, conjugated to ch128.1Av. The second level of targeting will occur through the

transcriptional restriction of the expression of the therapeutic gene expression using an immunoglobulin promoter (Ig). In this report, we show that ch128.1 and ch128.1Av are able to deliver lentiviruses into a panel of malignant B cells, within which the expression of EGFP is controlled by the Ig promoter. Additionally, we show delivery of a therapeutic gene in a prodrug strategy that leads to malignant plasma cell death. Our results suggest that these gene therapy strategies deserve further study as alternative treatment options for MM, and possibly other B-cell malignancies.

Materials and Methods

Lentiviral vectors

Schematic diagrams for each envelope construct are provided in Figure 1A. The envelope plasmids used in this study include VSV-G (vesicular stomatitis virus glycoprotein, Addgene, Cambridge, MA), to produce a virus with a pseudotyped envelope that confers a broad host cell tropism for use as a non-TfR targeted control virus, and vectors pseudotyped with chimeric Sindbis virus envelope proteins for use in antibody-targeted strategies. The 2.2 SINDBIS envelope has been previously described and consists of a modified SINDBIS envelope protein in which the IgG-binding domain of protein A (ZZ domain) has been inserted into the E2 coat protein [41]. Additionally, 2.2 SINDBIS contains mutations in the E2 protein that decrease the natural tropism of the virus while maintaining high viral titers [42]. The 2.2 SINDBIS envelope vector also has mutations in amino acids 226 and 227 of the E1 protein that have been reported to mediate fusion in the absence of the lipid cholesterol [43] and increase the infectivity of the virus [41]. The BAP SINDBIS envelope vector has also been previously described and was constructed by inserting the biotin adapter peptide (BAP) between the two flexible linkers of 2.2 1L1L [39].

The following self-inactivating (SIN) expression plasmids were used: FUGW, encoding EGFP under the control of the ubiquitin c (Ubi-c) promoter (Addgene); KIEIGP-EGFP-SIN, EGFP under the control of a synthetic Ig heavy chain promoter containing the murine kappa light chain 3' and intronic enhancer [44] (a kind gift from Dr. David Dingli, Mayo Clinic and Foundation, Rochester, MN); FUFUW and KIEIGP-FCU1-SIN were constructed by replacing the *EGFP* gene with the gene encoding the FCU1 enzyme (taken from pET9811 [45], a kind gift from Dr. Sherie Morrison, UCLA, Los Angeles, CA) using BamHI and XhoI. Prior to cloning, the XhoI site within the *FCU1* gene (corresponding to amino acids 95–96) was mutated from cytosine to guanine at residue 285 to disrupt this XhoI site while maintaining the same amino acid sequence. This mutagenesis was performed by Retrogen, Inc. (San Diego, CA). Schematic diagrams for each lentiviral expression plasmid are shown in Figure 1B. The packaging plasmid psPAX2 is a second-generation plasmid that produces high titer virus (Addgene). For the production of biotinylated viruses using the BAP SINDBIS envelope protein, the pSec BirA plasmid (a kind gift from Dr. Michael Barry, Baylor College of Medicine, Houston, TX) was also used for the expression of biotin ligase to produce biotinylated lentiviruses.

Production of recombinant lentiviruses

All lentiviruses were produced in 293T human embryonic kidney cells, using the calcium phosphate transfection method as described previously [42, 46]. Briefly, 293T cells were transfected with envelope protein expression vectors (10 µg), packaging plasmid psPAX2 (10 µg), and vector containing gene of interest with either Ubi-c or Ig promoter (15 µg). For production of biotinylated viruses, 6 µg of pSec BirA was also included and cells were cultured in Opti-MEM (Life Technologies Corporation, Carlsbad, CA, USA) containing 2% FBS and 500 µM of biotin (Sigma-Aldrich, St Louis, MO). Culture supernatant was subjected to ultracentrifugation on a 10% sucrose cushion and the virus pellet was resuspended in Hank's buffered salt solution (HBSS) (Corning, Manassas, VA). Biotinylated virus was dialyzed in PBS for 4 hours to eliminate residual biotin. The concentrations of virus were quantified by measuring the amount of viral capsid protein (p24) in the CFAR virology core laboratory at UCLA. Viruses were aliquoted and frozen at -80°C until use.

Recombinant antibody and fusion protein production

The anti-human transferrin receptor antibody (ch128.1), avidin fusion protein (ch128.1Av), and IgG3-Av (isotype control fusion protein specific for the hapten dansyl: 5-dimethylamino haphthalene-1-sulfonyl chloride) have been described previously [26, 27]. ch128.1 (previously known as anti-hTfR IgG3) is a mouse/human chimeric antibody with human IgG3 constant regions and the variable regions of the 128.1 murine monoclonal antibody specific for the human TfR1 (CD71). ch128.1Av (previously known as anti-hTfR IgG3-Av) consists of ch128.1 genetically fused to chicken avidin at the carboxy terminus of each heavy chain. The antibody and fusion proteins were expressed in murine myeloma cells and were purified from cell culture supernatants using affinity chromatography [26, 27, 47]. The ch128.1 antibody and the fusion proteins were dialyzed in 150 mM NaCl, 50 mM Tris-HCl, pH 7.8 and protein concentration was determined using the bicinchoninic acid assay kit (BCA; Thermo Fisher Scientific, Walnut, CA).

Western blot analysis

Viral vectors (0.3–0.5 µg protein) were separated on a 12% Bis-Tris NuPAGE gel (Life Technologies Corporation, Carlsbad, CA) under reducing conditions. Proteins were transferred to nitrocellulose (GE Healthcare Biosciences, Pittsburgh, PA). Immunoblot analysis of envelope proteins was performed with anti-Sindbis ascites fluid (ATCC, Manassas, VA) and HRP-conjugated anti-mouse IgG secondary antibody (GE Healthcare Biosciences). Biotinylation of envelope proteins was detected using HRP-conjugated NeutrAvidin® (Thermo Fisher Scientific). Protein bands were visualized using Chemiglow and Alpha Innotech FluorChem Imaging System (ProteinSimple, Santa Clara, CA).

Cell Lines

293T human embryonic kidney cells were cultured in IMDM (Life Technologies Corporation) containing 10% FBS (Hyclone Defined FBS, Thermo Fisher Scientific), 100 U/mL penicillin and 10 µg/mL streptomycin (Life Technologies Corporation). The following human cell lines were cultured in RPMI (Life Technologies Corporation)

containing 10% FBS (Atlanta Biologicals, Lawrenceville, GA): IM-9 (EBV-transformed B lymphoblastoid); U266, KMS-11, RPMI 8226, MM.1S (multiple myeloma); Jurkat (acute T cell leukemia); MOLT-4 and CCRF-CEM (acute T-lymphoblastic leukemia); and Z-138 and REC-1 (mantle cell lymphoma) cell lines. KMS-11 cells were a kind gift from Dr. Lawrence Boise (Emory University, Atlanta, GA). All other cell lines were purchased from ATCC (Manassas, VA). TfR1 expression on the surface of these cell lines has been previously shown for IM-9 and U266 [30, 34], KMS-11 [33], and Jurkat [30]. Expression on the surface of the other cell lines is shown in Supplementary Figure 1.

Transduction

Virus (40 ng p24) was conjugated with 1 µg of ch128.1, ch128.1Av, or IgG3-Av for 30 minutes on ice prior to transduction. 200,000 cells were incubated with viruses in 100 µl media for 2 hours in eppendorf tubes at 37°C, 5% CO₂. Cells were then resuspended in fresh media and plated in 24 well plates.

EGFP expression by flow cytometry

Cells transduced with vectors containing the *EGFP* gene were collected 4 days post-transduction, washed with PBS, resuspended in flow buffer (PBS buffer with 0.5% BSA, 2 mM EDTA) and fixed in 4% paraformaldehyde before being analyzed by flow cytometry on FACScan flow cytometer (BD Biosciences, San Jose, CA). Ten thousand events were recorded for each flow cytometry measurement. Data were analyzed using FCS Express V3 software (De Novo Software, Los Angeles, CA).

Production of soluble transferrin receptor (sTfR1)

BHK cells secreting His-tagged sTfR1 [48] (a kind gift from Dr. Anne B. Mason, University of Vermont, Burlington, VT) were cultured in IMDM with 10% FBS, 100 U/mL penicillin and 10 µg/mL streptomycin. Cells were seeded in roller bottles (Thermo Fisher Scientific Inc.) initially in IMDM medium and expanded in Pro293A-CDM serum-free medium (Lonza Group Ltd, Rockland, ME) after adherence to the surface of the rollerbottles. Cell supernatants were harvested and the sTfR1 was purified using a 9 mL Flex Column (ThermoFisher Scientific Inc.) containing Nickel Sepharose Excel (GE Healthcare). Protein was eluted from the column using 50 mM Tris-HCl, 200 mM NaCl and various concentrations of imidazole, ranging from 20–500 mM. Fractions containing the sTfR1 were pooled and dialyzed in 150 mM NaCl, 50 mM Tris-HCl, pH 7.8 and protein concentration was determined using the BCA assay kit.

In vitro cytotoxicity assay

Cells were transduced with the various viral vectors containing the *FCU1* gene (40 ng). The 5-fluorocytosine (5-FC) prodrug was added to the cells during plating, 2 hours post transduction. Cells were cultured for 4 days and cell viability was determined by transferring 100 µL of cells to 96-well plates in triplicate and incubating them with either 20 µl of MTS solution (Cell Titer 96® Aqueous One Solution Cell Proliferation Assay, Promega, Madison, WI) or 10 µl of WST-1 solution (Quick cell proliferation assay kit, Biovision, Milpitas, CA) for 4 hours at 37°C. Plates were read at 450 nm using a FilterMax F5 multi-

mode microplate reader (Molecular Devices, Sunnyvale, CA). 5-fluorouracil (5-FU; Sigma-Aldrich, St Louis, MO) was used to confirm the sensitivity of each cell line to the toxic metabolite. Significant differences in viability were calculated using the Student's *t*-test (unpaired samples, two-tailed, equal variance). *P* values < 0.05 were considered to be significant.

Results

B-cell specific expression using the Ig promoter

The B-cell specific promoter that we used contains a synthetic Ig promoter homologous to the murine Ig heavy chain promoter along with the murine kappa light chain 3' enhancer and the murine kappa light chain intronic enhancer [44]. This promoter with both enhancers, referred to as the Ig promoter, was chosen since high transgene expression levels (30–90%) were previously reported in MM cells using a lentiviral vector with the VSV-G coat protein and the *EGFP* gene under the control of this promoter [44]. In order to test the activity of the promoter in our system, we used VSV-G pseudotyped viruses encoding the *EGFP* gene under the control of either the Ig promoter or the ubiquitously active Ubi-c promoter. U266 human MM cells were chosen because they have been previously shown to be resistant to the cytotoxic effects of ch128.1Av alone [26, 34]. The percentage of EGFP expressing cells using the Ig promoter was comparable to that of Ubi-c promoter in U266 cells (Figure 2A). However, the mean fluorescence intensity (MFI) in the EGFP positive population was much higher in U266 cells transduced with viruses containing the Ig promoter (Figure 2B). As expected, in CCRF-CEM human acute T-lymphoblastic leukemia cells EGFP expression was only observed in cells transduced with the *EGFP* gene under the control of the Ubi-c promoter (Figure 2). Using either promoter, the percentage of EGFP expressing cells was highly variable among the various malignant B-cell lines that we tested (Table 1). Additionally, in most cell lines the percentage of EGFP expressing cells was lower with the Ig promoter compared to the Ubi-c promoter (Table 1). The MFI for all cell lines are shown in Table 2. Only in U266 and MM.1S cells was the MFI higher with the use of the Ig promoter. Taken together, these data confirm the specificity of the Ig promoter, along with its higher activity in MM cells.

Dual targeted lentiviruses to enhance specific gene delivery to malignant B cells

In order to target Tfr1-expressing cells, ch128.1 was conjugated with 2.2 SINDBIS pseudotyped viruses prior to transduction (Figure 3A). Viruses pseudotyped with the BAP SINDBIS envelope were conjugated with ch128.1Av (Figure 3B) as an alternative strategy to stabilize the conjugation between the targeting molecule and the virus and to examine if the strong biotin-avidin interaction contributes to more efficient gene delivery. Viral envelope proteins were analyzed by western blot. Figure 3C shows the presence of the Sindbis envelope proteins, as well as the biotinylated coat proteins. The E1 Sindbis coat protein is the lower band, while the upper band is E2 fused with E3. These data are consistent with our previous studies [39] and show that the pseudotyped viruses were produced as expected.

Both 2.2 SINDBIS and BAP SINDBIS viruses containing the *EGFP* gene under the transcriptional control of either the Ubi-c or Ig promoter were used to evaluate the efficacy of our dual targeted approaches. EGFP expression under the control of the Ubi-c promoter in U266 cells transduced with ch128.1 conjugated with 2.2 SINDBIS was comparable to that of cells transduced with VSV-G viruses (~ 40–50%; Figures 2 and 4A, Tables 1 and 3). However, using the Ig promoter, EGFP expression was lower with the 2.2 SINDBIS viruses compared to the VSV-G viruses. Since human IgG3 antibodies do not normally bind protein A [49, 50], the $\gamma 3$ heavy chain expression vectors used to produce ch128.1 and ch128.1Av contain an arginine to histidine mutation in the C_H3 domain at residue 435 (Morrison et. al, unpublished results). This point mutation has been shown to be sufficient to allow binding of IgG3 to protein A [50]. Thus, since a non-targeting IgG3 that binds protein A was not available, cells transduced with 2.2 SINDBIS virus alone (without conjugation to an antibody) were used as negative controls. No EGFP expression was observed with either promoter in these control cells. U266 cells transduced with ch128.1 Av conjugated to BAP-SINDBIS viruses showed lower EGFP expression with the Ubi-c promoter compared to ch128.1 targeted 2.2 SINDBIS viruses (Figure 4A), however, using the Ig promoter ch128.1Av targeted BAP SINDBIS viruses showed slightly higher EGFP expression compared to their 2.2 SINDBIS counterparts (30% versus 23%). Using both promoters, no EGFP expression was observed in U266 cells with non-targeted viruses, BAP SINDBIS conjugated to a non-specific IgG3-Av. EGFP expression in human CCRF-CEM T cells was only observed with targeted viruses containing the Ubi-c promoter and not the Ig promoter (Figure 4B). Data from additional cell lines are summarized in Tables 3–4. Representative flow cytometry results for each cell line are shown in Supplementary Figures 2–4. The requirement of TfR1 targeting with the targeted 2.2 SINDBIS viruses was demonstrated by adding excess soluble TfR1 (sTfR1) during transduction. In both U266 and RPMI-8226 cells, EGFP expression was reduced to background levels in the presence of sTfR1, independent of the promoter used (Figure 5). Together these data show that both ch128.1 and ch128.1Av can successfully deliver genes to TfR1-expressing cells and that the gene expression can be limited to malignant plasma cells.

Lentiviral-mediated delivery of the FCU-1 gene

Our EGFP data show that the dual targeted lentiviral approach works as expected. Therefore, we sought to deliver a therapeutic gene into malignant plasma cells for the purpose of cancer therapy. The pyrimidine analog 5-fluorouracil (5-FU) is widely used as a cancer therapy, alone or in combination with other chemotherapeutic agents, for the treatment of a range of cancers including colorectal, breast, and head and neck cancers [51]. It exerts its anti-cancer effect by incorporating into DNA and RNA and also by inhibiting thymidylate synthase. The *FCU1* gene is a chimeric yeast enzyme that consists of cytosine deaminase (CD) and uracil phosphoribosyltransferase (UPRT). CD converts non-toxic prodrug 5-fluorocytosine (5-FC) to the highly cytotoxic metabolites 5-FU, and UPRT in turn converts 5-FU into the toxic metabolite 5-fluorouridine 5'-monophosphate (5-FUMP). We have previously shown that an antibody-avidin fusion protein similar to ch128.1Av but targeting the rat TfR (anti-rat TfR IgG3-Av) could be used to deliver the biotinylated FCU1 protein to rat myeloma cells, which in the presence of (5-FC) was cytotoxic to these malignant cells [45].

Based on these results, we delivered the *FCUI* gene under the control of the Ig promoter in various cell lines. U266, CCRF-CEM, MM.1S, RPMI-8226, and KMS-11 cells were shown to be sensitive to the toxic metabolite 5-FU prior to the initiation of these studies (data not shown). In U266 cells in the presence of 5-FC, VSV-G pseudotyped viruses containing the *FCUI* gene under the control of either the Ubi-c or Ig promoter induced significant 5-FC dose-dependent cell death that was comparable using the two promoters (Figure 6A). 2.2 SINDBIS viruses conjugated to ch128.1 using the Ubi-c promoter also induced a dose-dependent loss in cell viability in the presence of 5-FC in U266 cells (Figure 6B). A slight increase in cell death was observed with the non-targeted virus combined with the highest concentration of 5-FC (10 mM); however, conjugation of the virus with ch128.1 showed a significant decrease in cell viability compared to this control (Figure 6B). The induction of cell death was weaker using the Ig promoter with a significant loss in viability only being observed with the 5 and 10 mM 5-FC. Additionally, the loss in viability between 2.2 SINDBIS viruses conjugated with ch128.1Av and the non-targeting virus control in the presence of 10 mM 5-FC was not significant (Figure 6B). BAP SINDBIS viruses conjugated with ch128.1Av showed a dose dependent induction of cell death in the presence of 5-FC with both promoters (Figure 6C). In both cases, viruses conjugated with ch128.1Av resulted in significant loss of cell viability, compared to viruses conjugated with IgG3-Av (negative, isotype control) in the presence of 10 mM 5-FC (Figure 6C). Similar experiments were conducted in MM.1S cells; however, the induction of cell death with the Ig promoter was much weaker and was not consistently significant (Supplementary Figure 5). It is important to note that the data presented in Figures 6–7 are compared to viruses in the absence of 5-FC, since slight losses in viability were observed in these cells (data not shown). These slight cytotoxic effects were non-specific and most likely due to infection itself: they were considered to be background levels.

To further explore the specific delivery and expression of a therapeutic gene, we examined cell viability in CCRF-CEM T cells transduced with viruses containing the VSV-G coat protein or the pseudotyped SINDBIS envelope proteins conjugated to ch128.1 or ch128.1Av with either the Ubi-c or Ig promoter. In these T cells using viruses with the VSV-G envelope and the Ubi-c promoter a significant dose-dependent induction of cell death was observed in the presence of 5-FC (Figure 7A). As expected, no loss of cell viability was observed using the Ig promoter, further confirming the specificity of the Ig promoter (Figure 7A). Similar to this, viruses with the 2.2 SINDBIS envelope conjugated to ch128.1 showed a significant dose dependent loss of cell viability in the presence of 5-FC. In this case, the non-targeted virus controls (virus not conjugated with an antibody) showed no loss of cell viability. Viruses with the 2.2 SINDBIS coat and the Ig promoter showed a slight decrease in cell viability only in the presence of 10 mM 5-FC. This difference was modest compared to those observed in U266 cells. Using the Ubi-c promoter, ch128.1Av conjugated with BAP SINDBIS viruses yielded a slight decrease in cell viability; however, this difference was not significant. As expected, no decrease in viability was observed in CCRF-CEM T cells using the Ig promoter and ch128.1Av conjugated with BAP SINDBIS viruses.

Discussion

In this study we demonstrated cell specific EGFP expression in malignant B cells but not in malignant T cells, confirming the specificity of the Ig promoter. Using VSV-G pseudotyped lentiviruses, the activity of the promoter was found to be heterogeneous among different types of malignant B-cells. However, a higher percentage of EGFP expressing cells was consistently detected in MM cell lines. The MFI for the EGFP positive cells were much higher in U266 and MM.1S cells, however, for the other malignant B cells this was not the case. The fact that the Ig promoter is more active in MM cells is not surprising, as these cells actively produce Ig. As expected, no EGFP expression was observed in the 3 malignant T-cell lines tested. This is consistent with prior observations from a study that used this Ig promoter, finding high EGFP expression in MM cell lines and no expression in non-myeloma cell lines [44]. This study also showed that lentiviruses pseudotyped with the VSV-G envelope carrying the human iodide symporter, under the control of the Ig promoter in combination with radioiodine, reduced non-specific infection and eradicated myeloma tumors *in vivo*. Together with the present studies, these results show that the use of this Ig promoter is highly effective in restricting transgene expression to myeloma cell lines. Whether this is also the case in primary malignant cells isolated from MM patients remains to be determined.

We have previously shown that ch128.1Av is able to deliver biotinylated pseudotyped lentiviral vectors resulting in EGFP expression in Jurkat T cells using a ubiquitous promoter [39]. Here we show that ch128.1 and ch128.1Av can be used to deliver the *EGFP* gene, with expression limited to malignant plasma cells and dependent on TfR1-mediated delivery. Overall, higher EGFP expression was observed with delivery through ch128.1, compared to ch128.1Av. The reason for this is unknown, but could be related to differences in intracellular trafficking as has been reported for the ch128.1 and ch128.1Av alone [26, 29]. Further studies are needed to explore this possibility. Using the Ubi-c promoter, similar levels of EGFP expression were observed in U266 cells transduced with either the VSV-G pseudotyped lentivirus or 2.2 SINDBIS viruses conjugated to ch128.1. 2.2 SINDBIS viruses conjugated to ch128.1 showed similar or higher EGFP expression compared to the VSV-G viruses using the Ubi-c promoter in all cell lines tested, suggesting that the TfR1 is a meaningful target for the gene therapy of cancer even with the use of a ubiquitously active promoter. This increased expression in some cells using the 2.2 SINDBIS viruses conjugated to ch128.1 could be due to different pathways of viral entry. VSV-G mediates viral entry through the LDL receptor, while targeted viruses are endocytosed through the TfR1. However, a lower percentage of cells showed EGFP expression with the Ig promoter in the malignant B cells tested that were transduced with 2.2 SINDBIS conjugated with 128.1 compared to VSV-G-containing viruses. This is most likely due to the fact that the Ig promoter is weaker or less active in certain cells than the Ubi-c promoter. Interestingly, the highest EGFP expression observed with the Ig promoter was with ch128.1 conjugated to 2.2 SINDBIS virus in MM.1S cells, while ch128.1Av conjugated to BAP SINDBIS had the highest EGFP expression in U266 cells, which could be due to the different characteristics of the cancer cells tested. In our panel of T cells, EGFP expression with ch128.1 conjugated to 2.2 SINDBIS viruses was similar to that of VSV-G pseudotyped lentivirus using the Ubi-

c promoter. Compared to these viruses, lower EGFP expression was observed with ch128.1Av conjugated with biotinylated viruses. The level of EGFP expression that we observed in Jurkat cells was comparable with our previously reported observations [39]. No EGFP expression was observed with the Ig promoter in T cells, as expected. Whether or not the viruses pseudotyped with 2.2 SINDBIS conjugated with ch128.1 will yield higher transduction efficiencies and transgene expression rates in *in vivo* (compared to BAP SINDBIS conjugated to ch128.1Av) remains to be determined.

Our EGFP data showed that our dual targeted approach worked as expected and led to high gene expression levels in malignant plasma cells. This suggests that other genes will also be specifically expressed in malignant plasma-cells. We chose a gene-directed enzyme-prodrug strategy since this system can enhance the selectivity of cancer chemotherapy and have the potential to target surrounding cells through the bystander effect [52]. We used the *FCUI* (*CD/UPRT*) gene since we had previously used it for protein delivery [45] as well as the fact that prodrug approaches using 5-FC have been reported to have a high bystander effect when compared to other prodrug strategies, including the herpes simplex virus thymidine kinase/ganciclovir system, since the bystander effect of 5-FC is not dependent on gap junctions [53, 54]. The CD/5-FC combination has been used to target cancer cells in various ways, including the use of Epstein Barr virus-based vectors, oncolytic measles viruses, and nanoparticles [55–59]. Additionally, clinical trials have been conducted in studies using CD in combination with 5-FC and have shown safety in humans [53]. Importantly, the delivery of *FCUI* via adenoviruses was shown to be a more effective prodrug activation system, compared to the thymidine kinase/ganciclovir and CD/5-FC systems *in vitro* [60]. However, a lentiviral strategy targeting the Tfr1 using an Ig promoter had not been previously explored in the field of cancer therapy.

Our data using the therapeutic gene *FCUI* did not always parallel our EGFP studies. Since the *EGFP* gene is a standard reporter gene for gene therapy studies, our data provide a cautionary note that the use of *EGFP* may not always predict therapeutic gene efficacy *in vitro*. However, given the fact that EGFP expression can be controlled in malignant B-cells, this suggests that the expression of other therapeutic genes besides *FCUI* may parallel EGFP expression. In general, the use of the Ubi-c promoter resulted in dose-dependent cell death when in the presence of the 5-FC prodrug. However, significant cell death using both promoters was only consistently detected in U266 cells but not in the other malignant B cells (MM.1S shown in Supplementary Figure 5; data not shown for other cell lines). The fact that our gene therapy strategies worked in U266 is highly important since these cells are inherently resistant to apoptosis due to the high expression of the anti-apoptotic protein Bcl-x_L [61]. Furthermore, U266 cells are not sensitive to the direct cytotoxic effects of ch128.1Av or ch128.1 [26, 34]. Thus, our gene therapy approaches may be a meaningful treatment option in patients with MM that is resistant to other therapeutics.

The reason that FCUI-induced cell death was not consistent in the other MM cell lines is not known at this time, but could be due to the lower expression of the FCUI enzyme. This could be problematic if a high expression level of the therapeutic gene is required for cytotoxicity. However, high expression of genes in a small population of cells *in vivo* can lead to a strong bystander effect, with toxic metabolites spreading to neighboring cells via

non-facilitated diffusion [54]. Furthermore, 5-FC has been shown to accumulate *in vivo* after multiple doses, producing a significant reduction in tumors containing only 2% of CD transduced cells [54]. It has also been shown that FCU1 expressing tumor cells can be enriched through concurrent treatment with an inhibitor of pyrimidine *de novo* synthesis and cytosine [62]. This leads to pyrimidine depletion-mediated death of non-transduced cells and rescue of FCU1 expressing cells via the pyrimidine salvage pathway. This enrichment step followed by the administration of 5-FC lead to a near-complete bystander effect and marked decrease in tumor growth in a syngeneic murine NXS2 neuroblastoma model [62]. This study showed that it is possible to overcome the low efficacy in gene transfer *in vivo*. Moreover, infiltration of CD4⁺ and CD8⁺ T lymphocytes and macrophages has been detected in murine hepatocellular carcinoma cells (of which only 5% expressed CD) in immunocompetent mice treated with 5-FC. This infiltration led to significant tumor reduction and even complete regression of tumors in some animals. These animals were also protected from the subsequent challenge with non-CD expressing tumor cells [63].

Toxicity to normal B-cells induced by our targeted gene therapy strategies was not tested in this study due to the difficulty in culturing primary B cells for extended periods of time. However, non-activated (resting) B cells express low levels of the Tfr1 and thus, are not expected to be vulnerable to the cytotoxic effects of ch128.1Av or ch128.1 conjugated with lentiviruses encoding a therapeutic gene. Upon activation of B cells, Tfr1 levels are known to increase, making this receptor a marker for B cell activation [64, 65]. Thus, toxicity to activated B cells would not be surprising. In fact, depletion of normal B cells occurs with other treatments for B-cell malignancies. Rituximab, which is used in the clinic for the treatment of NHL, causes transient depletion of normal B cells that can last for up to a year after cessation of treatment [66]. It is also important to note that hematopoietic stem cells lack Tfr1 expression [36–38] and are not vulnerable to the effects of ch128.1Av alone or conjugated to a toxin [33, 35]. Therefore, if B cell depletion does occur upon treatment, this cell population can be regenerated from the hematopoietic stem cells.

Transcriptionally restrictive gene expression using tissue specific promoters and viral vectors has been explored by others. Different B cell specific promoters have been used, mostly for the purpose of designing gene therapy strategies for B-cell disorders. These promoters include a murine Ig κ promoter combined with a murine Ig heavy chain intronic and 3' enhancers [67], the CD19 promoter [68], and various promoters (both ubiquitous and B-cell specific) combined with the murine heavy chain enhancer (E μ) and the 5' and 3' matrix attachment regions elements [69–73]. Our studies using antibody-mediated targeted lentiviral vectors with a B-cell specific promoter represent the first use of this approach. However, viruses pseudotyped with various SINDBIS envelopes containing the ZZ domain have been previously used to target other cancer types. In conjunction with a murine antibody targeting the human P-glycoprotein, viruses containing the m168 pseudotyped Sindbis envelope demonstrated enhanced *in vivo* targeting in a metastatic melanoma xenograft model [42]. In order to enhance the infectivity of the m168 envelope, SGN UTR mutations were introduced in order to create the 2.2 SINDBIS envelope [43]. Murine antibodies specific for the prostate stem cell antigen combined with lentiviruses pseudotyped with the 2.2 SINDBIS envelope and containing a prostate specific promoter (PSE-BC) have

been shown to target prostate cancer bone metastases *in vivo* after systemic administration [41]. One potential problem with the use of the 2.2 SINDBIS vector *in vivo* is the competition with endogenous serum IgG for binding to the ZZ domain, which could decrease tumor targeting and efficacy. In an attempt to circumvent this problem, we also used the avidin-biotin system to form a more stable complex of our antibody and the virus. Previous studies have also utilized the avidin-biotin system to enhance tumor targeting. Metabolically biotinylated adenoviral vectors have been constructed by fusing the BAP from the biotin-dependent transcarboxylase enzyme of *Propionibacterium shermanii* to the structural proteins fiber capsid [74] and protein pIX [75], allowing them to be conjugated to biotinylated ligands through the use of tetrameric avidin. Biotinylated viruses where the BAP is incorporated into the adenoviral fiber protein have been complexed with epidermal growth factor (EGF)-streptavidin to retarget the virus to EGF receptor expressing cells [76]. That study showed enhanced tumor targeting both *in vitro* and *in vivo*. The avidin-biotin system has also been used with lentiviral vectors with where avidin or streptavidin was fused to the transmembrane anchor of VSV-G on gp64 pseudotyped viruses [77]. These avidin-containing viruses were then conjugated to biotinylated radionuclides and used in a dual imaging approach in the rat brain. Whether or not the BAP SINDBIS virus conjugated to ch128.1Av is more stable in blood and has more anti-cancer activity *in vivo* (compared to 2.2 SINDBIS conjugated to ch128.1) remains to be determined.

In summary, this study serves as an initial proof-of-principle showing that ch128.1 and ch128.1Av are able to deliver pseudotyped lentiviruses into targeted cells and that high levels of gene expression can be restricted to malignant plasma cells. This approach minimizes gene expression in non-targeted cells, and thus decreases the potential for dangerous side effects that may occur with certain drug conjugates containing ch128.1Av. Additionally, this strategy is versatile and can be used with other therapeutic genes. For example, the use of a gene encoding a toxin that requires low transgene expression levels may be more beneficial. Moreover, other tissue specific promoters could be used to target other cancer types that express high levels of the TfR1. Additional studies are warranted to further explore the therapeutic potential of our dual targeted gene therapy approach.

Supplementary Material

Refer to Web version on PubMed Central for supplementary material.

Acknowledgments

We would like to thank Dr. David Dingli (Mayo Clinic and Foundation, Rochester, MN) and Dr. Michael Barry (Baylor College of Medicine, Houston, TX) for providing the KIEIgP-EGFP-SIN vector and biotin ligase vector, respectively. We would also like to thank Dr. Sherie Morrison (UCLA, Los Angeles, CA) for the pET9811 vector and Dr. Lawrence Boise (Emory University, Atlanta GA) for the KMS-11 cell line. Furthermore, we would like to thank Dr. Otoniel Martínez-Maza (UCLA, Los Angeles, CA) for carefully reviewing this manuscript. This work was supported in part by NIH/NCI R01CA107023 and K01CA138559, NIH/NIAID R21AI095004 and R01AI108400. The UCLA Jonsson Comprehensive Cancer Center and Center for AIDS Research Flow Cytometry Core Facility is supported by the NIH awards CA16042 and AI28697, and the Jonsson Cancer Center, the UCLA AIDS Institute, and the David Geffen School of Medicine at UCLA. The Center for AIDS Research Virology Core Lab is supported by the NIH award AI 28697 and by the UCLA AIDS institute and the UCLA Council of Bioscience Resources.

References

1. Shaffer AL, Rosenwald A, Staudt LM. Lymphoid malignancies: the dark side of B-cell differentiation. *Nat Rev Immunol.* 2002; 2:920–932. [PubMed: 12461565]
2. Siegel R, Naishadham D, Jemal A. Cancer statistics, 2013. *CA Cancer J Clin.* 2013; 63:11–30. [PubMed: 23335087]
3. Munshi NC, Anderson KC. New strategies in the treatment of multiple myeloma. *Clin Cancer Res.* 2013; 19:3337–3344. [PubMed: 23515406]
4. Kumar SK, Rajkumar SV, Dispenzieri A, et al. Improved survival in multiple myeloma and the impact of novel therapies. *Blood.* 2008; 111:2516–2520. [PubMed: 17975015]
5. Srivastava G, Rana V, Lacy MQ, et al. Long-term outcome with lenalidomide and dexamethasone therapy for newly diagnosed multiple myeloma. *Leukemia.* 2013 May 7. Epub ahead of print.
6. Mikhael JR, Dingli D, Roy V, et al. Management of newly diagnosed symptomatic multiple myeloma: updated Mayo Stratification of Myeloma and Risk-Adapted Therapy (mSMART) consensus guidelines 2013. *Mayo Clin Proc.* 2013; 88:360–376. [PubMed: 23541011]
7. Shan D, Ledbetter JA, Press OW. Apoptosis of malignant human B cells by ligation of CD20 with monoclonal antibodies. *Blood.* 1998; 91:1644–1652. [PubMed: 9473230]
8. Alexander DD, Mink PJ, Adami HO, et al. The non-Hodgkin lymphomas: a review of the epidemiologic literature. *Int J Cancer.* 2007; 120 (Suppl 12):1–39. [PubMed: 17405121]
9. Hennessy BT, Hanrahan EO, Daly PA. Non-Hodgkin lymphoma: an update. *Lancet Oncol.* 2004; 5:341–353. [PubMed: 15172354]
10. Coiffier B. Rituximab therapy in malignant lymphoma. *Oncogene.* 2007; 26:3603–3613. [PubMed: 17530014]
11. Coiffier B. Rituximab in combination with CHOP improves survival in elderly patients with aggressive non-Hodgkin's lymphoma. *Tumori.* 2002; 88:S26–28. [PubMed: 11989916]
12. Nastoupil LJ, Rose AC, Flowers CR. Diffuse large B-cell lymphoma: current treatment approaches. *Oncology (Williston Park).* 2012; 26:488–495. [PubMed: 22730604]
13. Hernandez-Ilizaliturri FJ, Gowda A, Czuczman MS. Development of targeted therapies for B-cell non-Hodgkin lymphoma and multiple myeloma. *Clin Adv Hematol Oncol.* 2004; 2:606–618. [PubMed: 16163245]
14. Cang S, Mukhi N, Wang K, Liu D. Novel CD20 monoclonal antibodies for lymphoma therapy. *J Hematol Oncol.* 2012; 5:64. [PubMed: 23057966]
15. Rezvani AR, Maloney DG. Rituximab resistance. *Best Pract Res Clin Haematol.* 2011; 24:203–216. [PubMed: 21658619]
16. Li ZM, Zucca E, Ghielmini M. Open questions in the management of mantle cell lymphoma. *Cancer Treat Rev.* 2013; 39:602–609. [PubMed: 23415066]
17. Shah BD, Martin P, Sotomayor EM. Mantle cell lymphoma: a clinically heterogeneous disease in need of tailored approaches. *Cancer Control.* 2012; 19:227–235. [PubMed: 22710898]
18. Skarbnik AP, Smith MR. Therapies for mantle cell lymphoma: current challenges and a brighter future. *Discov Med.* 2013; 15:177–187. [PubMed: 23545046]
19. Goy A, Kahl B. Mantle cell lymphoma: the promise of new treatment options. *Crit Rev Oncol Hematol.* 2011; 80:69–86. [PubMed: 21168343]
20. Daniels TR, Delgado T, Rodriguez JA, Helguera G, Penichet ML. The transferrin receptor part I: Biology and targeting with cytotoxic antibodies for the treatment of cancer. *Clin Immunol.* 2006; 121:144–158. [PubMed: 16904380]
21. Richardson DR, Ponka P. The molecular mechanisms of the metabolism and transport of iron in normal and neoplastic cells. *Biochim Biophys Acta.* 1997; 1331:1–40. [PubMed: 9325434]
22. Daniels TR, Bernabeu E, Rodriguez JA, et al. The transferrin receptor and the targeted delivery of therapeutic agents against cancer. *Biochim Biophys Acta.* 2012; 1820:291–317. [PubMed: 21851850]
23. Das Gupta A, Shah VI. Correlation of transferrin receptor expression with histologic grade and immunophenotype in chronic lymphocytic leukemia and non-Hodgkin's lymphoma. *Hematol Pathol.* 1990; 4:37–41. [PubMed: 2187855]

24. Daniels TR, Delgado T, Helguera G, Penichet ML. The transferrin receptor part II: targeted delivery of therapeutic agents into cancer cells. *Clin Immunol*. 2006; 121:159–176. [PubMed: 16920030]
25. Zatloukal K, Wagner E, Cotten M, et al. Transferrin infection: a highly efficient way to express gene constructs in eukaryotic cells. *Ann N Y Acad Sci*. 1992; 660:136–153. [PubMed: 1340117]
26. Ng PP, Helguera G, Daniels TR, et al. Molecular events contributing to cell death in malignant human hematopoietic cells elicited by an IgG3-avidin fusion protein targeting the transferrin receptor. *Blood*. 2006; 108:2745–2754. [PubMed: 16804109]
27. Ng PP, Dela Cruz JS, Sorour DN, et al. An anti-transferrin receptor-avidin fusion protein exhibits both strong proapoptotic activity and the ability to deliver various molecules into cancer cells. *Proc Natl Acad Sci U S A*. 2002; 99:10706–10711. [PubMed: 12149472]
28. Rodriguez JA, Helguera G, Daniels TR, et al. Binding specificity and internalization properties of an antibody-avidin fusion protein targeting the human transferrin receptor. *J Control Release*. 2007; 124:35–42. [PubMed: 17884229]
29. Rodriguez JA, Luria-Perez R, Lopez-Valdes HE, et al. Lethal iron deprivation induced by non-neutralizing antibodies targeting transferrin receptor 1 in malignant B cells. *Leuk Lymphoma*. 2011; 52:2169–2178. [PubMed: 21870996]
30. Ortiz-Sanchez E, Daniels TR, Helguera G, et al. Enhanced cytotoxicity of an anti-transferrin receptor IgG3-avidin fusion protein in combination with gambogic acid against human malignant hematopoietic cells: functional relevance of iron, the receptor, and reactive oxygen species. *Leukemia*. 2009; 23:59–70. [PubMed: 18946492]
31. Suzuki E, Daniels TR, Helguera G, et al. Inhibition of NF-kappaB and Akt pathways by an antibody-avidin fusion protein sensitizes malignant B-cells to cisplatin-induced apoptosis. *Int J Oncol*. 2010; 36:1299–1307. [PubMed: 20372806]
32. Li ZW, Chen H, Campbell RA, Bonavida B, Berenson JR. NF-kappaB in the pathogenesis and treatment of multiple myeloma. *Curr Opin Hematol*. 2008; 15:391–399. [PubMed: 18536579]
33. Daniels TR, Ortiz-Sanchez E, Luria-Perez R, et al. An antibody-based multifaceted approach targeting the human transferrin receptor for the treatment of B-cell malignancies. *J Immunother*. 2011; 34:500–508. [PubMed: 21654517]
34. Daniels TR, Ng PP, Delgado T, et al. Conjugation of an anti transferrin receptor IgG3-avidin fusion protein with biotinylated saporin results in significant enhancement of its cytotoxicity against malignant hematopoietic cells. *Mol Cancer Ther*. 2007; 6:2995–3008. [PubMed: 18025284]
35. Daniels-Wells TR, Helguera G, Rodriguez JA, et al. Insights into the mechanism of cell death induced by saporin delivered into cancer cells by an antibody fusion protein targeting the transferrin receptor 1. *Toxicol In Vitro*. 2013; 27:220–231. [PubMed: 23085102]
36. Gross S, Helm K, Gruntmeir JJ, et al. Characterization and phenotypic analysis of differentiating CD34+ human bone marrow cells in liquid culture. *Eur J Haematol*. 1997; 59:318–326. [PubMed: 9414644]
37. Bender JG, Unverzagt K, Walker DE, et al. Phenotypic analysis and characterization of CD34+ cells from normal human bone marrow, cord blood, peripheral blood, and mobilized peripheral blood from patients undergoing autologous stem cell transplantation. *Clin Immunol Immunopathol*. 1994; 70:10–18. [PubMed: 7505211]
38. Lansdorp PM, Dragowska W. Long-term erythropoiesis from constant numbers of CD34+ cells in serum-free cultures initiated with highly purified progenitor cells from human bone marrow. *J Exp Med*. 1992; 175:1501–1509. [PubMed: 1375263]
39. Morizono K, Xie Y, Helguera G, et al. A versatile targeting system with lentiviral vectors bearing the biotin-adaptor peptide. *J Gene Med*. 2009; 11:655–663. [PubMed: 19455593]
40. Thomas CE, Ehrhardt A, Kay MA. Progress and problems with the use of viral vectors for gene therapy. *Nat Rev Genet*. 2003; 4:346–358. [PubMed: 12728277]
41. Pariente N, Morizono K, Virk MS, et al. A novel dual-targeted lentiviral vector leads to specific transduction of prostate cancer bone metastases in vivo after systemic administration. *Mol Ther*. 2007; 15:1973–1981. [PubMed: 17653099]

42. Morizono K, Xie Y, Ringpis GE, et al. Lentiviral vector retargeting to P-glycoprotein on metastatic melanoma through intravenous injection. *Nat Med.* 2005; 11:346–352. [PubMed: 15711560]
43. Morizono K, Ringpis GE, Pariente N, Xie Y, Chen IS. Transient low pH treatment enhances infection of lentiviral vector pseudotypes with a targeting Sindbis envelope. *Virology.* 2006; 355:71–81. [PubMed: 16905172]
44. Dingli D, Diaz RM, Bergert ER, et al. Genetically targeted radiotherapy for multiple myeloma. *Blood.* 2003; 102:489–496. [PubMed: 12649158]
45. Asai T, Trinh R, Ng PP, et al. A human biotin acceptor domain allows site-specific conjugation of an enzyme to an antibody-avidin fusion protein for targeted drug delivery. *Biomol Eng.* 2005; 21:145–155. [PubMed: 15748688]
46. Morizono K, Bristol G, Xie YM, Kung SK, Chen IS. Antibody-directed targeting of retroviral vectors via cell surface antigens. *J Virol.* 2001; 75:8016–8020. [PubMed: 11483746]
47. Helguera G, Penichet ML. Antibody-cytokine fusion proteins for the therapy of cancer. *Methods Mol Med.* 2005; 109:347–374. [PubMed: 15585931]
48. Byrne SL, Leverence R, Klein JS, et al. Effect of glycosylation on the function of a soluble, recombinant form of the transferrin receptor. *Biochemistry.* 2006; 45:6663–6673. [PubMed: 16716077]
49. Janeway, CA.; Travers, P.; Walport, M.; Schlomchick, M. Chapter 4: The Generation of Lymphocyte Antigen Receptors. In: Lawrwnce, E., editor. *Immunobiology: the immune system in health and disease.* 6. New York: Garland Publishing; 2005. p. 135-164.
50. Natsume A, In M, Takamura H, et al. Engineered antibodies of IgG1/IgG3 mixed isotype with enhanced cytotoxic activities. *Cancer Res.* 2008; 68:3863–3872. [PubMed: 18483271]
51. Longley DB, Harkin DP, Johnston PG. 5-fluorouracil: mechanisms of action and clinical strategies. *Nat Rev Cancer.* 2003; 3:330–338. [PubMed: 12724731]
52. Springer CJ, Niculescu-Duvaz I. Prodrug-activating systems in suicide gene therapy. *J Clin Invest.* 2000; 105:1161–1167. [PubMed: 10791987]
53. Dachs GU, Hunt MA, Syddall S, Singleton DC, Patterson AV. Bystander or no bystander for gene directed enzyme prodrug therapy. *Molecules.* 2009; 14:4517–4545. [PubMed: 19924084]
54. Huber BE, Austin EA, Richards CA, Davis ST, Good SS. Metabolism of 5-fluorocytosine to 5-fluorouracil in human colorectal tumor cells transduced with the cytosine deaminase gene: significant antitumor effects when only a small percentage of tumor cells express cytosine deaminase. *Proc Natl Acad Sci U S A.* 1994; 91:8302–8306. [PubMed: 8058798]
55. Kenney S, Ge JQ, Westphal EM, Olsen J. Gene therapy strategies for treating Epstein-Barr virus-associated lymphomas: comparison of two different Epstein-Barr virus-based vectors. *Hum Gene Ther.* 1998; 9:1131–1141. [PubMed: 9625252]
56. Kaufmann JK, Bossow S, Grossardt C, et al. Chemovirotherapy of malignant melanoma with a targeted and armed oncolytic measles virus. *J Invest Dermatol.* 2013; 133:1034–1042. [PubMed: 23223133]
57. Zaoui K, Bossow S, Grossardt C, et al. Chemovirotherapy for head and neck squamous cell carcinoma with EGFR-targeted and CD/UPRT-armed oncolytic measles virus. *Cancer Gene Ther.* 2012; 19:181–191. [PubMed: 22076043]
58. Sher YP, Chang CM, Juo CG, et al. Targeted endostatin-cytosine deaminase fusion gene therapy plus 5-fluorocytosine suppresses ovarian tumor growth. *Oncogene.* 2013; 32:1082–1090. [PubMed: 22562248]
59. Zhang G, Liu T, Chen YH, et al. Tissue specific cytotoxicity of colon cancer cells mediated by nanoparticle-delivered suicide gene in vitro and in vivo. *Clin Cancer Res.* 2009; 15:201–207. [PubMed: 19118047]
60. Erbs P, Regulier E, Kintz J, et al. In vivo cancer gene therapy by adenovirus-mediated transfer of a bifunctional yeast cytosine deaminase/uracil phosphoribosyltransferase fusion gene. *Cancer Res.* 2000; 60:3813–3822. [PubMed: 10919655]
61. Catlett-Falcone R, Landowski TH, Oshiro MM, et al. Constitutive activation of Stat3 signaling confers resistance to apoptosis in human U266 myeloma cells. *Immunity.* 1999; 10:105–115. [PubMed: 10023775]

62. Unger MM, Wahl J, Ushmorov A, et al. Enriching suicide gene bearing tumor cells for an increased bystander effect. *Cancer Gene Ther.* 2007; 14:30–38. [PubMed: 17024230]
63. Kuriyama S, Kikukawa M, Masui K, et al. Cytosine deaminase/5-fluorocytosine gene therapy can induce efficient anti-tumor effects and protective immunity in immunocompetent mice but not in athymic nude mice. *Int J Cancer.* 1999; 81:592–597. [PubMed: 10225450]
64. Chiotoglou I, Smilevska T, Samara M, et al. Predominantly post-transcriptional regulation of activation molecules in chronic lymphocytic leukemia: the case of transferrin receptors. *Blood Cells Mol Dis.* 2008; 41:203–209. [PubMed: 18621559]
65. Epeldegui M, Thapa DR, De la Cruz J, et al. CD40 ligand (CD154) incorporated into HIV virions induces activation-induced cytidine deaminase (AID) expression in human B lymphocytes. *PLoS One.* 2010; 5:e11448. [PubMed: 20625427]
66. Kimby E. Tolerability and safety of rituximab (MabThera). *Cancer Treat Rev.* 2005; 31:456–473. [PubMed: 16054760]
67. Laurie KL, Blundell MP, Baxendale HE, et al. Cell-specific and efficient expression in mouse and human B cells by a novel hybrid immunoglobulin promoter in a lentiviral vector. *Gene Ther.* 2007; 14:1623–1631. [PubMed: 17851547]
68. Friedrich RI, Nopora K, Brocker T. Transcriptional targeting of B cells with viral vectors. *Eur J Cell Biol.* 2012; 91:86–96. [PubMed: 21458103]
69. Kerns HM, Ryu BY, Stirling BV, et al. B cell-specific lentiviral gene therapy leads to sustained B-cell functional recovery in a murine model of X-linked agammaglobulinemia. *Blood.* 2010; 115:2146–2155. [PubMed: 20093406]
70. Lutzko C, Senadheera D, Skelton D, Petersen D, Kohn DB. Lentivirus vectors incorporating the immunoglobulin heavy chain enhancer and matrix attachment regions provide position-independent expression in B lymphocytes. *J Virol.* 2003; 77:7341–7351. [PubMed: 12805432]
71. Moreau T, Barlogis V, Bardin F, et al. Development of an enhanced B-specific lentiviral vector expressing BTK: a tool for gene therapy of XLA. *Gene Ther.* 2008; 15:942–952. [PubMed: 18323795]
72. Mock U, Thiele R, Uhde A, Fehse B, Horn S. Efficient lentiviral transduction and transgene expression in primary human B cells. *Hum Gene Ther Methods.* 2012; 23:408–415. [PubMed: 23240650]
73. Sather BD, Ryu BY, Stirling BV, et al. Development of B-lineage predominant lentiviral vectors for use in genetic therapies for B cell disorders. *Mol Ther.* 2011; 19:515–525. [PubMed: 21139568]
74. Parrott MB, Adams KE, Mercier GT, et al. Metabolically biotinylated adenovirus for cell targeting, ligand screening, and vector purification. *Mol Ther.* 2003; 8:688–700. [PubMed: 14529842]
75. Campos SK, Parrott MB, Barry MA. Avidin-based targeting and purification of a protein IX-modified, metabolically biotinylated adenoviral vector. *Mol Ther.* 2004; 9:942–954. [PubMed: 15194061]
76. Pereboeva L, Komarova S, Roth J, Ponnazhagan S, Curiel DT. Targeting EGFR with metabolically biotinylated fiber-mosaic adenovirus. *Gene Ther.* 2007; 14:627–637. [PubMed: 17251987]
77. Kaikkonen MU, Lesch HP, Pikkarainen J, et al. (Strept)avidin-displaying lentiviruses as versatile tools for targeting and dual imaging of gene delivery. *Gene Ther.* 2009; 16:894–904. [PubMed: 19440224]

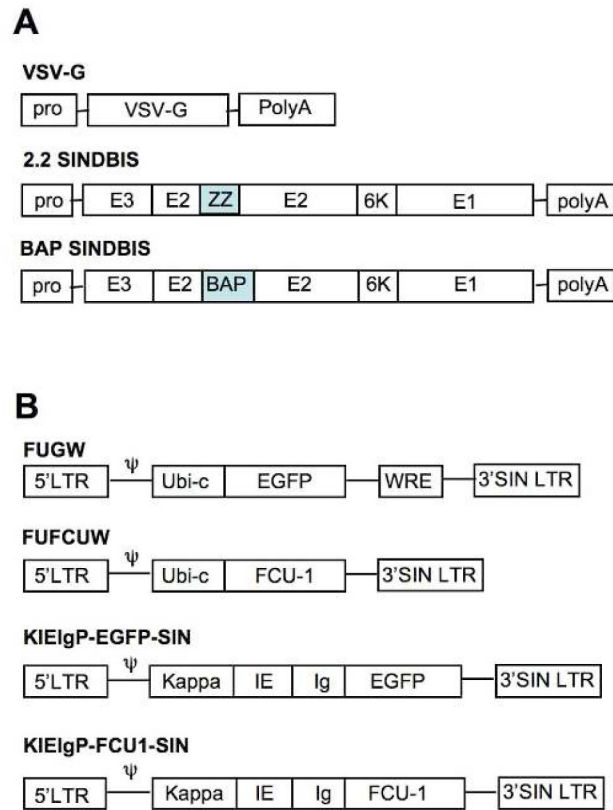

Figure 1. Schematic representation of lentiviral vectors

Schematic representation of A) lentiviral envelope plasmids and B) self-inactivating lentiviral expression vectors containing the ubiquitin c (Ubi-c) promoter or immunoglobulin (Ig) promoter. In the envelope vectors E2 mediates binding to target cells and E1 mediates fusion between the viral envelope and the target cell membrane. E3 and 6K are leader sequences for E2 and E1, respectively. ZZ: protein A Fc binding region; BAP: biotin adaptor protein; WRE: woodchuck hepatitis virus post-transcriptional regulatory element; ψ : packaging signal; Kappa: murine kappa light chain 3' enhancer; IE: murine kappa light chain intronic enhancer; Ig: immunoglobulin heavy chain promoter; SIN: self-inactivating; LTR: long terminal repeat.

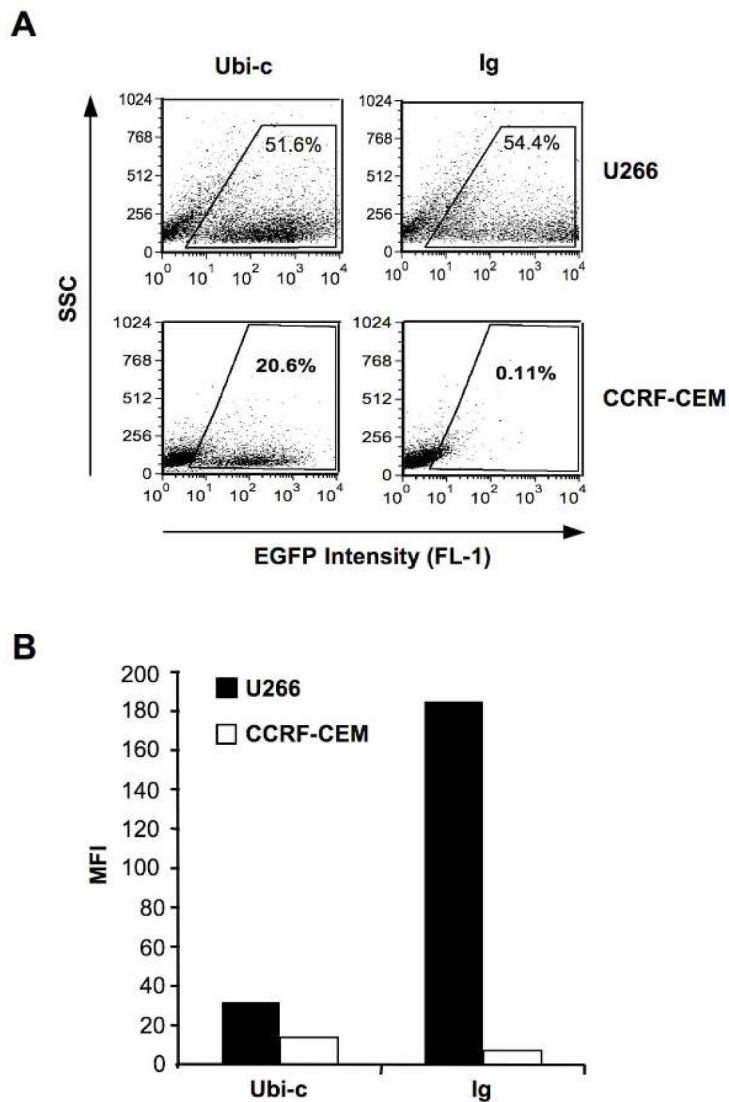

Figure 2. Specificity of the Ig promoter

U266 or CCRF-CEM cells were infected with VSV-G coated virus (40 ng p24) containing the *EGFP* gene under the control of the Ubi-c or Ig promoter. EGFP expression was analyzed 4 days post-infection via flow cytometry. Results are representative of at least 3 independent experiments. Panel A and panel B represent dot plots and a graph of the MFI for the EGFP positive populations, respectively. SSC: side scatter.

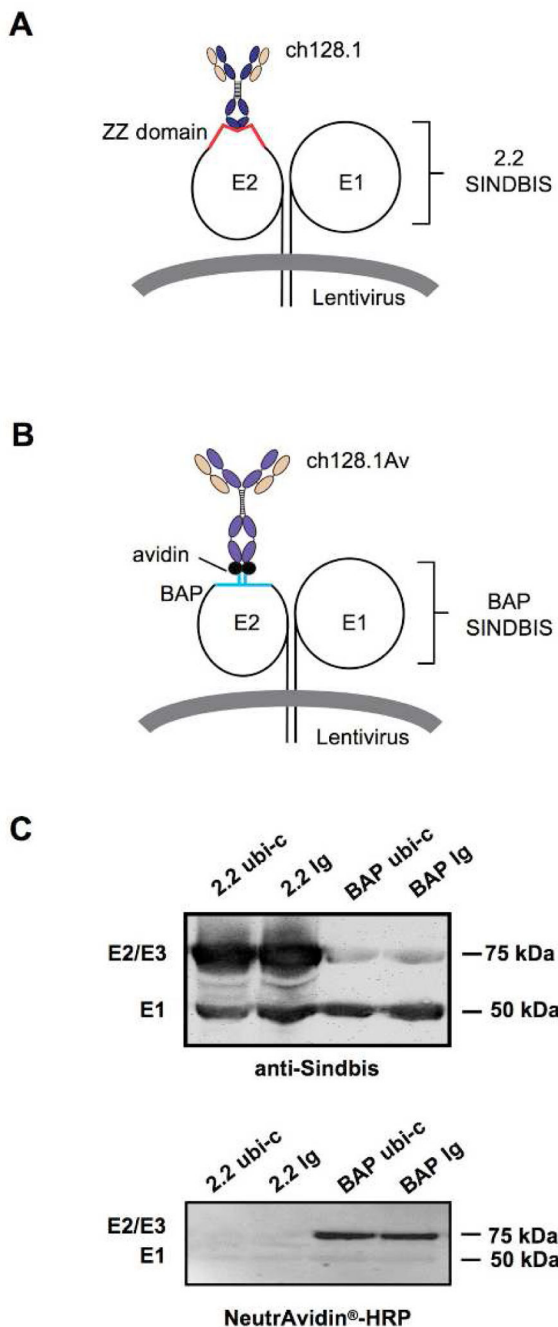

Figure 3. Targeting strategies and verification of pseudotyped viral coat proteins
 Schematic representation of viruses conjugated to A) ch128.1 through 2.2 SINDBIS and B) ch128.1Av through biotin-avidin interaction with BAP SINDBIS. C) Western blot analysis of chimeric Sindbis virus envelope proteins. Lentivirus pseudotyped with 2.2 SINDBIS or BAP SINDBIS produced in the presence of pSec BirA and biotin were analyzed using anti-Sindbis ascitic fluid and a secondary anti-mouse IgG-HRP or NeutrAvidin®-HRP.

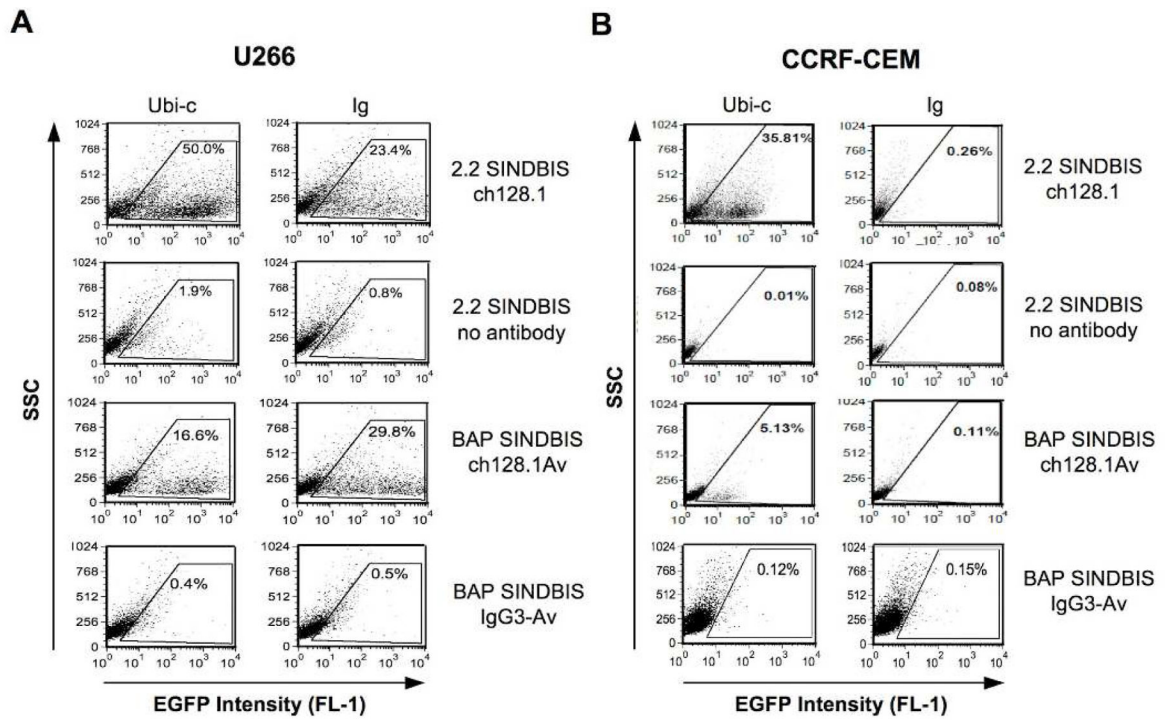

Figure 4. Targeted EGFP expression in B cells

U266 or CCRF-CEM cells were infected with virus conjugated to TfR1 targeting antibodies for 2 hours. Four days post-infection, cells were analyzed for EGFP expression via flow cytometry. EGFP expression with both 2.2 SINDBIS and BAP SINDBIS is shown in A) U266 human MM cells and B) CCRF-CEM human acute lymphoblastic leukemia T cells. Results are representative of 3 or more experiments.

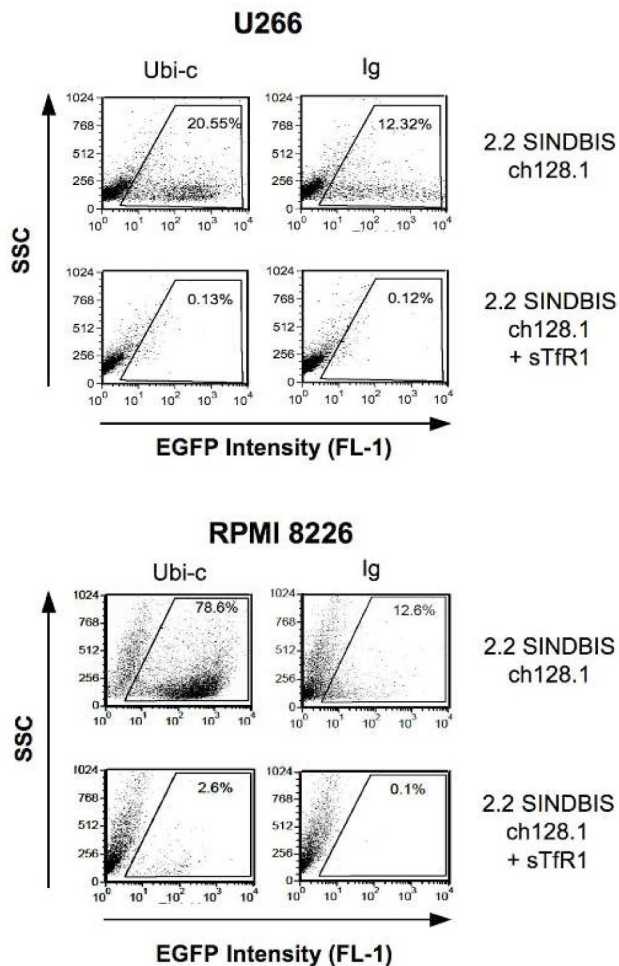

Figure 5. sTfR1 blocks TfR-mediated virus entry
 Cells were infected with 2.2 SINDBIS virus conjugated to ch128.1 in the presence or absence of 10 μ g soluble TfR1 (sTfR1) for 2 hours. Four days post-infection, cells were analyzed for EGFP expression via flow cytometry. EGFP expression is shown in A) U266 and B) RPMI 8226 cells. Data are representative of 2 experiments.

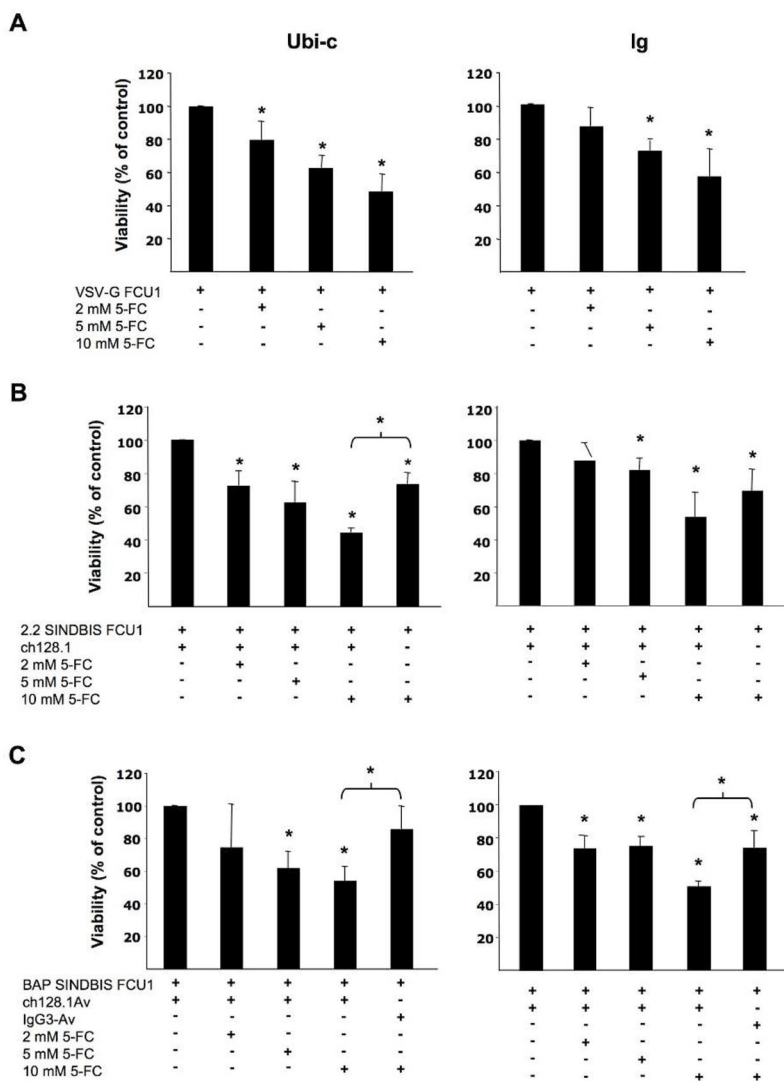

Figure 6. Specific delivery of FCU1 into malignant B cells and the induction of cell death in the presence of 5-FC

U266 cells were infected with the indicated virus particles with the A) VSV-G envelope, B) 2.2 SINDBIS envelope conjugated with ch128.1, or C) BAP SINDBIS envelope conjugated with ch128.1Av. Two-hours post-transduction cells were treated with various concentrations of 5-FC for 4 days. Direct treatment with 0.1mg/ml 5-FU was used as positive control. Cell viability was measured using the WST-1 or MTS assay. Data are the averages of 3 independent experiments (each performed in triplicate) and data are presented as a percentage of cells transduced with the same virus in the absence of 5-FC. Error bars indicate the standard deviation. * indicates $p < 0.05$ and shows significant difference when compared to control cells transduced but without the addition of 5-FC (unless indicated otherwise).

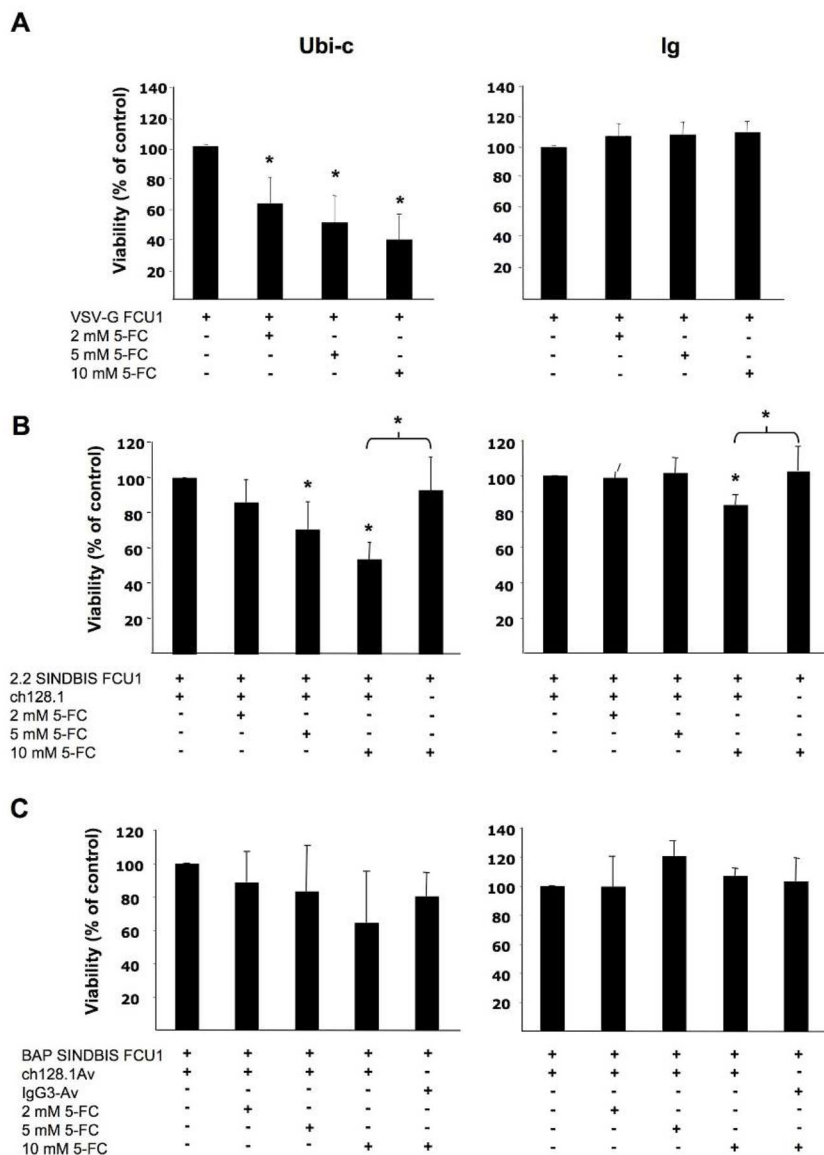

Figure 7. Evaluation of cytotoxicity in the presence of 5-FC in T cells
 CCRF-CEM T cells were infected with the indicated virus particles with the A) VSV-G envelope, B) 2.2 SINDBIS envelope with ch128.1, or C) BAP SINDBIS envelope with ch128.1Av. Cells were treated with various concentrations of 5-FC for 4 days. Direct treatment with 0.1mg/ml 5-FU was used as positive control. Cell viability was measured using the MTS assay. Data are the averages of 3 independent experiments (each performed in triplicate) and are presented as a percentage of cells transduced with the same virus but in the absence of 5-FC. Error bars indicate the standard deviation. * indicates $p < 0.05$ and show significant difference when compared to control cells transduced with the same virus but in the absence of 5-FC (unless indicated otherwise).

Table 1

Percentage of EGFP positive, VSV-G infected cells.

| | | Ubi-c | Ig | Number of independent experiments |
|--------------------------|------------------|--------------|--------------|-----------------------------------|
| Malignant B cells | | | | |
| U266 | MM | 47.5 (9.73) | 49.1 (11.83) | 4 |
| MM.1S | MM | 54.9 (21.03) | 48.1 (12.15) | 3 |
| RPMI 8226 | MM | 58.5 (3.91) | 12.6 (5.6) | 3 |
| KMS-11 | MM | 61.9 (4.16) | 16.2 (6.62) | 3 |
| Z-138 | MCL | 17.0 (4.75) | 7.4 (3.16) | 3 |
| REC-1 | MCL | | 2.5 (2.04) | 5 |
| IM-9 | B lymphoblastoid | 40.5 (17.34) | 2.9 (3.07) | 3 |
| Malignant T cells | | | | |
| CCRF-CEM | | 20.3 (5.79) | 0.2 (0.08) | 5 |
| MOLT-4 | | 31.3 (11.13) | 1.2 (1.84) | 5 |
| Jurkat | | 64.3 (2.83) | 2.6 (0.21) | 2 |

Data shown are the average (standard deviation) of the number of experiments indicated. MM: multiple myeloma; MCL: mantle cell lymphoma.

Table 2

Mean fluorescence intensity (MFI) of EGFP positive, VSV-G infected cells.

| | | Ubi-c | Ig | Number of independent experiments |
|--------------------------|------------------|---------------|---------------|-----------------------------------|
| Malignant B cells | | | | |
| U266 | MM | 38.5 (11.52) | 311.1(144.48) | 4 |
| MM.1S | MM | 43.6 (18.53) | 325.7 (26.98) | 3 |
| RPMI 8226 | MM | 132.5 (30.35) | 28.8 (10.91) | 3 |
| KMS-11 | MM | 96.6 (20.05) | 46.2 (22.61) | 3 |
| Z-138 | MCL | 13.0 (5.91) | 14.9 (5.47) | 3 |
| REC-1 | MCL | 7.0 (0.62) | 6.3 (0.71) | 5 |
| IM-9 | B lymphoblastoid | 69.7 (7.25) | 23.1 (12.01) | 3 |
| Malignant T cells | | | | |
| CCRF-CEM | | 28.1 (18.88) | 12.1 (7.99) | 5 |
| MOLT-4 | | 20.2 (7.55) | 14.6 (5.95) | 5 |
| Jurkat | | 62.1 (4.69) | 43.2 (3.49) | 2 |

Data shown are the average (standard deviation) of the number of experiments indicated. MM: multiple myeloma; MCL: mantle cell lymphoma.

Table 3

Percentage of EGFP positive, 2.2 SINDBIS infected cells.

| | U/bi-c | | | Ig | | |
|--------------------------|--------------|--------------|-------------|-------------|---------|-------------|
| | ch128.1 | no antibody | ch128.1 | no antibody | ch128.1 | no antibody |
| Malignant B cells | | | | | | |
| U266 | 42.3 (7.00) | 5.0 (5.50) | 17.0 (3.20) | 0.6 (0.30) | | 3 |
| MM.1S | 66.0 (0.32) | 0.8 (0.06) | 42.9 (3.34) | 0.7 (0.10) | | 3 |
| RPMI 8226 | 71.3 (4.18) | 2.4 (0.66) | 7.9 (1.65) | 0.2 (0.01) | | 4 |
| KMS-11 | 91.3 (1.27) | 1.0 (0.34) | 25.0 (7.05) | 0.1 (0.01) | | 3 |
| Z-138 | 24.3 (1.13) | 0.2 (0.16) | 8.2 (1.50) | 0.1 (0.02) | | 3 |
| REC-1 | 55.2 (5.44) | 0.9 (0.45) | 2.0 (0.64) | 0.3 (0.24) | | 3 |
| IM-9 | 41.8 (21.80) | 10.2 (14.70) | 1.4 (1.20) | 0.1 (0.80) | | 4 |
| Malignant T cells | | | | | | |
| CCR5-CEM | 40.2 (9.26) | 0.1 (0.09) | 0.4 (0.08) | 0.1 (0.02) | | 3 |
| MOLT-4 | 29.9 (8.43) | 0.5 (0.33) | 0.6 (0.22) | 0.3 (0.24) | | 2 |
| Jurkat | 33.6 (13.00) | 3.2 (2.60) | 0.6 (0.90) | 0.0 (0.00) | | 3 |

Data shown are the average (standard deviation) of the number of experiments indicated.

Table 4

Percentage of EGFP positive, BAP SINDBIS infected cells.

| | Ubi-c | | | Ig | | | Number of independent experiments |
|--------------------------|--------------|------------|-------------|------------|-----------|---------|-----------------------------------|
| | ch128.1AV | IgG3-Av | ch128.1AV | IgG3-Av | ch128.1AV | IgG3-Av | |
| Malignant B cells | | | | | | | |
| U266 | 11.9 (6.65) | 0.5 (0.19) | 28.7 (3.05) | 1.5 (1.69) | | | 3 |
| MM.1S | 33.2 (1.37) | 1.8 (0.50) | 14.0 (3.96) | 1.0 (0.46) | | | 3 |
| RPMI 8226 | 41.4 (15.25) | 2.0 (1.66) | 2.7 (0.47) | 0.5 (0.17) | | | 3 |
| KMS-11 | 44.0 (33.71) | 1.3 (1.29) | 7.2 (0.38) | 0.1 (0.09) | | | 3 |
| Z-138 | 14.0 (0.84) | 0.2 (0.11) | 6.2 (2.60) | 2.6 (2.20) | | | 3 |
| IM-9 | 4.8 (2.50) | 0.1 (0.02) | 2.7 (4.06) | 0.3 (0.31) | | | 3 |
| Malignant T cells | | | | | | | |
| CCRF-CEM | 9.5 (5.94) | 0.2 (0.11) | 0.2 (0.04) | 0.2 (0.05) | | | 3 |
| MOLT-4 | 8.8 (2.13) | 0.5 (0.23) | 0.3 (0.21) | 0.2 (0.05) | | | 3 |
| Jurkat | 24.4 (3.73) | 0.5 (0.28) | 0.6 (0.75) | 0.1 (0.18) | | | 2 |

Data shown are the average (standard deviation) of the number of experiments indicated.