

# UC Berkeley

## UC Berkeley Electronic Theses and Dissertations

### Title

Speaking Truth to Power

### Permalink

<https://escholarship.org/uc/item/8hf0k837>

### Author

Klugman, Noah

### Publication Date

2021

Peer reviewed|Thesis/dissertation

Speaking Truth to Power

by

Noah Klugman

A dissertation submitted in partial satisfaction of the

requirements for the degree of

Doctor of Philosophy

in

Engineering- Electrical Engineering and Computer Science

in the

Graduate Division

of the

University of California, Berkeley

Committee in charge:

Associate Professor Prabal Dutta, Chair

Professor Eric Brewer, Co-chair

Professor Catherine Wolfram

Fall 2021



Speaking Truth to Power

Copyright 2021  
by  
Noah Klugman

Abstract

Speaking Truth to Power

by

Noah Klugman

Doctor of Philosophy in Engineering- Electrical Engineering and Computer Science

University of California, Berkeley

Associate Professor Prabal Dutta, Chair

Professor Eric Brewer, Co-chair

Electricity is increasingly considered to be a human right. In much of the world, however, basic data about power outages and voltage quality is not available, making it difficult to ensure reliable service. Smart meters are difficult to deploy and slow to be adopted in lower-resourced areas, the same areas where frequent outages and voltage sags most impede economic growth.

In this work, I present evidence that by aggregating simple, noisy measurements from networked sensors installed at outlets in households and businesses, we can detect both large and small power outages and power-quality issues, enabling a utility-independent, agile, high-resolution, and low-cost system well suited for deployment in under-instrumented areas.

I design, deploy, and operate a large network of sensors—called PowerWatch—at outlets in households and businesses across Accra, Ghana. I show that this deployment, when coupled with cloud-based analytics, matches utility-reported rates of high- and medium-voltage outages at a fraction of the cost. Further this methodology provides a good estimate of low-voltage outages, potentially filling a critical data gap present in most countries.

The deployment methodology developed allows for longitudinal data to be gathered independently from the utility. Utility engineers are not required for sensor installation, and permission is not required as utility property is not impacted. I describe a number of novel measurement and analysis opportunities enabled by this independent deployment methodology, many of which are being piloted by *nLine*, the company I co-founded to continue improving this work.

Data from PowerWatch is being used by multiple governments and research institutions, including as a primary source for the Monitoring and Evaluation of the \$315 million USD, MCC-led Ghana Power Compact.

*“My holy of holies is the human body, health,  
intelligence, talent, inspiration, love  
and absolute freedom – freedom from violence and falsehood,  
no matter how the last two manifest themselves.”*

also

*“Reason and justice tell me there’s more love for humanity  
in electricity and steam than in chastity or  
vegetarianism.”*

— Anton Chekhov

For Lane.

For both Vicki Chessin and Duane Powell.

Thank you to my sister Sara and my parents Jeff and Elana for their support.

With love for past, current, and future kind, anxious, daring, and clever collaborators,  
colleagues, and friends.

# Contents

<b>Contents</b>	<b>iii</b>
<b>List of Figures</b>	<b>vi</b>
<b>List of Tables</b>	<b>xx</b>
<b>1 Introduction</b>	<b>1</b>
1.1 The Importance of Reliability . . . . .	2
1.2 Reliability Requires Grid-Performance Data . . . . .	6
1.3 Thesis Statement . . . . .	7
1.4 Dissertation Roadmap . . . . .	8
<b>2 Background</b>	<b>10</b>
2.1 Definitions . . . . .	10
2.1.1 The Grid . . . . .	10
2.1.2 Power Outages . . . . .	11
2.1.3 Voltage and Frequency . . . . .	13
2.2 Standard Reliability Metrics . . . . .	14
2.2.1 Good Reliability . . . . .	15
2.2.2 Good Reliability Data . . . . .	17
2.3 Causes of Performance Problems . . . . .	18
2.4 Existing Data Sources . . . . .	19
2.4.1 Meters . . . . .	21
2.4.2 Call Centers . . . . .	26
2.4.3 Surveys . . . . .	27
2.4.4 Non-Traditional Sensors . . . . .	30
2.5 Value of Utility-Independent Measurements . . . . .	33
2.5.1 National Security . . . . .	33
2.5.2 Targeted Actions . . . . .	35
2.5.3 Higher-Resolution Adherence Checks . . . . .	36
2.5.4 Public Benefit . . . . .	36
2.6 Stakeholders in Grid-Performance Data . . . . .	38

2.6.1	Utility Companies . . . . .	41
2.6.2	Regulators . . . . .	44
2.6.3	Ratepayers . . . . .	48
2.6.4	Investors . . . . .	53
2.6.5	Researchers . . . . .	54
2.7	The Grid and Climate Change . . . . .	55
2.7.1	Slowing Climate Change by Increasing Grid Efficiency . . . . .	57
2.7.2	Slowing Climate Change by Enabling Clean Generation . . . . .	61
2.7.3	Operational Challenges Caused by Climate Change . . . . .	62
2.8	Summary . . . . .	63
<b>3</b>	<b>The Deployment</b>	<b>64</b>
3.1	Ghana Context . . . . .	65
3.1.1	History of Poor Electricity Reliability . . . . .	65
3.1.2	Ground Truth Not Available . . . . .	66
3.1.3	Evaluation Goals . . . . .	67
3.2	PowerWatch Goals . . . . .	69
3.2.1	Improving Energy-Reliability Data Quality . . . . .	69
3.2.2	Developing an Independent Measurement Methodology . . . . .	70
3.2.3	Exploring Socioeconomic Impacts of Reliability . . . . .	71
3.3	Methodology . . . . .	72
3.4	Site Selection . . . . .	74
3.5	Sampling Strategy . . . . .	76
3.6	Deployment and Surveying Team . . . . .	77
3.7	Summary . . . . .	79
<b>4</b>	<b>The Device</b>	<b>80</b>
4.1	Architecture . . . . .	81
4.1.1	Sensor . . . . .	81
4.1.2	Cloud . . . . .	83
4.1.3	Outage Clustering . . . . .	83
4.1.4	Cost . . . . .	83
4.1.5	Deployment Management Tool . . . . .	84
4.1.6	Visualizations . . . . .	84
4.2	Device Performance . . . . .	85
4.2.1	In-Lab Testbed . . . . .	85
4.2.2	In-Field Analysis . . . . .	88
4.3	Summary . . . . .	90
<b>5</b>	<b>The Data</b>	<b>91</b>
5.1	Deployment Data . . . . .	91
5.1.1	Extracting Outages . . . . .	92

5.1.2	Sampling Evaluation . . . . .	97
5.2	Grid Data . . . . .	103
5.2.1	Original Deployment . . . . .	103
5.2.2	Expanded, <i>n</i> Line Deployment . . . . .	105
5.2.3	Fairness . . . . .	107
5.2.4	PowerWatch Data as Ground Truth . . . . .	110
5.3	Summary . . . . .	110
<b>6</b>	<b>Deployment Retrospective</b>	<b>112</b>
6.1	Small-Scale Pilot . . . . .	113
6.2	Medium-Scale Deployment . . . . .	114
6.2.1	Organizational Challenges . . . . .	114
6.2.2	Cultural Challenges . . . . .	115
6.2.3	Technical Challenges . . . . .	115
6.2.4	Operational Challenges . . . . .	116
6.2.5	Failures and Missteps . . . . .	116
6.3	Large-Scale Deployment . . . . .	117
6.3.1	Organizational and Cultural Challenges . . . . .	118
6.3.2	Technical Challenges . . . . .	118
6.3.3	Operational Challenges . . . . .	119
6.4	Summary . . . . .	119
<b>7</b>	<b>The Road Ahead</b>	<b>121</b>
7.1	<i>n</i> Line . . . . .	121
7.2	New Applications . . . . .	122
7.2.1	Health Care . . . . .	122
7.2.2	Targeting Micro-Grids . . . . .	123
7.2.3	Improving Remote Sensing . . . . .	124
7.3	Building the Macroscope . . . . .	124
	<b>Bibliography</b>	<b>125</b>

# List of Figures

- 1.1 **Although many countries collect data on power outages, very few make that data public, especially those located in Sub-Saharan Africa.** *Figures remade from “Digitalization and the Use of Technology in the Electricity Sector,” published by the World Bank Malaysia Hub in 2020 [3].* In (a) we can see that High Income OECD economies are nearly twice as likely to be calculating SAIDI and SAIFI than economies in Sub-Saharan Africa. In (b) we see that this data is even less likely to be published—only 2/3 of the population calculating SAIDI and SAIFI in (a) publish data. This reluctance to publish is seen even in the wealthiest economies. When researchers, regulators, and rate payers can not access this data, it limits the important roles they play in ensuring reliability [4, 5]. . . . . 2
- 1.2 **Poor grid reliability quickly impacts popular culture.** Picture (a) shows a recent article about the best tools to purchase for power outages from popular New York Times-owned recommendation blog Wirecutter [16]. Picture (b) is a photo I took of a billboard beside a major highway running through downtown San Francisco. Once you start looking, it is easy to find signs in popular media that energy reliability is something people care about. . . . . 3
- 1.3 **Images of frustration due to grid reliability.** In (a), protesters demand better power four years after the grid in Puerto Rico was devastated by Hurricane Maria [23]. Picture (b) is an image posted on the Facebook page of Todos Somos Pueblo, a collection of 30 Puerto Rican community groups focused on solving the lingering energy crisis on the island [24]. . . . . 4
- 1.4 **Access vs Population, and Reliability of Connection vs Population.** *Figure from “Electricity Reliability and Economic Development in Cities: A Microeconomic Perspective” [10].* We see that access, in (a), is clustered more tightly around 100% than reliability, in (b), indicating a global need either to broaden priorities to include reliability or improve existing strategies for achieving reliability [10, 30]. . . . . 5



2.1	<b>Basic model of the grid.</b> In this model we see the grid hierarchy as a function of voltage level. A few high-voltage lines each serve a large section of the grid; then more-numerous medium-voltage feeder lines serve smaller subsections of the grid; and then myriad low-voltage distribution lines serve individual households and businesses through the meter installed at the service connection. This simple model omits details that are less important for our primary sensing methodology including phases, customer segments, and the distinction between transmission and distribution networks. . . . .	11
2.2	Various parts of the energy supply chain that I photographed in Accra. . . . .	12
2.3	<b>Tool provided by the Electricity Company of Ghana (ECG) as used to calculate SAIDI and SAIFI for Achimota in September 2018.</b> <i>Figure modified from data provided by ECG [69].</i> The district rarely reports 33 KV and 11 KV events in these reports. Instead, these are collected at the head office for the entire Accra West region. Note the SAIFI of 0.03 and SAIDI of 0.01 from LV interruptions, which are 166 times lower than PowerWatch measurements (see Figure 5.5). The format of the spreadsheet gives hints of other common aggregations (i.e., HV, MV, LV). . . . .	15
2.4	<b>Simplified multi-tier matrix of energy access</b> <i>Figure is a screen capture from “Capturing the Multi-Dimensionality of Energy Access” from the World Bank and ESMAP [75].</i> The World Bank proposed this multi-tier framework in 2013. The goal was to create a weighted index of access to energy for a given geographical area based on multiple factors. This effort has been praised but its implementation has been controversial [74]. . . . .	16
2.5	<b>Subsections of two regulations in Ghana.</b> <i>(a) is a screen capture from L.I. 1935 [84] and (b) is a screen capture from L.I. 2413 [85].</i> In (a), L.I. 1935 specifies the number of hours annually that power outages are not to exceed for consumers in different areas. In (b), L.I. 2412 provides the schedule of reports generated by the utility for regulators. . . . .	17
2.6	<b>Recommendations for evaluating reliability data quality.</b> <i>Figure is a screen capture from “Data Standards for Integrated Energy Planning” [30].</i> These takeaways are from a July 2020 meeting hosted by SEforALL with 65 participants across 28 energy-planning organizations involved in generating, analyzing, or using energy data [30]. Many of these recommendations are more achievable using PowerWatch than other available systems. . . . .	18
2.7	<b>Causes of blackouts in the United States.</b> <i>Table from “Weather-Related Power Outages and Electric System Resiliency” for the Congressional Research Service [89].</i> . . . . .	19
2.8	<b>Low-voltage monitoring is a global problem.</b> <i>Figure shows a portion of a table from “Data Standards for Integrated Energy Planning,” by U.N. Sustainable Energy for All and U.K. Aid [30].</i> This table shows the current global availability of the datasets PowerWatch is able to measure, as collected across countries tracked by SE4All, and SE4All’s comments about these datasets. . . . .	20

- 2.9 **Customer-facing outage system from DTE Energy.** In (a), we see a very-high-resolution map of on-going outages tracked and displayed by DTE as screen captured from their website on December 11, 2021 [91]. In (b), screen captured from DTE’s website at the same time, we note that even though the utility has very-high-resolution maps, they still revert to asking customers to report the root cause of outages, going as far to display (b) to all users as a pop-up when their map is first loaded. . . . . 20
- 2.10 **Meeting Minutes from the July 2017 IEEE PES Distribution Reliability Working Group showing that utilities in the U.S. use multiple reliability metrics.** The above meeting-minutes excerpt describes results from a 30-state survey of mostly investor-owned utilities [92]. . . . . 21
- 2.11 **Approximate SCADA coverage in Accra.** ECG has installed SCADA on the high-voltage networks and some of the medium-voltage networks [94]. . . . . 22
- 2.12 **Global Smart Meter (Energy and Water) Penetration by Region.** *Figure adopted from “Smart Meter Market 2019,” from IoT Analytics [95].* Smart meters have been on the market for many years but adoption remains low, especially in Africa and South America [30, 95]. . . . . 23
- 2.13 **Smart metering has not been equally distributed across the United States.** *Figure is a screen capture from the U.S. Department of Energy’s “Smart Grid System Report: 2018 Report to Congress” [13].* This map shows the relatively unequal roll out of smart meters within the U.S., indicating that complex factors are involved in smart-meter adoption. Smart meters provide a very sparse sample of the low-voltage network in some states. . . . . 24
- 2.14 **A UI for a smart grid system in Florida.** *Figure is a screen capture from the U.S. Department of Energy’s “Smart Grid System Report: 2018 Report to Congress” [13].* While this particular display from 2018 may now be outdated, this type of dashboard represents the average, clunky user interface present in many public reports [5, 13, 49]. . . . . 25
- 2.15 **Average number of calls per user in a district in Accra from a 421-participant survey.** Despite the fact that, as shown in this figure, most people do not call to report power outages, the total annual cost of calls to ECG is not insignificant. Using an average cost per minute of 0.1132 Ghana Cedis (approx. 0.03 USD) [107], and an average call time of 2.33 minutes calculated from ECG call center data, we can estimate that an average call costs 0.264 Cedis (approx. 0.06 USD). We can then estimate that the total cost of calls ECG received in 2017 (with a cumulative time of 14.6 person years) would have been 870,548 Cedis (approx. 193,000 USD), or .00045% of Ghana’s GDP [108]. . . . . 26

- 2.16 **A flier mailed to my house in Ann Arbor, Michigan, around 2016.** This type of direct-to-consumer data collection is often recommended as a scalable way for collecting energy data [5, 13], but it has many downsides when compared to automated metering [5, 13, 112]. It is worth mentioning that my house at the time had a smart meter, making this data potentially already available, and my utility company, DTE, was piloting technology to give customers better access to their consumption data, indicating a willingness by the utility company to be transparent with consumers [91]. . . . . 27
- 2.17 **The homepage of the Afrobarometer Survey.** *Figure is a screen capture from [115].* Afrobarometer uses surveys to “collect and publish high-quality, reliable statistical data on Africa which is freely available to the public.” They also provide data-access and analysis tools, as well as their own research output. . . . . 28
- 2.18 **The Dumsor Report.** *Figure is a screen capture from the Dumsor Report [118].* One of the most accurate in-field reports of actual grid performance is from a two-week study conducted by collecting outage and activation reports from citizens around Accra, Ghana [117]. The methodology lay somewhere between crowdsourcing and sensing, as participants were paid to carefully record the precise time of every power outage and return over the two-week window [118]. . . . . 29
- 2.19 **Professional and low-cost meters.** In (a) we see a selection of professional power-quality meters on the market, screen captured from “MyFlukeStore.com” [137]. In (b) we see an emerging low-cost sensor market, screen captured from “Amazon.com” after a search for “power meter” in the United States [133]. . . . . 30
- 2.20 **Internet of Things devices are ubiquitous and capable of measuring grid reliability.** In (a) we see a screen capture from Microsoft’s “2019 Manufacturing Trends Report” showing that IoT device sales have skyrocketed in the past five years [148]. Many of these devices could measure power outages. In (b) and (c) we see screenshots of Ring notifications. In (b) the Ring alarm reports a power outage and in (c) the restoration is reported, providing a clear side channel for using these devices to coarsely measure outage duration. . . . . 32
- 2.21 **Quote from “Russia and Ukraine in a Standoff Over Crimea Power Outage,”** in *The New York Times*, November 26, 2015 [169]. . . . . 33
- 2.22 **Quote from “China Appears to Warn India: Push Too Hard and the Lights Could Go Out,”** in *The New York Times*, February 28, 2021 [170]. . . . . 34
- 2.23 **Quote from “Power shortage hits Central Asia,”** in *The New York Times*, February 26, 2009 [171]. . . . . 34
- 2.24 **Quote from “China Appears to Warn India: Push Too Hard and the Lights Could Go Out,”** in *The New York Times*, February 28, 2021 [170]. . . . . 34
- 2.25 **Quote from “Russia and Ukraine in a Standoff Over Crimea Power Outage,”** in *The New York Times*, November 26, 2015 [169]. . . . . 35
- 2.26 **Quote from “Power shortage hits Central Asia,”** in *The New York Times*, February 16, 2009 [171]. . . . . 35

2.27	<b>Quote from “Power Grid Is Attacked in Arkansas,”</b> in <i>The New York Times</i> , October 9, 2013 [172]. . . . .	35
2.28	<b>Quote from “Russia and Ukraine in a Standoff Over Crimea Power Outage,”</b> in <i>The New York Times</i> , November 26, 2015 [169]. . . . .	36
2.29	<b>Quote from “China Appears to Warn India: Push Too Hard and the Lights Could Go Out,”</b> in <i>The New York Times</i> , February 28, 2021 [170]. . . . .	36
2.30	<b>Quote from “Russia and Ukraine in a Standoff Over Crimea Power Outage,”</b> in <i>The New York Times</i> , November 26, 2015 [169]. . . . .	37
2.31	<b>Misinformation presents a threat.</b> <i>Figure is a screen capture from a Google Domains search for “outage” restricted to results ending with “.com”</i> [176]. The opportunity, indicated here by red boxes, for malicious parties to spread misinformation about power outages is present and hard to protect against as long as data remains highly distributed [13, 30]. . . . .	38
2.32	<b>Quote from “China Appears to Warn India: Push Too Hard and the Lights Could Go Out,”</b> in <i>The New York Times</i> , February 28, 2021 [170]. . . . .	38
2.33	<b>Key stakeholders in the U.S. energy market.</b> <i>Figure is a screen capture from “Electricity Evolution: Meet the Ringmasters”</i> [178]. . . . .	39
2.34	<b>Energy stakeholders in Ghana.</b> <i>Figure is a screen capture from “The Electricity Situation in Ghana: Challenges and Opportunities”</i> [179]. . . . .	40
2.35	<b>U.N. Energy Compact Stakeholders.]</b> <i>Figure is a screen capture from the “Energy Compact Overview” by the United Nations, as of October 26, 2021</i> [181]. Note the diversity of stakeholders involved with meeting the goals of SDG7. . . . .	41
2.36	<b>Utility applications enabled by different temporal resolution data.</b> <i>Figure is a screen capture from the U.S. Department of Energy document “2018 Smart Grid System Report: 2018 Report to Congress”</i> [13]. In this timeline, different utility applications are shown based on their required temporal resolution. PowerWatch, which currently achieves temporal resolution in the seconds, is therefore suited for supporting utility applications from the center of this timeline forward. . . . .	42
2.37	<b>Table to support utility cost/benefit analysis of reliability data.</b> <i>Table from “Guidebook for Cost/Benefit Analysis of Smart Grid Demonstration Projects,” by the Electric Power Research Institute for the U.S. Department of Energy</i> [49]. . . . .	43
2.38	<b>Table to support customer cost/benefit analysis of reliability data.</b> <i>Table from “Guidebook for Cost/Benefit Analysis of Smart Grid Demonstration Projects,” by the Electric Power Research Institute for the U.S. Department of Energy</i> [49]. . . . .	44
2.39	<b>Regulators are present in most countries reporting SAIDI and SAIFI in Sub-Saharan Africa.</b> <i>Figures remade from “Digitalization and the Use of Technology in the Electricity Sector” published by the World Bank Malaysia Hub in 2020</i> [3] . . . . .	45

2.40	<b>Discussions about climate change impact willingness to pay.</b> <i>Figure captured from “Discussion Sways Participants On Climate Change,” by NORC at the University of Chicago [193]. Across all demographic groups considered, a discussion on climate change improved willingness to use less electricity and pay more in taxes and energy costs. . . . .</i>	47
2.41	<b>People do not buy into a bad grid.</b> <i>Figure is screen capture from [10]. . . .</i>	49
2.42	<b>Cost incurred by hotels due to grid outages.</b> <i>Figure is a screen capture from “The Impact of Power Outage ‘Dumsor’ on the Hotel Industry: Evidence from Ghana” [202]. . . . .</i>	50
2.43	<b>Two-way mobile communication offered by Kenya Power and Light Company (KPLC) [205].</b> <i>I took this picture in Kenya in 2016. Based on conversations with KPLC, this service was provided based on demand. It also allowed KPLC to collect data from their participants. . . . .</i>	51
2.44	<b>An estimated 300K to 1.5M people search “power outage” each month in the United States.</b> <i>Figure is a screen capture from the Moz Keyword Explorer [206]. We see a large monthly volume for the search term “power outage” and that this volume is driven by traffic to outage maps at large utilities [206]. . . . .</i>	52
2.45	<b>Voltage problems change purchasing patterns.</b> <i>Figure is a screen capture from Jumia, a popular online retailer in Kenya, after a keyword search for “fridge guard” [209]. These devices provide stability for important appliances and are often necessary purchases. On December 17, 2021, the day this Figure was captured, 1 USD was 113 KSh [210]. . . . .</i>	53
2.46	<b>Research framework compiled from survey of recent academic publications.</b> <i>From “Electric grid reliability research” in Energy Informatics [215]. This framework was built from a review of 503 recent papers on electricity reliability. The authors explain: “The first theme, energy efficiency, drives the evolution of smart energy-saving systems. The second theme, renewable-energy supply, drives the advancement of smart grids. Finally, the third additional theme, service reliability, drives smart-grid reliability and resiliency” [215]. . . . .</i>	55
2.47	<b>Upcoming research and development needs to modernize the grid.</b> <i>Figure is a screen capture from the U.S. Department of Energy “Quadrennial Technology Review 2015” [216]. This table contains the steps needed to transition to a modern grid in the US as well as and the research directions required to take these steps [216]. . . . .</i>	56

- 2.48 **Table to support cost/benefit analysis of applications often considered beneficial for addressing climate change.** *Table from “Guidebook for Cost/Benefit Analysis of Smart Grid Demonstration Projects,” by the Electric Power Research Institute for the U.S. Department of Energy [49].* The blue “Benefits” columns describes, from the utility perspective, economic, reliability, environmental, and safety benefits available. The purple “Application” categories describe different applications often proposed as part of a climate change solution [244]. Of the three applications, Electricity Storage has the most indicated benefit to reliability. . . . . 58
- 2.49 **Electricity plays a significant role in emissions.** *Figure from the U.S. Environmental Protection Agency [242].* Better efficiency will reduce energy that is generated only to be lost on the network, potentially helping to reduce this share over time. . . . . 59
- 2.50 **Africa contributes around 3% of global CO2 emissions.** *Figures from “Each Country’s Share of CO2 Emissions” published by the Union of Concerned Scientists [250].* Emissions causing climate change largely stem from outside of Africa and South America. . . . . 60
- 2.51 **A striking number of countries in Africa do not report per capita energy consumption from renewable generation.** *Figure from Our World In Data [258].* Data on renewable usage is critical for ensuring long-term sustainability and can not be another generation of technology away if aggressive climate and social justice goals are to be met (many of which are targeting countries in Africa specifically) [4, 5, 184]. . . . . 61
- 3.1 **An ad for the Ghana Power Compact.** This ad, funded by the Ghana Power Compact, was one of many placed around Accra to raise awareness and support for the work underway [272]. . . . . 66
- 3.2 **Treatment and Control Sites** Distribution of treatment and control sites across Achimota district. Locations were chosen in part based on information about where SMEC will be injecting new transformers during their low-voltage line bifurcation project. . . . . 69
- 3.3 **Overview of deployment.** To support the goals of the deployment, our team selected sites that were being improved by the Ghana Power Compact and selected control sites. The technology was deployed in both sites along with surveys at the beginning and end of the deployment. This deployment strategy allowed us to meet our goals of evaluating the impact of grid improvements on power reliability and the socioeconomic impact of that reliability on consumers. . . . . 72



3.4	<b>The dataflow for the deployment.</b> While traditional surveying methods have a linear data flow where data is exported for later analysis, the integration of continuous sensing in the deployment generated feedback loops which created more places where state was stored and greater need to communicate this state, and amplified issues with errors during surveying. We implemented a deployment-management system to alleviate these problems. Red arrows show data flows that we first attempted to perform manually and later automated or facilitated with a deployment management tool. Blue arrows show data flows that we automated from the beginning because we anticipated their complexity before the medium-scale deployment. . . . .	73
3.5	<b>Some of the deployment meta systems.</b> In (a) we see a method used to ensure field officers received and properly notated a participant’s phone number, a critical step because this was how incentives were transferred and sensor maintenance was scheduled. In (b) we see an blank view into the deployment-management system, where field officers could view the state of the deployment in real time and autonomously schedule participant check ups. . . . .	74
3.6	<b>A typical site.</b> We deployed 3 PowerWatch in each site, and data can be grouped so that only data collected in this site is analyzed. Sites are selected using criteria described across Evaluation Design Reports of Mathematica Policy Research [212] and UC Berkeley [213] . . . . .	75
3.7	<b>PowerWatch Deployment Area.</b> Sensors were deployed in three of 26 districts in Accra. The deployment covered an area of approximately 130 square kilometers. This deployment was subsequently increased to 1,400 sensors and a much wider area by <i>nLine</i> , a startup I co-founded. . . . .	76
3.8	<b>Deployment methodology of sensors.</b> By randomly sampling households and firms under a transformer, sensors can detect high-voltage (HV), medium-voltage (MV), and a significant portion of low-voltage (LV) outages. Sensors might not detect single phase outages, as in the bottom outage of (d), because our sampling did not guarantee sensors were distributed across all possible phases in practice, due to both the difficulty of identifying the phase(s) to which a service was connected and manual phase switching by a household or firm. Sensors estimate the average frequency and duration of outages, which include both single-phase and service-level outages. . . . .	77
3.9	<b>Field officers in uniform.</b> Branding and messaging was especially important as the quality of our sample depends on long term positive relationships with participants. . . . .	78
4.1	<b>PowerWatch as deployed.</b> (a) PowerWatch PCB with cellular radio, SD card, and sensing circuits. (b) Assembled PowerWatch sensors with QR code scanned at installation to associate the sensor with a participant. (c) A field officer installing a PowerWatch sensor at a household outlet. . . . .	80

4.2 **PowerWatch System Architecture.** PowerWatch measures the grid by plugging in at outlets in homes or businesses, transmitting data about power quality over the cellular network, and clustering the data based on temporal and spatial characteristics of power outages. . . . . 81

4.3 **Evolution of PowerWatch with each deployment.** PowerWatch revision A consisted of an off-the-shelf compute/communication module and enclosure (A.1) and paired with a custom sensor front-end (A.2). Data from this revision informed the need for a better enclosure and more casing in revision B, which consisted of a custom sensing and communication board (B.1), enclosure with externally plugged power supply (B.2), and a separate grid voltage and frequency sensor (B.3). While the separate grid voltage and frequency sensor allowed for easier assembly, its complications led us to build revision C, a completely-encased custom sensor which plugs directly into the wall, to sense grid voltage and frequency. 82

4.4 **Early Engineering Dashboard.** This is accessed using a web browser. The table towards the top of the screen lists all sensors, the time since the last data received, the total time it has been deployed, and its current battery life. The bottom graph shows a time series representation of all PowerWatch devices. The orange line is all of the devices. The green line is all devices that believe the power is on. The blue line is all devices that believe the power is off. There are two outages present in this view, which can be seen as a spike in the blue line as more devices report that the power is off and a dip in the green line as less devices report power is on. While not the most aesthetically pleasing, it allowed us to handle medium to large scale deployments. . . . . 84

4.5 **PowerWatch data visualization** *Figure is screen capture from nLine’s data visualization system [290].* With the goal of supporting non-technical users, this dashboard was developed to allow for spatial and temporal queries to be trivially run, visualized, and analyzed across the PowerWatch dataset. nLine has since performed multiple training’s with utility and regulator stakeholders in Ghana on using this tool and will be making it available over the next year. . . . . 85

4.6 **Two testbeds.** In (a) we see an early, small test bed, and in (b) we see our testbed from two years later. As the technology has developed, supporting systems had to improve (see Chapter 6) and opportunities for further optimization like the tighter timing shown in Figure 4.8 arose frequently. . . . . 86

4.7 **Time range of testbed outages.** A testbed of sensors and programmable outlets generated two hundred outages of various sizes in a controlled setting. We observed the precision of outage timestamping, noting that for any given outage sensors may report that the same outage occurred up to 100s apart. This allowed us to parameterize clustering algorithms used to detect outages in the field. Newer firmware reduces temporal variance to less than 10s. . . . . 87

4.8 **Time range of testbed outages with improved firmware.** Improved firmware decreased the variance to closer to what would be expected, although leaving room for improvement in firmware optimization. . . . . 87



4.9 **Number of sensors reporting throughout the deployment.** Failures are either user unplugs (sensed by the accelerometer), sensors dying due to unsensed unplugs (such as those that occur when the wall switch is flipped), or unknown failures (likely also due to participants unplugging or turning off the sensors, as we observed no hardware or long-term software failure in collected sensors). Initial deployments occurred in June 2018, with some sensors retrieved in December 2018. Additional sensors were deployed in February and April 2019. Field staff actively attempted to maintain reliability from April to June 2019, greatly reducing the rate of sensor failure. Even without field staff support, the rate of failure lessened over time, demonstrating that our deployment methodology is sustainable if properly over-provisioned. . . . . 88

4.10 **Packet Reception Rate (PRR).** PRR was calculated by comparing each sensor’s expected reporting interval and sequence numbers with data received. Jumps in sequence number, or periods sensors did not report when expected, indicated a transmission failure due to lack of cellular connection or bugs in the firmware. Sensors were not included after permanent failure, and PRR was increased by local queuing. . . . . 89

4.11 **Time to acquire first successful GPS fix.** Note CDF axis stops at 0.8. From 462 sensor deployments, over 17% achieved a fix within the first hour after their deployment began, and over 29% within the first day. Over 65% achieved a fix within 30 days. The remaining 11% that achieved a fix were spread over 300 additional days. In 23.2% of the deployments the sensors never achieved a GPS fix. 90

5.1 **PowerWatch captured an outage reported in the news.** PowerWatch sensors and clustering algorithms perfectly captured a power outage event (“dumsor”) reported by GhanaWeb, a popular news source, to have occurred “around 21:00” on March 14, 2019 [301]. . . . . 93

5.2 **PowerWatch captured a period of instability under investigation by the Public Utilities Regulatory Commission of Ghana (PURC).** (a) is a screen capture of a public notice posted by PURC about the launch of an investigation into a period of disruption that occurred from 06/02/21 to 06/09/21. (b) shows data collected by PowerWatch. On the left of the display, SAIDI and SAIFI from the same week-long period the prior year (06/02/20 to 06/09/20) is shown to be much less than SAIDI and SAIFI from the week under investigation. . . . . 94

5.3 **Distribution of times between individual sensor unplug reports.** Over 40 % of sensor unplugs occurred within 100 seconds ( $10^2$ ) of another unplug report. Additionally, the flat section in the middle of the graph indicates that sensor unplug reports occurred largely in two modes: those highly correlated in time with other unplug events, and those occurring much more randomly in time. We believe the temporal correlation is due to outages, and that the presence of this correlation can be used to separate true unplug events from those not caused by grid failure. . . . . 95

- 5.4 **Voltage, frequency, and number of WiFi networks before and after an outage.** We time-aligned and averaged the voltage, frequency, and number of WiFi networks observed by PowerWatch sensors during small (clusters of 3 sensors) and large (clusters of 40 sensors) power outages and restorations. Sensors were “near” an outage if they were in the same site as a sensor in the outage. Voltage and frequency were not measured for sensors experiencing an outage. As cluster size increased, we observed that sensors not near an outage detected changes in frequency and voltage in response to the change in demand associated with an outage or restoration event. The change in number of nearby WiFi signals was similar—decreasing on outage and increasing on restoration. Together these signals corroborated that outages detected by PowerWatch were true outages. . . . . 97
- 5.5 **Comparison of PowerWatch S-SAIFI to the utility-reported SAIFI in quarter 3 of 2018.** Our large outage clusters closely compared to the combined medium- and high-voltage SAIFI reported by ECG, while low-voltage outages (small outage clusters) sensed by PowerWatch greatly exceeded low-voltage SAIFI reported by ECG. This provides evidence of the extent of under-sampling by the utility at the low-voltage level of the grid. . . . . 99
- 5.6 **Calculated S-SAIDI  $\pm$  one standard deviation as sites are removed from the dataset between June and August 2019.** To evaluate whether PowerWatch covered a sufficient sample of the grid to compute a representative S-SAIDI, we removed sites from the dataset in 30 rounds and observed the effect on S-SAIDI. We saw that as sites were removed, standard deviation of S-SAIDI remained relatively low and the mean value of S-SAIDI dropped slightly. . . . . 101
- 5.7 **Coverage dropout study from June to August 2019.** To evaluate the outage detection coverage of PowerWatch, we performed a dropout study, removing sites from our dataset and observing the impact of those removals. Specifically, we looked at the number of “additional sensors” that had been part of an outage cluster prior to the dropout, but which were no longer after a site was dropped. Intuitively, if removing a site causes many outages to either not be formed or shrink significantly in size, that would indicate that the site was essential to detect the correct extent of an outage and that we might be undersampling. During this time period, with no sites removed, there were 1,383 reports from sensors involved in outages of size  $\leq 3$ ; 1,030 reports from sensors involved in outages of size  $> 3$  and  $\leq 10$ ; and 3,969 reports from sensors involved in outages of size  $> 10$ . We observed that for outages containing more than three sensors, nearly 20 sites could be removed from our dataset before we started missing reports from additional sensors. This indicated we had deployed sufficient sensors to detect medium- and high-voltage outages, but, as expected, we did not have a high degree of coverage on the low-voltage network and needed to rely on sampling to estimate its reliability. 102

- 5.8 **Number of sensors reporting outages in a densely-instrumented site.** To better understand the limits of our low-voltage sampling, we deployed 25 sensors in a single site (under a single transformer) for two months and observed the results. We saw two groups of outages: larger outages, which impacted all or a significant portion of the site, and smaller outages, which might be a single phase or smaller. Larger outages comprised about 60% of the outages at this site, while smaller outages made up about 40%. This suggested that our primary deployment strategy of three sensors per site detected many, but not all, low-voltage outages. 103
- 5.9 **All outages PowerWatch detected from June 2018 to September 2019.** The outages are visualized on a timeline where the y axis shows the size of the outage (as the number of sensors impacted) on a log scale. Small perturbations are added to the location of the lines to make it easier to distinguish outages of the same size. PowerWatch detected 3,123 outages with an average duration of 1.7 hours. The longest outage lasted over 48 hours. The largest outage impacted a nearly-80 km<sup>2</sup> area, representing two-thirds of our deployed sensors. . . . . 104
- 5.10 **The number of hours respondents experienced below the target voltage band (207 Vrms) per day.** These measurements contain both the periodic 2 minute measurements as well as measurements taken on outage and restoration across 420 PowerWatch detects that 18% of voltages sensed are outside the desired range. . . . . 104
- 5.11 **Frequency in sample is unstable.** We see that while a majority of our samples are within the acceptable range around the nominal 50 HZ, there are still a significant number of readings that represent deviations beyond the acceptable range of 49.8 to 50.2 HZ. . . . . 105
- 5.12 **The average voltage (V) for participants, by month, in each district of Accra with PowerWatch sensors.** *Includes data collected by the initial PowerWatch deployments described in this work and in the 2019 COMPASS paper [308], text as well as additional data, analysis, and text produced by nLine from a commercial deployment of about 1,400 PowerWatch in Accra [279, 290].* Sensor voltage levels are averaged per participant, then collected and plotted as box plots for each month in each district. Outlier bars represent minimum and maximum average voltages, the green triangle represents the mean of the dataset, and the orange line represents the median. Seasonal trends are observed, as well as long-term voltage level improvements in Achimota and Kaneshie, especially for the lower quartile of participants. More analysis is necessary to attribute the underlying cause of these improvements. . . . . 106

- 5.13 **Daily Hours Undervoltage per Respondent (hours below 207 Vrms) vs Time (year-month) by District of Accra** *This includes data collected by the initial PowerWatch deployments described in this work and in the COMPASS 2019 paper [308] textitas well as additional data, analysis, and text produced by nLine from a commercial deployment of around 1400 PowerWatch in Accra [279, 290]. The average number of hours per day under the target voltage (207 Vrms) experienced by participants every month in each district. The number of hours per day under target voltage is calculated every day for each participant, then collected and plotted as box plots each month in each district. Outlier bars represent minimum and maximum average hours, the green triangle represents the mean, and the orange line represents the median of the dataset. Hours under target voltage better captures the performance of the grid under peak load than the average voltage. As with the average voltage, seasonal trends are observed, as well as long-term voltage stability improvements in Achimota and Kaneshie. More analysis is necessary to attribute the underlying cause of these improvements. Mampong has notably stable voltage with the exception of a few outliers, with nearly all Mampong participants receiving voltage consistently within the target range.* . . . . . 107
- 5.14 **Lorenz curves show us power-quality fairness across our participants.** *Work in progress from “Disaggregated power quality data reveal systemic inequality” by Adkins et al. (including myself) [309]. Lorenz curves for the four power-reliability and -quality metrics across the analysis sites exhibit inequality similar to those reported in other countries, and over larger geographic regions in Sub-Saharan Africa [78]. We note that as power quality worsens, so to does inequality of that measurement. We hypothesize that this is due to low power quality consistently impacting specific pieces of infrastructure.* . . . . . 108
- 5.15 **Heterogeneity in socioeconomic and power-quality indicators.** *Work in progress from “Disaggregated power quality data reveal systemic inequality” by Adkins et al. (including myself) [309]. Examples of power reliability, population, and demographic data split into analysis sites. The presence of inequality in power-reliability and -quality metrics is clear, and some visual correlation can be drawn between power measurements and demographic indicators.* . . . . . 109
- 5.16 **Exploring “reliability climates” and the impact of aggregated metrics like SAIDI and SAIFI.** *Work in progress from “Disaggregated power quality data reveal systemic inequality,” by Adkins et al. (including myself) [309]. This figure shows the error between per-site number and duration of outages and SAIFI and SAIDI metrics aggregated to the district level. We note that the distribution of sites below the mean is wider than those above the mean, indicating that a relatively small proportion of the population experiences significantly worse power.* 109
- 6.1 **Why sensors were uninstalled** . . . . . 117

- 6.2 **The PowerWatch assembly line.** Over the course of four weeks, 10 undergraduates worked 110 person-hours to assemble 295 PowerWatch sensors. They were responsible for assembling the plug; screwing together the enclosure; attaching the circuit board; connecting the battery, antenna, SIM card and SD card; and provisioning the device with base firmware. They worked from team-created assembly manuals and training materials. . . . . 118
- 7.1 **COVID-19 vaccine doses administered per 100 people.** *Figure is a screen capture from “Our World In Data” [328].* The vaccination gap across Africa is striking and brings to mind similar patterns in figures about grid reliability like Figure 2.51 and Figure 2.12. . . . . 123

# List of Tables

- 5.1 **Number of powered sensors within the convex hull of an outage.** Across all sizes of outages, very few powered sensors—at most 2—fall within the convex hull of a detected outage. This gave us confidence that outages detected by PowerWatch were true outages as we would not expect sensors within an outage area to be powered beyond anomalies such as the presence of a generator or concave grid shapes where separately-powered infrastructure encroached into the convex hull of an outage. . . . . 96
- 5.2 **Co-reporting rates and voltage correlation scores of sensors under the same infrastructure.** We identified sensors under the same infrastructure using maps available for a subset of the grid. We found that sensors under the same infrastructure experience higher rates of outage co-reporting. Similarly, a correlation on the first-differences of the reported voltage increased for sensors located under more-local infrastructure. This provided evidence that electrical connections were discernible from our data stream, and that applications such as automated topology detection and subsequent root-cause analysis might be possible even without maps of the grid. . . . . 96
- 5.3 **Equality of power reliability and quality metrics when comparing across four population weights and various demographic metrics.** *Work in progress from “Disaggregated power quality data reveal systemic inequality,” by Adkins et al. (including myself) [309].* We evaluate the ratio between the highest and lowest quartiles (75-25) and the Gini index for four population weights and a variety of demographic metrics. For all demographic metrics, sites are weighted by census population, then ordered by the demographic metric before performing the analysis. Therefore, the census population results serve as a baseline for all demographic metrics further down the table (marked with a \*), and no demographic metric can exceed the inequality of this first row. We pull out several key findings from this analysis: (1) power quality is more unequal than power reliability; (2) low levels of inequality are observed in our dataset with respect to number and duration of outages; and (3) demographic metrics that are intuitive predictors of wealth also exhibit significant inequality with respect to undervoltage. . . . . 110

- 6.1 **Pain points of different scales.** At each scale of deployment we ran into pain points—complexities that we perceived to be more difficult than would be expected by a simple increase in deployment size. We encountered many at the transition to medium scale, when local capacity needed to be built, expenses to operate the technology increased, lack of technical reliability became much more apparent, and systems that could once be human-operated had to be automated. Large scale brought new problems, the most notable being the inability to track deployment state without automated deployment management tools. . . . . 112

## Acknowledgments

This work was supported in part by the Millennium Challenge Corporation through the Development Impact Lab (USAID Cooperative Agreement AID-OAA-A-13-00002), part of the USAID Higher Education Solutions Network; in part by funding from the Department for International Development Energy and Economic Growth initiative (DFID EEG Project A0534A); and in part by the CONIX Research Center, one of six centers in JUMP, a Semiconductor Research Corporation (SRC) program sponsored by DARPA. This work was also the recipient of a 50K Siebel Energy Seed Grant, three different USAID DIL Explorer awards, and a 50K CITRIS seed grant.

Many other people helped make this undertaking possible including Jeff Garnett, Barry Deren, Hana Freymiller, Shreena Patel, and the rest of our contacts at the Millennium Challenge Corporation; Dr. Kofi Marfo, Sharon Abena Parku, and the rest of the monitoring and evaluation team at the Millennium Development Authority (MiDA); Simon Trace, and the rest of our contacts at DFID EEG, Duncan Chaplin and the rest of our contacts at Mathematica Policy Research, Korshi Da Seglah and Nana Bonku Eshun at Halges; Ing. Patrice Afenyo and other staff from the Electricity Company of Ghana, SMEC Ghana, and ESB International.

There is an incredibly long list of people who have been involved with this work from when it started in 2014.

My Thesis Committee members Associate Professor Prabal Dutta (co-chair), Professor Emeritus Eric Brewer (co-chair), and Professor Catherine Wolfram each improved the outcomes of this work significantly. I'm incredibly lucky to have had the chance to learn from this group, and I'll continue trying to meet the high bars you have set.

The other day I found the first email I sent Prabal, in which I say, at 3:14 PM on Dec 11, 2012, "I left your office today incredibly excited both about our conversation and the work you described. The projects you touched on struck me as important, interesting, and very worth doing." Nearly a decade later, I can't believe how well this feeling holds up. Prabal took multiple chances on me, and some of those times, I don't know if I would have done the same in his shoes. He opened doors for me nearly every time I asked, and then gave me space to take my own risks. I have laughed and cried in conversations with Prabal that span research, identity, impact, and phone cases. I am better for having had the benefit of his time.

Before joining Berkeley, I spent a summer in Eric's Technology and Infrastructure for Emerging Regions (TIER) group. The lab space was a bit chaotic; people were running around and building things, there were suitcases full of electronics ready to be deployed, and people had books about public policy on their desks. It felt so real; data was coming back from around the world. I quickly started looking up to Eric based on his vision for TIER, a feeling that only intensified as I learned about his role in conceptualizing and formalizing the overall field of Development Engineering. I am so grateful the consistent support he has provided to me and my work from the very first days of the project.



This work would not exist without Catherine being willing to engage (and reengage) with an interdisciplinary, high-overhead, high-risk project. Catherine, among other outputs, has given a master class in leading a complicated international project, demonstrating how to preserve a clear research agenda and balance team dynamics against the chaos of field work. After years of working with her, I really believe she is driven by a desire to do good. Once she interrupted part of a pitch I was giving to ask me something fundamental and hard about the system architecture that I was proposing. By doing this, she put the science above even the rush of a pitch we had 36 hours to give, demonstrating an integrity that is always present and that I strive to emulate.

I would like to acknowledge important other faculty. Associate Professor Jay Taneja from UMass Amherst has supported this project from nearly its inception, first as my supervisor at IBM Research, Nairobi. Jay pushed me to be a more rigorous, thorough, thoughtful, and relaxed person, and made my PhD significantly more meaningful and successful.

Continuing, I am especially grateful to the Chair of my Qualifying Examination Committee, Professor Seth Sanders for conducting what turned out to be a very valuable exam. From UCB, Associate Professor Duncan Callaway, Professor of Economics Edward Miguel, and Adjunct Professor Alexandra “Sascha” von Meier, and from Texas A&M Professor Steve Puller, each have contributed significant time and support. Professor Tom Anderson, Assistant Professor Kurtis Heimer, Associate Professor Melissa Densmore from the University of Cape Town Department of Computer Science, and Associate Professor Joyojeet Pal from the University of Michigan School of Information, each have been particularly friendly and helpful while navigating academic communities focused on development. Professor Evan Thomas and Professor Ashok Gadgil, and Alan Meier from Lawrence Berkeley National Laboratory have all provided helpful feedback on works in progress. Mark Brehob, Lecturer at the University of Michigan, believed in me when I needed it. Professor Thomas Askew and Professor Alyce Brady, both from Kalamazoo College, taught me how to study.

The list of names of student collaborators is large. If I forgot you, I am really sorry! Starting with PhD students, my first collaborator at UC Berkeley was Javier Rosa. I worked closely with Josh Adkins, Pat Pannuto, Andreas Biri, David Adrian, Rachel Warren, Branden Ghena, Meghan Clark, and Neal Jackson; each have made intellectual contributions to this work. I regularly seek power-systems advice from Laurel Dunn, Isa Farrall, and Mohini Bariya. I frequently consult with Danny Williams and Zakir Durumeric about particularly challenging problems to solve at scale. I advised Aldo Suseno, Brett Cooper, Gonzalo Bernard, Ivan Bobashev, Sandra Tamer, and Sophie Heart for a semester of their masters. Emily Paszkiewicz contributed significantly to the implementation of our clustering algorithms and Revati Thatte contributed significantly in sensor assembly and quality control.

I would like especially thank our local project manager in Accra, Kwame Abrokwah, our team of field supervisors Kelvin, Daniel, and Agnes, and our incredible field officers Daniel, Asamoah, Fancisca, Derrick L., Happy, Isaac, Eugene, Abigail, Agnes, Naomi, Sarah, Felicity, Obed, Seyramm, Franklin, Kelvin D., Kelvin G-N, Shammah, Matilda, Rose Bernasko, Derrick O., Phaniel, Priscilla, Jerry, Sylvester, Justice, Tracey, Martin, Wendy, Efyia, Maame, Claribel, Jude, Linda, Lord, Olivia, Issac, and Adelaide.

This work required a tremendous amount of administrative overhead, and without a team of administrators, and someone to wrangle them, we wouldn't have been able to keep afloat. Karen Notsund has changed my understanding of what helpful can be, she solved problems I didn't see coming, tolerates changing conditions in the field, balances last minute deadlines, and remains supportive and motivating. Without Karen, and her creative solutions to unsolvable bureaucracy, it is hard to imagine this work having occurred.

Others at UC Berkeley who have supported this work include staff from CEGA-Blum, the Energy Institute at Haas, SPO, IRB, and the Development Impact Laboratory. Individuals include Geetika Pandya, Carson Christiano, Gladys Khoury, Emily Harden-Antonio, Maryanne McCormick, Heather Kinlaw Lofthouse, Lina Nilsson, Sophi Martin, Anh-Thi Le, Ofir Reich, and Sarah White.

Veronica Jacome was the first person who taught me how to perform field work. Her patience and drive to take good measurements led to her tolerating a lot of mistakes, and she excels in turning frustration into lessons learned.

Matt Podolsky was completely indispensable throughout this work. He was an organizational core, training me on the inner workings of University systems, always ready to jump in, and always motivated to the best work possible. Thank you, Matt.

To everyone at *nLine* not previously mentioned, including (in no order) Genevieve Flaspohler, Margaret Odero, Alexandra Wall, Marguerite Cauchois, Jackson Goode, Clare-Joyce Ngoran, Molly Hickman, Samuel Laur, Paul Hynek, and Purity Musau. I can't wait to build more with you all.

Assistant Professor Susanna Berkouwer taught me to be clear about what I need, to be patient enough to listen and iterate, and to be are motivated enough to holistically fight for the project. I credit them for instilling in me many of the interpersonal and organization tools that were critical for completing this work and will be if we are lucky enough to scale. I've really had fun. Thank you.

To Josh, who has jumped into this work with me as the CTO of *nLine*: I recently received feedback from an *nLine* employee survey that together we "model healthy disagreement." I love this. Josh has taught me about both the importance of drawing lines and of taking risks. I know that whenever he strongly disagrees with me, he is likely seeing something I haven't yet that will convince me to reconsider my view. I also know that when I push back he respects me enough to remain open minded. So much of this work is due to his creativity, discipline, and drive to do good. It is rare to find such a motivated and passionate collaborator.

There is a multitude of other people who supported me. My family who let me run a bit wild. Jon Warthen and Rusty. Alice Brady and Tom Askew at Kalamazoo College. Steve Musko decided to proactively support some kid that he just met, opening doors for me that have been critical for becoming who I want to be. Danny Lam and Cindy Oda at JPL taught me about staying calm at the cutting edge, and showed me that good engineering happens so much more naturally among teams that respect and care for everyone regardless of their title. Finding my voice with MSL was really the first time I found my voice.

Finn and Neal, you modeled creativity. Ben, you are still the person who most consistently impresses me with what you are building. Lauren, Nic, Savanna, and Adam got me through a physics degree kicking and screaming. Natalie, Wade, and Scott went to Mars with me. Adam, Matt, Jack, Chris, Sebastian, Michelle, and Joe let me know that they saw value in me outside of my (non)ability to nail a problem set. This crew rewarded thinking outside of the box, never told me a good idea was bad, and I am lucky to count them in my corner. Zeal, Gabe, Danny, Taryn, Mahir, and Matthias together feel like my other research group. Michelle, let's record that album now. Erin and Adam, we can't wait to meet the new kid!

Lab11 is not really a place; it's more a mood. This is a group of people that flew across the country to attend my wedding, pushed me to be better, and that have been the closest thing to a gang I've even been a part of. In alphabetical order, while in Lab11 I overlapped with Josh Adkins, David Adrian (honorary), Andreas Biri, Brad Campbell, Meghan Clark, Sam DeBruin, Tess Despres, Genevieve Flaspohler, Branden Ghena, Brenhard Grobwindhager, Will Huang, Neal Jackson, Ben Kempke, Deepika Natarajan, Pat Pannuto, Shishir Patel, Rohit Ramesh, Jean-Luc Watson, Thomas Zachariah, and Alan Zhen. To each you, thank you for pushing me to be better. I'm always happy to edit a paper all night with each and every one of you whenever you next want.

# Chapter 1

## Introduction

Electricity has fundamentally and dramatically impacted human history. While the oldest living generation in the United States may remember their first grid connection, their grandchildren likely can't imagine a life without access to lights, refrigeration, television, computers, and modern medicine. Each of these essential services depends on electricity. Reliable and affordable electricity has become such a prerequisite for economic growth and personal well-being that there are increasing calls for electricity to be considered a fundamental human right [1].

If a reliable grid is something that should be available everywhere, it follows that the data needed to ensure grid reliability should also be available to quantify the quality of the service. Basic data about the duration and frequency of power outages helps decision-makers estimate the cost of power outages to the economy and to society as a whole, and take informed actions to improve the reliability of the power supply [2]. Further, this data empowers citizens and allows them “to hold electricity providers accountable” [2]. About 80% of countries collect data on the frequency and duration of power outages, but of those, only two thirds publish it [2]. Unsurprisingly, wealthier regions are more likely to both collect and publish this data, reflecting an economic barrier to entry (shown in Figure 1.1).

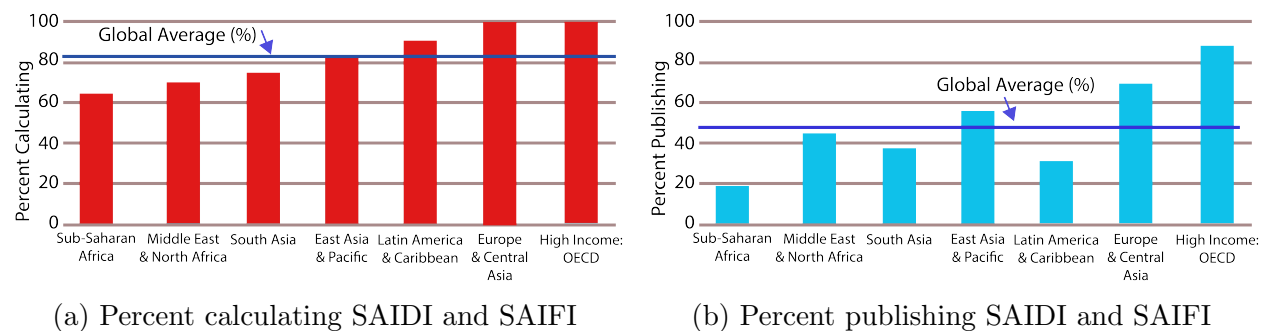

Figure 1.1: **Although many countries collect data on power outages, very few make that data public, especially those located in Sub-Saharan Africa.** *Figures remade from “Digitalization and the Use of Technology in the Electricity Sector,” published by the World Bank Malaysia Hub in 2020 [3].* In (a) we can see that High Income OECD economies are nearly twice as likely to be calculating SAIDI and SAIFI than economies in Sub-Saharan Africa. In (b) we see that this data is even less likely to be published—only 2/3 of the population calculating SAIDI and SAIFI in (a) publish data. This reluctance to publish is seen even in the wealthiest economies. When researchers, regulators, and rate payers can not access this data, it limits the important roles they play in ensuring reliability [4, 5].

This dissertation presents a scalable and cost-effective method for measuring grid reliability as experienced by customers, that is, at households and businesses anywhere on earth. Here, by grid reliability, we mean whether the power is on or off, and if on, the voltage and frequency at the customer site. But data alone isn’t enough to ensure grid reliability; that requires proactive actions from stakeholders. To maximize the likelihood that the data collected will inspire such actions, this work also describes techniques for deploying reliability sensors, extracting insights from the data stream, and presenting the right insights back to stakeholders.

## 1.1 The Importance of Reliability

Electric grids power economic activity throughout the world. However, frequent power outages and voltage fluctuations leave many consumers and businesses with only a fraction of the benefits of electrification [6–9]. Neglecting reliability is associated with a reduction in the demand, utilization, and social benefit of electricity [10].

There is often a line drawn between the needs of developing regions and those of more developed ones, but regardless of GDP, the need for reliable electricity is palpable. Grid reliability is intuitively important. Every reader will have experienced at least moderate inconvenience due to a power outage at some point in life. While even infrequent power outages and voltage swings have significant costs, a grid that is systemically unreliable—a reality in much of the developing world and an emerging reality in developed countries (see

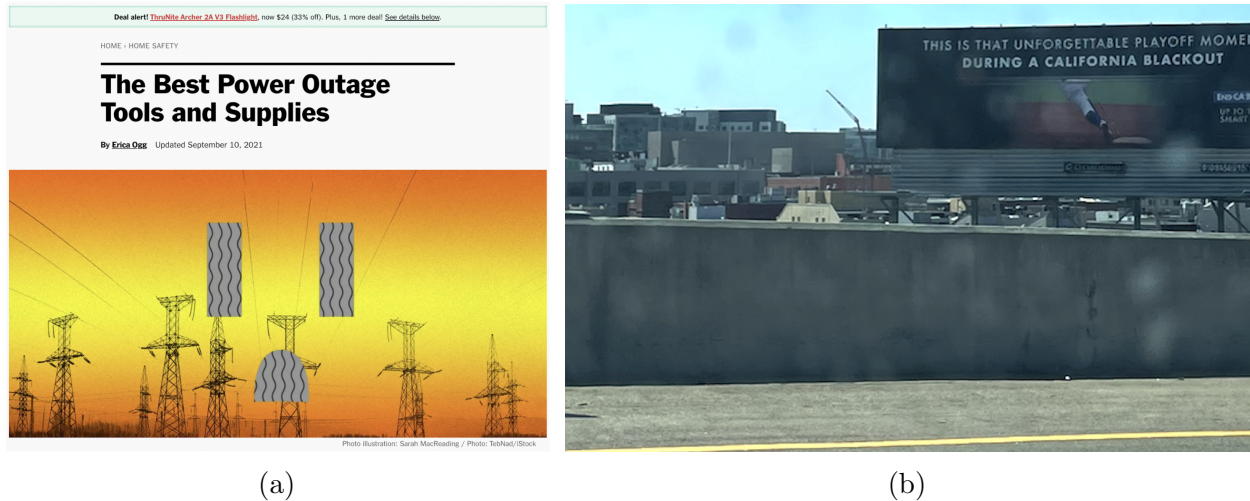

Figure 1.2: **Poor grid reliability quickly impacts popular culture.** Picture (a) shows a recent article about the best tools to purchase for power outages from popular New York Times-owned recommendation blog Wirecutter [16]. Picture (b) is a photo I took of a billboard beside a major highway running through downtown San Francisco. Once you start looking, it is easy to find signs in popular media that energy reliability is something people care about.

Section 2.7)—can have consequences that range from the destruction of appliances to the destabilization of governments [5, 11–13].

We do not need to look beyond the Electrical Engineering and Computer Science Department at UC Berkeley to observe serious problems caused by grid unreliability. Berkeley residents began experiencing “public safety power outages” in 2019, designed to help prevent wildfires. These power outages led to class cancellations [14]. In her 2020 blog post from the Haas Energy Institute at UC Berkeley, Catherine Wolfram described early results of survey work conducted at UC Berkeley exploring the costs of the public safety shut-offs. Along with high monetary costs from increases in generator purchases (nearly 15% of respondents paid on average \$1800 for a generator in the 6 months following the first outages), the survey found serious non-monetary costs, including “an elderly woman who was hospitalized after she fell grasping for her flashlight in the dark” and “a couple who couldn’t access their cell phone to report a medical emergency during the outage” [15].

Elsewhere in the United States, power outages have dramatically impacted health, safety, and economic development. The largest grid failure in the U.S. is still occurring in Puerto Rico, four years after Hurricane Maria hit in 2017 [17]. Due to a nearly unbelievable series of factors, including limited resources, political and bureaucratic missteps, and blatant corruption [18], much of the island remains plagued by unreliable grids and high cost per kilowatt [19]. Recently, in October 2021, nearly 4,000 people protested, wearing T-shirts that read, “Go to hell, Luma” (the private utility company tasked with improving the grid in 2018) [20]. The protesters “clapped or banged on pots while walking behind huge speakers on pickups that blasted slogans such as, ‘My power went out, damn it, and now my fridge will be ruined’



Figure 1.3: **Images of frustration due to grid reliability.** In (a), protesters demand better power four years after the grid in Puerto Rico was devastated by Hurricane Maria [23]. Picture (b) is an image posted on the Facebook page of Todos Somos Pueblo, a collection of 30 Puerto Rican community groups focused on solving the lingering energy crisis on the island [24].

” [20]. The people of Puerto Rico have real cause to be frustrated; while over \$2.4 billion has been spent to restore the grid since Hurricane Maria, power problems still significantly impact the ability to do business on the island [21] and, more alarmingly, mortality on the island has spiked [22].

As horrific as the situation in Puerto Rico is, in the aggregate the U.S., like other wealthy nations, experiences largely reliable power compared to the rest of the world [2, 4, 25]. Still, in an effort aimed in part at improving grid reliability, President Biden signed the Infrastructure Investment and Jobs Act, H.R. 3684, in 2021 [26]. The \$1.2 trillion package includes nearly \$65 billion to subsidize upgrades to domestic power infrastructure [27]. This type of investment is a promising step toward addressing parts of the U.S. grid that are nearing the types of system failures, like those experienced by Puerto Rico, that are otherwise not addressed by the market.

For the utilities and governments that can afford it, large and broadly-targeted investments like the Infrastructure Investment and Jobs Act, which liberally replace and modernize equipment, can greatly increase reliability for long periods. We can get a sense of the grid maintenance costs associated with such a blanket investment strategy by considering that utility companies in the United States invested approximately \$144 billion on their networks in 2016 alone, an investment equivalent to the 55th largest GDP that year [13].

This level of capital is not available in most countries. In lower-income economies, investments have mostly focused on improving access to the grid, nearly ignoring reliability all together until recently (outcomes of which are shown in Figure 1.4) [4, 10, 28, 29]. While



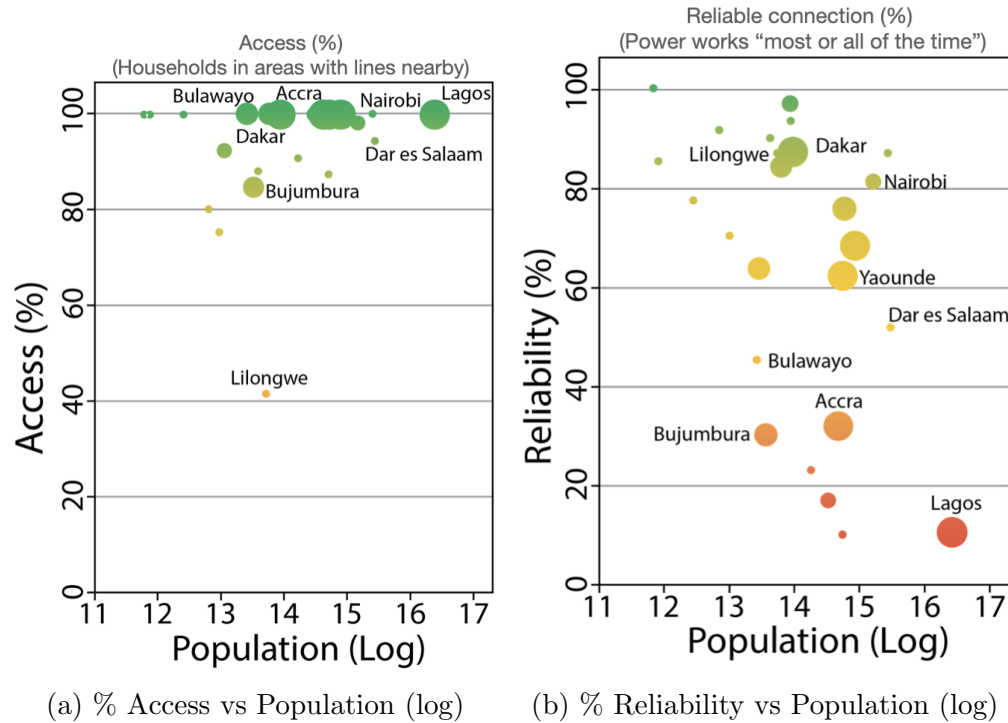

Figure 1.4: **Access vs Population, and Reliability of Connection vs Population.** Figure from “*Electricity Reliability and Economic Development in Cities: A Microeconomic Perspective*” [10]. We see that access, in (a), is clustered more tightly around 100% than reliability, in (b), indicating a global need either to broaden priorities to include reliability or improve existing strategies for achieving reliability [10, 30].

access has improved, reliability has not followed, and customers have been slow to adopt (shown in Figure 2.41).

Even in the wealthiest countries, however, the approach to grid maintenance of large, non-targeted investments is likely not sustainable [2, 13]. Richard Negrin, a Vice President of ComEd in Chicago, offers a rather vivid explanation of why periodic infusions of money alone are not the solution to grid reliability, saying, “The power grid is a living organism. If you are not building and working on it and giving it the care that it needs, it is dying over time” [31].

In developing and developed regions alike, grid infrastructure is not getting the care it needs, and performance is trending downward. Unfortunately, regions with fewer resources experience worse power on average, with the highest concentration of reliability issues observed in Sub-Saharan Africa [2, 30]. The African Development Bank observes that “energy sector bottlenecks and power shortages cost Africa between 2% and 4% of GDP” annually and that this is “undermining economic growth, employment creation and investment” [32]. In some countries, including Tanzania and Ghana, the African Development Bank observes 15% GDP losses “as a result of power outages” [32]. In aggregate across twenty-three countries in Africa,



power problems increase unemployment by nearly 35%, rising to 55% when considering only employment in the non-farm sector [33].

Voltage measurements and household surveys support the conclusion that having electricity *access* is not the same as having reliable electricity service; the quality of electricity shapes people’s ability to realize the promised benefits of their “access” [11]. Anecdotally, frequent outages constrain economic well-being by reducing the benefits from welfare-improving appliances like fans and refrigerators or income-generating assets like sewing machines. Voltage fluctuations do the same: sags diminish the value of household appliances, decrease appliance lifespans, and increase costs, while sudden spikes can break appliances [34]. In a survey of 151 participants in Zanzibar, households across the socioeconomic spectrum reported lights that were too dim to be useful and fridges that could not reliably store food [11]. One participant “reported that his fridge had broken after a power surge. Another agreed, noting that after a power outage, he came home to a broken television and fridge. Asked about the lifespan of light bulbs, one participant replied, ‘usually they last about three months. Electricity goes up and down, up and down. . . so they never last [as advertised].’ Many interviewees echoed this observation. An electric appliance shopkeeper noted that when customers purchased a fridge without a voltage stabilizer, they often returned to the store, fridge broken” [11].

The consequences of unreliable electricity extend far beyond economic costs, manifesting in innumerable ways. For example, nearly 1 billion people are estimated to not have access to adequate healthcare in low- and middle-income countries due to energy poverty [35]. Ninety million children go to primary schools without electricity and millions have no light to study at night. Students in Sudan improved pass rates on their exams from 57% to 97% after one year with electric lights [36]. Three billion people lack access to electric cooking, forcing them to rely on polluting alternatives estimated to contribute to over 3.8 million deaths annually [36]. Much of this harm is preventable, but reliability must improve significantly in the most resource-constrained areas [37].

## 1.2 Reliability Requires Grid-Performance Data

Unfortunately, when a grid is systemically unreliable, there is often no quick and easy fix. Grids are extraordinarily complicated, and the underlying problems causing performance issues may be difficult to track down using manual processes. Further, investing in improving service reliability is expensive, and if investments made on reliability do not sufficiently address underlying problems, there may not be another chance to afford additional improvements for many years [13].

Many electrical utilities, investors, and energy regulators are already under-resourced for the enormously complex and expensive task of planning, extending, and operating their current systems; they cannot easily launch programs to collect the data needed for increasing reliability [38]. To remedy this, governments and global development organizations are prioritizing investments to improve electricity reliability in low- and middle-income countries

(LMICs) [39, 40]. While it is true that power problems are often more likely in lower-income countries [30], many of the same fundamental improvements to reliability data are equally needed across high- and low-income countries. Better grid performance data is anticipated to improve efficiency and reliability in the power sector to such an extent that the United Kingdom Department of Energy calls this data “fundamental to the future of our economy” [5].

For many years, the transition to “smart grids,” which include components that automatically collect and respond to data, has been championed as a critical part of improving reliability [13]. Although the global market for ‘smart’ technologies is forecasted to reach \$92 billion [41], adoption of these technologies has been slow, especially in more financially-constrained geographies. The U.S. alone spent \$10 billion last year on smart meters, while the sum of spending across all emerging and developing economies was \$2 billion [42]. As a consequence, basic measurements of reliability—the number of outages, the duration of outages, the number of customers impacted—remain unavailable in many countries, creating an additional barrier to improving reliability in the countries that suffer the most unreliable grids [2, 5].

Even in countries with good data on grid performance, plenty of opportunities exist for improvement. The U.S. Department of Energy delivers a report to Congress every two years describing key advances in technology that are needed to ensure a more operationally-efficient, reliable, and resilient power grid. The most recent report identifies the need for better “modeling and analysis tools for both planning and operations purposes” [43]. Even in the U.S., where 88% of the population has “smart meters” [43], these new modeling and analysis tools will depend on “vastly greater amounts of data” [13].

### 1.3 Thesis Statement

If reliable electricity is really a human right, and ensuring grid reliability and efficiency requires reliability data, then gathering, analyzing, and reporting this datastream should be important stakeholders everywhere. However, for many utilities, measurement cost remains prohibitive and the increased transparency may bring unwanted scrutiny. This leaves stakeholders dependent on poor estimates of critical data points, including the number of power outages, the duration of power outages, the location of power outages, the average voltage served, and the number of voltage spikes and sags in their networks [5]. With high-powered microcontrollers and low-cost cellular networks both priced for pocket change, the fact that simple but essential reliability data is often not collected represents a lost opportunity. I therefore present the following thesis statement:

*By aggregating simple, noisy measurements from networked sensors installed at outlets in households and businesses at the edge of the grid, we can detect large and small power outages and power-quality issues, enabling a utility-independent, agile, high-resolution, and low-cost system well suited for deployment in under-instrumented areas.*

I will demonstrate that this technique matches utility-reported rates of high- and medium-voltage outages at a fraction of the cost. Further, this technique allows for a good estimate of low-voltage outages, filling a large data-gap. In this way, this work demonstrates a financially-viable path toward high- and medium-voltage monitoring for the most resource-constrained utilities.

This thesis is supported by the fact that our sensor deployment in Accra, Ghana, has been repeatedly extended and expanded by stakeholders. Further, after commercializing turn-key deployments of our sensor system—called PowerWatch—in 2019, I have successfully used PowerWatch to gather reliability data in five other countries in Sub-Saharan Africa, supporting actions of various multilateral energy stakeholders.

Thus, this thesis has been evaluated in multiple contexts and geographies, offering a blueprint to make automated monitoring of critical infrastructure performance more readily and equitably available.

## 1.4 Dissertation Roadmap

The rest of this work is divided into the following chapters:

Chapter 2 gives more background to this work, briefly introducing grids and grid reliability, current methods of collecting reliability data, and techniques similar to PowerWatch. I discuss the different stakeholder interests in reliability data, which I have not seen aggregated outside of this work and which are helpful for understanding some of the constraints influencing PowerWatch. I conclude by addressing the intersection of reliability data and climate change.

Chapter 3 describes the context in which PowerWatch was developed and deployed, and the goals of the deployment. I emphasize design decisions in PowerWatch that prioritize scale over accuracy, including the decision to install the sensors at outlets to maintain independence from the utility and to reduce deployment costs.

Chapter 4 presents the system architecture of PowerWatch as well as an evaluation of performance in the laboratory. I again emphasize design decisions in PowerWatch that prioritize scale over perfect accuracy, including the decision to use some off-the-shelf components to bootstrap reliability.

Chapter 5 evaluates the performance of the sensor in the field, demonstrating that a large-scale PowerWatch deployment is able to match utility-collected ground truth for medium- and high-voltage outages. I also present early results using data collected by the PowerWatch deployment. This deployment has been scaled to 1,400 devices and has been running for nearly 3 years. It is now being used as the highest-resolution data for evaluating a nearly-\$500 million USD investment in improving grid reliability in Accra, Ghana.

Chapter 6 describes some lessons learned for conducting similar deployments. Deploying PowerWatch at scale required significantly more automation than originally anticipated. I hope this chapter will be broadly useful for avoiding some of those surprises in future deployments.

Finally, Chapter 7 describes some takeaways of this work, including new, high-impact applications enabled by PowerWatch that remain to be explored.

# Chapter 2

## Background

This chapter contains much of the technical context referenced in later chapters. This includes basic definitions, including the definition of reliability, an overview of the structure of the electric grid, and standard metrics used to measure reliability. I go on to discuss current sources of data on reliability, including the use of manual tools like surveys and customer calls, and automated tools like smart meters. I then outline the various stakeholders interested in data on power outages and power quality. I conclude this chapter by describing the value of reliability data for both slowing the pace of climate change and preparing for its effects.

### 2.1 Definitions

While this work is about measuring grid reliability, a task that can be extremely complex, the following definitions provide enough context to follow the remainder of this dissertation. Because this dissertation measures grid reliability in Accra, Ghana, I take care to include and adopt the definition from Ghana when possible.

#### 2.1.1 The Grid

A typical grid encompasses *electricity generation* (using traditional power plants and/or renewables), the *transmission network* (high-voltage lines), and *distribution* (medium- and low-voltage lines), as well as *transformers* to step the voltage up or down. A very simple model of the grid showing the generation, transmission, and distribution hierarchy, as well as the high voltage (HV), medium voltage (MV), and low voltage (LV) designations, is shown in Figure 2.1. Figure 2.2 shows some of the individual components modeled in Figure 2.1 as photographed in Accra.

In the United States, the American National Standard for Electric Power Systems and Equipment—Voltage Ratings, or ANSI C84.1, defines *low voltage* as between 240 V and 600 V; *medium voltage* as between 2.4 kV and 69 kV; *high voltage* as between 115 kV and

230 kV; *extra-high voltage* as between 345 kV and 765 kV; and *ultra-high voltage* as 1.1 MV [44, 45].

In Ghana, the National Grid Code defines *low voltage* as between 0 V to 1 kV, *medium voltage* as from 1 kV to 36 kV, and *high voltage* as greater than 36 kV [46]. The Ghanaian definitions are used in this dissertation.

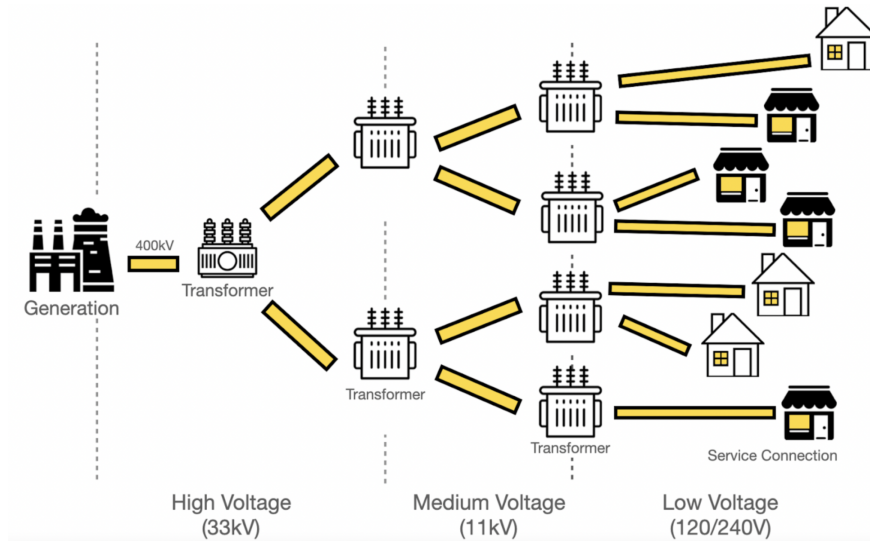

Figure 2.1: **Basic model of the grid.** In this model we see the grid hierarchy as a function of voltage level. A few high-voltage lines each serve a large section of the grid; then more-numerous medium-voltage feeder lines serve smaller subsections of the grid; and then myriad low-voltage distribution lines serve individual households and businesses through the meter installed at the service connection. This simple model omits details that are less important for our primary sensing methodology including phases, customer segments, and the distinction between transmission and distribution networks.

### 2.1.2 Power Outages

A *power outage* is “an interruption in the supply of electricity” [47]. A power outage ends when the supply of electricity is returned. The duration of the power outage is the length of time supply was interrupted. The Energy Commission of Ghana defines a *disturbance* as: “an unplanned event that produces an abnormal system condition or any occurrence that adversely affects normal power flow in a system” [48].

The *location* of the outage can mean two things. The first is the location that the outage was observed either by a meter or customer, and this is often how outages are discussed for operations and management applications [13, 49]. The second is the location of the infrastructure that failed as it relates to the energy-supply hierarchy. This location will be assigned to the level of the failure (i.e., a high-voltage outage would represent an outage that



(a) LV, MV, and future HV lines



(b) An HV transformer



(c) A 3-phase LV transformer



(d) A pre-paid meter

Figure 2.2: Various parts of the energy supply chain that I photographed in Accra.



occurred due to a failure of a high voltage (33 kV) line, even though this resulted in medium- and low-voltage infrastructure failing downstream).

### 2.1.3 Voltage and Frequency

Voltage and frequency standards are set most often at a national level [30, 50]. Around the world, grids use voltage and frequency combinations of 220-240 V and 50 Hz; 220-240 V and 60 Hz; 100-127 V and 60 Hz; and 100-127 V and 50 Hz. The two most common grid configurations are the 100-127 V and 60 Hz configuration used in North America and parts of South America and the 220-240 V and 50 Hz configuration used across Africa and Asia [51].

The “IEEE Recommended Practice for Monitoring Electric Power,” or IEEE-1159, contains a summary of power-quality definitions as well as discussions on areas where definitions are not well standardized [52]. IEEE-1159 is, however, focused on the United States and may not generalize. The “IEEE Standard Dictionary of Electrical and Electronic Terms,” or ANSI/IEEE Std 100-1992, is also a valuable resource for a broad range of definitions and explanations [53].

#### Voltage

In the United States, ANSI C84.1 provides a national standard for voltage regulation and defines the *nominal voltage* range for the U.S. 120 V system as +5% and -3.5%, or 114 V to 124 V [45]. In Ghana, the National Grid Code defines *nominal voltage* for its 240 v system as +/-5%, or 228 V to 252 V [46].

A *transient voltage disturbance* is when the line voltage drops for less than one half cycle of the waveform. A *voltage sag* is when the line voltage drops for a duration greater than one half cycle of the waveform to 500 ms. An event greater than 500 ms is considered an *undervoltage condition* [52]. The most common cause of voltage sags is thought to be large load changes, potentially caused by induction motors [11, 52, 54].

IEEE C62.41.2 “Recommended Practice on Characterization of Surges in Low-Voltage (1000 V and less) AC Power Circuits” defines *voltage surges* as: 1) either periodic or random events, 2) having a duration not to exceed one half-cycle of the normal mains waveform, 3) able to appear in any combination of line, neutral, or grounding conductors, and 4) able to “cause equipment damage or operational upset” [55].

#### Frequency

*Frequency stability* can be defined as “the ability of a power system to maintain steady frequency following a severe system upset resulting in a significant imbalance between generation and load” [56]. This happens when supply (generation) and demand (transmission and distribution) are not balanced, a condition that often occurs when there are severe system upsets [56]. Ghana defines a *nominal frequency* as between 49.8 and 50.2 Hz at all times



[57]. Grid frequency will become increasingly important to measure as distributed generation sources become more popular [58].

## 2.2 Standard Reliability Metrics

Different metrics are appropriate for different system topology, operating conditions, and research questions, leading to the observation that there is no single best, universal metric of reliability [59].

Two common metrics of energy reliability are the System Average Interruption Duration Index (SAIDI) and the System Average Interruption Frequency Index (SAIFI) [60]. These are key performance indicators for the Ghana Power Compact and therefore the main indicators estimated in this work. The construction of SAIDI and SAIFI is shown as Equation (2.1) and Equation (2.2).

$$SAIDI = \frac{\text{Total duration of sustained interruptions in a year}}{\text{Total number of consumers}} \quad (2.1)$$

$$SAIFI = \frac{\text{Total number of sustained interruptions in a year}}{\text{Total number of consumers}} \quad (2.2)$$

Calculation of SAIFI and SAIDI often requires isolating the metric for a specific stakeholder, for example a distribution company may calculate SAIDI and SAIFI by first removing any power-supply interruption caused by a failure or outage (planned or unplanned) in the generation or transmission networks [61].

SAIDI and SAIFI are relatively coarse metrics. Other common metrics include weighting outages by customers (such as in the Customer Average Interruption Duration Index, or CAIDI) or looking at different definitions of outages (such as in the Momentary Average Interruption Frequency Index, or MAIFI) [62]. Broadly, we find that reliability metrics can even be different for the household [63–66] and for the firm [59, 63, 67, 68]. Figure 2.3 shows a slightly modified spreadsheet used by the Electricity Company of Ghana when calculating SAIDI and SAIFI.

DISTRICT				Faults						
CUSTOMER POPULATION				No of Events	No of Customers			Customer. Hours		
METRO	URBAN	RURAL	TOTAL		Metro	Urban	Rural	Metro	Urban	Rural
98,251			98,251							
ECG	33KV EQUIPMENTS			0	0	0	0	0.0	0.0	0.0
	11KV EQUIPMENTS			0	0	0	0	0.0	0.0	0.0
	LV EQUIPMENTS			172	2,482	0	0	461.6	0.0	0.0
GRIDCO/ VRA	33KV INCOMERS									
	11KV INCOMERS									
GRAND TOTAL				172	2,482	0	0	462	0	0

DISTRICT				Planned Outage						
CUSTOMER POPULATION				No of Events	No of Customers			Customer. Hours		
METRO	URBAN	RURAL	TOTAL		Metro	Urban	Rural	Metro	Urban	Rural
98,251			98,251							
ECG	33KV EQUIPMENTS			0	0	0	0	0.0	0.0	0.0
	11KV EQUIPMENTS			0	0	0	0	0.0	0.0	0.0
	LV EQUIPMENTS			15	362	0	0	119.4	0.0	0.0
GRIDCO/ VRA	33KV INCOMERS									
	11KV INCOMERS									
GRAND TOTAL				15	362	0	0	119	0	0

DISTRICT				ECG Own Load Shedding/Emmergencies						
CUSTOMER POPULATION				No of Events	No of Customers			Customer. Hours		
METRO	URBAN	RURAL	TOTAL		Metro	Urban	Rural	Metro	Urban	Rural
98,251			98,251							
ECG	33KV EQUIPMENTS			0	0	0	0	0.0	0.0	0.0
	11KV EQUIPMENTS			0	0	0	0	0.0	0.0	0.0
	LV EQUIPMENTS			0	0	0	0	0.0	0.0	0.0
GRIDCO/ VRA	33KV INCOMERS									
	11KV INCOMERS									
GRAND TOTAL				0	0	0	0	0	0	0

SAIFI			
Metro	Urban	Rural	All
0.03	-	-	0.03

SAIDI			
Metro	Urban	Rural	All
0.01	-	-	0.01

Figure 2.3: Tool provided by the Electricity Company of Ghana (ECG) as used to calculate SAIDI and SAIFI for Achimota in September 2018. *Figure modified from data provided by ECG [69].* The district rarely reports 33 KV and 11 KV events in these reports. Instead, these are collected at the head office for the entire Accra West region. Note the SAIFI of 0.03 and SAIDI of 0.01 from LV interruptions, which are 166 times lower than PowerWatch measurements (see Figure 5.5). The format of the spreadsheet gives hints of other common aggregations (i.e., HV, MV, LV).

In this dissertation, I modify SAIDI and SAIFI by changing the total number of consumers to be equal to the participants in the outage. The logic behind this, and the new metrics Subsampled-SAIDI (3.1) and Subsampled-SAIFI (3.2), are described in Chapter 5.

### 2.2.1 Good Reliability

In their paper “Measuring ‘Reasonably Reliable’ Access to Electricity Services,” Ayaburia *et al.* use World Bank SAIDI and SAIFI data from 179 countries to find an average annual

global SAIDI of 84 hours and SAIFI of 52 [70]. (There are, however, problems with the accuracy of the World Bank SAIDI and SAIFI estimates which likely impact this average [71, 72].) The authors then propose a 12 hour a year 12 outage SAIDI threshold for “reasonable” reliability, and calculate that 3.5 billion people live in areas that do not meet this standard [70]. They do not claim that this threshold is correct, in fact they say it likely is not, rather, the contribution of this work is really in exploring the consequences of selecting some threshold value of reasonable reliability.

The World Bank proposed a five-tier system using tiers that each are a “combination of attributes that reflect the performance of the energy supply” (shown in Figure 2.4). Adding dimensionality to energy metrics collected is widely believed to have been an important and necessary step for the World Bank to have taken [73]. This work, however, has been highly controversial due to the World Bank’s choice of attributes, the number of tiers, and other methodological issues, slowing down wide-spread adoption [73–75].

Attributes of energy supply		Tier 0	Tier 1	Tier 2	Tier 3	Tier 4	Tier 5	
Capacity	Household electricity	No electricity <sup>a</sup>	Very low power	Low power	Medium power	High power		
	Household cooking	Inadequate capacity of the primary cooking solution				Adequate capacity of the primary cooking solution		
Duration and availability	Household electricity	<4 hours	4–8 hours		8–16 hours	16–22 hours	>22 hours	
	Household cooking	Inadequate availability of the primary cooking solution				Adequate availability of the primary cooking solution		
Reliability	Household electricity	Unreliable energy supply				Reliable energy supply		
Quality	Household electricity/cooking	Poor quality of energy supply			Good quality of energy supply			
Affordability	Household electricity	Unaffordable energy supply		Affordable energy supply				
	Household cooking	Unaffordable energy supply				Affordable energy supply		
Legality	Household electricity	Illegal energy supply			Legal energy supply			
Convenience	Household cooking	Time and effort spent sourcing energy cause inconvenience			Time and effort spent sourcing energy do not cause inconvenience			
Health and safety	Household electricity	Unhealthy and unsafe energy system				Healthy and safe energy system		
	Household cooking <sup>b</sup>	Level 0	Level 1	Level 2	Level 3	Level 4	Level 5	

Figure 2.4: **Simplified multi-tier matrix of energy access** *Figure is a screen capture from “Capturing the Multi-Dimensionality of Energy Access” from the World Bank and ESMAP [75].* The World Bank proposed this multi-tier framework in 2013. The goal was to create a weighted index of access to energy for a given geographical area based on multiple factors. This effort has been praised but its implementation has been controversial [74].

While both the World Bank and Ayaburia *et al.* proposed thresholds, there is still no global standard for what “reliable” means. “Resilience Metrics Development for Power Systems” has a very good discussion of on-going work to define appropriate metrics for reliability that extend beyond SAIDI and SAIFI to take into account higher-resolution data sources as well as the concerns of a wide variety of stakeholders.

Metric design is important for protecting and advancing the goals emerging under the banner of “energy justice” [76–78]. SAIDI and SAIFI have been identified as insufficient

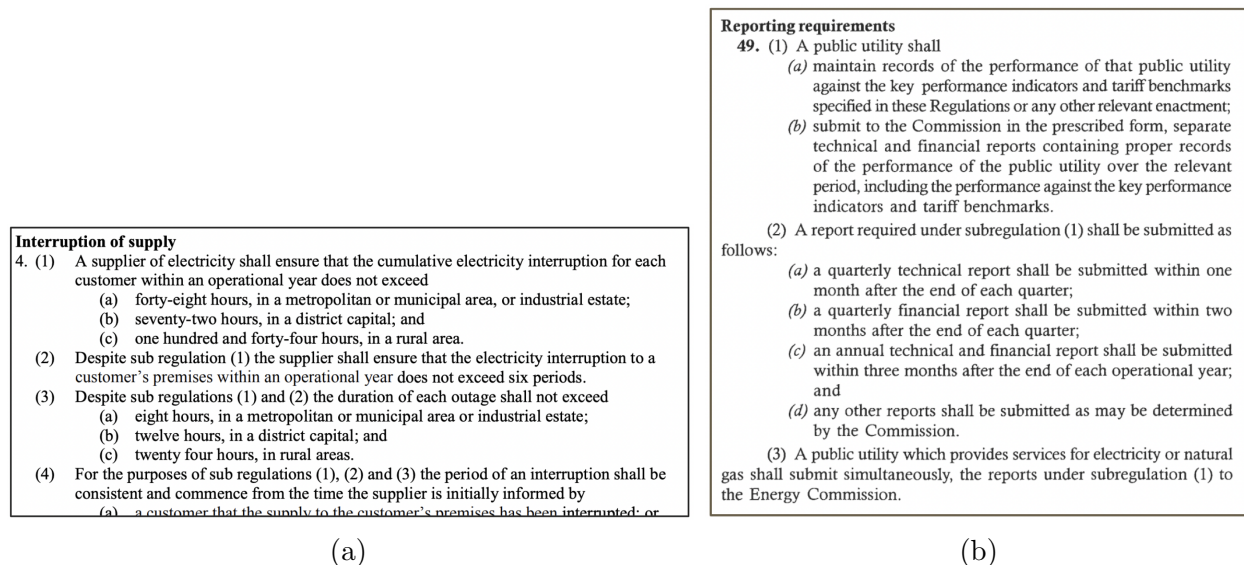

Figure 2.5: **Subsections of two regulations in Ghana.** (a) is a screen capture from *L.I. 1935* [84] and (b) is a screen capture from *L.I. 2413* [85]. In (a), *L.I. 1935* specifies the number of hours annually that power outages are not to exceed for consumers in different areas. In (b), *L.I. 2412* provides the schedule of reports generated by the utility for regulators.

for many pro-consumer applications [79–81]. Higher-resolution data allows for metrics that incorporate more dimensions of reliability and therefore may be more accurate [5, 13, 74, 82].

Given the lack of clarity around what constitutes “good enough” for number and length of power outages (in practice meaning “good enough” SAIDI and SAIFI [70]), power quality, a harder to measure set of signals, is often not prioritized or overlooked entirely [11, 13, 29, 82, 83].

## 2.2.2 Good Reliability Data

Figure 2.5 shows two regulations from Ghana relating to power outages. Figure 2.5a shows the order of magnitude for which annual SAIDI and SAIFI raises alarms for regulators. We can see the time resolution (hours) and the space resolution (distinguishing between cities, rural, and peri-urban areas). While this does not apply more generally, it does give us a concrete sense of what is “good enough” in one market.

Figure 2.5b describes the reporting requirements for public utilities, including the specific reports generated by the utility for the regulator. This fairly significant reporting overhead motivates the need to make data simple to access and process for busy utilities.

In July 2020, Sustainable Energy for All (SEforALL) hosted a workshop on improving and standardizing data used by governments and their partners for integrated energy planning 2020 [30]. This conversation appears to have made meaningful progress in advancing the conversation about reliability data for all regions. I excerpt the resulting report here in



**DEFINING DATA QUALITY**

In addition to being available, data must also be of sufficient quality in order for integrated electrification planning to be accurate, consistent and practical. While there is no standard definition of data quality in the context of electrification planning, participants generally agreed that it pertains to the following characteristics:

- Granularity / spatial resolution: The amount of spatial detail in a given observation or area
- Timeliness / temporal resolution: How often data of the same area are collected
- Accuracy: The degree or closeness to which data / information match the real values in the real world
- Consistency: Refers to the absence of apparent contradictions in and across datasets
- Completeness: A dataset is “complete”, if all the records are filled in for the area of interest (e.g. a good dataset for one county/district may not be useful or representative for national analysis).

Participants also cited several additional considerations that are related to and often cut across the characteristics mentioned above.

- The provenance and trustworthiness of the data. This typically refers to the trustworthiness of the data source, as well as the entities, systems and processes that influence the data.
- Interoperability — or the ability to exchange and make use of data/information across different data/modelling platforms — was also cited as being important. Here, the format of data is critical to its interoperability.
- In addition to the quality of data, the quality of metadata should be equally considered. This information accompanies each dataset and provides information on e.g., origin, date of first publishing, format and license/use rights. The same quality characteristics apply both to data and metadata.

Figure 2.6: **Recommendations for evaluating reliability data quality.** *Figure is a screen capture from “Data Standards for Integrated Energy Planning” [30]. These takeaways are from a July 2020 meeting hosted by SEforALL with 65 participants across 28 energy-planning organizations involved in generating, analyzing, or using energy data [30]. Many of these recommendations are more achievable using PowerWatch than other available systems.*

Figure 2.6 and strongly recommend the full report for further reading.

## 2.3 Causes of Performance Problems

Overloaded systems are one major source of unreliable power [63]. Overload occurs when a grid is asked to deliver more power than it is able, typically causing components in the grid to break and resulting in the loss of service. Overload paired with environmental conditions has been the root cause of many of the most significant power outages around the world [86].

Outages are frequently caused deliberately by utilities that are unable to meet demand, in order to prevent harm to the grid [64, 87]. These blackouts, although scheduled, do little to solve the greater problem of access to reliable power, and they will get worse in the face of increasing demand [88].

Statistics for Outage Cause Categories			
	% of events	Mean size in MW	Mean size in customers
Earthquake	0.8	1,408	375,900
Tornado	2.8	367	115,439
Hurricane/Tropical Storm	4.2	1,309	782,695
Ice Storm	5	1,152	343,448
Lightning	11.3	270	70,944
Wind/Rain	14.8	793	185,199
Other cold weather	5.5	542	150,255
Fire	5.2	431	111,244
Intentional attack	1.6	340	24,572
Supply shortage	5.3	341	138,957
Other external cause	4.8	710	246,071
Equipment Failure	29.7	379	57,140
Operator Error	10.1	489	105,322
Voltage reduction	7.7	153	212,900
Volunteer reduction	5.9	190	134,543

Figure 2.7: **Causes of blackouts in the United States.** Table from “Weather-Related Power Outages and Electric System Resiliency” for the Congressional Research Service [89].

## 2.4 Existing Data Sources

There are several popular methods of gathering basic reliability data. Manual methods include relying on customer calls to a call center; directly surveying customers; and performing spot measurements with handheld tools or with installed, simple analog meters. Automated methods include placing sensors on infrastructure or using “smart meters” to automatically collect and transmit billing and power-quality data back to a utility company.

While utilities in high-income countries have augmented grids with increasingly advanced sensors and utilities in lower-income economies have limited instrumentation due to budget constraints, across the income spectrum data is not as available as it needs to be [13, 29, 30, 49, 90]. Figure 2.8 shows the availability of specific datasets—datasets that PowerWatch can measure—in the countries tracked by SE4All [30].

Dataset	Availability	Comments
High-voltage lines (existing and planned)	Largely available	Requires information on country-specific HV datasets as there are often discrepancies between global/continental HV datasets and country-specific ones
Medium-voltage lines (existing and planned)	Partially available	Requires information on country-specific MV datasets as there are often discrepancies between global/continental MV datasets and country-specific ones
Low-voltage lines (existing and planned)	Limited	
Substation and transformers (existing and planned)	Limited	Datasets could be validated through a feedback loop from existing interventions (mini-grid)
Power plants (existing and planned)	Largely available	

Figure 2.8: **Low-voltage monitoring is a global problem.** *Figure shows a portion of a table from “Data Standards for Integrated Energy Planning,” by U.N. Sustainable Energy for All and U.K. Aid [30]. This table shows the current global availability of the datasets PowerWatch is able to measure, as collected across countries tracked by SE4All, and SE4All’s comments about these datasets.*

Even if data is collected, data accessibility and compatibility remain major bottlenecks [5, 13, 29]. Some utilities have been working to make the data they collect not just publicly available, but also useful and approachable for non-technical stakeholders [91]. This is an important part of the task, and closed data is a common problem for many stakeholders [5, 13, 24, 49].

A high-quality outage dashboard is shown in Figure 2.9. This particular dashboard is provided by DTE, a private U.S.-based utility with a large smart meter roll-out. DTE has improved this dashboard significantly over the years since I started this dissertation work.

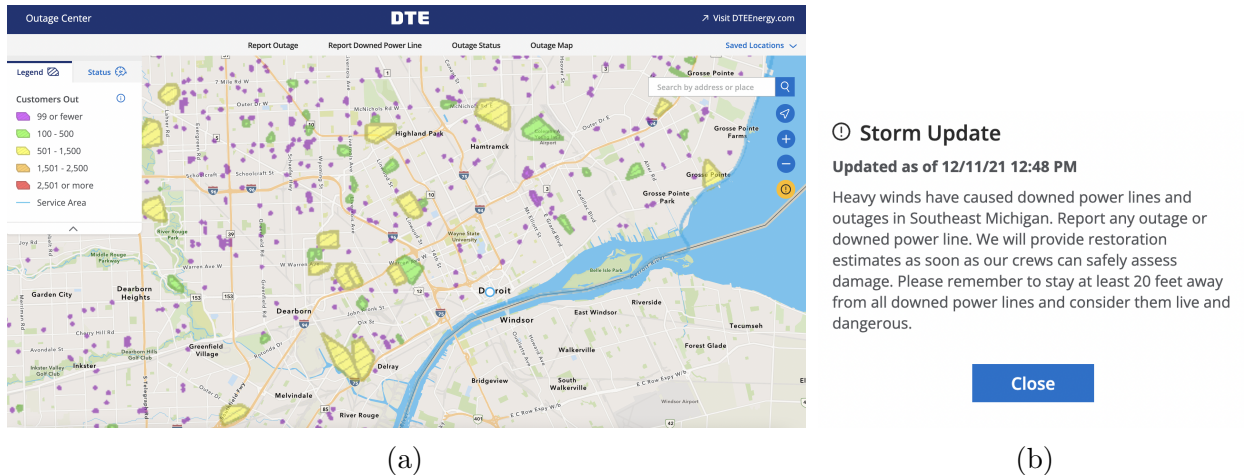

Figure 2.9: **Customer-facing outage system from DTE Energy.** In (a), we see a very-high-resolution map of on-going outages tracked and displayed by DTE as screen captured from their website on December 11, 2021 [91]. In (b), screen captured from DTE’s website at the same time, we note that even though the utility has very-high-resolution maps, they still revert to asking customers to report the root cause of outages, going as far to display (b) to all users as a pop-up when their map is first loaded.

However, data gaps clearly still exist even for the most advanced grids. Figure 2.10 shows a discussion from the July 2017 Meeting Minutes from the IEEE PES Distribution Reliability

Working Group about a recent survey of utilities in 30 U.S. states [92]. The survey results reflect the diversity of reliability metrics across states. It is also worth noting the use of IEEE 2.5 beta, which has been controversial due to this metric's unexpected sensitivity to historic data [93].

*What is being used for metrics?*  
 SAIFI, SAIDI and CAIDI (a few CEMix, MAIFI, CAIFI, ASAI, & other)  
*Association with employee incentive?*  
 Quite a few do use for incentives (about half)  
*Major storm exclusion*  
 (majority use IEEE 2.5 beta) others simultaneous percent out as well as named storms etc.  
*Formal metric for ranking reliability initiatives*  
 most have no specific metric

Figure 2.10: **Meeting Minutes from the July 2017 IEEE PES Distribution Reliability Working Group showing that utilities in the U.S. use multiple reliability metrics.** The above meeting-minutes excerpt describes results from a 30-state survey of mostly investor-owned utilities [92].

### 2.4.1 Meters

By measuring consumption, meters allow generation utilities to bill transmission and distribution utilities, and transmission and distribution utilities to bill individuals and businesses. Reducing the cost of human meter readers is the primary motivation for utilities to upgrade analog meters [29, 71].

Supervisory control and data acquisition (SCADA) systems use sensors placed on utility infrastructure and operated by the utility to provide data on consumption and reliability. SCADA systems also allow the utility to control the configuration of their network remotely, creating a single point of coordination for network operation for the parts of the network where SCADA is present.



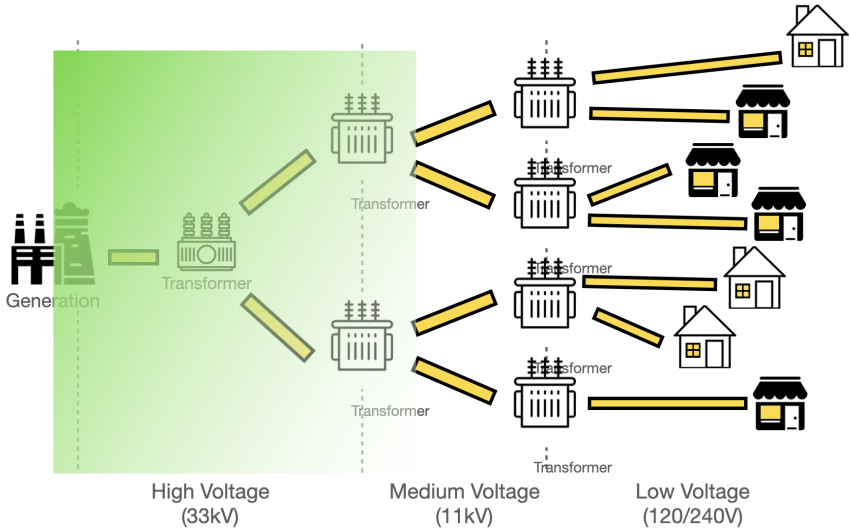

Figure 2.11: **Approximate SCADA coverage in Accra.** ECG has installed SCADA on the high-voltage networks and some of the medium-voltage networks [94].

Many countries, including most low- and middle-income countries, report grid reliability data that is primarily from sensors within the SCADA network and is therefore limited by where this network stops [5, 13, 29]. In Accra, like in many cities, SCADA covers only the HV network and parts of the MV network (shown in Figure 2.11) [4, 9, 94]. SCADA systems are very expensive and are often justified based on the need for billing between separate generation, transmission, and distribution utilities, as well as on their ability to enable some coarse control. The value-add of LV reliability data is likely not enough to justify the cost of SCADA expansion [3, 4, 29, 41, 71].

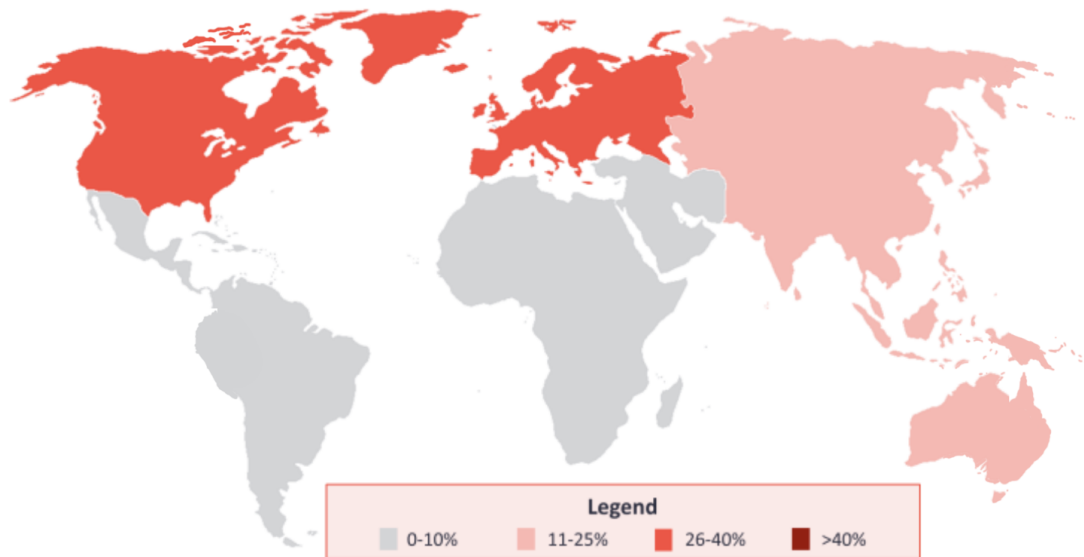
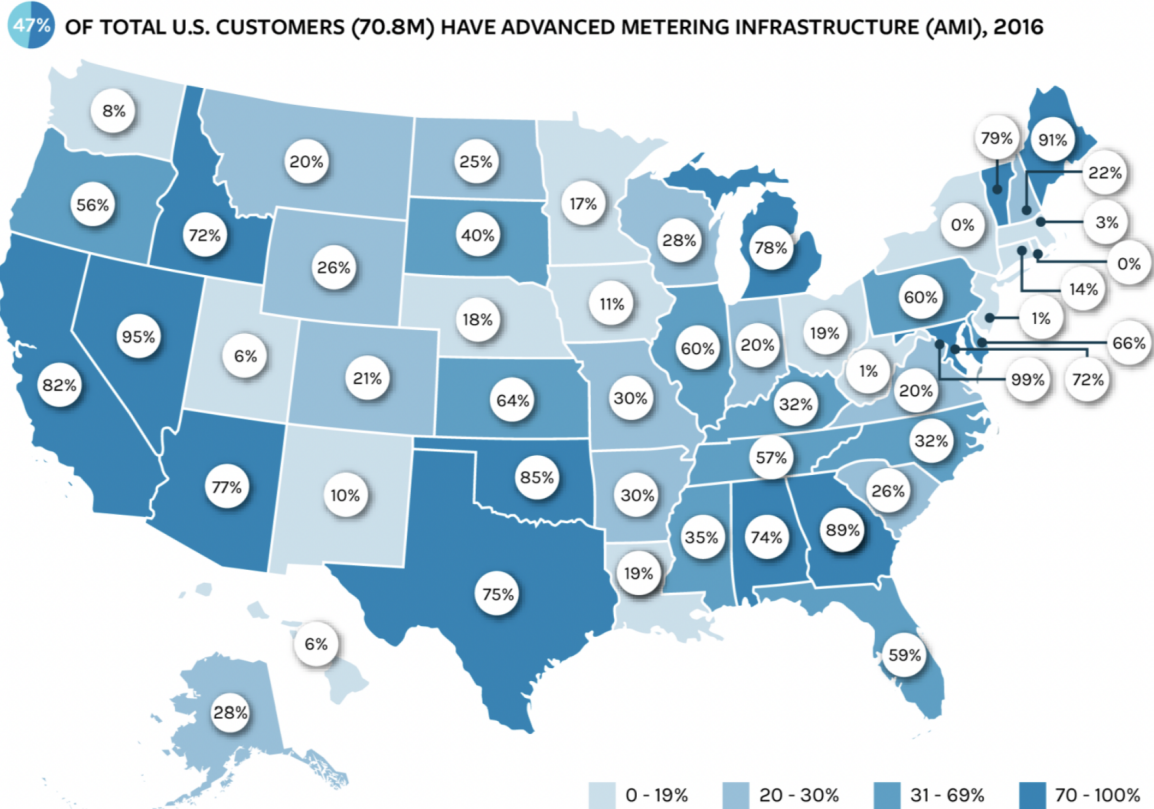

Figure 2.12: **Global Smart Meter (Energy and Water) Penetration by Region.** *Figure adopted from “Smart Meter Market 2019,” from IoT Analytics [95].* Smart meters have been on the market for many years but adoption remains low, especially in Africa and South America [30, 95].

At the distribution tier, state-of-the-art instrumentation—“smart meters”—have existed commercially for decades. Smart meters average and transmit consumption, voltage, and frequency data in relatively infrequent (e.g., 15 minute) reports [96]. The first smart meter entered the market in 1977, introducing a tool for measuring power quality at the household to an already-broad toolbox of methodologies for monitoring grid performance at the transmission and high-voltage distribution levels [97, 98]. But global adoption of smart meters has been exceptionally slow in many regions (see Figure 2.12) [95, 99]. Even in the U.S., adoption of smart meters varies widely by state, as shown in Figure 2.13.



Source: EIA, “Electric power sales, revenue, and energy efficiency: Form EIA-861,” 2016 data.  
 Differences in AMI deployment rates are often driven by state legislation or utility regulation, as some states require that regulators approve utilities’ cost recovery mechanisms.

Figure 2.13: **Smart metering has not been equally distributed across the United States.** Figure is a screen capture from the U.S. Department of Energy’s “Smart Grid System Report: 2018 Report to Congress” [13]. This map shows the relatively unequal roll out of smart meters within the U.S., indicating that complex factors are involved in smart-meter adoption. Smart meters provide a very sparse sample of the low-voltage network in some states.

Utilities in low- and middle-income countries have been particularly slow adopters of smart grid technology, citing significant barriers to entry, including large deployment costs, frequent procurement delays, and difficult integration with existing utility systems [29, 41, 100]. By 2020, over 40 years after smart meters entered the market, adoption in Africa and the Middle East was estimated to be at 5% [99].

Smart meter technology is often hard to use, increasing deployment costs and decreasing benefits, especially for non-technical stakeholders [49]. An example modern “smart grid” interface is shown in Figure 2.14. This is more than an aesthetic concern, and data visualization and analysis is regularly pointed out as a key improvement needed for Smart Grids to provide

the benefits they offer [5, 13, 49].

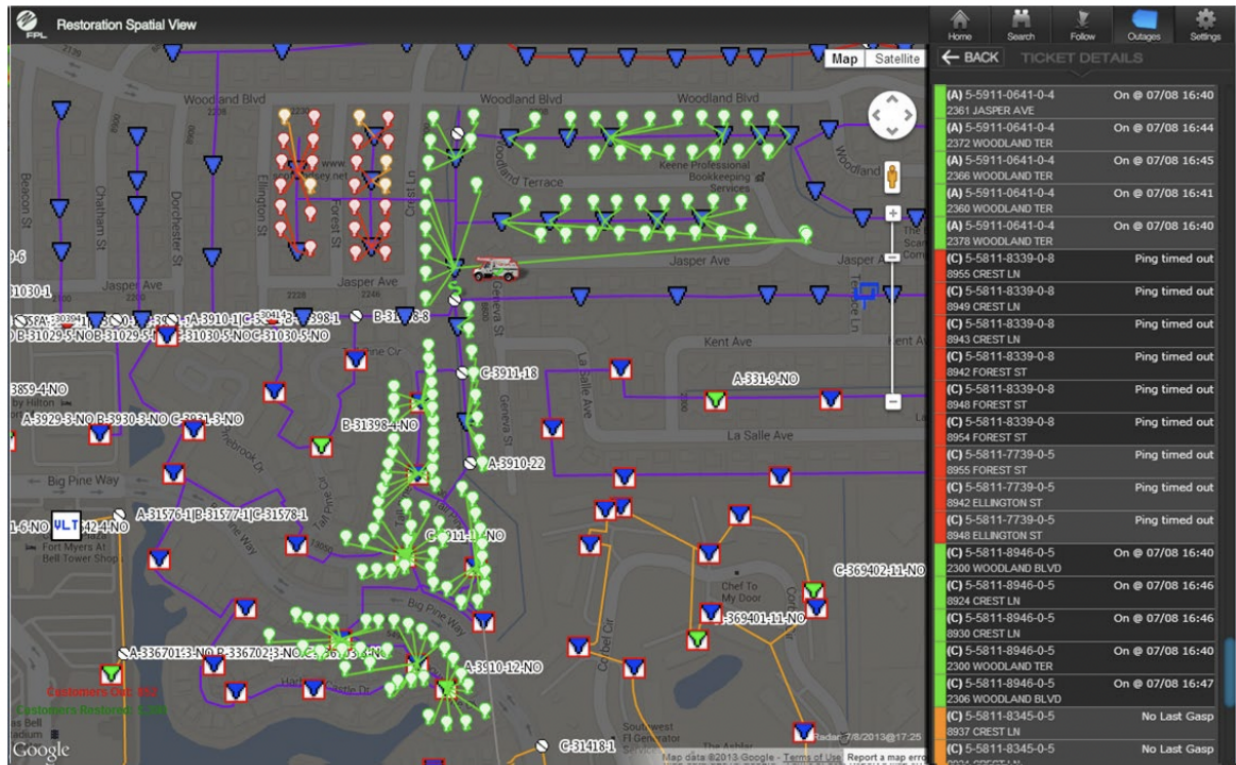

Image courtesy of LaMargo Sweezer-Fischer, Florida Power & Light.

Figure 2.14: A UI for a smart grid system in Florida. Figure is a screen capture from the U.S. Department of Energy’s “Smart Grid System Report: 2018 Report to Congress” [13]. While this particular display from 2018 may now be outdated, this type of dashboard represents the average, clunky user interface present in many public reports [5, 13, 49].

Pre-paid meters, which activate only when a customer purchases credit (reducing the need for meter readers), provides better information about consumption but little to no additional information about reliability [41, 71, 101]. Adopting smart meters is particularly challenging due to large investments recently made by many countries installing pre-paid meters, which can be difficult to justify replacing [71]. For example, the two major electric utilities in Ghana have made the deployment of prepaid meters a cornerstone of their strategic efforts to reduce electricity theft and improve collection ratios [102]. While pre-paid meters do not communicate with the utility [103], large pre-paid meter purchases in low- and middle-income countries still decrease the likelihood of rapid smart-meter adoption in the near future [104]. Work has been done to retrofit non-GSM-connected meters with GSM radios in developing countries, but this also has yet to scale due in part to cost [105].

## 2.4.2 Call Centers

Many utilities, including the Electricity Company of Ghana (ECG), depend on customer calls to estimate the numerator for both SAIDI and SAIFI at the low-voltage level. Analysis of data collected from the national call center in Accra suggests this data stream is sparse and noisy: dips in reporting occur during the day when people are at work and few reports occur during the night when people are asleep (if people call at all, see Figure 2.15). While some of these patterns may reflect an underlying reality (a grid may fail more often when it is operating at capacity, which is more likely in the middle of the day [106]), customer-call data is still likely under-sampling outages, particularly in the context where frequent outages and slow repair response times may reduce a willingness to report outages. Additionally, few customers call about power restoration, making duration for SAIDI difficult to estimate.

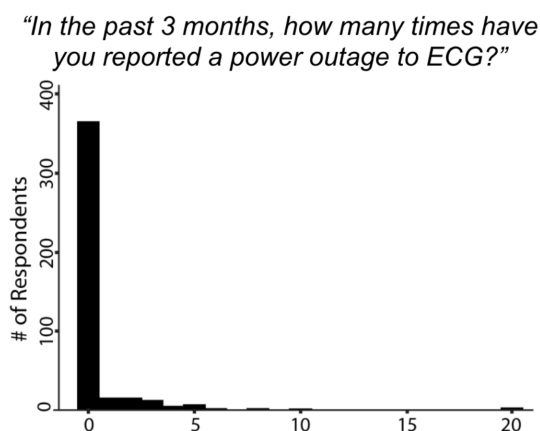

Figure 2.15: **Average number of calls per user in a district in Accra from a 421-participant survey.** Despite the fact that, as shown in this figure, most people do not call to report power outages, the total annual cost of calls to ECG is not insignificant. Using an average cost per minute of 0.1132 Ghana Cedis (approx. 0.03 USD) [107], and an average call time of 2.33 minutes calculated from ECG call center data, we can estimate that an average call costs 0.264 Cedis (approx. 0.06 USD). We can then estimate that the total cost of calls ECG received in 2017 (with a cumulative time of 14.6 person years) would have been 870,548 Cedis (approx. 193,000 USD), or .00045% of Ghana’s GDP [108].

Calls also may represent real costs in some regions. Based on a survey we conducted with some of our participants in Accra, the average call length, which we collected from the ECG call center, and the average cost per minute for a phone call in Ghana, we can estimate that the user who called 45 times—seen at the far right of Figure 2.15—would have a total of 11.88 Cedis (approx. 2.64 US Dollars) [107]. Even for the average caller who calls only once, the expense of calling likely represents a barrier to reporting. There are conflicting models about average earnings in Ghana. At the low end, the Ghanaian governmental organization Ghana Statistical Service reported an average daily earning of 14 Cedis in 2014 [109]. More recently, the World Bank estimated an average daily earning of 17 Cedis in Accra [108]. In the first



case, a single call would represent 1.88% of a caller's daily earning; in the second, 1.55%. This cost unfortunately disproportionately affects rural areas, where earnings are less and power quality is lower.

### 2.4.3 Surveys

A common method of collecting information about grid reliability used by all stakeholders is through directly surveying consumers [13, 29]. Two examples are shown in Figure 2.16 and Figure 2.43. However, depending on consumers is expensive and frequently error-prone, and therefore samples are infrequent, limiting trend analysis [30]. Further, survey data, which depends on consumers recalling the number and duration of power outages, may be more subject to noise than previously thought [110, 111].

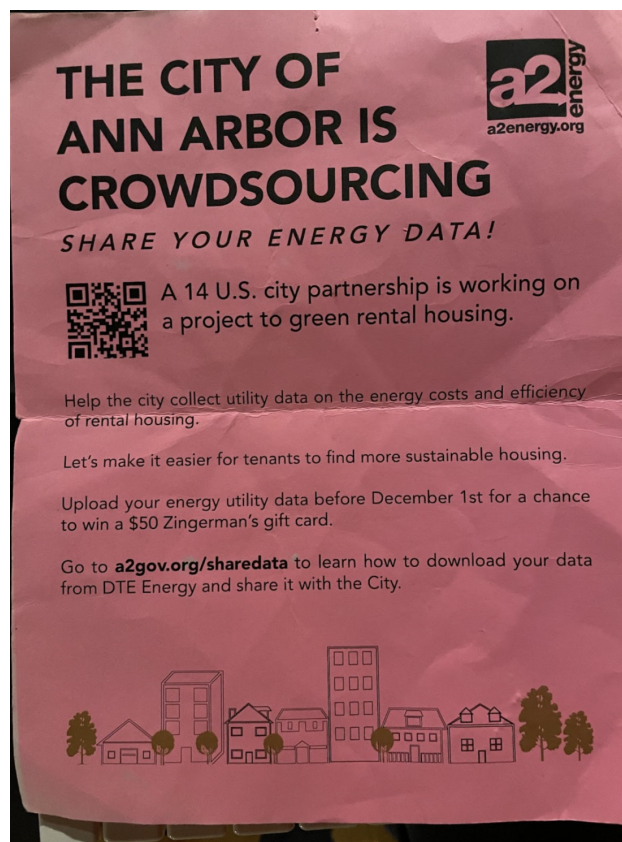

Figure 2.16: A flier mailed to my house in Ann Arbor, Michigan, around 2016. This type of direct-to-consumer data collection is often recommended as a scalable way for collecting energy data [5, 13], but it has many downsides when compared to automated metering [5, 13, 112]. It is worth mentioning that my house at the time had a smart meter, making this data potentially already available, and my utility company, DTE, was piloting technology to give customers better access to their consumption data, indicating a willingness by the utility company to be transparent with consumers [91].

The World Bank Ease of Doing Business Survey contains the best data on global grid reliability (a statement that likely still stands even in light of the serious problems recently uncovered with that program [113]) [29, 30]. In some cases, countries started collecting SAIDI (Equation (2.1)) and SAIFI (Equation (2.2)) due to the positive impact it would have on their Ease of Doing Business Ranking [114]. Because of the high incentive to report SAIDI and SAIFI provided by the World Bank, it is likely that the countries not reporting data do not have methods of collecting and reporting reliability data in place [30].

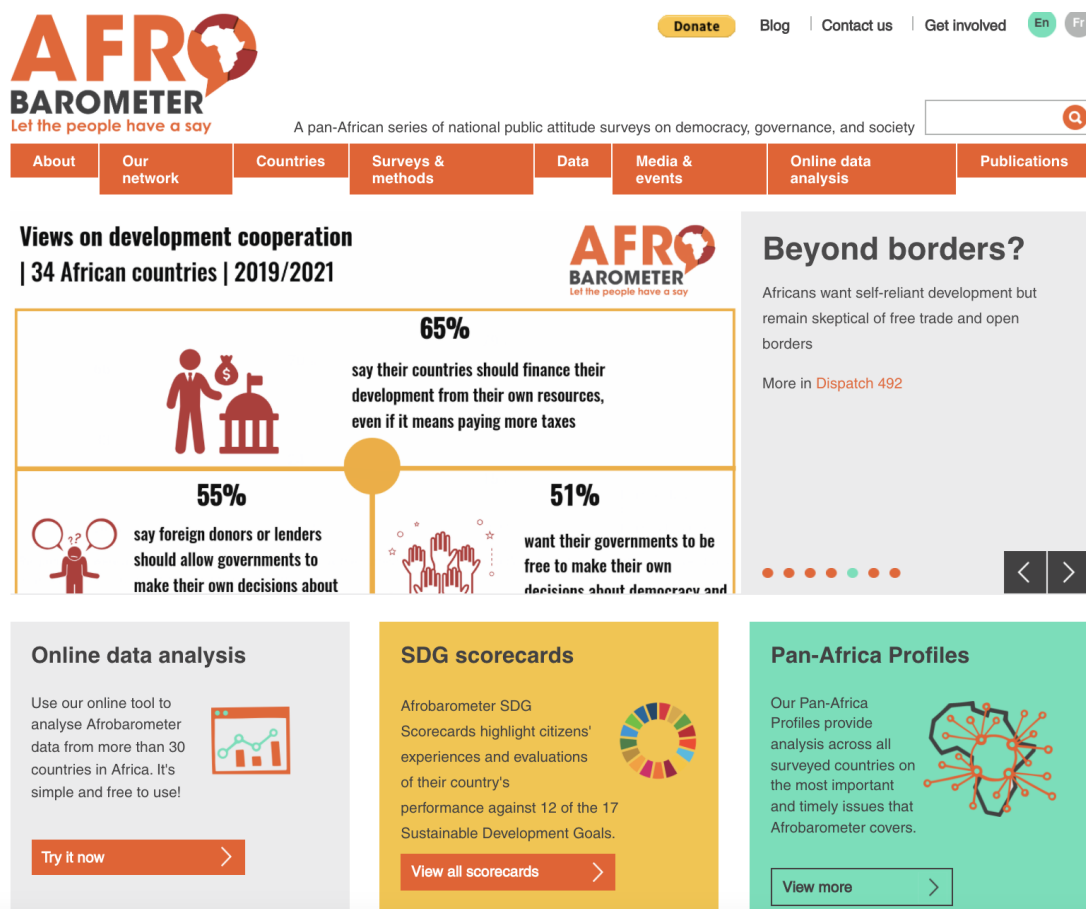

Figure 2.17: **The homepage of the Afrobarometer Survey.** *Figure is a screen capture from [115].* Afrobarometer uses surveys to “collect and publish high-quality, reliable statistical data on Africa which is freely available to the public.” They also provide data-access and analysis tools, as well as their own research output.

Afrobarometer markets itself as “the world’s leading source of high-quality data on what Africans are thinking” and describes its structure as a non-partisan, pan-African research institution [116]. They regularly survey 30+ countries about topics including energy reliability [115, 117]. Additionally, they provide an impressive data-access tool as well as regular research findings available for free on their website. While Afrobarometer certainly

provides an interesting model for higher-frequency survey data, surveys are not the perfect tool for all data collection [11, 71, 74, 110, 111].

While reliability is challenging to measure, the extreme unreliability in Accra recently motivated the Dumsor Report, shown in Figure 2.18, a two-week study of the actual grid “on-off” around the city [118]. The Dumsor Report was a very effective political tool, but its relatively short study period makes it difficult to use to inform necessary large-scale system investments, nor is it effective for evaluating improvements. The costly methodology of paying individuals to precisely record outages does not scale well beyond such a small study.

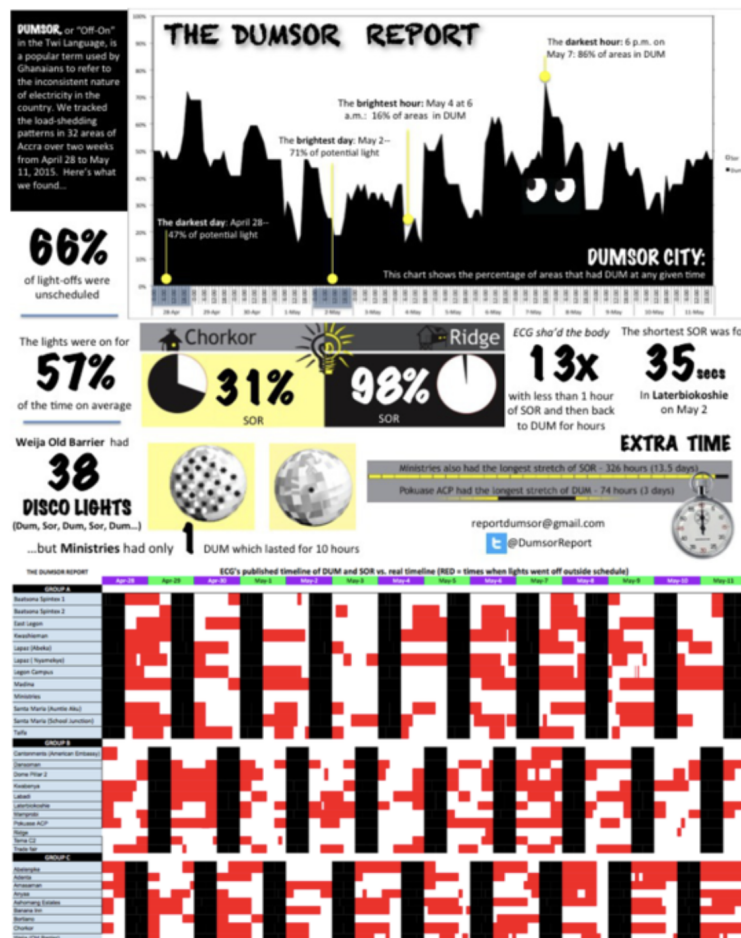

Figure 2.18: **The Dumsor Report**. Figure is a screen capture from the Dumsor Report [118]. One of the most accurate in-field reports of actual grid performance is from a two-week study conducted by collecting outage and activation reports from citizens around Accra, Ghana [117]. The methodology lay somewhere between crowdsourcing and sensing, as participants were paid to carefully record the precise time of every power outage and return over the two-week window [118].



## 2.4.4 Non-Traditional Sensors

Utilities, investors, researchers, and individuals have all developed new technologies capable of measuring power quality. Even in the U.S., which has a relatively well-monitored grid at the distribution level (see Figure 2.13), it is estimated that complete metering coverage is at least 20 years away [119], likely encouraging work on alternative methods of measuring reliability.

The distribution grid has many measurement points beyond the high-voltage transmission level, creating challenges for metering at scale. Some prior works address this problem with innovations around new sensor front-ends better able to scale, including transformer-mounted or substation-mounted sensors [120, 121], sparsely deployed micro-synchrophasors [122–124], circuit and load-level meters [50, 125, 126], social media mining [30, 127], and even mobile-phone-based<sup>1</sup> side-channels [131, 132].

There have been large improvements in the price and features of both professional-level and consumer-level power meters, shown in Figure 2.19a and Figure 2.19b, respectively [133, 134]. While these meters enable individuals to take measurements, they are often not easily aggregated due to siloed systems [135, 136].

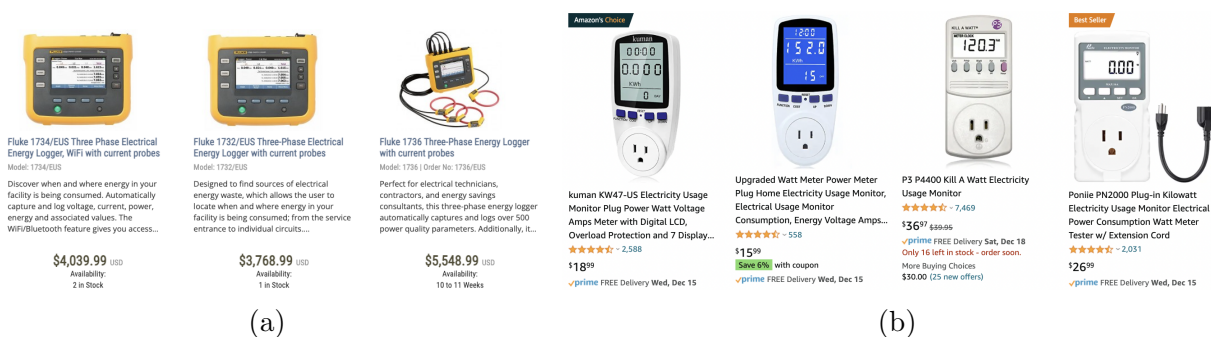

Figure 2.19: **Professional and low-cost meters.** In (a) we see a selection of professional power-quality meters on the market, screen captured from “MyFlukeStore.com” [137]. In (b) we see an emerging low-cost sensor market, screen captured from “Amazon.com” after a search for “power meter” in the United States [133].

A similar work to PowerWatch, developed concurrently, comes from the Prayas group, which designed and deployed a sensor to measure grid reliability by plugging in at outlets [138]. Along with partners in Kenya, this group has deployed hundreds of sensors, maintains an online map of power quality based on these deployments, and has published early results [138–140]. While this work is inspiring, it does not go as far as PowerWatch in using space-time clustering to filter the data stream, does not explore deployment management tools, and has been deployed less densely [139].

<sup>1</sup>Mobile-phone-based techniques, however, have been limited by recent privacy-preserving changes made by both Android and iOS [128, 129] as well as other OS challenges [130]

Work exists that evaluates the deployment methodology used in this dissertation in a different context [141], in which the “Grid Alert” system is used in 18 households in Kenya. This system collects the same data as PowerWatch and provides some additional, interesting features that may increase value to participants, including the ability for the sensor to act as a surge protector. The authors compare the sensed results against a survey asking participants to recall the number of outages they have experienced, finding that the sensors reported outages that roughly aligned with recall. This work goes further to describe aspects of the deployment methodology the participants found valuable, reporting that many people found particular value in measuring appliance consumption, a feature not currently present in PowerWatch [141].

Others have explored directly monitoring grids with small-scale sensor deployments. In 1994, 20 low-voltage data loggers were placed in customer residences to monitor the distribution feeder systems in Buffalo, New York, USA [142]. But this did not continue past a one-off deployment. More recent work proposes a sensor system for measuring low-voltage grid current and voltage at high rates [143]. While this provides an interesting high-resolution dataset on grid performance, its cost and complexity limit wide-area deployment. In [11], a small number of voltage sensors were installed in Zanzibar and used to explore low-voltage reliability and power quality in two villages on the island, resulting in a data series better reflecting the lived experience than more-aggregated SAIDI and SAIFI metrics.

Inexpensive IoT-class sensors promise added automated sensing in developing regions, but these have yet to be proven at scale [29, 41, 131, 144]. This is surprising. Over the course of my PhD work, embedded systems have become much more user friendly, to the point that nearly everyone reading this could buy an Arduino or Sparkfun (as I have done many times) and hook up a sensor that can take measurements similar to PowerWatch having never programmed or designed hardware before [145–147]. However, the same people who built the world’s most complicated machine—the grid—have not yet figured out how to build a low-cost system well-suited for scale.

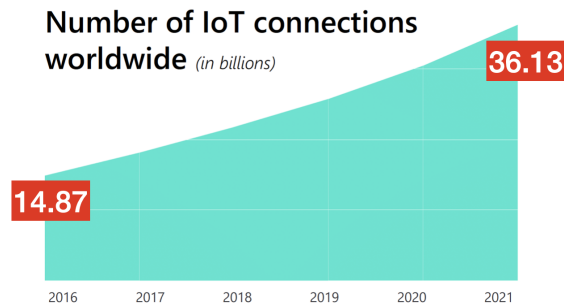

(a)

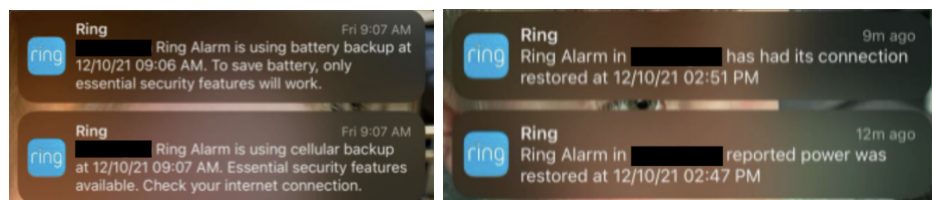

(b)

(c)

Figure 2.20: **Internet of Things devices are ubiquitous and capable of measuring grid reliability.** In (a) we see a screen capture from Microsoft’s “2019 Manufacturing Trends Report” showing that IoT device sales have skyrocketed in the past five years [148]. Many of these devices could measure power outages. In (b) and (c) we see screenshots of Ring notifications. In (b) the Ring alarm reports a power outage and in (c) the restoration is reported, providing a clear side channel for using these devices to coarsely measure outage duration.

Any on-the-ground sensor deployment requires a subset of stakeholders to give permission for installation and potentially to become involved in sensor maintenance and operation. The deployment methodology used in this work, to maintain independence, relies only on individuals deciding to participate, sidestepping the regulator and utility if need be. Individuals are frequently used by utilities and regulators to collect data about the grid (see Figure 2.16 and [5, 13, 29, 49]). Examples like the DumsorReport [118] and the frequent willingness to take to the street when power is bad [23, 24, 149] show people’s willingness to organize around taking important measurements when they believe these measurements matter.

“Off-the-ground,” or remotely collected, data can also be used to coarsely measure grid reliability. Common data sources include satellite imagery [150–152], internet scanning [153–157], and IoT side channels [158, 159]. These techniques have yet to be used at scale, although efforts like IoDA [157], AtlasAI [160], and Censys [156] may push the market forward, and early results are promising for applications that benefit from HV monitoring [150].

Satellite images, especially during the night, have been shown to be reasonable indicators of both the presence and usage of electricity in a region [150, 154, 161, 162]. This insight has led to satellite imagery being used successfully to study electrification in Vietnam [150], to

study the sharp rise in electricity usage accompanying military action [163], and to model the frequency of power outages in India [164, 165]. Unfortunately, there is a lack of good satellite data; by definition nightlight data is only available during the night, leading to limited utility for daytime satellite images, and current satellite data made available by sources like NASA is not high-enough resolution for household-level analysis [150–152]. An on-going project involving researchers at nLine, UMass Amherst, the Colorado School of Mines, and Atlas AI uses PowerWatch to improve the accuracy of nightlight-based techniques for measuring grid stability in Accra [166].

## 2.5 Value of Utility-Independent Measurements

There is both a national-security interest and a human-rights interest in having independently-collected data about grid stability [13, 30, 50]. In Ghana, the Ministry of Energy released a statement saying the “Government believes that the nation’s energy security is based on the security and diversity of fuel supply, reliability of energy infrastructure, and the Financial Viability of the energy sector.” The United States designated climate change a national security threat in an 2018 amendment to the National Defence Authorization Act, largely due to threats to grid reliability [167, 168].

Where basic reliability data does not exist, for some applications the benefits of collecting this data may far exceed the costs of a reasonably-priced measurement [49]. If data exists but is not readily available, in some cases regulators may want to sidestep utilities to directly measure grid reliability. Further, if data is urgently and unexpectedly needed, any measurement system must be able to be deployed quickly and, ideally, inexpensively.

### 2.5.1 National Security

Grids are prime targets in an invasion and are worth defending [50, 167, 168]. Destroying grids is a common tactic used by large and small forces because grids often have a single point of failure and the disruption can be catastrophic [13, 50, 167].

*Ground zero of the latest confrontation between Ukraine and Russia was a sea of mud and not much else on Wednesday. About half a dozen fighters, their boots sinking into a sodden field, were guarding the downed electricity pylons that were blown up last weekend, plunging much of the disputed Crimean peninsula and the Kherson region of mainland Ukraine into darkness. Activists from the Tatar minority and Ukrainian nationalists attacked the first repair crews and their police escorts seeking to restore the felled pylons, driving them away.*

Figure 2.21: **Quote from “Russia and Ukraine in a Standoff Over Crimea Power Outage,”** in *The New York Times*, November 26, 2015 [169].

Basic automated meters on HV and MV lines can help correlate events with changes in reliability, which may be important for protecting against large attacks. However, this analysis may be difficult to convince a utility to conduct [49]. The benefit of having higher-resolution monitoring techniques able to detect attacks is demonstrated in Figure 2.29 [13, 167, 170].

*Early last summer, Chinese and Indian troops clashed in a surprise border battle in the remote Galwan Valley, bashing each other to death with rocks and clubs. Four months later and more than 1,500 miles away in Mumbai, India, trains shut down and the stock market closed as the power went out in a city of 20 million people. Hospitals had to switch to emergency generators to keep ventilators running amid a coronavirus outbreak that was among India’s worst.*

Figure 2.22: **Quote from “China Appears to Warn India: Push Too Hard and the Lights Could Go Out,”** in *The New York Times*, February 28, 2021 [170].

*“As of Feb. 26, Tajik state energy company has made unscheduled use of 84 million kilowatt hours of electricity,” the state-owned Kazakhstan Electricity Grid Operating Company said.*

Figure 2.23: **Quote from “Power shortage hits Central Asia,”** in *The New York Times*, February 26, 2009 [171].

*After the Department of Homeland Security announced publicly that the American power grid was littered with code inserted by Russian hackers, the United States put code into Russia’s grid in a warning to President Vladimir V. Putin.*

Figure 2.24: **Quote from “China Appears to Warn India: Push Too Hard and the Lights Could Go Out,”** in *The New York Times*, February 28, 2021 [170].

Grids are often held hostage, an effective strategy for both nation states and smaller organizations based on the impact of power outages and the relative weakness of the grid system [167]. An example of power being held hostage is show in Figure 2.25.

*The Tatars, a Turkic Muslim minority that now numbers about 300,000, have memories of crushing brutality under Stalin’s rule; thousands were forced into exile and returned to Crimea only after the fall of the Soviet Union. Many said that their people again faced systematic repression, and the initial demands to restore power [in Crimea] included that all activists be released from jail, that the independent Tatar news media be restored and that international human rights monitors be allowed to operate.*

Figure 2.25: **Quote from “Russia and Ukraine in a Standoff Over Crimea Power Outage,”** in *The New York Times*, November 26, 2015 [169].

## 2.5.2 Targeted Actions

Short-term data on reliability collected quickly from unexpectedly at-risk areas could potentially prove valuable for something as small as catching a small number of bad actors during sabotage (Figure 2.27) to catching nation states impacting each other’s populations through disrupting power flow either actively (Figures 2.29, 2.24) or passively (Figure 2.26).

*Kazakhstan announced Thursday that it was pulling out of the Central Asian power grid to protect its energy supplies, a move that forced rolling blackouts and electricity rationing on its tiny neighbor Kyrgyzstan. Kazakhstan said it had to withdraw from the power grid because Tajikistan - another small and cash-strapped Central Asian nation - was taking more energy from the grid than it was producing, threatening to disrupt supplies in Kazakhstan.*

Figure 2.26: **Quote from “Power shortage hits Central Asia,”** in *The New York Times*, February 16, 2009 [171].

It is worth specifically mentioning that some reliability data could potentially help catch even very small actors (Figure 2.27). Taking longitudinal measurements of reliability in a hyper-targeted region is not easy with smart meters; if not already installed, installation is slow and expensive, and the data has to be exported.

*The federal authorities are investigating whether three recent attacks against the power grid in Arkansas are linked, and utility officials have asked residents to remain alert to the threat of more trouble.*

Figure 2.27: **Quote from “Power Grid Is Attacked in Arkansas,”** in *The New York Times*, October 9, 2013 [172].

### 2.5.3 Higher-Resolution Adherence Checks

All sides of a resolving conflict involving grid stability would likely have an interest in ensuring grid stability had been restored [13, 49, 171]. An example threshold of success to measure against is shown in Figure 2.28.

Longitudinal studies or measures that include a high-frequency or high-dimensional samples may allow for more nuanced adherence checks than otherwise possible (and the most likely method of surveying may not be affordable or safe) [5, 29, 30, 78, 173].

*The fighters were allowing some repair work to proceed on one pylon to restore power to about 200,000 customers in the immediate vicinity, work that the state-run electric company, Ukrenergo, said would be completed as early as Thursday.*

Figure 2.28: **Quote from “Russia and Ukraine in a Standoff Over Crimea Power Outage,”** in *The New York Times*, November 26, 2015 [169].

Changes in the grid may stem from causes thousands of miles away. To make these correlations, higher-frequency data is useful, letting investigators better align timelines between potentially causal events [13, 174]. An example alarm pattern can be derived from Figure 2.29.

*Now, a new study lends weight to the idea that those two events may well have been connected — as part of a broad Chinese cybercampaign against India’s power grid, timed to send a message that if India pressed its claims too hard, the lights could go out across the country. The study shows that as the standoff continued in the Himalayas, taking at least two dozen lives, Chinese malware was flowing into the control systems that manage electric supply across India, along with a high-voltage transmission substation and a coal-fired power plant.*

Figure 2.29: **Quote from “China Appears to Warn India: Push Too Hard and the Lights Could Go Out,”** in *The New York Times*, February 28, 2021 [170].

### 2.5.4 Public Benefit

There are significant benefits to providing populations with data about safety and security [13, 15, 30, 175]. A lack of data can make a hard situation harder by making it difficult for regulators and utilities to plan energy rations (Section 2.5.4).



*The Kazakh move means Kyrgyzstan must ration supplies in the northern half of the country, including the capital Bishkek, to avoid overloading the domestic grid, according to a spokeswoman for Kyrgyz power, Ulyana Konvalova.*

caption **Quote from “Power shortage hits Central Asia,”** in *The New York Times*, February 16, 2009 [171].

Individuals also need to plan around electricity availability. As shown in “Erratic electricity supply (Dumsor) and anxiety disorders among university students in Ghana: a cross sectional study,” which reports across 578 college students at the University of Ghana, “nearly 26% of students interviewed felt nervous, anxious or on edge almost every day due to the erratic power supply” during the Dumsor period (see Chapter 3) [175]. A lack of communication in situations like that in Figure 2.30 would only add to the stress of those populations.

*The situation has been at an impasse . . . with more than 1.2 million people in Crimea without power and no sign of any repair crews.*

Figure 2.30: **Quote from “Russia and Ukraine in a Standoff Over Crimea Power Outage,”** in *The New York Times*, November 26, 2015 [169].

However, as Figure 2.31 demonstrates, public knowledge also carries risks [13, 30]. Data governance continues to be a major problem between stakeholders [5, 30]. This should likely be formalized, as this data has significant political impacts and is often collected by 3rd parties (Figure 2.32).



✓ pgeoutage.com	\$12/year	♡	🛒
✓ rogersoutage.com	\$12/year	♡	🛒
✓ outagemyarea.com	\$12/year	♡	🛒
✓ outagemeaning.com	\$12/year	♡	🛒
✓ outagespanish.com	\$12/year	♡	🛒
✓ spectrumoutage.com	\$12/year	♡	🛒
✓ outagespectrum.com	\$12/year	♡	🛒
✓ outageinmyarea.com	\$12/year	♡	🛒
✓ outagexfinity.com	\$12/year	♡	🛒
✓ comcastoutage.com	\$12/year	♡	🛒
✓ dteoutagemap.com	\$12/year	♡	🛒

Figure 2.31: **Misinformation presents a threat.** Figure is a screen capture from a Google Domains search for “outage” restricted to results ending with “.com” [176]. The opportunity, indicated here by red boxes, for malicious parties to spread misinformation about power outages is present and hard to protect against as long as data remains highly distributed [13, 30].

*The flow of malware was pieced together by Recorded Future, a Somerville, Mass., company that studies the use of the internet by state actors. It found that most of the malware was never activated. And because Recorded Future could not get inside India’s power systems, it could not examine the details of the code itself, which was placed in strategic power-distribution systems across the country. While it has notified Indian authorities, so far they are not reporting what they have found.*

Figure 2.32: **Quote from “China Appears to Warn India: Push Too Hard and the Lights Could Go Out,”** in *The New York Times*, February 28, 2021 [170].

## 2.6 Stakeholders in Grid-Performance Data

Grid-performance data enables new operational paradigms that increase reliability, improve efficiency, and reduce costs [5]. Each type of stakeholder could potentially benefit from data

on reliability, motivating a high-level need for better data governance between stakeholders [5, 13, 177]. This is because, even within the same electricity market, data is used differently by, and has different value for, different stakeholders:

1. utilities wish to improve their efficiency and reliability and lower their operating costs;
2. regulators want sources of data independent of those provided by the businesses they are regulating;
3. investors in the grid want to maximize their investment returns;
4. researchers are interested in developing new or improved grid technologies and in understanding the impact of different operational, political, or social scenarios on reliability; and
5. individuals who depend on the grid for their health, education, and productivity may want to act to improve the performance of a grid or to anticipate grid-performance problems to minimize their impact.

The complicated relationships between stakeholders are shown at a high level in Figure 2.33 for the U.S. energy market and in more detail in Figure 2.34 for the Ghanaian energy market. While these markets provide mechanisms for give and take between stakeholders, much of the data necessary for public- and private-sector stakeholders is only available from the utility, creating a conflict of interest for the utility [5, 30, 84, 85, 178].

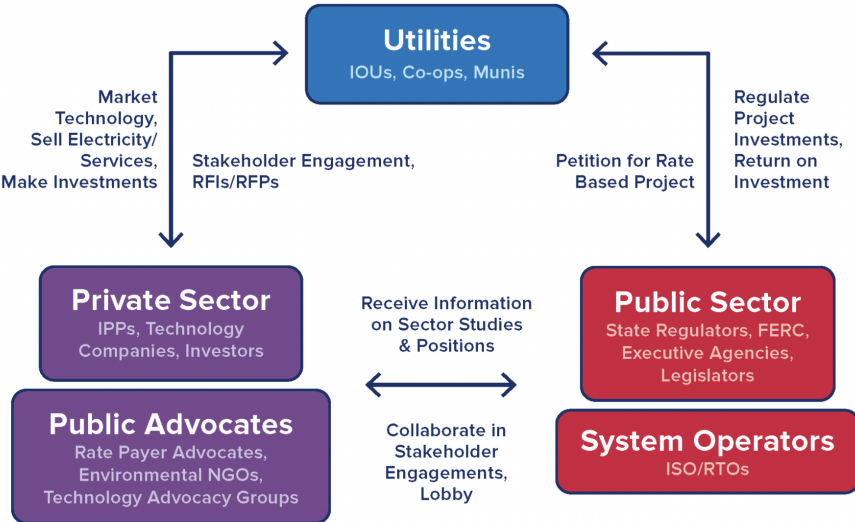

Figure 2.33: Key stakeholders in the U.S. energy market. Figure is a screen capture from “Electricity Evolution: Meet the Ringmasters” [178].

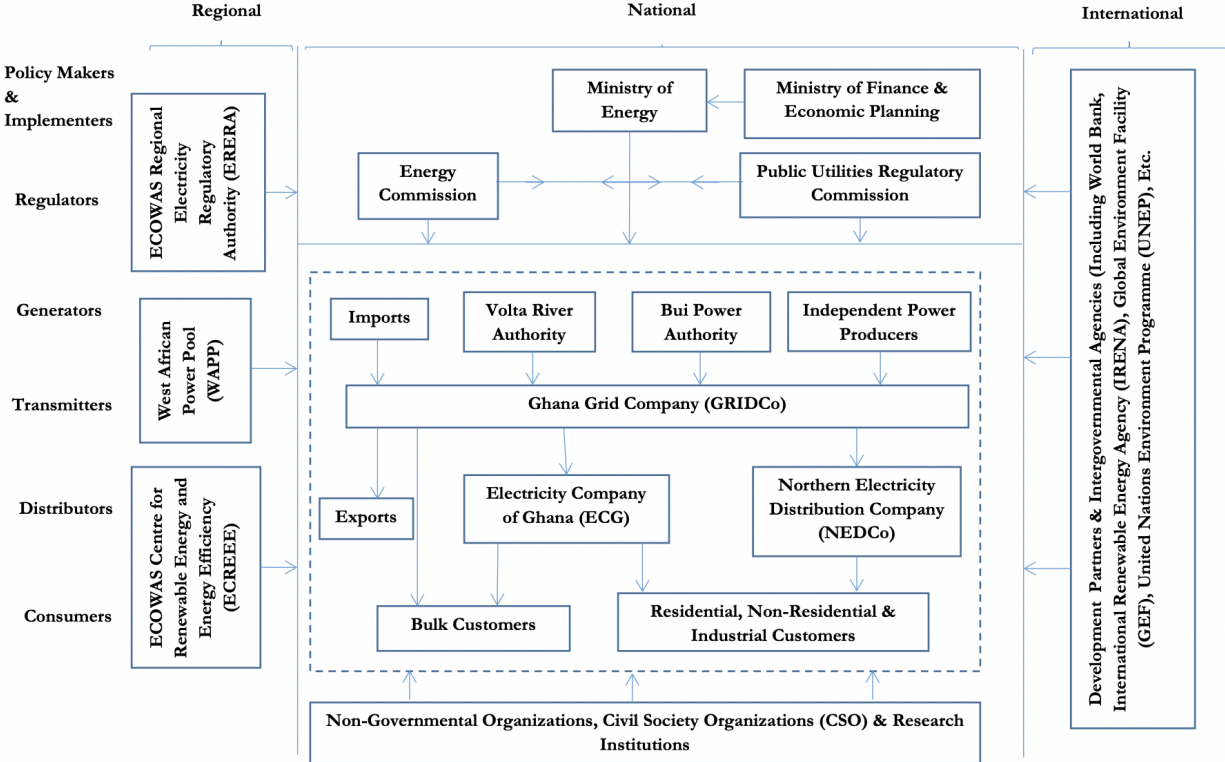

Figure 2.34: **Energy stakeholders in Ghana.** *Figure is a screen capture from “The Electricity Situation in Ghana: Challenges and Opportunities” [179].*

The U.N. recently launched a global call for “Energy Compacts” [180]. They define Energy Compacts as “voluntary commitments from Member States and all other stakeholders, such as companies, regional/local governments, NGOs and others, with the specific actions they will take to advance progress on SDG7 and net-zero emissions, designed to be fully in line with SDG Acceleration Actions and Nationally Determined Contributions under the Paris Agreement” [181]. The resulting list of stakeholders provides a view into the makeup of large-dollar stakeholders in the markets experiencing the worst reliability [37, 181].

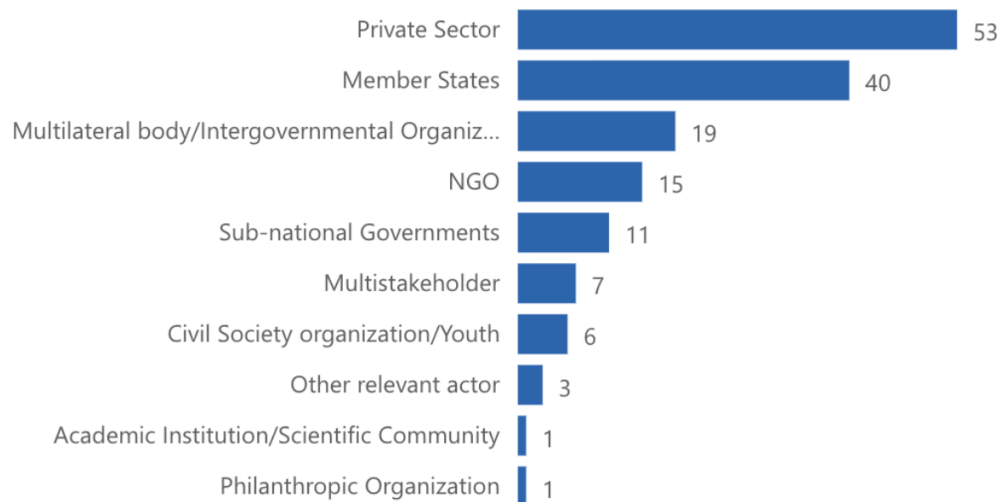
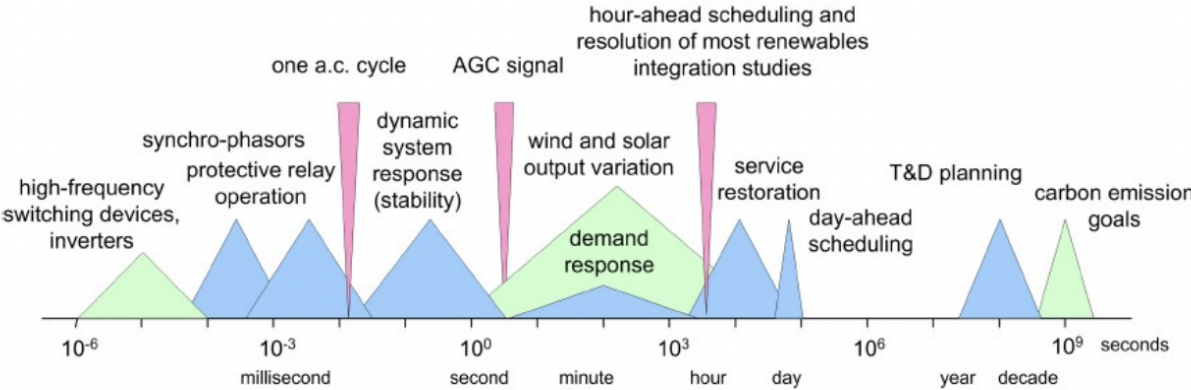

Figure 2.35: U.N. Energy Compact Stakeholders.] *Figure is a screen capture from the “Energy Compact Overview” by the United Nations, as of October 26, 2021 [181].* Note the diversity of stakeholders involved with meeting the goals of SDG7.

### 2.6.1 Utility Companies

The data needs of a utility depend on the applications of the data within the utility. Different utility decisions require different temporal fidelity (shown in Figure 2.36). PowerWatch takes samples with order minute accuracy, placing PowerWatch in the middle of Figure 2.36’s timeline.

Utilities are most often structured in one of three ways: as publicly owned; as a privately owned, regulated monopoly; or as a community-owned cooperative [182]. Privately owned utilities are more likely in wealthy countries, while the majority of utilities in the developing world are publicly owned [183].



Source: Developed by Alexandra von Meier.

Figure 2.36: **Utility applications enabled by different temporal resolution data.** Figure is a screen capture from the U.S. Department of Energy document “2018 Smart Grid System Report: 2018 Report to Congress” [13]. In this timeline, different utility applications are shown based on their required temporal resolution. PowerWatch, which currently achieves temporal resolution in the seconds, is therefore suited for supporting utility applications from the center of this timeline forward.

The right observations could enable utilities to enhance day-to-day operations (e.g., where to dispatch repair trucks) as well as long-term infrastructure planning (e.g., where to add transformers) [184, 185]. However, wealthier utilities—or utilities that receive more subsidies from wealthier governments—have more freedom to make larger, non-targeted infrastructure improvements [5]. They may therefore depend on data less, potentially slowing market support for innovation in data-collection techniques [5].

Using data provided by our partners IBM Research Africa and Kenya Power and Light Company (KPLC), we learned that 1/6 of trucks dispatched to repair an outage are not able to locate an outage, and 1/8 of trucks dispatched arrive after power is back on. These unnecessary or slow truck deployments waste large amounts of resources and leave customers in the dark for longer than necessary. In the U.S., DTE Energy estimates that it saves 76,000 unnecessary truck deployments annually using information from its 725,000 smart meters, resulting in an annual savings of approximately one million dollars [186].

Benefits for the utility based on various interventions are broken out in Figure 2.37 and Figure 2.38.

Benefits			Transmission	Distribution							Substation		
Type	Class	Benefit	Flow Control	Wide Area Sample & Visuals	Adaptive Protection	Automated Feeder Switching	Auto Islanding / Reconnect	Automated Volt/VAR Control	Enhanced Fault Protection	Real-time Load Transfer	Diagnosis & Alarm of Equipment State	Dynamic Capability Rating	Fault Current Limiting
Economic	Improved Asset Utilization	Optimized Generator Operation											
		Deferred Generation Investments											
		Reduced Ancillary Service Cost											
	T&D Capital Savings	Reduced Congestion Cost											
		Deferred Transmission Capital											
		Deferred Distribution Capital											
	T&D Operations and Management Savings	Reduced Equipment Failures											
		Lower Distribution Maintenance Cost											
		Lower Distribution Operations Cost											
		Reduced Meter Reading Cost											
Thrift Reduction	Reduced Electricity Theft												
Energy Efficiency	Reduced Electricity Losses												
Electricity Cost Savings	Reduced Electricity Cost												
Reliability	Power Interruptions	Reduced Sustained Outages											
		Reduced Major Outages											
		Reduced Restoration Cost											
Power Quality	Reduced Momentary Outages												
	Reduced Sags and Swells												
Air	Air Emissions	Reduced CO2 Emissions											
		Reduced SOx, NOx and PM-10											
Safety	Energy Security	Reduced Oil Usage (not monetized)											
		Reduced Wide-scale Blackouts											

Figure 2.37: Table to support utility cost/benefit analysis of reliability data. Table from “Guidebook for Cost/Benefit Analysis of Smart Grid Demonstration Projects,” by the Electric Power Research Institute for the U.S. Department of Energy [49].

This table shows possible data-driven interventions for the transmission network, distribution network, and on substations. The blue columns show how each intervention benefits a utility company.

Benefits			Application	
Type	Class	Benefit	Consumption Optimization	Real-time Load Data
Economic	Improved Asset Utilization	Optimized Generator Operation		
		Deferred Generation Investments		
		Reduced Ancillary Service Cost		
		Reduced Congestion Cost		
	T&D Capital Savings	Deferred Transmission Capital		
		Deferred Distribution Capital		
		Reduced Equipment Failures		
	T&D Operations and Management Savings	Lower Distribution Maintenance Cost		
		Lower Distribution Operations Cost		
		Reduced Meter Reading Cost		
Theft Reduction	Reduced Electricity Theft			
Energy Efficiency	Reduced Electricity Losses			
Electricity Cost Savings	Reduced Electricity Cost			
Reliability	Power Interruptions	Reduced Sustained Outages		
		Reduced Major Outages		
		Reduced Restoration Cost		
	Power Quality	Reduced Momentary Outages		
Reduced Sags and Swells				
Air	Air Emissions	Reduced CO2 Emissions		
		Reduced SOx, NOx and PM-10		
Safety	Energy Security	Reduced Oil Usage (not monetized)		
		Reduced Wide-scale Blackouts		

Figure 2.38: **Table to support customer cost/benefit analysis of reliability data.** Table from “*Guidebook for Cost/Benefit Analysis of Smart Grid Demonstration Projects,*” by the Electric Power Research Institute for the U.S. Department of Energy [49].

### 2.6.2 Regulators

Regulators, who play an important role in enforcing national reliability standards, can use grid-performance measurements to hold utilities accountable for system performance [9, 187], and can use targeted, higher-frequency measurements to evaluate the impact of a policy or program (as was done with the PowerWatch data, see Section 3.1.3).

There is a positive correlation between a country having a utility regulator and a country reporting power-outage and tariff information, shown as Figure 2.39. Globally, 89 percent of economies that publish data on outages have a utility regulator [3]. Regulators play an important role in promoting accountability, and governments commonly task regulators with monitoring providers directly [13, 30].



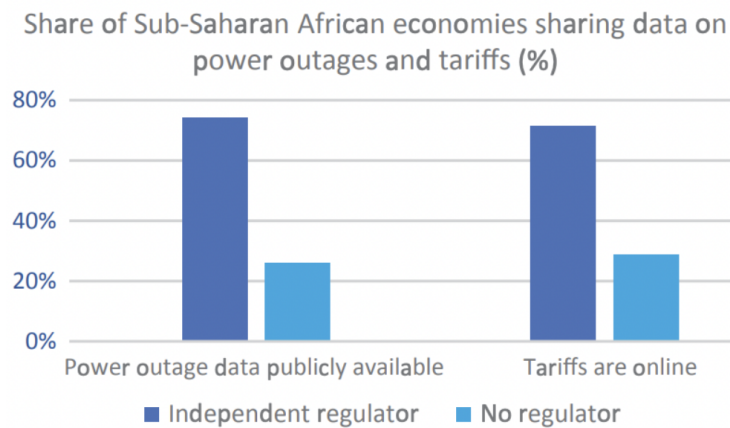

Figure 2.39: **Regulators are present in most countries reporting SAIDI and SAIFI in Sub-Saharan Africa.** *Figures remade from “Digitalization and the Use of Technology in the Electricity Sector” published by the World Bank Malaysia Hub in 2020 [3]*

All major utilities in the U.S. are required to publicly report past performance indices to independent regulators, but these reports are often highly aggregated [59]. In Britain, annual reports are made by utilities to the Office of Electricity Regulation, but these reports are also highly aggregated (i.e., 88 per 100 customers experienced an outage, 88.3% of faults were restored in three hours) [188]. Some publicly available, larger, household-level datasets do exist, typically in the thousands of households scale, but these are made available infrequently and generally cover only developed countries [189]. We were unable to find any public household-level datasets from utilities in developing countries. Based on datasets from the U.S., the authors of [190] found that a utility’s reliance on manual measurement methods under-reports reliability when compared to ground-truth data gathered from an automated outage management system. Further, the authors of [190] found that trusting only utility reliability measurements can introduce bias in measurement.

Smart-meters and other advanced metering infrastructure offer new opportunities to measure the efficacy of policies aimed at decreasing consumption (policies which, in turn, increase reliability). For example, the authors in [191] use smart-meter ground truth to show that in California, a 5% reduction in consumption is achieved with a subsidy program for energy-efficient AC units, providing evidence about where to set the socially-optimal marginal price. Many U.S. utilities gather information about reliability regardless of the presence of smart meters, although this effort is often highly aggregated [190]. Even in the presence of aggregated data or smart-meter data, there are few studies of large and representative sample sizes that can characterize patterns of usage across a region, in part because utilities rarely share data [5, 49, 189].



### **Information Changes Behavior**

Part of the role of a regulator is to share information with other stakeholders, often with the goal of adjusting behaviors [30]. In the United States, a majority of Americans surveyed said they would be willing to spend an extra \$25 per year for more renewable energy; support drops once the cost reaches \$50 per family per year [192]. However, the impact of sharing data on willingness to pay can be significant, as shown in Figure 2.40. As individuals may be most interested in individual-level data on outages (i.e. does the school have power rather than does the city have power), reliability data that reaches the LV network might be particularly valuable.

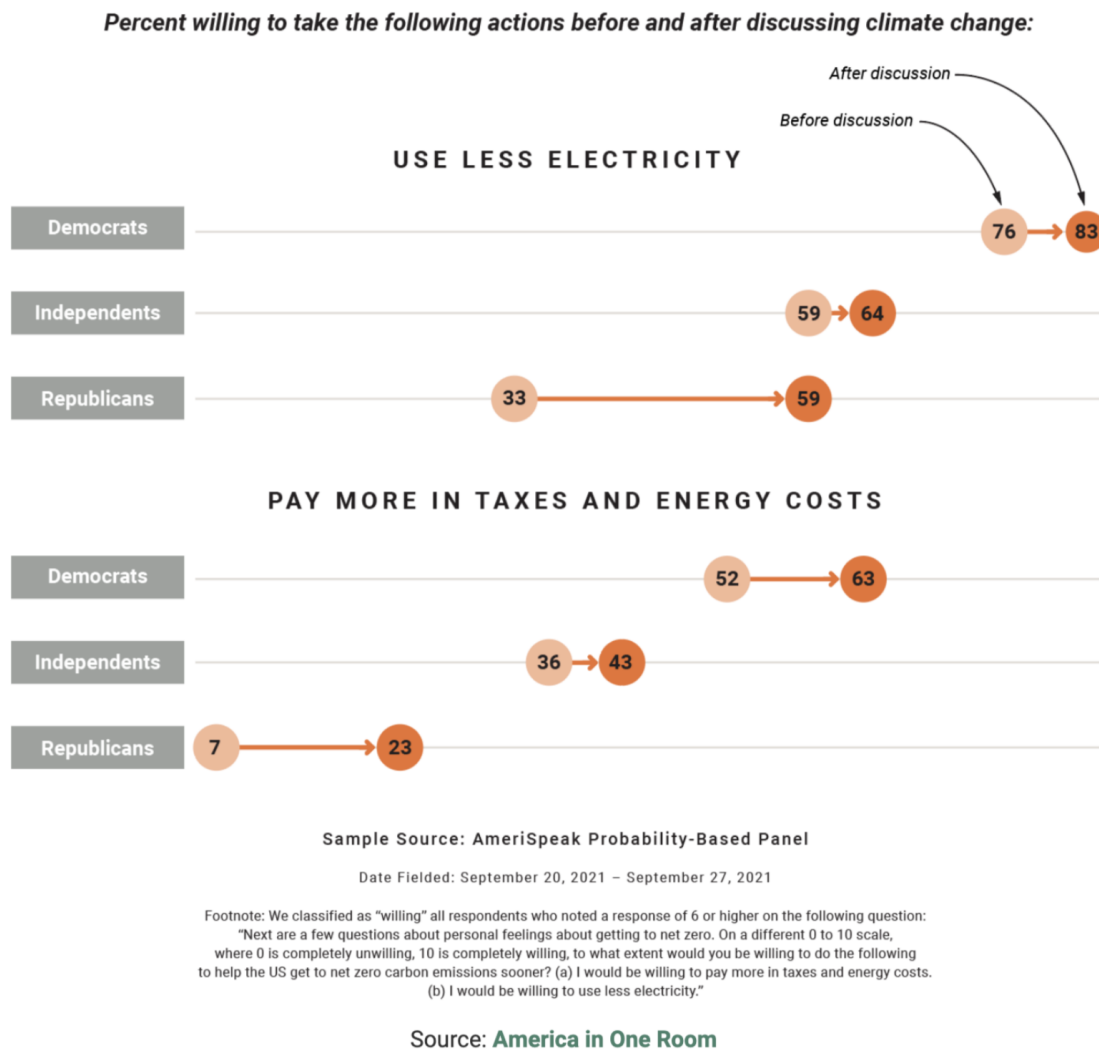

Figure 2.40: **Discussions about climate change impact willingness to pay.** *Figure captured from “Discussion Sways Participants On Climate Change,” by NORC at the University of Chicago [193].* Across all demographic groups considered, a discussion on climate change improved willingness to use less electricity and pay more in taxes and energy costs.

### Data Can Reveal Corruption

Regulators also need data to protect the public against those not acting in the public interest. Large-scale corruption may be on display in Puerto Rico where the Chief Executive of Luma, a private Canadian-American consortium tasked with improving the reliability of the grid, was just arrested due to his unwillingness to provide data to regulators [18]. Small-scale corruption is a major barrier to energy access [7, 11, 37]. In an interview published on the blog of the National Bureau of Asian Research, Dr. Charles K. Ebinger, the Director of the

Energy Security Initiative at the Brookings Institution, said:

India must also enforce regulations against energy and electricity wastage and cheating. Often it is the wealthy landlords who waste free and cheap electricity rather than the poor farmers it was intended to help. Bribes are often paid to meter-readers, and many government and military buildings and offices pay no electricity fees at all. Providing regulators with enforcement capacity would dramatically curb consumption and increase efficiency [12].

To measure the corruption like that described by Dr. Ebinger, a regulator will need data that is independently collected. For example, it is easy to imagine using PowerWatch to collect data to ensure that reliability is the same across wealthy and poor areas (we start to explore using PowerWatch for various fairness metrics in Section 5.2.3).

### Protecting Vulnerable Consumers

Giving consumers greater access to their energy data may not, however, help some of the most vulnerable consumer populations [173]. For example, an investigation of tariff rates conducted by the U.K.'s National Audit Office found that customers who had to pre-pay for their electricity due to previously unpaid bills (roughly half of whom had an annual income below £18,000) paid disproportionately more for their electricity than other customers because they did not have access to cheaper energy tariffs [194]. Further, there is a strong correlation between some dimensions of vulnerability (e.g., income, age, and physical disability) and some vulnerable consumers may not be confident using digital tools [173]. These consumers may need additional support networks to help them make use of available data [173].

### 2.6.3 Ratepayers

Individuals and businesses seek reliability measurements as a key input when deciding to enter an electricity market market [40, 195, 196], but the best publicly-available measurements of grid reliability are typically only at the country scale [197, 198]. *Barriers to Electrification for "Under Grid" Households in Rural Kenya* examines ratepayer-level grid connections in rural Kenya. The author finds a very low level of electricity adoption (5% and 22% of rural households and businesses, respectively) and identifies features of their dataset that emerge as predictors of adoption rates, including electrification rates over time, proximity to the network, and economic strength [199]. In areas with high variance in grid performance, the decision to enter the market would particularly benefit from higher-resolution data. As seen in Figure 2.41, as grid reliability decreases, so does willingness to pay to connect to the grid.

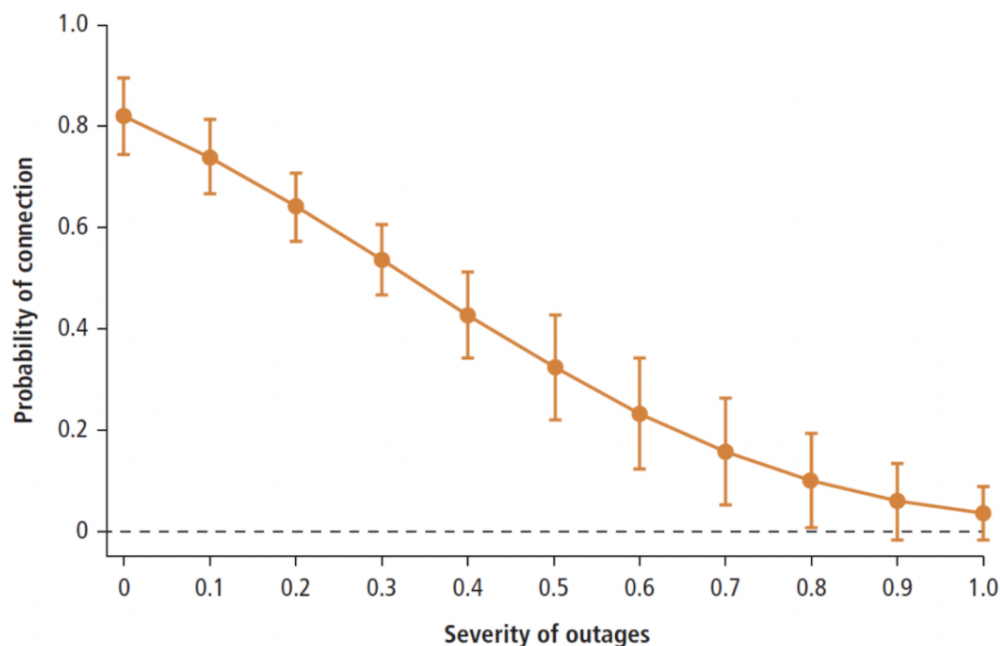

Figure 2.41: **People do not buy into a bad grid.** *Figure is screen capture from [10].*

### Commercial Ratepayers

Outage costs in the industrial and commercial sectors stem from four variables: 1) foregone profits, 2) lower productivity, 3) damage to materials, and 4) payments to labor without output. The duration and frequency of outages impacts the effect of these variables. For example, the cost of outages in the Netherlands, which occur for a household for only two hours every four years, has been estimated to be greater than \$50 million USD [200]. If the distributions of these variables is known, models can be created to help minimize costs [201]. Britain annually calculates the value of lost load, and this information is used when determining the optimal level of supply reliability and when setting prices [188].

Costs may also be different depending on industry. In “The Impact of Power Outage (Dumsor) on the Hotel Industry: Evidence from Ghana”, costs stemming from larger-than-normal outages were estimated through interviews with staff at hotels located in major cities in Ghana [202]. As shown in Figure 2.42, the impact of reliability on revenue is significant.

Additional Costs	Is there any additional cost when there is power outage?	
	Yes	
	Frequency	Percent
Cost of alternative power supply	88	27.9
Damage of plant and equipment	72	22.9
Perishability of items	68	21.6
Additional maintenance cost	87	27.6
<b>Total</b>	<b>315</b>	<b>100.0</b>

Figure 2.42: **Cost incurred by hotels due to grid outages.** *Figure is a screen capture from “The Impact of Power Outage ‘Dumsor’ on the Hotel Industry: Evidence from Ghana” [202].*

Large power consumers have enough influence to drive pro-consumer change. For example, Google just announced multiple investments in energy, including a pilot of Time-based Energy Attribute Certificates, which track how, where, and when electricity is produced to “bring transparency to granular clean electricity production data and consumer claims.” Similarly, Google gave 1,000,000 GBP to electricityMap [203] with the express purpose of “supporting efforts to expand access to electricity data globally,” and noting that by “bringing new data to the platform and making electricity data more accessible” this tool will “help policy makers, academic researchers and the private sector understand the key factors of sustainable electricity consumption, and drive demand for carbon-free solutions” [204].

### Individual Ratepayers

Individuals engage with power-outage data because power outages have a real cost. Technology like the USSD-based system deployed by Kenya Power and Light and advertised in Figure 2.43 have been quickly adopted. Similarly, people regularly turn to the internet and social media to learn about power outages Figure 2.44, and most utilities with the capacity host live outages maps [72]. It is not unreasonable to believe that a high-resolution outage map would be a popular service around the world for mitigating some of the individual costs associated with poor reliability.



Figure 2.43: **Two-way mobile communication offered by Kenya Power and Light Company (KPLC) [205].** I took this picture in Kenya in 2016. Based on conversations with KPLC, this service was provided based on demand. It also allowed KPLC to collect data from their participants.

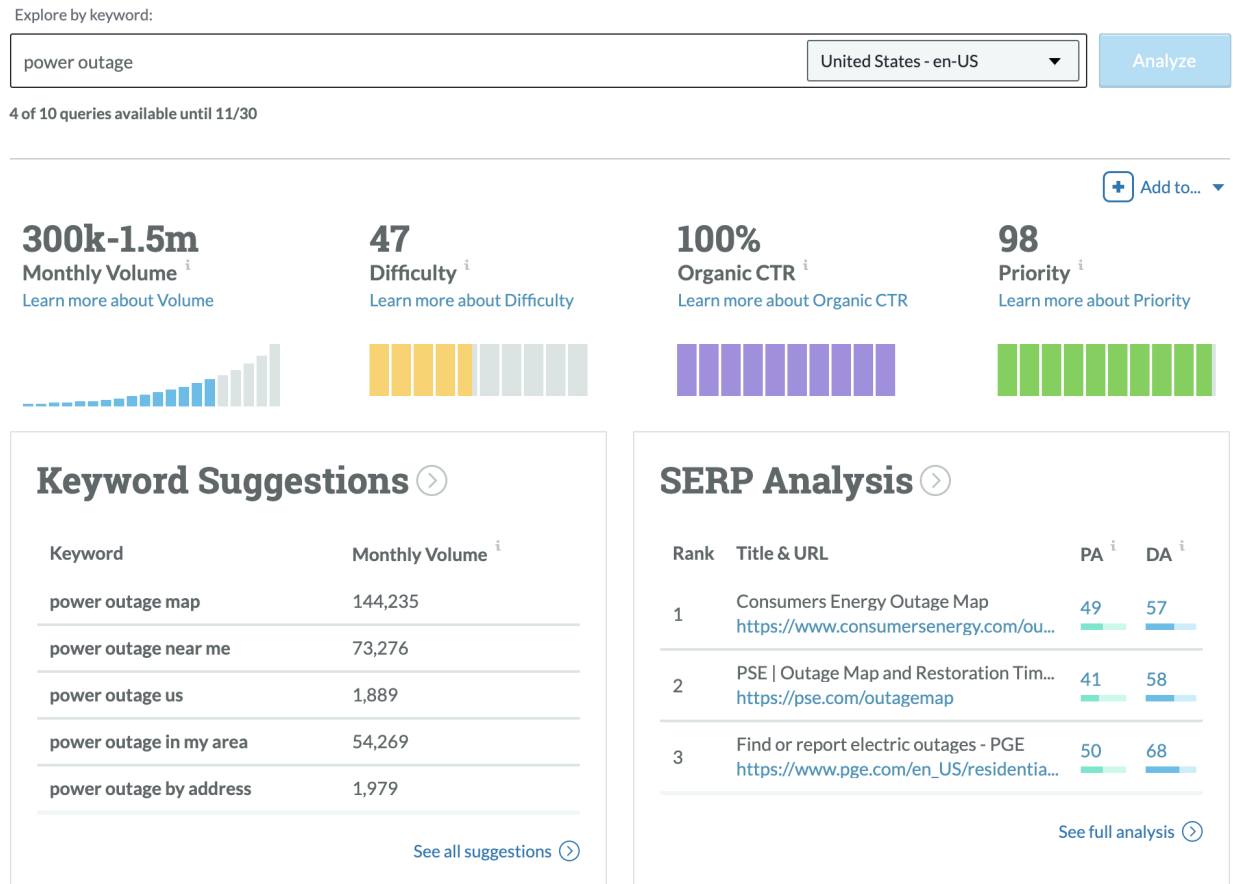

Figure 2.44: An estimated 300K to 1.5M people search “power outage” each month in the United States. Figure is a screen capture from the Moz Keyword Explorer [206]. We see a large monthly volume for the search term “power outage” and that this volume is driven by traffic to outage maps at large utilities [206].

## Unequal Costs

More disaggregated reliability data, matched with socioeconomic data, allows for a more nuanced exploration into costs incurred by specific groups of individuals due to poor grid reliability. Further, viewing the relative reliability experienced by one group against another could help quantify where one group is being treated unfairly [207].

For some populations, power outages are more costly due to environmental factors. For example, after Hurricane Ida knocked out power in Norco, Louisiana, experts pointed to a dangerous combination of widespread power outages and chemical leaks across 138 impacted industrial sites. The presence of these industrial sites makes the outage more costly for nearby residents both in the short term with risk of catastrophic failures at the sites and in the long term with the risk of chemical runoff [208].

In countries where the grid is systemically unreliable, costs may also include the need

for extra purchases like fridge guards, devices that protect large appliances from voltage instability. Typical fridge guards are shown Figure 2.45. For less-wealthy consumers, these purchases represent a greater burden [10]. Reliability data might help minimize this burden by helping an individual decide whether to make these purchases.



Figure 2.45: **Voltage problems change purchasing patterns.** Figure is a screen capture from Jumia, a popular online retailer in Kenya, after a keyword search for “fridge guard” [209]. These devices provide stability for important appliances and are often necessary purchases. On December 17, 2021, the day this Figure was captured, 1 USD was 113 KSh [210].

In the U.S., compared to Caucasian and Asian households, Black households spend the most on energy and, along with Latinx households, suffer from higher energy insecurity and energy poverty [211]. Black and Latinx households in the U.S. are therefore the most likely to have to make choices between electricity or other essential expenses [207]. Policies attempting to remedy this inequality could benefit from a method to ensure that the level of service to households is maintained after program implementation [211].

## 2.6.4 Investors

A lack of reliability data makes it difficult for investors to track outcomes of investments aimed at improving reliability [30, 66, 202, 212, 213]. This can be significant disincentive to invest [30, 181, 214].

For many years, a large amount of international aid was focused on increasing *access* to electricity by expanding the reach of the grid. Improvements in electricity reliability can be harder to achieve than improvements in access. However, in practice, poor reliability was found to reduce demand, utilization, and social benefit of electricity to the point where the power lines being run had little value [10, 75, 211]. Reassuringly, the importance of grid reliability is increasingly being recognized: the UN Sustainable Goals now specify that



access to electricity must also be reliable [39]. However, there is still no good guide for how grid-reliability outcomes should be measured before, during, and after intervention.

### 2.6.5 Researchers

Figure 2.46 shows a research taxonomy built from a review of 503 recent academic works relating to electricity reliability. The authors identify 4 common research questions:

- How does one assess or evaluate reliability of the power grid?
- How does one improve or enhance the reliability of the electric-power system?
- How should one plan reliability of the smart grid?
- What are the impacts of changes, including adding distributed-energy resources, new regulations, and investment projects, on the reliability of the electric-power system? [215]

Similarly, the U.S. Department of Energy compiled their views on the research and development needs for modernizing the grid in a 2015 Report to Congress (shown in Figure 2.47) [216].

Some research has investigated the major costs that businesses and households incur due to unreliable power. This research has found broadly that households experience a range of costs due to unreliable power, and that the exact cost a specific type of household might incur is hard to predict [64, 66, 217, 218]. Some types of firms incur higher costs from unreliable power than others, and the magnitude this cost can be predicted [59, 164, 219, 220]. Firms use a variety of techniques to mitigate costs due to grid failures, making it difficult to anticipate mitigation cost per firm [164, 220, 221]. Firms that provide their own generators are able to free themselves from many of the costs of unreliable power, in some cases reducing costs to a sub-percentage of revenue [220].

Reliability data traditionally has been difficult for researchers to access [5, 30]. Perhaps as a consequence, there is a relatively small amount of academic work specific to modeling energy adoption as it relates to reliability. This is surprising when compared to the large corpus of work related to the social and economic benefits of access to electricity [66, 222–226], energy markets in general [227–229], customer willingness-to-pay [230–233], and demand estimation [234, 235].

Energy data is becoming more available to researchers, in part due to new online tools. The World Bank provides a popular series of dashboards to allow for analysis across multiple indicators [236]. MCC is one of many U.S. federal agencies promoting open data [237]. Large data releases have been organized by the academy [238]. Smaller groups such as PRAYAS [140], Powermap.us citepowermap-us, the DumsorReport [118], electricityMap.org [203], Afrobarometer [115], Our World In Data [239], and the Catalyst Cooperative [240] have all released novel and influential data on grid reliability. Se4All has been pushing this

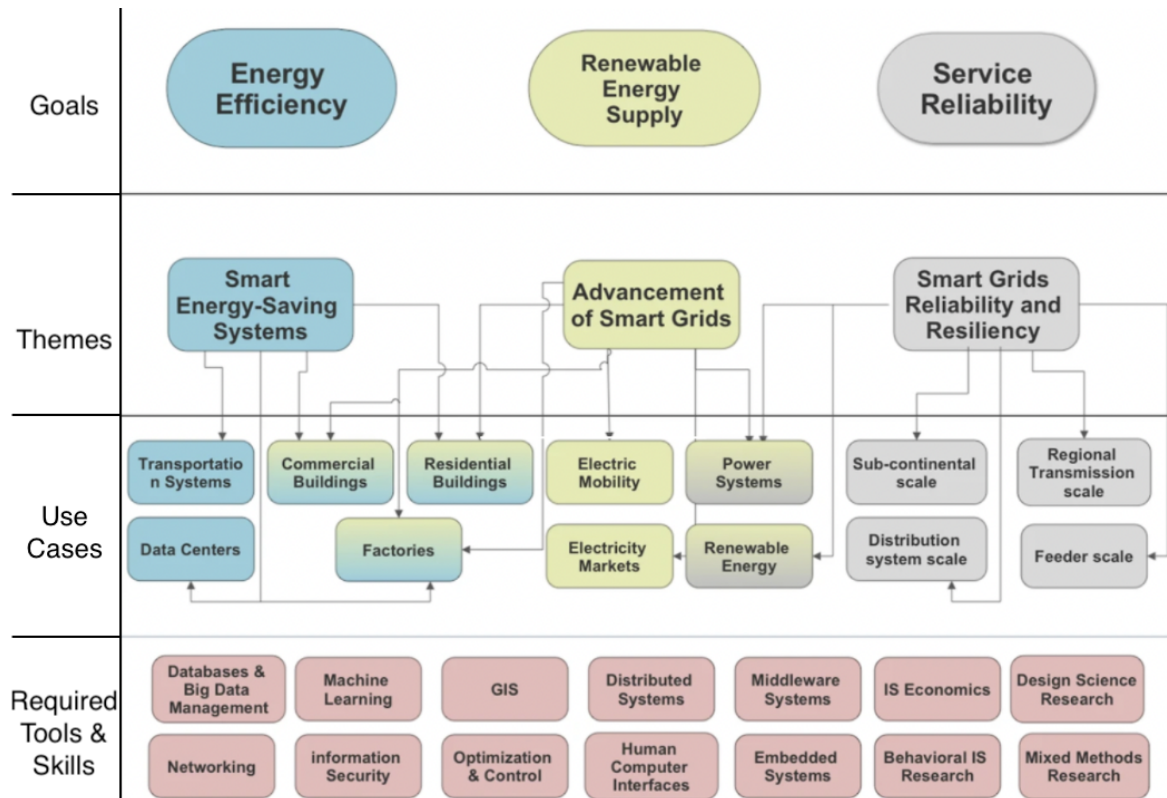

Figure 2.46: **Research framework compiled from survey of recent academic publications.** From “Electric grid reliability research” in *Energy Informatics* [215]. This framework was built from a review of 503 recent papers on electricity reliability. The authors explain: “The first theme, energy efficiency, drives the evolution of smart energy-saving systems. The second theme, renewable-energy supply, drives the advancement of smart grids. Finally, the third additional theme, service reliability, drives smart-grid reliability and resiliency” [215].

further, leading discussions across multiple stakeholders and countries about best practices in data governance as more data sources emerge [30].

## 2.7 The Grid and Climate Change

While current suffering due to unreliable grids is more than sufficient motivation to address the problem, a changing climate adds urgency to the pursuit of grid reliability. Grid reliability data will play a critical role in both reducing the rate of climate change and ensuring that, as the climate warms, grids continue to operate as expected.

When the UN Secretary-General Ban Ki-Moon announced the Sustainable Energy for All initiative in 2012, he explained his belief that energy will be central for both helping to end poverty and addressing climate change [28]. The World Resources Institute reports that energy consumption (including generation) accounts for 76% of greenhouse gases worldwide

Electric Systems	Characteristics		RD&D Needs
	Traditional	Modern	
<b>Generation</b>	<ul style="list-style-type: none"> <li>• Centralized</li> <li>• Dispatchable</li> <li>• Large thermal plants</li> <li>• Mechanically coupled</li> </ul>	<ul style="list-style-type: none"> <li>• Centralized and distributed</li> <li>• More Stochastic</li> <li>• Efficient and flexible units</li> <li>• Electronically coupled</li> </ul>	<ul style="list-style-type: none"> <li>• Planning tools</li> <li>• Energy storage</li> <li>• Control coordination</li> <li>• Flexible thermal generators</li> </ul>
<b>Transmission</b>	<ul style="list-style-type: none"> <li>• SCADA for status visibility (sampling, not high definition)</li> <li>• Operator-based controls (primarily load following and balancing)</li> <li>• Destabilizing effects</li> <li>• Congestion, despite underutilized capacity (limited flow control)</li> <li>• Threats/vulnerabilities not well defined</li> </ul>	<ul style="list-style-type: none"> <li>• High fidelity, time-synchronized measurements</li> <li>• Breadth &amp; depth in visibility</li> <li>• Automatic control</li> <li>• Switchable network relieves capacity constraints</li> <li>• Threats are considered and risks are appropriately managed</li> </ul>	<ul style="list-style-type: none"> <li>• Multi-terminal high-voltage direct current (HVDC)</li> <li>• Low-cost power flow controller technologies</li> <li>• Next-generation energy management systems (EMS)</li> <li>• Integrated planning tools</li> <li>• Security</li> <li>• Low-cost bulk storage</li> </ul>
<b>Distribution</b>	<ul style="list-style-type: none"> <li>• Limited visibility</li> <li>• Limited controllability</li> <li>• Radial design (one-way flow)</li> <li>• Floating on transmission</li> <li>• Increasing fault currents and voltage issues stressing system</li> <li>• Aging assets (unknown effects)</li> </ul>	<ul style="list-style-type: none"> <li>• Enhanced observability</li> <li>• Local, autonomous coordination</li> <li>• Network design and two-way flow</li> <li>• Backbone of delivery system</li> <li>• Self-healing</li> <li>• Active monitoring of asset conditions</li> </ul>	<ul style="list-style-type: none"> <li>• Security</li> <li>• Microgrids</li> <li>• Advanced distribution management systems (DMS)</li> <li>• Distribution and asset sensors</li> <li>• Solid-state transformer</li> <li>• Smart voltage regulation equipment</li> <li>• Community storage</li> </ul>
<b>Customers</b>	<ul style="list-style-type: none"> <li>• Uniformly high reliability, but insensitive to upstream issues</li> <li>• Energy consumers (kWh)</li> <li>• Predictable behavior based on historical needs and weather</li> <li>• Interconnection without integration</li> <li>• Growing intolerance to sustained outages</li> </ul>	<ul style="list-style-type: none"> <li>• Customer-determined reliability/PQ</li> <li>• Prosumers (integrated)</li> <li>• Variable behavior and technology adoption patterns</li> <li>• Plug/play functionality</li> <li>• Kept informed during outages (and before)</li> <li>• Hybrid AC/DC distribution</li> <li>• Data access (outage/usage)</li> </ul>	<ul style="list-style-type: none"> <li>• Single-customer microgrids</li> <li>• Building EMS</li> <li>• DER integration</li> <li>• Security</li> <li>• Transactive controls</li> <li>• Behind-the-meter storage</li> <li>• Low-cost sensors</li> </ul>

Figure 2.47: Upcoming research and development needs to modernize the grid. Figure is a screen capture from the U.S. Department of Energy “Quadrennial Technology Review 2015” [216]. This table contains the steps needed to transition to a modern grid in the US as well as and the research directions required to take these steps [216].

[241]. In the United States, electricity generation represents 25% of the overall sources of greenhouse gasses [242]. Globally that number rises to 31.9% [241]. By increasing reliability, utilities can increase energy efficiency, leading to fewer harmful emissions, and can better prepare the grid for integrations with new green energy sources.

### 2.7.1 Slowing Climate Change by Increasing Grid Efficiency

In the United States, roughly 40% of all the energy consumed is used to generate and distribute electricity [243]. Thus, there are large potential emissions savings from increases in efficiency in grid management [243]. In fact, the smart grid market is now considered to be driven by regulatory pressure to reduce carbon emission, a change from the more traditional application of reducing operational cost [41].

Benefits			Application		
Type	Class	Benefit	Distributed Generation	Electricity Storage	Plug-in Electric Vehicles
Economic	Improved Asset Utilization	Optimized Generator Operation			
		Deferred Generation Investments			
		Reduced Ancillary Service Cost			
		Reduced Congestion Cost			
	T&D Capital Savings	Deferred Transmission Capital			
		Deferred Distribution Capital			
		Reduced Equipment Failures			
	T&D Operations and Management Savings	Lower Distribution Maintenance Cost			
		Lower Distribution Operations Cost			
		Reduced Meter Reading Cost			
Theft Reduction	Reduced Electricity Theft				
Energy Efficiency	Reduced Electricity Losses				
Electricity Cost Savings	Reduced Electricity Cost				
Reliability	Power Interruptions	Reduced Sustained Outages			
		Reduced Major Outages			
		Reduced Restoration Cost			
	Power Quality	Reduced Momentary Outages			
Reduced Sags and Swells					
Air	Air Emissions	Reduced CO2 Emissions			
		Reduced SOx, NOx and PM-10			
Safety	Energy Security	Reduced Oil Usage (not monetized)			
		Reduced Wide-scale Blackouts			

Figure 2.48: Table to support cost/benefit analysis of applications often considered beneficial for addressing climate change. Table from “Guidebook for Cost/Benefit Analysis of Smart Grid Demonstration Projects,” by the Electric Power Research Institute for the U.S. Department of Energy [49]. The blue “Benefits” columns describes, from the utility perspective, economic, reliability, environmental, and safety benefits available. The purple “Application” categories describe different applications often proposed as part of a climate change solution [244]. Of the three applications, Electricity Storage has the most indicated benefit to reliability.

**Better Models of System and Load**

Specifically, two of the best tools for helping to reduce line loss include system models and load flow analysis, both of which require relatively high-frequency reliability data [49]. With better system models, decisions can be based on real-time and longitudinal information, and the impact of these decisions can be simulated [5, 245]. With better load flow analysis, operators can detect what infrastructure is causing network congestion, allowing for better decisions about maintenance and replacement timelines, as well as long-term network topologies [246]. In 2006 the President and CEO of Duke Energy, James E. Rodgers, described the importance of better data for increasing efficiency [247]:



“Going digital will allow us to monitor a lot of points in the system from a central point, which you can’t today. It’s kind of like fine-tuning or focusing in on a spot or a target. That’s better than how the grid operates today. And we lose somewhere between 8 and 9 percent of the electricity we produce on the grid. That’s called line loss. As we develop our capability to operate the grid, it will be a step in the direction of allowing us to try to reduce the amount of line loss. That’s a lot of energy.”

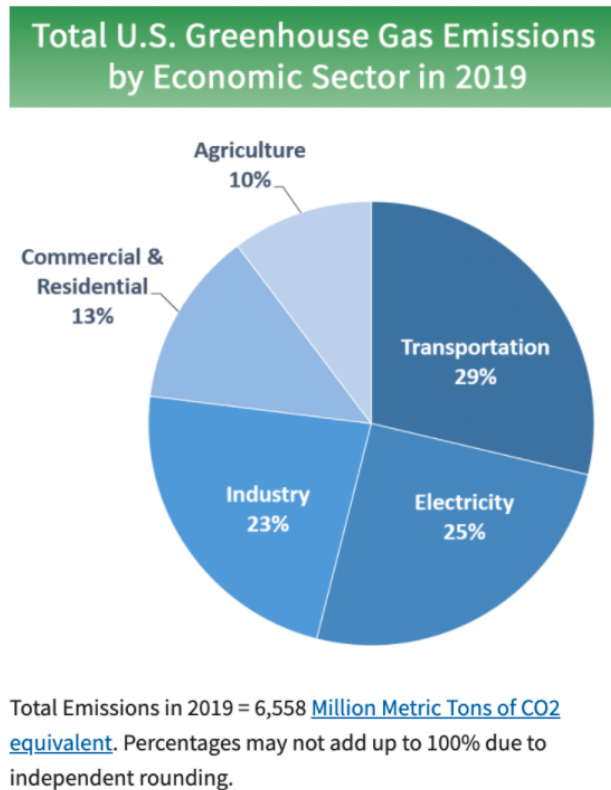

Figure 2.49: **Electricity plays a significant role in emissions.** *Figure from the U.S. Environmental Protection Agency [242].* Better efficiency will reduce energy that is generated only to be lost on the network, potentially helping to reduce this share over time.

The lowest-income countries experience the highest percentage of transmission and distribution losses on their networks. These transmission and distribution losses could likely be addressed, at least to some degree, using techniques well-established in wealthier countries. Reclaiming electricity lost in the transmission and distribution networks may reduce the amount of generation required to serve demand, decreasing generation emissions overall [13, 29, 32, 248]. Further, better-managed distribution systems would allow this loss to be converted into profit, so targeted interventions could increase the likelihood of affordable and reliable electricity while simultaneously reducing waste [249].

For countries with a relatively low total emissions, such as those in the developing world (shown in Figure 2.50, reducing emissions from a climate perspective may reasonably be less

persuasive [244].

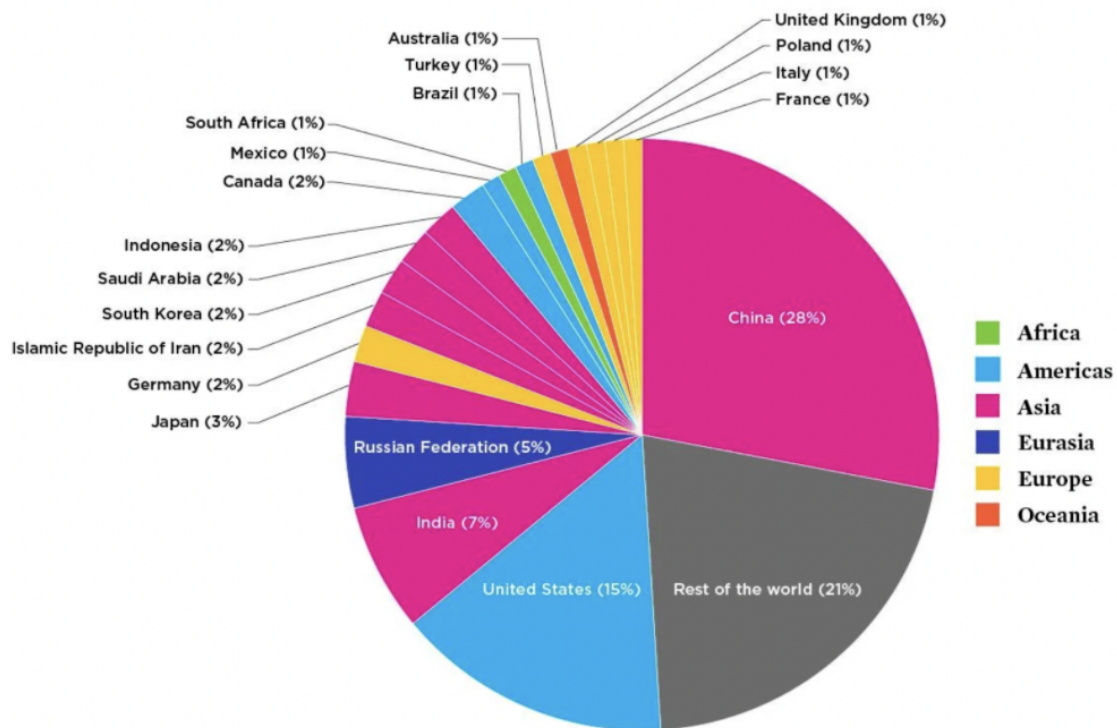

Figure 2.50: **Africa contributes around 3% of global CO<sub>2</sub> emissions.** *Figures from “Each Country’s Share of CO<sub>2</sub> Emissions” published by the Union of Concerned Scientists [250]. Emissions causing climate change largely stem from outside of Africa and South America.*

## Demand Response

Another large potential efficiency saving is through the implementation of pricing and behavior modification policies that involve customer decision making. Perhaps the policy with the most promise is demand response (DR) [13]. This is because “almost everywhere, marginal reductions in energy result in marginal reductions in coal and gas consumption” [49]. I discuss the specific interests of demand response for ratepayers in Section 2.6.3.

Demand response has long been a popular academic idea and is now being implemented successfully in pilot programs in a number of countries [251]. Its popularity is well-founded, as many estimates place potential energy savings in the double digit percentages of system-wide savings [71, 242, 251–253]. Further, these estimates are likely low, as in many parts of the world estimating demand is its own relatively-unsolved problem [2, 254, 255].

Demand response, like the data-driven techniques that best reduce line loss, requires fairly sophisticated technology, including high-resolution measurements of individual consumption, a real challenge for networks without smart meter deployments [256]. This complexity, along



with the additional complexity of educating customers, has led to slow scale adoption by even utilities familiar with cutting edge techniques [5].

## 2.7.2 Slowing Climate Change by Enabling Clean Generation

“Clean energy” technologies for generating electricity will be essential for slowing climate change. These include wind, solar, nuclear, biogas, and hydroelectric power. Renewable generation has been expensive to implement: the U.S. alone is forecast to spend \$370 billion on renewable generation in 2021, a massive 70% of the country’s total spending on generation capacity [257]. While some parts of the world have made large investments in these technologies, globally they remain largely out of reach [2]. Consequently, “clean” technologies account for only about 11% of global energy generation [258]. The spread of these technologies, and the markets they have not yet reached, is striking when visualized in Figure 2.51. Clearly, adoption has a long way to go, especially in Africa.

### Per capita energy consumption from renewables, 2019

Renewables is the sum of energy from hydropower, wind, solar, geothermal, wave and tidal, and bioenergy. Traditional biofuels are not included.

Our World  
in Data

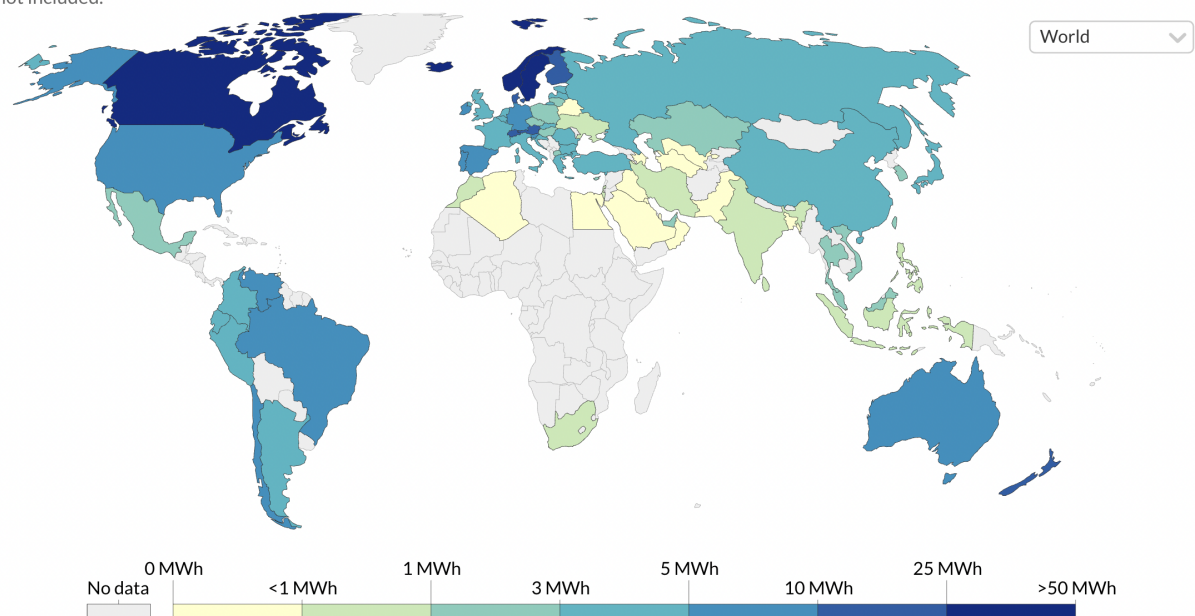

Source: Our World in Data based on BP Statistical Review of World Energy & UN Population Division

Note: 'Primary energy' refers to energy in its raw form, before conversion into electricity, heat or transport fuels. It is here measured in terms of 'input equivalents' via the substitution method: the amount of primary energy that would be required from fossil fuels to generate the same amount of electricity from renewables.

OurWorldInData.org/energy • CC BY

**Figure 2.51: A striking number of countries in Africa do not report per capita energy consumption from renewable generation.** *Figure from Our World In Data [258].* Data on renewable usage is critical for ensuring long-term sustainability and can not be another generation of technology away if aggressive climate and social justice goals are to be met (many of which are targeting countries in Africa specifically) [4, 5, 184].

“Clean” generation introduces operational complexities by changing the traditional structure of the grid from single, large sources of generation to multiple, small, and periodically-available sources [5, 13]. (For a simple model of the grid, which may help with clarity, see Figure 2.1). Wind and solar especially have challenged the traditional model of a grid, as both provide bursty power into distribution networks, making grids more difficult to balance [259]. For example, if wind picks up during a period of peak demand, a naive distribution network may start to provide more power than it is able to support, overloading and damaging equipment and leading to unplanned outages [112].

However, because “clean” generation is needed to slow climate change, the risk to reliability introduced by new sources of generation is necessary and, if acknowledged and anticipated, can likely be mitigated [5]. It will, therefore, be important that anywhere planning to incorporate “clean” generation also has the capacity to measure the impact this has on reliability [5]. It will also be important that the right data exists to inform new operational and long-term planning complexities [5]. Collecting reliability data will likely be a barrier to entry for large-scale integration of particular renewable generation models, an unfortunate fact for already-financially-burdened countries that do not currently collect reliability data due to cost [5, 32, 260].

### 2.7.3 Operational Challenges Caused by Climate Change

As the threat of climate change becomes more present, there has been increased global focus on ensuring our current grids will remain reliable in new and more dynamic environments. Already we see grids failing more often, and the call is getting louder and more urgent for new techniques to mitigate climate impact on grid reliability [5, 13, 23, 42, 261]. However, addressing the upcoming climate-related risk to grid reliability involves many of the same data-driven activities that are already employed to improve efficiency and better balance the transmission and distribution networks [13, 112, 168]. This overlap can be seen in Figures 2.37, 2.48, and 2.38. There is a clear and rare opportunity for significant investments in improving reliability to simultaneously improve the grid today while shoring against an increasingly-present but still hard-to-quantify risk caused by coming changes to the climate [13, 30].

Over the past few years, real impacts of climate change—which have included “storm surges that can knock out substations,” “heat waves that can cause power plants to falter,” and even rises in animal-related outages as habitats merge [168, 174, 262]—have made the threat hard to ignore. Investments in grid reliability are likely not coming fast enough to prevent further large-scale outages [13, 23, 168, 248]. On-the-record responses after recent storms took down the grid in Texas indicate an industry unprepared to deal with climate change. For example, one energy consultant stated frankly: “It’s fair to say there was this widespread assumption that the impacts of climate change and extreme weather would unfold more gradually, and there would be more time to prepare, but in the past few years, the entire industry has really been smacked upside the head” [248].

Oklahoma provides another example of the potential unpreparedness of the energy industry: In Oklahoma, a large U.S. energy producer and the 3rd most disaster-prone state, the State Energy Office is entirely federally funded and has only a single employee charged with constructing the state’s plan for energy emergencies [167].

In 2018, the United States designated climate change a national security threat in an amendment to the National Defence Authorization Act, largely due to threats to grid reliability [167]. In a report commissioned by Sandia National Laboratory titled “Improving Electric Utility and Community Grid Resilience Planning,” consultants from Synapse Energy described a mitigation technique where a stakeholder prioritizes resilience actions by considering three different, and potentially mutually-exclusive, optimizations:

1. avoiding or reducing consequences to key electric infrastructure;
2. avoiding or reducing consequences to priority customers; and
3. avoiding or reducing consequences in key geographic areas.

They point out that ensuring performance in one circumstance over the other can have “economic, social, and/or national security consequences” [168].

## 2.8 Summary

This chapter has provided some background information on the structure of grid itself, on SAIDI and SAIFI—two metrics of grid reliability—and on the previously-existing sources for reliability data. It outlined the varied interests of stakeholders in reliability data and concluded by describing the importance of this data in the face of climate change. In the next two chapters, I present PowerWatch, the sensor I developed to gather utility-independent, agile, high-resolution, and low-cost reliability data. Chapter 3 describes the context in which PowerWatch was designed and deployed and the methodology for deploying PowerWatch. Chapter 4 then presents the architecture underlying the PowerWatch system and an evaluation of the sensor’s performance in the lab and in the field.

## Chapter 3

# The Deployment

In this chapter, I introduce PowerWatch. PowerWatch is a system that combines plug-in sensors and an outage-detection algorithm to provide high-resolution, utility-independent measurement of distribution grids. These measurements are supporting the monitoring and evaluation of a \$498 million USD investment by the Millennium Challenge Corporation (MCC), a U.S. Government organization chartered to invest in infrastructure to reduce poverty and encourage economic growth. In 2014, MCC and the Government of Ghana signed the Ghana Power Compact, a \$498 million investment designed to improve the grid generation, transmission, and distribution systems in Ghana, to be implemented by the newly created Millennium Development Authority (MiDA) [263].

As independent evaluators of the Ghana Power Compact, we worked with MiDA and MCC while designing PowerWatch to distil the requirements of the sample. With them we scoped the sample to measuring power outage frequency and duration, voltage fluctuations, and frequency instabilities at the low-voltage level of the distribution grid in Accra, Ghana. Our interdisciplinary team included economists evaluating the socioeconomic impacts of these investments and engineers building the PowerWatch system to provide the data requirements of that evaluation.

This chapter also describes the local context in Ghana surrounding our design and deployment of PowerWatch. In particular, our methodology was impacted by Ghana's history of poor electricity reliability and lack of ground-truth data on reliability. I then present the goals of the PowerWatch deployment that informed our design and deployment methodology, specifically the goals of improving the accuracy of reliability metrics while maintaining independence from the utility and using our data to explore the socioeconomic impacts of reliability. Then I describe our deployment methodology, including how we selected the homes and businesses where PowerWatch sensors would be deployed and the team of local staff who conducted the deployment.

## 3.1 Ghana Context

Ghana is a West African country with a population of 30.8 million and a per-capita GDP of US\$2,266 in 2020 [264]. The grid has roughly 4,740,000 connections and experiences a peak load of 2,881 MW, a supply capacity of 4,695 MW, and an estimated 24.7% distribution loss rate as of 2019 [48]. The Electricity Company of Ghana (ECG) is the distribution utility in Ghana's capital city of Accra [265]. It is important to consider both the electrical and social constraints in Accra to contextualize the PowerWatch system design.

### 3.1.1 History of Poor Electricity Reliability

Electricity has the potential to provide substantial social and economic benefits [39, 266, 267]. In Ghana, however, the grid at times falls short of providing these promised benefits, resulting in customer frustrations that have culminated in civil unrest [8, 268]. From 2013 until 2015, the country experienced drastic electricity shortages, resulting in outages of six to 24 hours during 159 days of 2015. This period is known as “Dumsor,” a Twi word meaning “off-on.”

In April 2017, Ghanaian President Nana Addo discussed Dumsor at a National Policy Summit, stating, “A significant number of small, medium and large scale operators were all brought to their knees as a result of four years of dumsor induced by the mismanagement of the energy sector” [269]. He cited figures from Ghana's Institute of Statistical, Social and Economic Research showing that the country lost about GHc618 million in economic activity, or 2% of its GDP, in 2014 alone, with a cumulative loss of more than \$3 billion in economic activity over four years [269]. President Addo stated that, due to Dumsor, “the industrial sector has suffered one of the most significant setbacks in our history over the past few years” and “thousands of Ghanaians lost their jobs” [269].

While Dumsor has been largely mitigated with the introduction of new generation capacity [270], Ghana still reports longer and more frequent outages than countries with similar GDPs [271].

Partially in response to the Dumsor crisis, the country recently embarked on significant reforms to the entire electric grid, including adding new generation capacity, expanding the transmission network, and re-configuring the distribution network. These efforts have multiple goals, including cutting operational costs, reducing transmission and distribution losses, increasing affordable access to grid connections, and improving reliability. The country's current work to improve grid reliability motivated our selection of Ghana as the deployment venue for PowerWatch [40].



Figure 3.1: **An ad for the Ghana Power Compact.** This ad, funded by the Ghana Power Compact, was one of many placed around Accra to raise awareness and support for the work underway [272].

### 3.1.2 Ground Truth Not Available

To improve reliability, it is important to measure it [60, 196]. To understand how well infrastructure investments improve reliability, it is important to have baseline measurements [40]. In Accra, however, high-resolution measurements are limited. The highest spatial- and temporal-resolution measurements come from the ECG SCADA system. This system covers only high-voltage transmission lines and some portion of the medium-voltage distribution network [273].

Measurements of low-voltage outages come primarily from customer calls, a sparse and noisy data source for the reasons described in Section 2.4.2. To improve monitoring, ECG has recently started to deploy smart meters, but economic and social challenges create barriers to achieving broad smart-meter coverage in the short term [274–276]. ECG recently completed a much larger effort to install pre-paid meters, but these meters do not collect or communicate power quality measurements [94, 277].



### 3.1.3 Evaluation Goals

In this subsection I provide a brief introduction to the two evaluations that will use our data. It is outside the scope of this document to present these evaluations in detail; instead, please refer to the Evaluation Design Reports by University of California Berkeley [213] and Mathematica Policy Research [212] and to MCC directly [278]. The format of this subsection and some of the text is borrowed from the Updated GridWatch Inception Report produced for partners in Ghana by *nLine* (Section 7.1) and UC Berkeley [279].

#### Mathematica Policy Research

Borrowing heavily from their Evaluation Design Report, we see how Mathematica Policy Research plans to use the data collected by PowerWatch.

*The evaluation of the Ghana Power Compact will provide evidence on a range of interventions intended to improve utility functioning and financial health, electricity policy and regulation, electricity quality, access to legal electricity connections, and electricity demand profile. The evaluation will provide much-needed evidence on the effectiveness of a private concession in improving the performance of a struggling utility, in a context in which electricity quality and pricing is a highly charged political issue. The evaluation will also answer important implementation and performance questions about tariff setting, the enabling environment for private investment, and the utilities' financial position. Finally, the evaluation may be able to estimate impacts of an energy efficiency intervention on energy use in large government buildings in Ghana [212].*

To achieve these goals they will:

*use mixed-methods approaches to assess the program logic for the compact overall and for each of the component projects, and to address the research questions related to program implementation and the contribution of compact activities to key outcomes. We will also develop lessons learned for future investments in power sector reform programs and evaluate the sustainability of the projects over time [212].*

It is outside the scope of this document to enumerate the methods that Mathematica proposes to meet these goals. Instead, I focus on how Mathematica will consume the data generated by PowerWatch.

*The performance evaluations will make use of two types of data: longitudinal quantitative data and qualitative data. The longitudinal data will cover numerous key outcomes coming from administrative sources (financial and grid-based), electricity quality and reliability (that is, outage and voltage fluctuations) data from GridWatch, and a household and enterprise survey.*



*Using administrative and GridWatch data, including PowerWatch, we may be able to update the level and pace of outage reductions assumed in the model to match realized reductions across Greater Accra. In addition, we plan to use the GridWatch results to update the estimated impacts of outages on economic outcomes by business type (self-sufficient, vulnerable, and non-users of electricity).*

*We will use our household and enterprise survey and our proposed IV results to adjust the GridWatch impact estimates so that they can be used to estimate impacts for Greater Accra and for the different types of investments being made. . . . This adjustment will be done by using the GridWatch impact results by subgroup (for example by enterprise size) and multiplying those by the subgroup percentages found in our survey data for Greater Accra, and by doing something similar based on our IV results [212].*

### **UC Berkeley Economics**

The UC Berkeley-led impact evaluation includes faculty at the the University of Pennsylvania Wharton School, the Department of Economics at Texas A and M University, the Department of Agricultural and Resource Economics at UC Berkeley, and the Haas School of Business and Energy Institute at UC Berkeley.

At the highest level, in their evaluation this team aims to measure primary Compact outcomes, including the frequency (SAIFI) and duration (SAIDI) of outages, and voltage level irregularities, and then evaluate the socioeconomic impacts of improvements in those outcomes due to the Compact. Their study will first establish that there is variation in reliability across geographic areas—either between priority and non-priority feeder areas, or between areas served by new transformers injected as part of the LV-bifurcation work and areas without new transformers. The more treatment sites (i.e. newly injected transformers or areas with known priority feeders), the more confidence there is that differences measured are attributable to differences in reliability of the underlying infrastructure as opposed to inherent differences between the geographic areas. These sites are shown in Figure 3.2. This fine-grained analysis would not be possible with current utility-class data-collection methods in Accra.

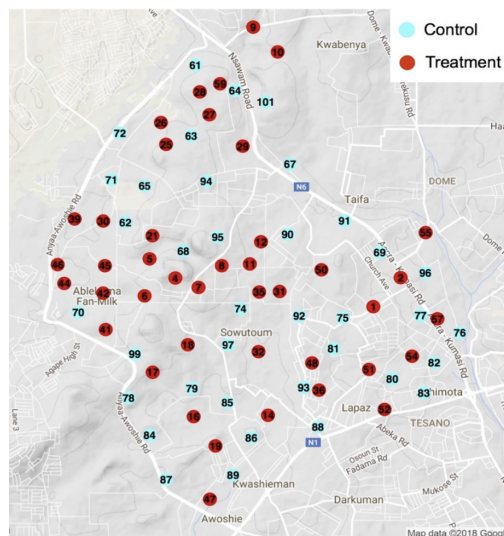

Figure 3.2: **Treatment and Control Sites** Distribution of treatment and control sites across Achimota district. Locations were chosen in part based on information about where SMEC will be injecting new transformers during their low-voltage line bifurcation project.

## 3.2 PowerWatch Goals

The high-level goals for the PowerWatch deployment were (1) to improve the accuracy of key performance metrics being tracked as part of the Ghana Power Compact (S-SAIDI and S-SAIFI as defined in Section 3.2.1), (2) while maintaining independence from the utility, and (3) to use this data which is less aggregated than other sources to more deeply explore the socioeconomic impacts of reliability. These closely map to the Evaluation goals presented in Section 3.1.3.

### 3.2.1 Improving Energy-Reliability Data Quality

The two common metrics of energy reliability described in Section 2.2—System Average Interruption Duration Index (SAIDI) and the System Average Interruption Frequency Index (SAIFI)—are also key performance indicators for the Ghana Power Compact.

Accurately calculating SAIDI and SAIFI requires information about the grid’s performance (the numerator) and underlying electrical configuration and customer make-up (the denominator). PowerWatch improves the estimate of the numerator; improving the accuracy of the denominator remains future work. In Ghana, the denominator cannot be easily determined due to a lack of accurate grid-infrastructure and customer maps. These information gaps are not uncommon, and many projects are ongoing around the world to map infrastructure and customers to improve the operation of utilities and the reporting of reliability metrics [161, 280, 281].

To quantify grid performance without estimating the number of customers impacted by a sensed outage, we defined two new indices: Subsampled SAIDI (S-SAIDI) and Subsampled SAIFI (S-SAIFI) as Equation (3.1) and Equation (3.2).

$$\text{S-SAIDI} = \frac{\text{Total duration of sustained interruptions in subsample}}{\text{Total size of subsample}} \quad (3.1)$$

$$\text{S-SAIFI} = \frac{\text{Total number of sustained interruptions in subsample}}{\text{Total size of subsample}} \quad (3.2)$$

As the size of the subsample increases and becomes more proportionate to population density, S-SAIDI and S-SAIFI approach SAIDI and SAIFI.

The PowerWatch sensor needed to detect the loss of power to calculate S-SAIFI and to detect the restoration of power to calculate S-SAIDI. To accurately capture power restorations, the sensor had to be able to keep time while not receiving power from the grid. For all timestamps, the sensor had to maintain temporal resolution in seconds. We assumed that this was sufficiently fast to observe grid behavior because outages impact the grid on the order of minutes [282]. Sensors also needed to report their location within tens of meters to allow PowerWatch to estimate the extent of an outage without relying on maps of underlying grid infrastructure. Finally, PowerWatch sensors had to detect grid voltage and frequency, features requested by stakeholders.

Currently, the Electric Company of Ghana (ECG), the power utility operating in Accra, depends on customer calls to estimate the numerator for both SAIDI and SAIFI at the low-voltage level—a method that suffers from the problems described in Section 2.4.2—and uses a supervisory control and data acquisition (SCADA) system that contains sensors on feeder lines, substations, and transmission lines to estimate the numerator for outages that occur at medium and high voltages.

Our deployment aimed to improve the estimation of the numerator of both SAIDI and SAIFI by placing sensors in the field that automatically report the location and duration of power outages.

### 3.2.2 Developing an Independent Measurement Methodology

To understand how well infrastructure improvements impact reliability, it is important to have utility-independent measurements [271]. Many widely-used tools, including SCADA and smart meter technologies, are dependent on utility participation, in part because they directly interface with utility property. From an academic perspective, independence is important as it allows for unbiased research output. Independence is often desired by regulators and investors as well, who may want to verify measurements provided by the utility, as the utility has incentives to report favorable reliability metrics.

Our deployment was designed to evaluate the feasibility and efficacy of a novel sensing methodology for monitoring the reliability of the electricity grid while working independently of the utility. Before PowerWatch, there existed no high-resolution source of independent data about grid reliability in Accra. Even if ECG were to deploy a wide-scale roll-out of advanced

metering infrastructure, PowerWatch’s ability to provide independent data provides value. This independence, along with PowerWatch’s low-voltage monitoring capacity, contributed to MCC and their local implementing partner, the Millennium Development Agency (MiDA), choosing to use PowerWatch as a primary source of data for their monitoring and evaluation efforts [283].

To maintain independence from the utility, we could not rely on the utility to attach sensors to their infrastructure; doing so could introduce sampling bias if the utility made only some infrastructure available [283]. Our physical sensor, PowerWatch, was designed to be installed at outlets in households and business. We also piloted an app, DumsorWatch, that was designed for personal smartphones[131]. Both PowerWatch and DumsorWatch were designed to be deployed and debugged by non-experts. This allowed us to choose deployment sites and deploy sensors without utility involvement. The data returned from our deployment is truly independent.

### 3.2.3 Exploring Socioeconomic Impacts of Reliability

The causal relationship between electricity reliability and socioeconomic well-being is not well understood. Anecdotally, frequent outages constrain economic well-being by reducing the benefits from welfare-improving appliances like fans and refrigerators or income-generating assets like sewing machines. The deployment was designed in part to generate reliability and socioeconomic data for an ongoing economic study that exploits two quasi-random sources of variation in reliability in Accra. By comparing households and firms whose socioeconomic characteristics are identical in expectation, and that differ only in terms of the quality and reliability of power they receive, we can estimate the causal effect of these attributes on socioeconomic outcomes such as well-being, productivity, and health for the residents of Accra.

A socioeconomic survey of approximately 60 minutes in length accompanied the deployment of each PowerWatch device with a respondent, and a shorter survey was administered to respondents who did not receive PowerWatch but did download DumsorWatch. All surveys were completed using SurveyCTO and participants were incentivized for their time. Surveys were verified using high-frequency checks to address any obvious data quality issues. Example data collected includes:

1. Demographics: name, age, education, income.
2. Electricity attributes: appliance and surge protector ownership, usage of electricity and generators.
3. Recall of power quality in the past 2, 7, and 30 days.
4. Social media usage and perceptions of the energy crisis.

Along with providing data, the survey was used to support the development and deployment of the technology itself. For example, we recorded in the survey a unique code for the

PowerWatch device and DumsorWatch app deployed with each respondent, and their phone number and GPS location, so that the sensors could later be associated to individuals. To inform DumsorWatch debugging, we asked about the way that residents of Accra employ their mobile phones, how many phones and SIM-cards they use, and how frequently they upgrade their phones. To inform the deployment of the PowerWatch device, we recorded whether the respondent turns off their electricity mains at night and whether they had any safety concerns about PowerWatch.

### 3.3 Methodology

We designed a deployment methodology to achieve the goals described in Section 3.2. Our methodology deployed our data-collection instruments at specific locations on the grid both to monitor the success of grid improvements performed in the Ghana Power Compact and to compare socioeconomic indicators across differing levels of reliability. We also designed and deployed deployment-management tools to assist implementation of the methodology.

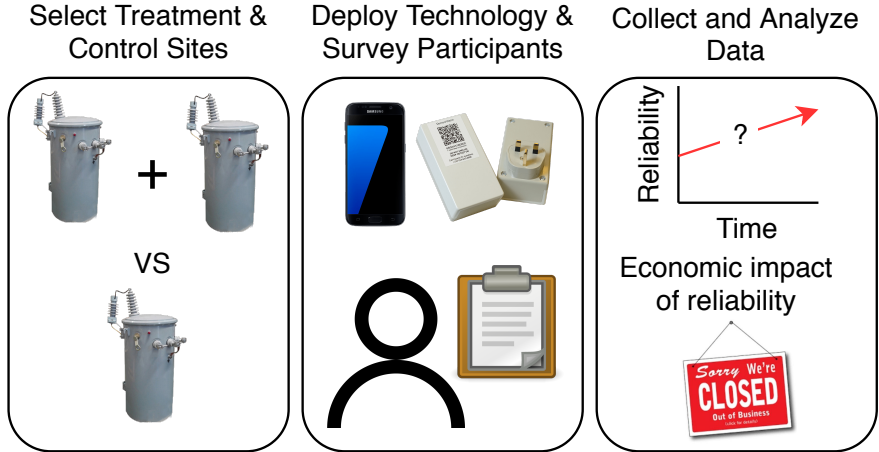

Figure 3.3: **Overview of deployment.** To support the goals of the deployment, our team selected sites that were being improved by the Ghana Power Compact and selected control sites. The technology was deployed in both sites along with surveys at the beginning and end of the deployment. This deployment strategy allowed us to meet our goals of evaluating the impact of grid improvements on power reliability and the socioeconomic impact of that reliability on consumers.

While I describe three deployments in Chapter 6, each with a differing level of scale, the overall structure of the deployment methodology remained consistent across these deployments. First, we developed criteria for site selection that allowed us to answer specific socioeconomic questions. Second, we devised a sampling scheme that gave sufficient coverage of each selected site, as well as sufficient redundancy to enable cross-validation of the new measurement

technology. Finally, we worked with a team of field officers to deploy in the selected sites, employing deployment-management tools to maintain and monitor the system.

As scale increased it became impossible to effectively record, connect, and correct critical deployment metadata. We had not anticipated the complexity of managing data about participants, devices, and app installs, each of which was collected by different systems, and some of which informed each other. This led to an ad-hoc sharing of information through our encrypted shared drive.

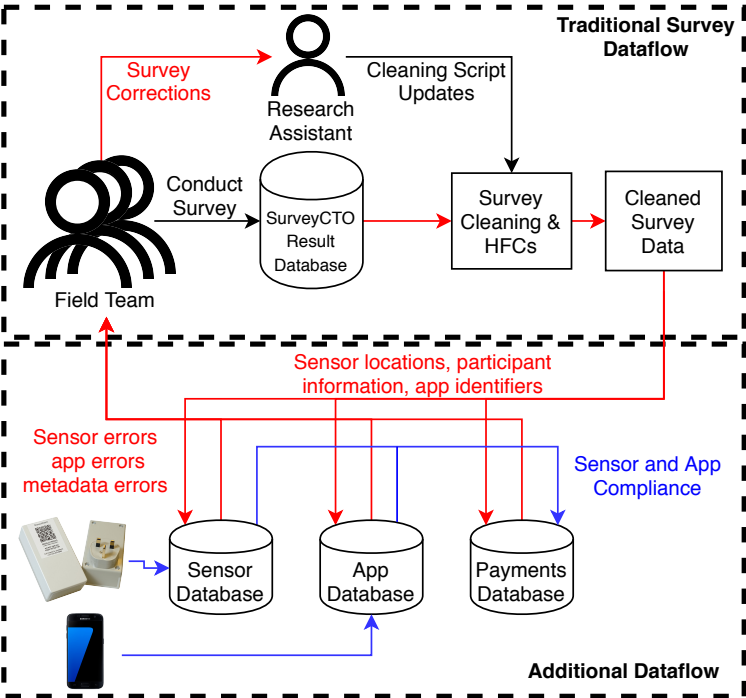

Figure 3.4: **The dataflow for the deployment.** While traditional surveying methods have a linear data flow where data is exported for later analysis, the integration of continuous sensing in the deployment generated feedback loops which created more places where state was stored and greater need to communicate this state, and amplified issues with errors during surveying. We implemented a deployment-management system to alleviate these problems. Red arrows show data flows that we first attempted to perform manually and later automated or facilitated with a deployment management tool. Blue arrows show data flows that we automated from the beginning because we anticipated their complexity before the medium-scale deployment.

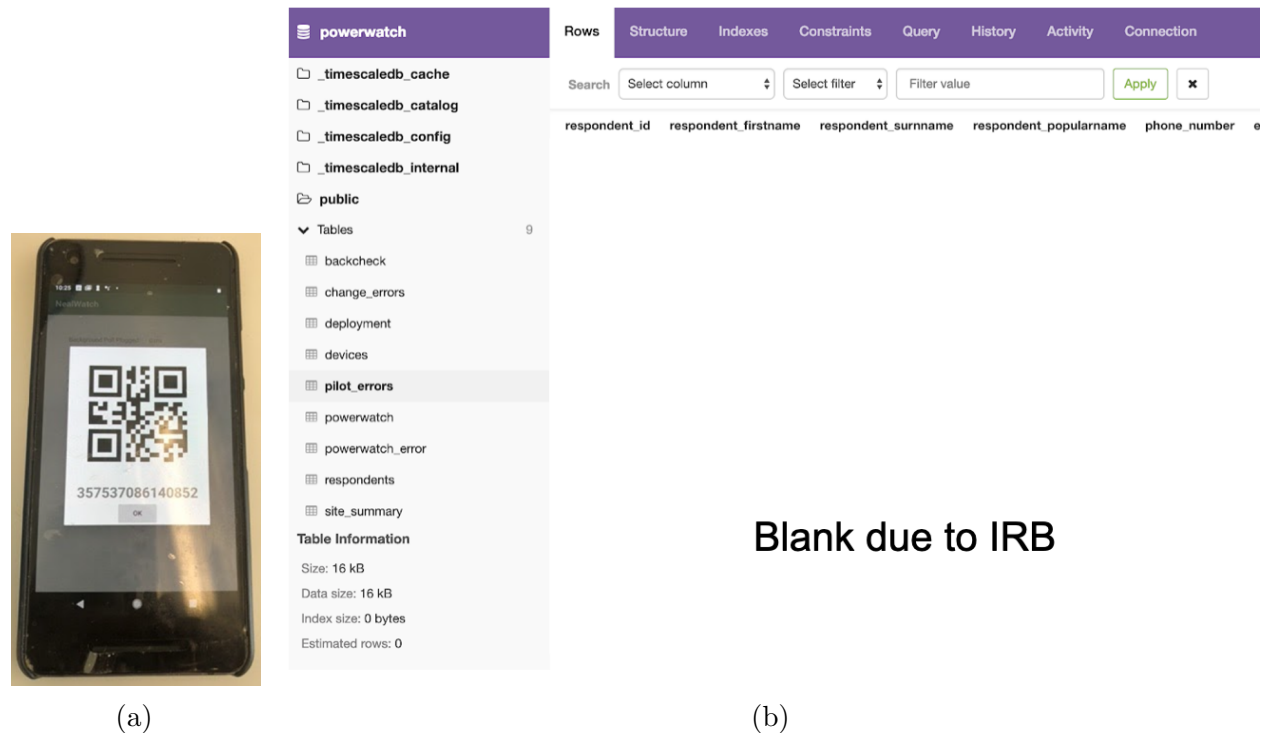

Figure 3.5: **Some of the deployment meta systems.** In (a) we see a method used to ensure field officers received and properly notated a participant’s phone number, a critical step because this was how incentives were transferred and sensor maintenance was scheduled. In (b) we see an blank view into the deployment-management system, where field officers could view the state of the deployment in real time and autonomously schedule participant check ups.

### 3.4 Site Selection

Accra is segmented into 26 districts; we deployed in three, shown in Figure 3.7. We chose our deployment sites based on the anticipated locations of new transformers, provided by the utility [275], to allow our data to be used in a formal impact evaluation being conducted by our collaborators Section 3.1.3.

We selected a subset of the sites where infrastructure upgrades were planned (*‘treatment sites’*) and then quasi-randomly selected a set of sites that were comparable in observable characteristics (*‘control sites’*) (see Section 3.1.3. For each site, we then defined a geographic surveying area that was the intersection of a 200 meter radius from the centroid of the site, and a 25 meter region extending from the low-voltage network being measured. This analysis was performed using GIS tools operating on a map of the grid in Accra provided to us by an independent contractor implementing the grid-improvement work.





Figure 3.6: **A typical site.** We deployed 3 PowerWatch in each site, and data can be grouped so that only data collected in this site is analyzed. Sites are selected using criteria described across Evaluation Design Reports of Mathematica Policy Research [212] and UC Berkeley [213]

Once the specific sites were selected, we targeted a deployment of three PowerWatch devices at each site. Using the GIS technology described above, we produced a series of maps marking the geographic area bounding each site. Field officers used these maps, along with the GPS coordinates for the sites, to identify the surveying area and deploy sensors accordingly.

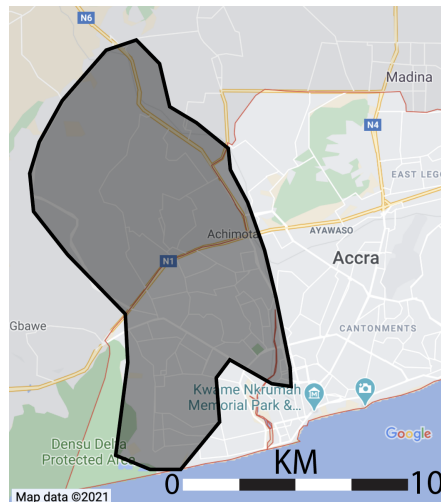

Figure 3.7: **PowerWatch Deployment Area.** Sensors were deployed in three of 26 districts in Accra. The deployment covered an area of approximately 130 square kilometers. This deployment was subsequently increased to 1,400 sensors and a much wider area by *nLine*, a startup I co-founded.

### 3.5 Sampling Strategy

We deployed our sensors with residents of Accra, either at their home or place of work (or both, if these were co-located), with an attempted 50% split between households and firms. Installing PowerWatch at consumer plugs allowed us to not depend on direct access to utility infrastructure, such as transformers or lines, and to measure power quality without utility participation at the point where it is least understood: the customer.

Our strategy was built around redundant sampling such that multiple sensors were placed under a single transformer. When all sensors in a group reported an outage at the same time, we could be confident it was due to an issue affecting the transformer rather than a single customer. Further, when we observed sensors below multiple transformers reporting outages simultaneously, we could infer the outage occurred at a higher level of the grid. This sampling strategy is shown in Figure 3.8.

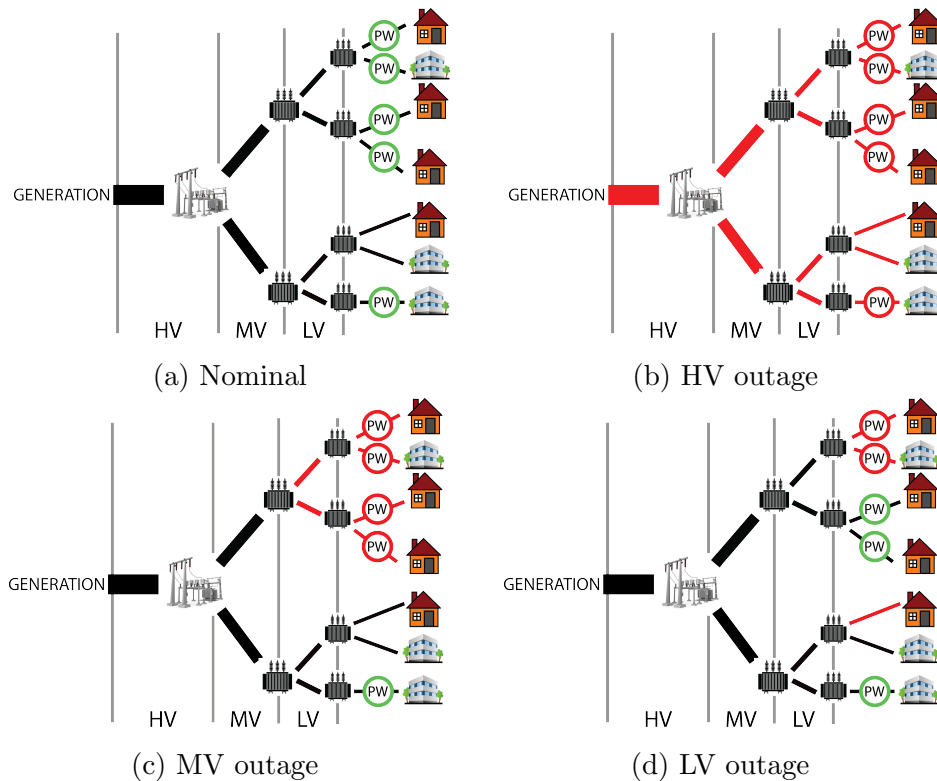

Figure 3.8: **Deployment methodology of sensors.** By randomly sampling households and firms under a transformer, sensors can detect high-voltage (HV), medium-voltage (MV), and a significant portion of low-voltage (LV) outages. Sensors might not detect single phase outages, as in the bottom outage of (d), because our sampling did not guarantee sensors were distributed across all possible phases in practice, due to both the difficulty of identifying the phase(s) to which a service was connected and manual phase switching by a household or firm. Sensors estimate the average frequency and duration of outages, which include both single-phase and service-level outages.

### 3.6 Deployment and Surveying Team

We developed a local staff structure that, compared to traditional survey work, uniquely supports our continuously operating deployment. This involves employing a full-time local field manager to oversee the initial roll-out and on-going maintenance of the system, and an auditor to follow up with participants who report problems over the phone and with sensors no longer functioning.

To implement our medium and large scale deployments, we temporarily employ an additional team of 10 field officers and three team leads. The field officers screen the occupants of potential sensor locations (called participants) to ensure their home or business is connected to and using the grid. After being informed about the collection, storage, and

use of data, participants provide consent to our collection of their personal data and data from PowerWatch. All participant interactions are approved by our IRB protocol.

After a participant consents, the field officer uses SurveyCTO [284] to collect information about the participant, the deployment location, and the sensor being deployed. Field officers plug in the sensor at the participant's home or business or, more recently due to COVID-19, instruct participants to plug the sensor into an available outlet. We conduct multiple training exercises with the entire team where each member learns about the technologies being deployed, and practices completing the survey and deploying the technologies.



Figure 3.9: **Field officers in uniform.** Branding and messaging was especially important as the quality of our sample depends on long term positive relationships with participants.

Field officers visit sites in groups of two to alleviate safety concerns. We provide team uniforms to make it clear they are part of an official project, as shown in Figure 3.9. We also provide backpacks to carry supplies, tablets for the survey, WiFi hotspots to upload the survey, flashlights for safety, and feature phones to verify the phone numbers of participants to ensure we know where to send the participation incentives.

The placement of PowerWatch sensors directly in homes and firms—where participants can unplug them, run generators, or fail to pay their meter—increases the noise of our data relative to a deployment on utility-owned equipment such as transformers. In a preemptive attempt to decrease the noise caused by a sampling strategy, we screen participants for specific criteria, including owning a phone with Android version 4.1–8.1 and being an active customer on the grid. We explain the goals, risks, and benefits of the project, and seek written consent. Finally, we provide a phone number if participants have any questions or concerns.

To further encourage continuous participation, we compensate participants with airtime credits on their mobile phone. Participants receive a small amount of airtime for initial recruitment, and they are automatically transferred 5 GHC (around US\$1) monthly as an incentive to keep the sensor installed and to offset any electricity costs incurred by participating.

Additionally, participants are provided a power strip to ensure the sensor does not take up a needed outlet.

Deployment costs were \$100,000 for just over one year of operation, including fieldwork for deployment and maintenance, a full-time project manager, and participant incentives. To reduce participant-incentive and maintenance costs, we developed the idea for an app that shows participants reliability information (e.g., alert them when there is an outage at their home) as an incentive to (continue to) participate and keep their sensors plugged into the grid.

### 3.7 Summary

In this chapter, I described PowerWatch, our system of networked sensors installed at outlets in households and businesses at the edge of the grid. I presented information on the context in Ghana that informed our deployment and on the high-level goals of the deployment, including the need for the system to be independent of the utility and gather sufficiently-high-resolution data to improve the accuracy of the performance metrics for the Ghana Power Compact and to study the socioeconomic impacts of reliability. I then describe the deployment methodology we designed to accomplish those goals. In the next chapter, I will describe the architecture of PowerWatch in more detail, discussing the design decisions made to ensure the system was utility-independent, agile, high resolution, and low cost.

# Chapter 4

## The Device

In this chapter, I describe the basic sensing hypothesis and architecture of PowerWatch. PowerWatch consists of an outage-detection sensor that plugs into an outlet and is installed in homes and businesses. It reports the state of the grid in near-real-time over a cellular back-haul to the cloud. The deployment methodology for PowerWatch is uniquely suited for applications that require utility independence, markets that require low-cost, high-resolution measurements of power outages and voltage quality, and stakeholders that have short timelines to deploy or need to take small, targeted samples (i.e., exploring reliability at health care clinics).

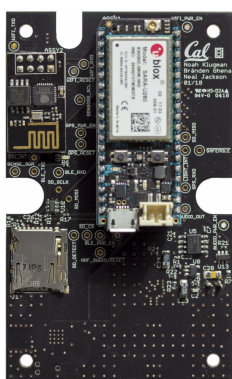

(a) PowerWatch PCB.



(b) PowerWatch sensors.



(c) Installation.

Figure 4.1: **PowerWatch as deployed.** (a) PowerWatch PCB with cellular radio, SD card, and sensing circuits. (b) Assembled PowerWatch sensors with QR code scanned at installation to associate the sensor with a participant. (c) A field officer installing a PowerWatch sensor at a household outlet.

Every two minutes, the PowerWatch sensor takes a reading of power state, grid voltage, grid frequency, GPS location and time, and cellular quality. Newer sensor versions interrupt on power-state change and record the timestamp (from an RTC) and acceleration (to help filter out user-unplug events). These measurements are stored locally on an SD card and



transmitted to the cloud when a cellular connection is available. A cloud-based analytics system searches for outage reports from multiple devices to ensure the validity of an outage, clustering outage reports into density-based clusters in both space and time to reject noise from a single sensor (i.e., a single participant unplugging a device or a pre-paid meter running out of credit) and ensure that only true outages are reported by the system. I conclude this chapter by describing the tests we performed in the lab to select the time and space parameters for the density-based outage-report clusters, and the tests we performed to evaluate the physical sensor’s performance in the field. In the following chapter, I describe the tests performed to evaluate whether the PowerWatch deployment successfully extracted outages from the data our sensors collected.

## 4.1 Architecture

The GridWatch architecture, shown in Figure 4.2, consists of: (1) an outage-detection sensor, PowerWatch, that is deployed in utility customer homes and businesses, (2) a cellular network link to the cloud, and (3) cloud-based data analytics that cluster reports from multiple sensors into outages.

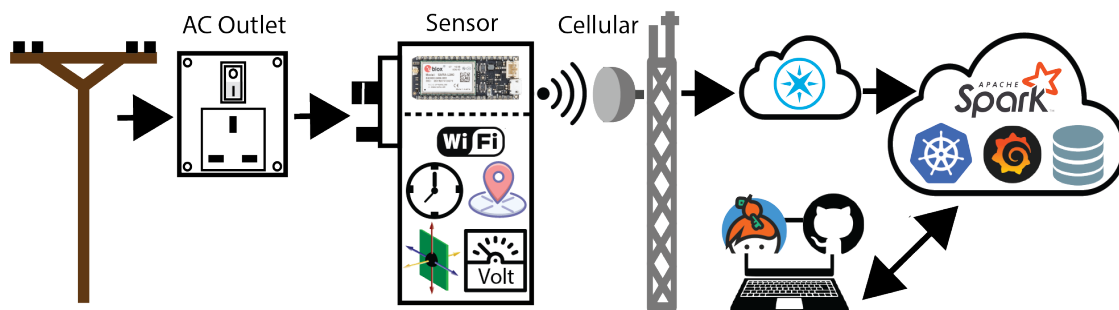

Figure 4.2: **PowerWatch System Architecture.** PowerWatch measures the grid by plugging in at outlets in homes or businesses, transmitting data about power quality over the cellular network, and clustering the data based on temporal and spatial characteristics of power outages.

### 4.1.1 Sensor

The PowerWatch sensor, shown in Figure 4.1, plugs into an outlet and reports the state of the grid over a cellular backhaul through a Particle Electron modem [285]. We selected a cellular backhaul before entering the field given the relatively high percentage of mobile phone users in Accra. Residents have an average of 1.37 mobile subscriptions and 90.0% own a mobile phone [286, 287].



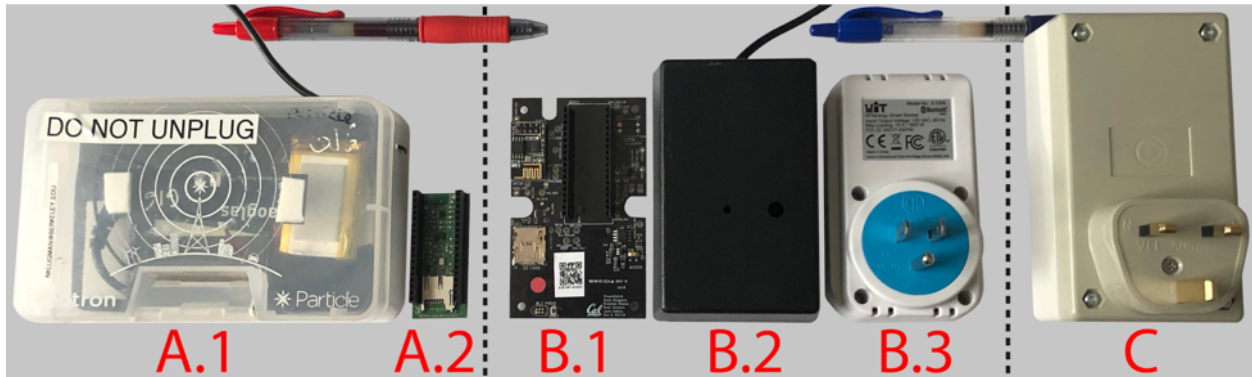

Figure 4.3: **Evolution of PowerWatch with each deployment.** PowerWatch revision A consisted of an off-the-shelf compute/communication module and enclosure (A.1) and paired with a custom sensor front-end (A.2). Data from this revision informed the need for a better enclosure and more casing in revision B, which consisted of a custom sensing and communication board (B.1), enclosure with externally plugged power supply (B.2), and a separate grid voltage and frequency sensor (B.3). While the separate grid voltage and frequency sensor allowed for easier assembly, its complications led us to build revision C, a completely-encased custom sensor which plugs directly into the wall, to sense grid voltage and frequency.

Every two minutes, the sensor takes a high-frequency sample of the voltage waveform at the outlet to calculate grid RMS voltage and frequency. It also records the number of nearby WiFi signals as secondary validation, as wireless hotspots may be grid powered. In addition, upon changes in power state, the device records the timestamp (from an on-board real-time clock) and current acceleration. Acceleration signals that a participant is interacting with the device, making it likely that any charge-state change at that time is a false positive and allowing us to more easily reject the data point.

The two-minute sampling interval was chosen as a tradeoff between data resolution and communication costs. This interval is more frequent than the 15-minute sampling rate used by most smart meters, which are considered state-of-the-art in calculating SAIDI and SAIFI. Additionally, for sensors with outage timestamping functionality, the sensor can report outages with second-level precision and of less than one minute duration, sufficient for detecting the IEEE’s definition of a sustained interruption [60].

The measurements are stored locally on an SD card and transmitted to the cloud when a cellular connection is available. The sensor contains a 2000 mAh battery, which can run the sensor for several days, longer than most outages in Accra. When the sensor is on battery power, it still reports data at the same frequency to our servers, a feature necessary for calculating outage duration.

Because PowerWatch sensors would not necessarily be collected at the end of the deployment, and the data they collect might be used in real-time in the future, the sensor needed to have a reliable wide-area network connection, with capacity measured in the low megabytes per month. This connection was used to collect data, to track system health parameters, and

to perform over-the-air firmware updates. Short network outages were tolerable because data could be stored locally and sent when the network returned.

### 4.1.2 Cloud

The core of the PowerWatch cloud receives data from PowerWatch sensors and stores that data in a PostgreSQL/TimescaleDB database [288]. Data is then joined with deployment metadata for further analysis. Data is not deleted from the sensor until the sensor receives confirmation the data was stored in the database.

Additional cloud services supporting PowerWatch include dashboards to monitor the deployment and inform field officers of non-functioning sensors, systems to transfer incentives to participants, and visualizations of outage data.

### 4.1.3 Outage Clustering

Outage reports from multiple sensors are combined to ensure the validity of an outage. We consider two co-reporting sensors sufficient to indicate an outage. To perform this clustering we use STDBSCAN [289], which clusters outage reports into density-based clusters in both time and space.

To select the time parameter for STDBSCAN, we created a testbed, described in detail in Section 4.2.1, to generate artificial outages and observed the time distribution of outage reports. Because the time range of the outage reports varied up to 100s, we conservatively used 100s as the time parameter for STDBSCAN, allowing the algorithm to cluster two sensors with a reporting-time discrepancy of up to 100s.

To derive the spatial parameter for STDBSCAN, we explored the spatial distribution of sensors within our deployment. We observed that adjacent sites would likely, but not necessarily, experience an outage at the same time [8, 282]. Therefore, for all sites we calculated the maximum distance between any site and its second-nearest site. Doing this—and excluding outliers whose second-nearest site is beyond 3x the inter-quartile range of the distribution—yielded a spatial clustering parameter of 2.4 km.

### 4.1.4 Cost

The PowerWatch sensor was originally optimized for reliability and ease of manufacturing at small quantities, rather than cost, and was made available to funding agencies for US\$187 per unit. The largest contributors to this cost were the populated PCB with power supply, GPS, and sensing circuitry (\$87), the Particle Electron (\$38), the enclosure (\$20), and assembly (\$10). Unoptimized communication and cloud infrastructure cost \$8 per sensor per month. Newer sensor designs, which maintain the same or greater functionality, are projected to cost \$30-\$40, and optimized communication and cloud costs should be less than \$1 per sensor per month.

### 4.1.5 Deployment Management Tool

We developed three software subsystems to support the deployment. These subsystems include (1) an automated incentive system to transfer the airtime incentives; (2) a deployment management system to a) keep track of sensor and participant state and b) display deployment health to the field management team; and (3) a data-visualization and analysis system. These subsystems were developed as a result of our experiences as the development scaled over time, discussed in Chapter 6.

### 4.1.6 Visualizations

We developed a number of different dashboard visualizations of the course of our deployments. Two of these are shown in Figures Figure 4.4 and Figure 4.5.

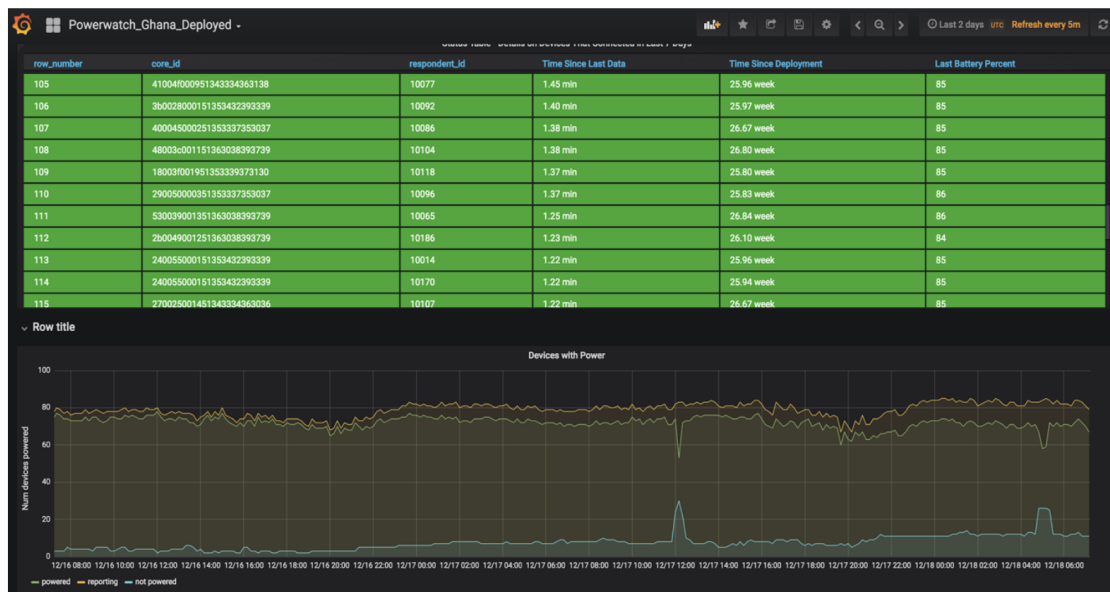

Figure 4.4: **Early Engineering Dashboard.** This is accessed using a web browser. The table towards the top of the screen lists all sensors, the time since the last data received, the total time it has been deployed, and its current battery life. The bottom graph shows a time series representation of all PowerWatch devices. The orange line is all of the devices. The green line is all devices that believe the power is on. The blue line is all devices that believe the power is off. There are two outages present in this view, which can be seen as a spike in the blue line as more devices report that the power is off and a dip in the green line as less devices report power is on. While not the most aesthetically pleasing, it allowed us to handle medium to large scale deployments.

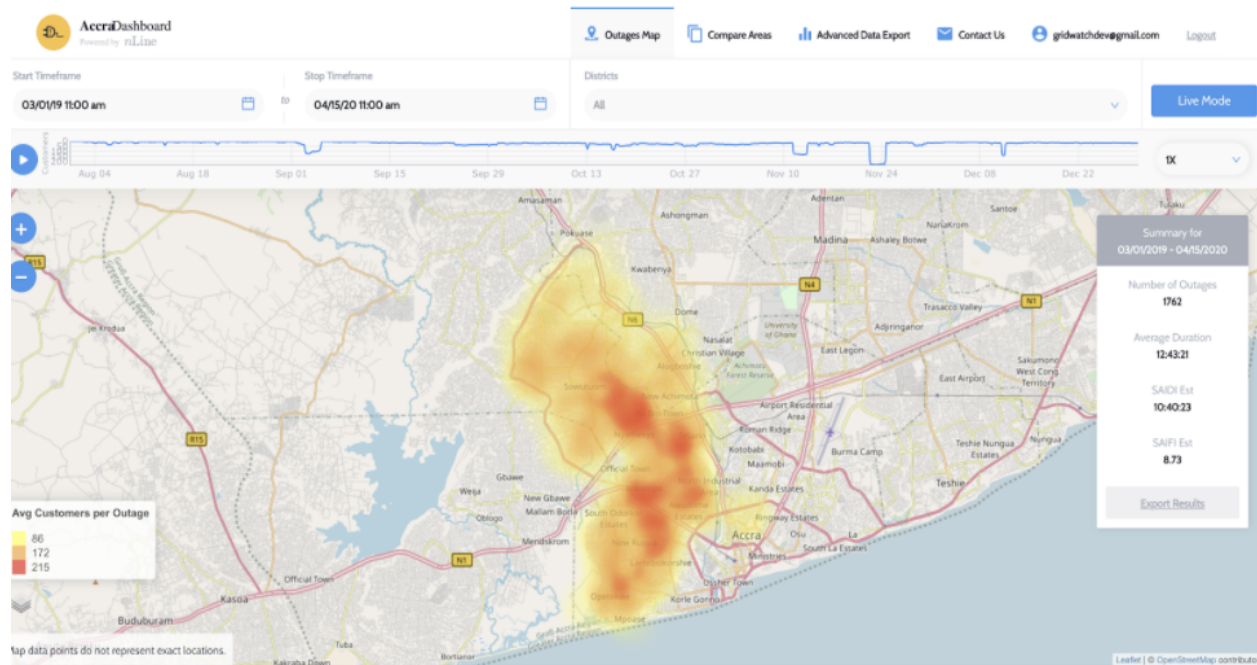

Figure 4.5: **PowerWatch data visualization** *Figure is screen capture from nLine’s data visualization system [290].* With the goal of supporting non-technical users, this dashboard was developed to allow for spatial and temporal queries to be trivially run, visualized, and analyzed across the PowerWatch dataset. nLine has since performed multiple trainings with utility and regulator stakeholders in Ghana on using this tool and will be making it available over the next year.

## 4.2 Device Performance

In all we have deployed 3 generations of PowerWatch sensors as UC Berkeley (and 1 further generation as nLine). With nLine we are now running 1400 sensors in Accra, as well as 110 PowerWatch deployment in Kenya, in 3 healthcare clinics in Rwanda, and in markets in Nigeria. Over the three years of deploying PowerWatch we have not experienced any catastrophic failures of the device (i.e. no fires, no participant harm).

### 4.2.1 In-Lab Testbed

We evaluated the performance of the sensors in the lab by using a testbed to create artificial outages. STDBSCAN [289], which we use to combine outage reports from multiple sensors to ensure the validity of an outage, clusters outage reports into density-based clusters in both time and space. STDBSCAN requires parameters to specify the minimum number of points within a density-based cluster and the maximum distance between points in both time and space.



(a)



(b)

Figure 4.6: **Two testbeds.** In (a) we see an early, small test bed, and in (b) we see our testbed from two years later. As the technology has developed, supporting systems had to improve (see Chapter 6) and opportunities for further optimization like the tighter timing shown in Figure 4.8 arose frequently.

To select the time parameter for STDBSCAN, we created a testbed to generate artificial outages of various sizes and observe the time distribution of outage reports in this controlled setting. The testbed consisted of three programmable outlets with 2, 8, and 30 sensors connected to each outlet, respectively. Because sensors were connected to the same outlet, we could ensure they experienced an artificial outage at the same time. Testbed sensors were programmed with the firmware version that contained the least precise outage timestamping.



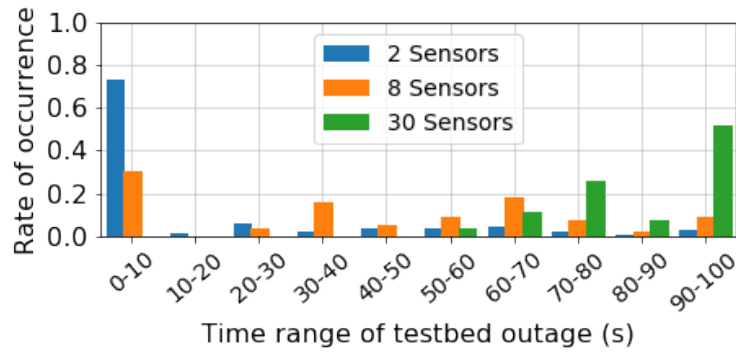

Figure 4.7: **Time range of testbed outages.** A testbed of sensors and programmable outlets generated two hundred outages of various sizes in a controlled setting. We observed the precision of outage timestamping, noting that for any given outage sensors may report that the same outage occurred up to 100s apart. This allowed us to parameterize clustering algorithms used to detect outages in the field. Newer firmware reduces temporal variance to less than 10s.

The resulting times from this experiment are shown in Figure 4.7. In 200 artificial outages, all sensors set up to experience an outage successfully reported that an outage occurred. For a given outage, the time range of the outage reports varied up to 100s (that is, a sensor reported that the outage occurred not more than 100s after it actually occurred). We therefore conservatively used 100s as the time parameter for STDBSCAN, allowing the algorithm to cluster two sensors with a reporting-time discrepancy of up to 100s. Data from more recent versions of the sensor report all outages within 4s of one another, which will allow us to further reduce the clustering time parameter. This improved timing is shown in Figure 4.8.

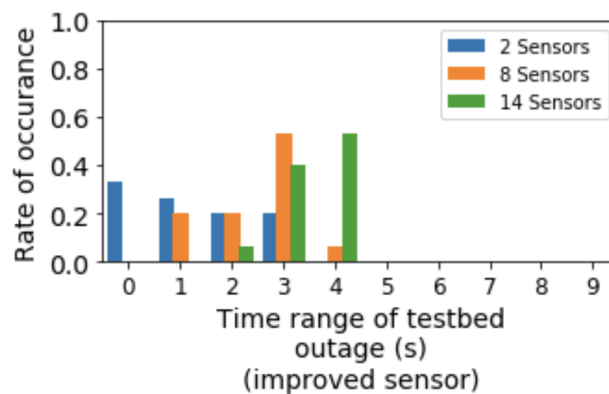

Figure 4.8: **Time range of testbed outages with improved firmware.** Improved firmware decreased the variance to closer to what would be expected, although leaving room for improvement in firmware optimization.

## 4.2.2 In-Field Analysis

We evaluated the performance of the sensors in the field by examining the sensor uptime, packet reception rate, and spatial and temporal accuracy of the sensors and the deployment. The sensor instrument performed as designed, staying alive and precise over long periods in a challenging environment.

### Uptime

Uptime across the PowerWatch deployment is shown in Figure 4.9. We measured average uptime across the deployment to be 73.6% with suspected unplug failures occurring 2.3% of the time, suspected sensor switch-offs occurring 5.2% of the time, and unknown failures occurring the remaining 18.9% of the time. Further, we found that at least two sensors (the minimum number for our outage detection algorithm to detect an outage localized at that site) are reporting per-site on 85.3% of site-days.

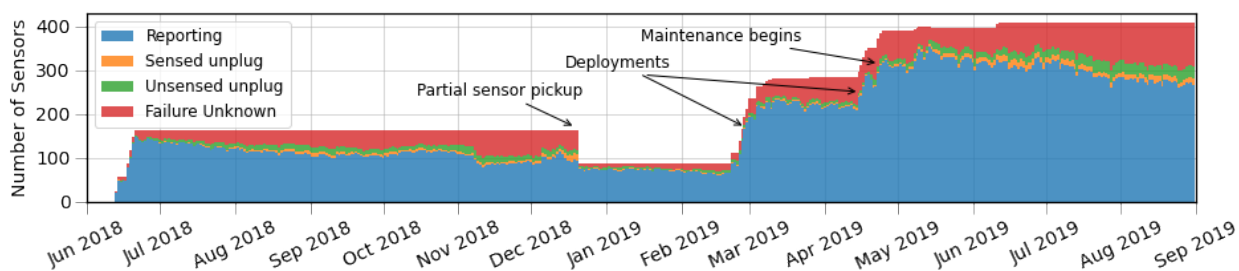

Figure 4.9: **Number of sensors reporting throughout the deployment.** Failures are either user unplugs (sensed by the accelerometer), sensors dying due to unsensed unplugs (such as those that occur when the wall switch is flipped), or unknown failures (likely also due to participants unplugging or turning off the sensors, as we observed no hardware or long-term software failure in collected sensors). Initial deployments occurred in June 2018, with some sensors retrieved in December 2018. Additional sensors were deployed in February and April 2019. Field staff actively attempted to maintain reliability from April to June 2019, greatly reducing the rate of sensor failure. Even without field staff support, the rate of failure lessened over time, demonstrating that our deployment methodology is sustainable if properly over-provisioned.

While we would like to collect more information about the causes of unknown failures, we note that when our field team called participants and asked them to re-plug-in their sensors, such as in May 2019, the sensor reporting rate increased significantly. This, along with the fact that we found all re-collected sensors to be functional when operated in a controlled setting, leads us to believe that most unknown failures are due to participant behavior.



### Packet Reception Rate

To measure the quality of the cellular backhaul we calculated the per-sensor packet reception rate (PRR) based on packet sequence numbers and their expected reporting interval, excluding sensors if they permanently fail. We saw a mean PRR of 97.4%, and that 95% of sensors had a PRR over 95%.

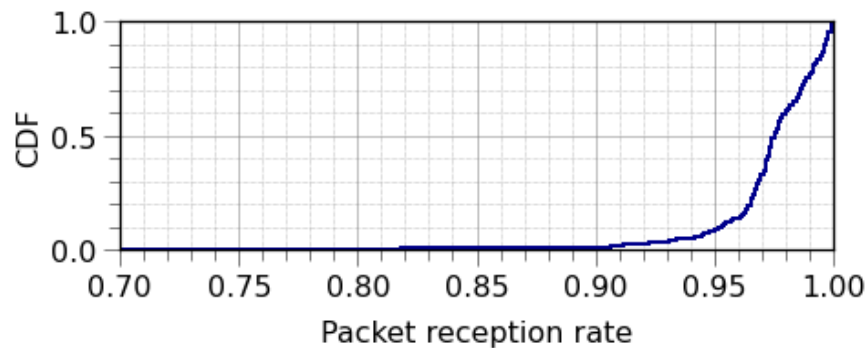

Figure 4.10: **Packet Reception Rate (PRR)**. PRR was calculated by comparing each sensor’s expected reporting interval and sequence numbers with data received. Jumps in sequence number, or periods sensors did not report when expected, indicated a transmission failure due to lack of cellular connection or bugs in the firmware. Sensors were not included after permanent failure, and PRR was increased by local queuing.

### GPS Performance Indoors

Because our sensors are deployed indoors, reception is a concern. The rate of GPS fix is low, with 44% of reports containing a GPS fix sufficient to get GPS time and 42.9% of reports containing a GPS fix sufficient for localization. Because the sensors are stationary, infrequent fixes are acceptable, especially when paired with a GPS point taken with a tablet at the time of deployment. 78.0% of sensors get a valid GPS fix at some point during their deployment. The wide variance in the time for each sensor to acquire its first GPS fix is shown in Figure 4.11. We conclude that while GPS is moderately successful indoors, it should not be depended on to be quick or universally present.

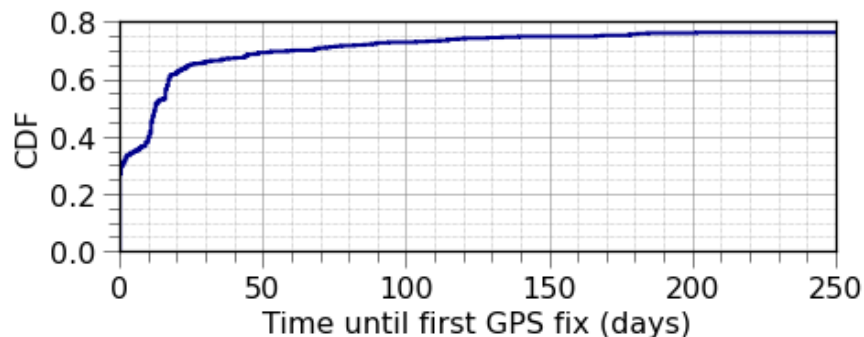

Figure 4.11: **Time to acquire first successful GPS fix.** Note CDF axis stops at 0.8. From 462 sensor deployments, over 17% achieved a fix within the first hour after their deployment began, and over 29% within the first day. Over 65% achieved a fix within 30 days. The remaining 11% that achieved a fix were spread over 300 additional days. In 23.2% of the deployments the sensors never achieved a GPS fix.

### Spatial Resolution

The location of a sensor is collected both at deployment by the field team and during the deployment by the sensor’s on-board GPS. As discussed above, 78.0 % of sensors obtained a valid GPS fix at some point during their deployment, which was used to verify and correct locations collected by the field team. All locations were collected to 10 m accuracy.

### Temporal Resolution

In the experimental setup for Figure 4.7, we detected 100 % of our over 100 simulated outages of various sizes using the first generation of our sensor, which had the least-precise outage timestamping ability of our sensors (no RTC). To measure the accuracy of our timestamping in the wild, we compared the reported timestamp to the GPS timestamp reported when a GPS fix is acquired, true for 44.0 % of sensor reports. We found that over 99 % of timestamps were within 10s of GPS time and over 99.9 % were within 60s of GPS time.

## 4.3 Summary

In this chapter I described how PowerWatch takes simple measurements—outage reports and voltage and frequency fluctuations—at outlets in households and businesses at the edge of grid and aggregates those measurements by clustering them. I then presented our in-lab tests and in-field analysis of the PowerWatch sensor itself, which we used to inform our outage clustering. In the next chapter I will describe the methods we used to evaluate the effectiveness of the overall deployment at detecting large and small outages and other power-quality issues.

# Chapter 5

## The Data

In this chapter I describe the methods used to validate that PowerWatch was, in fact, accurately detecting both large and small power outages including by finding anecdotal confirmation of large outages and through using spacial and temporal patterns in sensor reports. In the absence of ground truth on the accuracy of our outage-detection algorithm, we evaluated our sampling methodology with statistical and numerical methods. We conclude that our PowerWatch deployment does enable high-resolution measurements that improve existing measures of grid reliability in Accra. I conclude the chapter by presenting some of outage and power-quality data gathered by the deployment and some takeaways about how this data can be used in under-instrumented areas.

### 5.1 Deployment Data

We examined the performance of PowerWatch by considering both the methods used for extracting outages from a noisy datastream of outage reports and the suitability of our sample for estimating S-SAIFI and S-SAIDI.

Other evaluations of large-scale sensor networks deployed in the wild discuss challenges related to reliability, networking, node placement, security, and filtering noise introduced by leaving the lab [291–297]. We evaluate our system against similar considerations, particularly reliability, node placement, and filtering noise from our data stream. While the deployment in customer homes and businesses introduced significant noise—participants unplugged sensors, individual prepaid meters ran out of credit, and generators artificially restored power—we hypothesized that, with careful filtering, we could extract patterns from our data to give us confidence that a sensor was part of a true outage and that we were roughly measuring both the spatial extent of the outage and the grid voltage level at which the outage occurred.

Specifically, we looked for spatially- and temporally-related changes in power state across two or more sensors to classify an event as an outage, and we deployed three sensors at each site so outages would still be detected if a single sensor failed. By requiring a space-time cluster before classifying an outage, we filtered out noise created by placing sensors with

end-users. However, by not considering single-sensor reports as true outages, we did reject small outages that only affected one sensor.

To determine where in the grid hierarchy an outage occurred, we measured the number of sensors that observed an outage. Given a cluster of only two or three sensors, the point of failure was most likely on low-voltage infrastructure. Given an outage spanning multiple deployment sites, the point of failure was likely in a higher tier of the grid.

We then used measurements gathered by ECG’s SCADA system and numerical and statistical models to evaluate whether we deployed enough sensors to accurately calculate our S-SAIDI and S-SAIFI measurements. We concluded that our deployment sample was sufficient.

### 5.1.1 Extracting Outages

PowerWatch extracts outages from aggregated single-sensor reports by finding space-time clusters. Evaluating this technique would be a comparatively simple task with the presence of ground truth measurements; however, only limited ground truth exists from the utility at the high- and medium-voltage levels, and nearly no usable ground truth exists at the low-voltage levels (see Section 3.1.2).

PowerWatch is not the first deployment that lacks ground truth. Techniques to overcome this deficiency include methods that give confidence that a sample is representative [298] and unsupervised learning techniques that extract patterns. Both methods are common in Earth Science, where, like the grid, large-scale phenomena such as forest growth [299] or ocean eddy tracking [300] cannot be directly verified.

The limited ground-truth data that does exist—SCADA data for high- and medium-voltage outages, and customer calls and truck logs for medium- and low-voltage outages—was either not made available to our team or did not contain precise-enough space and time information to validate individual outage events.

Therefore, our evaluation augmented the limited ground-truth data that we did have with evaluations of the spatial-temporal relationships between sensor reports that we would only expect to see in true outages.

#### Initial Checks

We first searched for anecdotal confirmation that outages similar to those sensed were actually occurring in Accra. Large outages were sometimes reported in the news and were detected by PowerWatch (shown in Figure 5.1) [301].

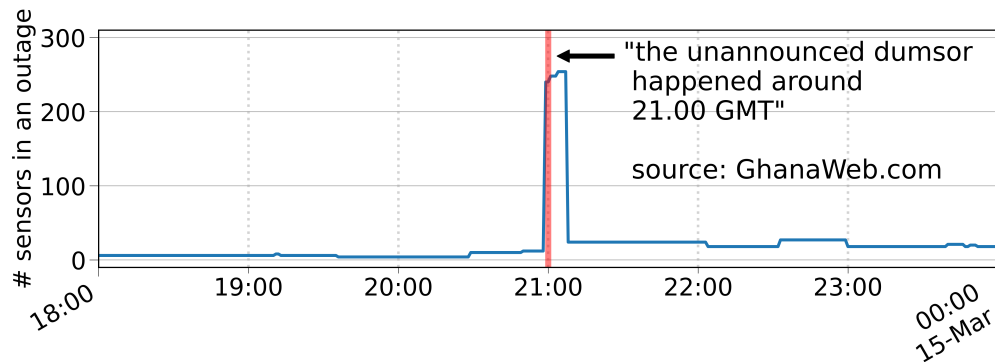

Figure 5.1: **PowerWatch captured an outage reported in the news.** PowerWatch sensors and clustering algorithms perfectly captured a power outage event (“dumsor”) reported by GhanaWeb, a popular news source, to have occurred “around 21:00” on March 14, 2019 [301].

We can also see anecdotal confirmation in our estimate of S-SAIDI (Equation (3.1)) and S-SAIFI (Equation (3.2)) in Figure 5.2. Figure 5.2a shows a PURC announcement of an investigation into a week-long period of grid instability. Figure 5.2b is a screen capture from PowerWatch’s Data Visualization System (described in Section 4.1.6). In Figure 5.2b we see that S-SAIDI and S-SAIFI are much higher during that week then they were during the same week a year earlier.

May 07, 2021

**PRESS RELEASE****REPORT ON PRELIMINARY INVESTIGATIONS INTO ERRATIC POWER SUPPLY**

The Public Utilities Regulatory Commission (PURC), as indicated in its Press Release dated March 11, 2021, has concluded preliminary investigations into the causes of recent erratic power supply and system collapse experienced in the country. The Commission has established through its regulatory monitoring that, the erratic power supply coupled with low voltages especially during peak hours have been caused by a number of factors across the value chain of electricity supply.

These include, but are not limited to, the following:

1. Technical challenges in the natural gas supply network;

(a)

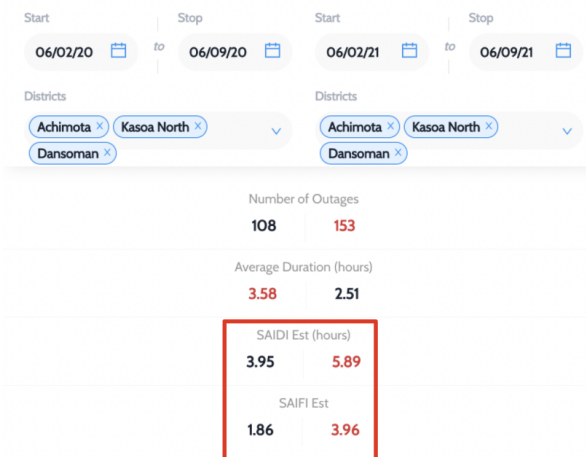

(b)

Figure 5.2: **PowerWatch captured a period of instability under investigation by the Public Utilities Regulatory Commission of Ghana (PURC).** (a) is a screen capture of a public notice posted by PURC about the launch of an investigation into a period of disruption that occurred from 06/02/21 to 06/09/21. (b) shows data collected by PowerWatch. On the left of the display, SAIDI and SAIFI from the same week-long period the prior year (06/02/20 to 06/09/20) is shown to be much less than SAIDI and SAIFI from the week under investigation.

Additionally, while the utility-reported repair logs were not precise enough to validate individual outages, we could compare their relative number to the outages sensed by PowerWatch. The repair logs we obtained indicated 1,449 repairs in just over five months in one district, while in that same time and district PowerWatch detected 575 outages. While PowerWatch detected fewer outages, this is as expected because PowerWatch is only covering part of the grid. By linearly extrapolating our coverage to the entire district, we predicted PowerWatch would have detected 1,801 outages in that period, similar to the number recorded in the logs.

### Temporal Patterns with Sensor Reports

When there was a power failure, the entire downstream network rapidly de-energizes. Thus, in the event of a true outage, we expected to see multiple PowerWatch sensor outage reports very close to one another in time. Conversely, we expected to see outage reports relatively randomly distributed in time in the event of a false outage caused, for example, by a participant unplugging a sensor or by a prepaid meter expiring. We expected the transition between these two temporal groupings to occur around the maximum time cluster of sensors reporting a true outage, about 100 s, as explored in Figure 4.7.

To test this hypothesis we considered the CDF of the time between an outage report and its next closest outage report, shown in Figure 5.3. In line with expectations, we saw a bimodal distribution of inter-sensor outage reporting times, with a transition between these

two modes occurring around 100s. This supported our hypothesis that true outages are distinguishable in the time domain.

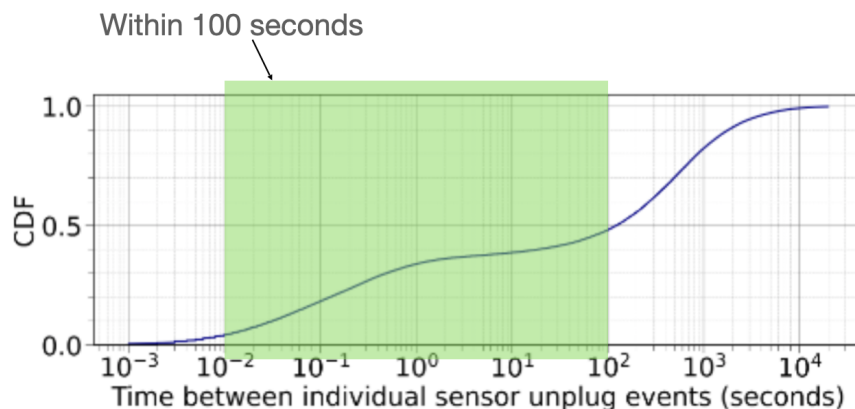

Figure 5.3: **Distribution of times between individual sensor unplug reports.** Over 40% of sensor unplugs occurred within 100 seconds ( $10^2$ ) of another unplug report. Additionally, the flat section in the middle of the graph indicates that sensor unplug reports occurred largely in two modes: those highly correlated in time with other unplug events, and those occurring much more randomly in time. We believe the temporal correlation is due to outages, and that the presence of this correlation can be used to separate true unplug events from those not caused by grid failure.

### Spatial Patterns with Sensor Reports

We expected most true outages to be spatially dense, as the spatial distribution of outages (especially small outages) is contiguous. Further, we did not expect to see many powered sensors within the extent of a detected outage, although some are possible due to generators and concave grid structures.

To test whether these properties were true in the PowerWatch dataset, we evaluated the number of powered sensors within the convex hull of the detected outages in Table 5.1. We found that, for all sizes of outages, the number of powered sensors within the convex hull was low, with no more than two powered sensors within the convex hull of any outage. The absence of powered sensors within the convex hull indicated that PowerWatch was sensing true outages.



Outage Size	Number of powered sensors within convex hull of an outage			
	Mean	Mean %	Max	Max %
3-10 Sensor Outages	0.03	0.33 %	2	20 %
10-30 Sensor Outages	0.09	0.51 %	2	11.76 %
30+ Sensor Outages	0.31	0.60 %	2	4.65 %

Table 5.1: **Number of powered sensors within the convex hull of an outage.** Across all sizes of outages, very few powered sensors—at most 2—fall within the convex hull of a detected outage. This gave us confidence that outages detected by PowerWatch were true outages as we would not expect sensors within an outage area to be powered beyond anomalies such as the presence of a generator or concave grid shapes where separately-powered infrastructure encroached into the convex hull of an outage.

	Same City	Same Feeder	Same TX
Percent co-reporting	4.5%	11.22%	11.64%
Correlation of voltage first differences	0.04	0.11	0.14

Table 5.2: **Co-reporting rates and voltage correlation scores of sensors under the same infrastructure.** We identified sensors under the same infrastructure using maps available for a subset of the grid. We found that sensors under the same infrastructure experience higher rates of outage co-reporting. Similarly, a correlation on the first-differences of the reported voltage increased for sensors located under more-local infrastructure. This provided evidence that electrical connections were discernible from our data stream, and that applications such as automated topology detection and subsequent root-cause analysis might be possible even without maps of the grid.

### Other Corroborating Signals

To further confirm that the outages extracted by our clustering algorithm were true outages, we examined other signals collected by PowerWatch for signs that an outage occurred. In Figure 5.4 we analyzed the voltage, frequency, and number of WiFi networks detected by sensors near an outage and by sensors not near, and thus not impacted by, the outage.

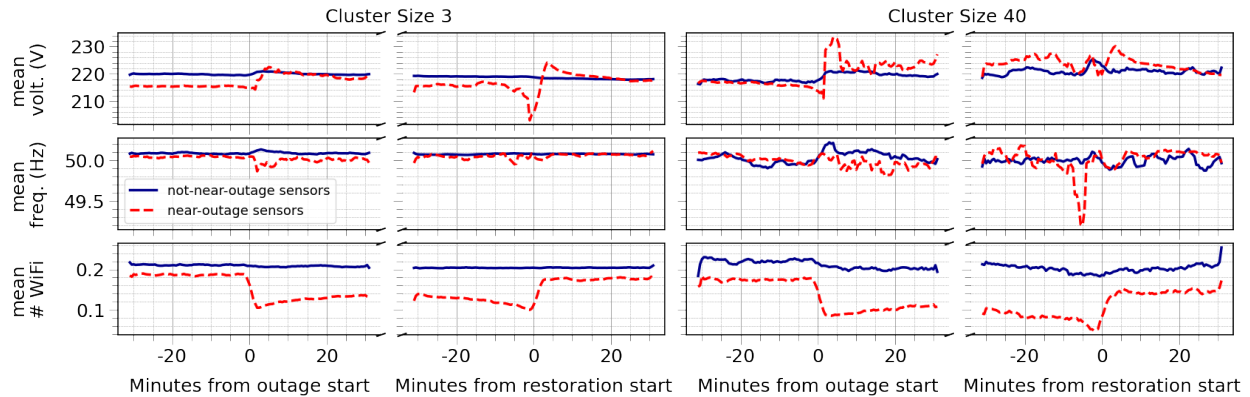

Figure 5.4: **Voltage, frequency, and number of WiFi networks before and after an outage.** We time-aligned and averaged the voltage, frequency, and number of WiFi networks observed by PowerWatch sensors during small (clusters of 3 sensors) and large (clusters of 40 sensors) power outages and restorations. Sensors were “near” an outage if they were in the same site as a sensor in the outage. Voltage and frequency were not measured for sensors experiencing an outage. As cluster size increased, we observed that sensors not near an outage detected changes in frequency and voltage in response to the change in demand associated with an outage or restoration event. The change in number of nearby WiFi signals was similar—decreasing on outage and increasing on restoration. Together these signals corroborated that outages detected by PowerWatch were true outages.

In sensors near small outage events, we saw a distinct rise in voltage after an outage and a distinct drop in voltage at the time of restoration. In larger outages, we saw similar effects impacting the entire network of sensors, as well as an increase in frequency throughout the entire network immediately after an outage. These changes in voltage and frequency were consistent with expectations about the impact of a sudden change in electric load, such as an outage, on voltage and frequency.

For both large and small outages, we saw a drop in the number of WiFi networks at the time of an outage and an increase in the number of WiFi networks at the time of a restoration, consistent with the loss of power to nearby WiFi access points.

### 5.1.2 Sampling Evaluation

While we did not have ground truth to tell us the exact accuracy of our outage-detection algorithms, the presence of both spatial and temporal relationships between reports collected by individual sensors in the field, described in Section 5.1.1 and Section 5.1.1, respectively, and the presence of expected voltage and frequency changes near an outage, described in Section 5.1.1, were best explained by a failure of the grid.

Using the presence of these relationships to bolster our assumption that outage events detected by PowerWatch were true outages, we moved forward to evaluate the ability of PowerWatch to sample the grid sufficiently to estimate S-SAIFI and S-SAIDI.

An optimal sampling strategy would have placed sensors such that they captured a representative view of the grid. Unfortunately, this could not be achieved easily in Accra, as there were few available high-resolution observations of the grid's performance and the available infrastructure maps were incomplete. Therefore, we evaluated our deployment methodology post-hoc, attempting to answer the following two questions: (1) whether we had deployed enough sensors to correctly detect and capture the extent of most high- and medium-voltage outages, and (2) whether we had deployed a sufficient subsample to trust our S-SAIDI and S-SAIFI calculations.

To answer these questions, we first compared our S-SAIFI measurements against the best available measurement of SAIFI, gathered by the ECG SCADA system, and then used both numerical and statistical methods to evaluate the predictive power of our subsample for estimating S-SAIDI.

### Comparing Against Ground Truth

We compared S-SAIFI against the SAIFI reported by the Electric Company of Ghana (ECG) in Q3 2018, the only SAIFI information we were able to collect. This ECG Q3 report included few low-voltage outages because there was no low-voltage automated monitoring. Some medium-voltage feeders were also not monitored by ECG's SCADA system. The ECG report was aggregated by district, allowing us to directly compare with the one district we had instrumented at the time of our analysis. Finally, ECG's calculation of SAIFI depended on ECG's knowledge of customer service connections in each district, but this data was not available to us.

To compare against the ECG Q3 report, in Figure 5.5 we compared the district-wide ECG-measured SAIFI to S-SAIFI measured by PowerWatch. The PowerWatch measurement was split into contributions from small clusters of fewer than ten sensors and large clusters of ten or more sensors. We expected the large clusters to correlate with the high- and medium-voltage outages in the ECG report and the small clusters to correlate with ECG-reported low-voltage outages.

When PowerWatch's S-SAIFI was calculated for larger outages, it closely matched the SAIFI reported by ECG. PowerWatch also detected a substantial number of smaller outages that were not detected by ECG. This data suggested ECG was under-sampling the grid and under-reporting smaller outages that affect customers.

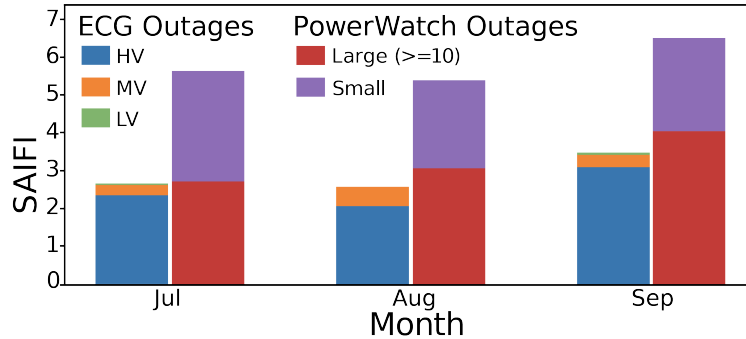

Figure 5.5: **Comparison of PowerWatch S-SAIFI to the utility-reported SAIFI in quarter 3 of 2018.** Our large outage clusters closely compared to the combined medium- and high-voltage SAIFI reported by ECG, while low-voltage outages (small outage clusters) sensed by PowerWatch greatly exceeded low-voltage SAIFI reported by ECG. This provides evidence of the extent of under-sampling by the utility at the low-voltage level of the grid.

### Combinatoric Method for Evaluating Coverage

While agreement with ECG’s SAIFI figures increased confidence in our sampling methodology, we further explored the power of our sample with statistical and numerical methods. We began by verifying that our deployment could cover a significant portion of the high- and medium-voltage grid.

We did not have accurate maps of the infrastructure in our deployment areas, but we did have the relative counts of infrastructure elements at each level of the grid. This provided sufficient information to construct a simple model that estimated the likelihood that our deployment would observe any given high- or medium-voltage failure.

To create this model, we assumed: (1) within each district, transformers were evenly distributed between substations, and (2) for every site, each transformer not yet instrumented had an equal chance of being selected. We then framed the coverage question as an urn problem that yielded the likelihood we had chosen at least one site from each substation (high voltage) and/or feeder (medium voltage) after selecting  $x$  sites, without replacement, in a given district.

The probability that our site excludes one or more substations is  $1 - P(\overline{S}_1 \cup \overline{S}_2 \cup \dots \cup \overline{S}_n)$ , where  $S_x$  represents the proposition that the sample includes the  $x^{\text{th}}$  site and  $\overline{S}_x$ , that the sample excludes that site.

Since the union of  $n$  propositions can be expressed as a sum of their intersections [302], we can write:

$$P\left(\bigcup_{i=1}^n A_i\right) = X_1 - X_2 + X_3 - \dots + (-1)^{n+1} X_n,$$

where  $X_k$ , in our case, is the sum, taken over all combinations of precisely  $k$  substations, of the probabilities that all those  $k$  substations were excluded from the sample.

Since we assume that each substation has the same number of sites beneath it and that sites are IID, this collapses to:

$$\binom{n}{1}P(\overline{S_1}) - \binom{n}{2}P(\overline{S_1} \cap \overline{S_2}) + \dots + (-1)^{n+1} \binom{n}{n}P(\overline{S_1} \cap \dots \cap \overline{S_n}),$$

where  $P(\overline{S_n}) = \binom{\text{transformers}}{x}^{-1} \binom{\text{transformers}}{\text{substations} \times x}^{\text{substations}-n}$ .

We find that of the many ways to choose 85 sites in Achimota ( $\binom{461}{85} \simeq 2.4 \times 10^{94}$ ), Dansoman ( $\binom{157}{38} \simeq 4.0 \times 10^{36}$ ), and Kaneshie ( $\binom{343}{28} \simeq 1.0 \times 10^{41}$ ), in all three districts, fewer than .01% excluded any substations, giving confidence that we should observe all high-voltage outages. Substituting feeders for substations in the equation above, we find that a random draw of 85 sites in Achimota will include all medium-voltage feeders with 44% probability.

### Dropout Study for Evaluating S-SAIDI

To determine whether our sample was large enough to capture the range of grid performance in Accra and estimate S-SAIDI, we conducted a similar dropout study to Section 5.1.2. We performed thirty rounds of dropout, randomly selecting sets of sites to remove and observing the effect of each site removal on S-SAIDI.

Had the distribution of outage durations changed significantly as we dropped out sites, we would have seen S-SAIDI vary widely, suggesting that we might be over- or under-sampling from parts of the grid with different interruption experiences. However, as seen in Figure 5.6, that was not the case. As we dropped out sites, there was a downward trend in the mean S-SAIDI, reflecting that the overall distribution of outage durations was asymmetric, with a tail containing a few long low-voltage outages; nevertheless, even as we dropped out 60+ sites, we did not see S-SAIDI deviate significantly from our unaltered dataset (41 hours).

This indicated that the PowerWatch deployment adequately sampled from the range of reliability present at our deployment sites.

As we removed sites, we also compared the distributions of outage durations between our full dataset and the sub-sample, using energy distance [303]. We used the implementation of the permutation test for equal distribution [304, 305] available from the *EUGENE* library [306]. The distributions did not significantly differ, meaning that the combined distribution did not change as a function of sites removed, further supporting that our sample was adequate to estimate S-SAIFI.

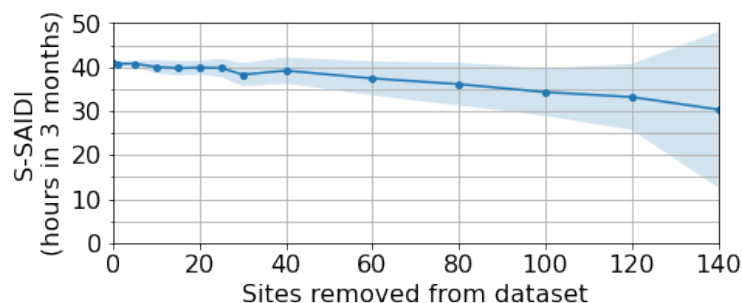

Figure 5.6: **Calculated S-SAIDI  $\pm$  one standard deviation as sites are removed from the dataset between June and August 2019.** To evaluate whether PowerWatch covered a sufficient sample of the grid to compute a representative S-SAIDI, we removed sites from the dataset in 30 rounds and observed the effect on S-SAIDI. We saw that as sites were removed, standard deviation of S-SAIDI remained relatively low and the mean value of S-SAIDI dropped slightly.

### Dropout Study for Evaluating Coverage

We verified our coverage model from our data by observing that if there was sufficient sensor coverage of a certain level of the grid, removing a small number of sensors from our dataset should not significantly impact either the number or size of outages detected at that level. We tested this hypothesis by performing a dropout study: removing sites from our dataset and observing the impact of the removals on the number and extent of outages detected by PowerWatch.

When removing a site in this study, we expected one of three outcomes: an outage might no longer be detected, the cluster size might become smaller, or a larger outage might become partitioned into two or more smaller outages. Without sufficient coverage, in each case we would expect that removing a single site would cause an outage to shrink by more than just the site dropped for the study; this would indicate that the removed site played a non-redundant role in our coverage.

We increasingly removed sites and counted the additionally-impacted sensors. Our results are shown in Figure 5.7.

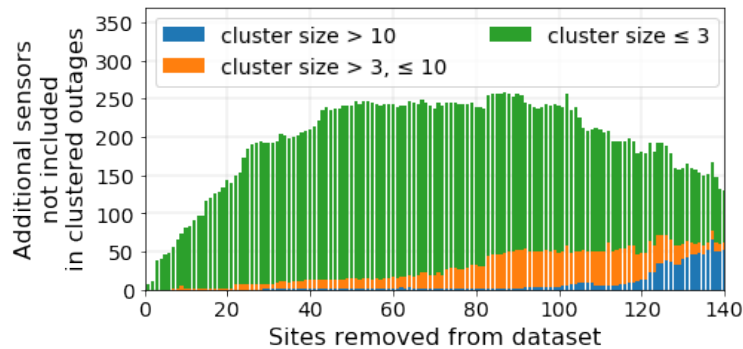

Figure 5.7: **Coverage dropout study from June to August 2019.** To evaluate the outage detection coverage of PowerWatch, we performed a dropout study, removing sites from our dataset and observing the impact of those removals. Specifically, we looked at the number of “additional sensors” that had been part of an outage cluster prior to the dropout, but which were no longer after a site was dropped. Intuitively, if removing a site causes many outages to either not be formed or shrink significantly in size, that would indicate that the site was essential to detect the correct extent of an outage and that we might be undersampling. During this time period, with no sites removed, there were 1,383 reports from sensors involved in outages of size  $\leq 3$ ; 1,030 reports from sensors involved in outages of size  $> 3$  and  $\leq 10$ ; and 3,969 reports from sensors involved in outages of size  $> 10$ . We observed that for outages containing more than three sensors, nearly 20 sites could be removed from our dataset before we started missing reports from additional sensors. This indicated we had deployed sufficient sensors to detect medium- and high-voltage outages, but, as expected, we did not have a high degree of coverage on the low-voltage network and needed to rely on sampling to estimate its reliability.

While, as we knew, our deployment was not dense enough to detect all low-voltage outages, our testing showed it was sufficient for estimating S-SAIDI and S-SAIFI. For all but the smallest outages, we had to remove more than 20 sites before the removed sites were no longer redundant. This suggested that we had sufficient coverage to cluster high- and medium-voltage outages in our deployment areas.

For small outages with three or fewer sensors, we saw signs of insufficient coverage immediately—as soon as a single site was removed from our dataset, small outages occurring outside of that site were no longer detected. This was unsurprising since, as shown in Figure 5.8, outages commonly occurred that only impacted parts of a site.



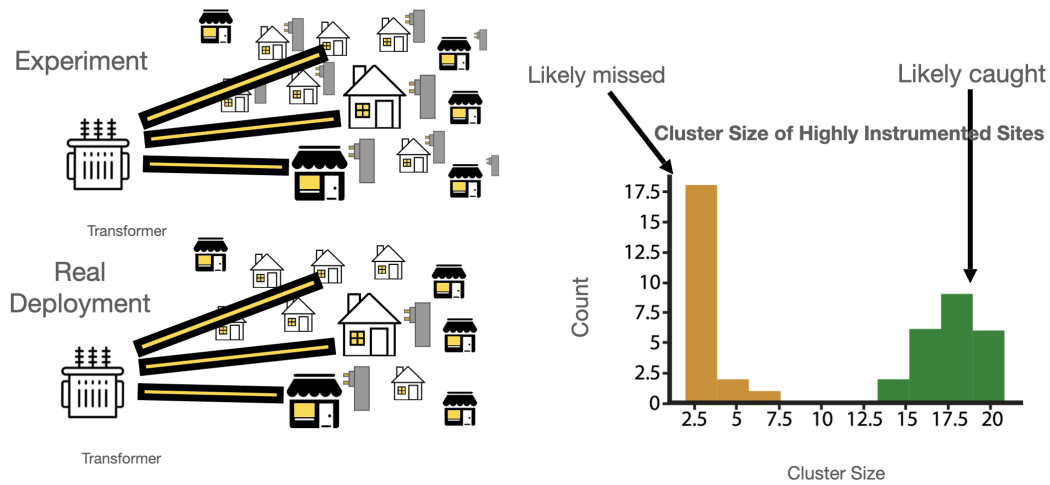

Figure 5.8: **Number of sensors reporting outages in a densely-instrumented site.** To better understand the limits of our low-voltage sampling, we deployed 25 sensors in a single site (under a single transformer) for two months and observed the results. We saw two groups of outages: larger outages, which impacted all or a significant portion of the site, and smaller outages, which might be a single phase or smaller. Larger outages comprised about 60% of the outages at this site, while smaller outages made up about 40%. This suggested that our primary deployment strategy of three sensors per site detected many, but not all, low-voltage outages.

## 5.2 Grid Data

In this section we describe some early findings about the performance of the grid. Much of the deeper analysis about grid performance is on-going and involves the researchers running the impact evaluations. The final reports generated for MCC about Ghana Power Compact, as well as aggregated data, are slated to be made public by MCC.

### 5.2.1 Original Deployment

From June 2018 to September 2019, using 427 PowerWatch sensors in Accra, We observed 3,123 outages with an average duration of 1.7 hours. The full set of outages is shown in Figure 5.9. Validating these outages is described in Section 5.1.1.

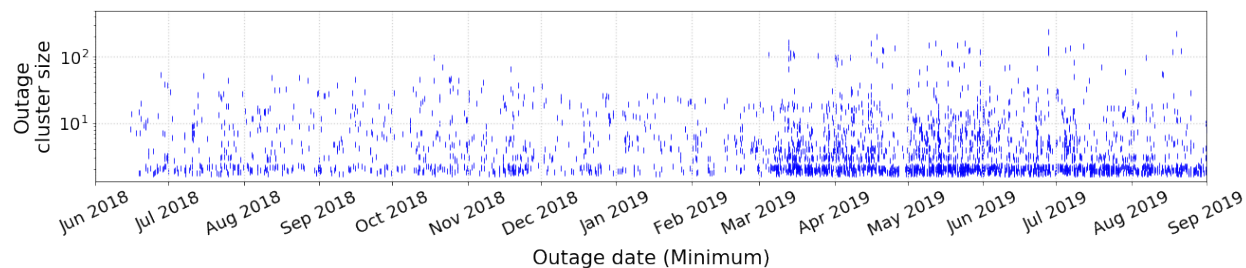

Figure 5.9: **All outages PowerWatch detected from June 2018 to September 2019.**

The outages are visualized on a timeline where the y axis shows the size of the outage (as the number of sensors impacted) on a log scale. Small perturbations are added to the location of the lines to make it easier to distinguish outages of the same size. PowerWatch detected 3,123 outages with an average duration of 1.7 hours. The longest outage lasted over 48 hours. The largest outage impacted a nearly-80 km<sup>2</sup> area, representing two-thirds of our deployed sensors.

In the original deployment of 427 PowerWatch devices, 18% of voltages sensed in Accra were outside the desired range. This would likely have a significant impact on appliances and contribute to the ubiquity of low-cost voltage stabilizers (see Figure 2.45) [52].

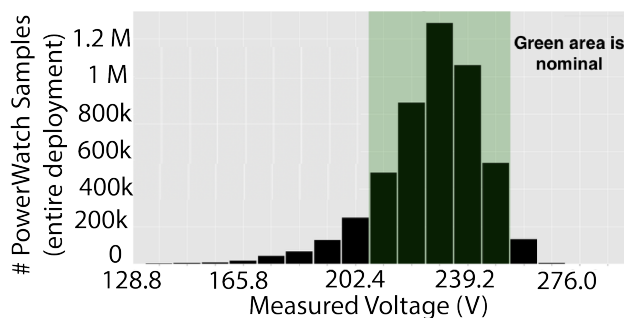

Figure 5.10: **The number of hours respondents experienced below the target voltage band (207 Vrms) per day.** These measurements contain both the periodic 2 minute measurements as well as measurements taken on outage and restoration across 420 PowerWatch detects that 18% of voltages sensed are outside the desired range.

We can similarly consider frequency across the participant population. ECG defines nominal frequency as 50 Hz and acceptable fluctuation as between 49.8 and 50.2 Hz [46]. In Figure 5.11, we show that 1.28% of measurements taken across the deployment are below 49.8 HZ and 25.45% of measurements are above 50.2 HZ. This sample shows clear problems with frequency stability that remain to be investigated in more detail.

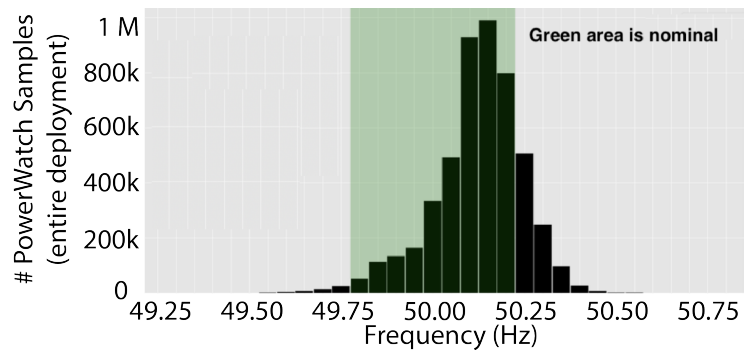

Figure 5.11: **Frequency in sample is unstable.** We see that while a majority of our samples are within the acceptable range around the nominal 50 HZ, there are still a significant number of readings that represent deviations beyond the acceptable range of 49.8 to 50.2 HZ.

## 5.2.2 Expanded, *n*Line Deployment

This work has expanded as part of the commercialization of PowerWatch with *n*Line. Commercialization allowed us to grow the deployment to around 1,400 sensors, which will continue running until 2023 (see Section 7.1). Figures 5.12, 5.13, and 5.11 contain data from this larger deployment as collected by *n*Line and delivered to UC Berkeley [69, 279, 307].

The average voltage per participant compared to the target voltage from the larger, *n*Line deployment is shown in Figure 5.12 and separated into districts [279]. Because this average may mask the low voltages experienced during peak demand, we also show the average number of hours per day below the target voltage range (207 Vrms) for each participant in Figure 5.13.

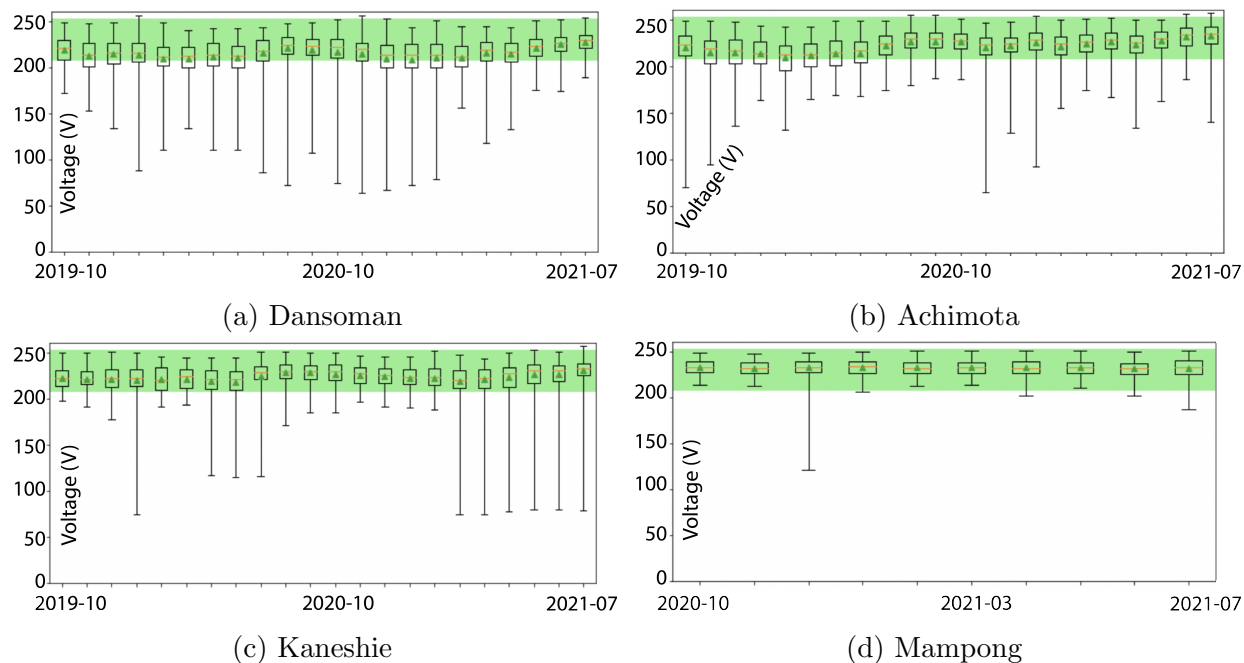

Figure 5.12: **The average voltage (V) for participants, by month, in each district of Accra with PowerWatch sensors.** Includes data collected by the initial PowerWatch deployments described in this work and in the 2019 COMPASS paper [308], text as well as additional data, analysis, and text produced by *nLine* from a commercial deployment of about 1,400 PowerWatch in Accra [279, 290]. Sensor voltage levels are averaged per participant, then collected and plotted as box plots for each month in each district. Outlier bars represent minimum and maximum average voltages, the green triangle represents the mean of the dataset, and the orange line represents the median. Seasonal trends are observed, as well as long-term voltage level improvements in Achimota and Kaneshie, especially for the lower quartile of participants. More analysis is necessary to attribute the underlying cause of these improvements.

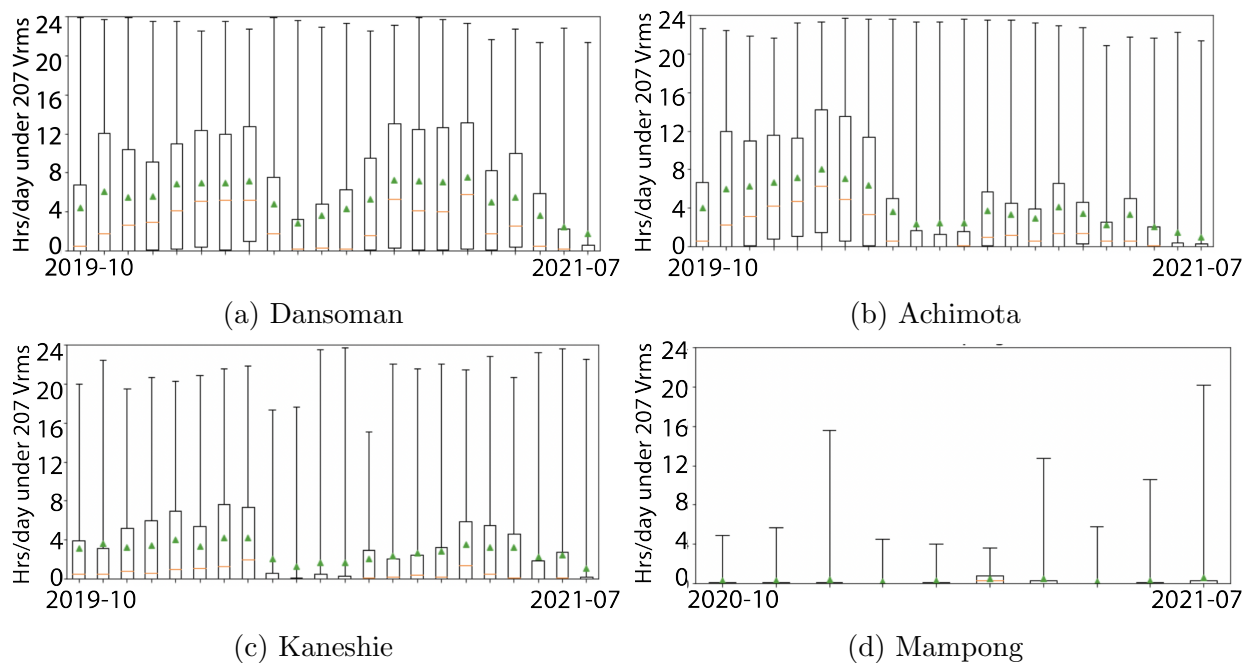

Figure 5.13: **Daily Hours Undervoltage per Respondent (hours below 207 Vrms) vs Time (year-month) by District of Accra** This includes data collected by the initial PowerWatch deployments described in this work and in the COMPASS 2019 paper [308] textitas well as additional data, analysis, and text produced by nLine from a commercial deployment of around 1400 PowerWatch in Accra [279, 290]. The average number of hours per day under the target voltage (207 Vrms) experienced by participants every month in each district. The number of hours per day under target voltage is calculated every day for each participant, then collected and plotted as box plots each month in each district. Outlier bars represent minimum and maximum average hours, the green triangle represents the mean, and the orange line represents the median of the dataset. Hours under target voltage better captures the performance of the grid under peak load than the average voltage. As with the average voltage, seasonal trends are observed, as well as long-term voltage stability improvements in Achimota and Kaneshie. More analysis is necessary to attribute the underlying cause of these improvements. Mampong has notably stable voltage with the exception of a few outliers, with nearly all Mampong participants receiving voltage consistently within the target range.

### 5.2.3 Fairness

ECG segments Accra into 18 districts, calculates SAIDI and SAIFI by district for internal purposes, and aggregates SAIDI and SAIFI for the entire city for public release. PowerWatch provides an opportunity to study electricity reliability at much higher resolution. Further, because this data is collected independently of the utility and the sample is roughly random, this dataset is well suited for exploring questions related to individual reliability and fairness.

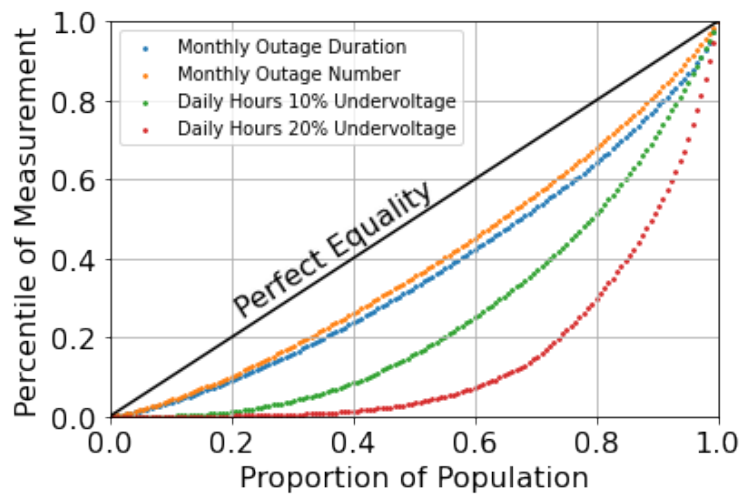

Figure 5.14: **Lorenz curves show us power-quality fairness across our participants.** Work in progress from “Disaggregated power quality data reveal systemic inequality” by Adkins *et al.* (including myself) [309]. Lorenz curves for the four power-reliability and -quality metrics across the analysis sites exhibit inequality similar to those reported in other countries, and over larger geographic regions in Sub-Saharan Africa [78]. We note that as power quality worsens, so to does inequality of that measurement. We hypothesize that this is due to low power quality consistently impacting specific pieces of infrastructure.

The following section describes work in progress by myself and four other researchers (engineers and economists) [309].

We can begin to use disaggregated data collected by PowerWatch and the Ghana Statistical Services to explore if there is systemic inequality across neighborhoods (Figure 5.14 and Figure 5.15). We find that reliability, especially voltage quality, is heterogeneous. We can then explore if reliability and voltage quality correlate with socioeconomic characteristics (see Table 5.3) [309, 310].

We can also quantify the effect of the aggregation level of SAIDI and SAIFI on masking potentially important heterogeneity [72, 81, 309]. Aggregation can have significant economic and political impacts. For example, improving reliability in the wealthiest areas can achieve the same aggregate as improving reliability in the poorest areas. Policy makers thus lack an incentive to address power quality in poor areas.

We propose the term “reliability subclimate” and track the loss of these subclimates across different aggregation levels. This early result is shown in Figure 5.16. This type of analysis could help inform future metric designs more appropriate for higher-frequency data than SAIDI and SAIFI [30, 81].

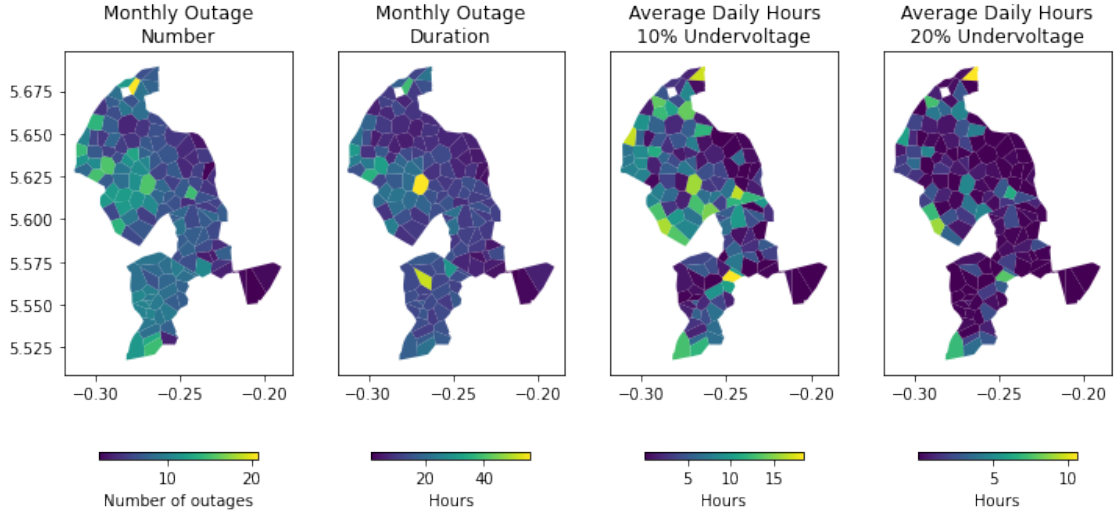

Figure 5.15: **Heterogeneity in socioeconomic and power-quality indicators.** *Work in progress from “Disaggregated power quality data reveal systemic inequality” by Adkins et al. (including myself) [309].* Examples of power reliability, population, and demographic data split into analysis sites. The presence of inequality in power-reliability and -quality metrics is clear, and some visual correlation can be drawn between power measurements and demographic indicators.

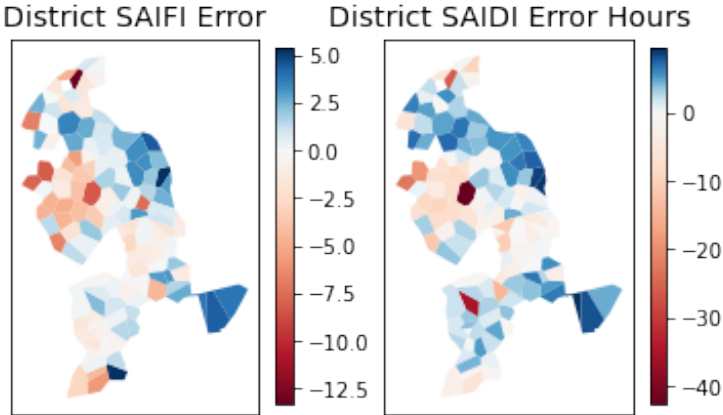

Figure 5.16: **Exploring “reliability climates” and the impact of aggregated metrics like SAIDI and SAIFI.** *Work in progress from “Disaggregated power quality data reveal systemic inequality,” by Adkins et al. (including myself) [309].* This figure shows the error between per-site number and duration of outages and SAIFI and SAIDI metrics aggregated to the district level. We note that the distribution of sites below the mean is wider than those above the mean, indicating that a relatively small proportion of the population experiences significantly worse power.



Analysis Metric	Power Reliability Metric							
	Outage Frequency		Outage Duration		Daily Hours Undervoltage 10%		Daily Hours Undervoltage 20%	
	75-25	Gini	75-25	Gini	75-25	Gini	75-25	Gini
Census population	2.59	0.20	2.89	0.23	22.27	0.45	212.96	0.66
Number electricity meters	2.76	0.21	3.17	0.25	24.38	0.47	263.09	0.67
Number buildings	2.79	0.22	3.50	0.27	29.04	0.49	375.96	0.68
WorldPop population	2.93	0.22	3.33	0.27	50.55	0.53	549.21	0.73
Population density	0.83	-0.02	0.99	0.00	1.00	0.05	0.69	0.01
Less than high school education*	1.22	0.04	1.18	0.03	2.42	0.16	5.99	0.23
Does not own computer*	1.14	0.03	1.12	0.02	2.17	0.15	3.69	0.20
Non-professional occupation*	1.08	0.01	1.07	0.00	1.87	0.15	2.84	0.20
Illiterate*	0.99	-0.00	0.93	-0.03	1.41	0.08	1.55	0.11
Cooks without gas/electricity*	1.14	0.02	1.07	0.00	1.63	0.10	2.79	0.18
Blue collar occupation*	1.18	0.02	1.14	0.03	2.37	0.14	4.64	0.16
Christian*	1.05	0.01	1.03	0.01	1.00	-0.04	1.12	-0.03
Animist*	0.99	0.02	0.95	0.01	0.90	0.06	0.86	0.11
Muslim*	1.01	-0.02	1.10	-0.01	0.91	0.03	0.65	-0.02

Table 5.3: **Equality of power reliability and quality metrics when comparing across four population weights and various demographic metrics.** *Work in progress from “Disaggregated power quality data reveal systemic inequality,” by Adkins et al. (including myself) [309].* We evaluate the ratio between the highest and lowest quartiles (75-25) and the Gini index for four population weights and a variety of demographic metrics. For all demographic metrics, sites are weighted by census population, then ordered by the demographic metric before performing the analysis. Therefore, the census population results serve as a baseline for all demographic metrics further down the table (marked with a \*), and no demographic metric can exceed the inequality of this first row. We pull out several key findings from this analysis: (1) power quality is more unequal than power reliability; (2) low levels of inequality are observed in our dataset with respect to number and duration of outages; and (3) demographic metrics that are intuitive predictors of wealth also exhibit significant inequality with respect to undervoltage.

### 5.2.4 PowerWatch Data as Ground Truth

With the accuracy of PowerWatch established, it opens the door for PowerWatch to provide ground truth for other sensors and measurement methods. With PowerWatch deployed as ground truth, the data from higher-resolution sensors, such as micro-PMUs, or side-channel measurements of the grid, such as satellite nightlights [122, 161] or internet scanning [154, 162], might be more accurately transformed or interpreted to help improve power reliability. Early results combining satellite nightlights with PowerWatch data show promising improvements in accuracy when using satellite nightlights to observe grid stability[166].

## 5.3 Summary

In this chapter, I presented data about the performance of the PowerWatch deployment itself and data that PowerWatch gathered about the performance of the grid. I demonstrated that we had deployed enough sensors to correctly detect and capture the extent of most

high- and medium-voltage outages and that we had deployed a sufficient subsample to trust our S-SAIDI and S-SAIFI calculation. I then presented results from the deployment about outages and voltage fluctuations in Accra. Finally, I concluded this chapter by outlining the potential for using PowerWatch data to further fairness in energy reliability and as ground truth for other reliability measurements.

## Chapter 6

# Deployment Retrospective

In this Chapter, I describe the lessons learned within the context of three PowerWatch deployments between May 2018 and June 2019. I break up lessons by scale, as each scale uncovered its own complexities and challenges, captured in Table 6.1.

Category	Small Scale	Medium Scale	Large Scale
Organizational	<ul style="list-style-type: none"> <li>Local SIM procurement</li> </ul>	<ul style="list-style-type: none"> <li>Hiring local staff</li> <li>Contracting local firms</li> <li>Paying outside free tier</li> </ul>	
Technical	<ul style="list-style-type: none"> <li>Global SIM operation</li> </ul>	<ul style="list-style-type: none"> <li>Custom hardware</li> <li>Firmware development</li> <li>App development</li> <li>SIM operation</li> </ul>	<ul style="list-style-type: none"> <li>Assembly</li> <li>Site selection</li> </ul>
Operational	<ul style="list-style-type: none"> <li>SIM top-up</li> </ul>	<ul style="list-style-type: none"> <li>Transportation</li> <li>Site selection</li> <li>Incentivizing participants</li> <li>Data sharing</li> </ul>	<ul style="list-style-type: none"> <li>Deployment management</li> </ul>
Cultural	<ul style="list-style-type: none"> <li>Learning local context</li> </ul>	<ul style="list-style-type: none"> <li>Local leader approval</li> <li>Survey design</li> </ul>	<ul style="list-style-type: none"> <li>Unexpected phone usages</li> </ul>

**Table 6.1: Pain points of different scales.** At each scale of deployment we ran into pain points—complexities that we perceived to be more difficult than would be expected by a simple increase in deployment size. We encountered many at the transition to medium scale, when local capacity needed to be built, expenses to operate the technology increased, lack of technical reliability became much more apparent, and systems that could once be human-operated had to be automated. Large scale brought new problems, the most notable being the inability to track deployment state without automated deployment management tools.

There is a strong tradition of research focusing on meta-insights gained from deploying information and communication technologies (ICT) for development. Lessons learned from others' experiences overlap with many of the lessons from our deployments, including recommendations to co-design with local practitioners or participants to increase the likelihood a

technology functions as intended in the local context [311–316]; reports on the difficulty of updating, debugging, and monitoring systems with unreliable communication infrastructure [312–315, 317–319]; emphasis on staffing and adequately training a local team to ensure a high quality deployment [312–315, 317, 320]; and techniques that can be taken to ensure the sustainability of a technology [314, 315, 319, 320].

Our work expands on prior work by presenting our experiences and lessons learned as a function of scale, emphasizing that as scale increases, challenges related to incorrectly managing an unfamiliar local context have a higher impact on the quality of the deployment and are harder to address post hoc.

Our deployment, where sensors were installed at participants homes in urban and peri-urban environments, is a bit unusual in ICT for development. Many works exist within rural contexts [312, 314, 315, 319, 321], contain a dependence on user interaction [312, 314, 315, 321], or have a deployment context within larger organizations [313, 322, 323]. Our experiences capture one of the first road maps for independent, in-home, non-rural, continuous sensing in the development context. I conclude this chapter by describing the risks and rewards of conducting interdisciplinary work like this.

## 6.1 Small-Scale Pilot

The first activity we performed was a deployment of 15 PowerWatch sensors and 5 DumsorWatch apps. The goal of this deployment was to validate that the technology could reliably sense power outages and transmit this information over many weeks in the field. We performed no survey work and no site selection work for the small-scale pilot. The primary challenges were related to producing the technology, connecting the PowerWatch sensors to the cellular network, and building enough local capacity for PowerWatch and DumsorWatch to be deployed.

In addition to testing the technology, we built relationships to support future scaling. We reached out to local stakeholders for feedback on our assumptions underlying the designs of our sensors. We were able to speak with engineers and managers at ECG, the Millennium Development Authority (MiDA), and various independent contractors involved in the Ghana Power Compact. Further, we received data from ECG that helped validate our hypothesis that the measurements of SAIDI and SAIFI could benefit from higher-resolution measurements.

Even at small scale, we experienced unanticipated technical challenges. To get PowerWatch on the cellular network, we initially attempted to use the global Particle IoT SIM cards that were included with our cellular modems. We found their connection to be much spottier than a local SIM, and Particle support had little insight into the nature of the underlying problem. Because of this, we decided to use SIM cards from the largest local carrier (MTN), but we encountered a 3 SIM-card-per-person limit upon purchase. Although we were able to get around this by visiting different stores, purchasing SIM cards in stores was not an option for future scale.

Another challenge was keeping SIM cards functional. Prepaid SIM cards require the purchase of data plans for the SIM, which is done using an Unstructured Supplementary Service Data (USSD) application that can only be run from within Ghana; there is no web-based account management or top-up available. We initially solved this problem by purchasing a 90-day data plan, the longest available. This was sufficient for our small-scale pilot but would not be viable for future deployments.

## 6.2 Medium-Scale Deployment

In our medium-scale deployment, 1,981 individuals downloaded the DumsorWatch app and 165 individuals installed PowerWatch sensors. Deployment activities took around one week for training, two weeks to survey participants and deploy PowerWatch sensors, and then another three weeks to conduct short surveys and install DumsorWatch apps. We ran this deployment for seven months.

Unlike the small-scale deployment, this scale required implementing our full deployment design, including hiring a full local implementing team, recruiting and incentivizing participants, choosing deployment sites, extracting value from the data streams, and fully implementing the survey instruments. The following subsections describe the changes experienced as we increased from small- to medium-scale, paying particular attention to the challenges extracted in Table 6.1.

### 6.2.1 Organizational Challenges

The medium-scale deployment was large enough that the financial responsibilities were significant. We had to start managing multiple monthly payments for cloud services and payments to local companies for cell network connectivity and incentive transfers. Most of this increase in complexity was ultimately handled by staff at the University of California, Berkeley, but establishing payment schedules took a large effort from the research team. The University still missed payments, causing frequent delays, especially when payment was needed in a short time frame (1-2 weeks).

Because prepaid SIM cards were not viable or purchasable through retail channels at the quantities now needed, we had to enter into a contract with the cellular provider, MTN. Despite multiple meetings, MTN was initially quite hesitant to provide the SIM cards due to concerns about whether our application was legitimate. We were ultimately able to overcome these concerns by visiting the MTN main office in our University-themed apparel, giving a technical demo, and answering questions about our backgrounds and affiliations.

At this scale, many of the cloud-based software services our systems were built upon were no longer eligible for free-tier usage. For one service in particular, this meant that we were going to be unable to continue with this technology without signing a multi-year contract that extended beyond the length of the deployment. We found a workaround for this deployment

by applying to a special program within the company, but future deployments would require more carefully considering pricing models for ancillary services.

### 6.2.2 Cultural Challenges

Visiting households and businesses required permission from the relevant local district government assemblies. We wrote letters of introduction and visited these assemblies to receive permissions, and this increased trust by participants.

Further, we worked with the field officers to refine the design of our survey. During training activities the field officers had the opportunity to react to survey questions and provide suggestions for improvement. We used this feedback to make the survey as appropriate and in line with our research objectives as possible. As field officers entered the field, we received continuous feedback on ways to improve our survey and deployment procedures.

Finally, we learned that a uniform would be valuable for building trust. We provided DumsorWatch branded shirts and backpacks for the field officers so they would project an official appearance when approaching participants. These are shown in Figure 3.9.

### 6.2.3 Technical Challenges

At this scale, frequently visiting sensors for debugging was no longer feasible, so we prioritized sensor stability and remote failure detection and mitigation. This work included developing a full, custom embedded-system for PowerWatch (shown in Figure 4.3 A.2) with built-in mechanisms to reset the device on failure. Additionally, we spent considerable time implementing and testing more reliable firmware, incorporating error-collection libraries, and building dashboards displaying the health of both PowerWatch and DumsorWatch. We assembled this version of PowerWatch over three days with the help of a team of fellow graduate students.

Another technical challenge was dealing with mobile phone heterogeneity. We had little insight into the types of mobile phones and versions of Android among our participants. Thus, we implemented DumsorWatch to be backwards compatible to 4.0.0, a version of Android no longer supported by Google [324]. Backward compatibility took considerable engineering effort, and had side effects such as making DumsorWatch incompatible with many modern Google cloud services, including Google’s bug tracking tools.

Finally, we experienced two challenges related to SIM card operations. First, we could not identify a way to test PowerWatch sensors in the United States using the MTN postpaid SIM cards. This led us to build a United States-based testbed before traveling to Ghana, and to perform final assembly and quality assurance in Ghana in the days leading up to the deployment. Second, MTN had not correctly provisioned the SIM cards it sold us and the cards could not access the network. This took multiple days of interacting MTN to fix, delaying deployment and making clear that MTN was not well-suited to manage large fleets of SIM cards assigned to an individual customer.

These problems led us to continue exploring global SIM card options, and we tested Twilio SIM cards during this deployment. We found they had similar problems to the Particle SIMs previously evaluated. We contacted Twilio support and found their documented list of Ghanaian network operators was out of date, making unlisted providers unavailable on the Twilio network and leading to a drop in service quality.

### 6.2.4 Operational Challenges

The operational challenges started with transporting our equipment to Ghana. We carried the PowerWatch sensors, power strips (handed out to participants as incentives), and equipment for field officers into Ghana in suitcases over multiple flights from the United States. PowerWatch sensors were carried on the plane whenever possible to minimize the chance the suitcase would be lost in baggage. This method of transportation worked but led to multiple confrontations with airport security in the United States and customs in Ghana. We were able to overcome these hurdles by providing documentation of our project and our letters of invitation, but this transportation method depended on our team being persistent and prepared with documentation, unwrapping all equipment, labeling all equipment with tags indicating it was property of the University of California and not for resale, and only traveling with a few suitcases at a time.

To implement our site-selection methodology we needed GIS maps of the grid. We worked with stakeholders to determine where the best maps of the grid were maintained, and obtained these maps after repeated visits to stakeholder offices. These maps were not perfect, but they included enough detail for our site-selection procedures.

At this scale it was not practical to transfer recurring incentives to participants by hand. We had anticipated this problem and designed an incentive management system to support this goal. The system was designed to capture user behavior (e.g., whether they completed a survey, installed DumsorWatch, kept DumsorWatch installed, etc.) and transfer airtime automatically. The actual transfer of airtime took place through a third-party API. We developed and tested the incentive transfer system alongside our deployment activities.

Finally, at this scale, the data collected was significant enough that stakeholders in the region began requesting access to the data. Because many of these stakeholders would be responsible for helping the project achieve further scale, we made an effort to develop and share anonymized visualizations and summary statistics.

### 6.2.5 Failures and Missteps

If I were to do this work again, I would have sketched out all moving parts of the deployment, including all stakeholders, and diagrammed the frequency and type of communication they require. This likely would have uncovered and allowed us to anticipate problems outside of the technical work before experiencing them.

One class of failures experienced at medium scale was attributable to simple technical immaturity. For example, we found bugs in both our automated incentive transfer system



and the third-party payment API used to incentivize participants. This API was provided by a small company, but we believed it to be the best option for transferring airtime in Ghana. Both technologies should have been more aggressively tested prior to launch.

The pain points at medium scale showed a clear need for a fleet of testing phones in Ghana against which we could implement continuous integration and automated testing of incentive transfers. However, as with most hardware-based testing systems, this was difficult to implement in practice. As a result, most participants experienced late payments, which we hypothesize caused the significant number of DumsorWatch uninstalls shown in Figure 6.1b.

du

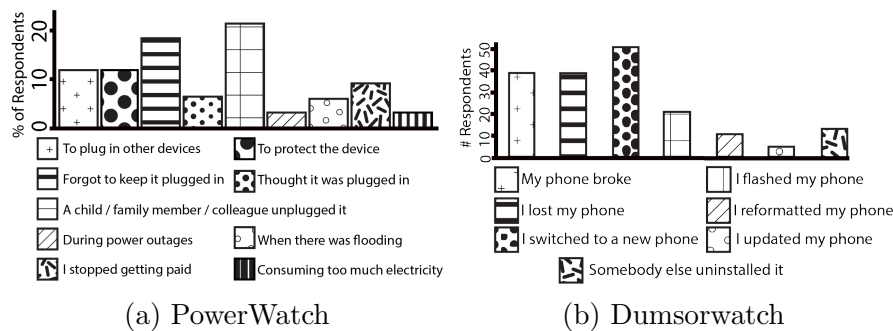

Figure 6.1: **Why sensors were uninstalled**

As described in Chapter 3 our deployment had lots of state saved in lots of places, making it difficult to manage without building up deployment management systems, shown in Figure 3.4. Prior to our deployment management systems, surveys containing participant and deployment placement information were uploaded by the field team and downloaded by the research team periodically. The surveys were then cleaned and provided as CSV files to the individual engineer handling either sensor management or the payment system. Errors in the surveys (common due to typos in long unique IDs) were communicated back to the field team via phone calls and emails, and the resultant corrections in the field would not always be communicated back to the research team. This was ineffective while we were in Ghana and completely collapsed after we returned and could not focus full-time on deployment upkeep. As devices moved, we received multiple, conflicting reports about their current location. As a result, we permanently lost the state of some devices; five devices are still completely unaccounted for. These issues continued to make data analysis, sensor debugging, and correlation of problems with a specific participant nearly impossible to manage for the devices in this deployment.

### 6.3 Large-Scale Deployment

Beginning in February 2019, we built on our medium-scale deployment, adding 292 new PowerWatch devices and 1,419 new app downloads in three districts of Accra. This resulted in a full deployment of 457 PowerWatch devices and 3,400 DumsorWatch apps.

### 6.3.1 Organizational and Cultural Challenges

The organizational and cultural challenges did not change from the medium-scale deployment. Existing service contracts were sufficient or easily renegotiated, and the field team scaled linearly with the size of deployment.

### 6.3.2 Technical Challenges

The increased number and technical complexity of the new PowerWatch sensors constructed for the large-scale deployment precluded relying on other graduate students to help assemble devices as we did with the medium-scale deployment; however, the scale was still too small to be cost- or time-effective for contracted assembly. Our solution was to build our own assembly line by hiring 10 undergraduates to assemble devices. This required developing discrete steps, trainings, and quality-assurance techniques. The PowerWatch assembly line can be seen in Figure 6.2. Ultimately this assembly line produced the 295 PowerWatch sensors over four weeks and 110 person-hours of total work, with a 97.6% yield rate, which was far better than we were anticipating. Although this activity was successful, difficulties in recruiting and paying students hourly, and challenges with the academic schedule, ensured that this model would not scale much beyond 400 units.



Figure 6.2: **The PowerWatch assembly line.** Over the course of four weeks, 10 undergraduates worked 110 person-hours to assemble 295 PowerWatch sensors. They were responsible for assembling the plug; screwing together the enclosure; attaching the circuit board; connecting the battery, antenna, SIM card and SD card; and provisioning the device with base firmware. They worked from team-created assembly manuals and training materials.

Similarly, the larger number of sites meant site selection was no longer easy to do by hand. This led us to develop a GIS-based site-selection system, using the GIS maps of the grid collected from utility. The maps had to be cleaned, and then the system could generate sites based on our site-selection rules, label those sites, and create site location images for the field officers. This system was designed and maintained by a dedicated graduate student.

We continued exploring global SIM card options, using Aeris SIM cards for a subset of this deployment. We found that, due to Aeris' focus on global IoT connectivity and the number of customers they had in Sub-Saharan Africa, Aeris SIM cards worked significantly better than Particle or Twilio SIMs in Ghana.

### 6.3.3 Operational Challenges

The biggest change for the large-scale deployment was addressing the operational issues described in Section 6.2.5, such as managing distributed state. We addressed these issues by designing custom deployment management software.

#### Interdisciplinary work is rewarding and risky

When first approached with the opportunity to run a deployment at scale in Accra, I was naively confident. I thought I could decompose the larger task of a deployment into subsystems, each of which could be effectively engineered, and I put together an incredible team to execute the vision and plan. However, in practice, well-designed subsystems are not enough. Critically, we overlooked the human links between these systems, leading to problems not due to sensors malfunctioning but instead from the complexities of sensor placement and upkeep as well as differences in incentives across our research team and their employing organizations.

#### The University

One of our primary operational challenges was interfacing with the University system. The administrative capacity of the University system was inadequate when it came to paying for the disparate set of services necessary to perform our deployment. Our university policy dictated a single day turn-around on wire transfers, but in practice this time was often over 15 days. Additionally, contracting with new companies, especially companies with which the University had never contracted before (the vast majority), often took months.

If we were to plan for this deployment again, we would build in significantly more time for delays and send more money than necessary to our stakeholders in Ghana early in the deployment so that they could better handle later delays in payment from the University. Still, it would be difficult to imagine the deployment running at its described pace without personal credit being extended by the research team. An alternative might be to partner with a more agile external organization to manage many of the relationships and payments.

## 6.4 Summary

In this chapter, I presented the challenges and lessons from each scale of our three PowerWatch deployments. In the first section, I described our small-scale pilot, where we experienced organizational, technical, and operational challenges with procuring and operating local SIMs, and cultural challenges as we learned the local context.

In the second section, I described our medium-scale deployment. At this scale, we experienced organizational challenges with hiring local staff, contracting with local companies, and growing beyond the free tier of our software services. We also faced technical challenges with developing our hardware, firmware, and app and with operating SIMs; operational challenges with transporting the sensors to Accra, selecting deployment sites, incentivising our participants to keep the sensors installed in their households and businesses, and sharing the data we gathered. We experienced cultural challenges with securing approval from local area leaders, refining our survey, and building participant trust with our field officers. Finally, I outlined some lessons learned from technical and deployment-management missteps during the medium-scale deployment.

In the third section, I described lessons learned from our large-scale deployment. While the organizational and cultural challenges did not change much from the medium scale, we faced new technical challenges with sensor assembly and deployment site selection, as well as operational challenges with our deployment-management system. In the final section, I described how the incentives and interfaces involved in interdisciplinary work like this pose challenges but also offer valuable opportunities for progressing important work. In the final chapter, I will discuss how our collection of lessons learned and the software meta-tools developed we developed may help inform future sensor system deployments.

# Chapter 7

## The Road Ahead

Having demonstrated a viable, cost-effective device, data-management platform, and deployment methodology for utility-independent power grid performance characterization, I will now describe the road ahead. This includes a short discussion of the logic behind the decision to commercialize this work, a short summary of new applications enabled by PowerWatch, and a vision for the future.

### 7.1 *n*Line

In late 2019 we received funding to scale the PowerWatch deployment in Accra to 1,400 sensors; this was the tipping point for our work outgrowing the lab. My advisor Professor Prabal Dutta, Joshua Adkins (a fellow PhD student in my research lab), and I founded *n*Line to “measure and improve the performance of critical infrastructure in order to meet the needs of all people and support sustainable, inclusive economic development.”

The name *n*Line pays homage to a common technique used to evaluate the impact of interventions, where one-time pre-intervention “*baseline*”, mid-intervention “*midline*”, and post-intervention “*endline*” measurements are taken. Data is rarely collected for impact evaluations outside these infrequent and discrete measurement windows. Borrowing our italic *n* from the common notation for sample size, the name *n*Line represents that we provide an “*n-line*” measurement—a continuous data stream.

At *n*Line, we continue the work in this dissertation by designing sensors and cloud services to determine when the grid fails, why it fails, and report what we learn back to utilities, regulators, researchers, investors, and ratepayers. More generally, we are working toward a general-purpose, infrastructure-quality monitoring solution that can be deployed quickly and for variable lengths of time and can operate either in collaboration with or independently from utility companies.

*n*Line has nearly 10 full-time data scientists, Masters of Public Policy, and project managers across three countries. We are currently working in partnership with utilities, donors, and research institutions to quantify power reliability in Ghana, Kenya, Sierra Leone,

Rwanda, the Democratic Republic of the Congo, and Nigeria. I am very excited to continue on as the CEO of *nLine* post-graduation.

## 7.2 New Applications

Since publishing our results, I have been approached at *nLine* by various stakeholders who are interested in PowerWatch for targeted measurements. PowerWatch has remained well suited for a variety of applications because it:

1. *can be installed without utility participation.* This reduces administrative overhead in coordinating with the utility for data and access to their physical property.
2. *can be installed quickly and managed easily.* Sensors can be carried into country, field officers can be trained quickly, the sensor installs in seconds, and deployment management is built-in as a first-order requirement.
3. *can be easily targeted.* Sites can be selected arbitrarily.
4. *can be moved.* Sensors can be reused, reducing cost.

While it remains future work to fully enumerate potential applications enabled by these freedoms, I do want to quickly mention four that are most exciting to me at the moment.

### 7.2.1 Health Care

Health care provisioning and basic services rely heavily on affordable and reliable electricity, and a lack of data on power quality and reliability hinders efforts to address the temperature-dependent supply chain, or cold chain, of COVID-19 vaccines in Africa.

One in four primary healthcare facilities in Sub-Saharan Africa lack access to power and more suffer from debilitating power outages. In late 2021, a group of 14 organizations launched a Multilateral Energy Compact for Health Facility Electrification, aimed at improving the electricity in over 25,000 clinics across sub-Saharan Africa, South Asia, and South-East Asia, each one serving an average of 5 to 10 thousand people. [325–327].

Along with P.I.s Daniel Kammen (UC Berkeley) and Rebecca Hernandez (UC Davis), *nLine* just received a competitive 2021 CITRIS Seed Awards for our proposal “The power of health in Africa: A novel data collection approach for analyzing how distributed energy systems support vaccine cold chain resilience.” In this work we will use PowerWatch to measure grid uptime at 100 clinics by deploying multiple PowerWatch sensors per building. Efforts will focus on locations in Rwanda and the Democratic Republic of the Congo. By collecting and monitoring spatiotemporal data continuously, this project can help electrification planners better rationalize infrastructure deployments and assist health sector professionals in identifying cold chain vulnerabilities.

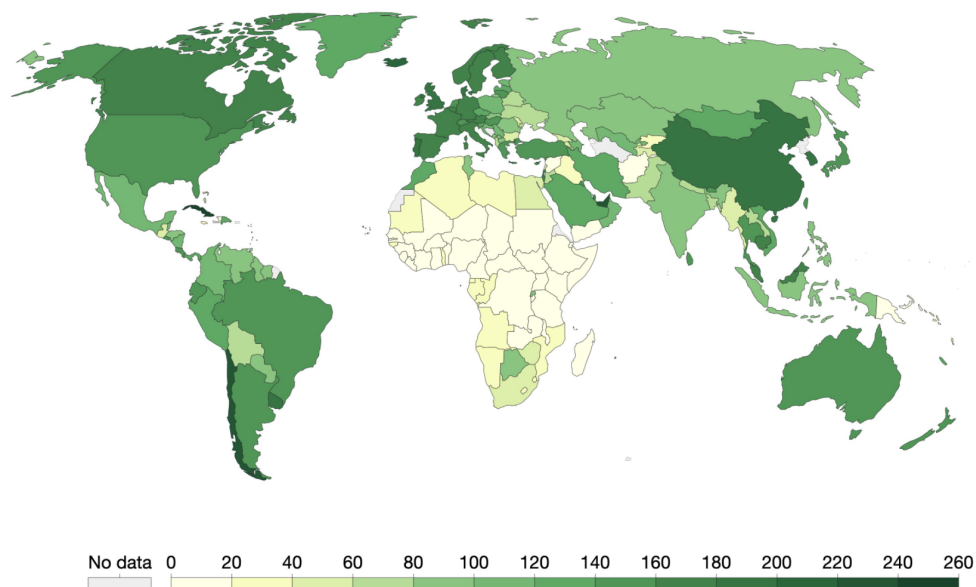

Figure 7.1: **COVID-19 vaccine doses administered per 100 people.** *Figure is a screen capture from “Our World In Data” [328].* The vaccination gap across Africa is striking and brings to mind similar patterns in figures about grid reliability like Figure 2.51 and Figure 2.12.

## 7.2.2 Targeting Micro-Grids

As the technology for deploying and maintaining small-scale distributed generation systems improves, it is tempting to imagine these systems filling in the gaps in electricity access that traditional grids have yet to reach [222]. Although there are cases where these systems are more appropriate than a traditional grid, the economies of scale achieved by even a small grid system uniquely allow a power utility to (theoretically) keep price per watt lower without compromising the reliability and quality of service [329]. This supportive economic model is the primary reason that grid systems enjoy a high popularity with development economists as one of the energy technologies that leads to the most favorable socioeconomic returns on investment [225, 330, 331].

Allee et. al describes that “Estimates of the electricity demand of unelectrified customers are a crucial input to selecting mini-grid sites, projecting revenue, and sizing system components to provide adequate capacity while minimizing capital costs. Typical customer survey-based demand estimates for these communities—where there are no historical data—are not reliable, typically overpredicting demand.” [332]. Demand estimates are improved with better quality reliability data [254].

Along with P.I. Jay Taneja (University of Massachusetts, Amherst), *nLine* has been contracted to provide a week-long measurement of micro-grid reliability in 109 markets as part of a much larger survey activity. The data collected will be used by the Rural



Electrification Agency to target a next stage of investments in micro-grids.

### 7.2.3 Improving Remote Sensing

Models that use low-resolution or highly-aggregated data from remote sensors to predict grid reliability often don't have ground truth data. AtlasAI describes their system as follows: "Our models analyze terabytes of satellite imagery to track, analyze and forecast regions of growth, stagnation and vulnerability at a 2km x 2km resolution across emerging markets." [160]. It follows that ground truth data with greater than 2km by 2km resolution could provide them unique and valuable insights into model performance, and indeed our early results in Shah et al. do show that when trained on PowerWatch data, satellite night-light based models perform better [166].

It seems that a model could be constructed that not only estimates a parameter, but also outputs a list of locations where higher resolution data would be most helpful for improving accuracy of future predictions. With *nLine*, I hope to continue exploring questions about how and when to use direct measurements to bootstrap accuracy in different remote sensing applications.

## 7.3 Building the Macroscope

I believe that domain scientists should no longer need to tolerate inadequate data to support their aims. This vision comes from four observations:

1. There is a growing pressure for reproducibility, transparency, fairness, and generalizability that can drive reform.
2. Low-cost sensor networks have existed for long enough that tools exist to allow relatively turn-key deployments.
3. The world has been blanketed with supporting infrastructure (i.e., GSM, phones, technical literacy) to allow sensor networks to be bootstrapped into existence.
4. Many deployment problems remain hard not due to technology but to poor communication between engineers and domain scientists.

The academy is well suited to play an important role in each of these, as long as the right incentives are offered for innovation across layers spanning the broadest political, electrical, academic, transportation, financial, and other chaotic sub-systems. It should be clear at this point that societal need for data about the world, sensor technology maturity, a global networking infrastructure, and better tools to facilitate communications are now in place. This means that academia-government-industrial partnerships can address ever-larger and more diffuse questions, signaling further progress toward a new scientific instrument—the macroscope.

# Bibliography

- [1] Mike Hughes. “Why Access To Energy Should Be A Basic Human Right”. In: *Forbes* (Dec. 2018). URL: <https://www.forbes.com/sites/mikehughes1/2018/12/10/why-access-to-energy-should-be-a-basic-human-right/>.
- [2] World Bank Malaysia Hub. *Digitalization and the Use of Technology in the Electricity Sector*. Doing Business Case Studies No. 1. May 2020. URL: <https://documents1.worldbank.org/curated/en/585901592343461602/pdf/Digitalization-and-the-Use-of-Technology-in-the-Electricity-Sector.pdf>.
- [3] World Bank Malaysia Hub. *Digitalization and the Use of Technology in the Electricity Sector*. Doing Business Case Studies No. 1. May 2020. URL: <https://documents1.worldbank.org/curated/en/585901592343461602/pdf/Digitalization-and-the-Use-of-Technology-in-the-Electricity-Sector.pdf>.
- [4] World Bank Group and the Energy Sector Management Assistant Program. *Overall Rise Scores*. July 2020. URL: <https://rise.esmap.org/>.
- [5] Catapult Energy Systems. *A strategy for a Modern Digitalised Energy System*. Energy Data Taskforce Report. URL: <https://esc-production-2021.s3.eu-west-2.amazonaws.com/2021/07/Catapult-Energy-Data-Taskforce-Report-A4-v4AW-Digital.pdf>.
- [6] Jean Arlet. “Electricity Tariffs, Power Outages and Firm Performance: A Comparative Analysis”. In: *Proceedings of the DECRG Kuala Lumpur Seminar Series*. Vol. 23. 2017.
- [7] Kenneth Lee, Eric Brewer, Carson Christiano, Francis Meyo, Edward Miguel, Matthew Podolsky, Javier Rosa, and Catherine Wolfram. “Electrification for “under grid” households in rural Kenya”. In: *Development Engineering* 1 (2016).
- [8] Kobina Aidoo and Ryan C Briggs. “Underpowered: Rolling blackouts in Africa disproportionately hurt the poor”. In: *African Studies Review* 62.3 (2019).
- [9] Vivien Foster, Samantha Witte, Sudeshna Ghosh Banerjee, and Alejandro Moreno. *Charting the diffusion of power sector reforms across the developing world*. The World Bank, 2017.
- [10] Paul J Gertler, Kenneth Lee, and A Mushfiq Mobarak. “Electricity Reliability and Economic Development in Cities: A Microeconomic Perspective”. In: (2017).

- [11] Veronica Jacome, Noah Klugman, Catherine Wolfram, Belinda Grunfeld, Duncan Callaway, and Isha Ray. “Power quality and modern energy for all”. In: *Proceedings of the National Academy of Sciences* 116.33 (Aug. 2019), pp. 16308–16313. ISSN: 0027-8424, 1091-6490. DOI: [10.1073/pnas.1903610116](https://doi.org/10.1073/pnas.1903610116).
- [12] *India’s Energy Policy and Electricity Production: Interview with Charles Ebinger*. Oct. 2011. URL: <https://www.nbr.org/publication/indias-energy-policy-and-electricity-production/>.
- [13] The United States Department of Energy. *Smart Grid System Report: 2018 Report to Congress*. Nov. 2018, p. 93. URL: <https://www.energy.gov/oe/downloads/2018-smart-grid-system-report>.
- [14] U. C. Berkeley Public Affairs. *Classes canceled Thursday 10/10 due to power outage*. Oct. 2019. URL: <https://news.berkeley.edu/2019/10/09/classes-will-resume-thursday-unless-there-is-a-power-outage/>.
- [15] Catherine Wolfram. *Electricity Outages Lead to Substantial Backup Generator Purchases*. May 2020. URL: <https://energyathaas.wordpress.com/2020/05/26/electricity-outages-lead-to-substantial-backup-generator-purchases/>.
- [16] Erica Ogg. “The Best Power Outage Tools and Supplies”. In: *The New York Times* (Sept. 2021). ISSN: 0362-4331. URL: <https://www.nytimes.com/wirecutter/reviews/tools-for-a-power-outage/>.
- [17] Peter Marsters and Trevor Houser. *America’s Biggest Blackout*. Nov. 2017. URL: <https://rhg.com/research/americas-biggest-blackout-2/>.
- [18] Patricia Mazzei. “Judge Orders Arrest of Puerto Rico Power Company Chief Executive”. In: *The New York Times* (Nov. 2021). ISSN: 0362-4331. URL: <https://www.nytimes.com/2021/11/10/us/puerto-rico-luma-stensby-arrest.html>.
- [19] Nicole Acevedo and Gabe Gutierrez. “As Puerto Rico’s power crisis worsens, lawmakers probing outages seek answers”. In: *NBC News* (Nov. 2021). URL: <https://www.nbcnews.com/news/latino/puerto-ricos-power-crisis-worsens-lawmakers-probing-outages-see-answe-rcna2920>.
- [20] Danica Coto. *Thousands march in Puerto Rico, outraged over power outages*. Oct. 2021. URL: <https://apnews.com/article/business-health-caribbean-power-outages-puerto-rico-b3afa248e406f33359fe3ca365dd221d>.
- [21] The Weekly Journal Newsroom. *PRCC Says Selective Power Outages Hinder Economic Development*. Sept. 2021. URL: [https://www.theweeklyjournal.com/business/prcc-says-selective-power-outages-hinder-economic-development/article\\_47c4971e-0c0d-11ec-976c-bf484fbbee0c.html](https://www.theweeklyjournal.com/business/prcc-says-selective-power-outages-hinder-economic-development/article_47c4971e-0c0d-11ec-976c-bf484fbbee0c.html).

- [22] Slawa Rokicki, Brian Mwesigwa, Laura Schmucker, and Jessica L. Cohen. “Shedding light on quality of care: a study protocol for a randomized trial evaluating the impact of the Solar Suitcase in rural health facilities on maternal and newborn care quality in Uganda”. In: *BMC Pregnancy and Childbirth* 19.1 (Aug. 2019), p. 306. ISSN: 1471-2393. DOI: [10.1186/s12884-019-2453-x](https://doi.org/10.1186/s12884-019-2453-x).
- [23] Patricia Mazzei. “‘Why Don’t We Have Electricity?’: Outages Plague Puerto Rico”. In: *The New York Times* (Oct. 2021). ISSN: 0362-4331. URL: <https://www.nytimes.com/2021/10/19/us/puerto-rico-electricity-protest.html>.
- [24] *Todos Somos Pueblo*. URL: <https://www.facebook.com/Todos-Somos-Pueblo-1613771775513535/>.
- [25] Internet Of Things from iSocket Systems. *Power outage news from around the world*. URL: <https://www.isocketpro.com/power-failures/news/>.
- [26] *H.R. 3684 - Infrastructure Investment and Jobs Act*. Nov. 2021. URL: <https://www.congress.gov/bill/117th-congress/house-bill/3684>.
- [27] *President Biden’s Bipartisan Infrastructure Law*. URL: <https://www.whitehouse.gov/bipartisan-infrastructure-law/>.
- [28] Sustainable Energy for All. *History*. URL: <https://www.seforall.org/who-we-are/history>.
- [29] World Bank Group. *Is the utility measuring the SAIDI and SAIFI or any other measurements for service reliability?* 2019. URL: <https://rise.worldbank.org/questions/utility-measuring-saidi-and-saifi-or-any-other-measurements-service-reliability-0>.
- [30] Sustainable Energy for all. *Data Standards for Integrated Energy Planning*. Oct. 2020, p. 29. URL: <https://www.seforall.org/system/files/2021-02/IEP-data-standards.pdf>.
- [31] Leslie Hurtado. ‘*An Electrical Outrage, Thousands in Puerto Rico Left in the Dark*’. Oct. 2021. URL: <https://news.wttw.com/2021/10/23/electrical-outrage-thousands-puerto-rico-left-dark>.
- [32] African Development Bank. *Light Up and Power Africa – A New Deal on Energy for Africa*. June 2019. URL: <https://www.afdb.org/en/the-high-5/light-up-and-power-africa-%5C%E2%5C%80%5C%93-a-new-deal-on-energy-for-africa>.
- [33] Trevor Alleyne. *Energy Subsidy Reform in Sub-Saharan Africa: Experiences and Lessons*. 13/2. 2013. URL: <https://www.imf.org/external/pubs/ft/dp/2013/afr1302.pdf>.
- [34] Sonesh Surana, Rabin Patra, Lakshminarayanan Subramanian, Sergiu Nedevschi, Yahel Ben-David, Manuel Ramos, and Eric Brewer. “Beyond Pilots: Keeping Rural Wireless Networks Alive”. In: (), p. 14.

- [35] Andrea Franco, Marjan Shaker, Dikolela Kalubi, and Silvia Hostettler. “A review of sustainable energy access and technologies for healthcare facilities in the Global South”. In: *Sustainable Energy Technologies and Assessments* 22 (Aug. 2017), pp. 92–105. ISSN: 2213-1388. DOI: [10.1016/j.seta.2017.02.022](https://doi.org/10.1016/j.seta.2017.02.022).
- [36] Abu Hasheem. “In Sudan, Where There is Power, There is Development”. In: *World Bank* (Feb. 2011). URL: <https://www.worldbank.org/en/news/feature/2011/02/08/in-sudan-where-there-is-power-there-is-development>.
- [37] United Nations Department of Economic and Sustainable Development Social Affairs. *Goal 7: Ensure access to affordable, reliable, sustainable and modern energy for all*. URL: <https://sdgs.un.org/goals/goal7>.
- [38] Jay Taneja. *Measuring Electricity Reliability in Kenya*. Tech. rep. Working paper, available at <http://blogs.umass.edu/jtaneja/files/2017/05/outages.pdf>, 2017.
- [39] D McCollum, L Gomez Echeverri, K Riahi, and S Parkinson. “Sdg7: Ensure access to affordable, reliable, sustainable and modern energy for all”. In: (2017).
- [40] Millennium Challenge Corporation. “Guidance on Common Indicators”. In: 3 (2008). URL: <https://www.mcc.gov/resources/doc-pdf/guidance-on-common-indicators>.
- [41] Research and Markets. *The Global Smart Grid Market is Expected to Reach \$92+ Billion by 2026*. May 2021. URL: <https://www.globenewswire.com/en/news-release/2021/05/11/2226895/28124/en/The-Global-Smart-Grid-Market-is-Expected-to-Reach-92-Billion-by-2026.html>.
- [42] International Energy Agency. *Smart Grids: More efforts needed*. Nov. 2021. URL: <https://www.iea.org/reports/smart-grids>.
- [43] *Frequently Asked Questions (FAQs) - U.S. Energy Information Administration*. URL: <https://www.eia.gov/tools/faqs/faq.php>.
- [44] PG and E. *Voltage Tolerance Boundary*. Jan. 1999, p. 6. URL: [https://www.pge.com/includes/docs/pdfs/mybusiness/customerservice/energystatus/powerquality/voltage\\_tolerance.pdf](https://www.pge.com/includes/docs/pdfs/mybusiness/customerservice/energystatus/powerquality/voltage_tolerance.pdf).
- [45] *ANSI C84.1 ELECTRIC POWER SYSTEMS AND EQUIPMENT - VOLTAGE RANGES*. URL: <http://www.powerqualityworld.com/2011/04/ansi-c84-1-voltage-ratings-60-hertz.html>.
- [46] Republic of Ghana. *National Electricity Grid Code*. Oct. 2009. URL: <http://energycom.gov.gh/files/National%5C%20Electricity%5C%20Grid%5C%20Code.pdf>.
- [47] *power outage*. URL: <https://dictionary.cambridge.org/us/dictionary/english/power-outage>.
- [48] Energy Commission Ghana. “National Energy Statistics 2000-2019”. In: (2019). URL: <http://www.energycom.gov.gh/files/2020%5C%20ENERGY%5C%20STATISTICS-revised.pdf>.

- [49] Electric Power Research Institute. “Guidebook for Cost/Benefit Analysis of Smart Grid Demonstration Projects”. In: (Dec. 2012), p. 118.
- [50] Bradford Campbell, Ye-sheng Kuo, and Prabal Dutta. “From Energy Audits to Monitoring Megawatt Loads: A Flexible and Deployable Power Metering System”. In: *IEEE/ACM Conference on Internet-of-Things Design and Implementation (IoTDI)*. 2018.
- [51] June 2019. URL: <https://www.kccscientific.com/50hz-60hz-guide-frequency-converter-power/>.
- [52] *IEEE 1159-2019 - IEEE Recommended Practice for Monitoring Electric Power Quality*. URL: <https://standards.ieee.org/standard/1159-2019.html>.
- [53] “IEEE Standard Dictionary of Electrical and Electronics Terms<sub>1980</sub>”. In: *IEEE Transactions on Power Apparatus and Systems* PAS-99.6 (Nov. 1980), 37a–37a. ISSN: 0018-9510. DOI: [10.1109/TPAS.1980.319816](https://doi.org/10.1109/TPAS.1980.319816).
- [54] Peternielsen Steffanhansen. *Voltage Sag - an overview*. 2002. URL: <https://www.sciencedirect.com/topics/engineering/voltage-sag>.
- [55] *PC62.41.2 - Recommended Practice on Characterization of Surges in Low-Voltage (1000 V and less) AC Power Circuits*. URL: [https://standards.ieee.org/project/C62\\_41\\_2.html](https://standards.ieee.org/project/C62_41_2.html).
- [56] IEEE/CIGRE Joint Task Force on Stability Terms and Definitions. “Definition and Classification of Power System Stability”. In: *IEEE Transactions on Power Systems* 19.3 (Aug. 2004), pp. 1387–1401. ISSN: 0885-8950. DOI: [10.1109/TPWRS.2004.825981](https://doi.org/10.1109/TPWRS.2004.825981).
- [57] Public Utilities Regulatory Commission Ghana. “Electricity Transmission Ancillary Services Pricing Policy and Guidelines (Final Draft)”. In: (June 2012), p. 21.
- [58] *IEEE 1547-2018 - IEEE Standard for Interconnection and Interoperability of Distributed Energy Resources with Associated Electric Power Systems Interfaces*. URL: <https://standards.ieee.org/standard/1547-2018.html>.
- [59] Roy Billinton and Wijarn Wangdee. “Predicting bulk electricity system reliability performance indices using sequential Monte Carlo simulation”. In: *Power Delivery, IEEE Transactions on* 21.2 (2006), pp. 909–917.
- [60] “IEEE Guide for Electric Power Distribution Reliability Indices”. In: *IEEE Std 1366, 2001 Edition* (2001), pp. i–. DOI: [10.1109/IEEESTD.2001.94438](https://doi.org/10.1109/IEEESTD.2001.94438).
- [61] Islamabad Electric Supply Company. *SAIFI/SAIDI*. URL: <https://iesco.com.pk/index.php/saifi-saidi>.
- [62] ewh.ieee.org. “Common T and D Reliability Indices”. In: (Nov. 2021), p. 1. URL: [https://www.ewh.ieee.org/r6/san\\_francisco/pes/pes\\_pdf/Reliability\\_and\\_Artificial\\_Intelligence/Common\\_T&D\\_Reliability\\_Indices.pdf](https://www.ewh.ieee.org/r6/san_francisco/pes/pes_pdf/Reliability_and_Artificial_Intelligence/Common_T&D_Reliability_Indices.pdf).



- [63] Molly Lipscomb, Ahmed Mobarak Mushfiq, and Tania Bahram. “Development effects of electrification: Evidence from the geologic placement of hydropower plants in Brazil”. In: (2011).
- [64] Meredith Fowlie, Michael Greenstone, and Catherine Wolfram. *Do energy efficiency investments deliver? Evidence from the weatherization assistance program*. Tech. rep. National Bureau of Economic Research, 2015.
- [65] Eliana Carranza and Robyn Meeks. “Shedding Light: Understanding the Role of Externalities in Energy Efficient Technology Adoption”. In: (2015).
- [66] Dominique P Van de Walle, Martin Ravallion, Vibhuti Mendiratta, and Gayatri B Koolwal. “Long-term impacts of household electrification in rural India”. In: *World Bank Policy Research Working Paper* 6527 (2013).
- [67] Maximilian Arnold, Han Rui, and Wolfram H Wellssow. “An approach to smart grid metrics”. In: *Innovative Smart Grid Technologies (ISGT Europe), 2011 2nd IEEE PES International Conference and Exhibition on*. IEEE. 2011.
- [68] Jaeseok Choi, Hongsik Kim, Junmin Cha, and Roy Billinton. “Nodal probabilistic congestion and reliability evaluations of a transmission system under the deregulated electricity market”. In: *Power Engineering Society Summer Meeting, 2001*. Vol. 1. IEEE. 2001, pp. 497–502.
- [69] *GridWatch Pilot Report, Version 3.0, 2018-02-26, Adkins et al. Delivered to MCC*.
- [70] John Ayaburi, Morgan Bazilian, Jacob Kincer, and Todd Moss. “Measuring “Reasonably Reliable” access to electricity services”. In: *The Electricity Journal* 33.7 (Aug. 2020), p. 106828. ISSN: 10406190. DOI: [10.1016/j.tej.2020.106828](https://doi.org/10.1016/j.tej.2020.106828).
- [71] Jay Taneja. “Measuring Electricity Reliability in Kenya”. In: (), p. 6. URL: <https://blogs.umass.edu/jtaneja/files/2017/05/outages.pdf>.
- [72] Laurel N. Dunn, Michael D. Sohn, Kristina Hamachi LaCommare, and Joseph H. Eto. “Exploratory analysis of high-resolution power interruption data reveals spatial and temporal heterogeneity in electric grid reliability”. In: *Energy Policy* 129 (June 1, 2019), pp. 206–214. ISSN: 0301-4215. DOI: [10.1016/j.enpol.2019.01.042](https://doi.org/10.1016/j.enpol.2019.01.042). URL: <https://www.sciencedirect.com/science/article/pii/S0301421519300424> (visited on 03/29/2021).
- [73] Shonali Pachauri and Narasimha D. Rao. “Advancing energy poverty measurement for SDG7”. In: *Progress in Energy* 2.4 (Sept. 2020), p. 043001. ISSN: 2516-1083. DOI: [10.1088/2516-1083/aba890](https://doi.org/10.1088/2516-1083/aba890).
- [74] Setu Pelz, Shonali Pachauri, and Sebastian Groh. “A critical review of modern approaches for multidimensional energy poverty measurement”. In: *WIREs Energy and Environment* 7.6 (2018), e304. ISSN: 2041-840X. DOI: [10.1002/wene.304](https://doi.org/10.1002/wene.304).



- [75] Mikul Bhatia and Nicolina Angelou. *Capturing the Multi-Dimensionality of Energy Access*. Live Wire 16. 2014. URL: <https://documents1.worldbank.org/curated/en/937711468320944879/pdf/88699-REVISED-LW16-Fin-Logo-OKR.pdf>.
- [76] Benjamin K. Sovacool and Michael H. Dworkin. *Global Energy Justice: Problems, Principles, and Practices*. Cambridge University Press, 2014.
- [77] Urban Energy Justice Lab. *Advancing research for a just and equitable energy future for all*. URL: <https://urbanenergyjusticelab.com/>.
- [78] Isa Ferrall, Arthur Jacquiau-Chamski, and Daniel M. Kammen. “Electricity reliability patterns in grids and minigrids in East Africa: A collaboration between RAEL and Sparkmeter”. Conference Presentation. Conference Presentation. Grid Reliability and Utility Operations Conference. Accra, Ghana, Feb. 4, 2020. URL: <https://energyeconomicgrowth.org/person/isa-ferrall>.
- [79] Evelyn Heylen, Marten Ovaere, Stef Proost, Geert Deconinck, and Dirk Van Hertem. “Fairness and inequality in power system reliability: Summarizing indices”. In: *Electric Power Systems Research* 168 (Mar. 1, 2019), pp. 313–323. ISSN: 0378-7796. DOI: 10.1016/j.epsr.2018.11.011. URL: <https://www.sciencedirect.com/science/article/pii/S0378779618303729> (visited on 03/29/2021).
- [80] Roshanak Nateghi, Seth Guikema, Yue Wu, and C Bruss. “Critical Assessment of the Foundations of Power Transmission and Distribution Reliability Metrics and Standards: Foundations of Power Systems Reliability Standards”. In: *Risk analysis : an official publication of the Society for Risk Analysis* 36 (May 15, 2015). DOI: 10.1111/risa.12401.
- [81] Isa Ferrall, Duncan Callaway, and Daniel Kammen. “Decentralized rooftop solar changes how we measure and compare the reliability of energy access”. Submitted for Publication. Submitted for Publication. University of California Berkeley, Jan. 29, 2021.
- [82] “Modernising consumer markets: Consumer Green Paper”. In: (Apr. 2018). URL: <https://www.gov.uk/government/consultations/consumer-green-paper-modernising-consumer-markets>.
- [83] A. Kannan, Vipul Kumar, T. Chandrasekar, and B. Justus Rabi. “A review of power quality standards, electrical software tools, issues and solutions”. In: *2013 International Conference on Renewable Energy and Sustainable Energy (ICRESE)*. Dec. 2013, pp. 91–97. DOI: 10.1109/ICRESE.2013.6927794.
- [84] Public Utilities Regulatory Commission. *Electricity Supply and Distribution (Standards of Performance) Regulations, L.I.1935*. 2008. URL: [https://www.powerutilityleadership.com/wp-content/uploads/2018/02/Ghana\\_Electricity\\_Supply\\_Distribution\\_Regulation.pdf](https://www.powerutilityleadership.com/wp-content/uploads/2018/02/Ghana_Electricity_Supply_Distribution_Regulation.pdf).

- [85] Public Utilities Regulatory Commission. *Public Utilities Regulatory Commission (Consumer Service) Regulations, L.I. 2413*. 2020. URL: <https://purc.com.gh/attachment/721760-20210305060329.pdf>.
- [86] Pouyan Pourbeik, Prabha S. Kundar, and Carson W. Taylor. “The anatomy of a power grid blackout”. In: *IEEE Power and Energy Magazine* 4.5 (2006).
- [87] Jen Lin-Liu and William Sweet. “News: energy tangle in China”. In: *IEEE Spectrum* 41.10 (2004).
- [88] Catherine Wolfram, Ori Shelef, and Paul J. Gertler. “How will energy demand develop in the developing world?” In: *National Bureau of Economic Research* No. w17747 (2012).
- [89] Richard J Campbell. “Weather-Related Power Outages and Electric System Resiliency”. In: *Congressional Research Service* (), p. 18.
- [90] Office of Electricity Delivery U.S. Department of Energy and Energy Reliability. “Large Power Transformers and the U.S. Electric Grid”. In: (June 2012), p. 55. URL: [https://www.energy.gov/sites/default/files/Large%5C%20Power%5C%20Transformer%5C%20Study%5C%20-%5C%20June%5C%202012\\_0.pdf](https://www.energy.gov/sites/default/files/Large%5C%20Power%5C%20Transformer%5C%20Study%5C%20-%5C%20June%5C%202012_0.pdf).
- [91] DTE Energy. *App and Energy Bridge Features*. URL: <https://www.newlook.dteenergy.com/wps/wcm/connect/dte-web/insight/insight-features>.
- [92] *IEEE PES Distribution Reliability Working Group Meeting: 2017 IEEE PES General Meeting, Meeting Minutes*. July 2017. URL: <https://cmte.ieee.org/pes-drwg/wp-content/uploads/sites/61/minutes-wgsd-2017-07.pdf>.
- [93] Universal Service Administrative Co. (USAC). *IEEE 2 5 beta method unraveled*. URL: <https://www.slideshare.net/NathanSubramaniamMBA/ieee-2-5-beta-method-unraveled-65645026>.
- [94] Electricity Company of Ghana. *Prepayment Metering*. 2019. URL: <http://www.ecgonline.info/index.php/customer-service/meter-information/prepayment-metering>.
- [95] Nov. 2019. URL: <https://iot-analytics.com/smart-meter-market-2019-global-penetration-reached-14-percent/>.
- [96] Lulu Wen, Kaile Zhou, Shanlin Yang, and Lanlan Li. “Compression of smart meter big data: A survey”. In: *Renewable and Sustainable Energy Reviews* 91 (2018).
- [97] T Paraskevakos. *Sensor monitoring device*. US Patent 3,842,208. Oct. 1974.
- [98] Simon Duque Anton, Daniel Fraunholz, Christoph Lipps, Frederic Pohl, Marc Zimmermann, and Hans D Schotten. “Two decades of SCADA exploitation: A brief history”. In: *IEEE Conference on Application, Information and Network Security (AINS)*. IEEE. 2017, pp. 98–104.

- [99] Pike Research. *Southeast Asia Smart Meter Market Overview: Market Trends, Challenges, Future plans and Opportunities*. 2012. URL: <https://www.engerati.com/sites/default/files/Andy%5C%20Bae.pdf>.
- [100] Christopher Guo, Craig A Bond, and Anu Narayanan. *The adoption of new smart-grid technologies: incentives, outcomes, and opportunities*. Rand Corporation, 2015.
- [101] Soma Shekara Sreenadh Reddy Depuru, Lingfeng Wang, and Vijay Devabhaktuni. “Smart meters for power grid: Challenges, issues, advantages and status”. In: *Renewable and sustainable energy reviews* 15.6 (2011), pp. 2736–2742.
- [102] Government of Ghana Ministry of Energy. *Energy Sector Recovery Program*. May 2019. URL: [http://energycom.gov.gh/files/2019%5C%201111%5C%20ESRP%5C%20ESTF\\_Clean\\_v3.0redacted%5C%20final.pdf](http://energycom.gov.gh/files/2019%5C%201111%5C%20ESRP%5C%20ESTF_Clean_v3.0redacted%5C%20final.pdf).
- [103] Ariel A Casarin and Luciana Nicollier. “Prepaid meters in electricity. A cost-benefit analysis”. In: *IAE Business School, Austral University* (2008).
- [104] Gill Owen and Judith Ward. “Smart meters: commercial, policy and regulatory drivers”. In: *Sustainability First* (2006).
- [105] Eliel Keelson, KO Boateng, and Isaac Ghansah. “A Smart Retrofitted Meter for Developing Countries”. In: *International Journal of Computer Applications* 90.5 (2014).
- [106] Jian He, Lin Cheng, and Yuan-zhang Sun. “Transformer real-time reliability model based on operating conditions”. In: *Journal of Zhejiang University-SCIENCE A* 8 (2007).
- [107] National Communications Authority. *Tariffs as at February 2016*. <https://nca.org.gh/assets/Uploads/Tariffs-as-at-February-2016.pdf>. (Accessed on 12/08/2017). 2017.
- [108] The World Bank Group. *Doing Business in Ghana*. <http://www.doingbusiness.org/data/exploreconomies/ghana/>. (Accessed on 12/08/2017). 2017.
- [109] *Ghana Living Standards Survey Report of the Fifth Round (GLSS 6)*. [www.statsghana.gov.gh/docfiles/glss6/GLSS6\\_Main%20Report.pdf](http://www.statsghana.gov.gh/docfiles/glss6/GLSS6_Main%20Report.pdf). (Accessed on 12/08/2017). 2014.
- [110] Narasimha D. Rao. “Does (better) electricity supply increase household enterprise income in India?” In: *Energy Policy* 57 (June 2013), pp. 532–541. ISSN: 0301-4215. DOI: 10.1016/j.enpol.2013.02.025.
- [111] Nava Raj Karki, Ajit Kumar Verma, Rajesh Karki, Deependra Kumar Jha, and Arabind Kumar Mishra. “Electricity outage cost estimation for government offices, institutions and few other specific customers”. In: *2010 2nd International Conference on Reliability, Safety and Hazard - Risk-Based Technologies and Physics-of-Failure Methods (ICRESH)*. Dec. 2010, pp. 386–390. DOI: 10.1109/ICRESH.2010.5779580.
- [112] Energy Networks Association. *Open Networks Project, Operational Forecasting*. WS1B P3. Jan. 2020. URL: <https://www.energynetworks.org/industry-hub/resource-library/open-networks-2020-ws1b-p3-operational-forecasting-final-report.pdf>.

- [113] David Theis. “World Bank Group to Discontinue Doing Business Report”. In: *The World Bank Group* (Oct. 2020). URL: <https://www.worldbank.org/en/news/statement/2021/09/16/world-bank-group-to-discontinue-doing-business-report>.
- [114] Rush Doshi, Judith G Kelley, and Beth A Simmons. “The power of ranking: The ease of doing business indicator and global regulatory behavior”. In: *International Organization* 73.3 (2019), pp. 611–643.
- [115] *Afrobarometer*. URL: <https://afrobarometer.org/>.
- [116] *About Afrobarometer — Afrobarometer*. URL: <https://afrobarometer.org/about>.
- [117] Kobina Aidoo and Ryan C. Briggs. “Underpowered: Rolling blackouts in Africa disproportionately hurt the poor”. In: *African Studies Review* 62.3 (Sept. 2019). ISSN: 0002-0206, 1555-2462. DOI: [10.1017/asr.2018.78](https://doi.org/10.1017/asr.2018.78).
- [118] Kobina Aidoo. *The Dumsor Report*. 2016. URL: <https://www.facebook.com/dumsorreport/posts/814442985328307>.
- [119] J. R. Minkel. “The 2003 Northeast Blackout—Five Years Later”. In: *Scientific American* 13 (2008).
- [120] Wood Mackenzie. *Transformer Monitoring Markets, 2013-2020: Technologies, Forecasts and Leading Vendors*. Nov. 2018. URL: <https://www.woodmac.com/our-expertise/focus/Power--Renewables/transformer-monitoring-markets-2013-2020-technologies-forecasts-and-leading-vendors/>.
- [121] URL: <https://www.landisgyr.eu/ezine-article/common-sensors-growth-sensors-distribution-grid/>.
- [122] Luca Schenato, Grazia Barchi, David Macii, Reza Arghandeh, Kameshwar Poolla, and Alexandra Von Meier. “Bayesian linear state estimation using smart meters and pmu measurements in distribution grids”. In: *IEEE International Conference on Smart Grid Communications*. 2014.
- [123] Alexandra Von Meier, David Culler, Alex McEachern, and Reza Arghandeh. “Micro-synchrophasors for distribution systems”. In: *ISGT 2014*. IEEE. 2014.
- [124] Alex McEachern. “Micro-synchrophasors for distribution grids: instrumentation lessons learned (so far!)” In: *Power Standards Lab* (2016), p. 26.
- [125] Samuel DeBruin, Branden Ghena, Ye-Sheng Kuo, and Prabal Dutta. “Powerblade: A low-profile, true-power, plug-through energy meter”. In: *ACM Conference on Embedded Networked Sensor Systems*. 2015.
- [126] Nipun Batra, Amarjeet Singh, and Kamin Whitehouse. “Exploring The Value of Energy Disaggregation Through Actionable Feedback”. In: *International Workshop on Non-Intrusive Load Monitoring*. 2016.

- [127] Udit Paul, Alexander Ermakov, Michael Nekrasov, Vivek Adarsh, and Elizabeth Belding. “Outage: Detecting Power and Communication Outages from Social Networks”. In: *Proceedings of The Web Conference 2020*. WWW ’20. Association for Computing Machinery, Apr. 2020, pp. 1819–1829. ISBN: 978-1-4503-7023-3. DOI: 10.1145/3366423.3380251. URL: <https://doi.org/10.1145/3366423.3380251>.
- [128] *Create a background service*. URL: <https://developer.android.com/training/run-background-service/create-service>.
- [129] *Background Tasks — Apple Developer Documentation*. URL: <https://developer.apple.com/documentation/backgroundtasks>.
- [130] Noah Klugman, Veronica Jacome, Meghan Clark, Matthew Podolsky, Pat Pannuto, Neal Jackson, Aley Soud Nassor, Catherine Wolfram, Duncan Callaway, Jay Taneja, and Prabal Dutta. “Experience: Android Resists Liberation from Its Primary Use Case”. In: *Proceedings of the 24th Annual International Conference on Mobile Computing and Networking*. ACM, Oct. 2018, pp. 545–556. ISBN: 978-1-4503-5903-0. DOI: 10.1145/3241539.3241583. URL: <https://dl.acm.org/doi/10.1145/3241539.3241583>.
- [131] Noah Klugman, Javier Rosa, Pat Pannuto, Matthew Podolsky, William Huang, and Prabal Dutta. “Grid watch: mapping blackouts with smart phones”. In: *Proceedings of the 15th Workshop on Mobile Computing Systems and Applications*. ACM. 2014.
- [132] Ayodeji Olalekan Salau, Adekunle Olugbenga Ejidokun, Olakanmi Adewara, Oludayo Samuel Ajala, Ezekiel Aliyu, and Thomas Kokumo Yesufu. “A GSM-based SMS power notification system for network operation centers”. In: *Int. J. Sci. Eng. Res.(IJSER)* 8 (2017).
- [133] *Amazon.com*. URL: [https://www.amazon.com/s?k=power+meter&ref=nb\\_sb\\_noss\\_2](https://www.amazon.com/s?k=power+meter&ref=nb_sb_noss_2).
- [134] “IEEE 1159-1995 - IEEE Recommended Practice for Monitoring Electric Power Quality”. In: *IEEE Std 1159-1995* (Nov. 1995), pp. 1–80. DOI: 10.1109/IEEESTD.1995.79050.
- [135] *DTE Insight Overview — DTE Energy*. URL: [https://www.newlook.dteenergy.com/wps/wcm/connect/dte-web/insight/insight-app/?utm\\_source=universal&utm\\_medium=vanity%5C%20url&utm\\_campaign=dte%5C%20insight](https://www.newlook.dteenergy.com/wps/wcm/connect/dte-web/insight/insight-app/?utm_source=universal&utm_medium=vanity%5C%20url&utm_campaign=dte%5C%20insight).
- [136] Thomas Zachariah, Noah Klugman, Bradford Campbell, Joshua Adkins, Neal Jackson, and Prabal Dutta. “The Internet of Things Has a Gateway Problem”. In: *Proceedings of the 16th International Workshop on Mobile Computing Systems and Applications*. ACM, Feb. 2015, pp. 27–32. ISBN: 978-1-4503-3391-7. DOI: 10.1145/2699343.2699344. URL: <https://dl.acm.org/doi/10.1145/2699343.2699344>.
- [137] *Fluke meters - MyFlukeStore.com*. URL: <https://www.myflukestore.com/>.
- [138] Prayas Energy Group. *Prayas*. URL: <http://www.watchyourpower.org/>.

- [139] Martin Kitetu and Alois Mbutura. “Regional Energy Supply Index (RESI): Using Open Source Data To Monitor Electricity Reliability Across Sub-Saharan Africa”. In: *2020 IEEE PES/IAS PowerAfrica*. IEEE. 2020, pp. 1–4.
- [140] Prayas Energy Group. *Prayas-ESMI*. URL: <http://www.watchyourpower.org/index.php>.
- [141] George Hope Chidziwisano, Susan Wyche, and Erick Oduor. “GridAlert: Using a Sensor-Based Technology to Monitor Power Blackouts in Kenyan Homes”. In: *Proceedings of the 2020 CHI Conference on Human Factors in Computing Systems*. CHI ’20. Association for Computing Machinery, Apr. 2020, pp. 1–13. ISBN: 978-1-4503-6708-0. DOI: 10.1145/3313831.3376500. URL: <https://doi.org/10.1145/3313831.3376500>.
- [142] Philip P Barker, James J Burke, RT Mancao, TA Short, Ch A Warren, CW Burns, and JJ Siewierski. “Power quality monitoring of a distribution system”. In: *IEEE transactions on power delivery* 9.2 (1994), pp. 1136–1142.
- [143] Heiko Maaß, Hüseyin Kemal Cakmak, Felix Bach, Ralf Mikut, Aymen Harrabi, Wolfgang Süß, Wilfried Jakob, Karl-Uwe Stucky, Uwe G Kühnapfel, and Veit Hagenmeyer. “Data processing of high-rate low-voltage distribution grid recordings for smart grid monitoring and analysis”. In: *EURASIP Journal on Advances in Signal Processing* 2015.1 (2015), p. 14.
- [144] Premise Data Corporation. *Accountability to Affected Populations (AAP) through Citizen-led Monitoring*. URL: <https://info.premise.com/accountability-to-affected-populations-aap-through-citizen-led-monitoring>.
- [145] *Arduino*. URL: <https://www.arduino.cc/>.
- [146] *SparkFun Electronics*. URL: <https://www.sparkfun.com/>.
- [147] daryllukas. *Power Outage Notifier*. URL: <https://www.instructables.com/Power-Outage-Notifier/>.
- [148] Microsoft Dynamics 365. *2019 Manufacturing Trends Report*. 2019. URL: <https://info.microsoft.com/rs/157-GQE-382/images/EN-US-CNTNT-Report-2019-Manufacturing-Trends.pdf>.
- [149] *Public anger rises as Kenyans wake up to 5-hour countrywide blackout*<sub>2020</sub>. July 2020. URL: <https://nation.africa/kenya/news/public-anger-rises-as-kenyans-wake-up-to-5-hour-countrywide-blackout-1225868>.
- [150] Brian Min and Kwawu Mensan Gaba. “Tracking Electrification in Vietnam Using Nighttime Lights”. In: *Remote Sensing* 6.10 (2014), pp. 9511–9529.
- [151] Colorado Schoole of Mines Payne Institute for Public Policy. *Nighttime Lights*. URL: <https://payneinstitute.mines.edu/eog/nighttime-lights/>.



- [152] Santiago Correa, Zeal Shah, and Jay Taneja. “This Little Light of Mine: Electricity Access Mapping Using Night-time Light Data”. In: *Proceedings of the Twelfth ACM International Conference on Future Energy Systems*. ACM, June 2021, pp. 254–258. ISBN: 978-1-4503-8333-2. DOI: [10.1145/3447555.3464871](https://doi.org/10.1145/3447555.3464871). URL: <https://dl.acm.org/doi/10.1145/3447555.3464871>.
- [153] et al. Padmanabhan Ramakrishna. “Residential links under the weather”. In: *Proceedings of the ACM Special Interest Group on Data Communication*. 2019.
- [154] Aaron Schulman and Neil Spring. “Pinging in the rain”. In: *ACM conference on Internet measurement*. ACM. 2011, pp. 19–28.
- [155] Lin Quan Quan, John Heidemann, and Yuri Pradkin. “Trinocular: Understanding Internet Reliability Through Adaptive Probing”. In: *Proceedings of the ACM SIGCOMM Conference, Hong Kong, China*. Aug. 2013.
- [156] URL: <https://censys.io/>.
- [157] *Internet Outage Detection and Analysis (IODA)*. URL: <https://www.caida.org/projects/ioda/>.
- [158] Alan Meier, Tsuyoshi Ueno, and Marco Pritoni. “Using data from connected thermostats to track large power outages in the United States”. In: *Applied Energy* 256 (Dec. 2019), p. 113940. ISSN: 0306-2619. DOI: [10.1016/j.apenergy.2019.113940](https://doi.org/10.1016/j.apenergy.2019.113940).
- [159] Ramakrishna Padmanabhan, Amogh Dhamdhere, Emile Aben, kc claffy kc, and Neil Spring. “Reasons Dynamic Addresses Change”. In: *Proceedings of the 2016 Internet Measurement Conference*. IMC '16. Association for Computing Machinery, Nov. 2016, pp. 183–198. ISBN: 978-1-4503-4526-2. DOI: [10.1145/2987443.2987461](https://doi.org/10.1145/2987443.2987461). URL: <https://doi.org/10.1145/2987443.2987461>.
- [160] *Atlas AI — Monitoring drivers of economic development*. URL: <https://www.atlasai.co/>.
- [161] Dimitry Gershenson, Brandon Rohrer, and Anna Lerner. *A new predictive model for more accurate electrical grid mapping*. 2019.
- [162] Ramakrishna Padmanabhan, Aaron Schulman, Alberto Dainotti, Dave Levin, and Neil Spring. “How to find correlated internet failures”. In: *International Conference on Passive and Active Network Measurement*. Springer. 2019.
- [163] John Agnew, Thomas Gillespie, Jorge Gonzalez, and Brian Min. “Baghdad nights: evaluating the US military ‘surge’ using nighttime light signatures”. In: *California Center for Population Research* (2008).
- [164] Muneeza Alam. “Coping with Blackouts: Power Outages and Firm Choices”. In: *Department of* (2013).
- [165] Michael L. Mann, Eli K. Melaas, and Arun Malik. “Using VIIRS Day/Night Band to Measure Electricity Supply Reliability: Preliminary Results from Maharashtra, India”. In: *Remote Sensing* 8.99 (Sept. 2016), p. 711. DOI: [10.3390/rs8090711](https://doi.org/10.3390/rs8090711).



- [166] Zeal Shah, Noah Klugman, Gabriel Cadamuro, Feng-Chi Hsu, Christopher D. Elvidge, and Jay Taneja. “The Electricity Scene from Above: Exploring Power Grid Inconsistencies Using Satellite Data in Accra, Ghana”. In: *Submission under review* (2021).
- [167] Environmental and Energy Study Institute. *Energy Emergency Preparedness: A Critical Federal-State-Private Sector Partnership — Briefing*. May 2017. URL: <https://www.eesi.org/briefings/view/051517states>.
- [168] Synapse Energy. *Improving Electric Utility and Community Grid Resilience Planning*. URL: <https://www.synapse-energy.com/project/improving-electric-utility-and-community-grid-resilience-planning>.
- [169] Alisa Sopova and Neil MacFarquhar. “Russia and Ukraine in a Standoff Over Crimea Power Outage”. In: *The New York Times* (Nov. 2015). ISSN: 0362-4331. URL: <https://www.nytimes.com/2015/11/26/world/europe/russia-and-ukraine-in-a-standoff-over-crimea-power-outage.html>.
- [170] David E. Sanger and Emily Schmall. “China Appears to Warn India: Push Too Hard and the Lights Could Go Out”. In: *The New York Times* (Feb. 2021). ISSN: 0362-4331. URL: <https://www.nytimes.com/2021/02/28/us/politics/china-india-hacking-electricity.html>.
- [171] “Power shortage hits Central Asia 2009”. In: *The New York Times* (Feb. 2009). URL: <https://www.nytimes.com/2009/02/26/world/asia/26iht-26kyrgyz.20458528.html?searchResultPosition=170>.
- [172] Alan Blinder. “Power Grid Is Attacked in Arkansas”. In: *The New York Times* (Oct. 2013). ISSN: 0362-4331. URL: <https://www.nytimes.com/2013/10/09/us/power-grid-is-attacked-in-arkansas.html>.
- [173] Ofgem. *Eight times as many people get a better deal in Ofgem’s collective switch trial*. Aug. 2018. URL: <https://www.ofgem.gov.uk/publications/eight-times-many-people-get-better-deal-ofgems-collective-switch-trial>.
- [174] Jon Mooallem. “Opinion: Squirrel Power!” In: *The New York Times* (Aug. 2013). ISSN: 0362-4331. URL: <https://www.nytimes.com/2013/09/01/opinion/sunday/squirrel-power.html>.
- [175] News Ghana. *Ghana Loses GHS2b/yr Yearly to Dumsor*. Apr. 2017. URL: <https://newsghana.com.gh/ghana-loses-ghs2byr-yearly-to-dumsor-minority/>.
- [176] URL: <https://domains.google.com/registrar/search?searchTerm=outage>.
- [177] Office of Electricity Delivery and Energy Reliability. *United States Electricity Industry Primer*. July 2015. URL: <https://www.energy.gov/sites/prod/files/2015/12/f28/united-states-electricity-industry-primer.pdf>.
- [178] URL: <https://cbey.yale.edu/our-stories/electricity-evolution-meet-the-ringmasters>.

- [179] Ebenezer Nyarko Kumi. “The Electricity Situation in Ghana: Challenges and Opportunities”. In: (), p. 30.
- [180] United Nations. *UN High-Level Dialog on Energy 2021: A Year of Energy Action*. URL: <https://www.un.org/en/hlde-2021/page/hlde-september-2021>.
- [181] *Energy Compacts Registry*. URL: <https://www.un.org/en/energycompacts/page/registry>.
- [182] POWER. *Public vs. Private: What’s Best for Power Customers?* Sept. 2019. URL: <https://www.powermag.com/public-vs-private-whats-best-for-power-customers/>.
- [183] Ahmad F. Alkhuzam, Jean Arlet, and Silvia Lopez Rocha. *Private versus public electricity distribution utilities: Are outcomes different for end-users?* May 2018. URL: <https://blogs.worldbank.org/developmenttalk/private-versus-public-electricity-distribution-utilities-are-outcomes-different-end-users>.
- [184] NETL Modern Grid Strat. “Adv. metering infrastructure”. In: (2008).
- [185] Cheryl A Warren, Dan J Pearson, and Michael T Sheehan. “A nationwide survey of recorded information used for calculating distribution reliability indices”. In: *IEEE Trans. on Power Delivery* 18 (2003).
- [186] Tollgrade. *DTE Energy: Building a Predictive Grid for the Motor City*. LightHouse Case Study - Predictive Grid Analytics, p. 3. URL: [https://enghousenetworks.com/tollgrade/wp-content/uploads/Case-Study\\_DTE\\_-EN140626\\_V11.pdf](https://enghousenetworks.com/tollgrade/wp-content/uploads/Case-Study_DTE_-EN140626_V11.pdf).
- [187] Benjamin K Sovacool and Michael H Dworkin. *Global energy justice*. Cambridge University Press, 2014.
- [188] KG Willis and GD Garrod. “Electricity supply reliability: Estimating the value of lost load”. In: *Energy Policy* 25.1 (1997), pp. 97–103.
- [189] Samuel Dalton Borgeson. *Targeted efficiency: Using customer meter data to improve efficiency program outcomes*. University of California, Berkeley, 2013.
- [190] Joseph H Eto. “An Examination of Temporal Trends in Electricity Reliability Based on Reports from US Electric Utilities”. In: (2013).
- [191] Kevin Novan and Aaron Smith. “The Incentive to Overinvest in Energy Efficiency: Evidence From Hourly Smart-Meter Data”. In: (2015).
- [192] Greta Guest. *Poll shows most Americans support renewable-energy standards — The University Record*. June 2015. URL: <https://record.umich.edu/articles/poll-shows-most-americans-support-renewable-energy-standards/>.
- [193] NORC at the University of Chicago. *Discussion Sways Participants On Climate Change*. Sept. 2021. URL: <https://www.norc.org/NewsEventsPublications/PressReleases/Pages/conversation-converges-opinions-on-climate-change.aspx>.
- [194] Feb. 2019. URL: <https://www.gov.uk/government/publications/consumer-vulnerability-challenges-and-potential-solutions/consumer-vulnerability-challenges-and-potential-solutions>.

- [195] IPMVP Committee. *International Performance Measurement and Verification Protocol: Concepts and options for determining energy and water savings, Volume I*. Tech. rep. National Renewable Energy Lab., Golden, CO (US), 2001.
- [196] “Sustainable Energy for All: Monitoring, Evaluation, and Learning Framework”. In: (2018). URL: [https://www.seforall.org/sites/default/files/SEforALL\\_MEL.0.PDF](https://www.seforall.org/sites/default/files/SEforALL_MEL.0.PDF).
- [197] Christopher D Gore. *Electricity in Africa: The politics of transformation in Uganda*. Boydell and Brewer, 2017.
- [198] World Bank Group. *Ease of Doing Business Rankings*. 2020. URL: <https://www.doingbusiness.org>.
- [199] Kenneth Lee, Eric Brewer, Carson Christiano, Francis Meyo, Edward Miguel, Matthew Podolsky, Javier Rosa, and Catherine Wolfram. *Barriers to Electrification for “Under Grid” Households in Rural Kenya*. Tech. rep. National Bureau of Economic Research, 2014.
- [200] Barbara E. Baarsma and J. Peter Hop. “Pricing power outages in the Netherlands”. In: *Energy* 34.9 (2009).
- [201] Asher Tishler. “Optimal production with uncertain interruptions in the supply of electricity: estimation of electricity outage costs”. In: *European Economic Review* 37.6 (1993), pp. 1259–1274.
- [202] Nana Ama Boansi Boakye, Frank B K Twenefour, and Mary McArthur-Floyd. “The Impact of Power Outage “Dumsor” on the Hotel Industry: Evidence from Ghana”. In: (2016), p. 9.
- [203] *Announcing our partnership with Google*. Apr. 2020. URL: <https://electricitymap.org/blog/announcing-our-partnership-with-google/>.
- [204] Michael Terrell. *The year in carbon-free energy at Google*. Dec. 2021. URL: <https://cloud.google.com/blog/topics/sustainability/the-year-in-carbon-free-energy-at-google/>.
- [205] Kenya Power. *kplc.co.ke*. <http://www.kplc.co.ke/>. (Accessed on 12/06/2017). 2017.
- [206] *Keyword Explorer - SEO Keyword Research Tool*. URL: <https://moz.com/explorer>.
- [207] Benjamin K. Sovacool. *Energy and Ethics: Justice and the Global Energy Challenge*. Energy, Climate and the Environment. Palgrave Macmillan, 2013.
- [208] Hiroko Tabuchi. “Lack of Power Hinders Assessment of Toxic Pollution Caused by Ida”. In: *The New York Times* (Sept. 2021). ISSN: 0362-4331. URL: <https://www.nytimes.com/2021/09/01/climate/hurricane-ida-toxic-pollution.html>.
- [209] *Shop and Buy Online*. URL: <https://www.jumia.co.ke/catalog/>.
- [210] *1 USD to KES - US Dollars to Kenyan Shillings Exchange Rate*. URL: <https://www.xe.com/currencyconverter/convert/?Amount=1&From=USD&To=KES>.

- [211] Kirsten Jenkins, Darren McCauley, Raphael Heffron, Hannes Stephan, and Robert Rehner. “Energy justice: A conceptual review”. In: *Energy Research and Social Science* 11 (Jan. 2016), pp. 174–182. ISSN: 2214-6296. DOI: [10.1016/j.erss.2015.10.004](https://doi.org/10.1016/j.erss.2015.10.004).
- [212] *Ghana Power Compact: Evaluation Design Report*. URL: <https://www.mathematica.org/publications/ghana-power-compact-evaluation-design-report>.
- [213] *Ghana Gridwatch Endline Evaluation*. URL: <https://govtribe.com/file/government-file/01-jofoc-ghana-gridwatch-endline-evaluation-dot-pdf>.
- [214] Jeffrey Delmon. *Public-Private Partnership Projects in Infrastructure: An Essential Guide for Policy Makers*. 2nd ed. Cambridge University Press, 2017.
- [215] Vivian Sultan and Brian Hilton. “Electric grid reliability research”. In: *Energy Informatics* 2.1 (May 2019), p. 3. ISSN: 2520-8942. DOI: [10.1186/s42162-019-0069-z](https://doi.org/10.1186/s42162-019-0069-z).
- [216] U.S. Department of Energy. *Quadrennial Technology Review 2015*. 2015. URL: <https://www.energy.gov/quadrennial-technology-review-2015>.
- [217] Taryn Dinkelman. “The effects of rural electrification on employment: New evidence from South Africa”. In: *The American Economic Review* (2011), pp. 3078–3108.
- [218] Aaron J. Praktiknjo, Alexander Hähnel, and Georg Erdmann. “Assessing energy supply security: Outage costs in private households”. In: *Energy Policy* 39.12 (2011).
- [219] Joseph Eto, Jonathan Koomey, Bryan Lehman, Nathan Martin, Evan Mills, Carrie Webber, and Ernst Worrell. “Scoping study on trends in the economic value of electricity reliability to the US economy”. In: *Lawrence Berkeley National Laboratory* (2001).
- [220] Hunt Allcott, Allan Collard-Wexler, and Stephen D. O’Connell. “How do electricity shortages affect productivity? evidence from India”. In: *NBER Working Paper 1997* (2014).
- [221] Karen Fisher-Vanden, Erin T. Mansur, and Qiong Juliana Wang. “Costly Blackouts? Measuring Productivity and Environmental Effects of Electricity Shortages”. In: *National Bureau of Economic Research* No. w17741 (2012).
- [222] Kilian Reiche, Alvaro Covarrubias, and Eric Martinot. “Expanding electricity access to remote areas: off-grid rural electrification in developing countries”. In: *Fuel* 1.1.2 (2000), pp. 1–4.
- [223] Andreas Kemmler. “Factors influencing household access to electricity in India”. In: *Energy for Sustainable Development* 11.4 (2007), pp. 13–20.
- [224] José Goldemberg, Emilio Lèbre La Rovere, and Suani Teixeira Coelho. “Expanding access to electricity in Brazil”. In: *Energy for sustainable development* 8.4 (2004), pp. 86–94.
- [225] Mark Davis. “Rural household energy consumption: the effects of access to electricity—evidence from South Africa”. In: *Energy Policy* 26.3 (1998), pp. 207–217.

- [226] Devi Datt Tewari and Tushaar Shah. “An assessment of South African prepaid electricity experiment, lessons learned, and their policy implications for developing countries”. In: *Energy Policy* 31.9 (2003), pp. 911–927.
- [227] A Kumar David and Fushuan Wen. “Strategic bidding in competitive electricity markets: a literature survey”. In: *Power Engineering Society Summer Meeting, 2000. IEEE*. Vol. 4. IEEE. 2000, pp. 2168–2173.
- [228] Eric Martinot, Akanksha Chaurey, Debra Lew, José Roberto Moreira, and Njeri Wamukonya. “Renewable energy markets in developing countries”. In: *Annual review of energy and the environment* 27.1 (2002), pp. 309–348.
- [229] Subhes C Bhattacharyya. *Energy economics: concepts, issues, markets and governance*. Springer Science & Business Media, 2011.
- [230] Torsten J Gerpott and Mathias Paukert. “Determinants of willingness to pay for smart meters: An empirical analysis of household customers in Germany”. In: *Energy Policy* 61 (2013), pp. 483–495.
- [231] Rafiq Dossani and V Ranganathan. “Farmers willingness to pay for power in India: conceptual issues, survey results and implications for pricing”. In: *Energy Economics* 26.3 (2004), pp. 359–369.
- [232] David A Hensher, Nina Shore, and Kenneth Train. “Willingness to pay for residential electricity supply quality and reliability”. In: *Applied Energy* 115 (2014), pp. 280–292.
- [233] Ben J McNair, Jeff Bennett, David A Hensher, and John M Rose. “Households willingness to pay for overhead-to-underground conversion of electricity distribution networks”. In: *Energy Policy* 39.5 (2011), pp. 2560–2567.
- [234] Robert Halvorsen. “Residential demand for electric energy”. In: *The Review of Economics and Statistics* (1975), pp. 12–18.
- [235] Peter Choynowski. *Measuring willingness to pay for electricity*. DIANE Publishing, 2008.
- [236] World Bank Group. *World Development Indicators*. URL: <https://databank.worldbank.org/source/world-development-indicators>.
- [237] *Open Data Catalog — Millennium Challenge Corporation*. URL: <https://data.mcc.gov/>.
- [238] *World Bank - Light Every Night - Registry of Open Data on AWS*. URL: <https://registry.opendata.aws/wb-light-every-night/>.
- [239] *Our World in Data*. URL: <https://ourworldindata.org>.
- [240] *We Set Energy Data Free*. URL: <https://catalyst.coop/>.
- [241] Mengpin Ge, Johannes Friedrich, and Leandro Vigna. “4 Charts Explain Greenhouse Gas Emissions by Countries and Sectors”. In: *World Resources Institute* (Feb. 2020). URL: <https://www.wri.org/insights/4-charts-explain-greenhouse-gas-emissions-countries-and-sectors>.

- [242] OAR US EPA. *Sources of Greenhouse Gas Emissions*. Dec. 2015. URL: <https://www.epa.gov/ghgemissions/sources-greenhouse-gas-emissions>.
- [243] Alan T. Crane. *Modernizing and Protecting the Electricity Grid*. Mar. 2010. URL: <https://nae.edu/18627/Modernizing-and-Protecting-the-Electricity-Grid>.
- [244] phys.org. *Africa needs energy for growth, leaders say ahead of climate talks*. Nov. 2015. URL: <https://phys.org/news/2015-11-africa-energy-growth-leaders-climate.html>.
- [245] *Computation Model Playing Critical Role in Better Grid Management*. Apr. 2021. URL: <https://www.nisc.coop/blog/computation-model-playing-critical-role-in-better-grid-management/>.
- [246] Jialiang Yi, Pengfei Wang, Phillip C Taylor, Peter J Davison, Pádraig F Lyons, D Liang, Stuart Brown, and David Roberts. “Distribution network voltage control using energy storage and demand side response”. In: *2012 3rd IEEE PES Innovative Smart Grid Technologies Europe (ISGT Europe)*. IEEE. 2012, pp. 1–8.
- [247] William J. Holstein. “How to Untangle the Power Grid, Digitally”. In: *The New York Times* (Dec. 2006). ISSN: 0362-4331. URL: <https://www.nytimes.com/2006/12/17/jobs/17advi.html>.
- [248] Brad Plumer and Ivan Penn. “Climate Crisis Catches Power Companies Unprepared”. In: *The New York Times* (July 2021). ISSN: 0362-4331. URL: <https://www.nytimes.com/2021/07/29/climate/electric-utilities-climate-change.html>.
- [249] Catherine Wolfram, Orié Shelef, and Paul Gertler. “How Will Energy Demand Develop in the Developing World?” In: *Journal of Economic Perspectives* 26.1 (Feb. 2012), pp. 119–138. ISSN: 0895-3309. DOI: 10.1257/jep.26.1.119.
- [250] *Each Country’s Share of CO2 Emissions — Union of Concerned Scientists*. URL: <https://www.ucsusa.org/resources/each-countrys-share-co2-emissions>.
- [251] International Energy Agency. *Demand Response: More efforts needed*. URL: <https://www.iea.org/reports/demand-response>.
- [252] A. J. Trueblood, Y. Y. Wu, and A. R. Ganji. “Potential For Energy, Peak Demand, and Water Savings in California Tomato Processing Facilities”. In: (2013). URL: <https://oaktrust.library.tamu.edu/handle/1969.1/149175>.
- [253] Samuel DeBruin, Branden Ghena, Ye-Sheng Kuo, and Prabal Dutta. “PowerBlade: A Low-Profile, True-Power, Plug-Through Energy Meter”. In: *Proceedings of the 13th ACM Conference on Embedded Networked Sensor Systems*. ACM, Nov. 2015, pp. 17–29. ISBN: 978-1-4503-3631-4. DOI: 10.1145/2809695.2809716. URL: <https://dl.acm.org/doi/10.1145/2809695.2809716>.
- [254] Simone Fobi, Varun Deshpande, Samson Ondiek, Vijay Modi, and Jay Taneja. “A longitudinal study of electricity consumption growth in Kenya”. In: *Energy Policy* 123 (Dec. 2018), pp. 569–578. ISSN: 0301-4215. DOI: 10.1016/j.enpol.2018.08.065.



- [255] Catherine D. Wolfram, Orié Shelef, and Paul J. Gertler. *How Will Energy Demand Develop in the Developing World?* Jan. 2012. URL: <https://papers.ssrn.com/abstract=1985080>.
- [256] SSEN and Sia Partners. *Operational Load Forecasting Solution*. Nov. 2021. URL: <https://ssen-transition.com/wp-content/uploads/2021/11/TRANSITION-Load-Forecasting-Dissemination-Report-Final-V3.pdf>.
- [257] International Energy Agency. *Report extract, Executive Summary, World Energy Investment 2021*. 2021. URL: <https://www.iea.org/reports/world-energy-investment-2021/executive-summary>.
- [258] *Per capita energy consumption from renewables*. URL: <https://ourworldindata.org/grapher/per-capita-renewables>.
- [259] *Wind Integration National Dataset Toolkit*. URL: <https://www.nrel.gov/grid/wind-toolkit.html>.
- [260] Millennium Challenge Corporation — *Reducing Poverty Through Growth*. URL: <https://mcc-393812369.us-east-1.elb.amazonaws.com/>.
- [261] “Zeta Knocks Out Power to 2 Million”. In: *The New York Times* (Oct. 2020). ISSN: 0362-4331. URL: <https://www.nytimes.com/2020/10/29/us/hurricane-zeta-louisiana-mississippi.html>.
- [262] “Kenya nationwide blackout caused by rogue monkey”. In: *BBC News* (June 2016). URL: <https://www.bbc.com/news/world-africa-36475667>.
- [263] Ghana News Agency. *President Akufo-Addo swears in new MiDA Board*. <http://www.ghananewsagency.org/politics/president-akufo-addo-swears-in-new-mida-board-114271>. (Accessed on 03/15/2019). 2017.
- [264] Internal Monetary Fund. “World economic outlook database”. In: *World Econ Finance Survey* (2020).
- [265] *Electricity Company of Ghana*. 2020. URL: <http://www.ecgonline.info>.
- [266] Brian Bowers. “Social benefits of electricity”. In: *IEE Proceedings A (Physical Science, Measurement and Instrumentation, Management and Education, Reviews)* 135 (1988).
- [267] Mamudu Hamidu and Alfred Sarbah. “An Assessment of the Electrical Energy Needs of Beauty Saloon Industry in Ghana”. In: *American Journal of Management Science and Engineering* 1 (2016).
- [268] Charles Ackah. “Electricity Insecurity and Its Impact on Micro and Small Businesses in Ghana”. In: *Study presented at Institute of Statistical, Social and Economic Research (ISSER) workshop, “Electricity Insecurity and Its Impact on the Economy of Ghana,” University of Ghana, Legon, May*. Vol. 14. 2015.
- [269] News Ghana. *Mahama Government’s Dumsor Cost Ghana US\$3 Billion - Nana Addo*. Apr. 2017. URL: <https://newsghana.com.gh/mahama-governments-dumsor-cost-ghana-us3-billion-nana-addo/>.



- [270] Caterina Clerici, Marisa Schwartz Taylor, and Kevin Taylor. *Dumsor: The Electricity Outages Leaving Ghana in the Dark*. 2016. URL: <https://interactive.aljazeera.com/aje/2016/ghana-electricity-outage-dumsor/index.html>.
- [271] Millennium Development Authority. “Ghana Monitoring and Evaluation Plan”. In: (2018). URL: <https://assets.mcc.gov/content/uploads/ghana-power-compact-me-plan.pdf>.
- [272] *Millennium Development Authority (MiDA) - Ghana Power Compact*. URL: <https://mida.gov.gh/pages/press-kits>.
- [273] Solomon Nunoo and Abel Kwesi Ofei. “Distribution automation (DA) using supervisory control and data acquisition (SCADA) with advanced metering infrastructure (AMI)”. In: *IEEE Conference on Innovative Technologies for an Efficient and Reliable Electricity Supply*. 2010.
- [274] Amevi Acakpovi, Ruhiya Abubakar, Nana Yaw Asabere, and Issah B Majeed. “Barriers and Prospects of Smart Grid Adoption in Ghana”. In: *Procedia Manufacturing* 35 (2019).
- [275] Millennium Development Authority. “Power Distribution Feasibility Studies, Ghana Phase II Feasibility Assessment”. In: (2014). URL: <https://www.mida.gov.gh/pages/view/90/Phase.II.Report.ECG.Final.112414-1.pdf>.
- [276] W Banuenumah, F Sekyere, and KA Dotche. “Field survey of smart metering implementation using a simple random method: A case study of new juaben municipality in ghana”. In: *IEEE PES PowerAfrica*. 2017.
- [277] John Quayson-Dadzie. “Customer perception and acceptability on the use of prepaid metering system in Accra west region of electricity company of Ghana”. PhD thesis. 2012.
- [278] Millennium Challenge Corporation. *Ghana - Line Bifurcation*. 2020. URL: <https://data.mcc.gov/evaluations/index.php/catalog/266/>.
- [279] Josh Adkins, Prabal Dutta, Noah Klugman, Matthew Podolsky, Jay Taneja, and Catherine Wolfram. *Updated Inception Report, Deliverable 1(d)*. Sept. 2021.
- [280] Prasad Tallapragada VSN, Maria Shkaratan, Ada Karina Izaguirre, Jaakko Helleranta, Saifur Rahman, and Sten Bergman. “Monitoring performance of electric utilities: indicators and benchmarking in sub-Saharan Africa”. In: (2009).
- [281] Joseph H Eto, Kristina H LaCommare, Peter Larsen, Annika Todd, and Emily Fisher. “Distribution-level electricity reliability: Temporal trends using statistical analysis”. In: *Energy policy* 49 (2012).
- [282] Rui Yao, Shaowei Huang, Kai Sun, Feng Liu, Xuemin Zhang, and Shengwei Mei. “A multi-timescale quasi-dynamic model for simulation of cascading outages”. In: *IEEE Transactions on Power Systems* 31 (2015).

- [283] Millennium Challenge Corporation. *Policy for Monitoring and Evaluation*. 2017. URL: <https://www.mcc.gov/resources/doc/policy-for-monitoring-and-evaluation>.
- [284] *SurveyCTO*. 2020. URL: <https://www.surveyccto.com/>.
- [285] Particle.io. *Electron Datasheet*. 2019. URL: <https://docs.particle.io/datasheets/cellular/electron-datasheet/>.
- [286] International Telecommunication Union. *Mobile Cellular 2000 - 2018*. 2019. URL: [https://www.itu.int/en/ITU-D/Statistics/Documents/statistics/2019/Mobile\\_cellular\\_2000-2018\\_Jun2019.xls](https://www.itu.int/en/ITU-D/Statistics/Documents/statistics/2019/Mobile_cellular_2000-2018_Jun2019.xls).
- [287] Ghana Statistical Service. “Ghana Living Standards Survey Round 6 (GLSS6)”. In: (2014).
- [288] Timescale. *TimescaleDB documentation*. 2019. URL: <https://docs.timescale.com/latest/main>.
- [289] ”Derya Birant and Alp Kut”. “ST-DBSCAN: An algorithm for clustering spatial-temporal data”. In: *”Data and Knowledge Engineering”* ”60” (2007).
- [290] *nLine*. URL: <https://nline.io/>.
- [291] Alan Mainwaring, David Culler, Joseph Polastre, Robert Szewczyk, and John Anderson. “Wireless sensor networks for habitat monitoring”. In: *ACM international workshop on Wireless sensor networks and applications*. 2002.
- [292] Prabal Dutta, Jonathan Hui, Jaein Jeong, Sukun Kim, Cory Sharp, Jay Taneja, Gilman Tolle, Kamin Whitehouse, and David Culler. “Trio: enabling sustainable and scalable outdoor wireless sensor network deployments”. In: *Proceedings of the 5th international conference on Information processing in sensor networks*. ACM. 2006, pp. 407–415.
- [293] Andreas Hasler, Igor Talzi, Christian Tschudin, and Stephan Gruber. “Wireless sensor networks in permafrost research - concept, requirements, implementation and challenges”. In: *Proc. 9th Int’l Conf. on Permafrost (NICOP 2008)*. 2008.
- [294] Octav Chipara, Chenyang Lu, Thomas C Bailey, and Gruia-Catalin Roman. “Reliable clinical monitoring using wireless sensor networks: experiences in a step-down hospital unit”. In: *Proceedings of the ACM conference on embedded networked sensor systems*. 2010.
- [295] Stephen Dawson-Haggerty, Steven Lanzisera, Jay Taneja, Richard Brown, and David Culler. “@ scale: Insights from a large, long-lived appliance energy WSN”. In: *Conference on Information Processing in Sensor Networks*. ACM. 2012.
- [296] Maxim Buevich, Dan Schnitzer, Tristan Escalada, Arthur Jacquiau-Chamski, and Anthony Rowe. “Fine-grained remote monitoring, control and pre-paid electrical service in rural microgrids”. In: *Intl. conference on Information processing in sensor networks*. IEEE Press. 2014.

- [297] Deepak Vasisht, Zerina Kapetanovic, Jongho Won, Xinxin Jin, Ranveer Chandra, Sudipta Sinha, Ashish Kapoor, Madhusudhan Sudarshan, and Sean Stratman. “Farmbeats: An iot platform for data-driven agriculture”. In: *Symp. on Networked Systems Design and Impl.* 2017.
- [298] Norman Johnson and Samuel Kotz. “Urn models and their applications: an approach to modern discrete probability theory”. In: *The Mathematical Gazette* 62 (1978).
- [299] Beh Boon Chun, Mohd Zubir Mat Jafri, and Lim Hwee San. “Mangrove mapping in Penang Island by using artificial neural network technique”. In: *IEEE Conference on Open Systems.* 2011.
- [300] James H Faghmous, Muhammed Uluyol, Luke Styles, Matthew Le, Varun Mithal, Shyam Boriah, and Vipin Kumar. “Multiple hypothesis object tracking for unsupervised self-learning: An ocean eddy tracking application”. In: *AAAI Conf. on Artificial Intelligence.* Citeseer. 2013.
- [301] GhanaWeb. “Dumsor hits parts of Ghana”. In: (2019). URL: <https://www.ghanaweb.com/GhanaHomePage/NewsArchive/Dumsor-hits-parts-of-Ghana-894685>.
- [302] John Haigh. *Probability models.* Springer Science and Business Media, 2013.
- [303] Gábor J Székely and Maria L Rizzo. “Energy statistics: A class of statistics based on distances”. In: *Journal of Statistical Planning and Inference* 143 (2013). ISSN: 0378-3758. URL: <https://www.sciencedirect.com/science/article/pii/S0378375813000633>.
- [304] Gábor J Székely and Maria L et al. Rizzo. “Testing for equal distributions in high dimension”. In: *InterStat* 5 (2004).
- [305] Bradley Efron and Robert J Tibshirani. “Permutation tests”. In: *An introduction to the bootstrap.* Springer, 1993.
- [306] Benjamin Jantzen. *The EUGENE Project: A toolbox for detecting, comparing, and characterizing dynamical kinds.* <https://github.com/jantzen/eugene/>. 2021.
- [307] *Procurement of Consultant Services for the GridWatch Scale-up, 2019-03-18, RFP:5741200/RFP/SSS Millennium Development Authority (MiDA) On Behalf of the Government of Ghana Millennium Challenge Account Entity Program.*
- [308] Noah Klugman, Catherine Wolfram, Jay Taneja, Prabal Dutta, Joshua Adkins, Susanna Berkouwer, Kwame Abrokwah, Ivan Bobashev, Pat Pannuto, Matthew Podolsky, Aldo Suseno, and Revati Thatte. “Hardware, apps, and surveys at scale: insights from measuring grid reliability in Accra, Ghana”. In: *Proceedings of the Conference on Computing and Sustainable Societies - COMPASS 19.* ACM Press, 2019, pp. 134–144. ISBN: 978-1-4503-6714-1. DOI: 10.1145/3314344.3332482. URL: <http://dl.acm.org/citation.cfm?doid=3314344.3332482>.
- [309] *Working title: Disaggregated power quality data reveal systemic inequality.* Dec. 2021.
- [310] *Ghana Statistical Services.* URL: <https://www.statsghana.gov.gh/>.

- [311] Salomao David, Amalia G Sabiescu, and Lorenzo Cantoni. “Co-design with communities. A reflection on the literature”. In: *Proceedings of the 7th International Development Informatics Association Conference*. IDIA Pretoria, South Africa. 2013, pp. 152–166.
- [312] Vijay Gabale, Rupesh Mehta, Jeet Patani, K. Ramakrishnan, and Bhaskaran Raman. “Deployments Made Easy: Essentials of Managing a (Rural) Wireless Mesh Network”. In: *Proceedings of the 3rd ACM Symposium on Computing for Development*. ACM DEV ’13. Bangalore, India: ACM, 2013, 10:1–10:10. ISBN: 978-1-4503-1856-3. DOI: 10.1145/2442882.2442896. URL: <http://doi.acm.org/10.1145/2442882.2442896>.
- [313] Rohit Chaudhri, Darivanh Vlachos, Gaetano Borriello, Kiersten Israel-Ballard, Anna Coutsooudis, Penny Reimers, and Noah Perin. “Decentralized Human Milk Banking with ODK Sensors”. In: *Proceedings of the 3rd ACM Symposium on Computing for Development*. ACM DEV ’13. Bangalore, India: ACM, 2013, 4:1–4:10. ISBN: 978-1-4503-1856-3. DOI: 10.1145/2442882.2442887. URL: <http://doi.acm.org/10.1145/2442882.2442887>.
- [314] Shaddi Hasan, Yahel Ben-David, Max Bittman, and Barath Raghavan. “The Challenges of Scaling WISPs”. In: *Proceedings of the 2015 Annual Symposium on Computing for Development*. DEV ’15. London, United Kingdom: ACM, 2015, pp. 3–11. ISBN: 978-1-4503-3490-7. DOI: 10.1145/2830629.2830637. URL: <http://doi.acm.org/10.1145/2830629.2830637>.
- [315] Carlos Rey-Moreno, Zukile Roro, William D. Tucker, Masbulele Jay Siya, Nicola J. Bidwell, and Javier Simo-Reigadas. “Experiences, Challenges and Lessons from Rolling out a Rural WiFi Mesh Network”. In: *Proceedings of the 3rd ACM Symposium on Computing for Development*. ACM DEV ’13. Bangalore, India: ACM, 2013, 11:1–11:10. ISBN: 978-1-4503-1856-3. DOI: 10.1145/2442882.2442897. URL: <http://doi.acm.org/10.1145/2442882.2442897>.
- [316] Nithya Ramanathan, Laura Balzano, Deborah Estrin, Mark Hansen, Thomas Harmon, Jenny Jay, William Kaiser, and Gaurav Sukhatme. “Designing wireless sensor networks as a shared resource for sustainable development”. In: *2006 International Conference on Information and Communication Technologies and Development*. IEEE. 2006, pp. 256–265.
- [317] Inés Bebea-González, J Antonio Paco, Leopoldo Liñán-Benitez, F Javier Simó-Reigadas, U Rey, and J Carlos. “Management framework for sustainable rural e-healthcare provision”. In: *Proceedings of the IADIS International Conference e-Society*. 2011, p. 157.
- [318] Yunhao Liu, Yuan He, Mo Li, Jiliang Wang, Kebin Liu, and Xiangyang Li. “Does wireless sensor network scale? A measurement study on GreenOrbs”. In: *IEEE Transactions on Parallel and Distributed Systems* 24.10 (2013), pp. 1983–1993.

- [319] John Butterworth, Sam Godfrey, Ali Regah, and Scott Short. “Monitoring and management of climate resilient water services in the Afar and Somali regions of Ethiopia”. In: (2018).
- [320] Andy Dearden and William D Tucker. “Moving ICTD research beyond bungee jumping: practical case studies and recommendations”. In: *IEEE Technology and Society magazine* 35.3 (2016), pp. 36–43.
- [321] Kurtis Heimerl, Janani Vasudev, Kelly G Buchanan, Tapan Parikh, and Eric Brewer. “A case study on designing interfaces for multiple users in developing regions”. In: *Proceedings of the First ACM Symposium on Computing for Development*. ACM, 2010, p. 9.
- [322] Zahir Koradia, C. Balachandran, Kapil Dadheech, Mayank Shivam, and Aaditeshwar Seth. “Experiences of Deploying and Commercializing a Community Radio Automation System in India”. In: *Proceedings of the 2Nd ACM Symposium on Computing for Development*. ACM DEV ’12. Atlanta, Georgia: ACM, 2012, 8:1–8:10. ISBN: 978-1-4503-1262-2. DOI: [10.1145/2160601.2160612](https://doi.org/10.1145/2160601.2160612). URL: <http://doi.acm.org/10.1145/2160601.2160612>.
- [323] Heather Underwood, S. Revi Sterling, and John K. Bennett. “The Design and Implementation of the PartoPen Maternal Health Monitoring System”. In: *Proceedings of the 3rd ACM Symposium on Computing for Development*. ACM DEV ’13. Bangalore, India: ACM, 2013, 8:1–8:10. ISBN: 978-1-4503-1856-3. DOI: [10.1145/2442882.2442893](https://doi.org/10.1145/2442882.2442893). URL: <http://doi.acm.org/10.1145/2442882.2442893>.
- [324] *Google Play services discontinuing updates for API levels 14 and 15*. Dec. 2018. URL: <https://android-developers.googleblog.com/2018/12/google-play-services-discontinuing.html>.
- [325] United Nations. *Multilateral Energy Compact for Health Facility Electrification*. URL: [https://www.un.org/sites/un2.un.org/files/multilateral\\_energy\\_compact\\_for\\_health\\_facility\\_electrification\\_-\\_final\\_1.pdf](https://www.un.org/sites/un2.un.org/files/multilateral_energy_compact_for_health_facility_electrification_-_final_1.pdf).
- [326] *SEforALL supports Energy Compact aimed at powering 25,000 healthcare facilities with clean energy*. URL: <https://www.seforall.org/news/seforall-supports-energy-compact-aimed-at-powering-25000-healthcare-facilities-with-clean>.
- [327] *Power Africa COVID-19 response*. Oct. 2021. URL: <https://www.usaid.gov/powerafrica/coronavirus>.
- [328] et. al Ritchie Hannah. “Coronavirus Pandemic (COVID-19)”. In: *Our World in Data* (2020). URL: <https://ourworldindata.org/coronavirus>.
- [329] Shelby Veazey. *Challenges Faced during Microgrid Implementation*. URL: <https://www.phoenixenergygroup.com/blog/challenges-faced-during-microgrid-implementation>.
- [330] International Energy Agency. *weo-2017 special report: energy access outlook*. 2017. URL: <https://www.iea.org/publications/freepublications/publication/weo-2017-special-report-energy-access-outlook.html>.

- [331] World Resources Institute. *Energy Access*. <http://www.wri.org/our-work/project/energy-access>. (Accessed on 12/06/2017). 2017.
- [332] Andrew Allee, Nathaniel J. Williams, Alexander Davis, and Paulina Jaramillo. “Predicting initial electricity demand in off-grid Tanzanian communities using customer survey data and machine learning models”. In: *Energy for Sustainable Development* 62 (June 2021), pp. 56–66. ISSN: 0973-0826. DOI: [10.1016/j.esd.2021.03.008](https://doi.org/10.1016/j.esd.2021.03.008).