

UC Berkeley

Archaeological Research Facility Stahl Reports

Title

Taraco Archaeological Project Report on 2003 Excavations at Kala Uyuni

Permalink

<https://escholarship.org/uc/item/8d35b0ns>

Authors

Bandy, Matthew
Hastorf, Christine A.
Steadman, Lee
[et al.](#)

Publication Date

2004-05-18

Taraco Archaeological Project
Report on 2003 Excavations at Kala Uyuni



Matthew Bandy, Christine Hastorf, Lee Steadman
Katherine Moore, Melissa Goodman Elgar, William Whitehead
Jose Luis Paz, Amanda Cohen, Maria Bruno, Andrew Roddick, Kirk Frye, Maria
Soledad Fernandez, Jose Capriles Flores, Mary Leighton

Report submitted to the Unidad Nacional de Arqueología de Bolivia
May 18, 2004

Table of Contents

1.Kala Uyuni: An Early Political Center in the Southern Titicaca Basin.....	5
Taraco Peninsula Culture History.....	6
The Taraco Peninsula Polity.....	8
Kala Uyuni.....	9
This Volume.....	11
2.Mapping, Photography, Database	13
Mapping.....	13
Methodology.....	13
Results.....	14
Database.....	15
Methodology and Design.....	15
Implementation.....	16
Results.....	16
Photography.....	16
3.Excavations in the AQ (Ayrampu Qontu) Sector	18
4.Excavaciones en el Sector KU (Kala Uyuni).....	21
Descripción de los Hallazgos.....	22
N830/E650.....	22
N890/E653.....	24
Conclusiones.....	28
5.Additional Excavations in the KU Area – N894/E639.....	34
6.Excavations in the AC (Achachi Coa Kkollu) Sector	38
Excavation of ASD-1: The Lower Court:.....	40
South Wall (Units N964.37/E923.91 and N962/E928).....	40
North Wall (Units N980.4/E928.18 and N979/E935):.....	41
East Wall and Burial #3 (Unit N972/ E933)	44
West Wall (Units N975/ E917 and N975/E 916).....	45
Inside ASD-1:	46
Unit N973.6/E928.11 and Unit N968/E921.....	46
Unit N968/ E921.....	46
Excavation of ASD-3: The Upper Court.....	48
West Wall (N1000/E947).....	48
North Wall (N1001/E955).....	50
South Wall (Unit N984/E955).....	51
East Wall (N991/E959).....	53
Center Unit (N993/E952.5).....	54
Excavation of the Midden:	

Units N990/E968 and N979/E957.....	57
Discussion.....	57
Concluding Remarks.....	59
7.Ceramic Analysis.....	60
Early Chiripa.....	61
Middle Chiripa	62
Late Chiripa.....	65
Tiwanaku I.....	74
8.Archaeobotany.....	80
In the field.....	80
In the laboratory.....	82
9.Animal Remains from the 2003 Season.....	83
Research Approaches for Kala Uyuni Bone	84
10.Microstratigraphy and Soils Analysis.....	86
Introduction.....	86
Methods.....	86
Natural Reference Samples (N1, N2).....	87
Excavations.....	88
Kala Uyuni Area (KU).....	88
Achachi Coa Collu Area (AC).....	89
Ayrampu Qontu Area (AQ).....	91
Ethnoarchaeological Study.....	92
Case Study in the Copralabra Pata Area (CP).....	93
Methods.....	93
Summary.....	94
11.Acknowledgements.....	96
12.Bibliography.....	97

Figures

Figure 1: Map of the Taraco Peninsula.....	6
Figure 2: Chronological chart.....	7
Figure 3: Contour Map of Coa Kkollu.....	13
Figure 4: TAP Database Schema.....	15
Figure 5: Map of AQ and KU areas.....	18
Figure 6: AQ North Profile.....	19
Figure 7: Area AQ Harris Matrix.....	20
Figure 8: Map of AQ and KU areas.....	21
Figure 9: Profile of N830/E650.....	22
Figure 10: Plan of ASD-2 Structure.....	23
Figure 11: Annotated photo of ASD-2 structure from West.....	24

Figure 12: Color-coded Harris Matrix of KU excavations.....	25
Figure 13: Complete KU Harris Matrix.....	26
Figure 14: N894/E639 North profile.....	35
Figure 15: KUAC sunken courts and excavation units.....	38
Figure 16: Harris Matrix for area AC.....	39
Figure 17: Unit N962/ E928, East Profile.....	41
Figure 18: Unit N980.40/ E928.18, East Profile.....	42
Figure 19: Unit N972/ E933, North Profile.....	43
Figure 20: Unit N972/ E933, Wall Elevation, Interior.....	44
Figure 21: Unit N973/E933, Burial #3 under court floor.....	45
Figure 22: Unit N975/E916 and Unit N975/E917 Profile.....	46
Figure 23: N1000/E947, South Profile.....	49
Figure 24: N1001 E955 West Profile.....	51
Figure 25: N984/E955 South Profile.....	52
Figure 26: N991/ E959 South Profile.....	53
Figure 27: Lightning Stone found between floors.....	54
Figure 28: N993/E952.5, central monolith, in profile.....	55
Figure 29: N993/E952.5 East Profile.....	56
Figure 30: Early and Middle Chiripa Ceramics.....	63
Figure 31: Middle and Late Chiripa Ceramics.....	64
Figure 32: Late Chiripa Ceramics.....	70
Figure 33: Late Chiripa Ceramics.....	72
Figure 34: Late Chiripa Jars.....	73
Figure 35: Tiwanaku I Ceramics.....	76
Figure 36: Tiwanaku I Ceramics.....	77

Tables

Table 1: Flotation samples processed by area.....	82
---------------------------------------------------	----

1. Kala Uyuni: An Early Political Center in the Southern Titicaca Basin

Matthew Bandy and Christine Hastorf

The Titicaca Basin of Peru and Bolivia is one of the relatively few regions of the world that witnessed an episode of primary or pristine (Fried 1967) state formation. This state, the Tiwanaku Polity, has been the focus of ongoing archaeological interest for the better part of the past century (Albarracín-Jordan 1996; Bennett 1934; Bermann 1994; Janusek 1994; Kolata 1982, 1993; Ponce Sangines 1981, 1995). Our understanding of the processes that lead to the formation of the Tiwanaku state, however, remains poorly developed. This is so despite the fact that research on the long Formative period that preceded and led to Tiwanaku state formation began very early (Bennett 1936; Kidder 1943) and continued at a modest pace throughout the 20th century (Chavez 1988; Browman 1978, 1980, 1981; Kidder 1955; Ponce Sangines 1970; Portugal Ortiz 1992).

In the past decade, however, there has been an explosion of research focused on the Titicaca Basin Formative (see Stanish 2003 for a recent synthesis). A large number of researchers have made rapid advances in our understanding of culture history and social process in the Titicaca Basin Formative. The Taraco Archaeological Project (TAP) has been a participant in this most recent wave of research activity. Since 1992, TAP has conducted excavations at the site of Chiripa. This work has been designed to provide a baseline cultural and ceramic chronology for the southern Titicaca Basin, and to identify the key social, economic, ideological and political processes taking place during the Formative. Our work at Chiripa has resulted in a detailed sequence of ritual architecture spanning the Early and Middle Formative periods, and has elucidated the origins and early development of the sunken court architectural form and the Yaya Mama Religious Tradition (Hastorf ed. 1999; Bandy 1999; Hastorf 2003). It has also produced information on the early development of Titicaca Basin agriculture and subsistence (Bruno and Whitehead 2003). Equally importantly, Lee Steadman, the project ceramicist, has produced a robust chronology of Early and Middle Formative period ceramics (Steadman 1999, 2001).

The work of TAP took a new direction with Bandy's 1998-1999 survey of the Taraco Peninsula (Bandy 2001). Using Steadman's ceramic chronology, Bandy was able to document the Taraco Peninsula settlement system from 1500 BC through the Spanish conquest. Significantly, this project was one of the first in the Titicaca Basin that was able to subdivide the Formative period into relatively fine-grained chronological units (see Lemuz 2001 for another chronologically fine-grained settlement analysis). Steadman's ceramic chronology, applied in the context of regional pedestrian survey,

permitted us for the first time to study changes and transformations within the Formative period at a regional scale.

The 2003 excavations at Kala Uyuni mark the beginning of a new phase in TAP's research. Our present project builds on questions raised by our long-term research at Chiripa in light of the regional data made available by Bandy's survey. We are now addressing questions of social change and evolution on a regional scale.

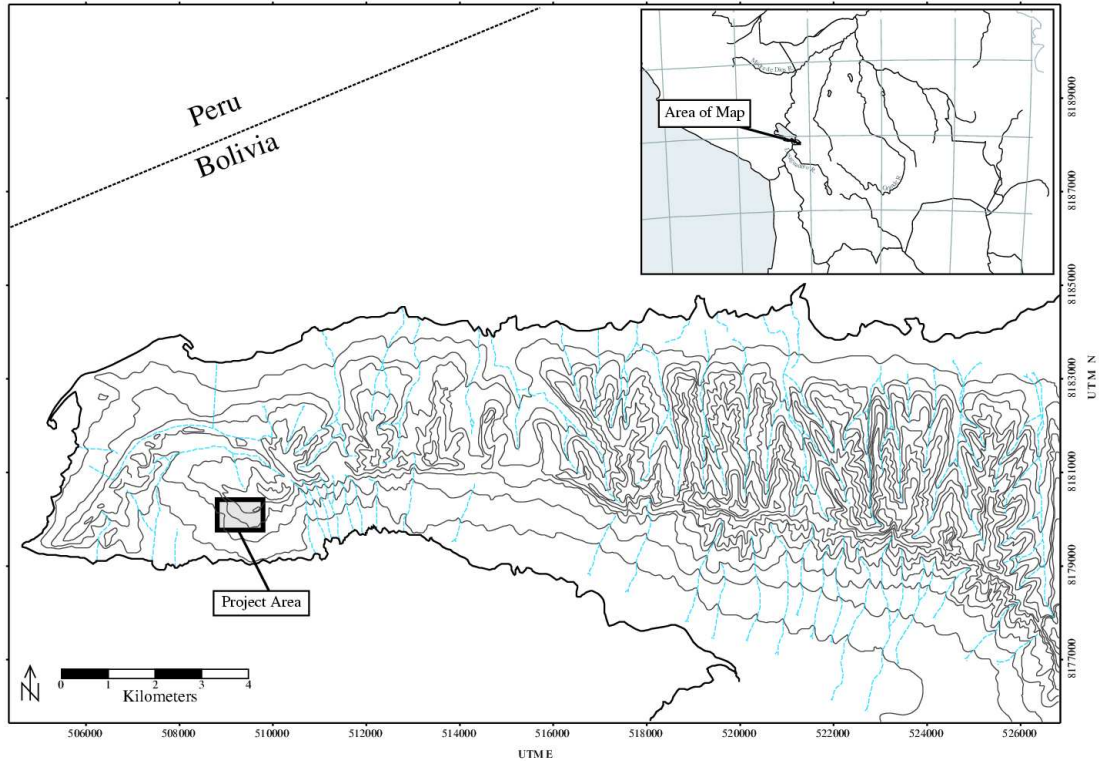

Figure 1: Map of the Taraco Peninsula

Taraco Peninsula Culture History

The Taraco Peninsula is a modest spit of land (approximately 100 square kilometers in area) projecting into the Bolivian portion of Lake Titicaca (Figure 1). The spine of the peninsula is formed by the Lomas de Taraco, a low range of hills rarely exceeding 4000 m.a.s.l. Politically, the peninsula is located within Canton Taraco, Ingavi Province, in the Department of La Paz, Bolivia. It lies approximately 80 km due west of the city of La Paz.

It is a common pattern cross-culturally that early agricultural village populations are not evenly distributed at a regional scale. Instead, early agricultural village

populations often seem to be tightly clustered in a relatively small area. Examples of such early agricultural village concentrations include the Etna subvalley of Oaxaca, and the Ixtapalapa area of the Basin of Mexico. The Taraco Peninsula appears to have been such a concentration. In the Early Formative (Early/Middle Chiripa phases, see Figure 2) the population density on the Taraco Peninsula has been estimated to be more than 8 persons per square kilometer, whereas the Juli-Pomata area at the same time (for example) had a population density of roughly 1 person per square kilometer (Bandy 2001: 104).

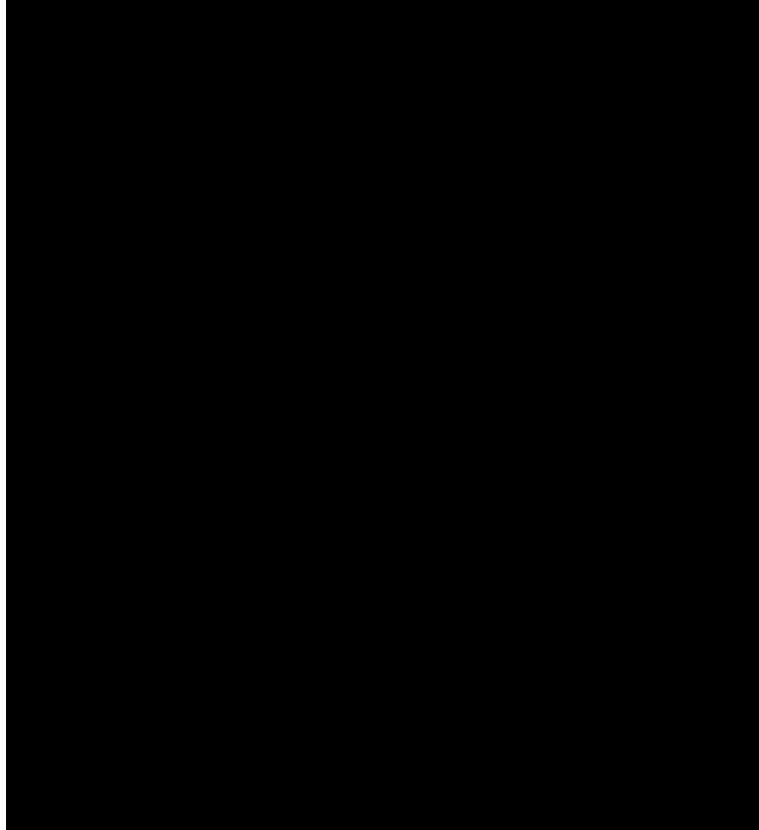

Figure 2: Chronological chart

The settlement dynamic of the Early and Middle Chiripa phases was fundamentally structured by the process of village fissioning. Bandy has documented that during these phases villages grew no larger than about 150 persons. Upon reaching this critical population size, the villages would split into two or more smaller villages (Bandy 2004).

In the Late Chiripa phase, however, around 800 BC, villages ceased fissioning and began to grow to much larger sizes, up to almost 450 persons in some cases. This change in the settlement process took place at about the same time that we see the emergence at Chiripa of the Yaya Mama Religious Tradition, an integrated suite of artifactual and architectural traits that appear to be related to public ceremonialism. Bandy (2004) and Hastorf (2003) have hypothesized that this public ritual activity served an integrative function, allowing the formation of much larger communities than was possible in earlier phases.

The Late Chiripa settlement system on the Taraco Peninsula was dominated by four major villages, each with a population of about 400 persons. Together, these four villages accounted for more than half the total population of the peninsula at the time. Chiripa was one of the major villages, and Kala Uyuni was another. Each of these villages appears to have been politically independent. Three of them, at least, had their own ceremonial precincts with sunken courts. All shared a common political culture, of which the Yaya Mama Religious Tradition is the material expression. The Late Chiripa phase may therefore be characterized as an autonomous village system, with no evidence of regional political hierarchy or the domination of one settlement by another.

The Taraco Peninsula Polity

This situation changed dramatically at the beginning of the Tiwanaku I phase (Figure 1). During this phase most of the old villages on the Taraco Peninsula actually decreased in size; they lost population. This was not an episode of depopulation on the peninsula, however; instead it was an episode of population aggregation. For while most of the old villages were reduced in population, one of the four major Late Chiripa phase villages grew very rapidly. This site was Kala Uyuni. During this phase, Kala Uyuni grew from its Late Chiripa population of about 360, to a Tiwanaku I phase maximum of around 900 inhabitants. In this phase, therefore, it grew to be more than twice as large as any other village on the Taraco Peninsula. For a variety of reasons, Bandy (2001: 190-196) has interpreted these data as indicating that Kala Uyuni achieved political dominance over the other Taraco Peninsula villages. The peninsula for the first time was unified politically. While many archaeologists would term this an instance of chiefdom formation, we prefer to use the term multi-community polity formation. Whatever term we use, however, a dramatic transformation had taken place in the history of Titicaca Basin civilization. We call this new political entity the Taraco Peninsula Polity.

Other episodes of multi-community polity formation seem to have taken place in the southern Titicaca Basin at about this same time. Tiwanaku was first occupied during this phase, apparently, and was probably the center of a polity similar to the Taraco Peninsula Polity. Other multi-community polities may have been centered at Kallamarka, and at the site of Kanamarka/Lakaya on the Peruvian side of the lake south of Yunguyu (Bandy 2001: 196; Stanish et al. 1997:92-93).

Multi-community polity formation was therefore a process that was taking place in many parts of the Titicaca Basin during the Late Formative. This process, and the political institutions and relations that resulted from it, were certainly implicated in the process of state formation that resulted in the formation of the Tiwanaku Polity at the end of the Late Formative. An understanding of multi-community polity

formation in the Late Formative Titicaca Basin is clearly necessary for any adequate model of Tiwanaku state formation. Furthermore, multi-community polity formation is an example of what Steward (1955: 8) called “phenomena of limited occurrence.” It is a general process that took place in many regions of the world at many different times. A model of multi-community polity formation for the southern Titicaca Basin will therefore have general anthropological applicability.

For all of these reasons, the current phase of TAP's research is focused on multi-community polity formation, with special reference to the case of the Taraco Peninsula Polity. Our excavations at Kala Uyuni in 2003 were the first of three planned seasons of excavations devoted to exploring this research problem.

Kala Uyuni

The archaeological site of Kala Uyuni is located in the modern community of Coa Kkollu. It is located on the south side of the peninsula between the towns of Taraco and Santa Rosa, as indicated on Figure 1. It was recorded by Bandy in his survey of the Taraco Peninsula. Kala Uyuni in fact consists of two separate and distinct sherd scatters, and for this reason it was initially recorded as two sites: T-232 (Kala Uyuni) and T-225 (Achachi Coa Kkollu).

T-225 is a ceramic scatter covering approximately 1.5 ha, and located on a relatively level terrace near the top of Cerro Achachi Coa Kkollu (Figure 3). Several worked limestone blocks are visible on the surface, and the site is characterized by a high density of ceramics and other cultural materials. Excavations in 2003, discussed by Cohen and Roddick in this report, revealed the presence of two sunken courts in this area (Figure 15). The ceramics include a high frequency of decorated sherds, as well as sherds of exotic styles either imported from the northern Titicaca Basin or manufacture in imitation of northern wares (Bandy 2001, Figure 6.2c, e, f). The sunken courts and the unusual ceramic assemblage together led Bandy to propose that this was a specialized ritual site of the Late Chiripa phase (2001: 122-123). This field assessment has been confirmed by the excavations reported in this volume. The principal occupation of T-225 pertains to the Late Chiripa phase (1.5 ha). Minor occupations (0.5 ha), without any apparent monumental architectural remains, are also documented for the Early Chiripa, Middle Chiripa, and Tiwanaku I phases. T-225 is referred to in this report as the Achachi Coa Kkollu sector, the AC area, or KUAC.

T-232 is a much larger ceramic scatter, located at the base of Cerro Achachi Coa Kkollu, and southwest of T-225 (Figure 3). The entire scatter extends over some 15 ha, covering the area from the base of the hill to the line of the modern road. The entire area of T-232 is devoted to modern cultivation. There are some topographical

features suggestive of mounds or terraces, but these are difficult to read. The area of the main Middle and Late Chiripa village (the AQ area, described by Bruno in this report) is distinguished by a substantial raised promontory, evident on the topographical map of the site (Figures 3 and 5). This feature is evidently a tell accumulation, related to the long-term occupation of that part of the site, and is unrelated to any intentional construction. Some worked limestone blocks are scattered about the site, but no monumental architectural constructions are evident on the surface.

The occupation of T-232 apparently began in the Early Chiripa phase. This occupation was not detected on the surface of the site, but Early Chiripa materials were encountered at the base of the AQ area excavations. By the Middle Chiripa phase T-232 had become a substantial village, covering 2.5 ha with some 127 estimated inhabitants. This influx of population was related to the fissioning and abandonment of the nearby major Early Chiripa village of Cerro Choncaya (T-2) around 1000 BC (Bandy 2004). By the Late Chiripa phase, T-232 had grown to be one of the major villages on the Taraco Peninsula, covering 5.25 ha with 291 estimated inhabitants. Combining T-232 with T-225, the Kala Uyuni community was almost as large as the contemporary occupation of Chiripa (T-1). Surface indications suggested that the Late Chiripa ceramic assemblage from T-232 was entirely domestic in nature, virtually lacking decorated or specialized wares and forms. This suggests that T-232 was a Late Chiripa domestic village, and that the public, ceremonial space associated with that village was located not in the village itself, but rather at T-225, on top of nearby Achachi Coa Kkollu.

In the Tiwanaku I phase, T-232 grew explosively to cover 14.75 ha with an estimated 883 inhabitants, becoming by far the largest site on the Taraco Peninsula. It was at this time that we believe Kala Uyuni became the capitol of the Taraco Peninsula Polity. The importance of Kala Uyuni in the Tiwanaku I phase is underscored by the fact that we recovered considerable numbers of Kalasasaya zoned-incised sherds from the surface (Bandy 2001: 166) and from excavated contexts (see Steadman's comments in her summary of the ceramics in this volume). These ceramics are very rare, and seem to occur almost exclusively at Tiwanaku I phase political centers (such as Kallamarka, Kanamarka/Lakaya, and Tiwanaku itself). The occupation of T-232 did not continue through the following Tiwanaku III phase, however. During the Tiwanaku III phase the area of the site was reduced to 1.5 ha, quite a small village. The virtual abandonment of the site may reflect the Taraco Peninsula's incorporation into an expanding Tiwanaku Polity at this time (Bandy 2001: 196-198). A portion of T-232 was reoccupied in the Tiwanaku IV-V phase, however. At this time Kala Uyuni was a substantial village of 5.25 ha, with an estimated population of almost 300 persons. Never again, however, did Kala Uyuni achieve the importance it had enjoyed in the Tiwanaku I phase.

Portions of T-232 are referred to in this volume as the KU or AQ areas. These excavation areas (see Figures 3 and 5) account for only a small part, however, of a very large sherd scatter.

This Volume

This volume presents the results of the 2003 excavations at Kala Uyuni. The first chapter, by Whitehead and Frye, provides information on our data processing system and mapping procedures. There follow a series of chapters describing excavations in three areas of the site.

Bruno describes excavations in the AQ area, where she excavated a deep, series of stratified midden deposits of the Early, Middle, and Late Chiripa phases. She excavated within the areas of the Middle and Late Chiripa village occupation. The materials from this excavation will provide invaluable data to compare with existing data from Chiripa.

Paz and Fernandez then describe their excavations in the KU area. Their excavations were located outside of the area of the Late Chiripa village occupation, but within the much larger Tiwanaku I site. The most important find in this area was the stone foundation of a small structure dating to the Tiwanaku I phase. Judging from the associated artifacts and from the architecture, it would appear that this structure served a non-domestic function. It may have been part of a larger complex of such structures in the KU area, though at the moment we have no firm evidence to that effect.

Bruno and Leighton then describe their stratigraphic excavations in the KU area, in a trench separate from but close to that of Paz and Fernandez. Importantly, they recovered a series of stratified deposits that may contain refuse related to activities carried out in the nearby structure excavated by Paz and Fernandez.

Cohen and Roddick continue the excavation report with their account of excavations in the upper (AC) sector of the site. Their excavation of a large number of units defined two sunken courts, located adjacent to one another on the upper slopes of Cerro Achachi Coa Kkollu. Both of these courts are trapezoidal in plan, and date to the Late Chiripa phase. Each revealed a complex sequence of construction and remodeling. One of the courts contained a sandstone monolith and a piece of portable stone sculpture in the Yaya Mama style. The other contained a human dedicatory burial in a construction context. Just as importantly, Cohen excavated a midden deposit associated with the use of the courts. Steadman's ceramic analysis, together with the excavation data, appear to indicate that the AC sector functioned as a

spatially distinct ceremonial sector for the Late Chiripa community of Kala Uyuni. This is a finding of great significance, as it should allow us to clearly distinguish public/ceremonial from domestic artifactual assemblages in the Lake Chiripa phase. Such a distinction was difficult to demonstrate at Chiripa, since ritual and domestic spaces were immediately adjacent to one another, and ritual and domestic refuse were commonly intermingled in the same midden deposits.

The volume closes with three chapters providing basic information on specialized analysis that was carried out in conjunction with the excavations. Steadman's chapter presents a very informative analysis of ceramics from the 2003 season. This report is very important for two reasons. First, it represents the first systematic description of a Chiripa ceramic assemblage from a southern Titicaca Basin site other than Chiripa itself. We are pleased to say that Steadman's Chiripa chronology appears to be valid for the Early and Middle Formative periods at Kala Uyuni, as well. Secondly, it contains the first description by TAP of a Late Formative I (Tiwanaku I) ceramic assemblage. In future seasons we expect this description to become formalized, and the TAP chronology to extend into the Late Formative as well. This is a very important undertaking, since Late Formative ceramics are at present the least well known of any period in southern Titicaca Basin prehistory.

Bruno and Whitehead describe the process by which flotation samples were recovered and processed. Moore and Goodman report progress on zooarchaeological and geoarchaeological analysis, respectively. Both of these researchers have a long-term commitment to working with TAP, and both have worked on materials from Chiripa in the past. Their work, then, forms part of an ongoing research program. Each describes the work they did in the 2003 season, and provides some preliminary information about their results.

The research reported in this volume is only the beginning of the second phase of the Taraco Archaeological Project's research. We expect to investigate a series of other sites on the Taraco Peninsula over the coming years. Our understanding of Formative period social processes will be greatly refined by these future excavations. Just as importantly, however, new questions and new interpretive challenges will come to light; questions that we cannot now anticipate or imagine.

2. Mapping, Photography, Database

William Whitehead and Kirk Frye

TAP uses digital mapping equipment and mapping software to create topographic maps, excavation maps, and location maps to visually represent the project area. The use of these technologies allows us to more accurately pinpoint our excavation units and archive our results for future archaeologists. A series of maps (Figures 1, 3, 5, 8, 15) show the area of excavations and local excavation units and features. Whitehead and Frye completed the mapping work during the 2003 field season.

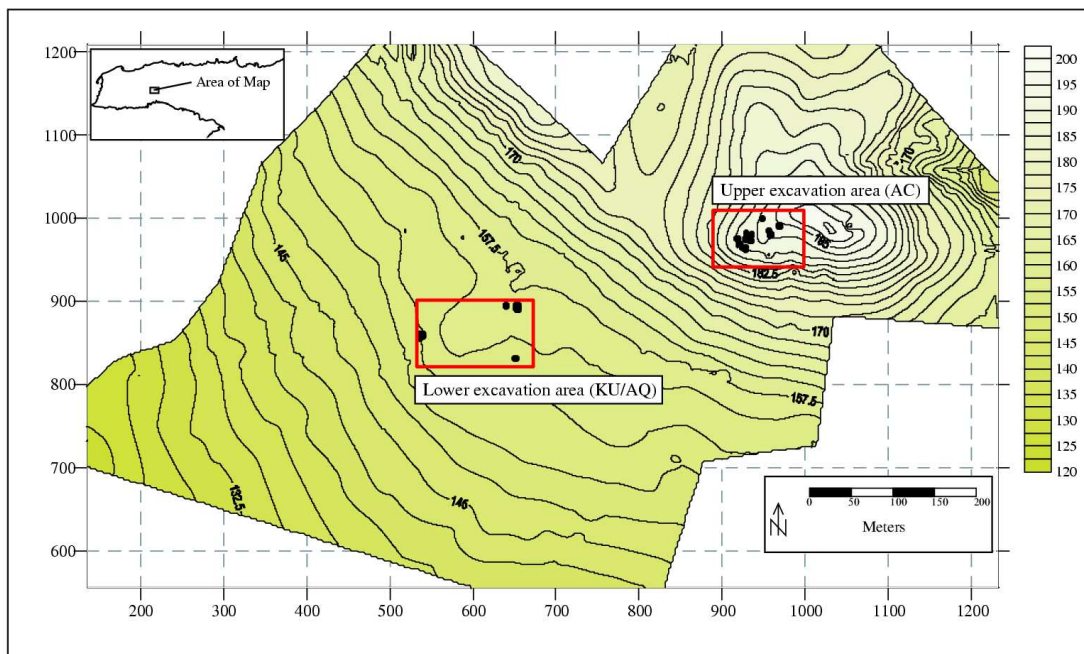

Figure 3: Contour Map of Coa Kkollu

Mapping

Methodology

Equipment: The primary instrument utilized was a Leica TC800, infrared Electronic Distance Measurement devise (EDM). This equipment allowed the survey team to record up to 400 points a day in optimal conditions. Measurement error was

approximately 1 cm per 100 horizontal meters.

Site Grid: Our first action was to establish a permanent concrete benchmark at the top of the Cerro Achachi Coa Collu, overlooking the site. This benchmark was arbitrarily assigned a coordinate of 1000 m North / 1000 m East / 200 m Elevation. A second concrete datum was placed 10 m due North from the primary datum, thus making it possible to reproduce the orientation of the site grid. During the course of the excavations a variety of secondary datum stations were placed about the site to create local working areas and to allow backsighting of the EDM as we progressed with mapping.

Placement of excavation units: The corners of all excavation units were placed as closely to meter vertices as possible, and all units were oriented to the cardinal directions. The corners of the excavation units were established using the EDM. With an accuracy of a few centimeters. The locations of the units on the main map are shown in Figure 3.

Computer techniques: The raw data was entered into Microsoft Excel and then imported into Surfer 7.0 for map production. The maps were subsequently manipulated using other drawing programs such as Adobe Illustrator 10 or Adobe Photoshop 7.0.

Predictive models for sunken court excavation: Having an accurate Digital Elevation Map was very helpful in locating and placing excavation units and allowing the accurate placement of units on an excavation grid so the data can be mapped and plotted accurately. The contour map was used to predict where the buried walls of the upper structure should be from the location of just a few stones. In the field it was hard to imagine and measure where the buried walls should be, but using the contour map and measurements of the lower court, the upper court walls were located by using the lower court as a template. The excavation team was able to place the units exactly over the North and East walls without having to guess where to place them. This saved us considerable time in the field.

Results

The area covered by the site map is approximately 1000 by 600 meters. The map was created from approximately 2300 points, covering 48 hectares for an average of one point for every 200 square meters. This was sufficient to define the major contours and to produce a usable map at a 2.5 meter contour interval. With the datum set at an arbitrary 200 meters the lowest elevation was 123.25 meters and the highest 200.31 meters. 200 meters of site elevation is roughly equivalent to 3900 meters above sea level.

Database

The Taraco Archaeological Database was created to store data and to allow in-the-field analysis to be performed on all the excavation information generated during the 2003 field season. The database was designed to integrate all the information from the excavations as quickly as possible and in an intuitive way. The current database is based on 5 years of experience in combining the TAP excavation technique and database design. The database is in a FileMaker 6.0 format and is capable of being used on both the Windows and Mac platforms. This flexibility was the primary reason FileMaker was chosen, together with its ease of use and graphical interface.

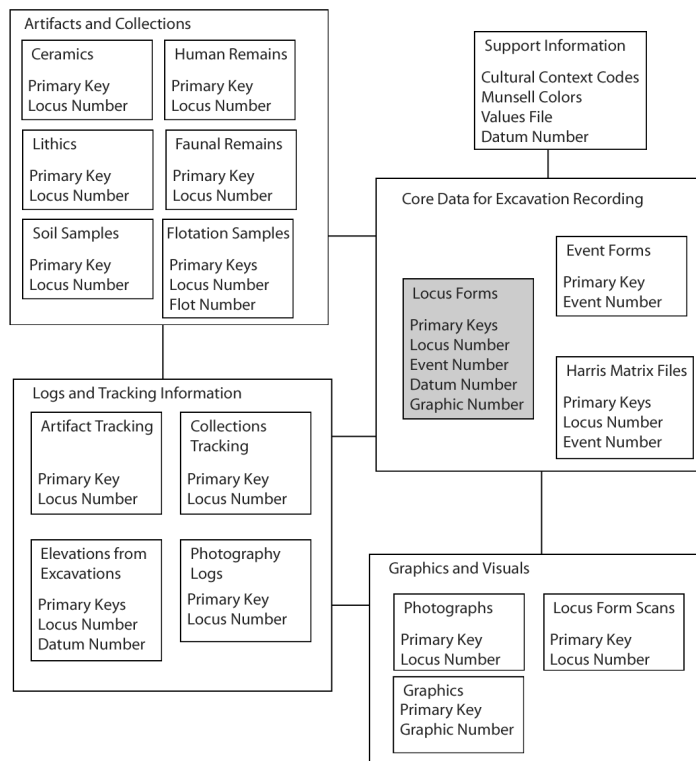

Figure 4: TAP Database Schema

related to the primary excavation form and to each other. This becomes more important as thousands of records are generated over the course of the excavation season. There are four main kinds of data in the database: 1) basic excavation data, 2) logs and tracking, 3) artifacts and collections, and 4) graphics and visuals. The basic excavation data is the Locus form, the Event log, and the Harris Matrix information derived from the Locus forms and Event log. The Logs and Tracking Information area contains all the information needed to maintain control over the thousands of photographs, artifacts and sample bags, and location data generated during the dig.

Methodology and Design

The data model is based on the concept of the locus and the event just as with the excavation techniques. The database schema is shown in Figure X. The primary keys are the locus number, event number, datum number, and graphic number, which are used to track each record in the data files. The most important data key is the locus number which almost every record in the data files contain, and using this at the primary key all materials and information can be

The primary files are Artifact Bag Tracking, Sample Collections Tracking, Elevations, and Photography logs. The Artifacts collected during the excavations (Ceramics, Lithics, Faunal Remains, Soils, Human Remains, and Flotation samples) are given to the specialist teams to process and analyze. These data files are linked to the main database by the locus number, and are under the control of each specialist team. All the graphics and visuals are stored and tracked in their own separate area and represent thousands of files of photographs, scans, and hand drawn graphics. All of these are tracked with the locus number and are linked to the main locus file.

Implementation

All of the written data on the locus forms was entered into the database in the field, along with all the individual logs. This was not only convenient but also necessary for creating accurate lists and catalogs for local and national authorities. The field data was also useful for laboratory analysis.

Results

The total amount of data produced was substantial. The database for 2003 is approximately 5.04 Gigabytes and contains 3,274 files. The locus file contains 402 records, and is 1.04 Megabytes of data. There were 230 events defined, 757 Locus Harris Matrix relationships records, 606 Event Harris Matrix relationships, 1193 artifact bags were tracked, 1098 piece plotted collections made (soils, flotation samples, and special finds), 2000 excavation elevations, 2368 digital photos, and another 1900 slide and black and white photos were taken. Because there were not only paper backups but also digital backups recorded on CDR media, TAP was able to leave the field with all the information in a secure and archived format.

Photography

TAP uses photography extensively to document its excavations. Three formats of recording media were used in 2003: 35mm positive color slide film (Kodak E100 – ISO 100), 35mm black and white negative film (Ilford Pan 100 - ISO 100), and digital imaging (4 Megapixel) were used. The basic strategy was to take at least one photograph of each format for every locus excavated and multiple photographs for important finds. In addition, artifacts were often photographed in the field.

Each roll of film was given a number or letter designation (numbers for color slide film and letters for black and white) and this information was used to log the photos taken in the field on the locus forms and in a separate photo log book. Digital photos were indexed by the date only, since these images were available to be used immediately.

Once developed, the color slides were mounted in plastic slide holders and stored in polypropylene archive binder pages. The black and white film was cut into five frame strips and stored in polypropylene binder pages. Backup CDs were created every week to ensure that digital photos would not be lost if the main computer were to be damaged.

Using these techniques some 2300 digital images were captured, and 1900 black and white negative and color slides were made (approximately 4 for each locus). Since everything was photographed using both digital and physical media, TAP has the security of having permanent image storage (film) and easily transferred and manipulated images for use in documents and in the database (digital). In the future we plan to extend our use of digital photography to the documentation of intermediate stages of the excavation of each.

3. Excavations in the AQ (Ayrampu Qontu) Sector

Maria Bruno

Between June 19 and July 10, 2003, I directed excavations in the Ayrampu Qontu sector of Kala Uyuni. This area was selected for excavation based on the high density of Early and Middle Formative period ceramics encountered by Dr. Matthew Bandy in his survey of the Taraco Peninsula (Bandy 2001). The density and utilitarian character of the ceramics led Bandy to conclude that this sector represented a Chirioa culture residential area. Recovery of a Chiripa period household has been a long-standing goal of the Taraco Archaeological Project and we hoped excavation of this area might encounter such remains. While a structure failed to materialize, nearly two meters of stratified, well-preserved midden was excavated. The associated material promises to provide important information on Chiripa period domestic village life.

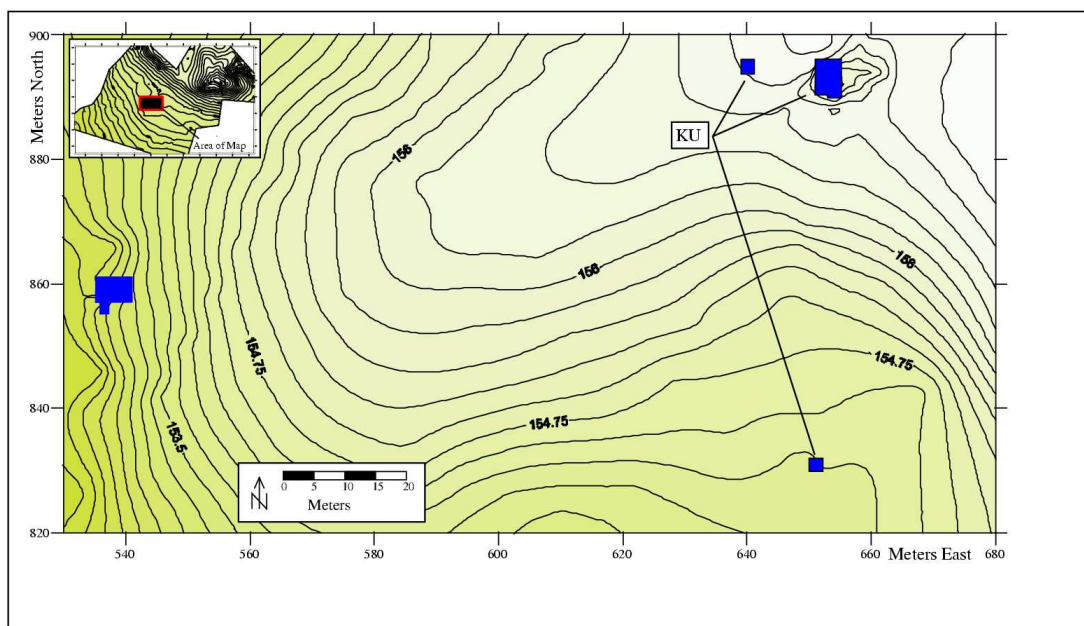

Figure 5: Map of AQ and KU areas

AQ area is located on the left side of the map

Altogether, we opened seven contiguous 2x2 meter units (Figure 5). Units N857/E535, N857/E537, and N855/E536 were opened as individual 2 x 2 meter units. Unit N855/E536 was reduced to 1x1 meter and served as our sounding. We also opened a large area, two 4x2 meter units, referred to as unit N859/E535.

We began with Unit N857/E539. After removing the plow zone (approximately 20 cm thick) we encountered several distinct deposits that appeared to run diagonally (south-west to north-east). Particularly suggestive were wide and linear deposits of a dense orange clay that we hypothesized might be the remains of an adobe wall. The other deposits consisted of dark, silty clay with flecks of charcoal that we hypothesized might be midden associated with the structure. An alternative explanation for these features, however, was that a series of strata had been deposited on a western trending slope, the crest of which was truncated by plowing. The truncation of these sloping strata could create a banded pattern such as we saw at the base of the plow zone. This second scenario ultimately proved to be true, as may be appreciated in the profile of the trench (Figure 6).

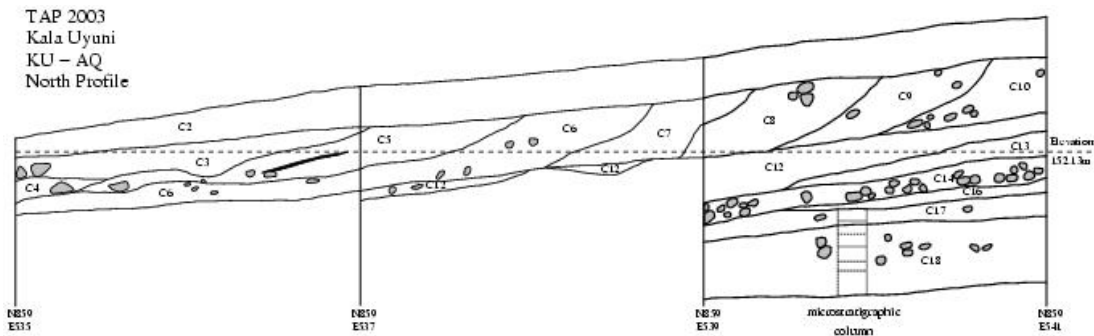

Figure 6: AQ North Profile

First, we decided to expand horizontally and removed the plow zone from Unit N857/E535 and the large Unit N859/E535. As a result of these excavations we were able to determine that the clay deposits did not form part of a structure. Instead, it appeared as if we had encountered a fairly complex series of superimposed midden and architectural rubble deposits. We therefore decided to rapidly excavate a 1x1 meter sounding in the southwest corner of unit N855/E536 in order to determine the depth of the site and the general stratigraphic sequence.

After completing excavation of the 1x1 meter sounding, we decided to excavate a larger area in order to obtain a good sample of stratified Chiripa period midden. We proceeded as always in reverse stratigraphic, first excavating midden event C-3 in the western section of Unit N857/E535 (Figure 6). Events C-4 and C-5 were also excavated in this unit, exposing Event C-6, which was previously exposed by the initial excavations in Unit N857/E537. A 50 cm balk was left on the eastern wall of Unit N857/N537, but we excavated Event C-6 as one locus that extended through both units. Beneath, we encountered Event C-7, which was perhaps the most extensive dump of adobe-like material. The bottom of C-7 was marked by the appearance of C-8, a dark midden that extended across through both units. Since it appeared that the archaeological deposits were deeper to the east, we decided to

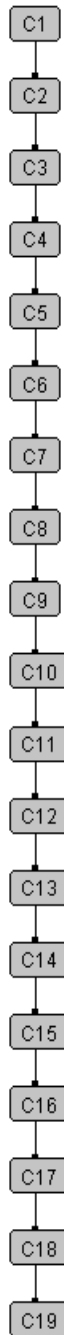

Figure 7: Area AQ
Harris Matrix

continue the excavations in Unit N857/E539 down to sterile so as to obtain a proper sample of the entire occupation sequence.

Altogether, we excavated 13 distinct midden events and 3 adobe dump/slump events. The midden events consisted primarily of silty clays with varying densities of carbon and clay inclusions, ranging in color from red to yellowish-green. Several of the midden events had very high densities of fish and camelid bone. Dr. Katherine Moore found several bone weaving tools such as shuttles, spindle whorls, and combs in her analysis of the bones from several of the midden deposits. There were also large quantities of ceramics in the midden deposits. In-field analysis of the ceramics suggests that they are overwhelming utilitarian, with very few decorated sherds present.

The majority of these midden events date to the Late Chiripa period. The earliest deposit, C-18, appears to be a mixture of Early and Middle Chiripa, with some Late Chiripa. While excavating the lowermost loci, we noted the occurrence of large pore sizes and insect disturbance by. These insects excavate burrows some 5 cm in diameter, which the often fill with a soil distinct from the primary matrix. This creates the appearance of many small lighter- or darker-colored circles in the soil. Dr. Melissa Goodman took a micromorphological block sample from this area, but her field assessment was that it was highly disturbed and that the Early and Middle Chiripa occupations/deposits (the earliest deposits in the AQ area) had most likely been homogenized by post-depositional bioturbation. Interestingly, however, Dr. Steadman detected a vertical separation of Early from Middle Chiripa in the ceramic assemblage of Event 18, so perhaps this movement may not have affected the larger artifacts.

The excavated deposits and their artifactual contents, therefore, support Dr. Bandy's hypothesis that Ayrampu Qontu was a Chiripa era domestic area. These midden deposits will provide rich data on changes and/or continuities in domestic life during the Late Chiripa period and to some extent the Early and Middle Chiripa periods also.

4. Excavaciones en el Sector KU (Kala Uyuni)

José Luis Paz, María Soledad Fernández

El sector denominado Kala Uyuni del sitio homónimo es una extensa planicie coluvial que está levemente inclinada hacia el sur, y dista aproximadamente 400 metros de las orillas del Lago Titicaca. En la actualidad, este asentamiento es utilizado como terreno agrícola por varias familias campesinas de la comunidad de Coa Kkollu, y la constante práctica de acumular piedras producto de la labranza a los costados de las parcelas ha provocado la aparición de varios montículos, los cuales se intercalan con algunos desniveles de altura que, según el diagnóstico del perforador,

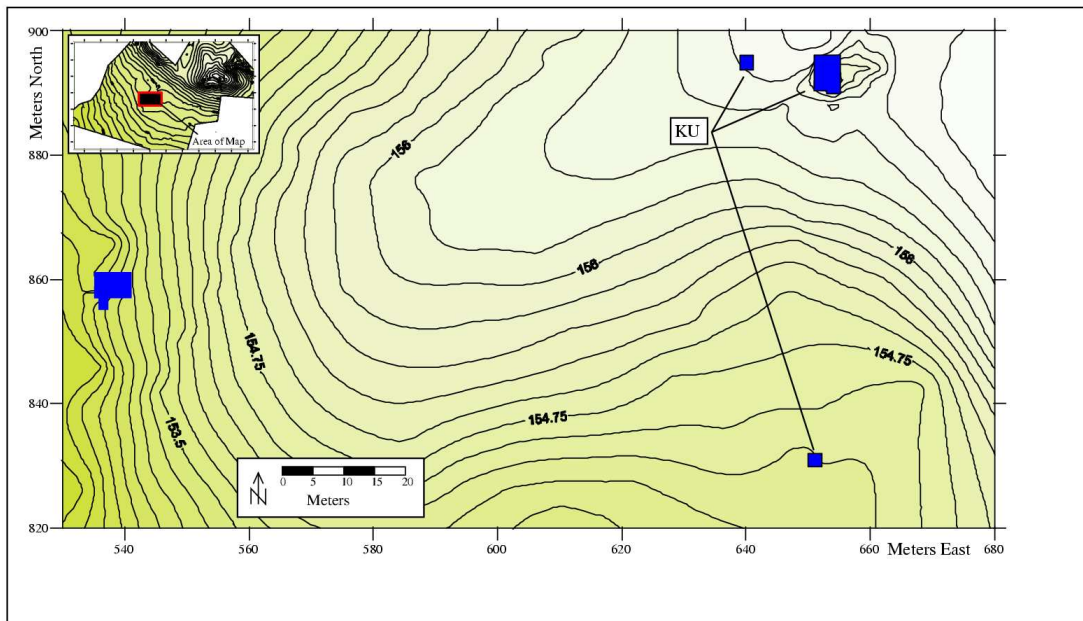

Figure 8: Map of AQ and KU areas

KU Area is to the right

se deben a los afloramientos de la roca madre. También existen varios cambios de coloración del suelo variables en intensidad y tamaño que se diseminan sin ningún orden aparente sobre la superficie, pero la mayor parte de ellos se originaron por la acumulación de estiércol sobre el terreno. Un tercer elemento que también debe ser considerado es la ya mencionada alta densidad de artefactos, principalmente cerámica, la cual exhibe marcados patrones de concentración y dispersión.

Este escenario nos condicionó a utilizar un perforador manual de 4' de diámetro para indagar la naturaleza de los eventos estratigráficos debajo de los sectores con mayor densidad de materiales del Período Formativo Medio y Tardío, en donde se realizaron 24 perforaciones orientadas en base a los ejes cardinales con intervalos de 10 ó 20 metros, además de otras 4 perforaciones en el centro de las manchas más nítidas de superficie. Este trabajo permitió identificar dos áreas de potencial interés para el desarrollo de nuestra investigación, y en cada una de ellas se excavó un sondeo de 2 x 2 metros cuyos hallazgos más sobresalientes serán descritos a continuación.

Descripción de los Hallazgos

N830/E650

El primer sondeo, en las coordenadas N830/E650 presenta un grueso estrato arcillo franco arenoso (7.5YR 3/6) que tiene bastantes artefactos Formativo Tardío y Tiwanaku (Evento B-3), y debajo, a 50 cm. de profundidad del datum, se encontró un

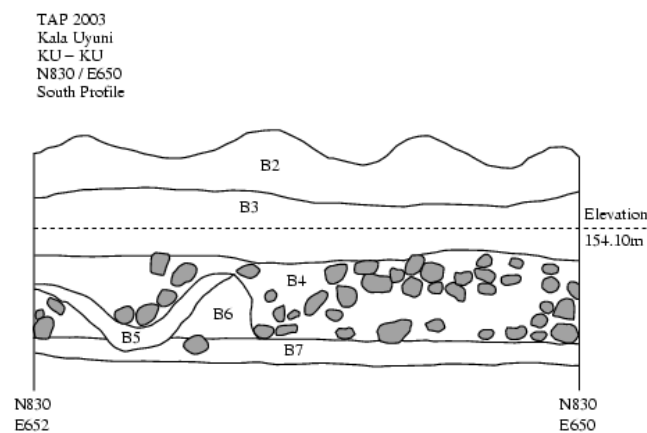

Figure 9: Profile of N830/E650

pequeño depósito que contiene muchas piedras (Evento B-4) y bastantes materiales de este último período. Este interesante caso de estratigrafía invertida aparentemente se debe a la erosión de los depósitos superiores, los cuales se acumularon sobre un nivel de ocupación Tiwanaku previamente existente. Además, es probable que la acumulación de piedras sea el relleno de nivelación de una plataforma, debido a la proximidad de un desnivel de altura 4 metros

hacia el sur. Otra particularidad de este evento es la presencia de las extremidades inferiores de un individuo adulto en el perfil oeste, las cuales se encontraban muy fragmentadas y sus superficies exhibían notorios resquebrajamientos y máculas (Kate Moore com. pers.). Estos atributos nos inducen a pensar en la remoción de un entierro temprano y en su posterior exposición a la intemperie (Schiffer 1996), pero no se ha descartado la presencia de una tumba Tiwanaku, aunque durante la excavación no se detectó ningún rasgo formalmente construido. Un segundo contexto encima del relleno de piedras es un pequeño fogón de 30 x 60 cm. y 15 cm. de profundidad en la esquina sureste (Evento B-5), el cual contiene mucha ceniza y cuyo corte cóncavo (Evento B-6) fue reforzado con un grueso cinturón de arcilla amarilla.

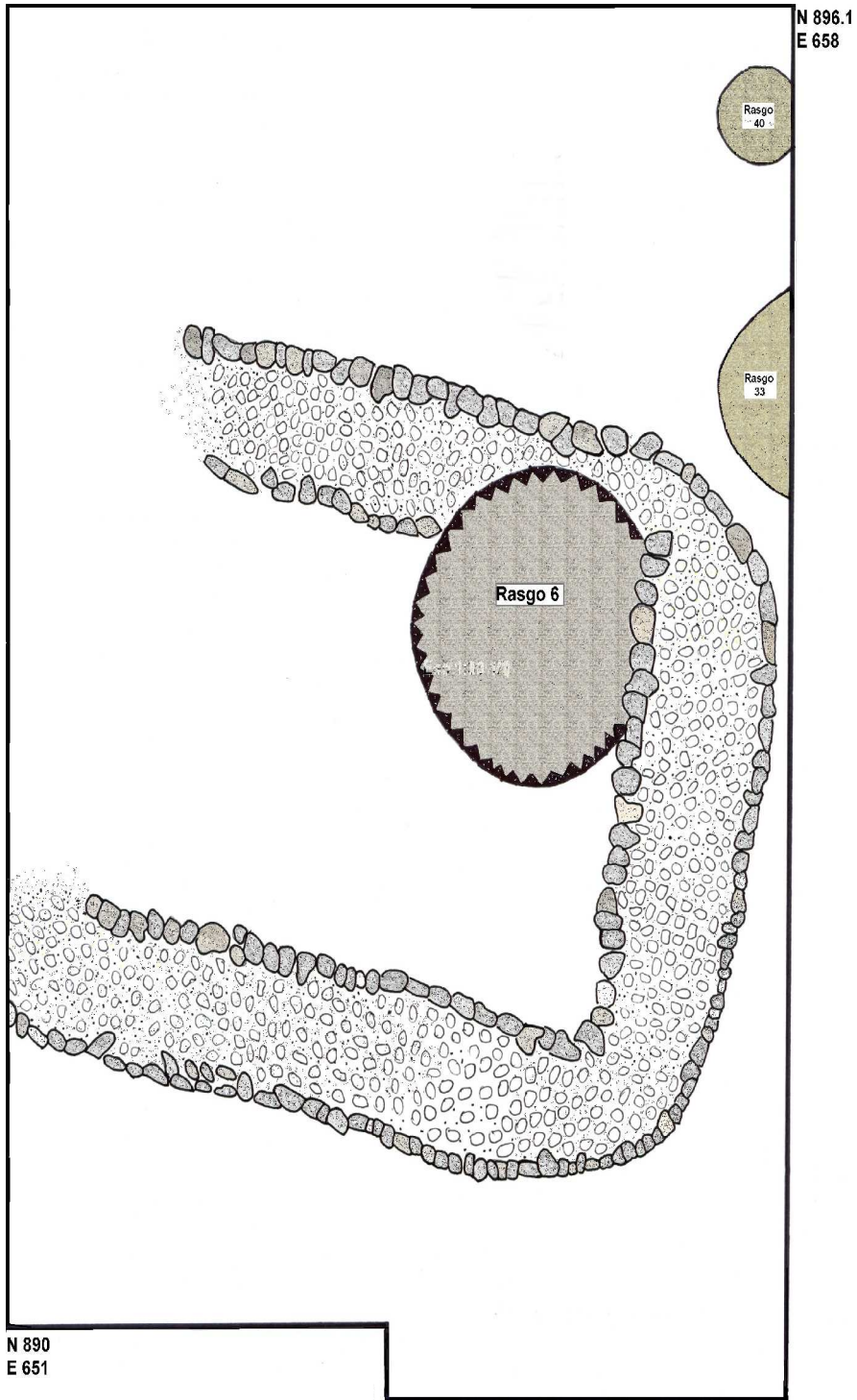

Figure 10: Plan of ASD-2 Structure

N890/E653

La segunda unidad, en las coordenadas N890/E653, sirvió para localizar la esquina sureste de una estructura Formativa Tardía (ASD-2), diagnóstico corroborado por los análisis cerámicos de la Dra. Lee Steadman. Esta edificación se encuentra a 1 metro de profundidad promedio bajo el datum, y para definir su forma y su extensión fue necesario excavar otras unidades adyacentes que en total suman 12 m².

El resultado de este trabajo fue la documentación de una estructura ligeramente trapezoidal que tiene las esquinas externas redondeadas, pero cuya única esquina interior es de 90°. Su cimiento sur mide 3,5 m., el norte 3 m., el este 2,8 m. y el oeste no pudo ser excavado porque se encuentra en el perfil (Figura 1). Sin embargo, la discontinuidad de algunas piedras sugiere que este último muro no está completo, quizás por un diferente grado de conservación, una destrucción efectuada en tiempos prehispánicos o una distinta técnica constructiva.

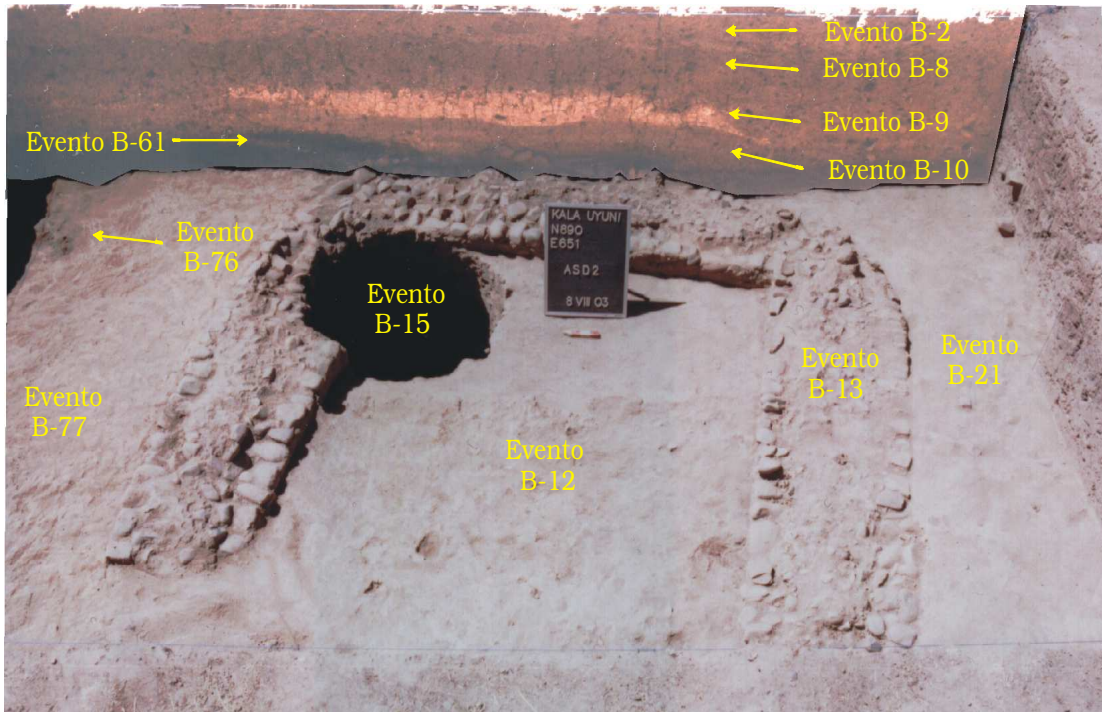

Figure 11: Annotated photo of ASD-2 structure from West

Observe the presence of gravels in the interior of the foundations, and the slope of Event B-9.

Estos cimientos (Evento B-13) constan de una doble hilera de cantos rodados y materiales líticos reutilizados (manos de moler, batanes rotos, etc.) que están separados por un espacio de 60 centímetros de grosor promedio, y en medio se

Figura 3.

Matriz Harris de las excavaciones en el área Kala uyuni

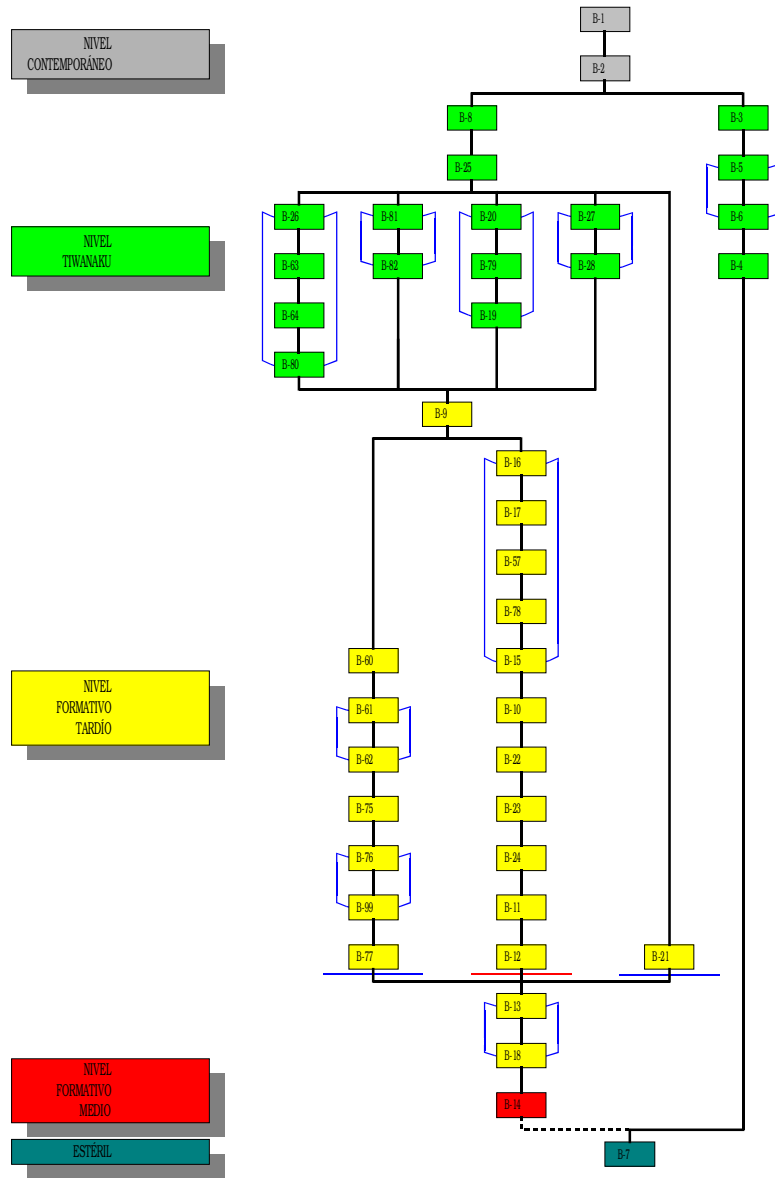
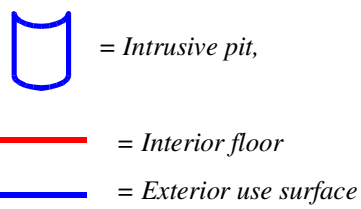

Figure 12: Color-coded Harris Matrix of KU excavations



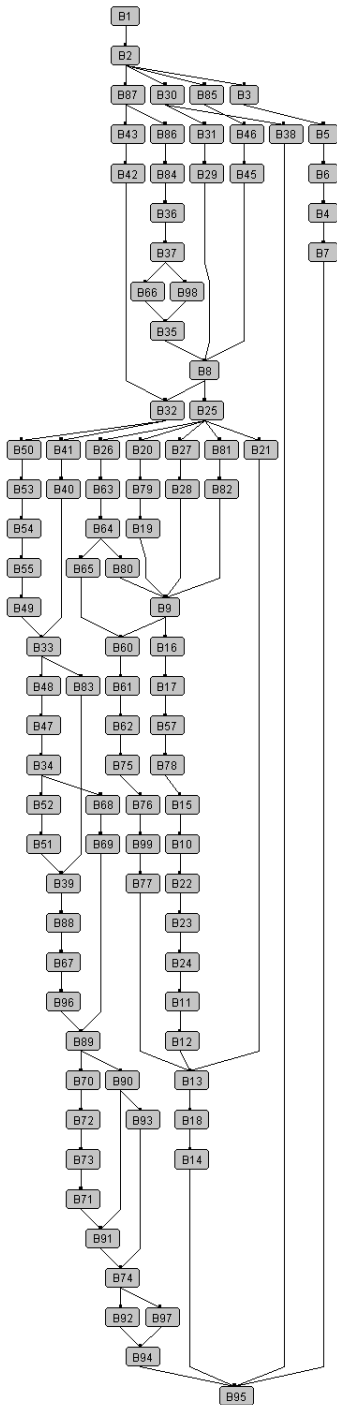

Figure 13: Complete KU Harris Matrix

encontraron pequeños guijarros, varios núcleos de adobe rojo (10YR 3/2) y algunos tiestos de filiación Chiripa. Todo este conglomerado, que en realidad son los muros de la estructura, estaba unido por una arcilla amarilla (10YR 7/6) muy compacta de 20 cm. de alto. No obstante, es nuestra impresión que el espacio entre los alineamientos de piedra era destinado al almacenamiento de bienes y/o productos, pero la posterior erosión de los muros relleno el mismo.

La entrada de la edificación se encuentra en la pared norte, debido a que esta es abruptamente interrumpida por un delgado estrato de arcilla amarilla (Evento B-24) que penetra desde el exterior mediante una ligera inclinación hacia el sur.

El piso de la estructura (Evento B-12) es una capa de arcilla amarilla (2.5Y 7/4) muy compacta de 3 centímetros de grosor promedio, y su superficie irregular presenta leves declives a los costados. Este rasgo estaba virtualmente limpio, y encima se descubrieron tres pequeños depósitos de textura arcillo franco arenosa (Eventos B-10, B-11 y B-23) que se intercalan con dos delgados lentes de arcilla amarilla (Eventos B-22 y B-24). Durante la excavación, se pensó que estos lentes representaban distintos momentos de ocupación, pero los análisis preliminares de la Dra. Lee Steadman señalan que ambos eventos pertenecen a la misma fase. En consecuencia, estos lentes podrían deberse a la degradación natural del piso, o acaso representan distintos períodos de erosión?.

Esta sucesión de estratos y lentes fue cubierta por una capa de arcilla amarilla (Evento B-9) que es muy gruesa en el perfil este y que posiblemente se originó por el colapso de los muros hacia el interior, los cuales posteriormente se erosionaron. El principal argumento de esta suposición es el contacto estratigráfico entre este contexto y los cimientos de la estructura a través de una marcada inclinación. Otra hipótesis que también

explicaría la aparición de este evento es la caída de un techo, pero no hemos detectado restos de paja y/o madera en el mismo.

Afuera de la estructura se registraron dos superficies de uso. La primera, al sur (Evento B-21), presenta tenues lentes de arcilla amarilla que están dispersos irregularmente, los cuales se asocian a una significativa cantidad de materiales. Además, en el perfil este se registró un pequeño pozo cóncavo de donde se extrajo un pequeño tazón entero que tiene los bordes ondulados. Por el contrario, la superficie de uso del sector norte (Evento B-77) es más continua y compacta, posee una fuerte concentración de ceniza que probablemente sea los restos de un fogón (Evento B-76), notorios lentes de arcilla y arena y varias piedras que están unidas por una arcilla amarilla muy dura. Su interfase contiene pocos artefactos, y al parecer, todos ellos emergieron hacia el estrato superior (Evento B-75), encima del cual se construyó un fogón de 70 x 30 cm. y 15 cm. de profundidad (Evento B-61) que esta incrustado en el perfil este. Estos datos demuestran que ambas superficies comparten la presencia de varios lentes de arcilla que se habrían originado por la erosión de los muros de adobe, pero por lo demás, son radicalmente diferentes. La mayor compactación de la superficie del norte se debería a un intenso pisoteo (Schiffer 1996), y los dos fogones que representan distintos momentos de ocupación están separados por un relleno (i.e., B-75). Antagónicamente, la discontinuidad de la superficie de uso del sur indicaría un menor trajín de la gente, aunque la mayor densidad de materiales señala el desarrollo de varias actividades.

Otro importante contexto es el pozo de 1,20 m. de diámetro y 2,5 m. de profundidad que llega hasta el nivel estéril (Evento B-15), el cual se sobrepuso y destruyó la esquina noreste de ASD-2 (ver Figuras 1 y 2). Este rasgo de forma acampanada contiene cuatro rellenos de textura tendiente a lo limoso (Eventos B-16, B-17, B-57 y B-78), varios lentes de ceniza, arcilla y arena y una treintena de artefactos líticos enteros (azadas, percutores, manos de mortero, etc.), siete batanes completos o rotos y varias vasijas rotas intencionalmente, entre las cuales se pudieron reconstruir dos grandes jarrones y algunos tazones que tienen una decoración análoga a la cerámica Kalasasaya de Tiwanaku. La presencia de estas vasijas decoradas y su rotura premeditada nos inducen a pensar que este rasgo era una ofrenda, aunque la hipótesis de un pozo de almacenamiento no esta descartada.

Interesantemente, en los perfiles de este pozo se pudo apreciar que el estrato sobre el cual se construyo la estructura ASD-2 contiene bastantes materiales de filiación Chiripa (Evento B-14), y debajo posiblemente exista otra edificación que estaría asociada a una compleja secuencia estratigráfica.

Todos estos contextos Formativo Tardíos (Figura 2) fueron cubiertos por un nivel de ocupación Tiwanaku que esta representado por cuatro pozos intrusivos y dos gruesos estratos: El primero de estos eventos (B-80) es un enorme hoyo de forma cóncava en el perfil norte, de 2,10 x 1,10 m. y 40 cm. de profundidad, y en su interior se hallaron bastantes piedras, ceniza y suelo arcillo limoso (Eventos B-26, B-63 y B-64), además

de dos diminutas vasijas, delgados fragmentos de instrumentos de cobre, varias concentraciones de cerámica y muchos huesos de pescado. La función de este rasgo es desconocida, pero tradicionalmente esta clase de contexto ha sido interpretado como basural (Bermann 1990; Janusek 1994). El segundo pozo (Evento B-19) está en el perfil oeste, sus dimensiones son 70 x 50 cm. y 25 cm. de profundidad y sus paredes de forma acampanada fueron reforzadas con arcilla amarilla (Evento B-79). Dentro de este rasgo solo se encontró suelo arcillo limoso (Evento B-20), y posiblemente era un pozo de almacenamiento debido a que este tipo de suelo generalmente se origina por la descomposición de los materiales orgánicos (Stein 1992); además, el cinturón de arcilla amarilla pudo haber servido para facilitar la conservación de los productos secos (Janusek 2001). El tercer pozo es de 30 cm. de diámetro y 15 cm. de profundidad y también está en el perfil oeste; su corte, nuevamente de forma acampanada (Evento B-82) fue utilizado para depositar un suelo arcillo limoso. Esta última característica apunta a un pozo de almacenamiento, pero la ausencia de arcilla amarilla en sus paredes indicaría otro uso. Finalmente, el evento B-28 es un hoyo de forma cónica de 60 x 30 cm. y 30 cm. de profundidad, donde fue colocada la caja torácica de un camélido adulto, varias partículas de carbón, bastantes huesos de pescado y suelo arcillo limoso (Evento B-27).

Estos rasgos yacen debajo de un estrato que está irregularmente distribuido (Evento B-25), el cual parece haberse formado por la deposición eólica debido a su textura predominantemente arenosa, pero el mismo contiene una inusitada cantidad de materiales Tiwanaku. Este nivel de ocupación fue cubierto por un grueso estrato arcillo arenoso de origen coluvial que está uniformemente distribuido por toda la excavación, y la parte superior del mismo actualmente es utilizada como la zona de arado (Evento B-2), mientras que la parte inferior (Evento B-8) permanece relativamente intacta.

Para finalizar, cabe mencionar que toda esta compleja deposición estratigráfica fue representada en una sola matriz (Figura 3), pese a que ambas excavaciones están distanciadas por más de 30 metros, debido a que se trata de la misma área de excavación (i.e., Kala Uyuni). También es necesario mencionar que hemos optado por enfatizar la ubicación de los rasgos culturales en la matriz Harris mediante el uso de símbolos (Paice 1991). (Christine, esto es optativo o debe ir en la parte de metodología).

Conclusiones

La estratigrafía del sector de Kala Uyuni se originó por la combinación de: 1) la meteorización del nivel estéril, 2) la erosión del coluvio superior, y 3) la deposición eólica. Las dos primeras fuentes de aporte contribuyeron de forma significativa a la composición de los estratos, y prueba de ello es que la mayoría de los depósitos

tienen texturas preponderantemente arcillosas y guijarros medianos y semiesféricos como inclusiones predominantes. Por el contrario, la deposición eólica generalmente se presenta como un simple componente del suelo, y solo en contadas ocasiones (e.g., los lentes de arena) aparece como un evento aislado.

Estos depósitos naturales se alternan con los rasgos culturales que “fácilmente” pueden ser reconocidos por sus texturas limosas y/o la presencia de ceniza en su interior, además de sus obvias formas y contenidos. Sin embargo, en la construcción de la estructura ASD-2 y de algunos pozos se utilizó una gran cantidad de arcilla amarilla, y esta alta incidencia se debe a la mayor disponibilidad de esta materia prima en el nivel estéril, o quizás a su traslado intencional desde una cercana fuente de abastecimiento.

Una segunda característica de la deposición estratigráfica de Kala Uyuni es la presencia de varias interfases graduales que se deben a largos procesos de estabilidad, los cuales delatan la formación de un suelo natural hablando en términos estrictamente geológicos (Schiffer 1996; Waters 1992). Otro aspecto que también debe ser tomado en cuenta es la emergencia de los materiales más tempranos hacia la superficie, y al parecer, la textura arcillosa de la mayoría de los estratos, la consecuente retención de humedad por parte del suelo y la posible proximidad de un nivel freático facilitaron la actuación de un proceso de disturbio, posiblemente la arcilloturbación (Ibíd.).

Con relación a la secuencia de ocupación, la primera fase de desarrollo corresponde al Período Formativo Medio y esta representada por un grueso estrato que tiene varios materiales pero que carece de una superficie de uso. Por ende, los cimientos de la estructura ASD-2 fueron cavados sobre un depósito donde no se desarrollaba ninguna actividad predecesora, aunque el reconocimiento de algunos tiestos Chiripa en los muros de la estructura confirma la destrucción intencionada de contextos más tempranos.

Después sobrevino un asentamiento del Período Formativo Tardío durante el cual se construyó la estructura ASD-2 con una clara función doméstica. Esta aseveración se fundamenta en tres hechos: 1) la inferencia de un techo, debido a que no se encontraron canales de desagüe y porque la relativa proximidad de sus muros permitía soportar el peso de un techo sin la necesidad de postes, 2) la ausencia de fogones y la escasa cantidad de materiales en su interior, en contraposición a la presencia de fogones y la alta densidad de artefactos en el exterior. Estas contradicciones demuestran que esta construcción era utilizada como un lugar de descanso y/o como refugio contra las inclemencias del tiempo y que el resto de las actividades se realizaban afuera (e.g., la preparación y la cocción de los alimentos), y 3) el reducido espacio dentro de esta habitación solo podía servir para albergar a un

reducido número de personas (e.g., un núcleo familiar).

Obviamente, esta hipótesis debe ser complementada con el análisis de los materiales, pero es nuestra impresión que: 1) la mayoría de la cerámica carece de decoración y hay una clara predominancia de las vasijas de cocción y servido, 2) los escasos artefactos líticos sirven para cortar, raer y para las labores de molienda, y 3) los pocos huesos de animales son el resultado del consumo humano.

La ocupación de esta estructura comenzó durante el Período Formativo Tardío, pero luego se dio un indeterminado lapso de abandono en el mismo período. Este hiato causó la erosión de sus paredes, y una vez acumulados pequeños estratos y lentes de arcilla se cavó un pozo encima de una de sus esquinas (Evento B-15) para arrojar varios artefactos líticos y diversas vasijas enteras, algunas de ellas decoradas. Este acto posiblemente tuvo connotaciones rituales y fue conducido y/o destinado a los antiguos ocupantes de esta edificación, e inmediatamente después se produjo el colapso intencional de sus muros. La posición horizontal de las paredes caídas facilitó la erosión de las mismas, y este proceso causó la formación del evento B-9 que esta restringido al interior de la estructura.

Toda esta interpretación se basa en los siguientes preceptos: 1) la función doméstica de ASD-2, 2) la mayoría de sus materiales tienen un obvio carácter utilitario, 3) las vasijas decoradas son de exclusivo uso ceremonial, 4) estas fueron rotas ex profeso, y 5) las mismas solo se encuentran en el evento B-15¹. Esta dualidad estipula que ciertas actividades ceremoniales no trascendían del ámbito familiar (e.g., challas, matrimonios, ritos de iniciación) y se realizaban ocasionalmente dentro de las estructuras domésticas (Bermann 1990; Hastorf 1999). Sin embargo, las vasijas decoradas también eran utilizadas como bienes de status, y su almacenamiento y uso selectivo era manipulado por los líderes locales y/o familiares para facilitar las relaciones y el intercambio con otros grupos influyentes (Bermann 1990; Browman 1984; Janusek & Kolata 2003). En consecuencia, existe la posibilidad de que los materiales del evento B-15, incluyendo los ceramios decorados, sean parte de un pozo de almacenamiento.

De cualquier modo, ambas posibilidades interpretativas estipulan que la funcionalidad de los rasgos culturales es específica (entierros, fogones, estructuras, etc.), pero esta depende de contextos más amplios (e.g., tumbas en sectores habitacionales, hornos en sitios defensivos, habitaciones en lugares de peregrinaje). Estos razonamientos establecen que no se pueden establecer divisiones taxativas entre los ordenes domésticos y ceremoniales en base a la decoración de la cerámica, ya que ambas actividades no son excluyentes entre sí durante el Período Formativo Tardío.

¹ Durante la excavación solo se pudo identificar tres tiestos decorados en las afueras de ASD-2.

Adicionalmente: 1) el alineamiento de piedras entre el perfil este de las excavaciones y el cimiento de ASD-2, 2) el excesivo grosor del evento B-8 que ha sido interpretado como un muro o techo caído y que indudablemente se prolonga hacia el este (ver Figura 2), y 3) la presencia de varias piedras que están unidas por una dura arcilla amarilla (posiblemente argamasa) en la esquina noreste, nos inducen a sospechar de la existencia de una estructura anexa a ASD-2. Estas dos estructuras estarían dispuestas alrededor de un patio en el norte, el cual puede ser reconocido por su superficie muy compacta, aunque la identificación de dos fases de ocupación contrasta con la deposición interna de la estructura. Consecuentemente, la superficie de uso del sector sur sería el área externa de este grupo de casas, y en ella se ejercían otro tipo de actividades.

Por otra parte, la estructura ASD-2 de Kala Uyuni muestra grandes similitudes morfológicas y organizativas (e.g., la ubicación de sus fogones) con las edificaciones de la primera fase de Lukurmata (Bermann 1990). Otra construcción similar fue reportada por Max Portugal Ortiz (1993) en Tiwanaku, la cual ha sido atribuida a la época I de la cultura homónima². Sin embargo, también existen notables diferencias entre ASD-2 y estas estructuras, como ser: 1) la forma redondeada de sus esquinas externas que parecen deberse a la mejor conservación de sus muros, 2) la ausencia de materiales sobre su piso que señala distintas intensidades de ocupación, el desarrollo de otro tipo de actividades e incluso diferentes grados de limpieza, 3) las divergencias en la forma y el grosor de los cimientos³ no solo apuntan a una mayor inversión de tiempo y esfuerzo con relación a otras estructuras del mismo período, sino que pone en evidencia diversas técnicas constructivas y posiblemente variadas funcionalidades, y 4) la posibilidad de que el espacio intermedio entre los cimientos de ASD-2 hubiese sido destinado al almacenamiento de bienes y/o productos nuevamente apunta a distinciones de uso.

Desafortunadamente, las demás estructuras del Período Formativo Tardío no son comparables a ASD-2. Por ejemplo, en Qeyakuntu, Janusek y Kolata (2003) hallaron un muro de forma arqueada que tiene cimientos de piedra y muros de adobe con guijarros que habrían colapsado, y esta construcción estaría asociada a un entierro humano y varios segmentos corporales. Paradójicamente, en Kirawi, los mismos investigadores encontraron la esquina del “edificio rojo” de probable función ritual, la cual tiene cimientos de arcilla de este color y en su interior existen dos pisos sobrepuestos completamente limpios. Una segunda construcción sería el “edificio multicolor” que tiene cimientos de adobe de color azul o gris y muros de arcilla

² Dentro de esta estructura se encontraron varios materiales cerámicos y líticos y un pequeño fogón (Portugal Ortiz 1993).

³ Se refiere a que los cimientos de ASD-2 constan de un doble alineamiento de piedras que están separadas por un espacio de 60 cm. de grosor promedio, mientras que las estructuras de Lukurmata presentan una doble hilera de cantos rodados de 30 cm. de grosor.

amarilla. Dentro de esta construcción de probable función doméstica se registraron 7 apisonados sobrepuestos de color rojo o amarillo, además de una patilla o banqueta de color azul, un fogón grande, un depósito rectangular y un hueco de poste, y en su exterior un pozo para almacenar productos secos, un entierro en forma de cista de un adolescente y un área de deshecho. Un tercer sitio que tendría edificaciones pertenecientes a este período es CK-70, y en el solo se descubrieron segmentos de muros que tienen tres agujeros de postes (Janusek & Kolata 2003).

Este escenario regional determina que no se puede concebir a todas las estructuras del Período Formativo Tardío como homogéneas, debido a que existen notables diferencias en la forma, el tamaño, el estilo arquitectónico, el contenido, la disposición de los rasgos, etc. Estas divergencias pueden reflejar simples variaciones en el comportamiento familiar (distinto aprovechamiento de los espacios, gusto, estética, etc.), cuestiones funcionales (viviendas, depósitos, etc.), de status (casas de elite, viviendas tradicionales), filiación étnica (distinciones a nivel de región, sitio o barrio, etc.) e incluso de género (viviendas familiares, de sacerdotisas, etc.). Lo cierto es que la organización doméstica del Período Formativo Tardío luce muy heterogénea, y resulta prematuro priorizar una sola línea de interpretación en el estado actual de las investigaciones.

Después del colapso y la erosión de los muros de ASD-2 se hizo presente una ocupación del Período Tiwanaku, pero a diferencia de otros sitios, no hubo una reocupación de la estructura ni una destrucción intencionada de la misma (Bermann 1990; Janusek 1994), tal vez porque esta ya se encontraba enterrada.

Este nivel Tiwanaku se caracteriza por la apertura de varios pozos intrusivos que difieren en forma y contenido, y si bien la funcionalidad de tres de ellos no puede ser discutida (i.e., un fogón, un pozo de almacenamiento y una ofrenda), la interpretación de los dos restantes (i.e., un basural y un segundo pozo de almacenamiento) es debatible. Estos datos demuestran que la forma del pozo determinaba el contenido del mismo, pero en algunos casos existe cierta combinación de elementos que puede ser atribuida a: 1) la construcción de varios hoyos de forma diferente pero destinados a la misma función (e.g., pozos de almacenamiento de forma cóncava o acampanada) ó viceversa (e.g., pozos cóncavos utilizados como áreas de almacenamiento o basurales), 2) el desconocimiento de varios usos para estos pozos (depósitos de granos, letrinas, zanjias, etc), y 3) la ambivalente función de algunos de estos contextos (e.g., depósitos de artefactos también utilizados como graneros, basurales aprovechados como letrinas). Estos argumentos demuestran que no se puede concebir intuitivamente a todos los pozos como basurales, y resulta imprescindible correlacionar las interpretaciones de campo con el respectivo análisis de sus materiales.

Una segunda particularidad de estos pozos es que todos ellos se encuentran a la misma profundidad en un espacio muy reducido, y pese a no haberse detectado una superficie de uso entre ellos, es evidente que en sus alrededores existía un área donde se desarrollaron varias actividades domésticas como el almacenamiento de productos, ofrendas, etc. (Bermann 1990; Goldstein 2000; Janusek 1994; entre otros).

Sin embargo, este asentamiento Tiwanaku no debe ser entendido como una simple superposición estratigráfica, sino más bien, como un complejo proceso que variaba en intensidad, magnitud y dinámica de ocupación de sitio a sitio y de región a región (Berenguer & Dauelsberg 1989; Browman 1997; Stanish 2003; entre otros). La prueba más fehaciente de esta aseveración es que las características de la deposición Tiwanaku en Kala Uyuni e Iwawi son radicalmente diferentes, debido a que este último sitio, ubicado a solo 5 kilómetros hacia el este, presenta restos de arquitectura cívico-ceremonial (Albarracin-Jordan 1996; Burkholder 1997; Isbell et al. 2002).

5. Additional Excavations in the KU Area – N894/E639

Maria Bruno, Mary Leighton

In order to complement the horizontal excavations being carried out by José Luis Paz and Soledad Fernandez in the Kala Uyuni area, we opened a single 2 x 2 meter unit, N894/E639, with the intention of reaching sterile and obtaining a sample of the entire occupational history of this area.

First, we removed the plow zone (B-2). Below this we encountered a Tiwanaku IV-V occupation that was represented in this unit by two horizontal strata, several pits, and two burials. Just below the plow zone is B-8, previously defined by Paz and Fernandez as “soil with artifacts”. We did not encounter the yellow clay layer (B-9) below B-8, as Paz and Fernandez did, but instead came upon a medium density midden (B-32). This was a yellowish-brown mottled deposit of silty clay with inclusions of limestone flecks and charcoal, and high artifact density.

Several pits were intrusive into these Tiwanaku deposits. Feature 8 (B-29, B-30, B-31), Feature 9 (B-35, B-36, B-37, B-66, B-84, B-98), Feature 18 (B-42, B-43), and Feature 41 (B-38, B-86, B-87) were all pits with mixed fills that date to the Tiwanaku V-VI period (see Figure 13 for Harris Matrix). Feature 41 included a cobble deposit (B-38) that may be related to some type of construction event. No other evidence of architecture was encountered in this trench, however.

Perhaps the best defined contexts we have for the Tiwanaku IV-V occupation in this trench are two burials. Burial #2, (Feature 14, Events B-40 and B-41) is a poorly preserved grass-lined child burial. Burial # 4 (Feature 16, Events B-45, B-46, and B-85) is the tomb of a well-preserved adult accompanied by a *sahumador* and blackware kero. The individual was in a seated flexed position facing east. The grave was a cyst tomb lined and capped with several large *batanes*.

Based on present analysis of the ceramics, it appears that the Classic Tiwanaku (Tiwanaku IV-V) to Late Formative (Tiwanaku I/III) stratigraphic transition occurs about 156.30 cm below datum at B-33. This deposit is a heterogeneous, silty clay loam medium density midden with many inclusions of yellow and red clay, limestone flecks, and charcoal. There was only a small proportion (6%) of Classic Tiwanaku pottery in this stratum and it may actually relate to the upper fill of Burial #4, which was mistakenly combined with B-33 (Locus 5265). The majority of the ceramics are Late Formative. Below B-33, we uncovered a yellow clay loam that extended through

the northern part of the unit. The clay was quite regular and compact and appeared to be a prepared surface (Event B-34, Feature 32). The ceramics from this surface are all Late Formative (Tiwanaku I-III) in date.

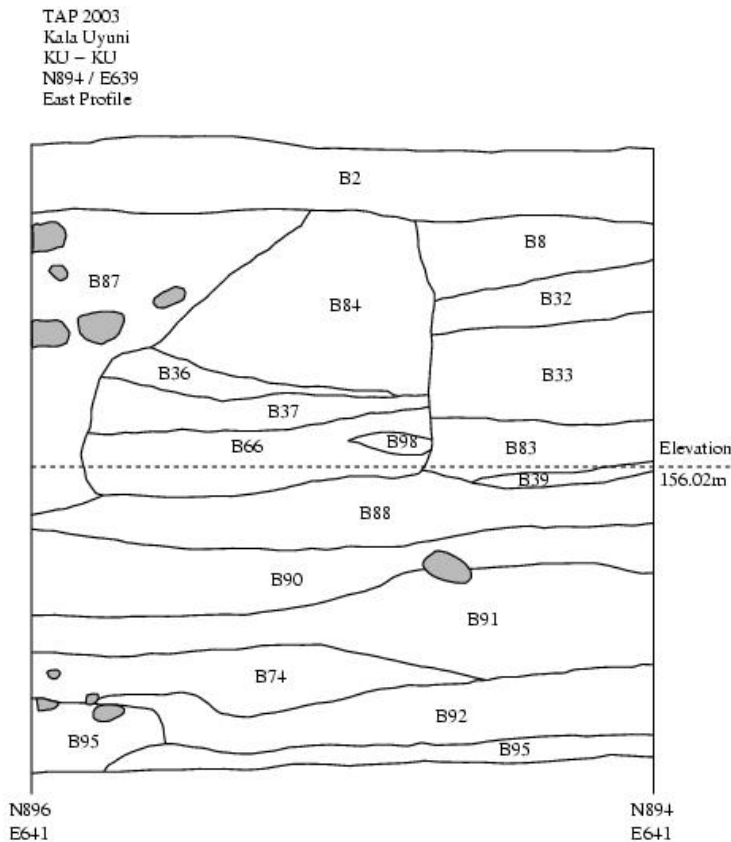

Figure 14: N894/E639 North profile

We also encountered pits at this same stratigraphic level. Feature 20 (B-47, B-48), in the southeast wall of the unit, was filled with ash and charcoal. Although the ceramics have not been analyzed, the pit cut is intrusive into B-33 and we hypothesize that this is a Late Formative pit. Also cut into B-33 was another pit, Feature 22 (B-49, B-50, B-53, B-54, B-55), in the center of the unit. This pit was about 30 cm deep and varied between 40-45 cm in diameter. This pit had very irregular boundaries and was difficult to define

during excavations. It contained four sequential fill events, two of which were almost pure ash and charcoal mixed with silty clay (B-50 and B-54), one that was a fairly dense clay loam of highly irregular thickness (B-53), and one that was primarily a dark silty clay loam with some charcoal and ash (B-55). Below the floor was a small ash pit (Feature 27; Events B-51 and B-52).

At about the depth of the floor, the stratigraphy in the unit became quite complicated and difficult to excavate. This was in part due to the presence of a pit, Feature 22, which made it difficult to follow any stratum across the unit, but also it seems that there were distinct depositional events in the northern and southern sectors of the unit. For example, to the south of the clay surface, at about the same depth, was a brown clay loam with artifacts (B-83) whose context was not discernible but appears to be roughly contemporaneous with B-34. Different deposits were found at relatively equal depths in the northern and southern sections of the unit to about 155.80 cm

below datum, approximately 50 cm below the first Late Formative stratum. Due to this complicated stratigraphy and often very subtle changes in depositional events, many loci had mixed events in this part of the excavation. Below, we provide descriptions of the events as they were encountered during the excavations, and later clarified by examination of the profile and the Harris Matrix.

Beneath the clay floor (B-34) in the northern area of the unit, we encountered a looser soil that was a brown, slightly mottled silty clay with pebble inclusions. We interpreted this event, B-39, as a medium density midden. Below this was a compact clay to clay loam deposit with large stains of bright yellow and orange soil and a relatively high density of artifacts. This event, B-67, appeared too thick to be a floor and was defined as a possible occupation zone. To the east, the stains of colored clay continued. The entire area seemed to have a similar quantity of artifacts and seemed equally heterogeneous. Therefore, we excavated it as a single event (Locus 5308). In the profile, however, we could see that to the east there were, in fact, two distinct deposits that were not recognized during the excavation. Two new events were defined after their identification in the profile, B-68 a fairly homogeneous deposit of yellow clay and B-69 a dark, organic lens.

Beneath the occupation zone (B-67), was a distinct deposit of yellow clay loam, with a lower artifact density and with charcoal inclusions, which we defined as a medium density midden (B-89). During the excavation of B-89 we also encountered a fairly large ash deposit, B-70, which seemed to be somewhat mixed with B-89. It appeared that perhaps bioturbation, particularly insects and animal burrowing, has disturbed the stratigraphy in the northwest corner of the unit at this depth. The high level of disturbance is may be related to the burial directly beneath these deposits.

Below B-89 and B-70, in the northwest corner of the unit, was a pit which contained two burials. The earliest burial, (Feature 31, B-73, Burial #5), was a fairly well-preserved adult in a flexed position, lying on its back and oriented east-west. Buried with this individual was a small Kalasasaya (red-rimmed) convex bowl. In order to remove the entire individual, we had to dig back into the western and northern walls. The skeleton was in good condition and we hope its analysis will provide much-needed bioarchaeological data on the Tiwanaku I period. Similar to the Classic Tiwanaku burial, this pit was lined and capped with large *batanes*. Just above this interment was another, less well-preserved individual (Feature 31, B-73, Burial #6). This person was even more embedded in the wall, so we just exposed the elements that fell within the unit, including parts of both feet and probably the right tibia and pelvis. This also appears to have been an adult or sub-adult, but we found no grave goods associated with it.

Returning to about the depth of B-67 (approximately 156.05 cm below datum), in the

southern area of the unit, we encountered another distinct deposit. B-88, a high density midden, was a heterogeneous silty clay loam deposit with inclusions of charcoal, limestone fragments, variously colored clay, and pockets of sand. This event was deposited prior to B-39, the possible clay surface, but later than B-67, the possible occupation zone. Directly beneath B-88 in the excavations was B-90, a medium density midden comprised of a sandy clay loam matrix with inclusions of charcoal. This midden appears to have been deposited prior to the midden B-89 found in the northern part of the unit.

At about 155.80 cm below datum, we finally found a deposit that extended across the entire unit, except for where disturbed by the burial. B-91 was a dark brown clay mottled with red, yellow, and orange clays, as well as charcoal. It contained many artifacts of all classes and we defined it as a high density midden. Beneath B-91, in the northern sector of the unit, we encountered another high density midden deposit, B-74, that was distinguished by its very high density of ash and charcoal. The final deposit above sterile soil was another high density midden B-92, in which was embedded a thin lens of ash and fish bones, B-97.

These Late Formative midden accumulations are interesting in that the majority of the ceramics that we recovered were often decorated and quite fine. Kalasasaya zoned-incised sherds were relatively common throughout, as were fragments of red-rimmed convex bowls. In some cases, we encountered nearly all of the pieces of broken pots or other vessels. Based on these preliminary observations we suggest that this may not have been domestic midden accumulation but was instead produced by more formal, ritual or festival, activities that involved the use of specialized serving and display vessels. These deposits may be related to activities carried out in and around ASD-2, structure encountered by Paz and Fernandez (page 34).

At the outset, we were hoping to also encounter Chiripa period deposits, providing information on the transition from the Middle to Late Formative at the site. Although we did not find any evidence of Chiripa occupation in this unit, these excavations provide one of the best Late Formative ceramic assemblages for the region. Analysis of the ceramics will hopefully provide a improved chronology for the Late Formative periods, allowing us to better differentiate Tiwanaku I and III. Additional artifact analysis of this unit will also shed light on the nature of activities at Kala Uyuni, the proposed center of the Taraco Peninsula Polity during the early Late Formative period.

6. Excavations in the AC (Achachi Coa Kkollu) Sector

Amanda Cohen and Andrew Roddick

The Achachi Coa Kkollu (AC) sector of Kala Uyuni is located on communal land, on top of a steeply sided hill (Figure 15), overlooking the Late Formative Kala Uyuni Village. The 2003 TAP excavations focused on three different activity areas at Achachi Coa Kkollu – the lower and upper sunken courts and a nearby midden. Our excavations were initially guided by the presence of several large white limestone

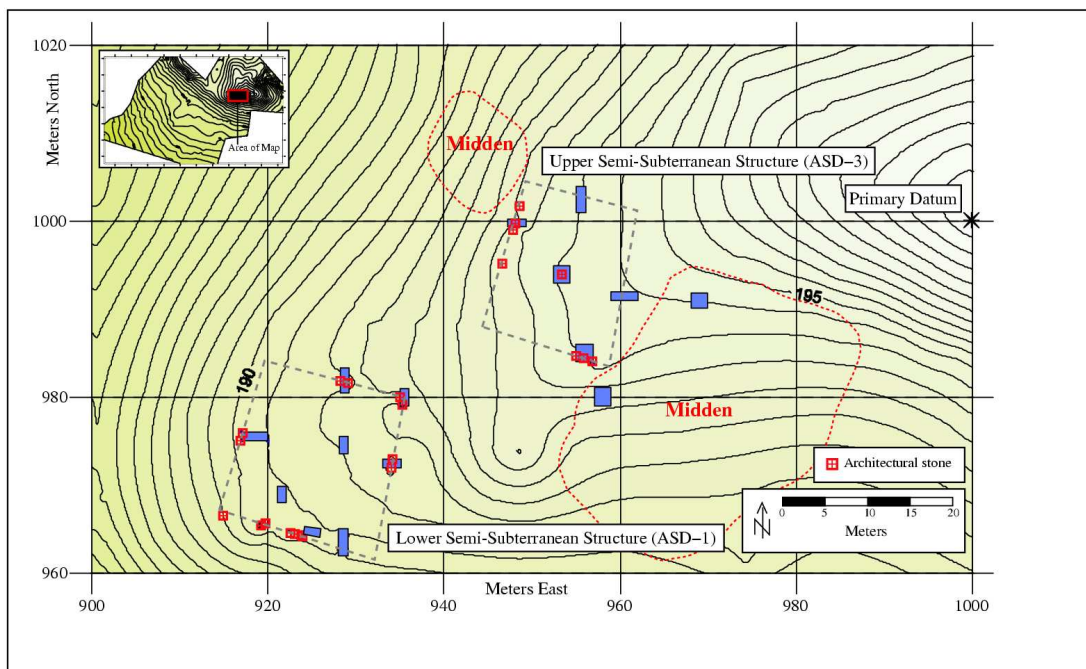

Figure 15: KUAC sunken courts and excavation units

Reconstructed sunken court perimeters and midden areas are indicated.

blocks protruding from the ground in the southwest corner of the area. These blocks had been originally identified by Bandy (2001: 122) while community members were in the process of digging up and inverting two of the stones as part of a local rain ceremony. Their presence, together with the continued ritual significance of this area to the local community, suggested that this may have been the ceremonial sector of the site in prehistory. The presence of these blocks and the high surface densities of Late Chiripa and Late Formative (Tiwanaku I/III) decorated ceramics, along with

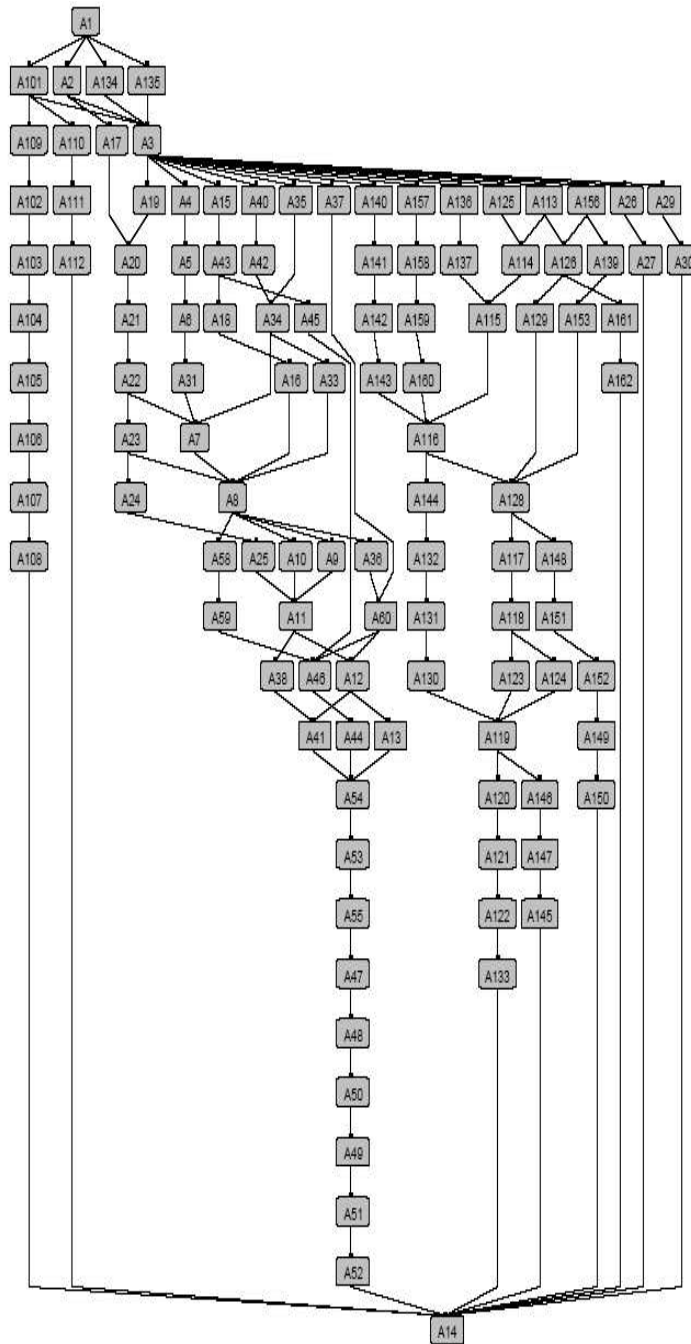

Figure 16:
Harris
Matrix for
area AC

lithic flakes, groundstone and projectile points, and specialty items such as stone labrets, beads, and exotic imported ceramics, hinted at subsurface architectural remains.

The 2003 excavations adjacent to the limestone blocks did indeed reveal a sunken court, deeply buried under a thick colluvial deposit (Event A3). We refer to this court

as the 'lower court' (ASD-1). Further exploration in the area upslope of the lower court identified a line of deeply bedded limestone blocks, as well as a large red sandstone block protruding from the surface. Excavations in this area revealed another sunken court, the 'upper court' (ASD-3), with a standing sandstone monolith in the center. Additionally, to the northwest and east of the upper sunken court (ASD-3), the surface soil was found to be considerably darker and exhibited a high density of artifacts, particularly bone, distinguishing it from the surface characteristics of the upper and lower courts themselves. Test excavations in this area revealed the presence of a midden deposit that we interpret as being related to the activities performed in the two courts.

Preliminary analysis of the ceramics from these three sections of the AC area seems to suggest use from the Early Chiripa phase spanning through to the Late Chiripa phase, though the majority of the materials seem to be diagnostic of Late Chiripa. The structures themselves seem to have been constructed and used in the Late Chiripa phase. We await further analysis from ceramicist Lee Steadman and radiocarbon dates to confirm the structures' period of use. The excavations and associated finds are briefly discussed below.

Excavation of ASD-1: The Lower Court:

South Wall (Units N964.37/E923.91 and N962/E928)

The excavation of the Lower Court (ASD-1) concentrated on defining the walls and both the interior and exterior surfaces of the structure. As in most of our Achachi Coa Kkollu units, we began by excavating a thick layer of colluvium (A3), with a highly mixed cultural matrix, before reaching any unmixed cultural deposits. This dense, hard, clay-rich, deposit had the effect of disguising sub-surface features as well as slowing excavations. Fortunately, however, the aforementioned limestone blocks were visible on the surface, and the surface topography seemed to indicate the presence of a sunken temple (see contour lines in Figure 15). We began excavating this part of the site with 2x1 and 3x1 meter excavation units in order to locate the walls. These southern units revealed a highly disturbed context near the wall, with architecture that was for the most part wall fall, and deep deposits of clays in the trough of the slope. Our first unit (N964.37/E923.91), on the downslope side of ASD-1, was especially shallow and disturbed, and as we placed the unit parallel to the wall, we simply encountered the top of the wall fall deposit.

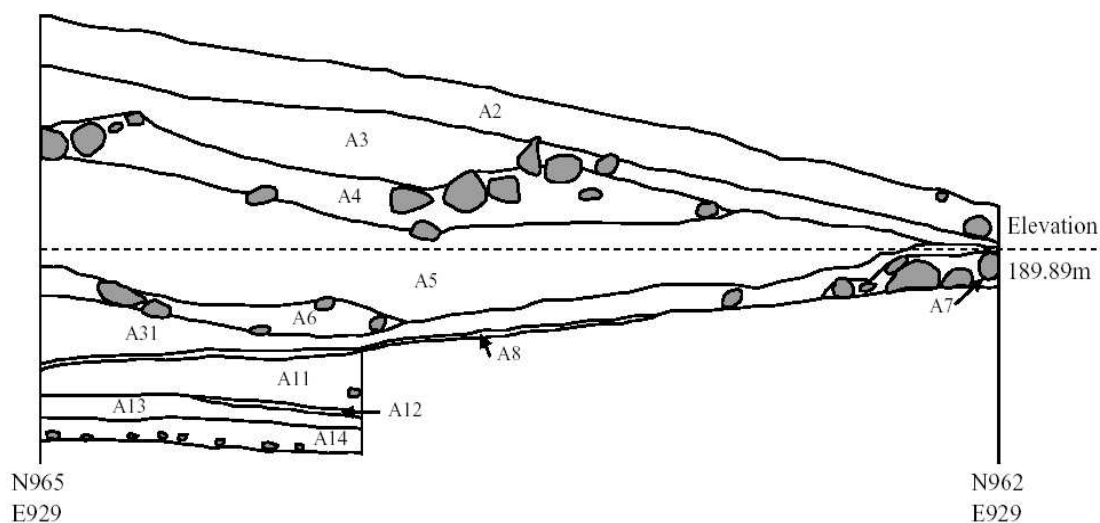

Figure 17: Unit N962/ E928, East Profile

These initial excavations did, however, allow floor and interior fill events to be recorded, as seen in the 3x1 meter unit of N962/E928 (Figure 17) – a unit that proved to be especially helpful in defining the sequence in the southern section of the court. After removing the post-abandonment depositional events (A3, A5) and the wall rubble events (A4, A6), we encountered the upper interior floor of the structure (A8). This yellow clay floor (8.5 YR 3/2) was very thin and was highly mixed (due to erosion and other post-depositional processes) with the above occupation zone and a lower fill. The hard floor extended below the southern wall, demonstrating clearly that the wall was built after the floor. Below this surface we encountered a fill level with some cobbles (A11, A9) and a lower clay floor with few inclusions (A12). This earlier floor was highly mottled, with carbon inclusions and a high density of Late Chiripa sherds. The clay was moist and much easier to excavate, but this also made it difficult to distinguish between the occupation zones and the original floor. There seem to have been several resurfacings of the floors, although there was no clear fill between the levels. It is important to note here that the floors of these structures were highly variable and difficult to define; it was only in the process of creating a Harris Matrix (Figure 2) that the A8 and A12 floors could be respectively linked between excavation units. Below the A12 floor we encountered a sub-floor fill (A13), and finally encountered a hard pebbly sterile deposit (A14).

North Wall (Units N980.4/E928.18 and N979/E935):

The two excavation units of the preserved north wall of ASD-1 permitted a better view of the lower court and a glimpse into the complex construction sequence, the wall construction technique and the exterior spaces of the court. Our units were

placed based on a hypothesized size of the structure, and after a failed attempt (see unit N973.6/E928.11 below), we succeeded in locating the northern wall approximately 21 meters north of the southern wall (Figure 15).

After excavating the A3 colluvium in unit N980.4/E928.18, we discovered a pit filled with ash and high densities of fish bones, along with a very low density of camelid bone, which had been excavated into the external sterile surface. As will be seen below, this seems to have been a standard practice for the surfaces surrounding the lower temple. We have no absolute dates on these pits yet, but if these distinct features are contemporary with the structure, we propose that they represent a repeated consumption activity, perhaps representing some sort of communal feasting .

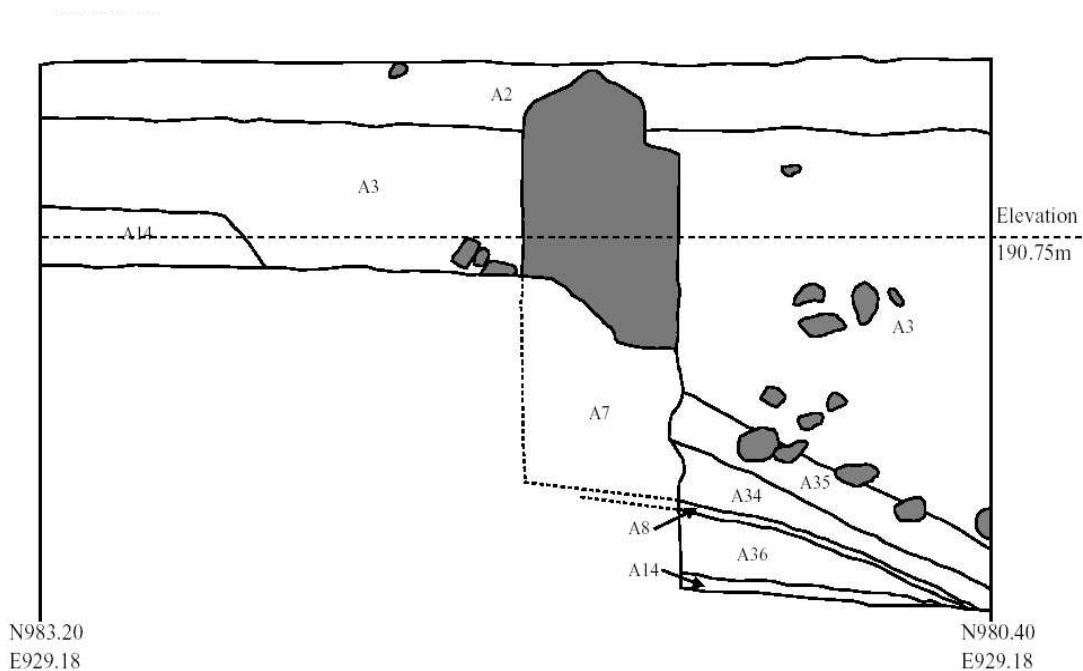

Figure 18: Unit N980.40/ E928.18, East Profile

We then encountered a very large limestone block in the center of the unit (Figure 18). Excavations revealed alternating limestone and cobble blocks, which were mortared with clay-rich soil. The wall in the north section was approximately 1 meter wide, and preserved to approximately 1 meter in height. Many of the upper cobbles had been dislodged and created a wall fall level (A35) which extended deeply into the unit, and was also associated with a water-deposited sediment derived from the wall (A34).

Below the base of the wall (approximately 10 centimeters beneath the top of the preserved wall) – and in contrast to the southern unit – we encountered the upper

floor (A8), which slanted steeply down into the interior of the court. Beneath this floor we identified an interior occupation zone (A36) above sterile (A14). It is important to note here that we did not find the lower, earlier A12 floor; it was neither visible in excavation nor in profile. The implications for this will be discussed below.

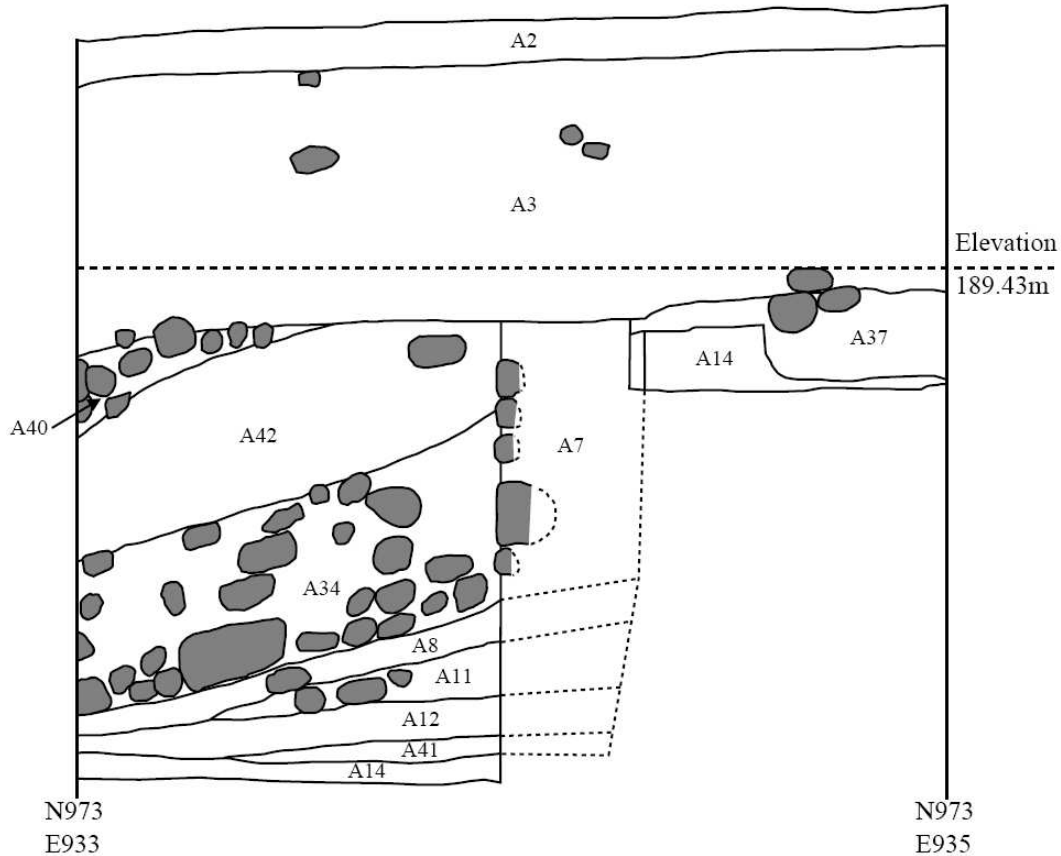

Figure 19: Unit N972/E933, North Profile

Unit N979/E935 contained the northeast corner of the structure, another fortuitous unit placement, although preservation here was poor. We excavated this 3x1 meter unit to the top of the wall. Outside of the structure, we encountered another fish midden pit, filled with ash (A29). This pit was cut into the exterior surface associated with the court, which consisted of the sterile subsoil. This northeast corner was constructed at an obtuse angle, which suggests that the structure was, in fact, trapezoidal in plan. This fits with evidence seen elsewhere for the Middle Formative Period (Late Chiripa and Late Qaluyu) in the Titicaca Basin (Chavez 1988; Cohen 2003; Hastorf ed. 2001; Bandy 2001: 131-132).

East Wall and Burial #3 (Unit N972/ E933)

The 2x1 meter unit of N972/ E933 offered another excellent profile of the

construction technique of the lower court, with good intact preservation of both cobbles and limestone blocks in the wall (A7). It also offered further evidence for the upper floor being located below the base of the wall (see Figures 19 and 20). As in previous ASD-1 units, the sterile sub-soil served as the exterior surface. We identified two additional fish bone and ash pits cut into this exterior, surface. The most notable part of this unit, however, was Burial 3, located in the clay of the A12 (lower) court floor.

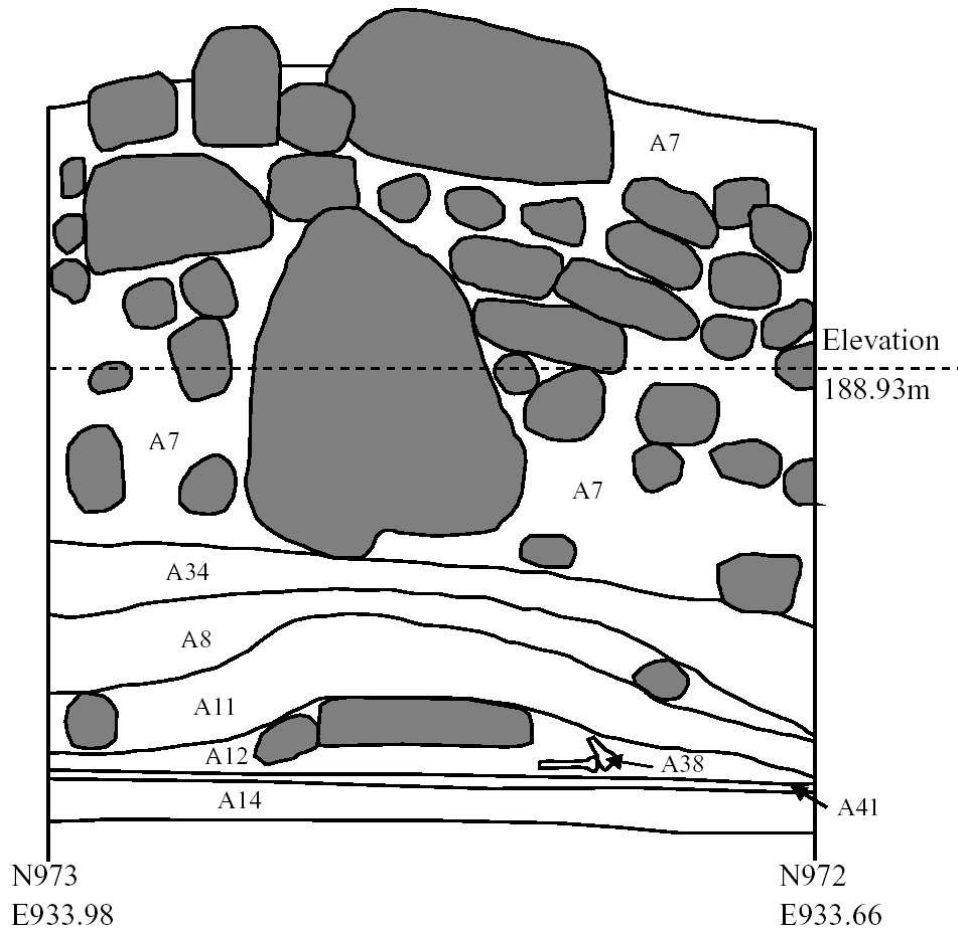

Figure 20: Unit N972/ E933, Wall Elevation, Interior

A38 is the right femur of the sub-floor burial

In the process of excavating to the interior A8 court floor, we encountered a cranium embedded in the clay. The cranium was significantly modified, and in poor condition. After excavating the cranium, we located most of the upper body. The individual was buried within the lower floor, on its back, with the cranium disarticulated and placed on its chest (Figure 21). The left arm was by its side, with the hand under the pelvis, whereas the right arm was raised beside the head. The legs

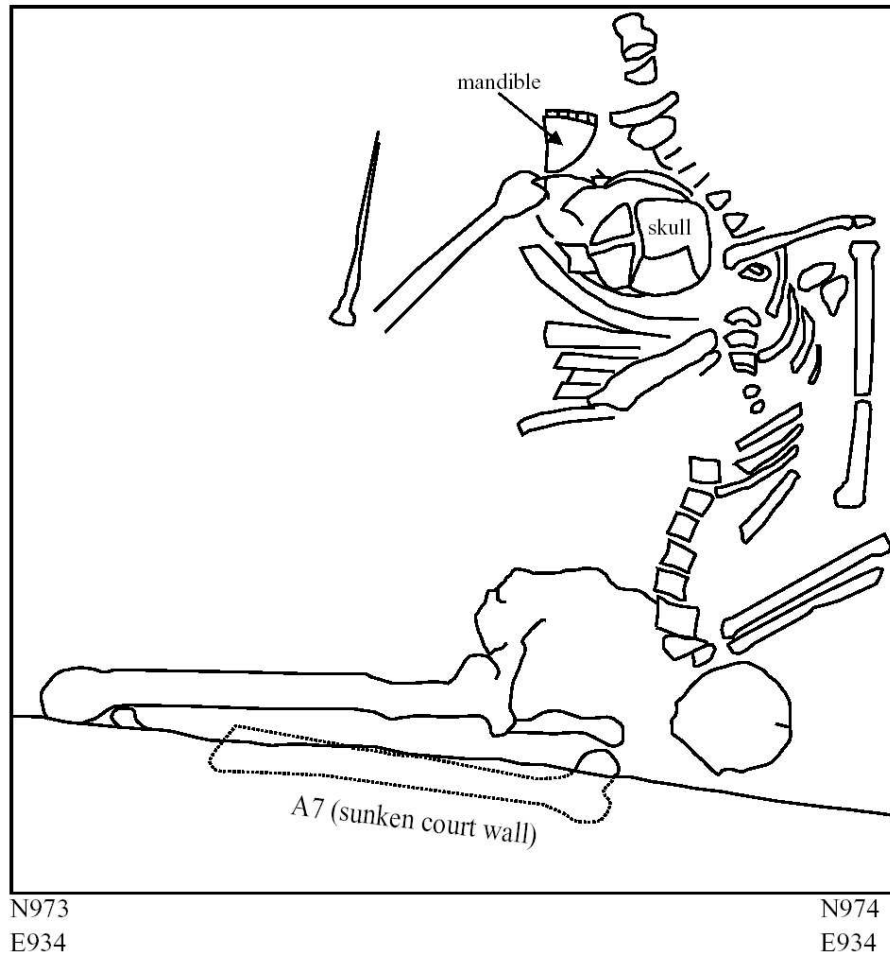

Figure 21: Unit N973/E933, Burial #3 under court floor

were bent up beside the body, with both femurs running parallel to the wall, and the lower legs positioned underneath the wall. There were no grave goods found with this individual. We interpret this body as a dedicatory or sacrificial offering, although we await Deborah Blom’s analysis. This body would have created a significant bump in the floor near the eastern wall, a visible reminder of the individual that was buried there (see Figure 20 profile). Below the body and the lower floor was a thin gray ash-rich lens (A41).

West Wall (Units N975/ E917 and N975/E 916)

The western wall of the structure gave us a very different perspective on the court. Here we found the wall construction directly upon sterile soil, with the absence of any limestone blocks interspersed with the cobble wall, suggesting that it represented an earlier manifestation of the court. On top of this cobble wall we encountered a coursed multi colored adobe/clay wall, with significant melting down into the lower

erosional layers. This wall was approximately 25 centimeters wide and thus much thinner than other sections of the structure which measured up to 75 centimeters wide.

We extended our 3x1 meter interior unit of N975/E917 westward one meter to N975/E916 to investigate the thickness and depth of the cut outside of the wall (Figure 22). This complex unit showed an interesting sequence of cuts, and more fish pits in the external areas of the court.

Inside ASD-1:

Unit N973.6/E928.11 and Unit N968/E921

Although most of the excavations of this season concentrated on the perimeter of ASD-1, we also excavated two units within the structure, with the aim of identifying

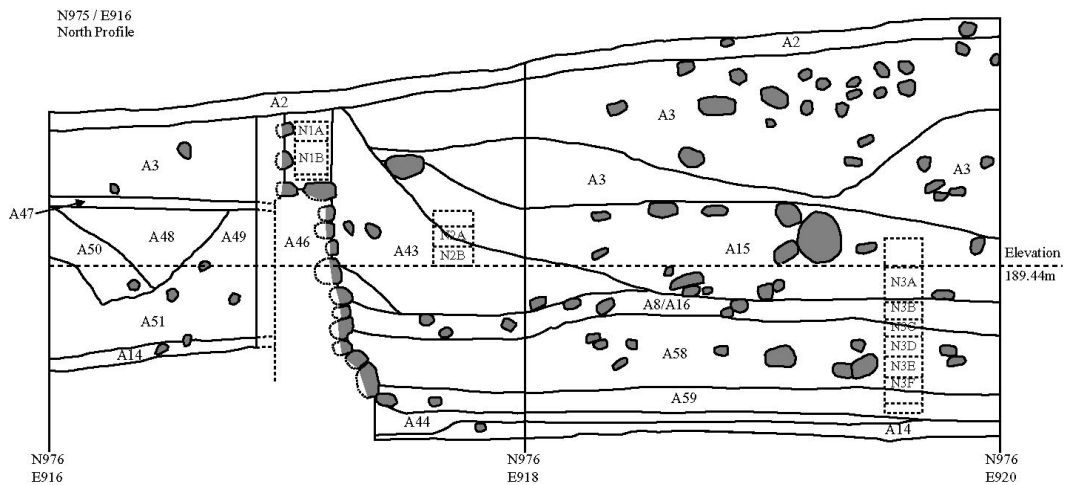

Figure 22: Unit N975/E916 and Unit N975/E917 Profile
Dashed boxes indicated micromorphological column samples

the floor construction, its elevation, and any floor features. Only one of these units (N968/ E921) reached the level of the floor and below to sterile, while the other was abandoned at an early stage of excavation (upon reaching the top of the wall rubble).

Unit N968/ E921

This unit, located within the lower court, was selected in order to identify the floor of the court and any associated materials and activities. Below the root zone, the unit was filled with a thick colluvial deposit (A3). As in other areas, A3 was hard, compact, and contained pottery from mixed time periods and a very low density of animal bone. Within the A3 deposit were found some disarticulated human bones

that seem to have been deposited with the colluvium. There was also an interesting feature that appeared to be the remains of a burnt offering, including fragments of a dog or fox jaw and burnt vegetable fibers, likely modern.

We then encountered two colluvial deposits (A19 and A20) that differed from A3. These were characterized by a low density of artifacts with a distinct soil matrix. Specifically, the clay-rich matrix of A3 was markedly different from the gritty, clay loam matrix of A19 and A20, which were also differentiated by a color change. This suggests that the source matrix of these deposits differed that of A3, and was possibly related to the erosion of architecture. Beneath the colluvial deposits were two events (A21 and A22) that seemed to be associated with the structure's abandonment. The matrix of A21 was different in that it contained patches of clay as well as 10-15% pebbles. Event A22 had an even higher percentage (20-25%) of pebbles as well as 1-2% cobbles. Both of these strata were easily distinguished from upper colluvial strata in that they exhibited a higher density of pottery sherds that were better preserved (less eroded). This suggests that they were not deposited by a colluvial process. According to Steadman's ceramic analysis, the pottery in these strata pertained to the Late Chiripa time period. We are therefore able to surmise that abandonment of this structure took place in the Late Chiripa phase.

Excavations in this unit identified two clay floors, indicating that the structure had been remodeled during its use life. The upper clay floor exhibited one floor feature (Feature 1), a depression that was lined with the same clay that comprised the floor. This feature was filled with a high density of cultural materials and around 50% pebbles. The base of this depression did not show any signs of burning. Neither was this depression the result of slump above a lower pit. Indeed, upon removal of the lining, the pit was found to be cut directly into sterile. It seems that this depression must have served some function related to the use of the structure. The floor (A8) in which this depression was formed was a compact clay with limestone inclusions and exhibited a number of flat-lying artifacts on its surface. Beneath the A8 floor was a fill layer (A23) that was darker in color and contained a higher density of artifacts. The lowermost floor (A12) was patchy and uneven in areas, measuring 1-2 cm in thickness. This poor condition may have been the cause for the reconstruction of the court. The lowermost floor had been placed above a sub-floor fill (A13) consisting of a silty clay artifact-rich deposit. Interestingly, both floors, the sub-floor and the between-floor fill contained both Middle and Late Chiripa ceramics. It is likely that the construction material for these strata was extracted from another part of AC area, possibly from an earlier midden. This could account for the presence of Middle Chiripa materials in what are clearly Late Chiripa deposits.

Excavation of ASD-3: The Upper Court

The main goals in the excavations of the upper court were similar to those of the lower court. Specifically, the aims were to expose the court walls and to determine the relationship between the walls and the floor. Excavations in the lower court had already indicated the construction technique used in the walls, as well as complicated issues such as the floor sequence. We placed units around the structure, initially in the western and southern walls, where we could see limestone protruding from the surface. The location of the northern and eastern walls was estimated from the orientation and size of the lower court, which had already been determined through excavation. Additionally, one 2x2 meter unit was placed around a protruding red sandstone block in what turned out to be the center of the court.

These excavations showed that this sunken court, like ASD-1, was trapezoidal in plan. Also, the structure is interesting in that it is not entirely semi-subterranean like other sunken courts with which we are familiar. Rather, depending upon the topography, some walls line the cut of the court, while others seem to be almost entirely above the prehistoric ground surface. Still, the floor sloped steeply, so that at the center it was approximately 60 cm below its elevation at the walls. The stratigraphic sequence of each unit is discussed in detail below, along with the sequence of construction and remodeling of the upper court.

West Wall (N1000/E947)

This unit was selected due to the position of several white limestone blocks that were slightly protruding from the surface of the slope above the lower court. These blocks were oriented in a roughly north-south linear arrangement and were deeply bedded. We oriented this 1x2m unit with the long axis across the expected line of the wall, where one large white limestone block protruded from the surface. The west wall excavation unit revealed a very complicated stratigraphic sequence (Figure 23).

The upper strata of this unit were similar to those in other parts of the Achachi Coa Kkollu sector. The A3 stratum was extremely compact, extending more deeply in the eastern part of the unit, above what was revealed as the court interior. As expected, the unit did identify the remains of a wall – later determined to be the western wall of a sunken court. Beneath the A3 colluvium was a layer of cobbles that we have identified as wall-fall. This wall-fall extended across most of the unit, concentrated to the east, and with the highest cobbles over the wall itself. Excavations revealed that most of the wall-fall was within what would be identified as the interior of the sunken court, and a small number of cobbles had fallen to the exterior. The wall-fall (A113) had fallen on top of a stratum of colluvium (A114) that likely collected post-abandonment. This colluvium was above what was later identified as the upper floor of the upper sunken court (A116). This floor was constructed of clay, varying in

color from red to yellow. Removal of the wall-fall exposed what remained of the stone base of the wall, consisting of only a few *in situ* stones to the north of the protruding limestone block.

The interior of the court proved to have a complicated stratigraphic sequence. As noted, the A116 floor was directly beneath a layer of colluvium. The upper floor was above an ash layer (A117) that in turn filled two pits that had been cut into an ashy lens (A118) and the surface of the lower clay floor (A119). Excavation of the lower floor revealed an ashy sub-floor layer (A120). Removal of the lower floor revealed a pit (Feature 23) that had been cut into sterile and filled with an ashy, silty clay deposit with charcoal inclusions (A121).

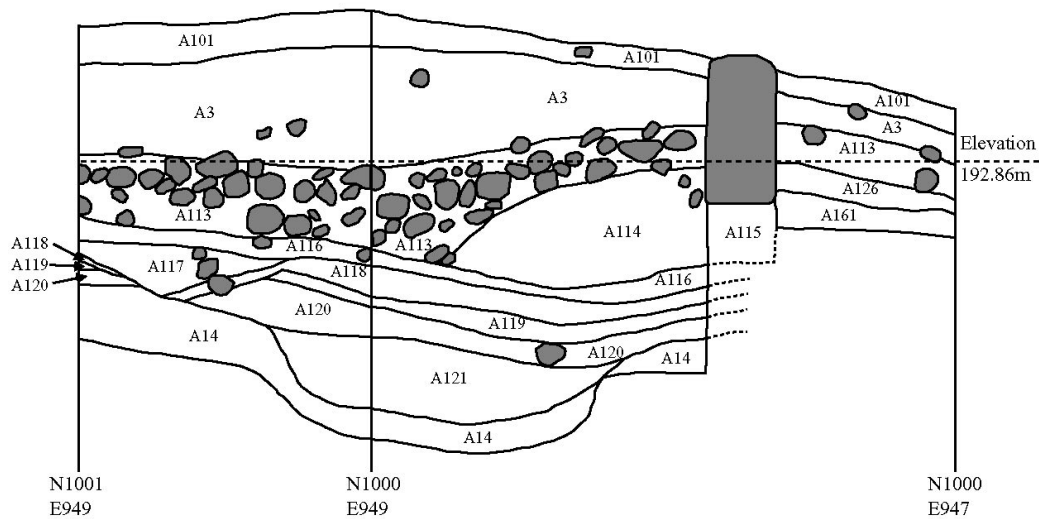

Figure 23: N1000/E947, South Profile

The exterior of the court was much less complicated. The wall fall was above an occupation zone (A126) that consisted of artifacts embedded in a silty clay matrix. This occupation zone was above sterile and its excavation revealed a pit (R42) that had been cut into sterile and contained a cobble fill (A161).

This unit was quite shallow compared with the majority of the units in the lower court. This is likely because this portion of the court was cut shallowly into the ground, and the wall would have protruded above ground surface. The colluvium, therefore, barely covers the lower portion of the wall, and the majority of the wall is not preserved. The wall itself shared similar construction techniques to those seen in ASD-1, with medium sized limestone blocks interspersed with cobbles. As noted above, this unit exposed two clay floors within the interior of the structure, indicating a reconstruction episode. The large pits and fill events are somewhat enigmatic.

They may indicate an abandonment of the courts before they were reconstructed, or may have pertained to rituals focused around the reconstruction. Also interesting is the earliest pit, cut into sterile and pre-dating the placement of the court. This suggests that the court may have been used for some time after the cut was made, but before the placement of the walls and floor of the earliest court.

North Wall (N1001/E955)

The placement of this unit, with the goal to expose the north wall of the upper court, was calculated based on the dimensions of the lower court, which had already been defined. As excavations revealed, our estimates of the upper court dimensions matched closely with those of the lower court.

As with other units in this sector, the uppermost strata are formed by the A3 colluvial deposit (Figure 24). Beneath the A3 was wall fall, indicating that we were close in our estimates of court size. Removal of the wall fall (A157), a high density of cobbles within a matrix similar to the A3 colluvium, revealed a dark, ashy deposit (A158). As with the above wall fall event, this deposit was mixed with cobbles, but was characterized by alternating thin lenses of ash, silt, and clay that seemed to have been the result of water deposits. The type of deposit suggests that A158 accumulated gradually, and likely represents court fill that was preserved by the collapse of the wall. Beneath A158 was a thick ash deposit (A159) that had accumulated against the interior wall of the court. The A159 deposit included decorated pottery as well as carbon, and was likely a deposit related to the use of the structure. Removal of the A159 deposit revealed a similar deposit (A160) that was characterized by alternating deposits of silt and clay within midden. It is likely, then, that A158, A159, and A160 all represent deposits that accumulated during the use of the structure, or immediately post-abandonment. These deposits were located immediately above a thick yellow clay floor (A127), which in turn, was above sterile.

The north wall was the best-preserved wall of the upper court. The sequence of wall construction was different from that in the other units, indicating that it had been constructed either at a different time, or by a different group of individuals. The wall construction sequence was as follows. First, the cut was made into sterile for the construction of the court. Next, a channel was cut into sterile to delineate the position of the wall. This trench was filled with two rows of well-sorted cobbles. Above this were placed the vertical limestone uprights, of which two are located in this unit. Next, the space between the uprights was filled with cobbles to complete the wall. Finally, the clay floor was placed, buttressing up against the wall, with a steeply angled slope. Note that in this segment of wall, the wall is constructed prior to the placement of the floor. This fact, along with the presence of only one floor in this area of the court, is key to our reconstruction of the construction sequence of the

court.

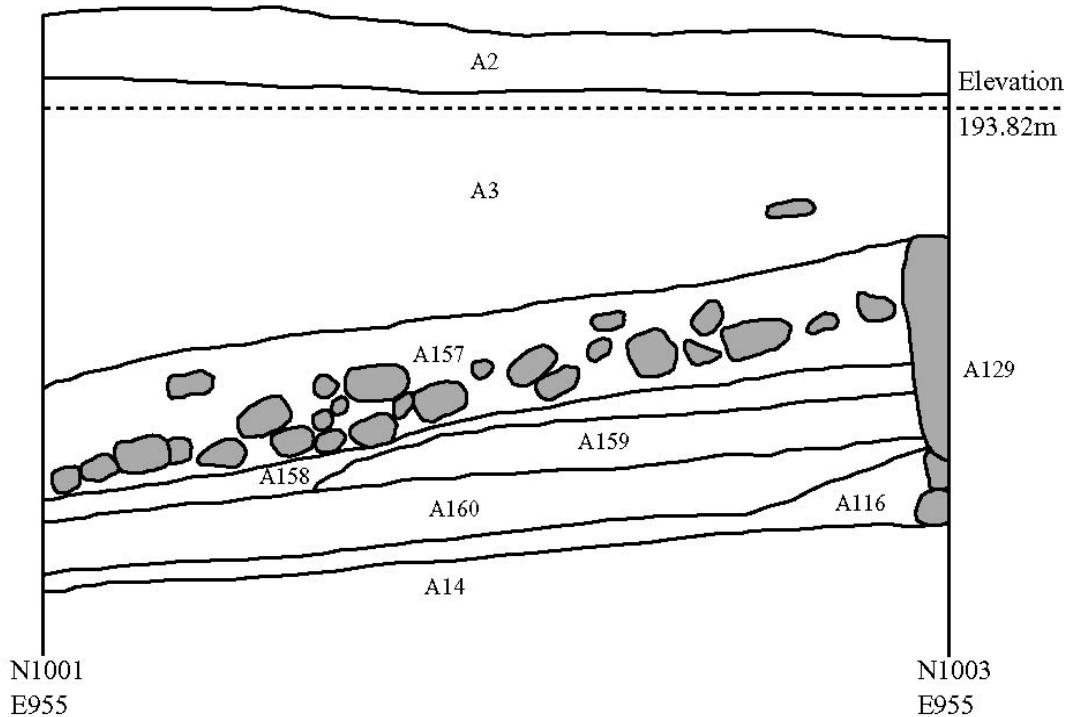

Figure 24: N1001 E955 West Profile

South Wall (Unit N984/E955)

The coordinates of this unit were selected due to its proximity to a large white limestone block protruding from the surface. This block was estimated to be close to the southeast corner of the structure. The unit was particularly important for information regarding the construction sequence of the wall itself.

The surface of this unit was covered with a modern rock pile, such as are common on agricultural fields in the region. This rock pile also included a large number of stone artifacts and ceramic sherds. Removal of the superficial rocks revealed that the pile extended beneath the surface; further excavations revealed that this area had likely been a rock pile for a long period of time. This rock concentration was stratigraphically above A3 deposits. A 10% sample of the A135 and A3 deposits were screened in this unit. Removal of the A3 deposits revealed wall fall (A136) from the south and east walls, along with the fill of the court that was stratigraphically beneath the wall fall. Later excavations of the east wall indicated that this unit was very close to the corner of the structure. The fill event (A137) was flecked with

yellow and red clay, and carbon, and included a noticeably high number of carbonized ceramics. Removal of this fill event revealed the clay floor and fully exposed the wall.

The floor sloped upwards towards the wall, passing beneath it. The slope of the floor in this unit was extreme. This floor (A116) was compact with yellow and red clay patches, along with carbon flecks and small pebbles, and the occasional cobble, embedded in the surface. The floor was positioned directly above sterile. As there is only one floor in this unit, this serves as a clue to its position in the construction sequence of the court – namely that it was part of the later expansion of the court.

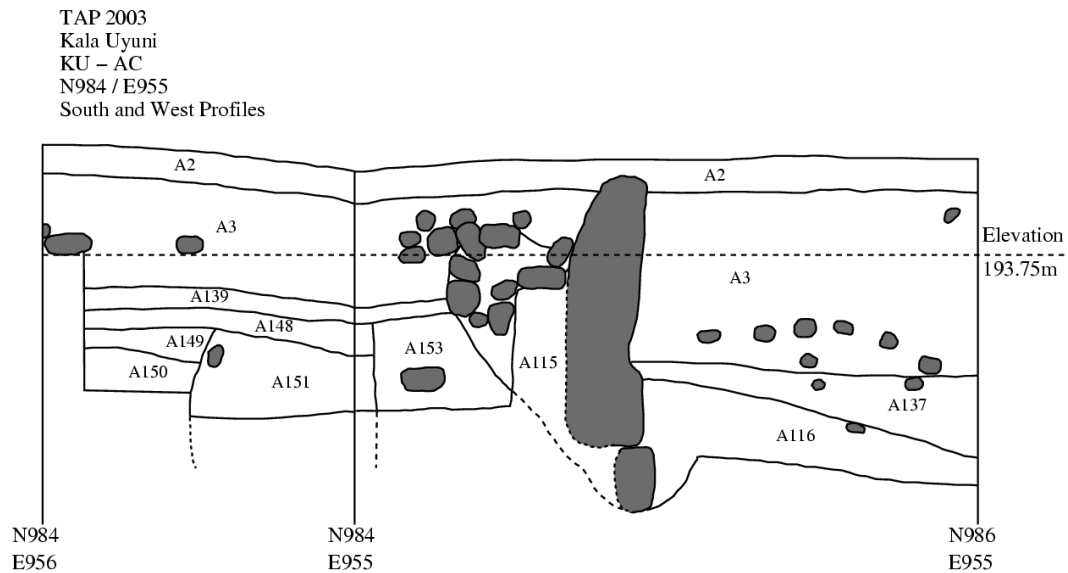

Figure 25: N984/E955 South Profile

The wall in this unit combined several white limestone uprights interspersed with cobbled sections. Within the wall was one very tall white limestone block, surrounded by smaller cobbles (Figure 25). Interestingly, however, this limestone block was inserted into a hole cut into sterile and later covered over by the floor. It would have served as an ‘anchor stone’ for the wall. This stone gives us an interesting sequence of the wall construction in this area of the court. The sequence is as follows: The cut of the court was made into sterile, with slope towards the north, sloping down away from the wall. The vertical uprights were placed in situ, with at least the one being anchored into the ground. The single clay floor in this unit was then placed above sterile, joining with the cut behind the wall. Cobbles were then arranged above the floor and around the anchor stone to complete the wall.

The area behind the wall is not well understood due to the narrow area exposed. Beneath A3 deposits, the exterior floor (A139) was identified, a patchy clay surface

with carbon inclusions. Its removal revealed a complicated sequence. However, it is clear that this area of the Achachi Coa Kkollu sector was in use prior to the construction of the ASD-3 court. In the very small area excavated, earlier pits as well as an earlier floor were identified, indicating that there had been earlier use of this area. We cannot at present say, however, whether this earlier use involved architecture. No evidence of earlier architecture was discovered. These pre-ASD-3 deposits have not yet been dated.

East Wall (N991/E959)

The location of this unit was estimated based on the measurements and orientation of the lower court. The east wall was poorly preserved due to its location on a low

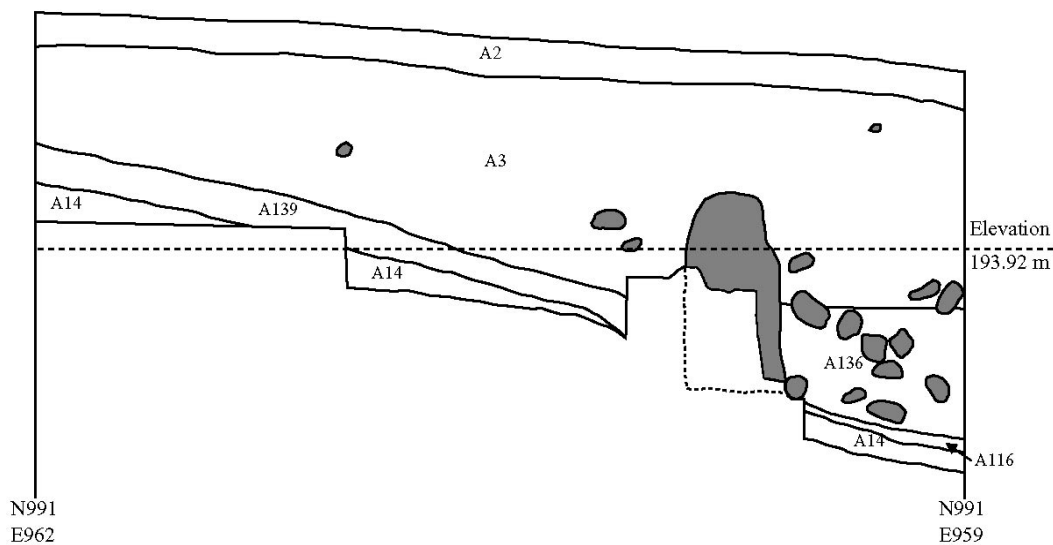

Figure 26: N991/ E959 South Profile

saddle of the mountain. As a result, only a thin layer of the A3 colluvial deposits covered the architecture, providing little protection (Figure 26). Beneath the A3 deposits were the remains of the wall fall (A136). The wall collapse was directly above the A116 floor on the interior of the court. The floor was highly deteriorated and difficult to identify in this unit. Excavations indicated that the east wall would have protruded well above the exterior ground surface of the court.

There was only one interior floor in this section of the court. One interesting element of this unit is the presence of midden over the exterior surface of the court. This links the midden to the east of the upper court (see discussion below) with the stratigraphic position of the court. This supports the idea that at least some of this midden was deposited during the use of the upper court.

Center Unit (N993/E952.5)

The central unit was placed around a protruding red sandstone block that was later identified as a standing monolith. Excavations went to sterile in the eastern half of the unit, and stopped above the upper floor in the western half. This unit revealed a great deal about the construction sequence of the court, and yielded two significant sculptural finds.

The A3 deposits in this central unit were quite deep, and included occasional cobble concentrations. Removal of the A3 colluvium revealed a rock pile (A140) that was, in turn, above additional colluvial deposits (Figure 29). The subsequent colluvium (A141) was relatively rich with cobbles (about 10% density). All of the colluvial deposits were screened using a 10% sampling strategy.

Removal of the A141 colluvial deposits revealed a stratum of cobbles. This cobble layer was clearly intentionally collected and distributed around the monolith, with the cobbles mounding up towards the monolith, in the center of the unit. Excavation of this cobble deposit (A142) revealed a fill layer (A143) that had a lower density of cobbles, but with a concentration of cobbles in a ring around the monolith. This ring seems to have been used to provide support to the monolith.

At this stage in the excavations, we chose to excavate the eastern half of the unit, leaving the western half unexcavated. This decision was made so as not to destabilize the standing monolith. Removal of the A143 fill level revealed the upper floor of the sunken court. The floor (A116) consisted of yellowish and reddish patches of clay, with occasional inclusions of pebbles and small cobbles. Beneath this floor was identified another rocky concentration (A144), consisting of approximately 40% cobbles and 15-20% pebbles, that served as a between floor fill. Within this A144 fill event was a truly unique discovery.

A Yaya-Mama carved stone pestle was recovered from this stone fill (Figure 27). This small piece of sculpture is carved with a cross formee on the top, and symmetrical serpentine patterns on either side. The base of the pestle shows signs of



Figure 27: Lightning Stone found between floors

having been used. Sergio Chavez (1971) has published similar examples of this style of sculpture, referring to them as Lightning Stones. Additional examples apparently exist in the collections of the Musee fur Volkerkunde in Berlin. The Kala Uyuni lightning stone seems to be the only example recovered from a scientific excavation in a secure stratigraphic context.

TAP 2003
Kala Uyuni
KU – AC
N993 / E952.5
Center Profile (E953.4)

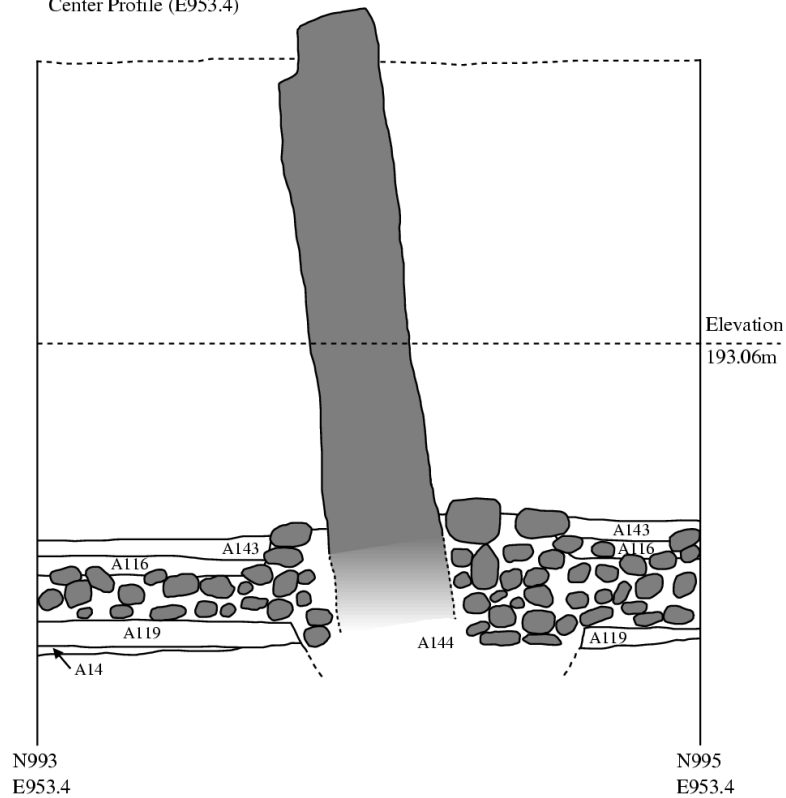

Figure 28: N993/E952.5, central monolith, in profile

Beneath the A144 fill event was the lower floor (A119) of the sunken court

(Figure 28). This was a mottled clay floor that passes under the rocky support for the monolith. Excavation of the floor revealed that it was placed directly above sterile. Interestingly, however, a pit (Feature 36) was found to be cut into sterile, beneath the A119 floor (Figure 29). The fill of this pit contained cobbles and large chunks of clay similar to that used in the construction of the floor.

These excavations revealed the full extent of the monolith as it stood above the surface. As noted, none of the structural supports were removed. We were careful to preserve its stability. The monolith was shaped but bore no iconography. Interestingly, the excavations did reveal the construction sequence involved in the placement of the monolith. The lower of the two floors was not associated with the placement of the monolith. Indeed, prior to the placement of the upper floor, a pit was dug for the monolith. The monolith was placed in the pit, with a stone support system wedged into place to prevent movement. The stone fill between the floors was then laid down, after which the upper floor was put in place. The monolith as it stands was therefore put in place at the time the upper court was remodeled.

While the context of the fill above the floor remain uncertain, we do know that the monolith was intentionally buried, and the upper floor completely covered, with a large mound of cobbles, effectively 'closing' the structure. We hypothesize that this event was related to a formal abandonment ritual.

TAP 2003
Kala Uyuni
KU – AC
N993 / E952.5
East Profile

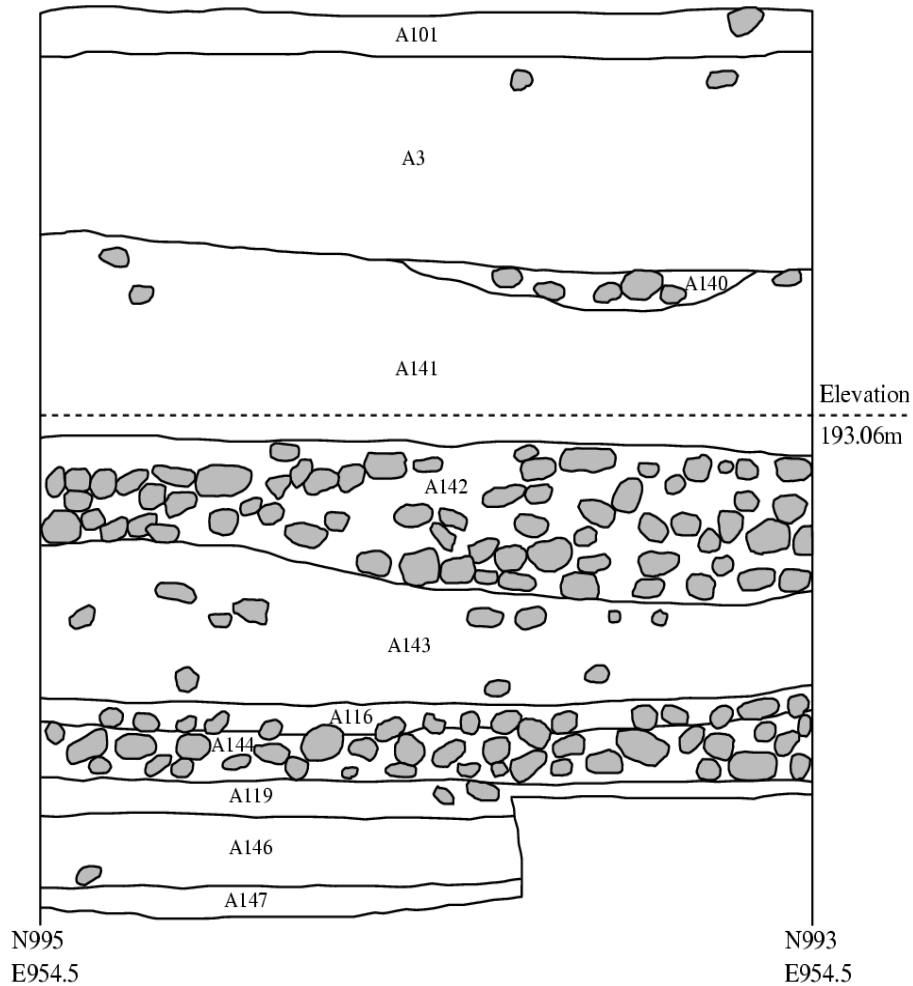

Figure 29: N993/E952.5 East Profile

Excavation of the Midden: Units N990/E968 and N979/E957

Two units were excavated within the midden deposit to the southeast of the upper sunken court. This area was selected because of the dark soil and the high density of surface artifacts. In particular, there was a high density of animal bone, which

distinguished this area from the courts, where colluvial deposition resulted in the destruction of most animal bone. This indicated different depositional processes at work in the midden area. Rather than colluvial deposition, it seems that this area was deflated or eroded to some extent. Excavations indicated that the midden area had been plowed for agricultural fields, although the plow marks suggested the use of *chakitaklla* (traditional foot plows) rather than ox-drawn plows.

Within these middens we found a high density of fish and animal bone, pottery and lithic materials. An interesting find was a scattered pile of burnt, well-sorted rocks (large pebble – small cobble size) that suggest a dump after a *huatia* (earth oven) cooking event. The ceramics are particularly intriguing. The lower stratum in each unit includes pottery from the Middle Chiripa phase, while the upper strata are predominantly from the Late Chiripa phase. The presence of Middle Chiripa ceramics indicates that there may have been an earlier ceremonial structure, or at least earlier ceremonial activities, on the site of the later ASD-1 and ASD-3 sunken courts. This hypothesis is supported by the finding of the floor exterior to the southern court wall, as revealed in unit N982 / E955.

Discussion

The two sunken courts excavated in the AC area have much in common, including form, orientation, ritual activities and construction sequence and technique. Both are trapezoidal in form, with the longest wall of the trapezoid facing south. The trapezoidal shape seems to have been maintained between the initial court construction and the expansion. The construction of sunken courts with a trapezoidal plan is becoming a diagnostic for Middle Formative courts, also existing at Chiripa (Hastorf ed. 2001; Bandy 1999, 2001) and at Huatacoa in the northern Titicaca Basin (Cohen 2003). Excavations in the courts and the midden indicate that this sector was occupied during the Middle Chiripa phase. However, the courts were not constructed until the Late Chiripa phase. Many later court deposits incorporate midden material diagnostic of the Middle and Late Chiripa Periods. Interestingly, there are no Tiwanaku or Late Formative artifacts associated with the use of the courts; these courts seem to have been abandoned after the Late Chiripa period. Analysis of the materials recovered from the Achachi Coa Kkollu sector are not yet finished. However, initial analysis of the ceramic assemblage indicate that both decorated and utilitarian wares are present in quantity. While this evidence may suggest an earlier domestic function for the area prior to the construction of the court, it may also be that this area was a long-term focus of public ceremonial activity for the Kala Uyuni community. In other words, there may have been a range of practices, incorporating a broad range of ceramic types.

Non-ceramic evidence also supports the attribution of a ritual function to the AC area

at least in the Late Chiripa phase. One example is the consistent presence of pits containing high densities of fish bones associated with the exterior surface of the lower court. These concentrations may perhaps be interpreted as evidence of feasting in the courts, although further corroborative evidence will be necessary before this hypothesis can be substantiated. Another example of ritual activity is the placement of a human sacrificial offering beneath the east wall and floor of the lower court. As we described above, it is likely that this individual was decapitated, as the head was found placed on the chest. Further, the splayed position of this individual is suggestive of the treatment given to captives, enemies, or offerings, rather than to revered ancestors. Similar examples of human sacrificial offerings related to sunken court construction events have been found at the roughly contemporaneous sunken court at Huatacoa in the Pukara Valley (Cohen 2003).

What is clear through these excavations is that both courts underwent similar and significant reconstruction events. The original courts were constructed in the Late Chiripa phase, yet little of those original structures has survived. The west wall of the lower court gives us a good idea of what this structure may have been like. The initial cut of the court was lined with a cobble wall. This earlier wall included no limestone blocks and is therefore clearly different from the later walls. The first clay floor was laid down after the wall was constructed. Above the base of the wall was an upper construction of alternating bands of yellow and red clay. It is unclear why, when all other walls were reconstructed, this single western wall of ASD-1 maintained the original wall construction. This may have been due to its state of conservation, or it may have held some special meaning; this specific part of the court wall would have been visible from the village (the KU area) below.

Sometime later, both sunken courts were remodeled. This remodeling involved an increase in the dimensions of the structures, with expansion taking place to the north and east (as indicated by the presence only of the later of the two floors adjacent to the north and east walls of both structures). In most cases, the walls were dismantled and reconstructed at the time of the expansion. Of course, the western wall of the lower court is an exception. It seems, in the case of the upper court, that white limestone anchor stones were set in place to delineate the line of the wall. Next, the northern wall was constructed, incorporating a well-built cobble foundation. The next step seems to have been the placement of the upper clay floor, which was placed above the lower floor and any between fill between the two floors. Finally, the remainder of the wall was constructed, incorporating both white limestone blocks and unmodified cobbles.

In the case of the upper court (ASD-3), it seems that the monolith was erected at the time this remodeling event took place. It is possible that the installation of the monolith was the motivating factor behind the expansion of this court. Whether or not

there was a central monolithic sculpture in the lower court (ASD-1) remains unknown, since the center of the court was not excavated, and the colluvium filling the structure is much deeper. Clearly, C14 dates will aid us in refining the construction sequences in this part of the site.

Concluding Remarks

All of the units excavated were backfilled, after either tyvek bags or tags were placed on the bottom and sides of the units to identify the excavated areas for any subsequent investigations. As both ASD-1 and ASD-3 are large structures they would clearly benefit from further excavations in the future. The 2003 excavations have provided much needed data for our understanding of the Late Chiripa phase of the Taraco Peninsula and the greater Titicaca Basin. Excavations in the Achachi Coa Kkollu sector showed an interesting pattern of sunken court construction and remodeling, as well as evidence for associated court activities.

7. Ceramic Analysis

Lee Steadman

A total of 415 bags of ceramics were recovered from the 2003 excavations at Kala Uyuni, including the multiple point provenienced specimens registered from certain loci. These ceramics were registered, washed, and then transferred to the ceramic laboratory for processing, where they were cataloged and analyzed. First, the diagnostic specimens (rims, bases, handles, decorated fragments etc.) were separated from the body sherds, and placed in their own smaller bag within the larger tyvek locus bag. Body sherds of less than 1 cm² were culled and also placed in their own smaller bag; these sherds will not be analyzed further as they are generally too small to determine surface color or finish accurately. All three categories of ceramic specimens, body sherds, diagnostics and small fragments, were counted, weighed, and recorded in the ceramic catalog database; the diagnostics specimens were also individually labeled with unique specimen numbers. In total, the Taraco Archaeological Project recovered 58,168 body sherds, 6547 diagnostics and 8870 small fragments during the 2003 field season.

The ceramics from loci which were chosen for further study were given one of three types of analysis, depending on the context of the locus. In cases where the locus was disturbed, but it was necessary to determine which phases were represented in the sample, the ceramics were categorized by phase and ware only. Ceramics from loci that were undisturbed, where the analysis of the materials would contribute to a comprehensive and detailed description of the ceramic assemblage from that phase in the ceramic sequence or the activities which took place in that part of the site, were given a more detailed attribute analysis. Attribute analyses have been used productively for the definition of ceramic sequences elsewhere in the Titicaca Basin (Steadman 1995; Chávez 1992; Chávez 1980/81; Lémuz 2001) and involve the observation and recording of individual ceramic attributes (paste, finish, surface color, vessel shape, rim shape, diameter etc.) rather than the definition of a fixed set of attributes, such as is used in a typological classification (Rowe 1959; Shepard 1956:307-318). Individual attribute analysis is a more sensitive and effective means of studying changes through time than a typological approach, which necessarily stresses the similarities among ceramics rather than their differences (see Steadman 1995:48-50 for further discussion). The attributes of the body sherds that were subjected to this detailed analysis were recorded on computer coding forms. Information on the diagnostic specimens was recorded on a more detailed form that allowed for the inclusion of more information on surface finish and details of shape,

manufacture, decoration etc., as well as providing a space to draw the specimen. This type of ceramic analysis is necessarily time consuming; as the 2003 excavations generated a large volume of ceramics, some of the ceramic bags were given a less detailed form of attribute analysis, particularly in cases where there were multiple loci from a single event, in which only the attributes of shape, size, exterior color and finish, decoration, and phase were recorded.

The ceramic laboratory was lucky to have many excellent ceramic assistants during the 2003 field season. Virgilio Rodriguez of Tiwanaku was in charge of the registry and cataloging of the ceramic material. Working on the ceramic analysis and diagnostic drawing were Doris Maldonado of the University of California, Berkeley, Nicola Sharratt of the University of Cambridge, England, and Christine Bare of the University of Pennsylvania. The author is deeply grateful to all of them for their hard work and dedication in the field; this report would not have been possible without them. The analysis of the Kala Uyuni ceramic data is still in progress, and not all the loci have been analyzed; the following is therefore only a preliminary report on the ceramic artifacts.

Early Chiripa

Early Chiripa ceramics were recovered from the lowest levels of the midden deposits, those resting on sterile, in both the AQ and AC sectors of the site, although in neither area were the deposits from this phase completely undisturbed. The principal Early Chiripa occupation appears to have been in the lower part of the site, in the AQ sector, where a Formative period domestic occupation was uncovered during the 2003 season. In the lowest levels of the midden deposits here, under the Middle and Late Chiripa levels, a modest Early Chiripa occupation was discovered. Severe bioturbation in this area (Goodman, this volume), has resulted in a mixing of ceramics in the lower part of this excavation unit, so that the Early Chiripa sample contained approximately 5% Middle Chiripa ceramics originating from the deposits above. Early Chiripa ceramics were also found at the top of the hill in the AC sector, in the lowest levels of the midden deposits located to the south and west of the upper sunken court. Early Chiripa specimens are rare in these events, however, comprising only about 5% of the ceramic sample in what is otherwise a predominantly Middle Chiripa ceramic assemblage, although they may once have represented a discrete event, since disturbed. The Early Chiripa ceramics recovered from the AC and AQ sectors of Kala Uyuni are similar; there is no indication of the existence of a specialized ceramic assemblage restricted to the AC area, as will occur later in the Chiripa period.

The Early Chiripa ceramic assemblage at Kala Uyuni is entirely domestic in character. No decorated ceramics were found at the site; decorated ceramics from this

phase have been recorded so far only in levels associated with the Early Chiripa occupation underneath the central mound at Chiripa itself (Steadman 1999a, 2001). Kala Uyuni Early Chiripa ceramics are very similar to the assemblage defined at Chiripa. Almost half of the sample is manufactured in a micaceous fiber-tempered paste with biotite and translucent and opaque quartz inclusions which is characteristic of the Early Chiripa phase (Steadman 1999b:62). Ceramics are mostly slipped brown or are an unslipped brown color, and the predominant finish is a complete coverage burnish. The small sample of diagnostic shapes contains several that are characteristic and limited to the Early Chiripa phase, such as the neckless olla (Fig 30a) and the collared olla (Fig 30b, similar to the neckless olla but with a thickened rim forming a short collar around the opening of the vessel). These are both shapes used as cooking vessels in the Early Chiripa phase. The rest of the sample consists of short and medium-necked ollas (Fig 30c-d, see Steadman 1995: 56-58 for vessel shape definitions). No bowls were recovered in the small Kala Uyuni sample. Although this shape is less common in the Early Chiripa phase at Chiripa than later in the sequence, its absence at Kala Uyuni is surely due to the small size of the sample. The percentage of red slipped specimens is relatively low at Kala Uyuni, only 6.5% of the sample, and the percentage of specimens with the daubed stucco finish, found exclusively on the bottoms of fiber-tempered cooking vessels (Steadman 1995:66-67; Steadman 1999b), is quite high. In fact, the percentage of sooted sherds and stucco finished sherds at Kala Uyuni is higher, and the percentage of bowls, red slipped, and decorated specimens lower, than any of the Early Chiripa deposits at Chiripa itself, including not only the areas of civic/ceremonial activity such as Santiago and under the mound, but also the various fill and midden deposits at that site. Compared to Chiripa, then, the Early Chiripa occupation at Kala Uyuni appears to have been smaller and more domestic in character.

Middle Chiripa

Middle Chiripa ceramics were found in the AQ and AC sectors of Kala Uyuni, in similar contexts as the Early Chiripa assemblages. In the AQ sector, Middle Chiripa ceramics occur in the midden deposits of the Formative period domestic occupation, overlying the Early Chiripa levels. Again, bioturbation has resulted in some mixing of the ceramics, so that the Middle Chiripa sample from these units contains approximately 2% Early Chiripa wares. In the AC sector, the lowest levels of the midden to the south and east of the upper court were found to have Middle Chiripa deposits, mixed with about 5% Early Chiripa as described previously. Middle Chiripa ceramics were also present in the predominately Late Chiripa midden events higher up in these same units, representing at least 35% of the sample from these levels, and also represent from 10% to 35% of the floor and subfloor fill deposits in certain sections of the Late Chiripa sunken courts, as detailed below.

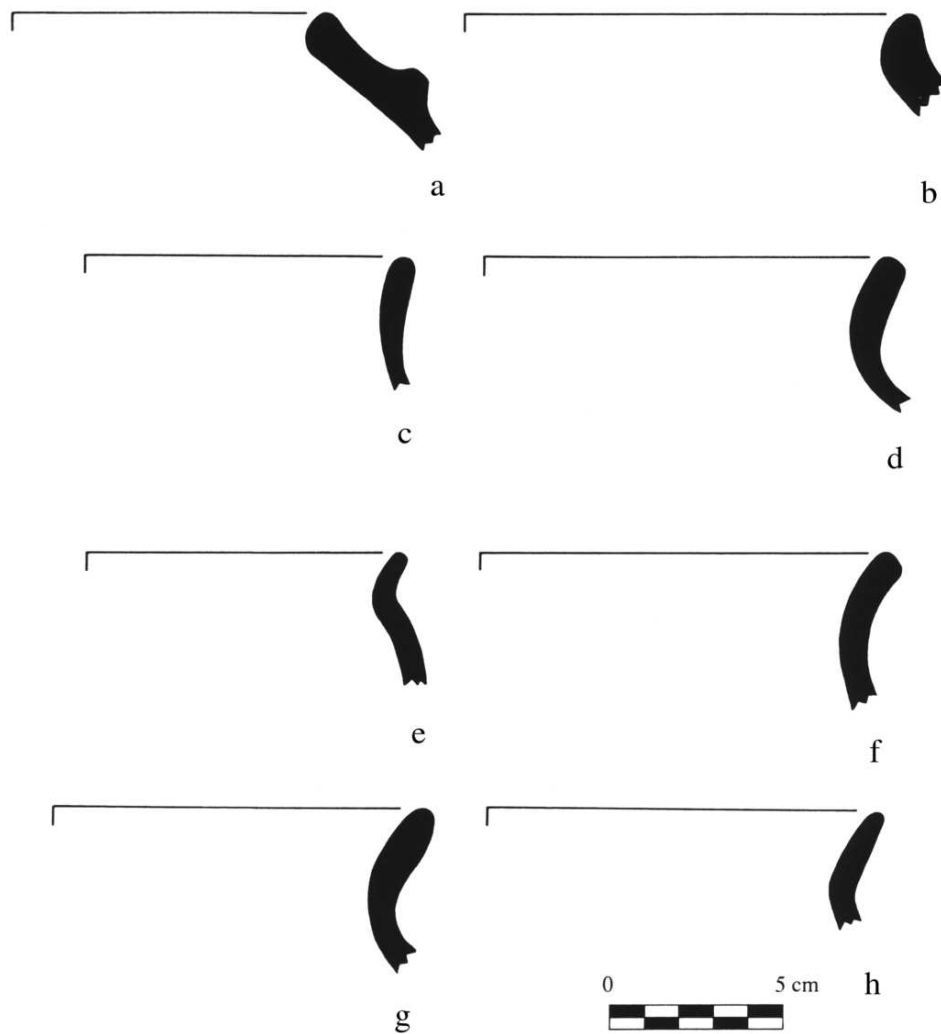

Figure 30: Early and Middle Chiripa Ceramics

Early Chiripa: neckless olla (a), collared olla (b), medium-necked ollas (c-d)

Middle Chiripa: short-necked olla (e), jar (f), medium-necked ollas (g-h)

As in the Early Chiripa phase, the Middle Chiripa ceramic assemblage at Kala Uyuni is essentially a domestic one. No decorated ceramics pertaining to this phase were found, as they have been at Chiripa (Steadman 1999a, 2001). Attributes of paste, finish, shape and carbonization all point to an assemblage used primarily for cooking, storage, and domestic serving. The most common pastes in the Middle Chiripa assemblage have dense, translucent, rounded quartz inclusions, one with fine-sized inclusions and the other medium. The popularity of these two pastes is particularly diagnostic of the Middle Chiripa phase (Steadman 1998, 1999b). The percentage of the fine inclusion version of this paste is somewhat higher than in the Chiripa

assemblage, and the medium version lower, indicating some, but not a great deal, of regional variation in the ceramics across the Taraco peninsula during this phase. Ceramics are mostly an unslipped red brown or brown color, or are slipped brown. Slipped sherds in general are less common than in the preceding phase, a trend which occurred also at Chiripa, while red slips specifically decrease to only 2% of the sample. A complete coverage burnish continues to be the most common finish. Stucco finishes average 23% of the sample across the various events at the site, similar to the figures at Chiripa itself, although red slips again are less common at Kala Uyuni than they are in all contexts dating to this phase at Chiripa.

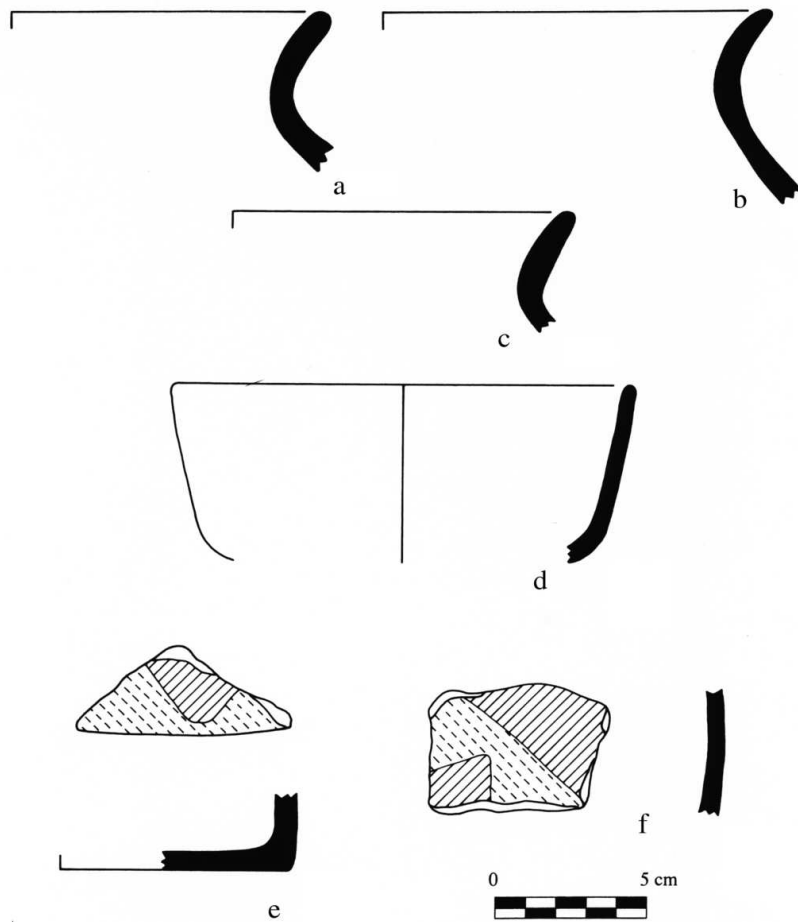

Figure 31: Middle and Late Chiripa Ceramics

Middle Chiripa: medium-necked ollas (a-c), bowl (d).

Late Chiripa: cream on red bowl base (e), cream on red body sherd (f)

The Middle Chiripa shape assemblage as recovered at Kala Uyuni consists mostly of necked vessels with direct rims. Two-thirds of these are medium-necked ollas (Fig 30g-h, 31a-c), with a lesser number of short-necked olla forms (Fig 30e) and jars (Fig

30f) and jars (Fig 31f). These shapes tend to be slipped brown, or have unslipped red brown surfaces. Bowls form only 14% of the total vessel shape sample (Fig 31d). Most have slightly flared sides and direct rims, although the sample also includes some slightly convex bowls. Bowls tend to have red brown slips or unslipped red brown surfaces; there are no red slipped or decorated bowls. There are also no large diameter bowls or large cooking vessels, those with diameters of over 27 cm. These vessels are found in feasting and civic/ceremonial contexts in the Middle Chiripa phase at Chiripa, where they would have been used to cook and serve the large quantities of food consumed at these gatherings (Steadman 2002). The lower percentage of red slipped specimens, and the absence of decorated wares and these large bowls, is consistent with the hypothesized village-level occupation of Kala Uyuni at this time (Bandy 2001). In general bowl diameters, which range from 11 to 24 cm with an average of 15cm, fall at the small end of the spectrum when compared with the Middle Chiripa vessel size classes at Chiripa, and the necked vessels, ranging from 14 to 25 cm with an average of 19 cm, would be classified as small and medium. The ware manufactured in a dense, high fired, fine-textured paste which occurs at Chiripa in this phase (Steadman 1999b:63) is also very rare at Kala Uyuni, forming less than 1% of the sample. At Chiripa, this ware was associated with large-scale cooking vessels in pits near the Middle Chiripa sunken court, and may have been used for chicha production or serving at these public occasions.

The analysis of excavated ceramics is still in progress, but at present there appear to be only slight differences in the Middle Chiripa ceramic assemblages between the AC and AQ sectors of the site. While in the Late Chiripa phase there is a clear distinction between the ceramics found in these two areas, there is less indication that the AC sector was the location of any special purpose activities in Middle Chiripa times. Sooted sherds are slightly more common, and red slipped wares less common in the AC sector when compared to AQ, which could indicate more cooking activities in the former area. Conversely, black, brown and brown slipped necked vessels, which are generally cooking shapes, are more common in the AQ sector, while bowls are extremely rare. Other attributes, however, such as paste, the percentage of stucco finishes, and vessel diameters, are indistinguishable between the two sectors of the site. The only item that may possibly distinguish the AC sector is the presence of a number of smaller, unslipped, bowls with direct rims in this part of the site, a shape that is absent in the AQ sector. Again, the vessel shape sample is too limited at this point to say whether this difference is significant, but it may be related to a small scale or relatively informal set of serving activities taking place in and restricted to the AC sector during this phase.

Late Chiripa

Late Chiripa ceramics were found in the upper levels of the AQ midden at Kala

Uyuni, and in a variety of contexts in the AC sector; the only Late Chiripa ceramics in the KU sector are a small number of specimens which appear to have been originally incorporated into the adobes used to construct the walls of ASD-2. In the AC sector, Late Chiripa ceramics were recovered, mixed with Middle Chiripa wares, from the upper levels of the midden units to the south and east of the upper court, as well as from the subfloor fill, both the upper and lower floors, and the post-use fill of the two Late Chiripa sunken courtyard structures. The ceramic assemblage recovered from these courts, however, was not uniform across the structures. Although predominantly Late Chiripa, the ceramic sample from the subfloor levels and both upper and lower floors (but not the post-use fill) in the southeast corner of the lower court and the west side of the upper court also contained from 10% to 35% Middle Chiripa ceramics. The attributes of the ceramics in these deposits and their distribution match those from the mixed Late Chiripa/Middle Chiripa events of the AC midden. It seems likely that the provenience of the ceramics from the mixed sunken court events is in fact the AC midden, and that soil from this area was used in the construction of the courts. The units with events containing mixed Late Chiripa/Middle Chiripa ceramics are 968 921 and 962 928 in the lower court and 1000 947 in the upper court (Unit 962 923 in the lower court had not yet been analyzed at the time of this writing, but will probably also prove to contain similar mixed ceramics).

The Late Chiripa phase is the first in which a substantial ceremonial sector existed at Kala Uyuni, with public architecture and finely finished ceramics for serving food and drink. Consequently, there are two distinct Late Chiripa ceramic assemblages at the site; a domestic assemblage, with a high percentage of utilitarian and cooking ceramics and few to no decorated specimens, and a higher status or ceremonial assemblage, with finer pastes, fewer cooking vessels, larger and more frequently red slipped and decorated bowls, specifically ceremonial vessels such as ceremonial burners ("incensarios"), and more red slipped, small, necked vessels for serving liquids. The high status assemblage is found only in the AC sector. In most of the excavation units in both the upper and lower courtyards, the post-use fill over the floor, the upper floor itself (event A8) and the fill between the upper and lower floors contained high status Late Chiripa ceramics. Unfortunately, the only lower floor or subfloor fill levels that have been analyzed to date are those from areas of the courtyards that have turned out to have mixed Middle/Late Chiripa ceramic assemblages derived from the AC midden.

The domestic Late Chiripa assemblage is found in various contexts at the site. All of the ceramics recovered from the midden in the AQ sector, location of the Formative period domestic occupation at Kala Uyuni, are domestic in character. In the AC sector, while the majority of unmixed Late Chiripa ceramic deposits contain high status wares, there are several events of Late Chiripa domestic ceramics. The events

that contain mixed Middle Chiripa/Late Chiripa domestic wares - the midden itself and the midden-derived construction soils – have been mentioned above. There are also several events of unmixed Late Chiripa ceramics whose provenience is again probably from the AC midden, in this case from purely Late Chiripa levels. In two units, the upper floor (A8) assemblage is predominantly midden-derived. In both cases, however, a handful of large bowls and decorated specimens were also present, deposited presumably during activities in the courts. The domestic assemblage from these units, therefore, is not exactly the same as that from the AC midden itself, reflecting as it does the presence of some high status wares in the deposits. The other AC location with unmixed midden-derived Late Chiripa domestic wares is the post-use fill in the southeast corner of the lower court, above the mixed Late/Middle Chiripa deposits, contrasting with the fill elsewhere in the court which contained more high status wares.

The physical separation between the primary domestic occupation at Kala Uyuni, the AQ sector at the lower elevations, and the ceremonial area, the AC sector near the top of the hill, means that at Kala Uyuni there is a very clear differentiation between the domestic and ceremonial/high status ceramic assemblages. This was not the case at Chiripa, where the distinction between the two assemblages was less defined. Few, if any, deposits, could be called purely and exclusively domestic, as within the area of the settlement itself, where the TAP excavations were located, all deposits contained a significant percentage of high status or red slipped wares, while the ceramic assemblages from civic/ceremonial events included a fairly high proportion of cooking and other utilitarian specimens. Furthermore, many of the sooted and cooking wares that we do find at the site are clearly a by-product of large-scale food preparation, such as would be necessary for feasting or other public food consumption, rather than of household-based activities.

The separation of assemblages at Kala Uyuni leads to some notable differences between the ceramics from Kala Uyuni and Chiripa. For example, the ceramic sample from AQ is composed of a larger proportion of purely domestic wares than any Chiripa event, with more coarse paste ceramics, fewer red slipped vessels, and more cooking ollas and jars than any context at Chiripa. Conversely, we find that the high status or ceremonial assemblage from the AC sunken courts is particularly weighted towards fancier vessels. There are, of course, fewer decorated ceramics at Kala Uyuni, with less variety of decorated wares, as this site is not as large nor does it enjoy the same regional importance as Chiripa, but large serving bowls and sooted "incensario" sherds make up the same proportion of the sample at the two sites, and unlike at Chiripa, there are very few utilitarian wares and coarse paste ceramics in the AC ceremonial assemblages. Cooking, even large scale cooking for feasts or other ceremonies, is mostly restricted to the AQ sector at Kala Uyuni. Food may have been carried up to the courts directly in serving vessels, or alternatively cooked food may

not have been as important a part of the activities taking place in the sunken courts at Kala Uyuni as it was at Chiripa. The completion of the analysis of the AC domestic midden deposits will add another dimension to our understanding of this distinction between domestic and ritual assemblages at Kala Uyuni, as this area seems to reflect a third set of activity patterns. The low percentage of red slipped and decorated wares, the lack of large serving bowls or small red-slipped ollas for serving liquids, and the higher proportion of stucco specimens in the AC midden is directly comparable to the AQ deposits, yet the paucity of cooking vessels, and the shape, diameter and surface finishes of most of the necked vessels is not like AQ, but rather comparable to the high status assemblage from the courts.

The Late Chiripa domestic assemblage at Kala Uyuni is composed principally of ceramics tempered with very coarse, chunky, opaque white quartz inclusions. This temper is characteristic of Late Chiripa ceramics as defined from the site of Chiripa itself (Steadman 1999b). The ceramic assemblage from the AQ sector specifically has the highest percentage of ceramics manufactured in this paste, 78% of the sample, more than any context at Chiripa itself. This may be due in part to regional variation in the popularity of this paste at Kala Uyuni, but it also reflects that fact that the AQ domestic midden is more purely utilitarian than any found at Chiripa. The domestic deposits in the AC sector also have a high percentage of this paste, although at 57% of the sample it is not as high as the AQ sector. The remainder of the Late Chiripa domestic sample is manufactured mostly in the paste with dense, translucent, rounded quartz fine inclusions. All in all, the Kala Uyuni paste assemblage is dominated by a few, particularly popular pastes, in contrast to the more varied paste distribution at Chiripa, reflecting less regional contacts at this smaller settlement than at the ceremonial center of Chiripa. About half the domestic sample, AC and AQ together, is unslipped, mostly brown or red brown in color, and a quarter slipped brown or dark brown. Red slipped wares are relatively rare, 8% of the sample, and decorated wares limited to a handful of sherds, representing 0.2% of the assemblage. A complete coverage burnish is the single most common surface finish (46% of the sample) followed by an approximately equal percentage (19 and 23%) of incompletely burnished and stucco specimens. Both the percentage of stucco sherds and those with sooted surfaces are significantly higher than in the high status deposits.

The Late Chiripa high status assemblage at Kala Uyuni has different suite of attributes. The paste with dense translucent, rounded fine inclusions is the single most common (54% of the sample), followed by the micaceous paste (the same that had been common in Early Chiripa times), which forms 25% of the sample. In the higher percentage of these two pastes, and the much lower percentage of the paste with chunky white quartz (now only 17% of the sample), the high status assemblage differs from the domestic one. This white quartz paste is, in fact, less common in the Kala Uyuni high status assemblage than it is in similar contexts at Chiripa, again

reflecting a greater differentiation at Kala Uyuni between domestic and high status contexts. About two thirds of the high status assemblage is slipped, in red brown, brown or red. This last is the single most common color in the sample, with 22% of the specimens having this attribute. Half the ceramics have a complete coverage burnish, with the majority of the remainder finished with an incomplete coverage burnish.

The Late Chiripa phase witnesses the first decorated ceramics in the Kala Uyuni assemblage. Naturally, most of the decorated wares in this phase occur in the high status assemblages from the AC sector; 5.8% of the ceramics from the upper floors and fill between the floors in both courts were decorated, and 3.8% of the fill deposits, for a total of 44 specimens (this figure is less than comparable contexts from Chiripa, where the percentage of decorated wares ranges from 6.7% to 14.5%). The first vessels that were clearly used for ceremonial purposes also date to this phase at the site. The two ceramic ceremonial shapes identified in the Late Chiripa assemblage at Chiripa are the ceramic trumpet and the incense burner bowl, characterized by sooted deposits in the interior. No Late Chiripa ceramic trumpets were recovered at Kala Uyuni, at least in the sample analyzed so far, but four decorated specimens with charred interiors were found. All come from finely finished cream on red bowls, and all are found in the upper floors of the courts, with specimens coming from both the upper and lower structures. There are some decorated wares as well in the domestic deposits recovered at Kala Uyuni, but their number is very small, 9 sherds in total, representing 0.3% of the domestic sample, most from the upper floor of the AC courts in what are otherwise midden-based assemblages.

Late Chiripa decorated ceramics at Kala Uyuni are comparable to those from the site of Chiripa itself. Fewer of the decorated wares at Kala Uyuni are manufactured in the fine micaceous paste than at Chiripa, although when taken separately, the proportion of micaceous paste specimens in the decorated sample from the courtyard floors (40%) is directly comparable to the proportions of this paste in similar civic-ceremonial contexts at Chiripa. Cream on red ceramics form the vast majority of the Kala Uyuni decorated wares, comprising 82% of the decorated ceramics (Figs 31a-f, 32a). This is somewhat more than the assemblage at Chiripa, where the greater variety of decorated wares means that cream on red ceramics make up only 74% of the sample, reflecting the greater level of public and ceremonial activity at that site and its wider regional contacts. As at Chiripa, cream on red specimens are decorated with motifs consisting mostly of diagonal elements and triangles. The other decorative types present at Kala Uyuni occur only in minor quantities. These include black on red wares, black on red with incision separating the color areas, wide line incised (Fig. 32b), red on cream, and modeled ceramics, all similar in style and motif to contemporary specimens from Chiripa. Most specimens are body sherds; the few rim and base specimens that can be classified as to vessel shape are almost all flat-

based bowls, generally with vertical sides and thickened rims, with one example of a decorated short-necked olla.

Bowls are more common in the Late Chiripa assemblage at Kala Uyuni than in the previous phase, forming from 17% to 27% of the classified shape assemblage, with random variability among the different contexts. They mostly have straight sides, with either a vertical (Fig. 32a) or slightly flared wall angle (Fig. 32c), the latter being more common. Rims are mostly direct, either rounded or flattened; about one quarter have rims with thickening at the lip. As at Chiripa itself, the vertical-sided bowls tend to be larger, have more examples with thickened rims and are more often slipped red

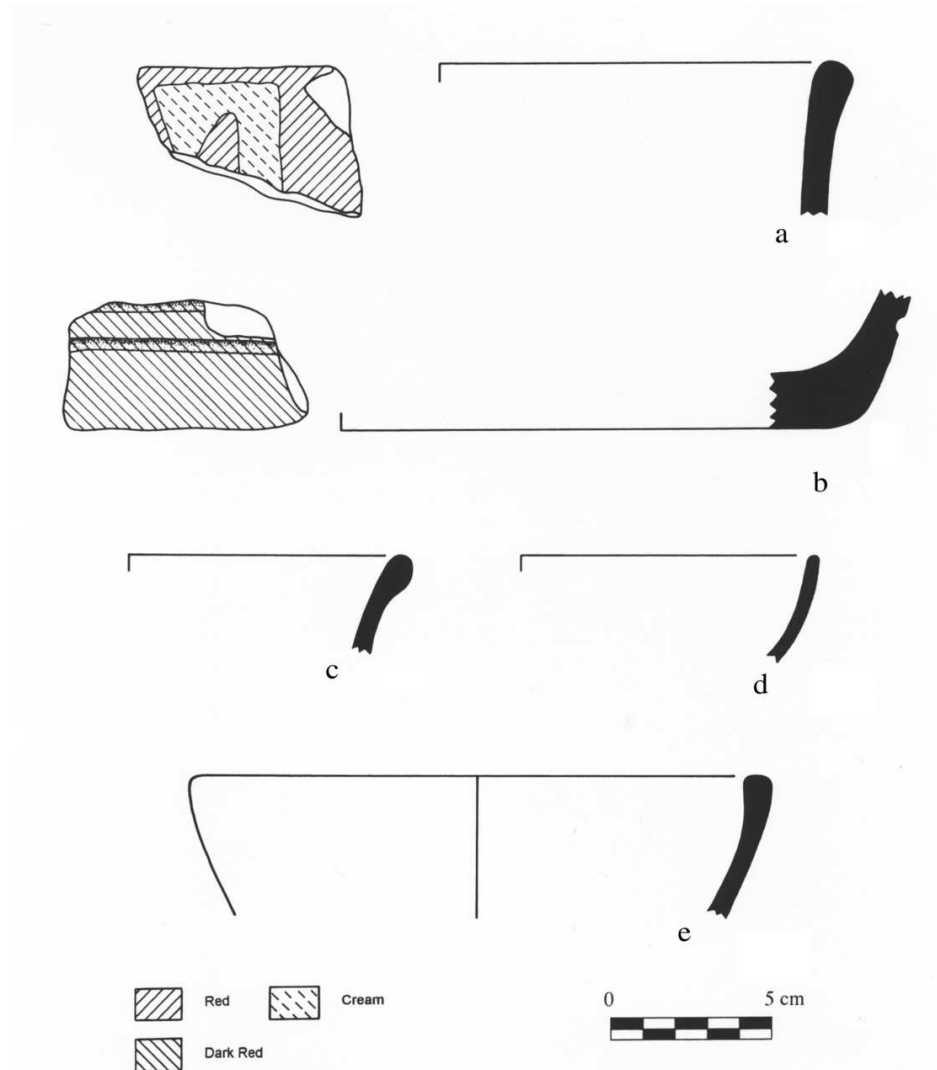

Figure 32: Late Chiripa Ceramics

cream on red bowl (a), wide-line incised bowl base (b), bowls (c-e)

and/or decorated than the slightly flared shape. Bowls with a slight convexity to the wall are also present but less common, forming 39% of the bowl sample (Fig. 32d-e). Rims on the convex bowls are direct. Surface color of the bowls varies by context; 60% of these vessels from the court floors are slipped red and 40% decorated, while in the midden and midden-derived domestic assemblages only 33% of the bowls are slipped red and 6% decorated, with the remainder mostly slipped in other colors, such as red brown or brown. Bowls at Kala Uyuni tend to be smaller than at Chiripa. Average bowl diameter in the high status assemblages is 22 cm; bowls in the domestic assemblage average 20 cm. This range is similar to the fill and wall fall deposits at Chiripa, and even the floor of the Late Chiripa sunken court at Llusco, but is not as large as the bowls associated with the Upper or Lower House structures on the Mound, or those from the Quispe sunken court (Hastorf et al. 1998, 1999; Bandy 1999, Paz 1999) which average from 26 to 28 cm in diameter.

Extra-large sized bowls, those with diameters greater than 30 cm, first appear at Chiripa in the Late Chiripa phase, and are believed to be indicative of an increasingly greater participation in public eating or feasting activities at the site, associated in all cases with sunken courtyard structures (Steadman 2002). Extra-large sized bowl also appear for the first time in the Late Chiripa phase at Kala Uyuni, where they are also associated specifically with the sunken structures; 40% of the bowls (2 of the 5 classified bowls, both decorated) from the upper floor of the courts are extra-large sized specimens, versus only 20% from the post-use fill of the courts and only 6% of the bowls from the domestic midden of AQ and the midden-derived AC contexts. Although the bowls from the court floors are on average smaller and less likely to be decorated than those from comparable civic/ceremonial contexts at Chiripa, the percentage of extra-large bowls specifically is directly comparable to the Chiripa figures.

Necked vessels in the Late Chiripa phase at Kala Uyuni are mostly either medium necked ollas (Figs. 33a-c) or jars (Figs. 33D-e, Fig. 34a-c); these two shapes represent 44% and 43% of the necked vessels respectively. Short-necked ollas, once a popular shape in the Early Chiripa phase, are a minor component of the assemblage. Looking at the distribution of necked vessels across the site, however, we see that although necked vessels are found in roughly even proportions in all contexts, jars specifically are considerably more common in the AQ midden, representing more than half of all the necked vessels found there, while medium necked ollas are more common in the AC deposits, both midden-derived and high status, where they form about half of the necked vessel sample. Necked vessels in the Late Chiripa phase served a variety of functions, but jars appear to have been the shape used most often for cooking. All sooted rim specimens where vessel shape can be precisely determined are jar shapes (for example Fig. 33e). Almost half the jar sample is slipped brown, the most of any necked vessel class, which is also the most common color for sooted body sherds and

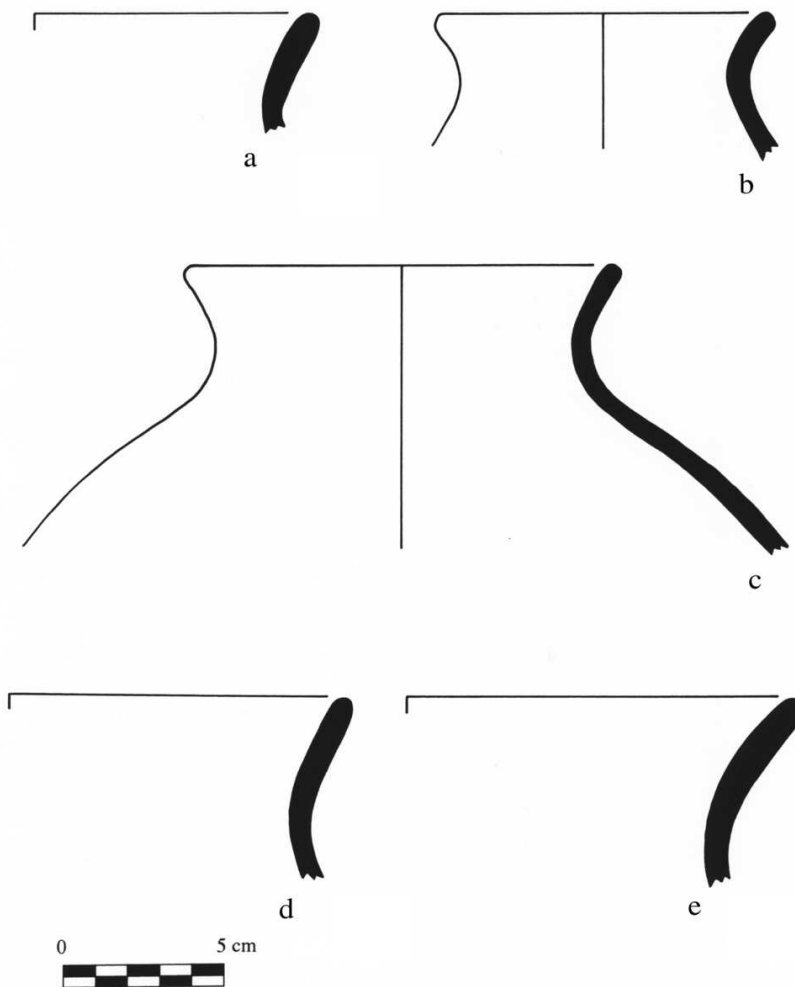

*Figure 33: Late Chiripa Ceramics
medium-necked ollas (a-c), jars (d-e)*

bases. The marked concentration of jar shapes in the AQ midden deposits strongly suggests that the focus of cooking activities was in this sector. Most other jars at Kala Uyuni are slipped red brown, while all necked vessels are burnished, with an incomplete coverage burnish being marginally more common. Almost a third of the medium-necked ollas is slipped brown, with a high percentage of unslipped pieces as well, but red slipped vessels are also common for this shape (Fig. 33a-b), close to a quarter of the specimens. Short-necked ollas are not used for cooking in this phase in the Chiripa sequence, but rather are a class of serving vessels found most commonly in the high status assemblages. They are the most likely to be slipped red of any necked vessel shape, almost a third of the sample being this color, and there are no known brown or black specimens. Although they represent only 13% of the necked

vessels at the site, they form a large component (45%) of the necked vessel sample from the floors of the sunken courts.

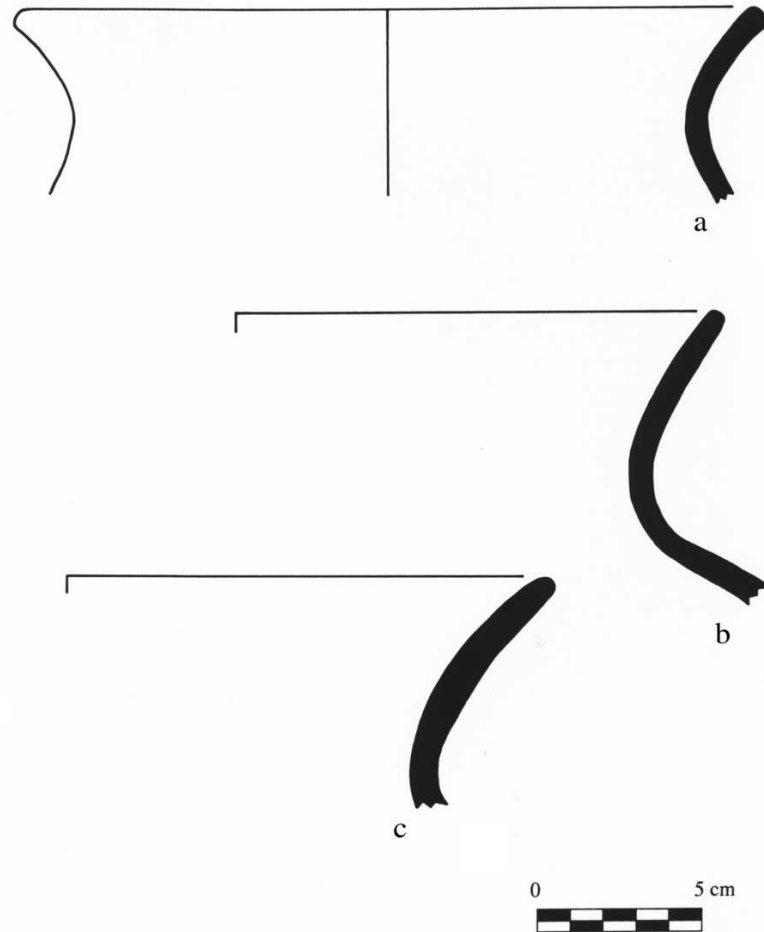

Figure 34: Late Chiripa Jars

Necked vessels in the AC sector of the site tend to be, on average, smaller than the AQ specimens. Average diameter of the necked vessels, both jars and ollas, from the domestic and high status deposits in AC ranges from 18 to 19.5 cm. The AQ ollas are similar in size, but the jars which are so concentrated in this sector tend to be larger, averaging of 23 cm. Extra-large necked vessels, those with diameters from 30 to 34 cm, associated at Chiripa with cooking for large feasts or other gatherings, are present but equally rare in both the AC and AQ sectors. However, the large and extra-large vessels that do occur in the AC sector are mostly red or red brown slipped, suggesting a serving function, while these same shapes in AQ are more likely to have attributes consistent with cooking vessels. At the other end of the spectrum, small, red slipped ollas, both short and medium-necked, with diameters from 8 to 15 cm are more than

twice as common in the floor deposits of the sunken courts than elsewhere at the site. At Chiripa, these vessels were concentrated in ceremonial structures, where they were believed to have been used for serving liquids. The necked vessel assemblage from the floors of the sunken courts, then, with its smaller vessels, fewer jars, and more short-necked ollas and small red slipped vessels, is more consistent with serving activities than the domestic assemblages from the AC sector and particularly the AQ midden.

Tiwanaku I

Tiwanaku I ceramics are present in the ceramic samples from the mixed upper levels in all sectors of the site; as a small component of the predominantly Late Chiripa deposits in the upper levels of the AQ and AC sectors, and as part of a mixed deposit containing Tiwanaku I through V ceramics in the KU sector. It is only in the KU sector, however, that unmixed Tiwanaku I ceramics were recovered. The floors and occupation zones in and around ASD-2, as well as the clay lenses and adobe wallfall in and over ASD-2 and the deposits under the structure, all contain Tiwanaku I ceramics. In most cases these deposits are unmixed; some events contained a small number of Late Chiripa wares that had originally been incorporated into the adobes used in the construction of the walls. Of the KU sample, only these events in and around ASD-2 have been analyzed. The deep unit in the KU sector, 894 639, also yielded an extensive sequence of Tiwanaku I events (see Paz and Bruno, this volume) and hence a large quantity of ceramics. As this unit has not yet been analyzed, the Tiwanaku I sample presently available is small; the description which follows must therefore be considered preliminary. The early data from the field suggest that the events immediately above the Tiwanaku I levels in this deep pit pertain to a different phase in the ceramic sequence, presumably Tiwanaku III. Completion of the analysis of the KU sector ceramics, then, will ultimately provide us with a comprehensive definition of both the Tiwanaku I and III ceramic assemblages at Kala Uyuni.

The Tiwanaku I phase marks a major change in ceramic style as well as technology; Tiwanaku I ceramics differ markedly from those of the Late Chiripa phase in all attributes, including paste, surface finish and color, vessel shape and, of course, decoration. Beginning in the Tiwanaku I phase, the ceramic assemblage at Kala Uyuni is no longer entirely fiber-tempered. Many of the Late Chiripa pastes carry over into this phase, most particularly the micaceous paste that had been common in Early Chiripa times and for decorated wares in the Late Chiripa phase. The proportion of this paste, in fact, increases in the Tiwanaku I phase to 38% of the sample. Fiber-tempered wares in general, however, make up only 49% of the Tiwanaku I ceramic assemblage. The remainder is manufactured in a suite of new mineral-tempered pastes, the most common of which (35% of the assemblage) can best be described as the micaceous paste without the fiber, as it has the same suite of inclusions, and the

same quantity of mica visible on the surface of the vessel. The small sample of Tiwanaku I ceramics analyzed to date suggests change through time in the distribution of pastes within this phase; the event under ASD-2, the earliest of those analyzed so far, has a higher proportion of the fiber-tempered micaceous ware and less of the mineral-tempered version than the events directly associated with ASD-2 itself, where the mineral-tempered version becomes the more common of the two. Mica-tempered ceramics, with varying proportions of mineral and fiber-tempered versions, have been reported elsewhere along the southern shores of the Lake as being characteristic of Late Formative or Tiwanaku I assemblages (Bandy 2001:168; Janusek 2002: 44,46; Lémuz 2001: 352; Ponce 1971:18).

Attributes of surface finish and color of the Tiwanaku I ceramics show a trend towards less attention to detail, and a more efficient and rapid mode of ceramic production. Almost three-quarters of the assemblage is unslipped. This is a significant increase from the Late Chiripa phase, where unslipped ceramics ranged from only one third to one half of the sample in different contexts at the site. A black, gray or brown unslipped color is the most common, this group forming 42% of the sample. Red slips are relatively rare, dropping from the high figures of the Late Chiripa phase to only 2% of the sample; most slipped Tiwanaku I ceramics are brown or red brown. The labor intensive surface finishes of the Late Chiripa phase, which were weighted heavily towards burnished vessels (70 to 80% of the vessels have some sort of burnish) are now replaced by an assemblage where half the ceramics have a simple wiped or smoothed surface finish (see Steadman 1995: 61-65 for definition of finishes). These finishes existed in the Late Chiripa phase but were rare, representing not more than 6% of that sample. The complete coverage burnish, once the single most common finish in the Late Chiripa sample, now occurs on only 6% of the ceramics. A shift away from burnished finishes towards an increasingly wiped assemblage is again found elsewhere in the southern and western Lake Titicaca Basin at the onset of the Late Formative (Janusek 2002:41; Lémuz 2001:365; Steadman 1995:303). Changes in how burnishes are applied to the vessel surface also occur at this time. Previously, vessels were always finished with horizontal burnishing strokes (except on the most finely finished vessels, burnishing troughs or streaks are easy to detect). In the Tiwanaku I phase 13% of the diagnostics were burnished using vertical strokes, a figure that will increase in subsequent Tiwanaku phases. Most of these diagnostic specimens are bases, but include necked vessel rims as well. Again, the appearance of vertical burnishes is a hallmark of the beginning of the Late Formative period elsewhere in the Lake Titicaca Basin (Steadman 1995:304).

One of the remarkable results of the 2003 TAP season at Kala Uyuni was the number of decorated Tiwanaku I specimens that were recovered from the excavations. These include monochrome slipped or unslipped incised trumpets, and an exceptional number of polychrome painted and incised wares. Outside of the burials from under

the fill of the Kalasasaya structure at Tiwanaku (Ponce 1971, 1993), only a handful of polychrome incised Tiwanaku I ceramics have been recovered from either excavations or surface collection (Albarracin-Jordan et al. 1993:Fig. 15; Bandy 2001:

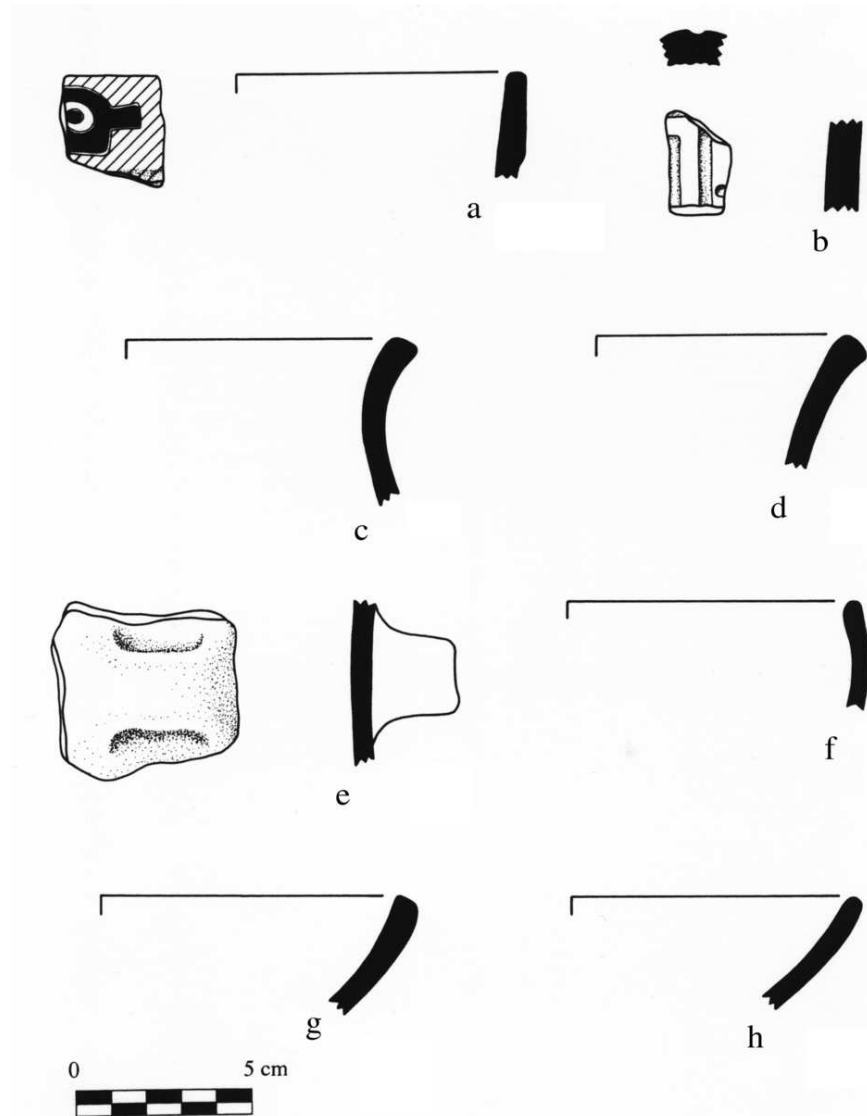

Figure 35: Tiwanaku I Ceramics

black, red and unslipped red-brown incised (a), incised blackware trumpet (b), jars (c-d), horizontal strap handle (e), bowls (f-h)

Fig. 7.1; Bermann 1994: Fig. 5.5; Janusek 2002:46). In the small sample of Tiwanaku I ceramics that have been analyzed from Kala Uyuni (a total of 392 fragments) there were only two decorated specimens, both from event B21, the surface outside of ASD-2. However, a quick survey of the drying screens in the field revealed

approximately thirty more polychrome incised sherds that have yet to be studied. The discovery of such a large quantity of decorated ceramics at Kala Uyuni not only will significantly increase the corpus of known decorated Tiwanaku I specimens from excavated contexts, but also supports Bandy's (2001: 176) hypothesis that this site was the center of a large multi-community polity during the Tiwanaku I phase. The

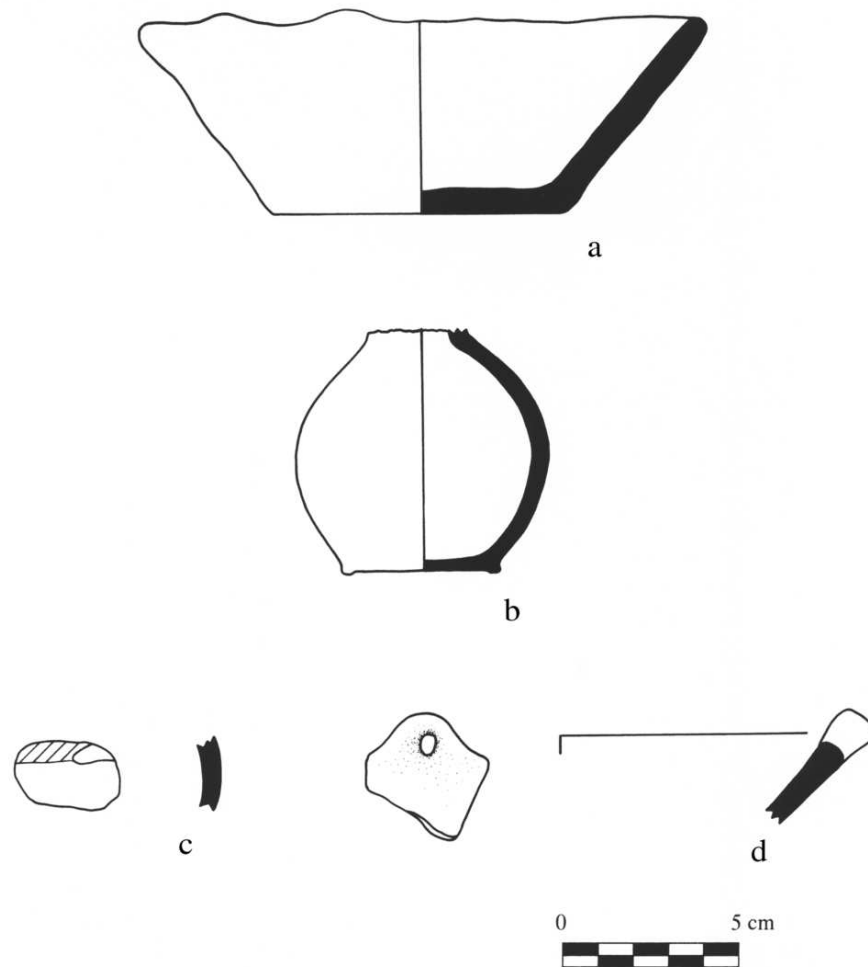

Figure 36: Tiwanaku I Ceramics

bowl with wavy rim (a), bottle with broken neck (b), fragment of a red-banded bowl, red slip on unslipped light brown surface ©, bowl with horizontal handle, rim angle unknown (d)

two decorated specimens in the analyzed sample are an unslipped incised blackware trumpet (Fig. 35b), and a rim with incision separating areas painted in black and red slip or left an unslipped red brown (Fig. 35a). This rim, with a wide thickened band

around the lip, is new in this phase, as is the vessel shape from which it probably comes, a straight-necked, globular bodied olla or jar (Ponce 1971: Fig 3.1). Bowls with charred interiors are also found associated with ASD-2, suggesting, as in the Late Chiripa phase, the burning of a ritual substance. There are three of these in the sample from in and under ASD-2, although in this case none are decorated (Fig. 35g-h).

As in other attributes, vessel shapes in the Tiwanaku I assemblage exhibit several significant changes from Chiripa times. Again, the sample is small, and further analysis will certainly increase our understanding of the shape assemblage. At present, however, it appears as if ollas, both short and medium-necked, are rare in Tiwanaku I times, as all recovered necked vessels are jars (Fig. 35c-d), mostly with medium rather than tall necks. All rims are direct and either slightly rounded or flat, sometimes with a point on the outside of the lip (Fig. 35c), or a depression or groove around the center of the lip left from the last stage of finishing. Both of these are new rim shapes in this phase, as is the popularity of flat rims in general. Jar diameters range from 14 to 22 cm, with an average of 17 cm. Jars are mostly wiped at the neck, often with incomplete burnishing on the body wall, and have red brown or brown slipped surfaces. Horizontal handles on necked vessels, present but very rare in the Late Chiripa phase, are now as common as vertical forms. Jars, aside from performing functions of storage and serving, also were used as cooking vessels. No sooted rims exist in the sample so far, but several bases, including a characteristic form with a thickened joint between wall and base, and a horizontal handle (Fig. 35e) exist with sooted interiors, all having attributes consistent with the jar rims in the sample.

Bowls are more common than necked vessels in the analyzed Tiwanaku I assemblage. While this may change as the analysis progresses, the proportion of bowls in the assemblage can certainly be said to increase in this phase. The vertical-walled bowls of the Late Chiripa phase are gone, and slightly flared walled specimens are rare. Instead convex, slightly convex, and incurving bowls make up the majority of the sample (5 of the 7 specimens, Fig. 35f-h). More than any other vessel shape, these newly popular curved walled bowls are more likely to be mineral rather than fiber-tempered. They are fairly small (average diameter 17 cm), with incompletely burnished or smoothed surfaces and a variety of slipped and unslipped colors. Convex or slightly convex bowls are frequently slipped red at the rim and in a band partway down the exterior and/or interior wall; this red banded bowl form is characteristic of Tiwanaku I assemblages around the southern Basin (Albarracin-Jordan and Mathews 1990: Fig 6b; Bandy 2001: Fig. 7.2r-u; Bermann 1994:Fig. 5.4; Janusek 2002: Fig. 3.11, 3.12; Ponce 1971). There are several of these specimens from the Kala Uyuni sample (Fig. 36c), unfortunately mostly body sherds and not rims, with a red band on either an slipped or unslipped light brown surface. Other special shapes recovered

from excavations in the KU sector include a complete flared walled bowl from above the lower floor of ASD-2 (Fig. 36a). This vessel is one of the three in the sample which have lightly sooted interiors, its wavy rim anticipating the incised scalloped edge bowls that become common in the following Tiwanaku III phase. Bowls with horizontal handles on the rim also occur in the ASD-2 sample (Fig. 36d, compare Janusek 2002: Fig. 3.11k,l), as do finely finished small bottles (Fig. 36b); this particular specimen has a light brown slip and a rubbed surface finish.

8. Archaeobotany

Maria Bruno and William Whitehead

In the field

The use of water flotation enables us to obtain a sample of carbonized botanical remains, small animal bones, lithics, and other artifacts from each locus excavated at Kala Uyuni during the 2003 field season. Each excavator followed the same protocol for collecting samples. At least one 10L soil sample was collected for each locus and placed in a hefty 20L plastic bag. This “bulk” sample was taken from a single location in the locus and its provenience recorded using x,y,z coordinates. The elevation was determined by taking an average from the top and base of where the soil was removed. If the excavator had a locus that was particularly rich in organic materials or information that could best be recovered through flotation, they placed all of the material in a flotation bag, regardless of volume. In contexts, such as floors or middens, a 10L “scatter” samples could be taken if the excavated deemed appropriate. Rather than taking the soil from one specific area in the locus, soil is taken from throughout the locus to provide an average view of the matrix. With all of the samples, the excavator created two label tags, both containing equal information on the locus, provenience, date, and excavators. One tag, made of tyvek paper, was placed inside the bag with the soil. The bag was tied with a string possessing a diamond tag with the proper information. The samples were brought back to the camp each day and stored in a shed outside the living quarters until floted.

This year we inaugurated a new flotation machine that was built in La Paz under the direction of Christine Hastorf. The machine was built using the modified SMAP design (Watson 1976; Hastorf 1999), which employs a 50 gallon oil drum into which fresh water is fed via 1.5 inch pipes and a shower head. A small Briggs and Stratton motor pumps water into the machine. A second bucket made from a smaller oil drum and about 1/4 of the length of the large drum has a 0.5mm stainless steel mesh bottom and fits into the larger drum and rests upon two support bars inside the large drum. Both drums possess pour spouts in which the water flows out of the machine. The machine also has two attached garden hoses with sprayers. The shower head feeding the water into the large drum enables the water to circulate gently through the bottom of the inner bucket mesh. This motion loosens the soil allowing the finer silts and clays to sink to the bottom of the oil drum while the lighter than water material, primarily carbonized plant remains, floats to the surface. The floating material pours out of the drums via the spout and into a steel 10L bucket that is attached to hooks at the end of the spout. The bucket has a window screen bottom so that water can flow

through it. A fine mesh cloth is placed on the bucket with clothes pins and catches the floated material coming from the spout. This material is called the light fraction. Larger artifacts that are separated from the soil by the water but do not float are caught by the mesh at the base of the inner bucket. This is called the heavy fraction.

The flotation team for 2003 was Meridith Sayre, Franz Choque, Primitivo Nina, and Facundo Llusco. Christine Hastorf and Maria Bruno carried out the training and William Whitehead supervised the process. The flotation machine was operated by at least two people everyday. We began the flotation in a spot close to Kala Uyuni where there was a spring and a natural pool of water. Unfortunately, the water did not regenerate enough each day to continue working here, so we moved the operations down to location near to the town of Coa Kkollu, named Uma Pampa where water was more abundant. Each day 18-24 samples were selected for processing. In total, 369 flotation samples were taken and floted from the archaeological excavations. In addition, we floted a number of 10L samples from the a recently abandoned house (see Goodman, page 86).

To begin, each sample is transferred into a clean bucket, its volume measured, and all of its information recorded in the flot log. Then, the bucket is filled with water so as to loosen the soil before placing it into the flot machine. Meanwhile, the primary flotation technician fills the machine with water until the level is such that the water flows gently over the spouts. This technician continues to monitor the water level and velocity throughout the day to assure that that no charred plant material is lost out of the catching bucket by overflow or splashing. He also emptied all of this water and accumulated sludge mid-day and refilled the main bucket so as to reduce the risk of contamination. Once the soil in the bucket is well-soaked (about 10-20 minutes) and the machine filled with water, the assistant flotation operator gradually pours the soil from one sample into the inner bucket resting in the large drum. The primary technician sprays the soil gently with water to minimize splashing and too speed up the transfer of soil. The bucket is sprayed clean and set aside for the next flotation sample. The primary technician then agitates the inner bucket by moving it up and down and in a rotational manner. This helps break up the soil and separate the artifacts. Meanwhile, the assistant sprays the fine mesh cloth as the light fraction material pours out of the spout and into the material in the bucket. This helps remove any floating silts and keeps the botanical fraction clean.

The primary technician monitors the quantity of charred material floating out of the inner bucket. When it appears that no more material is on the water surface, a fish-tank filter siphon is used to suck up all remaining charred materials floating in the water but not rising to the surface (Gumerman and Umento 1978). This is done by holding the siphon tube six inches above the bottom of the inner flotation bucket, draining the water into the light fraction catching bucket. The siphoning terminated

when no more charred material can be seen in the transfer tube. At this point, the water pressure is turned off to let any remaining charred materials float to the surface. Once this is done, the water is turned on to full force and allowed to run for several minutes to aid any heavier items float to the top. A tea strainer is drawn through the water, and when no more materials are found, the flotation process is complete. The fabric with the light fraction is removed from the bucket and tied with the diamond tag originally placed with the soil sample. These samples are placed on a clothes line to dry. The inner bucket is removed from the barrel with the heavy fraction at its base. These materials, along with the original tyvek tag written by the excavator, are poured onto a large cloth laid on the ground, which also has the flotation number written on it with a Sharpie waterproof pen. The heavy fraction materials dry in the sun throughout the day.

In the laboratory

Once dry, the light fractions were transferred to clean plastic bags with the original sample tag inside and an additional sticky label on the outside of the bag. These samples have been exported to the Archaeobotany Laboratory at the University of California, Berkeley with the permission of UNAR. These will be sorted in the laboratory by Maria Bruno for her dissertation thesis. The dry heavy fractions were also placed in large plastic bags with the original tyvek tag placed inside. We were able to complete the sorting of the heavy fractions in the in-field laboratory. This was completed by the flotation workers Franz Choque, Facundo Llusco, and Primitivo Nina with the help and supervision of William Whitehead and Meridith Sayre. Each heavy fraction sample was size sorted through a series of geological sieves with mesh sizes of 4mm, 2mm, and 0.5mm. Bones, fish scales, charred plant remains, lithics, metals, beads, and any other special find were sorted from every fraction and screen size. Ceramics were removed only from the 4mm fraction. Burned earth was recovered only from the 4mm and 2mm sieves. The finds were combined by type and placed in plastic bags with new labels indicating the provenience information from the original tyvek tag. The artifact types for each heavy fraction were recorded in the heavy fraction log. The artifacts were provided to each specialist for analysis. Bags with plant remains from the heavy fractions were attached to the outside of their corresponding light fraction bag and transported to Berkeley for analysis.

Area	Total Number of Flotation Samples	Total Volume Floated
Achachi Coa Collu	174	1612 L
Ayrampu Qontu	37	350 L
Kala Uyuni	130	1188 L

Table 1: Flotation samples processed by area

9. Animal Remains from the 2003 Season

Katherine Moore, University of Pennsylvania

During the 2003 TAP excavation season at the three Kala Uyuni areas, more than 300 loci were excavated. Animal bone was recovered by screening through 6 mm mesh from 280 loci. Bone from 79 of these samples was identified and described and is stored in Bolivia. Bone from the other 201 loci were loaned to me to complete analysis in the United States. Based on the 79 loci samples analyzed so far, it can be estimated that the total number of fragments in the KU sample will be approximately 100,000 to 200,000, not counting fish bones.

Large mammal bone from these samples have been identified according to taxon with reference to museum specimens and published metric standards using measurements made with dial calipers accurate to 0.05 mm. Weights and counts of all bone fragments were recorded in order to understand the use of different body parts and the process of bone fragmentation. The state of burning, modifications such as cut marks and tooth marks, and the state of weathering, erosion, and mineral deposition were recorded for every fragment. Bone from camelids, deer, and unidentifiable large mammal bone were bagged separately and then returned to their original bag for storage. Bone that was identified as human was bagged separately and stored with other human remains. Bone from other taxa, including birds, small mammals, amphibians, and fish, were removed from the large mammal samples and were bagged, labeled, and stored separately.

Bone was also recovered in the heavy fraction of the flotation samples through a 1 mm mesh. (Fractions recovered through the 0.5 mm mesh were scanned but not sorted; it is rare that any bone at all is identifiable from this fraction). During the 2003 seasons, 251 flotation samples were sorted which produced animal bone. Experience with bone samples from the Chiripa site (Moore, deFrance, and Steadman 1999) suggests that the flotation samples are particularly important in studying fish and other small scale animal remains. Gastropods and eggshell as well as bone are recovered in these samples. An overview of the flotation samples suggests the great variation in bone density between different excavation contexts at Kala Uyuni, already noted roughly by excavators. Most samples have 5-10 gm of bone recovered from a standard 10 l sample of soil, but several samples had more than 100 gm of bone. A subsample of these flotation samples will be sorted, weighed, and the identifiable fish and small mammals and birds identified.

Bone tools, fragments of finished tools, and bones with worked surfaces are handled separately as soon as they have been identified. Approximately 20 such tools were recognized by excavators during excavation. Another 170 tools and tool fragments were identified and analyzed while examining the large animal bone recovered as food remains. Perhaps another 300 tools could be expected from the samples of large mammals that still remain to be analyzed. Work at the Chiripa site indicates that scrapers dominated other categories of bone tool during the later formative and this pattern appears to be the case at the Kala Uyuni sites as well. Scrapers made of long bones, scapulae, ribs, and mandibles are much more common than net gauges, weaving combs, awls or ornaments such as beads. There is a complete sequence of bone tool manufacture in this collection, strongly suggesting that this was an important local craft.

Research Approaches for Kala Uyuni Bone

Analysis of tabulated results for the KU animal sample is in progress. Based on the work accomplished so far, three aspects of the sample are likely to produce the most significant insights into prehistoric animal use.

- 1) Analysis of the major large mammals used at the Kala Uyuni sites. The domesticated and wild camelids (llama, alpaca, vicuña, guanaco) is based on continuing study of measurements of long bones and teeth. Recent analysis of Lake Titicaca samples of camelid bone by Moore (Moore, de France, and Steadman, 1999) and previously by Ann Webster (1993) suggests that the range of body sizes in Formative through Tiwanaku sites is not similar to that found in modern populations. Modern populations divide easily between large forms (llamas and guanaco) and small forms (alpaca and vicuña) according to work in Peru (Kent 1983, Miller 1979, Miller and Gill 1990, Moore 1989). For the prehistoric *altiplano* of Bolivia, there appears to have been one or more camelid species in a size range intermediate between the large and small modern groups. Two explanations are being considered to explain this pattern: first, that modern samples from Peru used to develop the metric models are different from Bolivian populations because of some geographic or ecological effect. A second, and more interesting, possibility is that the prehistoric populations may have consisted of animals that were not, in fact, equivalent to the llamas and alpacas of today, but were rather animals that represented a different stage in the process of domestication or the results of selective breeding with different goals. These metric studies will be linked to the analysis of age and sex of the individual animals but it is already apparent that age data will be relatively scanty compared to the abundance of metric data.
- 2) The importance and nature of the use of wild animals at the KU sites. Wild fauna used at the sites included wild birds, fish, vicuña, deer, and possibly guanaco. I

will be analyzing these remains in collaboration with Susan deFrance and David Steadman. In particular, the samples examined so far show heavier use of birds, and to some extent fish, than in some of Late Chiripa samples from Chiripa. The screened samples will be analyzed in conjunction with the flotation samples to be able to accurately estimate their dietary importance. We will compile a chronology of locus samples that will allow us to compare the importance of lake-edge fauna over time to changing lake levels and settlement patterns.

- 3) Analysis of animal bones and bone tools hold considerable promise in improving our understanding of ceremonial and non-ceremonial (domestic) contexts at the site. While some animal bones are derived from food use others seem to represent offerings, based on the degree of fragmentation, burning, weathering, and the selection of skeletal elements. We also compare the range of activities and discard behaviors indicated by the range of taphonomic signatures on bone fragments with variation in the condition and composition of the botanical samples. We expect that a high proportion of high-value parts of the camelid skeleton would indicate ceremonial or public food preparation and distribution, but we remain aware of the how this signal may have been blurred by a number of post-discard events.

The bone tools from KU sites indicate a range of textile working activities including net manufacture, the use of narrow and broad awls often associated with basketry, ceramic shaping, and leather working, and several categories of ornaments, particularly beads. Bone tool waste (blanks and failed pieces) was found in the apparent area of manufacture, while finished bone tools were found in locations where they were being used, cached, deposited as offerings, or discarded after breaking.

10. Microstratigraphy and Soils Analysis

Melissa Goodman Elgar

Introduction

The Taraco Archaeological Project (TAP) has pursued high resolution geoarchaeological studies as part of its investigations of the development of early complex societies on the southern shores of Lake Titicaca, Bolivia. Collections of consolidated blocks of soil were collected from archaeological features in the 1996, 1998 and 1999 field for microscopic analysis in thin section. The emphasis of prior investigations was house floors and domestic deposits. Microstratigraphy of important deposits, such as occupation surfaces from the Formative mound at Chiripa, provided insight into the composition and use of these ancient structures. In other contexts, microscopic evidence of mixing through the activities of soil fauna, water and root helped to explain the apparent poor preservation of archaeological deposits (Goodman 1999). These investigations have been limited by the lack of published soil description of the natural soils and a dearth of archaeological reference material. Furthermore, the expense of producing thin sections has greatly restricted the number of contexts that may be investigated.

Building on this experience, the 2003 geoarchaeological studies aimed to generate a reference collection from ethnographic contexts and to expand the geoarchaeological methods used in order to advance the understanding of depositional sequences from the archaeological excavations. In the archaeological excavations, investigation of occupation surfaces and construction materials continues to be the priority of the 2003 geoarchaeological investigations with a focus on mudbrick, earthen flooring and clay plasters. Soil samples for these investigations were collected from archaeological, ethnographic and natural (reference) contexts.

Methods

Geoarchaeological investigations will concentrate on the physical and chemical analysis of bulk soil samples and the microscopic analysis of soil thin sections (soil micromorphology). Three sets of samples were collected: 1) depositional sequences from excavations, 2) natural profiles and 3) contemporary mudbrick structures. The collection of bulk soil samples was incorporated into the 2003 excavation methodology. Approximately 300g unconsolidated soil was collected by the excavators from each excavated context or stratum. The geoarchaeologist collected additional bulk samples in parallel sets with blocks for thin section analysis from all

contexts. The number of open trenches made routine sampling of soil blocks prohibitive and soil blocks were collected from well-preserved features on a judgmental basis in consultation with the excavators. Block samples are identified on profile and plan drawings [not included with this report].

In order to evaluate anthropogenic influences on soil, natural soil profiles are studied in the vicinity of archaeological sites. Elevation is an important factor of soil formation in the Andes and natural reference collections were taken from elevations parallel to the excavations to control for erosion. Bulk samples were collected from two profiles by natural strata and blocks were collected judgmentally within these sequences.

An ethnoarchaeological study was conducted in an abandoned domestic compound, site KUCP. This complex contained several distinct use-specific rooms and had been abandoned for about fifty years. The entire compound was surveyed and bulk samples were collected from each use area (e.g. patio, animal corral, kitchen, doorway). Three rooms were excavated and sampled for bulk soils, floatation samples and thin section soil blocks.

The total 2003 soil collection includes 229 bulk soil samples and 65 soil blocks. Priority samples were selected for export/processing based on field preservation and the remaining samples were archived in Bolivia. 129 bulk soil samples and 50 soil blocks were exported to the US for further analysis. Permission to export these samples was kindly granted by UNAR of Bolivia.

Thirty thin sections were produced by Spectrum Petrographics (Winston, OR) and these are being analyzed on a Nikon polarizing microscope in the Paleoethnobotanical Laboratory, University of California, Berkeley following standard soil micromorphological procedures (Vepraskas 2003). Bulk samples will be processed for particle size analysis, pH and EC. Further chemical and physical analyses will be conducted on selected samples to help determine formation and translocation processes as well as to aid in sourcing. For example, x-ray diffraction may be pursued to characterize distinctive mineral components.

Natural Reference Samples (N1, N2)

The hilly Taraco region is characterized by weathered riverine deposits and natural lacustrine terraces that are dissected by dry quebradas and waterways. Reconnaissance of the region surrounding the upland site of KUAC and the lower sites of KUAQ and KUKU identified soil profiles revealing several meters of exposed deposits. Consistent with their deposition in ancient river systems, these soils were characterized by stratified deposits of rounded, size-sorted, unconsolidated particles.

Bands of pea gravel and cobbles were interspersed with poorly-sorted, mixed soils, fine sands or silts. The finer deposits were often highly pigmented red or yellow silt. These distinctive color and texture differences suggest possible sources of cobbles, mudbrick and decorative plasters used in prehistoric constructions.

Two natural profiles were selected for comparison to archaeological materials. Natural 1 profile was located above an eroded *quebrada* to the SW of the upland temple complex (Area AC) at roughly the same elevation as the site. A-horizon development was visible on the surface followed by alternating bands of gravel, cobbles and finer material. Approximately 1.5m of this exposed profile was sampled for loose soils and intact blocks. A distinctive red silt layer was identified about halfway down the exposed profile. This deposit is similar in color and texture to occupation surfaces excavated in the AC area, as discussed below.

Natural 2 profile was located in a deep *quebrada* approximately 400m to the east of the low-lying AQ and KU areas of the site (see Figure 1). Over four meters of stratified deposits were revealed in alternating bands similar to Natural 1. The upper strata were predominantly red silty sand. A thick layer of yellow silty clay was exposed at the base of the profile, which was very similar to flooring and mortar encountered in the excavations. Loose soil samples were collected at intervals from this profile. Replicate blocks and loose soil samples were collected from the yellow basal stratum to test its resemblance to archaeological deposits.

Excavations

Kala Uyuni Area (KU)

Good preservation of floors and standing architectural features in the main excavation at KUKU were promising for thin section analysis and block sampling concentrated at this site. Although there were several intrusive Tiwanaku Classic pits in this area, the clay-rich deposits appear to have preserved buried soils by limiting widespread bioturbation between strata.

Excavation in the N980 VE657 area centered on a series of superimposed yellow clay surfaces that were interspersed by organic-rich fill. These were associated with a curved cobble wall with yellow silty clay mortar/plaster between cobbles and lining the wall interior. The yellow mortar/plaster was similar to the yellow natural deposits described above. The superimposed clay surface are of particular interest as it was unclear in the field if these derived from thick flooring or from melted mudbrick walling. This deposit extends beyond the wall downhill of the site in a thin band that end about 1 meter from the wall. This stratigraphy was difficult to relate to original architecture and may represent either a platform or the foundations of a walled

structure. The well preserved surfaces offer the opportunity to compare use-areas across the structure. Four columns of soil blocks were collected across these surfaces to aid these comparisons, of which three were exported.

This excavation is cut by a later intrusive pit of Tiwanaku I date. The soil matrix was a relatively homogeneous, organic dark-brown soil interspersed with occasional thin lenses that decreased with depth. The highly organic pit fill makes intense bioturbation likely as indicated by root and soil faunal channels. However, the larger artifacts from this feature may still be reasonably *in situ*.

No clear architecture was apparent in the adjacent excavation (N894/E639) at this site. The deposits were characterized by discontinuous layers of artifact-rich materials like midden that were similar in color and texture to deposits found in the SW corner of the excavation with the defined surfaces. If these deposits are continuous, this may indicate undulations in the original land surface that have subsequently been leveled by infilling. However, in this area the deposits are riddled with intrusive pits and burials with high levels of disturbance and bioturbation. The red sterile upon which the initial anthropogenic deposits of N894/E639 are situated is also found in the natural profile from the nearby quebrada. This stratum does not appear to be the original land surface and it may be hypothesized that the area around the site was selectively excavated to reveal the red soil. This could not be tested in the excavations with the standing cobble wall as their great depth and artifact density did not allow us to reach a comparable sterile level. Overall, the high disturbance and complex stratigraphy of N894/E639 made this excavation unit a poor candidate for intact microstratigraphy and the bulk soil samples often represented several visible strata. No samples were exported from this excavation.

Achachi Coa Kkollu Area (AC)

The KUAC excavations were aimed primarily at the elucidation of the form and perimeter of the temples rather than the identification of use-areas across the temple floor. As a result, excavation proceeded in a series of discontinuous 1x2m pits starting with large rock outcrops that were correctly assumed to be standing stones in walls. The large enclosed space and depth of archaeological deposits prevented a full excavation of the structures. As a result, the sampling strategy for geoarchaeological studies was largely opportunistic and concentrated on exposed floor sequences. Preservation and sampling conditions were generally better in the lower temple and four soil columns were collected. Abundant cobbles and indistinct stratigraphy complicated the recovery of soil blocks in the upper temple. In all, eighteen soil blocks were exported from KUAC and these concentrate in the lower temple. Fifty-two loose soil samples were exported from KUAC including full profiles of each pit where soil blocks were collected.

The open areas of these semi-subterranean structures had been entirely infilled since abandonment. The bulk of the fill was poorly-sorted silty clay containing considerable concentrations of cobbles and gravel. The development of an A-horizon across the AC area indicates that these events were not recent. The composition and structure of the fill is notable because the site is close to the summit of the hill without a particularly steep or large uphill slope area to contribute erosional material. Under seasonal rainfall and wind conditions, a gradual infilling of primarily finer material from upslope could be expected. However, the presence of large stones suggests high energy movements, such as landslides or human agency, contributed to infilling. This would imply considerable erosion of this hillside since its use as a temple in Late Chiripa times. The relatively unconsolidated nature of the natural sequence observed on the hilltop supports natural infilling of the temple complex but human intervention cannot be entirely ruled out.

The external surfaces of the temple complex are generally composed of a red silty-clay. This deposit is very similar to a layer found in the natural profile at the same elevation (Natural 1) and suggests that this red layer may have been selectively exposed around the cut features. Loose soil samples were collected to test this suggestion. Attempts to collect an intact soil block for thin section analysis were unsuccessful due to the rocky, crumbly nature of this deposit.

Both the preservation conditions and the sequence of deposition vary greatly between the excavated pits of the temple complex. Elucidation of the construction sequence may be complicated by changes in activities performed on the site and the possibility of remodeling over the use-life of the temple complex. Soil sampling concentrated on floors to help address these concerns. Superimposed floors were found in N962/E928 and two columns were collected from this pit. The preservation of fine stratigraphy was better on the southern side of the pit as revealed in the profile but some fine layers were excavated as mixed-event loci. In light of the better preservation, a soil column was exported from this trench.

The northern profile of N968/E921 was sampled for thin sections to form a comparison to occupational levels across the site. As the surface overburden was very similar to N962/E928, the upper strata were not sampled and block samples commenced with the first possible floor (Locus 5012). The occupation deposits were sampled at intervals to include the boundaries between archaeological layers where possible. The basal layers have sharply defined stratigraphy and the final soil block included three anthropogenic events and the sterile.

The excavation of the eastern temple wall (N975/E917) had a unique composite wall and several well preserved occupation surfaces. A series of samples were taken along the southern profile at three intervals. Two samples were collected from the wall itself which contained red and yellow earthen walling that appeared to be alternating red and yellow adobe bricks stacked above the stone wall. Before sampling, these deposits appeared to be formed by mudbricks because of the color separation between red and yellow soil. However, excavation of the feature revealed that the boundary between red and yellow soils so apparent on the wall surface did not extend into the wall nor did they separate along the boundary as would be expected of mudbricks. This suggests that the wall may have been made of *tapielera*, which is made by creating a mold for the wall, filling it with soil, in this case apparently in colored bands, and adding just enough water to consolidate the deposit as it dries (Schiffer *et al.* 1987).

A soil block was collected from a yellow, clay-rich deposit at approximately 108 cm below the datum, 73 cm to the temple interior from the wall. The key query of this deposit (Locus 5380) is whether it represents a floor or wash from the earthen walling described above. The sub-floor fill (Locus 5381) was also sampled in this location. An additional column of soil blocks was taken approximately 240 cm from the wall spanning 122-180 cm below the datum. This profile started at the upper boundary of the yellow floor/wash deposit and spanned several occupation deposits before reaching sterile below. A field acid test confirmed that the lower strata, including the sterile, are calcareous. This differs markedly from the basal deposits in all other excavated pits in the AC area and, along with the unusual nature of the wall, brings into question the relationship between this part of the complex to the rest of the temple.

Single soil blocks were also collected from floors in N993/E952.5 (Locus 5345) and N1000/E947 (Locus 5136) to compare floors across the site. In addition, loose soil samples from six other pits were also exported to further the comparisons between occupation levels across the structure.

Ayrampu Qontu Area (AQ)

The stratified midden deposits in the AQ area appeared at first to be ideal for thin section analysis. Soil micromorphology has been used to study midden deposits (e.g. Simpson *et al.* 1999) but requires close stratigraphic control. The AQ deposits, while apparently well-stratified, had very thin and often discontinuous layers so that most excavated loci were composed of multiple events. The resolution of the eighteen bulk soil samples collected from the AQ area is too coarse to control for microstratigraphy.

The highly organic deposits of the AQ area were disturbed by modern agriculture and bioturbation. Roots, earthworms and large tunneling insects locally called *bolos* riddled the excavations. Bolo burrows are 2-4cm wide and may be longer than a meter. The insects leave a hardened case at the ends of their tunnels and appear to move both vertically and laterally. As also observed in earlier excavations at Chiripa (Goodman 1999), this high level of mixing has serious implications for preservation of the archaeological deposits.

Lee Steadman determined that the base of N857/N537 contained mixed Early and Middle Chiripa ceramics. In order to investigate possible causes of this mixing, four block samples were collected from the lower deposits of the eastern wall of this pit. However, the abundant evidence of insects and roots identified during sampling suggests that these deposits were largely homogenized by bioturbation. Thus, the chocolate-brown soil of this locus represents conflated layers and implies a loss of the original stratigraphy. As the field evidence was so conclusive, further analysis of the blocks was considered unnecessary and they were not exported.

In the absence of structural features, it became clear that this site would not further elucidate prehispanic construction techniques and additional soil micromorphology columns were not collected. In light of the aims of the soil studies and the need to limit samples for exportation, KUAQ was considered too disturbed to merit further geoarchaeological analysis at this time and all samples were held in the soil archive in Bolivia.

Ethnoarchaeological Study

A primary concern is to better understand the construction, use and abandonment of mudbrick dwellings. Previous ethnoarchaeological studies of mudbrick structures provide insight into the decay of mudbrick but reveal great variation depending on local climate. Schiffer *et al* (1987) found salt promoted mudbrick decay in the hyper-arid southern Andes whereas water erosion caused most destruction of mud walls in West Africa (Mcintosh 1974, 1977). Published studies do not parallel conditions in the lakeside study region. Soil micromorphology studies using thin sections of earthen construction materials include ritual house floors in India (Boivin 1999) and the ongoing studies of Wendy Matthews and Burcu Tung at Çatalhöyük, which are largely unpublished. These studies provide a general background for investigations in Bolivia but variations in soil and environmental conditions as well as construction techniques are such that a local reference collection is desirable.

A study of contemporary domestic compounds was undertaken during the 2003 field season to gain insight into the lifecycles of earthen structures constructed in the vicinity of archaeological sites. The ethnoarchaeological study will be presented

briefly here (see Goodman Elgar *n.d.*). Key aims of this study are the assessment of adobe structure decomposition and the differentiation of floors from slumped adobe wall material. The sequence of disintegration of intact adobe walls into undifferentiated adobe melt is also crucial to our ability to identify these processes in archaeological deposits. This study will also test the general model that floors and similar interior surfaces are maintained free of debris during use but accumulate trash and other debris once they are abandoned.

Case Study in the Copralabra Pata Area (CP)

An abandoned domestic compound was selected for study based on the identification of a suitable informant, the presence of multiple use-areas, a variety of mudbrick types and evidence of remodeling. A suitable domestic compound was identified for study called Copralabra Pata (CP area) referring to the fact that the site had burned before house construction.

Construction materials used for this compound included: adobes (mudbricks), *tapialera* (large mudbrick blocks), *barro* (mud mortar), wall mud plaster, cobbles, wood (roof beams and some doors), *tortora* and *ichu* grasses (roofing). All materials are available locally and only eucalyptus wood would not have been available locally in ancient times. Food processing, human habitation, animal habitation and storage were spatially differentiated on the site. The compound was enclosed by a *tapialera* wall and contained two kitchens referred to as old and new, an intact room currently used for storage, a large abandoned room as well as chicken, guinea pig and pig/sheep pens.

Methods

Our informant provided information on local demographics, house construction, use of space, abandonment and decay. Interviews were conducted in Spanish over two weeks and approximately 1.5 hrs of video was recorded. The standing features were planned and photographed. Surface vegetation was cleared from all rooms, part of the patio and the slump adjacent the old kitchen before sampling. Loose soil and flotation samples were collected from the primary rooms, patio and outside the compound. Samples included ten liter bulk samples for botanical analysis, 300 g loose soil samples and intact blocks for soil micromorphology as well as phytolith and archive samples for two 1x1m units excavated on the main TAP grid (see below). The two kitchens had multiple hearths and were partly excavated and intensively sampled.

The thin section reference collection taken from KUCP included: intact and melted mudbricks, barro, packed earth flooring, hearths, heat treated flooring and heat treated mudbricks. Flotation samples were collected from the SE storeroom (1), corral (1),

the old kitchen (3), the new kitchen (9), the abandoned house (3), the patio (2), the excavated units (6) and a control from outside the compound (1). Sixteen micromorphology and nineteen loose soil samples were collected from the new house, new kitchen and old kitchen adobes, hearths and wall slump as well as from the excavated leveled new house. Bulk samples were floated on site, using a modified SMAP machine. In addition to the geoarchaeological studies, Kate Moore will study the bones and Maria Bruno will assess the botanicals as part of her doctoral dissertation. Lee Steadman identified modern ceramics in the field.

The processes of bioturbation were abundantly evident in the field. Several distinct insect populations had colonized the compound, each selecting different niches. For example, yellow worms concentrated in rotting roof material, while spiders lived in the cracks between adobes. Excavations of wall slump outside the compound showed intense levels of homogenization with the natural soil suggesting that unless construction materials are highly distinct from the natural soil, they will quickly blend into it. In contrast, buried and melted adobes within structures enjoyed a greater degree of preservation. However, the high levels of bioturbation by roots and soil fauna do indicate that earthen structures are vulnerable to rapid weathering under the conditions of the Taraco Peninsula.

Summary

Field observations indicated considerable bioturbation, especially by large soil fauna, at all sites in the Kala Uyuni area of the Taraco Peninsula. These observations informed the sampling strategy which concentrated on sequences of relatively undisturbed occupation deposits. The ethnoarchaeological soil study is the first collected in South America and will greatly improve the reliability of interpretations made from archaeological samples.

Preliminary analyses of the thin sections recovered from archaeological contexts indicate that the association of natural and archaeological materials will not be straightforward. The natural deposits, although indistinguishable in the field from KUKU surfaces, appear under the microscope to contain significantly less clay than the archaeological materials. One well preserved floor at KUKU shows finely laminated layers of clay. It would be tempting to suggest that these represent floor plastering events as was documented by Boivin (1999) for floors in India. However, the laminations are discontinuous with sections that are not horizontal. Further analysis is necessary to determine if these laminations are actually *in situ* to the archaeological site or if they derive from the parent geological deposit where the yellow soils were collected. The relationship between the naturals used in this study and archaeological deposits may be further complicated by surface weathering of the exposed natural surfaces used as natural controls. Testing this would require

industrialized auguring through the deposits, which may be beyond the budget of the current National Science Foundation grant.

Analysis of the ethnoarchaeological soil collections are the primary focus of current investigations and the results will be presented at the Society for American Archaeology Annual Meeting April 3rd, 2004 in Montreal. Further analyses of thin sections and bulk samples from archaeological contexts will be completed before the start of the 2004 summer field season in June.

11.Acknowledgements

The TAP project would like to thank Eduardo Pareja, Cesar Calisaya, and Javier Escalante of the Archaeological Program of the Ministry of Culture of Bolivia who helped with the permits and generally made us feel welcome to complete this research. The community of Coa Khollo was helpful and gracious to let us into their lives and agricultural fields. Katherine Moore gratefully acknowledges the assistance of Jose Capriles E., Christine Bare, and Fredrik Hiebert in processing faunal materials for research. Melissa Goodman Elgar notes that the Taraco Archaeological Project excavation team collected the bulk samples and helped select areas for thin section sampling including Matthew Bandy, Maria Bruno, Amanda Cohen, Jose Luis Paz and Andrew Roddick. Kate Moore assisted with the ethnoarchaeological fieldwork and Maria Bruno provided useful input on the project design. William Whitehead, Richard Elgar, and Kirk Drye assisted with videotaping, photography and mapping of the site. Thanks also to the members of the Coa Kkollu community who worked on the excavations, including Pacifico Choquetarqui, Facundo Cruz, Andres Apaza, Juan Condori, Placido Apaza, and Primitivo Nina. We would also like to thank Elsa Choque, Alicia Limachi, Franz Choque, and Facundo Llusco.

12. Bibliography

Albarracin-Jordan, Juan

1996 *Arqueología regional y dinámica segmentaria*. Editores Plural. La Paz.

Albarracin-Jordan, Juan, Carlos Lémuz, and José Luis Paz

1999 Investigaciones en Kallamarka: Primer informe de prospección. *Textos Antropológicos* 6:11-123. La Paz.

Albarracin-Jordan, Juan and James E. Mathews

1990 *Asentamientos prehispánicos del Valle de Tiwanaku*, Vol. 1. La Paz: Producciones CIMA.

Bandy, Matthew S.

1999 The Montículo Excavations. In *Early Settlement at Chiripa Bolivia*. Christine Hastorf, ed. Pp. 43-50. Contributions of the University of California Archaeological Research Facility, 57. Berkeley: Archaeological Research Facility.

2001 Population and History in the Ancient Titicaca Basin. Ph.D. dissertation, Department of Anthropology, University of California Berkeley. Electronic document, <http://andean.kulture.org/bandy/bandy-dissertation.pdf>.

2004 Fissioning, Scalar Stress, and Social Evolution in Early Village Societies. *American Anthropologist* 106(2): 322-333.

Berenguer, José and Percy Dauelsberg

1989 El norte grande en la orbita de Tiwanaku. En: *Culturas de Chile – Prehistoria: Desde sus Orígenes Hasta los Albores de la Conquista*: 129-180. Andrés Bello. Santiago de Chile.

Bermann, Marc

1990 Prehispanic household and empire at Lukurmata, Bolivia. Ph.D. Thesis, Department of Anthropology, University of Michigan.

1994 *Lukurmata: Household Archaeology in Prehispanic Bolivia*. Princeton, Princeton University Press.

Boivin, N.

- 2001 'Archaeological Science as Anthropology': Space, Time and Materiality in Rural India and the Ancient Past. Ph.D. thesis, Department of Archaeology, University of Cambridge.
- Browman, David L.
- 1978 The Temple of Chiripa (Lake Titicaca, Bolivia). In Matos Mendieta, R., editor, *El Hombre y La Cultura Andina, III Congreso Peruano*, pages 807-813. Editora Lasontay, Lima.
- 1980 Tiwanaku Expansion and Altiplano Economic Patterns. *Estudios Arqueológicos*, 5:107-120.
- 1981 New Light on Andean Tiwanaku. *American Scientist*, 69(4):408-419.
- 1984 Tiwanaku: development of interzonal trade and economic expansion in the altiplano. In *Social and economic organization in the prehispanic Andes*: 117-142. International Series 194. BAR: Oxford.
- 1997 Political institutional factors contributing to the integration of the Tiwanaku State. In *Emergence and Change in Early Urban Societies*: 229-243: Plenum. New York.
- Bruno, Maria and William Whitehead
- 2003 Chenopodium cultivation and Formative period agriculture at Chiripa, Bolivia. *Latin American Antiquity* 14(3):339-355.
- Burkholder, Joellen.
- 1997 Tiwanaku and the Anatomy of Time: A New Ceramic Chronology from the Iwawi Site, Department of La Paz. Ph.D. Thesis. Department of Anthropology, SUNY Binghamton.
- Chávez, Karen L. Mohr
- 1980 The Archaeology of Marcavalle, an Early Horizon site in the Valley of Cuzco, Peru. Part I. *Baessler-Archiv*, neue Folge, Vol. XXVIII, pp. 203-329. Berlin.
- 1981 The Archaeology of Marcavalle, an Early Horizon site in the Valley of Cuzco, Peru. Parts II and III. *Baessler-Archiv*, neue Folge, Vol. XXIX, pp.107-205, 241-386. Berlin.
- 1988 The significance of Chiripa in Lake Titicaca Basin developments. *Expedition* 30(3):17-26.

Chávez, Sergio J.

1975 The Arapa and Thunderbolt stelae: A case study of stylistic identity with implications for Pucara influence in the Area of Tiwanaku. *Nawpa Pacha* 13: 3-26.

1992 The Conventionalized Rules in Pucara Pottery Technology and Iconography: Implications for Socio-Political Developments in the Northern Lake Titicaca Basin. Ph.D. thesis, Department of Anthropology, Michigan State University, Lansing.

Cohen, Amanda B.

2003 Domestic and Ritual Architecture in the Pukara Valley Formative Period. Paper presented at the 68th annual meeting of the Society for American Archaeology Milwaukee, WI.

Fried, Morton

1967 *The Evolution of Political Society*. Random House, New York.

Goldstein, Paul S.

2000 Communities without borders: the vertical archipelago and diaspora communities in the southern Andes". In M. Canuto and J. Yaeger, eds., *The Archaeology of Communities. A New World Perspective*: 182-209. Routledge, London.

Goodman Elgar, Melissa A.

1999 Micromorphology of Depositional Sequences from Monticulo and Santiago Excavations. In Christine Hastorf (ed.), *Early Settlement in Chiripa, Bolivia: Research of the Taraco Archaeological Project* Berkeley, CA: Archaeological Research Facility Monograph Publications, UC, Berkeley, No 57.

2003 Ethnoarchaeological investigations of abandoned contemporary adobe mudbrick dwellings near Lake Titicaca, Bolivia. Unpublished manuscript in the author's possession.

Hastorf, Christine A.

2003 Community with the ancestors: ceremonies and social memory in the Middle Formative at Chiripa, Bolivia. *Journal of Anthropological Archaeology* 22:305-332.

Hastorf, Christine A., ed.

1999 *Early Settlement at Chiripa Bolivia*. Contributions of the University Of California Archaeological Research Facility 57. Archaeological Research

Facility, Berkeley.

Hastorf, Christine, Matthew Bandy, Rene Ayon, Emily Dean, Miriam Doutriaux, Kirk Frye, Rachel Goddard, Don Johnson, Katherine Moore, José Luis Paz, Daniel Puertas, Lee Steadman, and William Whitehead
1998 *Taraco Archaeological Project: 1998 Excavations at Chiripa, Bolivia*. Report submitted to the Dirección Nacional de Antropología y Arqueología, La Paz.

Hastorf, Christine, Matthew Bandy, Rene Ayon, Robin Beck, Miriam Doutriaux, José Luis Paz, Lee Steadman, and William Whitehead
1999 *Proyecto Arqueológico Taraco: 1999 Excavaciones en Chiripa, Bolivia*. Report submitted to the Dirección Nacional de Antropología y Arqueología, La Paz.

Isbell, William; Joellen Burkholder, and Juan Albarracín-Jordan
2002 Iwawi y Tiwanaku. *Gaceta Arqueológica Andina* 26: 139-170. Instituto Andino de Estudios Arqueológicos. Lima.

Janusek, John W.

1994 *State and Local Power in a Prehispanic Andean Polity: Changing Patterns of Urban Residence in Tiwanaku and Lukurmata*. Ph.D. Thesis, Department of Anthropology, University of Chicago, Chicago.

2001 Asentamiento rural y campos elevados de cultivo en el valle del Río Katari durante el Período Formativo Tardío. *Textos Antropológicos*, 13(1-2): 111-133. Universidad Mayor de San Andrés. La Paz.

2003 *Vessels, Time, and Society: Toward a Chronology of Ceramic Style in the Tiwanaku Heartland*. In Kolata, A., editor, *Tiwanaku and its Hinterland: Archaeological and Paleoecological Investigations of an Andean Civilization*, pp. 30-94 Smithsonian Institution Press, Washington D.C.

Janusek, John W. and Kolata, Alan

2001 *Prehispanic Rural History in the Rio Katari Valley*. In Kolata, A., editor, *Tiwanaku and its Hinterland: Archaeological and Paleoecological Investigations of an Andean Civilization*, pp. 129-174. Smithsonian Institution Press, Washington D.C.

Kent, Jonathan

1982 *The Domestication and Exploitation of the South American Camelids: Methods of Analysis and their Application to Circumlacustrine Archaeological Sites in Bolivia and Peru* PhD dissertation: Washington

University. Ann Arbor: University Microfilms.

Kidder III, Alfred

1943 *Some Early Sites in the Northern Lake Titicaca Basin*. volume 27 (1) of *American Archaeology and Ethnology*, Cambridge. Peabody Museum, Harvard University.

1956 Digging in the Lake Titicaca Basin. *University Museum Bulletin*, 20(3):16-29.

Kolata, Alan

1982 Tiwanaku: Portrait of an Andean Civilization. *Field Museum of Natural History Bulletin*, 53(8):15-24.

1993 *The Tiwanaku*. Blackwell, Cambridge.

Lémuz Aguirre, Carlos

2001 Patrones de Asentamiento Arqueológico en la Península de Santiago de Huata, Bolivia. Licenciatura thesis, Department of Social Sciences, Archaeology Division, Universidad Mayor de San Andrés, La Paz.

McIntosh, R.J.

1974 Archaeology and mud wall decay in a West African Village. *World Archaeology* **6**: 154-71.

1977 The excavation of mud structures: an experiment from West Africa. *World Archaeology* **9**: 185-199.

Miller, G. R.

1979 An Introduction to the Ethnoarchaeology of the Andean Camelids. Ph.D. Thesis, University of California, Berkeley. University Microfilms, Ann Arbor.

Miller, George R, and Ann L Gill

1990 Zooarchaeology at Pirincay, a Formative period site in highland Ecuador. *Journal of Field Archaeology*. 17:49-68

Moore, Katherine M.

1989 Hunting and the Origins of Herding in Highland Peru. Ph.D. Dissertation, University of Michigan Department of Anthropology.

1999 Chiripa Worked Bone and Bone Tools. In *Early Settlement at Chiripa, Bolivia: Research of the Taraco Archaeological Project*. Contributions of the

University of California Archaeological Research Facility, Berkeley, No. 57:73-94

Moore, Katherine M., S. deFrance, D. Steadman.

1999 Herds, Fish, and Fowl in the Domestic and Ritual Economy of Formative Chiripa. In *Early Settlement at Chiripa, Bolivia: Research of the Taraco Archaeological Project*. Contributions of the University of California Archaeological Research Facility, Berkeley, No. 57: 105-116.

Paice, Patricia

1991 Extensions to the Harris Matriz system to illustrate stratigraphic discussion of an archaeological site. *Journal of field archaeology* 18(1): 17-28.

Paz Soría, José Luis

1999 Excavations in the Llusco Area. In *Early Settlement at Chiripa, Bolivia: Research of the Taraco Archaeological Project*. Contributions of the University of California Archaeological Research Facility, Berkeley, No. 57: 31-36.

Ponce Sanginés, Carlos

1970 *Las Culturas Wankarani y Chiripa y su Relación con Tiwanaku*. Academia Nacional de Ciencias de Bolivia, La Paz. Publicación no. 25.

1971 *La cerámica de la época I de Tiwanaku*. Academia Nacional de Ciencias de Bolivia, Publicación no. 28. La Paz.

1981 *Tiwanaku: Espacio, Tiempo y Cultura. Ensayo de Síntesis Arqueológica*. Editorial Los Amigos del Libro, La Paz.

1993 La cerámica de la época I (aldeana) de Tiwanaku. *Pumapunku*, Año 2, no. 4, pp.48-89. Centro de Investigaciones Antropológicas Tiwanaku, La Paz.

Portugal Ortíz, Max

1992 Aspectos de la Cultura Chiripa. *Textos Antropológicos* 3:9-26.

1993 Trabajos arqueológicos de Tiwanaku. *Textos Antropológicos* 4: 9-50. Universidad Mayor de San Andrés. La Paz.

Rowe, John H.

1959 Archaeological dating and cultural process. *Southwestern Journal of Anthropology* 15(4):317-324.

- Schiffer, Michael B.
 1996 *Formation Processes of the Archaeological Record*. University of Utah Press, Salt Lake City.
- Schiffer, M.B., A.M. Barón, P.P. Cortés, and J. T. Sepulveda.
 1987 Deterioration of adobe structures: A case study from San Pedro de Atacama, Northern Chile. In D.T. Nash and M.D. Petralgia (eds), *Natural Formation Processes and the Archaeological Record*, 10-29. Oxford: BAR International Series 352.
- Shepard, Anna O.
 1956 *Ceramics for the Archaeologist*. Carnegie Institution of Washington, Publications 609. Washington, D.C.
- Simpson, I., Milek, K. and Guðmundsson, G.
 1999 A reinterpretation of the Great Pit at Hofstaðir, Iceland, using sediment thin section micromorphology. *Geoarchaeology* 14(6): 511-530.
- Stanish, Charles.
 2003 *Ancient Titicaca: The Evolution of Complex Society in Southern Peru and Northern Bolivia*. University of California Press, Berkeley.
- Stanish, C., de la Vega, E., Steadman, L., Chávez Justo, C., Frye, K., Onofre Mamani, L., Seddon, M., and Calisaya Chuquimia, P.
 1997 *Archaeological Survey in the Juli-Desaguadero Region of Lake Titicaca Basin, Southern Peru*. Fieldiana Anthropology. Field Museum of Natural History, Chicago.
- Steadman, Lee H.
 1995 Excavations at Camata; An Early Ceramic Chronology for the Western Titicaca Basin, Peru. Ph.D. Thesis, Department of Anthropology, University of California, Berkeley.
- 1998 Ceramics. In *Taraco Archaeological Project: 1998 Excavations at Chiripa, Bolivia*, by Christine Hastorf; Bandy, Matthew; Ayon, Rene; Dean, Emily; Doutriaux, Miriam; Frye, Kirk; Goddard, Rachel; Johnson, Don; Moore, Kate; Paz, José Luis; Puertas, Daniel; Steadman, Lee and Whitehead, William Report submitted to the Directorate of the Instituto Nacional de Antropología y Arqueología, La Paz.
- 1999a La Cerámica. In *Proyecto Arqueológico Taraco: 1999 Excavaciones en Chiripa, Bolivia*, by Christine Hastorf; Bandy, Matthew; Ayon, Rene; Beck,

Robin; Doutriaux, Miriam; Paz, José Luis; Steadman, Lee; Whitehead, William. Report submitted to the Dirección Nacional de Arqueología y Antropología de Bolivia, La Paz.

- 1999b The Ceramics. In *Early Settlement at Chiripa, Bolivia: Research of the Taraco Archaeological Project*, ed. by Christine A. Hastorf, pp. 61-72.. *Contributions of the University of California Archaeological Research Facility, No. 57*. Berkeley.
- 2001 Cerámica. In *El Período Formativo en Chiripa, Bolivia*, by Christine Hastorf, Matthew Bandy, William T. Whitehead and Lee Steadman. *Textos Antropológicos* Vol.13, nos.1-2, pp. 17-91. Universidad Mayor de San Andrés, La Paz.
- 2002 The Yaya-Mama Religious Tradition at Chiripa. Symposium paper presented at the 67th Annual Meeting of the Society for American Archaeology, Denver.

Stein, Julie K.

- 1992 Organic matter in archaeological contexts. In Vance T. Holliday, ed., *Soils in Archaeology: Landscape Evolution and Human Occupation*, pp. 193-216. Smithsonian Institution Press, Washington D.C.

Steward, Julian

- 1955 *Theory of Culture Change*. Urbana: University of Illinois Press.

Vepraskas, M.J. (ed.).

- 2003 *Guidelines for Analysis and Description of Soil and Regolith Thin Sections*. Madison, WI: SSSA.

Waters, Michael R.

- 1992 *Principles of Geoarchaeology: An American Perspective*. University of Arizona, Tucson.

Webster, Ann

- 1993 The Role of the Camelid in the Development of the Tiwanku State. Ph.D. Thesis, University of Chicago. University Microfilms, Ann Arbor.