

UC Davis

UC Davis Previously Published Works

Title

Hydraulic hazard exposure of humans swept away in a whitewater river

Permalink

<https://escholarship.org/uc/item/8cx5r659>

Authors

Strom, Michael A
Pasternack, Gregory B
Burman, Scott G
[et al.](#)

Publication Date

2017-04-19

DOI

10.1007/s11069-017-2875-6

Data Availability

The data associated with this publication are available upon request.

Peer reviewed

1 Hydraulic hazard exposure of humans swept away in a whitewater river

2

3 Michael A Strom^{1*}, Gregory B Pasternack¹, Scott G Burman¹, Helen E Dahlke¹, Samuel
4 Sandoval-Solis¹

5

6 *Corresponding author

7 E-mail address: mastrom@ucdavis.edu

8

9 ¹Department of Land, Air and Water Resources, University of California, Davis, One
10 Shields Avenue, Davis, CA, USA 95616

11

12

13 Cite as: Strom, M. A., Pasternack, G. B., Burman, S. G., Dahlke, H. E., Sandoval-Solis,
14 S. 2017. Hydraulic hazard exposure of humans swept away in a whitewater river.

15 Natural Hazards. doi:10.1007/s11069-017-2875-6

16

17 The final publication is available at Springer via [http://dx.doi.org/10.1007/s11069-017-](http://dx.doi.org/10.1007/s11069-017-2875-6)
18 [2875-6](http://dx.doi.org/10.1007/s11069-017-2875-6)

19

20 **Abstract**

21 Despite many deaths annually worldwide due to floods, no strategy exists to
22 mechanistically map hydraulic hazards people face when entrained in a river. Previous
23 work determined water depth–velocity product thresholds for human instability from
24 standing or walking positions. Because whitewater rivers attract diverse recreation that
25 risks entraining people into hazardous flow, this study takes the next step by predicting
26 the hazard pattern facing people swept away. The study site was the 12.2-km bedrock–
27 alluvial upper South Yuba River in the Sierra Nevada Mountains. A novel algorithm was
28 developed and applied to two-dimensional hydrodynamic model outputs to delineate
29 three hydraulic hazard categories associated with conditions for which people may
30 be unable to save themselves: emergent unsavable and steep emergent surfaces,
31 submerged unsavable surfaces, and hydraulic jumps. Model results were used to
32 quantify exposure of both an upright and supine entrained person to collision and body
33 entrapment hazards. Hazard exposure was expressed with two metrics: passage
34 proximity (how closely a body approached a hazard) and reaction time (time available to
35 respond to and avoid a hazard). Hazard exposure maps were produced for multiple
36 discharges, and the areal distributions of exposure were synthesized for the river
37 segment. Analyses revealed that the maximum hazard exposure occurred at an
38 intermediate discharge. Additionally, longitudinal profiles of the results indicated both
39 discharge-dependent and discharge-independent hazards. Relative to the upright body,
40 the supine body was overall exposed to less dangerous channel regions in passage
41 down the river, but experienced more abrupt encounters with the danger that did occur.

42 **Keywords:** Hydraulic hazards; River rapids; Floods; Hydraulic jumps; Whitewater

43 1. Introduction

44 Worldwide, more than 175,000 people were killed by freshwater floods from 1975
45 to 2001 (Jonkman 2005), and a review of river flood events found that the majority of
46 fatalities stemmed from drowning or physical trauma (Jonkman and Kelman 2005).
47 Current strategies for flow-related, or hydraulic, hazard assessments involve identifying
48 depth–velocity product thresholds above which humans lose stability from either a
49 standing or walking position. Theoretical studies have characterized friction (sliding) and
50 moment (toppling) instability mechanisms (Keller and Mitsch 1993; Lind et al. 2004;
51 Jonkman and Penning-Rowsell 2008; Xia et al. 2014), and experimental studies have
52 been used to evaluate the predicted thresholds for the occurrence of these mechanisms
53 (Foster and Cox 1973; Abt et al. 1989; Takahashi et al. 1992; Karvonen et al. 2000;
54 Jonkman and Penning-Rowsell 2008; Cox et al. 2010; Russo et al. 2013; Xia et al.
55 2014). Factors influencing the onset of human instability in a flow include body weight,
56 height, clothing, ground surface composition, slope, entrained debris, flow turbulence,
57 fluid density, psychology, experience, and other variables (Karvonen et al. 2000;
58 Chanson et al. 2014; Milanesi et al. 2015).

59 Relative to investigating the conditions for instability, simulating the fate of people
60 following the loss of stability has received little attention. McCarroll et al. (2015)
61 modeled the transport of bathers in a rip current as a series of particles in a flow field
62 and simulated multiple escape strategies to evaluate their success. The present study
63 also sought to predict the fate of people carried away in a flow, but in a whitewater river
64 that hosts multiple forms of recreation. The hydraulic hazard exposure of people swept
65 down a river was described, defined herein as the potential for entrained bodies to

66 encounter hazards and incur harm in the form of drowning or physical trauma. To be
67 conservative, it was assumed that any hazard exposure could produce harm and
68 therefore needed to be documented.

69 *1.1. Whitewater river hydraulic hazards*

70 Whitewater rivers contain a variety of elements that create channel complexity
71 and rapids that can be hazardous to people. Boulders transported into a channel by
72 tributaries and landsliding from cliff faces have been found to produce rapids (Dolan et
73 al. 1978; Graf 1979; Webb et al. 1988). Debris flow fan deposits at the mouths of
74 tributaries can be reworked by main channel flows to create downstream rock gardens
75 and additional rapids (Kieffer 1985; Webb et al. 1989). These rock features impose
76 lateral and vertical flow constrictions that generate several wave types, including abrupt
77 transitions from supercritical to subcritical flow in the form of hydraulic jumps (Leopold
78 1969; Kieffer 1985). The diverse morphologies and arrangements of rock elements and
79 their control on flow served as the basis for the classification of different channel units in
80 bedrock rivers (Grant et al. 1990). The flow features associated with whitewater rivers
81 also spurred the development of the International Scale of River Difficulty in the 1950s
82 by the association American Whitewater in an effort to classify and convey the
83 challenges of traversing rapids. The rating system was revised in 1998 to focus less on
84 describing individual hazards and more on expressing the intangible measure of overall
85 rapid difficulty (Belknap 1998). Consequently, by its design, the system offers no more
86 than qualitative characterizations of each of the six difficulty ratings at the scale of
87 individual rapids.

88 As an example of a hazardous whitewater river setting, the Mather Gorge and its
89 Great Falls on the Potomac River upstream of Washington, D.C. are notorious for
90 deaths due to deceptive waters and close proximity to a large urban center from which
91 people with varying hazard awareness travel for recreation. The Washington Post
92 published a visually interactive overview of hydraulic hazards present in this canyon
93 where 27 people died 2001–2013 (The perils at Great Falls, The Washington Post,
94 2013) and 51% of river accidents here are fatal, with 72% of these incidents originating
95 from shoreline-based activities that are not related to boating (Potomac River Gorge
96 Safety Press Conference, National Park Service, 2013). After getting swept from shore
97 or falling out of a craft, collisions and/or entrapment with emergent or submerged rocks
98 can cause physical trauma and/or drowning, and entrapment inside hydraulic jumps
99 exhibiting strong multiphase flow recirculation can hold a body underwater until death.

100 Although this study focuses on whitewater rivers, similar hydraulic hazards occur
101 during urban flooding, including during storm surges and tsunamis. Instead of
102 hazardous interactions with boulders and bedrock, collisions with and entrapment by
103 features of the urban landscape can cause physical trauma and drowning (Jonkman
104 2005). Both whitewater rivers and urban floods can also contain floating debris that
105 present an additional hazard, and Penning-Rowsell et al. (2005) introduced a flood
106 hazard equation that uses a debris factor to account for this. Thus, the new methods
107 presented in this study have broader significance to understanding natural flood
108 hazards.

109 1.2. *Meter-scale river maps and models*

110 Characterizing the exposure of humans to hydraulic hazards required a digital
111 terrain model of the topo-bathymetric surface and a hydrodynamic model with a
112 resolution commensurate with the human scale. To determine the local occurrence of
113 hydraulic hazards and then aggregate the results to coarser scales, data collection and
114 mechanistic modeling methods that resolve meter-scale variations were required.
115 Meter-scale data are increasingly available for free (e.g.,
116 <http://www.opentopography.org>) or can be collected at a rapidly decreasing cost with
117 increasing detail. Key technologies include airborne LiDAR mapping of the terrestrial
118 river corridor (Lane and Chandler 2003; Hilldale and Raff 2008), airborne bathymetric
119 LiDAR mapping of shallow, clear water (McKean et al. 2008), and boat-based
120 echosounding of the subaqueous riverbed (Vilming 1998; Muste et al. 2012). To
121 characterize spatially distributed, meter-scale river hydraulics over tens of kilometers at
122 many discharges, two-dimensional (2D) depth-averaged hydrodynamic modeling was
123 used.

124 1.3. *Study objectives*

125 For a segment of the upper South Yuba River (SYR) in Northern California, the
126 objectives of this study were to (1) conceptualize different hydraulic hazards and
127 delineate their locations for multiple discharges, (2) design hydraulics-based metrics to
128 quantify and map the exposure of an entrained human body in the upright and supine
129 positions to these hazards, and (3) determine trends in the hazards as a function of
130 discharge and longitudinal position in the river. This study introduces a systematic,

131 objective, and detailed approach to quantifying and mapping hydraulic hazard exposure
132 within the process-based research paradigm.

133 **2. Study area**

134 The 12.2-km SYR study segment was located on the west side of the Sierra
135 Nevada Mountains beginning at the coordinates {39°20'48.34"N, 120°41' 37.55"W} and
136 terminating at the town of Washington, California, at the coordinates {39°21'28.55"N,
137 120°48'11.54"W} (Fig. 1). A thorough description of the study segment is available in
138 Pasternack and Senter (2011), so only the essential details are provided here for
139 brevity. This region is characterized by a Mediterranean climate with an average annual
140 precipitation of 173.9 cm (Western Regional Climate Center) for 1914–2003 at Lake
141 Spaulding, 8 km upstream of the upper extent of the study segment. The drainage area
142 above Washington, CA, is 512.8 km² with 310.8 km² captured by Spaulding Dam.
143 Regulated releases and unregulated spills occur at the dam. The average daily flow for
144 1965–2014 measured just downstream at Langs Crossing (USGS gage 11414250) was
145 3.03 m³/s, while the average daily flow at Washington (USGS gage 11417000) for
146 1942–1972 was 8.44 m³/s. Inadequate historical flow records prior to flow regulation,
147 periodic, complex changes to flow regulation, interdecadal trends in the hydrologic
148 regime due to forest cover changes, and cumulative, unabated geomorphic impacts
149 from multiple, severe anthropogenic activities, such as hydraulic mining of hillsides,
150 preclude reasonable determination of bankfull discharge. Four tributaries drain into the
151 study segment and two more do so above the study segment but below the dam. The
152 maximum elevation in the watershed is 2552 m above mean sea level, and the channel
153 bed elevation within the study segment ranges from ~780 to 1015 m. Bed material

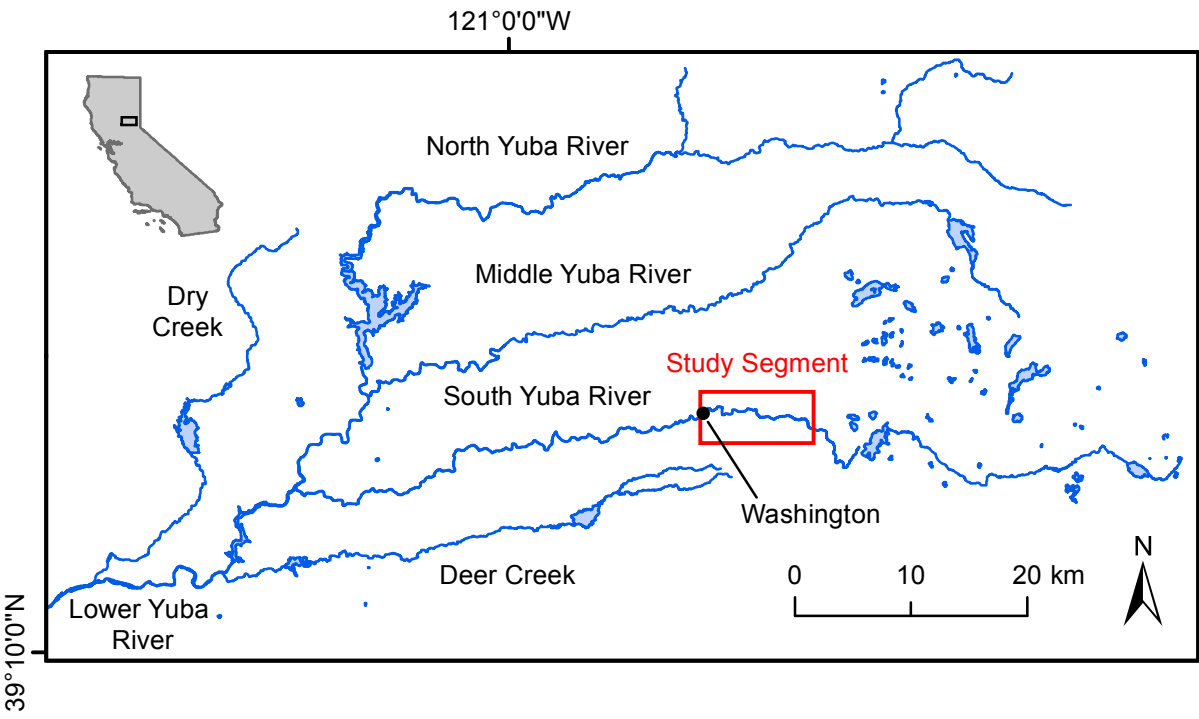

154 spans sand to large boulders, and extensive bedrock outcrops are associated with
155 canyons and pools. Hydraulic mining was performed at multiple sites within the study
156 segment and has contributed sediment to the channel (Pasternack and Senter 2011).

157 **3. Methods**

158 This article presents an approach to evaluate hydraulic hazards (Sects. 3.2 – 3.4)
159 and then applies it to a case study to find new insights about whitewater rivers. A high-
160 resolution DEM and 2D hydrodynamic model were used in this study, but those
161 elements and data underpinning them are not the focus herein. Increasingly, the
162 frontiers of river science are being built upon such models (e.g., Hauer et al. 2009;
163 Wyrick and Pasternack 2014; Gonzalez and Pasternack 2015; Strom et al. 2016), with
164 the aim of journal articles to present the novel developments. The underpinnings and
165 validation of the data and model are important background and thus explained in Online
166 Resource 1 to keep the article's focus on new science.

167 *3.1. Meter-scale data and hydrodynamic model*

168 Field data were used to characterize geomorphic, hydrologic, and hydraulic
169 attributes of the remote and hazardous SYR at ~1-5 m resolution, including 2D
170 hydrodynamic modeling. An airborne LiDAR survey mapped 34,113 large, emergent
171 boulders within the wetted area at the heavily regulated low base flow—an important and
172 unique aspect of this study in order to address hydraulic hazards (Pasternack and
173 Senter 2011).

174 A previously peer-reviewed, meter-scale 2D hydrodynamic model of the SYR
175 was used in this study. Three-dimensional (3D) hydrodynamic models are available, but

176 have high computational demands for the >10 km range and 1-m resolution needed.
177 The new science and methods in this study do not depend on whether the model is 2D
178 or 3D, just that the outputs are meter-scale to resolve hydraulic hazards. Scientific
179 exploration with 3D models is ongoing and can be expected to eventually surpass the
180 current use of 2D models. The use of a morphodynamic model was also not considered,
181 because this study only investigated a range of flows for which large boulders would not
182 be in transport (Pasternack and Senter 2011). This decision was made because most
183 recreational risk and mortality occur at flows when coarse sediment is not in motion.
184 Non-recreational mortality often does occur during extreme floods that are channel-
185 changing events, and this study does not address such geomorphic dynamism. The
186 Sedimentation and River Hydraulics Two-dimensional Model (Lai 2008) solved the
187 depth-averaged St. Venant equations using the finite-volume method to simulate both
188 subcritical and supercritical flows, which was key to predicting the occurrence of
189 hydraulic jump hazards. Model validation is detailed in Online Resource 1. Validation
190 results were within accepted standards (e.g., Gard 2003; Pasternack et al. 2006b;
191 Reinfelds et al. 2010).

192 The assumption of 2D flow is strictly violated through waterfalls and inside
193 hydraulic jumps, but these are a small fraction of the model domain. Additionally, our
194 field experience with evaluating model performance for point velocity in waterfalls of the
195 SYR revealed that the problem primarily affects the positioning of the peak velocity in a
196 vertical drop and not the presence and position of the hydraulic jump, which were more
197 critical for this study. Support for this viewpoint and application exists in the literature
198 where 2D models have been used to investigate settings with complex 3D flows, such

199 as dam-break-induced floods (Peng 2012), spillway flow (Ying and Wang 2012), and
200 other boulder-bed streams (Harrison and Keller 2007). Therefore, 2D modeling was
201 appropriate to use for this purpose of mapping hydraulic jumps.

202 Model results used in this study were for snowmelt-driven flows of 15, 31, 85,
203 and 196 m³/s, which correspond to the 70th, 82nd, 89th, and 92nd percentile values,
204 respectively, for the daily mean discharge series at the Langs Crossing gage. These
205 discharges are also higher than the daily mean flow reported for the Washington gage
206 at the downstream end of the segment, and they span the approximate discharge range
207 across which kayakers and rafters have been reported to run the river (Jolly Boys and
208 Golden Quartz runs of the South Yuba River, A Wet State,
209 <http://www.awetstate.com/1Alph.html#CA>).

210 3.2. *Human body abstraction*

211 A human body can assume multiple positions in a flow, which changes the
212 exposure to surrounding hazards. Floating with feet pointed downstream in the supine
213 position is a commonly reported strategy for safe passage known as defensive
214 swimming (Whitewater skill: How to swim, Rapid Media,
215 [https://www.rapidmedia.com/rapid/categories/skills/1288-whitewater-skill-how-to-](https://www.rapidmedia.com/rapid/categories/skills/1288-whitewater-skill-how-to-swim.html)
216 [swim.html](https://www.rapidmedia.com/rapid/categories/skills/1288-whitewater-skill-how-to-swim.html)), while floating with legs extended downward into the water column may be
217 used by someone who does not have this training or is otherwise unable to maintain the
218 supine position. While there are positions that are intermediate between these two, the
219 supine and upright positions correspond to the end members of exposure to hazards
220 beneath the water surface assuming that the head remains unsubmerged. The supine
221 position maximizes the distance between the body and a submerged hazard while the

222 upright position minimizes this distance. To represent both positions, two safety zones
223 were defined as the cylinders formed when a 1.8 m tall body was rotated about its
224 centroid in the upright (Fig. 2a) and supine (Fig. 2b) positions, giving cylinder radii of 0.9
225 m (Table 1). A cylinder height of 1.5 m was used for the upright body safety zone as it
226 was assumed that a person moving with legs fully extended downward was able to
227 maintain their head above the water. A height of 0.75 m was used for the supine body
228 safety zone. By tracking the location of the safety zone perimeter in relation to hazards,
229 a variety of different upright and supine body positions were accounted for.

230 3.3. *Delineation of hydraulic hazards*

231 To identify hydraulic hazards, hazard types were first defined and then algorithms
232 were developed to map their locations for each of the four discharges investigated. A
233 2D modeling approach was determined to be suitable for addressing two risks
234 associated with people in a river. First, people can collide with emergent and
235 submerged rocks that cause physical trauma. Second, people can get trapped below
236 the water surface by submerged rocks or hydraulic jumps, leading to drowning. There
237 was value in distinguishing between emergent and submerged rocks, because this
238 attribute affects one's ability to see the hazard and avoid it. Also, each one poses a
239 different kind of hazard. Emergent rocks primarily cause blunt force trauma and also
240 pose a risk of partial pinning or wrapping. Submerged rocks may also cause those, but
241 they are especially dangerous due to their potential to cause drowning due to foot
242 entrapment and pinning beneath the water surface by the flow. In conceptualizing the
243 hazards associated with rock elements, there existed significant uncertainty concerning
244 what sizes and spatial arrangements of rocks were most prone to causing physical

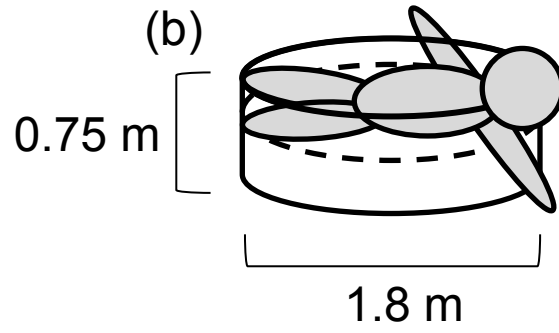
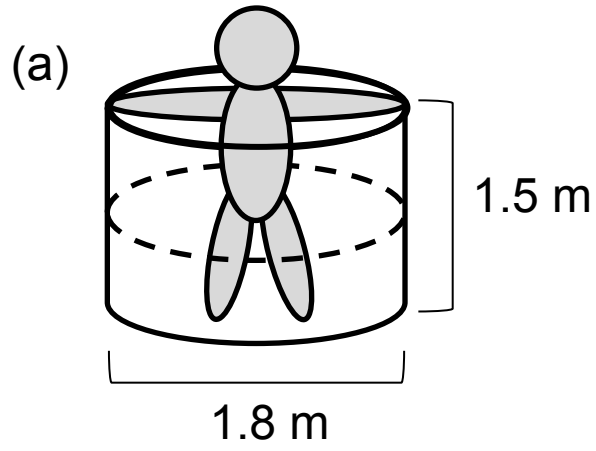

Table 1 Model parameters with values used for this study

Parameter	Value used	
	Upright	Supine
Threshold orientation angle for node in jump (°)	150	
Intermediate passage proximity (m)	0.9	
Max passage proximity (m)	1.8	
Intermediate reaction time (s)	5	
Max reaction time (s)	10	
	Body position	
	Upright	Supine
Safety zone radius (m)	0.9	0.9
Safety zone height (m)	1.5	0.75
Freely floating savability threshold (m^2/s)	0.3	0.3
Foot-entrapped savability threshold (m^2/s)	0.3	0.3
Distance required for a freely floating person to save themselves (m)	0	0
Max depth to assess freely floating savability (m)	1.5	0.75
Max depth to assess foot-entrapped savability (m)	1.5	0.75
Min depth to assess freely floating savability (m)	0	0
Min depth to assess foot-entrapped savability (m)	0	0

245 trauma or body entrapment. Assuming that substrate of any size and configuration had
246 the potential to cause harm under certain flow conditions, the literature on human
247 stability in a flow provided some basis for determining the flow conditions that would
248 make the substrate hazardous. A conservative assumption was also made to treat all
249 hydraulic jumps as hazardous since quantifying jump severity required complex
250 analyses beyond the scope herein. The below section introduces a concept used to
251 discriminate between safe and hazardous flow conditions for an entrained body followed
252 by sections that explain how each of the hydraulic hazard categories were defined and
253 delineated.

254 3.3.1. *Savability*

255 In keeping with past research concerned with human stability in a flow, this study
256 used a depth-velocity product for delineating the surface hazard types. Reported depth-
257 velocity product thresholds above which adult humans lose stability from an already
258 standing or walking position range from about 0.6-2 m²/s (Abt et al. 1989; Karvonen et
259 al. 2000), though the topic at hand for this study was not a statics problem involving the
260 loss of stability, but a dynamics problem involving the potential to regain stability
261 beginning from an entrained position. For a freely floating body, savability was defined
262 as the ability for the person to overcome further transport by regaining footing in a
263 stable, standing position with head above the water surface. For an entrained body that
264 suddenly experienced foot entrapment, savability referred to the capacity to avoid
265 getting swept over and held underwater, and instead maintain a controlled upright
266 position. A rock surface could therefore be described as savable if the ambient flow
267 conditions allowed a freely floating or foot-entrapped person to save themselves by

268 achieving a stable standing position. Halting one's forward progression while moving
269 freely with the flow or righting oneself following foot entrapment were not assumed to be
270 equivalent to maintaining upright stability from an already standing or walking position,
271 and it was reasoned that the threshold depth-velocity product below which saving was
272 possible must be lower than that for upright stability due to an entrained body's
273 momentum. A value of $0.3 \text{ m}^2/\text{s}$ was chosen for this study to be the threshold depth-
274 velocity product for savability (Table 1) with lower values corresponding to the absence
275 of hydraulic hazards given a person's ability to save themselves and avoid harm. A
276 similar approach was taken by McCarroll et al. (2015) to determine whether a simulated
277 bather had escaped a rip current and reached a safe area by evaluating both the depth
278 and a hazard rating that uses a depth-velocity product. Co-author Pasternack has
279 extensive personal experience with savability in whitewater rivers and training beginners
280 with river safety. From his experience, the threshold value is reasonable for normal
281 recreational boaters and swimmers. It will be significantly lower for inebriated
282 inadvertent swimmers (a common presence on whitewater rivers) and higher for
283 whitewater experts.

284 It is important to note that this threshold value is only a rough estimate as this
285 study did not aim to experimentally determine this value, but instead to introduce the
286 concept of savability for which future investigation is needed. For comparison, $0.3 \text{ m}^2/\text{s}$
287 falls within the low hazard category proposed by Cox et al. (2010) for children and
288 adults that permits stable standing and wading. These authors also suggested $0.8 \text{ m}^2/\text{s}$
289 as the working limit for trained safety personnel. While no depth and velocity data were
290 collected to identify the threshold for regaining stability, Cox et al. (2004) posited that

291 once footing is lost, less hazardous flow conditions are required for footing to be
292 regained due to greater bodily surface area presented to the flow. It is also more
293 challenging to perform an athletic dynamic maneuver to regain footing than it is to make
294 small weight shifts to sustain existing footing, especially as one becomes more tired
295 through the exertions of avoiding hydraulic hazards.

296 3.3.2. Emergent unsavable surface hazards

297 Since no strong basis existed for discriminating among different substrate sizes
298 and arrangements in terms of the associated hazard, the full topographic surface was
299 considered in the hydraulic hazard delineation. The perimeters of emergent surfaces
300 where depth = 0 m were first identified. Next, the perimeters were delineated as
301 emergent unsavable surface hazards for a freely floating or foot-entrapped body in the
302 upright position if the adjacent water had a depth <1.5 m and a depth-velocity product
303 >0.3 m²/s (Fig. 3; Table 1). This meant that upon encountering an emergent surface
304 under these flow conditions, a person could not save themselves to regain a stable
305 standing position and was instead at risk of experiencing involuntary physical contact
306 and associated harm.

307 In areas where emergent surfaces abutted water deeper than 1.5 m, the depth
308 was considered too great to permit a 1.8 m tall person to save themselves into a
309 standing position with head above the water surface. Therefore, the depth-velocity
310 product threshold was not evaluated in these situations. It was reasoned that emergent
311 surfaces next to deep, slow water were less likely to be hazardous than those next to
312 deep, fast water. However, no threshold velocity could be discerned for what constituted
313 hazardous due to the complexities of describing the interaction of a body with a near-

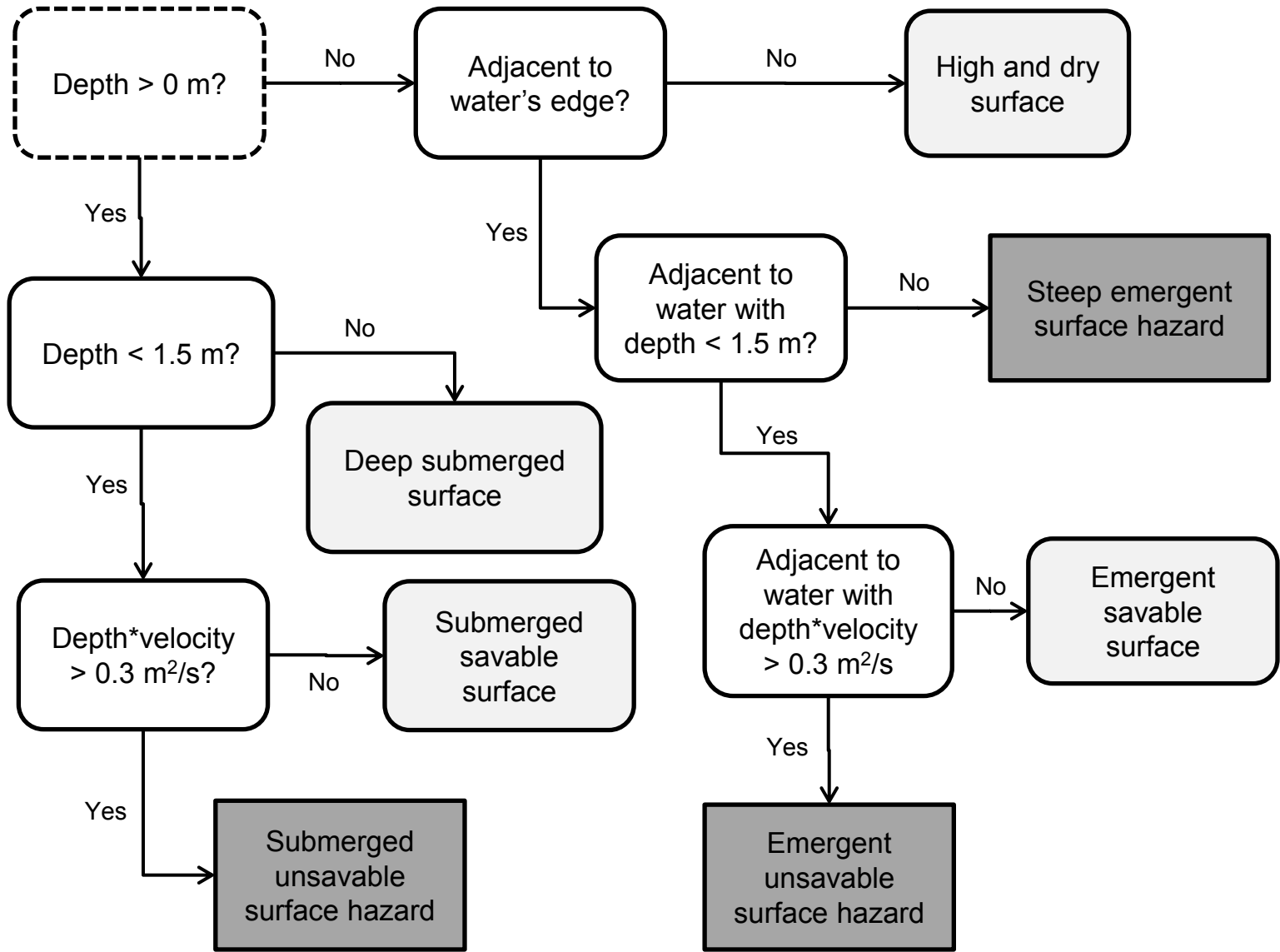

314 vertical rock surface, so the entirety of these surfaces was designated as steep
315 emergent surface hazards for the sake of caution. Very few of these hazards were
316 present along the study site, so they were lumped with the emergent unsavable surface
317 hazards.

318 3.3.3. *Submerged unsavable surface hazards*

319 Submerged surfaces were designated as unsavable and therefore hazards if flow
320 conditions prevented someone from regaining a standing position in these locations
321 such that a traumatic collision or underwater entrapment could result. Specifically,
322 submerged surfaces with depth <1.5 m and a depth-velocity product >0.3 m²/s were
323 identified as submerged unsavable surface hazards for a freely floating or foot-
324 entrapped body in the upright position (Fig. 3; Table 1). The savability threshold was
325 only evaluated for surfaces shallower than 1.5 m as deeper surfaces were considered to
326 be out of reach for a 1.8 m tall upright person to save themselves on. While there
327 conceivably existed a minimum depth for which a body was not at risk of submergence
328 and drowning regardless of velocity, regaining a controlled stance to avoid hazard
329 contact and physical trauma could still be inhibited given high velocity. Therefore, 0 m
330 was used as the lower depth limit for evaluating the savability threshold (Table 1).
331 Additionally, savable surfaces were also delineated as these locations were relevant to
332 later analyses.

333 Unsavable and savable surfaces exposed to a body in the supine position (Fig.
334 2b) were mapped using the same steps as those described above but with savability
335 evaluated down to a depth of 0.75 m (Table 1). This was intended to represent the
336 situation in which a freely floating or foot-entrapped person in the supine position

337 attempted to save themselves into a standing position on surfaces less than 0.75 m in
338 depth. While it was reasoned that the savability threshold for a supine body that's either
339 freely floating or foot entrapped should still fall below the threshold for stability from an
340 already standing position, there was no strong basis for altering the threshold relative to
341 that used for the freely floating or foot-entrapped upright body. Therefore, the savability
342 threshold was maintained at $0.3 \text{ m}^2/\text{s}$.

343 *3.3.4. Hydraulic jump hazards*

344 The final hazard described in this study was hydraulic jumps, which can occur
345 due to submerged surfaces and therefore account for an additional hazard associated
346 with these inundated features. The presence of aeration is a critical component of the
347 jump hazard (Valle and Pasternack 2002, 2006), as the level of aeration can be large
348 enough to prevent lifejacket buoyancy from supporting a person above the water
349 surface while also small enough to make the multiphase zone unbreathable. This study
350 only investigated the presence or absence of hydraulic jumps, as identified by the
351 transition from supercritical to subcritical flow in the 2D model output. The scheme
352 introduced in this study for locating hydraulic jumps is itself a novel tool that could be
353 used in the study of spatially explicit mountain river hydraulics. The general steps
354 involved identifying supercritical regions, isolating the perimeters of these regions, and
355 then analyzing the flow vectors at the model mesh nodes adjacent to the perimeters to
356 determine those downstream of and within a jump. The same hydraulic jumps hazards
357 were used for the supine body scenario as for the upright body, as these features were
358 assumed to be exposed to anything moving along at the water's surface.

359 For each modeled discharge, supercritical flow regions were identified, and the
360 orientations of the flow vectors at computational mesh nodes were computed to isolate
361 the nodes immediately downstream of the supercritical flow where jumps, by definition,
362 occurred. Given the angle α of the flow vector at each mesh node (Fig. 4a) and the
363 angle β associated with the line segment connecting that node to a point on the
364 perimeter of a supercritical flow region, the orientation angle γ of the flow vector to the
365 point was computed using the expressions below.

$$366 \quad \beta > \alpha: \gamma = |\beta - 180 - \alpha| \quad (1)$$

$$367 \quad \beta < \alpha: \gamma = |\beta + 180 - \alpha| \quad (2)$$

368 It was necessary to select a certain threshold orientation angle γ to isolate mesh
369 nodes sufficiently downstream of the supercritical flow to represent the jump location.
370 An angle of $\gamma = 90^\circ$ was tried initially, but this value erroneously included too many
371 mesh nodes on the upstream side of the supercritical flow due to raster edge effects. A
372 stricter threshold of $\gamma = 150^\circ$ was ultimately chosen such that the majority of the isolated
373 mesh nodes occurred along the appropriate downstream boundary of the supercritical
374 flow (Fig. 4b).

375 3.4. *Characterizing hazard exposure*

376 After delineating hazard locations, two criteria were introduced to describe the
377 instantaneous hazard exposure at any point in the river where a body might be located
378 during transit. These included passage proximity, i.e., how close a person would be
379 swept toward a hazard if they were unable to save themselves along the way, and
380 reaction time, i.e., how much time was available for the person to swim against the

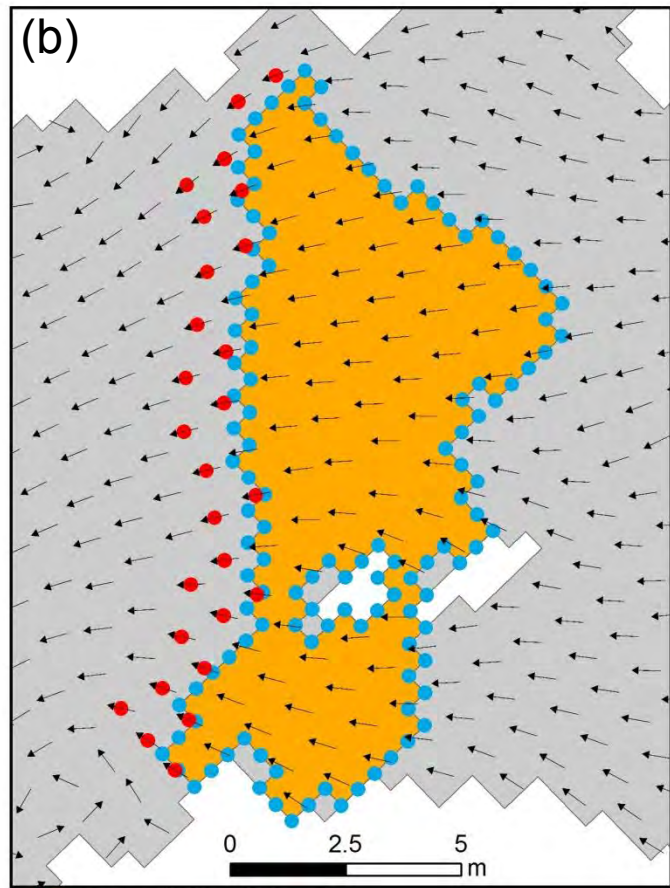
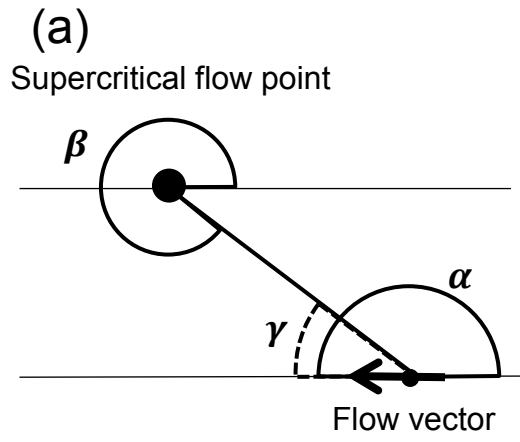

- Hydraulic jump hazard
- Supercritical flow and perimeter point ●
- Wetted area
- ↑ Flow vector

381 current to change their trajectory and avoid a close hazard encounter. A key factor in
382 evaluating hazard exposure is human motility that complicates the prediction of where a
383 body will move through a flow. Instead of trying to guess or simulate motile behavior
384 and determine the effects on hazard exposure, this study used the instantaneous
385 trajectory at all positions in the flow to map the hazard exposure and gage the need for
386 motility to avoid hazards. While hazard exposure was described using the hazard
387 locations, flow direction, and velocity magnitude, characterizing the vulnerability of
388 people to harm upon encountering a hazard was beyond the scope of this study. The
389 risk of physical trauma or drowning was represented by describing the hazard exposure
390 with the passage proximity and reaction time metrics and assuming that harm would
391 result if a hazard encounter were to occur.

392 An instantaneous trajectory of constant velocity and direction was projected from
393 the flow vector at each 2D model node, and these trajectory attributes were used to
394 quantify the two metrics as a means of characterizing the hazard exposure associated
395 with each node in the flow. This approach of projecting constant direction and velocity
396 can both over and underestimate the exposure to hazards, because at any given node
397 in the flow, the direction and velocity can either be more or less conducive to hazard
398 exposure than the conditions experienced by the body along the remainder of its actual
399 path. For example, the trajectory at one location might have a high velocity and be
400 directed at a hazard, while further down the path the velocity could decrease and the
401 direction change to a safer area, or vice versa.

402 3.4.1. *Passage proximity*

403 For a body moving along a constant trajectory set by the flow vector at the mesh
404 node to which the body's centroid was momentarily coincident, the passage proximity
405 represented the closest distance reached between the centroid and a point along the
406 perimeter of an unsavable surface, savable surface, or hydraulic jump. This occurred
407 when the orientation angle γ as calculated with Equations (1) or (2) between the
408 centroid and point equaled 90° , so this angle was used as the threshold for isolating
409 mesh nodes upstream of the points. For each of the four discharges, orientation angles
410 were calculated between each mesh node and each of the points. An upstream position
411 with an orientation angle less than 90° meant that the coincident centroid had yet to
412 reach its passage proximity p to the point (Fig. 5), while a downstream position meant
413 that the centroid would only be carried further away from the point. For those pairs of
414 nodes and points exhibiting an upstream node orientation, the orientation angle was
415 used to calculate the passage proximity as given below, while it was not appropriate to
416 compute the metric in the case of downstream node orientation.

$$417 \quad p = \sin(\gamma) x \quad (3)$$

418 3.4.2. *Reaction time*

419 Reaction time was introduced as the second metric to characterize exposure,
420 specifically to account for velocity and convey the imminence of a potential encounter.
421 This metric refers to the time available to avoid a hazard given the flow velocity
422 regardless of whether this time is sufficient for a person to actually avoid it, which
423 depends on a person's swimming ability, consciousness, etc. For a body moving along

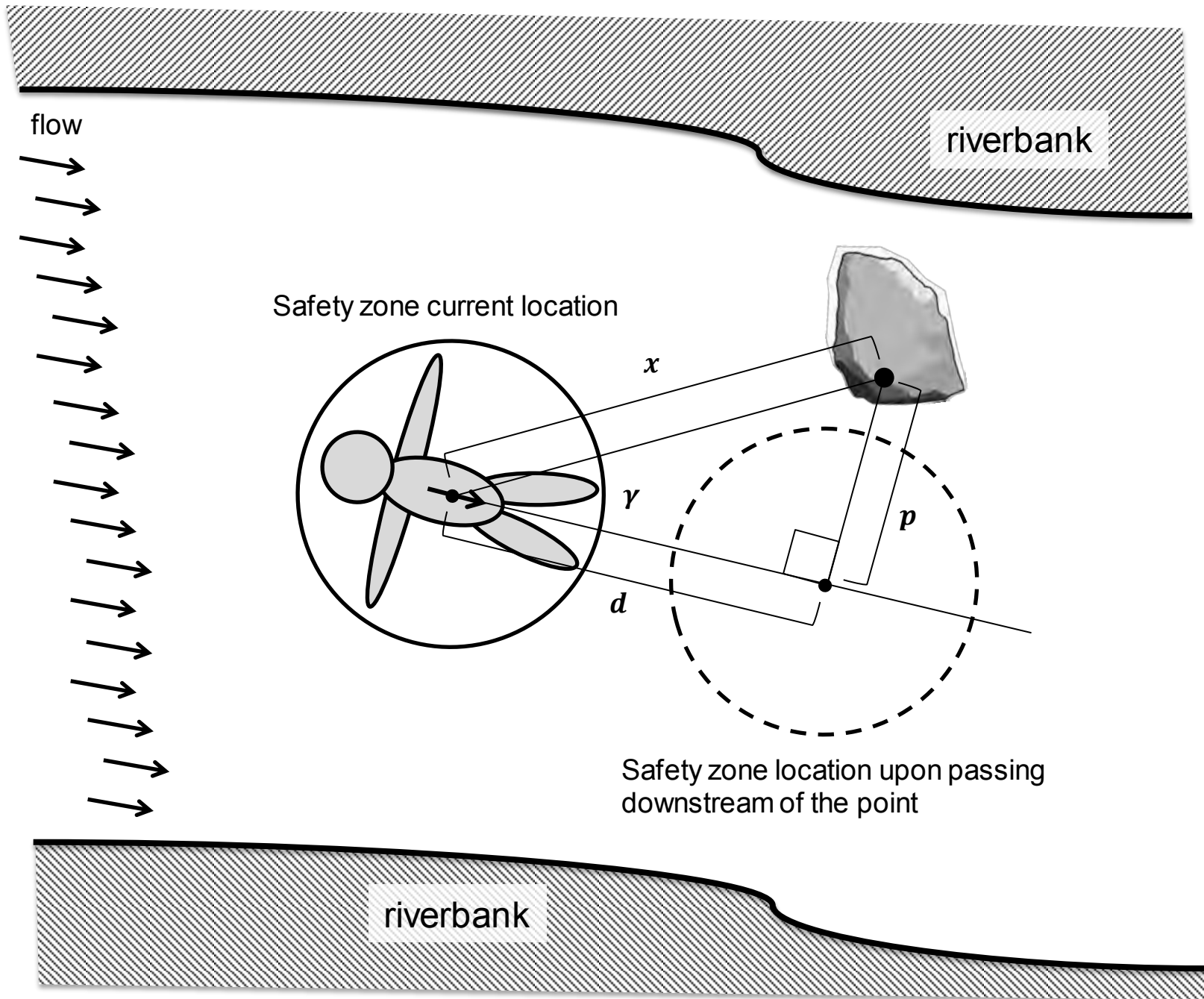

424 a constant trajectory at a velocity v , the reaction time computation depended on
 425 whether the body's centroid would reach within 0.9 m of an unsavable surface, savable
 426 surface, or hydraulic jump point. If the centroid was not going to approach the point
 427 within this distance ($p > 0.9$ m) as depicted in Fig. 5, then the reaction time was
 428 calculated as follows with d equal to the distance traveled by the body before passing
 429 downstream of the point.

$$430 \quad t = \frac{d}{v} = \frac{\cos(\gamma)x}{v} \quad (4)$$

431 Conversely, if the body's centroid was going to approach the point within this
 432 distance ($p < 0.9$ m), then the reaction time was computed using the below equations
 433 where lengths b , c , and r and angles e , f , and g are defined in Fig. 6.

$$434 \quad b = \tan(\gamma) x \quad (5)$$

$$435 \quad e = 90 - f - g = 90 - \cos^{-1}\left(\frac{p}{r}\right) - \cos^{-1}\left(\frac{p}{b}\right) \quad (6)$$

$$436 \quad c = \sin(e) r \quad (7)$$

$$437 \quad t = \frac{d}{v} = \frac{c}{\sin(\gamma)v} \quad (8)$$

438 3.4.3. Total hazard exposure

439 For each discharge, the computation of passage proximity and reaction time was
 440 first made separately for emergent unsavable surfaces, submerged unsavable surfaces,
 441 and hydraulic jumps to assess the exposure to each hazard category irrespective of the
 442 presence of the others. Savable surfaces were included in each computation to account
 443 for encounters with these safe areas that were assumed to permit saving. Only surfaces

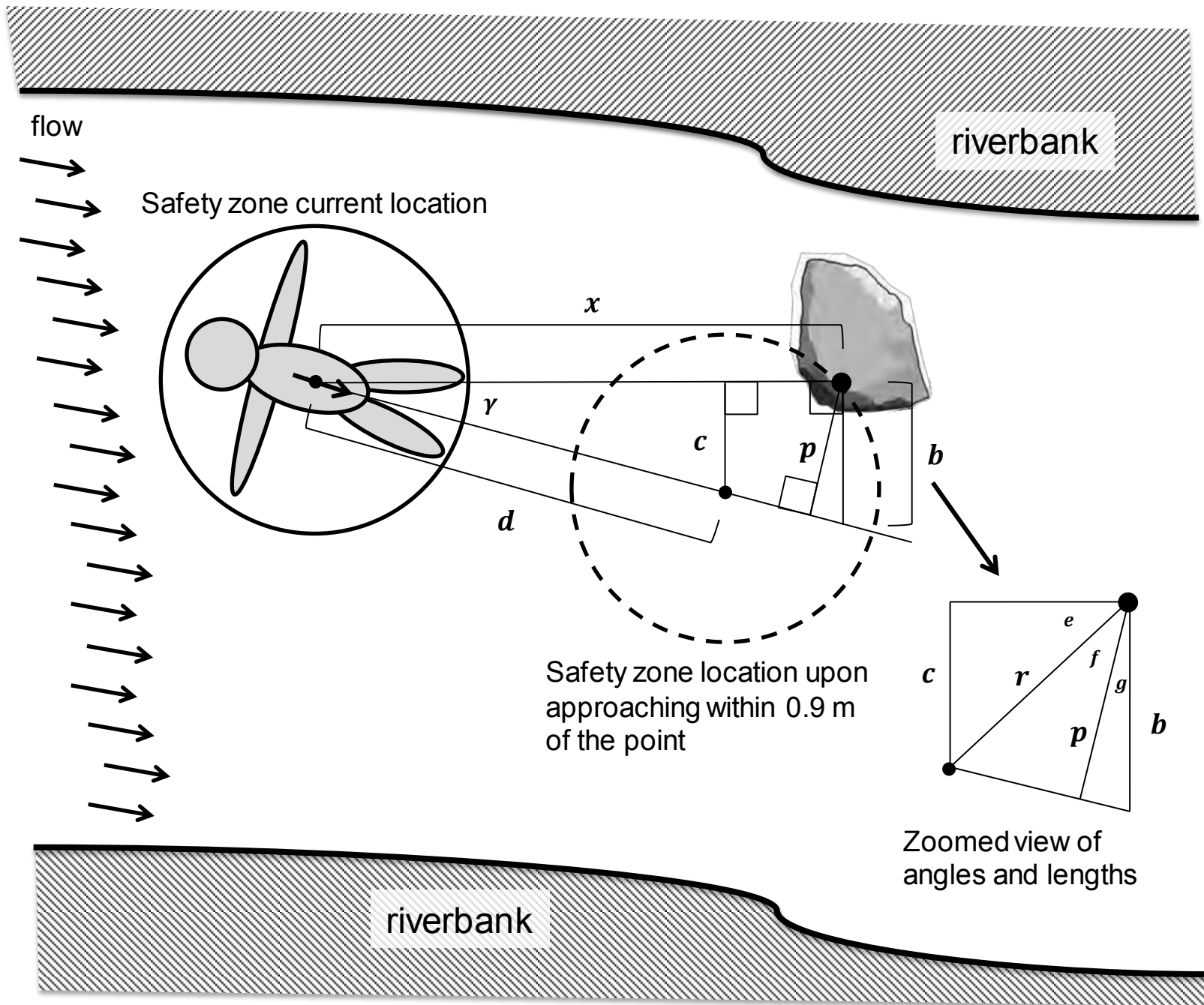

444 delineated with respect to the upright body's 1.5-m tall safety zone were used in these
445 individual hazard category computations. Next, the points for all the hazard categories
446 and savable surfaces were combined and the two metrics were again calculated to
447 characterize the total hazard exposure for the upright body. Total hazard exposure was
448 defined to be the exposure of a body to all of the three hazard types, and lastly it was
449 also calculated with the hazards delineated for the supine body such that a comparison
450 could be made with the total hazard exposure for the upright body.

451 3.4.4. Mapping hazard exposure

452 The next step was to bin the values of the two metrics for visual purposes as well
453 as to quantify the resulting areal extent of each bin. For example, how much of the river
454 segment at a given discharge exhibited the potential for encountering a hazard within 5
455 s? A baseline level of hazard exposure relevant for mapping was first established by
456 constraining the range of values for the metrics. A hazard with a sufficiently large
457 passage proximity, here defined as greater than twice the safety zone radius (1.8 m),
458 was treated as posing no threat to a body regardless of how short the reaction time was
459 (Table 1). Similarly, it was decided that hazards with reaction times larger than 10 s
460 were not a threat no matter how close the passage proximity was. These values were
461 somewhat arbitrarily chosen, but greater than 10 s was considered to be relatively safe
462 with adequate time for a person to evaluate the situation and react accordingly to the
463 flow, and over 1.8 m was judged to be plenty of distance between the hazard and
464 body's centroid to avoid an encounter.

465 Two scenarios were considered for assigning a passage proximity and reaction
466 time to each mesh node. Where encounters were predicted to occur between the safety

467 zone and multiple hazard points based on the velocity and trajectory associated with a
468 given node, the hazard point with the shortest reaction time for an encounter
469 determined both the passage proximity and reaction time for the node (Fig. 7a). Values
470 weren't assigned if the shortest reaction time was associated with a savable surface
471 point because these encounters were assumed to permit a person's saving and
472 avoidance of downstream hazards. If the safety zone was predicted to near miss hazard
473 points with passage proximities between 0.9 and 1.8 m, then the point with the closest
474 passage proximity was selected to set the values of the two metrics at the node (Fig.
475 7b).

476 After assigning metric values, rasters were created for passage proximity and
477 reaction time. To classify the values of the passage proximity (PP) raster in the context
478 of the human body safety zone dimensions, a rating of two (PP2) was assigned for
479 passage proximities less than 0.9 m that corresponded to hazard encounters (Fig. 7a).
480 This rating was also given to cells upstream and within 0.9 m of a hazard point, as
481 bodies in this area were being actively pushed into the hazard. A rating of one (PP1)
482 was given for passage proximities between 0.9 and 1.8 m, which represented the near-
483 miss scenario (Fig. 7b). A rating of zero (PP0) was assigned for cells with no
484 downstream hazards less than 10 s away or with passage proximities under 1.8 m. The
485 reaction times (RT) were assigned a rating of zero (RT0) for greater than 10 s or for
486 passage proximities over 1.8 m, one (RT1) for between 5 and 10 s, and two (RT2) for
487 under 5 s or if a cell was already within 0.9 m of a hazard point. For mapping the
488 exposure to submerged unsavable surface hazards, PP3 and RT3 were given to cells
489 that exhibited unsavable conditions to represent the immediate exposure of the body's

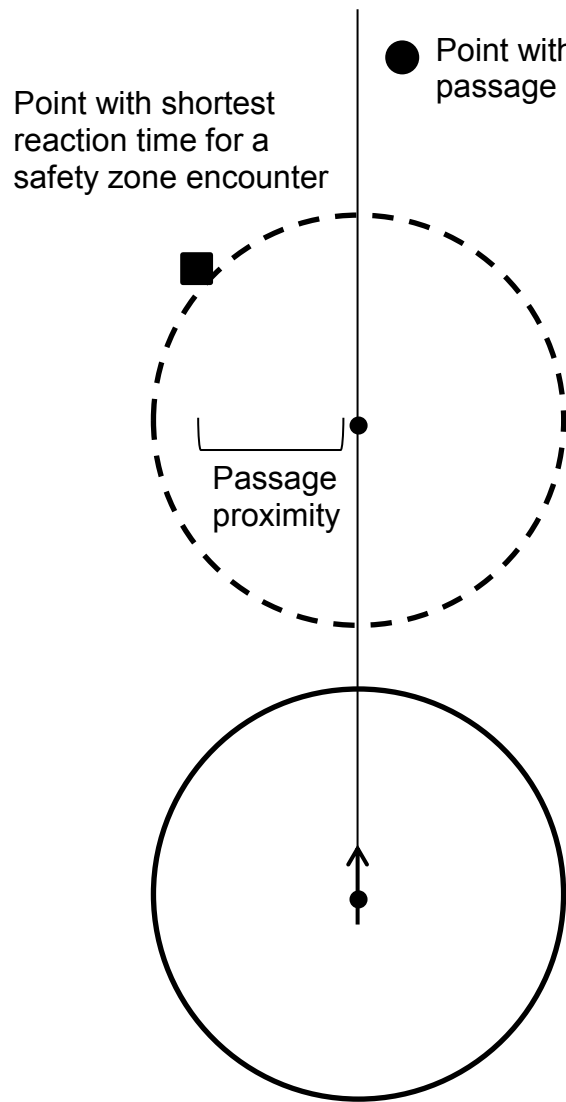

Point with shortest reaction time for a safety zone encounter

● Point with closest passage proximity

Passage proximity

(a)

Closest point to both safety zone centroids

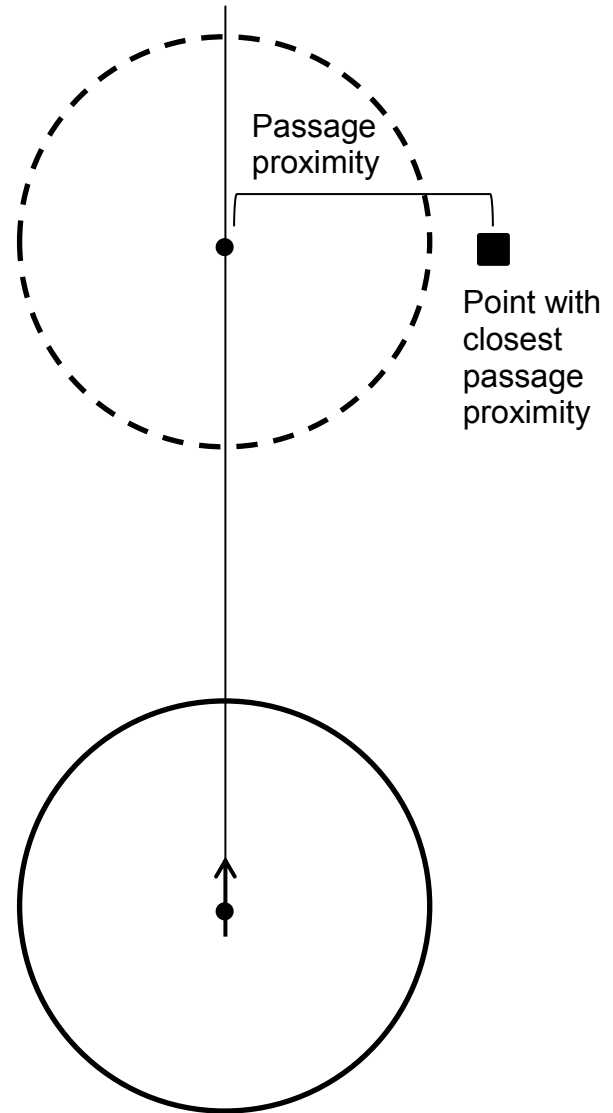

Passage proximity

■ Point with closest passage proximity

(b)

490 centroid to the underlying hazard. Overlapping passage proximity and reaction time
491 rating areas were then paired to express hazard exposure with six different ratings: no
492 hazard (PP0/RT0), distant near miss (PP1/RT1), imminent near miss (PP1/RT2), distant
493 collision (PP2/RT1), imminent collision (PP2/RT2), and immediate exposure (PP3/RT3).
494 For example, Fig. 8 shows an emergent surface bound by a dashed line with
495 hypothetical paired passage proximity and reaction time ratings on the upstream side of
496 the surface. Lastly, the fraction of the wetted area occupied by each paired rating for a
497 given discharge was computed.

498 3.4.5. Longitudinal profiles

499 To provide a basic landscape context for the hazard analysis, the average
500 elevation at each longitudinal position through the river valley was computed for the
501 study segment. Next, the longitudinal distribution of total hazard exposure for each
502 discharge was determined by computing the fraction of the wetted area at each position
503 along the river that exhibited some form of exposure, e.g., PP1/RT1 or PP1/RT2, from
504 at least one of the hazards. These hazard exposure, or danger, fractions were plotted
505 as a longitudinal series in the downstream direction to reveal the locations of more and
506 less dangerous regions encountered in passage down the river. Additionally, the
507 covariance between the danger fraction distribution at $15 \text{ m}^3/\text{s}$ and that at each of the
508 higher discharges was computed and plotted as longitudinal series to reveal how
509 increasing discharge influenced the locations of dangerous regions. Lastly, the
510 cumulative distribution of the longitudinal series of danger fractions was plotted for each
511 discharge. The raw danger areas were not used to generate these cumulative
512 distributions because the danger fractions more meaningfully represented the exposure

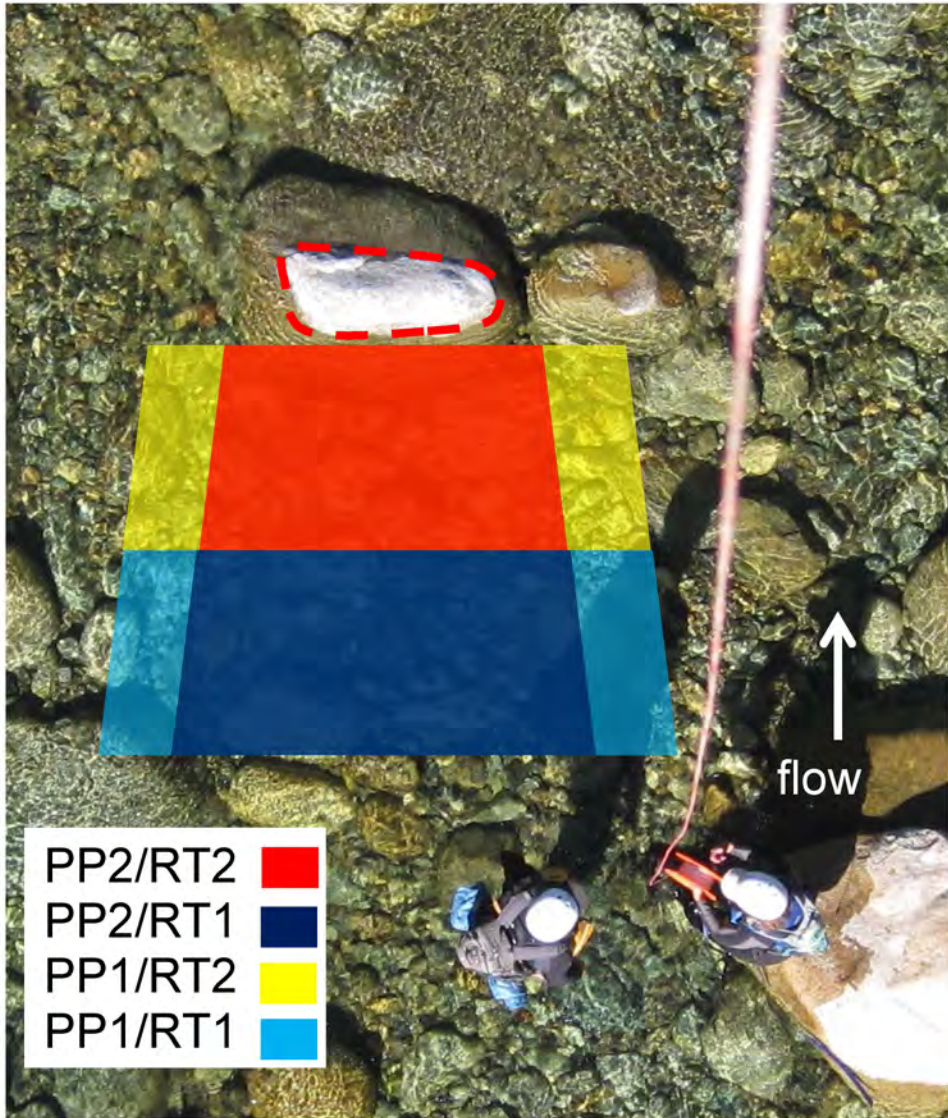

513 of a body to danger while in transit downstream. For example, a person could enter a
514 region of the river with a large total danger area, but the channel could be very wide
515 here such that the danger fraction is low. In contrast, a region that has less danger area
516 but is also very narrow would exhibit a high danger fraction, which accurately expresses
517 a more unavoidable exposure to hazards.

518 *3.4.6. Adjustable model parameters*

519 At this time, the model relies on new parameters that are logical and meet
520 whitewater expert judgment, but not well constrained with high scientific certainty. Most
521 scientific theories and engineering applications are first published and used with less-
522 constrained parameterizations as done here, and then future studies provide practical
523 refinements. The iterative development of the Universal Soil Loss Equation (Wischmeier
524 and Smith 1978; Renard et al. 1994) is a good example of that. Some highly popular
525 scientific parameters, such as channel roughness, remain contentious and uncertain
526 despite widespread study and application (Lane 2005; Ferguson 2010). In this case, the
527 model involved a highly hazardous phenomenon with many dangers in attempting field-
528 scale parameter calibration at the study site under the discharges of interest. In light of
529 this uncertainty, the assumptions behind the current model parameter values are
530 reported to convey the uncertainty of the results and highlight opportunities for
531 refinement.

532 Experiments in controlled flume settings can inform adjustments to the model
533 parameters listed in Table 1. The concept of savability was used to describe the
534 capacity for a person to regain a controlled upright stance with head above the water
535 surface starting from either a freely floating or foot-entrapped upright or supine position.

536 A single threshold was used to account for all four of these situations, but the ability to
537 save oneself in each scenario may actually correspond to different thresholds.
538 Additionally, a depth-velocity product might not be sufficient for capturing the savability
539 in the two freely floating situations as saving could also hinge on the distance over
540 which one is exposed to flow that does not exceed a certain threshold. Experimental
541 analysis could determine, for example, that a distance of 3 m is required for an adult
542 moving along with a current exhibiting a depth-velocity product of $0.2 \text{ m}^2/\text{s}$ to save
543 themselves. In this study, it was assumed that instantaneous saving was possible upon
544 encountering water with a depth-velocity product below $0.3 \text{ m}^2/\text{s}$. The minimum and
545 maximum depth for assessing savability could also be clarified as a function of subject
546 height. Lastly, the threshold orientation angle used to isolate mesh nodes downstream
547 of supercritical flow could be field validated by mapping the locations of hydraulic jumps
548 and comparing these to the node locations.

549 In contrast, other parameter values may be adjusted a priori depending on the
550 application. These include the safety zone dimensions, which are tied to the height of
551 the human subjects of interest as well as the maximum passage proximity and reaction
552 time used to map and analyze the hazard exposure.

553 3.4.7. Hazard model validation

554 At this time only limited validation of the hydraulic hazard model theorized and
555 applied to the validated 2D model was performed, which involved a visual comparison
556 of the predicted and observed hydraulic jump hazard locations. In addition, co-author
557 Pasternack used his expert whitewater experience and training in whitewater safety to
558 qualitatively evaluate whether the model results were reasonable at individual rapids in

559 the SYR as he has kayaked and swam portions of the river at different discharges.
560 Whole branches of science involve exploration of nature using back-of-the-envelope
561 calculations and numerical models with no chance for validation presently, such as
562 Earth's interior dynamism, landscape evolution modeling over thousands to millions of
563 years, geomorphic modeling of other planets, and various solar and galactic dynamics.
564 Natural hazards present a unique situation, because they involve the Earth's extreme
565 dynamics, with infrequent periodicity, large size, flashiness, and deadly hazards. A good
566 case in point of a model development arc is the SHALSTAB model for predicting maps
567 of shallow landslide hazards, whose equations and results were published with no
568 validation (Dietrich et al. 1992), leading to widespread usage in hazard management.
569 The authors published a field study with some model validation nine years later (Dietrich
570 et al. 2001). Even now, many flood hazard studies lack hydrodynamic validation data
571 (e.g., Chen and Liu 2016). Nevertheless, planners must design evacuation schemes
572 and management plans on the basis of whatever they can, so having the best analysis
573 possible is warranted regardless of the ideal of model validation.

574 If a sponsor were to fund a model validation effort to test the results of this model
575 in a future study, then the ideal approach would be to deploy human analogs into a
576 flood and use large-scale particle image velocimetry to measure passage proximity and
577 reaction time associated with each hydraulic hazard, and then compare those to model
578 predictions. Whitewater rivers with roads that run along them, like the one used in this
579 study or the North Fork of the Payette River in Idaho are excellent locations for testing.
580 Human test dummies replicate the dimensions, weight proportions and articulation of
581 the human body, while pig carcasses are widely regarded as the best organic analog of

582 humans. These could be positioned upstream either manually or using the robotic river
583 truss (Pasternack et al., 2006a). Pole-mounted cameras or tethered kite-blimps would
584 be deployed to capture the velocity field of the ambient flow and track the motion of the
585 test subject. These data would be used to measure passage proximities and compute
586 reaction times, ideally for a wide range of flows. Although this is not difficult to envision,
587 it would be costly and difficult to schedule in light of flood unpredictability. Since the
588 underlying topographic and hydraulic data for this study was collected in 2009,
589 California has experienced a historic drought and only a few days of flooding have
590 occurred between then and when this hazard study was completed.

591 One aspect of the model that was more amenable to validation was the
592 delineation of the hydraulic jump hazards since these could be safely photographed in
593 the field and compared to the locations mapped using the approach developed in this
594 study. For example, jump hazards were photographed during a flow of $4.4 \text{ m}^3/\text{s}$ at the
595 Langs Crossing gage and were visually compared to the locations of jumps delineated
596 with 2D model results for this flow. Figure 9 shows the confluence of Canyon Creek with
597 the South Yuba River where hydraulic jumps are associated with several steps.
598 Features such as the steps in the photo were represented well in the DEM, and the
599 corresponding flow acceleration was therefore reproduced closely by the 2D model. In
600 contrast, other locations with smaller-scale causes of flow acceleration, such as
601 individual boulders or shaped bedrock protrusions, were not as well captured in the
602 DEM and 1-m resolution computational mesh, so the occurrence of supercritical flow
603 was often underpredicted by the 2D model in these locations, leading to an
604 underpredicted occurrence of jump hazards. The eddy viscosity coefficient also affected

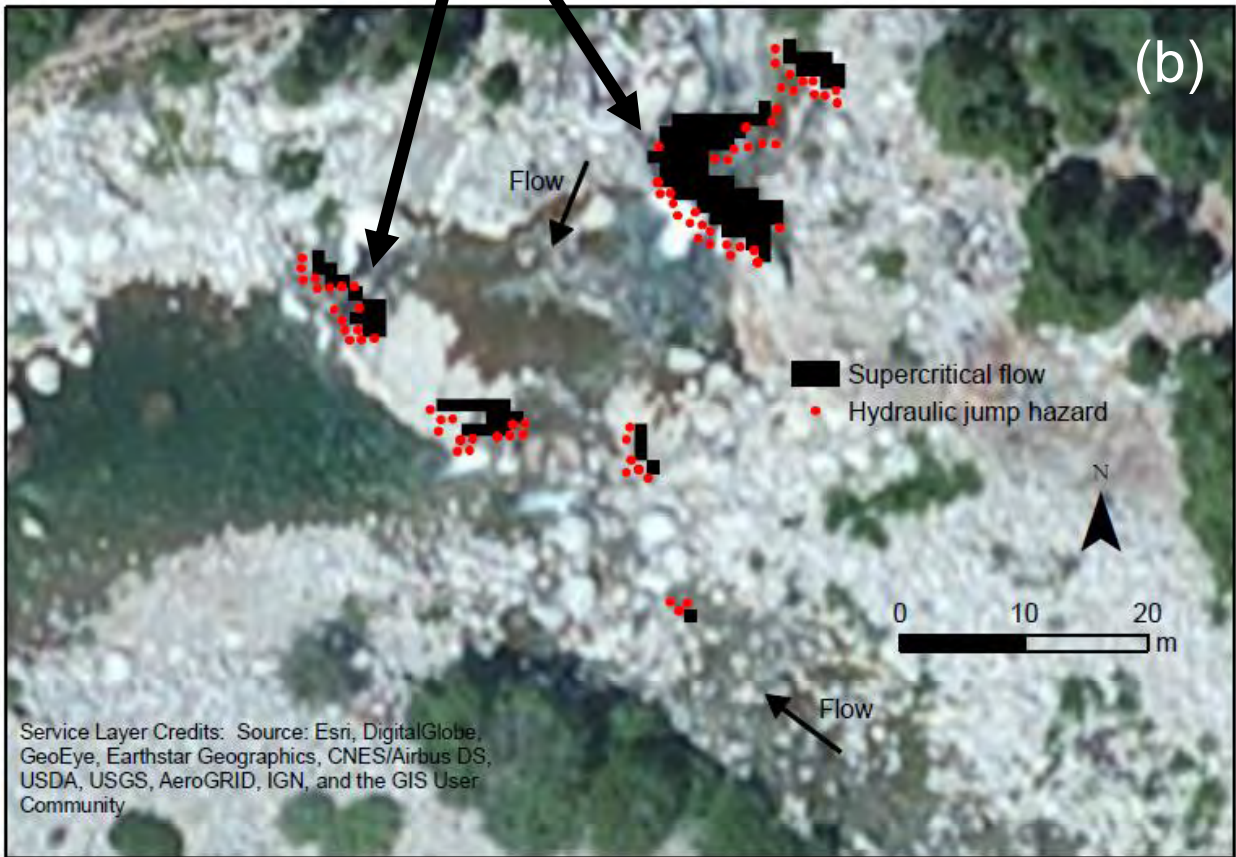

605 the extent of supercritical flow predicted by the 2D model as it determined the efficiency
606 of momentum transfer.

607 **4. Results**

608 *4.1. Hazard exposure maps*

609 Mapping the hazard exposure permitted visual assessment of how the algorithms
610 captured the interaction of the hazards with the hydraulics. Hazard exposure maps for
611 the full study segment at 31 m³/s for each hazard type as well as the total of all hazards
612 are provided in Online Resources 2-5. Fig. 10 illustrates the results for four different
613 scenarios for hazard encounters in the study segment, with the first two maps (Fig. 10a,
614 b) involving emergent unsavable surfaces, hydraulic jumps for the third map, and
615 submerged unsavable surfaces for the bottom map. While present in each of the maps,
616 the submerged unsavable surfaces (PP3/RT3) were only displayed in Fig. 10d.
617 Excluding the non-hazard area (PP0/RT0), the remaining PP/RT rating areas in each
618 map composed the danger zones for the mapped hazards. The danger zones and
619 component areas exhibited different shapes and sizes depending on the flow direction,
620 velocity magnitude, depth, and hazard configuration. In Fig. 10a, the danger zone
621 showed a flared upstream end due to convergent flow with more vectors oriented
622 directly to the hazard to produce either a near miss or an encounter. The danger zone in
623 Fig. 10b had a tapered tip because of flow that diverged from the hazard here and
624 expanded out toward the right bank, but bank narrowing just downstream converged
625 flow toward the hazard and enlarged the danger zone midsection.

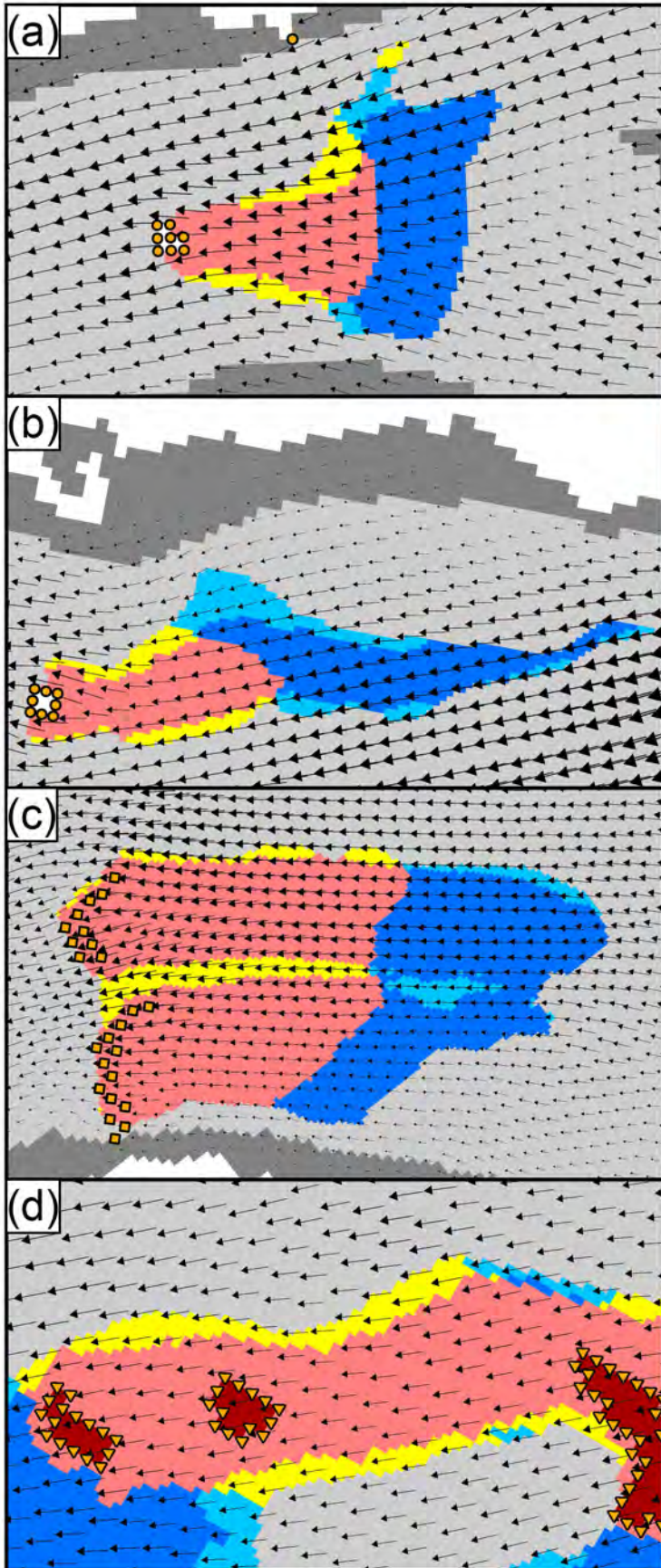

Channel Regions

- Emergent unsavable surface
- Hydraulic jump
- ▼ Submerged unsavable surface
- ↑ Flow vector
- PP0/RT0
- PP1/RT1
- PP1/RT2
- PP2/RT1
- PP2/RT2
- Submerged unsavable surface (PP3/RT3)
- Submerged savable surface

626 In addition to flow direction, velocity magnitude and depth influenced the danger
627 zones. The hazard points associated with two jumps are shown in Fig. 10c, with the
628 lower jump exhibiting a danger zone with a tip skewed away from the left bank. The
629 boundary between PP2/RT2 and PP2/RT1 also showed this skew which resulted from a
630 gradient in velocity laterally across the danger zone with slower velocities closer to the
631 left bank. The danger zone of the upper jump showed comparatively little skew due to
632 more uniform velocities across the width of the zone. However, the longitudinal extents
633 of the danger zone areas containing RT2 versus RT1 differed due to a velocity gradient
634 along the length of the zone. Flow accelerated toward the jump such that more of the
635 danger zone was within 5 s of a jump point, whereas the absence of a gradient would
636 yield equal longitudinal extents of areas within 5 and 10 s of a hazard. Depth was
637 relevant to the danger zones because the depth-velocity product determined the
638 distribution of submerged savable surfaces that suppressed the extent of the danger
639 zones. The left side of the lower danger zone in Fig. 10c lacked PP1/RT2 and PP1/RT1
640 area because the adjacent submerged savable surface was already within a body's
641 safety zone here for which saving was assumed to be possible.

642 The hazard configuration specifically affected the danger zone component areas.
643 The jumps present within the segment consisted of laterally distributed clusters of
644 hazard points such as those displayed in Fig. 10c. As a result, the danger zone areas
645 with PP2 were much more extensive than those with PP1 as hazard encounters rather
646 than near misses were more likely. Longitudinally distributed clusters of hazard points
647 like those shown in Fig. 10d favored areas with RT2 and not RT1, since flow was
648 consistently within 5 s of an encounter or near miss with a hazard. The PP2/RT1 and

649 PP1/RT1 area in the lower left and right corners of Fig. 10d was associated with
650 downstream submerged unsavable surface hazards not visible in the panel.

651 For a given site, increasing discharge had the potential to change flow direction,
652 velocity magnitude, depth, and hazard configuration to elicit the aforementioned
653 changes in danger zone shape and size. At 15 m³/s for the site shown in Fig. 11,
654 extensive submerged savable surface area limited the presence of emergent unsavable
655 surface hazards. Savable surfaces shrank considerably at 31 m³/s as depths and
656 velocities increased such that multiple emergent surfaces became hazards and grew
657 danger zones, including a particularly well-developed one just right of the map center.
658 Increasing discharge further reduced the savable surface area but also submerged the
659 emergent surfaces. This limited the longitudinal clustering of emergent unsavable
660 surface hazards, so the component areas with RT1 were not suppressed in the mid-
661 channel danger zones at 85 m³/s. While only one small mid-channel emergent surface
662 remained at the site in Fig. 11 at 196 m³/s, there was a prominent emergent surface
663 along the left bank that was not bordered by savable water and therefore showed a
664 substantial danger zone here. Increasing velocity as discharge rose resulted in longer
665 danger zones since more distant flow was within 10 s of a downstream hazard.

666 Lastly, Fig. 12 shows a site with two class IV+ rapids (“Fingers” and “Ledge” of
667 the Jolly Boys run of the South Yuba River, <http://www.awetstate.com/SYubaJB.html>)
668 and the interaction among all three hazards types that are individually displayed for the
669 upright body scenario at 31 m³/s. The upstream rapid was relatively shallow and strewn
670 with boulders that created multiple emergent unsavable surface hazards at 31 m³/s (Fig.
671 12b). Small patches of savable water were present around these emergent surfaces at

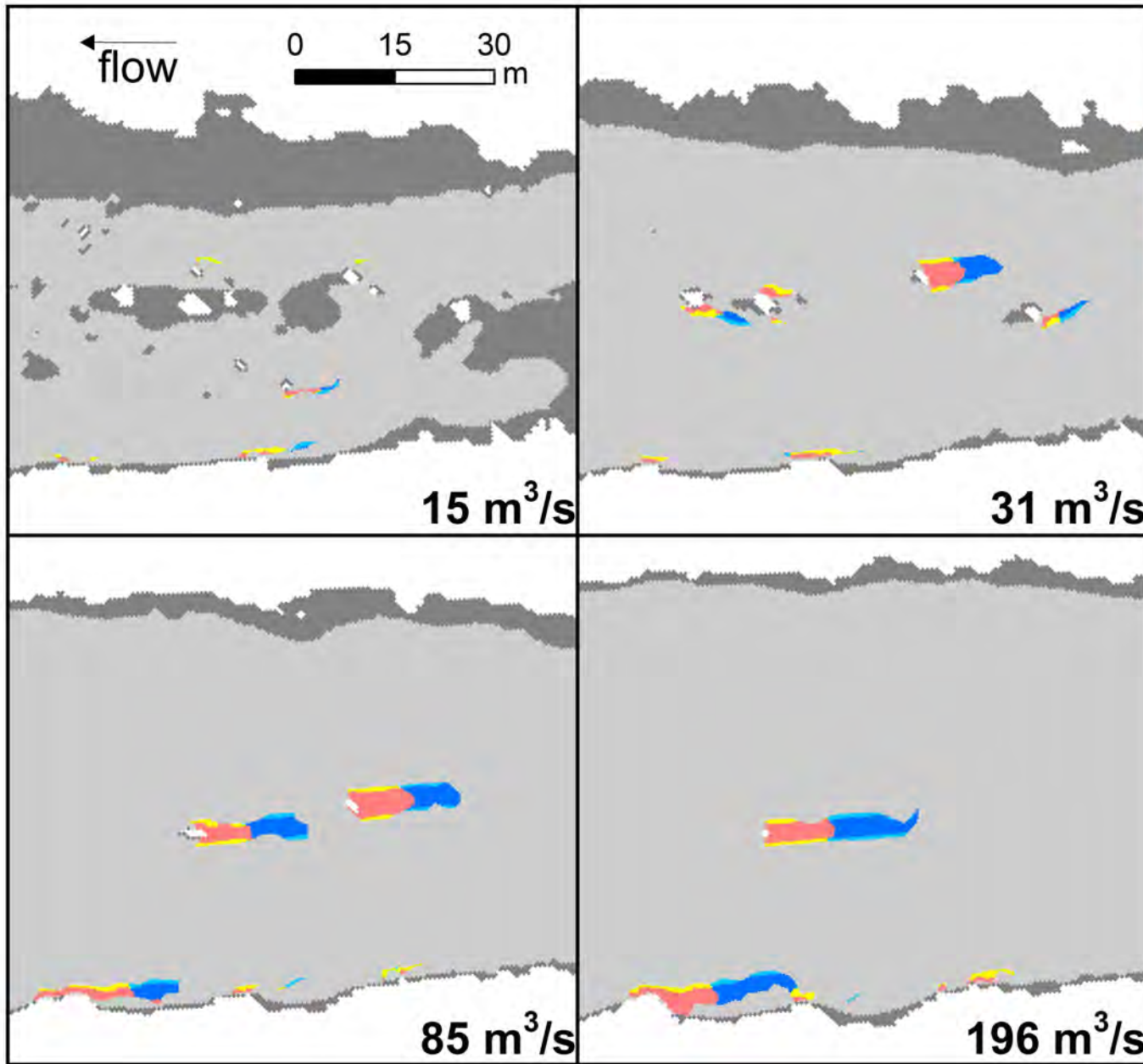

Channel Regions

- PP0/RT0
- PP1/RT1
- PP1/RT2
- PP2/RT1
- PP2/RT2
- Submerged savable surface

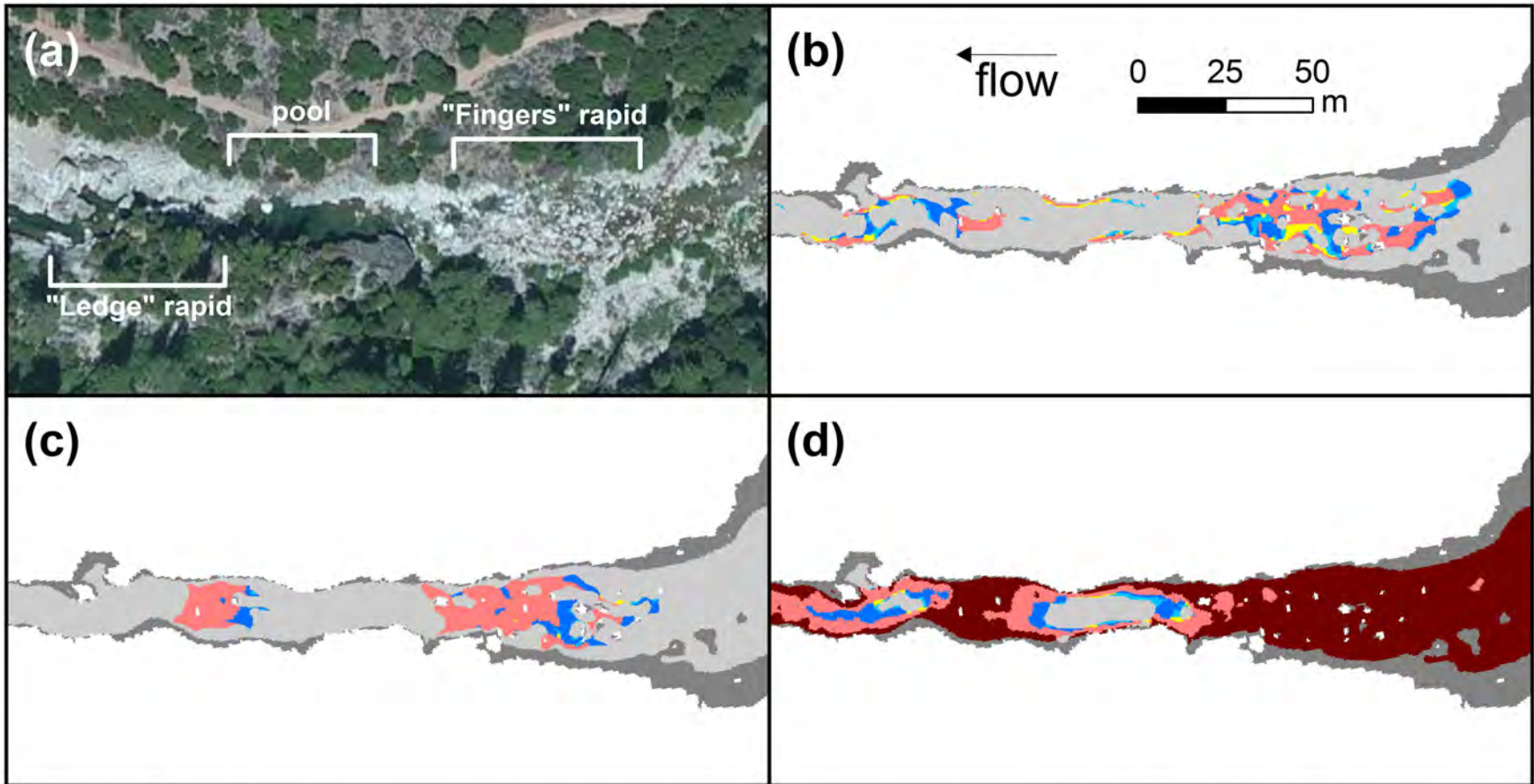

Channel Regions



Service Layer Credits: Source: Esri, DigitalGlobe, GeoEye, i-cubed, USDA, USGS, AEX, Getmapping, Aerogrid, IGN, IGP, swisstopo, and the GIS User Community

672 this discharge that limited the extent of the danger zones in some places. These
673 boulders also accelerated flow to form jump hazards here (Fig. 12c). Due to depths <1.5
674 m and high velocities, nearly all of the submerged surfaces here were unsavable (Fig.
675 12d). Just downstream was a pool adjacent to steep bedrock walls (Fig. 12a) where
676 slow velocities and large depths produced few hazards at 31 m³/s. The next rapid
677 occurred immediately downstream where the higher bed elevation and the narrow
678 bedrock walls converged flow to form a large jump hazard. Only a couple mid-channel
679 surfaces were emergent here, and the surfaces that were <1.5 m deep were mostly
680 unsavable.

681 4.2. Segment-scale areal fractions of hazard exposure

682 When the hazard exposure results were aggregated to the segment scale in the
683 form of areal fractions, multiple discharge-dependent trends were evident (Fig. 13). For
684 all discharges, the emergent unsavable surface (Fig. 13a) and jump hazards (Fig. 13b)
685 showed limited danger zone areas that occupied <10% of the river segment. In contrast,
686 over 45% of the segment contained the danger zones of submerged unsavable surface
687 hazards across all discharges (Fig. 13c). Both the emergent and submerged unsavable
688 surface hazards showed concave-down trends with peak danger zone areal fractions of
689 3.3% and 67%, respectively, at 31 m³/s, while the jump hazards exhibited a monotonic
690 increase in danger zone areal fraction as discharge rose, peaking at 6.0%. The danger
691 zone areal fractions for the total hazards exposed to an upright body (Fig. 13d) were
692 nearly identical to those for the submerged unsavable surfaces since these hazards
693 greatly outnumbered the jump and emergent unsavable surface hazards for all

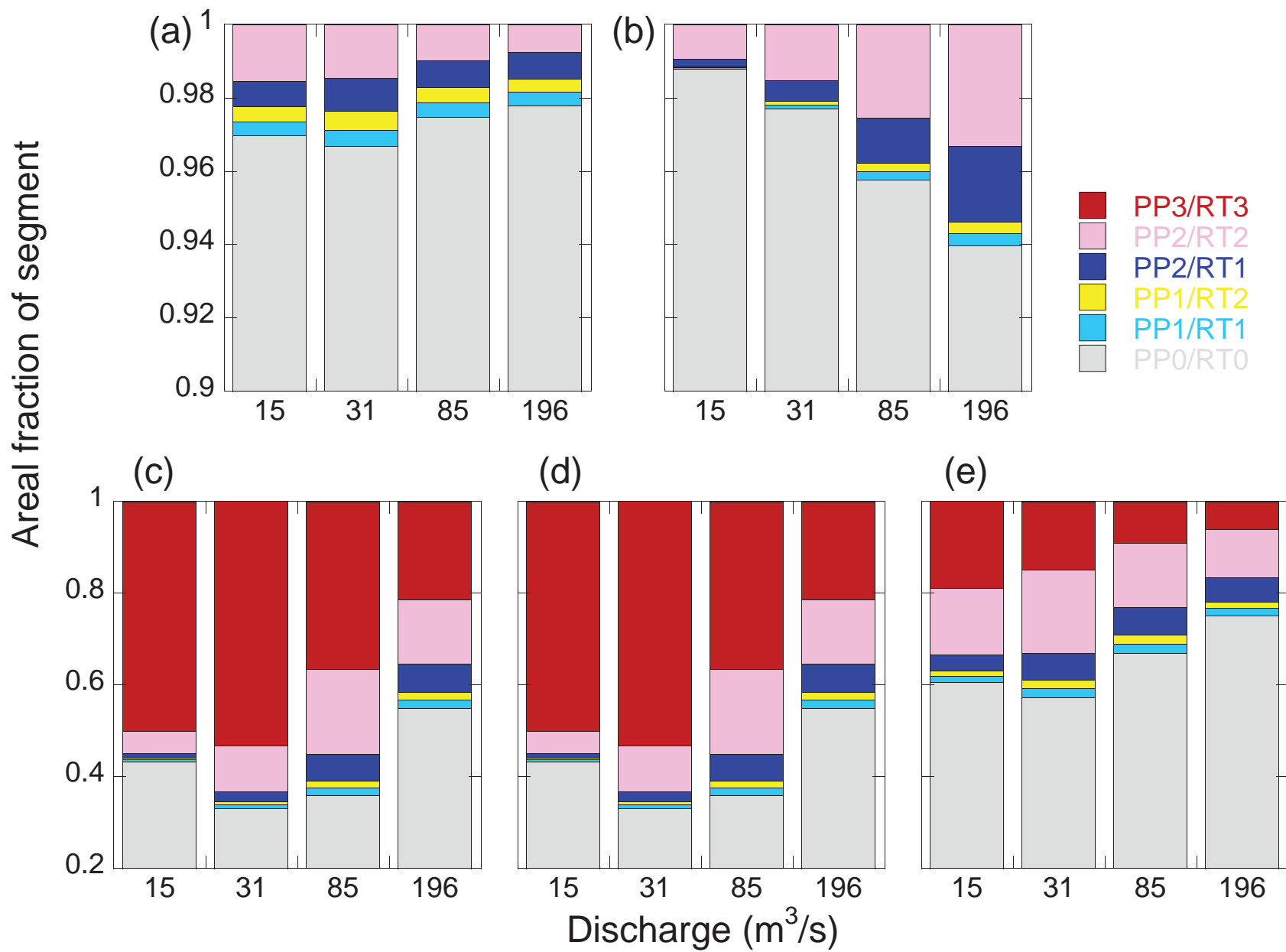

694 discharges. The total hazard areal fractions for the supine body position (Fig. 13e) were
695 substantially lower than these for the upright position.

696 The component fractions of the danger zones also changed across discharges,
697 i.e., the fractions of the danger zone areas occupied by the paired passage proximity
698 and reaction time ratings. For emergent unsavable surface and jump hazards,
699 increasing discharge coincided with an overall increase in each component area except
700 for clear declines in PP2/RT2 (Table 2). For submerged unsavable surface hazards and
701 the total hazards for both body positions, the PP3/RT3 area declined significantly as
702 discharge increased, while the remaining component areas showed overall increases.
703 PP3/RT3 was particularly dominant within the danger zones at 15 and 31 m³/s for
704 submerged unsavable surface hazards and total hazards for the upright position.

705 4.3. Longitudinal profiles

706 The profile of elevation along the valley centerline indicated the presence of two
707 dominant slopes across the study segment, with the steeper upstream region ending
708 abruptly at a large waterfall around river kilometer two (Fig. 14). Due to the local
709 variability in hazard occurrence and the associated danger zone extents, the
710 longitudinal distributions of the polygon danger fractions exhibited considerable noise.
711 The average danger fractions within 0.5-km windows along the study segment were
712 instead plotted to help visualize the trends (Fig. 14a, b). For both the upright (Fig. 14a)
713 and supine (Fig. 14b) body positions, high danger fractions for all discharges occurred
714 just upstream of the waterfall at river kilometer two with sharp drops in the danger
715 fractions immediately downstream. For the upright position, the danger fractions at 15,

Table 2 Danger zone component fractions for each hazard category

Hazard	Discharge (m ³ /s)	Component fractions for PP/RT rating area				
		PP1/RT1	PP1/RT2	PP2/RT1	PP2/RT2	PP3/RT3
Emergent unsavable surface	15	0.119	0.140	0.225	0.516	-
	31	0.136	0.151	0.271	0.442	-
	85	0.156	0.163	0.292	0.388	-
	196	0.170	0.162	0.324	0.344	-
Submerged unsavable surface	15	0.007	0.008	0.015	0.087	0.883
	31	0.012	0.011	0.032	0.150	0.795
	85	0.026	0.025	0.090	0.289	0.570
	196	0.039	0.037	0.136	0.314	0.474
Jump	15	0.029	0.029	0.169	0.774	-
	31	0.044	0.043	0.244	0.669	-
	85	0.056	0.053	0.290	0.601	-
	196	0.054	0.051	0.343	0.552	-
Total hazards- upright body	15	0.007	0.008	0.015	0.087	0.883
	31	0.012	0.011	0.032	0.150	0.795
	85	0.025	0.025	0.090	0.290	0.570
	196	0.037	0.035	0.135	0.321	0.471
Total hazards- supine body	15	0.032	0.032	0.089	0.367	0.480
	31	0.047	0.045	0.135	0.423	0.350
	85	0.064	0.058	0.182	0.425	0.272
	196	0.065	0.057	0.211	0.422	0.246

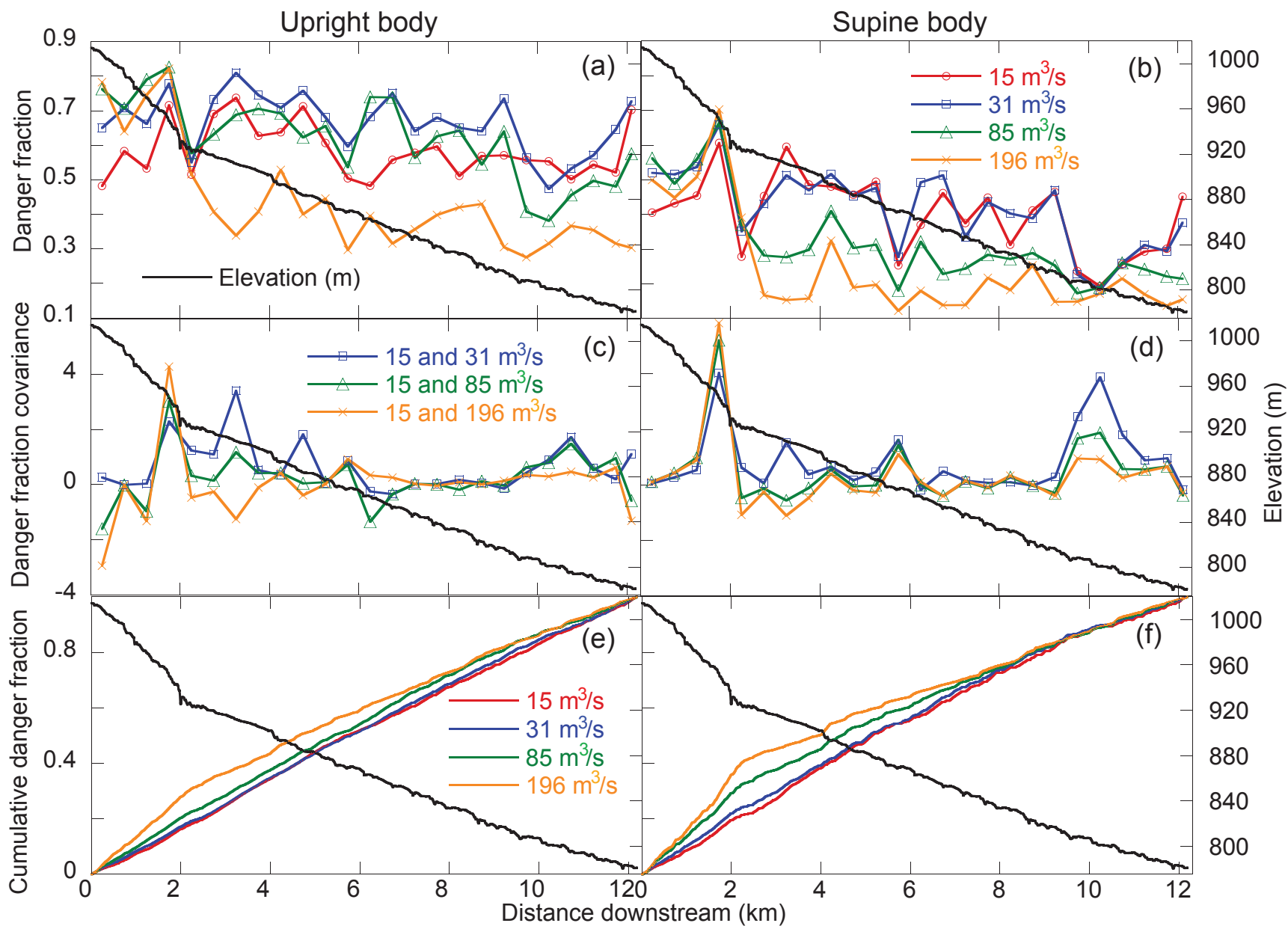

716 31, and 85 m³/s rose rapidly downstream of this point of low danger, while for the
717 supine position, only the 15 and 31 m³/s danger fractions showed a rapid increase here.

718 The covariance distributions revealed the presence of both discharge-dependent
719 and discharge-independent danger (Fig. 14c, d). A positive value of covariance at any
720 location in the profile meant that danger, or lack thereof, was discharge independent
721 between the two flows (i.e., between 15 m³/s and a higher flow), while negative values
722 indicated that the danger changed between the flows. Danger fraction covariance
723 showed more positive values for the supine (Fig. 14d) than the upright (Fig. 14c)
724 position, and both positions showed peaks for each distribution just upstream of the
725 waterfall. The cumulative distributions of danger fractions for all four discharges under
726 the supine body scenario (Fig. 14f) deviated more from a uniform distribution of danger
727 than those for the upright position (Fig. 14e), and the less smooth curves for the supine
728 position indicated greater local accumulations of danger fractions. Within the first two
729 river kilometers, the 196 m³/s distribution for both body positions showed the most
730 pronounced accumulation of danger fractions with progressively reduced accumulations
731 in order of decreasing discharge.

732 5. Discussion

733 5.1. *Understanding hazard exposure across the study segment*

734 In aggregating the hazard exposure results to the segment scale, there existed a
735 balance at 31 m³/s between the extent of surfaces that were exposed to a body in either
736 position and the extent of unsavable water that made these surfaces hazardous. The
737 overall decline in the danger zone areal fractions for emergent unsavable surface

738 hazards over the discharge series indicated that mid-channel emergent surfaces were
739 overwhelmingly inundated at the highest discharge. While emergent surface hazards
740 arose along the banks where unsavable water became more extensive with increasing
741 discharge, the danger zone areal fractions declined in part because these bank
742 locations constituted one-sided hazard exposure. Mid-channel hazards could be
743 encountered by a body from either side of the hazards, and the associated danger
744 zones were therefore larger than those for hazards along the banks. The decline was
745 additionally attributed to the decreasing wetted-perimeter-to-wetted-area ratio with rising
746 discharge as hazard recruitment along the banks did not counter the expansion in
747 channel area. The submerged unsavable surface hazards also declined overall with
748 discharge, as once the mid-channel surfaces were submerged too deeply, only narrow
749 bands of these submerged hazards were present along the banks. The danger zone
750 areal fractions for both surface hazards did increase from 15 to 31 m³/s before
751 declining, as the factors responsible for the occurrence of these hazards were optimized
752 at this intermediate discharge. Velocities overall continued to increase beyond 31 m³/s,
753 and the extent of unsavable water expanded. However, the mid-channel surfaces were
754 inundated too deeply at higher discharges to be hazards. In contrast, the inundation of
755 surfaces created additional flow-accelerating features, e.g., boulders over which water
756 spilled at high velocity, that expanded the extent of not only unsavable water but also
757 supercritical flow and jump hazards. These conditions were prevalent enough to
758 compensate for the drowning out of features that accelerated flow at lower discharges,
759 such that the danger zone areal fractions for jump hazards monotonically rose with
760 discharge.

761 Regarding the danger zone component fractions, relatively low velocities and
762 hazard clustering favored immediate hazard exposure. At $15 \text{ m}^3/\text{s}$, the majority of the
763 danger zone area for emergent unsavable surface and jump hazards consisted of
764 immediate exposure in the form of PP2/RT2, as low velocities limited the extent of
765 upstream waters within 10 s of the hazards. For submerged hazards, the unsavable
766 surfaces themselves (PP3/RT3) dominated not only the danger zones but also much of
767 the entire channel, such that the remaining component areas occupied limited space.
768 Lateral and longitudinal clustering of the hazards interacted with relatively low velocities
769 to restrict the expression of the other component areas. With increasing discharge,
770 these other component fractions rose because increasing velocities enlarged the
771 channel area not immediately exposed to but within 10 s of the hazards.

772 Relative to the upright body, the supine body was subjected to lower total hazard
773 exposure while passing down the river, but this danger was less uniformly experienced
774 with sudden transitions from safe pools to hazardous rapids. The differences in the
775 results between the two positions were explained by the channel geometry in the lateral
776 and longitudinal directions. The safety zone height was reduced by a factor of two from
777 1.5 to 0.75 m to account for the supine body position, and the extent of the submerged
778 unsavable surfaces (PP3/RT3) for each discharge was reduced to less than half of that
779 for the upright position. This indicated that the cross-sectional channel geometry overall
780 produced a disproportionately greater decrease in hazardous surface area for every unit
781 decrease in depth. The longitudinal profiles of danger fractions for both body positions
782 showed a discharge-independent presence of hazard exposure just upstream of the
783 waterfall near river kilometer two. Regardless of the discharge and body position, there

784 were always features here that generated hazards and yielded a peak in the danger
785 fraction profile. The discharge independence of the danger upstream of the waterfall
786 was confirmed by the positive covariance values for each distribution at this location
787 along the river. The 85 m³/s profile for the upright position increased between river
788 kilometers two and 3.75 but remained low for the supine position, as this region of the
789 segment was plane bed with few features to create hazards under high discharges and
790 a supine body position. Deep pools, such as the one present around river kilometer
791 5.75, had slow velocities and drowned-out surfaces that produced discharge-
792 independent safety as supported by low danger fractions and positive covariance for
793 each distribution here. The negative covariance between 15 and 196 m³/s for the
794 upright body revealed that channel locations switched from dangerous to safe (river
795 kilometers 3.25 and 12.1) or vice versa (river kilometer 0.25) for this position between
796 these two discharges. The region that became more dangerous was explained by a
797 secondary channel thread that was relatively calm at 15 m³/s but became much more
798 hazardous at 196 m³/s. For both body positions, increasing discharge corresponded to
799 an upstream loading of the danger fraction cumulative distributions as hazards were
800 largely drowned out beyond river kilometer two. Relative to the cumulative distributions
801 for the upright body, the more abrupt increases in the distributions for the supine body
802 indicated a greater sensitivity to the dichotomous step-pool channel geometry that was
803 present along much of the segment.

804 5.2. Model implications

805 This study has broached the topic of how to mechanistically characterize the
806 exposure of people to hazards upon entrainment in a whitewater river. Flood-related

807 deaths are not linked exclusively to whether or not people have been swept away. A
808 survey of people affected by the Bangladesh cyclone of 1991 found that 112 out of 285
809 people (39%) who were carried away by the storm surge died (Bern et al., 1993). The
810 hazard delineation procedure used herein offers a foundation for identifying the
811 locations of hazards for which refinements can be adopted depending on the setting.
812 For example, the automated mapping of unsavable surfaces in an urban flood
813 environment can be paired with the manual delineation of specific features that are of
814 particular concern for causing physical trauma and body entrapment. However, the
815 model developed in this study does not account for changes to the landscape as a
816 result of flood flows that may alter the hydraulics and the distribution of hazards, such
817 as the mobilization of debris in an urban setting (Chanson et al., 2014). The methods
818 introduced in this study also do not address other urban flood hazards including
819 drowning within a vehicle that's driven into floodwaters.

820 Given the complexity of predicting where a volitional, inertial body would move
821 within a flow field, multiple simplifications were made that permitted a substantive first
822 step for this line of research. Instantaneous hazard exposure was quantified for any
823 point in the flow where a body could be present, though Lagrangian particle tracking
824 would be the next logical step to more rigorously assess the hazard exposure of a body
825 moving along a path through the flow under a variety of different scenarios. This
826 includes someone who has fallen out of their raft within a rapid or someone who has
827 lost stability while evacuating a residence and swept down a flooded street. This could
828 also help determine the connectivity of safe flow regions present along a river or flooded

829 neighborhood through which people may be carried with relatively low exposure to
830 hazards.

831 **6. Conclusion**

832 This study presented a new, analytical approach to characterizing the exposure
833 of people to hazards within a flow. LiDAR and two-dimensional model results for a
834 segment of the South Yuba River offered a unique opportunity to delineate hazards and
835 mechanistically describe the exposure of an entrained body to these features for a
836 whitewater river setting. Passage proximity and reaction time were introduced as
837 metrics derived from the velocity magnitude and direction to express a body's hazard
838 exposure. Increasing discharge produced concave-down trends in the body's exposure
839 to emergent and submerged unsavable surface hazards, while a monotonic increase
840 occurred for exposure to jump hazards. The total hazard exposure faced by a body
841 moving down the river in the upright position was greater than that for a supine body,
842 although the supine body experienced a less uniform exposure to hazards including
843 abrupt encounters with dangerous channel regions. Further investigation is needed for
844 the concept of savability given its importance to quantifying hazard exposure, such that
845 the model may be applied to other dangerous flow settings like urban floods.

846 **Acknowledgements**

847 No external grant was provided directly for this work. Indirect support was
848 received from the USDA National Institute of Food and Agriculture, Hatch project
849 number #CA-D-LAW-7034-H. Precursor data were collected for different purposes with
850 an award from the Instream Flow Assessment Program of the Public Interest Energy

851 Research Program of the California Energy Commission. The Instream Flow
852 Assessment Program was administered by the Center of Aquatic Biology and
853 Aquaculture of the University of California, Davis. This project involved a large
854 collaborative effort that was only possible by gracious contributions of effort and
855 resources by many people, including relicensing stakeholders, their consultants, our
856 paid project staff, and UC Davis student volunteers. Helpful reviews and feedback of the
857 final technical report with the 2D model and other precursor study components leading
858 up the work herein were provided by Professor Allen James (University of South
859 Carolina), Dudley Reiser (R2 Resource Consultants, Inc), Michael Barclay (HDR/DTA),
860 Thomas Studley (PG&E), and Dr. Joshua Wyrick (Lafayette College). Lastly, Daniel
861 Brasuell provided assistance in locating the rapids present along the study segment.

862 **References**

863 Abt SR, Wittler RJ, Taylor A, Love DJ (1989) Human stability in a high flood hazard.
864 Water Resour Bull 25(4):881-890. doi: 10.1111/j.1752-1688.1989.tb05404.x

865 Belknap L (1998) Upgrading the American version of the International Scale of River
866 Difficulty. American Whitewater.

867 <https://www.americanwhitewater.org/content/Wiki/safety:introratings?>.

868 Bern C, Sniezek J, Mathbor GM, Siddiqi MS, Ronsmans C, Chowdhury AMR,
869 Choudhury AE, Islam K, Bennish M, Noji E, Glass RI (1993) Risk Factors for
870 Mortality in the Bangladesh Cyclone of 1991. Bulletin of the WHO 71:73-78.

871 Chanson H, Brown R, McIntosh D (2014) Human body stability in floodwaters: the 2011
872 flood in Brisbane CBD. 5th IAHR International Symposium on Hydraulic
873 Structures 1-9, The University of Queensland

874 Chen WB, Liu WC (2016) Assessment of storm surge inundation and potential hazard
875 maps for the southern coast of Taiwan. *Nat Hazards* 82(1): 591-616 doi:
876 10.1007/s11069-016-2199-y

877 Cox RJ, Yee M, Ball JE (2004) Safety of people in flooded streets and floodways,
878 National Conference on Hydraulics in Water Engineering, Engineers Australia

879 Cox RJ, Shand TD, Blacka MJ (2010) Australian Rainfall and Runoff revision project 10:
880 Appropriate safety criteria for People, Engineers Australia

881 Dietrich WE, Bellugi D, Real de Asua R (2001) Validation of the Shallow Landslide
882 Model, SHALSTAB, for forest management. In: Wigmosta MS, Burges SJ (eds)
883 Land Use and Watersheds: Human influence on hydrology and geomorphology
884 in urban and forest areas, vol Water Science and Application 2. American
885 Geophysical Union, pp 195-227

886 Dietrich WE, Wilson CJ, Montgomery DR, McKean J, Bauer R (1992) Erosion
887 Thresholds and Land Surface-Morphology *Geology* 20:675-679

888 Dolan R, Howard A, Trimble D (1978) Structural control of the rapids and pools of the Colorado
889 River in the Grand Canyon. *Science* 202(4368): 629-631 doi:
890 10.1126/science.202.4368.629

891 Ferguson R (2010) Time to abandon the Manning equation? *Earth Surf Proc Land*
892 35:1873-1876 doi: 10.1002/esp.2091

893 Foster DN, Cox RJ (1973) Stability of children on roads used as floodways. University of
894 New South Wales Water Research Laboratory Technical Report 73(13)

895 Gard M (2003) Flow-habitat relationships for spring-run Chinook salmon spawning in
896 Butte Creek. Energy Planning and Instream Flow Branch Butte Creek 2D
897 Modeling Final Report, U.S. Fish and Wildlife Service

898 Gonzalez RL, Pasternack GB (2015) Re-envisioning cross-sectional hydraulic geometry
899 as spatially explicit hydraulic topography. *Geomorphology* 246:394–406 doi:
900 10.1016/j.geomorph.2015.06.024

901 Graf WL (1979) Rapids in canyon rivers. *J Geol* 533-551

902 Grant GE, Swanson FJ, Wolman MG (1990) Pattern and origin of stepped-bed
903 morphology in high-gradient streams, Western Cascades, Oregon. *Geol Soc Am*
904 *Bull* 102(3):340-352 doi: 10.1130/0016-
905 7606(1990)102<0340:PAOOSB>2.3.CO;2

906 Harrison LR, Keller EA (2007) Modeling forced pool–riffle hydraulics in a boulder-bed
907 stream, southern California. *Geomorphology* 83(3):232-248 doi:
908 10.1016/j.geomorph.2006.02.024

909 Hauer C, Mandlbürger G, Habersack H (2009) Hydraulically related hydromorphological
910 units: description based on a new conceptual mesohabitat evaluation model
911 (MEM) using LiDAR data as geometric input. *River Res Appl* 25:29-47
912 doi:10.1002/rra.1083

913 Hilldale RC, Raff D (2008) Assessing the ability of airborne LiDAR to map river
914 bathymetry. *Earth Surf Proc Land* 33(5):773-783 doi: 10.1002/esp.1575

915 Jonkman SN (2005) Global perspectives on loss of human life caused by floods. *Nat*
916 *Hazards* 34(2):151-175 doi: 10.1007/s11069-004-8891-3

917 Jonkman SN, Kelman I (2005) An analysis of the causes and circumstances of flood
918 disaster deaths. *Disasters* 29(1):75-97 doi: 10.1111/j.0361-3666.2005.00275.x

919 Jonkman SN, Penning-Rowsell E (2008) Human Instability in Flood Flows. *J Am Water*
920 *Resour As* 44(5):1208-1218 doi: 10.1111/j.1752-1688.2008.00217.x

921 Karvonen RA, Hepojoki A, Huhta HK, Louhio A (2000) The use of physical models in
922 dam-break analysis. RESCDAM Final Report, Helsinki University of Technology,
923 Helsinki, Finland

924 Keller RJ, Mitsch B (1993) Safety aspects of the design of roadways as floodways.
925 Urban Water Research Association of Australia

926 Kieffer SW (1985) The 1983 hydraulic jump in Crystal Rapid: Implications for river-
927 running and geomorphic evolution in the Grand Canyon. *J Geol* 385-406

928 Lai YG (2008) SRH-2D version 2: Theory and User's Manual. U.S. Department of the
929 Interior, Bureau of Reclamation

930 Lane SN (2005) Roughness – time for a re-evaluation? *Earth Surf Proc Land* 30:251-
931 253 doi: 10.1002/esp.1208

932 Lane SN, Chandler JH (2003) Editorial: the generation of high quality topographic data
933 for hydrology and geomorphology: new data sources, new applications and new
934 problems. *Earth Surf Proc Land* 28(3):229-230 doi: 10.1002/esp.479

935 Leopold LB (1969) The rapids and the pools—Grand Canyon. U.S. Geological Survey
936 Professional Paper 669:131-145

937 Lind N, Hartford D, Assaf H (2004) Hydrodynamic Models of Human Instability in a
938 Flood. *J Am Water Resour As* 40(1):89-96 doi: 10.1111/j.1752-
939 1688.2004.tb01012.x

940 McCarroll RJ, Castelle B, Brander RW, Scott T (2015) Modelling rip current flow and
941 bather escape strategies across a transverse bar and rip channel morphology.
942 *Geomorphology* 246:502-518 doi: 10.1016/j.geomorph.2015.06.041

943 McKean JA, Isaak DJ, Wright CW (2008) Geomorphic controls on salmon nesting
944 patterns described by a new, narrow-beam terrestrial-aquatic lidar. *Front Ecol*
945 *Environ* 6(3):125–130 doi: 10.1890/070109

946 Milanese L, Pilotti M, Ranzi R (2015) A conceptual model of people's vulnerability to
947 floods. *Water Resour Res* 51(1):182-197 doi: 10.1002/2014WR016172

948 Muste M, Kim D, Merwade V (2012) Modern Digital Instruments and Techniques for
949 Hydrodynamic and Morphologic Characterization of River Channels. In: Church
950 M et al. (ed) *Gravel-Bed Rivers: Processes, Tools, Environments*, John Wiley &
951 Sons, Ltd., Chichester, UK pp 315-341

952 Pasternack GB, Valle BL, Paige D, Shaw M (2006a) Portable apparatus and method for
953 measuring hydraulic features in rivers and streams. United States Patent Office,
954 Patent #7062962

955 Pasternack GB, Ellis CR, Leier KA, Valle BL, Marr JD (2006b) Convergent hydraulics at
956 horseshoe steps in bedrock rivers. *Geomorphology* 82(1):126-145

957 Pasternack GB, Senter AE (2011) 21st Century instream flow assessment framework
958 for mountain streams. California Energy Commission, PIER, CEC-500-2013-059

959 Peng SH (2012) 1D and 2D Numerical Modeling for Solving Dam-Break Flow Problems
960 Using Finite Volume Method. *J Appl Math* 2012
961 <http://dx.doi.org/10.1155/2012/489269>.

962 Penning-Rowsell EC, Floyd P, Ramsbottom D, Surendran S (2005) Estimating injury
963 and loss of life in floods: A deterministic framework. *Nat Hazards* 36:43-64 doi:
964 10.1007/s11069-004-4538-7

965 Reinfelds I, Lincoln-Smith M, Haeusler T, Ryan D, Grouns I (2010) Hydraulic
966 assessment of environmental flow regimes to facilitate fish passage through
967 natural riffles: Shoalhaven river below Tallowa Dam, New South Wales,
968 Australia. *River Res Appl* 26(5):589–604 doi: 10.1002/rra.1262.

969 Renard KG, Foster GR, Yoder DC, McCool DK (1994) RUSLE Revisited - Status,
970 Questions, Answers, and the Future *J Soil Water Conserv* 49:213-220

971 Russo B, Gómez M, Macchione F (2013) Pedestrian hazard criteria for flooded urban
972 areas. *Nat Hazards* 69(1):251-265 doi: 10.1007/s11069-013-0702-2

973 Strom MA, Pasternack GB, Wyrick JR (2016) Reenvisioning velocity reversal as a
974 diversity of hydraulic patch behaviours. *Hydrol Process* 30(13):2348-2365 doi:
975 10.1002/hyp.10797

976 Takahashi S, Endoh K, Muro ZI (1992) Experimental study on people's safety against
977 overtopping waves on breakwaters. *Report on the Port and Harbour Institute*
978 34(4):4-31

979 Valle BL, Pasternack GB (2002) TDR Measurements of Hydraulic Jump Aeration in the
980 South Fork of the American River, California. *Geomorphology* 42(1):153-165
981 doi:10.1016/S0169-555X(01)00083-6

982 Valle BL, Pasternack GB (2006) Air concentrations of submerged and unsubmerged
983 hydraulic jumps in a bedrock step-pool channel. *J Geophys Res* 111(F3):1-12
984 doi: 10.1029/2004JF000140

985 Vilming S (1998) The development of the multibeam echosounder: An historical
986 account. J Acoust Soc Am 103(2935) <http://dx.doi.org/10.1121/1.422177>

987 Webb RH, Pringle PT, Reneau SL, Rink GR (1988) Monument Creek debris flow, 1984:
988 Implications for formation of rapids on the Colorado River in Grand Canyon
989 National Park. Geology 16(1):50-54 doi: 10.1130/0091-7613(1988)
990 016<0050:MCDFIF>2.3.CO;2

991 Webb RH, Pringle PT, Rink GR (1989) Debris flows from tributaries of the Colorado
992 River, Grand Canyon National Park, Arizona. U.S. Geological Survey
993 Professional Paper 87-118

994 Western U.S. Historical Summaries by State, Annual Precipitation Averages and
995 Extremes. Western Regional Climate Center.
996 <http://www.wrcc.dri.edu/htmlfiles/ca/ca.ppt.ext.html>. Accessed 23 October 2010

997 Wischmeier WH, Smith DD (1978) Predicting rainfall erosion losses: a guide to
998 conservation planning. Agriculture Handbook 537, United States Department of
999 Agriculture, Washington, DC

1000 Wyrick JR, Pasternack GB (2014) Geospatial organization of fluvial landforms in a
1001 gravel-cobble river: beyond the riffle-pool couplet. Geomorphology 213:48-65 doi:
1002 10.1016/j.geomorph.2013.12.040

1003 Xia J, Falconer RA, Wang Y, Xiao X (2014) New criterion for the stability of a human
1004 body in floodwaters. J Hydraul Res 52(1):93-104 doi:
1005 10.1080/00221686.2013.875073

1006 Ying X, Wang SS (2010) Evaluation of 2D shallow-water model for spillway flow with a
1007 complex geometry. J Hydraul Res 48(2):265–268 doi:
1008 10.1080/00221681003704178
1009

Corrected, accepted

1010 **Figure Captions**

1011 **Fig. 1** Study segment location in California and within the Yuba River watershed

1012 **Fig. 2** Human body safety zones for the (a) upright and (b) supine positions

1013 **Fig. 3** Decision tree for the surface hazard delineation that begins with the dashed-line
1014 rounded box in the upper left and ends with hazardous surfaces in the dark-shaded
1015 squared boxes and safe surfaces in the light-shaded rounded boxes

1016 **Fig. 4** (a) Orientation γ of the flow vector to the supercritical flow point given the vector
1017 angle α and the angle β of the line connecting the vector to the point; (b) a site
1018 demonstrating the delineated jump hazard points

1019 **Fig. 5** Scenario in which the body's centroid does not approach within 0.9 m of a
1020 hazardous surface, savable surface, or hydraulic jump point

1021 **Fig. 6** Scenario in which the body's centroid does approach within 0.9 m of a hazardous
1022 surface, savable surface, or hydraulic jump point

1023 **Fig. 7** The appropriate hazard points, marked as squares, for setting the reaction time
1024 rating at a mesh node given (a) a PP2 rating and (b) a PP1 rating

1025 **Fig. 8** Kite-blimp imagery of the SYR with the dashed-line perimeter of an emergent
1026 surface plus the associated hypothetical paired rating areas

1027 **Fig. 9** (a) Photo looking upstream at hydraulic jumps at the confluence of Canyon Creek
1028 (left) and the South Yuba River (right); (b) predicted locations of supercritical flow and
1029 hydraulic jumps for the discharge in (a) (aerial imagery shows a lower baseflow)

1030 **Fig. 10** Four scenarios with different danger zone shapes and sizes and flow vectors
1031 scaled independently for each panel to the velocity magnitude

1032 **Fig. 11** A site at four different discharges with danger zones mapped for emergent
1033 unsavable surface hazards only

1034 **Fig. 12** (a) Aerial imagery of two rapids with (b) emergent unsavable surface hazards,
1035 (c) jump hazards, and (d) submerged unsavable surface hazards for an entrained
1036 upright body at 31 m³/s

1037 **Fig. 13** Segment-scale areal fractions of exposure to (a) emergent unsavable surface
1038 hazards, (b) jump hazards, (c) submerged unsavable surface hazards, (d) total hazards
1039 for the upright body, and (e) total hazards for the supine body

1040 **Fig. 14** Longitudinal profiles of valley centerline elevation and danger fractions
1041 averaged within 0.5 km windows for (a) the upright and (b) supine bodies; longitudinal
1042 profiles of danger fraction covariance averaged within 0.5 km windows for (c) the upright
1043 and (d) supine bodies; longitudinal profiles of cumulative danger fractions for (e) the
1044 upright and (f) supine bodies

Supplemental materials

Topographic mapping data

For the SYR, the entire 12.2 km study segment was surveyed in the summer of 2009. Airborne LiDAR data of the terrestrial river corridor as well as bedrock outcrops and emergent boulders in the wetted base flow channel averaged 1 point per 0.74 m. Because the SYR had many large emergent boulders within the wetted area at base flow, the LiDAR survey was able to map many of them with multiple points; then a novel data-processing and object identification workflow was used to delineate each boulder as an object (Pasternack and Senter 2011). In this way, 34,113 individual boulders were explicitly resolved in the DEM—an important and unique aspect of this study in order to address hydraulic hazards. Ground-based wadeable channel surveys were done using a Leica TPS1200 robotic total station, a Topcon GTS-603 total station, and Trimble 5700 RTK GPS. Survey point density was ~1 point every 5 m on a rough grid and 1 point every 1 m along the thalweg. Bathymetric data was collected in pools using a pontoon-mounted Sonarmite echosounder coupled to a Trimble 5700 RTK GPS. This rig was floated laterally and longitudinally along pool cross-sections spaced ~5 m apart, and with data collected on a 5 s time interval. Combining these data collection methods, the segment-averaged topographic point density was 38-39 points per 100 m² both within and beyond the 0.283 m³/s base flow domain.

Data collected using different observational methods were compared (i.e., every method against every other method) where they overlapped to assess uncertainty, with full details reported in Pasternack and Senter (2011). Each survey method involved internal performance tests, such as backsight checks, GPS root mean square values,

and comparison of airborne LiDAR observations to ground-based observations on flat, smooth roads. Internal checks were within typical high-quality standards, which is within 0.5-10 cm for vertical accuracy in rough terrain and over long distances with a steep valley slope. Uncertainty assessment becomes more complicated when comparing methods, because (1) LiDAR and echosounders observe an area, while pole-mounted instruments observe mm-scale points and (2) grain-scale topographic relief in the SYR mountain channel easily ranges from 2 to 200 cm. Even with the rapid advancements in landform mapping detail and accuracy as used in this study and even if the technologies are performing equally in both settings, mountain channel comparisons will underperform lowland channel comparisons, because of the greater range of topographic variability in the mapped units, including sharp slope breaks. For instance, whereas 208 observed deviations between LiDAR and RTK GPS points on flat, smooth roads showed that 45% of deviations were within 2.5 cm of each other, 66% within 5 cm, and 96% within 10 cm, 247 observed deviations between LiDAR and ground-based instruments in the topographically complex river corridor showed that 18% were within 5 cm, 43% within 10 cm, 85% within 25 cm and 98% within 50 cm. Nevertheless, accuracy performance within the river corridor was well within the range of grain-scale relief, a key performance target.

Two-dimensional hydrodynamic modeling

Two-dimensional models of both segments were made using the Surface-water Modeling System v.10.0 (Aquaveo, LLC, Provo, UT) and run using Sedimentation and River Hydraulics (SRH-2D, v. 2.1) according to the procedures of Pasternack (2011). SRH-2D is a 2D finite-volume model that solves fluid mechanics equations to produce

an estimate for depth and velocity at each computational node (Lai 2008). SRH-2D implements a hybrid structured-unstructured mesh that can use both quadrilateral and triangular elements of any size allowing for mesh detail comparable to any finite-element model.

Although this study focuses on four modeled flows associated with the spring snowmelt hydrological regime with respect to investigating hydraulic hazards, flows were actually modeled over three orders of magnitude for three hydrologic seasons (dry, wet, and snowmelt) for additional hydraulic, geomorphic, and ecological analyses (Pasternack and Senter 2011). Input discharge was obtained from USGS gaging stations on the South Yuba River at Lang's Crossing (#11414250) and on Canyon Creek below Bowman (#11416500). The South Yuba River has substantial ungaged accretionary flows, so a thorough hydrological analysis was completed (Pasternack and Senter, 2011) yielding regression relations to estimate accretionary flows from the major ungaged tributaries for three different hydrological seasons (wet, dry, and snowmelt). A stage-discharge relation was made between the total gaged inflows (SYR at Lang's Crossing plus Canyon Creek below Bowman) and observed water surface elevations at the exit of the study segment for total inflows ranging from 0.424 to 200.65 m³/s. The time lag between inflow gage values and outflow WSE values was estimated for both gages and accounted for in the stage-discharge relation. For the remote outlet of the upstream computational mesh there was no appropriate location for a stage recorder. That model's downstream WSE was set to equal the simulated WSE at the entrance to the downstream computational mesh for that flow simulation.

To simulate hydrodynamics over the discharge range investigated with reasonable computational efficiency, it is beneficial to create different computational meshes that span key inundation extents and divide the length of a river segment into two or more linked sections. For the SYR, two inundation extents ($< \sim 30 \text{ m}^3/\text{s}$ and $< \sim 200 \text{ m}^3/\text{s}$) and two longitudinal sections (study entrance to upstream of confluence with Canyon Creek, and upstream of Canyon Creek to study terminus) were used, all with 1-m internodal spacing. The downstream low and high flow meshes had 331,593 and 467,272 elements, respectively. The upstream low and high flow meshes had 284,461 and 396,615 elements, respectively. For each flow-regime simulation, the results from the two reaches were merged to create a single point file for evaluation in GIS using the output processing workflows explained in Pasternack (2011).

Roughness associated with resolved bedform topography (e.g., alluvial bars, partially to fully emergent boulders and boulder clusters, and bedrock outcrops) was explicitly represented in the detailed channel DEM and the 1 m resolution computational mesh. Given the heterogeneity of bed material, bedrock, and vegetation as well as the presence of all such features impacting hydraulic roughness across a wide range of flows, unresolved bed roughness was parameterized using a spatially and flow independent Manning's n value of 0.1. This value was confirmed through depth and velocity validation as well as sensitivity analysis.

Extensive model validation was performed for model simulations over two orders of magnitude of flow ranges (~ 0.62 to $26.5 \text{ m}^3/\text{s}$ combined flow from the two inflow gages). Mass conservation between specified input flow and computed output flows for simulations of observed conditions was within 1%, except for the lowest flow simulation

of the upstream mesh. That one run had a loss of 1.9%, which was considered reasonable given the extreme complexity of the channel topography and uncertainty in accretionary flows at the lowest discharge (which is well below the base flow discharge used for MU mapping in this study). WSE performance was tested by comparing 17,198 pairs of model predictions against LiDAR observations throughout the two meshes at base flow for a mean signed deviation of -2.8 cm. Performance was best where the water surface was flat and smooth and worst in steep sites with waves, but data from all areas were aggregated to obtain the unsigned statistical distribution of error. For unsigned deviations, 34% of test points were within 5 cm vertical, 51% within 10 cm, and 91% within 25 cm. Surface velocity magnitude was measured at 273 locations and compared to depth-averaged model predictions using the method of Barker (2011), yielding a good predicted versus observed r^2 of 0.61. Further analysis revealed that r^2 was 0.8 when velocities were limited to those in pools or transitional areas between pools and other morphological units. It was 0.5-0.64 on planar surfaces in the channel and in the floodway. The only unsatisfactory performance occurred in steep sites with waves where r^2 was 0.06. Median unsigned velocity magnitude error was 28% for all observations, but also varied depending on morphological unit type from 21-36%. Interestingly, steep sites with waves had a reasonable median unsigned error of 25%. Overall, the SYR 2D model met all common standards of 2D model performance in aggregate, but some care was needed in the use of values at the steepest sites where the horizontal flow assumption was violated. Even though SRH-2D is assumed to be stable for simulating extremely steep reaches, model performance in predicting precise velocities appears to suffer in such areas. Prediction accuracy only matters to the extent

that velocity and depth values are above the thresholds to correctly classify locations as hydraulic jumps or proximal to emergent and submerged rocks and banks.

References

Barker JR (2011) Rapid, abundant velocity observation to validate million-element 2D hydrodynamic models. M.S. thesis, University of California Davis, Davis,

California

Lai YG (2008) SRH-2D version 2: Theory and User's Manual. U.S. Department of the Interior, Bureau of Reclamation

Pasternack GB (2011) 2D Modeling and Ecohydraulic Analysis. Createspace, Seattle,

WA

Pasternack GB, Senter AE (2011) 21st Century instream flow assessment framework

for mountain streams. California Energy Commission, PIER, CEC-500-2013-059

SYR Emergent Unsavable Surface Hazards at 31 m³/s, p. 1

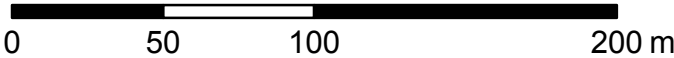
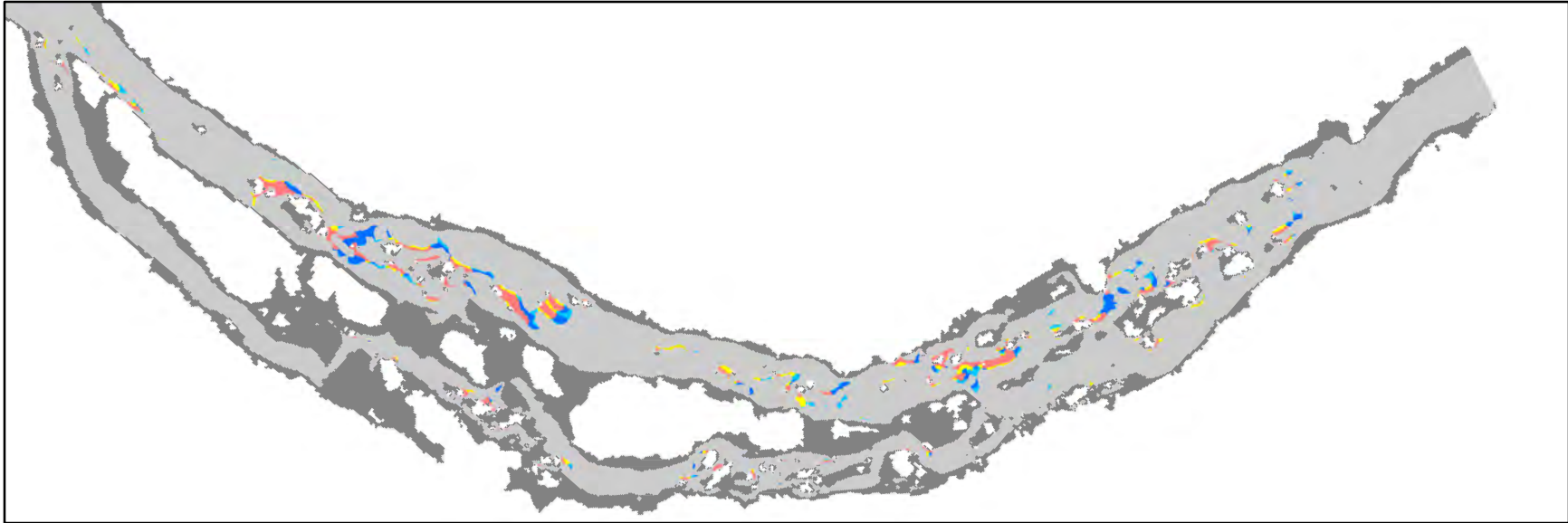

Channel Regions

Light Gray	PP0/RT0	Yellow	PP1/RT2	Red	PP2/RT2
Cyan	PP1/RT1	Blue	PP2/RT1	Dark Gray	Submerged savable surface

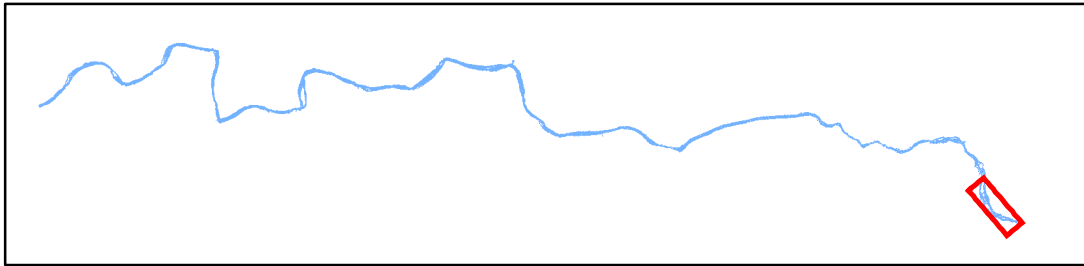

SYR Emergent Unsavable Surface Hazards at 31 m³/s, p. 2

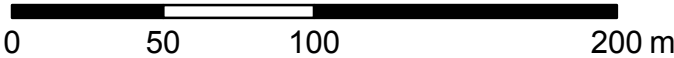

Channel Regions

Light Grey	PP0/RT0	Yellow	PP1/RT2	Red	PP2/RT2
Cyan	PP1/RT1	Blue	PP2/RT1	Dark Grey	Submerged savable surface

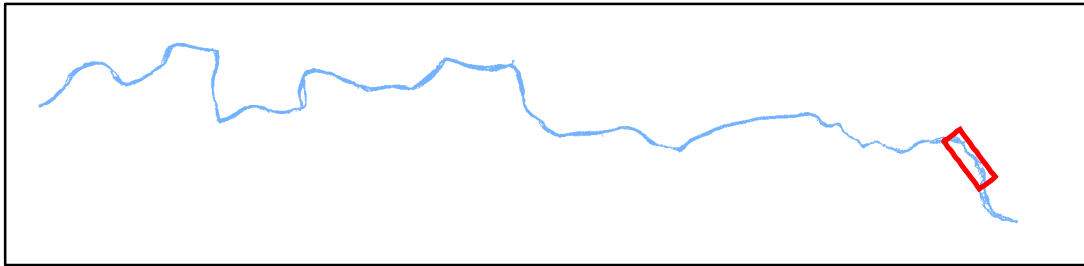

SYR Emergent Unsavable Surface Hazards at 31 m³/s, p. 3

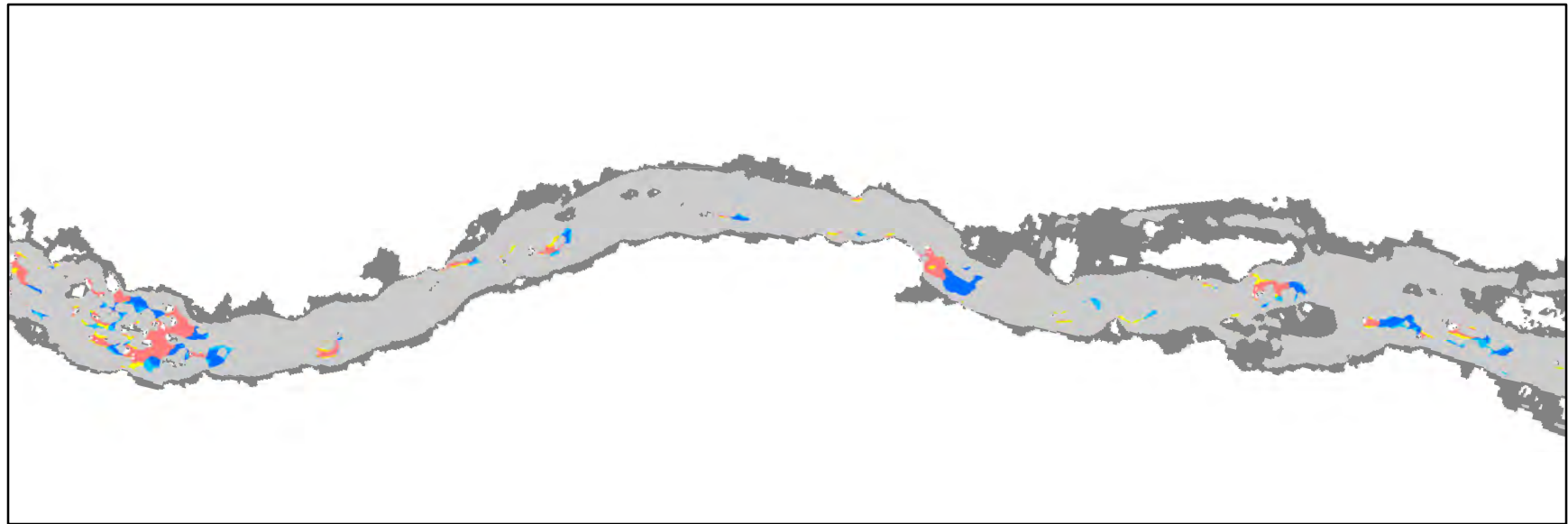

0 50 100 200 m



Channel Regions

PP0/RT0	PP1/RT2	PP2/RT2
PP1/RT1	PP2/RT1	Submerged savable surface

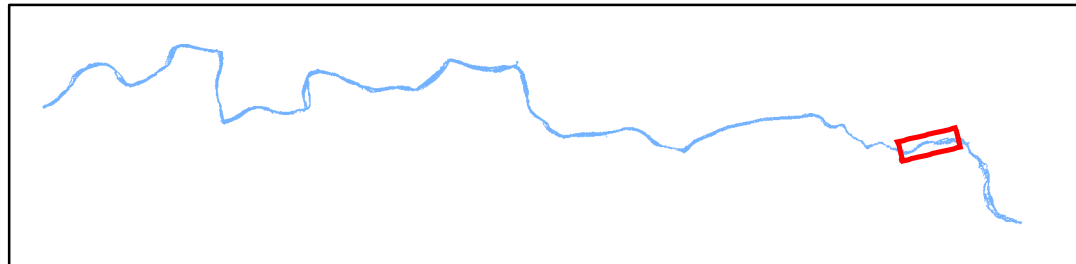

SYR Emergent Unsaveable Surface Hazards at 31 m³/s, p. 4

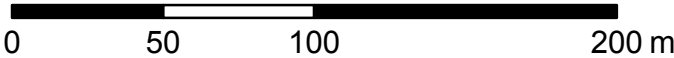
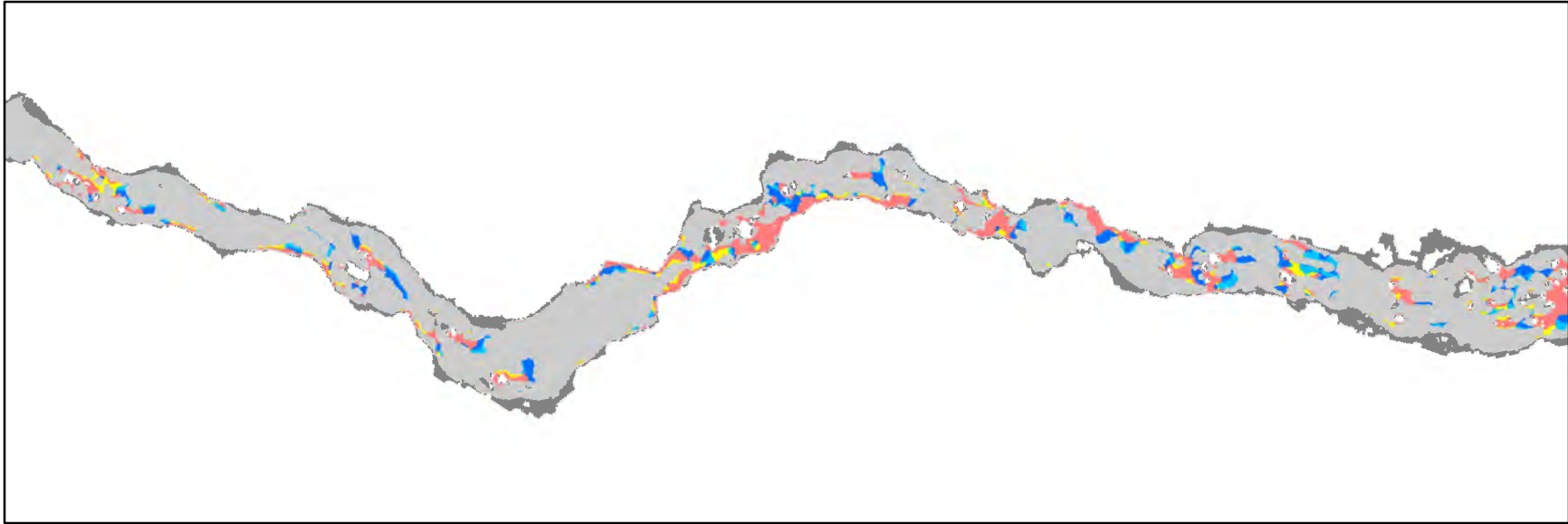

Channel Regions

Light Gray	PP0/RT0	Yellow	PP1/RT2	Red	PP2/RT2
Cyan	PP1/RT1	Blue	PP2/RT1	Dark Gray	Submerged saveable surface

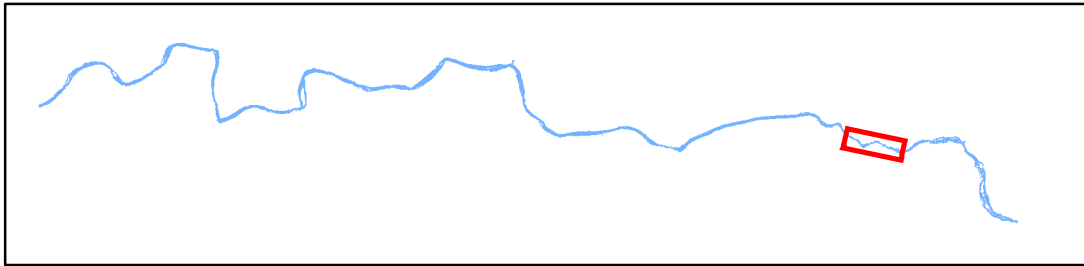

SYR Emergent Unsavable Surface Hazards at 31 m³/s, p. 5

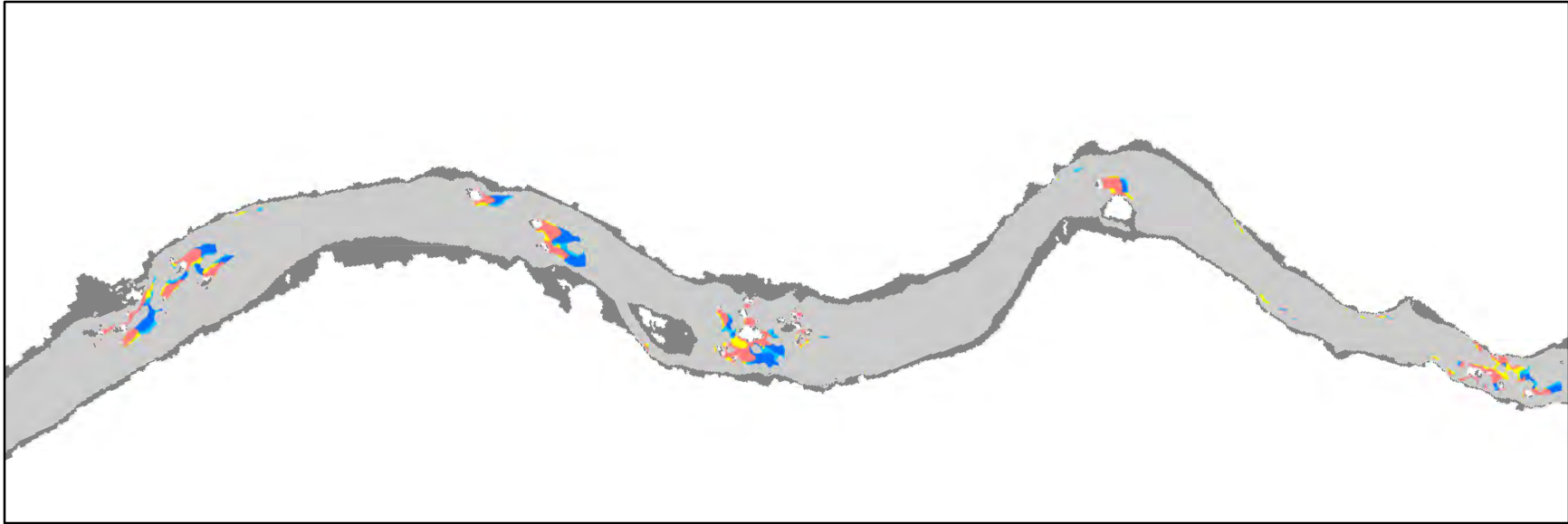

0 50 100 200 m



Channel Regions

- | | | | | | |
|------------|---------|--------|---------|-----------|---------------------------|
| Light Gray | PP0/RT0 | Yellow | PP1/RT2 | Red | PP2/RT2 |
| Cyan | PP1/RT1 | Blue | PP2/RT1 | Dark Gray | Submerged savable surface |

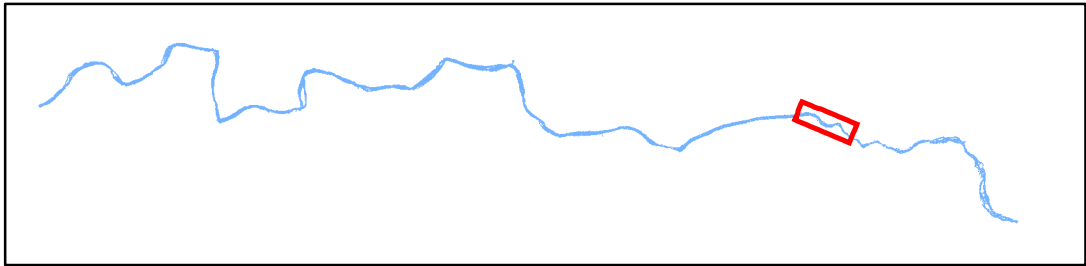

SYR Emergent Unsaveable Surface Hazards at 31 m³/s, p. 6

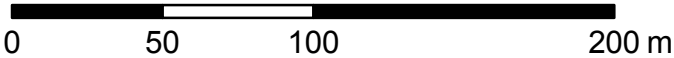
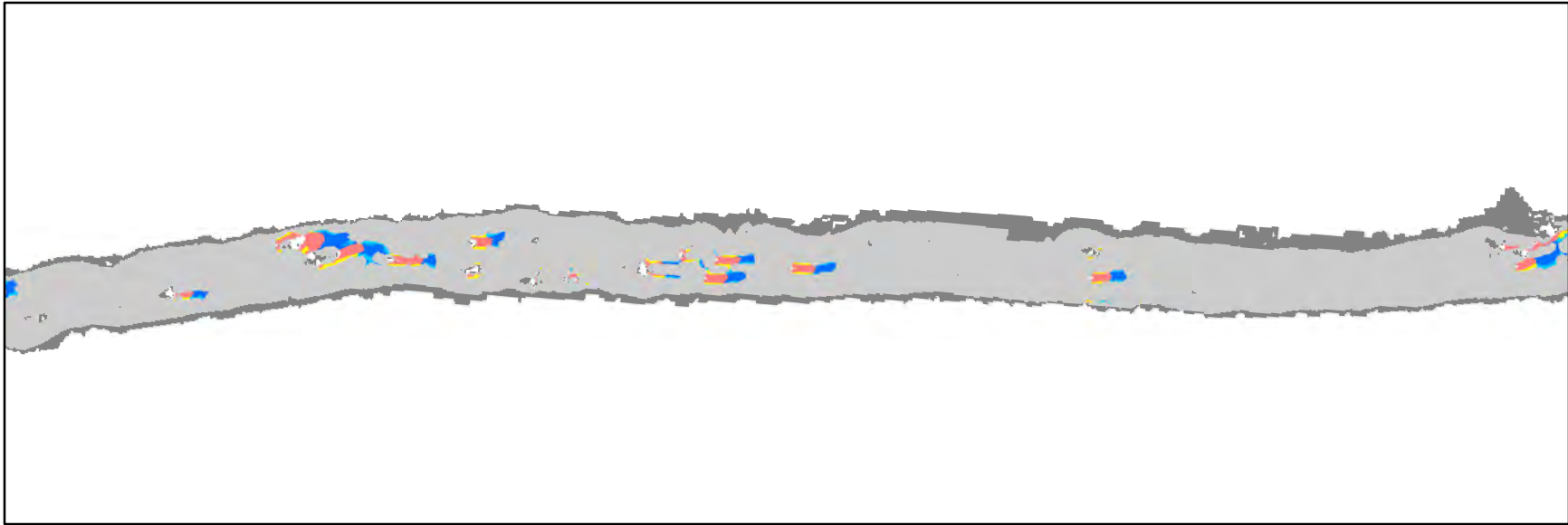

Channel Regions

Grey	PP0/RT0	Yellow	PP1/RT2	Red	PP2/RT2
Cyan	PP1/RT1	Blue	PP2/RT1	Dark Grey	Submerged savable surface

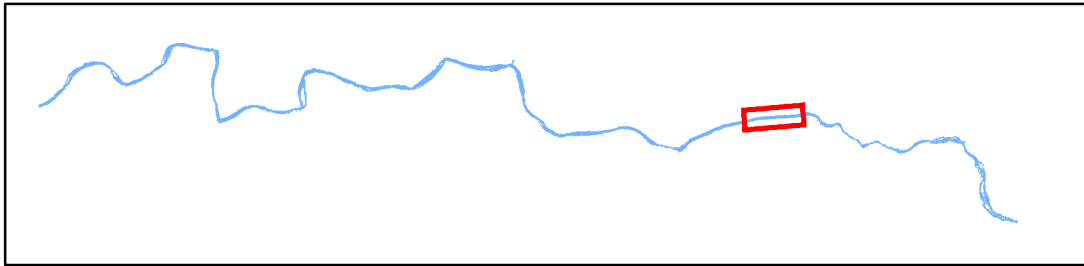

SYR Emergent Unsavable Surface Hazards at 31 m³/s, p. 7

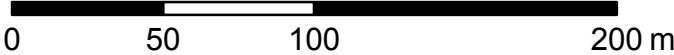
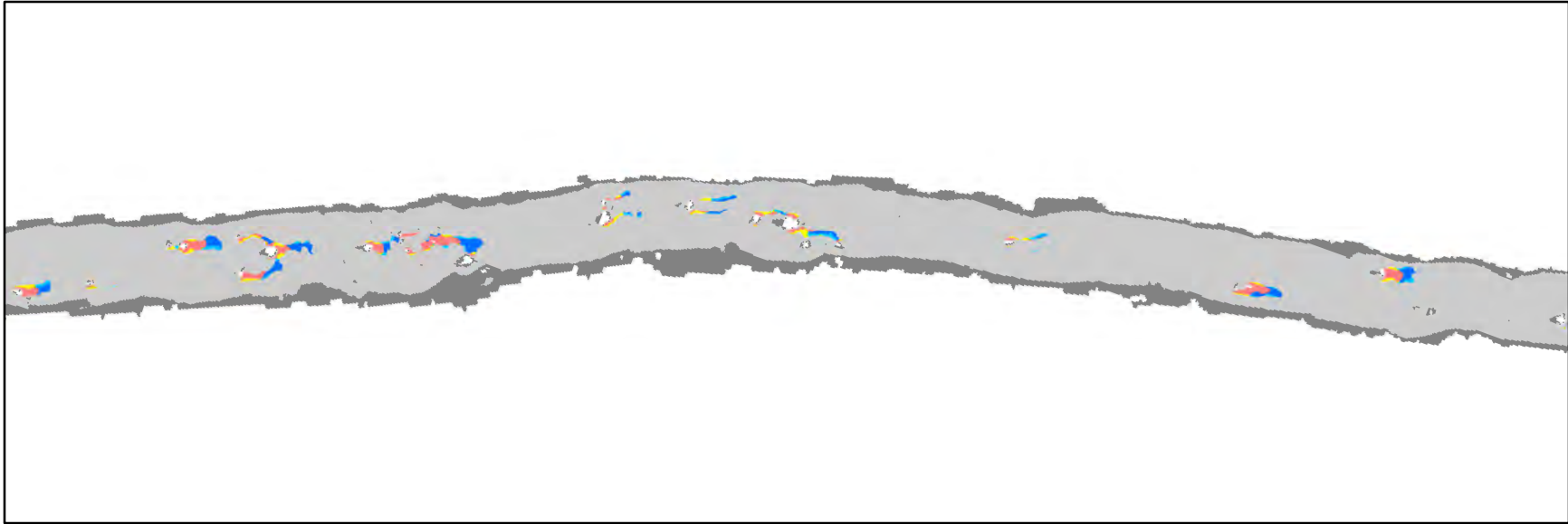

Channel Regions

Grey	PP0/RT0	Yellow	PP1/RT2	Red	PP2/RT2
Cyan	PP1/RT1	Blue	PP2/RT1	Dark Grey	Submerged savable surface

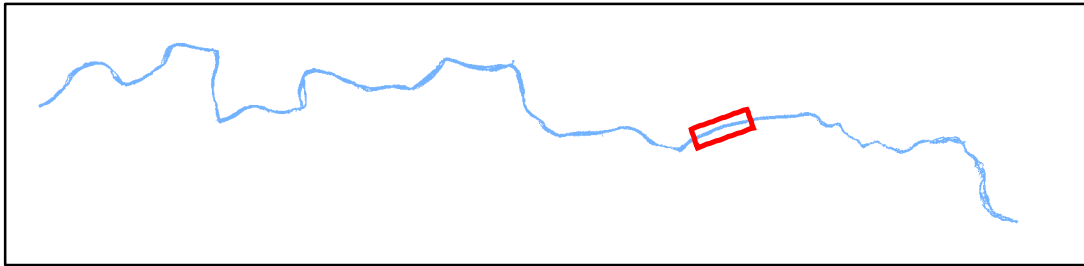

SYR Emergent Unsaveable Surface Hazards at 31 m³/s, p. 8

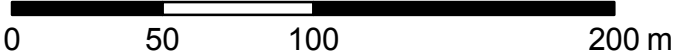
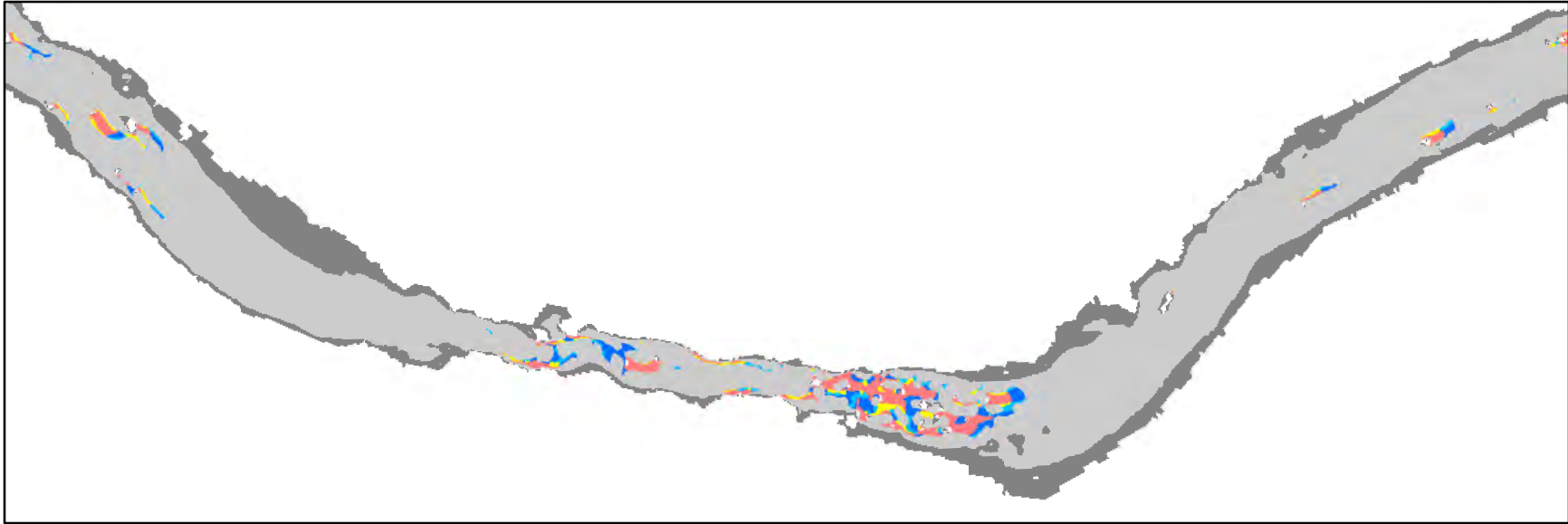

Channel Regions

Light Gray	PP0/RT0	Yellow	PP1/RT2	Red	PP2/RT2
Cyan	PP1/RT1	Blue	PP2/RT1	Dark Gray	Submerged savable surface

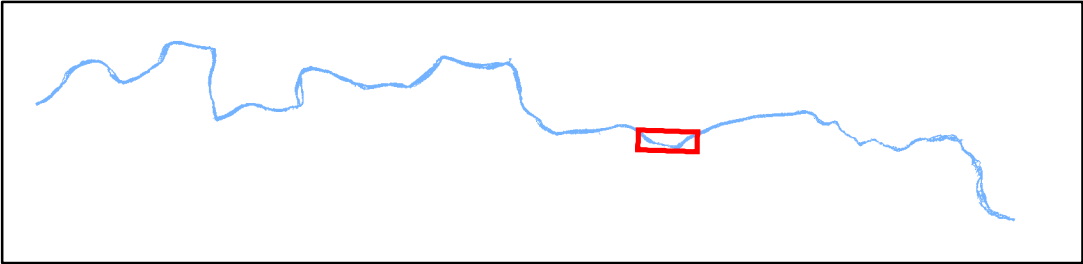

SYR Emergent Unsaveable Surface Hazards at 31 m³/s, p. 9



0 50 100 200 m



Channel Regions

- | | | |
|---------|---------|---------------------------|
| PP0/RT0 | PP1/RT2 | PP2/RT2 |
| PP1/RT1 | PP2/RT1 | Submerged savable surface |

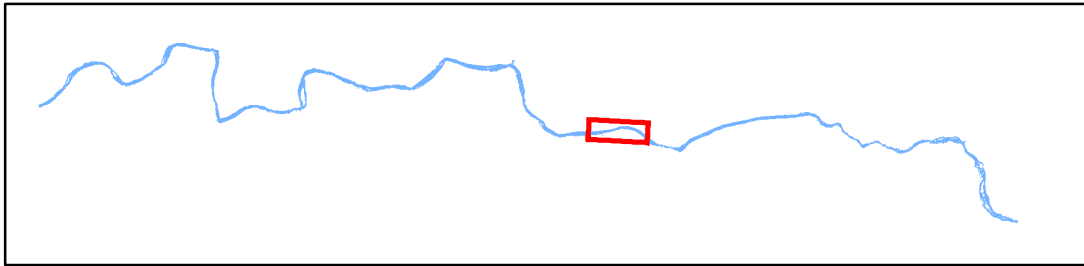

SYR Emergent Unsaveable Surface Hazards at 31 m³/s, p. 10

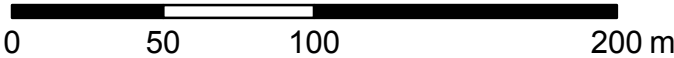

Channel Regions

Light Gray	PP0/RT0	Yellow	PP1/RT2	Red	PP2/RT2
Cyan	PP1/RT1	Blue	PP2/RT1	Dark Gray	Submerged savable surface

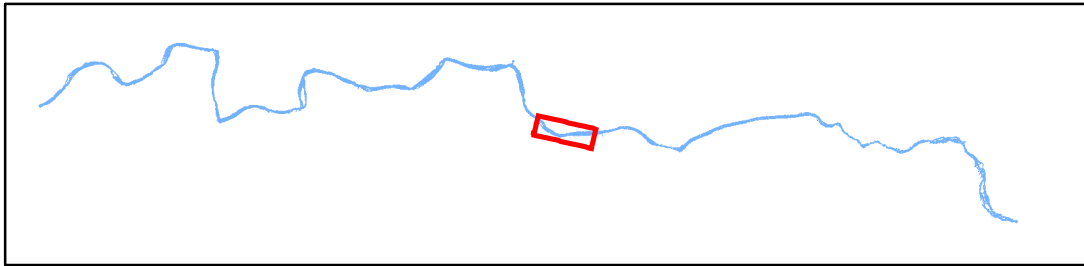

SYR Emergent Unsaveable Surface Hazards at 31 m³/s, p. 11

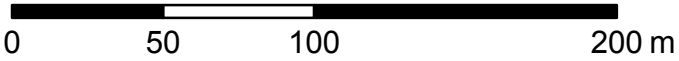
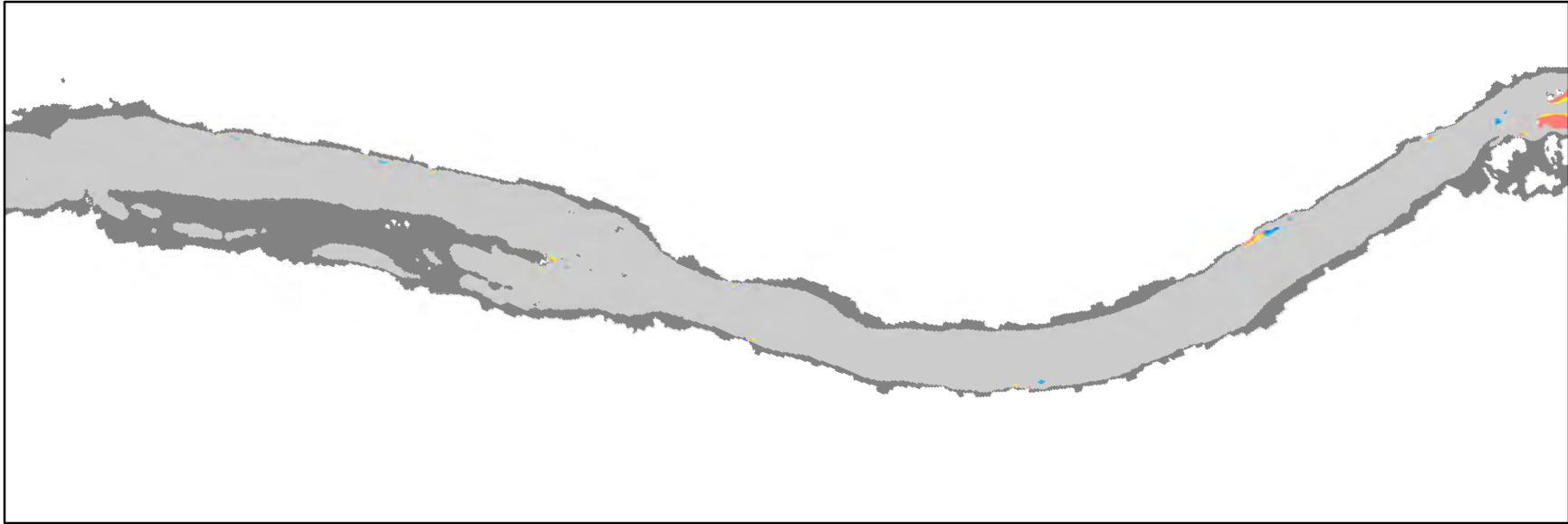

Channel Regions

Light Gray	PP0/RT0	Yellow	PP1/RT2	Red	PP2/RT2
Cyan	PP1/RT1	Blue	PP2/RT1	Dark Gray	Submerged savable surface

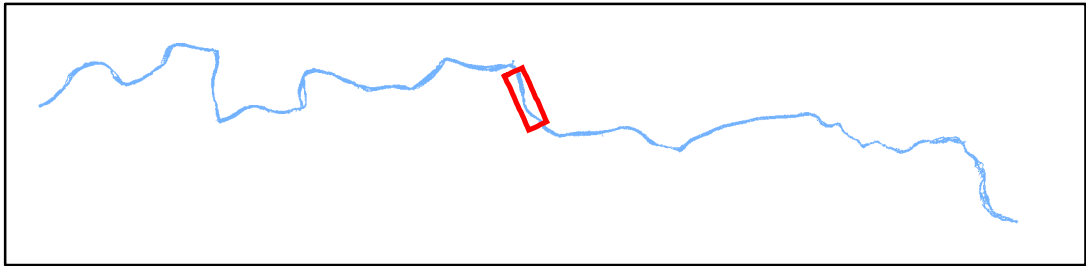

SYR Emergent Unsaveable Surface Hazards at 31 m³/s, p. 12

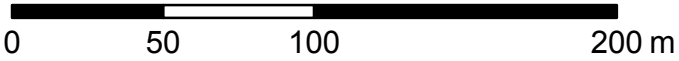
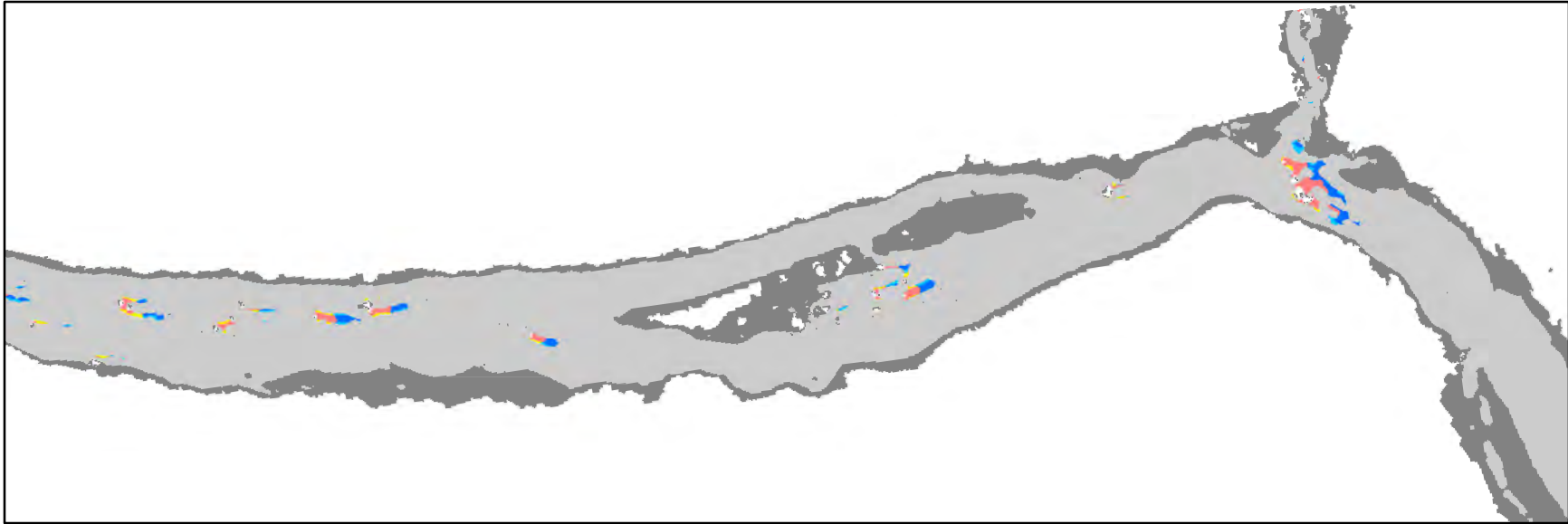

Channel Regions

Light Gray	PP0/RT0	Yellow	PP1/RT2	Red	PP2/RT2
Cyan	PP1/RT1	Blue	PP2/RT1	Dark Gray	Submerged savable surface

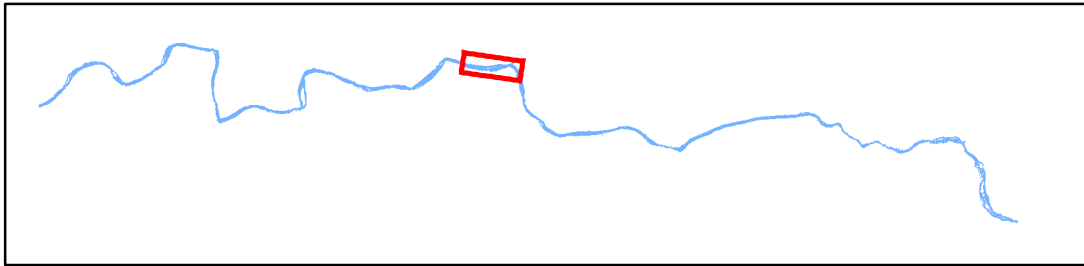

SYR Emergent Unsaveable Surface Hazards at 31 m³/s, p. 13

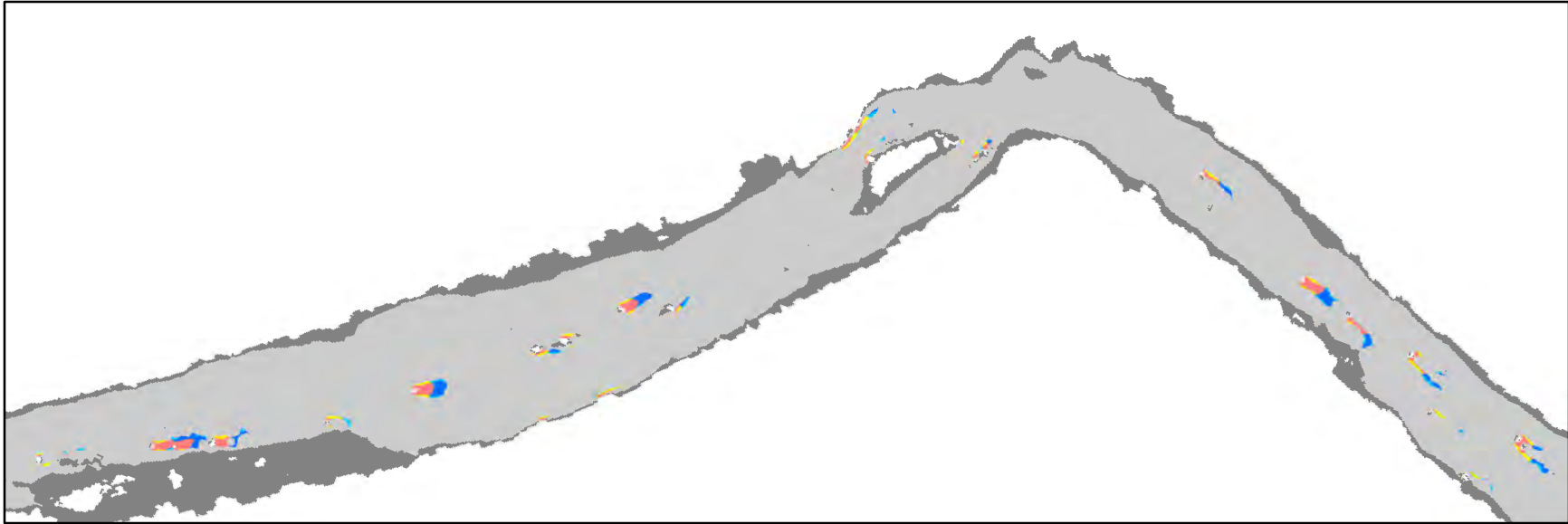

0 50 100 200 m



Channel Regions

Light Gray	PP0/RT0	Yellow	PP1/RT2	Red	PP2/RT2
Cyan	PP1/RT1	Blue	PP2/RT1	Dark Gray	Submerged savable surface

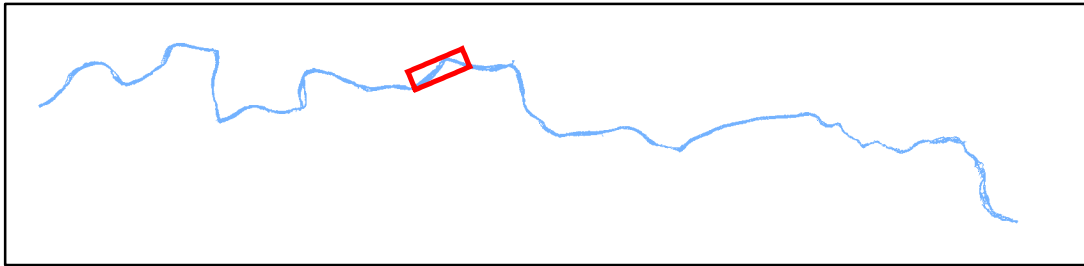

SYR Emergent Unsaveable Surface Hazards at 31 m³/s, p. 14

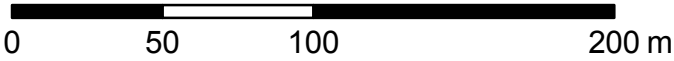
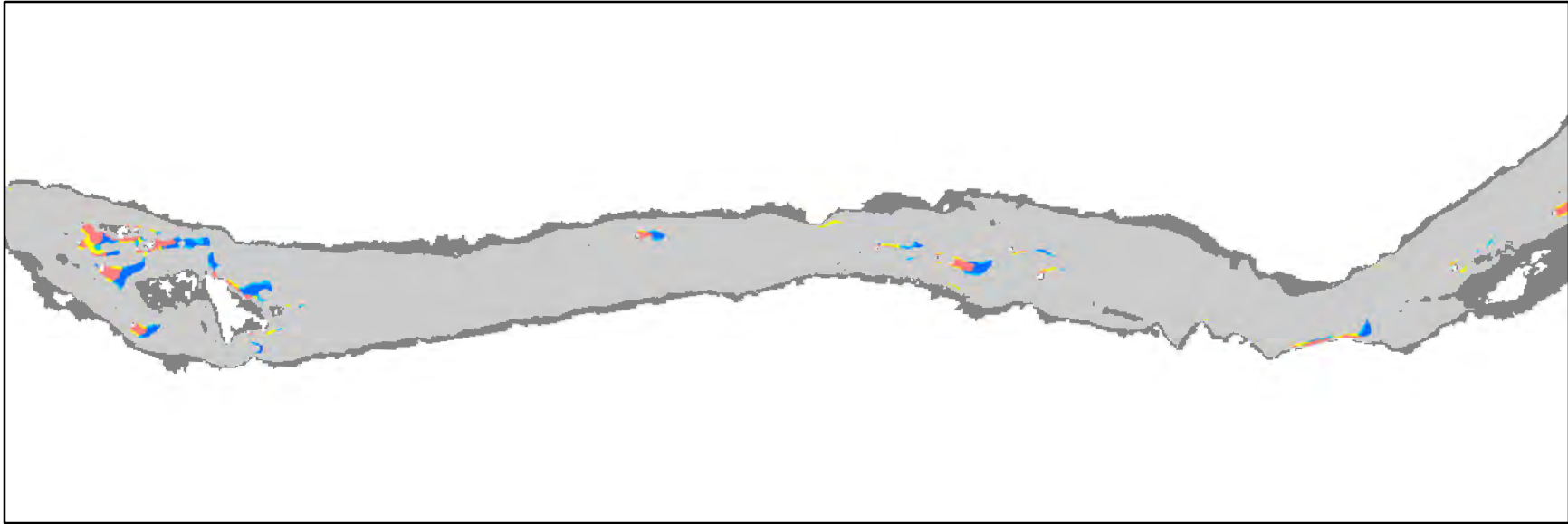

Channel Regions

Light Gray	PP0/RT0	Yellow	PP1/RT2	Red	PP2/RT2
Cyan	PP1/RT1	Blue	PP2/RT1	Dark Gray	Submerged savable surface

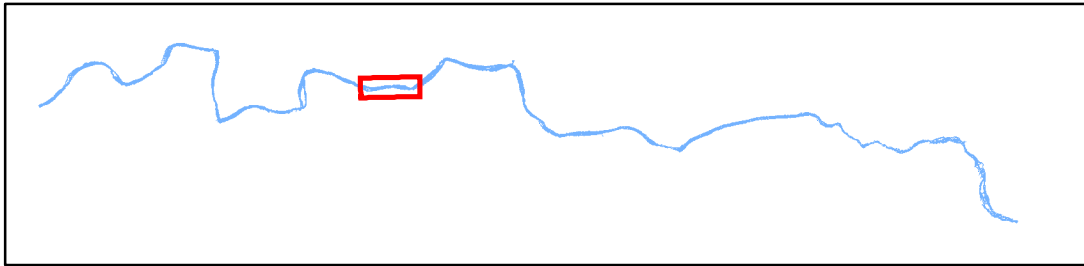

SYR Emergent Unsaveable Surface Hazards at 31 m³/s, p. 15

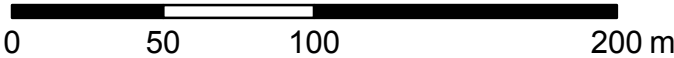
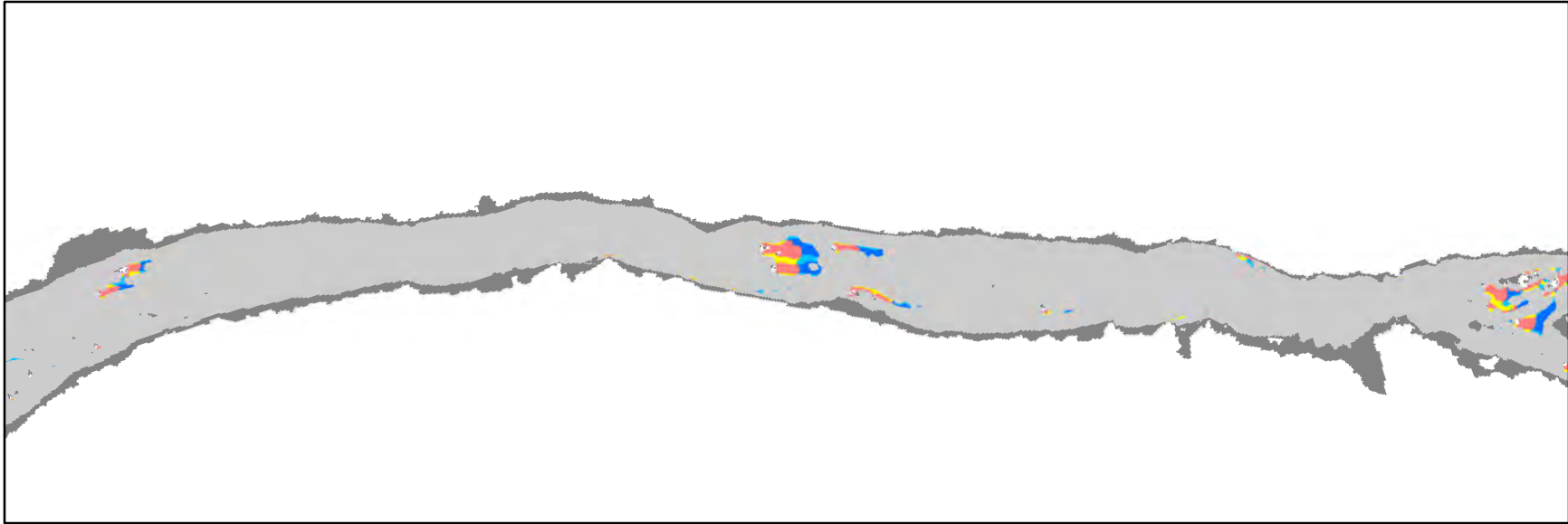

Channel Regions

Grey	PP0/RT0	Yellow	PP1/RT2	Red	PP2/RT2
Cyan	PP1/RT1	Blue	PP2/RT1	Dark Grey	Submerged savable surface

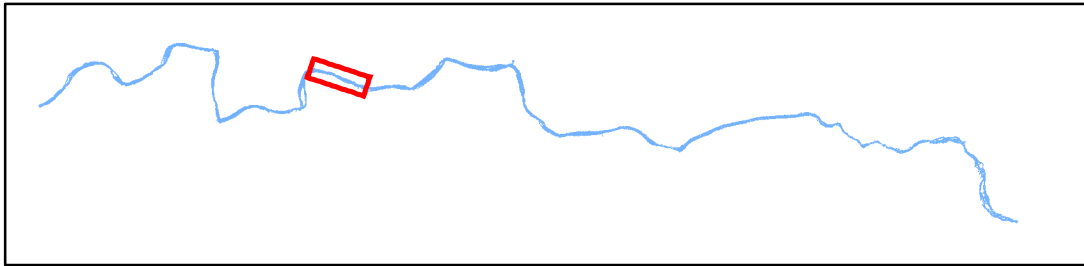

SYR Emergent Unsaveable Surface Hazards at 31 m³/s, p. 16

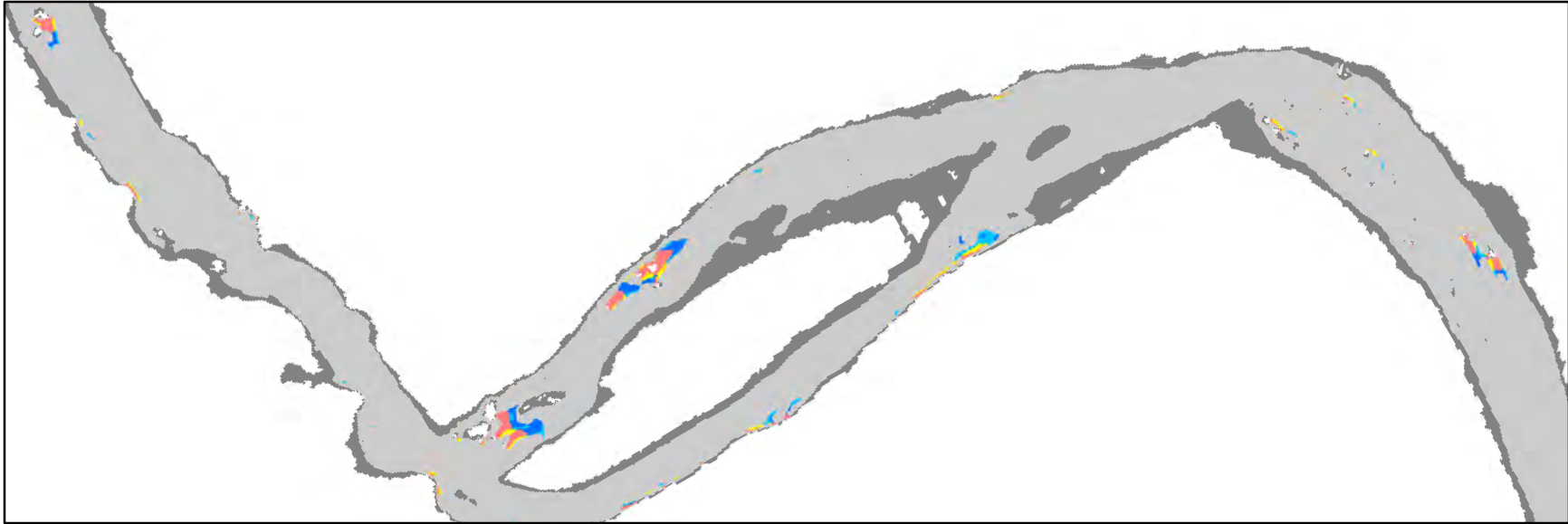

0 50 100 200 m



Channel Regions



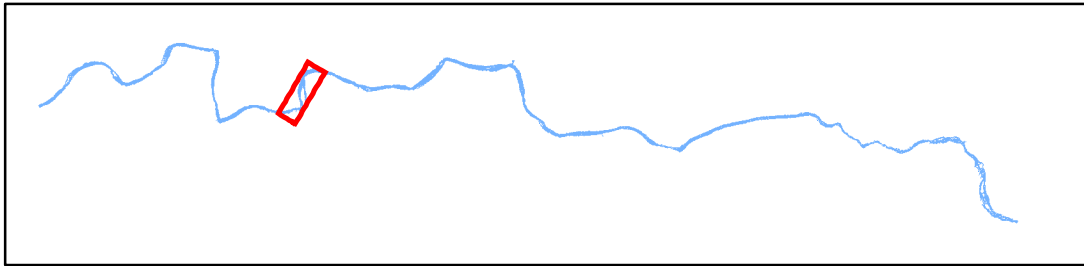

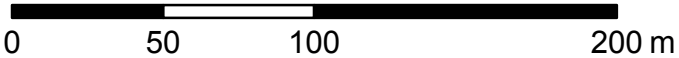
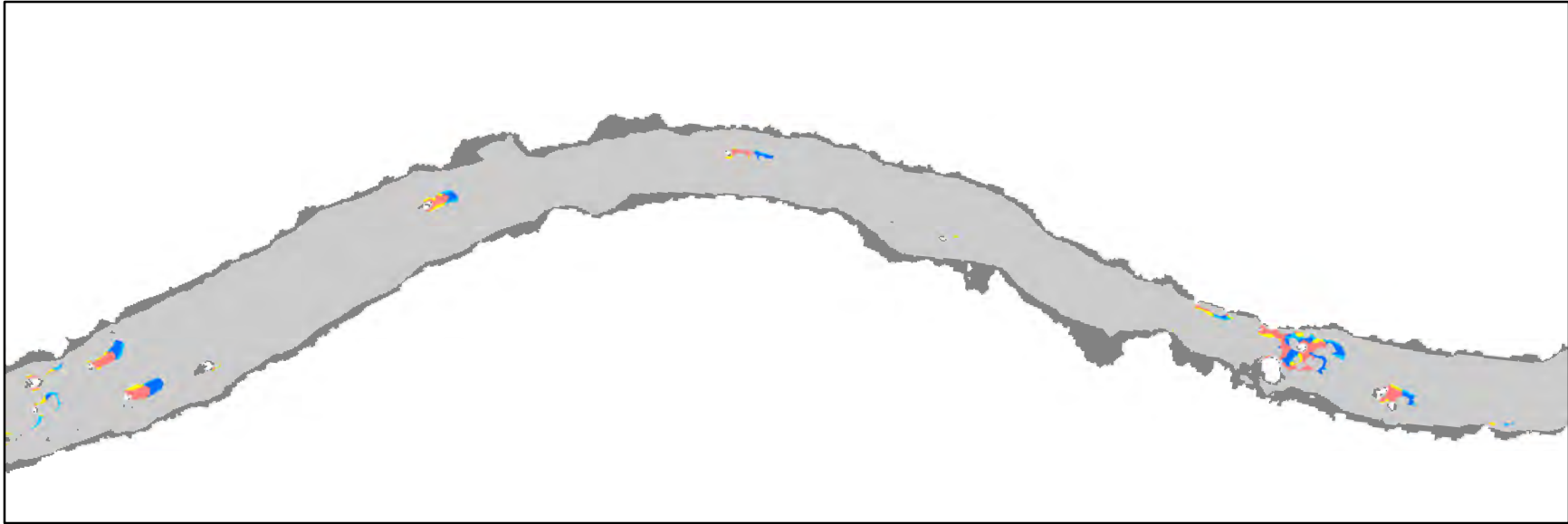

- | | | | | | |
|------------|---------|--------|---------|-----------|---------------------------|
| Light Gray | PP0/RT0 | Yellow | PP1/RT2 | Red | PP2/RT2 |
| Cyan | PP1/RT1 | Blue | PP2/RT1 | Dark Gray | Submerged savable surface |



SYR Emergent Unsaveable Surface Hazards at 31 m³/s, p. 17



Channel Regions

 PP0/RT0	 PP1/RT2	 PP2/RT2
 PP1/RT1	 PP2/RT1	 Submerged savable surface

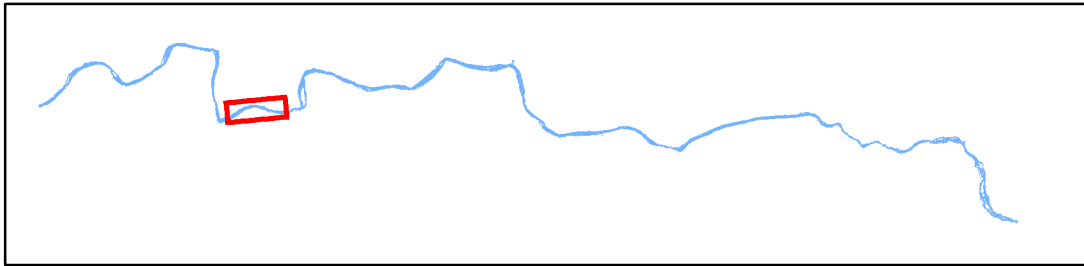

SYR Emergent Unsavable Surface Hazards at 31 m³/s, p. 18

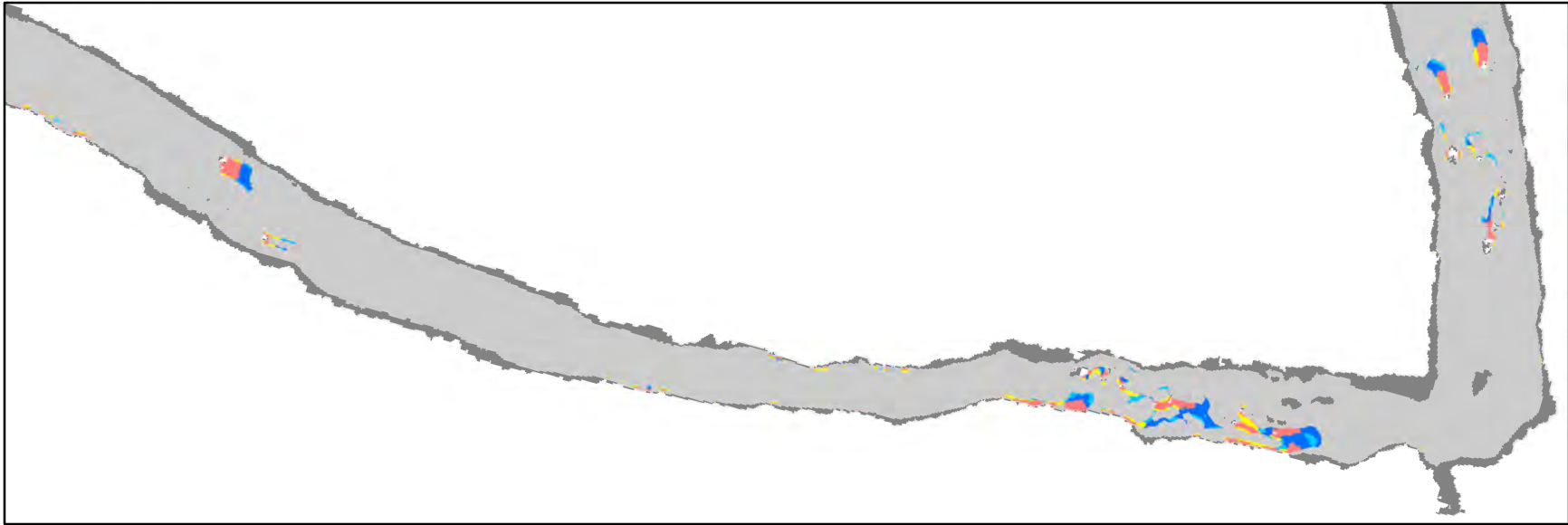

0 50 100 200 m



Channel Regions

- | | | |
|---------|---------|---------------------------|
| PP0/RT0 | PP1/RT2 | PP2/RT2 |
| PP1/RT1 | PP2/RT1 | Submerged savable surface |

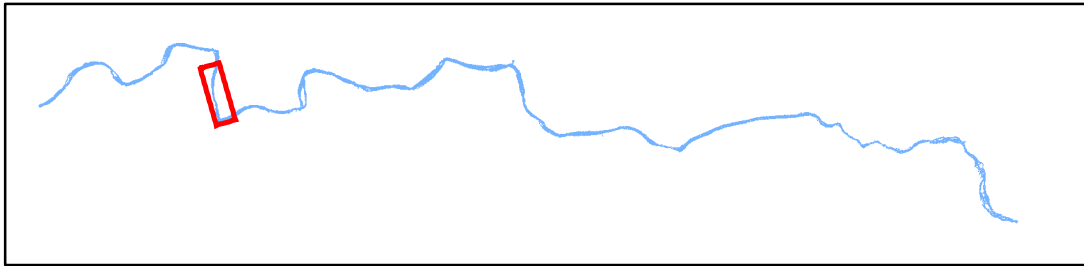

SYR Emergent Unsaveable Surface Hazards at 31 m³/s, p. 19

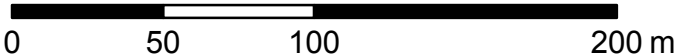
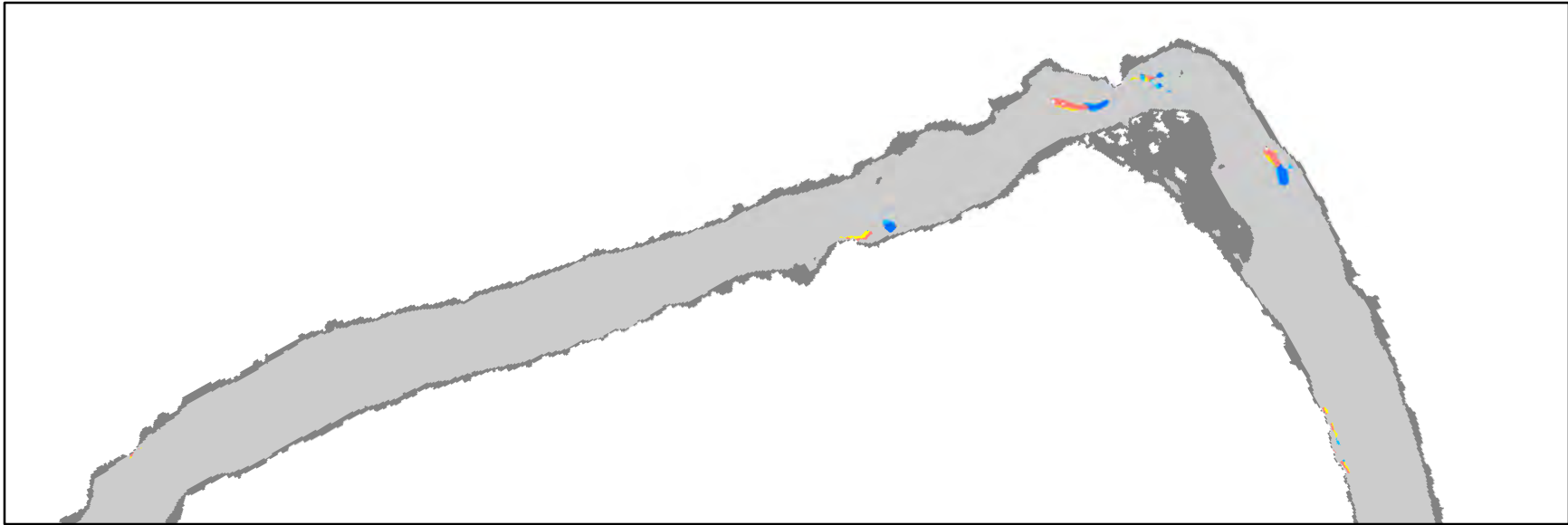

Channel Regions

PP0/RT0	PP1/RT2	PP2/RT2
PP1/RT1	PP2/RT1	Submerged savable surface

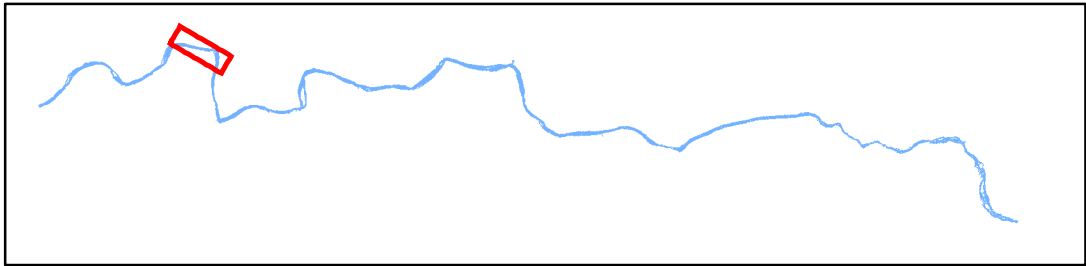

SYR Emergent Unsaveable Surface Hazards at 31 m³/s, p. 20

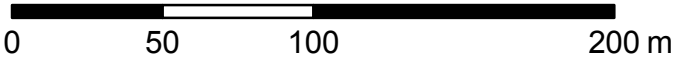
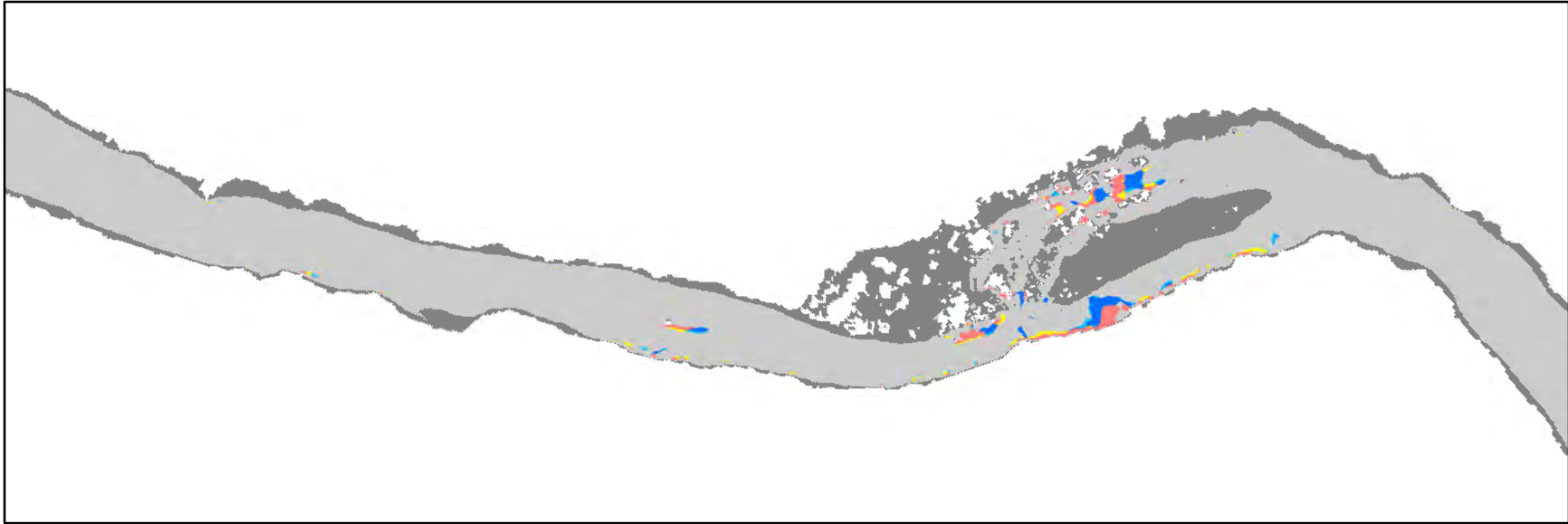

Channel Regions

PP0/RT0	PP1/RT2	PP2/RT2
PP1/RT1	PP2/RT1	Submerged saveable surface

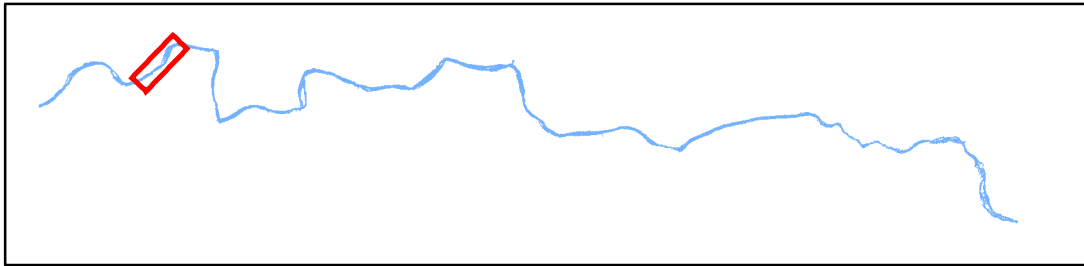

SYR Emergent Unsaveable Surface Hazards at 31 m³/s, p. 21

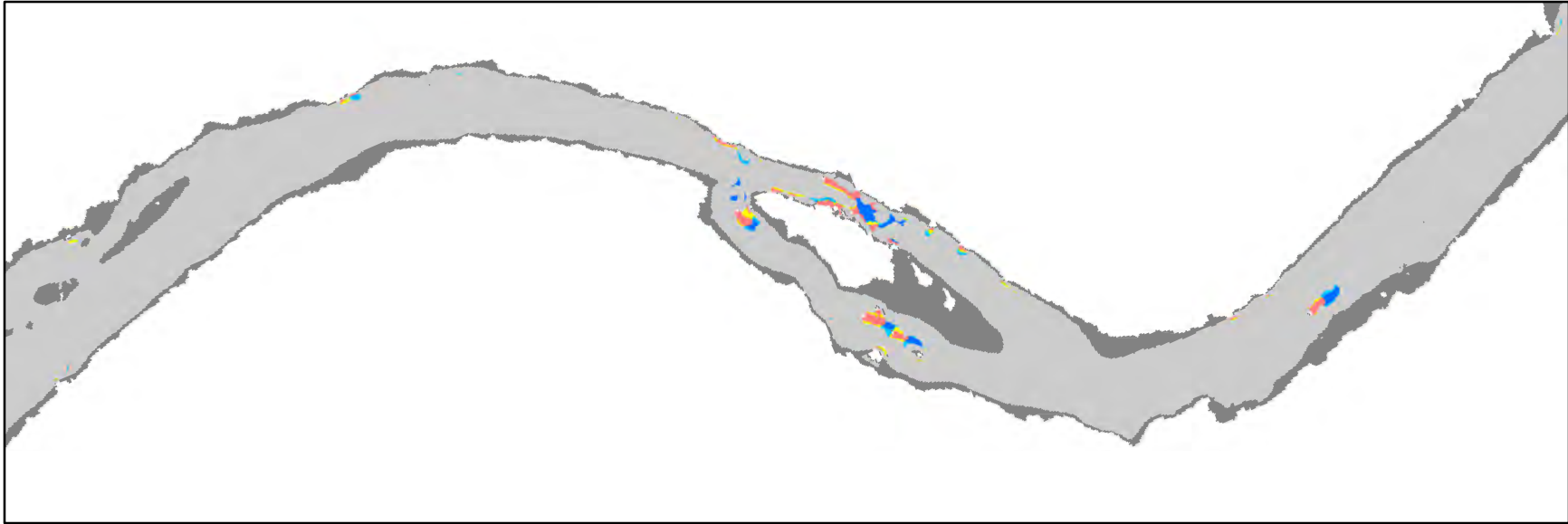

0 50 100 200 m



Channel Regions

PP0/RT0	PP1/RT2	PP2/RT2
PP1/RT1	PP2/RT1	Submerged savable surface

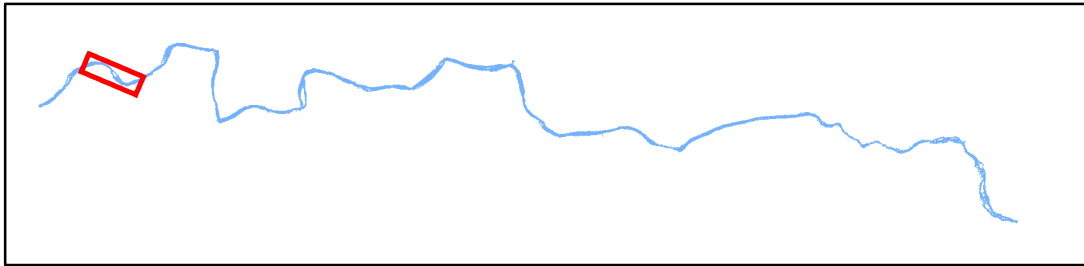

SYR Emergent Unsaveable Surface Hazards at 31 m³/s, p. 22

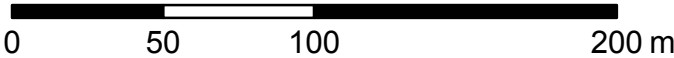
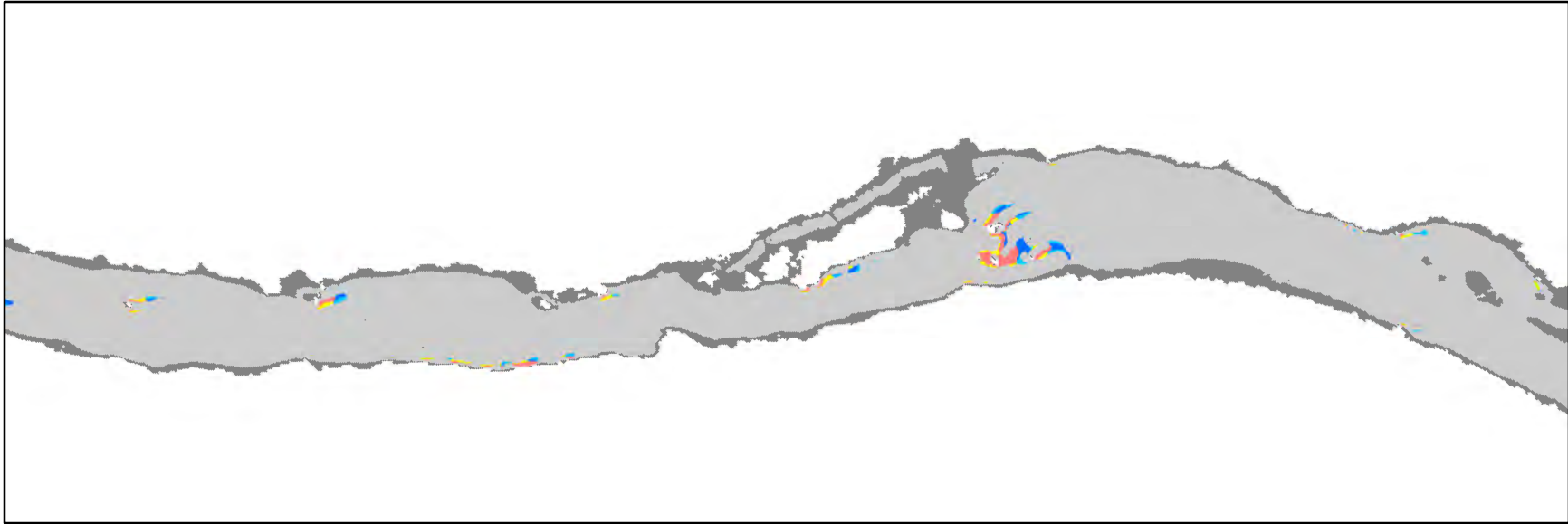

Channel Regions

Light Gray	PP0/RT0	Yellow	PP1/RT2	Red	PP2/RT2
Cyan	PP1/RT1	Blue	PP2/RT1	Dark Gray	Submerged savable surface

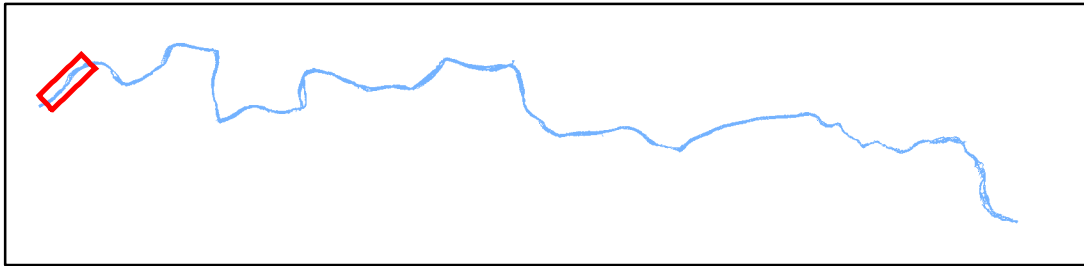

SYR Emergent Unsaveable Surface Hazards at 31 m³/s, p. 23

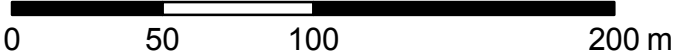
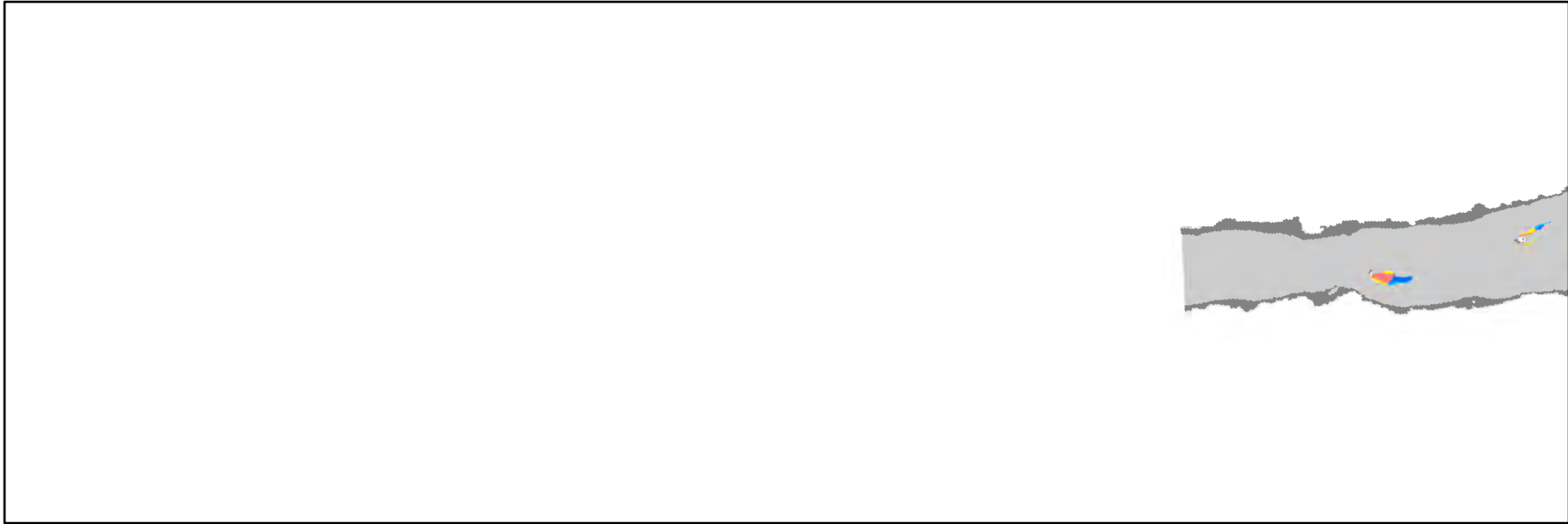

Channel Regions

Light Grey	PP0/RT0	Yellow	PP1/RT2	Red	PP2/RT2
Cyan	PP1/RT1	Blue	PP2/RT1	Dark Grey	Submerged savable surface

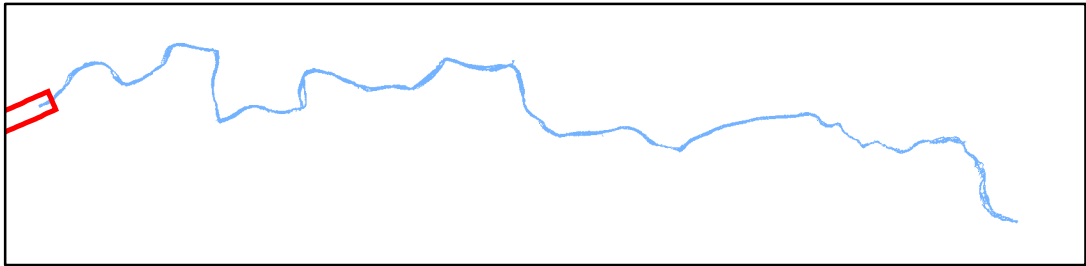

SYR Jump Hazards at 31 m³/s, p. 1

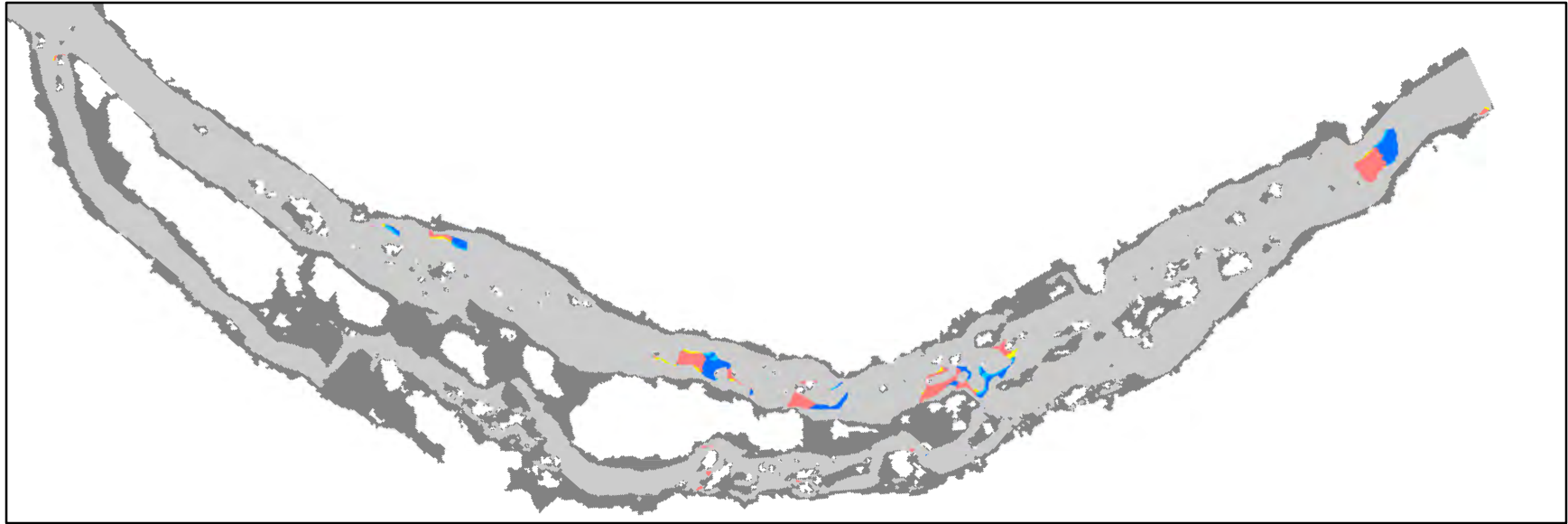

0 50 100 200 m

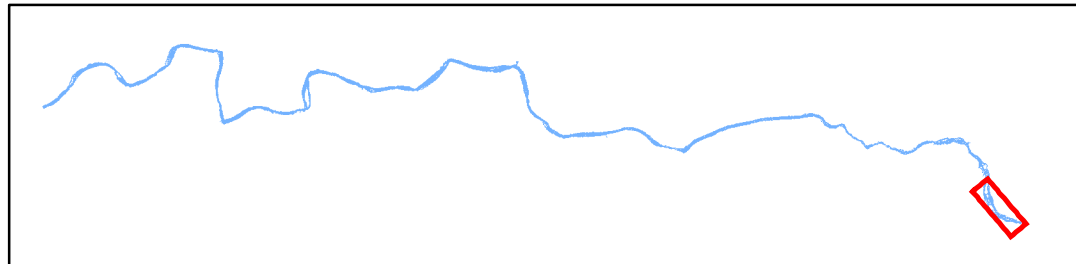
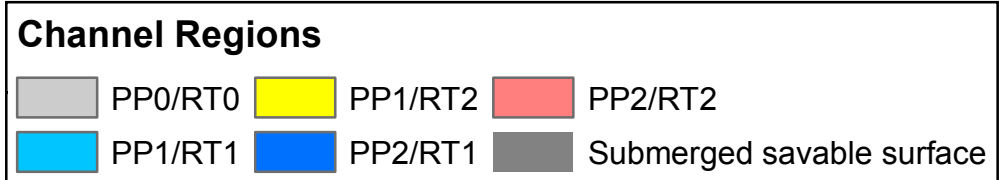

SYR Jump Hazards at 31 m³/s, p. 2

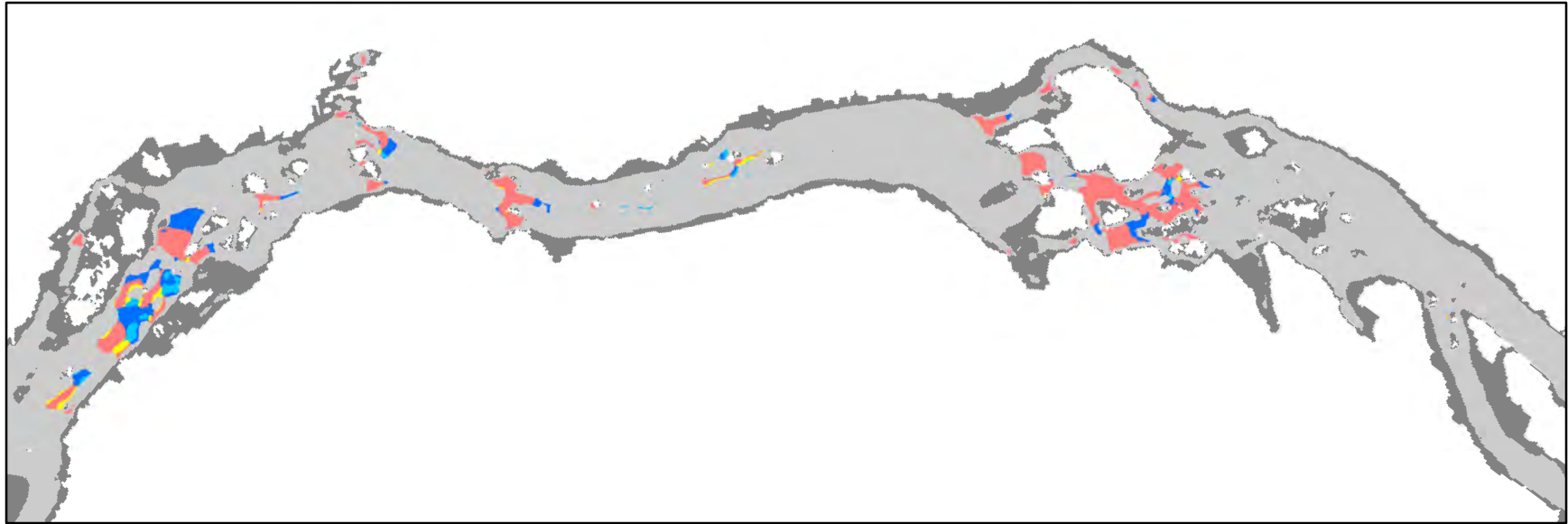

0 50 100 200 m



Channel Regions

Grey	PP0/RT0	Yellow	PP1/RT2	Red	PP2/RT2
Cyan	PP1/RT1	Blue	PP2/RT1	Dark Grey	Submerged savable surface

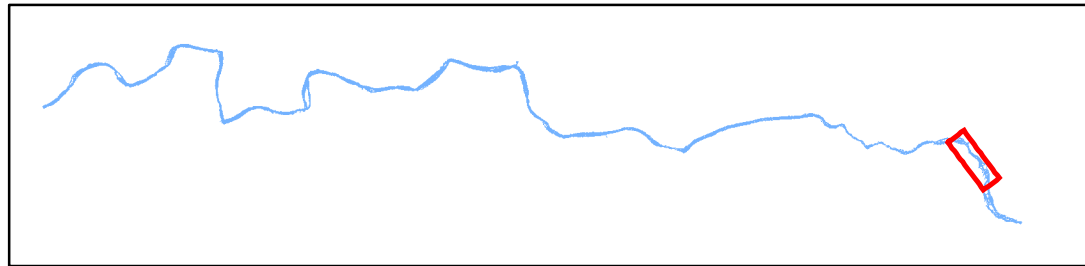



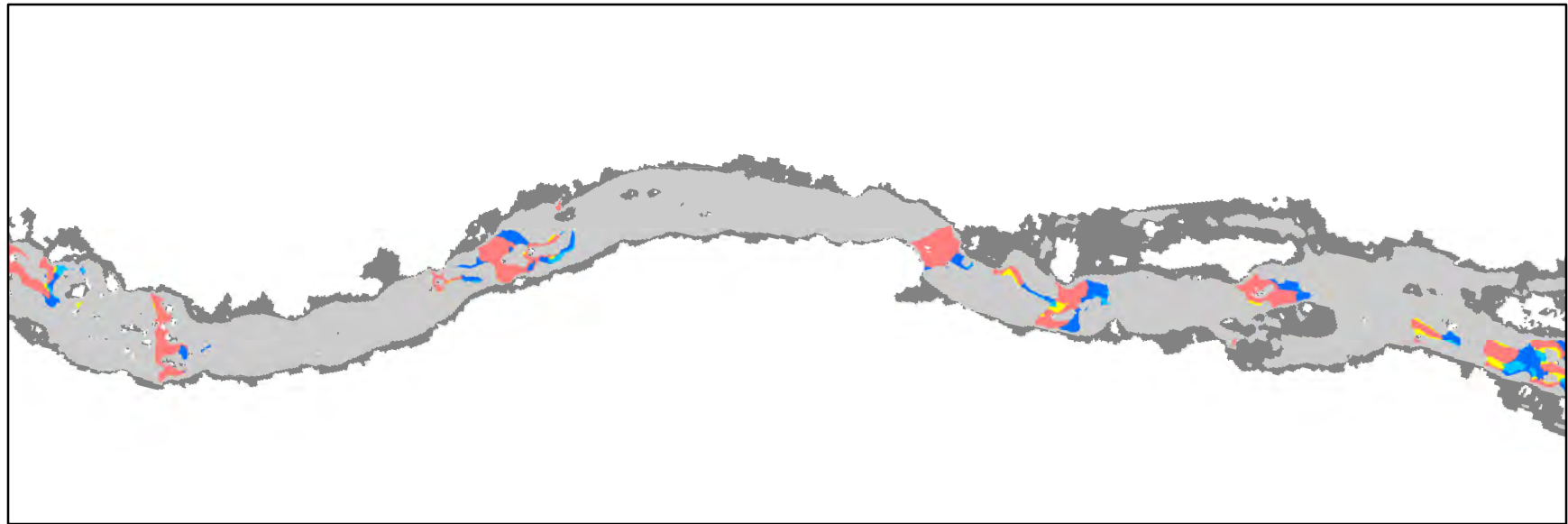



SYR Jump Hazards at 31 m³/s, p. 3



0 50 100 200 m



Channel Regions					
	PP0/RT0		PP1/RT2		PP2/RT2
	PP1/RT1		PP2/RT1		Submerged savable surface

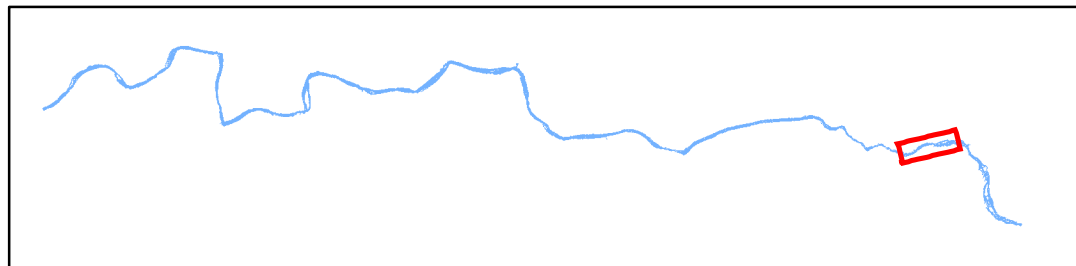

SYR Jump Hazards at 31 m³/s, p. 4

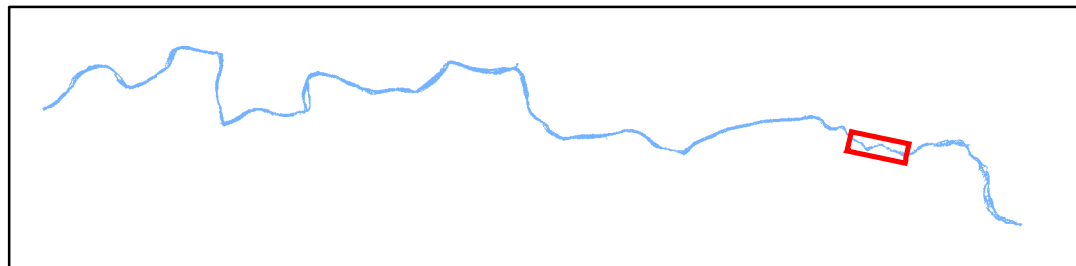
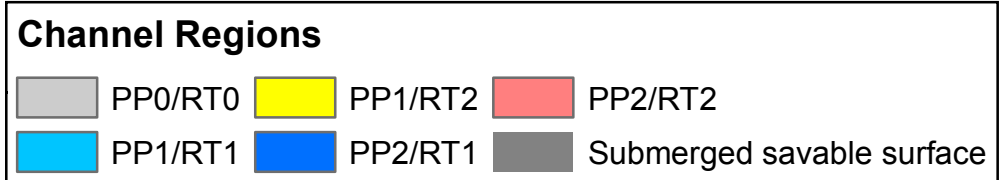
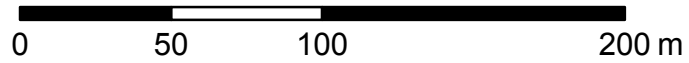
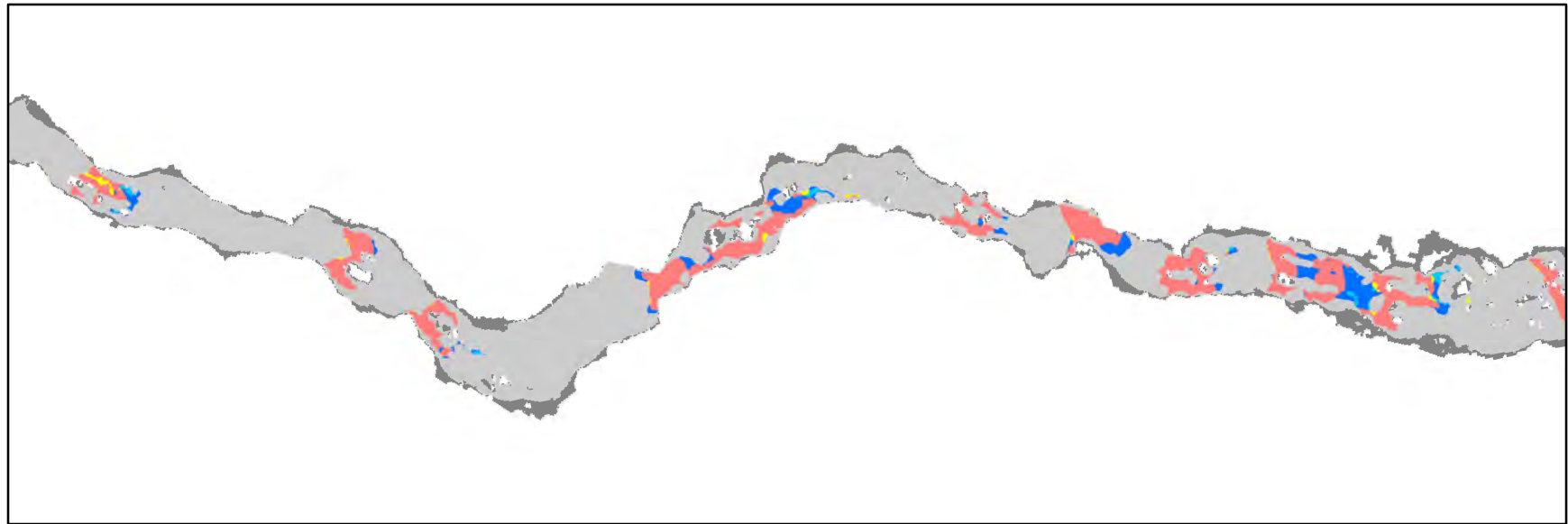

SYR Jump Hazards at 31 m³/s, p. 5

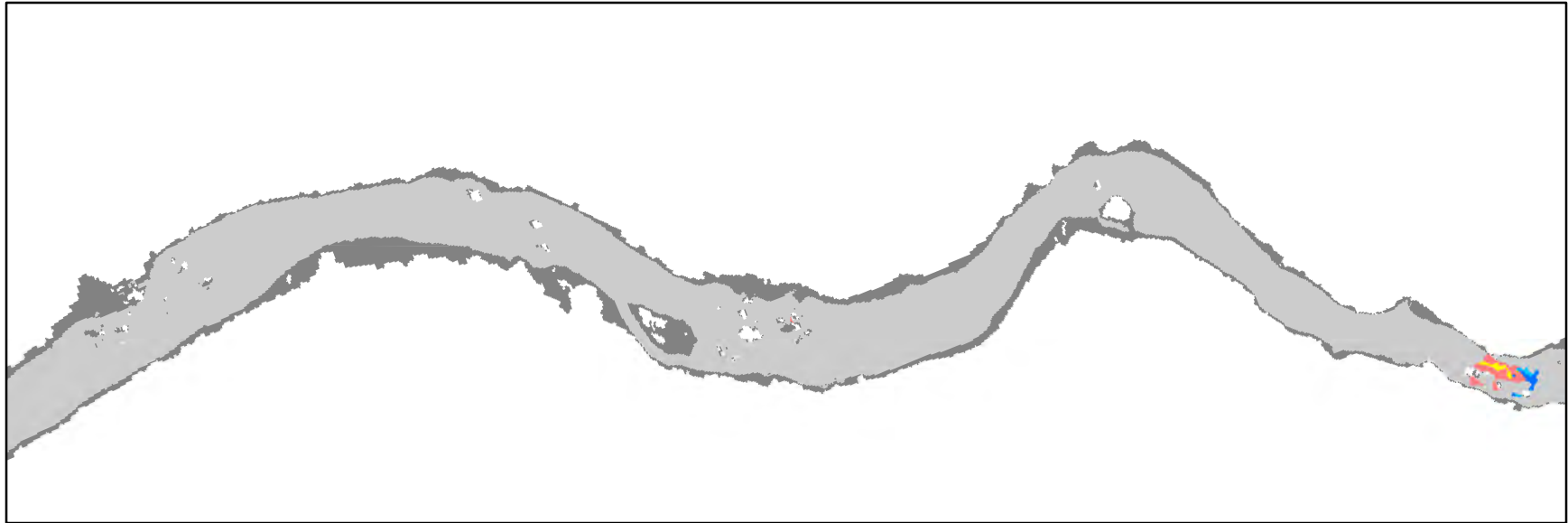

0 50 100 200 m

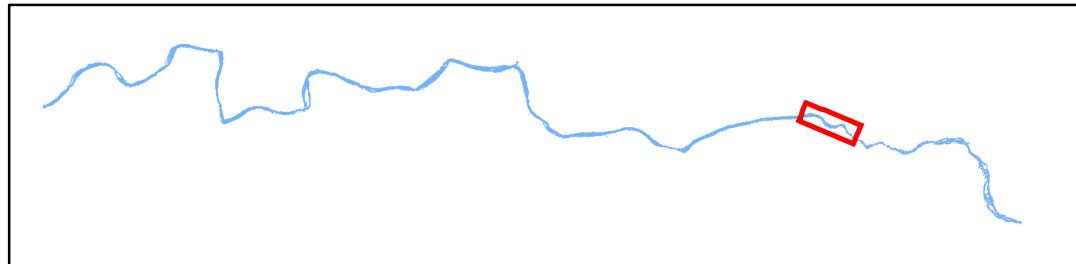
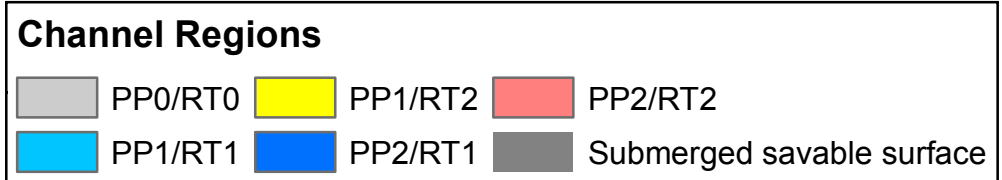

SYR Jump Hazards at 31 m³/s, p. 6

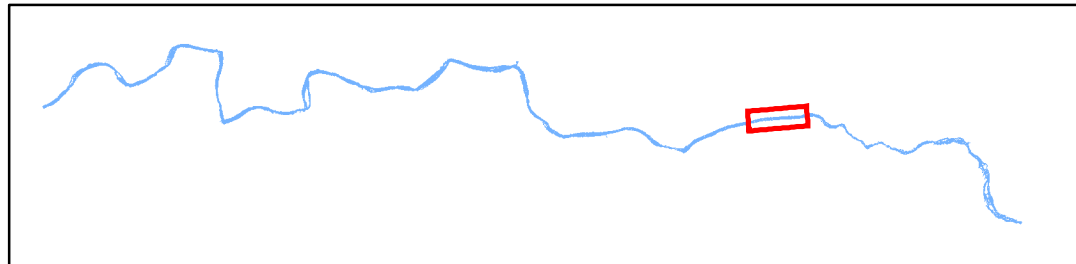
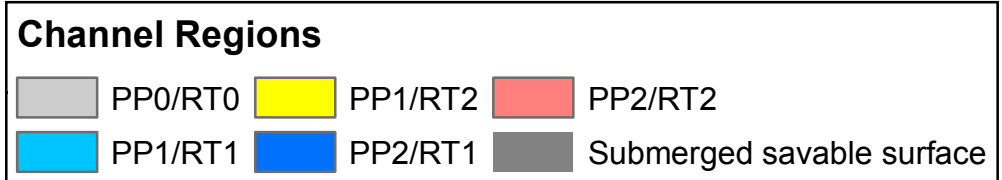
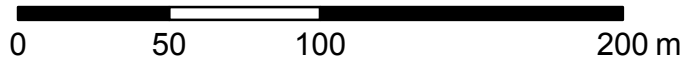
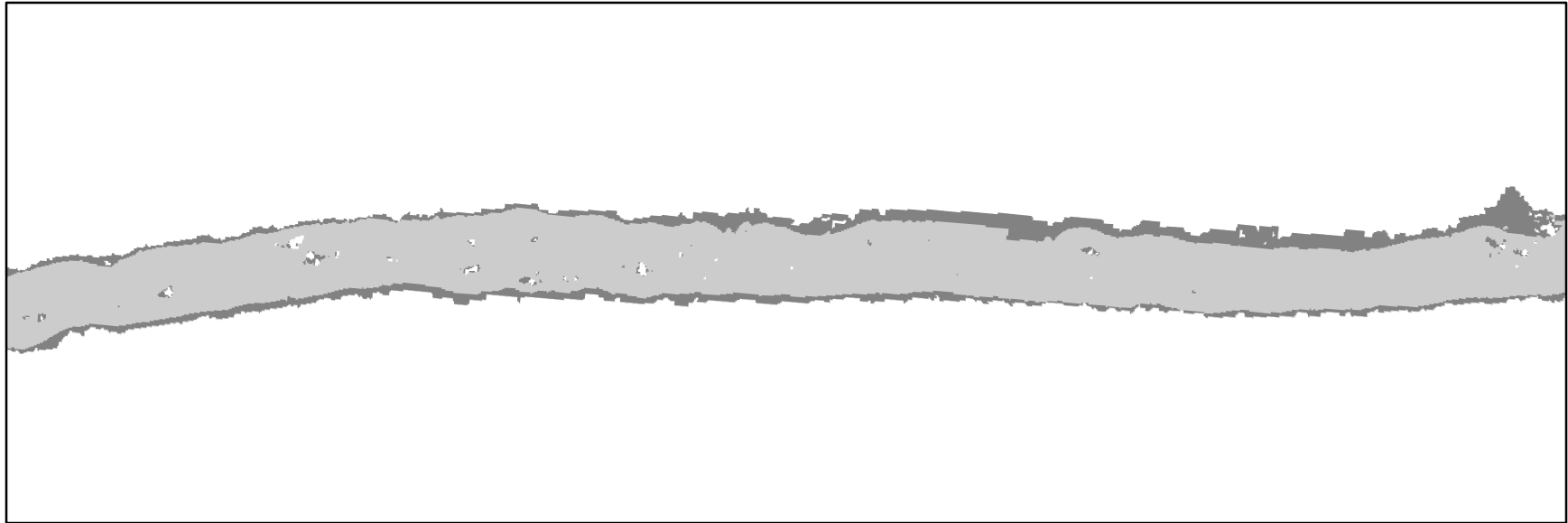

SYR Jump Hazards at 31 m³/s, p. 7

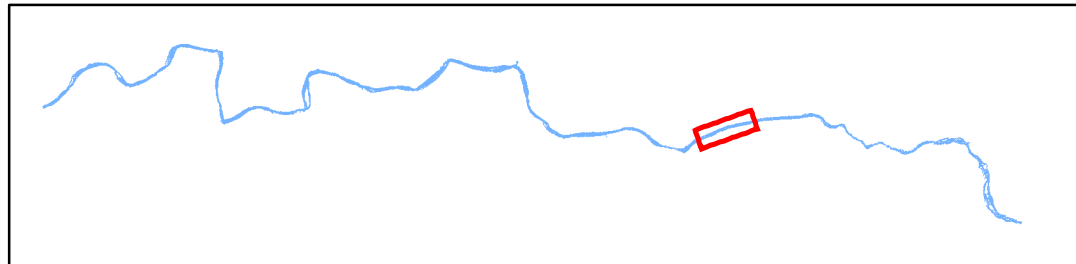
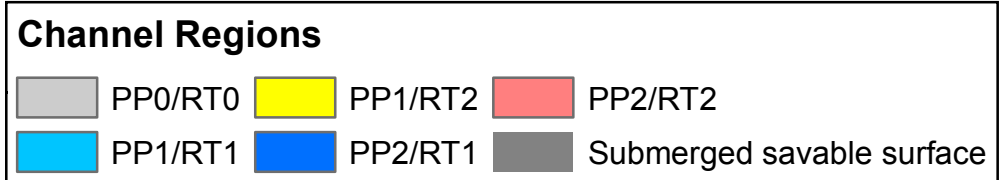
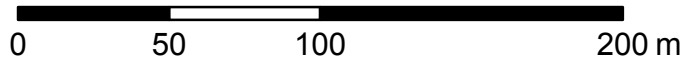
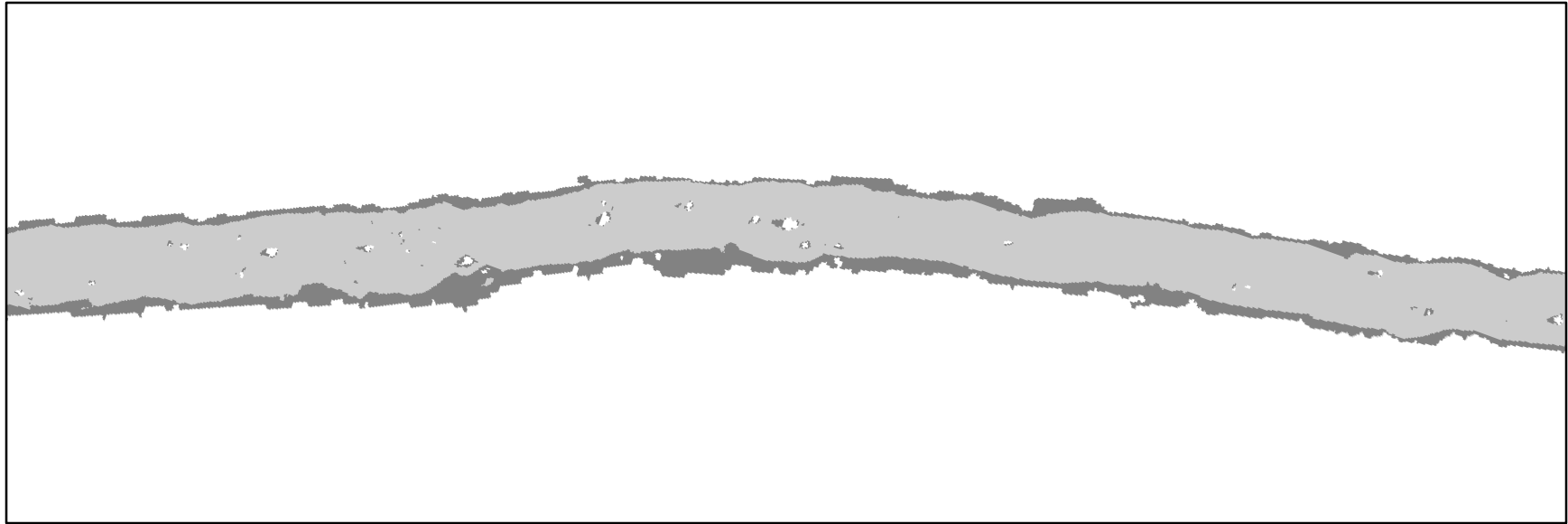

SYR Jump Hazards at 31 m³/s, p. 8

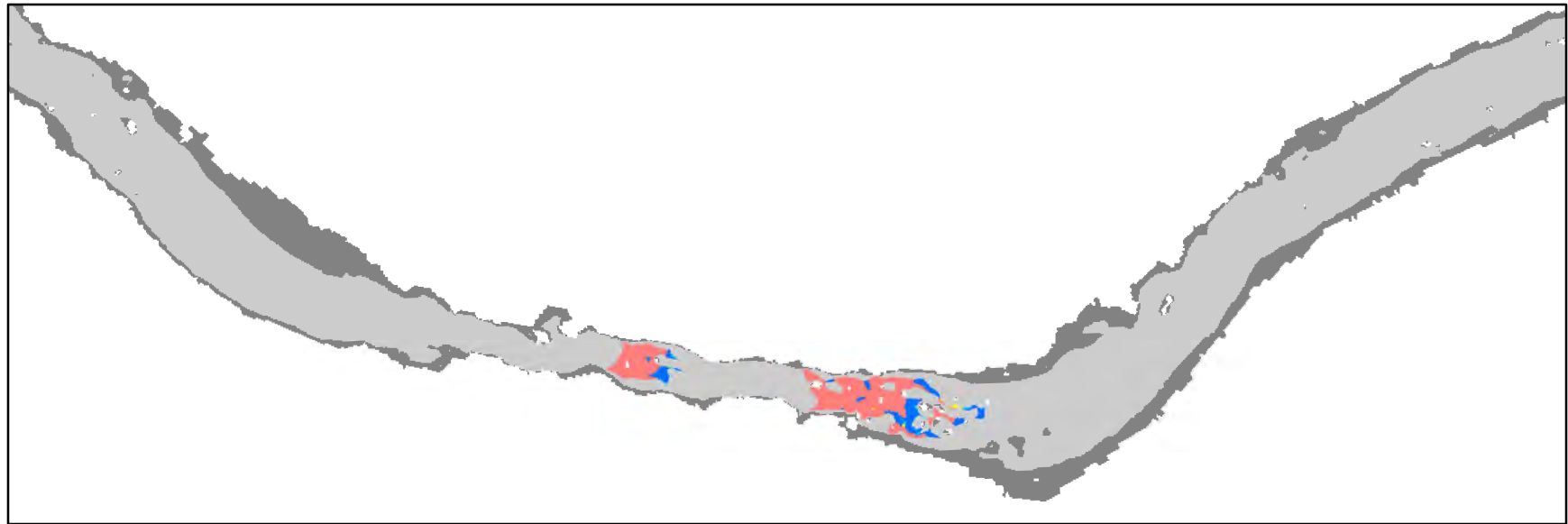

0 50 100 200 m

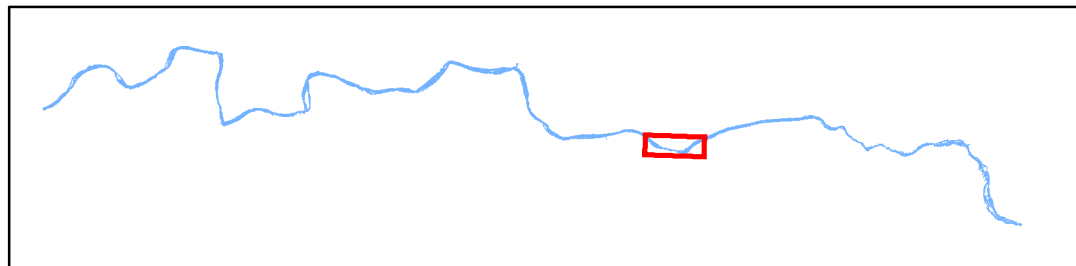
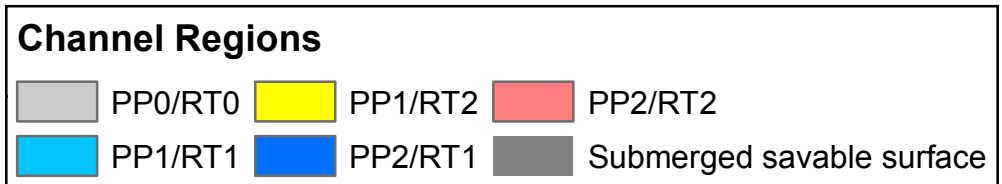

SYR Jump Hazards at 31 m³/s, p. 9

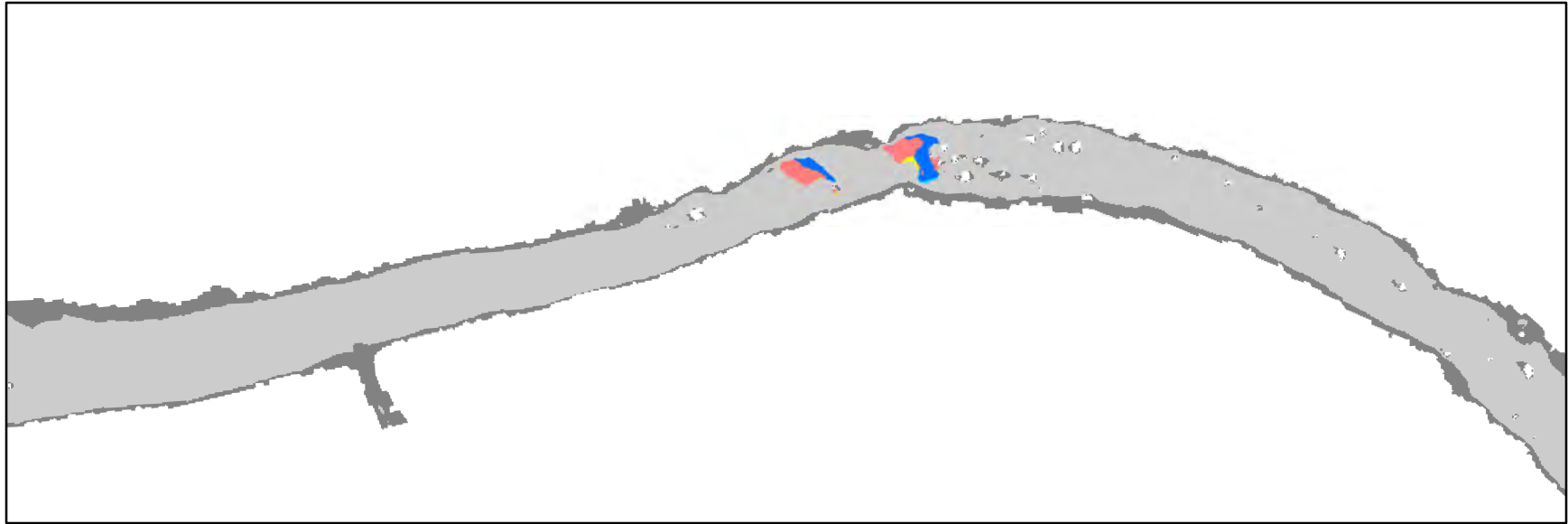

0 50 100 200 m

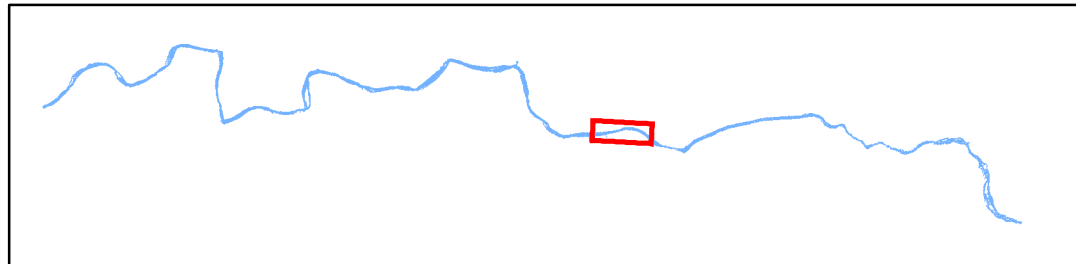
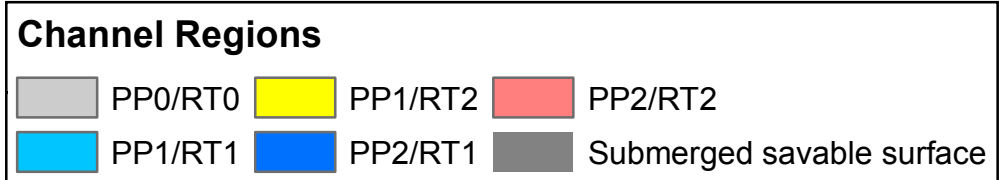

SYR Jump Hazards at 31 m³/s, p. 10

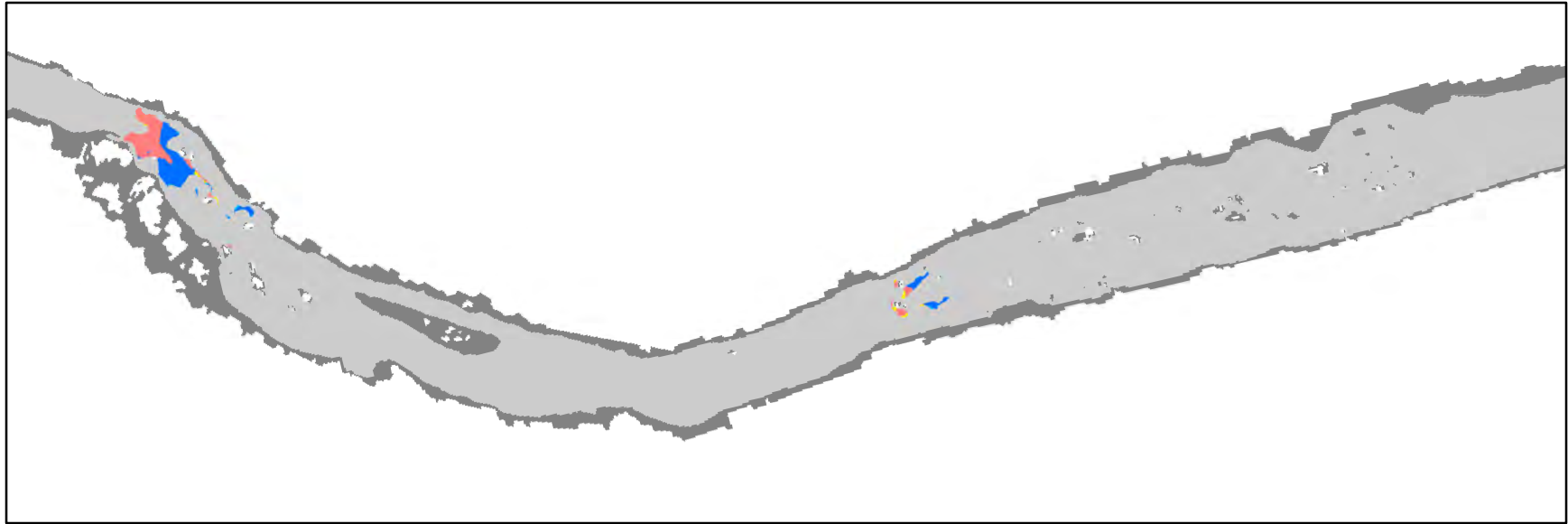

0 50 100 200 m



Channel Regions

Light Grey	PP0/RT0	Yellow	PP1/RT2	Red	PP2/RT2
Cyan	PP1/RT1	Blue	PP2/RT1	Dark Grey	Submerged savable surface

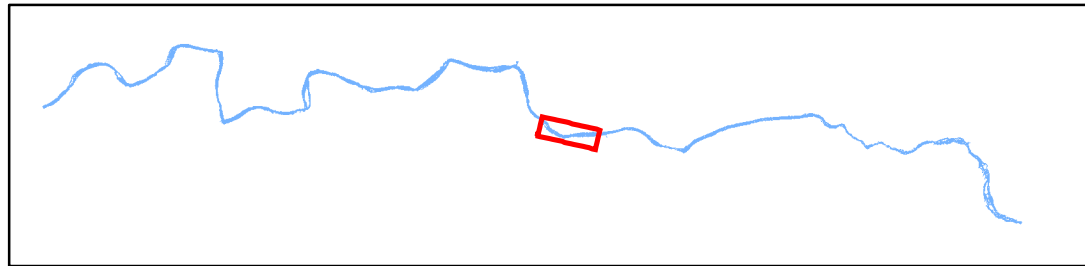



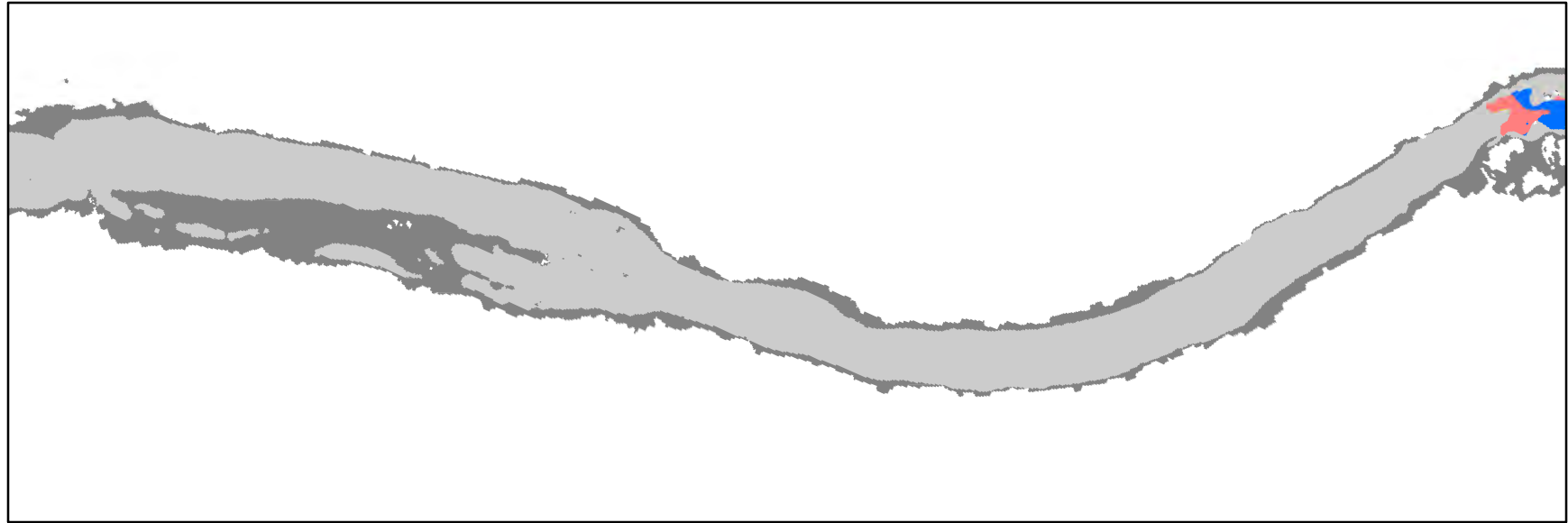



SYR Jump Hazards at 31 m³/s, p. 11



0 50 100 200 m



Channel Regions

 PP0/RT0	 PP1/RT2	 PP2/RT2
 PP1/RT1	 PP2/RT1	 Submerged savable surface

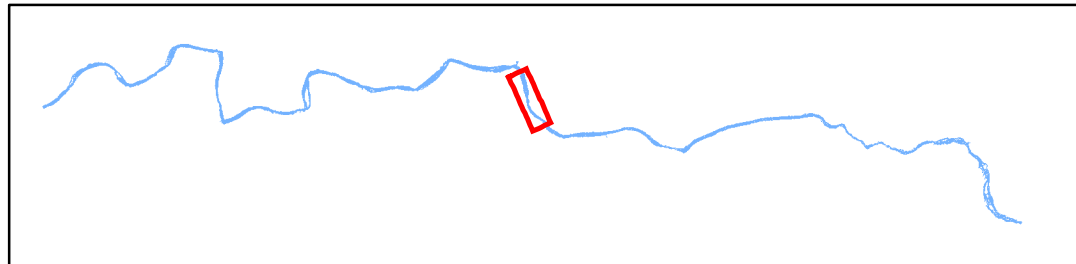

SYR Jump Hazards at 31 m³/s, p. 12

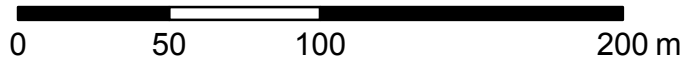
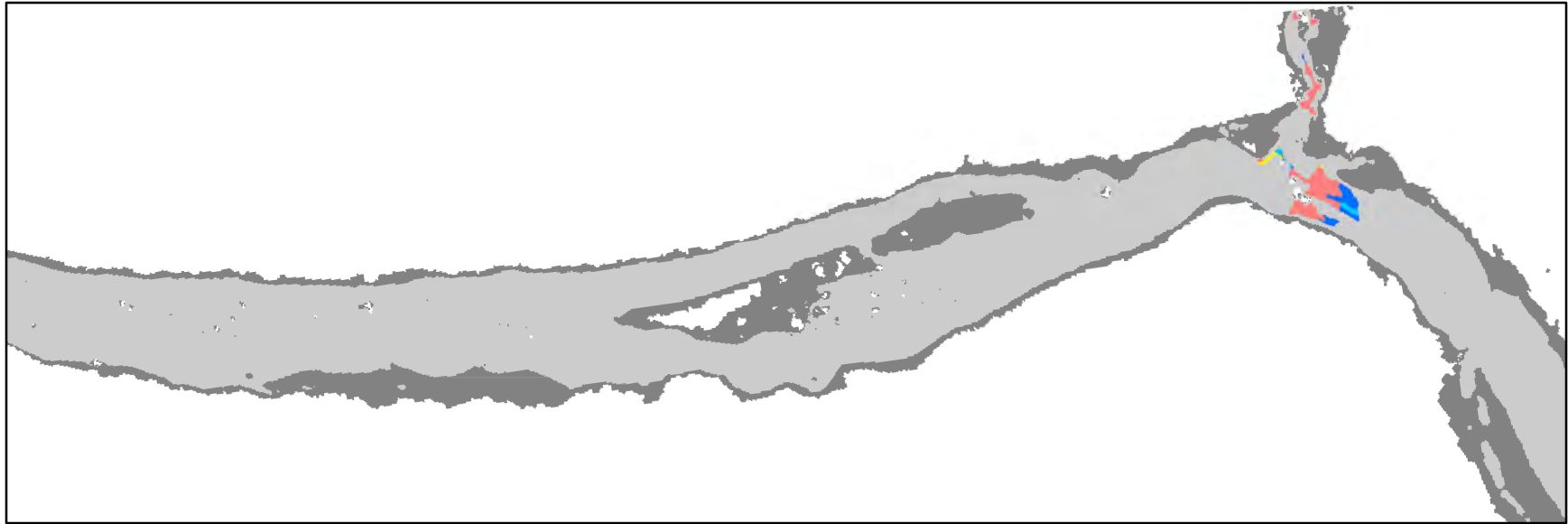

Channel Regions

Light Gray	PP0/RT0	Yellow	PP1/RT2	Red	PP2/RT2
Cyan	PP1/RT1	Blue	PP2/RT1	Dark Gray	Submerged savable surface

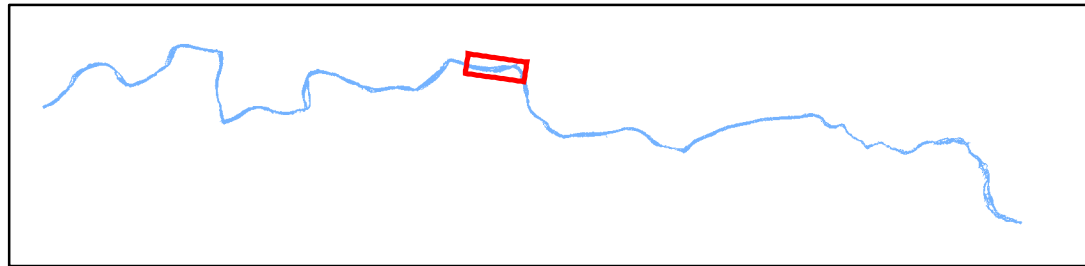



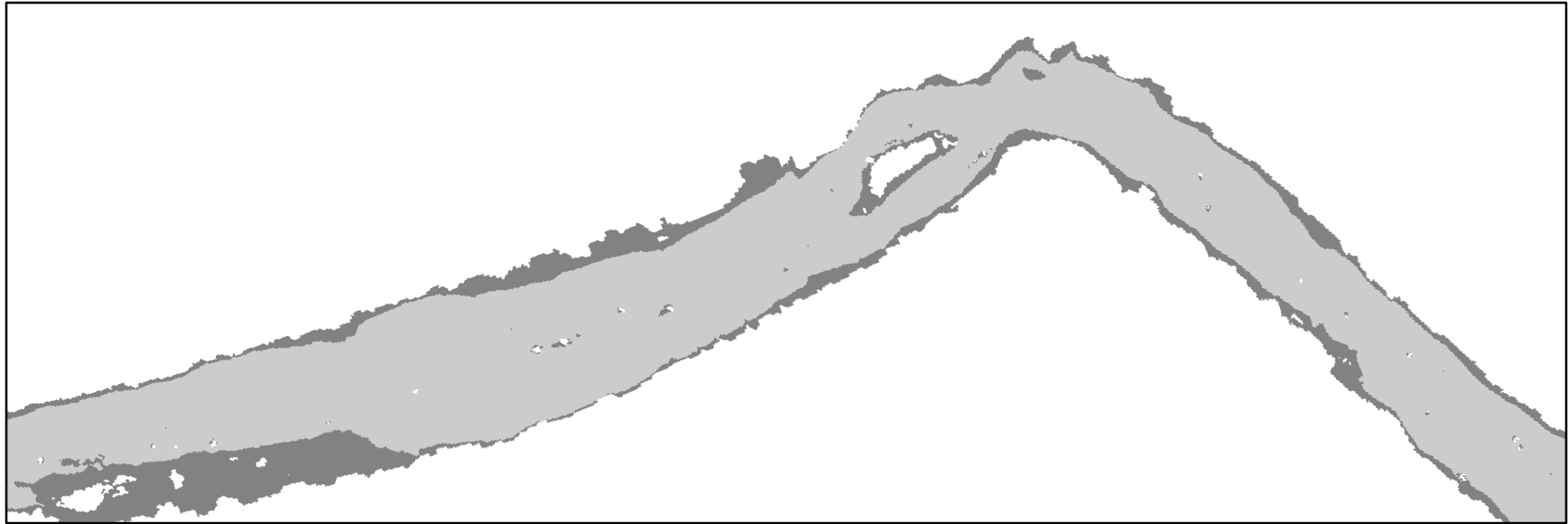



SYR Jump Hazards at 31 m³/s, p. 13



0 50 100 200 m



Channel Regions

 PP0/RT0	 PP1/RT2	 PP2/RT2
 PP1/RT1	 PP2/RT1	 Submerged savable surface

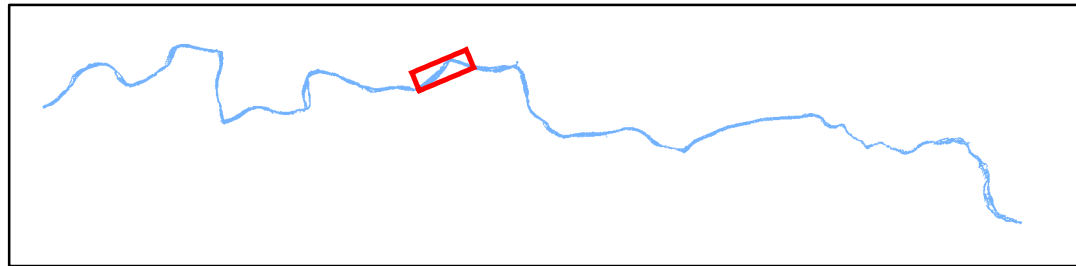

SYR Jump Hazards at 31 m³/s, p. 14

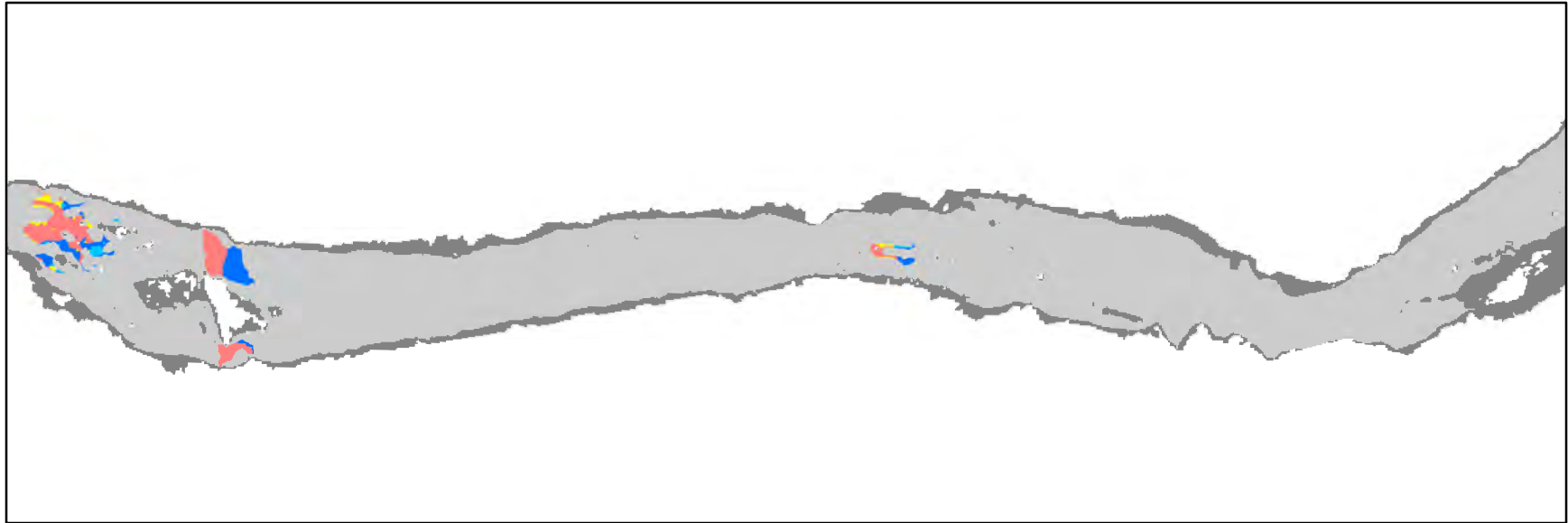

0 50 100 200 m

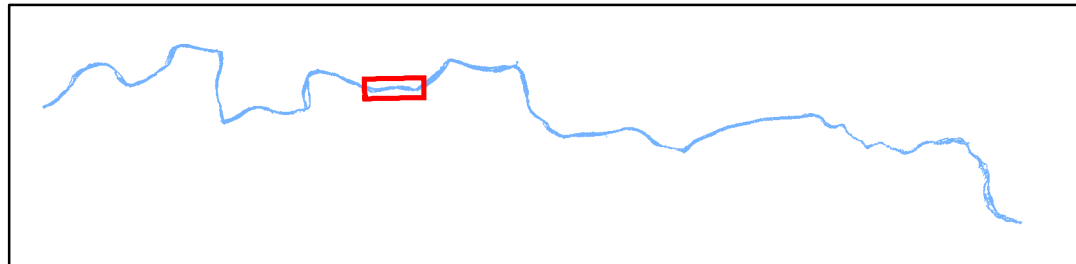
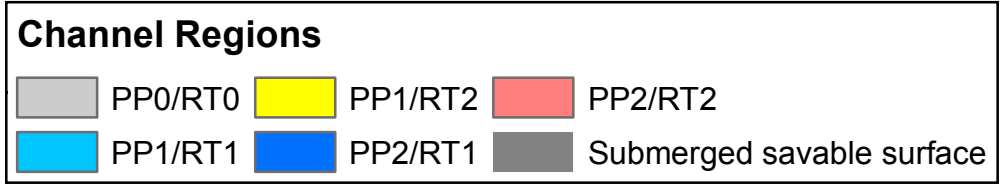

SYR Jump Hazards at 31 m³/s, p. 15

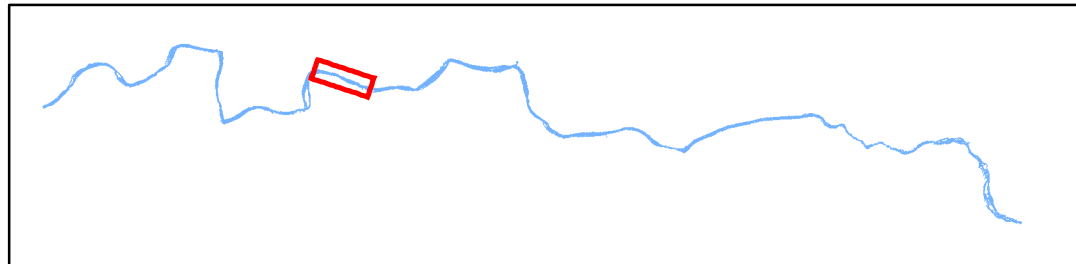
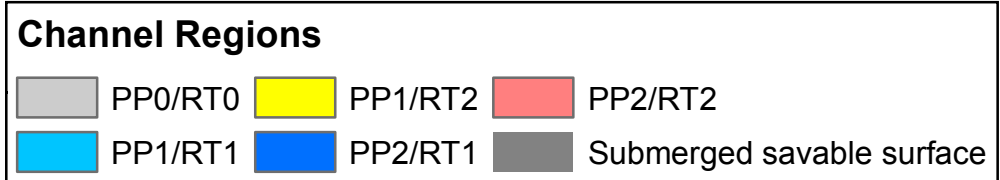
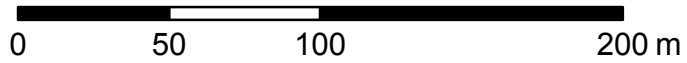
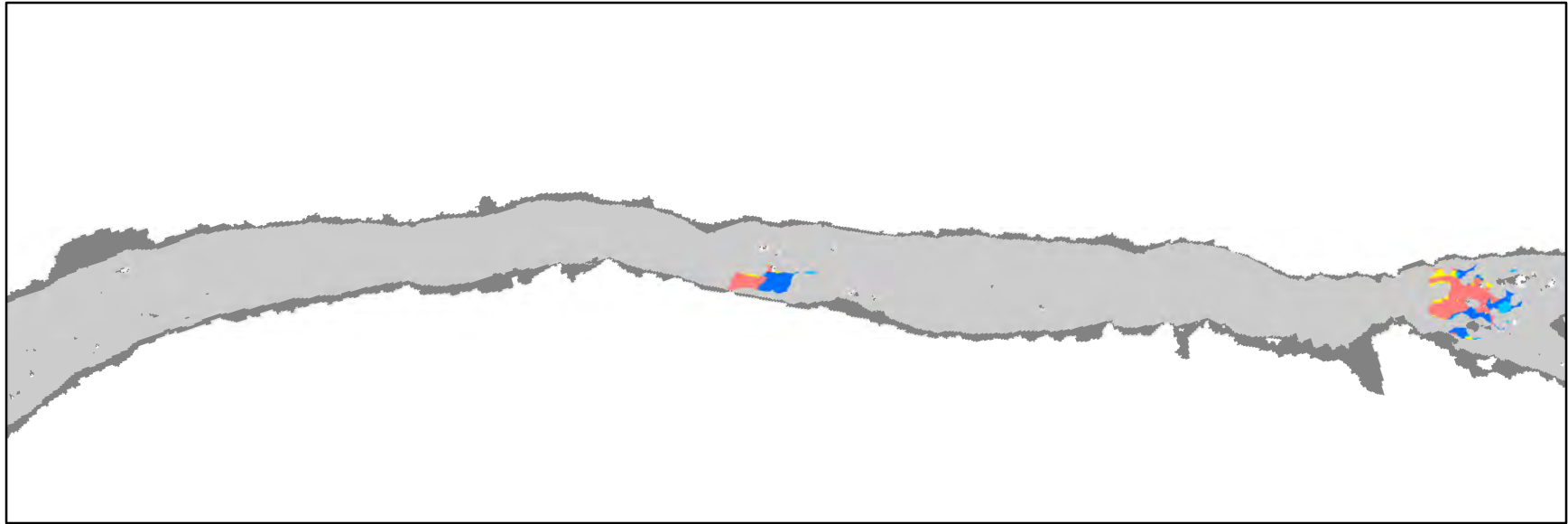

SYR Jump Hazards at 31 m³/s, p. 16

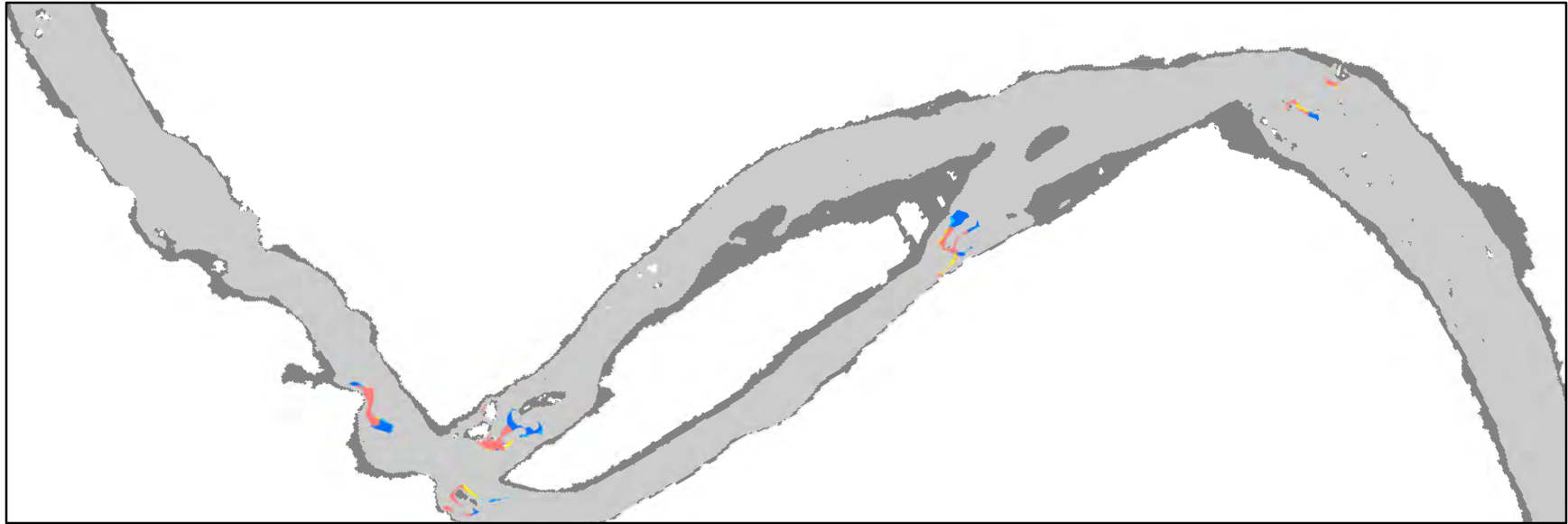

0 50 100 200 m

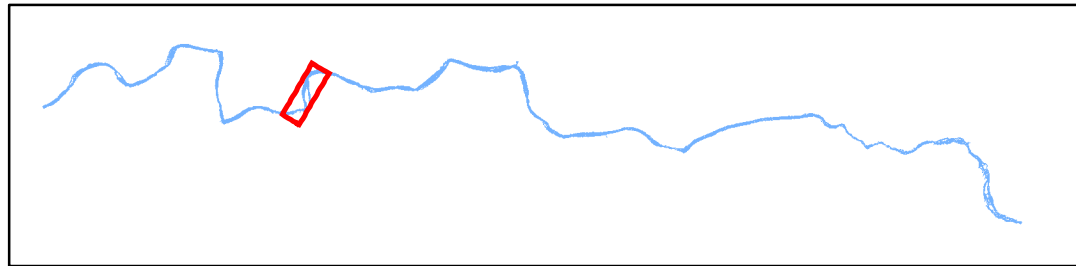
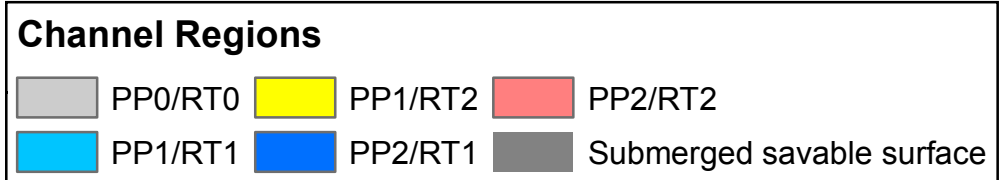

SYR Jump Hazards at 31 m³/s, p. 17

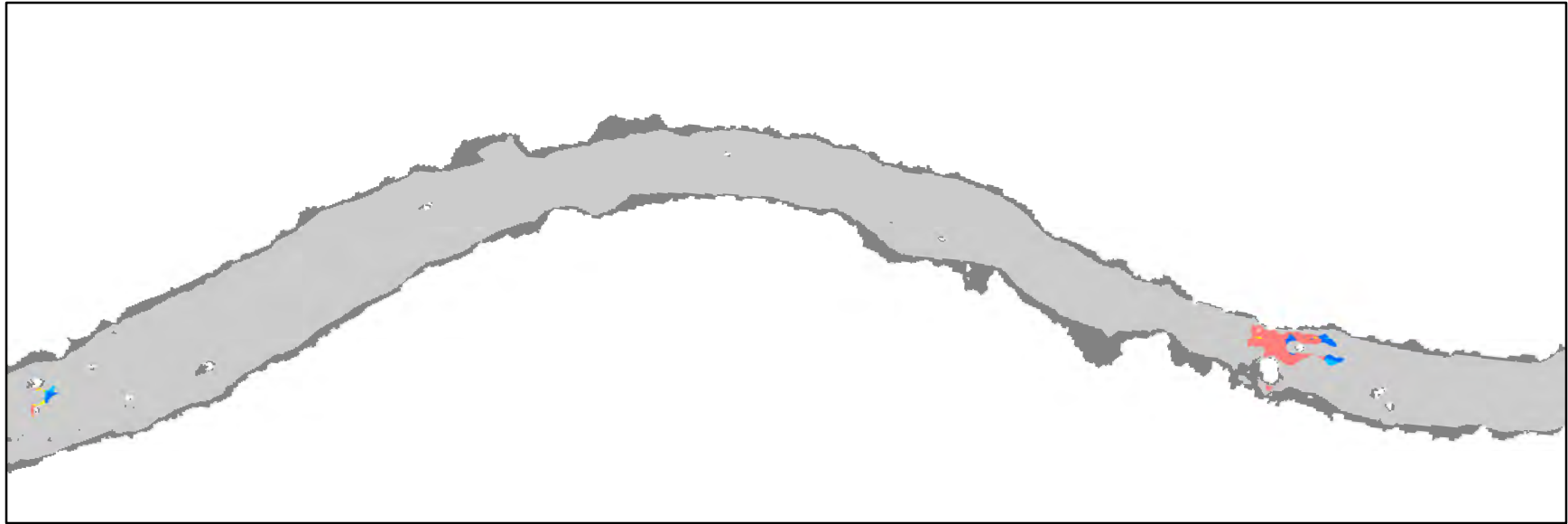

0 50 100 200 m



Channel Regions

Light Gray	PP0/RT0	Yellow	PP1/RT2	Red	PP2/RT2
Cyan	PP1/RT1	Blue	PP2/RT1	Dark Gray	Submerged savable surface

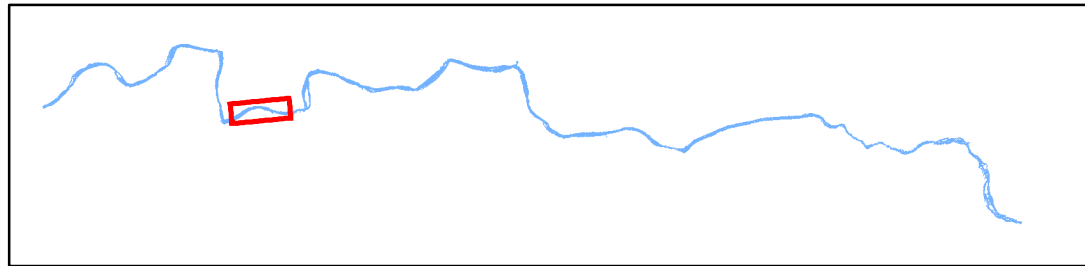



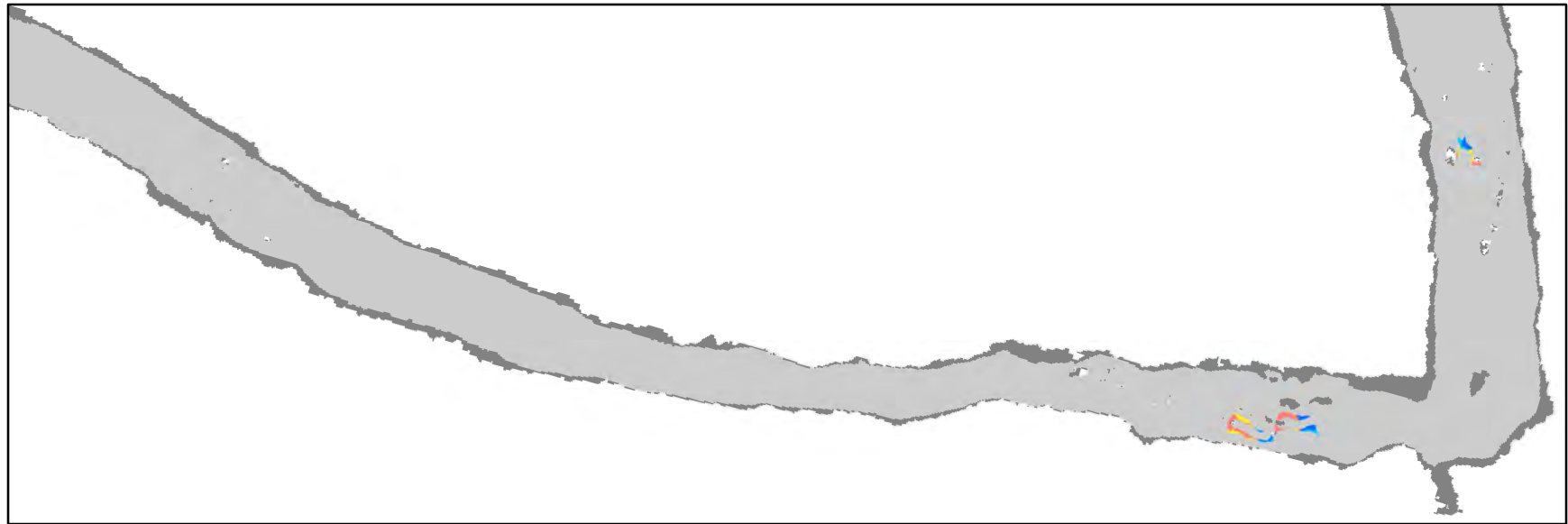



SYR Jump Hazards at 31 m³/s, p. 18



0 50 100 200 m



Channel Regions

 PP0/RT0	 PP1/RT2	 PP2/RT2
 PP1/RT1	 PP2/RT1	 Submerged savable surface

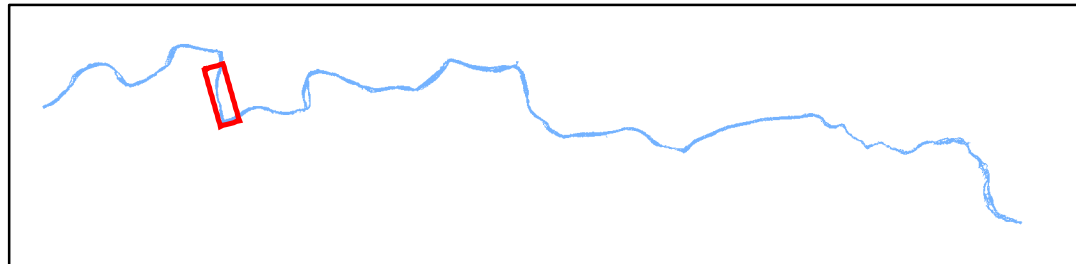



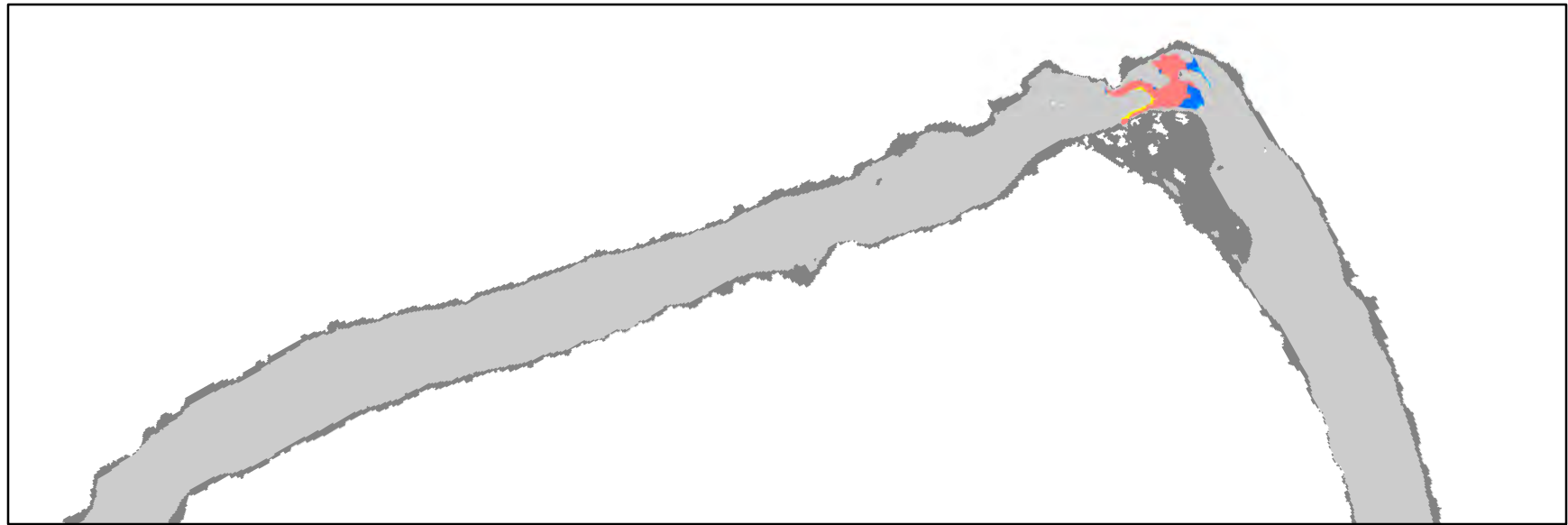



SYR Jump Hazards at 31 m³/s, p. 19



0 50 100 200 m



Channel Regions

 PP0/RT0	 PP1/RT2	 PP2/RT2
 PP1/RT1	 PP2/RT1	 Submerged savable surface

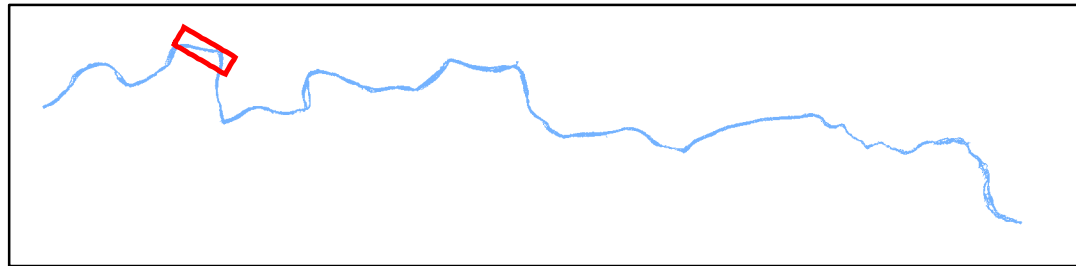

SYR Jump Hazards at 31 m³/s, p. 20

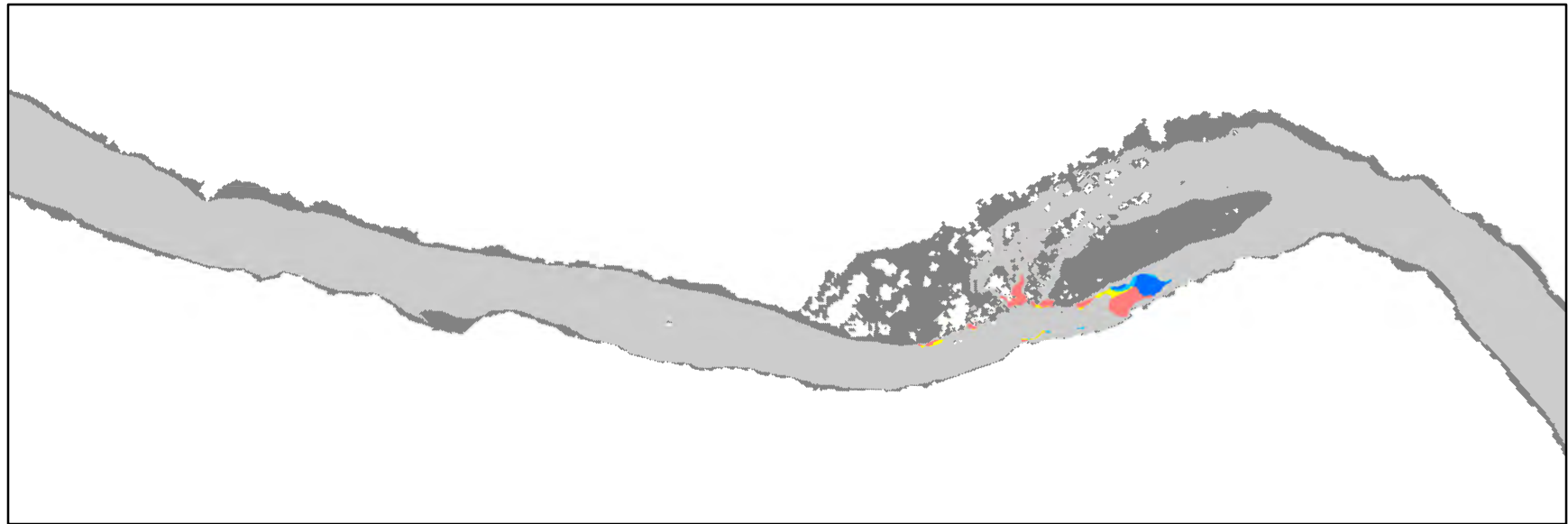

0 50 100 200 m

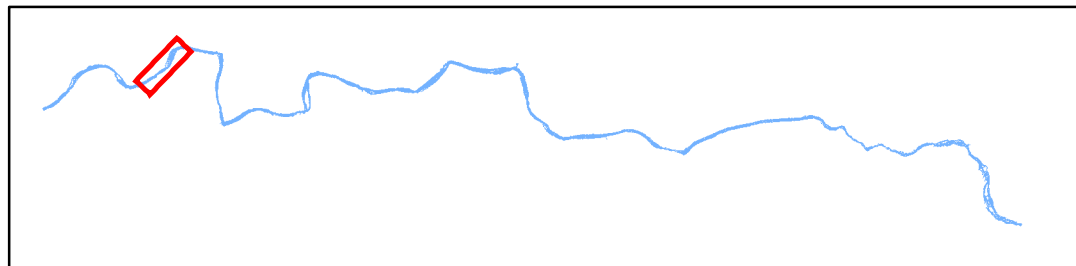
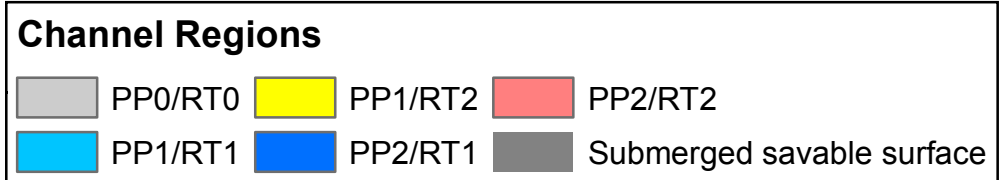

SYR Jump Hazards at 31 m³/s, p. 21

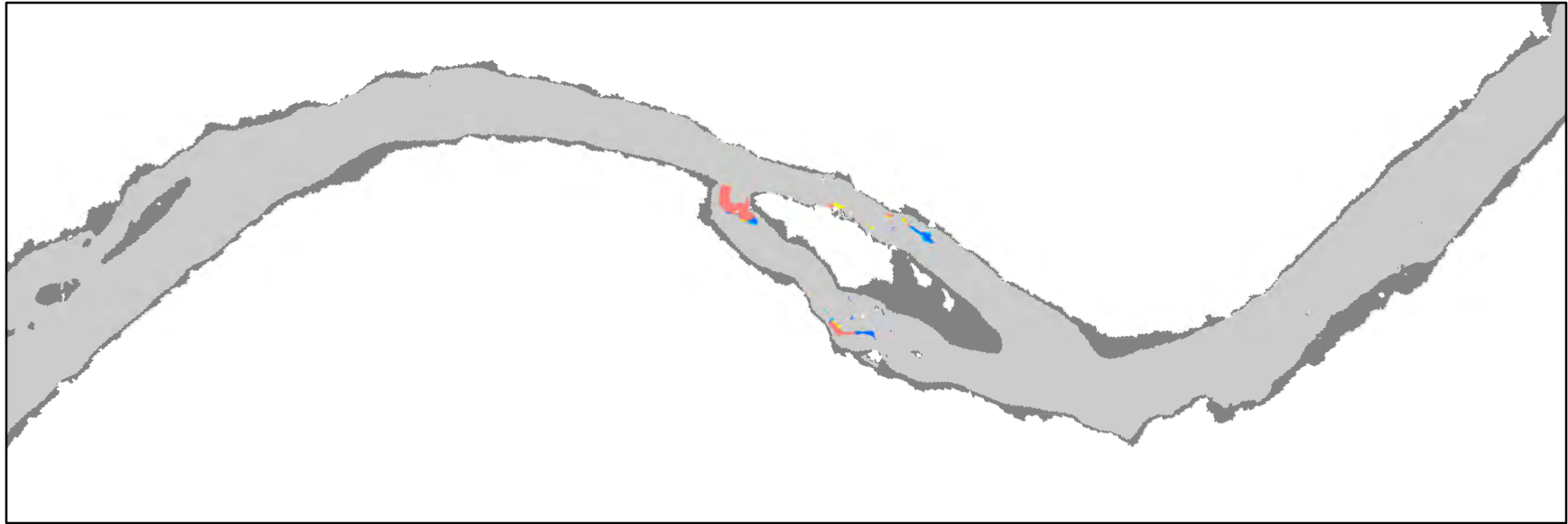

0 50 100 200 m



Channel Regions

Light Gray	PP0/RT0	Yellow	PP1/RT2	Red	PP2/RT2
Cyan	PP1/RT1	Blue	PP2/RT1	Dark Gray	Submerged savable surface

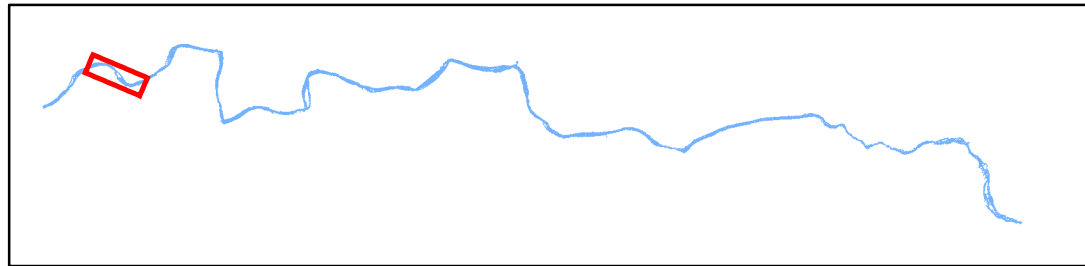

SYR Jump Hazards at 31 m³/s, p. 22

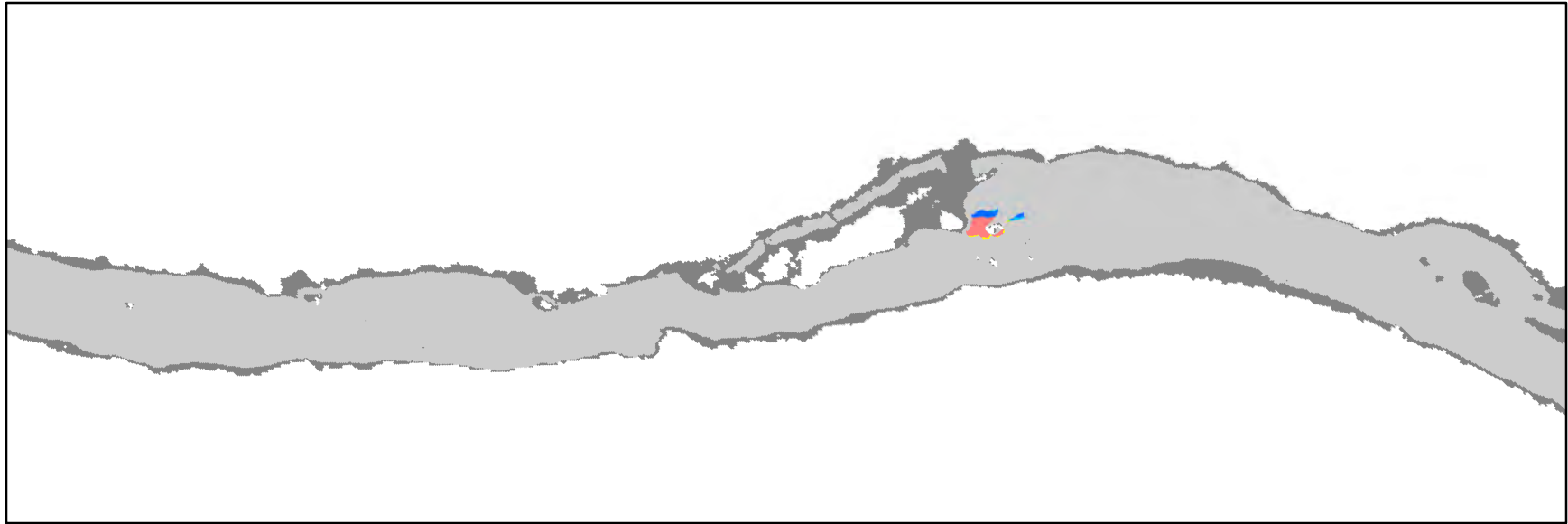

0 50 100 200 m



Channel Regions

Light Gray	PP0/RT0	Yellow	PP1/RT2	Red	PP2/RT2
Cyan	PP1/RT1	Blue	PP2/RT1	Dark Gray	Submerged savable surface

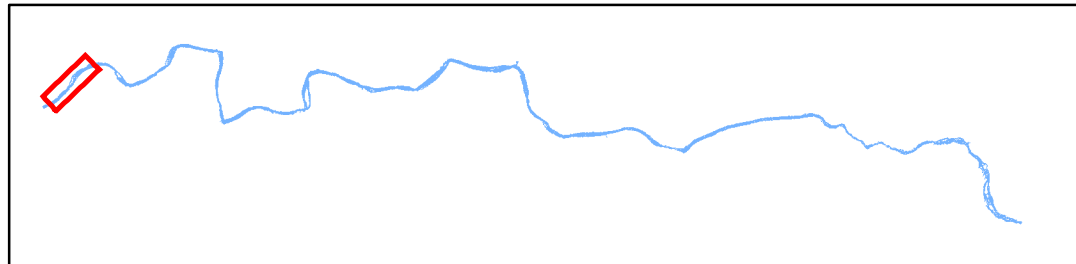

SYR Jump Hazards at 31 m³/s, p. 23

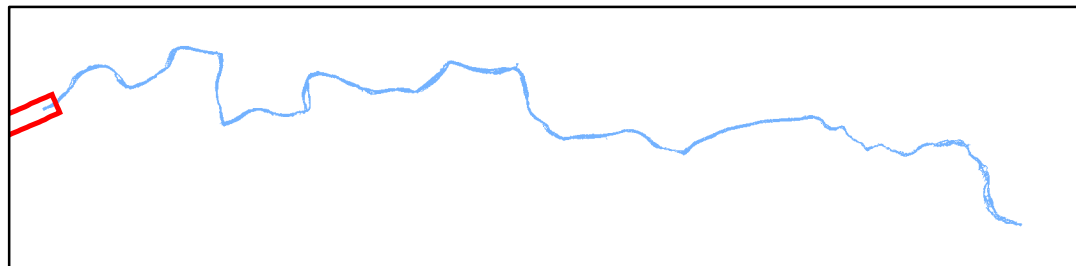
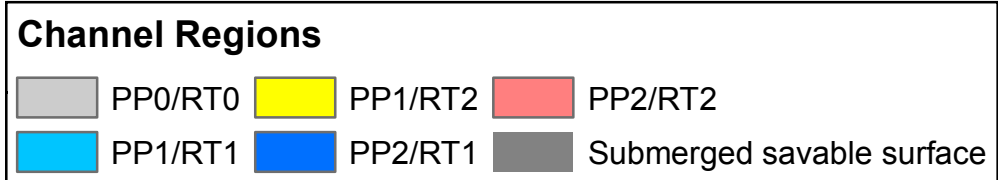
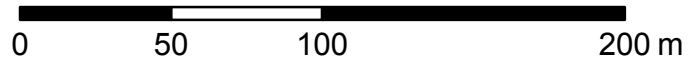
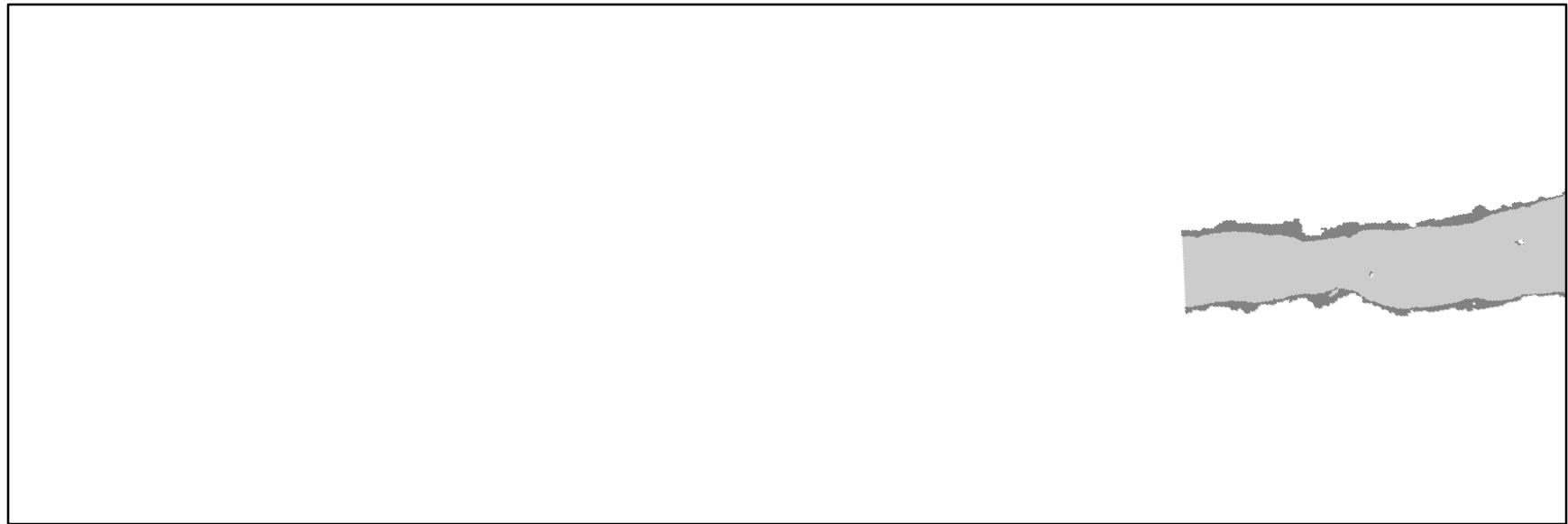



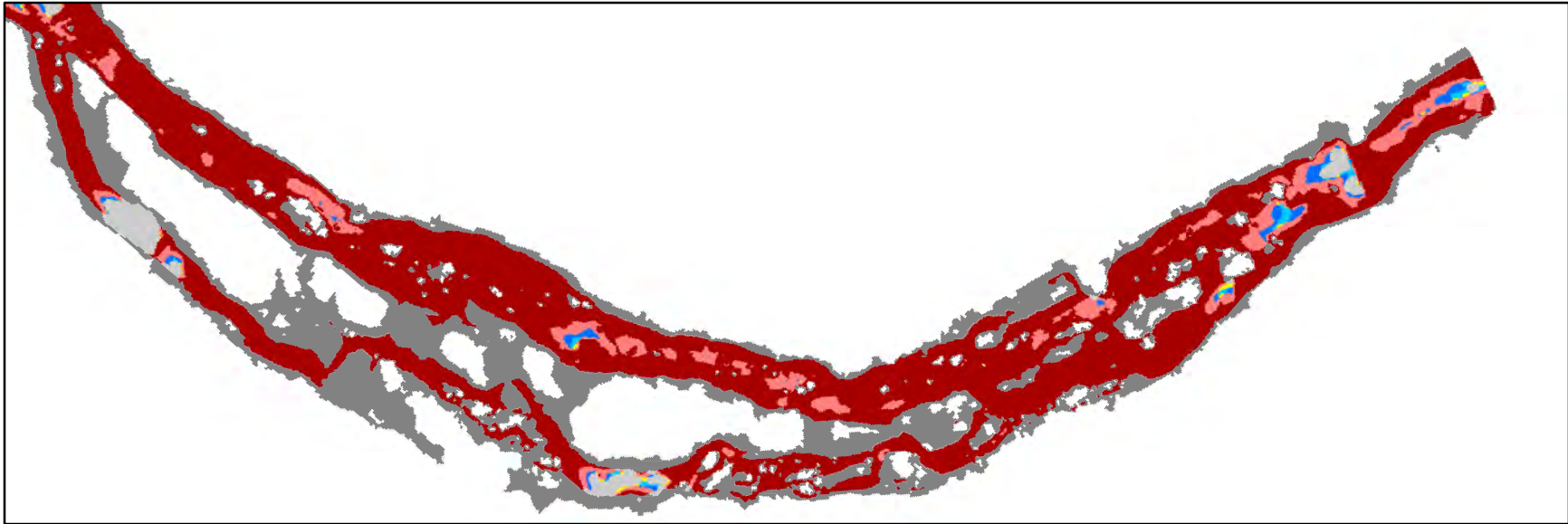



SYR Submerged Unsavable Surface Hazards for Upright Body at 31 m³/s, p. 1



0 50 100 200 m



Channel Regions

- | | | |
|---|--|---|
|  PP0/RT0 |  PP1/RT2 |  PP2/RT2 |
|  PP1/RT1 |  PP2/RT1 |  Submerged unsavable surface (PP3/RT3) |
| | |  Submerged savable surface |

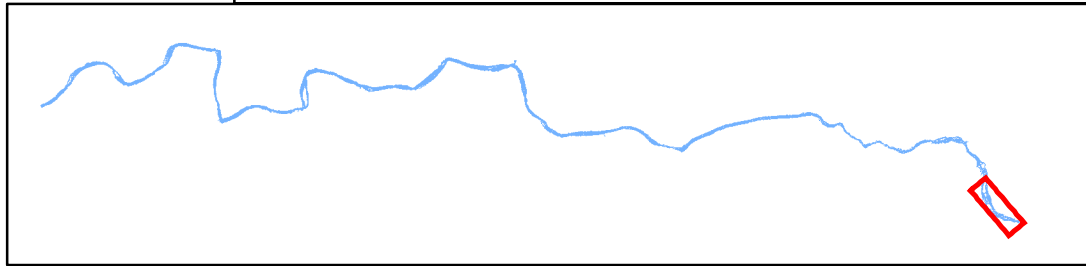

SYR Submerged Unsavable Surface Hazards for Upright Body at 31 m³/s, p. 2

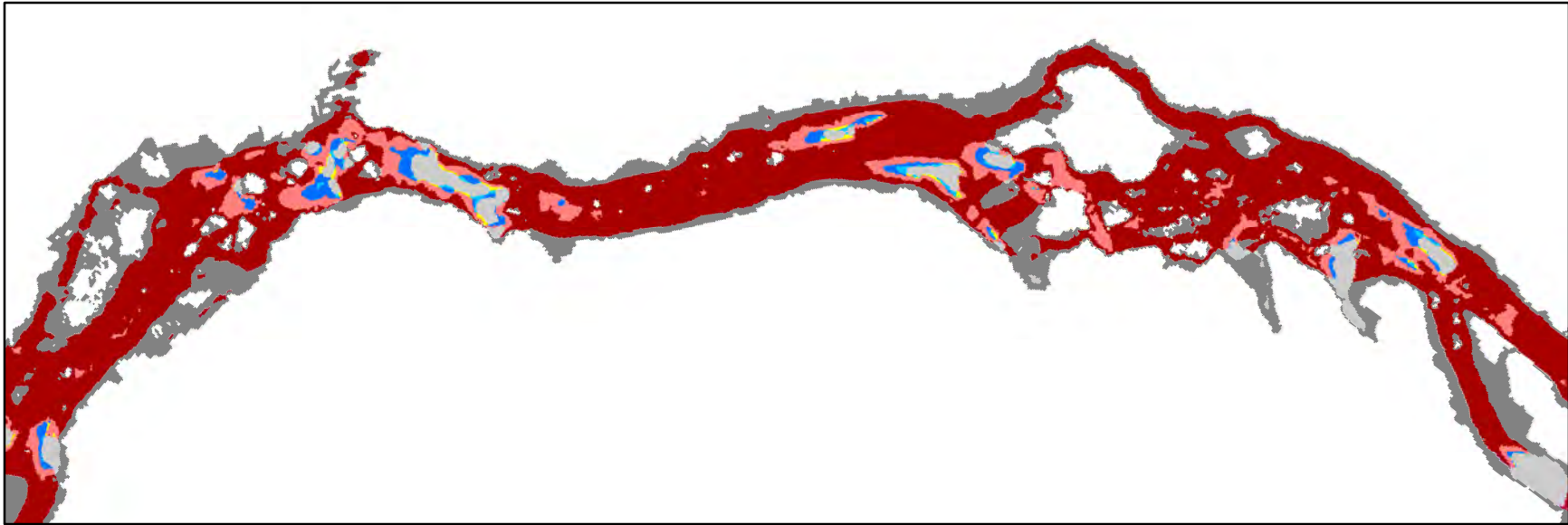

0 50 100 200 m



Channel Regions		
PP0/RT0	PP1/RT2	PP2/RT2
PP1/RT1	PP2/RT1	Submerged unsavable surface (PP3/RT3)
		Submerged savable surface

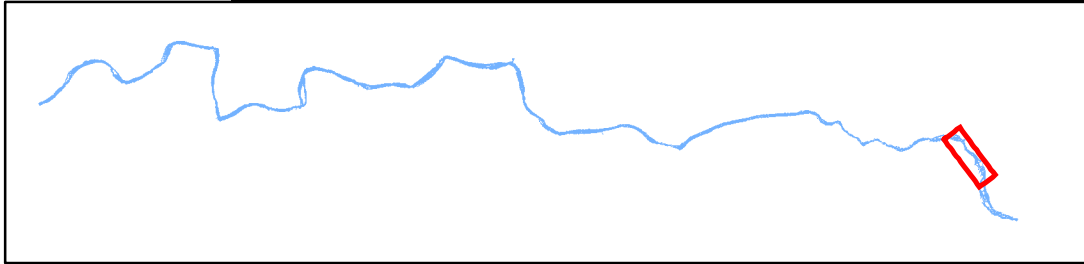



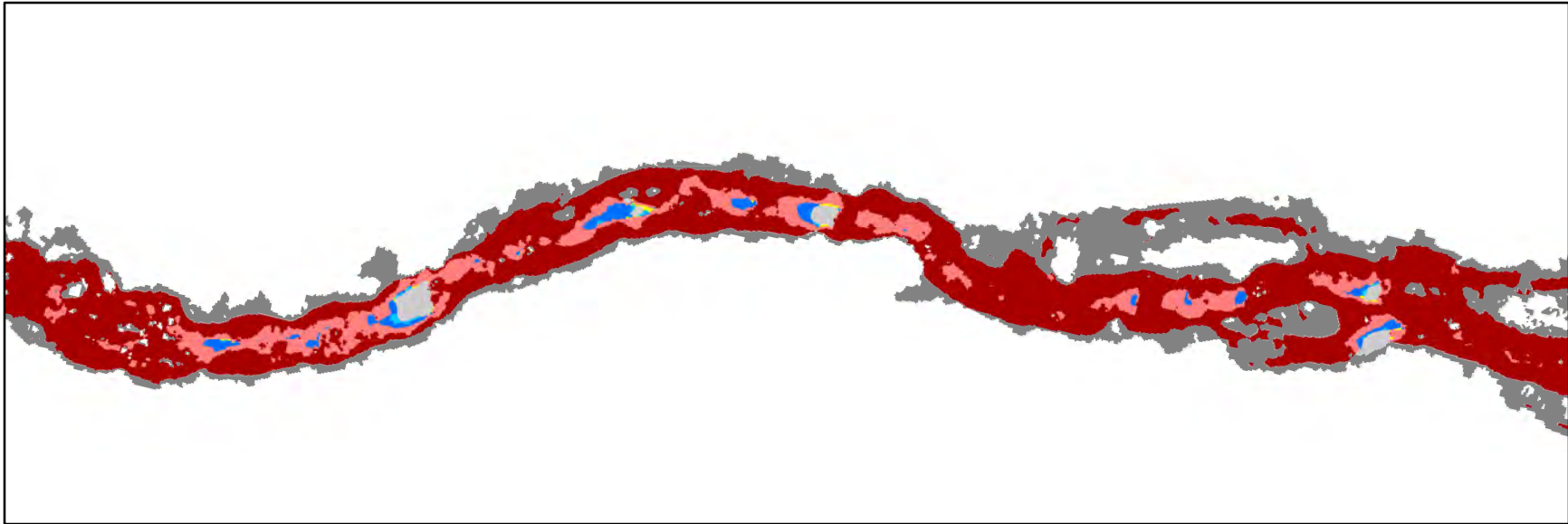



SYR Submerged Unsaveable Surface Hazards for Upright Body at 31 m³/s, p. 3



0 50 100 200 m



Channel Regions

- | | | |
|---|--|---|
|  PP0/RT0 |  PP1/RT2 |  PP2/RT2 |
|  PP1/RT1 |  PP2/RT1 |  Submerged unsavable surface (PP3/RT3) |
| | |  Submerged savable surface |

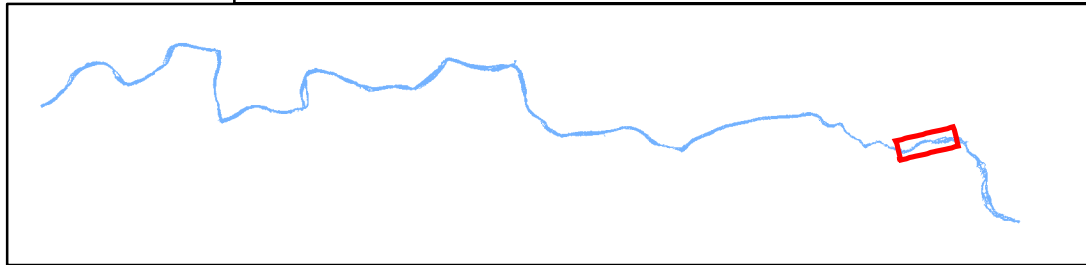



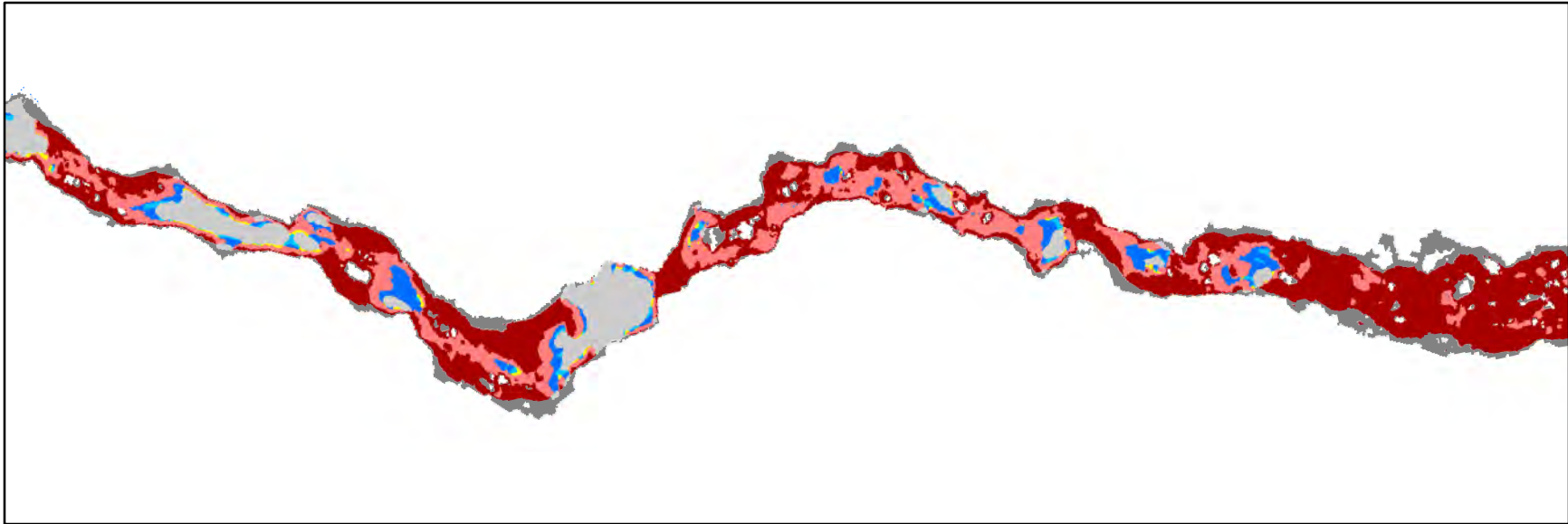



SYR Submerged Unsavable Surface Hazards for Upright Body at 31 m³/s, p. 4



0 50 100 200 m



Channel Regions

 PP0/RT0	 PP1/RT2	 PP2/RT2
 PP1/RT1	 PP2/RT1	 Submerged unsavable surface (PP3/RT3)
		 Submerged savable surface

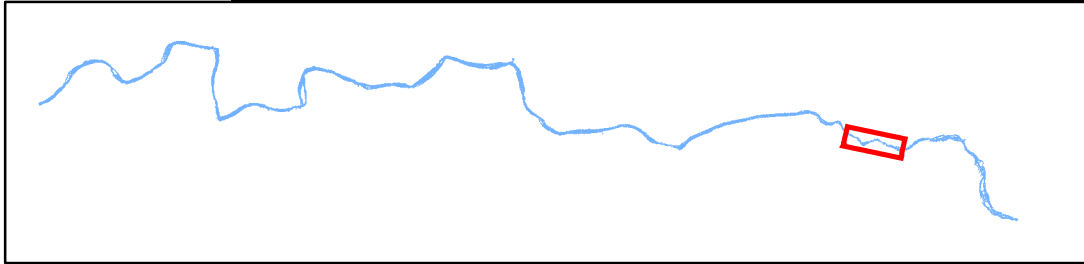

SYR Submerged Unsaveable Surface Hazards for Upright Body at 31 m³/s, p. 5

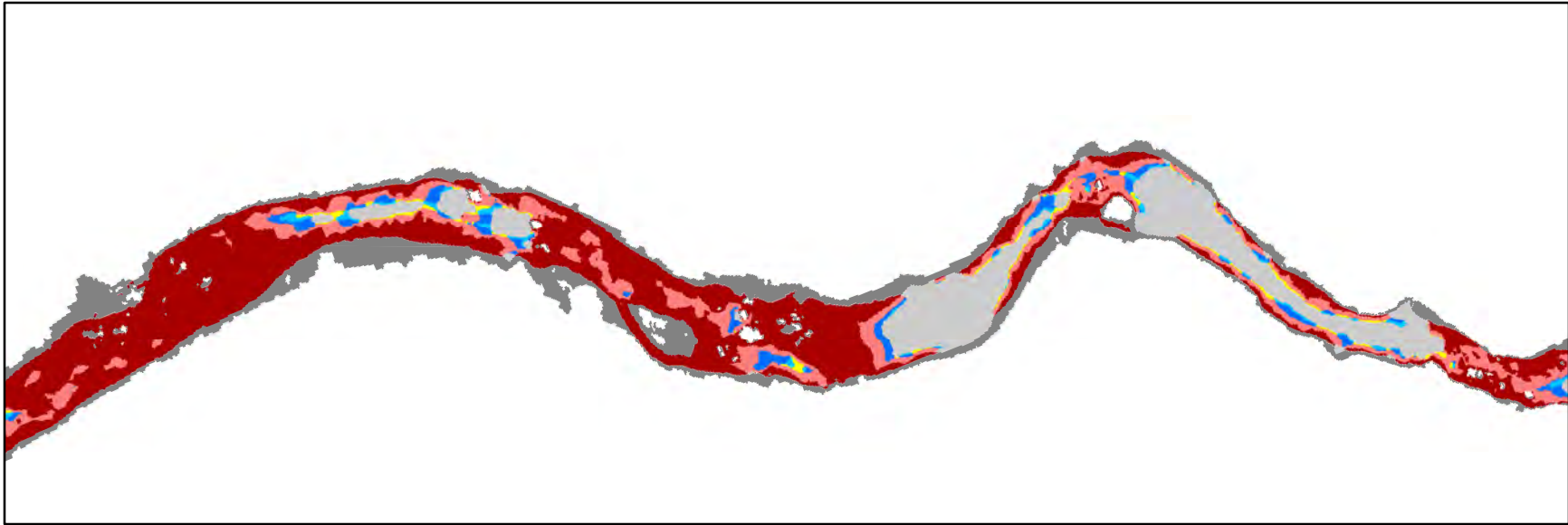

0 50 100 200 m



Channel Regions		
PP0/RT0	PP1/RT2	PP2/RT2
PP1/RT1	PP2/RT1	Submerged unsaveable surface (PP3/RT3)
		Submerged savable surface

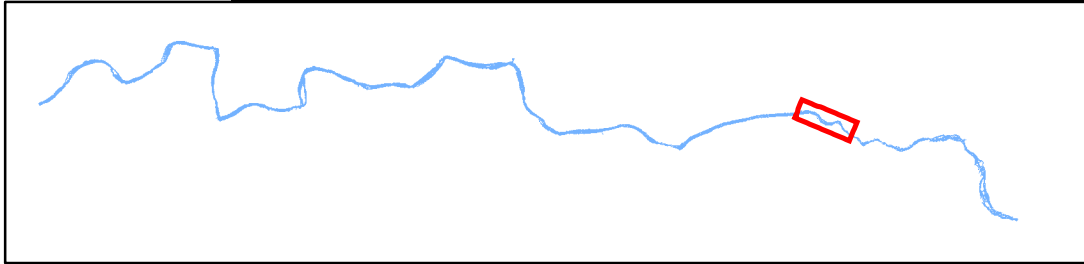

SYR Submerged Unsaveable Surface Hazards for Upright Body at 31 m³/s, p. 6

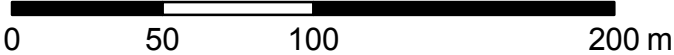
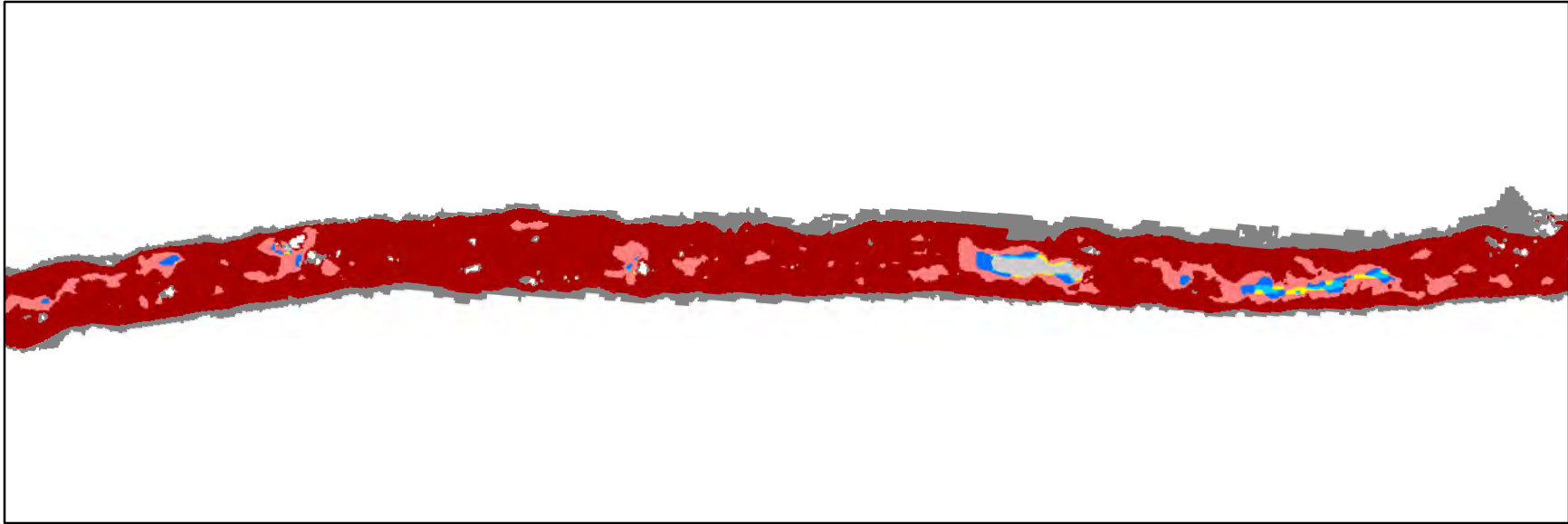

Channel Regions

PP0/RT0	PP1/RT2	PP2/RT2
PP1/RT1	PP2/RT1	Submerged unsaveable surface (PP3/RT3)
		Submerged saveable surface

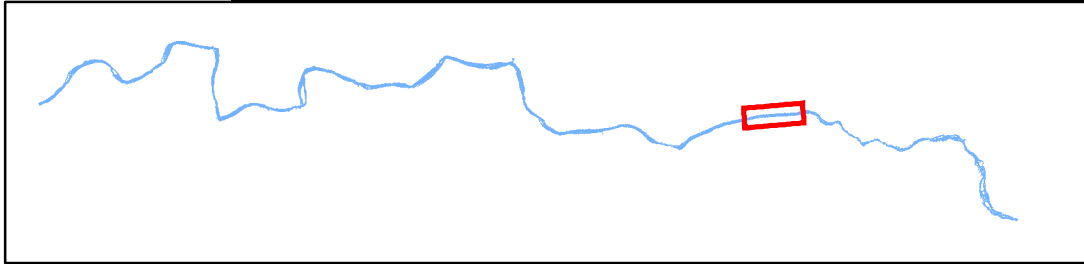

SYR Submerged Unsaveable Surface Hazards for Upright Body at 31 m³/s, p. 7

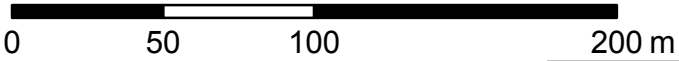
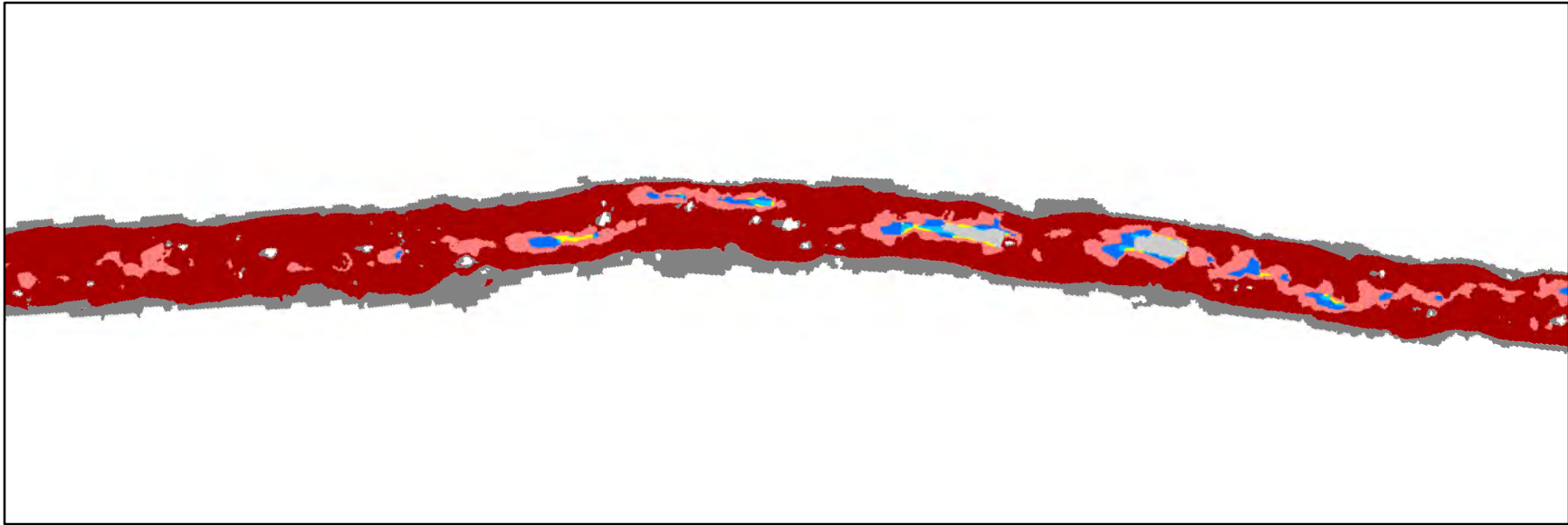

Channel Regions

PP0/RT0	PP1/RT2	PP2/RT2
PP1/RT1	PP2/RT1	Submerged unsaveable surface (PP3/RT3)
		Submerged saveable surface

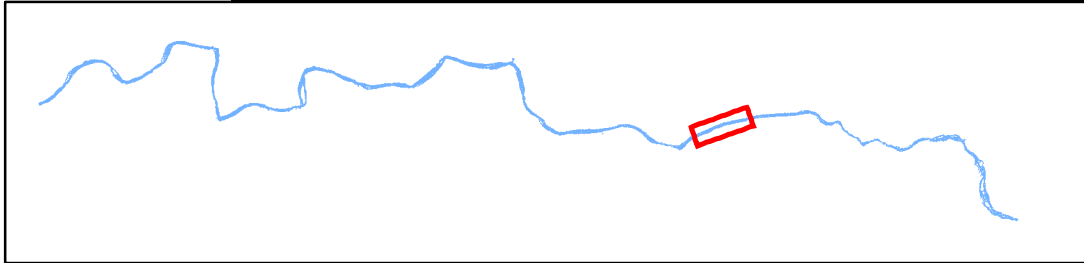



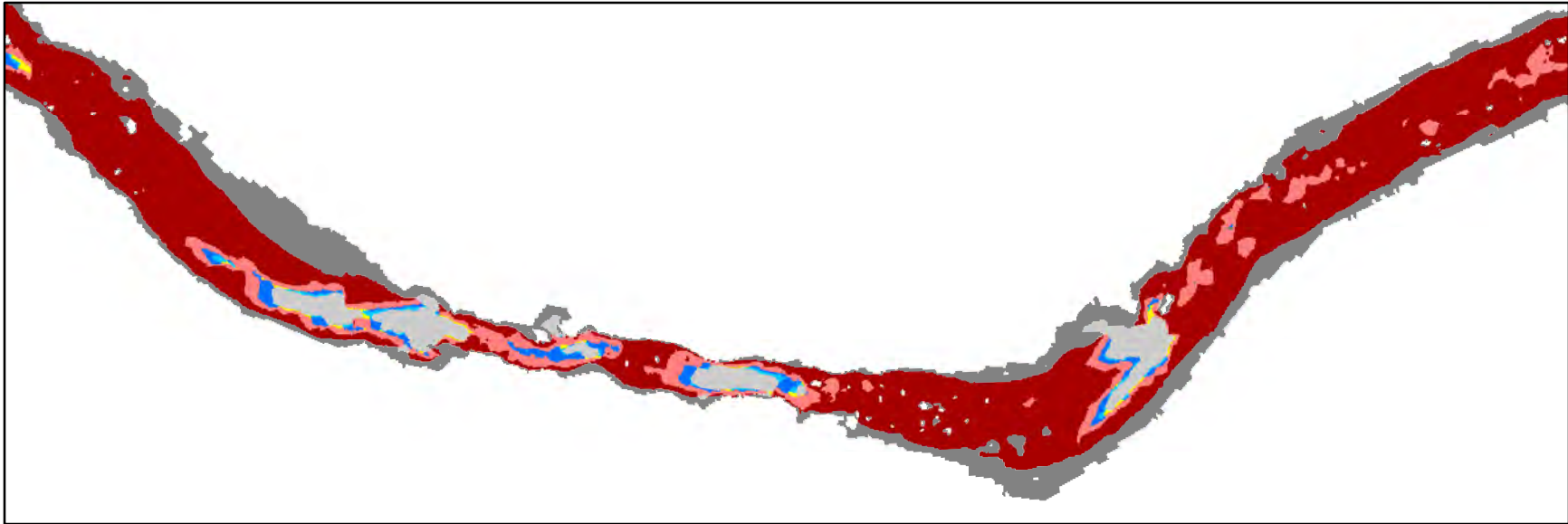



SYR Submerged Unsaveable Surface Hazards for Upright Body at 31 m³/s, p. 8



0 50 100 200 m



Channel Regions

- | | | |
|---|--|--|
|  PP0/RT0 |  PP1/RT2 |  PP2/RT2 |
|  PP1/RT1 |  PP2/RT1 |  Submerged unsaveable surface (PP3/RT3) |
| | |  Submerged saveable surface |

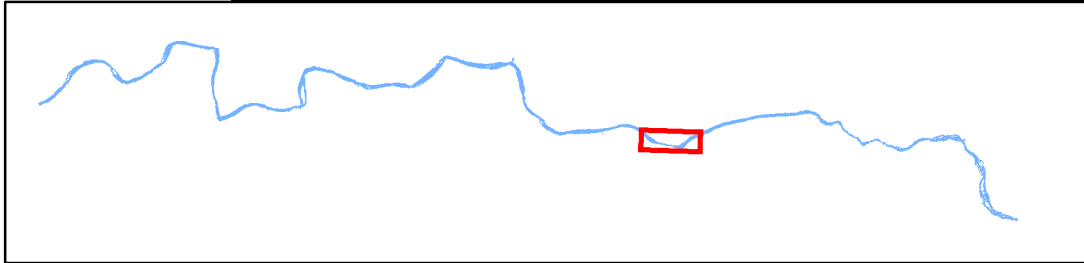

SYR Submerged Unsaveable Surface Hazards for Upright Body at 31 m³/s, p. 9

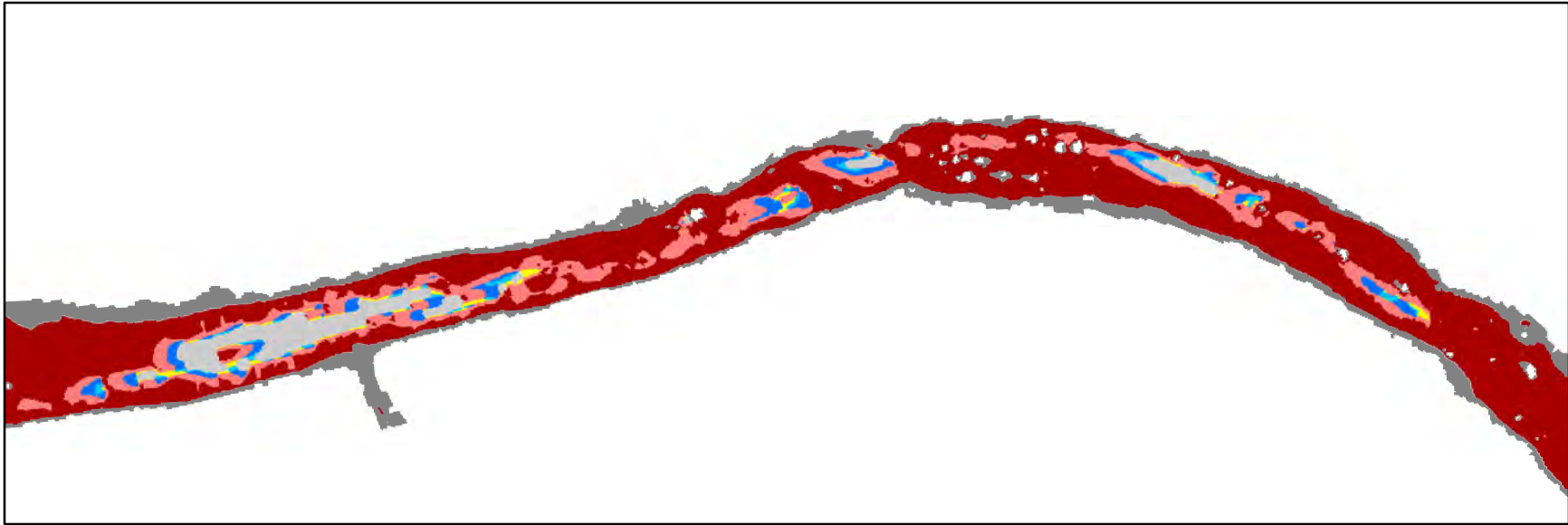

0 50 100 200 m



Channel Regions		
PP0/RT0	PP1/RT2	PP2/RT2
PP1/RT1	PP2/RT1	Submerged unsaveable surface (PP3/RT3)
		Submerged saveable surface

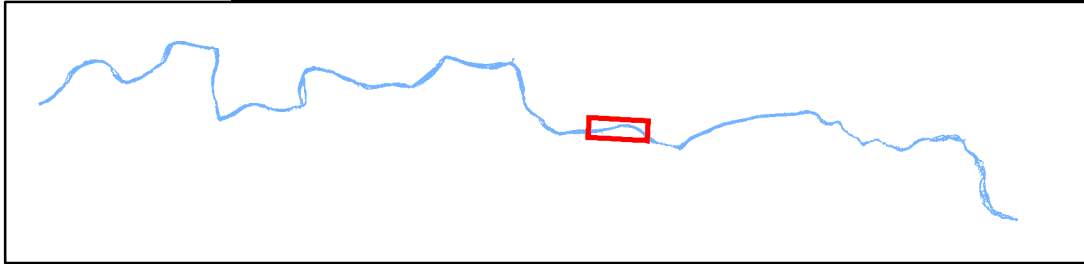

SYR Submerged Unsaveable Surface Hazards for Upright Body at 31 m³/s, p. 10

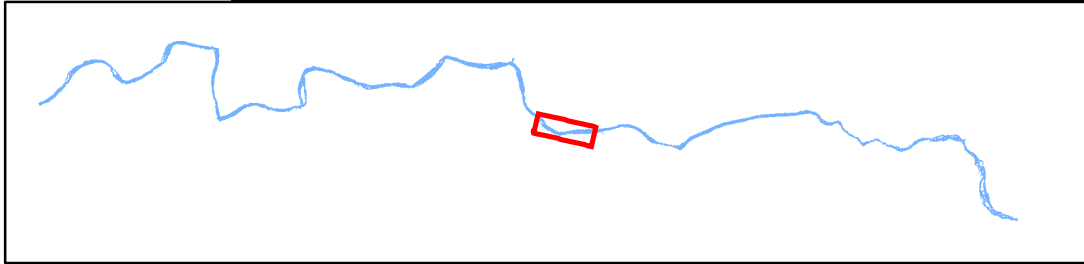
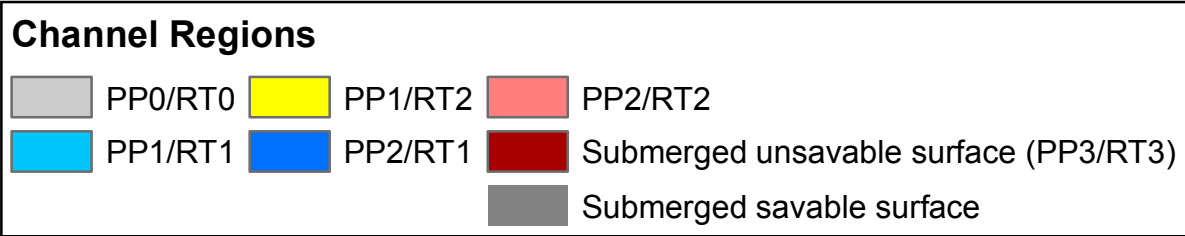
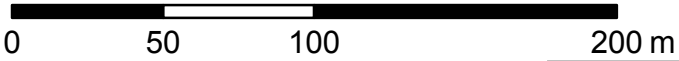
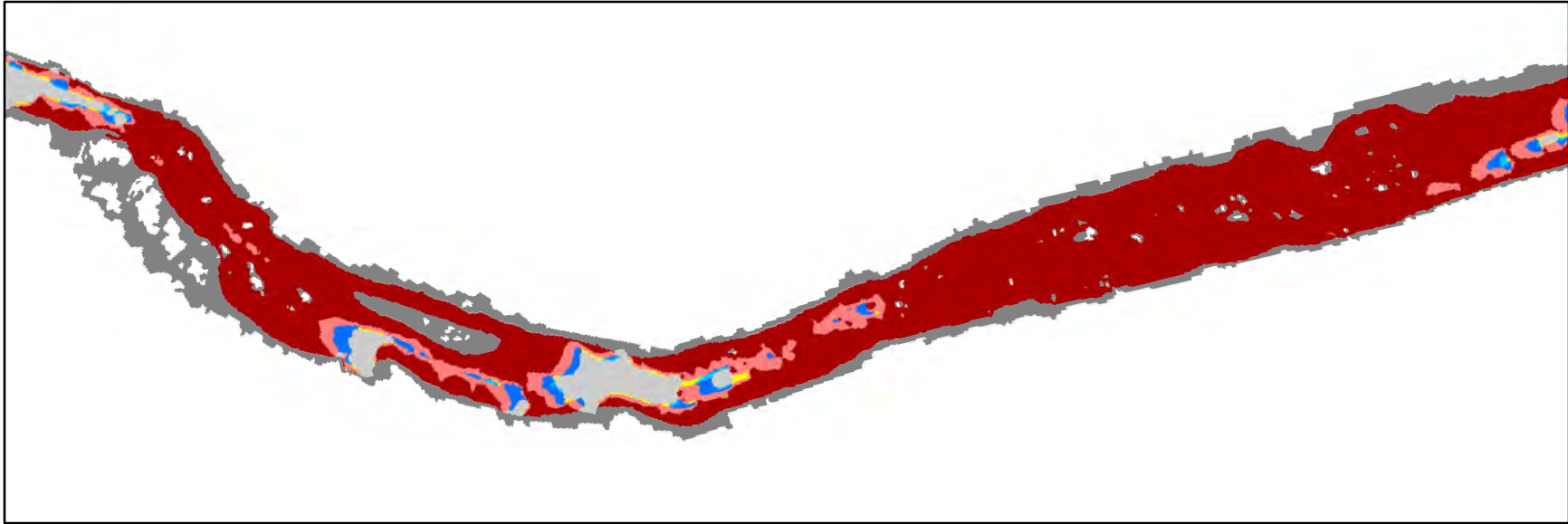



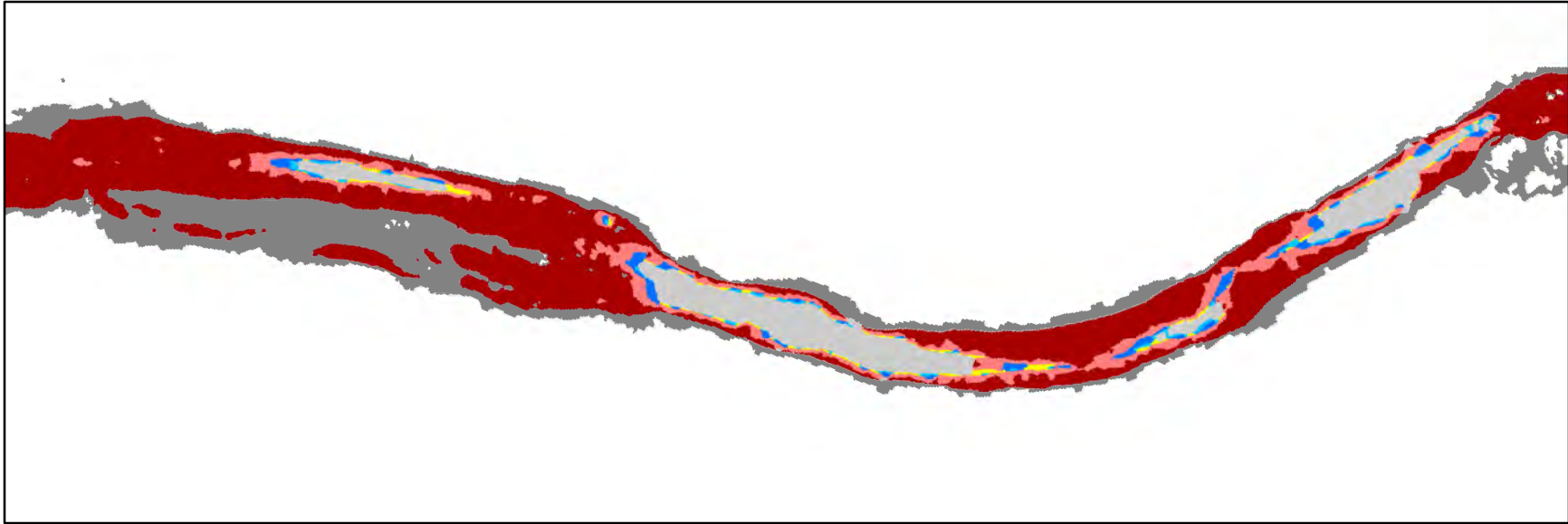



SYR Submerged Unsavable Surface Hazards for Upright Body at 31 m³/s, p. 11



0 50 100 200 m



Channel Regions

- | | | |
|---|--|---|
|  PP0/RT0 |  PP1/RT2 |  PP2/RT2 |
|  PP1/RT1 |  PP2/RT1 |  Submerged unsavable surface (PP3/RT3) |
| | |  Submerged savable surface |

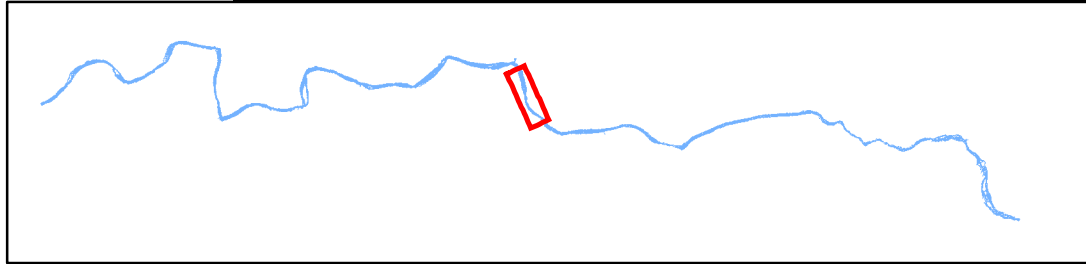

SYR Submerged Unsavable Surface Hazards for Upright Body at 31 m³/s, p. 12

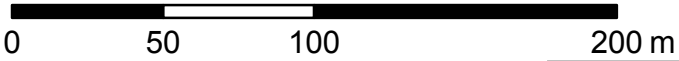
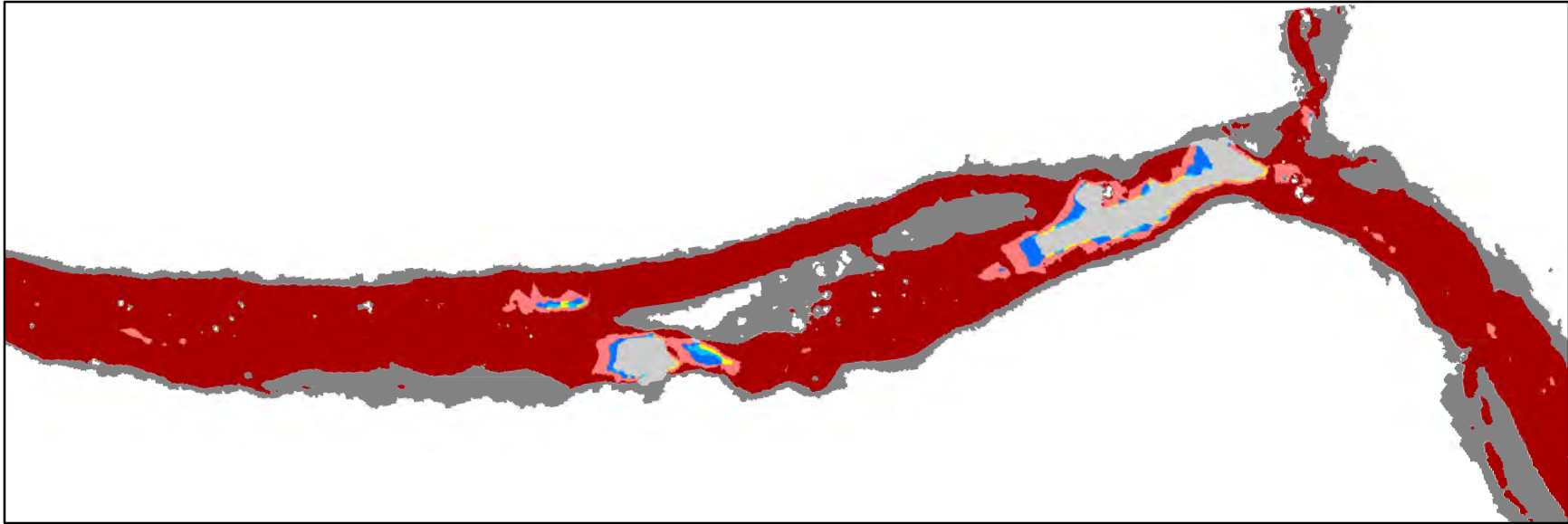

Channel Regions

PP0/RT0	PP1/RT2	PP2/RT2
PP1/RT1	PP2/RT1	Submerged unsavable surface (PP3/RT3)
		Submerged savable surface

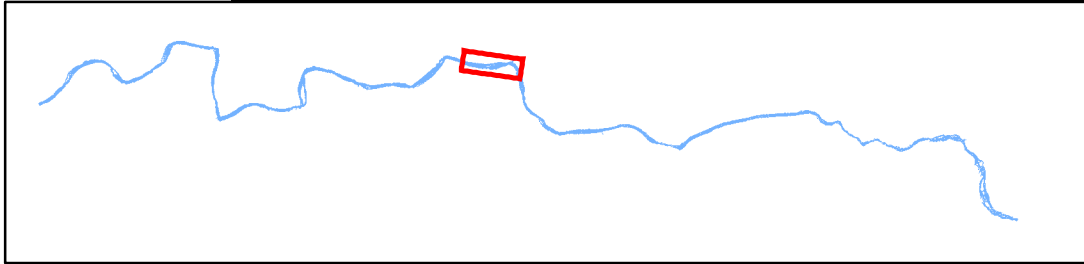



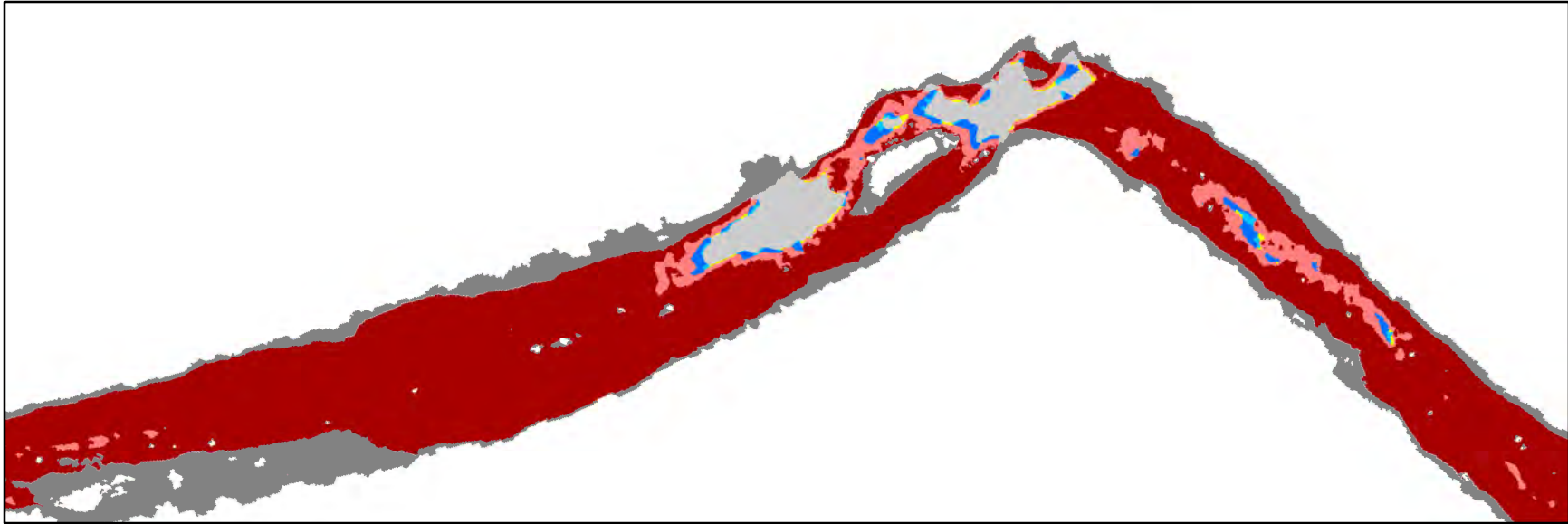



SYR Submerged Unsaveable Surface Hazards for Upright Body at 31 m³/s, p. 13



0 50 100 200 m



Channel Regions

- | | | |
|---|--|--|
|  PP0/RT0 |  PP1/RT2 |  PP2/RT2 |
|  PP1/RT1 |  PP2/RT1 |  Submerged unsaveable surface (PP3/RT3) |
| | |  Submerged saveable surface |

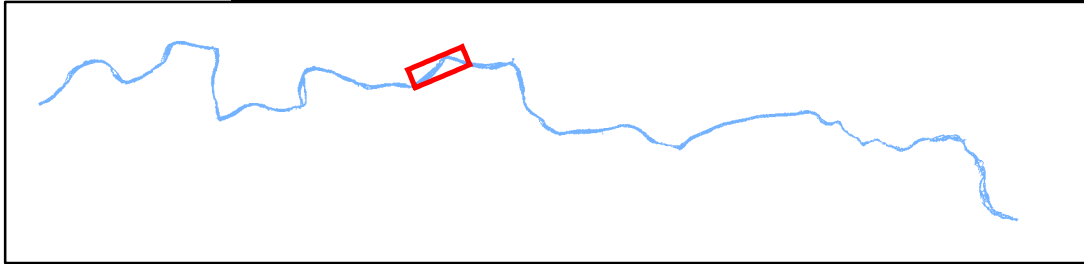

SYR Submerged Unsaveable Surface Hazards for Upright Body at 31 m³/s, p. 14

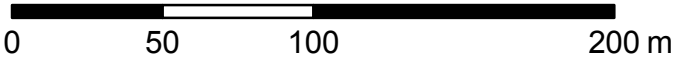
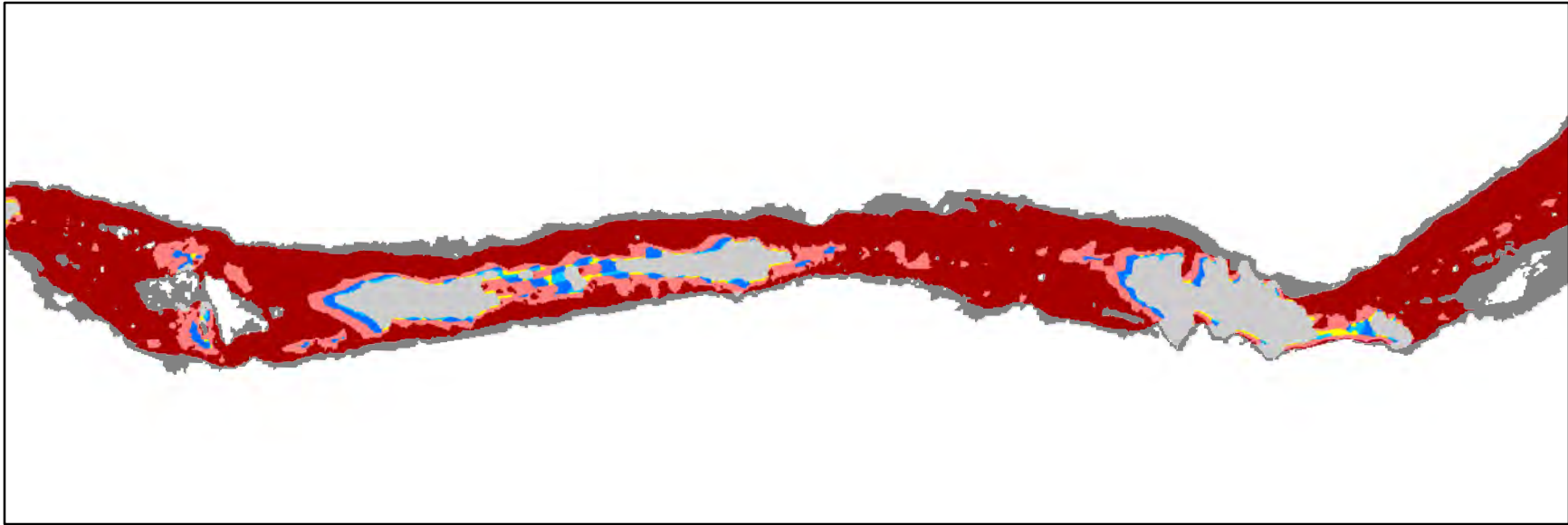

Channel Regions

PP0/RT0	PP1/RT2	PP2/RT2
PP1/RT1	PP2/RT1	Submerged unsaveable surface (PP3/RT3)
		Submerged saveable surface

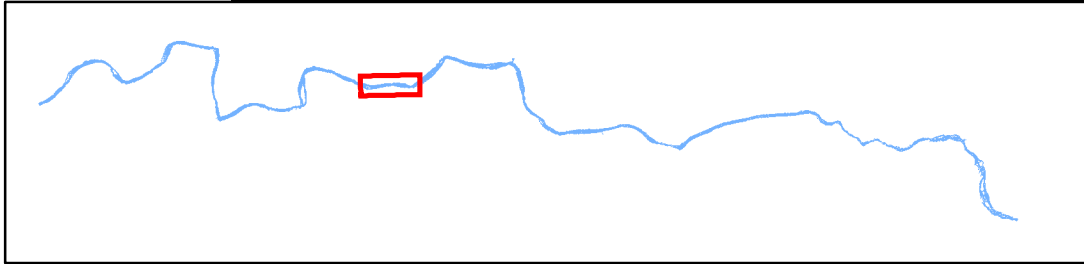

SYR Submerged Unsaveable Surface Hazards for Upright Body at 31 m³/s, p. 15

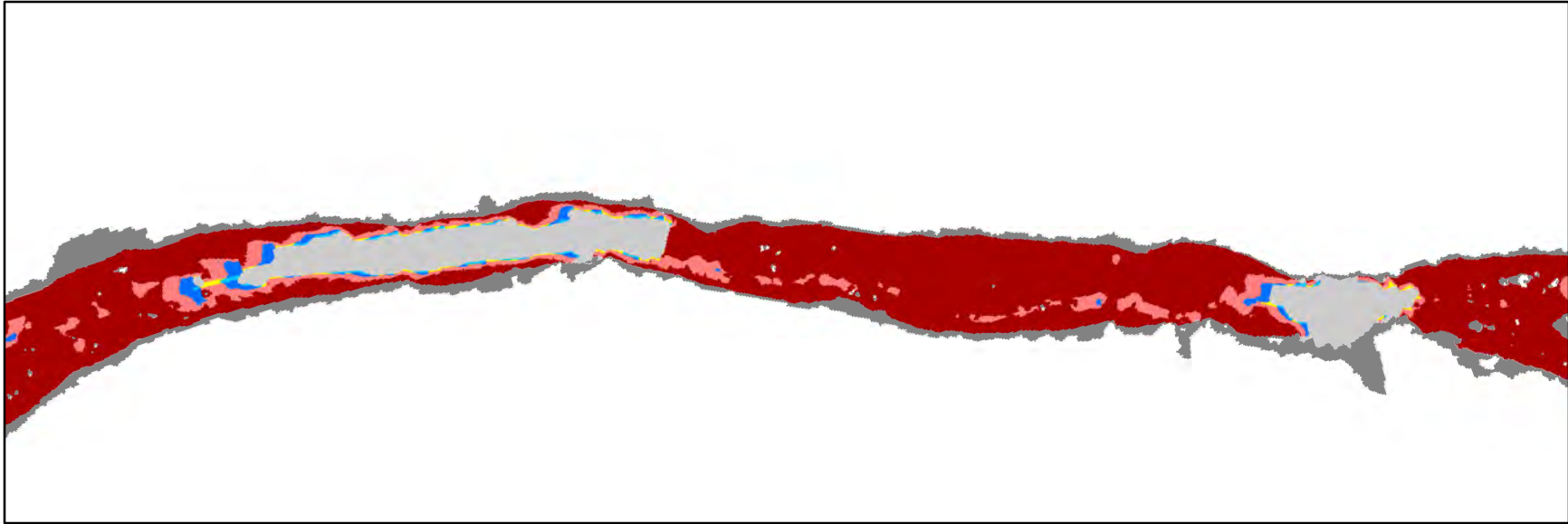

0 50 100 200 m



Channel Regions

PP0/RT0	PP1/RT2	PP2/RT2
PP1/RT1	PP2/RT1	Submerged unsavable surface (PP3/RT3)
		Submerged savable surface

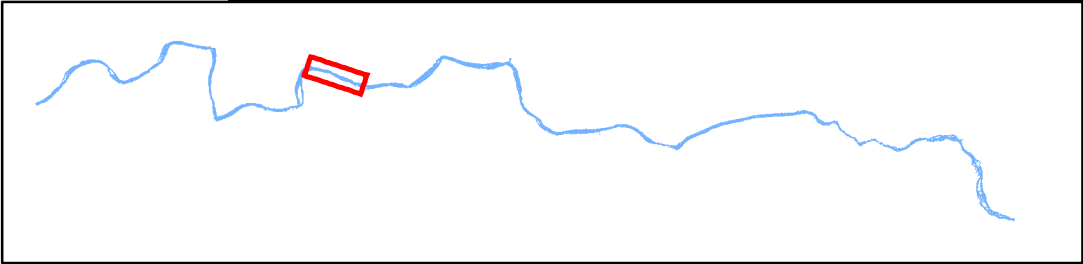

SYR Submerged Unsaveable Surface Hazards for Upright Body at 31 m³/s, p. 16

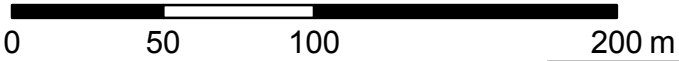
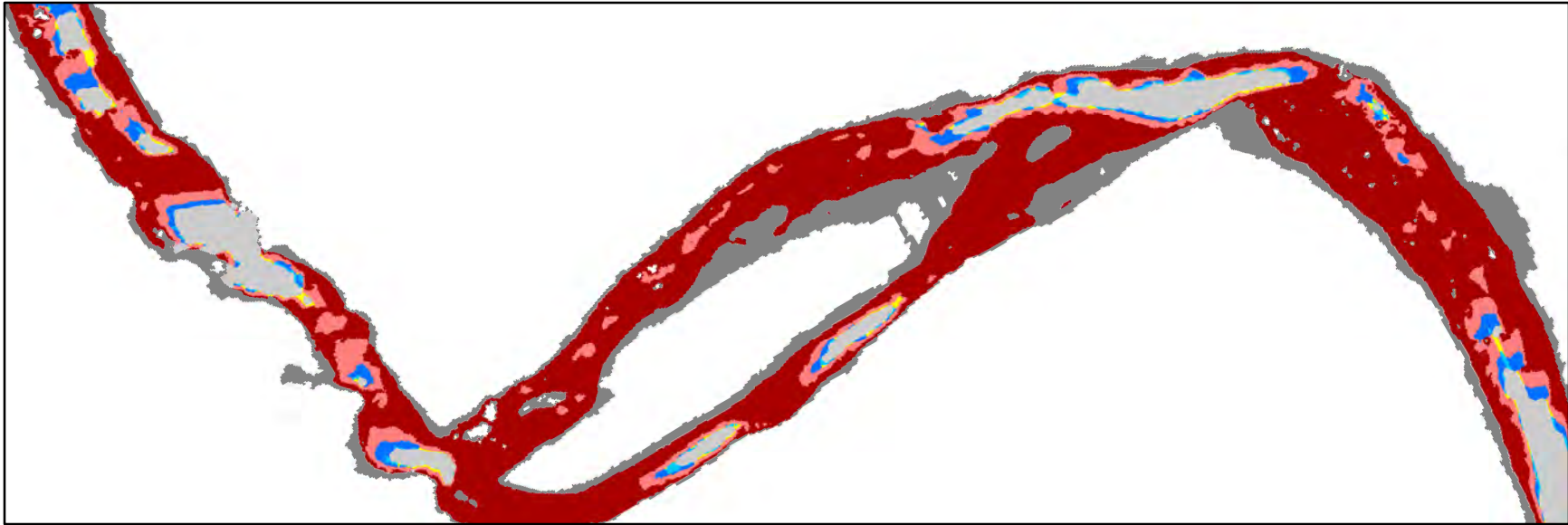

Channel Regions					
Light Grey	PP0/RT0	Yellow	PP1/RT2	Light Red	PP2/RT2
Cyan	PP1/RT1	Blue	PP2/RT1	Dark Red	Submerged unsavable surface (PP3/RT3)
Dark Grey	Submerged savable surface				

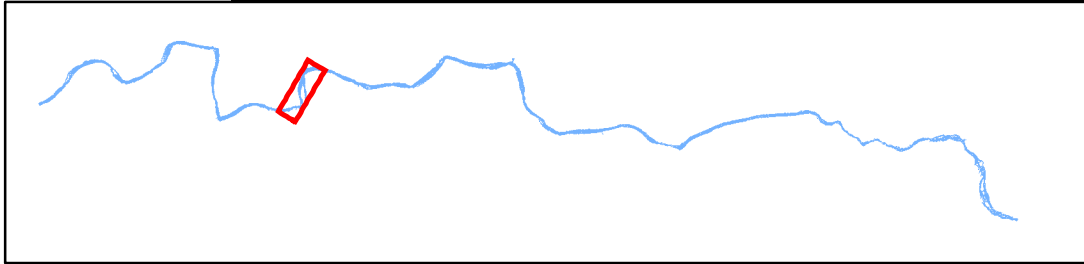

SYR Submerged Unsaveable Surface Hazards for Upright Body at 31 m³/s, p. 17

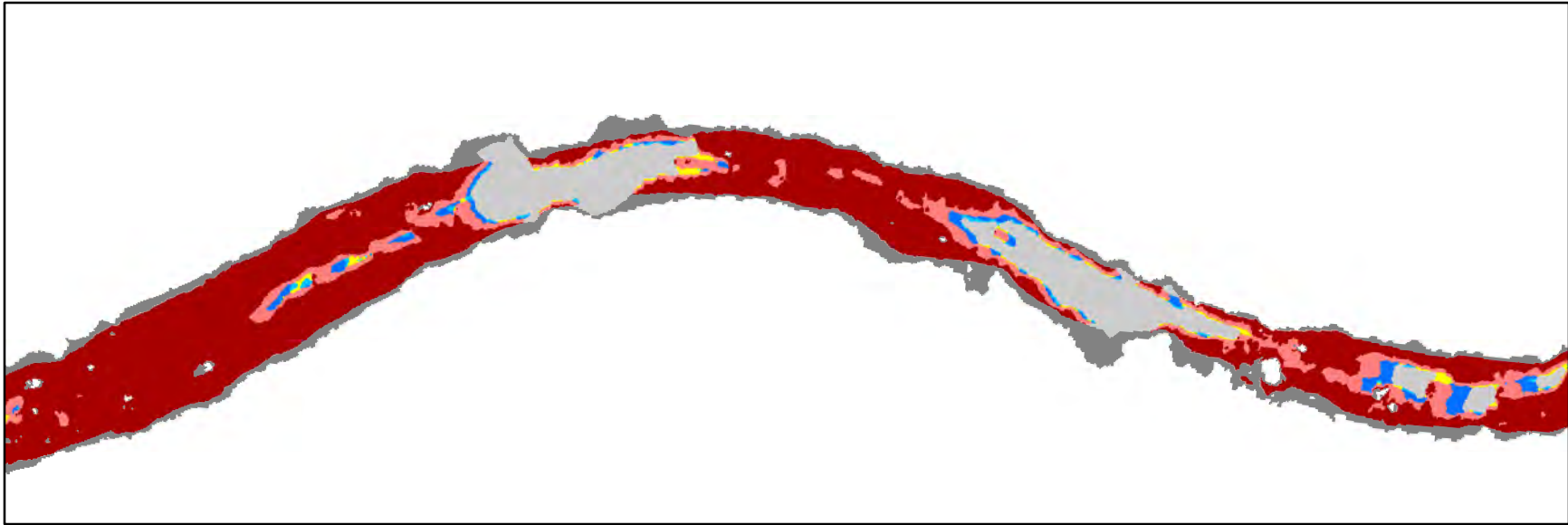

0 50 100 200 m



Channel Regions

PP0/RT0	PP1/RT2	PP2/RT2
PP1/RT1	PP2/RT1	Submerged unsavable surface (PP3/RT3)
		Submerged savable surface

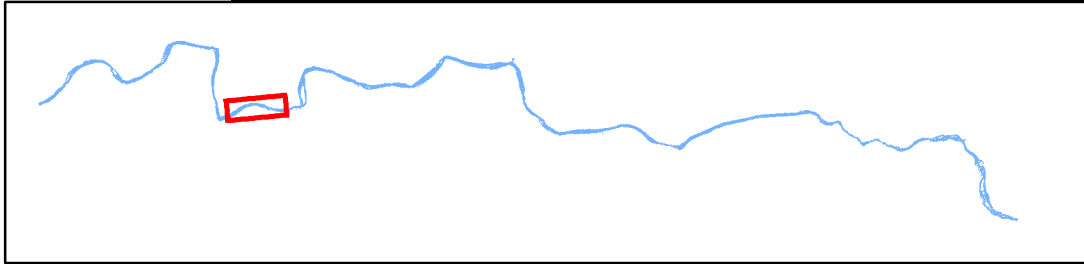



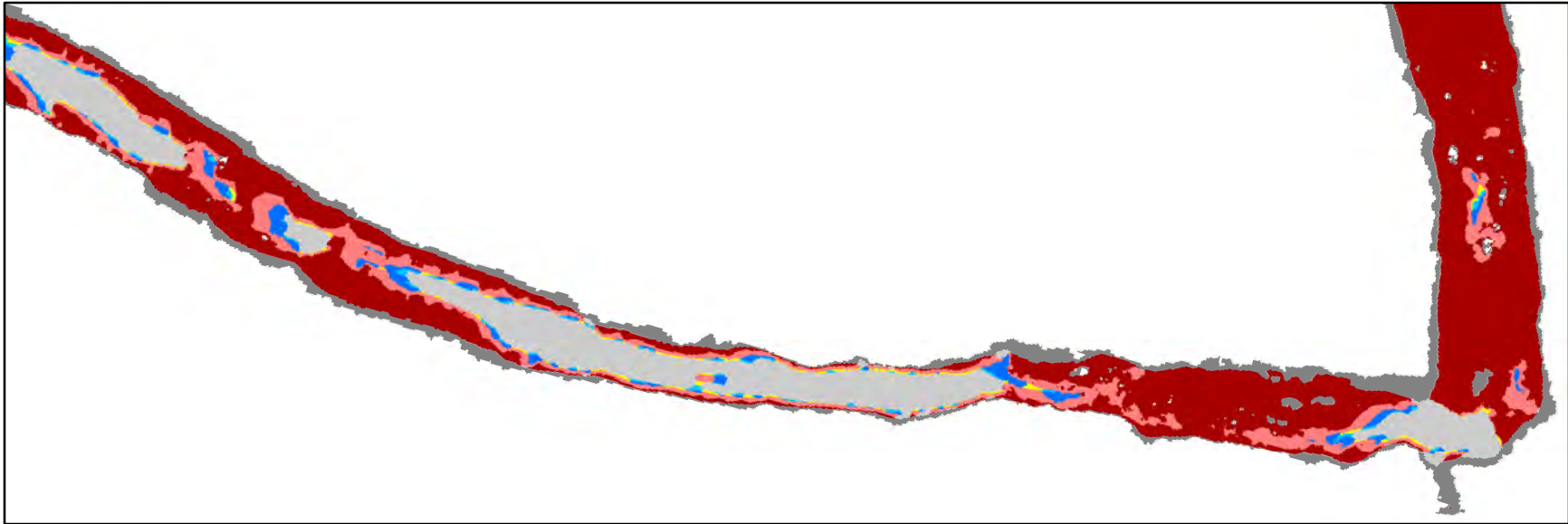



SYR Submerged Unsaveable Surface Hazards for Upright Body at 31 m³/s, p. 18



0 50 100 200 m



Channel Regions

- | | | |
|---|--|--|
|  PP0/RT0 |  PP1/RT2 |  PP2/RT2 |
|  PP1/RT1 |  PP2/RT1 |  Submerged unsaveable surface (PP3/RT3) |
| | |  Submerged saveable surface |

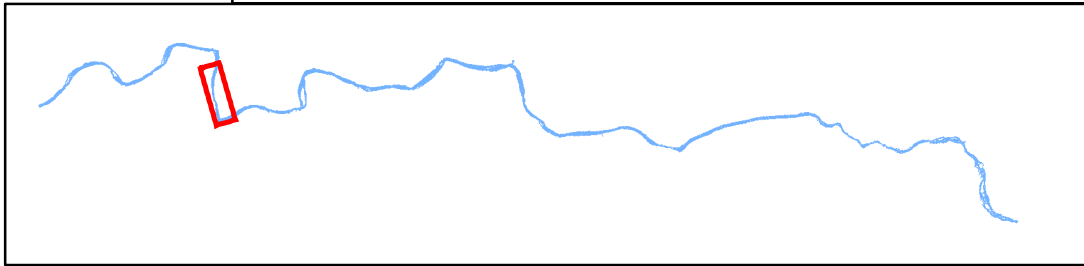

SYR Submerged Unsavable Surface Hazards for Upright Body at 31 m³/s, p. 19

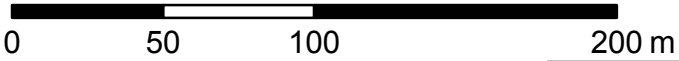
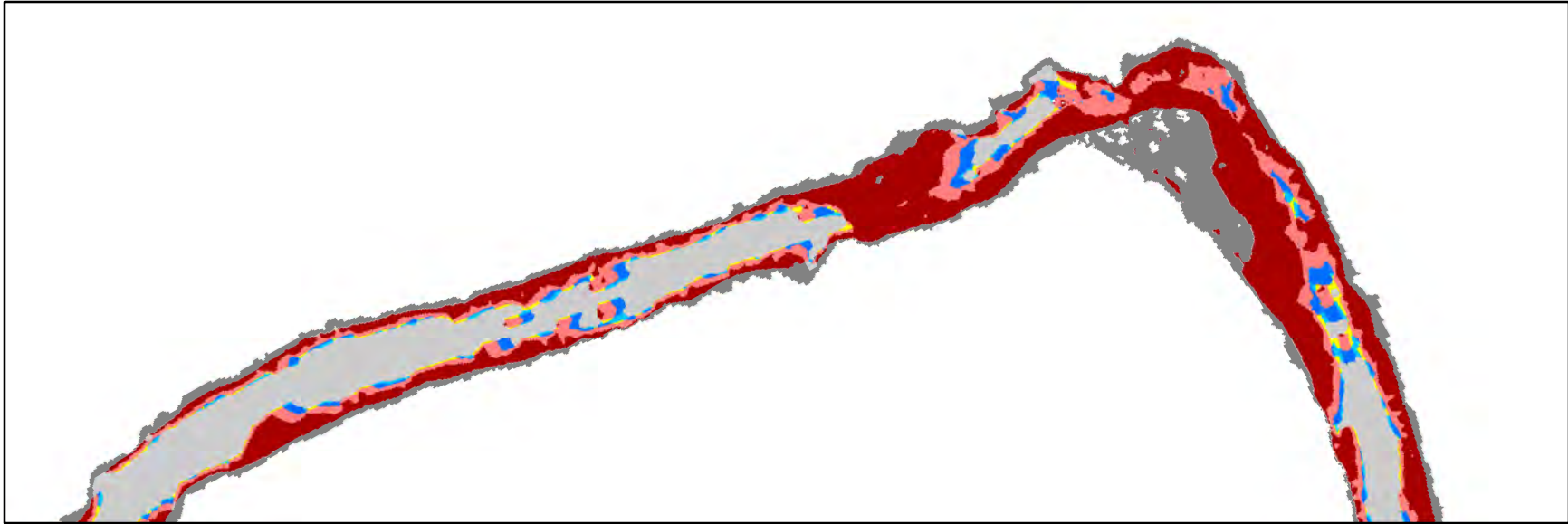

Channel Regions

Grey	PP0/RT0	Yellow	PP1/RT2	Light Red	PP2/RT2
Cyan	PP1/RT1	Blue	PP2/RT1	Dark Red	Submerged unsavable surface (PP3/RT3)
Dark Grey	Submerged savable surface				

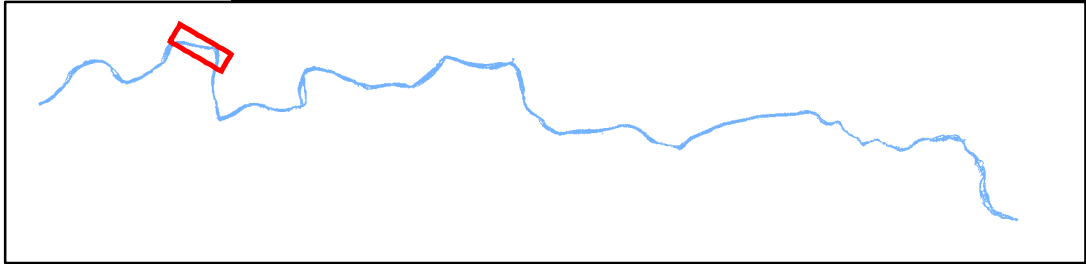

SYR Submerged Unsaveable Surface Hazards for Upright Body at 31 m³/s, p. 20

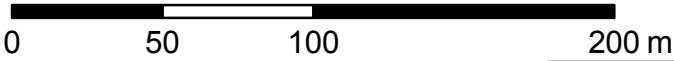
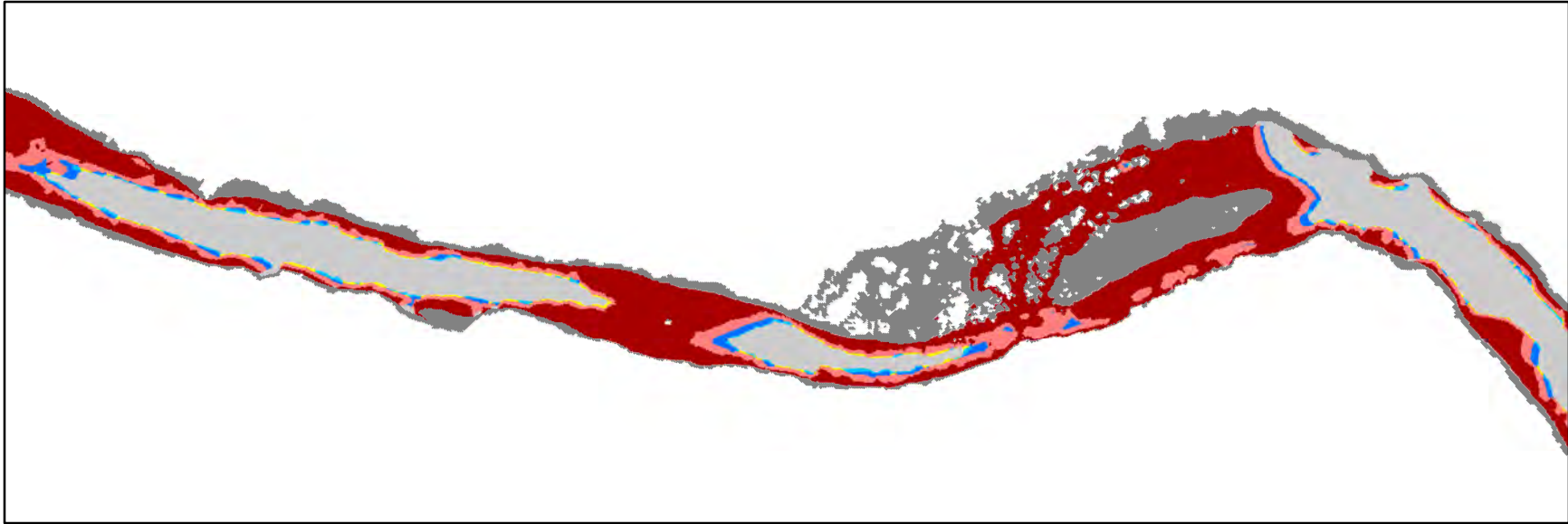

Channel Regions

PP0/RT0	PP1/RT2	PP2/RT2
PP1/RT1	PP2/RT1	Submerged unsavable surface (PP3/RT3)
		Submerged savable surface

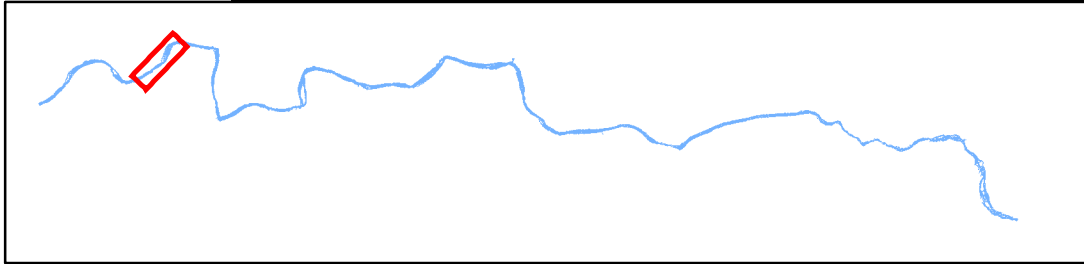

SYR Submerged Unsaveable Surface Hazards for Upright Body at 31 m³/s, p. 21

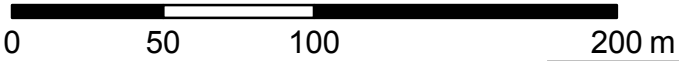
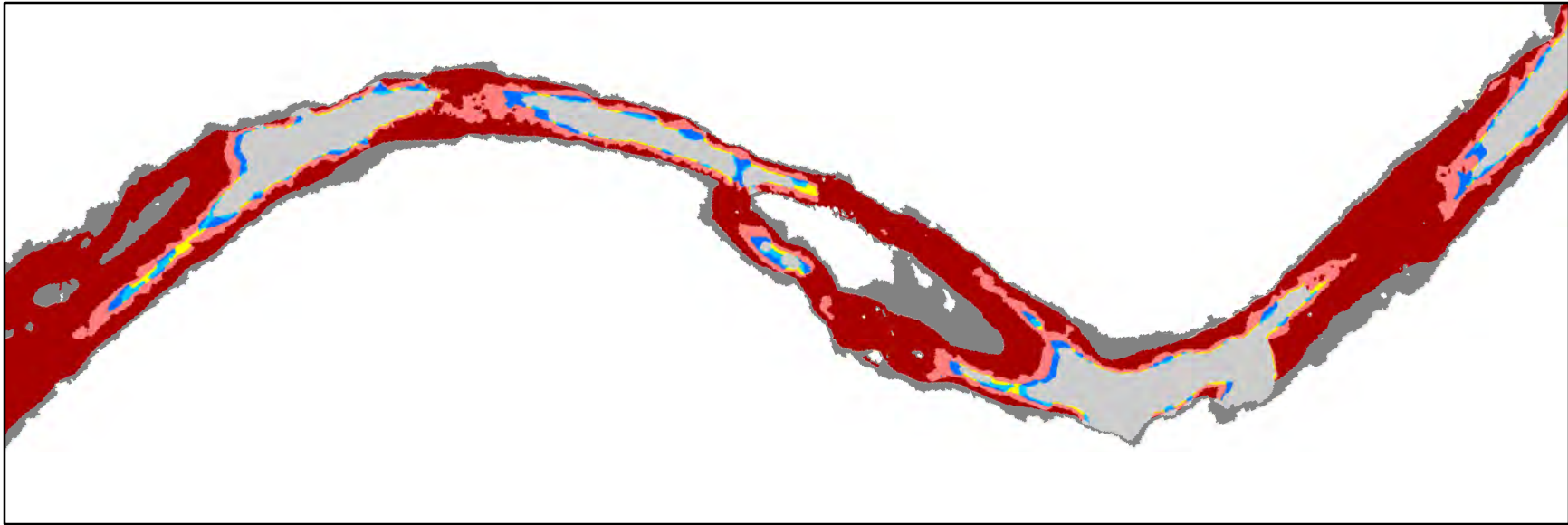

Channel Regions		
PP0/RT0	PP1/RT2	PP2/RT2
PP1/RT1	PP2/RT1	Submerged unsavable surface (PP3/RT3)
		Submerged savable surface

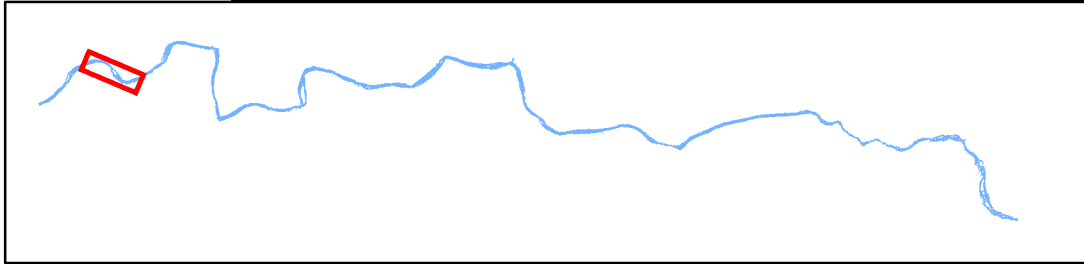

SYR Submerged Unsavable Surface Hazards for Upright Body at 31 m³/s, p. 22

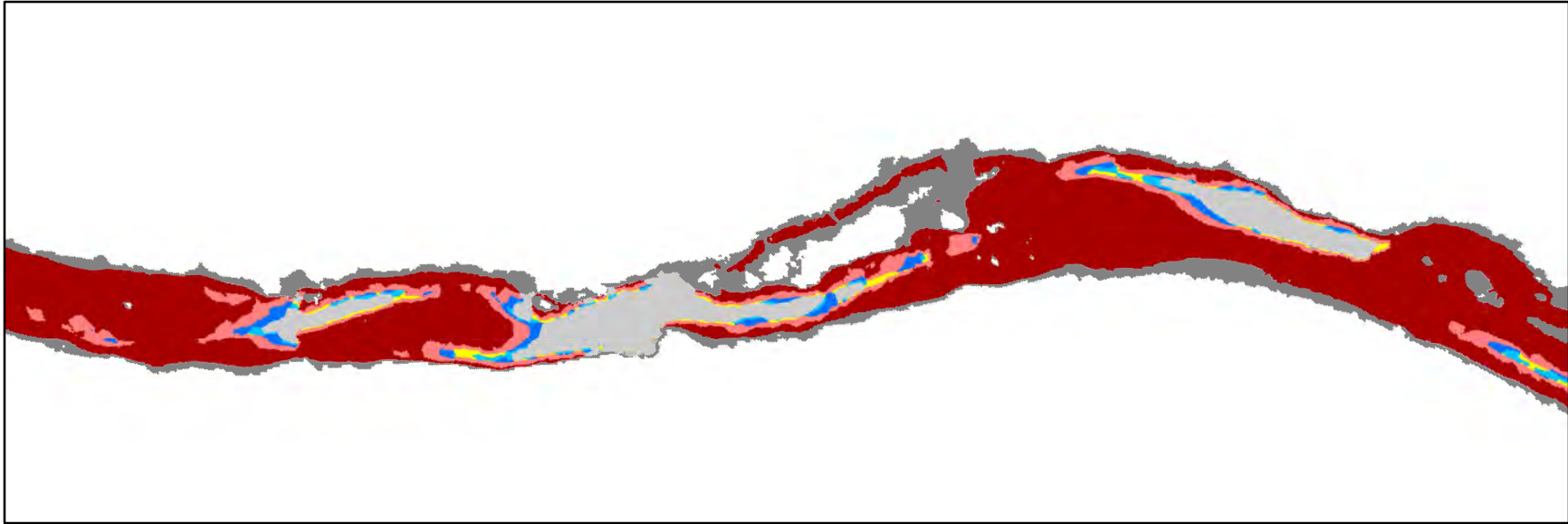

0 50 100 200 m



Channel Regions

PP0/RT0	PP1/RT2	PP2/RT2
PP1/RT1	PP2/RT1	Submerged unsavable surface (PP3/RT3)
		Submerged savable surface

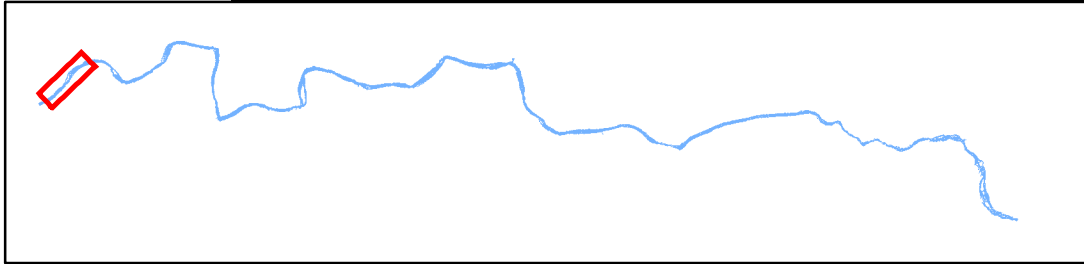

SYR Submerged Unsavable Surface Hazards for Upright Body at 31 m³/s, p. 23

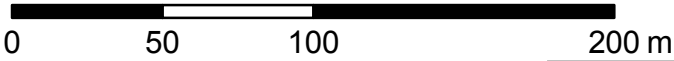
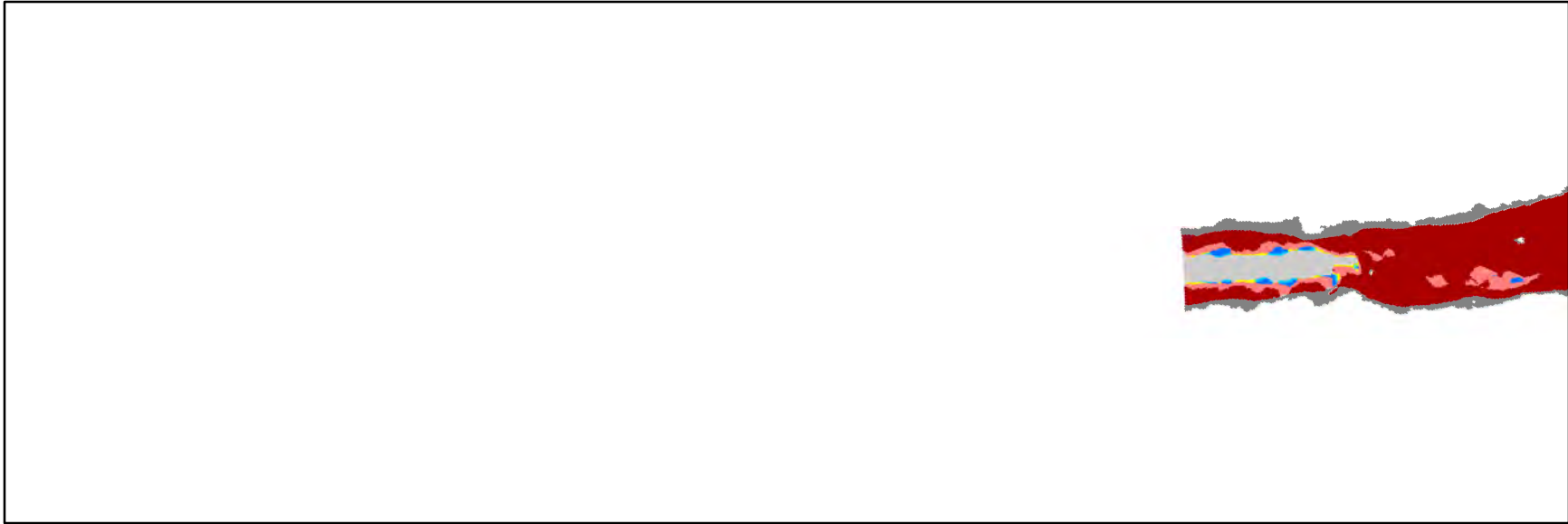

Channel Regions

PP0/RT0	PP1/RT2	PP2/RT2
PP1/RT1	PP2/RT1	Submerged unsavable surface (PP3/RT3)
		Submerged savable surface

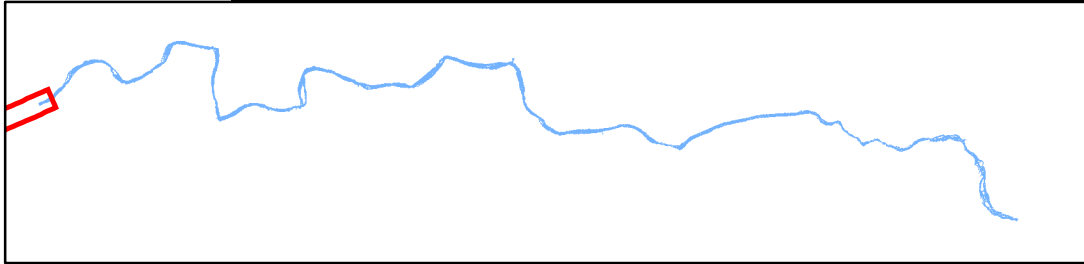

SYR Total Hazards for Upright Body at 31 m³/s, p. 1

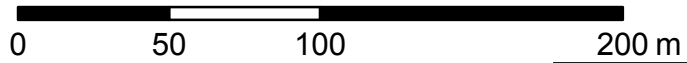
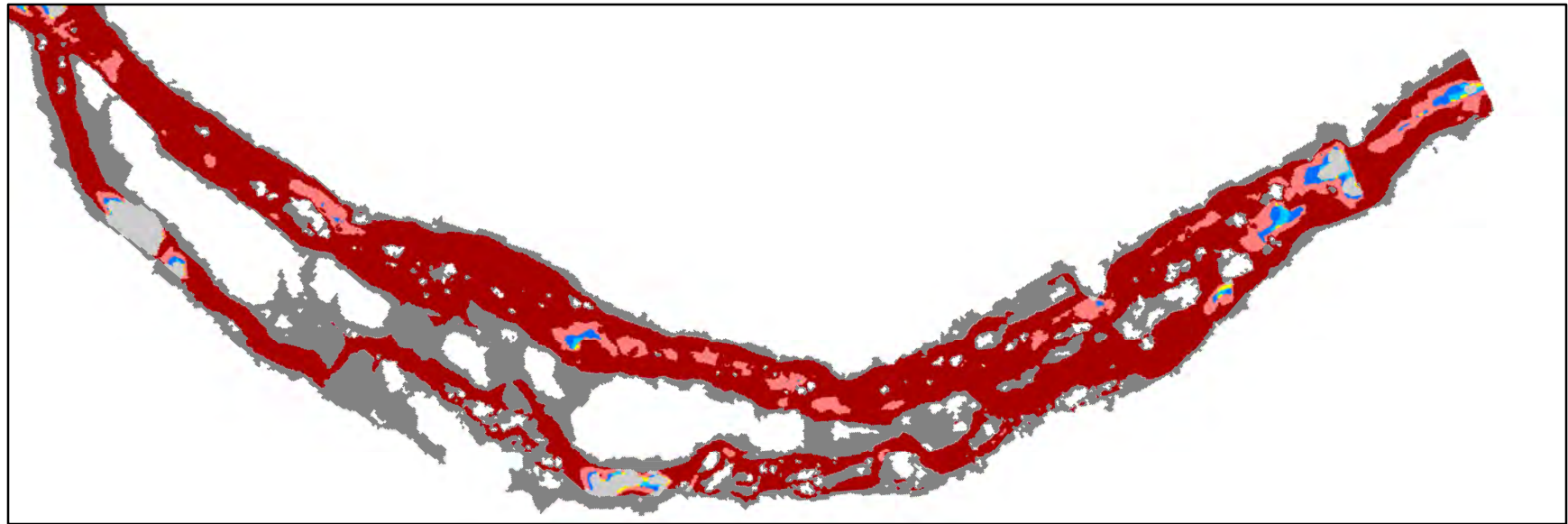

Channel Regions



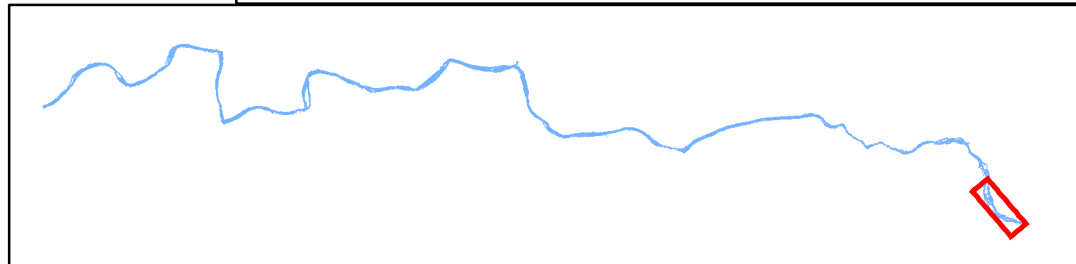

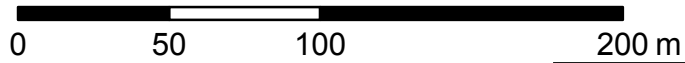
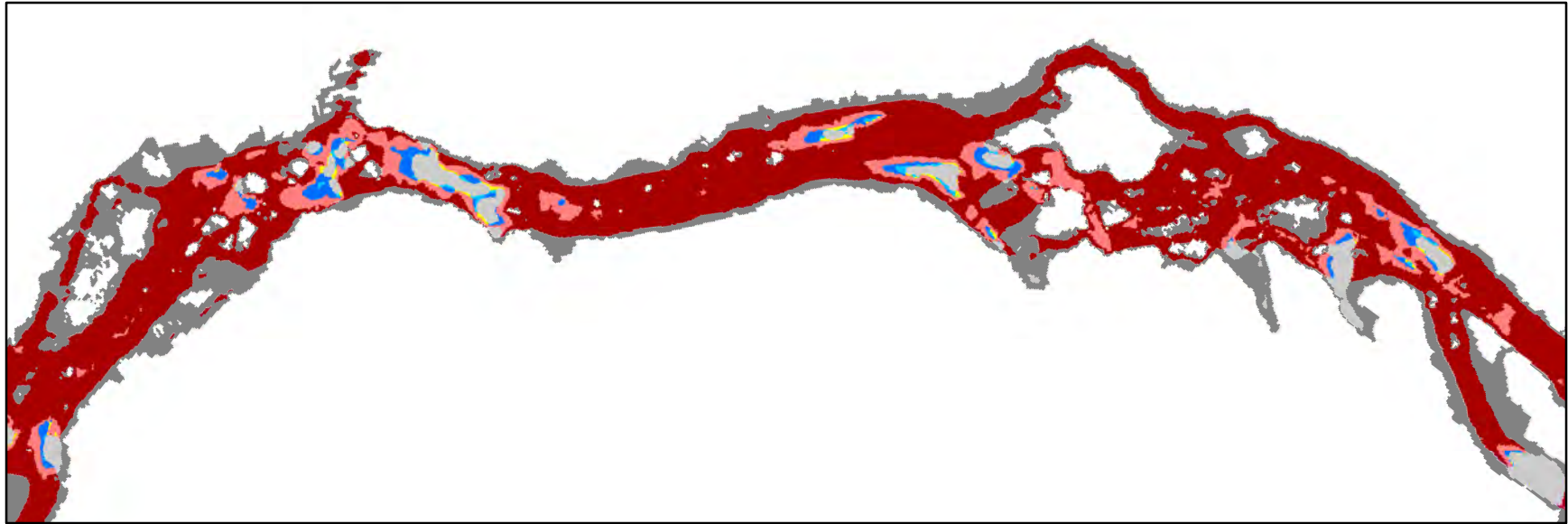

PP0/RT0	PP1/RT2	PP2/RT2
PP1/RT1	PP2/RT1	Submerged unsavable surface (PP3/RT3)
		Submerged savable surface



SYR Total Hazards for Upright Body at 31 m³/s, p. 2



Channel Regions

- | | | |
|---|--|---|
|  PP0/RT0 |  PP1/RT2 |  PP2/RT2 |
|  PP1/RT1 |  PP2/RT1 |  Submerged unsavable surface (PP3/RT3) |
| | |  Submerged savable surface |

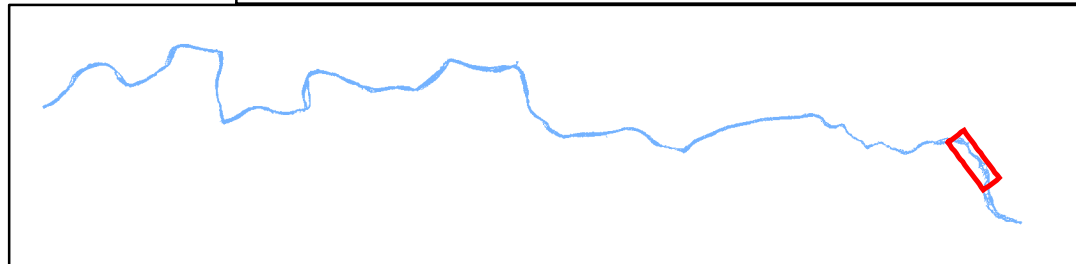

SYR Total Hazards for Upright Body at 31 m³/s, p. 3

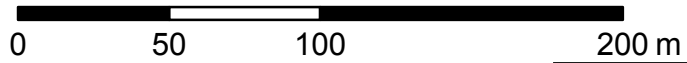
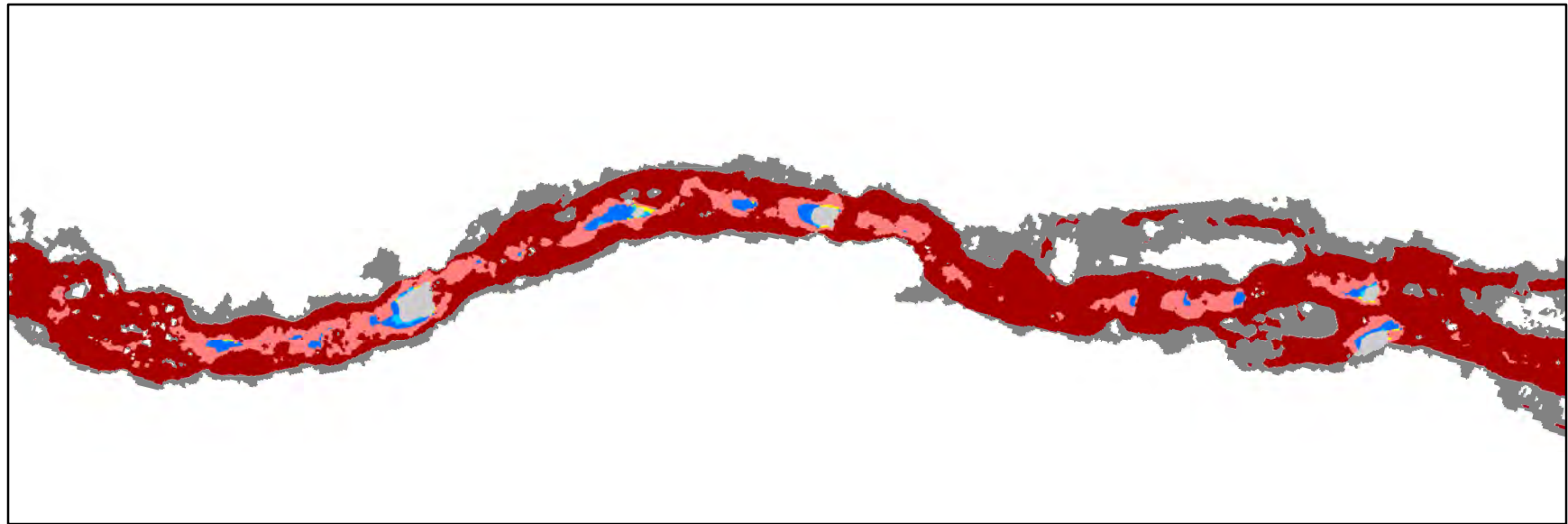

Channel Regions

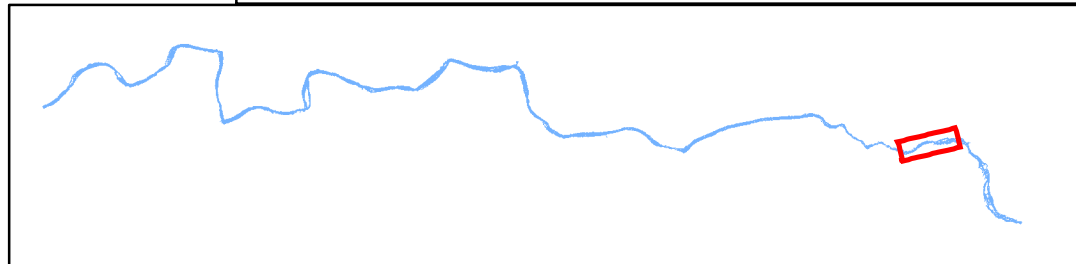
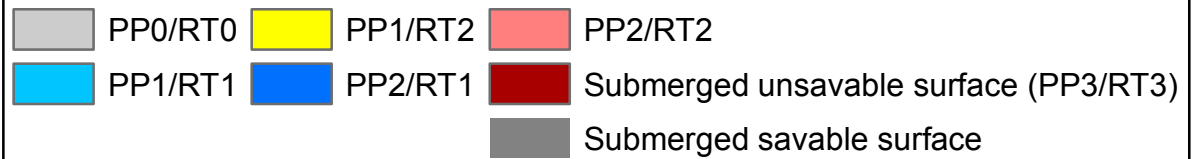

SYR Total Hazards for Upright Body at 31 m³/s, p. 4

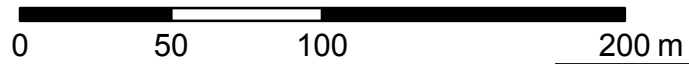
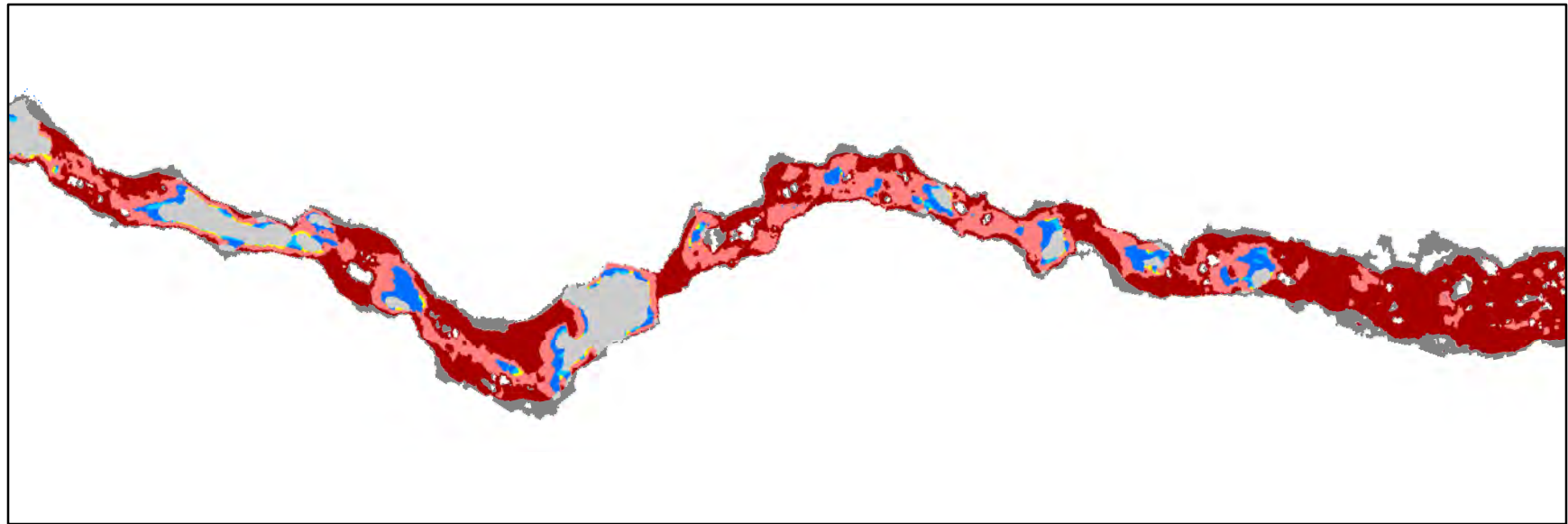

Channel Regions

Grey	PP0/RT0	Yellow	PP1/RT2	Light Red	PP2/RT2
Cyan	PP1/RT1	Blue	PP2/RT1	Dark Red	Submerged unsavable surface (PP3/RT3)
Dark Grey					Submerged savable surface

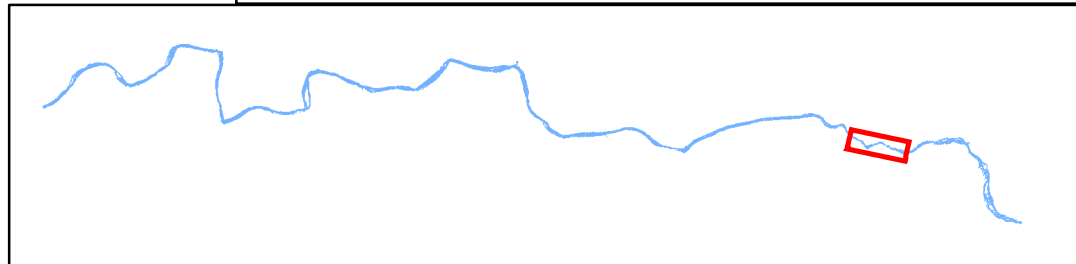

SYR Total Hazards for Upright Body at 31 m³/s, p. 5

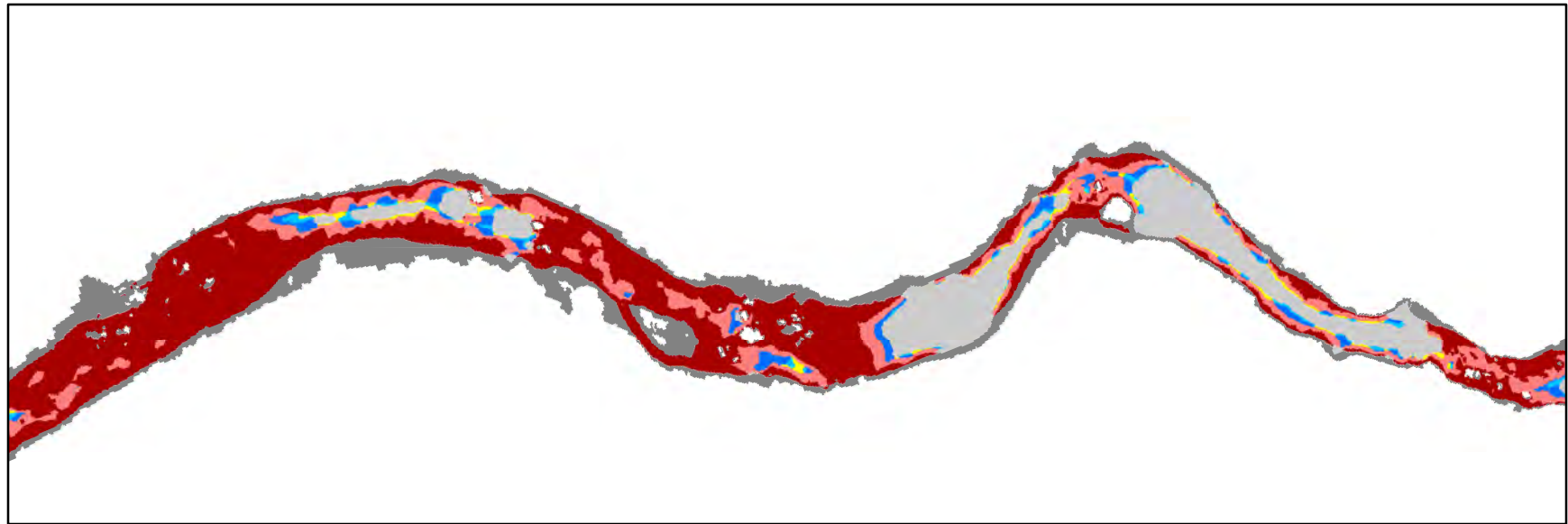

0 50 100 200 m



Channel Regions



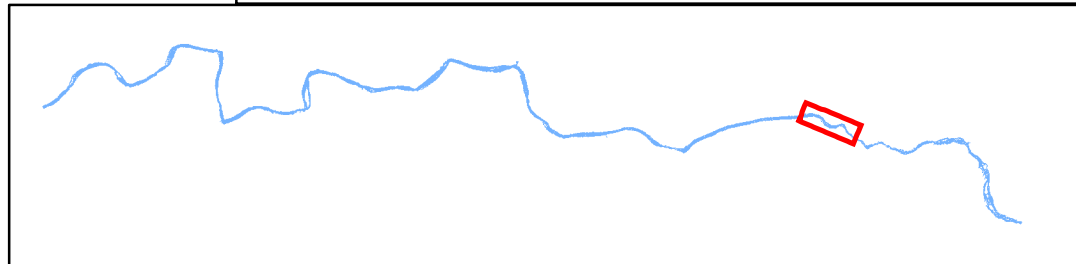

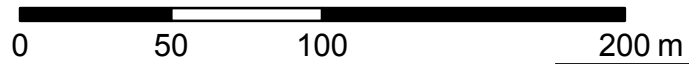
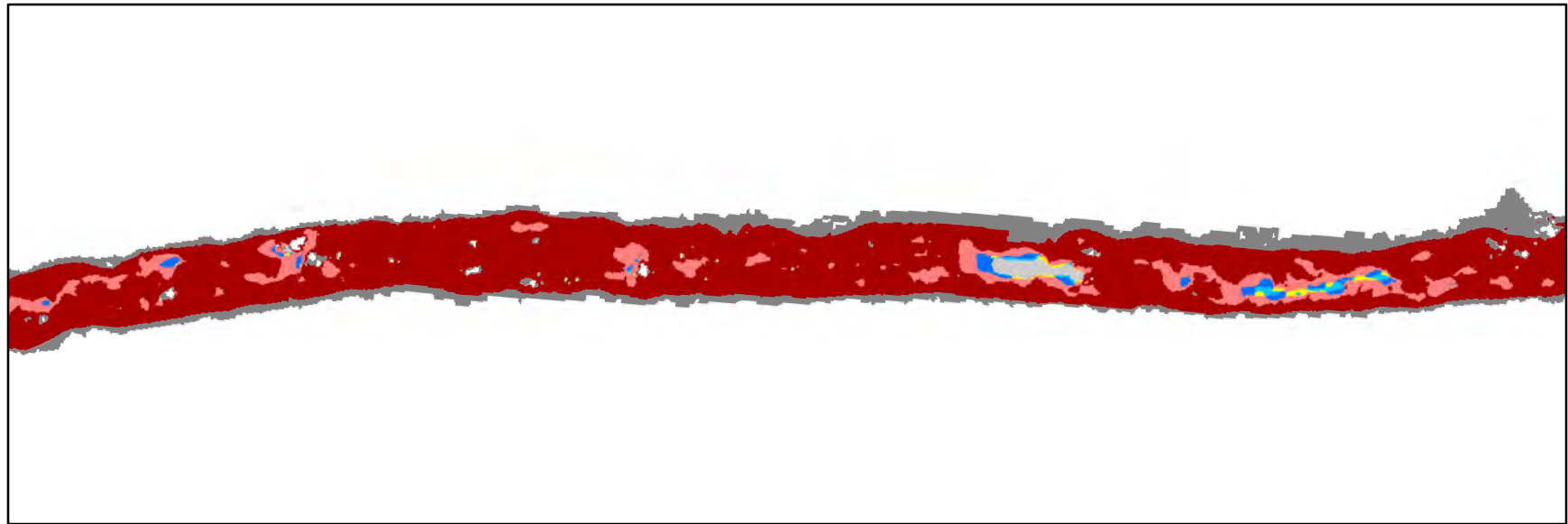

PP0/RT0	PP1/RT2	PP2/RT2
PP1/RT1	PP2/RT1	Submerged unsavable surface (PP3/RT3)
		Submerged savable surface



SYR Total Hazards for Upright Body at 31 m³/s, p. 6



Channel Regions

	PP0/RT0		PP1/RT2		PP2/RT2
	PP1/RT1		PP2/RT1		Submerged unsavable surface (PP3/RT3)
					Submerged savable surface

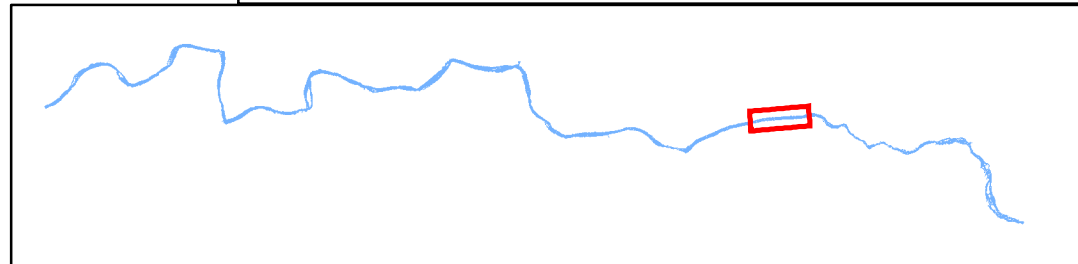

SYR Total Hazards for Upright Body at 31 m³/s, p. 7

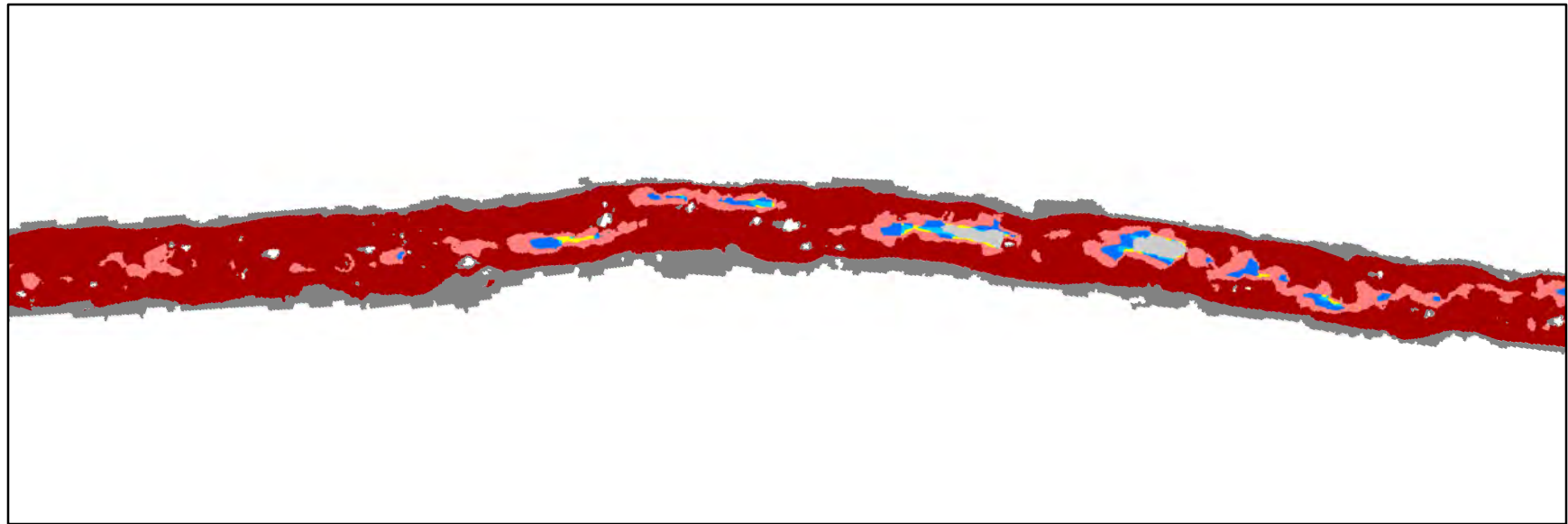

0 50 100 200 m



Channel Regions

PP0/RT0	PP1/RT2	PP2/RT2
PP1/RT1	PP2/RT1	Submerged unsavable surface (PP3/RT3)
		Submerged savable surface

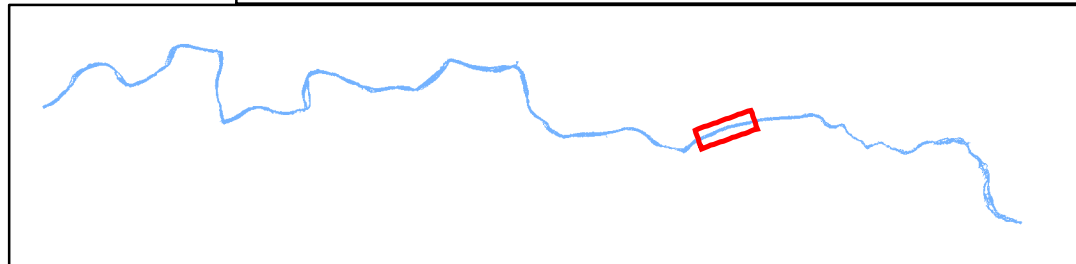



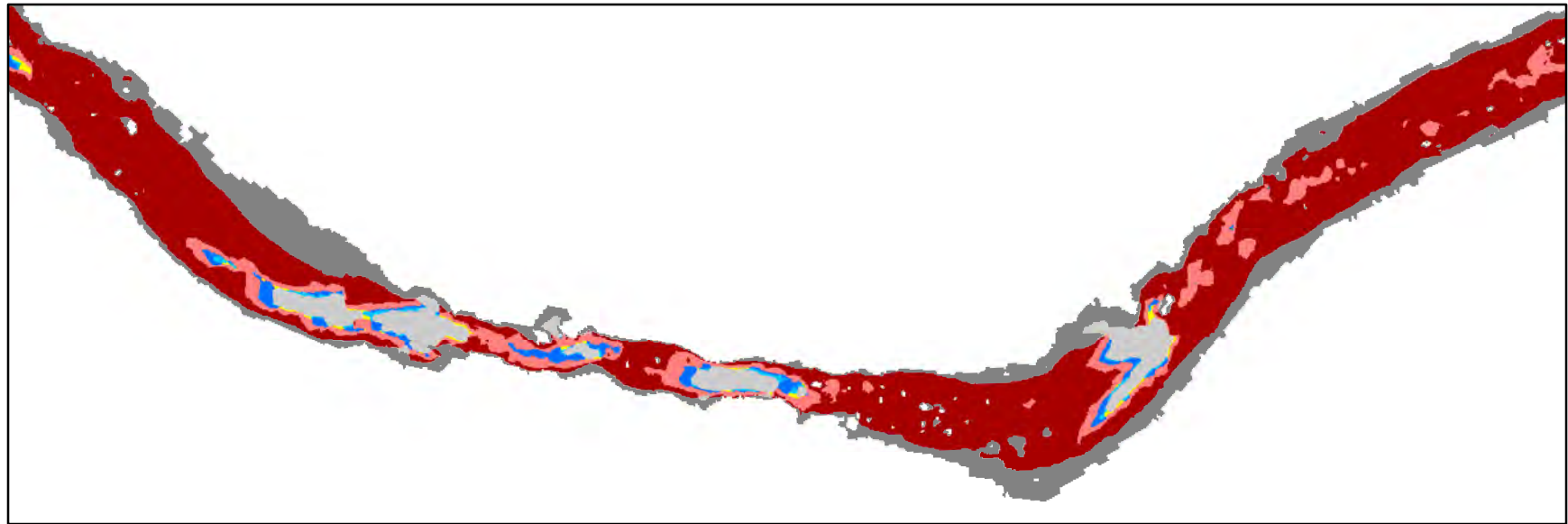



SYR Total Hazards for Upright Body at 31 m³/s, p. 8



0 50 100 200 m



Channel Regions



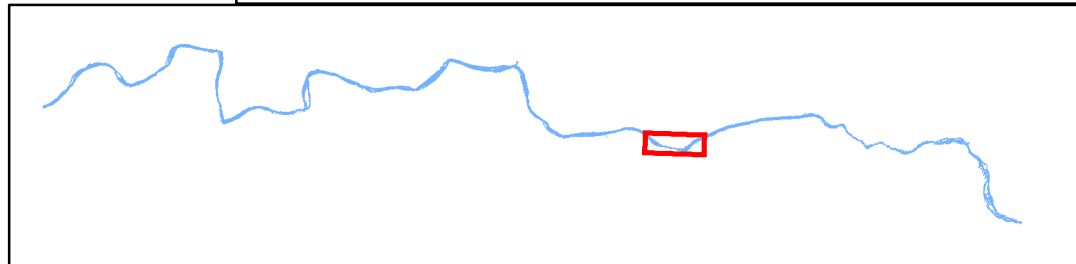

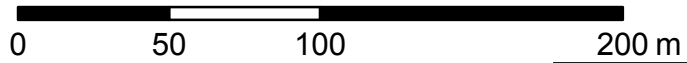
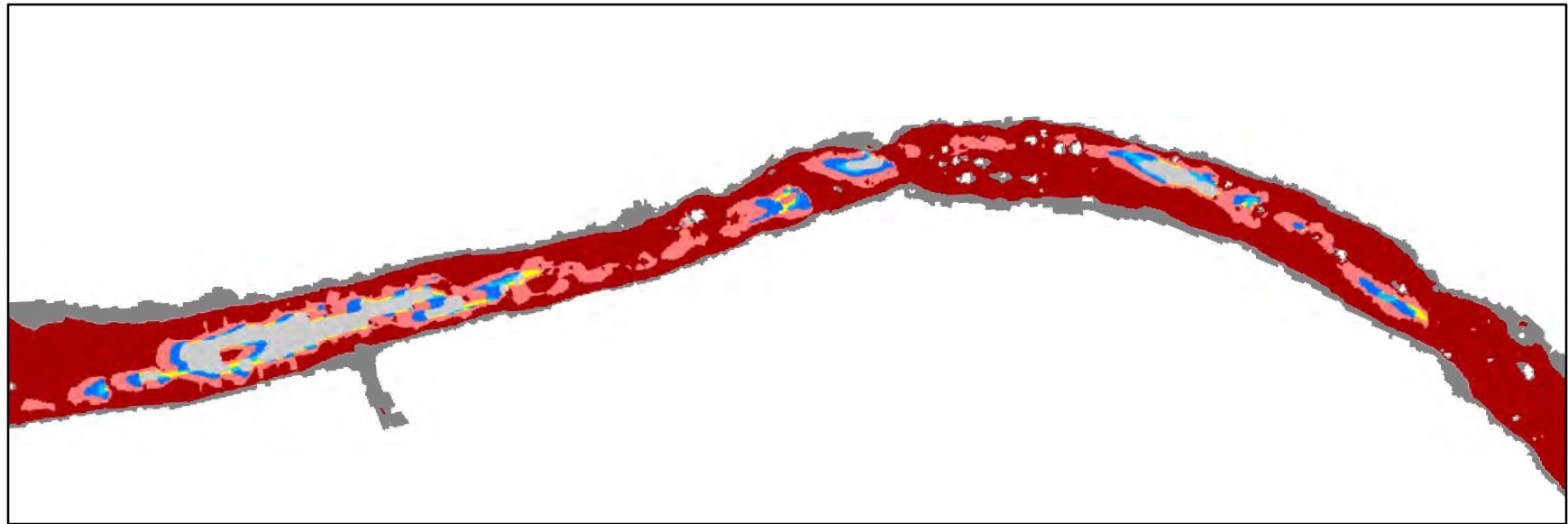

	PP0/RT0		PP1/RT2		PP2/RT2
	PP1/RT1		PP2/RT1		Submerged unsavable surface (PP3/RT3)
	Submerged savable surface				



SYR Total Hazards for Upright Body at 31 m³/s, p. 9



Channel Regions

	PP0/RT0		PP1/RT2		PP2/RT2
	PP1/RT1		PP2/RT1		Submerged unsavable surface (PP3/RT3)
	Submerged savable surface				

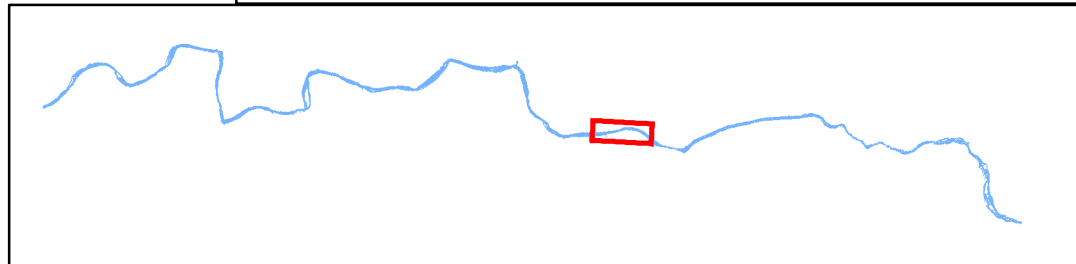

SYR Total Hazards for Upright Body at 31 m³/s, p. 10

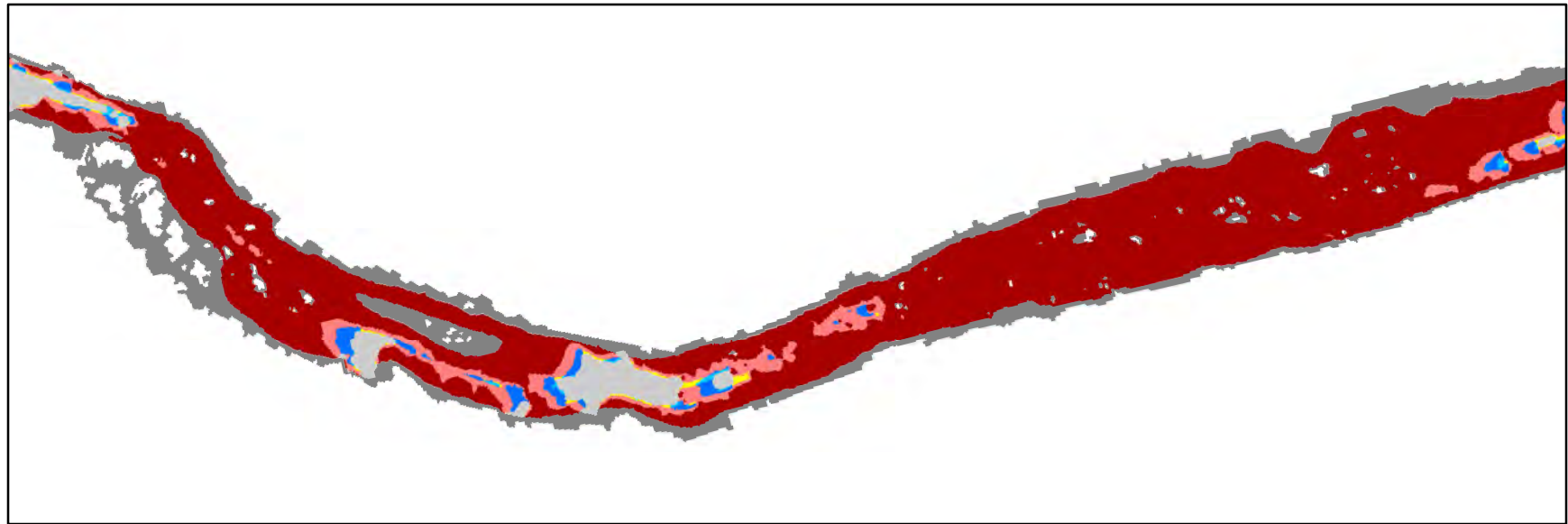

0 50 100 200 m



Channel Regions

PP0/RT0	PP1/RT2	PP2/RT2
PP1/RT1	PP2/RT1	Submerged unsavable surface (PP3/RT3)
		Submerged savable surface

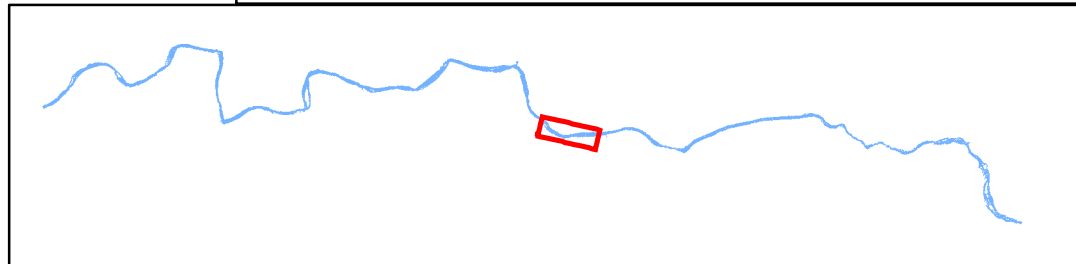

SYR Total Hazards for Upright Body at 31 m³/s, p. 11

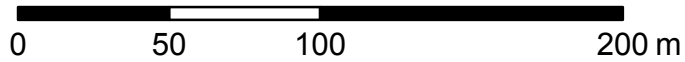
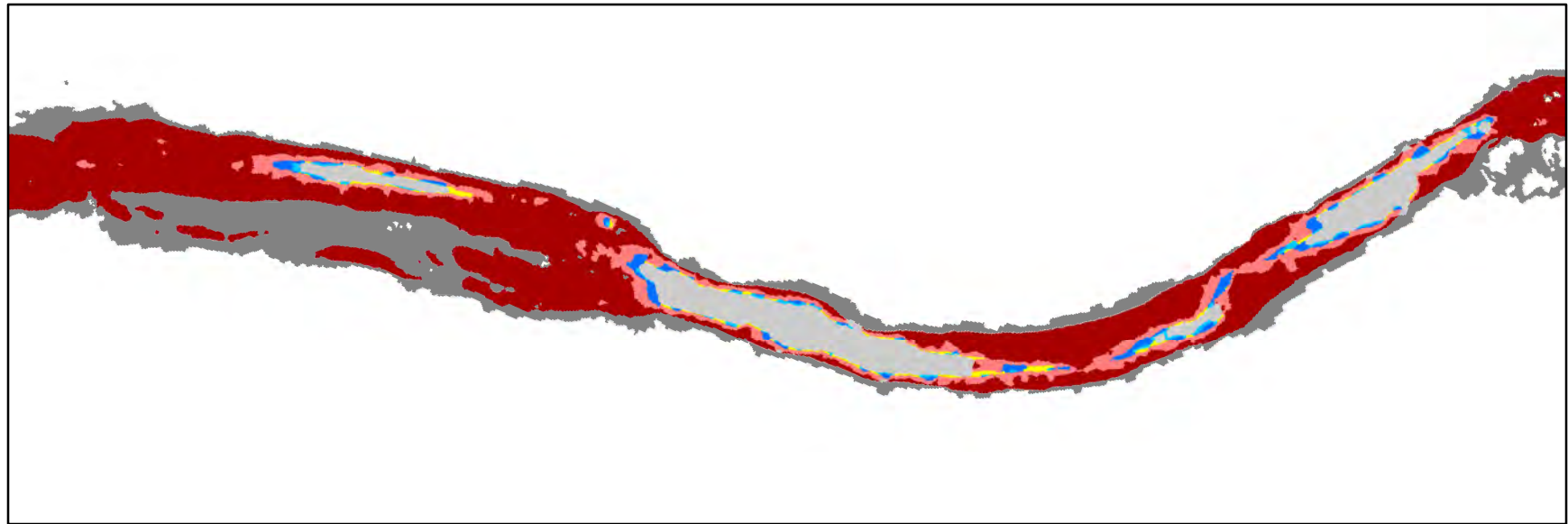

Channel Regions

Grey	PP0/RT0	Yellow	PP1/RT2	Light Red	PP2/RT2
Light Blue	PP1/RT1	Dark Blue	PP2/RT1	Dark Red	Submerged unsavable surface (PP3/RT3)
Dark Grey					Submerged savable surface

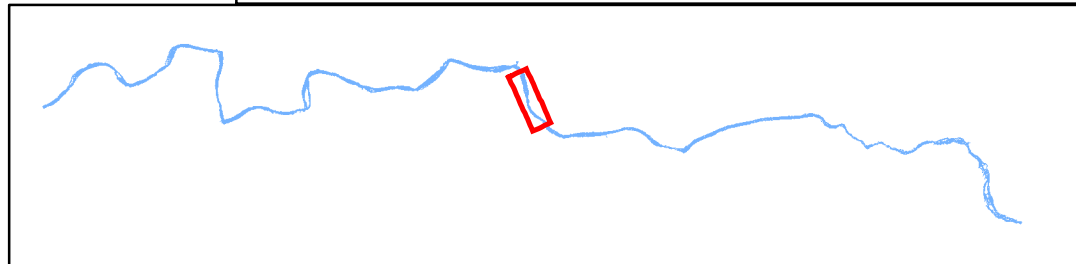



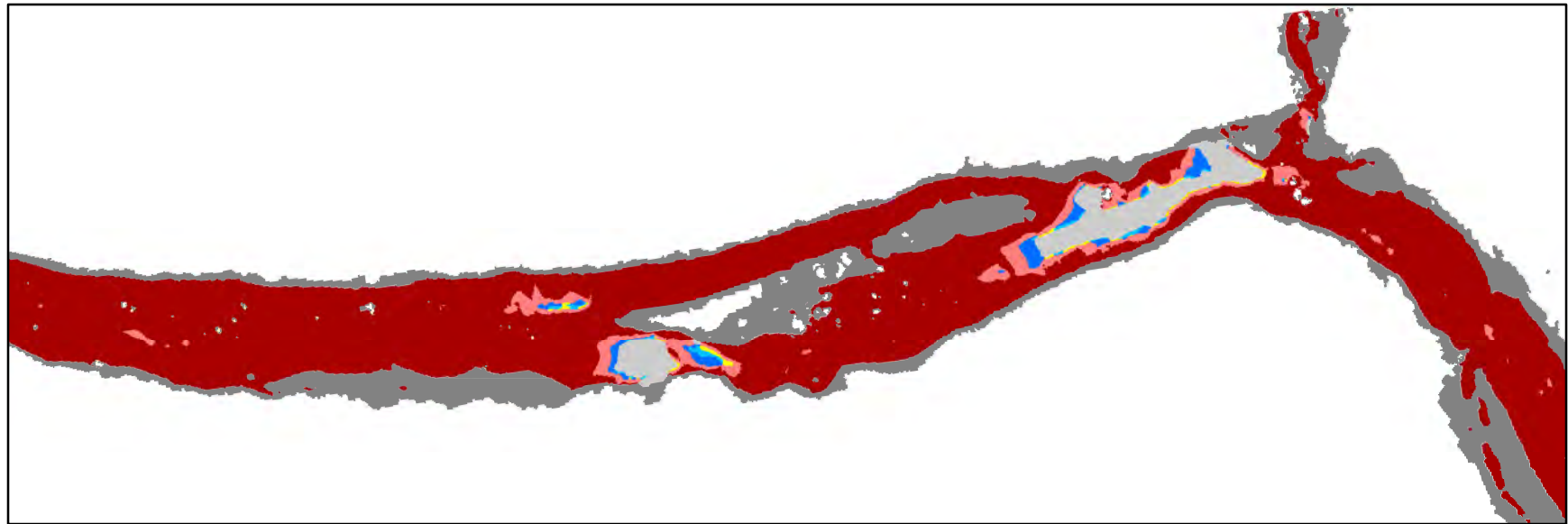



SYR Total Hazards for Upright Body at 31 m³/s, p. 12



0 50 100 200 m



Channel Regions

- | | | |
|---|--|---|
|  PP0/RT0 |  PP1/RT2 |  PP2/RT2 |
|  PP1/RT1 |  PP2/RT1 |  Submerged unsavable surface (PP3/RT3) |
| | |  Submerged savable surface |

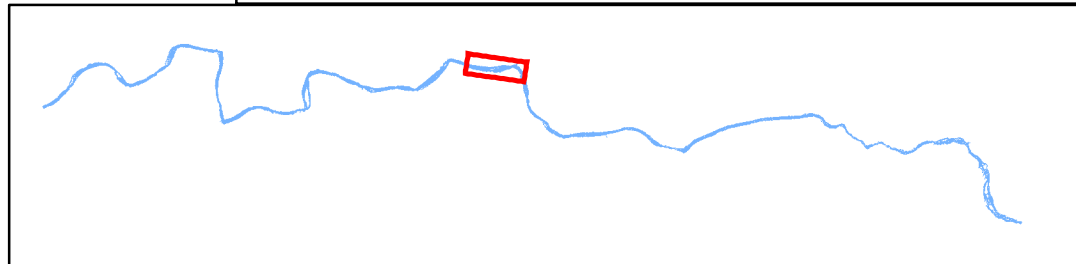

SYR Total Hazards for Upright Body at 31 m³/s, p. 13

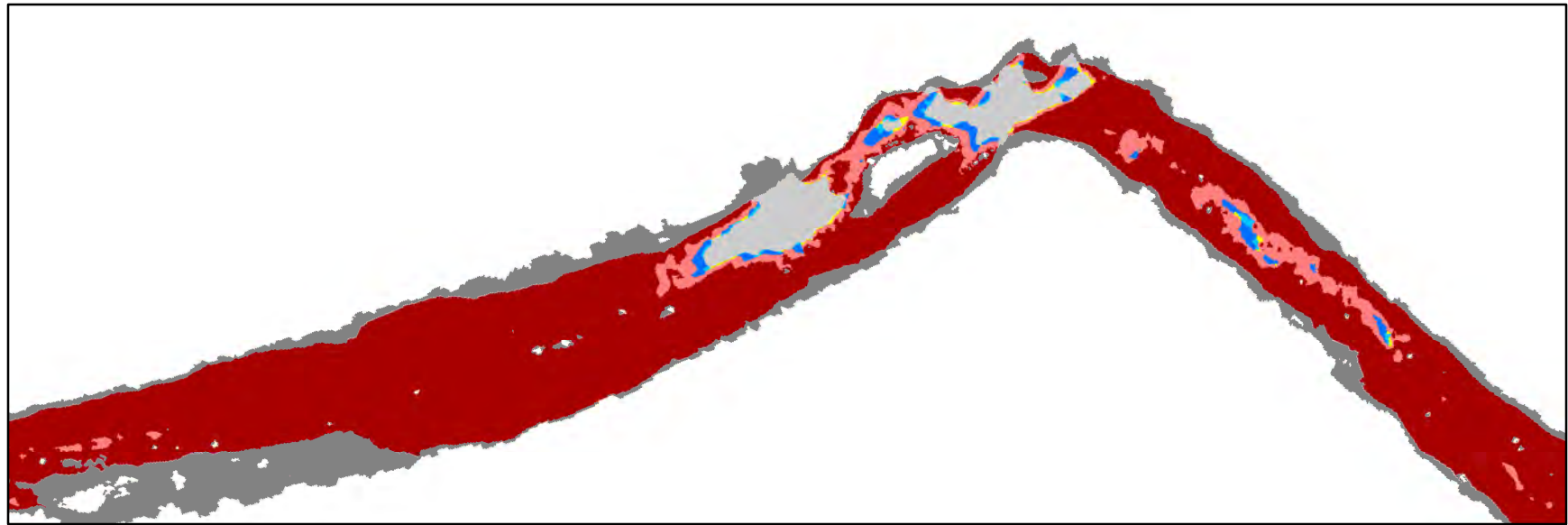

0 50 100 200 m



Channel Regions

PP0/RT0	PP1/RT2	PP2/RT2
PP1/RT1	PP2/RT1	Submerged unsavable surface (PP3/RT3)
		Submerged savable surface

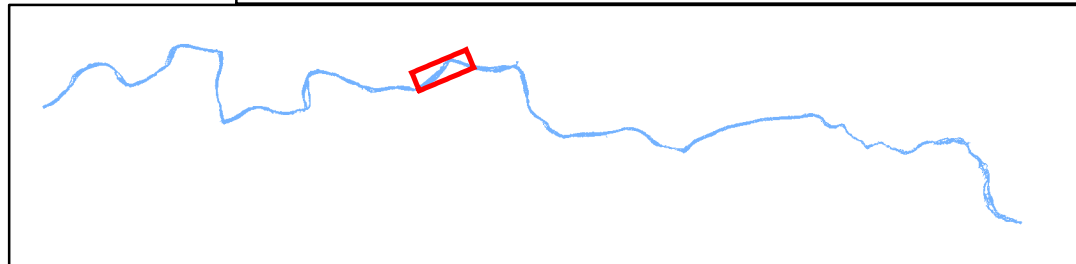

SYR Total Hazards for Upright Body at 31 m³/s, p. 14

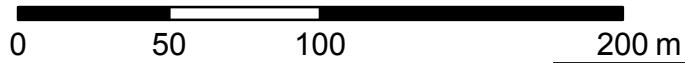
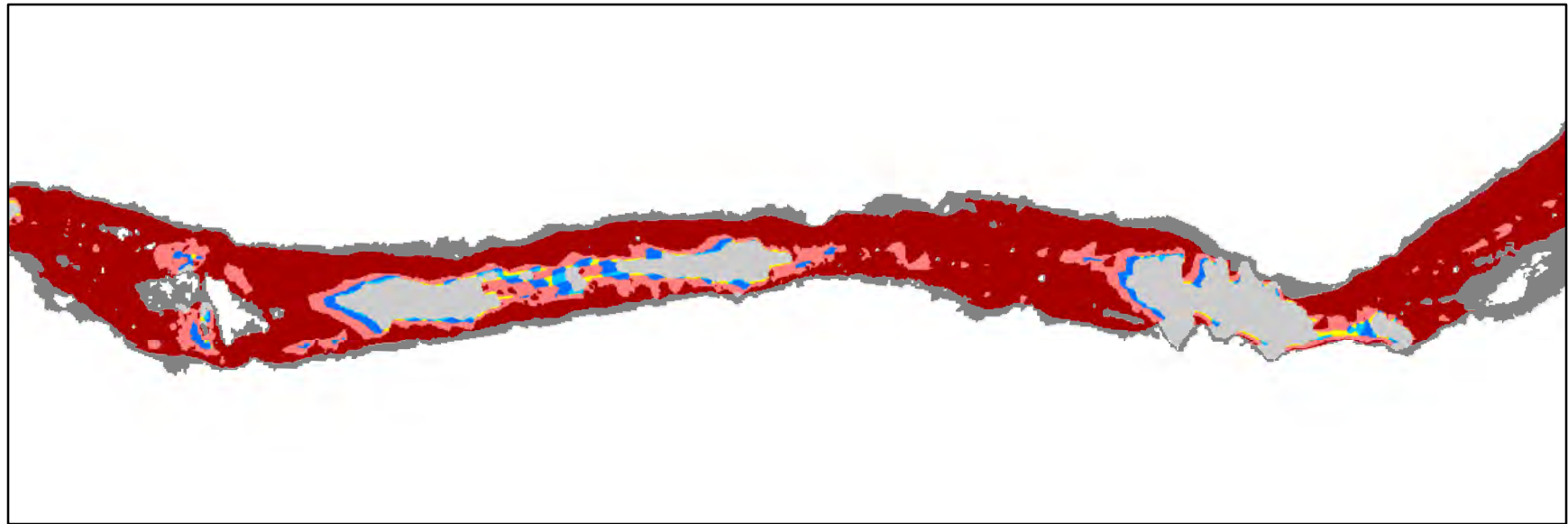

Channel Regions



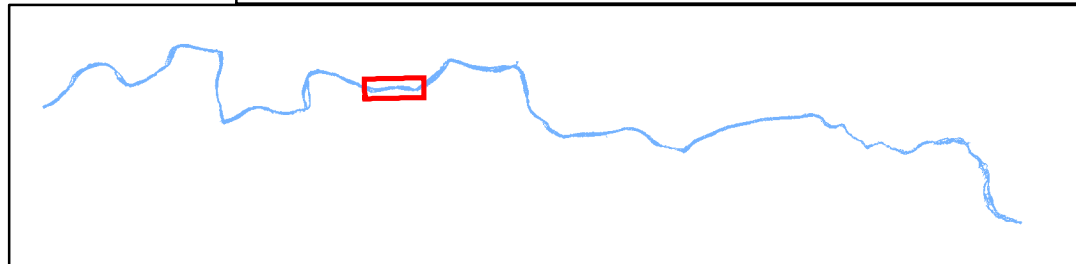

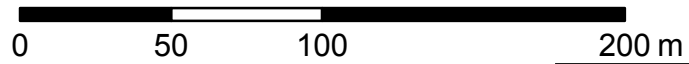
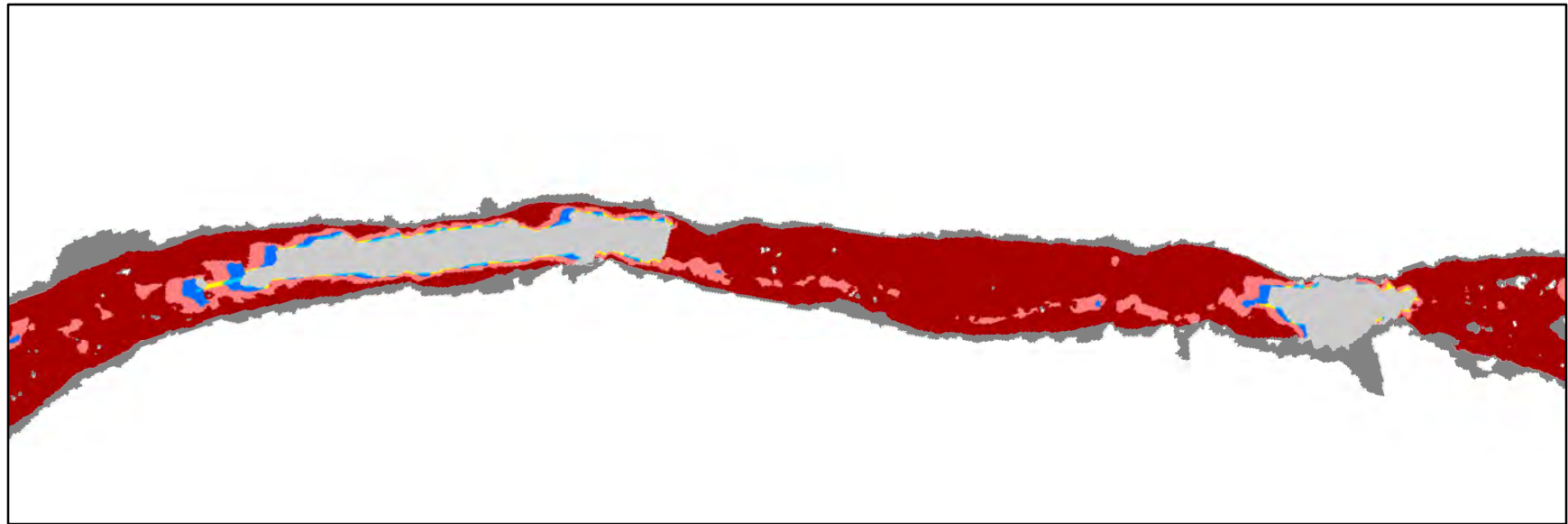

PP0/RT0	PP1/RT2	PP2/RT2
PP1/RT1	PP2/RT1	Submerged unsavable surface (PP3/RT3)
		Submerged savable surface



SYR Total Hazards for Upright Body at 31 m³/s, p. 15



Channel Regions

	PP0/RT0		PP1/RT2		PP2/RT2
	PP1/RT1		PP2/RT1		Submerged unsavable surface (PP3/RT3)
					Submerged savable surface

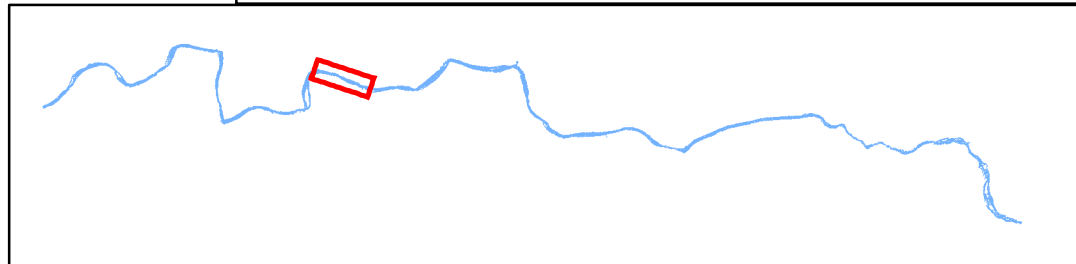

SYR Total Hazards for Upright Body at 31 m³/s, p. 16

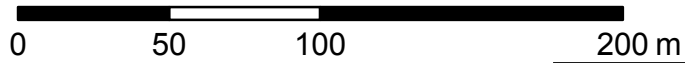
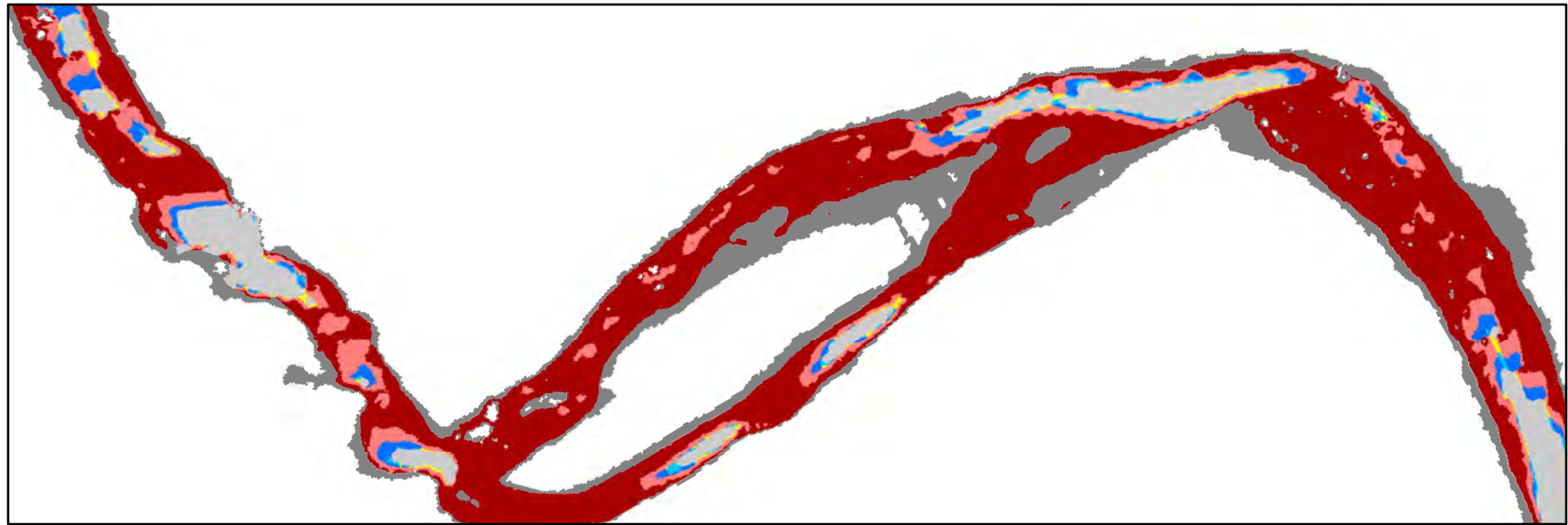

Channel Regions

PP0/RT0	PP1/RT2	PP2/RT2
PP1/RT1	PP2/RT1	Submerged unsavable surface (PP3/RT3)
		Submerged savable surface

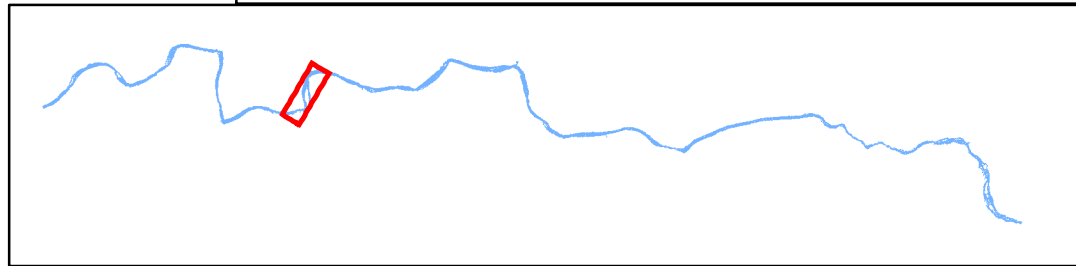

SYR Total Hazards for Upright Body at 31 m³/s, p. 17

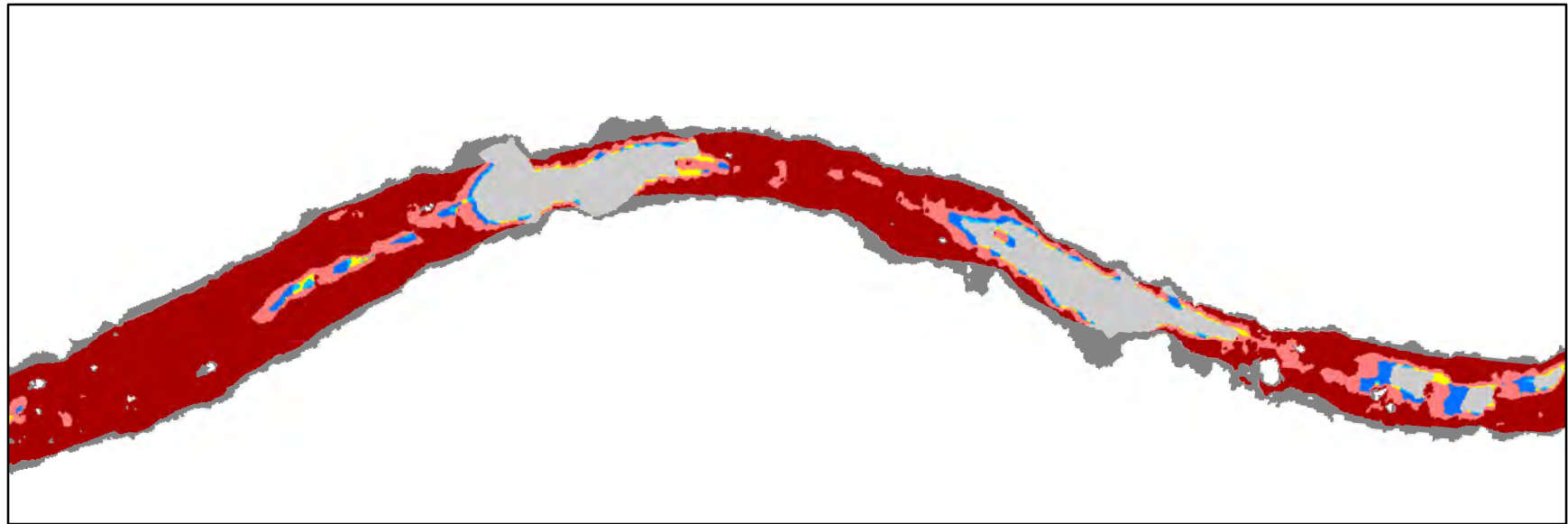

0 50 100 200 m



Channel Regions

PP0/RT0	PP1/RT2	PP2/RT2
PP1/RT1	PP2/RT1	Submerged unsavable surface (PP3/RT3)
		Submerged savable surface

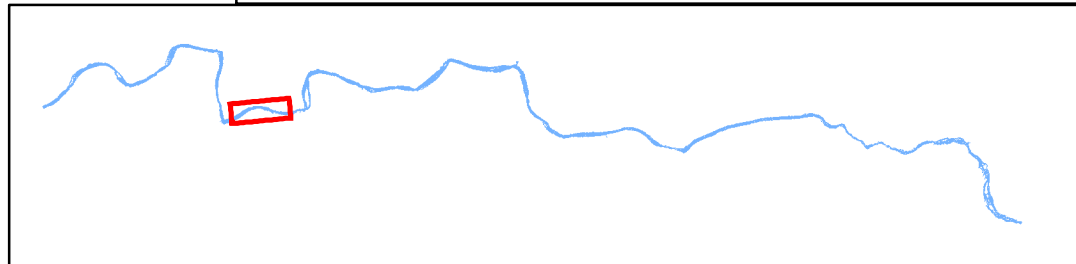



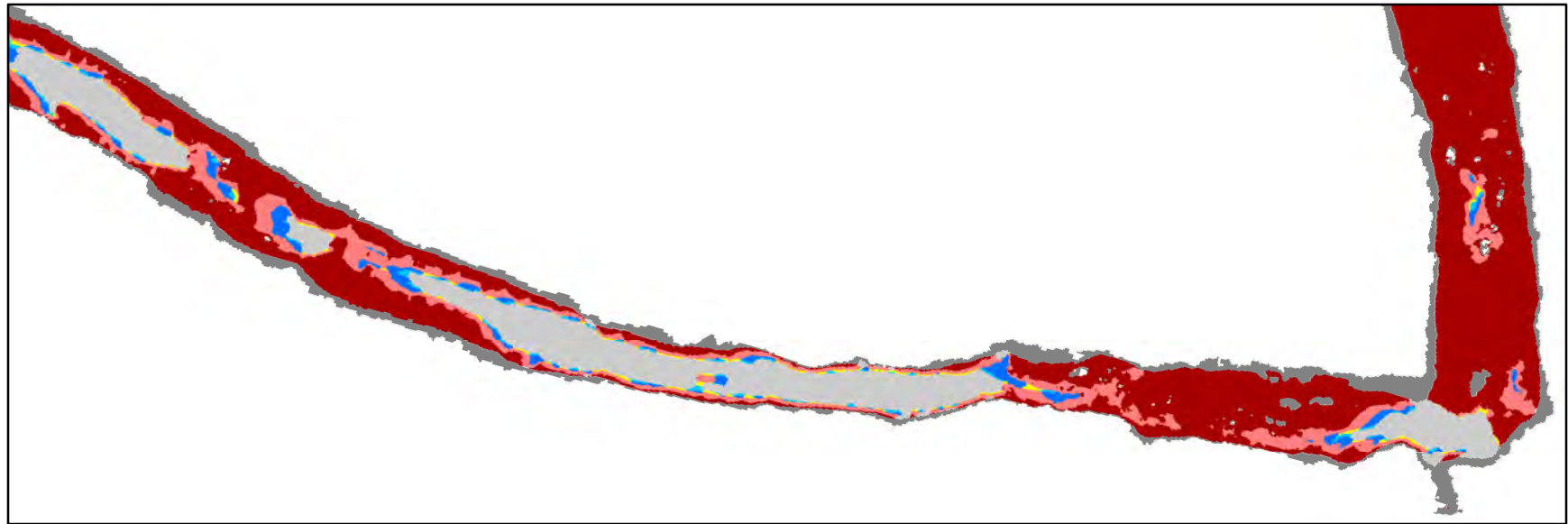



SYR Total Hazards for Upright Body at 31 m³/s, p. 18



0 50 100 200 m



Channel Regions

- | | | |
|---|--|---|
|  PP0/RT0 |  PP1/RT2 |  PP2/RT2 |
|  PP1/RT1 |  PP2/RT1 |  Submerged unsavable surface (PP3/RT3) |
| | |  Submerged savable surface |

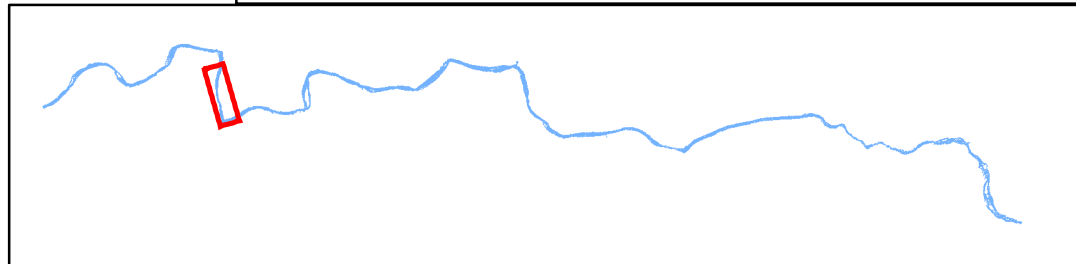

SYR Total Hazards for Upright Body at 31 m³/s, p. 19

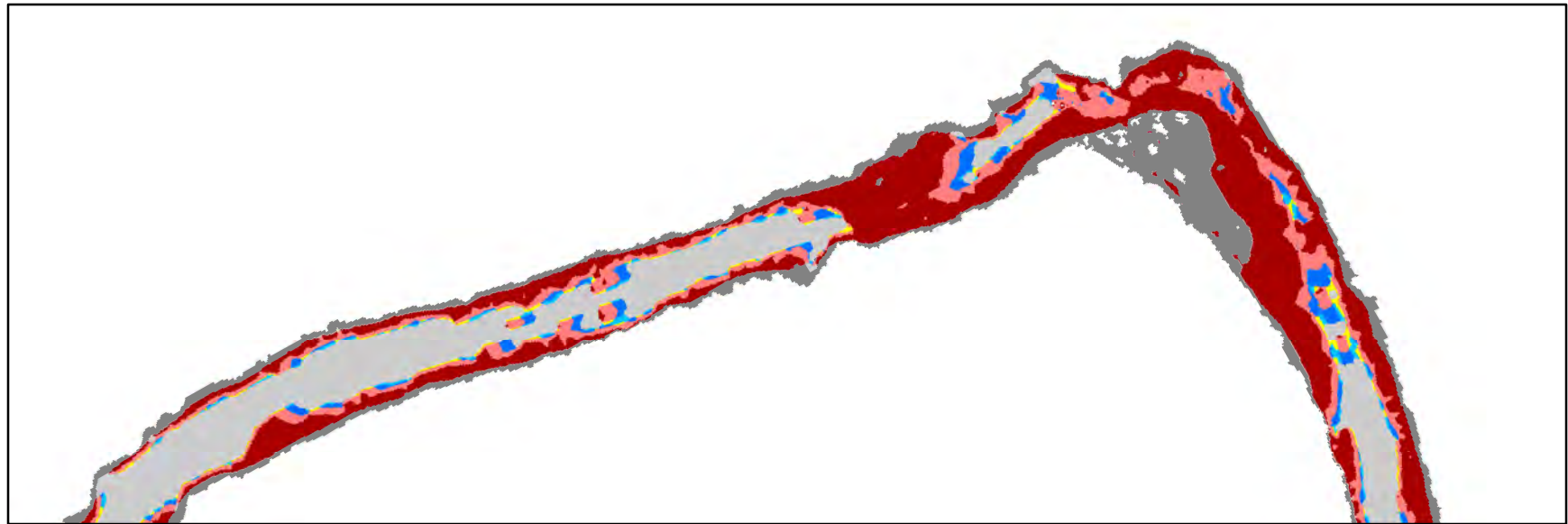

0 50 100 200 m



Channel Regions

PP0/RT0	PP1/RT2	PP2/RT2
PP1/RT1	PP2/RT1	Submerged unsavable surface (PP3/RT3)
		Submerged savable surface

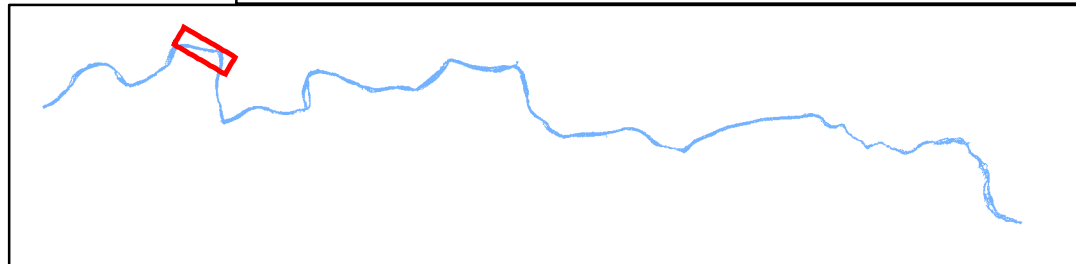

SYR Total Hazards for Upright Body at 31 m³/s, p. 20

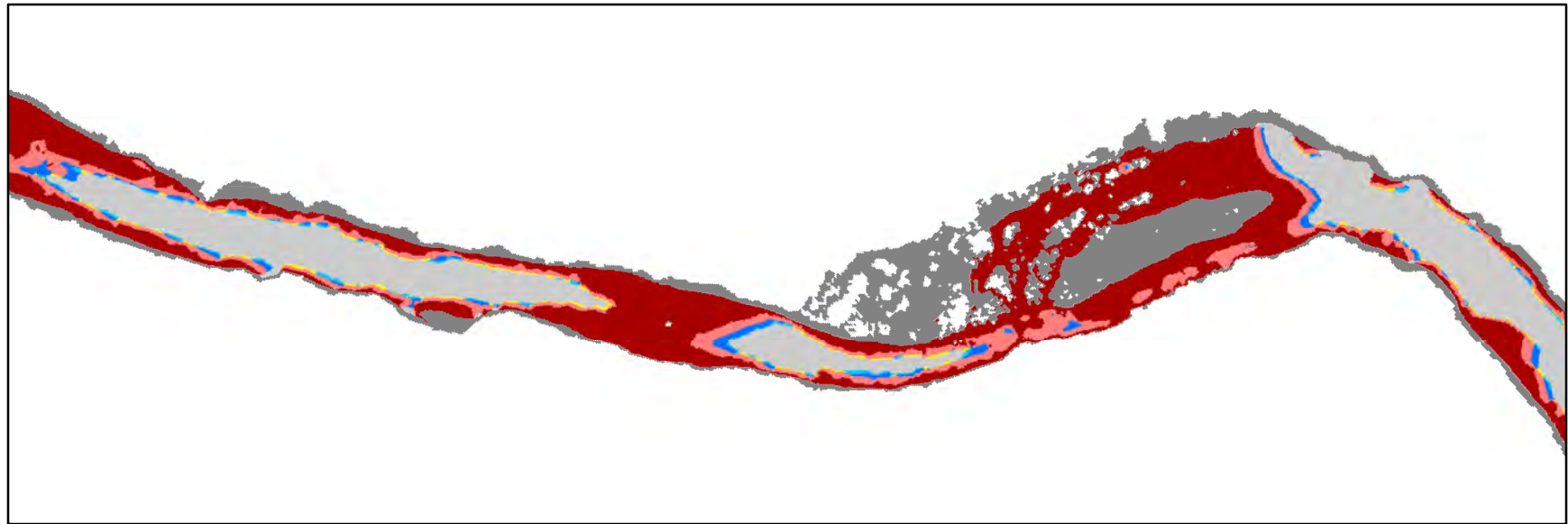

0 50 100 200 m



Channel Regions



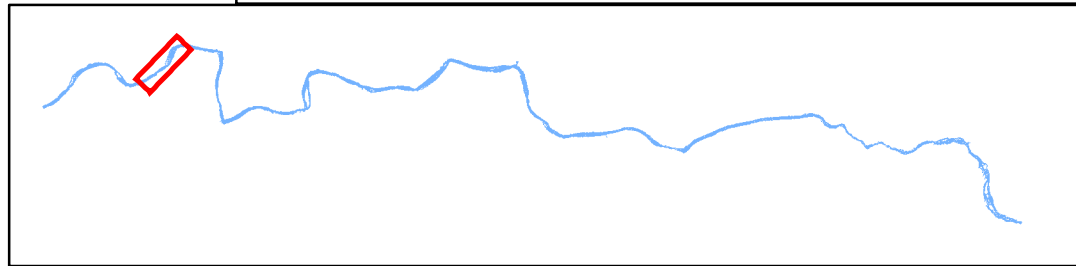

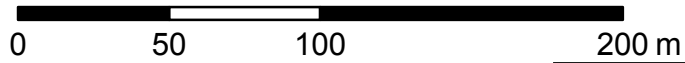
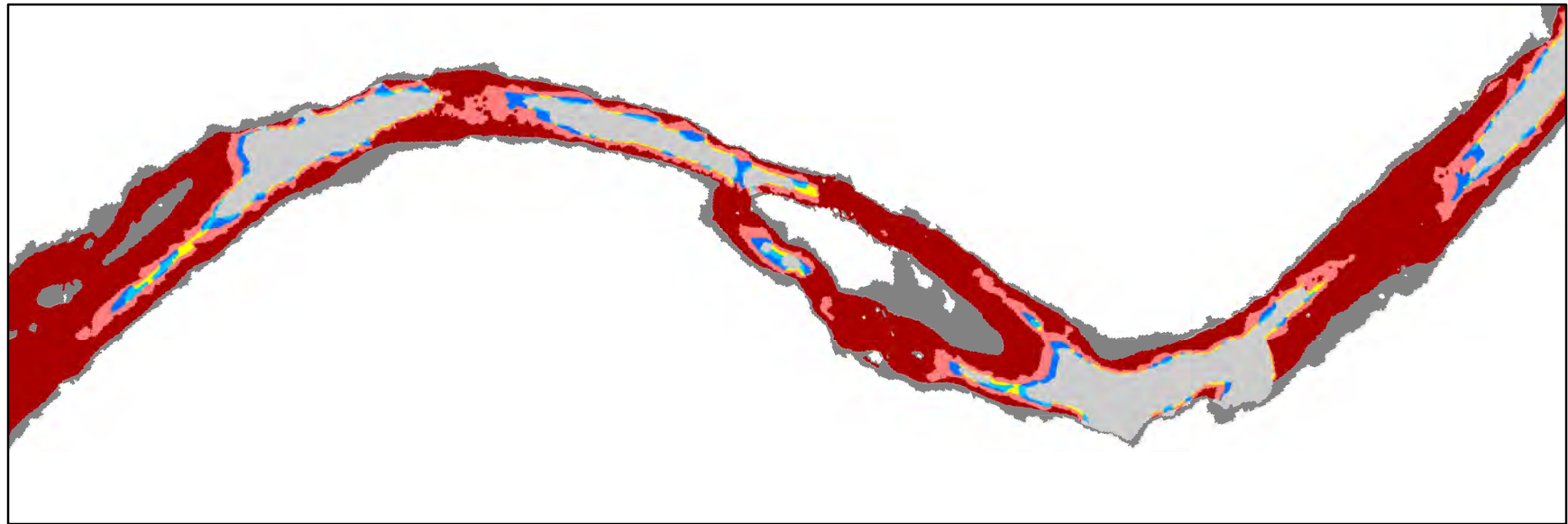

PP0/RT0	PP1/RT2	PP2/RT2
PP1/RT1	PP2/RT1	Submerged unsavable surface (PP3/RT3)
		Submerged savable surface



SYR Total Hazards for Upright Body at 31 m³/s, p. 21



Channel Regions

	PP0/RT0		PP1/RT2		PP2/RT2
	PP1/RT1		PP2/RT1		Submerged unsavable surface (PP3/RT3)
					Submerged savable surface

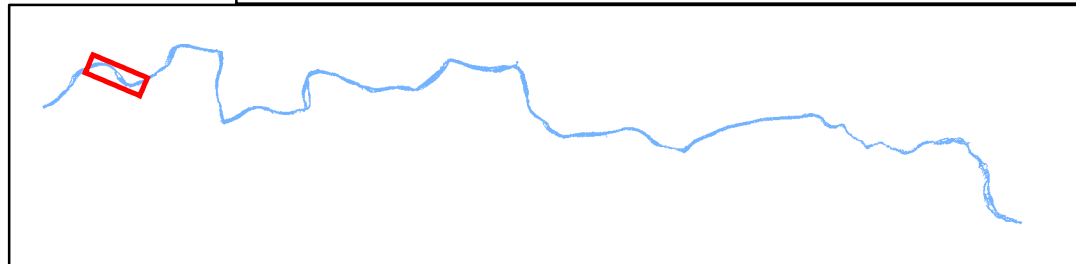



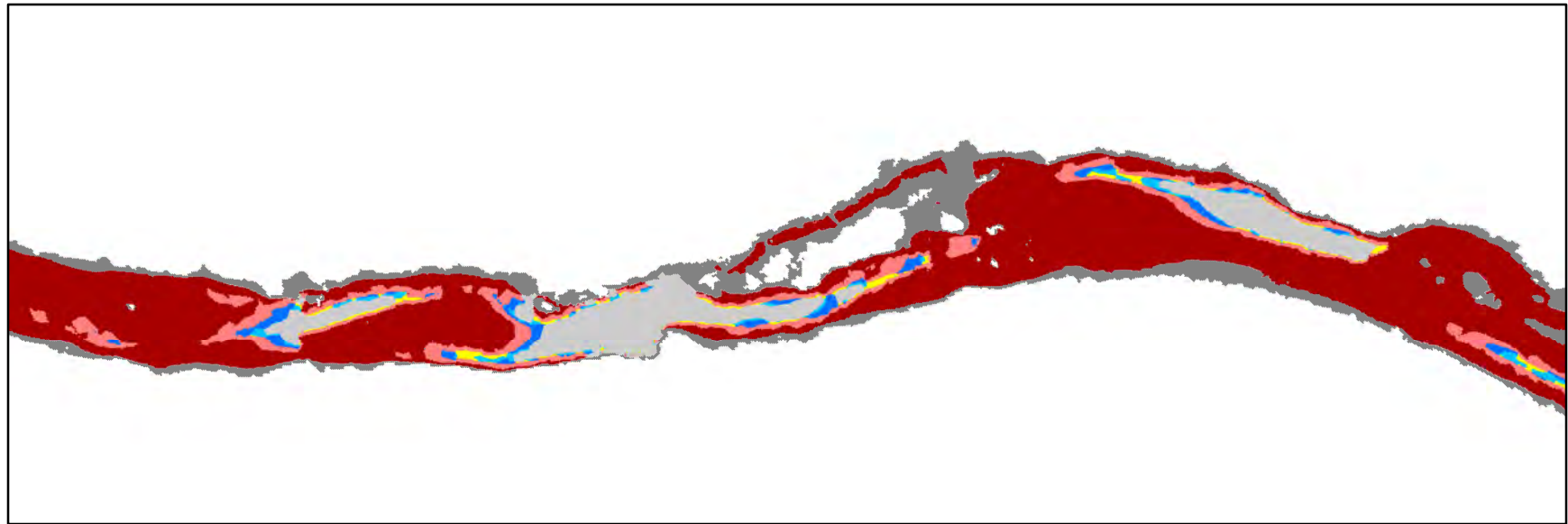



SYR Total Hazards for Upright Body at 31 m³/s, p. 22



0 50 100 200 m



Channel Regions

- | | | |
|---|--|---|
|  PP0/RT0 |  PP1/RT2 |  PP2/RT2 |
|  PP1/RT1 |  PP2/RT1 |  Submerged unsavable surface (PP3/RT3) |
| | |  Submerged savable surface |

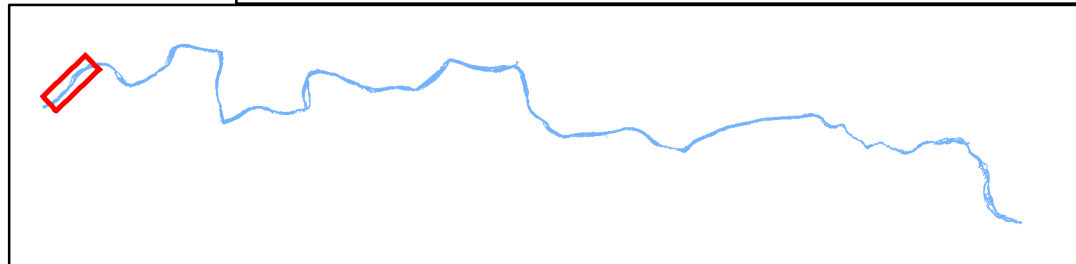



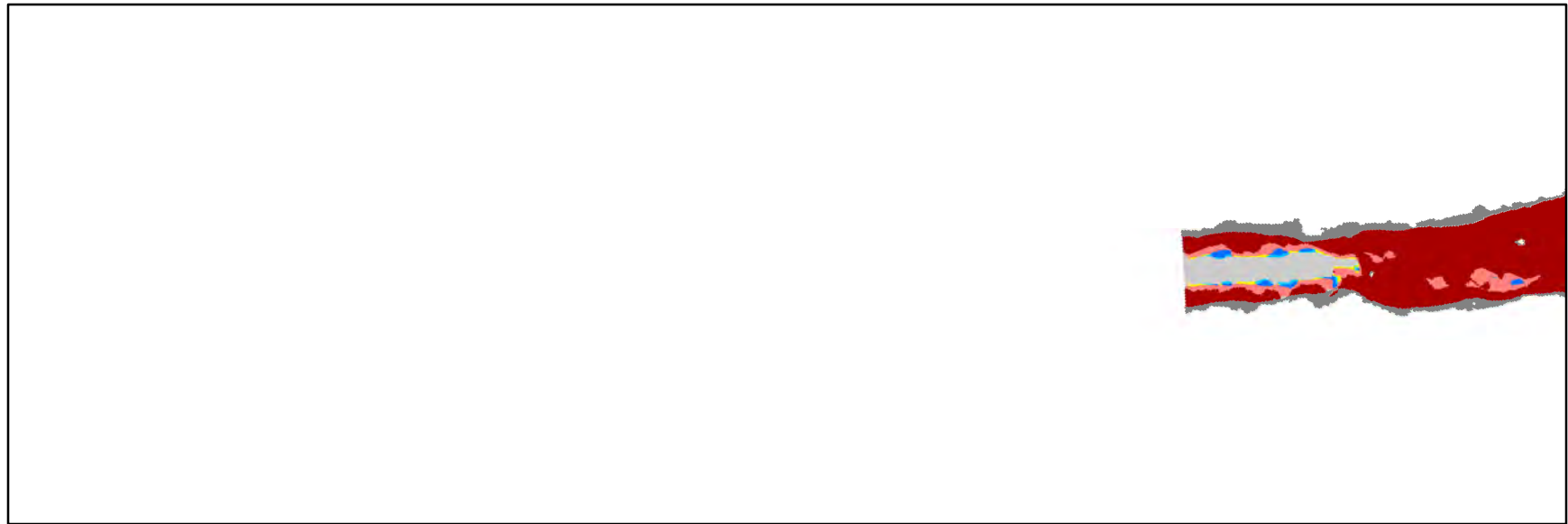



SYR Total Hazards for Upright Body at 31 m³/s, p. 23



0 50 100 200 m



Channel Regions

	PP0/RT0		PP1/RT2		PP2/RT2
	PP1/RT1		PP2/RT1		Submerged unsavable surface (PP3/RT3)
					Submerged savable surface

