

# Lawrence Berkeley National Laboratory

## Lawrence Berkeley National Laboratory

### **Title**

Course Notes: United States Particle Accelerator School Beam Physics with Intense Space-Charge

### **Permalink**

<https://escholarship.org/uc/item/8cj2r3j9>

### **Author**

Barnard, J.J.

### **Publication Date**

2008-11-20

**Course Notes:**  
**United States Particle Accelerator School**  
**Beam Physics with Intense Space-Charge**

J.J. Barnard and S.M. Lund

Lawrence Livermore National Laboratory  
Livermore, CA 94550  
and  
Accelerator Fusion Research Division  
Ernest Orlando Lawrence Berkeley National Laboratory  
Berkeley, CA 94720

June 2008

Presented at  
Annapolis MD, 16-27 June 2008

This work was supported by the Director, Office of Science, Office of Fusion Energy Sciences, of the U.S. Department of Energy under Contract No. DE-AC02-05CH11231, and the U.S. Department of Energy, Lawrence Livermore National Laboratory under Contract DE-AC52-07NA27344



**LLNL-AR-407617**

**Beam Physics  
with Intense Space-Charge**

**Lecturers:**

**John J. Barnard and Steven M. Lund  
Lawrence Livermore National Laboratory  
Lawrence Berkeley National Laboratory**

**Grader:**

**Christos Papadopoulos  
University of Maryland**

**Course Notes:**

**United States Particle Accelerator School  
Held 16-27 June, 2008  
Annapolis, Maryland  
Sponsored by University of Maryland at  
College Park**

Prepared under the auspices of the US Department of Energy at the Lawrence Livermore and Lawrence Berkeley National Laboratories under Contracts No. DE-AC52-07NA27344 and DE-AC02-05CH11231.

## **Beam Physics with Intense Space Charge**

Instructors: John Barnard and Steven Lund, Lawrence Livermore National Laboratory

### **Purpose and Audience**

The purpose of this course is to provide a comprehensive introduction to the physics of beams with intense space charge. This course is suitable for graduate students and researchers interested in accelerator systems that require sufficient high intensity where mutual particle interactions in the beam can no longer be neglected. *Prerequisites: undergraduate level Electricity and Magnetism and Classical Mechanics. Some familiarity with plasma physics, special relativity, and basic accelerator physics is recommended but not required.*

### **Objectives**

This course is intended to give the student a broad overview of the dynamics of beams with strong space charge. The emphasis is on theoretical and analytical methods of describing the acceleration and transport of beams. Some aspects of numerical and experimental methods will also be covered. Students will become familiar with standard methods employed to understand the transverse and longitudinal evolution of beams with strong space charge. The material covered will provide a foundation to design practical architectures.

### **Instructional Method**

Lectures will be given during morning sessions, followed by afternoon discussion sessions, which will engage the student on the material covered in lecture. Daily problem sets will be assigned that will be expected to be completed outside of scheduled class sessions. Problem sets will generally be due the morning of the next lecture session. A final take home exam will be given on the second Thursday, and will cover the contents of the entire course. Two instructors will be available for guidance during evening homework sessions.

### **Course Content**

In this course, we will introduce you to the physics of intense charged particle beams, focusing on the role of space charge. The topics include: particle equations of motion, the paraxial ray equation, and the Vlasov equation; 4-D and 2-D equilibrium distribution functions (such as the Kapchinskij-Vladimirskij, thermal equilibrium, and Neuffer distributions), reduced moment and envelope equation formulations of beam evolution; transport limits and focusing methods; the concept of emittance and the calculation of its growth from mismatches in beam envelope and from space-charge non-uniformities using system conservation constraints; the role of space-charge in producing beam halos; longitudinal space-charge effects including small amplitude and rarefaction waves; stable and unstable oscillation modes of beams (including envelope and kinetic modes); the role of space charge in the injector; and algorithms to calculate space-charge effects in particle codes. Examples of intense beams will be given primarily from the ion and proton accelerator communities with applications from, for example, heavy-ion fusion, spallation neutron sources, nuclear

waste transmutation, etc.

### **Reading Requirements**

Extensive class notes will be provided that will serve as the primary reference. (*To be provided by the USPAS*) "The Theory and Design of Charged Particle Beams" Second Edition, Updated and Expanded by Martin Reiser, Wiley & Sons 2008.

### **Credit Requirements**

Students will be evaluated based on performance: final exam (20 % of course grade), homework assignments (80 % of course grade).

Sep 17, 08 17:46	00.outline.txt	Page 1/11
US Particle Accelerator School sponsored by University of Maryland at College Park Annapolis, Maryland Monday June 16 - Friday June 27, 2008  LLNL: UCRL-?TBD? LBNL: LBNL-?TBD?	"Beam Physics with Intense Space Charge"  Lecturers: John J. Barnard and Steven M. Lund Lawrence Livermore National Laboratory  Grader: Christos Papadopoulos University of Maryland  List of file format suffixes: .txt => ascii text .pdf => Adobe Acrobat pdf .html => html .ppt => Microsoft Power Point (produced by OpenOffice Conversion) .xls => Microsoft Excel (produced on OpenOffice Conversion) .odp => Open Document Presentation (Open Office) .odw => Open Document Writer (Open Office) .ods => Open Document Spread Sheet (Open Office)  Author abbreviations: JJB - Notes by J.J. Barnard SML - Notes by S.M. Lund  4 Class material can be found in the following files and directories:  00.cover.pdf 00.cover.ppt Cover used in paper printing of class material.  00.outline.txt 00.outline.pdf Outline and file list (this file).  00.overview.txt 00.overview.pdf Class overview in text and pdf formats.  00.schedule.pdf 00.schedule.xls Actual schedule of class lectures.  01.intro.pdf (JJB) Introductory lecture surveying basic concepts.  02.env_eqns.pdf (JJB) Introduction to envelope equations.  03.curr_lim.pdf (JJB) Introduction to current limits.  04.tpe.pdf (SML) Transverse particle equations of motion.  05.ted_full.pdf (SML) full version 05.ted.pdf slides 05.ted_ho.pdf slides -- hand out version 05.ted_app_a.pdf handwritten notes -- Appendix A 05.ted_app_b.pdf handwritten notes -- Appendix B	

Sep 17, 08 17:46	00.outline.txt	Page 2/11
Transverse equilibrium distributions.  06.pr_full.pdf (SML) full version 06.pr.pdf slides 06.pr_ho.pdf slides -- hand out version 06.pr_sup.pdf handwritten note supplement Transverse particle resonances with application to rings.  07.inj_long_I.pdf (JJB) Injectors and longitudinal physics, part I.  08.long_II.pdf (JJB) Longitudinal physics, part II.  09.long_III.pdf (JJB) Longitudinal physics, part III.  10.tce_full.pdf (SML) full version 10.tce.pdf slides 10.tce_ho.pdf slides -- hand out version 10.tce_sec9.pdf handwritten note supplement -- Sec 9 Centroid and envelope evolution including envelope modes and stability.  11.env_modes_halo.pdf (JJB) Continuous focusing envelope modes and beam halo.  12.tks_full.pdf (SML) full version 12.tks.pdf slides 12.tks_ho.pdf slides -- hand out version 12.tks_sup.pdf handwritten note supplement Transverse kinetic stability: conservation constraints, kinetic stability bounds, normal modes on a KV beam, and other beam stability topics.  13.press_scat_elec.pdf (JJB) Vacuum, scattering, and electron effects.  14.apps.pdf (JJB) Applications: Heavy ion fusion overview and final focus.  15.st_full.pdf (SML) full version 15.st.pdf slides 15.st_ho.pdf slides -- hand out version 15.st_sup.pdf handwritten note supplement Numerical simulations of beams.  16.summary_jjb.pdf (JJB) Summary of lectures by J.J. Barnard.  grades_evaluations (directory) Note: This directory is only distributed to the instructors. evaluations.pdf Student evaluations of class.  grade_sheet.pdf Formal grade sheet turned in to the USPAs. homeworkandgrades.xls All grades on problem sets and final. students.pdf Listing of students and institutions, and credit status both preliminary and final.  audio (directory) Note: This directory is not included in most distributions (large file size) movies (directory)		

Sep 17, 08 17:46	00.outline.txt	Page 3/11
<p>Note: This directory is not included in most distributions (large file size)</p> <p>ESQfastrise_zx.mpg 3D injector simulation with a fast rise voltage pulse.</p> <p>ESQslowrise_zx.mpg 3D injector simulation with a slow rise voltage pulse.</p> <p>hcx.mov Simulation of the HCX experiment from the source.</p> <p>hollow_movie.mpg Simulation on the evolution of a nonuniform density beam.</p> <p>photos (directory)</p> <p>problems (directory) Note: This directory is only distributed to the instructors.</p> <p>All files pdf scans of handwritten problems and solutions</p> <p>01_set1_probs.pdf Problem Set #1 01_set1_sols.pdf Solution Set #1</p> <p>02_set2_probs.pdf Problem Set #2 02_set2_sols.pdf Solution Set #2</p> <p>03_set3_probs.pdf Problem Set #3 03_set3_sols.pdf Solution Set #3</p> <p>04_set4_probs.pdf Problem Set #4 04_set4_sols.pdf Solution Set #4</p> <p>05_set5_probs.pdf Problem Set #5 05_set5_sols.pdf Solution Set #5</p> <p>06_set6_probs.pdf Problem Set #6 06_set6_sols.pdf Solution Set #6</p> <p>07_set7_probs.pdf Problem Set #7 07_set7_sols.pdf Solution Set #7</p> <p>08_set8_probs.pdf Problem Set #8 08_set8_sols.pdf Solution Set #8</p> <p>09_final_probs.pdf Final Exam Problems. (Final Exam counts for 2 sets) 09_final_sols.pdf Final Exam Solutions</p> <p>collections directory containing: SML: Collections of problems and solutions sorted by topic (only a subset were used in this class) problems_prob and solutions_sol files</p> <p>tpe_prob.pdf Transverse particle equations of motion tpe_sol.pdf</p> <p>ted_prob.pdf Transverse equilibrium distributions ted_sol.pdf</p> <p>pr_prob.pdf Circular accelerators and resonance effects in rings pr_sol.pdf</p> <p>tce_prob.pdf Transverse centroid and envelope descriptions of beam evolution tce_sol.pdf</p> <p>st_prob.pdf Simulation techniques for intense beams</p>		

Sep 17, 08 17:46	00.outline.txt	Page 4/11
<p>st_sol.pdf</p> <p>simulations (directory) Note: This directory not included in most distributions. Material used in class demonstrations of simulations.</p> <p>ag-slice.py Python input script for example WARP PIC code simulations. This file was used in one interactive class session to carry out example simulations by making simple variants of this example run. See script header for instructions on running this script and viewing the output files.</p> <p>ag-slice.000.cgm cgm output file produced by WARP simulation ag-slice.py</p> <p>uspas (directory) Note: This directory is not included in most distributions. The information contained is available on the uspas web site: <a href="http://uspas.fnal.gov">http://uspas.fnal.gov</a></p> <p>uspas.pdf Information on the school.</p> <p>uspas_local.pdf Local school info.</p> <p>participants.pdf Full list of school participants.</p> <p>Course Outline:</p> <p>Note: This outline and the distribution files are arranged in logical presentation order. In the actual class, there were deviations from this order due to practical constraints. The actual order of material presented can be found in 00_schedule.pdf.</p> <p>"Beam Physics with Intense Space-Charge"</p> <p>Lecturers: John J. Barnard and Steven M. Lund Lawrence Livermore National Laboratory</p> <p>Simulations and Grading: Christos Papadopoulos University of Maryland</p> <p>1. Introduction to the Physics of Beams and Basic Parameters (JJB) 01.intro.pdf pdf scan, handwritten notes and slides</p> <p>1.1 Particle equations of motion 1.2 Dimensionless parameters: Perveance, phase advance, space charge tune depression 1.3 Plasma physics of beams: collisions, Debye Length 1.4 Kimontovich equation, Vlasov equation, Liouville's theorem 1.4 Emittance and brightness</p> <p>2. Envelope Equations-I (JJB) 02.env_eqns.pdf pdf scan, handwritten notes and slides</p> <p>2.1 Paraxial Ray Equation 2.2 Envelope equations for axially symmetric beams 2.3 Cartesian equations of motion 2.3.1 Quadrupole focusing 2.3.2 Space charge force for elliptical beams 2.4 Envelope equations for elliptically symmetric beams</p> <p>3. Current Limits in Accelerators and Centroid equations-I (JJB)</p>		

Sep 17, 08 17:46	00.outline.txt	Page 5/11
03.curr_lims.pdf	pdf scan, handwritten notes and slides	
3.1	Axissymmetric beams	
3.1.1	Solenoids	
3.1.2	Einzel Lenses	
3.2	Elliptically symmetric beams	
3.2.1	Derivation of space charge term in envelope equation with elliptical symmetry	
3.2.2	Current limit for quadrupoles using Fourier transforms	
3.3	Current limit for continuous focusing	
3.3.1	Calculation of $\sigma_{\text{max}}$ (using matrix multiplication)	
3.3.2	Comparison of quadrupole current limit (from Fourier transform, and matrix methods)	
3.4	Centroid equations (first order moments)	
3.4.1	Space charge and focusing forces	
3.5	Image forces (effect on centroid and envelope)	
4.	Transverse Particle Equations of Motion (SML)	
04.tpe.pdf	pdf conversion of Open Office document	
04.tpe_ho.pdf	04.tpe.pdf in handout form (4 slides per page)	
04.tpe_full.pdf	04.tpe_ho.pdf oriented for 2-sided printing	
4.1	Particle Equations of Motion	
4.1.A	Introduction: The Lorentz Force Equation	
4.1.B	Applied Fields	
4.1.C	Machine Lattice	
4.1.D	Self Fields	
4.1.E	Equations of Motion in $s$ and the Paraxial Approximation	
4.1.F	Summary: Transverse Particle Equations of Motion	
4.1.G	Overview of Analysis to Come	
4.1.H	Bent Coordinate System and Particle Equations of Motion with Dipole Bends and Axial Momentum Spread	
4.2	Transverse Particle Equations of Motion in Linear Focusing Channels	
4.2.A	Introduction	
4.2.B	Continuous Focusing	
4.2.C	Alternating Gradient Quadrupole Focusing - Electric Quadrupoles	
4.2.D	Alternating Gradient Quadrupole Focusing - Magnetic Quadrupoles	
4.2.E	Solenoidal Focusing	
4.2.F	Summary of Transverse Particle Equations of Motion	
Appendix A:	Quadrupole Skew Coupling	
Appendix A:	The Larmor Transform to Express Solenoidal Focused Particle Equations of Motion in Uncoupled Form	
4.3	Description of Applied Focusing Fields	
4.3.A	Overview	
4.3.B	Magnetic Field Expansions for Focusing and Bending	
4.3.C	Hard Edge Equivalent Models	
4.3.D	2D Transverse Multipole Magnetic Moments	
4.3.E	Good Field Radius	
4.3.F	Example Permanent Magnet Assemblies	
4.4	Transverse Particle Equations of Motion with Nonlinear Applied Fields	
4.4.A	Overview	
4.4.B	Approach 1: Explicit 3D Form	
4.4.C	Approach 2: Perturbed Form	
4.5	Linear Equations of Motion Without Space-Charge, Acceleration, and Momentum Spread	
4.5.A	Hill's equation	
4.5.B	Transfer Matrix Form of the Solution to Hill's Equation	
4.5.C	Wronskian Symmetry of Hill's Equation	
4.5.D	Stability of Solutions to Hill's Equation in a Periodic Lattice	
4.6	Hill's Equation: Floquet's Theorem and the Phase-Amplitude Form of the Particle Orbit	
4.6.A	Introduction	
4.6.B	Floquet's Theorem	
4.6.C	Phase-Amplitude Form of the Particle Orbit	
4.6.D	Summary: Phase-Amplitude Form of the Solution to Hill's Equation	
4.6.E	Points on the Phase-Amplitude Formulation	
4.6.F	Relation Between the Principal Orbit Functions and the Phase-Amplitude Form Orbit Functions	

Sep 17, 08 17:46	00.outline.txt	Page 6/11
4.6.G	Undepressed Particle Phase Advance	
Appendix C:	Calculation of $w(s)$ from Principal Orbit Functions	
4.7	Hill's Equation: The Courant-Snyder Invariant and the Single-Particle Emittance	
4.7.A	Introduction	
4.7.B	Derivation of the Courant-Snyder Invariant	
4.7.C	Lattice Maps	
4.8	Hill's Equation: The Betatron Formulation of the Particle Orbit and Maximum Orbit Excursions	
4.8.A	Formulation	
4.8.B	Maximum Orbit Excursions	
4.9	Momentum Spread Effects and Bending	
4.9.A	Overview	
4.9.B	Chromatic Effects	
4.9.B	Dispersive Effects	
4.10	Acceleration and Normalized Emittance	
4.10.A	Introduction	
4.10.B	Transformation to Normal Form	
4.10.C	Phase-Space Relations Between Transformed and Untransformed Systems	
Appendix D:	Accelerating Fields and Calculation of Changes in $\gamma$ and $\beta$	
Contact	Information	
References		
Acknowledgments		
5.	Transverse Equilibrium Distribution Functions (SML)	
05.ted.pdf	pdf conversion of Open Office document	
05.ted_ho.pdf	05.ted.pdf in handout form (4 slides per page)	
05.ted_app.pdf	appendix A and B, pdf scan, handwritten notes	
05.ted_full.pdf	combined file: 05.ted_ho.pdf, 05.ted_app_a.pdf, 05.ted_app_b.pdf oriented for printing	
5.1	Vlasov Model	
Vlasov-Poisson	System	
Review:	Lattices: Continuous, Solenoidal, and Quadrupole	
Review:	Undepressed Particle Phase Advance	
5.2	Vlasov Equilibria	
Equilibrium	Conditions	
Single	Particle Constants of the Motion	
Discussion:	Plasma Physics Approach to Beam Physics	
5.3	The KV Equilibrium Distribution	
Hill's	Equation with Linear Space-Charge Forces	
Review:	Courant-Snyder Invariants	
Courant-Snyder	Invariants for a Uniform Density Elliptical Beam	
KV	Envelope Equations	
Canonical	Form of the KV Distribution Function	
Matched	Envelope Structure	
Depressed	Particle Orbits	
rms	Equivalent Beams	
Discussions/	Comments on the KV Model	
Appendix A:	Self-Fields of a Uniform Density Elliptical Beam in Free Space (handwritten notes)	
Derivation #1:	Direct	
Derivation #2:	Simplified	
Appendix B:	Canonical Transforms of the KV Distribution (handwritten notes)	
Canonical	Transforms	
Simplified	Moment Calculations	
5.4	The Continuous Focusing Limit of the KV Distribution	
Reduction	of Elliptical Model	
Wavenumbers	of Particle Oscillations	
Distribution	Form	
Discussion		
5.5	Continuous Focusing Equilibrium Distributions	
Equilibrium	Form	
Poisson's	Equation	
Moments	and rms Equivalent Beam Envelope Equation	

- Example Distributions
- 5.6 Continuous Focusing: The Waterbag Equilibrium Distribution  
Distribution Form  
Poisson's Equation  
Solution in Terms of Accelerator Parameters  
Equilibrium Properties
  - 5.7 Continuous Focusing: The Thermal Equilibrium Distribution  
Overview  
Distribution Form  
Poisson's Equation  
Solution in Terms of Accelerator Parameters  
Equilibrium Properties
  - 5.8 Continuous Focusing: Debye Screening in a Thermal Equilibrium Beam  
Solution for Characteristic Debye Screening
  - 5.9 Continuous Focusing: The Density Inversion Theorem  
Relation of Density Profile to the Full Distribution Function  
Example Application to the KV Distribution
  - 5.10 Comments on the Plausibility of Smooth, non-KV Vlasov Equilibria  
in Periodic Focusing Lattice  
Discussion  
Contact Information  
References
6. Transverse Particle Resonances with Application to Circular Accelerators (SML)  
06.pr.pdf pdf conversion of Open Office document  
06.pr\_ho.pdf 06.pr.pdf in handout form (4 slides per page)  
06.pr\_sup.pdf pdf scan, handwritten notes for slides not yet converted to Open Office  
06.pr\_full.pdf combined file: 06.pr\_ho.pdf, 06.pr\_sup.pdf oriented for printing
  - 6.1 Overview  
Hill's Equation Review: Betatron Form of Phase-Amplitude Solution  
Transform Approach  
Random and Systematic Perturbations Acting on Orbits
  - 6.2 Floquet Coordinates  
Transformation of Hill's Equation to a Simple Harmonic Oscillator  
Phase-Space Structure of Solution  
Expression of the Courant-Snyder Invariant  
Phase-Space Area Transform
  - 6.3 Perturbed Hill's Equation in Floquet Coordinates  
Transformation Result for x-Equation
  - 6.4 Sources and Forms of Perturbation Terms  
Power Series Expansion of Perturbations  
Connection to Multipole Errors
  - 6.5 Perturbed Solution: Resonances  
Fourier Expansion of Perturbations and Resonance Terms  
Resonance Conditions
  - 6.6 Machine Operating Points: Restrictions Resulting from Resonances  
Tune Restrictions from Low Order Resonances
  - 6.7 Space-Charge Effects  
Coherent and Incoherent Tune Shifts  
Laslett Limit  
Contact Information  
References  
Acknowledgments
  7. Injectors and Longitudinal Physics Part I (JJB)  
07.inj\_long\_I.pdf pdf scan, handwritten notes and slides
  - 7.1 Diodes and Injectors  
7.1.1 Space-charge limited flow and child-Langmuir law  
7.1.2 Pierce electrodes  
7.1.3 Transients in injectors and Lampel-Tiefenback solution  
7.2 Injector Choices

8. Longitudinal Physics Part II (JJB)  
08.long\_II.pdf pdf scan, handwritten notes and slides
- 8.1 Acceleration -- introduction
- 8.2 Space charge of short bunches (in rf-accelerators)
- 8.3 Space charge of long bunches (g-factor model)
- 8.4 Longitudinal 1D Vlasov equation
- 8.5 Longitudinal fluid equation
- 8.4 Longitudinal space charge waves
- 8.5 Longitudinal rarefaction waves and bunch end control
9. Longitudinal Physics Part III (JJB)  
09.long\_III.pdf pdf scan, handwritten notes and slides
- 9.1 Longitudinal cooling from acceleration
- 9.2 Longitudinal resistive instability
- 9.3 Bunch compression
- 9.4 Longitudinal envelope equation
- 9.4 Neuffer distribution function
10. Transverse Centroid and Envelope Descriptions of Beam Evolution (SML)  
10.tce.pdf pdf conversion of Open Office document  
10.tce\_ho.pdf 10.tce.pdf in handout form (4 slides per page)  
10.tce\_sec9.pdf pdf scan, handwritten notes and slides for sec9 (2006 uspas)  
10.tce\_full.pdf combined pdf file: 10.tce\_ho.pdf, 10.tce\_sec9.pdf oriented for printing
- 10.1 Overview
- 10.2 Derivation of Centroid and Envelope Equations of Motion  
Statistical Averages  
Particle Equations of Motion  
Distribution Assumptions  
Self-Field Calculation: Direct and Image  
Coupled Centroid and Envelope Equations of Motion
- 10.3 Centroid Equations of Motion  
Single Particle Limit: Oscillation and Stability Properties  
Effect of Driving Errors  
Effect of Image Charges
- 10.4 Envelope Equations of Motion  
KV Envelope Equations  
Applicability of Model  
Properties of Terms
- 10.5 Matched Envelope Solutions  
Construction of Matched Solution  
Symmetries of Matched Envelope: Interpretation via KV Envelope Equations  
Examples
- 10.6 Envelope Perturbations  
Perturbed Equations  
Matrix Form: Stability and EigenMode Symmetries  
Decoupled Modes  
General Mode Limits
- 10.7 Envelope Modes in Continuous Focusing  
Normal Modes: Breathing and Quadrupole Modes  
Driven Modes
- 10.8 Envelope Modes in Periodic Focusing Channels  
Solenoidal Focusing  
Quadrupole Focusing  
Mode Launching
- 10.9 Transport Limit Scaling Based on Envelope Models  
(see handwritten notes)  
Overview  
Example Calculation for a Periodic FODO Quadrupole Transport Channel  
Discussion on Application of Formulas in Design

Results of More Detailed Models

10.10 Centroid and Envelope Descriptions via  
1st Order Coupled Moment Equations  
Formulation  
Example Illustration - Familiar KV Envelope Model  
Contact Information  
References

11. Continuous Focusing Envelope Modes and Beam Halo (JJB)  
11.env\_modes\_halo.pdf pdf scan, handwritten notes and slides

11.1 Envelope modes of unbunched beams in continuous focusing  
11.2 Envelope modes of bunched beams in continuous focusing  
11.3 Halos from mismatched beams  
11.3.1 What is halo? Why do we care  
11.3.2 Qualitative picture of halo formation: mismatches  
resonantly drive particles to large amplitude  
11.3.3 Core/particle models  
11.3.4 Amplitude phase analysis

12. Transverse Kinetic Stability (SML)  
12.tks.pdf pdf conversion of Open Office document  
12.tks\_ho.pdf 12.tks.pdf in handout form (4 slides per page)  
12.tks\_sup.pdf pdf scan, handwritten notes supplementing Sec. 4

12.tks\_full.pdf combined pdf file: 12.tks\_ho.pdf, 12.tks\_sup.pdf  
oriented for printing

12.1 Overview: Machine Operating Points  
Notions of Beam Stability  
Tiefenback Experimental Results for Quadrupole Transport

12.2 Overview: Collective Modes and Transverse Kinetic Stability  
Possibility of Collective Internal Modes  
Vlasov Model Review  
Plasma Physics Approach to Understanding Higher Order Instability

12.3 Linearized Vlasov Equation  
Equilibrium and Perturbations  
Linear Vlasov Equation  
Method of Characteristics  
Discussion

12.4 Collective Modes on a KV Equilibrium Beam  
KV Equilibrium  
Linearized Equations of Motion  
Solution of Equations  
Mode Properties  
Physical Mode Components Based on Fluid Model  
Periodic Focusing Results

12.5 Global Conservation Constraints  
Conserved Quantities  
Implications  
12.6 Kinetic Stability Theorem  
Effective Free Energy  
Free Energy Expansion in Perturbations  
Perturbation Bound and a Sufficient Condition for Stability  
Interpretation and Example Applications

12.7 rms Emittance Growth and Nonlinear Forces  
Equations of Motion  
Coupling of Nonlinear Forces to rms Emittance Evolution

12.8 rms emittance Growth and Nonlinear Space-Charge Forces  
Equations of Motion  
rms Equivalent Beam Forms  
Wangler's Theorem

12.9 Uniform Density Beams and Extreme Energy States  
Variational Formulation  
Self-Field Energy Minimization

12.10 Collective Relaxation and rms Emittance Growth  
Conservation Constraints

Relaxation Processes  
Emittance Growth Bounds from Space-Charge Nonuniformities

12.11 Halo Induced Mechanism of Higher-Order Instability  
Halo Model for an Elliptical Beam  
Pumping Mechanism  
Stability Properties

12.12 Phase Mixing and Landau Damping in Beams  
(to be added in future versions)  
Contact Information  
References

13. Pressure, Scattering, and Electron Effects (JJB)  
13.press\_scat\_elec.pdf pdf scan, handwritten notes and slides

13.1 Beam/beam Coulomb collisions  
13.2 Beam/residual-gas scattering  
13.3 Charge-changing processes  
13.4 Wall effects  
13.4.1 gas pressure instability  
13.5 Electron cloud processes  
13.5.1 Multiple-bunch beam-induced multipacting  
13.5.2 Single-bunch beam-induced multipacting  
13.6 Electron-ion instability

14. Applications: Heavy Ion Fusion and Final Focus (JJB)  
14.apps.pdf pdf scan, handwritten notes and slides

14.1 An application of intense beams: Heavy Ion Fusion  
14.1.1 Requirements  
14.1.2 Targets for inertial confinement fusion  
14.1.3 Accelerator  
14.1.4 Drift compression  
14.1.5 Final focus  
14.2 Final focus  
14.2.1 Predicting spot size using envelope equation  
and estimate of effects from chromaticity

14.3 Experiments for Heavy Ion Fusion

15. Numerical Simulations (SML)  
15.st.pdf pdf conversion of Open Office document  
15.st\_ho.pdf 15.st.pdf in handout form (4 slides per page)  
15.st\_sup.pdf pdf scan, handwritten notes supplementing unfinished sections

15.st\_full.pdf combined file: 15.st\_ho.pdf, 15.st\_sup.pdf  
oriented for printing

15.1 Why Numerical Simulation?  
15.2 Classes of Intense Beam Simulations  
15.2.A Overview  
15.2.B Particle Methods  
15.2.C Distribution Methods  
15.2.D Moment Methods  
15.2.E Hybrid Methods

15.3 Overview of Basic Numerical Methods  
15.3.A Discretizations  
15.3.B Discrete Numerical Operations  
- Derivatives  
- Quadrature  
- Irregular Grids and Axisymmetric Systems  
15.3.C Time Advance  
- Overview  
- Euler and Runge-Kutta Advances  
- Solution of Moment Methods

15.4 Numerical Methods for Particle and Distribution Methods  
14.4.A Overview  
14.4.B Integration of Equations of Motion



Sep 17, 08 17:46	00.outline.txt	Page 11/11
<ul style="list-style-type: none"> <li>- Leapfrog Advance for Electric Forces</li> <li>- Leapfrog Advance for Electric and Magnetic Forces</li> <li>- Numerical Errors and Stability of the Leapfrog Method</li> <li>- Illustrative Examples</li> <li>15.4.C Field Solution               <ul style="list-style-type: none"> <li>- Electrostatic Overview</li> <li>- Green's Function Approach</li> <li>- Gidded Field Solution: Equation and Boundary Conditions</li> <li>- Methods of Gridded Field Solution</li> <li>- Spectral Methods and the FFT</li> </ul> </li> <li>15.4.D Weighting: Depositing Particles on the Field Mesh and Interpolating Fields to the Particles               <ul style="list-style-type: none"> <li>- Overview of Approaches</li> <li>- Approaches: Nearest Grid Point, Cloud in Cell, Area, Splines</li> </ul> </li> <li>15.4.E Computational Cycle for Particle in Cell Simulations</li> <li>15.5 Diagnostics</li> <li>15.6 Initial Distribution and Particle Loading</li> <li>15.7 Numerical Convergence</li> <li>15.8 Practical Considerations               <ul style="list-style-type: none"> <li>15.8.A Overview</li> <li>15.8.B Fast Memory</li> <li>15.8.C Run Time</li> <li>15.8.D Machine Architectures</li> </ul> </li> <li>15.9 Overview of the WARP Code</li> <li>15.10 Example Simulations</li> </ul>		
Contact Information Acknowledgments References		
16. Summary of Lectures by John J. Barnard (JJB) 16.summary_jjb.pdf pdf scan, handwritten notes and slides		
<ul style="list-style-type: none"> <li>∅ 16.1 Emission and phase space review</li> <li>16.2 Particle equations of motion (radial and Cartesian)</li> <li>16.3 Summary of 6 statistical envelope equations and two equations based on particular distribution functions</li> <li>16.4 Current limits</li> <li>16.5 Using envelope equations to estimate spot size</li> <li>16.6 Longitudinal dynamics summary</li> <li>16.7 Instability summary</li> <li>16.8 Halo summary</li> <li>16.9 Electron, gas, pressure, and scattering effects summary</li> <li>16.10 Summary of HIF</li> </ul>		

Sponsored by the University of Maryland at College Park  
 US Particle Accelerator School, June 16-27, 2008, Annapolis, Maryland

Course Instructors: John J. Barnard (JB) and Steven M. Lund (SL), Lawrence Livermore National Laboratory  
 Recitations and Grading: Christos Papadopoulos (CP), University of Maryland

Monday 6/16		Tuesday 6/17		Wednesday 6/18		Thursday 6/19		Friday 6/20	
9:00 am	Class Organization	Envelope Equations	Current Limits	Injectors/Longitudinal Beam Physics I	Longitudinal Beam Physics II	Longitudinal Beam Physics III			
- 10:30 am	Envelope Equations	JB	JB	JB	JB	JB			
10:30 am	Transverse Particle Equations of Motion I	Transverse Particle Equations of Motion II	Transverse Particle Equations of Motion II	Distribution Functions	Transverse Distribution Functions II	Resonances			
- 12:00 noon	Equations of Motion I	SL	SL	SL	SL	SL			
- 12:00 noon - 1:00 pm	Lunch	Lunch	Lunch	Lunch	Lunch	Lunch			
1:00 pm	Transverse Particle Equations of Motion I	Transverse Particle Equations of Motion II	Transverse Particle Equations of Motion II	Tran. Dist. Functions I	Tran. Dist. Funcs. II	Simulation Techniques I			
- 2:00 pm	Equations of Motion I	SL	SL	SL	SL	SL			
2:00pm	Carry Over	Carry Over	Carry Over	Carry Over	Carry Over	Carry Over			
- 3:00 pm		+ Recitation	+ Recitation	+ Recitation	+ Recitation	+ Recitation			
3:00 pm		CP	CP	CP	CP	CP			
4:00 pm									
6:00 pm - ?	Homework 1	Homework 2	Homework 3	Homework 4	Homework 5				

Monday 6/23		Tuesday 6/24		Wednesday 6/25		Thursday 6/26		Friday 6/27	
9:00 am	Modes in Continuous Focusing and Halo	Pressure/Scattering/ Electron Effects	Heavy Ion Fusion/ Final Focusing	Review of Material	Review of Material	To Be Determined			
10:30 am	JB	JB	JB	JB	JB				
10:30 am	Transverse Centroid and Envelope Equations	Transverse Centroid and Envelope Equations	Transverse Kinetic Stability I	Simulation Techniques II	Simulation Techniques II	Final Exam Review			
- 12:00 noon	SL	SL	SL	SL	SL	SL			
- 12:00 noon - 1:00 pm	Lunch	Lunch	Lunch	Lunch	Lunch	Lunch			
1:00 pm	Tran. Cen. Env. Eqns. I	Tran. Cen. Env. Eqns. II	Tran. Kin. Stability II	Simulation Techs. III	Simulation Techs. III				
- 2:00 pm	SL	SL	SL	SL	SL				
2:00pm	Carry Over	Carry Over	Carry Over	Carry Over	Carry Over	Carry Over			
- 3:00 pm	+ Recitation	+ Recitation	+ Recitation	+ Recitation	+ Recitation	+ Recitation			
3:00 pm	CP	CP	CP	CP	CP	CP			
- 4:00 pm									
6:00 pm - ?	Homework 6	Homework 7	Homework 8	Homework 8	Homework 8	Take-home final			

Carry Over: Over time lectures will be caught up prior to the Recitation to avoid falling behind schedule  
 Homework: Collaboration with other students in class and hints from grader or instructors are allowed. (80% of grade)  
 Take-Home Final: No collaboration allowed (20% of grade)

John Barnard  
Steven Lund  
USPAS  
June 2008

I. Introduction

(related reading in parentheses)

Particle motion (Reiser 2.1)

Equation of motion (Reiser 2.1)

Dimensionless quantities (Reiser 4.2)

Plasma physics of beams (Reiser  
3.2, 4.1)

Emittance and brightness (Reiser 3.1  
- 3.2)

# PARTICLE EQUATIONS OF MOTION / DIMENSIONLESS QUANTITIES

CONSIDER THE LORENTZ FORCE ON A PARTICLE UNDER THE INFLUENCE OF ELECTRIC AND MAGNETIC FORCES.

$$\frac{d\mathbf{p}}{dt} = q(\mathbf{E} + \mathbf{v} \times \mathbf{B}) \quad [\text{SI units}]$$

$$\mathbf{p} = \gamma m \mathbf{v} \quad \gamma = \frac{1}{\sqrt{1 - \beta^2}} \quad \beta = \frac{v}{c}$$

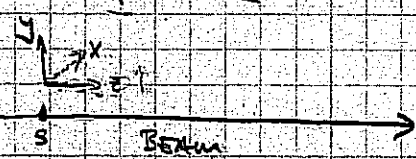

CONSIDER THE X-COMPONENT OF THE MOTION (TRANSVERSE TO THE STREAMING MOTION OF THE PARTICLE)

TRANSFORM TO S' AS THE INDEPENDENT VARIABLE:

$$dt = \frac{ds}{v_z} \quad \Rightarrow \quad v_x = \frac{dx}{dt} = v_z x' \quad \frac{d}{dt} = \frac{d}{ds}$$

$$m v_z \frac{d}{ds} (\gamma v_z x') = q(\mathbf{E} + \mathbf{v} \times \mathbf{B})_x$$

$$\gamma m v_z^2 x'' + x' m v_z \frac{d}{ds} (\gamma v_z) = q(\mathbf{E} + \mathbf{v} \times \mathbf{B})_x$$

$$\Rightarrow x'' + \left[ \frac{1}{\gamma v_z^2} \frac{d}{ds} (\gamma v_z) \right] x' = \frac{q}{\gamma m v_z^2} (\mathbf{E} + \mathbf{v} \times \mathbf{B})_x$$

National Brand 42-182 100 SHEETS Made in U.S.A.

NOW CONSIDER AN UNBUNCHED BEAM OF UNIFORM DENSITY  $\rho$   
AND CIRCULAR CROSS SECTION

$$\nabla \cdot \underline{E} = \frac{\rho}{\epsilon_0}$$

$$2\pi r E_r = \pi r^2 \frac{\rho}{\epsilon_0} \quad (\text{Gauss theorem})$$

$$E_r = \frac{\rho}{2\epsilon_0} r = \frac{\lambda}{2\pi\epsilon_0} \frac{r}{r_b^2}$$

$$E_x = E_r \cos\theta = E_r \left(\frac{x}{r}\right) = \frac{\lambda}{2\pi\epsilon_0} \frac{x}{r_b^2}$$



$$\lambda = \pi r_b^2 \rho$$

Similarly  $\nabla \times \underline{B} = \mu_0 \underline{J}$

$$2\pi r B_\theta = \mu_0 \rho v_z \pi r^2 \quad (\text{Stokes theorem})$$

$$B_\theta = \frac{\mu_0 \lambda v_z}{2\pi} \frac{r}{r_b^2}$$

$$B_y = \frac{\mu_0 \lambda v_z}{2\pi} \frac{x}{r_b^2} \quad (B_z = 0)$$

$$\text{Let } (\underline{E} + \underline{v} \times \underline{B})_x = (E_x - v_z B_y)^{\text{self}} + (E_x + v_y B_z - v_z B_y)^{\text{ext}}$$

$$\Rightarrow x'' + \left[ \frac{1}{\gamma m v_z^2} - \gamma v_z^2 \right] x' = \frac{q}{\gamma m v_z^2} \frac{\lambda}{2\pi\epsilon_0} \frac{x}{r_b^2} [1 - \mu_0 \epsilon_0 v_z^2] + \frac{q}{\gamma m v_z^2} (\underline{E} + \underline{v} \times \underline{B})_x^{\text{ext}}$$

$$\text{Using } \mu_0 \epsilon_0 = \frac{1}{c^2}$$

$$\text{Assuming } \beta_x^2 + \beta_y^2 \ll 1 \Rightarrow \gamma^2 \approx \frac{1}{1 - v_z^2/c^2} \quad (\text{PARAXIAL APPROXIMATION})$$

( $\Rightarrow \beta_x^2 + \beta_y^2 \ll 1$ ; HERE  $\sim$  INDICATES VALUE IN COMOVING FRAME  
[NON-RELATIVISTIC MOTION IN COMOVING FRAME].)

LUMPING EXTERNAL FORCE INTO A LINEAR FIELD

$$x'' + \frac{1}{\gamma v_z} \frac{d}{ds} (\gamma v_z^2) x' \approx \frac{q}{\gamma^3 m v_z^2} \frac{\lambda}{2\pi \epsilon_0} \frac{x}{r_b^2} - K(z) x$$

↑  
EXTERNAL FORCES

$$\approx Q \frac{x}{r_b^2} - K(z) x$$

$$Q \equiv \frac{q \lambda}{2\pi \epsilon_0 \gamma^3 m v_z^2} = \text{GENERALIZED PERVEANCE}$$

$$= \frac{(q/e)}{(m/m_{\text{rest}})} \frac{2I}{I_0} \frac{1}{\gamma^3 \beta^3}$$

here  $qV \equiv (\gamma - 1) m c^2$

$$I_0 = \frac{4\pi \epsilon_0 m_{\text{rest}} c^3}{e} \approx 31 \text{ MA}$$

$$\left\{ \begin{array}{l} \frac{x}{4\pi \epsilon_0 V} \quad \text{for } \gamma^2 v_z^2 \ll c^2 \\ \frac{\lambda}{2\pi \epsilon_0 V (qV/mc)^2} \quad \text{for } \gamma^2 v_z^2 \gg c^2 \end{array} \right.$$

Also note in non-relativistic limit  $Q = \left(\frac{m}{2q}\right) \frac{v_z^2 - 1}{4\pi \epsilon_0 c} = \left(\frac{I}{V^{3/2}}\right)$   
 (same scaling as original term permeance characterizing microtms).

$$Q \approx \frac{\oint_{\text{SELF}}}{V} = \frac{\int_0^{r_b} (E_r - v_z B_\theta) dr}{V} = \frac{\text{POTENTIAL ENERGY OF BEAM PARTICLE}}{\text{KINETIC ENERGY OF " "}}$$

SOMETIMES PERIODIC FOCUSING IS EMPLOYED

$$K(z) = K(z + S)$$

S = PERIOD

FOR SOME PURPOSES A SUITABLE CONSTANT CAN BE FOUND WHICH CAPTURES SLOW VARIATION OF THE PARTICLE MOTION. (SMOOTH FOCUSING APPROX.)

$$\Rightarrow x'' + \frac{1}{\gamma v_z} \frac{d}{ds} (\gamma v_z^2) x' = Q \frac{x}{r_b^2} - k_{p0}^2 x$$

$k_{p0} \equiv$  "UNDRESSSED RETRORON FREQUENCY"

$Q_0 \equiv k_{p0} S =$  UNDESSSED HALF ADVANCE



IF  $\frac{dV_z}{dz} = 0$  [drifting beams]

$$x'' = - \left[ k_p^2 - \frac{0}{v_z^2} \right] x$$

$$= -k_p^2 \left[ 1 - \frac{0}{v_z^2} \right] x \equiv -k_p^2 x$$

↑ "DEPRESSED BETTUN FREQUNCY"

$$\equiv \left( \frac{\omega_p}{\omega_0} \right)^2 \equiv \text{"TUNE DEPRESSION"}^2$$

EFFECT OF SPACE CHARGE IS TO LOWER FREQUENCY OF HARMONIC OSCILLATIONS

$$\frac{\omega}{\omega_0} = 0 \Rightarrow \text{FULLY TUNE DEPRESSED}$$

$$\frac{\omega}{\omega_0} = 1 \Rightarrow \text{NO SPACE-CHARGE DEPRESSION}$$

# Space charge reduces betatron phase advance

Without space charge:

$$X = X_i \cos [k_{\beta 0}(s - s_i)] + \frac{X_i'}{k_{\beta 0}} \sin [k_{\beta 0}(s - s_i)]$$

Particle orbit

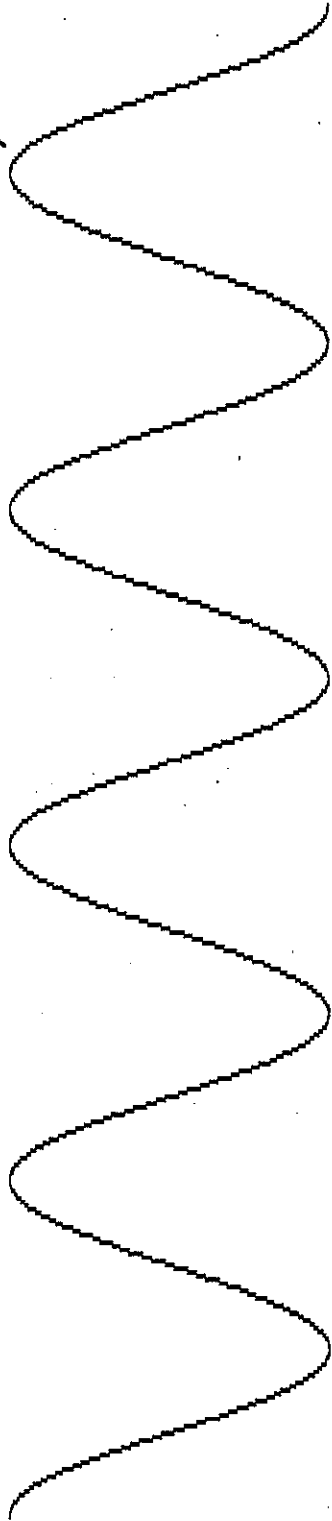

With space charge:

Particle orbit



$$\sigma/\sigma_0 \sim 5/18 \sim 0.277$$

$$X = X_i \cos [k_{\beta 0} \frac{\sigma}{\sigma_0}(s - s_i)] + \left(\frac{X_i'}{\frac{\sigma}{\sigma_0}}\right) \frac{1}{k_{\beta 0}} \sin [k_{\beta 0} \frac{\sigma}{\sigma_0}(s - s_i)]$$

Beam envelope

J. BARNAUD

(5)



The Heavy Ion Fusion Virtual National Laboratory



# BENDING BEAMS

RETURNING TO PARTICLE EQUATION WITH ARBITRARY  $\underline{E}$ ,  $\underline{B}$ :

$$x'' + \left[ \frac{1}{\gamma m v_z} \frac{d(\gamma m v_z)}{ds} \right] x' = \frac{q}{\gamma m v_z^2} (\underline{E} + \underline{v} \times \underline{B})_x$$

IF EXTERNAL FORCE IS PROPORTIONAL TO  $-x$   
 $\Rightarrow$  FOCUSING (HARMONIC OSCILLATIONS)

HOWEVER, IF  $\underline{E} + \underline{v} \times \underline{B} = \text{CONSTANT}$

$\Rightarrow$  BENDING

EXAMPLE: IF  $\underline{B} = B_y \hat{e}_y$   
 $\underline{v} = v_0 \hat{e}_z + v_x \hat{e}_x$  where  $v_0 \gg v_x$

$$\Rightarrow x'' = \frac{q B_y}{\gamma m v_z} = \frac{B_y}{[BP]} \quad [BP] \equiv \text{RIGIDITY} = \frac{\gamma m v_z^2}{q} = \frac{p}{q}$$

$$x' = \frac{B_y}{[BP]} z + x_0'$$

$$x = \frac{B_y}{[BP]} \frac{z^2}{2} + x_0' z + x_0$$

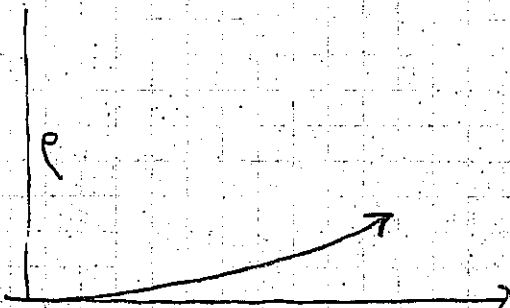

$p = \text{RADIUS OF CURVATURE OF ARC} = \frac{[BP]}{B_y}$

(BENDING CAN ALSO BE CARRIED OUT WITH ELECTRIC FIELDS  $\underline{E}_x = \text{constant}$ )

PLASMA PHYSICS OF BEAMS

PHYSICS OF SPACE-CHARGE  $\equiv$  PHYSICS OF SELF-FIELDS  
 $\equiv$  PLASMA PHYSICS OF PARTICLE BEAMS

PLASMA PARAMETER

$$q\phi_{IP} = \frac{1}{4\pi\epsilon_0} \frac{q^2}{r_{IP}}$$

$$\approx \frac{1}{4\pi\epsilon_0} n_0^{1/3} q^2$$

AVERAGE POTENTIAL ENERGY  $q\phi_{IP}$   
 OF PARTICLE DUE TO ITS NEAREST  
 NEIGHBOR ( $q$  = charge of particle)

IF  $q\phi_{IP} \ll k_B T$   $\Rightarrow$  PLASMA (weakly coupled plasma)

DEFINE  $\lambda_D = \frac{(k_B T / m)^{1/2}}{(n_0 q^2 / \epsilon_0 m)^{1/2}} = \frac{v_{TH}}{\omega_p} = \left( \frac{k_B T \epsilon_0}{n_0 q^2} \right)^{1/2} =$  DEBYE LENGTH

= SHIELDING DISTANCE EVEN  
 IN NON-NEUTRAL PLASMA

DEFINE  $\Lambda = \frac{4\pi}{3} n_0 \lambda_D^3 \equiv$  PLASMA PARAMETER

$$\sim \left( \frac{k_B T}{q\phi_{IP}} \right)^{3/2} \gg 1$$

Klimontovich Equation

REF. "INTRO. TO PLASMA THEORY", D.R. NICHOLSON, WILEY, 1973.

Let  $N(x, v, t) = \sum_{i=1}^{N_0} \delta(x - x_i(t)) \delta(v - v_i(t))$

No particles;  $x_i, v_i$  are position and velocity of  $i^{th}$  particle

$\dot{x}_i = v_i$       $m \dot{v}_i = q E^m [x_i(t), t] + q [v_i \times B^m [x_i(t), t]]$  (non-relativistic)

$N(x, v, t)$  = "density" of particles in phase space

$\int N d^3x d^3v = N_0$

Let  $u = x - x_i(t)$

$\frac{d}{dt} f(u) = f'(u)$

$\frac{\partial}{\partial x} f(u) = f'(u) (-\dot{x}(t)) = -\dot{x}(t) \frac{d}{dx} f(u)$

Taking derivative:

$\frac{\partial N}{\partial t}(x, v, t) = \sum_{i=1}^N \dot{x}_i(t) \cdot \nabla_x [\delta(x - x_i(t)) \delta(v - v_i(t))] - \sum_{i=1}^N \dot{v}_i(t) \cdot \nabla_v [\delta(x - x_i(t)) \delta(v - v_i(t))]$

MAXWELL'S EQUATIONS:

$\nabla \cdot E^m = \rho$

$\nabla \cdot B^m = 0$

$\nabla \times E^m = -\frac{\partial B^m}{\partial t}$

$\nabla \times B^m = \mu_0 \underbrace{q \int v N(x, v, t) d^3v}_{J^m} + \frac{\partial E^m}{\partial t}$

$\Rightarrow \frac{\partial N}{\partial t}(x, v, t) = - \sum_{i=1}^{N_0} \dot{v}_i(t) \cdot \nabla_v [\delta(x - x_i(t)) \delta(v - v_i(t))] - \sum_{i=1}^{N_0} \left( \left( \frac{q}{m} \right) E^m + \left( \frac{q}{m} \right) [v_i \times B^m [x_i(t), t]] \right) \cdot \nabla_v [\delta(x - x_i(t)) \delta(v - v_i(t))]$

Note that  $v_i(t) \delta(v - v_i(t)) = v \delta(v - v_i(t))$  so,

$\Rightarrow \frac{\partial N}{\partial t}(x, v, t) = - v \cdot \nabla_v \sum_{i=1}^{N_0} \delta(x - x_i(t)) \delta(v - v_i(t)) - \left( \frac{q}{m} E^m(x, t) + \frac{q}{m} (v \times B^m(x, t)) \right) \cdot \nabla_v \sum_{i=1}^N \delta(x - x_i(t)) \delta(v - v_i(t))$

$\nabla_x =$  spatial gradient  
 $\nabla_v =$  gradient w.r.t 3 velocity variables

$\frac{\partial N}{\partial t}(x, v, t) = - v \cdot \nabla_v N(x, v, t) + \frac{q}{m} (E^m + v \times B^m) \cdot \nabla_v N(x, v, t)$

Klimontovich Equation

Total derivative along an orbit:

$$\frac{D}{Dt} = \frac{\partial}{\partial t} + \underbrace{\frac{dx}{dt}}_{\text{orbit}} \cdot \nabla_x + \underbrace{\frac{dv}{dt}}_{\text{orbit}} \cdot \nabla_v$$

$$\Rightarrow \boxed{\frac{D}{Dt} N(x, v, t) = 0}$$

Note that  $N = 0$  or  $\infty$ , nothing in between.

$$\text{Let } f(x, v, t) = \frac{\int_{\Delta x^3 \Delta v^3} N(x, v, t) \delta^3 x \delta^3 v}{\Delta x^3 \Delta v^3}$$

over some box in phase space  
 $\Delta x$  &  $\Delta v$  are the size of box

$$\equiv \langle N(x, v, t) \rangle$$

Assume  $n^{-1/3} \ll \Delta x \ll \lambda_D$   
so that  $f(x, v, t)$  is smooth function.

$$\begin{aligned} \text{Then } N &= f + \delta f \\ E^3 &= E + \delta E \\ B^3 &= B + \delta B \end{aligned}$$

$$\begin{aligned} A &= \langle N \rangle \\ E &= \langle E^3 \rangle \\ B &= \langle B^3 \rangle \end{aligned}$$

$$\begin{aligned} \langle \delta f \rangle &= 0 \\ \langle \delta E \rangle &= 0 \\ \langle \delta B \rangle &= 0 \end{aligned}$$

$$\Rightarrow \underbrace{\frac{\partial f}{\partial t} + v \cdot \nabla_x f + \frac{q}{m} (E + v \times B) \cdot \nabla_v f}_{\text{SMOOTHLY VARYING PART}} = - \frac{q}{m} \underbrace{\langle (\delta E + v \times \delta B) \cdot \nabla_v \delta f \rangle}_{\text{AVERAGE OF "SILLY" QUANTITIES "DISCRETE / PARTICLE EFFECTS" OR "COLLISIONS"}}$$

If collisions are neglected (set RMS to zero):

Vlasov-EQUATION

$$\frac{\partial f}{\partial t} + v \cdot \nabla_x f + \frac{q}{m} (E + v \times B) \cdot \nabla_v f = 0$$

$$\Rightarrow \boxed{\frac{Df}{Dt} = 0}$$

PHASE SPACE DENSITY CONSTANT ON TRAJECTORIES, (LIOUVILLE'S THEOREM)

THE RHS IS DUE TO COLLISIONS WITH

NON-SMOOTH FIELDS:

VERY HEURISTICALLY

$$-\frac{q}{m} \langle (\delta \underline{E} + \underline{v} \times \delta \underline{B}) \cdot \nabla_v \delta f \rangle \sim \nu_c f$$

$$\nu_c \sim \sigma n v$$

$$\sigma \sim \pi r_c^2 \text{ where } r_c \text{ is given by } kT \sim \frac{q^2}{4\pi\epsilon_0 r_c}$$

$$\Rightarrow \nu_c \sim \pi \left( \frac{q^2}{4\pi\epsilon_0 kT} \right)^2 n_0 \left( \frac{kT}{m} \right)^{1/2} \leftarrow \text{(FOR LARGE ANGLE COLLISIONS)}$$

(VERY ROUGH, BUT MAIN SCALING IS CORRECT, WITH LOGARITHMIC CORRECTION FACTOR)

ON LHS OF VLASOV EQUATION:

$$\frac{q}{m} E \nabla_v f \sim \left( \frac{q \lambda_D n_0}{\epsilon_0} \right) \frac{f}{v_{TH}} \text{ where } v_{TH} \sim \sqrt{\frac{kT}{m}}$$

$$\frac{\text{COLLISION TERM}}{\text{LHS}} \sim \frac{1}{16 \lambda_D^3 n_0} = \frac{1}{16 \Lambda}$$

# Accelerator beams are non-neutral plasmas

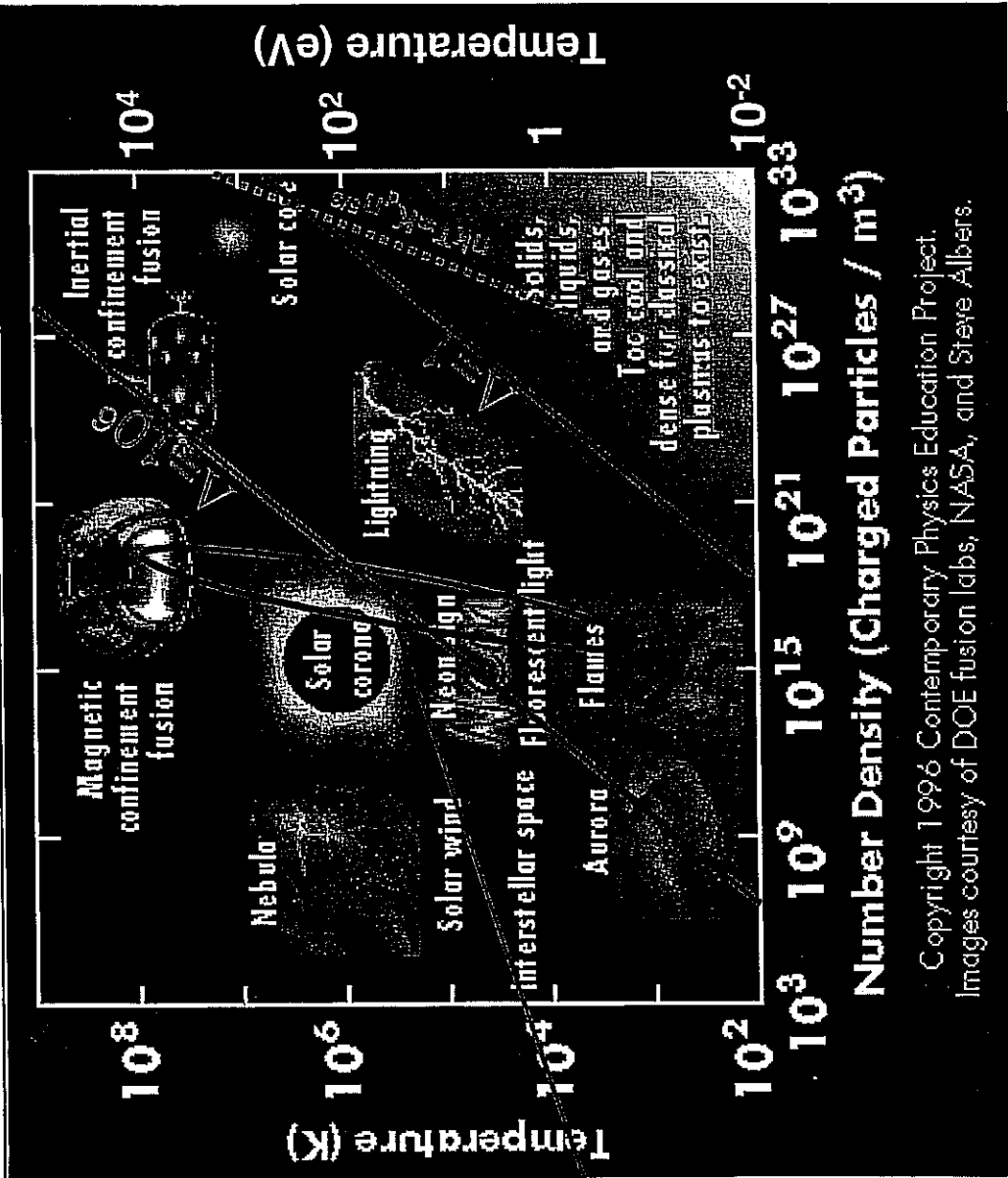

Accelerator beams  
for Heavy Ion Fusion

Number Density (Charged Particles /  $m^3$ )

Copyright 1996 Contemporary Physics Education Project.  
Images courtesy of DOE fusion labs, NASA, and Steve Albers.

The Heavy Ion Fusion Virtual National Laboratory



DESCRIPTION OF THE BEAM

LIUVILLE'S THEOREM:  $\frac{df}{dt} = 0$  along a trajectory  
in phase space.

$$\text{Let } dN = f dx dy dz dp_x dp_y dp_z$$

The continuity equation in phase space is:

$$\frac{\partial f}{\partial t} + \nabla \cdot (f \underline{v}) = 0$$

$$\text{where } \underline{v} = \frac{d}{dt} \begin{pmatrix} q_1 \\ q_2 \\ q_3 \\ p_1 \\ p_2 \\ p_3 \end{pmatrix}$$

$$\nabla \cdot \underline{a} = \frac{\partial a_1}{\partial q_1} + \frac{\partial a_2}{\partial q_2} + \frac{\partial a_3}{\partial q_3} + \frac{\partial a_4}{\partial p_1} + \frac{\partial a_5}{\partial p_2} + \frac{\partial a_6}{\partial p_3}$$

( $\underline{v}$  &  $\nabla$  are the 6-D velocity & divergence, respectively).

If the system is governed by a Hamiltonian  $H(\underline{q}, \underline{p}, t)$

$$\dot{q}_i = \frac{\partial H}{\partial p_i} \quad \dot{p}_i = -\frac{\partial H}{\partial q_i}$$

$$\text{Now, } \nabla \cdot \underline{v} = \sum_{i=1}^3 \frac{\partial \dot{q}_i}{\partial p_i} + \frac{\partial \dot{p}_i}{\partial q_i} = \sum_{i=1}^3 \frac{\partial^2 H}{\partial q_i \partial p_i} - \frac{\partial^2 H}{\partial p_i \partial q_i} = 0$$

$$\Rightarrow \frac{\partial f}{\partial t} + f \underbrace{\nabla \cdot \underline{v}}_0 + \underline{v} \cdot \nabla f = 0$$

$$\Rightarrow \boxed{\frac{df}{dt} = 0 \text{ on trajectory}}$$

Emittance & Brightness

LIOUVILLE'S EQUATION OR VLAOV EQUATION  $\Rightarrow \frac{dN}{dx dy dz dx dp_y dp_z} = \text{const}$

IF  $x'' = f(x)$  AND NOT FUNCTIONS (y & z)  
 $y'' = f(y) = \dots$  (x, & z)  
 $z'' = f(z) = \dots$  (x, & y)

THEN  $\frac{dN}{dx dp_x} = \text{const}; \frac{dN}{dy dp_y} = \text{const} \& \frac{dN}{dz dp_z} = \text{const}$

separately.

1st DEFINITION:

EMITTANCE: USE TRACE-SPACE OF ALL PARTICLES IN A GIVEN SLICE OF BEAM.

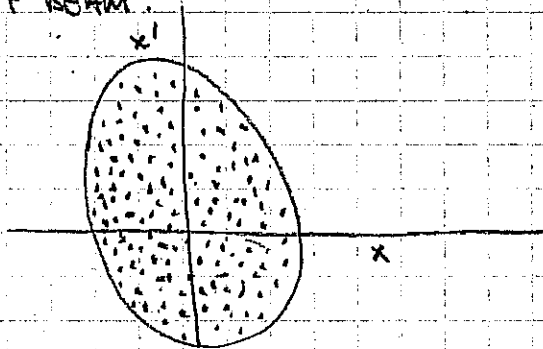

INSTEAD OF  $p_x$  USE  $x' = \frac{v_x}{v_z}$  (FOR NON-ACCELERATING PARALLEL BEAM,  $x'$  PROPORTIONAL TO MOMENTUM)

EMITTANCE  $\equiv \frac{1}{\pi}$  AREA OF SMALLEST ELLIPSE WHICH ENCLOSES

ALL PARTICLES. (TRACE-SPACE DEFINITION)

(INTUITIVELY, PRODUCT OF WIDTH IN  $x$ , TIMES WIDTH IN  $x'$ , SO IT IS ESSENTIALLY (WITHIN FACTOR OF  $\pi$ ) = HALF SCALE AREA OF BEAM.

2ND DEFINITION INVOLVES STATISTICAL AVERAGES OF 2ND ORDER QUANTITIES (SUCH AS RMS).

$$\epsilon_x \equiv 4 (\langle x^2 \rangle \langle x'^2 \rangle - \langle x x' \rangle^2)^{1/2}$$

For an upright uniform beam (in phase space):  $\langle x^2 \rangle = \frac{v_x^2}{4}$   $\langle x'^2 \rangle = \frac{x'_{max}}{4}$   
 $\& \langle x x' \rangle = 0$

$$\Rightarrow \epsilon_x = v_x x'_{max} = \frac{\text{Area}}{\pi}$$



NORMALIZED EMITTANCE

For a beam that is accelerating, return to  $x, p_x$  as definition of phase space area:

$p_x = \gamma m v_x = \gamma m v_z x'$  AGAIN, ASSUMING  $v \approx v_z$

$\Rightarrow \epsilon_{nx} \equiv 4\gamma_p (\langle x^2 \rangle \langle x'^2 \rangle - \langle x x' \rangle^2)^{1/2} = \gamma \beta \epsilon_x$   
 $= \frac{4}{m} (\langle x^2 \rangle \langle p_x^2 \rangle - \langle x p_x \rangle^2)^{1/2}$

SINCE EMITTANCE IS THE AVERAGE PHASE SPACE AREA OF BEAM (AVERAGING OVER EMITTANCE SPACE) THE EMITTANCE IN GENERAL SHOWS AS A BEAM FILMENTS (ENGULFING EMITTANCE SPACE).

BRIGHTNESS

THE DENSITY OF PARTICLES IN 6-D PHASE SPACE IS:

$\frac{dN}{dx dy dz dx' dy' dz'} = f$  ← MICROSCOPIC DENSITY

DEFINE A QUANTITY  $\bar{f}$  WHICH IS THE PHASE-SPACE DENSITY IN AN AVERAGE SENSE

$\bar{f} = \left\langle \frac{dN}{dx dy dz dx' dy' dz'} \right\rangle = \frac{(I dt)/q}{\pi^3 \epsilon_{nx} \epsilon_{ny} \epsilon_{nz}}$

Note  $f(x, p) = \text{constant}$  along a trajectory, whereas  $\bar{f}$  usually is a decreasing function of  $z$ .

NORMALIZED BRIGHTNESS  $B_n \equiv \frac{I}{\epsilon_{nx} \epsilon_{ny}}$

IS A USEFUL MEASURE OF 4D AVERAGE PHASE SPACE DENSITY, (if  $dt = \text{constant}$ ,  $f \perp$  all motion is uncoupled.)

For non-accelerating beams the unnormalized brightness  $B$  (also if  $dt = \text{const.}$   $f \perp$  all motion uncoupled)

$\Rightarrow B_n \equiv \frac{I}{\epsilon_x \epsilon_y}$  MEASURES PHASE SPACE DENSITY.



**Emittance constant for linear force profile & matched beams**

Linear force profile ( $x'' = -k^2 x$ )  $\Rightarrow$  Phase space area preserved, ellipse stays elliptical.

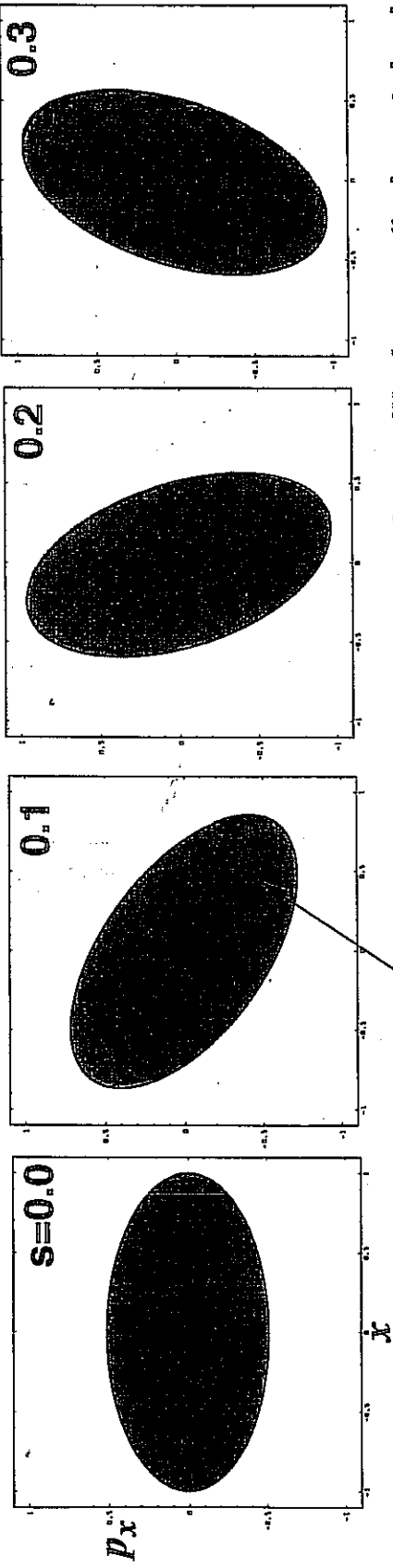

Emittance = phase space area  
 Emittance constant if forces linear  
 Here, width of beam is oscillating or "mismatched."

Non-linear forces (e.g.  $x'' = -k^2 x + \epsilon x^3$ )  $\Rightarrow$  position-dependent frequency  
 $\Rightarrow$  phase mixing, increasing effective area  $\Rightarrow$  Emittance increases if forces non-linear

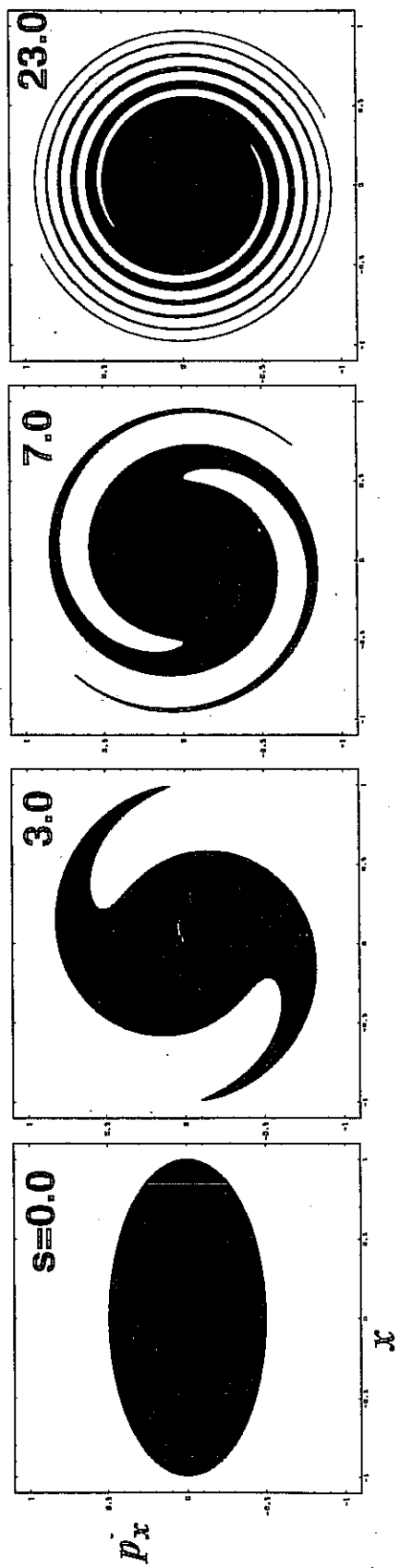

John Barnard  
Steven Lund  
USPAS  
June 2008

## II. Envelope Equations

Paraxial Ray Equation

Envelope equations for axially  
symmetric beams

Cartesian equation of motion

Envelope equations for elliptically  
symmetric beams

## Roadmap:

Single particle equation with Lorentz force  
 $q(\mathbf{E} + \mathbf{v} \times \mathbf{B})$



Make use of:

1. Paraxial (near-axis) approximation  
( $r \ll 1/k_{\beta 0}$  and  $x' = v_x/v_z \ll 1$ )
2. Conservation of canonical angular momentum
3. Axisymmetry  $f(r,z)$



Paraxial Ray Equation for Single Particle

Next take statistical averages over the distribution function

⇒ Moment equations

Express some of the moments in terms of the rms radius and emittance

⇒ Envelope equations (axi-symmetric case)

Some focusing systems have quadrupolar symmetry  
Rederive envelope equations in cartesian coordinates  
( $x,y,z$ ) rather than radial ( $r,z$ )

START WITH NEWTON'S EQUATION WITH THE LORENZ FORCE:

$$\frac{d\mathbf{p}}{dt} = q(\mathbf{E} + \mathbf{v} \times \mathbf{B})$$

In cartesian coordinates:

$$\frac{d}{dt}(\gamma m \dot{x}) = \dot{\gamma} m \dot{x} + \gamma m \ddot{x} = q(E_x + \dot{y} B_z - \dot{z} B_y)$$

$$\frac{d}{dt}(\gamma m \dot{y}) = \dot{\gamma} m \dot{y} + \gamma m \ddot{y} = q(E_y + \dot{z} B_x - \dot{x} B_z)$$

$$\frac{d}{dt}(\gamma m \dot{z}) = \dot{\gamma} m \dot{z} + \gamma m \ddot{z} = q(E_z + \dot{x} B_y - \dot{y} B_x)$$

In cylindrical coordinates: (use  $\frac{d\hat{e}_r}{dt} = \hat{e}_\theta \dot{\theta}$ ;  $\frac{d\hat{e}_\theta}{dt} = -\hat{e}_r \dot{\theta}$ )

$$\frac{d}{dt}(\gamma m \dot{r}) - \gamma m r \dot{\theta}^2 = q(E_r + r \dot{\theta} B_z - \dot{z} B_\theta) \quad (\text{I})$$

$$\frac{1}{r} \frac{d}{dt}(\gamma m r^2 \dot{\theta}) = q(E_\theta + \dot{z} B_r - \dot{r} B_z) \quad (\text{II})$$

$$\frac{d}{dt}(\gamma m \dot{z}) = q(E_z + \dot{r} B_\theta - r \dot{\theta} B_r) \quad (\text{III})$$

When  $\frac{\partial}{\partial t} = 0$ :

$$\underline{\mathbf{E}} = -\nabla\phi = \hat{e}_r \left[ -\frac{\partial\phi}{\partial r} - \frac{\partial A_\theta}{\partial t} \right] + \hat{e}_\theta \left[ -\frac{\partial\phi}{\partial \theta} \right] + \hat{e}_z \left[ -\frac{\partial\phi}{\partial z} - \frac{\partial A_z}{\partial t} \right]$$

$$\underline{\mathbf{B}} = \nabla \times \underline{\mathbf{A}} = \hat{e}_r \left[ \frac{\partial}{\partial z} (r A_\theta) \right] + \hat{e}_\theta \left[ \frac{\partial A_r}{\partial z} - \frac{\partial A_z}{\partial r} \right] + \hat{e}_z \left[ \frac{1}{r} \frac{\partial}{\partial r} (r A_\theta) \right]$$

$$\begin{aligned} q r (E_\theta + \dot{z} B_r - \dot{r} B_z) &= q \left( -\frac{\partial r A_\theta}{\partial t} - \dot{z} \frac{\partial r A_\theta}{\partial z} - r \frac{\partial}{\partial r} (r A_\theta) \right) \\ &= -q \left[ \frac{\partial}{\partial t} + \mathbf{v} \cdot \frac{\partial}{\partial \mathbf{x}} \right] (r A_\theta) \\ &= -q \frac{d}{dt} (r A_\theta) \end{aligned} \quad (\text{IV})$$

$$\text{Eqn II} \Rightarrow \frac{d}{dt} (\gamma m r^2 \dot{\theta} + q r A_\theta) = 0$$

$$\underline{p} = p_r \hat{e}_r + p_\theta^* \hat{e}_\theta + p_z \hat{e}_z$$

where  $p_r = \gamma m \dot{r}$   
 $p_\theta^* = \gamma m r \dot{\theta}$   
 $p_z = \gamma m \dot{z}$

$$\frac{d\underline{p}}{dt} = \dot{p}_r \hat{e}_r + p_r \dot{\hat{e}}_r + \dot{p}_\theta^* \hat{e}_\theta + p_\theta^* \dot{\hat{e}}_\theta + \dot{p}_z \hat{e}_z$$

$$\Rightarrow \frac{d\underline{p}}{dt} = (\dot{p}_r - p_\theta^* \dot{\theta}) \hat{e}_r + (p_r \dot{\theta} + \dot{p}_\theta^*) \hat{e}_\theta + \dot{p}_z \hat{e}_z$$

WHERE WE HAVE USED:

$$\frac{d\hat{e}_r}{dt} = \hat{e}_\theta \dot{\theta} \quad \& \quad \frac{d\hat{e}_\theta}{dt} = -\hat{e}_r \dot{\theta}$$

$$\Rightarrow \frac{d\underline{p}}{dt} = \left[ \frac{d}{dt} (\gamma m \dot{r}) - \frac{d}{dt} (\gamma m r \dot{\theta}^2) \right] \hat{e}_r$$

$$+ \left[ \gamma m r \dot{\theta} + \frac{d}{dt} (\gamma m r \dot{\theta}) \right] \hat{e}_\theta$$

$$= \frac{1}{r} \frac{d}{dt} (\gamma m r^2 \dot{\theta})$$

$$+ \frac{d}{dt} (\gamma m \dot{z}) \hat{e}_z$$

(NOTE: ON THIS PAGE  $p_\theta^* \equiv \theta$ -component of MECHANICAL MOMENTUM  
 NOT TO BE CONFUSED WITH  $p_\theta = \gamma m r^2 \dot{\theta} + q^m A_\theta \equiv \theta$ -component  
 OF CANONICAL ANGULAR <sup>3D</sup>MOMENTUM)

# CONSERVATION OF CANONICAL ANGULAR MOMENTUM

J. BANIK (2)

DEFINE  $p_\theta = \gamma m r^2 \dot{\theta} + q r A_\theta$

$$\frac{d}{dt} p_\theta = 0$$

(CONSERVATION OF CANONICAL ANGULAR MOMENTUM)

NOTE THAT THE FLUX ENCLOSED BY A CIRCLE OF RADIUS  $r$

$$\psi = \int \underline{B} \cdot d\underline{A} = \int (\nabla \times \underline{A}) \cdot d\underline{A} = \oint \underline{A} \cdot d\underline{l} = 2\pi r A_\theta$$

$$p_\theta = \gamma m r^2 \dot{\theta} + \frac{q}{2\pi} \psi$$

IS CONSERVED ALONG AN ORBIT IN AXISYMMETRIC GEOMETRIES

"EXTERNAL"

(REISEL SECTION 3.3)

J. BALWANT

(3)

ELECTRIC & MAGNETIC FIELDS WITH RADIAL SYMMETRY

CONSIDER THE EXTERNAL FIELD: (TIME STEADY VACUUM SOLUTION)

$$\nabla \times \underline{B} = 0 \quad \& \quad \nabla \times \underline{E} = 0$$

$$\nabla \cdot \underline{B} = 0 \quad \& \quad \nabla \cdot \underline{E} = 0 \quad \Rightarrow \quad \underline{E} \& \underline{B} = -\nabla \phi$$

Let  $\phi = \sum_{\nu=0}^{\infty} f_{2\nu}(z) r^{2\nu}$       $\nabla^2 \phi = 0 \Rightarrow \bar{\phi} = \sum_{\nu=0}^{\infty} \frac{(1)^{\nu}}{\nu!} \frac{\partial^{2\nu} f(0,z)}{\partial z^{2\nu}} \left(\frac{r}{z}\right)^{2\nu}$

$$\Rightarrow \bar{\phi} = \bar{\phi}(0,z) - \frac{1}{4} \frac{\partial^2 \bar{\phi}(0,z)}{\partial z^2} r^2 + \frac{1}{64} \frac{\partial^4 \bar{\phi}(0,z)}{\partial z^4} r^4$$

Let  $B_z(0,z) = B(z)$      &     Let  $\bar{\phi}(0,z) = V(z)$

$$B_z(r,z) = B(z) - \frac{r^2}{4} \frac{\partial^2 B}{\partial z^2} + \frac{r^4}{64} \frac{\partial^4 B}{\partial z^4} + \dots$$

$$B_r(r,z) = -\frac{r}{2} \frac{\partial B}{\partial z} + \frac{r^3}{16} \frac{\partial^3 B}{\partial z^3} + \dots$$

$$\bar{\phi}(r,z) = V(z) = \frac{1}{4} V'' r^2 + \frac{r^4}{64} \frac{\partial^4 V}{\partial z^4}$$

$$\Rightarrow E_r = \frac{1}{2} V'' r - \frac{r^3}{16} \frac{\partial^4 V}{\partial z^4}$$

Also,  $\psi \approx \pi r^2 B(z)$



$$\nabla^2 \phi = \frac{1}{r} \frac{\partial}{\partial r} \left( r \frac{\partial \phi}{\partial r} \right) + \frac{\partial^2 \phi}{\partial z^2} = 0$$

$$f(r, z) = \sum_{\nu=0}^{\infty} f_{2\nu}(z) r^{2\nu} = f_0 + f_2 r^2 + f_4 r^4$$

$$\sum_{\nu=1}^{\infty} [2\nu + 2\nu(\nu-1)] f_{2\nu} r^{2\nu-2} + \sum_{\nu=0}^{\infty} f_{2\nu}'' r^{2\nu} = 0$$

# PARAXIAL RAY EQUATION

$$(I) \Rightarrow \frac{d}{dt} (\gamma m \dot{r}) - \gamma m r \dot{\theta}^2 = q \left( \frac{V''}{z} r + r \dot{\theta} B \right) + q \left( E_r^{self} - v_z B_\theta^{self} \right)$$

$\uparrow$   
 INERTIAL

$\uparrow$   
 CENTRIFUGAL

$\uparrow$   
 $E_r$   
 external

$\uparrow$   
 $v_\theta B_z$   
 external

$\uparrow$   $\uparrow$   
 SELF  
 FIELDS

Now use s as independent variable  $v_z dt = ds$

$$v_z \frac{d}{ds} (\gamma m v_z \dot{r}') - \gamma m v_z^2 r \dot{\theta}'^2 = q \left( \frac{V''}{z} r + r v_z \dot{\theta}' B \right) + q \left( E_r^{self} - v_z B_\theta^{self} \right)$$

EXPANDING 1<sup>st</sup> term and  $v_z \approx v$ ; AND DIVIDING BY  $\gamma m v^2$ :

$$r'' - r \dot{\theta}'^2 + \frac{\gamma'}{\beta \gamma} r' = \frac{q}{\gamma m \beta^2 c^2} \left( \frac{V''}{z} r + r \beta c \dot{\theta}' B + E_r^{self} - v_z B_\theta^{self} \right) \quad (P1)$$

Using CANONICAL MOMENTUM, eliminate  $\theta'$  via

$$\theta' = \frac{p_\theta - \frac{q\psi}{2\pi}}{\gamma m r^2 \beta c} = \frac{p_\theta}{\gamma m r^2 \beta c} - \frac{qB}{2\gamma \beta m c} = \frac{p_\theta}{\gamma m r^2 \beta c} - \frac{\omega_c}{2\gamma \beta c}$$

where we define  $\omega_c \equiv \frac{qB}{m}$

ADDING THE TWO  $\theta'$  TERMS IN THE EQUATION (P1)

$$\begin{aligned} -r \dot{\theta}'^2 - \frac{r \omega_c \theta'}{\gamma \beta c} &= \frac{-p_\theta^2}{\gamma^2 m^2 r^3 \beta^2 c^2} + \frac{p_\theta \omega_c}{\gamma^2 m \beta^2 c^2 r} - \frac{r \omega_c^2}{4 \gamma^2 \beta^2 c^2} \\ &\quad - \frac{p_\theta \omega_c}{\gamma^2 m \beta^2 c^2 r} + \frac{r \omega_c^2}{2 \gamma^2 \beta^2 c^2} \\ &= \frac{-p_\theta^2}{\gamma^2 m^2 r^3 \beta^2 c^2} + \frac{r \omega_c^2}{2 \gamma^2 \beta^2 c^2} \end{aligned}$$

So equation (P1) becomes:

$$r'' + \frac{\gamma'}{\beta^2 \gamma} r' = \frac{q}{\gamma m \beta^2 c^2} \left( \frac{V''}{2} r \right) + \frac{r \omega_c^2}{2 \gamma^2 \beta^2 c^2} + \frac{p_0^2}{\gamma^2 m^2 \beta^2 c^2} + \frac{q}{\gamma m \beta^2 c^2} \left[ E_r^{self} - v_z B_\theta^{self} \right] \quad (P2)$$

Now  $\gamma' m c^2 = q \frac{E \cdot v}{v_z} \Rightarrow \gamma'' = \left( V'' + \frac{\partial^2 \phi^{self}}{\partial z^2} \right) \frac{q}{m c^2}$

CALCULATING  $\frac{q}{\gamma m \beta^2 c^2} \left[ \frac{V''}{2} r + E_r^{self} - v_z B_\theta^{self} \right]$ :

$$\nabla^2 \phi^{self} = -\frac{\rho}{\epsilon_0} \Rightarrow \frac{1}{r} \frac{\partial}{\partial r} \left( r \frac{\partial \phi}{\partial r} \right) = -\frac{\rho}{\epsilon_0} - \frac{\partial^2 \phi^{self}}{\partial z^2}$$

$$\Rightarrow \frac{\partial}{\partial r} \left( r \frac{\partial \phi}{\partial r} \right) = -\frac{r \rho(r)}{\epsilon_0} - \frac{r \partial^2 \phi^{self}}{\partial z^2}$$

$$r \frac{\partial \phi}{\partial r} = -\frac{1}{2\pi \epsilon_0} \int_0^r 2\pi r' \rho(r') dr - \frac{r^2}{2} \frac{\partial^2 \phi}{\partial z^2}$$

$$= -\frac{1}{2\pi \epsilon_0} \lambda(r) - \frac{r^2}{2} \frac{\partial^2 \phi^{self}}{\partial z^2}$$

$$\Rightarrow E_r^{self} = \frac{\lambda(r)}{2\pi \epsilon_0 r} + \frac{r}{2} \frac{\partial^2 \phi^{self}}{\partial z^2}$$

$$\nabla \times \underline{B} = \mu_0 \underline{J} \Rightarrow 2\pi r B_\theta = \mu_0 \int_0^r 2\pi r' J_z(r') dr = \mu_0 v_z \lambda(r)$$

$$B_\theta^{self} = \frac{\mu_0 v_z \lambda(r)}{2\pi r} = \frac{v_z}{c^2} \frac{\lambda(r)}{2\pi \epsilon_0 r}$$

$$\left[ \frac{V''}{2} r + E_r^{self} - v_z B_\theta^{self} \right] = \left[ \frac{r}{2} \left( V'' + \frac{\partial^2 \phi^{self}}{\partial z^2} \right) + \left( 1 - \frac{v_z^2}{c^2} \right) \frac{\lambda(r)}{2\pi \epsilon_0 r} \right]$$

$\underbrace{\hspace{10em}}_{-\frac{m c^2}{q} \gamma''} \quad \underbrace{\hspace{10em}}_{1/r^2}$

So equation (P2) becomes: "THE PARAXIAL RAY EQUATION:"

$$r'' + \frac{\gamma'}{\beta^2 \gamma} r' + \frac{\gamma''}{2\beta^2 \gamma} r + \left( \frac{\omega_c}{2\gamma\beta c} \right)^2 r - \left( \frac{p_0}{\gamma\beta mc} \right)^2 \frac{1}{r^3} - \frac{q}{\gamma^3 m v_z^2} \frac{\lambda(r)}{2\pi r} = 0$$

INERTIAL
E<sub>r</sub>  
(CONVERGENCE OF FIELD LINES)
V<sub>0</sub>B<sub>z</sub>  
- CENTRIFUGAL
CENTRIFUGAL
SELF FIELD



## ENVELOPE EQUATION FOR AXISYMMETRIC BEAMS

$$\text{LET } r_b^2 = 2 \langle r^2 \rangle = 2(\langle x^2 \rangle + \langle y^2 \rangle) = 4 \langle x^2 \rangle$$

for an  
axisymmetric  
beam

$$2r_b r_b' = 4 \langle r r' \rangle \quad \Rightarrow \quad r_b' = \frac{2 \langle r r' \rangle}{r_b}$$

$$\begin{aligned} r_b'' &= \frac{2 \langle r r'' \rangle + 2 \langle r'^2 \rangle}{r_b} - \frac{2 \langle r r' \rangle}{r_b^2} \left( \frac{2 \langle r r' \rangle}{r_b} \right) \\ &= 2 \frac{\langle r r'' \rangle}{r_b} + \frac{4 \langle r'^2 \rangle}{r_b} - 4 \frac{\langle r r' \rangle^2}{r_b^2} \end{aligned}$$

WHAT IS  $\langle r r'' \rangle$ ?

RECALL EQUATION P1 (ON PATH TO MAXWELL EQUATION):

$$r'' - r\theta'^2 + \frac{\gamma'}{\beta^2 \gamma} r' = \frac{q}{\gamma m \beta^2 c^2} \left( \frac{V''}{2} r + r \rho c \theta' B + E_r^{\text{self}} - v_e B_z^{\text{self}} \right)$$

P1 may be rewritten:

$$r'' - r\theta'^2 + \frac{\gamma'}{\beta^2 \gamma} r' = \frac{q}{\gamma m \beta^2 c^2} \left[ \frac{-mc^2 \gamma''}{9} \frac{r}{2} + \frac{\lambda(r)}{\gamma^2 2\pi \epsilon_0 r} + r \rho c \theta' B \right]$$

→

$$\boxed{r'' + \frac{\gamma'}{\beta^2 \gamma} r' + \frac{\gamma''}{2\beta^2 \gamma} r - \frac{q}{\gamma^3 m v_e^2} \frac{\lambda(r)}{2\pi \epsilon_0 r} - \frac{\omega_c}{\gamma \rho c} \theta' r - r\theta'^2 = 0}$$

What is  $\langle r r'' \rangle$ ?

$$\langle r r'' \rangle + \frac{-\omega_c}{\gamma \rho c} \langle \theta' r^2 \rangle - \langle r^2 \theta'^2 \rangle + \dots = 0$$

$$\langle p_r \rangle^2 = \gamma^2 m^2 \beta^2 c^2 \langle r^2 \theta'^2 \rangle + \frac{\omega_c^2}{4} m^2 \langle r^2 \rangle + \omega_c \gamma m^2 \beta c \langle r^2 \theta' \rangle \langle r' \rangle$$

$$\Rightarrow \frac{-\omega_c}{\gamma \rho c} \langle \theta' r^2 \rangle = \frac{-\omega_c}{\gamma \rho c} \left[ \frac{\langle p_r \rangle^2}{\omega_c \gamma m^2 \beta c \langle r^2 \rangle} - \frac{\omega_c \langle r^2 \rangle}{4 \gamma \rho c} - \frac{\gamma \rho c \langle r^2 \theta'^2 \rangle}{\omega_c \langle r^2 \rangle} \right]$$

$$\Rightarrow \langle r r'' \rangle = \frac{\langle p_r \rangle^2}{\gamma^2 m^2 \beta^2 c^2 \langle r^2 \rangle} - \frac{\omega_c^2 \langle r^2 \rangle}{4 \gamma^2 \beta^2 c^2} - \frac{\langle r^2 \theta'^2 \rangle}{\langle r^2 \rangle} + \langle r^2 \theta'^2 \rangle + \dots = 0$$

$$\Rightarrow \langle r r'' \rangle = \frac{\gamma'}{\beta^2 \gamma} \langle r r' \rangle + \frac{\gamma''}{2\beta^2 \gamma} \langle r^2 \rangle - \frac{q}{\gamma^3 m v_e^2} \frac{\langle \lambda(r) \rangle}{2\pi \epsilon_0} + \frac{\langle p_0 \rangle^2}{(\gamma m \beta c)^2 \langle r^2 \rangle} - \frac{\omega_c^2 \langle r^2 \rangle}{4(\beta^2 \beta c)^2} - \frac{\langle r^2 \theta' \rangle^2}{\langle r^2 \rangle} + \langle r^2 \theta'^2 \rangle$$

$$\begin{aligned} r_b'' &= \frac{2 \langle r r'' \rangle}{r_b} + \frac{4 \langle r^2 \rangle \langle r'^2 \rangle - 4 \langle r r' \rangle^2}{r_b^3} \\ &= \frac{\gamma'}{\beta^2 \gamma} \frac{2 \langle r r' \rangle}{r_b} + \frac{\gamma''}{2\beta^2 \gamma} \frac{2 \langle r^2 \rangle}{r_b} - \frac{2q}{\gamma^3 m v_e^2} \frac{\langle \lambda(r) \rangle}{2\pi \epsilon_0} \frac{1}{r_b} \\ &\quad + \frac{\langle p_0 \rangle^2}{(\gamma m \beta c)^2} \frac{2}{\langle r^2 \rangle r_b} - \frac{\omega_c^2}{4(\beta^2 \beta c)^2} \frac{2 \langle r^2 \rangle}{r_b} - \frac{2 \langle r^2 \theta' \rangle^2}{r_b \langle r^2 \rangle} \\ &\quad + \frac{2 \langle r^2 \theta'^2 \rangle}{r_b} + \frac{4 \langle r^2 \rangle \langle r'^2 \rangle - 4 \langle r r' \rangle^2}{r_b^3} \end{aligned}$$

Using  $r_b^2 \equiv 2 \langle r^2 \rangle$  &  $r_b' = \frac{2 \langle r r' \rangle}{r_b}$

ENVELOPE EQUATION

$$\Rightarrow \left\{ r_b'' + \frac{\gamma'}{\beta^2 \gamma} r_b' + \frac{\gamma''}{2\beta^2 \gamma} r_b + \left( \frac{\omega_c}{2\gamma \beta c} \right)^2 r_b + \frac{-4 \langle p_0 \rangle^2}{(\gamma m \beta c)^2 r_b^3} - \frac{E_r^2}{r_b^3} - \frac{Q}{r_b} = 0 \right.$$

WHERE  $E_r^2 = 4(\langle r^2 \rangle \langle r'^2 \rangle - \langle r r' \rangle^2) + \langle r^2 \rangle \langle r^2 \theta'^2 \rangle - \langle r^2 \theta' \rangle^2$



# ENVELOPE EQUATION -- CONTINUED

$$r_b'' + \frac{\gamma'}{\beta^2 \gamma} r_b' + \frac{\gamma''}{2\beta^2 \gamma} r_b + \left( \frac{\omega_c}{2\gamma\beta c} \right)^2 r_b - \frac{4\langle p_0 \rangle^2}{(m\beta c)^2} r_b^3 - \frac{E_r^2}{r_b^3} - \frac{Q}{r_b} = 0$$

COMPARE WITH THE SINGLE PARTICLE PARAXIAL RAY EQUATION:

$$r'' + \frac{\gamma'}{\beta \gamma} r' + \frac{\gamma''}{2\beta^2 \gamma} r + \left( \frac{\omega_c}{2\gamma\beta c} \right)^2 r - \left( \frac{p_0}{\gamma m \beta c} \right)^2 \frac{1}{r^3} - \frac{q}{\gamma^3 m v_z^2} \frac{\lambda(r)}{2\pi \epsilon_0 r} = 0$$

INITIAL
 $E_r$ 
 $v_0 B_z$  - CENTRIFUGAL
CENTRIFUGAL
 $E_r - v_z B_0$  self field

$$E_r^2 = 4(\langle v^2 \rangle \langle v'^2 \rangle - \langle r r' \rangle^2 + \langle v^2 \rangle \langle v'^2 \theta'^2 \rangle - \langle r^2 \theta'^2 \rangle)$$

NOTE THAT FOR AXISYMMETRIC BEAMS ( $\rho = \rho(r)$  ONLY)

$$\langle v^2 \rangle = \langle x^2 \rangle + \langle y^2 \rangle = 2\langle x^2 \rangle$$

$$\Rightarrow 2\langle r r' \rangle = 4\langle x x' \rangle$$

$$\& \langle x'^2 \rangle + \langle y'^2 \rangle = 2\langle x'^2 \rangle = \langle v'^2 \rangle + \langle r'^2 \theta'^2 \rangle$$

DEFINE  $E_x^2 = 16(\langle x^2 \rangle \langle y'^2 \rangle - \langle x x' \rangle^2)$

$$\Rightarrow \boxed{E_r^2 = E_x^2 - 4\langle r^2 \theta'^2 \rangle}$$

## EXAMPLES OF SYSTEMS WITH AXIAL SYMMETRY

- PERIODIC SOLENOIDS
- EINZEL LENSES
- CONTINUOUS FOCUSING

## EXAMPLES OF SYSTEMS WITHOUT AXIAL SYMMETRY

- ELECTRIC OR MAGNETIC QUADRUPOLE
- ⇒ USE CARTESIAN COORDINATES WITH  
ELLIPTICAL SPACE CHARGE SYMMETRY

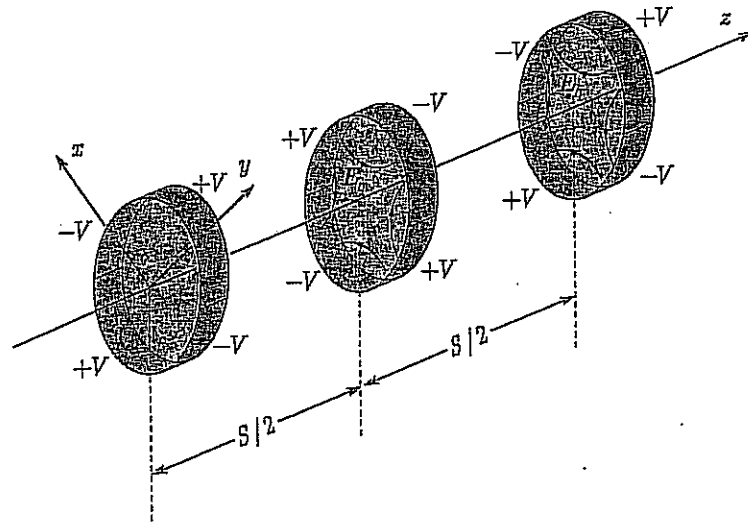

Figure 3.3. Schematic of conductor configuration with applied voltages producing an alternating-gradient quadrupole electric field with axial periodicity length  $S$ .

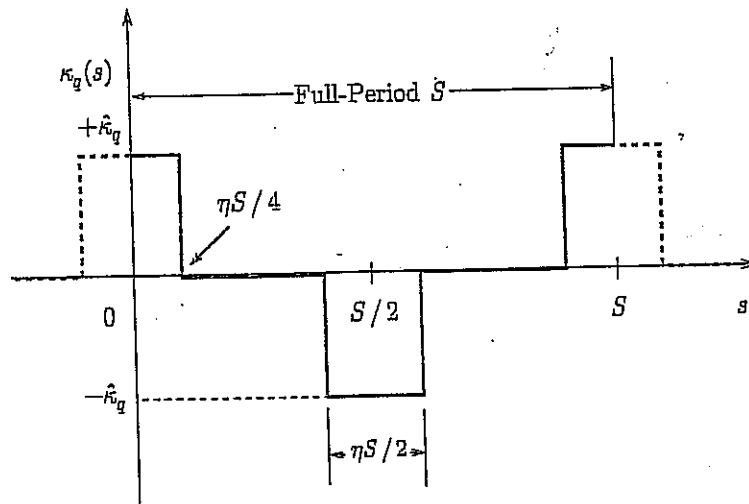

Figure 3.7. Alternating step-function model of a periodic quadrupole lattice with filling factor  $\eta$  for the lens elements. The figure shows a plot of the quadrupole coupling coefficient  $\kappa_q(s)$  versus  $s$  for one full period ( $S$ ) of the lattice. Such a configuration is often called a FODO transport lattice (acronym for focusing-off-defocusing-off).

FIGURES FROM DAVIDSON & QIM, 2003

figure from  
Davidson & Qin, 2003.

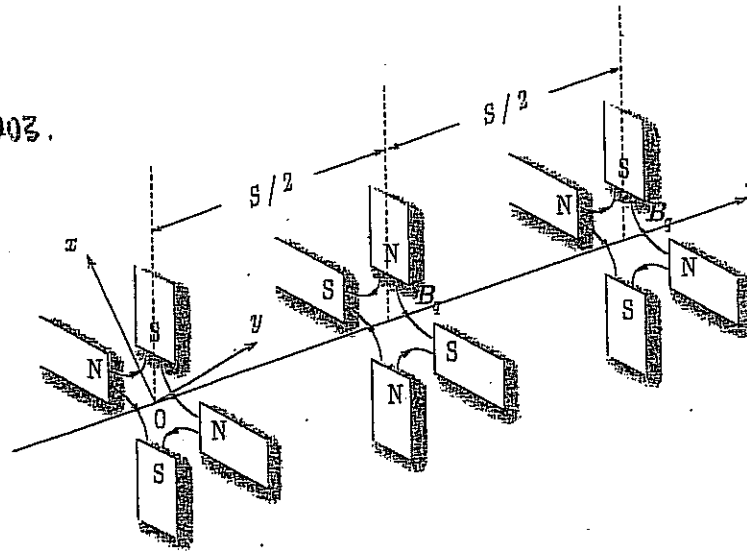

Figure 3.1. Schematic of magnet sets producing an alternating-gradient quadrupole field with axial periodicity length  $S$ .

J. BARWIND

(13)

2 ≡ BEAM OPTICS AND FOCUSING SYSTEMS WITHOUT SPACE CH

FROM REISER, p. 112

$$E_x = -E'x$$

$$E_y = E'y$$

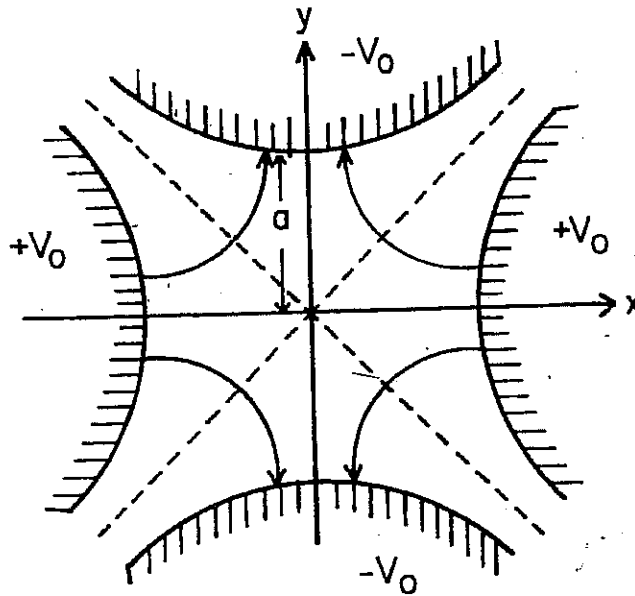

$$F_x = -qE'x$$

$$F_y = qE'y$$

ELECTROSTATIC QUADS

Figure 3.15. Electrodes and force lines in an electrostatic quadrupole.

$$B_x = B'y$$

$$B_y = B'x$$

$$F_x = -qV_z B'x$$

$$F_y = qV_x B'y$$

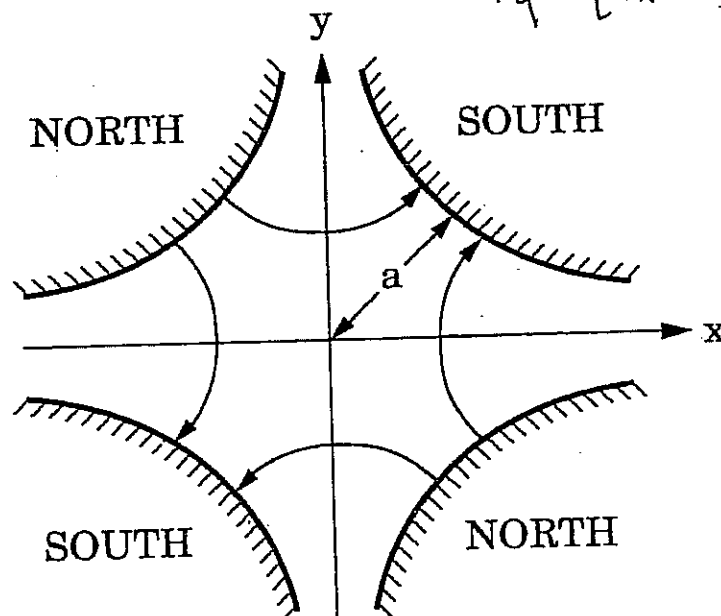

MAGNETIC QUADS

# QUADRUPOLE FOCUSING

Now, relax radial symmetry:

For  $\nabla \cdot E = 0$  or  $\nabla \times B = 0$

EXPAND FIELD IN CYLINDRICAL "MULTIPOLES":

$$E_r, B_r = \sum_{n=1}^{\infty} f_n r^{n-1} \cos(n\theta)$$

$$E_\theta, B_\theta = \sum_{n=1}^{\infty} f_n r^{n-1} \sin(n\theta)$$

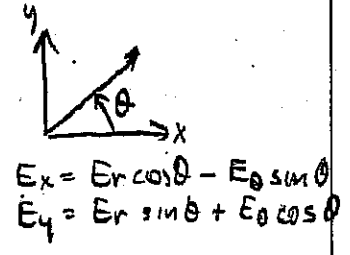

$n=1 \Rightarrow$  dipole  $\begin{cases} E_r = f_1 \cos \theta \\ E_\theta = -f_1 \sin \theta \end{cases} \Rightarrow \begin{cases} E_x = f_1 \\ E_y = 0 \end{cases}$

$n=2 \Rightarrow$  quadrupole  $\begin{cases} E_r = f_2 r \cos 2\theta \\ E_\theta = -f_2 r \sin 2\theta \end{cases} \Rightarrow \begin{cases} E_x = f_2 x \\ E_y = -f_2 y \end{cases}$

NOTE: ABOVE EXPANSION IS VALID WHEN  $E$  OR  $B \neq$  function( $z$ ).  
 FOR MAGNETS OF FINITE AXIAL EXTENT, FOR EACH FUNDAMENTAL  $n$ -pole, A SET OF HIGHER ORDER MULTIPOLES WITH SAME AZIMUTHAL SYMMETRY ARE REQUIRED TO SATISFY  $\nabla^2 \phi = 0$ .

FOR EXAMPLE FOR A FUNDAMENTAL QUADRUPOLE THE FIELD MAY BE EXPLAINED:

$$E_r = \sum_{\nu=0}^{\infty} f_{2,\nu}(z) [1+\nu] r^{1+2\nu} \cos[2\nu\theta]$$

$$E_\theta = \sum_{\nu=0}^{\infty} -f_{2,\nu}(z) r^{1+2\nu} \sin[2\nu\theta]$$

$$E_z = \sum_{\nu=0}^{\infty} \frac{1}{2} \frac{df_{2,\nu}}{dz} r^{2+2\nu} \cos 2\nu\theta$$

with  $f_{2,\nu+1}(z) = \frac{-1}{4(\nu+1)(\nu+3)} \frac{d^2 f_{2,\nu}}{dz^2}(z)$

SEE LUND, S. M. (1996)  
 FOR EXAMPLE. HIF note 9(1)  
 LNL.

Heavy ion accelerators use alternating gradient quadrupoles to focus (confine) the beams (non-neutral plasmas)



Space-charge forces and thermal forces act to expand beam

Quadrupoles (magnetic or electric):

- alternately provide inward then outward impulse
- focus in one plane and defocus in other
- act as linear lenses. (Force proportional to distance from axis).

Horizontal (x) plane:

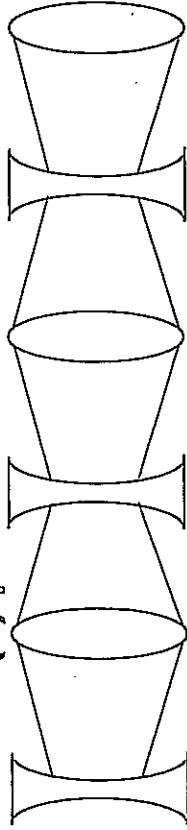

Vertical (y) plane:

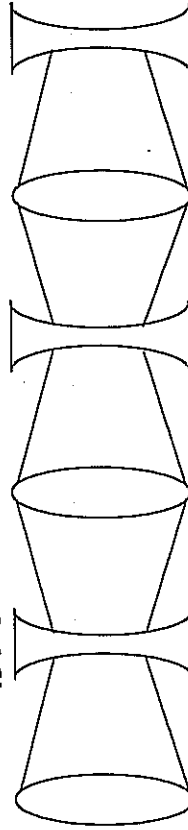

Average displacement is larger in focusing lenses so the net effect is focusing.

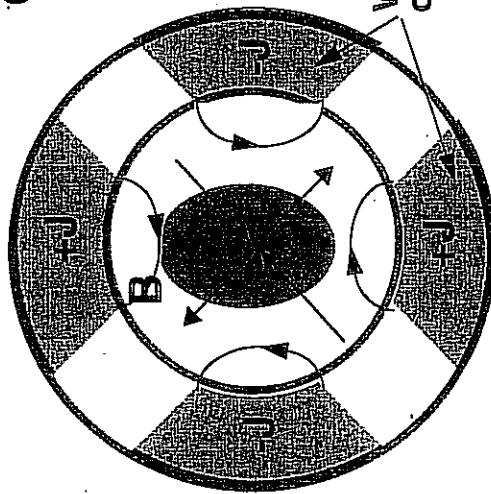

Magnetic quad

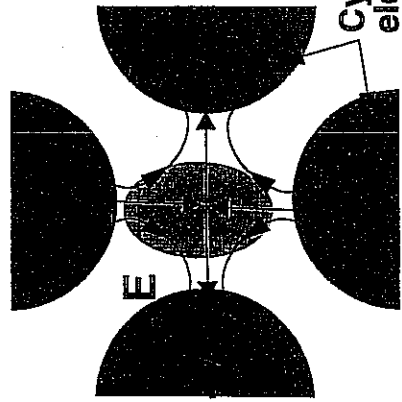

Electric quad

# Space charge reduces betatron phase advance

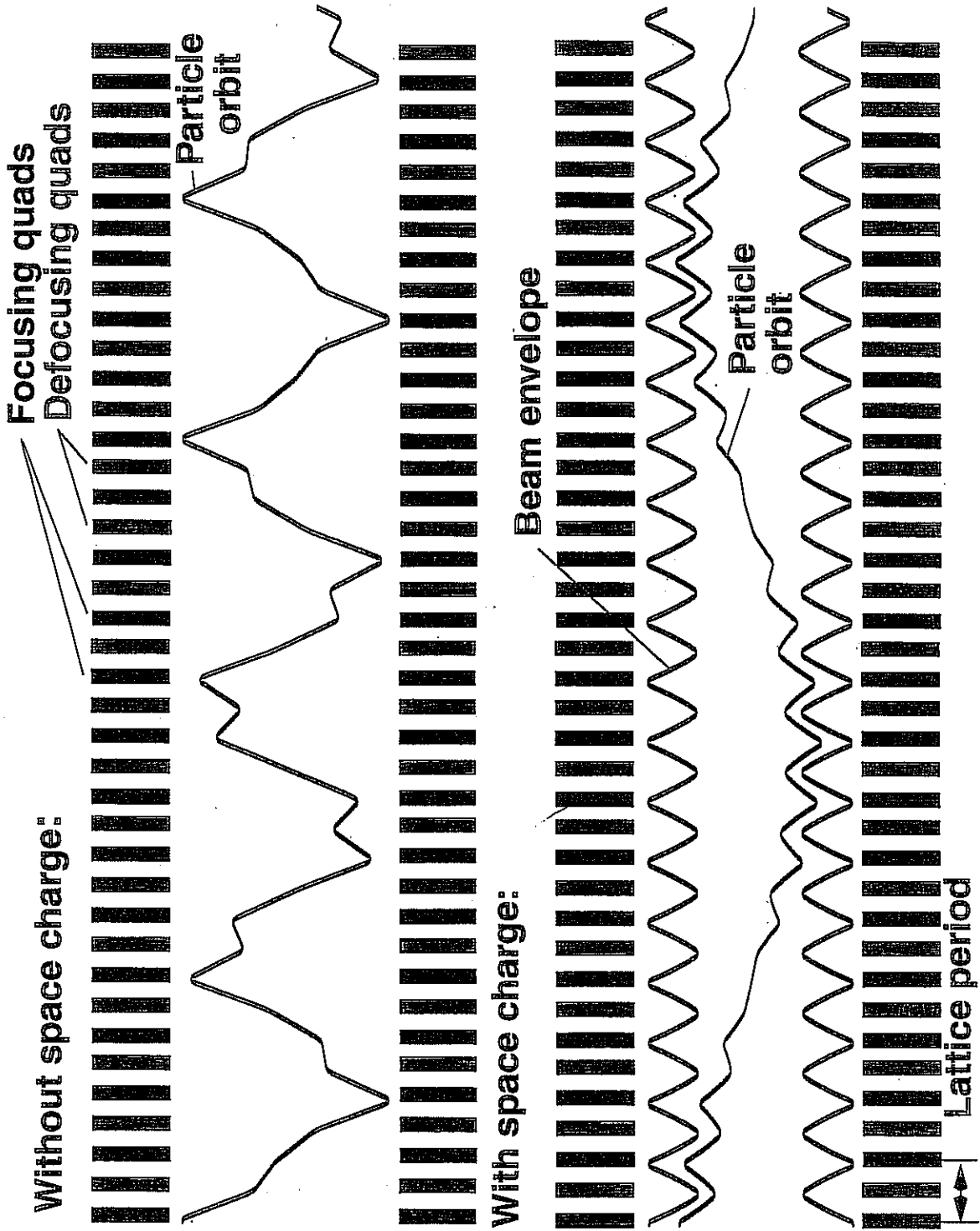

J. BALNARD (C)  
(17)



John Barnard  
Steven Lund  
USPAS  
June 2008

## Current limits

- A. Axisymmetric
  - 1. Solenoids
  - 2. Einzel lens
- B. Quadrupolar
  - 1. Derivation of envelope equations with elliptic symmetry
  - 2. Current limit using fourier transform method

DEVELOPED  
 YESTERDAY WE DERIVED THE PARAXIAL RAY EQUATION FOR PARTICLES IN  
 AXISYMMETRIC SYSTEMS:

$$r'' + \underbrace{\frac{\gamma'}{\beta^2 \gamma}}_{\text{INERTIAL}} r' + \underbrace{\frac{\gamma''}{2\beta^2 \gamma}}_{E_n} r + \underbrace{\left(\frac{\omega_c}{2\gamma\beta c}\right)^2}_{V_0 B_E - \text{CENTRIFUGAL}} r - \underbrace{\left(\frac{p_0}{\gamma\beta m c}\right)^2 \frac{1}{r^3}}_{\text{CENTRIFUGAL}} - \underbrace{\frac{q}{\gamma^3 \beta^3 v_z^2} \frac{\lambda(r)}{2\pi r}}_{\text{SELF-FIELD}} = 0$$

$$\theta' = \frac{p_0}{\gamma m v_z^2 \beta c} - \frac{\omega_c}{2\gamma\beta c} \leftarrow \text{CONSTANCY \& DEFINITION OF CANONICAL MOMENTUM}$$

ENVELOPE EQUATION FOR AXISYMMETRIC BEAM

$$r_b'' + \frac{\gamma' r_b'}{\beta^2 \gamma} + \frac{\gamma''}{2\beta^2 \gamma} r_b + \left(\frac{\omega_c}{2\gamma\beta c}\right)^2 r_b - \frac{4 \langle K_n \rangle^2}{(\gamma\beta m c)^2 r_b^3} - \frac{E_n^2}{\gamma_b^3} - \frac{Q}{r_b} = 0$$

$$E_n^2 \equiv 4(\langle n^2 \rangle \langle r_b^2 \rangle - \langle r_b n \rangle^2) + \langle n^2 \rangle \langle n^2 \theta'^2 \rangle - \langle r_b^2 \theta'^2 \rangle$$

### Periodic Einzel lenses

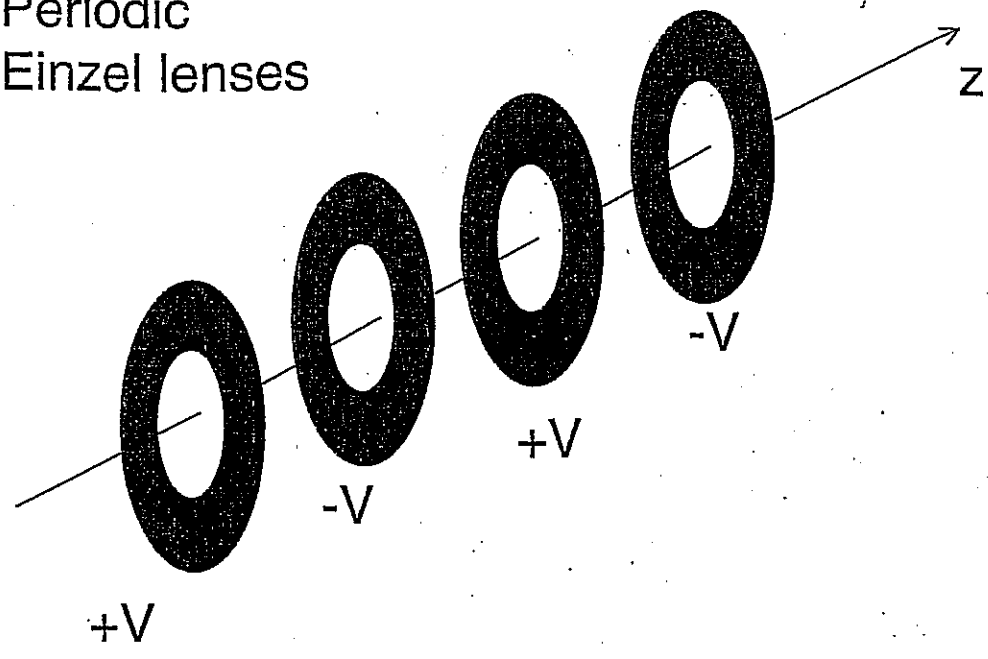

### PERIODIC SOLENOIDS

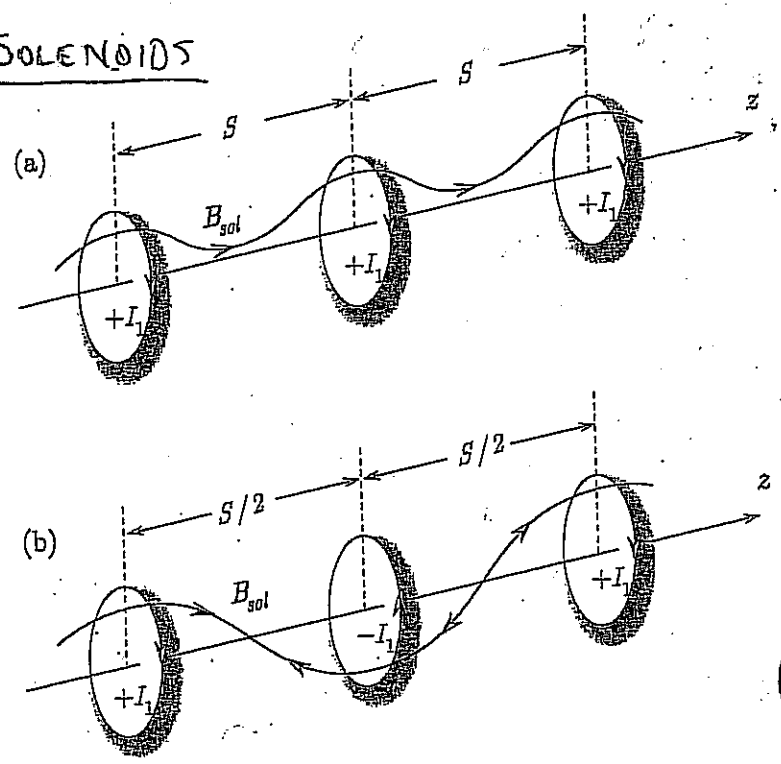
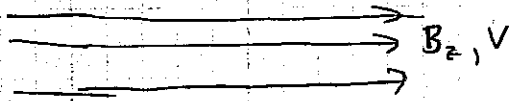

Figure 3.2. Schematic of magnet sets producing a periodic focusing solenoidal field with axial periodicity length  $S$ . In Fig. 3.2 (a), successive coils are spaced by  $S$  and have the same current polarity  $+I_1, +I_1, \dots$ . In Fig. 3.2 (b), successive coils are spaced by  $S/2$  and have alternating current polarities  $+I_1, -I_1, +I_1, \dots$ .

(FIGURE FROM DAVIDSON & QIN, 2003) P. 55  
 "PHYSICS OF INTENSE CHARGED PARTICLE BEAMS IN HIGH ENERGY ACCELERATORS"



# SOLENOIDAL FOCUSING



Let  $\gamma' = \gamma'' = 0$

FOR MAXIMUM TRANSPORT  $P_0 = 0$  &  $E_r^z = 0$

$$\Rightarrow r_b'' + \left(\frac{\omega_c}{2\gamma\beta c}\right)^2 r_b = \frac{Q}{r_b}$$

FOR A MATCHED BEAM:

$$Q_{max} = \left(\frac{\omega_c}{2\gamma\beta c}\right)^2 r_b^2$$

HEURISTICALLY:

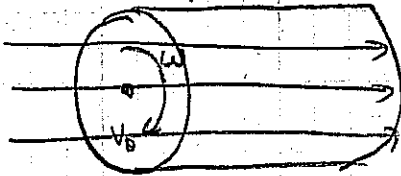

$v_0 = \omega r$

$$m\omega^2 r + Qm v_0^2 \left(\frac{r}{r_b^2}\right) = q \frac{\omega r}{v_0} B$$

↑  
centrifugal force

↑  
SPACE CHARGE FORCES

↑  
MAGNETIC FORCE INWARD

$$\Rightarrow \omega^2 + \frac{Qv^2}{r_b^2} = \omega\omega_c$$

$\omega\omega_c - \omega^2 = \text{MAXIMUM WHEN } \omega = \frac{\omega_c}{2}$

$$\Rightarrow Q_{max} = \left(\frac{\omega_c^2}{4}\right) \left(\frac{r_b^2}{v^2}\right)$$

50 SHEETS FILLED 5 SQUARE  
 50 SHEETS FILLED 5 SQUARE  
 100 SHEETS FILLED 5 SQUARE  
 40 SHEETS FILLED 5 SQUARE  
 20 SHEETS FILLED 5 SQUARE  
 20 RECYCLED WHITE 5 SQUARE  
 MADE IN U.S.A.



# SOLENOIDAL FOCUSING - CONTINUED

IN REALITY BEAM ACQUIRES  $v_{\theta}$  AS BEAM ENTERS SOLENOID:

CONSIDER SIMPLE STEP FUNCTION APPROXIMATION TO SOLENOID FIELD:

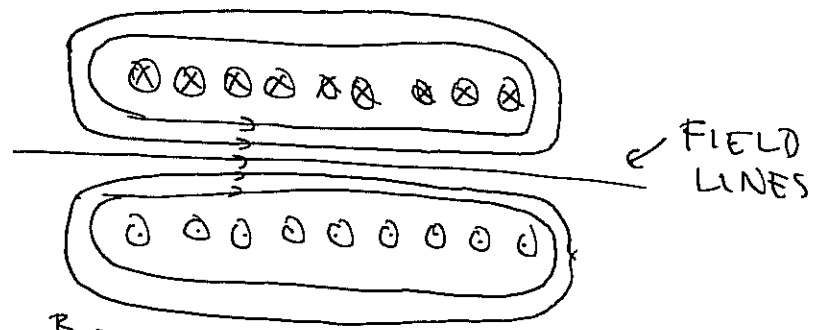

LET  $B_z = B_0 \left[ \Theta(z) + \Theta(l_m - z) - 1 \right] = \begin{cases} 0 & z < 0 \\ B_0 & 0 < z < l_m \\ 0 & z \geq l_m \end{cases}$

$\frac{\partial B_z}{\partial z} = B_0 [\delta(z) + \delta(l_m - z)]$

MEM  $\Theta(z) = \begin{cases} 1 & z > 0 \\ 0 & z < 0 \end{cases}$

As we found earlier  $\nabla \cdot B = 0 \Rightarrow$

$B_r(r, z) \approx -\frac{r}{z} \frac{\partial B_z}{\partial z} + \dots = -\frac{r}{z} B_0 [\delta(z) + \delta(l_m - z)]$

$\Delta p_{\theta}^* = q \int v_z B_r dt = \int_{-\infty}^{0+t} q B_r dz = -nq \frac{B_0}{z}$

$\Rightarrow v_{\theta} = r \frac{q B_0}{2m} = \frac{r \omega_c}{z}$

# FINZEL LENS

J. BARNARD

(5)

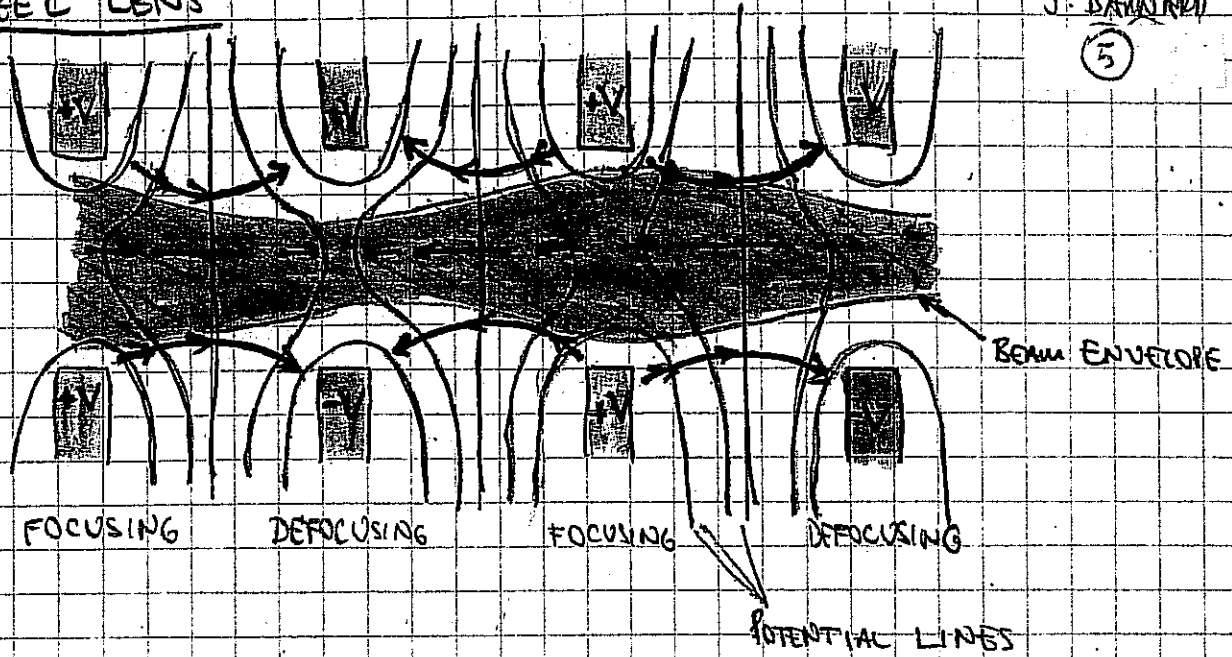

FOCUSING OCCURS AT LARGE RADII THAN DEFOCUSING

⇒ NET INWARD FORCE

EINZEL LENS - ANALYSIS (DERIVATION FROM ED LEE)

$$\text{NOW, LET } \omega_c = \langle p_0 \rangle = E_r^2 = 0$$

$$\Rightarrow r_b'' + \frac{\gamma'}{\beta^2 \gamma} r_b' + \frac{\gamma''}{2\beta^2 \gamma} r_b - \frac{Q}{r_b} = 0$$

ALSO ASSUME  $\beta \ll 1$ , NON-RELATIVISTIC BEAM  $\rightarrow \gamma' \approx \beta \beta'$   
 $\gamma'' \approx \beta'^2 + \beta'' \beta$

$$r_b'' + \frac{\beta'}{\beta} r_b' + \left[ \frac{1}{2} \frac{\beta'^2}{\beta^2} + \frac{1}{2} \frac{\beta''}{\beta} \right] r_b - \frac{Q}{r_b} = 0$$

To eliminate  $r_b'$  term try substitution

$$r_b = \left( \frac{\beta_0}{\beta} \right)^{1/2} R$$

$$r_b' = \left( \frac{\beta_0}{\beta} \right)^{1/2} R' - \frac{1}{2} \left( \frac{\beta}{\beta_0} \right)^{-3/2} R \beta'$$

$$r_b'' = \left( \frac{\beta_0}{\beta} \right)^{1/2} R'' - \left( \frac{\beta}{\beta_0} \right)^{-3/2} R' \beta' + \frac{3}{4} \left( \frac{\beta}{\beta_0} \right)^{-5/2} R \beta'^2 - \frac{1}{2} \left( \frac{\beta}{\beta_0} \right)^{-3/2} R \beta''$$

$$\Rightarrow \left( \frac{\beta_0}{\beta} \right)^{1/2} R'' + \frac{3}{4} \left( \frac{\beta}{\beta_0} \right)^{-5/2} \frac{\beta'^2}{\beta^2} R = \frac{Q}{R} \left( \frac{\beta}{\beta_0} \right)^{1/2}$$

$$\Rightarrow \boxed{R'' = \frac{Q}{R} \left( \frac{\beta}{\beta_0} \right) - \frac{3}{4} \left( \frac{\beta'}{\beta} \right)^2 R}$$

EINZEL LENS - CONTINUUM

MODEL: LET  $\phi = \phi_0 \cos\left(\frac{\pi z}{L}\right)$

$$\frac{1}{2} m v^2 + q \phi = \text{constant}$$

$$\Rightarrow v^2 = v_0^2 + \frac{2q\phi}{m} \cos\left(\frac{\pi z}{L}\right)$$

$$v' = -\frac{q\phi_0}{m v} \left(\frac{\pi}{L}\right) \sin\left(\frac{\pi z}{L}\right)$$

IF  $\left(\frac{2q\phi_0}{m}\right) \ll v_0^2$ :  $\left(\frac{\beta'}{\beta}\right)^2 \approx \left(\frac{q\phi_0}{m v_0^2}\right)^2 \left(\frac{\pi}{L}\right)^2 \sin^2\left(\frac{\pi z}{L}\right)$

FOR EQUILIBRIUM LOOK AT D.C. COMPONENT:  $\sin^2(kz) = \frac{1}{2} - \frac{1}{2} \cos 2z$

$$R R'' = 0 \Rightarrow \frac{Q}{R} = \frac{3}{4} \left(\frac{\beta'}{\beta}\right)^2 R$$

$$R \bar{E} \left(\frac{\beta'}{\beta_0}\right)^{1/2} r_b \Rightarrow \bar{R} = r_b$$

$$\left(\frac{\beta'}{\beta}\right)^2 = \frac{1}{2} \left(\frac{q\phi_0}{m v_0^2}\right)^2 \left(\frac{\pi}{L}\right)^2$$

$$\Rightarrow Q_{\max} = \frac{3\pi^2}{8} \left(\frac{q\phi_0}{m v_0^2}\right)^2 \left(\frac{r_b}{L}\right)^2$$



BEAM OPTICS AND FOCUSING SYSTEMS WITHOUT SPACE CH

FROM  
 REISEL, p.112

$$E_x = -E'x$$

$$E_y = E'y$$

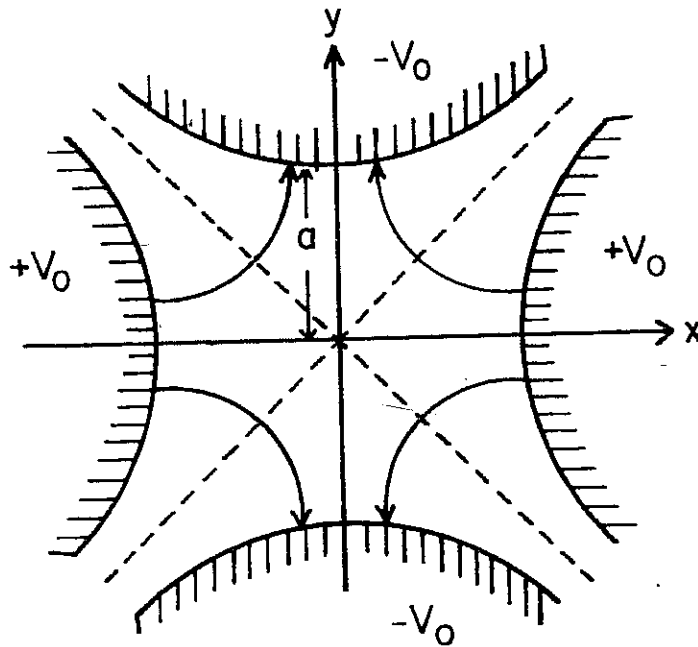

$$F_x = -qE'x$$

$$F_y = qE'y$$

ELECTROSTATIC  
 QUADS

Figure 3.15. Electrodes and force lines in an electrostatic quadrupole.

$$B_x = B'y$$

$$B_y = B'x$$

$$F_x = -qV_z B'x$$

$$F_y = qV_z B'y$$

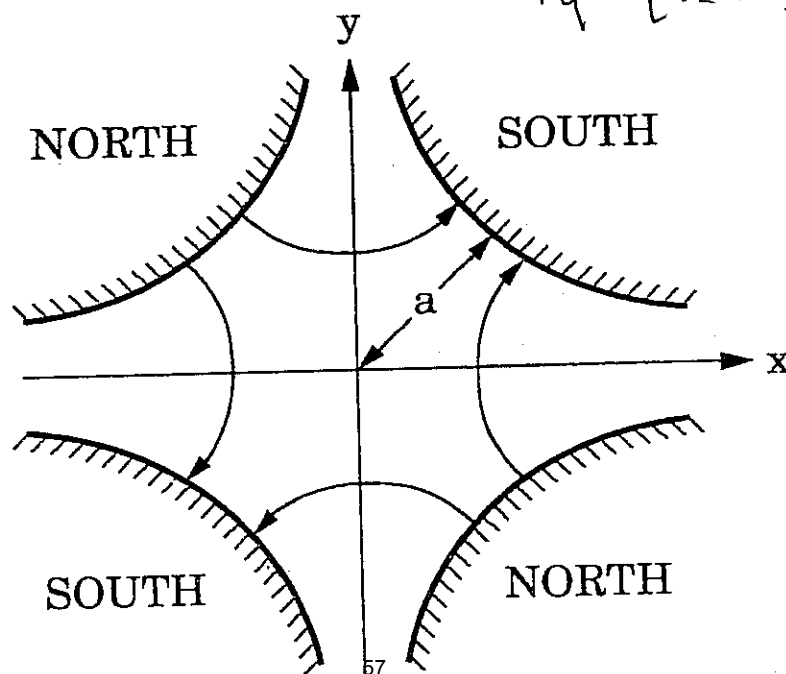

MAGNETIC  
 QUADS

EQUATION OF MOTION

RETURN TO X, Y COORDINATES

$$x'' + \frac{1}{\gamma v_z} \frac{d}{ds} (\gamma v_z) x' = \frac{-q}{\gamma^3 m v_z^2} \frac{\partial \phi}{\partial x} \pm \begin{cases} \frac{q B'}{\gamma m v_z^2} x & \text{for magnetic quadrupoles} \\ \frac{q E'}{\gamma m v_z^2} x & \text{for electric quadrupoles} \end{cases}$$

Let  $\frac{\gamma m v_z}{q} = \frac{p}{q} \equiv [B'] \equiv \text{RIGIDITY}$

$$y'' + \frac{1}{\gamma v_z} \frac{d}{ds} (\gamma v_z) y' = \frac{-q}{\gamma^3 m v_z^2} \frac{\partial \phi}{\partial y} \mp \begin{cases} \frac{B'}{[B']} y & \text{magnetic} \\ \frac{q E'}{\gamma m v_z^2} y & \text{electric} \end{cases}$$

ENVELOPE EQUATION

$$r_x^2 = 4 \langle x^2 \rangle; \quad r_y^2 = 4 \langle y^2 \rangle$$

$$r_x' = \frac{4 \langle x x' \rangle}{r_x}$$

$$r_x'' = \frac{4 \langle x x'' \rangle}{r_x} + \frac{E_x^2}{\gamma_x^3}; \quad E_x^2 = 16 (\langle x^2 \rangle \langle x'^2 \rangle - \langle x x' \rangle^2)$$

$$r_y'' = \frac{4 \langle y y'' \rangle}{r_y} + \frac{E_y^2}{\gamma_y^3}; \quad E_y^2 = 16 (\langle y^2 \rangle \langle y'^2 \rangle - \langle y y' \rangle^2)$$

for magnetic focusing:

$$r_x'' + \frac{1}{\gamma v_z} \frac{d}{ds} (\gamma v_z) r_x' + \frac{4q}{\gamma^3 m v_z^2} \frac{\langle x \frac{\partial \phi}{\partial x} \rangle}{r_x} \mp \frac{B'}{[B']} r_x - \frac{E_x^2}{\gamma_x^3} = 0$$

$$r_y'' + \frac{1}{\gamma v_z} \frac{d}{ds} (\gamma v_z) r_y' + \frac{4q}{\gamma^3 m v_z^2} \frac{\langle y \frac{\partial \phi}{\partial y} \rangle}{r_y} \pm \frac{B'}{[B']} r_y - \frac{E_y^2}{\gamma_y^3} = 0$$

(for electric focusing  $\frac{B'}{[B']} \rightarrow \frac{q E'}{\gamma m v_z^2}$ )

SPACE CHARGE TERM WITH ELLIPTICAL SYMMETRY

#4: ELLIPTICAL SYMMETRY:  $\rho = \rho \left( \frac{x^2}{a^2} + \frac{y^2}{b^2} \right)$

CAN BE SHOWN THAT  $\langle x \frac{\partial \phi}{\partial x} \rangle = \frac{-\lambda}{4\pi\epsilon_0} \frac{a^2}{v_x + v_y}$

$\langle y \frac{\partial \phi}{\partial y} \rangle = \frac{-\lambda}{4\pi\epsilon_0} \frac{b^2}{v_x + v_y}$

DEFINING  $Q = \frac{2q\lambda}{4\pi\epsilon_0 \gamma^3 m v_z^2}$

$$v_x'' = \frac{1}{\gamma v_z^2} \frac{d}{ds} (\gamma v_z) v_x' = \frac{2Q}{v_x + v_y} = \frac{B'}{[B_0]} v_x - \frac{v_x'^2}{v_x + v_y} = 0$$

$$v_y'' + \frac{1}{\gamma v_z^2} \frac{d}{ds} (\gamma v_z) v_y' - \frac{2Q}{v_x + v_y} = \frac{B'}{[B_0]} v_y - \frac{v_y'^2}{v_x + v_y}$$

(for Electric Focusing  $\frac{B'}{[B_0]} = \frac{qE'}{m\gamma^3 v_z^2}$ )

# SPACE CHARGE TERN WITH ELLIPTICAL SYMMETRY II

J. BARONAD

(10)

ELLIPTICAL SYMMETRY:

$$\rho = \rho \left( \frac{x^2}{r_x^2} + \frac{y^2}{r_y^2} \right)$$

CAN BE SHOWN THAT  
(Sacherer, 1971)

$$\left\langle x \frac{\partial \phi}{\partial x} \right\rangle = \frac{-\lambda}{4\pi\epsilon_0} \frac{r_x}{r_x + r_y}$$

$$\left\langle y \frac{\partial \phi}{\partial y} \right\rangle = \frac{-\lambda}{4\pi\epsilon_0} \frac{r_y}{r_x + r_y}$$

OUTLINE OF PROOF: (From R. Ryne)

$$\text{Let } \chi = \frac{x^2}{r_x^2 + s} + \frac{y^2}{r_y^2 + s}$$

$$\text{DEFINE } \eta(\chi) \text{ such that } \rho(x, y) = \frac{d\eta(\chi)}{d\chi} \Big|_{s=0} = \hat{\rho}(\chi) \Big|_{s=0}$$

$$\text{So } \rho = \hat{\rho} \left( \frac{x^2}{r_x^2} + \frac{y^2}{r_y^2} \right) = \hat{\rho}(\chi) \Big|_{s=0}$$

$$\text{DEFINE } \Phi(x, y) = \frac{-r_x r_y}{4\epsilon_0} \int_0^\infty \frac{\eta(\chi) ds}{\sqrt{r_x^2 + s} \sqrt{r_y^2 + s}}$$

It follows that  $\frac{\partial^2 \Phi}{\partial x^2} + \frac{\partial^2 \Phi}{\partial y^2} = -\frac{\rho}{\epsilon_0}$  AND SO IT A SOLUTION OF POISSON'S EQUATION (since  $\Phi \rightarrow 0$  as  $x, y \rightarrow \infty$ )

WHAT IS  $\left\langle x \frac{\partial \phi}{\partial x} \right\rangle$ ?

$$\left\langle x \frac{\partial \phi}{\partial x} \right\rangle = \frac{-r_x r_y}{4\lambda \epsilon_0} \int_{-\infty}^{\infty} dx \int_{-\infty}^{\infty} dy \times \rho(x, y) \int_0^\infty \frac{\eta' \frac{\partial \chi}{\partial x} ds}{\sqrt{r_x^2 + s} \sqrt{r_y^2 + s}}$$

$$\text{where } \lambda = \int_{-\infty}^{\infty} dx \int_{-\infty}^{\infty} dy \rho(x, y)$$

So  $\langle x \frac{\partial \phi}{\partial x} \rangle = \frac{-2v_x v_y}{4\lambda \epsilon_0} \int_{-\infty}^{\infty} dx \int_{-\infty}^{\infty} dy x^2 \rho \left( \frac{x^2}{v_x^2} + \frac{y^2}{v_y^2} \right) \int_0^{\infty} \frac{\rho \left( \frac{x^2}{v_x^2 + s} + \frac{y^2}{v_y^2 + s} \right) ds}{(v_x^2 + s)^{3/2} (v_y^2 + s)^{3/2}}$

Let  $r \cos \theta = \frac{x}{\sqrt{v_x^2 + s}}$        $r \sin \theta = \frac{y}{\sqrt{v_y^2 + s}}$

det J =  $\sqrt{v_x^2 + s} \sqrt{v_y^2 + s} r$       where J is the Jacobian  
 $dx dy = \det J \cdot dr d\theta$

$\Rightarrow \langle x \frac{\partial \phi}{\partial x} \rangle = \frac{-2v_x v_y}{\lambda 2 \epsilon_0} \int_0^{\infty} ds \int_0^{2\pi} d\theta \int_0^{\infty} dr r^3 \rho(r^2) \rho \left( \frac{r^2 \cos^2 \theta}{v_x^2 + s} + \frac{r^2 \sin^2 \theta}{v_y^2 + s} \right) \cos^2 \theta$

Let  $r'^2 = \frac{v_x^2 + s}{v_x^2} r^2 \cos^2 \theta + \frac{v_y^2 + s}{v_y^2} r^2 \sin^2 \theta$   
 $= r^2 \left[ 1 + s \left( \frac{\cos^2 \theta}{v_x^2} + \frac{\sin^2 \theta}{v_y^2} \right) \right]$

with r fixed  $2r' dr' = r^2 \left( \frac{\cos^2 \theta}{v_x^2} + \frac{\sin^2 \theta}{v_y^2} \right) ds$

$\Rightarrow \langle x \frac{\partial \phi}{\partial x} \rangle = \frac{-v_x v_y}{2\lambda \epsilon_0} \int_0^{\infty} ds \int_0^{2\pi} d\theta \int_r^{\infty} dr' \frac{2r' dr' r^3 \rho(r^2) \rho(r'^2) \cos^2 \theta}{r^2 \left( \frac{\cos^2 \theta}{v_x^2} + \frac{\sin^2 \theta}{v_y^2} \right)}$

$\int_0^{2\pi} \frac{\cos^2 \theta d\theta}{\frac{\cos^2 \theta}{v_x^2} + \frac{\sin^2 \theta}{v_y^2}} = \frac{2\pi v_x^2 v_y}{v_x + v_y}$

$\Rightarrow \langle x \frac{\partial \phi}{\partial x} \rangle = \frac{-v_x^3 v_y}{\lambda 2\pi \epsilon_0 (v_x + v_y)} \int_0^{\infty} dr 2\pi r \rho(r^2) \int_r^{\infty} dr' 2\pi r' \rho(r'^2)$

Recall  $\lambda = \iint_{-\infty}^{\infty} dx dy \rho(x, y) = \iint_{-\infty}^{\infty} dx dy \rho \left( \frac{x^2}{v_x^2} + \frac{y^2}{v_y^2} \right)$

Let  $\frac{x}{v_x} = r \cos \theta$        $\frac{y}{v_y} = r \sin \theta$       det J =  $v_x v_y r$   
 $\Rightarrow \lambda = \int_0^{\infty} \int_0^{2\pi} \rho(r^2) v_x v_y r dr d\theta = 2\pi v_x v_y \int_0^{\infty} dr r \rho(r^2)$

Now  $\int_0^\infty dr r \rho(r^2) \int_0^\infty dr' r' \rho(r'^2) = \frac{1}{2} \int_0^\infty dr r \rho(r^2) \int_0^\infty dr' r' \rho(r'^2)$

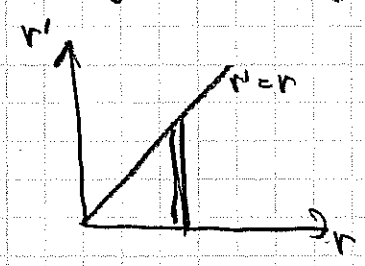

(By symmetry & consideration of diagram at left.)

$$\Rightarrow \left\langle x \frac{\partial \psi}{\partial x} \right\rangle = \frac{-\lambda}{4\pi E_0} \frac{r_x}{r_x + r_y}$$

# CURRENT LIMIT FOR QUADRUPOLES

$\frac{1}{2} \frac{d}{ds}$

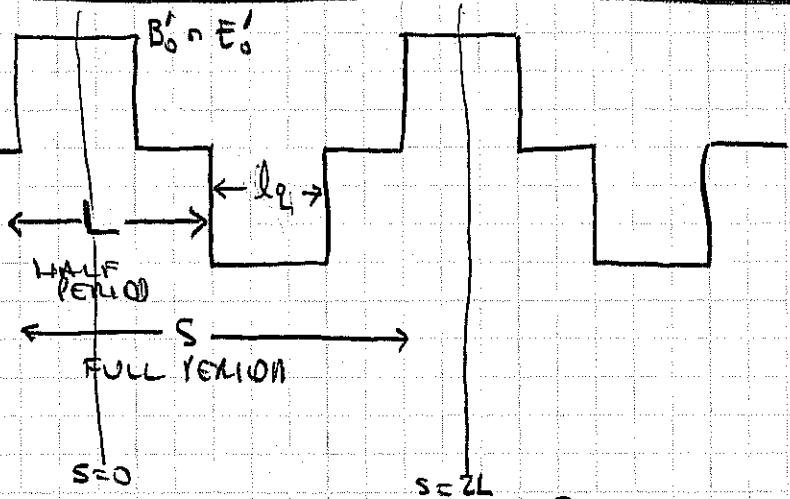

$$k = \begin{cases} \frac{B'_0}{CB(\beta)} & \text{MAGNETIC} \\ \frac{qE'_0}{\gamma m v^2} & \text{ELECTRIC} \end{cases}$$

$$r_x'' + k f(s) r_x - \frac{2Q}{r_x + r_y} = 0$$

(NOTE WE HAVE SET  $\epsilon = 0$ ).

$$r_y'' - k f(s) r_y - \frac{2Q}{r_x + r_y} = 0$$

$$f(s) = \begin{cases} 1 & 0 < s < \eta L/2 \\ -1 & L - \eta L/2 < s < L + \eta L/2 \\ 1 & 2L - \eta L/2 < s < 2L \\ 0 & \text{otherwise} \end{cases}$$

$$\frac{1}{L} \int_0^{2L} f(s) \cos\left(\frac{\pi s}{L}\right) ds = \left(\frac{4}{\pi}\right) \sin\left(\frac{\eta \pi}{2}\right) = \text{fourier amplitude at fundamental lattice frequency}$$

$$\text{Let } r_x = r_b \left(1 + \delta \cos\left(\frac{\pi s}{L}\right)\right)$$

$$r_y = r_b \left(1 - \delta \cos\left(\frac{\pi s}{L}\right)\right)$$

$$\text{Let } k f(s) \rightarrow k \left(\frac{4}{\pi}\right) \sin\left(\frac{\eta \pi}{2}\right) \cos\left(\frac{\pi s}{L}\right)$$

COLLECTING "FAST" TERMS AND "SLOW" TERMS

$$\left[ -\frac{\pi^2}{L^2} r_b \delta + k r_b \left(\frac{4 \sin(\frac{\eta \pi}{2})}{\pi}\right) \right] \cos\left(\frac{\pi s}{L}\right) = 0 \quad (\text{fast})$$

$$\delta k r_b \left(\frac{2 \sin(\frac{\eta \pi}{2})}{\pi}\right) = \frac{Q}{r_b} \quad (\text{slow})$$

$$\text{Fast} \Rightarrow \delta = \frac{4kL^2}{\pi^3} \sin\left(\frac{\eta \pi}{2}\right) \quad \& \quad Q_{\text{max}} \approx \frac{2\eta^2 k^2 L^2}{\pi^2} \left(\frac{\sin(\frac{\eta \pi}{2})}{(\frac{\eta \pi}{2})}\right)^2 r_b^2$$

### CONTINUOUS FOCUSING

$$v_x'' = -k_{p0}^2 v_x + \frac{2Q}{v_x + v_y} - \frac{e^2}{v_x^2}$$

$$v_y'' = -k_{p0}^2 v_y + \frac{2Q}{v_x + v_y} - \frac{e^2}{v_y^2}$$

CURRENT LIMIT BALANCES PERVEANCE & EXTERNAL FOCUSING ( $v_x = v_y = v_b$ ):

$$k_{p0}^2 v_b = \frac{Q_{max}}{v_b}$$

Effective  $k_{p0}^2$  FOR QUADRUPOLES FOUND FROM DOMINANT FOURIER COMPONENT

$$k_{p0}^2 = \frac{2\eta^2 k^2 L^2}{\pi^2} \left( \frac{\sin(\frac{\eta\pi}{2})}{\frac{\eta\pi}{2}} \right)^2 \quad \text{where } k = \frac{B'}{B_p}$$

FOR CONTINUOUS FOCUSING:  $k_{p0}^2 = \frac{Q_0^2}{4L^2}$

ELIMINATING L:

$$Q_{max} = \frac{\eta k Q_0}{\sqrt{2}\pi} \left( \frac{\sin \frac{\eta\pi}{2}}{\frac{\eta\pi}{2}} \right) v_b^2 \quad \leftarrow \text{PERVEANCE LIMIT FOR FODO QUADRUPOLES}$$



# Envelope instabilities set upper limit on "single particle" phase advance $\sigma_0$



Experimental data (Tiefenback, 1986) from LBL's Single Beam Transport Experiment (SBTE)

79

Experimental limits on beam stability in terms of  $\sigma$  and  $\sigma_0$

$$\sigma_0 < 85^\circ$$

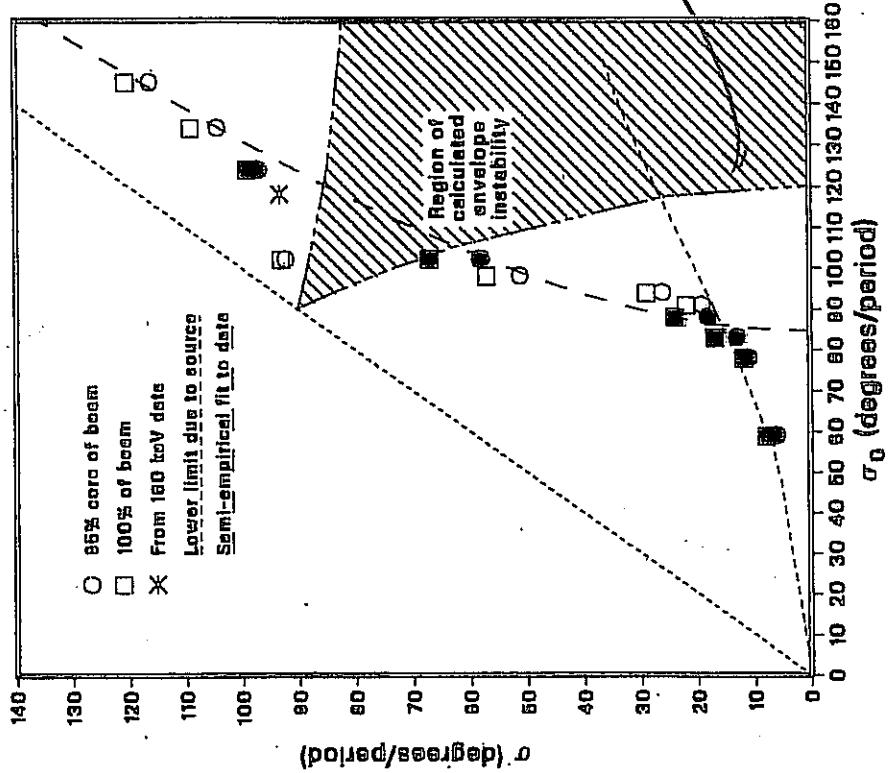

SEE STALLMENT & REISEL, PARTICLE ACCELERATORS 14, 227, (1974) & LUND & BUKH, PLUSTAB, I, 024801 (2004)

J. BACKHAUS

SEE LUND & CHAWLA 2006, NIIMPR-A, FOR HIGHER ORDER PARTICLES - LATTICE RESONANCES WHICH CLARIFIES  $\sigma_0 = 85^\circ$  LIMIT

## QUADRUPOLE CURRENT LIMIT - CONTINUED

$$Q_{max} \approx \frac{\mu_0 \epsilon_0}{\sqrt{2}\pi} \left( \frac{\sin \frac{n\pi}{2}}{\frac{n\pi}{2}} \right) V_b^2$$

$$\text{here } k = \begin{cases} \frac{dB/dx}{[B]} \approx \frac{B}{[B] r_p} & \text{(MAGNETIC QUAD FODO)} \\ \frac{q dE/dx}{\gamma m v_z^2} \approx \frac{Zq V_q}{\gamma m v_z^2 r_p^2} & \text{(ELECTRIC QUAD FODO)} \end{cases}$$

where  $V_q = \frac{1}{2} \frac{dE}{dx} r_p^2$

So

$$Q_{max} \approx \frac{\mu_0 \epsilon_0}{\sqrt{2}\pi} \left( \frac{\sin \frac{n\pi}{2}}{\frac{n\pi}{2}} \right) \begin{cases} \frac{B v_b}{[B]} \left[ \frac{r_b}{r_p} \right] & \text{(MAGNETIC QUAD)} \\ \frac{Zq V_q}{\gamma m v_z^2} \left[ \frac{r_b^2}{r_p^2} \right] & \text{(ELECTRIC QUAD)} \end{cases}$$

# Summary of Current Limits From Different Focusing Methods

## EINZEL LENS

$$Q_{max} \approx \frac{3\pi^2}{8} \left( \frac{q\beta_0}{m_0 v_0^2} \right)^2 \left( \frac{V_0}{L} \right)^2$$

## SOLENOIDS

$$Q_{max} = \left( \frac{\omega_c V_0}{2\gamma\beta c} \right)^2$$

## QUADRUPOLE FOCUSING

$$Q_{max} \approx \frac{1}{\sqrt{2}\pi} \left( \frac{\sin \frac{\pi}{2}}{\frac{\pi}{2}} \right)$$

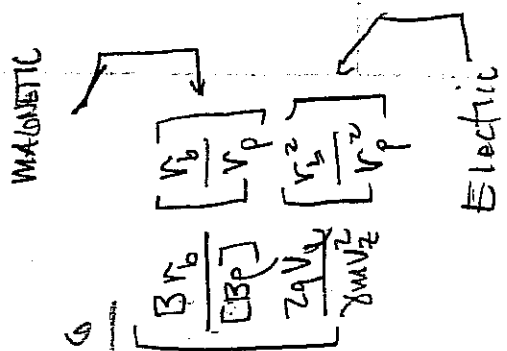

## FOR NON-RELATIVISTIC BEAMS

$$\lambda_{max} \propto \frac{Q_0}{V}$$

$$\lambda_{max} \propto \frac{1}{m} B^2 r_p^2$$

$$\left\{ \begin{array}{l} B_1 V_0 r_p \\ N q \end{array} \right.$$

NOTE

- $Q_0$  = Voltage between Einzel lenses
- $V_0$  = Voltage on a grid relative to ground
- $V$  = particle energy /  $e$

# Transverse Particle Equations of Motion\*

Steven M. Lund

Lawrence Livermore National Laboratory (LLNL)

Steven M. Lund and John J. Barnard

“Beam Physics with Intense Space-Charge”

US Particle Accelerator School

University of Maryland, held at Annapolis, MD

16-27 June, 2008

(Version 20080624)

\* Research supported by the US Dept. of Energy at LLNL and LBNL under contract Nos. DE-AC52-07NA27344 and DE-AC02-05CH11231.

SM Lund, USPAS, June 2008

Transverse Particle Equations

1

## Transverse Particle Equations: Outline

- 1) Particle Equations of Motion
  - 2) Transverse Particle Equations of Motion in Linear Focusing Channels
  - 3) Description of Applied Focusing Fields
  - 4) Transverse Particle Equations of Motion with Nonlinear Applied Fields
  - 5) Transverse Particle Equations of Motion Without Space-Charge, Acceleration and Momentum Spread
  - 6) Floquet's Theorem and the Phase-Amplitude Form of Particle Orbits
  - 7) The Courant-Snyder Invariant and the Single-Particle Emittance
  - 8) The Betatron Formulation of the Particle Orbit
  - 9) Momentum Spread Effects
  - 10) Acceleration and Normalized Emittance
- References

SM Lund, USPAS, June 2008

Transverse Particle Equations

2

## Particle Equations of Motion: Detailed Outline

- 1) Particle Equations of Motion
  - A. Introduction: The Lorentz Force Equation
  - B. Applied Fields
  - C. Machine Lattice
  - D. Self Fields
  - E. Equation of Motion in  $s$  and the Paraxial Approximation
  - F. Summary: Transverse Particle Equations of Motion
  - G. Overview of Analysis to Come
  - H. Bent Coordinate System and Particle Equations of Motion with Dipole Bends and Axial Momentum Spread

SM Lund, USPAS, June 2008

Transverse Particle Equations

3

## Detailed Outline - 2

- 2) Transverse Particle Equations of Motion in Linear Focusing Channels
  - A. Introduction
  - B. Continuous Focusing
  - C. Alternating Gradient Quadrupole Focusing – Electric Quadrupoles
  - D. Alternating Gradient Quadrupole Focusing – Magnetic Quadrupoles
  - E. Solenoidal Focusing
  - F. Summary of Transverse Particle Equations of Motion

**Appendix A: Quadrupole Skew Coupling**

**Appendix B: The Larmor Transform to Express Solenoidal Focused Particle Equations of Motion in Uncoupled Form**
- 3) Description of Applied Focusing Fields
  - A. Overview
  - B. Magnetic Field Expansions for Focusing and Bending
  - C. Hard Edge Equivalent Models
  - D. 2D Transverse Multipole Magnetic Moments
  - E. Good Field Radius
  - F. Example Permanent Magnet Assemblies

SM Lund, USPAS, June 2008

Transverse Particle Equations

4

## Detailed Outline - 3

### 4) Transverse Particle Equations of Motion with Nonlinear Applied Fields

- A. Overview
  - B. Approach 1: Explicit 3D Form
  - C. Approach 2: Perturbed Form
- ### 5) Linear Equations of Motion Without Space-Charge, Acceleration, and Momentum Spread
- A. Hill's equation
  - B. Transfer Matrix Form of the Solution to Hill's Equation
  - C. Wronskian Symmetry of Hill's Equation
  - D. Stability of Solutions to Hill's Equation in a Periodic Lattice

SM Lund, USPAS, June 2008

Transverse Particle Equations

5

69

## Detailed Outline - 4

### 6) Hill's Equation: Floquet's Theorem and the Phase-Amplitude Form of the Particle Orbit

- A. Introduction
- B. Floquet's Theorem
- C. Phase-Amplitude Form of the Particle Orbit
- D. Summary: Phase-Amplitude Form of the Solution to Hill's Equation
- E. Points on the Phase-Amplitude Formulation
- F. Relation Between the Principal Orbit Functions and the Phase-Amplitude Form Orbit Functions
- G. Undepressed Particle Phase Advance

### Appendix C: Calculation of w(s) from Principal Orbit Functions

### 7) Hill's Equation: The Courant-Snyder Invariant and the Single-Particle Emittance

- A. Introduction
- B. Derivation of the Courant Snyder Invariant
- C. Lattice Maps

SM Lund, USPAS, June 2008

Transverse Particle Equations

6

## Detailed Outline - 5

### 8) Hill's Equation: The Betatron Formulation of the Particle Orbit and

#### Maximum Orbit Excursions

- A. Formulation
- B. Maximum Orbit Excursions

### 9) Momentum Spread Effects and Bending

- A. Overview
- B. Chromatic Effects
- C. Dispersive Effects

### 10) Acceleration and Normalized Emittance

- A. Introduction
- B. Transformation to Normal Form
- C. Phase-Space Relations between Transformed and Untransformed Systems

### Appendix D: Accelerating Fields and Calculation of Changes in $\gamma$ and $\beta$

#### Contact Information

#### References

#### Acknowledgments

SM Lund, USPAS, June 2008

Transverse Particle Equations

7

## S1: Particle Equations of Motion

### S1A: Introduction: The Lorentz Force Equation

The Lorentz force equation of a charged particle is given by (SI Units):

$$\frac{d}{dt} \mathbf{p}_i(t) = q_i [\mathbf{E}(\mathbf{x}_i, t) + \mathbf{v}_i(t) \times \mathbf{B}(\mathbf{x}_i, t)]$$

$m_i$ ,  $q_i$  ... particle mass, charge  $i$  = particle index

$\mathbf{x}_i(t)$  ... particle coordinate  $t$  = time

$\mathbf{p}_i(t) = m\gamma_i(t)\mathbf{v}_i(t)$  ... particle momentum

$\mathbf{v}_i(t) = \frac{d}{dt} \mathbf{x}_i(t) = c\vec{\beta}_i(t)$  ... particle velocity

$\gamma_i(t) = \frac{1}{\sqrt{1 - \beta_i^2(t)}}$  ... particle gamma factor

Total

Applied

Self

Electric Field:  $\mathbf{E}(\mathbf{x}, t) = \mathbf{E}^a(\mathbf{x}, t) + \mathbf{E}^s(\mathbf{x}, t)$

Magnetic Field:  $\mathbf{B}(\mathbf{x}, t) = \mathbf{B}^a(\mathbf{x}, t) + \mathbf{B}^s(\mathbf{x}, t)$

SM Lund, USPAS, June 2008

Transverse Particle Equations

8

# S1B: Applied Fields

Transverse Focusing Optics:

## Electric Quadrupole

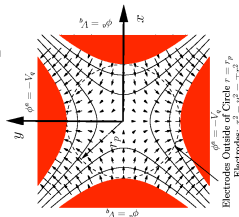

## Magnetic Quadrupole

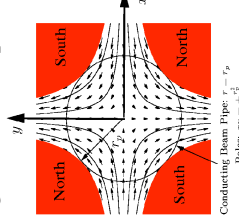

## Solenoid

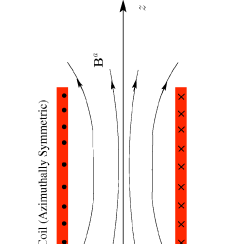

## Dipole Bends:

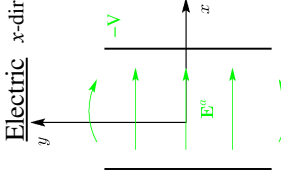

## Magnetic x-direction bend

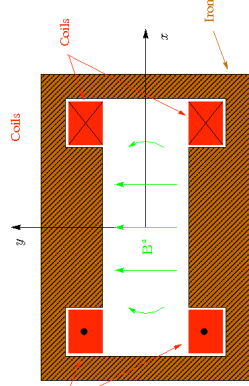

## Longitudinal Acceleration:

### RF Cavity

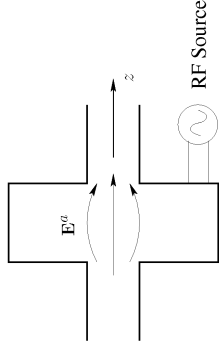

### Induction Cell

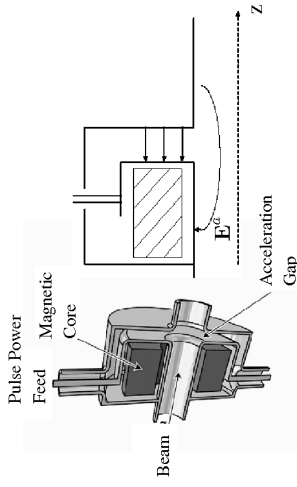

# S1C: Machine Lattice

Applied field structures are often arranged in a regular (periodic) lattice for beam transport/acceleration:

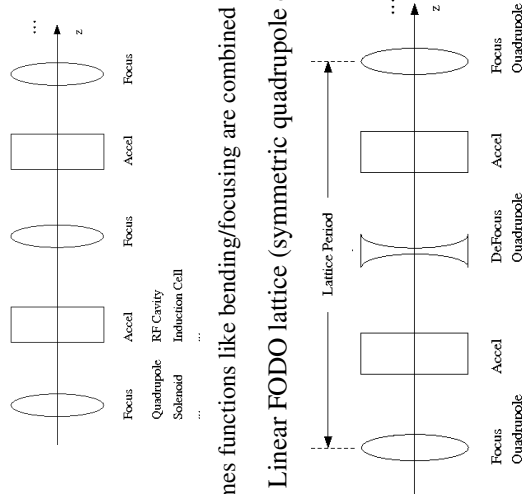

◆ Sometimes functions like bending/focusing are combined into a single element

Example – Linear FODO lattice (symmetric quadrupole doublet)

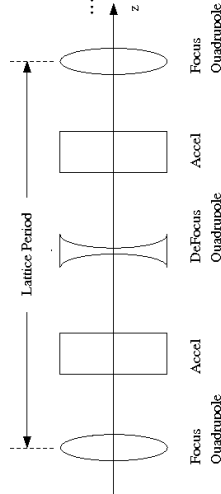

Lattices for rings and some beam insertion/extraction sections also incorporate bends and more complicated periodic structures:

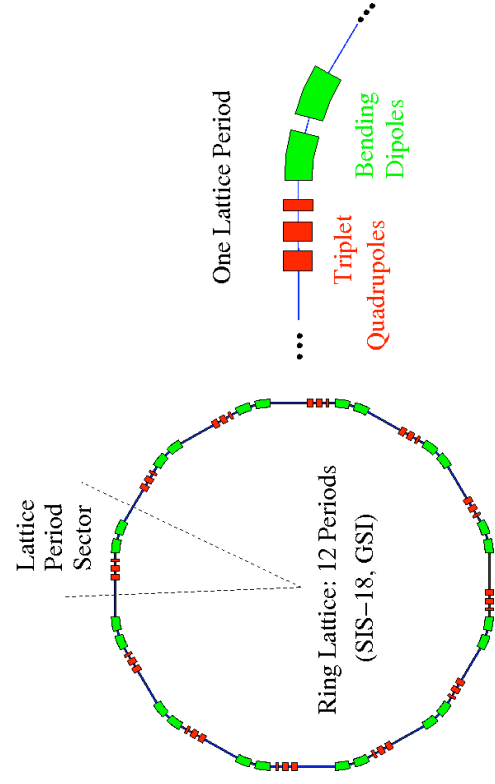

## SID: Self fields

Self-fields are generated by the distribution of beam particles:

- Charges
- Currents

### Particle at Rest

(pure electrostatic)

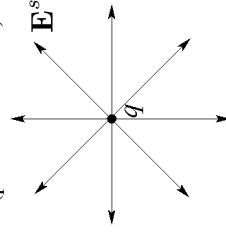

$$\mathbf{B}^s = 0$$

### Particle in Motion

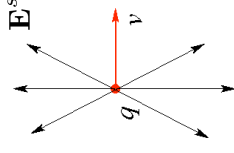

Obtain from  
Lorentz boost  
of rest-frame field:  
see Jackson,  
*Classical  
Electrodynamics*

- Superimpose for all particles in the beam distribution
- Accelerating particles also radiate

- We neglect electromagnetic radiation in this class

(see: J.J. Barnard, **Intro Lectures**)

/// Aside: Notation:

$$\nabla \equiv \hat{\mathbf{x}} \frac{\partial}{\partial x} + \hat{\mathbf{y}} \frac{\partial}{\partial y} + \hat{\mathbf{z}} \frac{\partial}{\partial z}$$

$$= \hat{\mathbf{r}} \frac{\partial}{\partial r} + \frac{\hat{\theta}}{r} \frac{\partial}{\partial \theta} + \hat{\mathbf{z}} \frac{\partial}{\partial z}$$

$$= \frac{\partial}{\partial \mathbf{x}}$$

$$= \frac{\partial}{\partial \mathbf{x}_\perp} + \hat{\mathbf{z}} \frac{\partial}{\partial z}$$

$$\begin{aligned} \mathbf{x} &= \hat{\mathbf{x}}x + \hat{\mathbf{y}}y + \hat{\mathbf{z}}z \\ &= \mathbf{x}_\perp + \hat{\mathbf{z}}z \end{aligned}$$

### Cartesian Representation

### Cylindrical Representation

$$x = r \cos \theta$$

$$y = r \sin \theta$$

### Abbreviated Representation

### Resolved Abbreviated Rep.

Resolved into Perpendicular ( $\perp$ ) and Parallel ( $z$ ) components

$$\mathbf{x}_\perp \equiv \hat{\mathbf{x}}x + \hat{\mathbf{y}}y$$

///

The electric ( $\mathbf{E}$ ) and magnetic ( $\mathbf{B}$ ) fields satisfy the **Maxwell Equations**. The linear structure of the Maxwell equations can be exploited to resolve the field into **Applied** and **Self-Field** components:

### Applied Fields (often quasi-static)

- Generated by elements in lattice

$$\nabla \cdot \mathbf{E}^a = \frac{\rho^a}{\epsilon_0} \quad \nabla \times \mathbf{B}^a = \mu_0 \mathbf{J}^a + \frac{1}{c^2} \frac{\partial \mathbf{E}^a}{\partial t}$$

$$\nabla \times \mathbf{E}^a = -\frac{\partial \mathbf{B}^a}{\partial t} \quad \nabla \cdot \mathbf{B}^a = 0$$

$\rho^a$  = applied charge density  
 $\mathbf{J}^a$  = applied current density

$$\frac{1}{\mu_0 \epsilon_0} = c^2$$

+ Boundary Conditions on  $\mathbf{E}^a$  and  $\mathbf{B}^a$

- Boundary conditions depend on the total fields  $\mathbf{E}$ ,  $\mathbf{B}$  and if separated into Applied and Self-Field components, care is required

### Self-Fields (dynamic, evolve with beam)

- Generated by particles in the beam

$$\nabla \cdot \mathbf{E}^s = \frac{\rho^s}{\epsilon_0} \quad \nabla \times \mathbf{B}^s = \mu_0 \mathbf{J}^s + \frac{1}{c^2} \frac{\partial \mathbf{E}^s}{\partial t}$$

$$\nabla \times \mathbf{E}^s = -\frac{\partial \mathbf{B}^s}{\partial t} \quad \nabla \cdot \mathbf{B}^s = 0$$

$\rho^s$  = beam charge density  
 $\mathbf{J}^s$  = beam current density

$$= \sum_{i=1}^N q_i \delta[\mathbf{x} - \mathbf{x}_i(t)]$$

$\mathbf{J}^s$  = beam current density

$$= \sum_{i=1}^N q_i \mathbf{v}_i(t) \delta[\mathbf{x} - \mathbf{x}_i(t)]$$

$$\frac{1}{c^2} \frac{\partial \mathbf{E}^s}{\partial t}$$

$i$  = particle index  
( $N$  particles)

$q_i$  = particle charge

$\mathbf{x}_i$  = particle coordinate

$\mathbf{v}_i$  = particle velocity

$$\delta(\mathbf{x}) \equiv \delta(x)\delta(y)\delta(z)$$

$\delta(x) \equiv$  Dirac-delta function

$$\sum_{i=1}^N \dots = \text{sum over beam particles}$$

+ Boundary Conditions on  $\mathbf{E}^s$  and  $\mathbf{B}^s$   
from material structures, radiation conditions, etc.

In accelerators, there is ideally a **single species** of particle:

$$\begin{matrix} q_i \rightarrow q \\ m_i \rightarrow m \end{matrix}$$

**Large Simplification!**

Multi-species results in more complex collective effects

Motion of particles within axial slices of the “bunch” are **highly directed**:

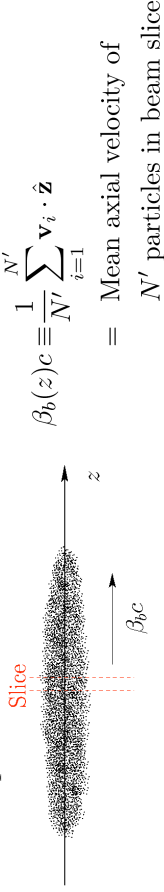

$$\frac{d}{dt} \mathbf{x}_i(t) = \hat{\mathbf{z}} \beta_b(z)c + \delta \mathbf{v}_i$$

$$|\delta \mathbf{v}_i| \ll |\beta_b|c \quad \text{Paraxial Approximation}$$

There are typically **many particles**:

$$\begin{aligned} \rho^s &= \sum_{i=1}^N q_i \delta[\mathbf{x} - \mathbf{x}_i(t)] & \mathbf{J}^s &= \sum_{i=1}^N q_i \mathbf{v}_i(t) \delta[\mathbf{x} - \mathbf{x}_i(t)] \\ &\simeq \rho(\mathbf{x}, t) \text{ continuous charge-density} & &\simeq \beta_b c \rho(\mathbf{x}, t) \hat{\mathbf{z}} \text{ continuous axial current-density} \end{aligned}$$

The self-field force can be simplified:

See also: J.J. Barnard, **Intro. Lectures**

Plug in self-field forms:

$$\begin{aligned} \mathbf{F}_i^s &= q \mathbf{E}_i^s + q \mathbf{v}_i \times \mathbf{B}_i^s & \text{0 Neglect: Paraxial} & \dots \Big|_i \equiv \dots \Big|_{\mathbf{x}=\mathbf{x}_i} \\ &\simeq q \left[ -\frac{\partial \phi}{\partial \mathbf{x}} \Big|_i + (\beta_b c \hat{\mathbf{z}} + \delta \mathbf{v}_i) \times \left( \frac{\partial}{\partial \mathbf{x}} \times \hat{\mathbf{z}} \frac{\beta_b \phi}{c} \right) \Big|_i \right] \end{aligned}$$

Resolve into transverse (x and y) and longitudinal (z) components. After some algebra, find:

$$\begin{aligned} \mathbf{F}_i^s &= \underbrace{-\frac{q}{\gamma_b^2} \frac{\partial \phi}{\partial \mathbf{x}_\perp} \Big|_i}_{\text{Transverse}} - \underbrace{\hat{\mathbf{z}} q \frac{\partial \phi}{\partial z} \Big|_i}_{\text{Longitudinal}} \\ \gamma_b &\equiv \frac{1}{\sqrt{1 - \beta_b^2}} \quad \text{Axial relativistic gamma of beam} \end{aligned}$$

The beam evolution is typically **sufficiently slow** (for heavy ions) where we can **neglect radiation** and approximate the self-field Maxwell Equations as:

See: J. J. Barnard, **Intro. Lectures: Electrostatic Approximation**

$$\begin{aligned} \mathbf{E}^s &= -\nabla \phi \\ \mathbf{B}^s &= \nabla \times \mathbf{A} \quad \mathbf{A} = \hat{\mathbf{z}} \frac{\beta_b}{c} \phi \\ \nabla^2 \phi &= \frac{\partial}{\partial \mathbf{x}} \cdot \frac{\partial}{\partial \mathbf{x}} \phi = -\frac{\rho^s}{\epsilon_0} \\ &+ \text{Boundary Conditions on } \phi \end{aligned}$$

**Vast Reduction of self-field model:**

**But still complicated!**

Resolve the **Lorentz force** acting on beam particles into

**Applied and Self-Field** terms:

$$\mathbf{F}_i(\mathbf{x}_i, t) = q \mathbf{E}(\mathbf{x}_i, t) + q \mathbf{v}_i(t) \times \mathbf{B}(\mathbf{x}_i, t)$$

**Applied:**

$$\mathbf{F}_i^a = q \mathbf{E}_i^a + q \mathbf{v}_i \times \mathbf{B}_i^a$$

**Self-Field:**

$$\mathbf{F}_i^s = q \mathbf{E}_i^s + q \mathbf{v}_i \times \mathbf{B}_i^s$$

$$\begin{aligned} \mathbf{F}_i &= \mathbf{F}_i^a + \mathbf{F}_i^s \\ \mathbf{E} &= \mathbf{E}^a + \mathbf{E}^s \\ \mathbf{B} &= \mathbf{B}^a + \mathbf{B}^s \end{aligned}$$

$$\mathbf{E}^a(\mathbf{x}_i, t) \equiv \mathbf{E}_i^a \text{ etc.}$$

**/// Aside: Singular Self Fields**

In *free space*, the beam potential generated from the singular charge density:

$$\rho^s \equiv \sum_{i=1}^N q_i \delta[\mathbf{x} - \mathbf{x}_i(t)]$$

is

$$\phi(\mathbf{x}) = \frac{q}{4\pi\epsilon_0} \sum_{i=1}^N \frac{1}{|\mathbf{x} - \mathbf{x}_i|}$$

Thus, the force of a particle at  $\mathbf{x} = \mathbf{x}_i$  is:

$$\mathbf{F}_i = -q \frac{\partial \phi}{\partial \mathbf{x}} \Big|_i = \frac{q^2}{4\pi\epsilon_0} \sum_{j=1}^N \frac{(\mathbf{x}_i - \mathbf{x}_j)}{|\mathbf{x}_i - \mathbf{x}_j|^{3/2}}$$

Which diverges due to the  $i = j$  term. This divergence is essentially “erased” when the continuous charge density is applied:

$$\rho^s = \sum_{i=1}^N q_i \delta[\mathbf{x} - \mathbf{x}_i(t)] \longrightarrow \rho(\mathbf{x}, t)$$

Effectively removes effect of collisions

See: J.J. Barnard, **Intro Lectures** for more details

- Find collisionless Vlasov model of evolution is often adequate **///**



The particle equations of motion in  $\mathbf{x}_i - \mathbf{v}_i$  phase-space variables become:

$$\frac{d}{dt} \mathbf{x}_{\perp i} = \mathbf{v}_{\perp i}$$

$$\frac{d}{dt} (m\gamma_i \mathbf{v}_{\perp i}) \simeq \underbrace{q\mathbf{E}_{\perp i}^a + q\beta_b c \hat{\mathbf{z}} \times \mathbf{B}_{\perp i}^a + qB_{z i}^a \mathbf{v}_{\perp i} \times \hat{\mathbf{z}}}_{\text{Applied}} - q \frac{1}{\gamma_b^2} \frac{\partial \phi}{\mathbf{x}_{\perp i}} \quad \text{Self}$$

**Longitudinal**

$$\frac{d}{dt} z_i = v_{z i}$$

$$\frac{d}{dt} (m\gamma_i v_{z i}) \simeq \underbrace{qE_{z i}^a - q(v_{x i} B_{y i}^a - v_{y i} B_{x i}^a)}_{\text{Applied}} - q \frac{\partial \phi}{\partial z} \quad \text{Self}$$

In the remainder of this (and most other) lectures, we analyze **Transverse Dynamics**. **Longitudinal Dynamics** will be covered in J.J. Barnard lectures

- Except near injector, acceleration is typically slow
- Fractional change in  $\gamma_b, \beta_b$  small over characteristic transverse dynamical scales such as lattice period and betatron oscillation periods
- Regard  $\gamma_b, \beta_b$  as specified functions given by the “acceleration schedule”

In the **paraxial approximation**,  $x'$  and  $y'$  can be interpreted as the (small magnitude) angles that the particles make with the  $z$ -axis:

$$x - \text{angle} = \frac{v_{x i}}{v_{z i}} \simeq \frac{v_{x i}}{\beta_b c} = x'_i$$

$$y - \text{angle} = \frac{v_{y i}}{v_{z i}} \simeq \frac{v_{y i}}{\beta_b c} = y'_i$$

The angles will be *small* in the paraxial approximation:

$$v_{x i}^2, v_{y i}^2 \ll \beta_b^2 c^2 \implies x_i'^2, y_i'^2 \ll 1$$

Since the spread of axial momentum/velocities is small in the paraxial approximation, a thin axial slice of the beam maps to a thin axial slice and  $s$  can also be thought of as the axial coordinate of the slice in the accelerator lattice

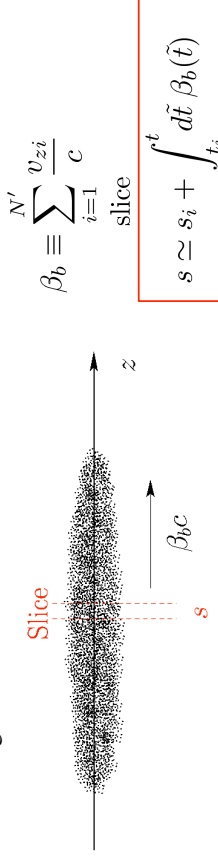

## SIE: Equations of Motion in $s$ and the Paraxial Approximation

In transverse accelerator dynamics, it is convenient to employ the axial coordinate ( $s$ ) of the particle in the accelerator as the **independent** variable:

$$s \equiv s_i + \int_{t_i}^t dt v_{z i}(\tilde{t})$$

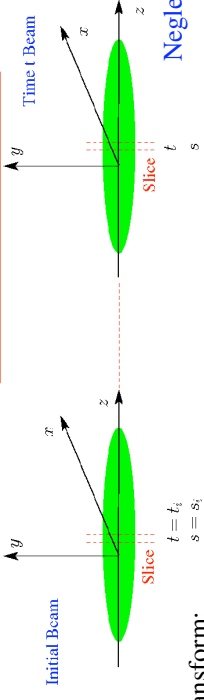

Transform: **Neglect: Paraxial 0**

$$\frac{ds}{dt} = v_{z i} \implies \frac{dx_i}{dt} = \frac{ds}{dt} \frac{dx_i}{ds} = v_{z i} \frac{dx_i}{ds} = (\beta_b c + \delta v_{z i}) \frac{dx_i}{ds} \simeq \beta_b c \frac{dx_i}{ds}$$

Denote:

$$' \equiv \frac{d}{ds}$$

$$v_{x i} = \frac{dx_i}{dt} \simeq \beta_b c x'_i$$

$$v_{y i} = \frac{dy_i}{dt} \simeq \beta_b c y'_i$$

Transverse particle equations of motion:

$$\frac{d}{dt} (m\gamma_i \mathbf{v}_{\perp i}) \simeq \underbrace{q\mathbf{E}_{\perp i}^a + q\beta_b c \hat{\mathbf{z}} \times \mathbf{B}_{\perp i}^a}_{\text{Term 1}} + \underbrace{qB_{z i}^a \mathbf{v}_{\perp i} \times \hat{\mathbf{z}}}_{\text{Term 2}} - q \frac{1}{\gamma_b^2} \frac{\partial \phi}{\mathbf{x}_{\perp i}}$$

Transform **Terms 1 and 2** in the particle equation of motion:

$$\text{Term 1: } \frac{d}{dt} \left( m\gamma_i \frac{d\mathbf{x}_{\perp i}}{dt} \right) = m v_{z i} \frac{d}{ds} \left( \gamma_i v_{z i} \frac{d\mathbf{x}_{\perp i}}{ds} \right)$$

$$= m \gamma_i v_{z i}^2 \frac{d^2}{ds^2} \mathbf{x}_{\perp i} + m \left( \frac{d}{ds} \mathbf{x}_{\perp i} \right) \frac{d}{ds} (\gamma_i v_{z i})$$

Term 1A      Term 1B

Approximate:

$$\text{Term 1A: } m \gamma_i v_{z i}^2 \frac{d^2}{ds^2} \mathbf{x}_{\perp i} \simeq m \gamma_b \beta_b^2 c^2 \frac{d^2}{ds^2} \mathbf{x}_{\perp i} = m \gamma_b \beta_b^2 c^2 \mathbf{x}_{\perp i}''$$

$$\text{Term 1B: } m \left( \frac{d}{ds} \mathbf{x}_{\perp i} \right) v_{z i} \frac{d}{ds} (\gamma_i v_{z i}) \simeq m \left( \frac{d}{ds} \mathbf{x}_{\perp i} \right) \beta_b c \frac{d}{ds} (\gamma_b \beta_b c)$$

$$\simeq m \beta_b c^2 (\gamma_b \beta_b)' \mathbf{x}_{\perp i}'$$

Using the approximations 1A and 1B gives for Term 1:

$$m \frac{d}{dt} \left( \gamma_i \frac{d\mathbf{x}_{\perp i}}{dt} \right) \simeq m \gamma_b \beta_b^2 c^2 \left[ \mathbf{x}'_{\perp i} + \frac{(\gamma_b \beta_b)'}{(\gamma_b \beta_b)} \mathbf{x}'_{\perp i} \right]$$

Similarly we approximate in Term 2:

$$q B_{z i}^a \mathbf{v}_{\perp i} \times \hat{\mathbf{z}} \simeq q B_{z i}^a \beta_b c \mathbf{x}'_{\perp i} \times \hat{\mathbf{z}}$$

Using the reduced expressions for Terms 1 and 2 obtains the reduced transverse equation of motion:

$$\mathbf{x}''_{\perp i} + \frac{(\gamma_b \beta_b)'}{(\gamma_b \beta_b)} \mathbf{x}'_{\perp i} = \frac{q}{m \gamma_b \beta_b^2 c^2} \mathbf{E}_{\perp i}^a + \frac{q}{m \gamma_b \beta_b c} \hat{\mathbf{z}} \times \mathbf{B}_{\perp i}^a + \frac{q B_{z i}^a}{m \gamma_b \beta_b c} \mathbf{x}'_{\perp i} \times \hat{\mathbf{z}} - \frac{q}{\gamma_b^3 \beta_b^2 c^2} \frac{\partial \phi}{\partial \mathbf{x}_{\perp i}} \Big|_i$$

- Will be analyzed extensively in lectures that follow in various limits to better understand structure of solutions

## SIF: Summary: Transverse Particle Equations of Motion

$$\mathbf{x}''_{\perp} + \frac{(\gamma_b \beta_b)'}{(\gamma_b \beta_b)} \mathbf{x}'_{\perp} = \frac{q}{m \gamma_b \beta_b^2 c^2} \mathbf{E}_{\perp}^a + \frac{q}{m \gamma_b \beta_b c} \hat{\mathbf{z}} \times \mathbf{B}_{\perp}^a + \frac{q B_z^a}{m \gamma_b \beta_b c} \mathbf{x}'_{\perp} \times \hat{\mathbf{z}} - \frac{q}{\gamma_b^3 \beta_b^2 c^2} \frac{\partial}{\partial \mathbf{x}_{\perp}} \phi$$

$\mathbf{E}^a$  = Applied Electric Field

$\mathbf{B}^a$  = Applied Magnetic Field

$$\nabla^2 \phi = \frac{\partial}{\partial \mathbf{x}} \cdot \frac{\partial}{\partial \mathbf{x}} \phi = -\frac{\rho}{\epsilon_0}$$

+ Boundary Conditions on  $\phi$

$$l \equiv \frac{d}{ds} \quad \gamma_b \equiv \frac{1}{\sqrt{1 - \beta_b^2}}$$

- Drop particle  $i$  subscripts (in most cases) henceforth to simplify notation
- Neglects axial energy spread, bending, and electromagnetic radiation
- $\gamma_b$  factors different in applied and self-field terms:  
In  $-\frac{q}{m \gamma_b^3 \beta_b^2 c^2} \frac{\partial}{\partial \mathbf{x}} \phi$ , contributions to  $\gamma_b^3$ :  
 $\gamma_b \implies$  Kinematics  
 $\gamma_b^2 \implies$  Self-Magnetic Field Corrections (leading order)

## SIG: Overview: Analysis to Come

Much of accelerator physics centers on understanding the evolution of beam particles in 4-dimensional  $x$ - $x'$  and  $y$ - $y'$  phase space.

Typically, restricted 2-dimensional phase-space projections in  $x$ - $x'$  and/or  $y$ - $y'$  are analyzed to simplify interpretations:

- When forces are linear particles tend to move on ellipses of constant area
  - Ellipse may elongate/shrink and rotate as beam evolves in lattice
- Nonlinear force components distort orbits and cause undesirable effects
  - Growth of effective phase-space area

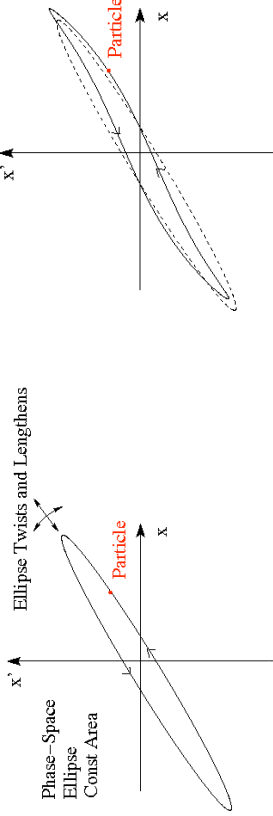

The “effective” phase-space volume of a distribution of beam particles is of fundamental interest

Effective area measure in

$x$ - $x'$  phase-space is the

$x$ -emittance  $\epsilon_x$

Statistical ”Area”  $\sim \pi \epsilon_x$

$$\epsilon_x = 4 \left[ \langle x^2 \rangle_{\perp} \langle x'^2 \rangle_{\perp} - \langle x x' \rangle_{\perp}^2 \right]^{1/2}$$

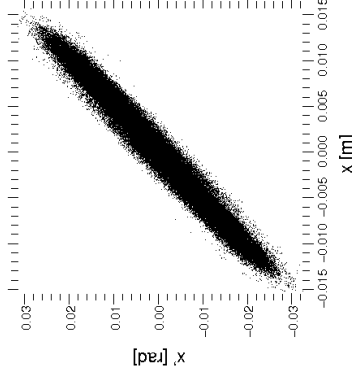

We will find in statistical beam descriptions that:

Larger/Smaller beam phase-space areas  
(Larger/Smaller emittances)



Harder/Easier to focus beam on small final spots

Much of advanced accelerator physics centers on understanding and controlling **emittance growth** due to **nonlinear forces** arising from both space-charge and the applied focusing. In the remainder of the next few lectures we will review the physics of transverse particle dynamics of particles moving in linear applied fields. Later we will generalize concepts to include forces from space-charge and

## SIH: Bent Coordinate System and Particle Equations of Motion with Dipole Bends and Axial Momentum Spread

The previous equations of motion can be applied to dipole bends provided the  $x, y, z$  coordinate system is fixed. In practice, it can prove more convenient to employ coordinates that follow the beam in a bend.

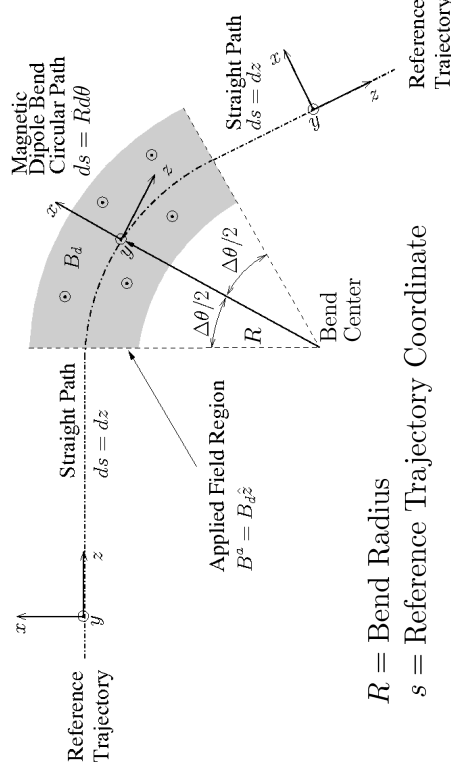

$R$  = Bend Radius

$s$  = Reference Trajectory Coordinate

In this perspective, dipoles are adjusted given the design momentum of the reference particle to bend the orbit through a radius  $R$ .

- Bends usually only in one plane (say  $x$ )
- Implemented by a dipole applied field:  $E_x^a$  or  $B_y^a$
- Easy to apply material analogously for  $y$ -plane bends, if necessary

Denote:

$$p_0 = m\gamma_b\beta_b c = \text{design momentum}$$

Then a magnetic  $x$ -bend through a radius  $R$  is specified by:

$$\mathbf{B}^a = B_y^a \hat{y} = \text{const in bend}$$

$$\frac{1}{R} = \frac{qB_y^a}{p_0}$$

Analogous formula for **Electric Bend** will be derived in problem set

The **particle rigidity** is defined as ( $[B\rho]$  read as one symbol called “B-Rho”):

$$[B\rho] \equiv \frac{p_0}{q} = \frac{m\gamma_b\beta_b c}{q}$$

is often applied to express the bend result as:

$$\frac{1}{R} = \frac{B_y^a}{[B\rho]}$$

Comments on bends:

- $R$  can be **positive** or **negative** depending on sign of  $B_y^a/[B\rho]$
- For **straight** sections,  $R \rightarrow \infty$  (or equivalently,  $B_y^a = 0$ )
- Lattices often made from discrete element dipoles and straight sections with separated function optics
  - Bends sometimes provide “edge focus” in a ring
  - Sometimes elements for bending/focusing are combined
- For a ring, dipoles strengths are tuned with particle rigidity/momentum so the reference orbit makes a closed path lap through the circular machine
  - Dipoles adjusted as particles gain energy to maintain closed path
  - In a Synchrotron dipoles and focusing elements are adjusted together to maintain focusing and bending properties with energy gain. This is the origin of the name “Synchrotron.”
- Total bending strength of a ring in Tesla-meters limits the ultimately achievable particle energy/momentum in the ring

/// Example: Typical separated function lattice in a Synchrotron

Focus Elements in Red  
Bending Elements in Green

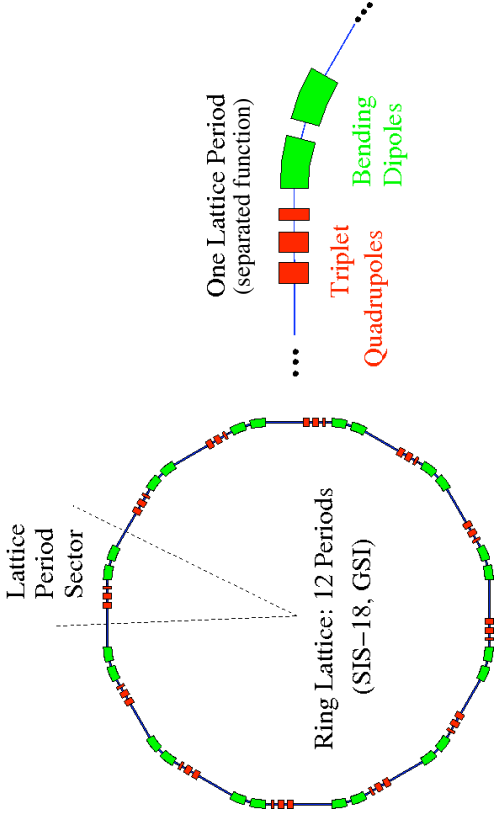

Transverse particle equations of motion including “off-momentum” effects:

- See texts such as Edwards and Syphers for guidance on derivation steps
- Full derivation is beyond needs/scope of this class

$$\begin{aligned}
 x'' + \frac{(\gamma_b \beta_b)'}{(\gamma_b \beta_b)} x' + \left[ \frac{1}{R^2(s)} \frac{1-\delta}{1+\delta} + \frac{1}{m\gamma_b \beta_b^2 c^2} \frac{1}{(1+\delta)^2} \frac{E_x^a}{(1+\delta)^2} \right] x &= \frac{\delta}{1+\delta} R(s) + \frac{q}{m\gamma_b \beta_b^2 c^2} \frac{1}{(1+\delta)^2} \frac{E_x^a}{(1+\delta)^2} \\
 - \frac{q}{m\gamma_b \beta_b c} \frac{1}{1+\delta} + \frac{B_s^a}{m\gamma_b \beta_b c} \frac{1}{1+\delta} y' - \frac{q}{m\gamma_b^3 \beta_b^2 c^2} \frac{1}{1+\delta} \frac{\partial \phi}{\partial x} \\
 y'' + \frac{(\gamma_b \beta_b)'}{(\gamma_b \beta_b)} y' &= \frac{q}{m\gamma_b \beta_b^2 c^2} \frac{1}{(1+\delta)^2} + \frac{E_y^a}{m\gamma_b \beta_b c} \frac{1}{1+\delta} + \frac{B_x^a}{m\gamma_b \beta_b c} \frac{1}{1+\delta} \\
 - \frac{q}{m\gamma_b \beta_b c} \frac{1}{1+\delta} x' - \frac{q}{m\gamma_b^3 \beta_b^2 c^2} \frac{1}{1+\delta} \frac{\partial \phi}{\partial y} \\
 p_0 = m\gamma_b \beta_b c &= \text{Design Momentum} \quad \frac{1}{R(s)} \Big|_{\text{Dipole}} = \frac{B_y^a(s)}{[B\rho]} \quad [B\rho] = \frac{p_0}{q} \\
 \delta \equiv \frac{\delta p}{p_0} &= \text{Fractional Momentum Error} \quad \frac{R(s)}{[B\rho]} = \frac{[B\rho]}{[B\rho]}
 \end{aligned}$$

Comments:

- Design bends only in  $x$  and  $B_y^a$ ,  $E_x^a$  contain no dipole terms (design orbit)
  - Dipole components set via the design bend radius  $R(s)$
- Equations contain only low-order terms in momentum spread  $\delta$

For “off-momentum” errors:

$$\begin{aligned}
 p_s &= p_0 + \delta p \\
 p_0 &= m\gamma_b \beta_b c = \text{design momentum} \\
 \delta p &= \text{off-momentum}
 \end{aligned}$$

This will modify the particle equations of motion, particularly in cases where there are bends since particles with different momenta will be bent at different radii

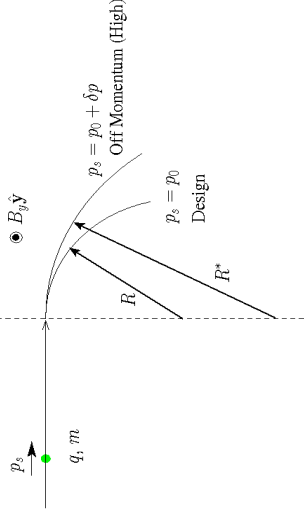

- Not usual to have acceleration in bends
  - Dipole bends and quadrupole focusing are sometimes combined

Comments continued:

- Equations are often applied linearized in  $\delta$
- Achromatic focusing lattices are often designed using equations with momentum spread to obtain focal points independent of  $\delta$  to some order
- $x$  and  $y$  equations differ significantly due to bends modifying the  $x$ -equation when  $R(s)$  is finite
- It will be shown in the problems that for electric bends:

$$\frac{1}{R(s)} = \frac{E_x^a(s)}{\beta_b c [B\rho]}$$

- Applied fields for focusing:  $\mathbf{E}_\perp^a$ ,  $\mathbf{B}_\perp^a$ ,  $B_s^a$  must be expressed in the bent  $x,y,s$  system of the reference orbit
  - Includes error fields in dipoles
  - Self fields may also need to be solved taking into account bend terms
  - Often can be neglected in Poisson's Equation

$\nabla^2$  Operator Modified  
(add equation in future versions)

## S2: Transverse Particle Equations of Motion in Linear Focusing Channels S2A: Introduction

$$\begin{aligned}
 x'' + \frac{(\gamma_b \beta_b)'}{(\gamma_b \beta_b)} x' &= \frac{q}{m \gamma_b^3 \beta_b^2 c^2} E_x^a - \frac{q}{m \gamma_b \beta_b c} B_y^a + \frac{q}{m \gamma_b \beta_b c} B_z^a y' \\
 &\quad - \frac{q}{m \gamma_b^3 \beta_b^2 c^2} \frac{\partial \phi}{\partial x} \\
 y'' + \frac{(\gamma_b \beta_b)'}{(\gamma_b \beta_b)} y' &= \frac{q}{m \gamma_b \beta_b c} E_y^a + \frac{q}{m \gamma_b \beta_b c} B_x^a - \frac{q}{m \gamma_b \beta_b c} B_z^a x' \\
 &\quad - \frac{q}{m \gamma_b^3 \beta_b^2 c^2} \frac{\partial \phi}{\partial y}
 \end{aligned}$$

Equations previously derived under assumptions:

- ♦ No bends (fixed  $x$ - $y$ - $z$  coordinate system with no local bends)
- ♦ Paraxial equations ( $x'^2, y'^2 \ll 1$ )
- ♦ No dispersive effects ( $\beta_b$  same all particles), acceleration allowed ( $\beta_b \neq \text{const}$ )
- ♦ Electrostatic and leading-order (in  $\beta_b$ ) self-magnetic interactions

SM Lund, USPAS, June 2008

Transverse Particle Equations

37

77

The applied focusing fields

$$\begin{aligned}
 \text{Electric: } & E_x^a, E_y^a, E_z^a \\
 \text{Magnetic: } & B_x^a, B_y^a, B_z^a
 \end{aligned}$$

must be specified as a function of  $s$  and the transverse particle coordinates  $x$  and  $y$  to complete the description

- ♦ Consistent change in axial velocity ( $\beta_b c$ ) due to  $E_z^a$  must be evaluated
    - Typically due to RF cavities and/or induction cells
  - ♦ Restrict analysis to fields from applied focusing structures
- Intense beam accelerators and transport lattices are designed to optimize

*linear* applied focusing forces with terms:

$$\begin{aligned}
 \text{Electric: } E_x^a &\simeq (\text{function of } s) \times (x \text{ or } y) \\
 E_y^a &\simeq (\text{function of } s) \times (x \text{ or } y)
 \end{aligned}$$

$$\begin{aligned}
 \text{Magnetic: } B_x^a &\simeq (\text{function of } s) \times (x \text{ or } y) \\
 B_y^a &\simeq (\text{function of } s) \times (x \text{ or } y) \\
 B_z^a &\simeq (\text{function of } s)
 \end{aligned}$$

SM Lund, USPAS, June 2008

Transverse Particle Equations

38

Common situations that realize these linear applied focusing forms will be overviewed:

- ♦ Continuous Focusing (see: S2B)
- ♦ Quadrupole Focusing
  - Electric (see: S2C)
  - Magnetic (see: S2D)
- ♦ Solenoidal Focusing (see: S2E)

Other situations that will not be covered (typically more nonlinear optics):

- ♦ Enzil Lens (see: J.J. Barnard, [Intro Lectures](#))
- ♦ Plasma Lens
- ♦ Wire guiding

SM Lund, USPAS, June 2008

Transverse Particle Equations

39

## S2B: Continuous Focusing

Assume constant electric field applied focusing force:

$$\begin{aligned}
 \mathbf{B}^a &= 0 \\
 \mathbf{E}_{\perp}^a &= E_x^a \hat{\mathbf{x}} + E_y^a \hat{\mathbf{y}} = -\frac{m \gamma_b \beta_b^2 c^2 k_{\beta 0}^2}{q} \mathbf{x}_{\perp} & k_{\beta 0}^2 &\equiv \text{const} > 0 \\
 E_z^a &= 0 & [k_{\beta 0}^2] &= \frac{\text{rad}}{\text{m}^2}
 \end{aligned}$$

Continuous focusing equations of motion:

- ♦ Insert field components into linear applied field equations and collect terms

$$\mathbf{x}_{\perp}'' + \frac{(\gamma_b \beta_b)'}{(\gamma_b \beta_b)} \mathbf{x}_{\perp}' + k_{\beta 0}^2 \mathbf{x}_{\perp} = -\frac{q}{m \gamma_b^3 \beta_b^2 c^2} \frac{\partial \phi}{\partial \mathbf{x}_{\perp}}$$

Even this simple model can become complicated

- ♦ Space charge:  $\phi$  must be calculated consistent with beam evolution
- ♦ Acceleration: acts to damp orbits (see: S10)

SM Lund, USPAS, June 2008

Transverse Particle Equations

40

Simple model in limit of no acceleration ( $\gamma_b \beta_b \simeq \text{const}$ ) and negligible space-charge ( $\phi \simeq \text{const}$ ):

$$\mathbf{x}_{\perp}'' + k_{\beta 0}^2 \mathbf{x}_{\perp} = 0$$

$\implies$  orbits simple harmonic oscillators

General solution is elementary:

$$\begin{aligned} \mathbf{x}_{\perp} &= \mathbf{x}_{\perp}(s_i) \cos[k_{\beta 0}(s - s_i)] + [\mathbf{x}'_{\perp}(s_i)/k_{\beta 0}] \sin[k_{\beta 0}(s - s_i)] \\ \mathbf{x}'_{\perp} &= -k_{\beta 0} \mathbf{x}_{\perp}(s_i) \sin[k_{\beta 0}(s - s_i)] + \mathbf{x}'_{\perp}(s_i) \cos[k_{\beta 0}(s - s_i)] \end{aligned}$$

$\mathbf{x}_{\perp}(s_i) =$  Initial coordinate

$\mathbf{x}'_{\perp}(s_i) =$  Initial angle

### Problem with continuous focusing model:

The continuous focusing model is realized by a stationary ( $m \rightarrow \infty$ ) partially neutralizing uniform background of charges filling the beam pipe. To see this apply Maxwell's equations to the applied field to calculate an applied charge density:

$$\rho^a = \epsilon_0 \frac{\partial}{\partial \mathbf{x}} \cdot \mathbf{E}^a = - \frac{2m\epsilon_0 \gamma_b \beta_b^2 c^2 k_{\beta 0}^2}{q} = \text{const}$$

- ◆ Unphysical model, but commonly employed since it represents the average action of more physical focusing fields in a simpler to analyze model
  - Demonstrate later in simple examples and problems given
- ◆ Continuous focusing can provide reasonably good estimates for more realistic periodic focusing models if  $k_{\beta 0}^2$  is appropriately identified in terms of “equivalent” parameters *and* the periodic system is stable.
  - See lectures that follow and homework problems for examples

### /// Example: Particle Orbits in Continuous Focusing

Particle phase-space in  $x$ - $x'$  with only applied field

$$k_{\beta 0} = 2\pi \text{ rad/m} \quad x(0) = 1 \text{ mm}$$

$$\phi \simeq 0 \quad \gamma_b \beta_b = \text{const} \quad x'(0) = 0$$

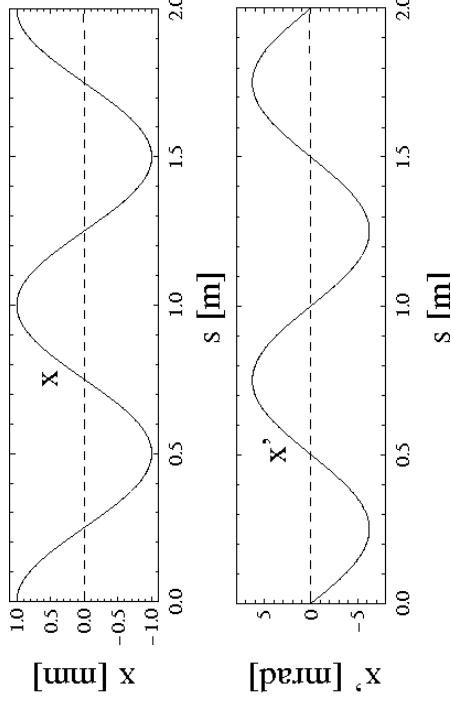

◆ Orbits in the applied field are just simple harmonic oscillators

In more realistic models, one requires that *quasi-static* focusing fields in the machine aperture satisfy the **vacuum Maxwell equations**

$$\begin{aligned} \nabla \cdot \mathbf{E}^a &= 0 & \nabla \cdot \mathbf{B}^a &= 0 \\ \nabla \times \mathbf{E}^a &= 0 & \nabla \times \mathbf{B}^a &= 0 \end{aligned}$$

- ◆ Require in the region of the beam
- ◆ Applied field sources outside of the beam region

The vacuum Maxwell equations constrain the 3D form of applied fields resulting from spatially localized lenses. The following cases can be exploited to optimize linear focusing strength in physically realizable systems while keeping the model relatively simple:

- 1) **Alternating Gradient Quadrupoles** with transverse orientation
  - Electric Quadrupoles (see: **S2C**)
  - Magnetic Quadrupoles (see: **S2D**)
- 2) **Solenoidal Magnetic Fields** with longitudinal orientation (see: **S2E**)



## S2C: Alternating Gradient Quadrupole Focusing

### Electric Quadrupoles

In the axial center of a long **electric quadrupole**, model the fields as 2D transverse

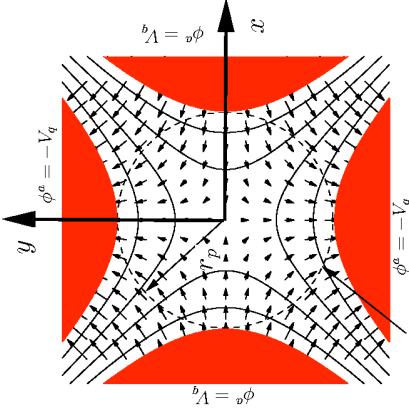

Electrodes Outside of Circle  $r = r_p$   
Electrodes:  $x^2 - y^2 = \mp r_p^2$

- ▶ Electrodes hyperbolic
- ▶ Structure infinitely extruded along  $z$

#### 2D Transverse Fields

$$\mathbf{B}^a = 0$$

$$E_x^a = -Gx$$

$$E_y^a = Gy$$

$$E_z^a = 0$$

$$G \equiv \frac{2V_q}{r_p^2} = -\frac{\partial E_x^a}{\partial x} = \frac{\partial E_y^a}{\partial y}$$

= Electric Gradient

$$V_q = \text{Pole Voltage}$$

$$r_p = \text{Pipe Radius (clear aperture)}$$

Quadrupoles actually have finite axial length in  $z$ . Model this by taking the gradient  $G$  to vary in  $s$ , i.e.,  $G = G(s)$  with  $s = z - z_{\text{center}}$  (straight section)

- ▶ Variation is called the **fringe-field** of the focusing element
- ▶ Variation will violate the Maxwell Equations in 3D
  - Provides a reasonable first approximation in many applications
- ▶ Usually quadrupole is long, and  $G(s)$  will have a flat central region and rapid variation near the ends

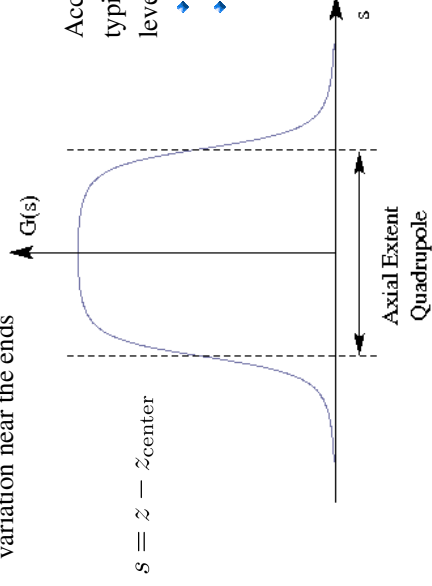

Accurate fringe calculation typically requires higher level modeling:

- ▶ 3D analysis
- ▶ Detailed geometry

For many applications the actual quadrupole fringe function  $G(s)$  is replaced by a simpler function to allow more idealized modeling

- ▶ Replacements should be made in an “equivalent” parameter sense to be detailed later (see: lectures on **Transverse Centroid and Envelope Modeling**)
- ▶ Fringe functions sometimes replaced by **piecewise constant**  $G(s)$ 
  - Often called “**hard-edge**” approximation
- ▶ See **S3** and Lund and Bukh, PRSTAB 7 924801 (2004), Appendix C for more details on equivalent models

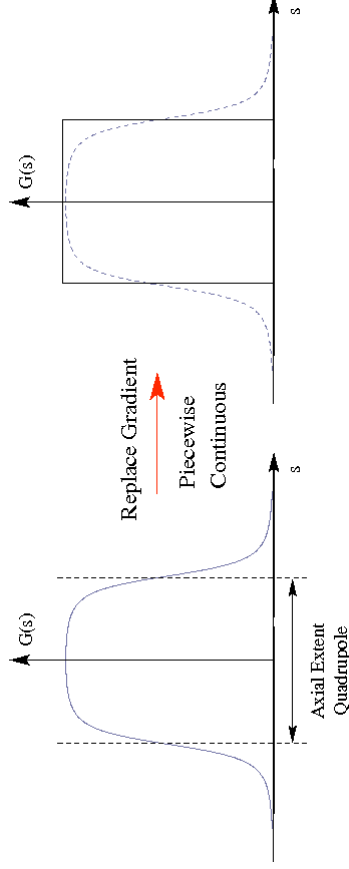

Replace Gradient  
Piecewise  
Continuous

#### Electric quadrupole equations of motion:

- ▶ Insert applied field components into linear applied field equations and collect terms

$$x'' + \frac{(\gamma_b \beta_b)'}{(\gamma_b \beta_b)} x' + \kappa(s)x = -\frac{q}{m\gamma_b^3 \beta_b^2 c^2} \frac{\partial \phi}{\partial x}$$

$$y'' + \frac{(\gamma_b \beta_b)'}{(\gamma_b \beta_b)} y' - \kappa(s)y = -\frac{q}{m\gamma_b^3 \beta_b^2 c^2} \frac{\partial \phi}{\partial y}$$

$$\kappa(s) = \frac{qG}{m\gamma_b \beta_b^2 c^2} = \frac{G}{\beta_b c [B\rho]}$$

$$G = -\frac{\partial E_x^a}{\partial y} = \frac{\partial E_y^a}{\partial x} = \frac{2V_q}{r_p^2} \quad [B\rho] = \frac{m\gamma_b \beta_b c}{q}$$

- ▶ For **positive/negative**  $\kappa$ , the applied forces are **Focusing/defocusing** in the  $x$ - and  $y$ -planes
- ▶ The  $x$ - and  $y$ -equations are decoupled

Quadrupoles must be arranged in a lattice where the particles traverse a sequence of optics with **alternating gradient** to focus strongly in all directions

- ◆ Alternating gradient necessary to provide focusing in both  $x$ - and  $y$ -planes
- ◆ **Alternating Gradient Focusing** often abbreviated “**AG**” and is sometimes called “**Strong Focusing**”
- ◆ Parameters should be tuned with particle properties and oscillation phases for proper operation
  - **F** (Focus) in plane placed where excursions (on average) are small
  - **D** (deFocus) placed where excursions (on average) are large
  - **O** (drift) allows axial separation between elements

/// Example: Particle Orbits in a FODO Periodic Quadrupole Focusing Lattice:

Particle phase-space in  $x$ - $x'$  with only hard-edge applied field

$$L_p = 0.5 \text{ m} \quad \kappa = \pm 50 \text{ in Quads} \quad x(0) = 1 \text{ mm}$$

$$\eta = 0.5 \quad \phi \simeq 0 \quad \gamma_b \beta_b = \text{const} \quad x'(0) = 0$$

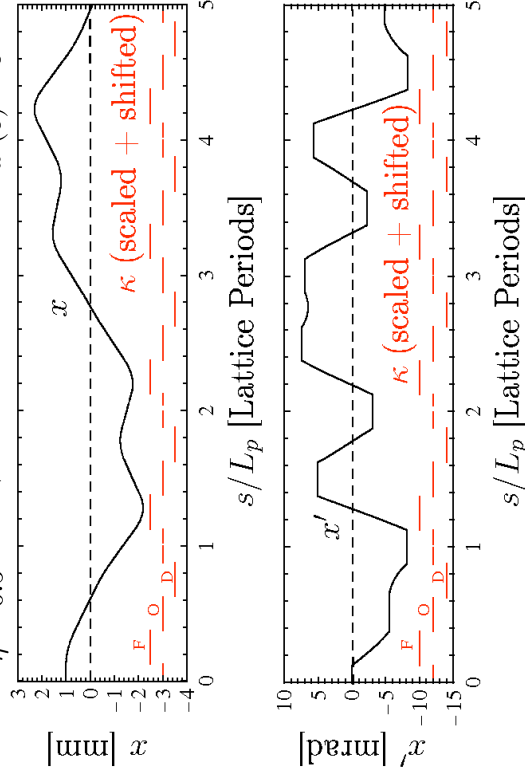

Example **Quadrupole FODO periodic lattices** with piecewise constant  $\kappa_x$

◆ FODO: [Focus drift(O) DeFocus Drift(O)] has equal length drifts and same length F and D quadrupoles

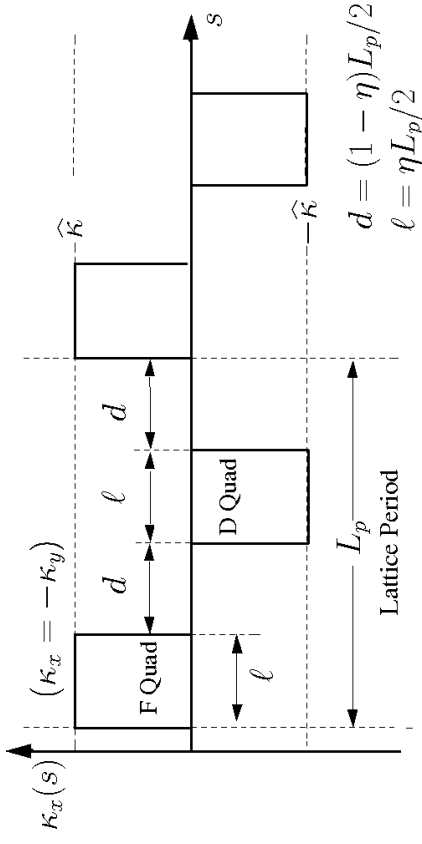

$$\eta = \text{Occupancy} \in (0, 1]$$

**Comments on Orbits:**

- ◆ Orbits strongly deviate from simple harmonic form due to AG focusing
  - Multiple harmonics present
- ◆ Orbit tends to be farther from axis in **focusing quadrupoles** and closer to axis in **defocusing quadrupoles** to provide net focusing
- ◆ Will find later that if the focusing is sufficiently strong that the orbit can become unstable (see: **S5**)
- ◆  $y$ -orbit has the same properties as  $x$ -orbit due to the periodic structure and AG focusing
- ◆ If quadrupoles are rotated about their  $z$ -axis of symmetry, then the  $x$ - and  $y$ -equations become cross-coupled. This is called quadrupole skew coupling (see: **Appendix A**)

Some properties of particle orbits in quadrupoles with  $\kappa = \text{const}$  will be analyzed in the problem sets



## S2D: Alternating Gradient Quadrupole Focusing Magnetic Quadrupoles

In the axial center of a long magnetic quadrupole, model fields as 2D transverse

### 2D Transverse Fields

$$\mathbf{E}^a = 0$$

$$B_x^a = Gy$$

$$B_y^a = Gx$$

$$B_z^a = 0$$

$$G \equiv \frac{B_q}{r_p} = \frac{\partial B_x^a}{\partial y} = \frac{\partial B_y^a}{\partial x} \\ = \text{Magnetic Gradient}$$

$$B_q = |\mathbf{B}^a|_{r=r_p} = \text{Pole Field}$$

$$r_p = \text{Pipe Radius}$$

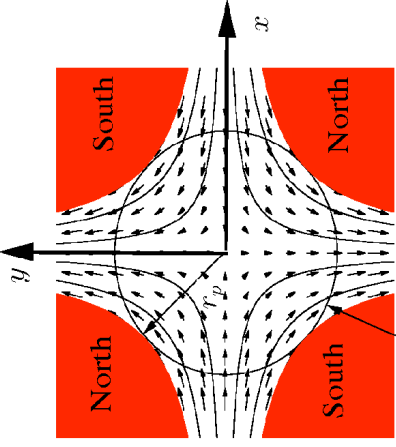

Conducting Beam Pipe:  $r = r_p$   
Poles:  $xy = \pm \frac{r_p^2}{2}$

- ♦ Magnetic (ideal iron) poles hyperbolic
- ♦ Structure infinitely extruded along  $z$

## S2E: Solenoidal Focusing

The field of an ideal magnetic solenoid is invariant under transverse rotations about it's axis of symmetry ( $z$ ) can be expanded in terms of the on-axis field as:

Coil (Azimuthally Symmetric)

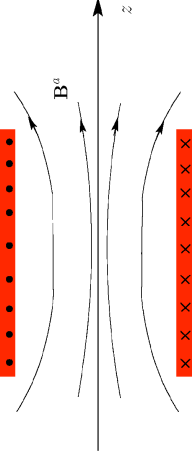

$$\mathbf{E}^a = 0$$

$$\mathbf{B}_\perp^a = \frac{1}{2} \sum_{\nu=1}^{\infty} \frac{(-1)^\nu}{\nu!(\nu-1)!} \frac{\partial^{2\nu-1} B_{z0}(z)}{\partial z^{2\nu-1}} \left( \frac{|\mathbf{x}_\perp|}{2} \right)^{2\nu-2} \mathbf{x}_\perp$$

$$B_z^a = B_{z0}(z) + \sum_{\nu=1}^{\infty} \frac{(-1)^\nu}{(\nu!)^2} \frac{\partial^{2\nu} B_{z0}(z)}{\partial z^{2\nu}} \left( \frac{|\mathbf{x}_\perp|}{2} \right)^{2\nu}$$

$$B_{z0}(z) \equiv B_z(\mathbf{x}_\perp = 0, z) = \text{On-Axis Field}$$

See Reiser,  
*Theory and Design  
of Charged  
Particle Beams,*  
Sec. 3.3.1

Analogously to the electric quadrupole case, take  $G = G(s)$

- ♦ Same comments made on electric quadrupole fringe in S2C are directly applicable to magnetic quadrupoles

Magnetic quadrupole equations of motion:

- ♦ Insert field components into linear applied field equations and collect terms

$$x'' + \frac{(\gamma_b \beta_b)'}{(\gamma_b \beta_b)} x' + \kappa(s)x = -\frac{q}{m\gamma_b^3 \beta_b^2 c^2} \frac{\partial \phi}{\partial x}$$

$$y'' + \frac{(\gamma_b \beta_b)'}{(\gamma_b \beta_b)} y' - \kappa(s)y = -\frac{q}{m\gamma_b^3 \beta_b^2 c^2} \frac{\partial \phi}{\partial y}$$

$$\kappa(s) = \frac{qG}{m\gamma_b \beta_b c} = \frac{G}{[B\rho]}$$

$$G = \frac{\partial B_x^a}{\partial y} = \frac{\partial B_y^a}{\partial x} = \frac{B_q}{r_p} \quad [B\rho] = \frac{m\gamma_b \beta_b c}{q}$$

- ♦ Equations identical to the electric quadrupole case in terms of  $\kappa(s)$
- ♦ All comments made on electric quadrupole focusing lattice are immediately applicable to magnetic quadrupoles; just apply different  $\kappa$  definition in design

For modeling, we truncate the expansion using only leading-order terms to obtain:

- ♦ Corresponds to linear dynamics in the equations of motion

$$B_x = -\frac{1}{2} \frac{\partial B_{z0}(z)}{\partial z} x$$

$$B_y = -\frac{1}{2} \frac{\partial B_{z0}(z)}{\partial z} y$$

$$B_z = B_{z0}(z) \\ = \text{On-Axis Field}$$

Note that this truncated expansion is divergence free:

$$\nabla \cdot \mathbf{B}^a = -\frac{1}{2} \frac{\partial B_{z0}}{\partial z} \frac{\partial}{\partial x_\perp} \cdot \mathbf{x}_\perp + \frac{\partial}{\partial z} B_{z0} = 0$$

but not curl free within the vacuum aperture:

(add analysis in future versions)

**Solenoid equations of motion:**

- Insert field components into linear applied field equations and collect terms

$$\begin{aligned}
 x'' + \frac{(\gamma_b \beta_b)'}{(\gamma_b \beta_b)} x' - \frac{\omega_c'(s)}{2\gamma_b \beta_b c} y - \frac{\omega_c(s)}{\gamma_b \beta_b c} y' &= -\frac{q}{m\gamma_b^3 \beta_b^2 c^2} \frac{\partial \phi}{\partial x} \\
 y'' + \frac{(\gamma_b \beta_b)'}{(\gamma_b \beta_b)} y' + \frac{\omega_c'(s)}{2\gamma_b \beta_b c} x + \frac{\omega_c(s)}{\gamma_b \beta_b c} x' &= -\frac{q}{m\gamma_b^3 \beta_b^2 c^2} \frac{\partial \phi}{\partial y}
 \end{aligned}$$

$$\omega_c(s) = \frac{qB_{z0}(s)}{m} = \text{Cyclotron Frequency (in applied axial magnetic field)}$$

- Equations are linearly **cross-coupled** in the applied field terms
  - $x$  equation depends on  $y, y'$
  - $y$  equation depends on  $x, x'$

If the beam space-charge is *axisymmetric*:

$$\frac{\partial \phi}{\partial \mathbf{x}_\perp} = \frac{\partial \phi}{\partial r} \frac{\partial \mathbf{x}_\perp}{\partial r} = \frac{\partial \phi}{\partial r} \frac{\mathbf{x}_\perp}{r}$$

then the space-charge term also decouples under the **Larmor transformation** and the equations of motion can be expressed in fully **uncoupled form**:

$$\begin{aligned}
 \tilde{x}'' + \frac{(\gamma_b \beta_b)'}{(\gamma_b \beta_b)} \tilde{x}' + \kappa(s) \tilde{x} &= -\frac{q}{m\gamma_b^3 \beta_b^2 c^2} \frac{\partial \phi}{\partial r} \frac{\tilde{x}}{r} \\
 \tilde{y}'' + \frac{(\gamma_b \beta_b)'}{(\gamma_b \beta_b)} \tilde{y}' + \kappa(s) \tilde{y} &= -\frac{q}{m\gamma_b^3 \beta_b^2 c^2} \frac{\partial \phi}{\partial r} \frac{\tilde{y}}{r} \\
 \kappa(s) &\equiv \left[ \frac{\omega_c(s)}{2\gamma_b \beta_b c} \right]^2 = k_L^2(s)
 \end{aligned}$$

Will demonstrate this in problems for the simple case of:  
 $\omega_c(s) = \text{const}$

- Because Larmor frame equations are in the same form as continuous and quadrupole focusing with a different  $\kappa$ , for solenoidal focusing we implicitly work in the Larmor frame and simplify notation by dropping the tildes:

$$\tilde{\mathbf{x}}_\perp \rightarrow \mathbf{x}_\perp$$

It can be shown (see: **Appendix B**) that the linear cross-coupling in the applied field can be removed by an  $s$ -varying transformation to a rotating “Larmor” frame:

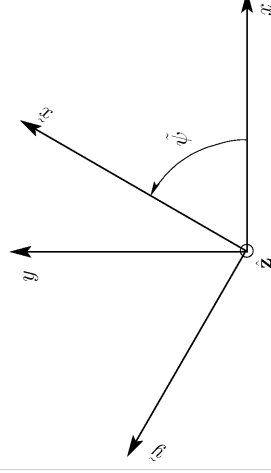

$$\begin{aligned}
 \tilde{x} &= x \cos \tilde{\psi}(s) + y \sin \tilde{\psi} \\
 \tilde{y} &= -x \sin \tilde{\psi}(s) + y \cos \tilde{\psi} \\
 \tilde{\psi}(s) &= \int_{s_i}^s d\tilde{s} k_L(\tilde{s}) \\
 k_L(s) &\equiv \frac{\omega_c(s)}{2\gamma_b \beta_b c} \\
 &= \text{Larmor wave number} \\
 s &= s_i \text{ defines initial condition}
 \end{aligned}$$

~ used to denote rotating frame variables

**/// Aside: Notation:**

A common theme of this class will be to introduce new effects and generalizations while keeping formulations looking as similar as possible to the most simple representations given. When doing so, we will often use “tildes” to denote transformed variables to stress that the new coordinates have, in fact, a more complicated form that must be interpreted in the context of the analysis being carried out. Some examples:

- Larmor frame transformations for Solenoidal focusing
- See: **Appendix B**
- Normalized variables for analysis of accelerating systems
- See: **S10**
- Coordinates expressed relative to the beam centroid
- See: S.M. Lund, lectures on **Transverse Centroid and Envelope Model**

///

- Solenoid periodic lattices** can be formed similarly to the quadrupole case
- Drifts placed between solenoids of finite axial length
    - Allows space for diagnostics, pumping, acceleration cells, etc.
  - Analogous equivalence cases to quadrupole
    - Piecewise constant  $\kappa$  often used
  - Fringe can be more important for solenoids

Simple hard-edge solenoid lattice with piecewise constant  $\kappa$

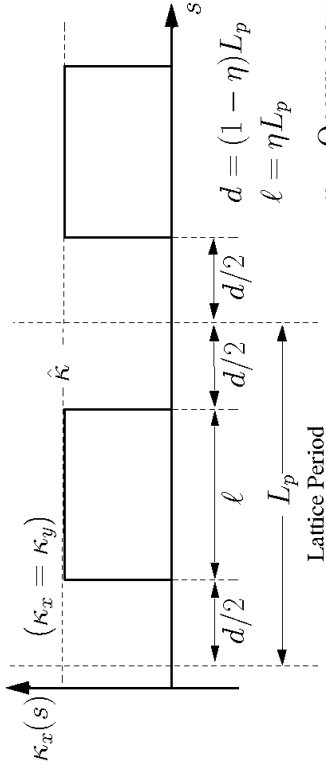

$$\eta = \text{Occupancy} \in (0, 1]$$

**Comments on Orbits:**

- Larmor-frame orbits strongly deviate from simple harmonic form due to periodic focusing
  - Multiple harmonics present
  - Less complicated than quadrupole AG focusing case when interpreted in the Larmor frame due to the optic being focusing in both planes
- Orbits can be transformed back into the Laboratory frame using Larmor transform (see: **Appendix B**)
  - Laboratory frame orbit exhibits more complicated x-y plane coupled oscillatory structure
- Will find later that if the focusing is sufficiently strong that the orbit can become unstable (see: **S5**)
- y-orbits have same properties as the x-orbits due to the equations being decoupled and identical in form in each plane

Some properties of particle orbits in solenoids with  $\kappa = \text{const}$  will be analyzed in the problem sets

**Example: Larmor Frame Particle Orbits in a Periodic Solenoidal Focusing**

Lattice:  $\tilde{x} - \tilde{x}'$  phase-space for hard edge elements and applied fields  
 $L_p = 0.5 \text{ m}$     $\kappa = 20 \text{ in Solenoids}$     $\tilde{x}(0) = 1 \text{ mm}$   
 $\eta = 0.5$     $\phi \simeq 0$     $\gamma_b \beta_b = \text{const}$     $\tilde{x}'(0) = 0$

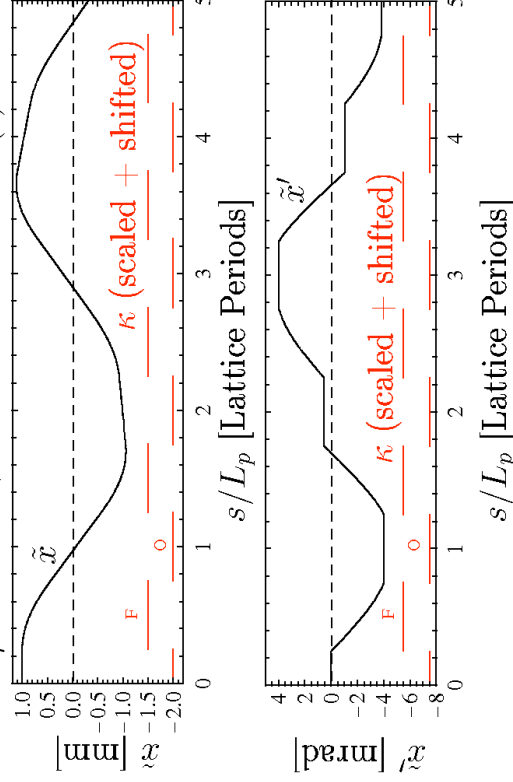

**S2F: Summary of Transverse Particle Equations of Motion**

In linear applied focusing channels, without momentum spread or radiation, the particle equations of motion in both the x- and y-planes expressed as:

$$x'' + \frac{(\gamma_b \beta_b)'}{(\gamma_b \beta_b)} x' + \kappa_x(s)x = -\frac{q}{m\gamma_b^3 \beta_b^2 c^2} \frac{\partial}{\partial x} \phi$$

$$y'' + \frac{(\gamma_b \beta_b)'}{(\gamma_b \beta_b)} y' + \kappa_y(s)y = -\frac{q}{m\gamma_b^3 \beta_b^2 c^2} \frac{\partial}{\partial y} \phi$$

$\kappa_x(s) = x$ -focusing function of lattice  
 $\kappa_y(s) = y$ -focusing function of lattice

**Common focusing functions:**

**Continuous:**  
 $\kappa_x(s) = \kappa_y(s) = k_{\beta 0}^2 = \text{const}$

**Quadrupole (Electric or Magnetic):**

$$\kappa_x(s) = -\kappa_y(s) = \kappa(s)$$

**Solenoidal (equations must be interpreted in Larmor Frame: see Appendix B):**

$$\kappa_x(s) = \kappa_y(s) = \kappa(s)$$

It is instructive to review the structure of solutions of the transverse particle equations of motion in the absence of:

Space-charge:  $\frac{\partial \phi}{\partial x} \sim \frac{\partial \phi}{\partial y} \sim 0$

Acceleration:  $\gamma_b \beta_b \simeq \text{const} \implies \frac{(\gamma_b \beta_b)'}{(\gamma_b \beta_b)} \simeq 0$

In this simple limit, the  $x$  and  $y$ -equations are of the same Hill's Equation form:

$$\begin{aligned} x'' + \kappa_x(s)x &= 0 \\ y'' + \kappa_y(s)y &= 0 \end{aligned}$$

- These equations are central to transverse dynamics in conventional accelerator physics (weak space-charge and acceleration)
    - Will study how solutions change with space-charge in later lectures
- In many cases beam transport lattices are designed where the applied focusing functions are **periodic**:

$$\begin{aligned} \kappa_x(s + L_p) &= \kappa_x(s) \\ \kappa_y(s + L_p) &= \kappa_y(s) \end{aligned} \quad L_p = \text{Lattice Period}$$

However, the focusing functions need not be periodic:

- Often take periodic or continuous in this class for simplicity of interpretation
- Focusing functions can vary strongly in many common situations:
- Matching and transition sections
  - Strong acceleration
  - Significantly different elements can occur within periods of lattices in rings
    - "Panofsky" type wide aperture quadrupoles for beam insertion and extraction in a ring

**Example of Non-Periodic Focusing Functions: Beam Matching Section**

Maintains alternating-gradient structure but not quasi-periodic

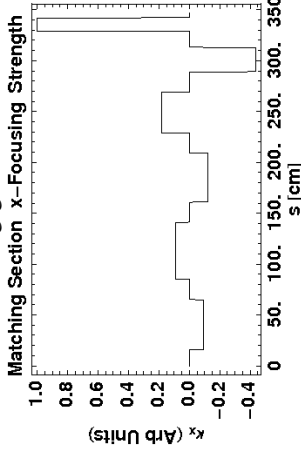

Example corresponds to High Current Experiment Matching Section (hard edge equivalent) at LBNL (2002)

Common, simple examples of periodic lattices:

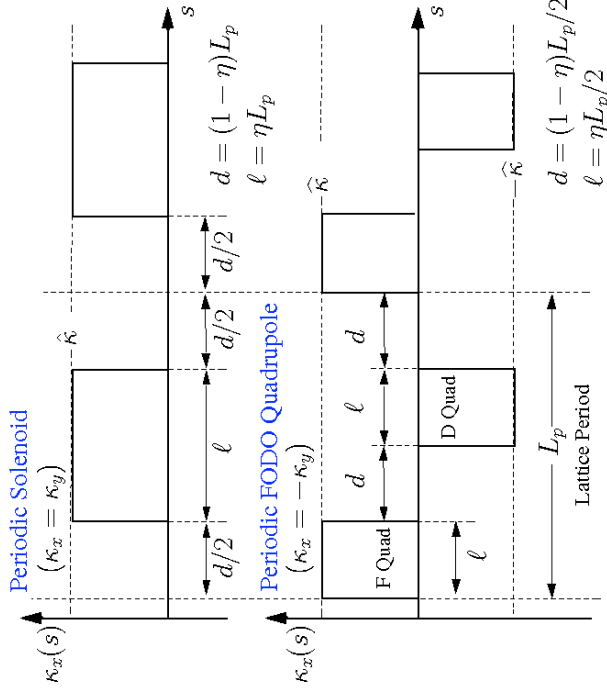

Equations presented in this section apply to a single particle moving in a beam under the action of linear applied focusing forces. In the remaining sections, we will (mostly) neglect space-charge ( $\phi \rightarrow 0$ ) as is conventional in the standard theory of low-intensity accelerators.

- What we learn from treatment will later aid analysis of space-charge effects
- Appropriate variable substitutions will be made to apply results
- Important to understand basic applied field dynamics since space-charge complicates
  - Results in plasma-like collective response

**Example:** We will see in **Transverse Centroid and Envelope Descriptions of Beam Evolution** that the linear particle equations of motion can be applied to analyze the evolution of a beam when image charges are neglected

$$\begin{aligned} x &\rightarrow x_c \equiv \langle x \rangle_{\perp} & x &- \text{centroid} \\ y &\rightarrow y_c \equiv \langle y \rangle_{\perp} & y &- \text{centroid} \end{aligned}$$

///

## Appendix A: Quadrupole Skew Coupling

Consider a quadrupole actively rotated through an angle  $\psi$  about the  $z$ -axis:

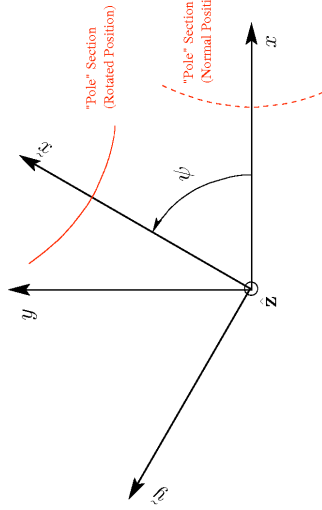

### Transforms

$$\begin{aligned}\tilde{x} &= x \cos \psi + y \sin \psi \\ \tilde{y} &= -x \sin \psi + y \cos \psi \\ x &= \tilde{x} \cos \psi - \tilde{y} \sin \psi \\ y &= \tilde{x} \sin \psi + \tilde{y} \cos \psi\end{aligned}$$

### Normal Orientation Fields

#### Electric

$$\begin{aligned}E_x^a &= -Gx \\ E_y^a &= Gy\end{aligned}$$

#### Magnetic

$$\begin{aligned}B_x^a &= Gy \\ B_y^a &= Gx\end{aligned}$$

$$G = G(s)$$

= Field Gradient  
(Electric or Magnetic)

A1

For *both* electric and magnetic focusing quadrupoles, these field component projections can be inserted in the linear field Eqns of motion to obtain:

#### Skew Coupled Quadrupole Equations of Motion

$$\begin{aligned}x'' + \frac{(\gamma_b \beta_b)'}{(\gamma_b \beta_b)} x' + \kappa \cos(2\psi)x + \kappa \sin(2\psi)y &= -\frac{q}{m\gamma_b^3 \beta_b^2 c^2} \frac{\partial \phi}{\partial x} \\ y'' + \frac{(\gamma_b \beta_b)'}{(\gamma_b \beta_b)} y' - \kappa \cos(2\psi)y + \kappa \sin(2\psi)x &= -\frac{q}{m\gamma_b^3 \beta_b^2 c^2} \frac{\partial \phi}{\partial y}\end{aligned}$$

$$\kappa = \begin{cases} \frac{G}{\beta_b c [B\rho]}, & \text{Electric Focusing} \\ \frac{G}{[B\rho]}, & \text{Magnetic Focusing} \end{cases}$$

System is *skew coupled*:

- $x$ -equation depends on  $y$ ,  $y'$  and  $y$ -equation on  $x$ ,  $x'$  for  $\psi \neq 0, \pi, 2\pi, \dots$
- Skew-coupling considerably complicates dynamics
- Unless otherwise specified, we consider only quadrupoles with “normal” orientation with  $\psi = 0$
- Skew coupling errors or intentional skew couplings can be important
  - Leads to transfer of oscillations energy between  $x$  and  $y$ -planes
  - Invariants much more complicated to construct/interpret

A3

## Rotated Fields

### Electric

$$\begin{aligned}E_x^a &= E_x^a \cos \psi - E_y^a \sin \psi & E_x^a &= -G\tilde{x} = -G(x \cos \psi + y \sin \psi) \\ E_y^a &= E_x^a \sin \psi + E_y^a \cos \psi & E_y^a &= G\tilde{y} = G(-x \sin \psi + y \cos \psi)\end{aligned}$$

Combine equations, collect terms, and apply trigonometric identities to obtain:

$$\begin{aligned}E_x^a &= -G \cos(2\psi)x - G \sin(2\psi)y & 2 \sin \psi \cos \psi &= \sin(2\psi) \\ E_y^a &= -G \sin(2\psi)x + G \cos(2\psi)y & \cos^2 \psi - \sin^2 \psi &= \cos(2\psi)\end{aligned}$$

### Magnetic

$$\begin{aligned}B_x^a &= B_x^a \cos \psi - B_y^a \sin \psi & B_x^a &= G\tilde{y} = G(-x \sin \psi + y \cos \psi) \\ B_y^a &= B_x^a \sin \psi + B_y^a \cos \psi & B_y^a &= G\tilde{x} = G(x \cos \psi + y \sin \psi)\end{aligned}$$

Combine equations, collect terms, and apply trigonometric identities to obtain:

$$\begin{aligned}B_x^a &= -G \sin(2\psi)x + G \cos(2\psi)y \\ B_y^a &= G \cos(2\psi)x + G \sin(2\psi)y\end{aligned}$$

A2

The skew coupled equations of motion can be alternatively derived by actively rotating the quadrupole equation of motion in the form:

$$\begin{aligned}x'' + \frac{(\gamma_b \beta_b)'}{(\gamma_b \beta_b)} x' + \kappa(s)x &= -\frac{q}{m\gamma_b^3 \beta_b^2 c^2} \frac{\partial \phi}{\partial x} \\ y'' + \frac{(\gamma_b \beta_b)'}{(\gamma_b \beta_b)} y' - \kappa(s)y &= -\frac{q}{m\gamma_b^3 \beta_b^2 c^2} \frac{\partial \phi}{\partial y}\end{aligned}$$

• Steps are then identical whether quadrupoles are electric *or* magnetic

A4

## Appendix B: The Larmor Transform to Express Solenoidal Focused Particle Equations of Motion in Uncoupled Form

Solenoid equations of motion:

$$\begin{aligned} x'' + \frac{(\gamma_b \beta_b)'}{(\gamma_b \beta_b)} x' - \frac{\omega'_c(s)}{2\gamma_b \beta_b c} y - \frac{\omega_c(s)}{\gamma_b \beta_b c} y' &= -\frac{q}{m\gamma_b^3 \beta_b^2 c^2} \frac{\partial \phi}{\partial x} \\ y'' + \frac{(\gamma_b \beta_b)'}{(\gamma_b \beta_b)} y' + \frac{\omega'_c(s)}{2\gamma_b \beta_b c} x + \frac{\omega_c(s)}{\gamma_b \beta_b c} x' &= -\frac{q}{m\gamma_b^3 \beta_b^2 c^2} \frac{\partial \phi}{\partial y} \end{aligned}$$

$$\omega_c(s) = \frac{qB_{z0}(s)}{m} = \text{Cyclotron Frequency} \quad (\text{in applied axial magnetic field})$$

To simplify algebra, introduce the **complex** coordinate

$$\underline{z} \equiv x + iy \quad i \equiv \sqrt{-1}$$

Note\* context clarifies use of  $i$  (particle index, initial cond, complex  $i$ )  
Then the two equations can be expressed as a single complex equation

$$\underline{z}'' + \frac{(\gamma_b \beta_b)'}{(\gamma_b \beta_b)} \underline{z}' + i \frac{\omega'_c(s)}{2\gamma_b \beta_b c} \underline{z} + i \frac{\omega_c(s)}{\gamma_b \beta_b c} \underline{z}' = -\frac{q}{m\gamma_b^3 \beta_b^2 c^2} \left( \frac{\partial \phi}{\partial x} + i \frac{\partial \phi}{\partial y} \right) \quad \text{B1}$$

If the potential is also axisymmetric with  $\phi = \phi(r)$  :

$$\frac{\partial \phi}{\partial x} + i \frac{\partial \phi}{\partial y} = \frac{\partial \phi}{\partial r} \frac{\underline{z}}{r} \quad r \equiv \sqrt{x^2 + y^2}$$

then the complex form equation of motion reduces to:

$$\underline{z}'' + \frac{(\gamma_b \beta_b)'}{(\gamma_b \beta_b)} \underline{z}' + i \frac{\omega'_c(s)}{2\gamma_b \beta_b c} \underline{z} + i \frac{\omega_c(s)}{\gamma_b \beta_b c} \underline{z}' = -\frac{q}{m\gamma_b^3 \beta_b^2 c^2} \frac{\partial \phi}{\partial r} \frac{\underline{z}}{r}$$

Following Wiedemann, Vol II, pg 82, introduce a transformed complex variable that is a local ( $s$ -varying) rotation:

$$\underline{z} \equiv \underline{z} e^{-i\tilde{\psi}(s)} = \tilde{x} + i\tilde{y}$$

$\tilde{\psi}(s)$  = phase-function (real-valued)

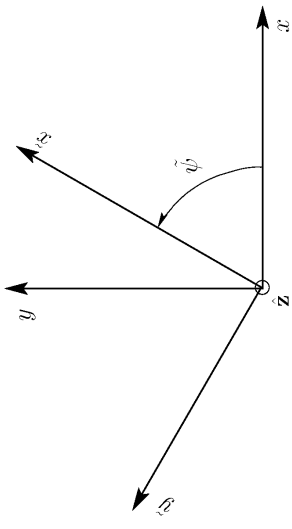

B2

Then:

$$\begin{aligned} \underline{z} &= \underline{z} e^{i\tilde{\psi}} \\ \underline{z}' &= \left( \underline{z}' + i\tilde{\psi}' \underline{z} \right) e^{i\tilde{\psi}} \\ \underline{z}'' &= \left( \underline{z}'' + 2i\tilde{\psi}' \underline{z}' + i\tilde{\psi}'' \underline{z} - \tilde{\psi}'^2 \underline{z} \right) e^{i\tilde{\psi}} \end{aligned}$$

and the complex form equations of motion become:

$$\begin{aligned} \underline{z}'' + \left[ i \left( 2\tilde{\psi}' + \frac{\omega_c}{\gamma_b \beta_b c} \right) + \frac{(\gamma_b \beta_b)'}{(\gamma_b \beta_b)} \right] \underline{z}' \\ + i \left[ -\tilde{\psi}'' - \frac{\omega_c}{\gamma_b \beta_b c} \tilde{\psi}' + i \left( \tilde{\psi}'' + \frac{\omega'_c(s)}{2\gamma_b \beta_b c} + \frac{(\gamma_b \beta_b)'}{(\gamma_b \beta_b)} \tilde{\psi}' \right) \right] \underline{z} \\ = -\frac{q}{m\gamma_b^3 \beta_b^2 c^2} \frac{\partial \phi}{\partial r} \frac{\underline{z}}{r} \end{aligned}$$

Free to choose the form of  $\tilde{\psi}$  Can choose to eliminate imaginary terms in [ ... ] by taking:

$$\tilde{\psi}' \equiv -\frac{\omega_c}{2\gamma_b \beta_b c} \quad \implies \quad \tilde{\psi}'' = -\frac{\omega'_c}{2\gamma_b \beta_b c} + \frac{\omega_c}{2c} \frac{(\gamma_b \beta_b)'}{(\gamma_b \beta_b)^2}$$

Using these results, the complex form equations of motion reduce to:

$$\underline{z}'' + \frac{(\gamma_b \beta_b)'}{(\gamma_b \beta_b)} \underline{z}' + \left( \frac{\omega_c}{2\gamma_b \beta_b c} \right)^2 \underline{z} = -\frac{q}{m\gamma_b^3 \beta_b^2 c^2} \frac{\partial \phi}{\partial r} \frac{\underline{z}}{r}$$

Or using  $\underline{z} = \tilde{x} + i\tilde{y}$ , the equations can be expressed in decoupled  $\tilde{x}, \tilde{y}$  variables in the **Larmor Frame** as:

$$\begin{aligned} \tilde{x} + \frac{(\gamma_b \beta_b)'}{(\gamma_b \beta_b)} \tilde{x}' + \kappa_s(s) \tilde{x} &= -\frac{q}{m\gamma_b^3 \beta_b^2 c^2} \frac{\partial \phi}{\partial r} \frac{\tilde{x}}{r} \\ \tilde{y} + \frac{(\gamma_b \beta_b)'}{(\gamma_b \beta_b)} \tilde{y}' + \kappa_s(s) \tilde{y} &= -\frac{q}{m\gamma_b^3 \beta_b^2 c^2} \frac{\partial \phi}{\partial r} \frac{\tilde{y}}{r} \\ \kappa_s(s) \equiv k_L^2(s) \quad k_L(s) \equiv \frac{\omega_c(s)}{2\gamma_b \beta_b c} \quad \omega_c(s) \equiv \frac{qB_{z0}(s)}{m} \\ &= \text{Larmor Wave-Number} \end{aligned}$$

Equations of motion are uncoupled but must be interpreted in the rotating Larmor frame

Same form as quadrupoles but with focusing function same sign in each plane



The rotational transformation to the **Larmor Frame** can be effected by integrating the equation for  $\tilde{\psi}' = -\frac{\omega_c}{2\gamma_b\beta_b}$

$$\tilde{\psi}(s) = -\frac{1}{2\gamma_b\beta_b c} \int_{s_i}^s d\tilde{s} \omega_c(\tilde{s}) = -\int_{s_i}^s d\tilde{s} k_L(\tilde{s})$$

Here,  $s_i$  is some value of  $s$  where the initial conditions are taken.

- Take  $s = s_i$  where axial field is zero for simplest interpretation (see: pg B6)

Because

$$\tilde{\psi}' = -\frac{\omega_c}{2\gamma_b\beta_b}$$

the local  $\tilde{x} - \tilde{y}$  Larmor frame is rotating at  $1/2$  of the local  $s$ -varying cyclotron frequency

- If  $B_{z0} = \text{const}$ , then the Larmor frame is uniformly rotating as is well known from elementary textbooks (see problem sets)

B5

The solution in the laboratory frame can be expressed in component form using the real and imaginary parts of the complex form transformations to obtain:

$$\begin{pmatrix} x \\ x' \\ y \\ y' \end{pmatrix} = \begin{pmatrix} \cos \tilde{\psi} & 0 & -\sin \tilde{\psi} & 0 \\ k_L \sin \tilde{\psi} & \cos \tilde{\psi} & \cos \tilde{\psi} & -\sin \tilde{\psi} \\ \sin \tilde{\psi} & 0 & \cos \tilde{\psi} & 0 \\ -k_L \cos \tilde{\psi} & \sin \tilde{\psi} & k_L \sin \tilde{\psi} & \cos \tilde{\psi} \end{pmatrix} \begin{pmatrix} \tilde{x} \\ \tilde{x}' \\ \tilde{y} \\ \tilde{y}' \end{pmatrix}$$

Here we used the transforms and

$$\begin{aligned} \tilde{z} &= \tilde{x} + i\tilde{y} \\ \tilde{z}' &= \tilde{x}' + i\tilde{y}' \end{aligned}$$

B7

The complex form phase-space transformation and inverse transformations are:

$$\begin{aligned} \tilde{z} &= \tilde{z} e^{i\tilde{\psi}} & \tilde{z} &= \tilde{z} e^{-i\tilde{\psi}} \\ \tilde{z}' &= (\tilde{z}' + i\tilde{\psi}' \tilde{z}) e^{i\tilde{\psi}} & \tilde{z}' &= (\tilde{z}' - i\tilde{\psi}' \tilde{z}) e^{-i\tilde{\psi}} \\ \tilde{z} &= x + iy & \tilde{z} &= \tilde{x} + i\tilde{y} & \tilde{\psi}' &= -\frac{\omega_c}{2\gamma_b\beta_b c} = -k_L \\ \tilde{z}' &= x' + iy' & \tilde{z}' &= \tilde{x}' + i\tilde{y}' \end{aligned}$$

Apply to:

- Project initial conditions from lab-frame when integrating equations
- Project integrated solution back to lab-frame to interpret solution

If the initial condition  $s = s_i$  is taken **outside of the magnetic field** where  $B_{z0}(s_i) = 0$ , then:

$$\begin{aligned} \tilde{x}(s = s_i) &= x(s = s_i) & \tilde{x}'(s = s_i) &= x'(s = s_i) \\ \tilde{y}(s = s_i) &= y(s = s_i) & \tilde{y}'(s = s_i) &= y'(s = s_i) \\ \tilde{z}(s = s_i) &= z(s = s_i) & \tilde{z}'(s = s_i) &= z'(s = s_i) \end{aligned}$$

B6

### S3: Description of Applied Focusing Fields

#### S3A: Overview

Applied fields for focusing, bending, and acceleration enter the equations of motion via:  $\mathbf{E}^a = \text{Applied Electric Field}$

$\mathbf{B}^a = \text{Applied Magnetic Field}$

Generally, these fields are produced by sources (often static or slowly varying in time) located outside an aperture or so-called pipe radius  $r = r_p$ . For example, the **electric and magnetic quadrupoles of S2:**

#### Electric Quadrupole

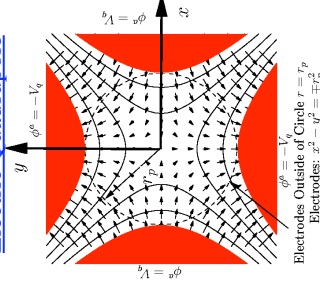

#### Magnetic Quadrupole

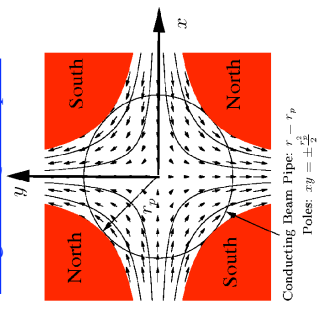

Electrodes:  $x^2 - y^2 = \pm r_p^2$   
Poles:  $xy = \pm \frac{r_p^2}{2}$

Conducting Beam Pipe:  $x = -r_p$   
Poles:  $xy = \pm \frac{r_p^2}{2}$

The fields of such classes of magnets obey the [vacuum Maxwell Equations](#) within the aperture:

$$\begin{aligned} \nabla \cdot \mathbf{E}^a &= 0 & \nabla \cdot \mathbf{B}^a &= 0 \\ \nabla \times \mathbf{E}^a &= -\frac{\partial}{\partial t} \mathbf{B}^a & \nabla \times \mathbf{B}^a &= \frac{1}{c^2} \frac{\partial}{\partial t} \mathbf{E}^a \end{aligned}$$

If the fields are static or sufficiently slowly varying (quasistatic) where the time derivative terms can be neglected, then the fields in the aperture will obey the [static vacuum Maxwell equations](#):

$$\begin{aligned} \nabla \cdot \mathbf{E}^a &= 0 & \nabla \cdot \mathbf{B}^a &= 0 \\ \nabla \times \mathbf{E}^a &= 0 & \nabla \times \mathbf{B}^a &= 0 \end{aligned}$$

In general, optical elements are tuned to [limit](#) the strength of [nonlinear field terms](#) so the beam experiences primarily [linear applied fields](#).

- Linear fields allow better preservation of beam quality
- Removal of *all* nonlinear fields cannot be accomplished
- 3D structure of the Maxwell equations precludes for finite geometry optics
- Even in finite geometries deviations from optimal structures and symmetry will result in nonlinear fields

The design of optimized electric and magnetic optics for accelerators is a specialized topic with a vast literature. It is not possible to cover this topic in this brief survey. In the remaining part of this section we will overview a limited subset of material on [magnetic optics](#) including:

- (see: [S3B](#)) [Magnetic field expansions](#) for focusing and bending
- (see: [S3C](#)) [Hard edge equivalent models](#)
- (see: [S3D](#)) [2D multipole models](#) and nonlinear field scalings
- (see: [S3E](#)) [Good field radius](#)

Much of the material presented can be immediately applied to static [Electric Optics](#) since the vacuum Maxwell equations are the same for static [Electric](#)  $\mathbf{E}^a$  and [Magnetic](#)  $\mathbf{B}^a$  fields in vacuum.

As an example of this, when an ideal 2D iron magnet with infinite hyperbolic poles is truncated radially for finite 2D geometr, this leads to nonlinear focusing fields even in 2D:

- Truncation necessary along with confinement of return flux in yoke

[Cross-Sections of Iron Quadrupole Magnets](#)

[Ideal \(infinite geometry\)](#)

[Practical \(finite geometry\)](#)

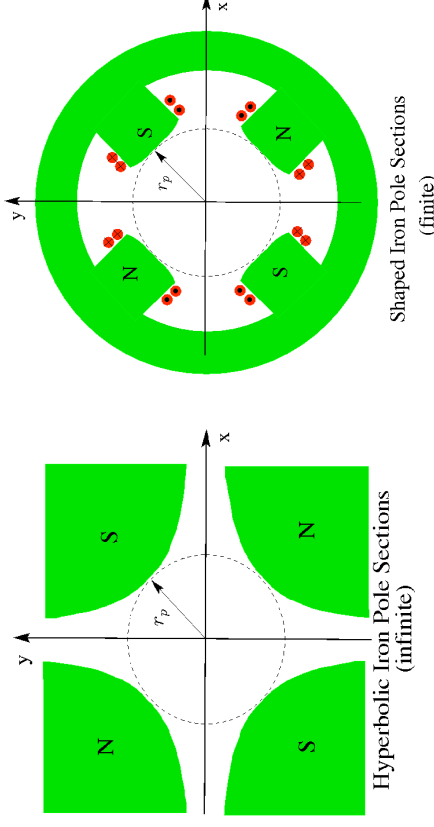

### S3B: Magnetic Field Expansions for Focusing and Bending

Transverse magnetic forces enter the transverse equations of motion (see: [S1](#), [S2](#))

via: **Force:**  $\mathbf{F}_{\perp}^a \simeq q\beta_b c \hat{\mathbf{z}} \times \mathbf{B}_{\perp}^a$

**Field:**  $\mathbf{B}_{\perp}^a = \hat{\mathbf{x}}B_x^a + \hat{\mathbf{y}}B_y^a$

Combined these give:

$$\begin{aligned} F_x^a &\simeq -q\beta_b c B_y^a \\ F_y^a &\simeq q\beta_b c B_x^a \end{aligned}$$

Field components entering these expressions can be expanded about  $\mathbf{x}_{\perp} = 0$

- Element center and design orbit taken to be  $\mathbf{x}_{\perp} = 0$

$$\begin{aligned} B_x^a &= B_x^a(0) + \frac{2}{\partial y} \frac{\partial B_x^a}{\partial x}(0)y + \frac{3}{\partial x} \frac{\partial B_x^a}{\partial x}(0)x & \text{Nonlinear Focus} \\ &+ \frac{1}{2} \frac{\partial^2 B_x^a}{\partial x^2}(0)x^2 + \frac{\partial^2 B_x^a}{\partial x \partial y}(0)xy + \frac{1}{2} \frac{\partial B_x^a}{\partial y}(0)y^2 + \dots \\ B_y^a &= B_y^a(0) + \frac{2}{\partial x} \frac{\partial B_y^a}{\partial x}(0)x + \frac{\partial B_y^a}{\partial y}(0)y & \text{Nonlinear Focus} \\ &+ \frac{1}{2} \frac{\partial^2 B_y^a}{\partial x^2}(0)x^2 + \frac{\partial^2 B_y^a}{\partial x \partial y}(0)xy + \frac{1}{2} \frac{\partial B_y^a}{\partial y}(0)y^2 + \dots \end{aligned}$$

Terms:

- 1: Dipole Bend
- 2: Normal Quad Focus
- 3: Skew Quad Focus



Sources of undesired nonlinear applied field components include:

- ▶ Intrinsic finite 3D geometry and the structure of the Maxwell equations
- ▶ Systematic errors or sub-optimal geometry associated with practical trade-offs in fabricating the optic
- ▶ Random construction errors in individual optical elements
- ▶ Alignment errors of magnets in the lattice giving field projections in unwanted directions
- ▶ Excitation errors effecting the field strength
  - Currents in coils not correct and/or unbalanced

More advanced treatments exploit less simple power-series expansions to express symmetries more clearly:

- ▶ Maxwell equations constrain structure of solutions
- ▶ Forms appropriate for bent coordinate systems in dipole bends can become complicated

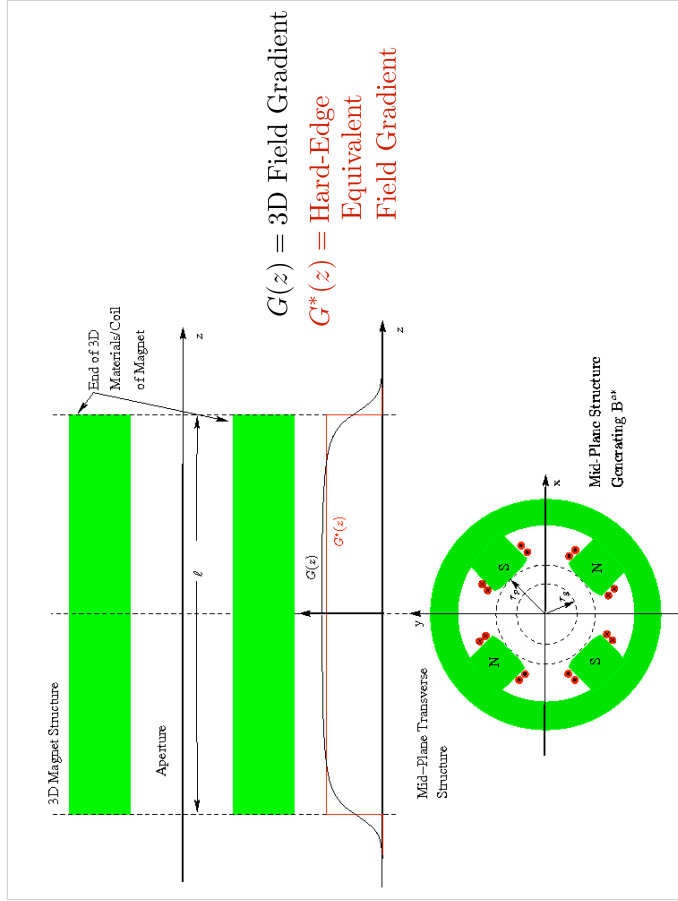

### S3C: Hard Edge Equivalent Models

Real 3D magnets can often be modeled with sufficient accuracy by 2D hard-edge “equivalent” magnets that give the same approximate focusing impulse to the particle as the full 3D magnet

- ▶ Objective is to provide same approximate applied focusing “kick” to particles with different gradient focusing functions  $G(s)$

See Figure Next Slide

Many prescriptions exist for calculating the effective axial length and strength of hard-edge equivalent models

- ▶ See Review: Lund and Bukh, PRSTAB 7 204801 (2004), Appendix C

Here we overview a simple equivalence method that has been shown to work

For a relatively long, but finite axial magnet with 3D gradient function:

$$G(z) \equiv \left. \frac{\partial B_x^a}{\partial y} \right|_{x=y=0}$$

Take hard-edge equivalent parameters:

- ▶ Assume  $z = 0$  at the axial magnet mid-plane

Gradient:  $G^* \equiv G(z = 0)$

Axial Length:  $\ell \equiv \frac{1}{G(z = 0)} \int_{-\infty}^{\infty} dz G(z)$

- ▶ More advanced equivalences can be made based more on particle optics
  - Disadvantage of such methods is “equivalence” changes with particle energy and must be revisited as optics are tuned

### S3D: 2D Transverse Multipole Magnetic Fields

In many cases, it is sufficient to characterize the field errors in 2D hard-edge equivalent as:

$$B_x(x, y) = \frac{1}{\ell} \int_{-\infty}^{\infty} dz B_x^a(x, y, z)$$

$$B_y(x, y) = \frac{1}{\ell} \int_{-\infty}^{\infty} dz B_y^a(x, y, z)$$

↑ 2D Effective Fields     ↑ 3D Fields

Operating on the vacuum Maxwell equations with:  $\int_{-\infty}^{\infty} \frac{dz}{\ell} \dots$   
yields the (exact) 2D Transverse Maxwell equations:

$$\frac{\partial B_x(x, y)}{\partial x} = -\frac{\partial B_y(x, y)}{\partial y}$$

$$\frac{\partial B_x(x, y)}{\partial y} = \frac{\partial B_y(x, y)}{\partial x}$$

The  $B_n$  are called "multipole coefficients" and give the structure of the field. The multipole coefficients can be resolved into real and imaginary parts as:

$$\underline{B}_n = b_n + ia_n$$

$$a_n \implies \text{"Normal" Multipoles}$$

$$b_n \implies \text{"Skew" Multipoles}$$

Some algebra identifies the polynomial symmetries of the terms as:

Index $n$	Name	Normal Field Components	Skew Field Components
		$B_x r_p^{n-1} / b_n$	$B_y r_p^{n-1} / b_n$
$n = 1$	Dipole	0	1
$n = 2$	Quadrupole	$y$	$x$
$n = 3$	Sextupole	$2xy$	$x^2 - y^2$
$n = 4$	Octupole	$3x^2y - y^3$	$x^3 - 3xy^2$
$\vdots$	$\vdots$	$\vdots$	$\vdots$
$\vdots$	$\vdots$	$\vdots$	$\vdots$

**Comments:**

- Reason for pole names most apparent from polar representation (see following pages) and sketches of the magnetic pole structure
- Caution: In Europe, poles are often labeled with index  $n - 1$

These equations are recognized as the Cauchy-Riemann conditions for a complex field variable:

$$\underline{B} = B_y + iB_x \quad i \equiv \sqrt{-1}$$

Notation:

Underlines denote complex variables  
to be an analytical function of the complex variable:

$$\underline{z} = x + iy \quad i \equiv \sqrt{-1}$$

- Note that the  $x$  and  $y$  components are exchanged from the "usual" complex ordering in the field variable  $\underline{B}$ . This is not a typo.
- The coordinate  $\underline{z}$  has the usual ordering

It follows that  $\underline{B}(\underline{z})$  can be analyzed using the full power of the highly developed theory of analytical functions of a complex variable.

Expand  $\underline{B}(\underline{z})$  as a Laurent Series within the vacuum aperture as:

$$\underline{B}(\underline{z}) = B_y + iB_x = \sum_{n=1}^{\infty} \underline{B}_n \left( \frac{\underline{z}}{r_p} \right)^{n-1}$$

$\underline{B}_n = \text{const (complex)}$

$n = \text{Multipole Index}$       $r_p = \text{Aperture "Pipe" Radius}$

Magnetic Pole Symmetries (normal orientation):

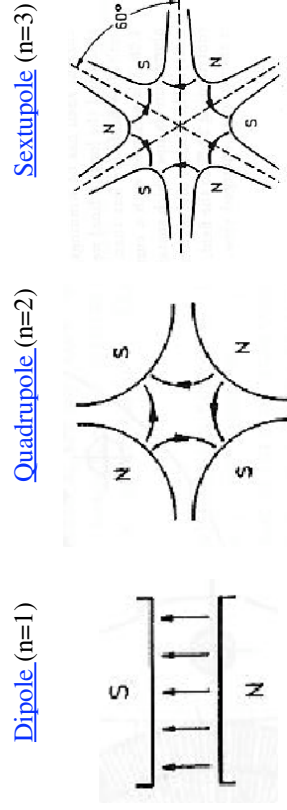

- Actively rotate structures clockwise through an angle of  $\pi / (2n)$  for skew component symmetries

Higher order multipole coefficients (larger  $n$  values) leading to nonlinear focusing forces decrease rapidly within the aperture. To see this use a polar representation for  $\underline{z}$ ,  $\underline{B}_n$

$$\underline{z} = x + iy = r e^{i\theta}$$

$$r = \sqrt{x^2 + y^2}$$

$$\theta = \arctan[y, x]$$

$$\underline{B}_n = |\underline{B}_n| e^{i\psi_n} \quad \psi_n = \text{Real Const}$$

Thus, the  $n$ th order multipole terms scale as

$$\underline{B}_n \left( \frac{\underline{z}}{r_p} \right)^{n-1} = |\underline{B}_n| \left( \frac{r}{r_p} \right)^{n-1} e^{i[(n-1)\theta + \psi_n]}$$

- Unless the coefficient  $|\underline{B}_n|$  is very large, high order terms in  $n$  will become small rapidly as  $r_p$  decreases
- Better field quality can be obtained for a given magnet design by simply making the clear bore  $r_p$  larger, or alternatively using smaller bundles (more tight focus) of particles
  - Larger bore machines/magnets cost more. So designs become trade-off between cost and performance.
  - Stronger focusing can also be unstable (see: **S5**)

### S3E: Good Field Radius

Often a magnet design will have a so-called “good-field” radius  $r = r_g$  that the maximum field errors are specified on.

- In superior designs the good field radius can be around ~70% or more of the clear bore aperture to the beginning of material structures of the magnet.
- Beam particles should evolve with radial excursions with  $r < r_g$

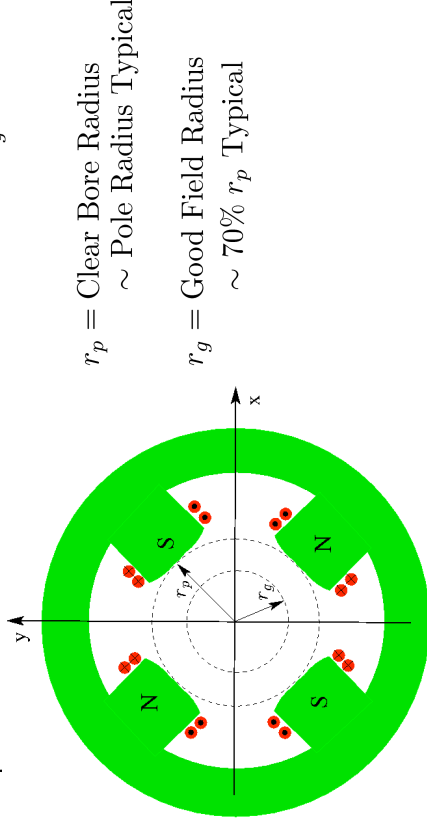

$r_p =$  Clear Bore Radius  
~ Pole Radius Typical

$r_g =$  Good Field Radius  
~ 70%  $r_p$  Typical

### Comments:

- Particle orbits are designed to remain within radius  $r_g$
- Field error statements are readily generalized to 3D since:

$$\nabla \cdot \mathbf{B}^a = 0 \quad \implies \quad \nabla^2 \mathbf{B}^a = 0$$

$$\nabla \times \mathbf{B}^a = 0$$

and therefore each component of  $\mathbf{B}^a$  satisfies a Laplace equation within the vacuum aperture. Therefore, field errors decrease when moving within a source-free region.

### S3F: Example Permanent Magnet Assemblies

A few examples of practical permanent magnet assemblies with field contours are provided to illustrate error field structures in practical devices

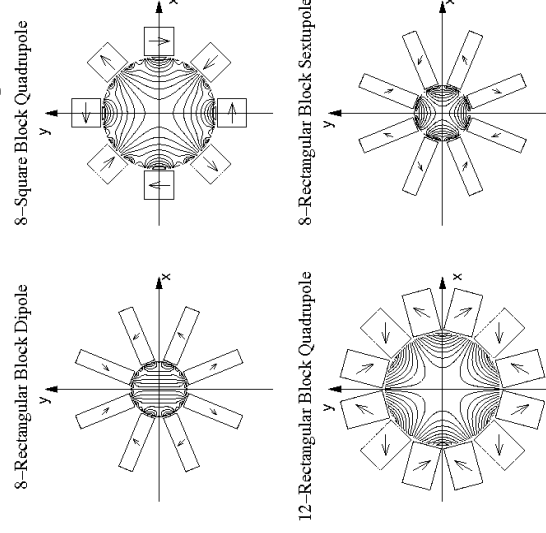

For more info on permanent magnet design see: Lund and Halbach, Fusion Engineering Design, **32-33**, 401-415 (1996)

## S4: Transverse Particle Equations of Motion with Nonlinear Applied Fields S4A: Overview

In S1 we showed that the particle equations of motion can be expressed as:

$$\mathbf{x}'_{\perp}'' + \frac{(\gamma_b \beta_b)'}{(\gamma_b \beta_b)} \mathbf{x}'_{\perp} = \frac{q}{m \gamma_b \beta_b^2 c^2} \mathbf{E}_{\perp}^a + \frac{q}{m \gamma_b \beta_b c} \hat{\mathbf{z}} \times \mathbf{B}_{\perp}^a + \frac{q B_z^a}{m \gamma_b \beta_b c} \mathbf{x}'_{\perp} \times \hat{\mathbf{z}} - \frac{q}{\gamma_b^3 \beta_b^2 c^2} \partial \mathbf{x}_{\perp}$$

When momentum spread is neglected and results are interpreted in a Cartesian coordinate system (no bends). In S2, we showed that these equations can be further reduced when the applied focusing fields are linear to:

$$\begin{aligned} x'' + \frac{(\gamma_b \beta_b)'}{(\gamma_b \beta_b)} x' + \kappa_x(s)x &= -\frac{q}{m \gamma_b^3 \beta_b^2 c^2} \frac{\partial \phi}{\partial x} \\ y'' + \frac{(\gamma_b \beta_b)'}{(\gamma_b \beta_b)} y' + \kappa_y(s)y &= -\frac{q}{m \gamma_b^3 \beta_b^2 c^2} \frac{\partial \phi}{\partial y} \end{aligned}$$

where  $\kappa_x(s) = x$ -focusing function of lattice

$\kappa_y(s) = y$ -focusing function of lattice

describe the linear applied focusing forces and the equations are implicitly analyzed in the rotating Larmor frame when  $B_z^a \neq 0$ .

Lattice designs attempt to minimize nonlinear applied fields. However, the 3D Maxwell equations show that there will always be some finite nonlinear applied fields for an applied focusing element with finite extent. Applied field nonlinearities also result from:

- Design idealizations
- Fabrication and material errors

The largest source of nonlinear terms will depend on the case analyzed.

**Nonlinear applied fields must be added back in the idealized model when it is appropriate to analyze their effects**

- Common problem to address when carrying out large-scale numerical simulations to design/analyze systems

There are two basic approaches to carry this out:

- Approach 1: Explicit 3D Formulation**
- Approach 2: Perturbations About Linear Applied Field Model**

## S4B: Approach 1: Explicit 3D Formulation

This is the simplest. Just employ the full 3D equations of motion expressed in terms of the applied field components  $\mathbf{E}^a$ ,  $\mathbf{B}^a$  and avoid using the focusing functions  $\kappa_x$ ,  $\kappa_y$

Comments:

- Most easy to apply in computer simulations where many effects are simultaneously included
  - Simplifies comparison to experiments when many details matter for high level agreement
- Simplifies simultaneous inclusion of transverse and longitudinal effects
  - Accelerating field  $E_z^a$  can be included to calculate changes in  $\beta_b$ ,  $\gamma_b$
  - Transverse and longitudinal dynamics cannot be fully decoupled in high level modeling – especially try when acceleration is strong in systems like injectors
- Can be applied with time based equations of motion (see: S1)
  - Helps avoid unit confusion and continuously adjusting complicated equations of motion to identify the axial coordinate  $s$  appropriately

## S4C: Approach 2: Perturbations About Linear Applied Field Model

Exploit the linearity of the Maxwell equations to take:

$$\begin{aligned} \mathbf{E}_{\perp}^a &= \mathbf{E}_{\perp}^a|_L + \delta \mathbf{E}_{\perp}^a \\ \mathbf{B}^a &= \mathbf{B}^a|_L + \delta \mathbf{B}^a \end{aligned}$$

where

$\mathbf{E}_{\perp}^a|_L$ ,  $\mathbf{B}^a|_L$  are the linear field components incorporated in  $\kappa_x$ ,  $\kappa_y$

to express the equations of motion as:

$$\begin{aligned} x'' + \frac{(\gamma_b \beta_b)'}{(\gamma_b \beta_b)} x' + \kappa_x x &= \frac{q}{m \gamma_b \beta_b^2 c^2} \delta E_x^a - \frac{q}{m \gamma_b \beta_b c} \delta B_y^a + \frac{q}{m \gamma_b \beta_b c} \delta B_z^a y' \\ &\quad - \frac{q}{m \gamma_b^3 \beta_b^2 c^2} \frac{\partial \phi}{\partial x} \\ y'' + \frac{(\gamma_b \beta_b)'}{(\gamma_b \beta_b)} y' + \kappa_y y &= \frac{q}{m \gamma_b \beta_b^2 c^2} \delta E_y^a + \frac{q}{m \gamma_b \beta_b c} \delta B_x^a - \frac{q}{m \gamma_b \beta_b c} \delta B_z^a x' \\ &\quad - \frac{q}{m \gamma_b^3 \beta_b^2 c^2} \frac{\partial \phi}{\partial y} \end{aligned}$$

This formulation can be most useful to understand the effect of deviations from the usual linear model where intuition is developed

**Comments:**

- Best suited to non-solenoidal focusing
  - Simplified Larmor frame analysis for solenoidal focusing is only valid for axisymmetric potentials  $\phi = \phi(r)$  which may not hold in the presence of non-ideal perturbations.
  - Applied field perturbations  $\delta \mathbf{E}_\perp^a$ ,  $\delta \mathbf{B}^a$  would also need to be projected into the Larmor frame
- Applied field perturbations  $\delta \mathbf{E}_\perp^a$ ,  $\delta \mathbf{B}^a$  will not necessarily satisfy the 3D Maxwell Equations by themselves
  - Follows because the linear field components  $\mathbf{E}_\perp^a|_L$ ,  $\mathbf{B}^a|_L$  will not, in general, satisfy the 3D Maxwell equations by themselves

For a periodic lattice:

$$\kappa(s + L_p) = \kappa(s)$$

$$L_p = \text{Lattice Period}$$

/// Example: Hard-Edge Periodic Focusing Function

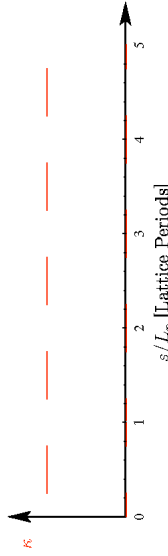

For a ring (i.e., circular accelerator), one also has the “superperiod” condition:

$$\kappa(s + \mathcal{C}) = \kappa(s)$$

$$\mathcal{C} = \mathcal{N}L_p = \text{Ring Circumference}$$

$$\mathcal{N} = \text{Superperiod Number}$$

- Distinction matters when there are (field) construction errors in the ring
  - Repeat with superperiod but not lattice period
- See lectures on: **Particle Resonances**

**S5: Linear Transverse Particle Equations of Motion without Space-Charge, Acceleration, and Momentum Spread**

**S5A: Hill's Equation**

Neglect:

- Space-charge effects:  $\partial\phi/\partial\mathbf{x} \simeq 0$
- Nonlinear applied focusing and bends:  $\mathbf{E}^a$ ,  $\mathbf{B}^a$  have only linear focus terms
- Acceleration:  $\gamma_b\beta_b \simeq \text{const}$
- Momentum spread effects:  $v_{zi} \simeq \beta_b c$

Then the transverse particle equations of motion reduce to **Hill's Equation**:

$$x''(s) + \kappa(s)x(s) = 0$$

$x = \perp$  particle coordinate

(i.e.,  $x$  or  $y$  or possibly combinations of coordinates)

$s =$  Axial coordinate of reference particle

$$l = \frac{d}{ds}$$

$\kappa(s) =$  Lattice focusing function (linear fields)

/// Example: Period and Superperiod distinctions for errors in a ring

- Magnet with systematic defect will be felt every lattice period
- Magnet with random (fabrication) defect felt once per lap

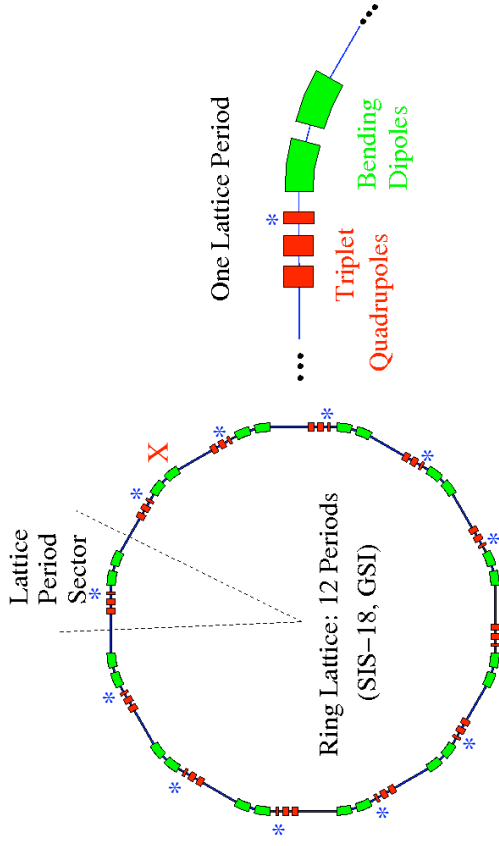



## S5B: Transfer Matrix Form of the Solution to Hill's Equation

Hill's equation is linear. The solution with initial condition:

$$\begin{aligned} x(s = s_i) &= x(s_i) & s = s_i &= \text{Axial location} \\ x'(s = s_i) &= x'(s_i) & & \text{of initial condition} \end{aligned}$$

can be uniquely expressed in matrix form ( $\mathbf{M}$  is the transfer matrix) as:

$$\begin{aligned} \begin{bmatrix} x(s) \\ x'(s) \end{bmatrix} &= \mathbf{M}(s|s_i) \cdot \begin{bmatrix} x(s_i) \\ x'(s_i) \end{bmatrix} \\ &= \begin{bmatrix} C(s|s_i) & S(s|s_i) \\ C'(s|s_i) & S'(s|s_i) \end{bmatrix} \cdot \begin{bmatrix} x(s_i) \\ x'(s_i) \end{bmatrix} \end{aligned}$$

Where  $C(s|s_i)$  and  $S(s|s_i)$  are “cosine-like” and “sine-like” principal trajectories satisfying:

$$\begin{aligned} C''(s|s_i) + \kappa(s)C(s|s_i) &= 0 & C(s_i|s_i) &= 1 & C'(s_i|s_i) &= 0 \\ S''(s|s_i) + \kappa(s)S(s|s_i) &= 0 & S(s_i|s_i) &= 0 & S'(s_i|s_i) &= 1 \end{aligned}$$

Transfer matrices will be worked out in the problems for a few simple focusing systems discussed in S2 with the additional assumption of piecewise constant  $\kappa(s)$

1) Drift:  $\kappa = 0$

$$\mathbf{M}(s|s_i) = \begin{bmatrix} 1 & s - s_i \\ 0 & 1 \end{bmatrix}$$

2) Continuous Focusing:  $\kappa = k_{\beta 0}^2 = \text{const} > 0$

$$\mathbf{M}(s|s_i) = \begin{bmatrix} \cos[k_{\beta 0}(s - s_i)] & \frac{1}{k_{\beta 0}} \sin[k_{\beta 0}(s - s_i)] \\ -k_{\beta 0} \sin[k_{\beta 0}(s - s_i)] & \cos[k_{\beta 0}(s - s_i)] \end{bmatrix}$$

3) Solenoidal Focusing:  $\kappa = \hat{\kappa} = \text{const} > 0$

Results are expressed within the rotating Larmor Frame

(same as continuous focusing with reinterpretation of variables)

$$\mathbf{M}(s|s_i) = \begin{bmatrix} \cos[\sqrt{\hat{\kappa}}(s - s_i)] & \frac{1}{\sqrt{\hat{\kappa}}} \sin[\sqrt{\hat{\kappa}}(s - s_i)] \\ -\sqrt{\hat{\kappa}} \sin[\sqrt{\hat{\kappa}}(s - s_i)] & \cos[\sqrt{\hat{\kappa}}(s - s_i)] \end{bmatrix}$$

4) Quadrupole Focusing-Plane:  $\kappa = \hat{\kappa} = \text{const} > 0$

(Obtain from continuous focusing case)

$$\mathbf{M}(s|s_i) = \begin{bmatrix} \cos[\sqrt{\hat{\kappa}}(s - s_i)] & \frac{1}{\sqrt{\hat{\kappa}}} \sin[\sqrt{\hat{\kappa}}(s - s_i)] \\ -\sqrt{\hat{\kappa}} \sin[\sqrt{\hat{\kappa}}(s - s_i)] & \cos[\sqrt{\hat{\kappa}}(s - s_i)] \end{bmatrix}$$

5) Quadrupole DeFocusing-Plane:  $\kappa = -\hat{\kappa} = \text{const} < 0$

(Obtain from quadrupole focusing case with  $\hat{\kappa} \rightarrow i\hat{\kappa}$   $i = \sqrt{-1}$ )

$$\mathbf{M}(s|s_i) = \begin{bmatrix} \cosh[\sqrt{\hat{\kappa}}(s - s_i)] & \frac{1}{\sqrt{\hat{\kappa}}} \sinh[\sqrt{\hat{\kappa}}(s - s_i)] \\ \sqrt{\hat{\kappa}} \sinh[\sqrt{\hat{\kappa}}(s - s_i)] & \cosh[\sqrt{\hat{\kappa}}(s - s_i)] \end{bmatrix}$$

6) Thin Lens:  $\kappa(s) = \frac{1}{f} \delta(s - s_0)$   $s_0 = \text{const} = \text{Axial Location Lens}$

$f = \text{const} = \text{Focal Length}$

$\delta(x) = \text{Dirac-Delta Function}$

$$\mathbf{M}(s_0^+|s_0^-) = \begin{bmatrix} 1 & 0 \\ -\frac{1}{f} & 1 \end{bmatrix}$$

## S5C: Wronskian Symmetry of Hill's Equation

An important property of this linear motion is a Wronskian invariant/symmetry:

$$\begin{aligned} W(s|s_i) &\equiv \det \mathbf{M}(s|s_i) = \det \begin{bmatrix} C(s|s_i) & S(s|s_i) \\ C'(s|s_i) & S'(s|s_i) \end{bmatrix} \\ &= C(s|s_i)S'(s|s_i) - C'(s|s_i)S(s|s_i) = 1 \end{aligned}$$

/// Proof: Abbreviate Notation  $C \equiv C(s|s_i)$  etc.

Multiply Equations of Motion for  $C$  and  $S$  by  $S$  and  $C$ , respectively:

$$-S(C'' + \kappa C) = 0$$

$$+C(S'' + \kappa S) = 0$$

Add Equations:

$$CS'' - SC'' + \kappa(CS - SC) = 0$$

$$\implies \frac{dW}{ds} = 0 \implies W = \text{const}$$

Apply initial conditions:

$$W(s) = W(s_i) = C_i S_i' - C_i' S_i = 1 \cdot 1 - 0 \cdot 0 = 1 \quad ///$$

/// Example: Continuous Focusing: Transfer Matrix and Wronskian

$$\kappa(s) = k_{\beta 0}^2 = \text{const} > 0$$

Principal orbit equations are simple harmonic oscillators with solution:

$$C(s|s_i) = \cos[k_{\beta 0}(s - s_i)] \quad C'(s|s_i) = -k_{\beta 0} \sin[k_{\beta 0}(s - s_i)]$$

$$S(s|s_i) = \frac{\sin[k_{\beta 0}(s - s_i)]}{k_{\beta 0}} \quad S'(s|s_i) = \cos[k_{\beta 0}(s - s_i)]$$

Transfer matrix gives the familiar solution:

$$\begin{bmatrix} x(s) \\ x'(s) \end{bmatrix} = \begin{bmatrix} \cos[k_{\beta 0}(s - s_i)] & \frac{\sin[k_{\beta 0}(s - s_i)]}{k_{\beta 0}} \\ -k_{\beta 0} \sin[k_{\beta 0}(s - s_i)] & \cos[k_{\beta 0}(s - s_i)] \end{bmatrix} \cdot \begin{bmatrix} x(s_i) \\ x'(s_i) \end{bmatrix}$$

Wronskian invariant is elementary:

$$W = \cos^2[k_{\beta 0}(s - s_i)] + \sin^2[k_{\beta 0}(s - s_i)] = 1$$

///

Clarification of stability notion: Unstable Orbit

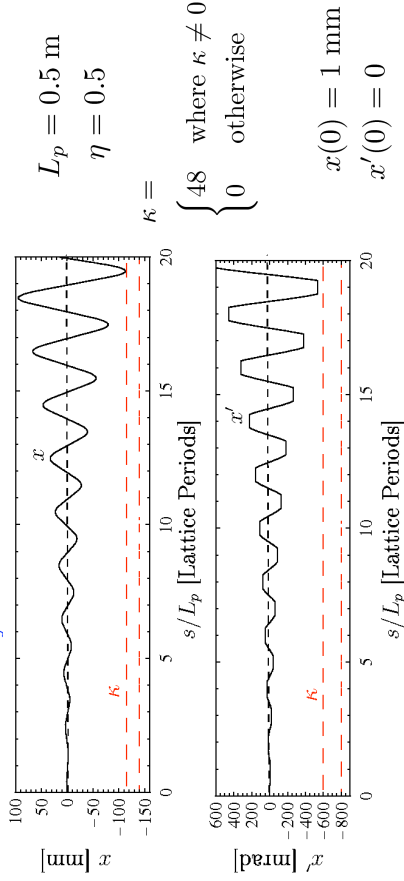

For energetic particle:  
 $H = \frac{1}{2}x'^2 + \frac{1}{2}\kappa x^2 \sim \text{Large, but } \neq \text{const}$

where  $|x'|$  small,  $|x|$  large  
 where  $|x|$  small,  $|x'|$  large

The matrix criterion corresponds to our intuitive notion of stability: as the particle advances there are no large oscillation excursions in position and angle.

S5D: Stability of Solutions to Hill's Equation in a Periodic Lattice

The transfer matrix must be the same in any period of the lattice:

$$\mathbf{M}(s + L_p | s_i + L_p) = \mathbf{M}(s | s_i)$$

For a propagation distance  $s - s_i$  satisfying

$$NL_p \leq s - s_i \leq (N + 1)L_p \quad N = 0, 1, 2, \dots$$

the transfer matrix can be resolved as

$$\begin{aligned} \mathbf{M}(s | s_i) &= \mathbf{M}(s - NL_p | s_i) \cdot \mathbf{M}(s_i + NL_p | s_i) \\ &= \mathbf{M}(s - NL_p | s_i) \cdot [\mathbf{M}(s_i + L_p | s_i)]^N \\ &\quad \text{Residual} \quad \quad \quad N \text{ Full Periods} \end{aligned}$$

For a lattice to have stable orbits, both  $x(s)$  and  $x'(s)$  should remain bounded on propagation through an arbitrary number  $N$  of lattice periods. This is equivalent to requiring that the elements of  $\mathbf{M}$  remain bounded on propagation through any number of lattice periods:  $\mathbf{M}^N \equiv [\mathbf{M}^N]_{ij}$

$$\lim_{N \rightarrow \infty} |\mathbf{M}^N]_{ij}| < \infty \implies \text{Stable Motion}$$

To analyze the stability condition, examine the eigenvectors/eigenvalues of  $\mathbf{M}$  for transport through one lattice period:

$$\begin{aligned} \mathbf{M}(s_i + L_p | s_i) \cdot \mathbf{E} &\equiv \lambda \mathbf{E} \\ \mathbf{E} &= \text{Eigenvector} \\ \lambda &= \text{Eigenvalue} \end{aligned}$$

- ◆ Eigenvectors and Eigenvalues are generally complex
- ◆ Eigenvectors and Eigenvalues generally vary with  $s_i$
- ◆ Two independent Eigenvectors and Eigenvalues
  - Degeneracies special case

Derive the two independent eigenvectors/eigenvalues through analysis of the characteristic equation: Abbreviate Notation

$$\mathbf{M}(s_i + L_p | s_i) = \begin{bmatrix} C(s_i + L_p | s_i) & S(s_i + L_p | s_i) \\ C'(s_i + L_p | s_i) & S'(s_i + L_p | s_i) \end{bmatrix} \equiv \begin{bmatrix} C & S \\ C' & S' \end{bmatrix}$$

Nontrivial solutions exist when:

$$\det \begin{bmatrix} C - \lambda & S \\ C' & S' - \lambda \end{bmatrix} = \lambda^2 + (C + S')\lambda + (CS' - SC') = 0$$

But we can apply the **Wronskian condition**:

$$CS' - SC' = 1$$

and we make the notational definition

$$C + S' = \text{Tr } \mathbf{M} \equiv 2 \cos \sigma_0$$

The **characteristic equation** then reduces to:

$$\lambda^2 - 2\lambda \cos \sigma_0 + 1 = 0 \quad \cos \sigma_0 \equiv \frac{1}{2} \text{Tr } \mathbf{M}(s_i + L_p | s_i)$$

- The use of  $2 \cos \sigma_0$  to denote  $\text{Tr } \mathbf{M}$  is in anticipation of later results (see S6) where  $\sigma_0$  is identified as the phase-advance of a stable orbit

There are two solutions to the characteristic equation that we denote  $\lambda_{\pm}$

$$\lambda_{\pm} = \cos \sigma_0 \pm \sqrt{\cos^2 \sigma_0 - 1} = \cos \sigma_0 \pm i \sin \sigma_0 = e^{\pm i \sigma_0}$$

$$\mathbf{E}_{\pm} = \text{Corresponding Eigenvectors} \quad i \equiv \sqrt{-1}$$

- Note that:  $\lambda_+ \lambda_- = 1$   
 $\lambda_+ = 1/\lambda_-$

Consider a vector of **initial conditions**:

$$\begin{bmatrix} x(s_i) \\ x'(s_i) \end{bmatrix} = \begin{bmatrix} x_i \\ x'_i \end{bmatrix}$$

The eigenvectors  $\mathbf{E}_{\pm}$  span two-dimensional space. So any initial condition vector can be expanded as:

$$\begin{bmatrix} x_i \\ x'_i \end{bmatrix} = \alpha_+ \mathbf{E}_+ + \alpha_- \mathbf{E}_-$$

$$\alpha_{\pm} = \text{Complex Constants}$$

Then using  $\mathbf{M}\mathbf{E}_{\pm} = \lambda_{\pm} \mathbf{E}_{\pm}$

$$\mathbf{M}^N(s_i + L_p | s_i) \begin{bmatrix} x_i \\ x'_i \end{bmatrix} = \alpha_+ \lambda_+^N \mathbf{E}_+ + \alpha_- \lambda_-^N \mathbf{E}_-$$

Therefore, if  $\lim_{N \rightarrow \infty} \lambda^N$  is bounded, then the motion is **stable**. This will always be the case if  $|\lambda_{\pm}| \leq 1$ , corresponding to  $\sigma_0$  real with  $|\cos \sigma_0| \leq 1$

This implies **for stability** on the orbit that we must have:

$$\frac{1}{2} |\text{Trace } \mathbf{M}(s_i + L_p | s_i)| = \frac{1}{2} |C(s_i + L_p | s_i) + S'(s_i + L_p | s_i)|$$

$$= |\cos \sigma_0| \leq 1$$

In a periodic focusing lattice, this important **stability condition** places restrictions on the lattice structure (focusing strength) that are generally interpreted in terms of **phase advance limits** (see: S6).

- Accelerator lattices almost always tuned for single particle stability to maintain beam control
  - Even for intense beams, beam centroid approximately obeys single particle equations of motion when image charges are negligible
- Space-charge and nonlinear applied fields can further limit particle stability
  - Resonances: see: **Particle Resonances** ....
  - Envelope Instability: see: **Transverse Centroid and Envelope** ....
  - Higher Order Instability: see: **Transverse Kinetic Stability**
- We will show (see: S6) that for stable orbits  $\sigma_0$  can be interpreted as the phase-advance of single particle oscillations

/// Example: **Continuous Focusing Stability**

$$\kappa(s) = k_{\beta 0}^2 = \text{const} > 0$$

**Principal orbit** equations are simple harmonic oscillators with solution:

$$C(s | s_i) = \cos[k_{\beta 0}(s - s_i)] \quad C'(s | s_i) = -k_{\beta 0} \sin[k_{\beta 0}(s - s_i)]$$

$$S(s | s_i) = \frac{\sin[k_{\beta 0}(s - s_i)]}{k_{\beta 0}} \quad S'(s | s_i) = \cos[k_{\beta 0}(s - s_i)]$$

**Stability bound** then gives:

$$\frac{1}{2} |\text{Trace } \mathbf{M}(s_i + L_p | s_i)| = \frac{1}{2} |C(s_i + L_p | s_i) + S'(s_i + L_p | s_i)|$$

$$= |\cos(k_{\beta 0}(s - s_i))| \leq 1$$

- Always satisfied for real  $k_{\beta 0}$
- Confirms known result using formalism: **continuous focusing stable**
  - Energy not pumped into or out of particle orbit

The simplest example of the stability criterion applied to periodic lattices will be given in the problem sets: **Stability of a periodic thin lens lattice** ///

- Analytically find that lattice unstable when focusing kicks sufficiently strong



More advanced treatments

- See: Dragt, *Lectures on Nonlinear Orbit Dynamics*, AIP Conf Proc 87 (1982) show that symplectic 2x2 transfer matrices associated with Hill's Equation have only two possible classes of eigenvalue symmetries:

1) Stable

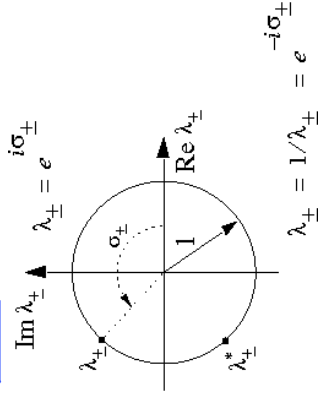

Occurs for:

$$0 \leq \sigma_0 \leq 180^\circ/\text{period}$$

- Limited class of possibilities simplifies analysis of focusing lattices

2) Unstable, Lattice Resonance

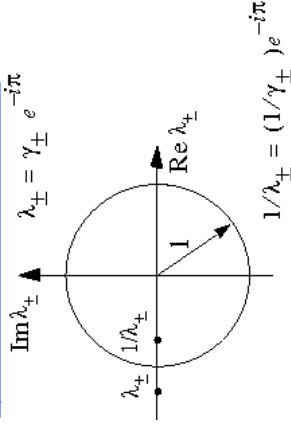

Occurs in bands when focusing strength is increased beyond  $\sigma_0 = 180^\circ/\text{period}$

S6: Hill's Equation: Floquet's Theorem and the Phase-Amplitude Form of the Particle Orbit S6A: Introduction

In this section we consider Hill's Equation:

$$x''(s) + \kappa(s)x(s) = 0$$

subject to a periodic applied focusing function

$$\kappa(s + L_p) = \kappa(s)$$

$$L_p = \text{Lattice Period}$$

- Many results will also hold in more complicated form for a non-periodic  $\kappa(s)$

S6B: Floquet's Theorem

Floquet's Theorem (proof: see standard Mathematics and Mathematical Physics Texts)

The solution to Hill's Equation  $x(s)$  has two linearly independent solutions that can be expressed as:

$$x_1(s) = w(s)e^{i\mu s}$$

$$x_2(s) = w(s)e^{-i\mu s}$$

$$i = \sqrt{-1}$$

$$\mu = \frac{1}{2} \text{Tr} \mathbf{M}(s_i + L_p | s_i) = \cos \sigma_0$$

$$= \text{const} = \text{Characteristic Exponent}$$

Where  $w(s)$  is a periodic function:

$$w(s + L_p) = w(s)$$

- Theorem as written only applies for  $\mathbf{M}$  with non-degenerate eigenvalues. But a similar theorem applies in the degenerate case.
- A similar theorem is also valid for non-periodic

S6C: Phase-Amplitude Form of Particle Orbit

As a consequence of Floquet's Theorem, any (stable or unstable) nondegenerate solution to Hill's Equation can be expressed in phase-amplitude form as:

$$x(s) = A(s) \cos \psi(s) \quad A(s) = \text{Amplitude Function}$$

$$A(s + L_p) = A(s) \quad \psi(s) = \text{Phase Function}$$

Derive equations of motion for  $A, \psi$  by taking derivatives of the phase-amplitude form for  $x(s)$ :

$$x = A \cos \psi$$

$$x' = A' \cos \psi - A\psi' \sin \psi$$

$$x'' = A'' \cos \psi - A'\psi' \sin \psi - A\psi'' \sin \psi - A\psi'^2 \cos \psi$$

then substitute in Hill's Equation:

$$x'' + \kappa x = [A'' + \kappa A - A\psi'^2] \cos \psi - [2A'\psi' + A\psi''] \sin \psi = 0$$

$$x'' + \kappa x = [A'' + \kappa A - A\psi'^2] \cos \psi - [2A'\psi' + A\psi''] \sin \psi = 0$$

We are free to introduce an additional constraint between  $A$  and  $\psi$  :

♦ Two functions  $A, \psi$  to represent one function  $x$  allows a constraint  
Choose:

$$\text{Eq. (1)} \quad 2A'\psi' + A\psi'' = 0 \quad \implies \quad \text{Coefficient of } \sin \psi \text{ zero}$$

Then to satisfy Hill's Equation for all  $\psi$  the, coefficient of  $\cos \psi$  must also vanish giving:

$$\text{Eq. (2)} \quad A'' + \kappa A - A\psi'^2 = 0 \quad \implies \quad \text{Coefficient of } \cos \psi \text{ zero}$$

$$\text{Eq. (2) Analysis (coefficient of } \cos \psi \text{): } A'' + \kappa A - A\psi'^2 = 0$$

With the choice of amplitude rescaling,  $w^2\psi' = 1$  and Eq. (2) becomes:

$$w'' + \kappa w - \frac{1}{w^3} = 0$$

Floquet's theorem tells us that we are free to restrict  $w$  to be a periodic solution:

$$w(s + L_p) = w(s)$$

Reduced Expressions for  $x$  and  $x'$ :

Using  $A = A_i w$  and  $w^2\psi' = 1$  :

$$x = A \cos \psi$$

$$x' = A' \cos \psi - A\psi' \sin \psi$$

$$\implies$$

$$x = A_i w \cos \psi$$

$$x' = A_i w' \cos \psi - \frac{A_i}{w} \sin \psi$$

$$\text{Eq. (1) Analysis (coefficient of } \sin \psi \text{): } 2A'\psi' + A\psi'' = 0$$

Simplify:

$$2A'\psi' + A\psi'' = \frac{(A^2\psi')'}{A} = 0 \quad A \neq 0$$

Will show later that this assumption met for all  $s$

$$\implies (A^2\psi')' = 0$$

Integrate once:

$$A^2\psi' = \text{const}$$

One commonly rescales the amplitude  $A(s)$  in terms of an auxiliary amplitude functions  $w(s)$ :

$$A(s) = A_i w(s) \quad A_i = \text{const} = \text{Initial Amplitude}$$

such that

$$w^2\psi' \equiv 1$$

This equation can then be integrated to obtain the **phase-function** of the particle:

$$\psi(s) = \psi_i + \int_{s_i}^s \frac{d\bar{s}}{w^2(\bar{s})} \quad \psi_i = \text{const} = \text{Initial Phase}$$

### S6D: Summary: Phase-Amplitude Form of Solution to Hill's Eqn

$$x(s) = A_i w(s) \cos \psi(s)$$

$A_i = \text{const} = \text{Initial Amplitude}$

$$x'(s) = A_i w'(s) \cos \psi(s) - \frac{A_i}{w(s)} \sin \psi(s)$$

$\psi_i = \text{const} = \text{Initial Phase}$

where  $w(s)$  and  $\psi(s)$  are amplitude- and phase-functions satisfying:

Amplitude Equations

$$w''(s) + \kappa(s)w(s) - \frac{1}{w^3(s)} = 0$$

Phase Equations

$$\psi'(s) = \frac{1}{w^2(s)}$$

$$\psi(s) = \psi_i + \int_{s_i}^s \frac{d\bar{s}}{w^2(\bar{s})}$$

$$\psi(s) = \psi_i + \Delta\psi(s)$$

Initial ( $s = s_i$ ) amplitudes are constrained by the particle initial conditions as:

$$x(s = s_i) = A_i w_i \cos \psi_i$$

$$x'(s = s_i) = A_i w'_i \cos \psi_i - \frac{A_i}{w_i} \sin \psi_i$$

or

$$A_i \cos \psi_i = x(s = s_i) / w_i$$

$$w_i \equiv w(s = s_i)$$

$$A_i \sin \psi_i = x'(s = s_i) w'_i - x'(s = s_i) w_i$$

$$w'_i \equiv w'(s = s_i)$$

## S6E: Points on the Phase-Amplitude Formulation

1)  $w(s)$  can be taken as positive definite

$$w(s) > 0$$

/// Proof: Sign choices in  $w$ :

Let  $w(s)$  be positive at some point. Then the equation:

$$w'' + \kappa w - \frac{1}{w^3} = 0$$

Insures that  $w$  can never vanish or change sign. This follows because whenever  $w$  becomes small,  $w'' \simeq 1/w^3 \gg 0$  can become arbitrarily large to turn  $w$  before it reaches zero. Thus, to fix phases, we conveniently require that  $w > 0$ .  
///

- ◆ Proof verifies assumption made in analysis that  $A = A_i w \neq 0$
- ◆ Conversely, one could choose  $w$  negative and it would always remain negative for analogous reasons. This choice is *not* commonly made.
- ◆ Sign choice removes ambiguity in relating initial conditions  $x(s_i), x'(s_i)$  to  $A_i, \psi_i$

Will be independent of  $s_i$  since  $w$  is a periodic function with period  $L_p$

- ◆ Will show that (see later in this section)

$$\Delta\psi(s_i + L_p) \equiv \sigma_0$$

is the undepressed phase advance of particle oscillations

5)  $w(s)$  has dimensions  $[w] = \text{Sqrt}[\text{meters}]$

- ◆ Can prove inconvenient in applications and motivates the use of an alternative “betatron” function

$$\beta(s) \equiv w^2(s)$$

with dimension  $[\beta] = \text{meters}$  (see: [S7](#) and [S8](#))

6) On the surface, what we have done: Transform the linear Hill's Equation to a form where a solution to nonlinear axillary equations for  $w$  and  $\beta$  are needed via the phase-amplitude method seems insane ..... why do it?

- ◆ Method will help identify the useful Courant-Snyder invariant which will aid interpretation of the dynamics (see: [S7](#))
- ◆ Decoupling of initial conditions in the phase-amplitude method will help simplify understanding of bundles of particles in the distribution

2)  $w(s)$  is a unique periodic function

- ◆ Can be proved using a connection between  $w$  and the principal orbit functions  $C$  and  $S$  (see: [Appendix C](#) and [S7](#))
- ◆  $w(s)$  can be regarded as a special, periodic function describing the lattice

3) The amplitude parameters

$$w_i \equiv w(s = s_i)$$

$$w'_i \equiv w'(s_i)$$

depend *only* on the periodic lattice properties and are independent of the particle initial conditions  $x(s_i), x'(s_i)$

4) The phase-advance

$$\Delta\psi(s) = \int_{s_i}^{s_i + L_p} \frac{d\tilde{s}}{w^2(\tilde{s})}$$

depends on the choice of initial condition  $s_i$ . However, the phase-advance through one lattice period

$$\Delta\psi(s_i + L_p) = \int_{s_i}^{s_i + L_p} \frac{d\tilde{s}}{w^2(\tilde{s})}$$

## S6F: Relation between Principal Orbit Functions and Phase-Amplitude Form Orbit Functions

The transfer matrix  $\mathbf{M}$  of the particle orbit can be expressed in terms of the principal orbit functions  $C$  and  $S$  as (see: [S4](#)):

$$\begin{bmatrix} x(s) \\ x'(s) \end{bmatrix} = \mathbf{M}(s|s_i) \cdot \begin{bmatrix} x(s_i) \\ x'(s_i) \end{bmatrix} = \begin{bmatrix} C(s|s_i) & S(s|s_i) \\ C'(s|s_i) & S'(s|s_i) \end{bmatrix} \cdot \begin{bmatrix} x(s_i) \\ x'(s_i) \end{bmatrix}$$

Use of the phase-amplitude forms and some algebra identifies (see problem sets):

$$C(s|s_i) = \frac{w(s)}{w_i} \cos \Delta\psi(s) - w'_i w(s) \sin \Delta\psi(s)$$

$$S(s|s_i) = w_i w(s) \sin \Delta\psi(s)$$

$$C'(s|s_i) = \left( \frac{w'(s)}{w_i} - \frac{w'_i}{w(s)} \right) \cos \Delta\psi(s) - \left( \frac{1}{w_i w(s)} + w'_i w'(s) \right) \sin \Delta\psi(s)$$

$$S'(s|s_i) = \frac{w_i}{w(s)} \cos \Delta\psi(s) + w_i w'(s) \sin \Delta\psi(s)$$

$$\Delta\psi(s) \equiv \int_{s_i}^s \frac{d\tilde{s}}{w^2(\tilde{s})} \quad w_i \equiv w(s = s_i) \quad w'_i \equiv w'(s = s_i)$$

/// **Aside:** Alternatively, it can be shown (see: [Appendix C](#)) that  $w(s)$  can be related to the principal orbit functions calculated over one Lattice period by:

$$\begin{aligned} w^2(s) = \beta(s) &= \sin \sigma_0 \frac{S(s|s_i)}{S(s_i + L_p|s_i)} \\ &+ \frac{S(s_i + L_p|s_i)}{\sin \sigma_0} \left[ C(s|s_i) + \frac{\cos \sigma_0 - C(s|s_i)S(s|s_i)}{S(s_i + L_p|s_i)} S(s|s_i) \right]^2 \\ \sigma_0 &\equiv \int_{s_i}^s \frac{d\tilde{s}}{w^2(\tilde{s})} \end{aligned}$$

The formula for  $\sigma_0$  in terms of principal orbit functions is useful:

- $\sigma_0$  (phase advance, see: [S6G](#)) is often specified for the lattice and the focusing function  $\kappa(s)$  is tuned to achieve the specified value
- Shows that  $w(s)$  can be constructed from two principal orbit integrations over one lattice period
  - Integrations must generally be done numerically for  $C$  and  $S$
  - No root finding required for initial conditions to construct periodic  $w(s)$
  - $s_i$  can be anywhere in the lattice period and  $w(s)$  will be independent of the specific choice of  $s_i$

• The form of  $w^2(s)$  suggests an underlying **Courant-Snyder Invariant** (see: [S7](#) and [Appendix C](#))

- $w^2 = \beta$  can be applied to calculate max beam particle excursions in the absence of space-charge effects (see: [S8](#))
  - Useful in machine design
  - Exploits **Courant-Snyder Invariant**

///

## S6G: Undepressed Particle Phase Advance

We can now concretely connect  $\sigma_0$  for a stable orbit to the advance in particle oscillation phase  $\Delta\psi$  through one lattice period:

From [S5D](#):

$$\cos \sigma_0 \equiv \frac{1}{2} \text{Tr } \mathbf{M}(s_i + L_p | s_i)$$

Apply the principal orbit representation of  $\mathbf{M}$

$$\text{Tr } \mathbf{M}(s_i + L_p | s_i) = C(s_i + L_p | s_i) + S'(s_i + L_p | s_i)$$

and use the phase-amplitude identifications of  $C$  and  $S'$  calculated in [S6F](#):

$$\begin{aligned} \text{Tr } \mathbf{M}(s_i + L_p | s_i) &= \frac{1}{2} \left( \frac{w(s_i + L_p)}{w_i} + \frac{w_i}{w(s_i + L_p)} \right) \cos \Delta\psi(s_i + L_p) \\ &+ \frac{1}{2} (w_i w'(s_i + L_p) - w'_i w(s_i + L_p)) \sin \Delta\psi(s_i + L_p) \end{aligned}$$

By periodicity:

$$\begin{aligned} w(s_i + L_p) = w(s_i) = w_i & \quad \text{coefficient of } \cos \Delta\psi = 1 \\ w'(s_i + L_p) = w'(s_i) = w'_i & \quad \implies \quad \text{coefficient of } \sin \Delta\psi = 0 \end{aligned}$$

Applying these results gives:

$$\cos \sigma_0 = \cos \Delta\psi(s_i + L_p) = \frac{1}{2} \text{Tr } \mathbf{M}(s_i + L_p | s_i)$$

Thus,  $\sigma_0$  is identified as the **phase advance** of a stable particle orbit through one lattice period:

$$\sigma_0 = \Delta\psi(s_i + L_p) = \int_{s_i}^{s_i + L_p} \frac{ds}{w^2(s)}$$

• Again verifies that  $\sigma_0$  is independent of  $s_i$  since  $w(s)$  is periodic with period  $L_p$

• The **stability criterion** (see: [S5](#))

$$\frac{1}{2} |\text{Tr } \mathbf{M}(s_i + L_p | s_i)| = |\cos \sigma_0| < 1$$

is concretely connected to the particle phase advance through one lattice period providing a useful physical interpretation



## 2) Periodic Solenoidal Focusing

Results are interpreted in the rotating Larmor frame (see S2 and Appendix A)

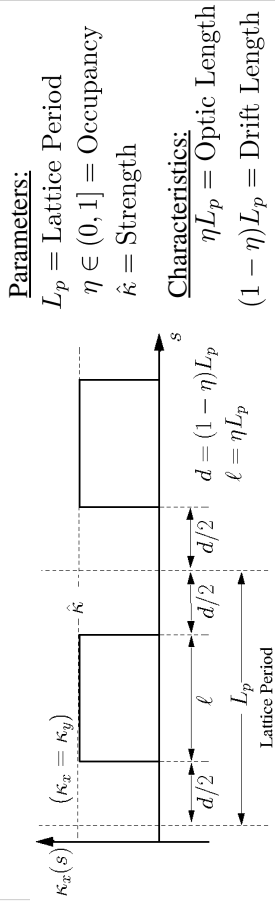

Calculation gives:

$$\cos \sigma_0 = \cos(2\Theta) - \frac{1 - \eta}{\eta} \Theta \sin(2\Theta) \quad \Theta \equiv \frac{\eta}{2} \sqrt{\hat{k}} L_p$$

- Can be unstable when  $\hat{k}$  becomes large
- Energy can pump into or out of particle orbit

## Phase-Space Evolution in the Larmor frame (see also: S7):

- Phase-Space ellipse rotates and evolves in periodic lattice
- $\tilde{y} - \tilde{y}'$  phase-space properties same as in  $\tilde{x} - \tilde{x}'$ 
  - Phase-space structure in  $x-x', y-y'$  phase space is complicated

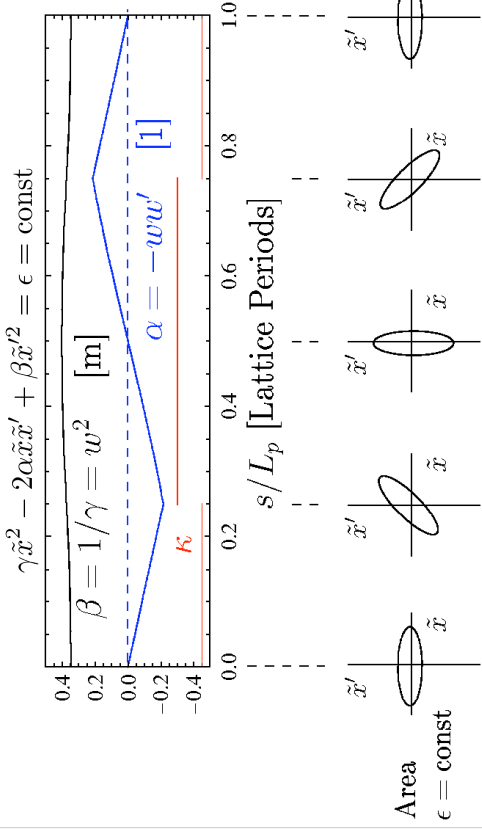

## Rescaled Larmor-Frame Principal Orbit Evolution:

$L_p = 0.5 \text{ m}$       1:  $\tilde{x}(0) = 1 \text{ mm}$     2:  $\tilde{x}(0) = 0 \text{ mm}$   
 $\sigma_0 = \pi/3 = 60^\circ$  ( $\kappa = 8.558 \text{ m}^{-2}$ )     $\tilde{x}'(0) = 0 \text{ mrad}$      $\tilde{x}'(0) = 1 \text{ mrad}$   
 $\eta = 0.5$

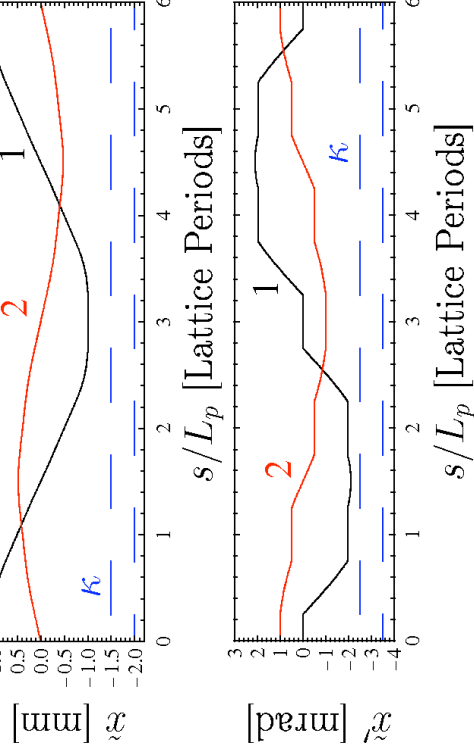

Principal orbits in  $\tilde{y} - \tilde{y}'$  phase-space are identical

## Comments on periodic solenoid results:

- Larmor frame analysis greatly simplifies results
  - 4D coupled orbit in  $x-x', y-y'$  phase-space will be much more intricate in structure
- Phase-Space ellipse rotates and evolves in periodic lattice
- Periodic structure of lattice changes orbits from simple harmonic



### 3) Periodic Quadrupole Doublet Focusing

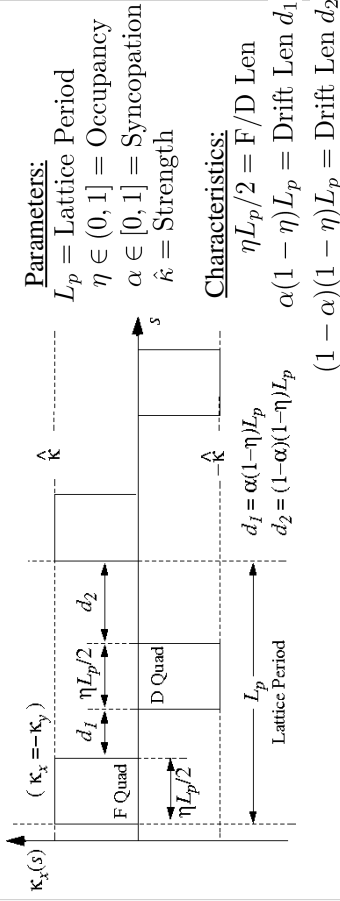

Calculation gives:

$$\cos \sigma_0 = \cos \Theta \cosh \Theta + \frac{1-\eta}{\eta} \Theta (\cos \Theta \sinh \Theta - \sin \Theta \cosh \Theta) \quad \Theta \equiv \frac{\eta}{2} \sqrt{|\hat{\kappa}|} L_p$$

$$- 2\alpha(1-\alpha) \frac{(1-\eta)^2}{\eta^2} \Theta^2 \sin \Theta \sinh \Theta$$

→ Can be unstable when  $\hat{\kappa}$  becomes large

- Energy can pump into or out of particle orbit

### Special Case Doublet Focusing: Periodic Quadrupole FODO Lattice

**Parameters:**  
 $L_p =$  Lattice Period  
 $\eta \in (0, 1] =$  Occupancy  
 $\hat{\kappa} =$  Strength

**Characteristics:**  
 $\eta L_p/2 = \ell =$  F/D Len  
 $(1-\eta)L_p/2 = d =$  Drift Len

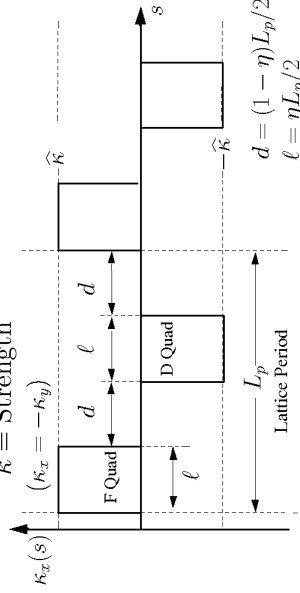

Phase advance formula reduces to:

$$\cos \sigma_0 = \cos \Theta \cosh \Theta + \frac{1-\eta}{\eta} \Theta (\cos \Theta \sinh \Theta - \sin \Theta \cosh \Theta)$$

$$- \frac{(1-\eta)^2}{2\eta^2} \Theta^2 \sin \Theta \sinh \Theta \quad \Theta \equiv \frac{\eta}{2} \sqrt{|\hat{\kappa}|} L_p$$

→ Analysis shows FODO provides stronger focus for same integrated field gradients than doublet due to symmetry

### Comments on Parameters:

→ The “syncopation” parameter  $\alpha$  measures how close the Focusing (F) and Defocusing (D) quadrupoles are to each other in the lattice

$$\alpha = 0 \implies d_1 = 0 \quad d_2 = (1-\eta)L_p$$

$$\alpha \in [0, 1] \quad \alpha = 1 \implies d_1 = (1-\eta)L_p \quad d_2 = 0$$

The range  $\alpha \in [1/2, 1]$  can be mapped to  $\alpha \in [0, 1/2]$  by simply relabeling quantities. Therefore, we can take:

$$\alpha \in [0, 1/2]$$

→ The special case of a doublet lattice with  $\alpha = 1/2$  corresponds to equal drift lengths between the F and D quadrupoles and is called a **FODO lattice**

$$\alpha = 1/2 \implies d_1 = d_2 \equiv d = (1-\eta)L_p/2$$

Phase advance constraint will be derived for FODO case in problems (algebra much simpler than doublet case)

### Rescaled Principal Orbit Evolution:

$L_p = 0.5$  m  
 $\sigma_0 = \pi/3 = 60^\circ$  ( $\kappa = 39.24$  m $^{-2}$ )  
 $\eta = 0.5$

1:  $x(0) = 1$  mm    2:  $x'(0) = 0$  mrad  
 $x'(0) = 0$  mrad     $x'(0) = 1$  mrad

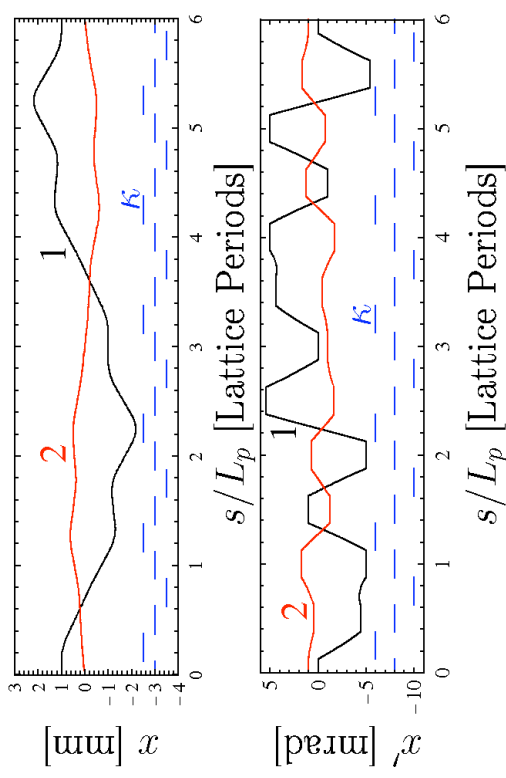

**Phase-Space Evolution (see also: S7):**

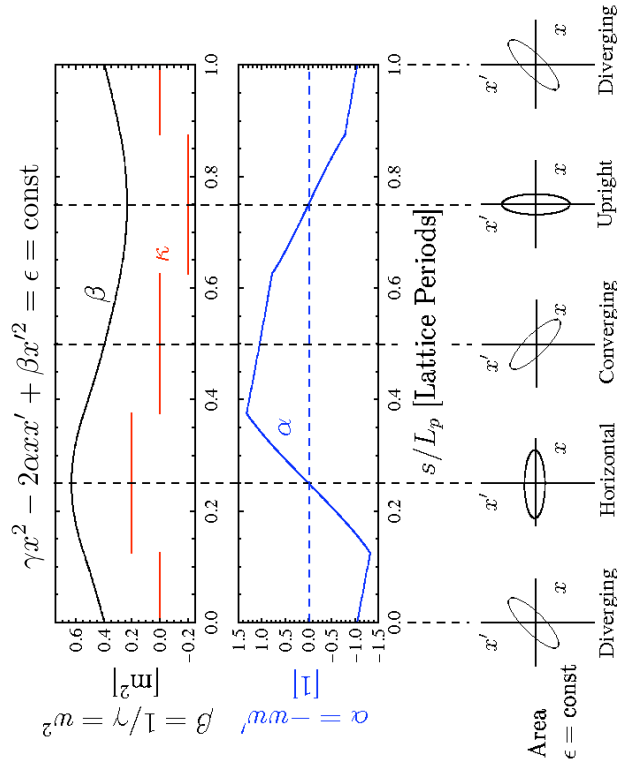

**Comments on periodic FODO quadrupole results:**

- Phase-Space ellipse rotates and evolves in periodic lattice
- Evolution more intricate for Alternating Gradient (AG) focusing than for solenoidal focusing in the Larmor frame
- Harmonic content of orbits larger for AG focusing than solenoidal focusing
- Orbit and phase space evolution analogous in  $y$ - $y'$  plane
- Simply related by an shift in  $s$  of the lattice

**Contrast of Principal Orbits for different focusing:**

- Use previous examples with “equivalent” focusing strength  $\sigma_0 = 60^\circ$
- Note that periodic focusing adds harmonic structure

**1) Continuous Focusing**

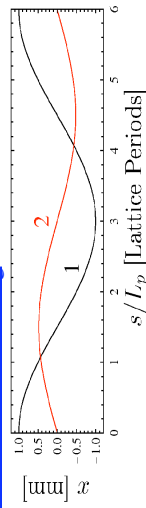

Simple Harmonic Oscillator

**2) Periodic Solenoidal Focusing (Larmor Frame)**

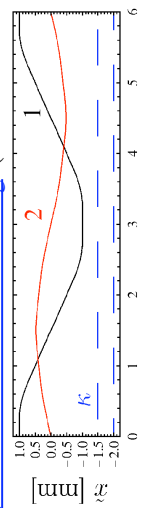

Simple harmonic oscillations modified with additional harmonics due to periodic focus

**3) Periodic FODO Quadrupole Doublet Focusing**

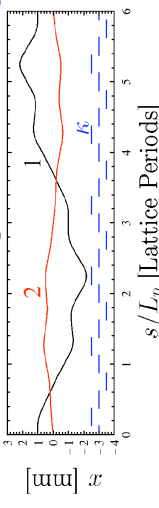

Simple harmonic oscillations more strongly modified due to periodic AG focus

**4) Thin Lens Limits**

Convenient to simply understand analytic scaling

$$\kappa_x(s) = \frac{1}{f} \delta(s - s_0)$$

$s_0 = \text{Optic Location} = \text{const}$   
 $f = \text{focal length} = \text{const}$

Transfer Matrix:

$$\begin{pmatrix} x \\ x' \end{pmatrix}_{s=s_0^+} = \begin{bmatrix} 1 & 0 \\ -1/f & 1 \end{bmatrix} \cdot \begin{pmatrix} x \\ x' \end{pmatrix}_{s=s_0^-}$$

Graphical Interpretation:

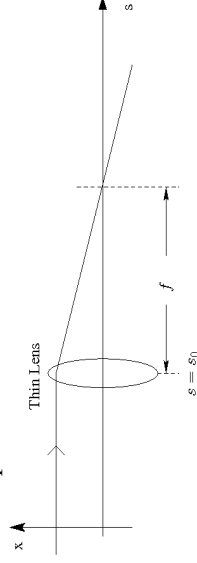



The thin lens limit of “thick” hard-edge solenoid and quadrupole focusing lattices presented can be obtained by taking:

**Solenoids:**  $\hat{k} \equiv \frac{1}{\eta f L_p}$  then take  $\lim_{\eta \rightarrow 0}$

**Quadrupoles:**  $\hat{k} \equiv \frac{2}{\eta f L_p}$  then take  $\lim_{\eta \rightarrow 0}$

This obtains when applied in the previous formulas:

$$\cos \sigma_0 = \begin{cases} 1 - \frac{1}{2} \frac{L_p}{f}, & \text{thin-lens periodic solenoid} \\ 1 - \frac{\alpha}{2} (1 - \alpha) \left( \frac{L_p}{f} \right)^2, & \text{thin-lens quadrupole doublet} \end{cases}$$

These formulas can also be derived directly from the drift and thin lens transfer matrices as

**Periodic Solenoid**

$$\cos \sigma_0 = \frac{1}{2} \text{Tr} \begin{bmatrix} 1 & L_p \\ 0 & 1 \end{bmatrix} \begin{bmatrix} 1 & 0 \\ -\frac{1}{f} & 1 \end{bmatrix} = 1 - \frac{1}{2} \frac{L_p}{f}$$

**Periodic Quadrupole Doublet**

$$\cos \sigma_0 = \frac{1}{2} \text{Tr} \begin{bmatrix} 1 & 0 \\ -\frac{1}{f} & 1 \end{bmatrix} \begin{bmatrix} 1 & \alpha L_p \\ 0 & 1 \end{bmatrix} \begin{bmatrix} 1 & 0 \\ \frac{1}{f} & 1 \end{bmatrix} = 1 - \frac{\alpha}{2} (1 - \alpha) \left( \frac{L_p}{f} \right)^2$$

Using these results, plot the **Field Gradient and Integrated Gradient** for quadrupole doublet focusing needed for  $\sigma_0 = 80^\circ$  per lattice period

$$\text{Gradient} \sim |\hat{k}| L_p^2 \sim \hat{G} \ell$$

$$\text{Integrated Gradient} \sim \eta |\hat{k}| L_p^2 / 2 \sim \hat{G} \ell$$

$\sigma_0 = 80^\circ$  / (Lattice Period) Quadrupole Doublet

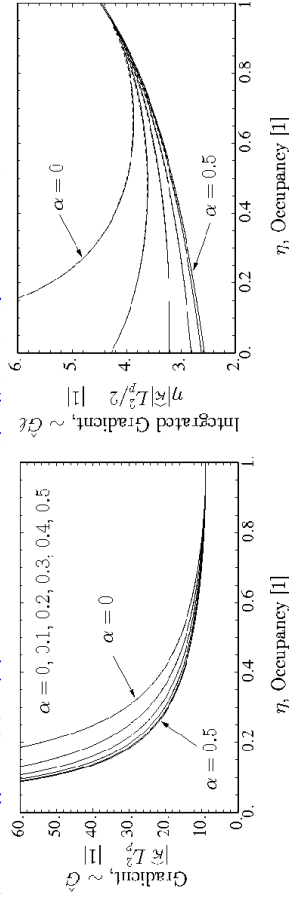

- ▶ Exact (non-expanded) solutions plotted dashed (almost overlay)
- ▶ Gradient and integrated gradient required depend only weakly on syncopation factor  $\alpha$  when  $\alpha$  is near  $1/2$
- ▶ Stronger gradient required for low occupancy  $\eta$  but integrated gradient varies little with  $\eta$

Expanded phase advance formulas (thin lens type limit and similar) can be useful in system design studies

- ▶ Desirable to derive simple formulas relating magnet parameters to  $\sigma_0$ 
  - Clear analytic scaling trends clarify design trade-offs
- ▶ For hard edge periodic lattices, expand formula for  $\cos \sigma_0$  to leading order in  $\Theta = \sqrt{|\hat{k}|} \eta L_p / 2$

/// Example: Periodic Quadrupole Doublet Focusing:

- ▶ Expand previous formula

$$\cos \sigma_0 = 1 - \frac{(\eta \hat{k} L_p^2)^2}{32} \left[ \left( 1 - \frac{2}{3} \eta \right) - 4 \left( \alpha - \frac{1}{2} \right)^2 (1 - \eta)^2 \right]$$

where:

$$\hat{k} = \begin{cases} \frac{\hat{G}}{[B\rho]}, & \text{Magnetic Quadrupoles} \\ \frac{\hat{G}}{\beta_0 c [B\rho]}, & \text{Electric Quadrupoles} \end{cases} \quad \hat{G} = \text{Hard-Edge Field Gradient}$$

**Appendix C: Calculation of  $w(s)$  from Principal Orbit Functions**

Evaluate principal orbit expressions of the transfer matrix through one lattice period using

$$w(s_i + L_p) = w_i$$

$$w'(s_i + L_p) = w'_i$$

and

$$\Delta \psi(s_i + L_p) = \int_{s_i}^{s_i + L_p} \frac{ds}{w^2(s)} = \sigma_0$$

to obtain (see principal orbit formulas expressed in phase-amplitude form):

$$C(s_i + L_p | s_i) = \cos \sigma_0 - w_i w'_i \sin \sigma_0$$

$$S(s_i + L_p | s_i) = w_i^2 \sin \sigma_0$$

$$C'(s_i + L_p | s_i) = - \left( \frac{1}{w_i^2} + w_i w'_i \right) \sin \sigma_0$$

$$S'(s_i + L_p | s_i) = \cos \sigma_0 + w_i w'_i \sin \sigma_0$$



## S7: Hill's Equation: The Courant-Snyder Invariant and Single Particle Emittance

### S7A: Introduction

Constants of the motion can simplify the interpretation of dynamics in physics

- Desirable to identify constants of motion for Hill's equation for improved understanding of focusing in accelerators
- Constants of the motion are not immediately obvious for Hill's Equation due to s-varying focusing forces related to  $\kappa(s)$  can add and remove energy from the particle
  - Wronskian symmetry is one useful symmetry
  - Are there other symmetries?

#### Question:

For Hill's equation:

$$x'' + \kappa(s)x = 0$$

does a quadratic invariant exist that can aid interpretation of the dynamics?

Answer we will find:

Yes, the Courant-Snyder invariant

Comments:

- Very important in accelerator physics
  - Helps interpretation of linear dynamics
- Named in honor of Courant and Snyder who popularized it's use in Accelerator physics while co-discovering alternating gradient (AG) focusing in a single seminal (and very elegant) paper:
  - Courant and Snyder, *Theory of the Alternating Gradient Synchrotron*, Annals of Physics **3**, 1 (1958).
  - Christofilos also understood AG focusing in the same period using a more heuristic analysis

### /// Illustrative Example: Continuous Focusing/Simple Harmonic Oscillator

Equation of motion:

$$x'' + k_{\beta 0}^2 x = 0 \quad k_{\beta 0}^2 = \text{const} > 0$$

Constant of motion is the well-know Hamiltonian/Energy:

$$H = \frac{1}{2}x'^2 + \frac{1}{2}k_{\beta 0}^2 x^2 = \text{const}$$

which shows that the particle moves on an ellipse in x-x' phase-space with:

- Location of particle on ellipse set by initial conditions
- All initial conditions with same energy/H give same ellipse

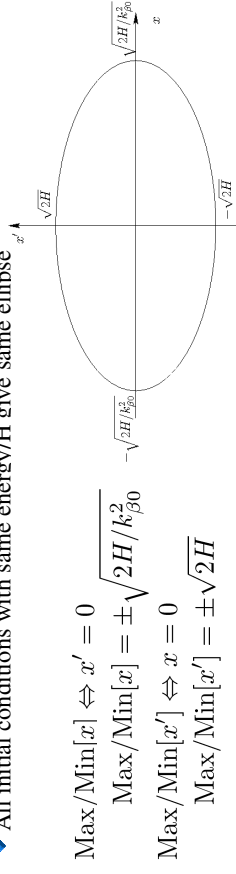

$$\text{Max/Min}[x] \Leftrightarrow x' = 0$$

$$\text{Max/Min}[x] = \pm \sqrt{2H/k_{\beta 0}^2}$$

$$\text{Max/Min}[x'] \Leftrightarrow x = 0$$

$$\text{Max/Min}[x'] = \pm \sqrt{2H}$$

///

### S7B: Derivation of Courant-Snyder Invariant

The phase amplitude method described in S6 makes identification of the invariant elementary. Use the phase amplitude form of the orbit:

$$x(s) = A_i w(s) \cos \psi(s)$$

$$x'(s) = A_i w'(s) \cos \psi(s) - \frac{A_i}{w(s)} \sin \psi(s)$$

$A_i, \psi_i = \psi(s_i)$   
set by initial  
at  $s = s_i$

where

$$w'' + \kappa(s)w - \frac{1}{w^3} = 0$$

Re-arrange the phase-amplitude trajectory equations:

$$\frac{x}{w} = A_i \cos \psi$$

$$wx' - w'x = A_i \sin \psi$$

square and add the equations to obtain the Courant-Snyder invariant:

$$\left(\frac{x}{w}\right)^2 + (wx' - w'x)^2 = A_i^2 (\cos^2 \psi + \sin^2 \psi) = A_i^2 = \text{const}$$

**Comments on the Courant-Snyder Invariant:**

- ◆ Simplifies interpretation of dynamics (will show how shortly)
- ◆ Extensively used in accelerator physics
- ◆ Quadratic structure in  $x$ - $x'$  defines a **rotated ellipse** in  $x$ - $x'$  phase space.
- ◆ Because  $w^2 \left(\frac{x}{w}\right)' = wx' - w'x$

the Courant-Snyder invariant can be alternatively expressed as:

$$\left(\frac{x}{w}\right)^2 + \left[w^2 \left(\frac{x}{w}\right)'\right]^2 = \text{const}$$

- ◆ *Cannot* be interpreted as a conserved energy!

The point that the Courant-Snyder invariant is *not* a conserved energy should be elaborated on. The equation of motion:

$$x'' + \kappa(s)x = 0$$

Is derivable from the Hamiltonian

$$\frac{d}{ds}x = \frac{\partial H}{\partial x'} = x'$$

$$H = \frac{1}{2}x'^2 + \frac{1}{2}\kappa x^2 \implies \frac{d}{ds}x' = -\frac{\partial H}{\partial x} = -\kappa x \implies x'' + \kappa x = 0$$

$H$  is the energy:

$$H = \frac{1}{2}x'^2 + \frac{1}{2}\kappa x^2 = T + V$$

$$T = \frac{1}{2}x'^2 = \text{Kinetic "Energy"}$$

$$V = \frac{1}{2}\kappa x^2 = \text{Potential "Energy"}$$

Apply the chain-Rule with  $H = H(x, x'; s)$ :

$$\frac{dH}{ds} = \frac{\partial H}{\partial s} + \frac{\partial H}{\partial x} \frac{dx}{ds} + \frac{\partial H}{\partial x'} \frac{dx'}{ds}$$

Apply the equation of motion:

$$\frac{d}{ds}x = \frac{\partial H}{\partial x'} \quad \frac{d}{ds}x' = -\frac{\partial H}{\partial x}$$

$$\frac{dH}{ds} = \frac{\partial H}{\partial s} - \frac{dx'}{ds} \frac{dx}{ds} + \frac{dx}{ds} \frac{dx'}{ds} = \frac{\partial H}{\partial s} = \frac{1}{2}\kappa' x^2 \neq 0$$

$$\implies H \neq \text{const}$$

- ◆ Energy of a "kicked" oscillator with  $\kappa(s) \neq \text{const}$  is not conserved
- ◆ Energy should not be confused with the Courant-Snyder invariant

/// Aside: Only for the special case of **continuous focusing** (i.e., a simple Harmonic oscillator) are the Courant-Snyder invariant and energy simply related:

**Continuous Focusing:**  $\kappa(s) = k_{\beta 0}^2 = \text{const}$

$$\implies H = \frac{1}{2}x'^2 + \frac{1}{2}k_{\beta 0}^2 x^2 = \text{const}$$

$$w \text{ equation: } w'' + k_{\beta 0}^2 w - \frac{1}{w^3} = 0$$

$$\implies w = \sqrt{\frac{1}{k_{\beta 0}}} = \text{const}$$

**Courant-Snyder Invariant:**  $\left(\frac{x}{w}\right)^2 + (wx' - w'x)^2 = \text{const}$

$$\implies \left(\frac{x}{w}\right)^2 + (wx' - w'x)^2 = k_{\beta 0}x^2 + \frac{x'^2}{k_{\beta 0}}$$

$$= \frac{2}{k_{\beta 0}} \left(\frac{1}{2}x'^2 + \frac{1}{2}\kappa x^2\right)$$

$$= \frac{2H}{k_{\beta 0}} = \text{const} \quad ///$$

Interpret the **Courant-Snyder invariant**:

$$\left(\frac{x}{w}\right)^2 + (wx' - w'x)^2 = A_i^2 = \text{const}$$

by expanding and isolating terms quadratic in  $x$ - $x'$  phase-space variables:

$$\left[\frac{1}{w^2} + w'^2\right]x^2 + 2[-ww']xx' + [w^2]x'^2 = A_i^2 = \text{const}$$

The three coefficients in [...] are functions of  $w$  and  $w'$  only and therefore are *functions of the lattice only* (not particle initial conditions). They are commonly called "**Twiss Parameters**" and are expressed denoted as:

$$\gamma x^2 + 2\alpha x x' + \beta x'^2 = A_i^2 = \text{const}$$

$$\gamma(s) \equiv \frac{1}{w^2(s)} = \frac{1 + \alpha^2(s)}{\beta(s)}$$

$$\beta(s) \equiv w^2(s)$$

$$\alpha(s) \equiv -w(s)w'(s)$$

- ◆ Only 2 of the three Twiss parameters are "independent" (i.e.,  $w, w'$  determine all 3)

The area of the invariant ellipse is:

- Apply standard formulas from Analytic Geometry or calculate

$$\text{Area} = \int_{\text{ellipse}} dx dx' = \frac{\pi A_i^2}{\sqrt{\gamma\beta - \alpha^2}} = \pi A_i^2 \equiv \pi\epsilon$$

where  $\epsilon$  is the **single-particle emittance**:

- Emittance is the area of the orbit in  $x$ - $x'$  phase-space divided by  $\pi$

$$\gamma x^2 + 2\alpha x x' + \beta x'^2 = \epsilon$$

See problem sets for critical point calculation

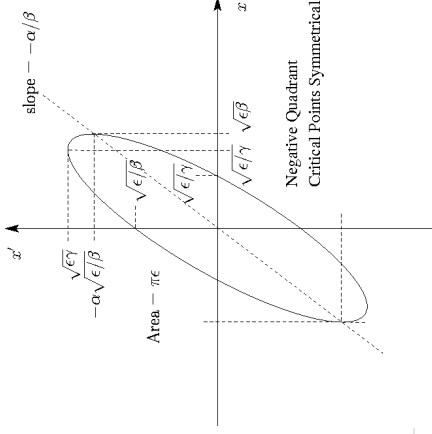

/// Aside: **Emittance Units and choices of definition:**

$x$  has dimensions of length and  $x'$  is a dimensionless angle. So  $x$ - $x'$  phase-space area and  $\epsilon$  has dimensions [ $[\epsilon]$ ] = length. A common choice of units is millimeters (mm) and milliradians (mrad), e.g.,

$$\epsilon = 10 \text{ mm-mrad}$$

The definition of the emittance employed is not unique and different workers use a wide variety of symbols. Some common notational choices:

$$\blacktriangleright \pi\epsilon \rightarrow \epsilon \quad \epsilon \rightarrow \epsilon \quad \epsilon \rightarrow E$$

- Write the emittance values in units with a  $\pi$ , e.g.,

$$\epsilon = 10.5 \pi - \text{mm-mrad}$$

Use caution! Understand conventions being used before applying results!

///

**Properties of Courant-Snyder Invariant:**

- The ellipse will rotate and change shape as the particle advances through the focusing lattice, but the instantaneous area of the ellipse ( $\pi\epsilon = \text{const}$ ) remains constant.
- The location of the particle on the ellipse and the size (area) of the ellipse depends on the initial conditions of the particle.
- The orientation of the ellipse is independent of the particle initial conditions. All particles move on nested ellipses.
- Quadratic in the  $x$ - $x'$  phase-space coordinates, but is *not* the transverse particle energy (which is not conserved).

### S7C: Lattice Maps

The Courant-Snyder invariant helps us understand the phase-space evolution of the particles. Knowing how the ellipse transforms (twists and rotates without changing area) is equivalent to knowing the dynamics of a *bundle* of particles.

To see this:

General  $s$ :

$$\gamma x^2 + 2\alpha x x' + \beta x'^2 = \epsilon$$

$$\beta_i \equiv \beta(s = s_i) \quad x_i \equiv x(s = s_i)$$

$$\gamma_i x_i^2 + 2\alpha_i x_i x'_i + \beta_i x_i'^2 = \epsilon \quad \alpha_i \equiv \alpha(s = s_i) \quad x'_i \equiv x'(s = s_i)$$

$$\gamma_i \equiv \gamma(s = s_i)$$

Apply the components of the transport matrix:

$$\begin{bmatrix} x \\ x' \end{bmatrix} = \mathbf{M}(s|s_i) \cdot \begin{bmatrix} x_i \\ x'_i \end{bmatrix} = \begin{bmatrix} C(s|s_i) & S(s|s_i) \\ C'(s|s_i) & S'(s|s_i) \end{bmatrix} \cdot \begin{bmatrix} x_i \\ x'_i \end{bmatrix}$$

Invert 2x2 matrix and apply  $\det \mathbf{M} = 1$  (Wronskian):

$$\Rightarrow \begin{bmatrix} x_i \\ x'_i \end{bmatrix} = \begin{bmatrix} S' & -S \\ -C' & C \end{bmatrix} \cdot \begin{bmatrix} x \\ x' \end{bmatrix} \quad C \equiv C(s|s_i), \text{ etc.}$$

Insert expansion for  $x_i$ ,  $x'_i$  in the initial ellipse expression, collect factors of  $x^{\wedge 2}$ ,  $xx'$ , and  $x'^{\wedge 2}$ , and equate to general  $s$  ellipse expression:

$$\begin{aligned} & [\gamma_i S'^2 - 2\alpha_i S' C' + \beta_i C'^2] x^2 \\ & + 2[-\gamma_i S S' + \alpha_i (C S' + S C') - \beta_i C C'] x x' \\ & + [\gamma_i S^2 - 2\alpha_i S C + \beta_i C^2] x'^2 \\ & = \gamma x^2 + 2\alpha x x' + \beta x'^2 \end{aligned}$$

Collect coefficients of  $x^{\wedge 2}$ ,  $xx'$ , and  $x'^{\wedge 2}$  and summarize in matrix form:

$$\begin{bmatrix} \gamma \\ \alpha \\ \beta \end{bmatrix} = \begin{bmatrix} S'^2 & -2C'S' & C'^2 \\ -SS' & CS' + SC' & -CC' \\ S^2 & -2CS & C^2 \end{bmatrix} \cdot \begin{bmatrix} \gamma_i \\ \beta_i \\ \alpha_i \end{bmatrix}$$

This result can be applied to illustrate how a bundle of particles will evolve from an initial location in the lattice subject to the linear focusing optics in the machine using only principal orbits  $C$ ,  $S$ ,  $C'$ , and  $S'$

- Principal orbits will generally need to be calculated numerically
- Intuition can be built up using simple analytical results (hard edge etc)

## S8: Hill's Equation: The Betatron Formulation of the Particle Orbit and Maximum Orbit Excursions S8A: Formulation

The phase-amplitude form of the particle orbit analyzed in S6 of

$$x(s) = A_i w(s) \cos \psi(s)$$

$$[[w]] = (\text{meters})^{1/2}$$

is not a unique choice. Here,  $w$  has dimensions  $[[w]] = (\text{meters})^{1/2}$ , which can render it inconvenient in applications. Due to this and the utility of the Twiss parameters used in describing orientation of the phase-space ellipse associated with the Courant-Snyder invariant (see: S7) on which the particle moves, it is convenient to define an alternative, **Betatron** representation of the orbit with:

$$x(s) = \sqrt{\epsilon} \sqrt{\beta(s)} \cos \psi(s)$$

Betatron function:  $\beta(s) \equiv w^2(s)$

Emitance:  $\epsilon \equiv A_i^2 = \text{const}$

Phase:  $\psi(s) = \psi_i + \int_{s_i}^s \frac{d\tilde{s}}{\beta(\tilde{s})} = \psi_i + \Delta\psi(s)$

- The betatron function has dimensions  $[[\beta]] = \text{meters}$

## Example: Ellipse Evolution in a simple kicked focusing lattice

Drift:  $\begin{bmatrix} C & S \\ C' & S' \end{bmatrix} = \begin{bmatrix} 1 & s - s_i \\ 0 & 1 \end{bmatrix}$

$$\begin{aligned} \gamma &= \gamma_i \\ \alpha &= -\gamma_i(s - s_i) + \alpha_i \\ \beta &= \gamma_i(s - s_i)^2 - 2\alpha_i(s - s_i) + \beta_i \end{aligned}$$

Thin Lens: focal length  $f$

$$\begin{bmatrix} C & S \\ C' & S' \end{bmatrix} = \begin{bmatrix} 1 & 0 \\ -1/f & 1 \end{bmatrix}$$

$$\begin{aligned} \gamma &= \gamma_i + 2\alpha_i/f + \beta_i/f^2 \\ \alpha &= -\beta_i/f + \alpha_i \\ \beta &= \beta_i \end{aligned}$$

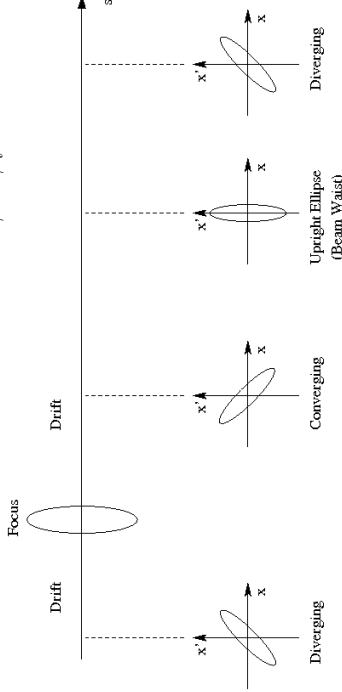

For further examples of phase-space ellipse evolutions in standard lattices, see: S6G

## Comments:

- Use of the symbol  $\beta$  for the betatron function does not result in confusion with relativistic factors such as  $\beta_b$  since the context of use will make clear
  - Relativistic factors often absorbed in lattice focusing function and do not directly appear in the dynamical descriptions
- The initial phase  $\psi_i$  will differ in the  $w$ - and betatron phase-amplitude forms in order to match initial conditions in  $x$  and  $x'$  at
  - We do not distinguish for reasons of notational simplicity
- The change in phase  $\Delta\psi$  is the same for both formulations:

$$\Delta\psi(s) = \int_{s_i}^s \frac{d\tilde{s}}{w^2(\tilde{s})} = \int_{s_i}^s \frac{d\tilde{s}}{\beta(\tilde{s})}$$

Add material on initial condition correspondence in future editions of notes



From the equation for  $w$ :

$$w''(s) + \kappa(s)w(s) - \frac{1}{w^3(s)} = 0$$

$$w(s + L_p) = w(s) \quad w(s) > 0$$

the betatron function is described by:

$$\frac{1}{2}\beta(s)\beta'(s) - \frac{1}{4}\beta^2(s) + \kappa(s)\beta^2(s) = 1$$

$$\beta(s + L_p) = \beta(s) \quad \beta(s) > 0$$

- The betatron function can, analogously to the  $w$ -function, as a special function defined by the periodic lattice
- Again, the equation is nonlinear and must generally be solved numerically

From:

$$x_m''(s) + \kappa(s)x_m(s) - \frac{1}{x_m^3(s)} = 0$$

$$x_m(s + L_p) = x_m(s) \quad w(s) > 0$$

We immediately obtain an equation for the maximum locus (envelope) of radial particle excursions  $x_m = \sqrt{\epsilon_m}w$  as:

$$x_m''(s) + \kappa(s)x_m(s) - \frac{\epsilon_m^2}{x_m^3(s)} = 0$$

$$x_m(s + L_p) = x_m(s) \quad x_m(s) > 0$$

Comments:

- Equation is **analogous to the statistical envelope equation** derived by J.J. Barnard in the **Intro Lectures** when a space-charge term is added and the max single particle emittance is interpreted as a statistical emittance
  - correspondence will become more concrete in later lectures
- This correspondence will be developed more extensively in later lectures on **Transverse Centroid and Envelope Descriptions of Beam Evolution** and **Transverse Equilibrium Distributions**

## S8B: Maximum Orbit Excursions

From the orbit equation

$$x = \sqrt{\epsilon\beta} \cos \psi$$

the **maximum** and **minimum** possible **particle excursions** occur where:

$$\cos \psi = +1 \quad \rightarrow \quad \text{Max}[x] = \sqrt{\epsilon\beta(s)} = \sqrt{\epsilon}w(s)$$

$$\cos \psi = -1 \quad \rightarrow \quad \text{Min}[x] = -\sqrt{\epsilon\beta(s)} = -\sqrt{\epsilon}w(s)$$

Thus, the max radial extent of *all* particle oscillations  $\text{Max}[x] \equiv x_m$  in the beam distribution occurs for the particle with the max single particle emittance since the particles move on nested ellipses:

$$\text{Max}[\epsilon] \equiv \epsilon_m$$

$$x_m(s) = \sqrt{\epsilon_m\beta(s)} = \sqrt{\epsilon_m}w(s)$$

- Assumes sufficient numbers of particles to populate all possible phases
- $x_m$  corresponds to the min possible machine aperture to prevent particle losses
  - Practical aperture choice influenced by: resonance effects due to nonlinear applied fields, space-charge, scattering, finite particle lifetime, ...

## S9: Momentum Spread Effects and Bending

### S9A: Formulation

Except for brief digressions in **S1** and **S4**, we have concentrated on particle dynamics where all particles have the design longitudinal momentum:

$$p_s = m\gamma_b\beta_b c = \text{const}$$

Realistically, there will always be a finite spread of particle momentum within a beam slice, so we take:

$$p_s = p_0 + \delta p$$

$$p_0 \equiv m\gamma_b\beta_b c = \text{Design Momentum}$$

$$\delta p \equiv \text{Off Momentum}$$

Typical values of momentum spread in a beam with a single species of particles with conventional sources and accelerating structures:

$$\frac{|\delta p|}{p_0} \sim 10^{-2} \rightarrow 10^{-6}$$

The spread of particle momentum can modify particle orbits, particularly when dipole bends are present since the bend radius depends strongly on the particle momentum

To better understand this effect, we analyze the particle equations of motion with leading-order momentum spread (see: S1) effects retained:

$$x''(s) + \left[ \frac{1}{R^2(s)} \frac{1-\delta}{1+\delta} + \frac{\kappa_x(s)}{(1+\delta)^n} \right] x(s) = \frac{\delta}{1+\delta} \frac{1}{R(s)}$$

$$y''(s) + \frac{\kappa_y(s)}{(1+\delta)^n} y(s) = 0$$

Magnetic Dipole Bend

$$\frac{1}{R(s)} = \frac{B_y^a|_{\text{dipole}}}{[B\rho]}$$

$R(s)$  = Local Bend Radius  
for design momentum  $p_0$   
( $R \rightarrow \infty$  in straight sections)

$$\frac{\delta p}{p_0} \equiv \kappa_{x,y} = \text{Focusing Functions (using design momentum)}$$

$$[B\rho] = \frac{p_0}{q}$$

$$n = \begin{cases} 1, & \text{Magnetic Quadrupoles} \\ 2, & \text{Solenoids, Electric Quadrupoles} \end{cases}$$

Neglects:

- ▶ Space-charge:  $\phi \rightarrow 0$
- ▶ Nonlinear applied focusing:  $\mathbf{E}^a, \mathbf{B}^a$  contain only linear focus terms
- ▶ Acceleration:  $p_0 = m\gamma_b\beta_b = \text{const}$

### S9B: Chromatic Effects

Present in both  $x$ - and  $y$ -equations of motion and result from applied focusing strength changing with deviations in momentum:

$$x''(s) + \frac{\kappa_x(s)}{(1+\delta)^n} x(s) = 0$$

$$R \rightarrow \infty$$

to neglect bending terms

$$y''(s) + \frac{\kappa_y(s)}{(1+\delta)^n} y(s) = 0$$

$\kappa_{x,y} = \text{Focusing Functions}$   
with  $\gamma_b, \beta_b$  calculated from  $p_0$

- ▶ Generally of lesser importance (smaller corrections) relative to dispersive terms (S9C) *except* where the beam is focused onto a target (small spot) or when momentum spreads are large
- ▶ Lectures by J.J. Barnard on **Heavy Ion Fusion and Final Focusing** will overview consequences of chromatic effects in final focus optics

In the equations of motion, it is important to understand that  $B_y^a$  of the magnetic bends are set from the radius  $R$  required by the design particle orbit (see: S1 for details)

- ▶ Equations must be modified slightly for electric bends (see S1)
- ▶  $y$ -plane bends also require modification

The **focusing strengths** are defined with respect to the **design momentum**:

$$\kappa_x = \begin{cases} \frac{qG}{m\gamma_b\beta_b^2c^2}, & G = \text{Electric Quadrupole Gradient} \\ \frac{qG}{m\gamma_b\beta_b c}, & G = \text{Magnetic Quadrupole Gradient} \\ \frac{qB_{z0}}{4m\gamma_b^2\beta_b^2c^2}, & B_{z0} = \text{Solenoidal Magnetic Field} \end{cases}$$

$\gamma_b, \beta_b$  calculated from  $p_0$

Terms in the equations of motion associated with momentum spread ( $\delta$ ) can be lumped into two classes:

- 1) **Chromatic** -- Associated with Focusing
- 2) **Dispersive** -- Associated with Dipole Bends

### S9C: Dispersive Effects

Present in only the  $x$ -equation of motion and result from bending. Neglecting chromatic terms:

$$x''(s) + \left[ \frac{1}{R^2(s)} \frac{1-\delta}{1+\delta} + \kappa_x(s) \right] x(s) = \frac{\delta}{1+\delta} \frac{1}{R(s)}$$

Term 1

Term 2

Particles are bent at different radii when the momentum deviates from the design value ( $\delta \neq 0$ ) leading to changes in the particle orbit

- ▶ Dispersive terms contain the bend radius  $R$

Generally, the bend radii  $R$  are large and  $\delta$  is small, and we can take to leading order:

$$\text{Term 1: } \left[ \frac{1}{R^2} \frac{1-\delta}{1+\delta} + \kappa_x \right] x \simeq \kappa_x x$$

$$\text{Term 2: } \frac{\delta}{1+\delta} \frac{1}{R} \simeq \frac{\delta}{R}$$



The equations of motion then become:

$$x''(s) + \kappa_x(s)x(s) = \frac{\delta}{R(s)}$$

$$y''(s) + \kappa_y(s)y(s) = 0$$

→ The **y-equation is not changed** from the usual **Hill's Equation**

Generally, the x-equation is solved for periodic lattices by exploiting the linear structure of the equation and linearly resolving:

$$x(s) = x_h(s) + x_p(s)$$

$$x_h \equiv \text{Homogeneous Solution}$$

$$x_p \equiv \text{Particular Solution}$$

where  $x_h$  is the **general** solution to the Hill's Equation:

$$x_h''(s) + \kappa_x(s)x_h(s) = 0$$

and  $x_p$  is the **periodic** solution to:

$$x_p = \delta \cdot D \quad D''(s) + \kappa_x(s)D(s) = \frac{1}{R(s)}$$

$$D \equiv \text{Dispersion Function} \quad D(s + L_p) = D(s)$$

/// Example: Dispersion broadens the x-distribution

**Uniform Bundle of particles  $D = 0$**       **Same Bundle of particles  $D \neq 0$**

→ Gaussian distribution of momentum spread distorts the x-y distribution extents in x but not in y

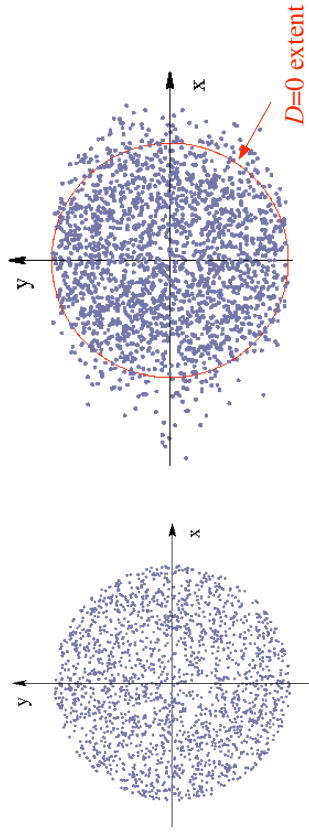

This convenient resolution of the orbit  $x(s)$  can *always* be made because the homogeneous solution will be adjusted to match any initial condition

Note that  $\delta D$  provides a measure of the offset of the particle orbit relative to the design orbit resulting from a small deviation of momentum ( $\delta$ )

- $x(s) = 0$  defines the design orbit
- $[[D]] = \text{meters}$
- $\delta \cdot D = \text{Orbit offset in meters}$

/// Example: Simple piecewise constant focusing and bending lattice

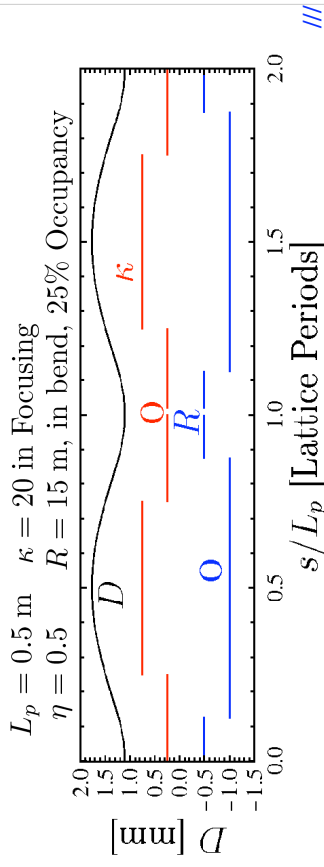

Many **rings** are designed to focus the dispersion function  $D(s)$  to small values in straight sections even though the lattice has strong bends

- Desirable since it allows smaller beam sizes at locations near where  $D = 0$  and these locations can be used to insert and extract (kick) the beam into and out of the ring with minimal losses
  - Since average value of  $D$  is dictated by ring size and focusing strength (see example next page) this variation in values can lead to  $D$  being larger in other parts of the ring
- Quadrupole triplet focusing lattices are often employed in rings since the optics allows sufficient flexibility to tune  $D$  without dramatically changing particle phase advances

/// Example: Continuous Focusing in a Continuous Bend

$$\kappa_x(s) = k_{\beta 0}^2 = \text{const}$$

$$R(s) = R = \text{const}$$

Dispersion equation becomes:

$$D'' + k_{\beta 0}^2 D = \frac{1}{R}$$

With solution:

$$D = \frac{1}{k_{\beta 0}^2 R} = \text{const}$$

From this result we can crudely estimate the average value of the dispersion function in a ring with periodic focusing by taking:

$$R = \text{Avg Radius Ring}$$

$$L_p = \text{Lattice Period (Focusing)}$$

$$\sigma_{0,x} = x\text{-Plane Phase Advance}$$

$$\implies k_{\beta 0} \sim \frac{\sigma_0}{L_p} \implies D \sim \frac{L_p^2}{\sigma_0^2 R}$$

///

S10: Acceleration and Normalized Emittance

S10A: Introduction

If the beam is accelerated longitudinally, the  $x$ -particle equation of motion (see: S1 and S2) is:

$$x'' + \frac{(\gamma_b \beta_b)'}{(\gamma_b \beta_b)} x' + \kappa_x x = - \frac{q}{m \gamma_b^3 \beta_b^2 c^2} \frac{\partial \phi}{\partial x}$$

Analogous equation holds in  $y$

Neglects:

- ▶ Nonlinear applied focusing fields
- ▶ Momentum spread effects

Comments:

- ▶  $\gamma_b, \beta_b$  are regarded as prescribed functions of  $s$  set by the acceleration schedule of the machine
- ▶ Variations in  $\gamma_b, \beta_b$  due to acceleration must be included in and/or compensated by adjusting the strength of the optics via  $\kappa_x, \kappa_y$
- Scaling different for electric and magnetic optics (see: S2)

Comments Continued:

- ▶ In typical accelerating systems, changes in  $\gamma_b \beta_b$  are slow and the fractional changes in the orbit induced by acceleration are small
- Exception near an injector since the beam is often not yet energetic
- ▶ The acceleration term:

$$\frac{(\gamma_b \beta_b)'}{(\gamma_b \beta_b)} > 0$$

will act to damp particle oscillations (see following slides for motivation)

Even with acceleration, we will find that there is a Courant-Snyder invariant (normalized emittance) that is valid in an analogous context as in the case without acceleration provided phase-space coordinates are chosen to compensate for the damping of particle oscillations

Acceleration Factor: Characteristics of

Relativistic Factor

$$\gamma_b \beta_b \simeq \begin{cases} \gamma_b, & \text{Relativistic Limit} \\ \beta_b, & \text{Nonrelativistic Limit} \end{cases}$$

$$\gamma_b \equiv \frac{1}{\sqrt{1 - \beta_b^2}}$$

Beam/Particle Kinetic Energy:

$$\mathcal{E}_b(s) = (\gamma_b - 1) m c^2 = \text{Beam Kinetic Energy}$$

- ▶ Function of  $s$  specified by Acceleration schedule for transverse dynamics
- ▶ See Appendix D for calculation of  $\mathcal{E}_b$  and  $\gamma_b \beta_b$  from longitudinal dynamics and J.J. Barnard lectures on Longitudinal Dynamics

Approximate energy gain from average gradient:

$$\mathcal{E}_b \simeq \mathcal{E}_i + G(s - s_i)$$

$$\mathcal{E}_i = \text{const} = \text{Initial Energy}$$

$$G = \text{const} = \text{Average Gradient}$$

- ▶ Real energy gain will be rapid when going through discrete acceleration gaps

$$\mathcal{E}_b \simeq \begin{cases} \gamma_b m c^2, & \text{Relativistic Limit} \\ \frac{1}{2} m \beta_b^2 c^2, & \text{Nonrelativistic Limit} \end{cases}$$

Identify relativistic factor with average gradient energy gain:

Relativistic Limit:

$$\gamma_b \simeq \frac{\mathcal{E}_b}{mc^2} = \frac{\mathcal{E}_i}{mc^2} + \frac{G}{mc^2}(s - s_i)$$

$$\Rightarrow \frac{(\gamma_b \beta_b)'}{(\gamma_b \beta_b)} \simeq \frac{\gamma_b'}{\gamma_b} \simeq \frac{1}{\left(\frac{\mathcal{E}_i}{G} - s_i\right) + s} \sim \frac{1}{s}$$

Nonrelativistic Limit:

$$\beta_b \simeq \sqrt{2 \frac{\mathcal{E}_b}{mc^2}} = \sqrt{2 \frac{\mathcal{E}_i}{mc^2} + 2 \frac{G}{mc^2}(s - s_i)}$$

$$\Rightarrow \frac{(\gamma_b \beta_b)'}{(\gamma_b \beta_b)} \simeq \frac{\beta_b'}{\beta_b} = \frac{1/2}{\left(\frac{\mathcal{E}_i}{G} - s_i\right) + s} \sim \frac{1}{2s}$$

Expect Relativistic and Nonrelativistic motion to have similar solutions

- Parameters for each case will often be quite different

Solving for the constants in terms of the particle initial conditions:

$$\begin{bmatrix} x_i \\ x_i' \end{bmatrix} = \begin{bmatrix} J_0(\xi_i) & Y_0(\xi_i) \\ -k_{\beta 0} J_1(\xi_i) & -k_{\beta 0} Y_1(\xi_i) \end{bmatrix} \cdot \begin{bmatrix} C_1 \\ C_2 \end{bmatrix}$$

$$x_i \equiv x(s = s_i)$$

$$x_i' \equiv x'(s = s_i)$$

$$\xi_i \equiv k_{\beta 0} \frac{\mathcal{E}_i}{G} = \xi(s = s_i)$$

Invert matrix to solve for constants in terms of initial conditions:

$$\Rightarrow \begin{bmatrix} C_1 \\ C_2 \end{bmatrix} = \frac{1}{\Delta} \begin{bmatrix} -k_{\beta 0} Y_1(\xi_i) & -Y_0(\xi_i) \\ k_{\beta 0} J_1(\xi_i) & J_0(\xi_i) \end{bmatrix} \cdot \begin{bmatrix} x_i \\ x_i' \end{bmatrix}$$

$$\Delta \equiv k_{\beta 0} [Y_0(\xi_i) J_1(\xi_i) - J_0(\xi_i) Y_1(\xi_i)]$$

Comments:

- Bessel functions behave like damped harmonic oscillators
- See any texts on Mathematical Physics or Applied Mathematics
- Nonrelativistic limit solution is *not* described by a Bessel Function solution
- Properties of solution will be similar though (similar special function)
- The coefficient in the damping term  $\propto x'$  has a factor of 2 difference, preventing exact Bessel function form

Aside: Acceleration and Continuous Focusing Orbits with  $\kappa_x = k_{\beta 0}^2 = \text{const}$

Assume relativistic motion and negligible space-charge:

$$\frac{(\gamma_b \beta_b)'}{(\gamma_b \beta_b)} \simeq \frac{\gamma_b'}{\gamma_b} = \frac{1}{\left(\frac{\mathcal{E}_i}{G} - s_i\right) + s} \quad \frac{\partial \phi}{\partial x} \simeq 0$$

Then the equation of motion reduces to:

$$x'' + \frac{1}{\left(\frac{\mathcal{E}_i}{G} - s_i\right) + s} x' + k_{\beta 0}^2 x = 0$$

This equation is the equation of a Bessel Function of order zero:

$$\frac{d^2 x}{d\xi^2} + \frac{1}{\xi} \frac{dx}{d\xi} + x = 0 \quad \xi = k_{\beta 0} s + k_{\beta 0} \left(\frac{\mathcal{E}_i}{G} - s_i\right)$$

$$C_1 = \text{const} \quad C_2 = \text{const}$$

$J_n =$  Order  $n$  Bessel Func  
(1st kind)

$Y_n =$  Order  $n$  Bessel Func  
(2nd kind)

$$x = C_1 J_0(\xi) + C_2 Y_0(\xi)$$

$$x' = -C_1 k_{\beta 0} J_1(\xi) - C_2 k_{\beta 0} Y_1(\xi)$$

Using this solution, plot the orbit for (contrived parameters for illustration only):

$$k_{\beta 0} = \frac{\sigma^0}{L_p} \quad \sigma_0 = 90^\circ / \text{Period} \quad \mathcal{E}_i = 1000 \text{ MeV}$$

$$G = 100 \text{ MeV/m}$$

$$x(0) = 10 \text{ mm}$$

$$L_p = 0.5 \text{ m}$$

$$x'(0) = 0 \text{ mrad}$$

$$s_i = 0$$

$$\frac{\gamma_{bi}}{\gamma_b} = \frac{1}{1 + (G/\mathcal{E}_i)(s - s_i)}$$

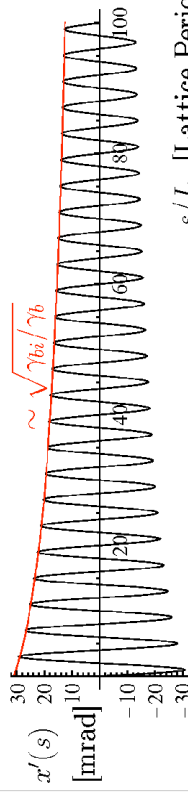
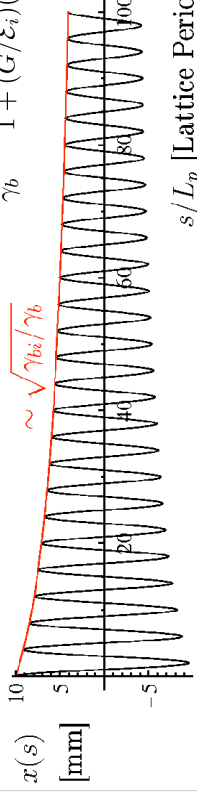

Solution shows damping: phase volume scaling  $\sim 1/(\gamma_b \beta_b) \simeq 1/\gamma_b$

## S10B: Transformation to Normal Form

“Guess” transformation to apply motivated by conjugate variable arguments (see: J.J. Barnard, [Intro. Lectures](#))

$$\tilde{x} \equiv \sqrt{\gamma_b \beta_b} x$$

Then:

$$\begin{aligned} x &= \frac{1}{\sqrt{\gamma_b \beta_b}} \tilde{x} \\ x' &= \frac{1}{\sqrt{\gamma_b \beta_b}} \tilde{x}' - \frac{1}{2} \frac{(\gamma_b \beta_b)'}{(\gamma_b \beta_b)^{3/2}} \tilde{x} \\ x'' &= \frac{1}{\sqrt{\gamma_b \beta_b}} \tilde{x}'' - \frac{(\gamma_b \beta_b)'}{(\gamma_b \beta_b)^{3/2}} \tilde{x}' + \left[ \frac{3}{4} \frac{(\gamma_b \beta_b)''}{(\gamma_b \beta_b)^{5/2}} - \frac{1}{2} \frac{(\gamma_b \beta_b)'''}{(\gamma_b \beta_b)^{3/2}} \right] \tilde{x} \end{aligned}$$

The inverse phase-space transforms will also be useful later:

$$\begin{aligned} \tilde{x} &= \sqrt{\gamma_b \beta_b} x \\ \tilde{x}' &= \sqrt{\gamma_b \beta_b} x' + \frac{1}{2} \frac{(\gamma_b \beta_b)'}{\sqrt{\gamma_b \beta_b}} x \end{aligned}$$

Using these results, Poisson's equation becomes:

$$\left( \frac{\partial^2}{\partial \tilde{x}^2} + \frac{\partial^2}{\partial \tilde{y}^2} \right) \phi = -\frac{\rho}{\gamma_b \beta_b \epsilon_0}$$

Or defining a transformed potential  $\tilde{\phi}$

$$\begin{aligned} \tilde{\phi} &= \gamma_b \beta_b \phi \\ \left( \frac{\partial^2}{\partial \tilde{x}^2} + \frac{\partial^2}{\partial \tilde{y}^2} \right) \tilde{\phi} &= -\frac{\rho}{\epsilon_0} \end{aligned}$$

Applying these results, the x-equation of motion with acceleration becomes:

$$\tilde{x}'' + \left[ \kappa_x + \frac{1}{4} \frac{(\gamma_b \beta_b)''}{(\gamma_b \beta_b)^2} - \frac{1}{2} \frac{(\gamma_b \beta_b)'''}{(\gamma_b \beta_b)} \right] \tilde{x} = -\frac{q}{m \gamma_b^3 \beta_b^2 c^2} \frac{\partial \tilde{\phi}}{\partial \tilde{x}}$$

◆ Usual form of the space-charge coefficient with  $\gamma_b^3 \beta_b^2$  rather than  $\gamma_b^2 \beta_b$  is restored when expressed in terms of the transformed  $\tilde{\phi}$  potential

Applying these results, the particle x-equation of motion with acceleration becomes:

$$\tilde{x}'' + \left[ \kappa_x + \frac{1}{4} \frac{(\gamma_b \beta_b)''}{(\gamma_b \beta_b)^2} - \frac{1}{2} \frac{(\gamma_b \beta_b)'''}{(\gamma_b \beta_b)} \right] \tilde{x} = -\frac{q}{m \gamma_b^3 \beta_b^2 c^2} \frac{\partial \phi}{\partial \tilde{x}}$$

Note:

◆ Factor of  $\gamma_b \beta_b$  difference from untransformed expression in the space-charge coupling coefficient

It is instructive to also transform the Poisson equation associated with the space-charge term:

$$\left( \frac{\partial^2}{\partial x^2} + \frac{\partial^2}{\partial y^2} \right) \phi = -\frac{\rho}{\epsilon_0}$$

Transform:

$$\begin{aligned} \frac{\partial^2}{\partial x^2} &= \left( \frac{\partial \tilde{x}}{\partial x} \frac{\partial}{\partial \tilde{x}} \right) \left( \frac{\partial \tilde{x}}{\partial x} \frac{\partial}{\partial \tilde{x}} \right) = \gamma_b \beta_b \frac{\partial^2}{\partial \tilde{x}^2} \\ \frac{\partial^2}{\partial y^2} &= \left( \frac{\partial \tilde{y}}{\partial y} \frac{\partial}{\partial \tilde{y}} \right) \left( \frac{\partial \tilde{y}}{\partial y} \frac{\partial}{\partial \tilde{y}} \right) = \gamma_b \beta_b \frac{\partial^2}{\partial \tilde{y}^2} \end{aligned}$$

An additional step can be taken to further stress the correspondence between the transformed system with acceleration and the untransformed system in the absence of acceleration.

Denote an effective focusing strength:

$$\tilde{\kappa}_x \equiv \kappa_x + \frac{1}{4} \frac{(\gamma_b \beta_b)''}{(\gamma_b \beta_b)^2} - \frac{1}{2} \frac{(\gamma_b \beta_b)'''}{(\gamma_b \beta_b)}$$

$\tilde{\kappa}_x$  incorporates acceleration terms beyond  $\gamma_b, \beta_b$  factors already included in the definition of  $\kappa_x$  (see: [S2](#)):

$$\kappa_x = \begin{cases} \frac{qG}{m \gamma_b \beta_b^2 c^2}, & G = \text{Electric Quadrupole Gradient} \\ \frac{qG}{m \gamma_b \beta_b c}, & G = \text{Magnetic Quadrupole Gradient} \\ \frac{qB_{z0}}{4m \gamma_b^2 \beta_b^2 c^2}, & B_{z0} = \text{Solenoidal Magnetic Field} \end{cases}$$

The transformed equation of motion with acceleration then becomes:

$$\tilde{x}'' + \tilde{\kappa}_x \tilde{x} = -\frac{q}{m \gamma_b^3 \beta_b^2 c^2} \frac{\partial \tilde{\phi}}{\partial \tilde{x}}$$

The transformed equation with acceleration has the same form as the equation in the absence of acceleration. If space-charge is negligible ( $\phi \rightarrow 0$ ) we have:

[Accelerating System](#) [Non-Accelerating System](#)

$$\tilde{x}'' + \tilde{\kappa}_x \tilde{x} = 0 \quad \iff \quad x'' + \kappa_x x = 0$$

Therefore, *all previous analysis on phase-amplitude methods and Courant-Snyder invariants* associated with Hill's equation in  $x-x'$  phase-space can be immediately applied to  $\tilde{x} - \tilde{x}'$  phase-space for an accelerating beam

$$\begin{aligned} \left(\frac{\tilde{x}}{\tilde{w}_x}\right)^2 + (\tilde{w}_x \tilde{x}' - \tilde{w}_x' \tilde{x})^2 &= \tilde{\epsilon} = \text{const} \\ \tilde{w}_x'' + \tilde{\kappa} \tilde{w}_x - \frac{1}{\tilde{w}_x^3} &= 0 \\ \tilde{w}_x(s + L_p) &= \tilde{w}_x(s) \\ \pi \tilde{\epsilon} &= \text{Area traced by orbit} = \text{const} \\ &\text{in } \tilde{x}-\tilde{x}' \text{ phase-space} \end{aligned}$$

- ◆ Focusing field strengths need to be adjusted to maintain periodicity of  $\kappa_x$  in the presence of acceleration
- Not possible to do exactly, but can be approximate for weak acceleration

Based on this area transform, if we define the (instantaneous) phase space area of the orbit trace in  $x-x'$  to be  $\pi \epsilon_x$  “regular emittance”, then this emittance is related to the “normalized emittance”  $\tilde{\epsilon}_x$  in  $\tilde{x} - \tilde{x}'$  phase-space by:

$$\begin{aligned} \tilde{\epsilon}_x &= \gamma_b \beta_b \epsilon_x \\ &\equiv \text{Normalized Emittance} \equiv \epsilon_{n,x} \end{aligned}$$

- ◆ Factor  $\gamma_b \beta_b$  compensates for acceleration induced damping in particle orbits
- ◆ Normalized emittance is very important in design of lattices to transport accelerating beams
  - Designs usually made assuming conservation of normalized emittance
- ◆ Same result that J.J. Barnard motivated in the [Intro](#). [Lectures](#) using alternative methods

## S10C: Phase Space Relation Between Transformed and UnTransformed Systems

It is instructive to relate the transformed phase-space area in tilde variables to the usual  $x-x'$  phase area:

$$d\tilde{x} \otimes d\tilde{x}' = |J| dx \otimes dx'$$

where  $J$  is the Jacobian:

$$\begin{aligned} J &\equiv \det \begin{bmatrix} \frac{\partial \tilde{x}}{\partial x} & \frac{\partial \tilde{x}}{\partial x'} \\ \frac{\partial \tilde{x}'}{\partial x} & \frac{\partial \tilde{x}'}{\partial x'} \end{bmatrix} \\ &= \det \begin{bmatrix} \sqrt{\gamma_b \beta_b} & 0 \\ \frac{1}{2} \frac{(\gamma_b \beta_b)'}{\sqrt{\gamma_b \beta_b}} & \sqrt{\gamma_b \beta_b} \end{bmatrix} = \gamma_b \beta_b \end{aligned}$$

Apply the inverse transforms derived previously

Thus:

$$d\tilde{x} \otimes d\tilde{x}' = \gamma_b \beta_b dx \otimes dx'$$

## Appendix D: Accelerating Fields and Calculation of Changes in gamma\*beta

The transverse particle equation of motion with acceleration was derived in a Cartesian system by approximating (see: [S1](#)):

$$\frac{d}{dt} \left( m \gamma \frac{d\mathbf{x}_\perp}{dt} \right) \simeq q \mathbf{E}_\perp^a + q \beta_b c \hat{\mathbf{z}} \times \mathbf{B}_\perp^a + q B_z^a \mathbf{v}_\perp \times \hat{\mathbf{z}} - q \frac{1}{\gamma_b^2} \frac{\partial \phi}{\partial \mathbf{x}_\perp}$$

$$m \frac{d}{dt} \left( \gamma \frac{d\mathbf{x}_\perp}{dt} \right) \simeq m \gamma_b \beta_b^2 c^2 \left[ \mathbf{x}_\perp'' + \frac{(\gamma_b \beta_b)'}{(\gamma_b \beta_b)} \mathbf{x}_\perp' \right]$$

to obtain:

$$\begin{aligned} \mathbf{x}_\perp'' + \frac{(\gamma_b \beta_b)'}{(\gamma_b \beta_b)} \mathbf{x}_\perp' &= \frac{q}{m \gamma_b \beta_b^2 c^2} \mathbf{E}_\perp^a + \frac{q}{m \gamma_b \beta_b c} \hat{\mathbf{z}} \times \mathbf{B}_\perp^a + \frac{q B_z^a}{m \gamma_b \beta_b c} \mathbf{x}_\perp' \times \hat{\mathbf{z}} \\ &\quad - \frac{q}{\gamma_b^3 \beta_b^2 c^2} \frac{\partial}{\partial \mathbf{x}_\perp} \phi \end{aligned}$$

Changes in  $\gamma_b, \beta_b$  are calculated from the longitudinal particle equation of motion:

$$\frac{d}{dt} \left( m\gamma \frac{dz}{dt} \right) \simeq qE_z^a - q(v_x B_y^a - v_y B_x^a) - q \frac{\partial \phi}{\partial z}$$

Term 1      Term 2      Term 3

Using steps similar to those in S1, we approximate terms:

**Term 1:**  $\frac{d}{dt} \left( \gamma \frac{dz}{dt} \right) \simeq c^2 \beta_b (\gamma_b \beta_b)'$        $\frac{dz}{dt} = v_z \simeq \beta_b c$        $\gamma \simeq \gamma_b$

**Term 2:**  $\frac{q}{m} E_z^a \simeq -\frac{q}{m} \frac{\partial \phi^a}{\partial s} \Big|_{x=y=0}$

•  $\phi^a$  is a quasi-static approximation accelerating potential (see next pages)

**Term 3:**  $-q(v_x B_y^a - v_y B_x^a) = -q \left( \frac{dx}{dt} B_y^a - \frac{dy}{dt} B_x^a \right) \simeq 0$

• Transverse magnetic fields typically only weakly change particle energy and terms can be neglected relative to others **D2**

The longitudinal particle equation of motion for  $\gamma_b, \beta_b$  then reduces to:

$$\beta_b (\gamma_b \beta_b)' \simeq -\frac{q}{mc^2} \frac{\partial \phi^a}{\partial s} \Big|_{x=y=0}$$

Some algebra then shows that:

$$\begin{aligned} \gamma_b' &= \left( \frac{1}{\sqrt{1-\beta_b^2}} \right)' = \gamma_b^3 \beta_b \beta_b' \\ \implies \beta_b (\gamma_b \beta_b)' &= \beta_b^2 \gamma_b' + \gamma_b \beta_b \beta_b' \\ &= (1 + \gamma_b^2 \beta_b^2) \gamma_b \beta_b \beta_b' = \gamma_b^3 \beta_b \beta_b' \\ &= \gamma_b' \end{aligned}$$

Giving:

$$\gamma_b' = -\frac{q}{mc^2} \frac{\partial \phi^a}{\partial s} \Big|_{x=y=0}$$

Which can then be integrated to obtain:

$$\gamma_b = \frac{q}{mc^2} \phi^a (r=0, z=s) + \text{const} \quad \beta_b = \sqrt{1 + 1/\gamma_b^2}$$

**D3**

We denote the on-axis accelerating potential as:

$$V(s) \equiv \phi^a (x=y=0, z=s)$$

• Can represent RF or induction accelerating gap fields

• See: J.J. Barnard lectures for more details

Giving:

$$\gamma_b = \frac{q}{mc^2} V(s) + \text{const} \quad \beta_b = \sqrt{1 + 1/\gamma_b^2}$$

These equations can be solved for the consistent variation of  $\gamma_b(s), \beta_b(s)$  in the **transverse equations of motion**:

$$\begin{aligned} \mathbf{x}_\perp'' + \frac{(\gamma_b \beta_b)'}{(\gamma_b \beta_b)} \mathbf{x}_\perp' &= \frac{q}{m\gamma_b \beta_b^2 c^2} \mathbf{E}_\perp^a + \frac{q}{m\gamma_b \beta_b c} \hat{\mathbf{z}} \times \mathbf{B}_\perp^a + \frac{q B_z^a}{m\gamma_b \beta_b c} \mathbf{x}_\perp' \times \hat{\mathbf{z}} \\ &\quad - \frac{q}{\gamma_b^3 \beta_b^2 c^2} \partial \mathbf{x}_\perp \phi \end{aligned}$$

**D4**

## Nonrelativistic limit results

In the **nonrelativistic** limit:

$$\gamma_b \simeq 1 + \frac{1}{2} \beta_b^2 \quad \beta_b^2 \ll 1$$

Giving the familiar result of a nonrelativistic particle gaining energy when falling down a potential gradient:

$$\frac{1}{2} m_0 \beta_b^2 c^2 \simeq q\phi^a (r=0, z=s) + \text{const} \quad \beta_b^2 \ll 1$$

Using this result, in the nonrelativistic limit we can take in the transverse particle equation of motion:

$$\frac{(\gamma_b \beta_b)'}{(\gamma_b \beta_b)} \simeq \frac{1}{2} \frac{V'}{V}$$

**D5**



## Quasistatic potential expansion

In the quasistatic approximation, the accelerating potential can be expanded in the axisymmetric limit as:

- ♦ See: J.J. Barnard, **Intro Lectures**; and Reiser, *Theory and Design of Charged Particle Beams*, (1994, 2008) Sec. 3.3.

$$\phi^a = V(z) - \frac{1}{4} \frac{\partial^2}{\partial z^2} V(z)(x^2 + y^2) + \frac{1}{64} \frac{\partial^4}{\partial z^4} V(z)(x^2 + y^2)^2 + \dots$$

The longitudinal acceleration also result in a transverse focusing field

$$\mathbf{E}_{\perp}^a = \mathbf{E}_{\perp}^a|_{\text{foc}} - \frac{\partial \phi^a}{\partial \mathbf{x}_{\perp}}$$

$\mathbf{E}_{\perp}^a|_{\text{foc}}$  = Fields from Focusing Optics

$$-\frac{\partial \phi^a}{\partial \mathbf{x}_{\perp}} = \frac{1}{2} \frac{\partial^2}{\partial z^2} V(z) \mathbf{x}_{\perp} = \text{Focusing Field from Acceleration}$$

- ♦ Results can be used to cast acceleration terms in more convenient forms. See J.J. Barnard lectures for more details.

**D6**

SM Lund, USPAS, June 2008

Transverse Particle Equations

205

118

These slides will be corrected and expanded for reference and any future editions of the US Particle Accelerator School class: *Beam Physics with Intense Space Charge*, by J.J. Barnard and S.M. Lund

Corrections and suggestions are welcome. Contact:

Steven M. Lund  
Lawrence Berkeley National Laboratory  
BLDG 47 R 0112  
1 Cyclotron Road  
Berkeley, CA 94720-8201

[SMLund@lbl.gov](mailto:SMLund@lbl.gov)  
(510) 486 – 6936

Please do not remove author credits in any redistributions of class material.

SM Lund, USPAS, June 2008

Transverse Particle Equations

206

## References: For more information see:

Earlier versions of course notes posted online (present will also be posted with corrections):

J. Barnard and S. Lund, *Intense Beam Physics*, US Particle Accelerator School Notes, [http://uspas.fnal.gov/lect\\_note.html](http://uspas.fnal.gov/lect_note.html) (2006, 2004)

Basic introduction on many of the topics covered:

M. Reiser, *Theory and Design of Charged Particle Beams*, Wiley (1994, revised 2008)

Review by author (with similar perspective to notes) with material on phase advances, lattice focusing strength, etc.

S.M. Lund and B. Bukh, Stability Properties of the Transverse Envelope Equations Describing Intense Ion Beam Transport, *Phys. Rev. Special Topics – Accelerators and Beams* (2004).

Hill's Equation, Floquet's theorem, Courant-Snyder invariants, and dispersion functions:

H. Wiedermann, *Particle Accelerator Physics*, Springer-Verlag (1995)

Particle equations of motion with bends and momentum spread:

D.A. Edwards and M.J. Syphers, *An Introduction to the Physics of High Energy Accelerators*, Wiley (1993).

Original, classic paper on strong focusing and Courant-Snyder invariants applied to accelerator physics. Remains one of the best formulated treatments to date:

E.D. Courant and H. S. Snyder, Theory of the Alternating Gradient Synchrotron, *Annals Physics* **3**, 1 (1958).

More mathematical treatment of transfer matrices and stability

A. Dragt, *Lectures on Nonlinear Orbit Dynamics*, in "Physics of High Energy Accelerators," edited by R.A. Carrigan, F.R. Hudson, and M. Month (AIP Conf. Proc. No. 87, New York, 1982), p. 147.

Phase-amplitude methods, Larmor frame:

J.D. Lawson, *The Physics of Charged Particle Beams*, Oxford University Press (1977).

Solenoidal focusing and the Larmor frame:

H. Wiedermann, *Particle Accelerator Physics II: Nonlinear and Higher Order Beam Dynamics*, Springer (1995).

SM Lund, USPAS, June 2008

Transverse Particle Equations

207

SM Lund, USPAS, June 2008

Transverse Particle Equations

208

## Acknowledgments:

Klaus Halbach educated one of the authors (S.M. Lund) on the use of complex variable theory to simplify analysis of multipole fields employed in

**S3: Description of Applied Focusing Fields.**

Considerable help was provided by Giuliano Franchetti (GSI) in educating one of the authors (S.M. Lund) in phase-amplitude methods described in this lecture.

Edward P. Lee (LBNL) helped formulate parts of material presented in

**S10: Acceleration and Normalized Emittance.**



# Transverse Equilibrium Distribution Functions\*

Steven M. Lund

Lawrence Livermore National Laboratory (LLNL)

Steven M. Lund and John J. Barnard  
™ Beam Physics with Intense Space-Charge<sup>f</sup>

US Particle Accelerator School

University of Maryland, held at Annapolis, MD  
16-27 June, 2008  
(Version 20080625)

\* Research supported by the US Dept. of Energy at LLNL and LBNL under contract Nos. DE-AC52-07NA27344 and DE-AC02-05CH1231.

SM Lund, USPAS, June 2008

Transverse Equilibrium Distributions 1

# Transverse Equilibrium Distribution Functions: Outline

Vlasov Model  
Vlasov Equilibria  
The KV Equilibrium Distribution  
Continuous Focusing Limit of the KV Equilibrium Distribution  
Equilibrium Distributions in Continuous Focusing Channels  
Continuous Focusing: The Waterbag Equilibrium Distribution  
Continuous Focusing: The Thermal Equilibrium Distribution  
Continuous Focusing: Debye Screening in a Thermal Equilibrium Beam  
Continuous Focusing: The Density Inversion Theorem  
References

SM Lund, USPAS, June 2008

Transverse Equilibrium Distributions 2

# Transverse Equilibrium Dist. Functions: Detailed Outline

## 1) Transverse Vlasov-Poisson Model

Vlasov-Poisson System  
Review: Lattices: Continuous, Solenoidal, and Quadrupole  
Review: Undepressed Particle Phase Advance

## 2) Vlasov Equilibria

Equilibrium Conditions  
Single Particle Constants of the Motion  
Discussion: Plasma Physics Approach to Beam Physics

# Detailed Outline - 2

## 3) The KV Equilibrium Distribution

Hillis Equation with Linear Space-Charge Forces  
Review: Courant-Snyder Invariants  
Courant-Snyder Invariants for a Uniform Density Elliptical Beam  
KV Envelope Equations  
KV Equilibrium Distribution  
Canonical Form of the KV Distribution Function  
Matched Envelope Structure  
Depressed Particle Orbits  
rms Equivalent Beams  
Discussion/Comments on the KV model

**Appendix A: Self-fields of a Uniform Density Elliptical Beam in Free Space**  
Derivation #1, direct  
Derivation #2, simplified

**Appendix B: Canonical Transformation of the KV Distribution**  
Canonical Transforms  
Simplified Moment Calculation

SM Lund, USPAS, June 2008

Transverse Equilibrium Distributions 3

Transverse Equilibrium Distributions 4

## Detailed Outline - 3

### 4) The Continuous Focusing Limit of the KV Equilibrium Distribution

Reduction of Elliptical Beam Model  
Wavenumbers of Particle Oscillations  
Distribution Form  
Discussion

### 5) Continuous Focusing Equilibrium Distributions

Equilibrium Form  
Poisson's Equation  
Moments and the rms Equivalent Beam Envelope Equation  
Example Distributions

### 6) Continuous Focusing: The Waterbag Equilibrium Distribution

Distribution Form  
Poisson's Equation  
Solution in Terms of Accelerator Parameters  
Equilibrium Properties

SM Lund, USPAS, June 2008

Transverse Equilibrium Distributions 5

122

## Detailed Outline - 4

### 7) Continuous Focusing: The Thermal Equilibrium Distribution

Overview  
Distribution Form  
Poisson's Equation  
Solution in Terms of Accelerator Parameters  
Equilibrium Properties

### 8) Continuous Focusing: Debye Screening in a Thermal Equilibrium Beam

Poisson's equation for the perturbed potential due to a test charge  
Solution for characteristic Debye screening

### 9) Continuous Focusing: The Density Inversion Theorem

Relation of density profile to the full distribution function

### 10) Comments on the Plausibility of Smooth, non-KV Vlasov Equilibria in

Periodic Focusing Lattices

Discussion

Contact Information

References

SM Lund, USPAS, June 2008

Transverse Equilibrium Distributions 6

## S1: Transverse Vlasov-Poisson Model: for a coasting, single species beam

with electrostatic self-fields propagating in a linear focusing lattice:

$\mathbf{x}_\perp, \mathbf{x}'_\perp$  transverse particle coordinate, angle  
 $q, m$  charge, mass  
 $\gamma_b, \beta_b$  axial relativistic factors  
Vlasov Equation (see J.J. Barnard, **Introductory Lectures**):

$$\frac{d}{ds} f_\perp = \frac{\partial f_\perp}{\partial s} + \frac{d\mathbf{x}_\perp}{ds} \cdot \frac{\partial f_\perp}{\partial \mathbf{x}_\perp} + \frac{\partial f_\perp}{\partial s} = 0$$

Particle Equations of Motion:

$$\frac{d}{ds} \mathbf{x}_\perp = \frac{\partial H_\perp}{\partial \mathbf{x}'_\perp} \quad \frac{d}{ds} \mathbf{x}'_\perp = -\frac{\partial H_\perp}{\partial \mathbf{x}_\perp}$$

Hamiltonian (see S.M. Lund, lectures on **Transverse Particle Equations of Motion**):

$$H_\perp = \frac{1}{2} \mathbf{x}'_\perp \cdot \mathbf{x}'_\perp + \frac{1}{2} \kappa_x(s) x^2 + \frac{1}{2} \kappa_y(s) y^2 + \frac{q}{m\gamma_b^3 \beta_b^2 c^2} \phi$$

Poisson Equation:

$$\left( \frac{\partial^2}{\partial x^2} + \frac{\partial^2}{\partial y^2} \right) \phi = -\frac{q}{\epsilon_0} \int d^2 \mathbf{x}'_\perp f_\perp$$

+ boundary conditions on  $\phi$

SM Lund, USPAS, June 2008

Transverse Equilibrium Distributions 7

### 7) Continuous Focusing: The Thermal Equilibrium Distribution

Overview  
Distribution Form  
Poisson's Equation  
Solution in Terms of Accelerator Parameters  
Equilibrium Properties

### 8) Continuous Focusing: Debye Screening in a Thermal Equilibrium Beam

Poisson's equation for the perturbed potential due to a test charge  
Solution for characteristic Debye screening

### 9) Continuous Focusing: The Density Inversion Theorem

Relation of density profile to the full distribution function

### 10) Comments on the Plausibility of Smooth, non-KV Vlasov Equilibria in

Periodic Focusing Lattices

Discussion

Contact Information

References

SM Lund, USPAS, June 2008

Transverse Equilibrium Distributions 6

Hamiltonian expression of the Vlasov equation:

$$\begin{aligned} \frac{d}{ds} f_\perp &= \frac{\partial f_\perp}{\partial s} + \frac{d\mathbf{x}_\perp}{ds} \cdot \frac{\partial f_\perp}{\partial \mathbf{x}_\perp} + \frac{d\mathbf{x}'_\perp}{ds} \cdot \frac{\partial f_\perp}{\partial \mathbf{x}'_\perp} = 0 \\ &= \frac{\partial f_\perp}{\partial s} + \frac{\partial H_\perp}{\partial \mathbf{x}'_\perp} \cdot \frac{\partial f_\perp}{\partial \mathbf{x}_\perp} - \frac{\partial H_\perp}{\partial \mathbf{x}_\perp} \cdot \frac{\partial f_\perp}{\partial \mathbf{x}'_\perp} = 0 \end{aligned}$$

Using the equations of motion:

$$\begin{aligned} \frac{d}{ds} \mathbf{x}_\perp &= \frac{\partial H_\perp}{\partial \mathbf{x}'_\perp} = \mathbf{x}'_\perp \\ \frac{d}{ds} \mathbf{x}'_\perp &= -\frac{\partial H_\perp}{\partial \mathbf{x}_\perp} = -\left( \kappa_x x \hat{\mathbf{x}} + \kappa_y y \hat{\mathbf{y}} + \frac{q}{m\gamma_b^3 \beta_b^2 c^2} \frac{\partial \phi}{\partial \mathbf{x}_\perp} \right) \end{aligned}$$

$$\frac{\partial f_\perp}{\partial s} + \mathbf{x}'_\perp \cdot \frac{\partial f_\perp}{\partial \mathbf{x}_\perp} - \left( \kappa_x x \hat{\mathbf{x}} + \kappa_y y \hat{\mathbf{y}} + \frac{q}{m\gamma_b^3 \beta_b^2 c^2} \frac{\partial \phi}{\partial \mathbf{x}_\perp} \right) \cdot \frac{\partial f_\perp}{\partial \mathbf{x}'_\perp} = 0$$

In formal dynamics, a **Poisson Bracket** notation is frequently employed:

$$\begin{aligned} \frac{d}{ds} f_\perp &= \frac{\partial f_\perp}{\partial s} + \frac{\partial H_\perp}{\partial \mathbf{x}'_\perp} \cdot \frac{\partial f_\perp}{\partial \mathbf{x}_\perp} - \frac{\partial H_\perp}{\partial \mathbf{x}_\perp} \cdot \frac{\partial f_\perp}{\partial \mathbf{x}'_\perp} = 0 \\ &\equiv \frac{\partial f_\perp}{\partial s} + \{H_\perp, f_\perp\} = 0 \end{aligned}$$

↑  
Poisson Bracket

SM Lund, USPAS, June 2008

Transverse Equilibrium Distributions 8

### Comments on Vlasov-Poisson Model

- Collisionless Vlasov-Poisson model good for intense beams with many particles
  - Collisions negligible, see: J.J. Barnard, **Intro. Lectures**
- Vlasov-Poisson model can be solved as an initial value problem

- $f_{\perp}(\mathbf{x}_{\perp}, \mathbf{x}'_{\perp}, s = s_i) = \text{Initial}$  "condition" (function) specified
- Vlasov-Poisson model solved for subsequent evolution in  $s$  for  $f_{\perp}(\mathbf{x}_{\perp}, \mathbf{x}'_{\perp}, s)$  for  $s \geq s_i$

- The coupling to the self-field via the Poisson equation makes the Vlasov-Poisson model *highly nonlinear*

$$\rho = q \int d^2 x'_{\perp} f_{\perp} \left( \frac{\partial^2}{\partial x^2} + \frac{\partial^2}{\partial y^2} \right) \phi = -\frac{\rho}{\epsilon_0}$$

- Vlasov-Poisson system is written without acceleration, but the transforms developed to identify the normalized emittance in the lectures on **Transverse Particle Equations of Motion** can be exploited to generalize all result presented to (weakly) accelerating beams (interpret in tilde variables)
- For solenoidal focusing the system must be interpreted in the rotating

Larmor Frame, see: lectures on **Transverse Particle Equations of Motion**

### Example Hamiltonians:

Continuous focusing  $\kappa_x = \kappa_y = k_{\beta 0}^2 = \text{const}$

$$H_{\perp} = \frac{1}{2} \mathbf{x}'_{\perp}{}^2 + \frac{1}{2} k_{\beta 0}^2 \mathbf{x}_{\perp}^2 + \frac{q}{m\gamma_b^3 \beta_b^2 c^2} \phi$$

Solenoidal focusing (in Larmor frame variables)  $\kappa_x = \kappa_y = \kappa(s)$

$$H_{\perp} = \frac{1}{2} \mathbf{x}'_{\perp}{}^2 + \frac{1}{2} \kappa \mathbf{x}_{\perp}^2 + \frac{q}{m\gamma_b^3 \beta_b^2 c^2} \phi$$

Quadrupole focusing  $\kappa_x = -\kappa_y = \kappa(s)$

$$H_{\perp} = \frac{1}{2} \mathbf{x}'_{\perp}{}^2 + \frac{1}{2} \kappa x^2 - \frac{1}{2} \kappa y^2 + \frac{q}{m\gamma_b^3 \beta_b^2 c^2} \phi$$

### Review: Focusing lattices, continuous and periodic (simple piecewise constant):

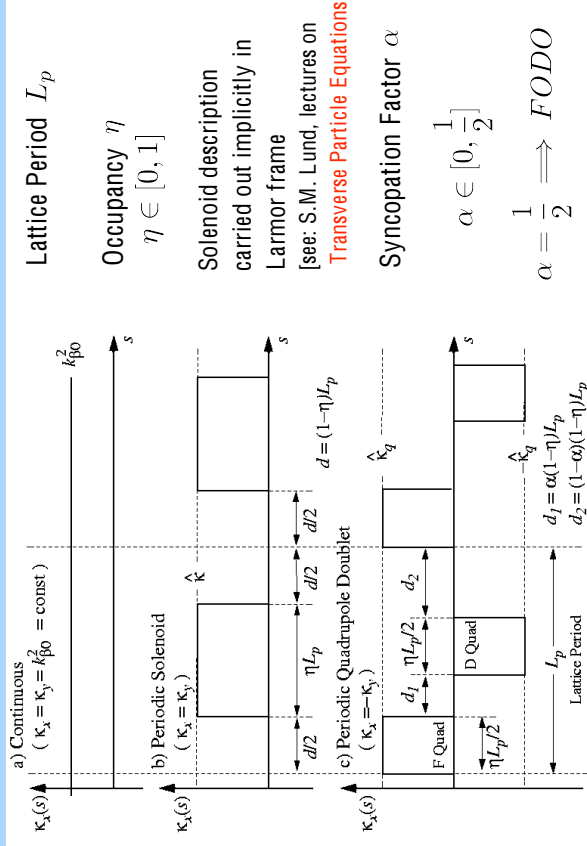

Review: Undepressed particle phase advance!  $\sigma_0$  is typically employed to characterize the applied focusing strength of periodic lattices: see: S.M. Lund lectures on **Transverse Particle Equations of Motion**

x-orbit without space-charge satisfies Hillis equation

$$x''(s) + \kappa_x(s)x(s) = 0$$

$$\begin{pmatrix} x(s) \\ x'(s) \end{pmatrix} = \mathbf{M}_x(s | s_i) \cdot \begin{pmatrix} x(s_i) \\ x'(s_i) \end{pmatrix} \quad \mathbf{M}_x = 2 \times 2 \text{ Transfer Matrix from } s = s_i \text{ to } s$$

Undepressed phase advance

$$\cos \sigma_{0x} = \frac{1}{2} \text{Tr} \mathbf{M}_x(s_i + L_p | s_i)$$

- Subscript used stresses -plane value and zero ( = 0) space-charge effects
- Single particle (and centroid) stability requires:

$$\frac{1}{2} \text{Tr} \mathbf{M}_x(s_i + L_p | s_i) < 1 \implies \sigma_{0x} < 180^\circ$$

Analogous equations hold in the  $y$ -plane [Courant and Snyder, Annals of Phys. 3, 1 (1958)]

The **undepressed phase advance** can also be equivalently calculated from:

$$w_{0x}'' + \kappa_x w_{0x} - \frac{1}{w_{0x}^3} = 0 \quad w_{0x}(s + L_p) = w_{0x}(s)$$

$$\sigma_{0x} = \int_{s_i}^{s_i + L_p} \frac{ds}{w_{0x}^2} \quad w_{0x} > 0$$

→ Subscript stresses -plane value and zero ( = 0) space-charge effects

**S2: Vlasov Equilibria:** Plasma physics-like approach is to resolve the system into an equilibrium + perturbation and analyze stability Equilibrium constructed from single-particle constants of motion  $C_i$

$$f_{\perp} = f_{\perp}(\{C_i\}) \geq 0 \implies \text{equilibrium}$$

$$\frac{d}{ds} f_{\perp}(\{C_i\}) = \sum_i \frac{\partial f_{\perp}}{\partial C_i} \frac{dC_i}{ds} = 0$$

Comments:

- Equilibrium is an exact solution to Vlasov's equation that *does not change* in 4D phase-space as advances
- Projections of the distribution can evolve in general cases
- Requirement of positive  $f_{\perp}(\{C_i\})$  results from single particle species
- Particle conversation constraints are in the presence of (possibly -varying) applied and space-charge forces
  - Highly non-trivial!
  - Only one exact solution known for -varying focusing using Courant-Snyder invariants: the KV distribution to be analyzed in this lecture

**Typical single particle constants of motion:**

Transverse Hamiltonian for continuous focusing:

$$H_{\perp} = \frac{1}{2} \mathbf{x}'_{\perp}{}^2 + \frac{1}{2} k_{\beta 0}^2 \mathbf{x}_{\perp}^2 + \frac{q}{m \gamma_b^3 \beta_b^2 c^2} \phi = \text{const}$$

$$k_{\beta 0}^2 = \text{const}$$

→ Not valid for periodic focusing systems!

Angular momentum for systems invariant under azimuthal rotation:

$$P_{\theta} = xy' - yx' = \text{const}$$

→ Subtle point: This form is really a **Canonical Angular Momentum** and applies to solenoidal magnetic focusing when the variables are expressed in the **rotating Larmor frame** (i.e., in the  $\tilde{\mathbf{r}}$  variables)

- see: S. M. Lund, lectures on **Transverse Particle Equations Axial kinetic energy** for systems with no acceleration:

$$\mathcal{E} = (\gamma_b - 1) m c^2 = \text{const}$$

→ Trivial for a coasting beam with  $\gamma_b \beta_b = \text{const}$

**More on other classes of constraints later ...**

**/// Example:** Continuous focusing  $f_{\perp} = f_{\perp}(H_{\perp})$

$$H_{\perp} = \frac{1}{2} \mathbf{x}'_{\perp}{}^2 + \frac{1}{2} k_{\beta 0}^2 \mathbf{x}_{\perp}^2 + \frac{q}{m \gamma_b^3 \beta_b^2 c^2} \phi \quad \text{no explicit dependence}$$

$$\frac{df_{\perp}}{ds} = \frac{\partial f_{\perp}}{\partial s} + \frac{\partial f_{\perp}}{\partial \mathbf{x}'_{\perp}} \cdot \frac{\partial H_{\perp}}{\partial \mathbf{x}'_{\perp}} - \frac{\partial f_{\perp}}{\partial \mathbf{x}_{\perp}} \cdot \frac{\partial H_{\perp}}{\partial \mathbf{x}_{\perp}} \quad \text{see problem sets for detailed argument}$$

$$= \frac{\partial f_{\perp}}{\partial H_{\perp}} \frac{\partial H_{\perp}}{\partial s} + \frac{\partial f_{\perp}}{\partial H_{\perp}} \frac{\partial H_{\perp}}{\partial \mathbf{x}'_{\perp}} \cdot \frac{\partial H_{\perp}}{\partial \mathbf{x}'_{\perp}} - \frac{\partial f_{\perp}}{\partial H_{\perp}} \frac{\partial H_{\perp}}{\partial \mathbf{x}_{\perp}} \cdot \frac{\partial H_{\perp}}{\partial \mathbf{x}_{\perp}} = 0$$

Showing that  $f_{\perp} = f_{\perp}(H_{\perp})$  exactly satisfies Vlasov's equation for continuous focusing

→ Also, for physical solutions must require:  $f_{\perp}(H_{\perp}) \geq 0$

→ To be appropriate for single species with positive density

→ Huge variety of equilibrium function choices  $f_{\perp}(H_{\perp})$

can be made to generate many radically different equilibria

- Infinite variety in function space

→ Does **NOT** apply to systems with -varying focusing  $\kappa_x \rightarrow k_{\beta 0}^2$

- Can provide a rough guide if we can approximate: **///**

## Plasma physics approach to beam physics:

Resolve:

$$f(\mathbf{x}_\perp, \mathbf{x}'_\perp, s) = f_\perp(\{C_i\}) + \delta f_\perp(\mathbf{x}_\perp, \mathbf{x}'_\perp, s)$$

equilibrium
perturbation
 $f_\perp \gg |\delta f_\perp|$

and carry out equilibrium + stability analysis

Comments:

- ▶ Attraction is to parallel the impressive successes of plasma physics
  - Gain insight into preferred state of nature
  - ▶ Beams are born off a source and may not be close to an equilibrium condition
  - Appropriate single particle constants of the motion unknown for periodic focusing lattices other than the (unphysical) KV distribution
  - ▶ Intense beam self-fields and finite radial extent vastly complicate equilibrium description and analysis of perturbations
    - It is not clear if smooth Vlasov equilibria exist in periodic focusing
    - Higher model detail vastly complicates picture!
  - ▶ If system can be tuned to more closely resemble a relaxed, equilibrium, one might expect less deleterious effects based on plasma physics analogies

SM Lund, USPAS, June 2008

Transverse Equilibrium Distributions 17

## S3: The KV Equilibrium Distribution

[Kapchinskij and Vladimirov, Proc. Int. Conf. On High Energy Accel., p. 274 (1959); and Review: Lund, Kikuchi, and Davidson, PRSTAB, to be published, (2008)]  
 Assume a uniform density elliptical beam in a periodic focusing lattice

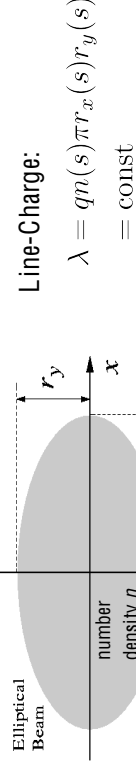

Free-space self-field solution within the beam (see: Appendix A) is:

$$\phi = -\frac{\lambda}{2\pi\epsilon_0} \left[ \frac{x^2}{(r_x + r_y)r_x} + \frac{y^2}{(r_x + r_y)r_y} \right] + \text{const}$$

$$\begin{aligned} -\frac{\partial\phi}{\partial x} &= \frac{\lambda}{\pi\epsilon_0} \frac{x}{(r_x + r_y)r_x} \\ -\frac{\partial\phi}{\partial y} &= \frac{\lambda}{\pi\epsilon_0} \frac{y}{(r_x + r_y)r_y} \end{aligned}$$

valid only within the beam!

SM Lund, USPAS, June 2008

Transverse Equilibrium Distributions 18

The particle equations of motion:

$$\begin{aligned} x'' + \kappa_x x &= -\frac{q}{m\gamma_b^3\beta_b^2c^2} \frac{\partial\phi}{\partial x} \\ y'' + \kappa_y y &= -\frac{q}{m\gamma_b^3\beta_b^2c^2} \frac{\partial\phi}{\partial y} \end{aligned}$$

become within the beam:

$$\begin{aligned} x''(s) + \left\{ \kappa_x(s) - \frac{2Q}{[r_x(s) + r_y(s)]r_x(s)} \right\} x(s) &= 0 \\ y''(s) + \left\{ \kappa_y(s) - \frac{2Q}{[r_x(s) + r_y(s)]r_y(s)} \right\} y(s) &= 0 \end{aligned}$$

Here, is the dimensionless perveance defined by:

$$Q = \frac{q\lambda}{2\pi\epsilon_0 m\gamma_b^3\beta_b^2c^2} = \text{const}$$

- ▶ Same measure of space-charge intensity used by J.J. Barnard in Intro. Lectures
- ▶ Properties/interpretations of the perveance will be extensively developed in this and subsequent lectures

SM Lund, USPAS, June 2008

Transverse Equilibrium Distributions 19

If we regard the envelope radii  $r_x, r_y$  as specified functions of  $s$ , then these equations of motion are Hill's equations familiar from elementary accelerator physics:

$$\begin{aligned} x''(s) + \kappa_x^{\text{eff}}(s)x(s) &= 0 \\ y''(s) + \kappa_y^{\text{eff}}(s)y(s) &= 0 \\ \kappa_x^{\text{eff}}(s) &= \kappa_x(s) - \frac{2Q}{[r_x(s) + r_y(s)]r_x(s)} \\ \kappa_y^{\text{eff}}(s) &= \kappa_y(s) - \frac{2Q}{[r_x(s) + r_y(s)]r_y(s)} \end{aligned}$$

Suggests Procedure:

- ▶ Calculate Courant-Snyder invariants under assumptions made
- ▶ Construct a distribution function of Courant-Snyder invariants that generates the uniform density elliptical beam projection assumed
  - **Nontrivial step:** guess and show that it works

Resulting distribution will be an equilibrium that does not evolve in 4D phase-space, but lower-dimensional phase-space projections can evolve in

SM Lund, USPAS, June 2008

Transverse Equilibrium Distributions 20

**Review (1):** The Courant-Snyder invariant of Hill's equation [Courant and Snyder, Annl. Phys. 3, 1 (1958)]

Hill's equation describes a zero space-charge particle orbit in linear applied focusing fields:

$$x''(s) + \kappa(s)x(s) = 0$$

As a consequence of Floquet's theorem, the solution can be cast in phase-amplitude form:

$$x(s) = A_i w(s) \cos \psi(s)$$

where  $w(s)$  is the periodic amplitude function satisfying

$$w''(s) + \kappa(s)w(s) - \frac{1}{w^3(s)} = 0$$

$$w(s + L_p) = w(s) \quad w(s) > 0$$

$\psi(s)$  is a phase function given by

$$\psi(s) = \psi_i + \int_{s_i}^s \frac{d\bar{s}}{w^2(\bar{s})}$$

$A_i$  and  $\psi_i$  are constants set by initial conditions at  $s = s_i$

**Review (2):** The Courant-Snyder invariant of Hill's equation

From this formulation, it follows that

$$x(s) = A_i w(s) \cos \psi(s)$$

$$x'(s) = A_i w'(s) \cos \psi(s) - \frac{A_i}{w(s)} \sin \psi(s)$$

or

$$\frac{x}{w} = A_i \cos \psi$$

$$w x' - w' x = A_i \sin \psi$$

square and add equations to obtain the Courant-Snyder invariant

$$\left(\frac{x}{w}\right)^2 + (w x' - w' x)^2 = A_i^2 = \text{const}$$

- Simplifies interpretation of dynamics
- Extensively used in accelerator physics

**Review (1):** The Courant-Snyder invariant of Hill's equation [Courant and Snyder, Annl. Phys. 3, 1 (1958)]

Hill's equation describes a zero space-charge particle orbit in linear applied focusing fields:

$$x''(s) + \kappa(s)x(s) = 0$$

As a consequence of Floquet's theorem, the solution can be cast in phase-amplitude form:

$$x(s) = A_i w(s) \cos \psi(s)$$

where  $w(s)$  is the periodic amplitude function satisfying

$$w''(s) + \kappa(s)w(s) - \frac{1}{w^3(s)} = 0$$

$$w(s + L_p) = w(s) \quad w(s) > 0$$

$\psi(s)$  is a phase function given by

$$\psi(s) = \psi_i + \int_{s_i}^s \frac{d\bar{s}}{w^2(\bar{s})}$$

$A_i$  and  $\psi_i$  are constants set by initial conditions at  $s = s_i$

**Phase-amplitude description of particles evolving within a uniform density beam:**

**Phase-amplitude form of -orbit equations:**

$$x(s) = A_{xi} w_x(s) \cos \psi_x(s)$$

$$x'(s) = A_{xi} w'_x(s) \cos \psi_x(s) - \frac{A_{xi}}{w_x(s)} \sin \psi_x(s)$$

where

$$w_x''(s) + \kappa_x(s)w_x(s) - \frac{2Q}{[r_x(s) + r_y(s)]r_x(s)} w_x(s) - \frac{1}{w_x^3(s)} = 0$$

$$w_x(s + L_p) = w_x(s) \quad w_x(s) > 0$$

$$\psi_x(s) = \psi_{xi} + \int_{s_i}^s \frac{d\bar{s}}{w_x^2(\bar{s})}$$

identifies the Courant-Snyder invariant

$$\left(\frac{x}{w_x}\right)^2 + (w_x x' - w'_x x)^2 = A_{xi}^2 = \text{const}$$

Analogous equations hold for the y-plane

**The KV envelope equations:**

Define maximum Courant-Snyder invariants:

$$\varepsilon_x \equiv \text{Max}(A_{xi}^2)$$

$$\varepsilon_y \equiv \text{Max}(A_{yi}^2)$$

These values must correspond to the beam-edge:

$$r_x(s) = \sqrt{\varepsilon_x} w_x(s)$$

$$r_y(s) = \sqrt{\varepsilon_y} w_y(s)$$

The equations for  $w_x$  and  $w_y$  can then be rescaled to obtain the familiar

**KV envelope equations for the matched beam envelope**

$$r_x''(s) + \kappa_x(s)r_x(s) - \frac{2Q}{r_x(s) + r_y(s)} - \frac{\varepsilon_x^2}{r_x^3(s)} = 0$$

$$r_y''(s) + \kappa_y(s)r_y(s) - \frac{2Q}{r_x(s) + r_y(s)} - \frac{\varepsilon_y^2}{r_y^3(s)} = 0$$

$$r_x(s + L_p) = r_x(s) \quad r_x(s) > 0$$

$$r_y(s + L_p) = r_y(s) \quad r_y(s) > 0$$

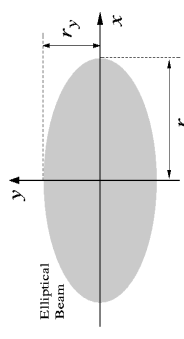

Elliptical Beam



Use variable rescalings to denote  $x$  and  $y$ -plane Courant-Snyder invariants as:

$$\left(\frac{x}{w_x}\right)^2 + (w_x x' - w'_x x)^2 = A_{xi}^2 = \text{const}$$

$$\left(\frac{x}{r_x}\right)^2 + \left(\frac{r_x x' - r'_x x}{\varepsilon_x}\right)^2 = C_x = \text{const}$$

$$\left(\frac{y}{r_y}\right)^2 + \left(\frac{r_y y' - r'_y y}{\varepsilon_y}\right)^2 = C_y = \text{const}$$

Kapchinskij and Vladimirkij constructed a delta-function distribution of a linear combination of these Courant-Snyder invariants that generates the correct uniform density elliptical beam needed for consistency with the assumptions:

$$f_{\perp} = \frac{\lambda}{q\pi^2 \varepsilon_x \varepsilon_y} \delta[C_x + C_y - 1]$$

- ▶ Delta function means the sum of the  $x$ - and  $y$ -invariants is a constant
- ▶ Other forms cannot generate the needed uniform density elliptical beam projection (see: S9)

The KV equilibrium is constructed from the Courant-Snyder invariants:

KV equilibrium distribution:

$$f_{\perp}(\mathbf{x}_{\perp}, \mathbf{x}'_{\perp}, s) = \frac{\lambda}{q\pi^2 \varepsilon_x \varepsilon_y} \delta \left[ \left(\frac{x}{r_x}\right)^2 + \left(\frac{r_x x' - r'_x x}{\varepsilon_x}\right)^2 + \left(\frac{y}{r_y}\right)^2 + \left(\frac{r_y y' - r'_y y}{\varepsilon_y}\right)^2 - 1 \right] = \text{const}$$

$\delta(x) =$  Dirac delta function

This distribution generates (see: proof in Appendix B) the correct uniform density elliptical beam:

$$n = \int d^2 x'_{\perp} f_{\perp} = \begin{cases} \frac{\lambda}{q\pi r_x r_y}, & x^2/r_x^2 + y^2/r_y^2 < 1 \\ 0, & x^2/r_x^2 + y^2/r_y^2 > 1 \end{cases}$$

Obtaining this form consistent with the assumptions, thereby

demonstrating full self-consistency of the KV equilibrium distribution.

- Full 4-D form of the distribution does not evolve in
- Projections of the distribution can (and generally do!) evolve in

/// Comment on notation of integrals:

- 2<sup>nd</sup> forms useful for systems with azimuthal spatial or annular symmetry

Spatial

$$\int d^2 x_{\perp} \dots \equiv \int_{-\infty}^{\infty} dx \int_{-\infty}^{\infty} dy \dots$$

Cylindrical Coordinates:

$$x = r \cos \theta$$

$$y = r \sin \theta$$

Angular

$$\int d^2 x'_{\perp} \dots \equiv \int_{-\infty}^{\infty} dx' \int_{-\infty}^{\infty} dy' \dots$$

Angular

Cylindrical Coordinates:

$$x' = r' \cos \theta'$$

$$y' = r' \sin \theta'$$

Comment on angle integral representation:

$$[[r']] = \text{Angle} \quad r' \in [0, \infty)$$

$$\theta' \neq \frac{d}{ds} \theta \quad [[\theta']] = \text{rad} \quad \theta' \in [-\pi, \pi]$$

$$x' = r' \cos \theta' \quad [[x']] = \text{Angle} \quad x' \in (-\infty, \infty)$$

$$y' = r' \sin \theta' \quad [[y']] = \text{Angle} \quad y' \in (-\infty, \infty)$$

Comment on notation of integrals (continued):  
Axisymmetry simplifications

Spatial: for some function  $f(\mathbf{x}_\perp^2) = f(r^2)$

$$\int d^2x_\perp f(\mathbf{x}_\perp^2) = 2\pi \int_0^\infty dr r f(r^2)$$

$$= \pi \int_0^\infty dr^2 f(r^2)$$

$$= \pi \int_0^\infty dw f(w)$$

Angular: for some function  $g(\mathbf{x}_\perp'^2) = g(r'^2)$

$$\int d^2x'_\perp g(\mathbf{x}_\perp'^2) = 2\pi \int_0^\infty dr' r' g(r'^2)$$

$$= \pi \int_0^\infty dr'^2 g(r'^2)$$

$$= \pi \int_0^\infty du g(u)$$

Cylindrical Coordinates:

$$x = r \cos \theta$$

$$y = r \sin \theta$$

$$w = r^2$$

Angular

Cylindrical Coordinates:

$$x' = r' \cos \theta'$$

$$y' = r' \sin \theta'$$

$$u = r'^2$$

///

Moments of the KV distribution can be calculated directly from the distribution to further aid interpretation: [see: [Appendix B](#) for details]

Full 4D average:  $\langle \dots \rangle_\perp \equiv \frac{\int d^2x_\perp \int d^2x'_\perp \dots f_\perp}{\int d^2x_\perp \int d^2x'_\perp f_\perp}$

Restricted angle average:  $\langle \dots \rangle_{\mathbf{x}'_\perp} \equiv \frac{\int d^2x'_\perp \dots f_\perp}{\int d^2x'_\perp f_\perp}$

Envelope edge radius:

$$r_x = 2 \langle x^2 \rangle_\perp^{1/2}$$

rms edge emittance (maximum Courant-Snyder invariant):

$$\varepsilon_x = 4 [ \langle x^2 \rangle_\perp \langle x'^2 \rangle_\perp - \langle x x' \rangle_\perp^2 ]^{1/2} = \text{const}$$

Coherent flows (within the beam, zero otherwise):

$$\langle x' \rangle_{\mathbf{x}'_\perp} = r'_x \frac{x}{r_x}$$

Angular spread (x-temperature, within the beam, zero otherwise):

$$T_x \equiv \langle (x' - \langle x' \rangle_{\mathbf{x}'_\perp})^2 \rangle_{\mathbf{x}'_\perp} = \frac{\varepsilon_x^2}{2r_x^2} \left( 1 - \frac{x^2}{r_x^2} - \frac{y^2}{r_y^2} \right)$$

Summary of 1<sup>st</sup> and 2<sup>nd</sup> order moments of the KV distribution:

Moment	Value
$\int d^2x'_\perp x' f_\perp$	$r'_x \frac{x}{r_x} n$
$\int d^2x'_\perp y' f_\perp$	$r'_y \frac{y}{r_y} n$
$\int d^2x'_\perp x'^2 f_\perp$	$\left[ r_x'^2 \frac{x^2}{r_x^2} + \frac{r_y'^2}{2r_y^2} \left( 1 - \frac{x^2}{r_x^2} - \frac{y^2}{r_y^2} \right) \right] n$
$\int d^2x'_\perp y'^2 f_\perp$	$\left[ r_y'^2 \frac{y^2}{r_y^2} + \frac{r_x'^2}{2r_x^2} \left( 1 - \frac{x^2}{r_x^2} - \frac{y^2}{r_y^2} \right) \right] n$
$\int d^2x'_\perp x x' f_\perp$	$\frac{r_x'^2}{r_x} x^2 n$
$\int d^2x'_\perp y y' f_\perp$	$\frac{r_y'^2}{r_y} y^2 n$
$\int d^2x'_\perp (x y' - y x') f_\perp$	0
$\langle x^2 \rangle_\perp$	$\frac{r_x^2}{4}$
$\langle y^2 \rangle_\perp$	$\frac{r_y^2}{4}$
$\langle x'^2 \rangle_\perp$	$\frac{r_x'^2}{4} + \frac{r_y'^2}{4r_x^2}$
$\langle y'^2 \rangle_\perp$	$\frac{r_y'^2}{4} + \frac{r_x'^2}{4r_y^2}$
$\langle x x' \rangle_\perp$	$\frac{r_x'^2}{4}$
$\langle y y' \rangle_\perp$	$\frac{r_y'^2}{4}$
$\langle x y' - y x' \rangle_\perp$	0
$16 [ \langle x^2 \rangle_\perp \langle x'^2 \rangle_\perp - \langle x x' \rangle_\perp^2 ]$	$\varepsilon_x^2$
$16 [ \langle y^2 \rangle_\perp \langle y'^2 \rangle_\perp - \langle y y' \rangle_\perp^2 ]$	$\varepsilon_y^2$

All 1<sup>st</sup> and 2<sup>nd</sup> order moments not listed vanish, i.e.,

$$\int d^2x'_\perp x y f_\perp = 0$$

$$\langle x y \rangle_\perp = 0$$

see reviews by:

(limit of results presented)  
Lund and Bukh, PRSTAB 024801 (2004), Appendix A

S.M. Lund, T. Kikuchi, and R.C. Davidson, PRSTAB, to be published (2008)

Canonical transformation illustrates KV distribution structure:

[Davidson, Physics of Nonneutral Plasmas, Addison-Wesley (1990), and [Appendix B](#)]

Phase-space transformation:

$$X = \frac{\sqrt{\varepsilon_x} x}{r_x}$$

$$X' = \frac{r_x x' - r'_x x}{\sqrt{\varepsilon_x}}$$

$$dx dy = \frac{r_x r'_y}{\sqrt{\varepsilon_x \varepsilon_y}} dX dY$$

$$dx' dy' = \frac{\sqrt{\varepsilon_x \varepsilon_y}}{r_x r'_y} dX' dY'$$

$$dx dy dx' dy' = dX dY dX' dY'$$

Courant-Snyder invariants in the presence of beam space-charge are then simply:

$$X^2 + Y'^2 = \text{const}$$

and the KV distribution takes the simple, *symmetrical* form:

$$f_\perp(x, y, x', y', s) = f_\perp(X, Y, X', Y') = \frac{\lambda}{q \pi^2 \varepsilon_x \varepsilon_y} \delta \left[ \frac{X^2 + Y'^2}{\varepsilon_x} + \frac{Y^2 + Y'^2}{\varepsilon_y} - 1 \right]$$

from which the density and other projections can be (see: [Appendix B](#)) calculated

more easily:

$$n = \int d^2x'_\perp f_\perp = \frac{\lambda}{q \pi r_x r_y} \int_0^\infty dU^2 \delta \left[ U^2 - \left( 1 - \frac{x^2}{r_x^2} - \frac{y^2}{r_y^2} \right) \right]$$

$$= \begin{cases} \frac{\lambda}{q \pi r_x r_y} & x^2/r_x^2 + y^2/r_y^2 < 1 \\ 0, & x^2/r_x^2 + y^2/r_y^2 > 1 \end{cases}$$



## KV Envelope equation

The envelope equation reflects low-order force balances

$r_x'' + \kappa_x r_x - \frac{2Q}{r_x + r_y} = 0$	$r_x''(s + L_p) = 0$
$r_y'' + \kappa_y r_y - \frac{2Q}{r_x + r_y} = 0$	$r_y''(s + L_p) = 0$

Applied Focusing Lattice  
 Space-Charge Defocusing  
 Thermal Defocusing  
 Terms: Lattice Perveance Emittance

### Comments:

- Envelope equation is a projection of the 4D invariant distribution
- Envelope evolution equivalently given by moments of the 4D equilibrium distribution
- Most important basic design equation for transport lattices with high space-charge intensity
- Simplest consistent model incorporating applied focusing, space-charge defocusing, and thermal defocusing forces
- Starting point of almost all practical machine design!

### Comments Continued:

- Beam envelope matching will be covered in much more detail in S.M. Lund lectures on **Centroid and Envelope Description of Beams**
- Requires specific initial conditions for periodic evolution
 
$$r_x(s_i), r_y(s_i), r_x'(s_i), r_y'(s_i)$$
- Instabilities of envelope equations are well understood and real (to be covered: see S.M. Lund lectures on **Centroid and Envelope Description of Beams**)
  - Must be avoided for reliable machine operation

The matched solution to the KV envelope equations reflects the symmetry of the focusing lattice and must in general be calculated numerically

$$r_x(s + L_p) = r_x(s)$$

$$r_y(s + L_p) = r_y(s)$$

$$\varepsilon_x = \varepsilon_y$$

### Solenoidal Focusing

$$(Q = 6.6986 \times 10^{-4})$$

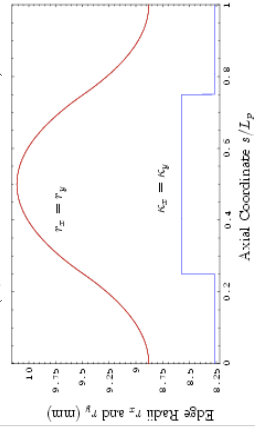

**Parameters**

$$L_p = 0.5 \text{ m}, \sigma_0 = 80^\circ, \eta = 0.5$$

$$\varepsilon_x = 50 \text{ mm-mrad}$$

$$\sigma/\sigma_0 = 0.2$$

### FODO Quadrupole Focusing

$$(Q = 6.5614 \times 10^{-4})$$

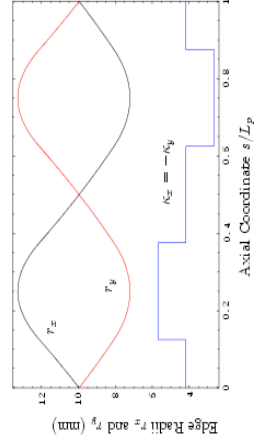

The matched beam is the most radially compact solution to the envelope equations rendering it highly important for beam transport

Some phase-space projections of a matched KV equilibrium beam in a periodic FODO quadrupole transport lattice

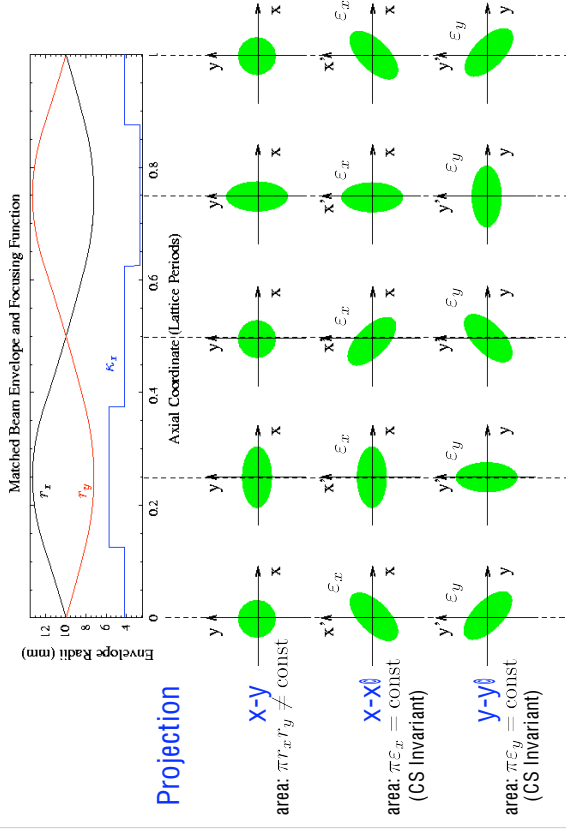

KV model shows that particle orbits in the presence of space-charge can be strongly modified  $\pm$  space charge slows the orbit response:

Matched envelope:

$$r_x''(s) + \kappa_x(s)r_x(s) - \frac{2Q}{r_x(s) + r_y(s)} - \frac{\varepsilon_x^2}{r_x^3(s)} = 0$$

$$r_y''(s) + \kappa_y(s)r_y(s) - \frac{2Q}{r_x(s) + r_y(s)} - \frac{\varepsilon_y^2}{r_y^3(s)} = 0$$

$$r_x(s + L_p) = r_x(s) \quad r_x(s) > 0$$

$$r_y(s + L_p) = r_y(s) \quad r_y(s) > 0$$

Equation of motion for x-plane "depressed" orbit in the presence of space-charge:

$$x''(s) + \kappa_x(s)x(s) - \frac{2Q}{[r_x(s) + r_y(s)]r_x(s)}x(s) = 0$$

All particles have the same value of depressed phase advance (similar Eqns in ):

$$\sigma_x \equiv \psi_x(s_i + L_p) - \psi_x(s_i) = \varepsilon_x \int_{s_i}^{s_i+L_p} \frac{ds}{r_x^2(s)}$$

Contrast: Review, the undepressed particle phase advance calculated in the lectures on **Transverse Particle Equations of Motion**

The undepressed phase advance in defined as the phase advance of a particle in the absence of space-charge ( $\sigma = 0$ ):

Denote by  $\sigma_{0x}$  to distinguished from the "depressed" phase advance  $\sigma_x$  in the presence of space-charge

$$w_{0x}'' + \kappa_x w_{0x} - \frac{1}{w_{0x}^3} = 0 \quad w_{0x}(s + L_p) = w_{0x}(s)$$

$$\sigma_{0x} = \int_{s_i}^{s_i+L_p} \frac{ds}{w_{0x}^2} \quad w_{0x} > 0$$

This can be equivalently calculated from the matched envelope with  $\sigma = 0$ :

$$r_{0x}'' + \kappa_x r_{0x} - \frac{\varepsilon_x^2}{r_{0x}^3} = 0 \quad r_{0x}(s + L_p) = r_{0x}(s)$$

$$\sigma_{0x} = \varepsilon_x \int_{s_i}^{s_i+L_p} \frac{ds}{r_{0x}^2} \quad r_{0x} > 0$$

Value of  $\varepsilon_x$  is arbitrary (answer for  $\sigma_{0x}$ 's independent)

Depressed particle -plane orbits within a matched KV beam in a periodic FODO quadrupole channel for the matched beams previously shown

**Solenoidal Focusing** (Larmor frame orbit):

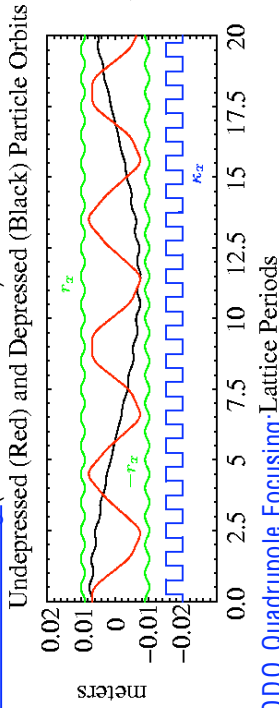

**FODO Quadrupole Focusing**: Lattice Periods

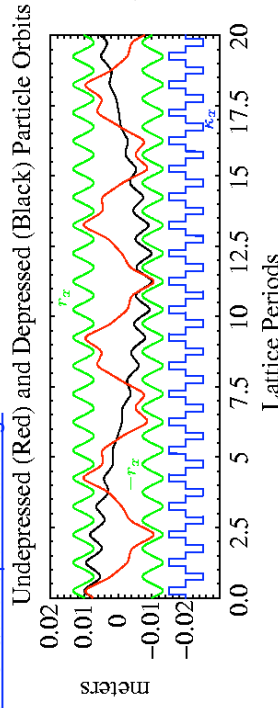

Depressed particle phase advance provides a convenient measure of space-charge strength

For simplicity take (plane symmetry in average focusing and emittance)

$$\sigma_{0x} = \sigma_{0y} \equiv \sigma_0 \quad \varepsilon_x = \varepsilon_y \equiv \varepsilon$$

Depressed phase advance within a matched beam

$$\sigma = \varepsilon \int_{s_i}^{s_i+L_p} \frac{ds}{r_x^2(s)} = \varepsilon \int_{s_i}^{s_i+L_p} \frac{ds}{r_y^2(s)}$$

$$\lim_{Q \rightarrow 0} \sigma = \sigma_0$$

Normalized space charge strength

$$\sigma / \sigma_0 \rightarrow 0 \quad \text{Cold Beam (space-charge dominated)} \quad \varepsilon \rightarrow 0$$

$$\sigma / \sigma_0 \rightarrow 1 \quad \text{Warm Beam (kinetic dominated)} \quad Q \rightarrow 0$$

$$0 \leq \sigma / \sigma_0 \leq 1$$

For example matched envelope presented earlier:

**Undepressed phase advance:**  $\sigma_0 = 80^\circ$   
**Depressed phase advance:**  $\sigma = 16^\circ \rightarrow \sigma/\sigma_0 = 0.2$

Solenoidal Focusing (Larmor frame orbit):

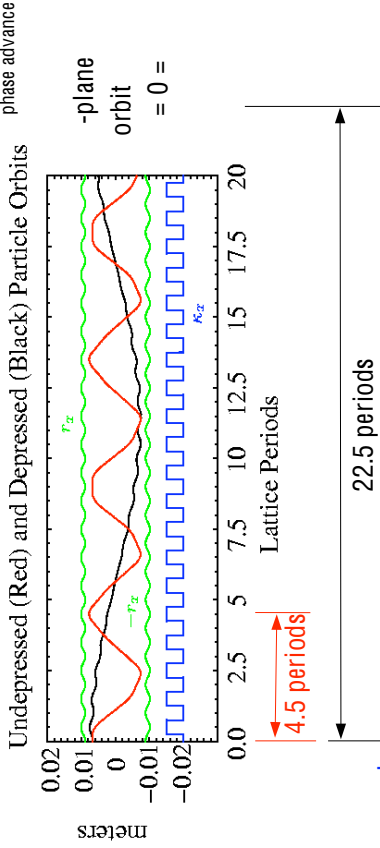

**Comment:**

All particles in the distribution will, of course, always move in response to both applied and self-fields. You cannot turn off space-charge for an undepressed orbit. It is a convenient conceptual construction to help understand focusing properties.

SM Lund, USPAS, June 2008

Transverse Equilibrium Distributions 41

The rms equivalent beam model helps interpret general beam evolution in terms of an "equivalent" local KV distribution

For the same focusing lattice, replace any beam charge  $\rho(x, y)$  density by a uniform density KV beam in each axial slice ( $s$ ) using averages calculated from the actual "real" beam distribution with:

$$\langle \dots \rangle_{\perp} \equiv \frac{\int d^2x_{\perp} \int d^2x'_{\perp} \dots f_{\perp}}{\int d^2x_{\perp} \int d^2x'_{\perp} f_{\perp}} \quad f_{\perp} = \text{real distribution}$$

rms equivalent beam:

Quantity	KV Equiv.	Calculated from Distribution
Perveance	$Q$	$= q^2 \int d^2x_{\perp} \int d^2x'_{\perp} f_{\perp} / [2\pi\epsilon_0 \gamma_b^3 \beta_b^2 c^2]$
$x$ -edge radius	$r_x$	$= 2 \langle x^2 \rangle_{\perp}^{1/2}$
$y$ -edge radius	$r_y$	$= 2 \langle y^2 \rangle_{\perp}^{1/2}$
$x$ -emittance	$\epsilon_x$	$= 4 [\langle x^2 \rangle_{\perp} \langle x'^2 \rangle_{\perp} - \langle xx' \rangle_{\perp}]^{1/2}$
$y$ -emittance	$\epsilon_y$	$= 4 [\langle y^2 \rangle_{\perp} \langle y'^2 \rangle_{\perp} - \langle yy' \rangle_{\perp}]^{1/2}$

SM Lund, USPAS, June 2008

Transverse Equilibrium Distributions 42

Sacherer expanded the concept of rms equivalency by showing that the equivalency works exactly for beams with elliptic symmetry space-charge [Sacherer, IEEE Trans. Nucl. Sci. 18, 1101 (1971), J.J. Barnard, **Intro. Lectures**]

For any beam with elliptic symmetry charge density in each transverse slice:

$$\rho = \rho \left( \frac{x^2}{r_x^2} + \frac{y^2}{r_y^2} \right)$$

Based on:

$$\left\langle \frac{\partial \phi}{\partial x} \right\rangle_{\perp} = - \frac{\lambda}{4\pi\epsilon_0} \frac{r_x}{r_x + r_y}$$

see J.J. Barnard intro. lectures

the KV envelope equations

$$\begin{aligned} r_x''(s) + \kappa_x(s)r_x(s) - \frac{2Q}{r_x(s) + r_y(s)} - \frac{\epsilon_x^2(s)}{r_x^3(s)} &= 0 \\ r_y''(s) + \kappa_y(s)r_y(s) - \frac{2Q}{r_x(s) + r_y(s)} - \frac{\epsilon_y^2(s)}{r_y^3(s)} &= 0 \end{aligned}$$

remain valid when (averages taken with the full distribution):

$$Q = \frac{q\lambda}{2\pi\epsilon_0 m \gamma_b^3 \beta_b^2 c^2} = \text{const} \quad \lambda = q \int d^2x_{\perp} \rho = \text{const}$$

$$r_x = 2 \langle x^2 \rangle_{\perp}^{1/2} \quad \epsilon_x = 4 [\langle x^2 \rangle_{\perp} \langle x'^2 \rangle_{\perp} - \langle xx' \rangle_{\perp}]^{1/2}$$

$$r_y = 2 \langle y^2 \rangle_{\perp}^{1/2} \quad \epsilon_y = 4 [\langle y^2 \rangle_{\perp} \langle y'^2 \rangle_{\perp} - \langle yy' \rangle_{\perp}]^{1/2}$$

The emittances must, in general, evolve in  $s$  under this model

(see SM Lund lectures on *Transverse Kinetic Stability*)

SM Lund, USPAS, June 2008

Transverse Equilibrium Distributions 44

**Comments on rms equivalent beam concept:**

- ◆ The emittances will generally evolve in
  - Means that the equivalence must be recalculated in every slice as the emittances evolve
  - For reasons to be analyzed later (see S.M. Lund lectures on **Kinetic Stability of Beams**), this evolution is often small
- ◆ Concept is highly useful
  - KV equilibrium properties well understood and are approximately correct to model lowest order "real" beam properties
  - See, Reiser, *Theory and Design of Charged Particle Beams* (1994, 2008) for a detailed discussion of rms equivalence

SM Lund, USPAS, June 2008

Transverse Equilibrium Distributions 43

## Further comments on the KV equilibrium: Distribution Structure

KV equilibrium distribution:

$$f_{\perp} \sim \delta[\text{Courant-Snyder invariants}]$$

Forms a highly singular hyper-shell in 4D phase-space

Schematic:

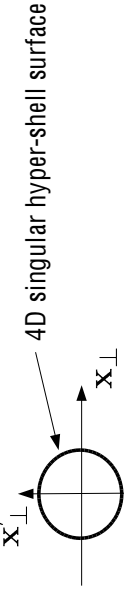

→ Singular distribution has large  $\mathbb{W}$ Free-Energy] to drive many instabilities

- Low order envelope modes are physical and highly important

(see: lectures by S. M. Lund on **Centroid and Envelope Descriptions of Beams**)

→ Perturbative analysis shows strong collective instabilities

- Hofmann, Laslett, Smith, and Haber, Part. Accel. 13, 145 (1983)

- Higher order instabilities (collective modes) have unphysical aspects due to (delta-function) structure of distribution and must be applied with care (see: lectures by S. M. Lund on **Kinetic Stability of Beams**)

- Instabilities can cause problems if the KV distribution is employed as an initial beam state in self-consistent simulations

## Further comments on the KV equilibrium: 2D Projections

All 2D projections of the KV distribution are **uniformly filled ellipses**

→ Not very different from what is often observed in experimental measurements and self-consistent simulations of stable beams with strong space-charge

→ Falloff of distribution at "edges" can be rapid, but smooth, for strong space-charge

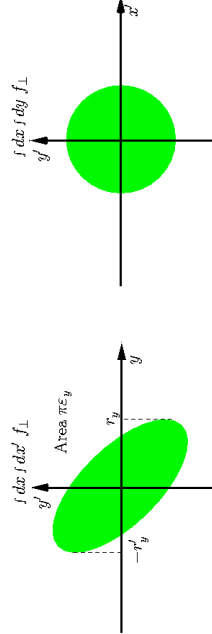
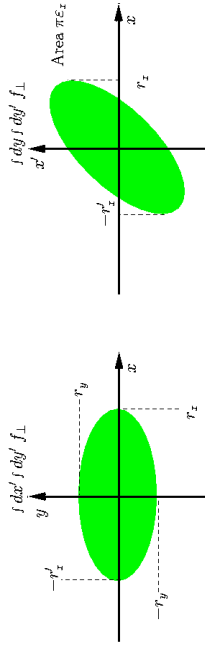

Preview: lecture on **Centroid and Envelope Descriptions of Beams**: Instability bands of the KV envelope equation are well understood in periodic focusing channels and must be avoided in machine operation

### Envelope Mode Instability Growth Rates

Solenoid ( $\eta = 0.25$ )

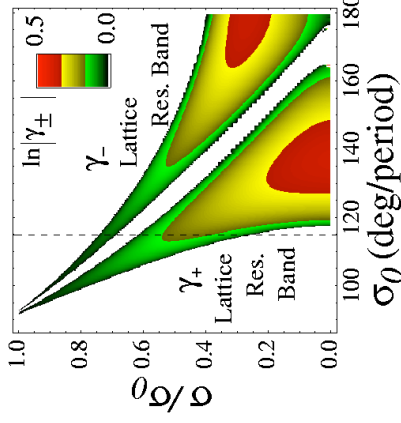

Quadrupole FODO ( $\eta = 0.70$ )

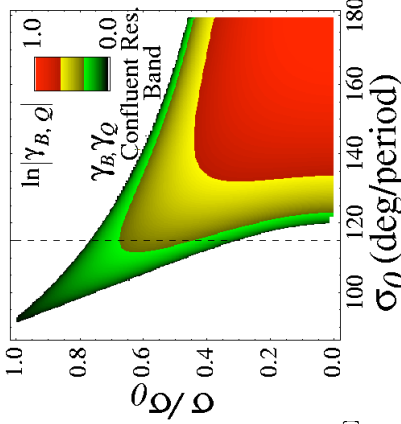

[S. M. Lund and B. Bukh, PRSTAB 024801 (2004)]

## Further comments on the KV equilibrium:

Angular Spreads: Coherent and Incoherent

Angular spreads within the beam:

Coherent (flow):

$$\langle x' \rangle_{x_{\perp}} \equiv \frac{\int d^2 x'_{\perp} x'_{\perp} f_{\perp}}{\int d^2 x'_{\perp} f_{\perp}} = r'_{\perp} \frac{x}{r_x}$$

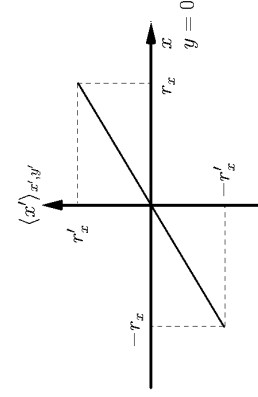

Incoherent (temperature):

$$\langle (x')^2 \rangle_{x_{\perp}} \equiv \frac{\int d^2 x'_{\perp} x'^2_{\perp} f_{\perp}}{\int d^2 x'_{\perp} f_{\perp}} = \frac{\epsilon_x^2}{2r_x^2} \left( 1 - \frac{x^2}{r_x^2} - \frac{y^2}{r_y^2} \right)$$

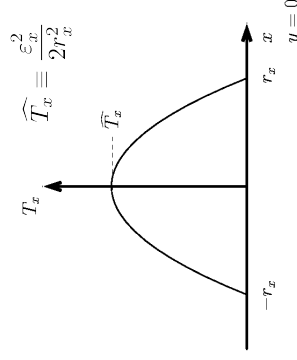

→ Coherent flow required for periodic focusing to conserve charge

→ Temperature must be zero at the beam edge since the distribution edge is sharp

→ Parabolic temperature profile is consistent with linear grad P pressure forces in a fluid model interpretation of the (kinetic) KV distribution

### Further comments on the KV equilibrium:

- The KV distribution is the *only* exact equilibrium distribution formed from Courant-Snyder invariants of linear forces valid for periodic focusing channels:
- Low order properties of the distribution are physically appealing
  - Illustrates relevant Courant-Snyder invariants in simple form
    - Later arguments demonstrate that these invariants should be a reasonable approximation for beams with strong space charge
  - KV distribution does not have a 3D generalization [see F. Sacherer, Ph.d. thesis, 1968]
- Strong Vlasov instabilities associated with the KV model render the distribution inappropriate for use in evaluating machines at high levels of detail:
- Instabilities are not all physical and render interpretation of results difficult
    - Difficult to separate physical from nonphysical effects in simulations
- Possible Research Problem (unsolved in 40+ years!):
- Can a valid Vlasov equilibrium be constructed for a *smooth* (non-singular), nonuniform density distribution in a linear, periodic focusing channel?
- Not clear what invariants can be used or if any can exist
    - Nonexistence proof would also be significant
  - Lack of a smooth equilibrium does not imply that real machines cannot work!

SM Lund, USPAS, June 2008

Transverse Equilibrium Distributions 49

133

Because of a lack of theory for a smooth, self-consistent distribution that would be more physically appealing than the KV distribution we will examine smooth distributions in the idealized continuous focusing limit (after an analysis of the continuous limit of the KV theory):

- Allows more classic "plasma physics" like analysis
  - Illuminates physics of intense space charge
  - Lack of continuous focusing in the laboratory will prevent over generalization of results obtained
- A 1D analog to the KV distribution called the "Neuffer Distribution" is useful in longitudinal physics
- Based on linear forces with a "g-factor" model
  - Distribution is not singular in 1D
  - See: J.J. Barnard, lectures on [Longitudinal Physics](#)

SM Lund, USPAS, June 2008

Transverse Equilibrium Distributions 50

### Appendix A: Self-Fields of a Uniform Density Elliptical Beam in Free-Space

See handwritten notes

SM Lund, USPAS, June 2008

Transverse Equilibrium Distributions 51

### Appendix B: Canonical Transformation of the KV Distribution

See handwritten notes

SM Lund, USPAS, June 2008

Transverse Equilibrium Distributions 52

### S4: Continuous Focusing limit of the KV Equilibrium Distribution

Continuous focusing, axisymmetric beam

$$\begin{aligned} \kappa_x(s) &= \kappa_y(s) = k_{\beta 0}^2 = \text{const} \\ \varepsilon_x &= \varepsilon_y \equiv \varepsilon \\ r_x &= r_y \equiv r_b \end{aligned}$$

Undepressed betatron wavenumber

KV envelope equation

$$\begin{aligned} r_x'' + \kappa_x r_x - \frac{2Q}{r_x + r_y} - \frac{\varepsilon_x^2}{r_x^3} &= 0 \\ r_y'' + \kappa_y r_y - \frac{2Q}{r_x + r_y} - \frac{\varepsilon_y^2}{r_y^3} &= 0 \end{aligned}$$

immediately reduces to:

$$r_b'' + k_{\beta 0}^2 r_b - \frac{Q}{r_b} - \frac{\varepsilon^2}{r_b^3} = 0$$

with solution

$$r_b = \left( \frac{Q + \sqrt{4k_{\beta 0}^2 \varepsilon^2 + Q^2}}{2k_{\beta 0}^2} \right)^{1/2} = \text{const}$$

Continuous Focusing KV Equilibrium  $\pm$   
Undepressed and depressed particle orbits in the  $x$ -plane

$$k_{\beta} = \frac{\sigma}{\sigma_0} k_{\beta 0} \quad \frac{\sigma}{\sigma_0} = 0.2 \quad = 0 =$$

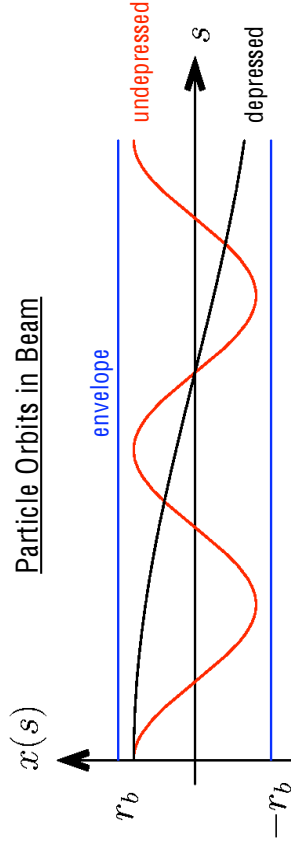

Much simpler in details than the periodic focusing case, but qualitatively similar in that space-charge depresses the rate of particle phase advance

Similarly, the particle equations of motion within the beam are:

$$\begin{aligned} x'' + \left\{ \kappa_x - \frac{2Q}{[r_x + r_y]r_x} \right\} x &= 0 \\ y'' + \left\{ \kappa_y - \frac{2Q}{[r_x + r_y]r_y} \right\} y &= 0 \end{aligned}$$

reduce to

$$x_{\perp}'' + k_{\beta}^2 x_{\perp} = 0$$

Depressed betatron wavenumber

$$k_{\beta} \equiv \sqrt{k_{\beta 0}^2 - \frac{Q}{r_b^2}} = \text{const}$$

with solution

$$x_{\perp}(s) = x_{\perp i} \cos[k_{\beta}(s - s_i)] + \frac{x'_{\perp i}}{k_{\beta}} \sin[k_{\beta}(s - s_i)]$$

Space-charge tune depression (rate of phase advance same everywhere,  $L_p$  arb.)

$$\frac{k_{\beta}}{k_{\beta 0}} = \frac{\sigma}{\sigma_0} = \left( 1 - \frac{Q}{k_{\beta 0}^2 r_b^2} \right)^{1/2} \quad 0 \leq \frac{\sigma}{\sigma_0} \leq 1 \quad Q \rightarrow 0$$

$$\Rightarrow k_{\beta 0}^2 r_b^2 = Q$$

envelope equation

Continuous Focusing KV Beam  $\pm$  Equilibrium Distribution Form

Using

$$\lambda = q\pi\hat{r}_b^2 \quad \hat{n} = \text{const} \quad \text{density within the beam}$$

for the beam line charge and

$$\delta(\text{const} \cdot x) = \frac{\text{const}}{\delta(x)}$$

the full elliptic beam KV distribution can be expressed as :

See next slide for steps involved in the form reduction

$$\begin{aligned} f_{\perp} &= \frac{\lambda}{q\pi^2 \varepsilon_x \varepsilon_y} \delta \left[ \left( \frac{x}{r_x} \right)^2 + \left( \frac{r_x x' - r'_x x}{\varepsilon_x} \right)^2 + \left( \frac{y}{r_y} \right)^2 + \left( \frac{r_y y' - r'_y y}{\varepsilon_y} \right)^2 - 1 \right] \\ &= \frac{\hat{n}}{2\pi} \delta(H_{\perp} - H_{\perp b}) \end{aligned}$$

where

$$H_{\perp} = \frac{1}{2} x_{\perp}^2 + \frac{\varepsilon^2}{2r_b^4} x_{\perp}^2$$

-- Hamiltonian

(on-axis value 0 ref)

$$= \frac{1}{2} x_{\perp}^2 + \frac{1}{2} k_{\beta 0}^2 x_{\perp}^2 + \frac{q\phi}{m\gamma_b^3 \beta_b^2 c^2}$$

$$H_{\perp b} \equiv \frac{\varepsilon^2}{2r_b^2} = \text{const}$$

-- Hamiltonian at beam edge



/// Aside: Steps of derivation

Using:  $\epsilon_x = \epsilon_y \equiv \epsilon$   
 $r_x = r_y \equiv r_b = \text{const}$   
 $\lambda = q\pi\hat{n}r_b^2 = \text{const}$

$$f_{\perp} = \frac{\lambda}{q\pi^2\epsilon_x\epsilon_y} \delta \left[ \left( \frac{x}{r_x} \right)^2 + \left( \frac{y}{r_y} \right)^2 + \left( \frac{r_x x' - r'_x x}{\epsilon_x} \right)^2 + \left( \frac{r_y y' - r'_y y}{\epsilon_y} \right)^2 - 1 \right]$$

$$= \frac{\hat{n}r_b^2}{\pi\epsilon^2} \delta \left( \frac{x^2}{r_b^2} + \frac{y^2}{r_b^2} + \frac{r_b^2 x'^2}{\epsilon^2} + \frac{r_b^2 y'^2}{\epsilon^2} - 1 \right)$$

Using:  $\delta(\text{const} \cdot x) = \frac{\delta(x)}{\text{const}}$

$$f_{\perp} = \frac{\hat{n}}{2\pi} \delta \left( \frac{1}{2} \mathbf{x}_{\perp}^2 + \frac{\epsilon^2}{2r_b^4} \mathbf{x}_{\perp}^2 - \frac{\epsilon^2}{2r_b^2} \right)$$

The solution for the potential for the uniform density beam inside the beam is:

$$\frac{1}{r} \frac{\partial}{\partial r} r \frac{\partial \phi}{\partial r} = -\frac{\lambda}{\pi\epsilon_0 r_b^2} \longrightarrow \phi = -\frac{\lambda}{4\pi\epsilon_0 r_b^2} \mathbf{x}_{\perp}^2 + \text{const}$$

Equilibrium distribution

$$f_{\perp}(H_{\perp}) = \frac{\hat{n}}{2\pi} \delta(H_{\perp} - H_{\perp b})$$

$$H_{\perp b} = \frac{\epsilon^2}{2r_b^2} = \text{const}$$

$$\hat{n} = \text{const}$$

then it is straightforward to explicitly calculate (see homework problems)

**Density:**  $n = \int d^2 x'_{\perp} f_{\perp} = \begin{cases} \hat{n}, & 0 \leq r < r_b \\ 0, & r_b < r \end{cases}$

**Temperature:**  $T_x = \gamma_b m \beta_b^2 c^2 \int d^2 x'_{\perp} x'^2 f_{\perp} = \begin{cases} \hat{T}_x (1 - r^2/r_b^2), & 0 \leq r < r_b \\ 0, & r_b < r \end{cases}$

Density

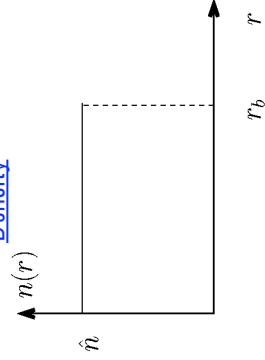

Temperature

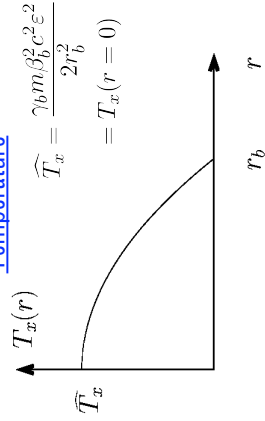

The Hamiltonian becomes:

$$H_{\perp} = \frac{1}{2} \mathbf{x}_{\perp}^2 + \frac{1}{2} k_{\beta 0}^2 \mathbf{x}_{\perp}^2 + \frac{q\phi}{m\gamma_b^3 \beta_b^2 c^2}$$

$$= \frac{1}{2} \mathbf{x}_{\perp}^2 + \frac{1}{2} k_{\beta 0}^2 \mathbf{x}_{\perp}^2 - \frac{q\lambda}{4\pi m\gamma_b^3 \beta_b^2 c^2} \mathbf{x}_{\perp}^2 + \text{const}$$

$$= \frac{1}{2} \mathbf{x}_{\perp}^2 + \frac{1}{2} k_{\beta 0}^2 \mathbf{x}_{\perp}^2 - \frac{Q}{2r_b^2} \mathbf{x}_{\perp}^2 + \text{const}$$

From the equilibrium envelope equation:

$$k_{\beta 0}^2 = \frac{Q}{r_b^2} + \frac{\epsilon^2}{r_b^4}$$

The Hamiltonian reduces to:

$$H_{\perp} = \frac{1}{2} \mathbf{x}_{\perp}^2 + \frac{\epsilon^2}{2r_b^4} \mathbf{x}_{\perp}^2 + \text{const}$$

with edge value (turning point with zero angle):

$$H_{\perp b} \equiv \frac{\epsilon^2}{2r_b^2} + \text{const}$$

Giving (constants are same in Hamiltonian and edge value and subtract out):

$$f_{\perp} = \frac{\hat{n}}{2\pi} \delta \left( \frac{1}{2} \mathbf{x}_{\perp}^2 + \frac{\epsilon^2}{2r_b^4} \mathbf{x}_{\perp}^2 - \frac{\epsilon^2}{2r_b^2} \right) = \frac{\hat{n}}{2\pi} \delta(H_{\perp} - H_{\perp b})$$

Continuous Focusing KV Beam ± Comments

For continuous focusing,  $H_{\perp}$  is a single particle constant of the motion (see problem sets), so it is not surprising that the KV equilibrium form reduces to a delta function form of  $f_{\perp}(H_{\perp})$

→ Because of the delta-function distribution form, all particles in the continuous focusing KV beam have the same transverse energy with  $H_{\perp} = H_{\perp b} = \text{const}$

Several textbook treatments of the KV distribution derive continuous focusing versions and then just write down (if at all) the periodic focusing version based on Courant-Snyder invariants. This can create a false impression that the KV distribution is a Hamiltonian-type invariant in the general form.

→ For non-continuous focusing channels there is no simple relation between Courant-Snyder type invariants and  $H_{\perp}$

## S5: Equilibrium Distributions in Continuous Focusing Channels

Take

$$\kappa_x(s) = \kappa_y(s) = k_{\beta 0}^2 = \text{const}$$

- Real transport channels have s-varying focusing functions
  - For a rough correspondence to physical lattices take:  $k_{\beta 0} = \sigma_0 / L_p$
- A valid family of **equilibria** can be constructed for any choice of function:

$$f_{\perp} = f_{\perp}(H_{\perp}) \geq 0 \quad H_{\perp} = \frac{1}{2} \mathbf{x}_{\perp}^2 + \frac{1}{2} k_{\beta 0}^2 \mathbf{x}_{\perp}^2 + \frac{q\phi}{m\gamma_b^3 \beta_b^2 c^2}$$

must be calculated consistently from the (generally nonlinear) **Poisson equation**:

$$\left( \frac{\partial^2}{\partial x^2} + \frac{\partial^2}{\partial y^2} \right) \phi = -\frac{q}{\epsilon_0} \int d^2 x'_{\perp} f_{\perp}(H_{\perp})$$

- Solutions generated will be steady-state ( $\partial/\partial s = 0$ )
- When  $f_{\perp} = f_{\perp}(H_{\perp})$ , the Poisson equation *only* has axisymmetric solutions with  $\partial/\partial \theta = 0$  [see: Lund, PRSTAB 10, 064203 (2007)]

The Hamiltonian is only equivalent to the Courant-Snyder invariant in continuous focusing (see: **Transverse Particle Equations**). In periodic focusing channels  $\kappa_x(s)$  and  $\kappa_y(s)$  vary in  $s$  and the Hamiltonian is *not* a constant of the motion.

SM Lund, USPAS, June 2008

Transverse Equilibrium Distributions 61

The axisymmetric Poisson equation simplifies to:

$$\frac{1}{r} \frac{\partial}{\partial r} \left( r \frac{\partial \phi}{\partial r} \right) = -\frac{qn}{\epsilon_0} = -\frac{q}{\epsilon_0} \int d^2 x'_{\perp} f_{\perp}(H_{\perp})$$

Introduce a **streamfunction**

$$\psi(r) = \frac{1}{2} k_{\beta 0}^2 r^2 + \frac{q\phi}{m\gamma_b^3 \beta_b^2 c^2}$$

$$r = \sqrt{x^2 + y^2}$$

then

$$H_{\perp} = \frac{1}{2} \mathbf{x}_{\perp}^2 + \psi$$

and system axisymmetry can be exploited to calculate the **beam density** (see earlier aside slides on integral symmetries for steps) as:

$$n(r) = \int d^2 x'_{\perp} f_{\perp}(H_{\perp}) = 2\pi \int_{\psi}^{\infty} dH_{\perp} f_{\perp}(H_{\perp})$$

The **Poisson equation** can then be expressed in terms of the stream function as:

$$\frac{1}{r} \frac{\partial}{\partial r} \left( r \frac{\partial \psi}{\partial r} \right) = 2k_{\beta 0}^2 - \frac{2\pi q^2}{m\epsilon_0 \gamma_b^3 \beta_b^2 c^2} \int_{\psi(r)}^{\infty} dH_{\perp} f_{\perp}(H_{\perp})$$

SM Lund, USPAS, June 2008

Transverse Equilibrium Distributions 62

To characterize a choice of equilibrium function  $f_{\perp}(H_{\perp})$ , the (transformed) Poisson equation must be solved

- Equation is, in general, *highly* nonlinear rendering the procedure difficult

Some general features of equilibria can still be understood:

- Apply rms equivalent beam picture and interpret in terms of moments
- Calculate equilibria for a few types of very different functions to understand the likely range of characteristics

SM Lund, USPAS, June 2008

Transverse Equilibrium Distributions 63

## Moment properties of continuous focusing equilibrium distributions

Equilibria with *any* valid equilibrium  $f_{\perp}(H_{\perp})$  satisfy the rms equivalent beam matched beam envelope equation:

$$k_{\beta 0}^2 r_b - \frac{Q}{r_b} - \frac{\epsilon^2}{r_b^3} = 0$$

- Describes average radial force balance of particles
  - Uses the result (see J.J. Barnard, **Intro. Lectures**):  $\langle x \partial \phi / \partial x \rangle_{\perp} = -\lambda / (8\pi\epsilon_0)$
- where

$$Q = \frac{q\lambda}{2\pi\epsilon_0 m\gamma_b^3 \beta_b^2 c^2} = \text{const} \quad \lambda = q \int d^2 x_{\perp} \int d^2 x'_{\perp} f_{\perp}(H_{\perp})$$

$$r_b^2 = 2 \langle r^2 \rangle_{\perp} = \frac{\int_0^{\infty} dr r^3 \int_{\psi}^{\infty} dH_{\perp} f_{\perp}(H_{\perp})}{\int_0^{\infty} dr r \int_{\psi}^{\infty} dH_{\perp} f_{\perp}(H_{\perp})}$$

$$\epsilon^2 = 2r_b^2 \langle \mathbf{x}_{\perp}^2 \rangle_{\perp} = 2r_b^2 \frac{\int_0^{\infty} dr r \int_{\psi}^{\infty} dH_{\perp} (H_{\perp} - \psi) f_{\perp}(H_{\perp})}{\int_0^{\infty} dr r \int_{\psi}^{\infty} dH_{\perp} f_{\perp}(H_{\perp})}$$

$$\langle \dots \rangle_{\perp} = \frac{\int d^2 x_{\perp} \int d^2 x'_{\perp} \dots f_{\perp}(H_{\perp})}{\int d^2 x_{\perp} \int d^2 x'_{\perp} f_{\perp}(H_{\perp})}$$

SM Lund, USPAS, June 2008

Transverse Equilibrium Distributions 64



Parameters used to define the equilibrium function

$$f_{\perp}(H_{\perp})$$

should be cast in terms of

$$Q, \varepsilon, r_b$$

for use in accelerator applications. The rms equivalent beam equations can be used to carry out needed parameter eliminations. Such eliminations can be highly nontrivial due to the nonlinear form of the equations.

A kinetic temperature can also be calculated

$$T_x = \langle x'^2 \rangle_{x'_{\perp}} \quad \langle \dots \rangle_{x'_{\perp}} \equiv \frac{\int d^2 x'_{\perp} \dots f_{\perp}}{\int d^2 x'_{\perp} f_{\perp}}$$

$$n(r)T_x(r) = \frac{1}{2} \int d^2 x'_{\perp} \mathbf{x}'_{\perp}{}^2 f_{\perp}(H_{\perp}) = 2\pi \int_{\psi}^{\infty} dH_{\perp} (H_{\perp} - \psi) f_{\perp}(H_{\perp})$$

which is also related to the emittance,

$$\langle x'^2 \rangle_{\perp} = \frac{\int d^2 x_{\perp} n T_x}{\int d^2 x_{\perp} n} \quad \varepsilon^2 = 16 \langle x'^2 \rangle_{\perp} \langle x'^2 \rangle_{\perp} = 4r_b^2 \frac{\int d^2 x_{\perp} n T_x}{\int d^2 x_{\perp} n}$$

**Preview of what we will find:** When relative space-charge is strong, all smooth equilibrium distributions expected to look similar

Constant charge and focusing:  $Q = 10^{-4}$   $k_{\beta 0}^2 = \text{const}$

Vary relative space-charge strength:  $\sigma/\sigma_0 = 0.1, 0.2, \dots, 0.9$

[Waterbag Distribution](#)

[Thermal Distribution](#)

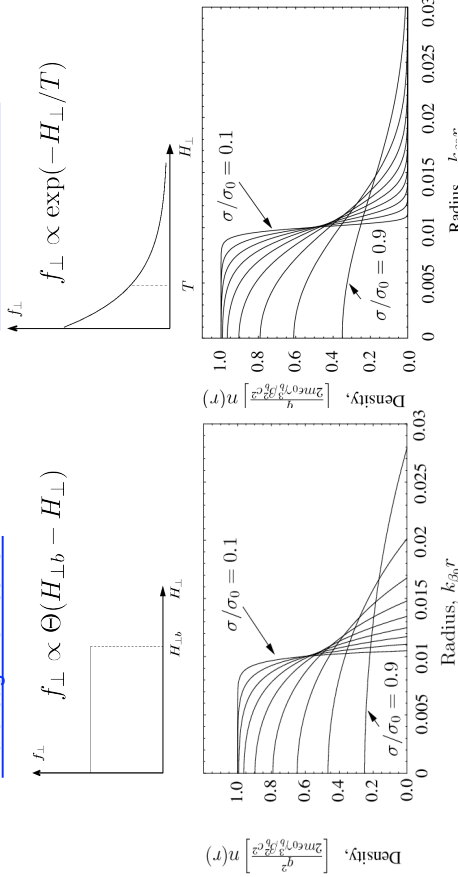

Edge shape varies with distribution choice, but cores similar when  $\sigma/\sigma_0$  small

**Choices of continuous focusing equilibrium distributions:**

Common choices for  $f_{\perp}(H_{\perp})$  analyzed in the literature:

1) **KV** (already covered)

$$f_{\perp} \propto \delta(H_{\perp} - H_{\perp b})$$

$$H_{\perp b} = \text{const}$$

2) **Waterbag** (to be covered)

[see M. Reiser, *Charged Particle Beams*, (1994, 2008)]

$$f_{\perp} \propto \Theta(H_{\perp b} - H_{\perp})$$

$$\Theta(x) = \begin{cases} 0, & x < 0 \\ 1, & 0 < x \end{cases}$$

3) **Thermal** (to be covered)

[see M. Reiser, Davidson, *Neutral Plasmas*, 1990]

$$f_{\perp} \propto \exp(-H_{\perp}/T)$$

$$T = \text{const} > 0$$

Infinity of choices can be made for an infinity of papers!

➔ Fortunately, range of behavior can be understood with a few reasonable choices

**S6: Continuous Focusing: The Waterbag Equilibrium Distribution:**

[Reiser, *Theory and Design of Charged Particle Beams*, Wiley (1994, 2008); and Review: Lund, Kikuchi, and Davidson, PRSTAB, to be published (2008)]

Waterbag distribution:

$$f_{\perp}(H_{\perp}) = f_0 \Theta(H_b - H_{\perp}) \quad f_0 = \text{const}$$

$$H_b = \text{const} \quad \text{Edge Hamiltonian}$$

$$\Theta(x) = \begin{cases} 1, & x > 0 \\ 0, & x < 0 \end{cases}$$

The physical edge radius  $r_e$  of the beam will be related to the edge Hamiltonian:

$$H_{\perp}|_{r=r_e} = H_b \quad \text{Note (generally):} \quad r_e \neq r_b \equiv 2(x^2)_{\perp}^{1/2} \\ r_e > r_b$$

Using previous formulas the equilibrium density can then be calculated as:

$$H_{\perp} = \mathbf{x}'_{\perp}{}^2/2 + \psi \quad \psi = k_{\beta 0}^2 r^2/2 + \frac{q\phi}{m\gamma_b^3 \beta_0^2 c^2}$$

$$n(r) = \int d^2 x'_{\perp} f_{\perp} = 2\pi f_0 \begin{cases} H_b - \psi(r), & \psi < H_b \\ 0, & \psi > H_b. \end{cases}$$

The Poisson equation of the equilibrium can be expressed within the beam ( $r < r_e$ ) as:

$$\frac{1}{r} \frac{\partial}{\partial r} \left( r \frac{\partial \psi}{\partial r} \right) - k_0^2 \psi = 2k_{\beta 0}^2 - k_0^2 H_b$$

$$k_0^2 \equiv \frac{2\pi q^2 f_0}{\epsilon_0 m \gamma_b^3 \beta_b^2 c^2} = \text{const}$$

This is a modified Bessel function equation and the solution within the beam regular at the origin  $r = 0$  and satisfying  $\psi(r = r_e) = H_b$  is given by

$$\psi(r) = H_b - 2 \frac{k_{\beta 0}^2}{k_0^2} \left[ 1 - \frac{I_0(k_0 r)}{I_0(k_0 r_e)} \right]$$

where  $I_\ell(x)$  is a modified Bessel function of order  $\ell$

The density is then expressible within the beam ( $r < r_e$ ) as:

$$n(r) = 4\pi f_0 \frac{k_{\beta 0}^2}{k_0^2} \left[ 1 - \frac{I_0(k_0 r)}{I_0(k_0 r_e)} \right]$$

$$= \frac{2\epsilon_0 m \gamma_b^3 \beta_b^2 c^2 k_{\beta 0}^2}{q^2} \left[ 1 - \frac{I_0(k_0 r)}{I_0(k_0 r_e)} \right]$$

Similarly, the local beam temperature within the beam can be calculated as:

$$T_x(r) = \langle x^2 \rangle_{x_\perp} = \frac{k_{\beta 0}^2}{k_0^2} \left[ 1 - \frac{I_0(k_0 r)}{I_0(k_0 r_e)} \right]$$

$$\propto n(r)$$

The proportionality between the temperature ( $T_x$ ) and the density ( $n$ ) is a consequence of the waterbag equilibrium distribution choice and is *not* a general feature of continuous focusing.

The waterbag distribution expression can now be expressed as:

$$f_\perp(\mathbf{x}_\perp, \mathbf{x}'_\perp) = f_0 \Theta \left( 2 \frac{k_{\beta 0}^2}{k_0^2} \left[ 1 - \frac{I_0(k_0 r)}{I_0(k_0 r_e)} \right] - \frac{1}{2} \mathbf{x}'_\perp{}^2 \right)$$

♦ The edge Hamiltonian value  $H_b$  has been eliminated

♦ Parameters are:

- $f_0$  .... distribution normalization
- $k_0 r_e$  .... scaled edge radius
- $k_{\beta 0}/k_0$  .... scaled focusing strength

Parameters preferred for accelerator applications:

$$k_{\beta 0}, Q, \quad \varepsilon_x = \varepsilon_y = \varepsilon_b$$

Needed constraints to eliminate parameters in terms of our preferred set will now be derived.

## Parameters constraints for the waterbag equilibrium beam

First calculate the beam line-charge:

$$\lambda = 2\pi q \int_0^{r_e} dr r n(r) = 4\pi^2 q f_0 \frac{k_{\beta 0}^2}{k_0^2} r_e^2 \left[ 1 - \frac{2}{k_0 r_e} \frac{I_1(k_0 r_e)}{I_0(k_0 r_e)} \right]$$

$$\lambda = 2\pi q \int_0^{r_e} dr r n(r) = 4\pi^2 q f_0 \frac{k_{\beta 0}^2}{k_0^2} r_e \frac{I_2(k_0 r_e)}{I_0(k_0 r_e)}$$

here we have employed the modified Bessel function identities ( $\ell$  integer):

$$\frac{d}{dx} [x^\ell I_\ell(x)] = x^\ell I_{\ell-1}(x),$$

$$-\frac{2\ell}{x} I_\ell(x) = I_{\ell+1}(x) - I_{\ell-1}(x),$$

Similarly, the beam rms edge radius can be explicitly calculated as:

$$r_b^2 = 2 \langle r^2 \rangle_\perp = 2 \frac{\int_0^{r_e} dr r^3 n(r)}{\int_0^{r_e} dr r n(r)}$$

$$\left( \frac{r_b}{r_e} \right)^2 = \frac{I_0(k_0 r_e)}{I_2(k_0 r_e)} - \frac{4}{(k_0 r_e)^2} \left[ 2 + \frac{(k_0 r_e)}{I_2(k_0 r_e)} \frac{I_3(k_0 r_e)}{I_2(k_0 r_e)} \right]$$

The **perveance** is then calculated as:

$$Q \equiv \frac{q\lambda}{2\pi\epsilon_0 m \gamma_b^3 \beta_b^2 c^2} = (k_{\beta 0} r_e)^2 \frac{I_2(k_0 r_e)}{I_0(k_0 r_e)}$$

The edge and perveance equations can then be combined to obtain a parameter constraint relating  $k_0 r_e$  to desired system parameters:

$$\frac{k_{\beta 0}^2 r_b^2}{Q} = \frac{I_0^2(k_0 r_e)}{I_2^2(k_0 r_e)} - \frac{4}{(k_0 r_e)^2} \left[ \frac{I_0(k_0 r_e)}{I_2(k_0 r_e)} + (k_0 r_e) \frac{I_0(k_0 r_e) I_3(k_0 r_e)}{I_2^2(k_0 r_e)} \right]$$

Here, any of the 3 system parameters on the LHS may be eliminated using the matched beam envelope equation to effect alternative parameterizations:

$$k_{\beta 0}^2 r_b - \frac{Q}{r_b} - \frac{\epsilon_b^2}{r_b^3} = 0 \quad \longrightarrow \quad \text{eliminate any of: } k_{\beta 0}^2, r_b, Q$$

The rms equivalent beam concept can also be applied to show that:

$$\frac{k_{\beta 0}^2 r_b^2}{Q} = \frac{1}{1 - (\sigma/\sigma_0)^2}$$

rms equivalent KV measure of  $\sigma/\sigma_0$

- Space-charge really nonlinear and the Waterbag equilibrium has a spectrum of  $\sigma$

The constraint is plotted over the full range of effective space-charge strength:

$$\frac{1}{1 - (\sigma/\sigma_0)^2} = \frac{I_0^2(k_0 r_e)}{I_2^2(k_0 r_e)} - \frac{4}{(k_0 r_e)^2} \left[ \frac{I_0(k_0 r_e)}{I_2(k_0 r_e)} + (k_0 r_e) \frac{I_0(k_0 r_e) I_3(k_0 r_e)}{I_2^2(k_0 r_e)} \right]$$

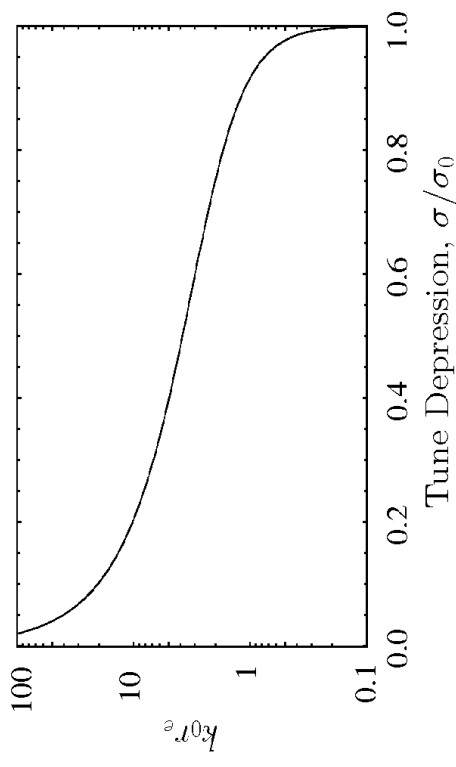

- Equilibrium parameter  $k_0 r_e$  uniquely fixes effective space-charge strength

**////Aside:** Parameter choices and limits of the constraint equation

Some prefer to use an alternative space-charge strength measure to  $\sigma/\sigma_0$  and use a so-called **self-field parameter** defined in terms of the on-axis plasma frequency of the distribution:

**Self-field parameter:**

$$s_b \equiv \frac{\hat{\omega}_p^2}{2\gamma_b^3 \beta_b^2 c^2 k_{\beta 0}^2} \quad \hat{\omega}_p^2 \equiv \frac{q^2 \hat{n}}{m\epsilon_0} \quad \hat{n} = n(r=0) = \text{on-axis plasma density}$$

For a KV equilibrium,  $s_b$  and  $\sigma/\sigma_0$  are simply related:

$$s_b = 1 - \left( \frac{\sigma}{\sigma_0} \right)^2$$

For a waterbag equilibrium,  $s_b$  and  $k_0 r_e$  (from which  $\sigma/\sigma_0$  can be calculated) are related by:

$$s_b = 1 - \frac{1}{I_0(k_0 r_e)}$$

Generally, for smooth (non-KV) equilibria,  $s_b$  turns out to be a logarithmically insensitive parameter for strong space-charge strength (see tables in **S6** and **S7**) ///

**Use parameter constraints to plot properties of waterbag equilibrium**

- Density and temperature profile at fixed line charge and focusing strength

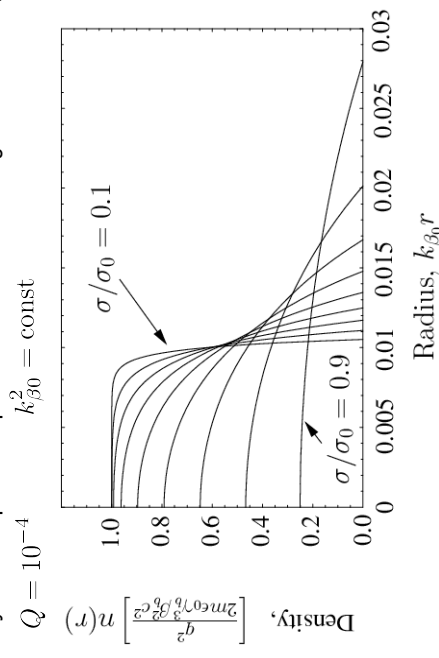

- Parabolic density for weak space-charge and flat in the core out to a sharp edge for strong space charge
- For the waterbag equilibrium, temperature ( ) is proportional to density ( ) so the same curves apply for ( )

2) Phase-space boundary of distribution at fixed line charge and focusing strength  
 $Q = 10^{-4}$   
 $k_{\beta 0}^2 = \text{const}$

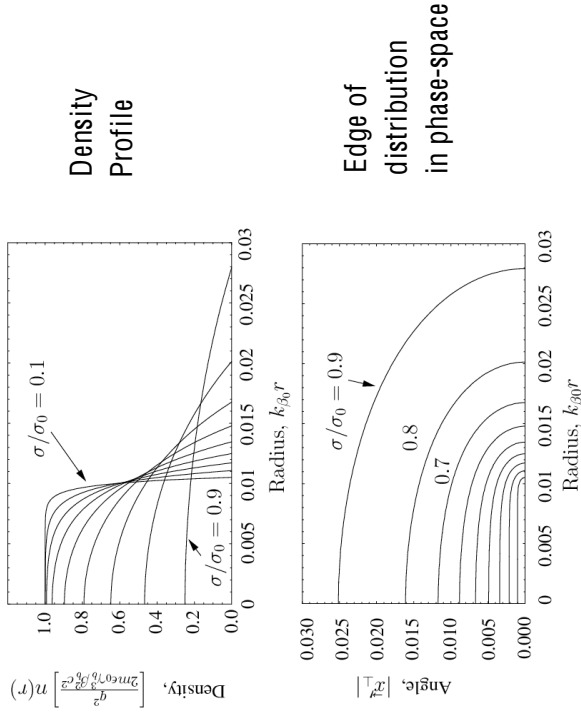

**S7: Continuous Focusing: The Thermal Equilibrium Distribution:**

[Davidson, Physics of Nonneutral Plasma, Addison Wesley (1990) and Reiser, Theory and Design of Charged Particle Beams, Wiley (1994, 2008)]  
 In an infinitely long continuous focusing channel, collisions will eventually relax the beam to **thermal equilibrium**. The Fokker-Planck equation predicts that the unique Maxwell-Boltzmann distribution describing this limit is:

$$\lim_{s \rightarrow \infty} f_{\perp} \propto \exp\left(-\frac{H_{\text{rest}}}{T}\right)$$

$H_{\text{rest}}$  = single particle Hamiltonian of beam in rest frame (energy units)

$T = \text{const}$  Thermodynamic temperature (energy units)

Beam propagation time in transport channel is generally short relative to collision time, inhibiting full relaxation

- Collective effects may enhance relaxation rate
  - Wave spectrums likely large for real beams and enhanced by transient and nonequilibrium effects
  - Random errors acting on system may enhance and lock-in phase mixing

3) Summary of scaled parameters for example plots:

$\sigma/\sigma_0$	$s_b$	$\frac{k_{\beta 0}^2 r_e^2}{Q}$	$k_0 r_e$	$\frac{r_e}{r_b}$	$\frac{k_0}{k_{\beta 0}}$	$Q = 10^{-4}$
0.9	0.2502	5.263	1.112	1.217	39.81	$10^3 \times k_{\beta 0} \epsilon_b$ 0.4737
0.8	0.4666	2.778	1.709	1.208	84.87	0.2222
0.7	0.6477	1.961	2.304	1.197	137.5	0.1373
0.6	0.7916	1.563	2.979	1.183	201.5	0.09375
0.5	0.8968	1.333	3.821	1.166	283.8	0.06667
0.4	0.9626	1.190	4.978	1.144	398.7	0.04762
0.3	0.9928	1.099	6.789	1.118	579.3	0.03297
0.2	0.9997	1.042	10.25	1.085	925.6	0.02083
0.1	1.0000	1.010	20.38	1.046	1938.	0.01010

**Continuous focusing thermal equilibrium distribution**

Analysis of the rest frame transformation shows that the 2D Maxwell-Boltzmann distribution (careful on frame for temperature definition!) is:

$$f_{\perp}(H_{\perp}) = \frac{m\gamma_b\beta_b^2 c^2 \hat{n}}{2\pi T} \exp\left(-\frac{m\gamma_b\beta_b^2 c^2 H_{\perp}}{T}\right)$$

$H_{\perp} = \frac{1}{2} \mathbf{x}_{\perp}^2 + \frac{1}{2} k_{\beta 0}^2 \mathbf{x}_{\perp}^2 + \frac{q\phi}{m\gamma_b^3 \beta_b^2 c^2}$  Temperature (energy units, lab frame)  
 $\frac{1}{2} \mathbf{x}_{\perp}^2 + \psi$   $n(r=0) = \hat{n} = \text{const}$  on-axis density  
 $\phi(r=0) = 0$  (reference choice)

The density can then be conveniently calculated in terms of a scaled stream function:

$$n(r) = \int d^2 x'_{\perp} f_{\perp} = \hat{n} e^{-\psi}$$

$$\tilde{\psi}(r) \equiv \frac{m\gamma_b\beta_b^2 c^2 \psi}{T} = \frac{1}{T} \left( \frac{m\gamma_b\beta_b^2 c^2 k_{\beta 0}^2}{2} r^2 + \frac{q\phi}{\gamma_b} \right)$$

and the - and -temperatures are equal and spatially uniform with:

$$T_x = \gamma_b m \beta_b^2 c^2 \frac{\int d^2 x'_{\perp} x'^2 f_{\perp}}{\int d^2 x'_{\perp} f_{\perp}} = T = \text{const}$$

## Scaled Poisson equation for continuous focusing thermal equilibrium

To describe the thermal equilibrium density profile, the Poisson equation must be solved. In terms of the scaled streamfunction:

$$\frac{1}{\rho} \frac{\partial}{\partial \rho} \left( \rho \frac{\partial \tilde{\psi}}{\partial \rho} \right) = 1 + \Delta - e^{-\tilde{\psi}}$$

$$\tilde{\psi}(\rho=0) = 0 \quad \frac{\partial \tilde{\psi}}{\partial \rho}(\rho=0) = 0$$

Here,

$$\lambda_D = \left( \frac{\epsilon_0 T}{q^2 \hat{n}} \right)^{1/2} \quad \text{Debye length formed from the peak, on-axis beam density} \quad \rho = \frac{r}{\gamma_b \lambda_D} \quad \text{Scaled radial coordinate in rel. Debye lengths}$$

$$\hat{\omega}_p = \left( \frac{q^2 \hat{n}}{\epsilon_0 m} \right)^{1/2} \quad \text{Plasma frequency formed from on-axis beam density} \quad \lambda_D = \left( \frac{T}{\hat{\omega}_p^2 m} \right)^{1/2}$$

$$\Delta = \frac{2\gamma_b^3 \beta_b^2 c^2 k_{\perp 0}^2}{\hat{\omega}_p^2} - 1 \quad \text{Dimensionless parameter relating the ratio of applied to space-charge defocusing forces}$$

- Equation is highly nonlinear, but can be solved (approximately) analytically
- Scaled solutions depend only on the single dimensionless parameter #

SM Lund, USPAS, June 2008

Transverse Equilibrium Distributions 81

## Numerical solution of scaled thermal equilibrium Poisson equation in terms of a normalized density

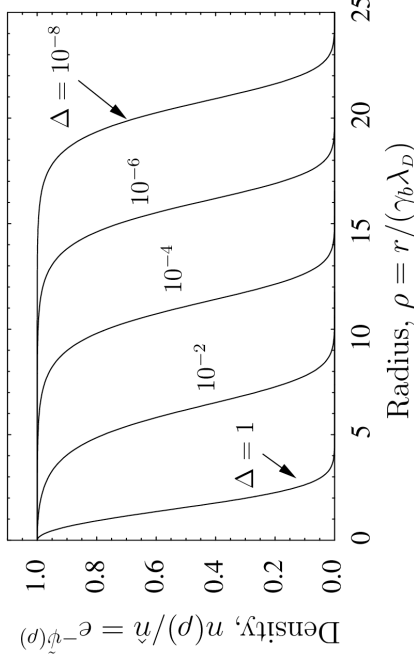

- Equation is highly nonlinear and must, in general, be solved numerically

- Dependence on # is very sensitive
- For small #, the beam is nearly uniform in the core
- Edge fall-off is always in a few Debye lengths when # is small
- Edge becomes very sharp at fixed beam line-charge

SM Lund, USPAS, June 2008

Transverse Equilibrium Distributions 82

## /// Aside: Approximate Analytical Solution for the Thermal Equilibrium

Density/Potential

Using the scaled density

$$N \equiv \frac{\hat{n}}{\hat{n}} = e^{-\tilde{\psi}}$$

the equilibrium Poisson equation can be equivalently expressed as:

$$\frac{\partial^2 N}{\partial \rho^2} - \frac{1}{N} \left( \frac{\partial N}{\partial \rho} \right)^2 + \frac{1}{\rho} \frac{\partial N}{\partial \rho} = N^2 - (1 + \Delta)N$$

$$N(\rho=0) = 1$$

$$\left. \frac{\partial N}{\partial \rho} \right|_{\rho=0} = 0$$

This equation has been analyzed to construct limiting form analytical solutions for both large and small  $\Delta$  [see: Starsev and Lund, PoP 15, 043101 (2008)]

- Large  $\Delta$  solution  $\Rightarrow$  warm beam  $\Rightarrow$  Gaussian-like radial profile
- Small  $\Delta$  solution  $\Rightarrow$  cold beam  $\Rightarrow$  Flat core, bell shaped profile
- Highly nonlinear structure, but approx solution has very high accuracy out to where the density becomes exponentially small!

SM Lund, USPAS, June 2008

Transverse Equilibrium Distributions 83

## Large $\Delta$ solution:

$$N \simeq \exp \left[ -\frac{1 + \Delta}{4} \rho^2 \right]$$

- Accurate for  $\Delta \gtrsim 0.1$  [For full error spec. see: PoP 15, 043101 (2008)]

## Small $\Delta$ solution:

$$N \simeq \frac{\left(1 + \frac{1}{2}\Delta + \frac{1}{24}\Delta^2\right)^2}{\left\{1 + \frac{1}{2}\Delta I_0(\rho) + \frac{1}{24}[\Delta I_0(\rho)]^2\right\}^2}$$

$$I_0(x) = 0^{\text{th}} \text{ order Modified Bessel Function of 1}^{\text{st}} \text{ kind}$$

- Highly accurate for  $\Delta \lesssim 0.1$  [For full error spec. see: PoP 15, 043101 (2008)]

Special numerical methods have also been developed to calculate or

- $\psi = -\ln N$  to arbitrary accuracy for any value of  $\Delta$ , however small [see: Lund, Kikuchi, and Davidson, PRSTAB, to be published, (2008) Appendices F, G]
- Extreme flatness of solution for small  $\Delta \lesssim 10^{-8}$  creates numerical precision problems that require special numerical methods to address
- Method was used to verify accuracy of small  $\Delta$  solution above

SM Lund, USPAS, June 2008

Transverse Equilibrium Distributions 84

## Parameters constraints for the thermal equilibrium beam

Parameters employed in  $f_{\perp}(H_{\perp})$  to specify the equilibrium are (+ kinematic factors):  $\hat{n}$ ,  $T$ ,  $\Delta$

Parameters preferred for accelerator applications:

$$k_{\beta 0}, Q, \varepsilon_x = \varepsilon_y = \varepsilon_b$$

Needed constraints can be calculated directly from the equilibrium:

$$Q = \left( \frac{T}{\gamma_b m_i \beta_b^2 c^2} \right) \int_0^{\infty} dpp e^{-\psi}$$

$$k_{\beta 0}^2 \varepsilon_b = 4 \left( \frac{T}{\gamma_b m_i \beta_b^2 c^2} \right) \left[ 4 \left( \frac{T}{\gamma_b m_i \beta_b^2 c^2} \right) + Q \right]$$

$$k_{\beta 0}^2 = \left( \frac{T}{\gamma_b m_i \beta_b^2 c^2} \right) \frac{1 + \Delta}{2(\gamma_b \lambda_D)^2}$$

Also useful,

$$\varepsilon_b^2 = 16 \frac{T}{\gamma_b m_i \beta_b^2 c^2} \langle x^2 \rangle_{\perp}^2 = 4 \left( \frac{T}{\gamma_b m_i \beta_b^2 c^2} \right) r_b^2$$

$$r_b^2 = 4 \langle x^2 \rangle_{\perp} = \frac{1}{k_{\beta 0}^2} \left[ 4 \left( \frac{T}{\gamma_b m_i \beta_b^2 c^2} \right) + Q \right]$$

Example of derivation steps applied to derive previous constraint equations:

**Line charge:** 
$$\lambda = \frac{\gamma_b^2 T}{2q} \int_0^{\infty} d\rho \rho e^{-\psi}$$

**rms edge radius:** 
$$r_b^2 = 4 \langle x^2 \rangle_{\perp} = 2 \gamma_b^2 \lambda_D^2 \int_0^{\infty} d\rho \rho^3 e^{-\psi} / \int_0^{\infty} d\rho \rho e^{-\psi}$$

**rms edge emittance:**

$$\varepsilon_b^2 = \varepsilon_x^2 = 16 [ \langle x^2 \rangle_{\perp} \langle x'^2 \rangle_{\perp} - \langle x x' \rangle_{\perp}^2 ]$$

$$= 16 \frac{T}{\gamma_b m_i \beta_b^2 c^2} \langle x^2 \rangle_{\perp} = 4 \left( \frac{T}{\gamma_b m_i \beta_b^2 c^2} \right) r_b^2$$

**Matched envelope equation:**

$$r_b'' + k_{\beta 0}^2 r_b - \frac{Q}{r_b} - \frac{\varepsilon_b^2}{r_b^3} = 0$$

These constraints must, in general, be solved numerically

- Useful to probe system sensitivities in relevant parameters

### Examples:

1) rms equivalent beam tune depression as a function of #

$$\frac{\sigma}{\sigma_0} = \sqrt{1 - \frac{Q}{k_{\beta 0}^2 r_b^2}} = \left\{ 1 - \frac{[\int_0^{\infty} d\rho \rho e^{-\psi}]^2}{(1 + \Delta) \int_0^{\infty} dpp^3 e^{-\psi}} \right\}^{1/2}$$

R.H.S function of # only

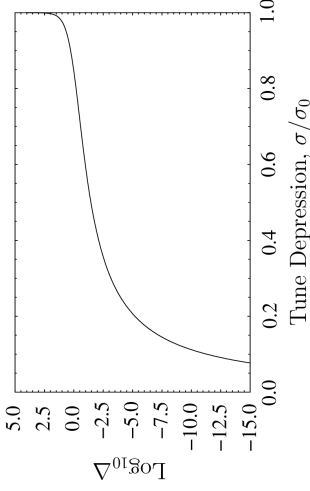

**rms equivalent KV measure of  $\sigma/\sigma_0$**

- Space-charge really nonlinear and the Thermal equilibrium has a spectrum of  $\sigma$

- Small rms equivalent tune depression corresponds to *extremely* small values of #
- Special numerical methods generally must be employed to calculate equilibrium

2) Density profile at fixed line charge and focusing strength

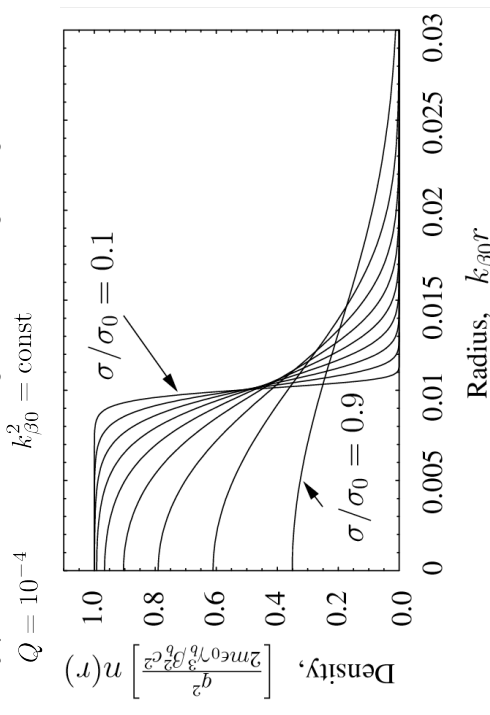

◆ Density profile changes with scaled T

- Low values yields a flat-top  $\Rightarrow \sigma/\sigma_0 \rightarrow 0$
- High values yield a Gaussian like profile  $\Rightarrow \sigma/\sigma_0 \rightarrow 1$



### 3) Distribution contours at fixed line charge and focusing strength

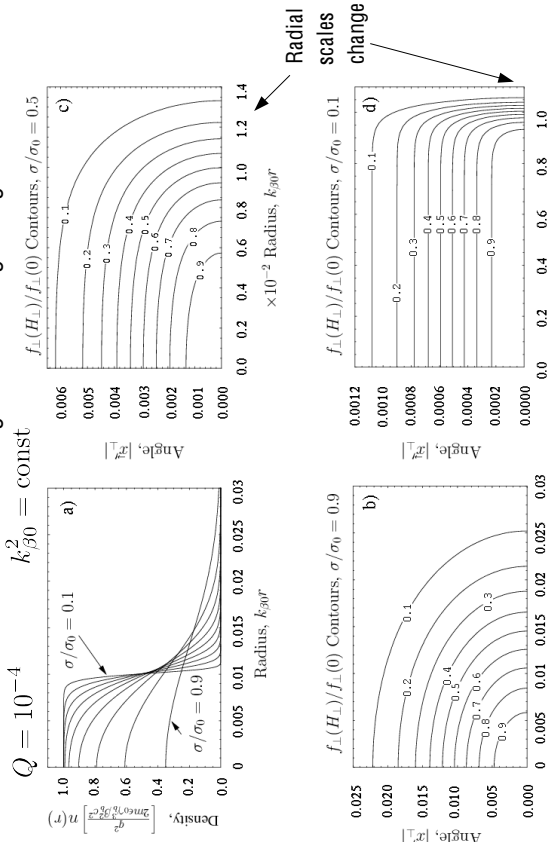

→ Particles will move approximately force-free till approaching the edge where it is rapidly bent back (see Debye screening analysis this lecture)

### Scaled parameters for examples 2) and 3)

$\sigma/\sigma_0$	$\Delta$	$s_b$	$k_{\beta 0} \gamma_b \lambda_D$	$Q = 10^{-4}$
0.9	1.851	0.3508	12.33	$\frac{T}{m\gamma_b \beta_b^2 c^2} 10^3 \times k_{\beta 0} \epsilon_b$ 1.065 × 10 <sup>-4</sup> 0.4737
0.8	6.382 × 10 <sup>-1</sup>	0.6104	6.034	4.444 × 10 <sup>-5</sup> 0.2222
0.7	2.649 × 10 <sup>-1</sup>	0.7906	3.898	2.402 × 10 <sup>-5</sup> 0.1373
0.6	1.059 × 10 <sup>-1</sup>	0.9043	2.788	1.406 × 10 <sup>-5</sup> 0.09375
0.5	3.501 × 10 <sup>-2</sup>	0.9662	2.077	8.333 × 10 <sup>-6</sup> 0.06667
0.4	7.684 × 10 <sup>-3</sup>	0.9924	1.549	4.762 × 10 <sup>-6</sup> 0.04762
0.3	6.950 × 10 <sup>-4</sup>	0.9993	1.112	2.473 × 10 <sup>-6</sup> 0.03297
0.2	6.389 × 10 <sup>-6</sup>	1.0000	0.7217	1.042 × 10 <sup>-6</sup> 0.02083
0.1	4.975 × 10 <sup>-12</sup>	1.0000	0.3553	2.525 × 10 <sup>-7</sup> 0.01010

### Comments on continuous focusing thermal equilibria

From these results it is not surprising that the KV model works well for real beams with strong space-charge (i.e. rms equivalent  $\sigma/\sigma_0$  small) since the edges of a smooth thermal distribution become sharp

→ Thermal equilibrium likely overestimates the edge with since  $T = \text{const}$ , whereas a real distribution likely becomes colder near the edge  
However, the beam edge contains strong nonlinear terms that will cause deviations from the KV model

- Nonlinear terms can radically change the stability properties (stabilize fictitious higher order KV modes)
- Smooth distributions contain a spectrum of particle oscillation frequencies that are amplitude dependent

### S8: Continuous Focusing: Debye Screening in a Thermal Equilibrium Beam

[Davidson, *Physics of Nonneutral Plasmas*, Addison Wesley (1990)]

We will show that space-charge and the applied focusing forces of the lattice conspire together to **Debye screen interactions** in the core of a beam with high space-charge intensity

- Will systematically derive the Debye length employed by J.J. Barnard in the **Introductory Lectures**
- The applied focusing forces are analogous to a stationary neutralizing species in a plasma

// Review:

Free-space field of a 'bare' test line-charge  $\lambda_t$  at the origin  $r = 0$

$$\rho(r) = \lambda_t \frac{\delta(r)}{2\pi r} \quad \frac{1}{r} \frac{\partial}{\partial r} \left( r \frac{\partial \phi}{\partial r} \right) = -\frac{\lambda_t}{2\pi \epsilon_0} \frac{\delta(r)}{r}$$

solution (use Gauss' theorem) shows long-range interaction

$$\phi = -\frac{\lambda_t}{2\pi \epsilon_0} \ln(r) + \text{const}$$

$$E_r = -\frac{\partial \phi}{\partial r} = \frac{\lambda_t}{2\pi \epsilon_0 r}$$

Place a *small* test line charge at  $r = 0$  in a thermal equilibrium beam:

$$\frac{1}{r} \frac{\partial}{\partial r} \left( r \frac{\partial \phi}{\partial r} \right) = -\frac{q}{\epsilon_0} \int d^2 x'_\perp f_\perp(H_\perp) - \frac{\lambda_t}{2\pi\epsilon_0} \frac{\delta(r)}{r}$$

Thermal Equilibrium Test Line-Charge

Set:

$\phi_0 = \phi_0 + \delta\phi$        $\phi_0 =$  Thermal Equilibrium potential with no test line-charge  
 $\delta\phi =$  Perturbed potential from test line-charge

Assume thermal equilibrium adapts adiabatically to the test line-charge:

$$n_t(r) = \int d^2 x'_\perp f_\perp(H_\perp) = \hat{n} e^{-\tilde{\psi}} = \hat{n} e^{-\tilde{\psi}_0(r)} e^{-q\delta\phi/(\gamma_b^2 T)} \ll 1$$

$$\simeq \hat{n} e^{-\tilde{\psi}_0(r)} \left( 1 - \frac{q\delta\phi}{\gamma_b^2 T} \right)$$

Yields:

$$\frac{1}{r} \frac{\partial}{\partial r} \left( r \frac{\partial \delta\phi}{\partial r} \right) = -\frac{q^2}{\epsilon_0 \gamma_b^2 T} \hat{n} e^{-\tilde{\psi}_0(r)} - \frac{\lambda_t}{2\pi\epsilon_0} \frac{\delta(r)}{r}$$

Assume a relatively cold beam so the density is flat near the test line-charge:

$$\hat{n} e^{-\tilde{\psi}_0(r)} \simeq \hat{n}$$

This gives:

$$\frac{1}{r} \frac{\partial}{\partial r} \left( r \frac{\partial \delta\phi}{\partial r} \right) - \frac{\delta\phi}{\gamma_b^2 \lambda_D^2} = -\frac{\lambda_t}{2\pi\epsilon_0} \frac{\delta(r)}{r}$$

$$\lambda_D = \left( \frac{\epsilon_0 T}{q^2 \hat{n}} \right)^{1/2} = \text{Debye radius formed from peak, on-axis beam density}$$

Derive a general solution by connecting solution very near the test charge with the general solution for  $r$  nonzero:

Near solution: ( $r \rightarrow 0$ )

$$\frac{\delta\phi}{\gamma_b^2 \lambda_D^2} \text{ Negligible } \rightarrow \frac{1}{r} \frac{\partial}{\partial r} \left( r \frac{\partial \delta\phi}{\partial r} \right) = -\frac{\lambda_t}{2\pi\epsilon_0} \frac{\delta(r)}{r}$$

The free-space solution can be immediately applied:

$$\delta\phi \simeq -\frac{\lambda_t}{2\pi\epsilon_0} \ln(r) + \text{const}$$

$$r \rightarrow 0$$

General Exterior Solution: ( $r \neq 0$ )

The delta-function term vanishes giving:

$$\frac{1}{\rho} \frac{\partial}{\partial \rho} \left( \rho \frac{\partial \delta\phi}{\partial \rho} \right) - \delta\phi = 0 \quad \rho \equiv \frac{r}{\gamma_b \lambda_D}$$

This is a modified Bessel equation of order 0 with general solution:

$$\delta\phi = C_1 I_0(\rho) + C_2 K_0(\rho) \quad I_0(x) = \text{Modified Bessel Func, 1st kind}$$

$$K_0(x) = \text{Modified Bessel Func, 2nd kind}$$

$$C_1, C_2 = \text{constants}$$

Connection and General Solution:

Use limiting forms:

$$\rho \ll 1 \quad \rho \gg 1$$

$$I_0(\rho) \rightarrow 1 + \Theta(\rho^2) \quad I_0(\rho) \rightarrow \frac{e^\rho}{\sqrt{2\pi\rho}} [1 + \Theta(1/\rho)]$$

$$K_0(\rho) \rightarrow -[\ln(\rho/2) + 0.5772 \dots + \Theta(\rho^2)] \quad K_0(\rho) \rightarrow \sqrt{\frac{\pi}{2\rho}} [1 + \Theta(1/\rho)]$$

Comparison shows that we must choose for connection to the near solution and regularity at infinity:

$$C_1 = 0$$

$$C_2 = \frac{\lambda_t}{2\pi\epsilon_0}$$

General solution shows **Debye screening** of test charge in the core of the beam:

$$\delta\phi = \frac{\lambda_t}{2\pi\epsilon_0} K_0 \left( \frac{r}{\gamma_b \lambda_D} \right) \quad K_0(x) \quad \text{Order Zero Modified Bessel Function}$$

$$\simeq \frac{\lambda_t}{2\sqrt{2\pi\epsilon_0}} \frac{1}{\sqrt{r/(\gamma_b \lambda_D)}} e^{-r/(\gamma_b \lambda_D)} \quad r \gg \gamma_b \lambda_D$$

◆ Screened interaction does not require overall charge neutrality!

- Beam particles redistribute to screen bare interaction
- Beam behaves as a plasma and expect similar collective waves etc.
- ◆ Same result for all smooth equilibrium distributions and in 1D, 2D, and 3D
- Reason why lower dimension models can get the "right" answer for collective interactions in spite of the Coulomb force varying with dimension
- ◆ Explains why the radial density profile in the core of space-charge dominated beams are expected to be flat



**S9: Continuous Focusing: The Density Inversion Theorem**  
Shows and dependencies are strongly connected in an equilibrium

For: 
$$H_{\perp} = \frac{1}{2} \mathbf{x}_{\perp}^2 + \frac{1}{2} k_{\beta 0}^2 \mathbf{x}_{\perp}^2 + \frac{q\phi}{m\gamma_b^3 \beta_b^2 c^2}$$

calculate the beam density 
$$\psi \equiv \frac{1}{2} k_{\beta 0}^2 r^2 + \frac{q\phi}{m\gamma_b^3 \beta_b^2 c^2}$$

$$n(r) = \int d^2 x_{\perp} f_{\perp}(H_{\perp}) = 2\pi \int_0^{\infty} dU f_{\perp}(U + \psi(r))$$

differentiate: 
$$\frac{\partial n}{\partial \psi} = 2\pi \int_0^{\infty} dU \frac{\partial}{\partial \psi} f_{\perp}(U + \psi) = 2\pi \int_0^{\infty} dU \frac{\partial}{\partial U} f_{\perp}(U + \psi)$$

$$= 2\pi \lim_{U \rightarrow -\infty} f_{\perp}(U + \psi) - 2\pi f_{\perp}(\psi)$$

↖ 0  
bounded distribution

$$f_{\perp}(H_{\perp}) = -\frac{1}{2\pi} \frac{\partial n}{\partial \psi} \Big|_{\psi=H_{\perp}} \quad \psi(r) = \frac{1}{2} k_{\beta 0}^2 r^2 + \frac{q\phi(r)}{m\gamma_b^3 \beta_b^2 c^2}$$

Assume that  $n(r)$  is specified, then the Poisson equation can be integrated:

$$\psi(r) - \frac{q\phi(r)}{m\gamma_b^3 \beta_b^2 c^2} = \frac{1}{2} k_{\beta 0}^2 r^2 - \frac{q}{m\gamma_b^3 \beta_b^2 c^2 \epsilon_0} \int_0^r d\tilde{r} \int_0^{\tilde{r}} n(\tilde{r})$$

For  $n(r) = \text{const}$  
$$\int_0^r \frac{d\tilde{r}}{\tilde{r}} \int_0^{\tilde{r}} n(\tilde{r}) \propto r^2$$

This suggests that  $(r)$  is monotonic in  $r$  when  $d n(r)/dr$  is monotonic. Apply the chain rule:

**Density Inversion Theorem**

$$f_{\perp}(H_{\perp}) = -\frac{1}{2\pi} \frac{\partial n}{\partial \psi} \Big|_{\psi=H_{\perp}} = -\frac{1}{2\pi} \frac{\partial n(r)/\partial r}{\partial \psi(r)/\partial r} \Big|_{\psi=H_{\perp}}$$

$$\psi(r) = \frac{1}{2} k_{\beta 0}^2 r^2 + \frac{q\phi}{m\gamma_b^3 \beta_b^2 c^2}$$

For specified monotonic  $n(r)$  the density inversion theorem can be applied with the Poisson equation to calculate the corresponding equilibrium  $f_{\perp}(H_{\perp})$

**Comments on density inversion theorem:**

- Shows that the and dependence of the distribution are *inextricably linked* for an equilibrium distribution function  $f_{\perp}(H_{\perp})$
- Not so surprising -- equilibria are highly constrained
- If  $df_{\perp}(H_{\perp})/dH_{\perp} \leq 0$  then the kinetic stability theorem (see: S.M. Lund, lectures on Transverse Kinetic Stability) shows that the equilibrium is also stable

**// Example: Application of the inversion theorem to the KV equilibrium**

$$n = \begin{cases} \hat{n}, & 0 \leq r < r_b \\ 0, & r_b < r \end{cases} \longrightarrow \frac{\partial n}{\partial r} = -\hat{n} \delta(r - r_b)$$

property of delta-function: 
$$\delta(f(x)) = \sum_i \frac{\delta(x - x_i)}{|df/dx|_{x=x_i}}$$

$$f(x_i) = 0$$

$x_i$  is root of  $f$

use:  $\psi(r_b) = H_{\perp}|_{x_{\perp}=0} = H_{\perp b}$

$$f_{\perp}(H_{\perp}) = -\frac{1}{2\pi} \frac{\partial n}{\partial \psi} \Big|_{\psi=H_{\perp}} = \frac{\hat{n}}{2\pi} \delta(H_{\perp} - H_{\perp b})$$

Expected KV form //

Similar application of derivatives with respect to Courant-Snyder invariants can "derive" the needed form for the KV distribution of an elliptical beam without guessing.

**S10: Comments on the Plausibility of Smooth, Vlasov Equilibria in Periodic Transport Channels**

The KV and continuous models are the only (or related to simple transforms thereof) known exact beam equilibria. Both suffer from idealizations that render them inappropriate for use as initial distribution functions for detailed modeling of stability in real accelerator systems:

- KV distribution has an unphysical singular structure giving rise to collective instabilities with unphysical manifestations
  - Low order properties (envelope and some features of low-order plasma modes) are physical and very useful in machine design
- Continuous focusing is inadequate to model real accelerator lattices with periodic or -varying focusing forces
  - Kicked oscillator intrinsically different than a continuous oscillator

There is much room for improvement in this area, including study if smooth equilibria exist in periodic focusing and implications if no exact equilibria exist.

Large envelope flutter associated with strong focusing can result in a rapid high-order oscillating force imbalance acting on edge particles of the beam

Temperature Flutter

Elliptical rms Equivalent Beam

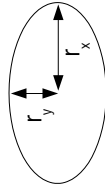

Example Systems  $(r_{\max}/r_{\min})^2$

AG Trans:  $\theta_0 = 60^\circ$   $\sim 2.5$

AG Trans:  $\theta_0 = 100^\circ$   $\sim 4.9$

$\varepsilon_x^2 \propto T_x r_x^2 \simeq \text{const} \Rightarrow T_x \propto \frac{1}{r_x^2}$  Matching Section  $\sim 15$  Possible

Characteristic Plasma Frequency of Collective Effects

Continuous Focusing Estimate

$$\sigma_{\text{plasma}} \sim \frac{L_p}{r_b} \sqrt{2Q} \quad \text{Typical: } \sigma_{\text{plasma}} \sim 105^\circ/\text{period}$$

Temperature asymmetry in beam will rapidly fluctuate with lattice periodicity

- Converging plane => Warmer
- Diverging plane => Colder
- Collective plasma wave response slower than lattice frequency
- Beam edge will not be able to adapt rapidly enough
- Collective waves will be launched from lack of local force balance near the edge

It is clear from these considerations that if smooth [equilibrium] beam distributions exist for periodic focusing, then they are highly nontrivial

Would a nonexistence of an equilibrium distribution be a problem:

- Real beams are born off a source that can be simulated
    - Propagation length can be relatively small in linacs
  - Transverse confinement can exist without an equilibrium
    - Particles can turn at large enough radii forming an edge
    - Edge can oscillate from lattice period to lattice period without pumping to large excursions
- Might not preclude long propagation with preserved statistical beam quality
- Even approximate equilibria would help sort out complicated processes:
- Reduce transients and fluctuations can help understand processes in simplest form
    - Allows more [plasma physics] type analysis and advances
  - Beams in Vlasov simulations are often observed to settle down to a fairly regular state after an initial transient evolution
    - Extreme phase mixing leads to an effective relaxation

The continuous focusing equilibrium distribution suggests that varying Debye screening together with envelope flutter would require a rapidly adapting beam edge in a smooth, periodic equilibrium beam distribution

$$f_{\perp} = \frac{m\gamma_b\beta_b^2 c^2 \hat{n}}{2\pi T} \exp\left(-\frac{m\gamma_b\beta_b^2 c^2 H_{\perp}}{T}\right)$$

Continuous Focusing Thermal Equilibrium Beam

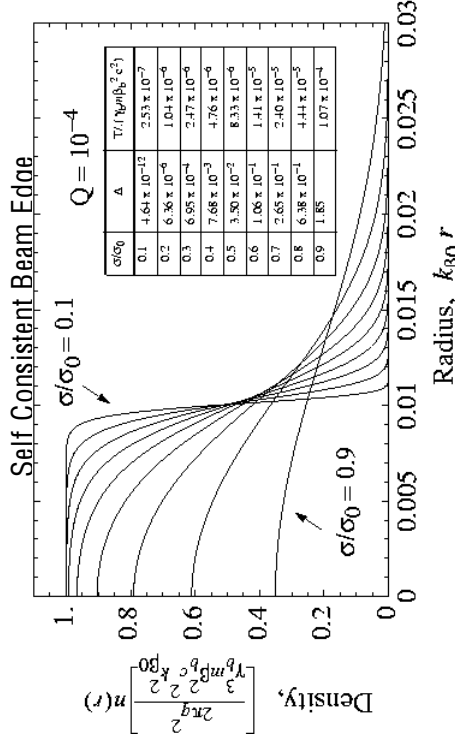

These slides will be corrected and expanded for reference and any future editions of the US Particle Accelerator School class:

*Beam Physics with Intense Space Charge*, by J.J. Barnard and S.M. Lund

Corrections and suggestions are welcome. Contact:

Steven M. Lund  
Lawrence Berkeley National Laboratory  
BLDG 47 R 0112  
1 Cyclotron Road  
Berkeley, CA 94720-8201

SM Lund@lbl.gov  
(510) 486 ± 6936

Please do not remove author credits in any redistributions of class material.

## References: For more information see:

- M. Reiser, *Theory and Design of Charged Particle Beams*, Wiley (1994, 2008)
- R. Davidson, *Theory of Nonneutral Plasmas*, Addison-Wesley (1989)
- R. Davidson and H. Qin, *Physics of Intense Charged Particle Beams in High Energy Accelerators*, World Scientific (2001).
- H. Wiedermann, *Particle Accelerator Physics*, Springer-Verlag (1995)
- J. Barnard and S. Lund, *Intense Beam Physics*, US Particle Accelerator School Notes, [http://uspas.fnal.gov/lect\\_note.html](http://uspas.fnal.gov/lect_note.html) (2006)
- F. Sacherer, *Transverse Space-Charge Effects in Circular Accelerators*, Univ. of California Berkeley, Ph.D Thesis (1968).
- S. Lund and B. Bukh, Review Article: *Stability Properties of the Transverse Envelope Equations Describing Intense Beam Transport*, PRST-Accel. and Beams 7, 024801 (2004).
- D. Nicholson, *Introduction to Plasma Theory*, Wiley (1983)
- I. Kaphinskij and V. Vladimirkij, in *Proc. Of the Int. Conf. On High Energy Accel. and Instrumentation* (CERN Scientific Info. Service, Geneva, 1959) p. 274

Appendix A  
Self Fields of a Uniform Density Elliptical Beam in Free Space

$$\left(\frac{\partial^2}{\partial x^2} + \frac{\partial^2}{\partial y^2}\right)\phi = \begin{cases} -\frac{\lambda}{\pi\epsilon_0 r_x r_y} & ; \frac{x^2}{r_x^2} + \frac{y^2}{r_y^2} < 1 \\ 0 & ; \frac{x^2}{r_x^2} + \frac{y^2}{r_y^2} > 1 \end{cases}$$

$$\frac{\partial\phi}{\partial r} \sim \frac{\lambda}{2\pi\epsilon_0 r} \quad \text{as } r \rightarrow \infty.$$

The solution to this system to an arb. constant has been formally constructed by Landau & Lifshitz and others (gravitational field analog) as:

$$\phi = -\frac{\lambda}{4\pi\epsilon_0} \left\{ \int_0^{\xi} \frac{ds}{\sqrt{[(r_x^2+s)(r_y^2+s)]^{1/2}}} + \int_{\xi}^{\infty} \frac{ds}{\sqrt{[(r_x^2+s)(r_y^2+s)]^{1/2}}} \left( \frac{x^2}{r_x^2+s} + \frac{y^2}{r_y^2+s} \right) \right\} + \text{const.}$$

where

$$\begin{cases} \xi = 0 & ; \text{ when } (x/r_x)^2 + (y/r_y)^2 < 1 \\ \xi = \text{root of } \frac{x^2}{r_x^2+\xi} + \frac{y^2}{r_y^2+\xi} = 1 & ; \text{ when } (x/r_x)^2 + (y/r_y)^2 > 1 \end{cases}$$

Trivially for  $x=y=0$   
 $\phi(x=y=0) = \text{const.}$

Calculate:

$$\frac{\partial\phi}{\partial x} = -\frac{\lambda}{4\pi\epsilon_0} \left\{ \int_0^{\infty} \frac{ds}{\sqrt{[(r_x^2+s)(r_y^2+s)]^{1/2}}} \frac{\partial}{\partial x} \left[ \frac{x^2}{r_x^2+s} + \frac{y^2}{r_y^2+s} \right] \right\}$$

$$\left. \begin{aligned} \text{If } \xi \neq 0 & \Rightarrow 1 = \frac{x^2}{r_x^2+\xi} + \frac{y^2}{r_y^2+\xi} \\ \xi = 0 & \Rightarrow \frac{\partial\xi}{\partial x} = 0 \end{aligned} \right\} \Rightarrow \text{end term vanishes}$$

$$\frac{\partial \phi}{\partial x} = - \frac{\lambda}{2\pi\epsilon_0} \int_{\xi}^{\infty} \frac{ds}{[(r_x^2+s)(r_y^2+s)]^{1/2}} \frac{x}{r_x^2+s}$$

by symmetry

$$\frac{\partial \phi}{\partial y} = - \frac{\lambda}{2\pi\epsilon_0} \int_{\xi}^{\infty} \frac{ds}{[(r_x^2+s)(r_y^2+s)]^{1/2}} \frac{y}{r_y^2+s}$$

Differentiating again and using the chain rule:

$$\left(\frac{\partial^2}{\partial x^2} + \frac{\partial^2}{\partial y^2}\right)\phi = - \frac{\lambda}{2\pi\epsilon_0} \left\{ \int_{\xi}^{\infty} \frac{ds}{[(r_x^2+s)(r_y^2+s)]^{1/2}} \left[ \frac{1}{r_x^2+s} + \frac{1}{r_y^2+s} \right] - \frac{1}{[(r_x^2+s)(r_y^2+s)]^{1/2}} \left[ \frac{x \partial s / \partial x}{r_x^2+s} + \frac{y \partial s / \partial y}{r_y^2+s} \right] \right\}$$

Must show that the r.h.s. reduces to the needed forms for:

case 1 exterior  $\xi$  satisfies:  $\frac{x^2}{r_x^2+\xi} + \frac{y^2}{r_y^2+\xi} = 1$

case 2 interior  $\xi = 0$

case 1 (exterior:  $x^2/r_x^2 + y^2/r_y^2 > 1$ )

Differentiate  $\frac{x^2}{r_x^2+\xi} + \frac{y^2}{r_y^2+\xi} = 1$

$$\Rightarrow \frac{\partial \xi}{\partial x} = \frac{2x}{(r_x^2+\xi) \left[ \frac{x^2}{(r_x^2+\xi)^2} + \frac{y^2}{(r_y^2+\xi)^2} \right]}$$

$$\frac{\partial \xi}{\partial y} = \frac{2y}{(r_x^2+\xi) \left[ \frac{x^2}{(r_x^2+\xi)^2} + \frac{y^2}{(r_y^2+\xi)^2} \right]}$$

$$\Rightarrow \frac{x \partial \xi / \partial x}{r_x^2+\xi} + \frac{y \partial \xi / \partial y}{r_y^2+\xi} = 2 \left[ \frac{x^2}{(r_x^2+\xi)^2} + \frac{y^2}{(r_y^2+\xi)^2} \right] \frac{1}{\left[ \frac{x^2}{(r_x^2+\xi)^2} + \frac{y^2}{(r_y^2+\xi)^2} \right]} = 2$$

Also need integrals like:  $w^2 = s + r_y^2$

$$I_x(\xi) = \int_{\xi}^{\infty} \frac{ds}{[(r_x^2+s)(r_y^2+s)]^{1/2}} \frac{1}{r_x^2+s} = 2 \int_{\sqrt{r_x^2+\xi}}^{\infty} \frac{dw}{(r_x^2-r_y^2+w^2)^{3/2}}$$

This integral can be done using tables:

$$I_x(\xi) = \frac{zW}{(r_x^2 - r_y^2) \sqrt{r_x^2 - r_y^2 + W^2}} \Bigg|_{W=\sqrt{r_x^2 + \xi}}^{W \rightarrow \infty} = \frac{z}{r_x^2 - r_y^2} \frac{-z \sqrt{r_y^2 + \xi}}{(r_x^2 - r_y^2) \sqrt{r_x^2 + \xi}}$$

Similarly:

$$I_y(\xi) = \int_{\xi}^{\infty} \frac{ds}{[(r_x^2 + s)(r_y^2 + s)]^{1/2} (r_y^2 + s)} = \frac{z}{r_y^2 - r_x^2} \frac{-z \sqrt{r_x^2 + \xi}}{(r_y^2 - r_x^2) \sqrt{r_y^2 + \xi}}$$

$$\int_0^{\infty} \frac{ds}{[(r_x^2 + s)(r_y^2 + s)]^{1/2}} \left[ \frac{1}{r_x^2 + s} + \frac{1}{r_y^2 + s} \right] = I_x(\xi) + I_y(\xi)$$

$$= \frac{z}{r_x^2 - r_y^2} \left( \frac{\sqrt{r_x^2 + \xi}}{\sqrt{r_y^2 + \xi}} - \frac{\sqrt{r_y^2 + \xi}}{\sqrt{r_x^2 + \xi}} \right) = \frac{z}{[(r_x^2 + \xi)(r_y^2 + \xi)]^{1/2}}$$

Using these results:

$$\left( \frac{\partial^2}{\partial x^2} + \frac{\partial^2}{\partial y^2} \right) \phi = -\frac{\lambda}{2\pi\epsilon_0} \left\{ \frac{z}{[(r_x^2 + \xi)(r_y^2 + \xi)]^{1/2}} - \frac{z}{[(r_x^2 + \xi)(r_y^2 + \xi)]^{1/2}} \right\} = 0 \quad \text{checks. } \checkmark$$

Case 2 (Interior:  $x^2/r_x^2 + y^2/r_y^2 < 1$ )

$$\xi = 0 \Rightarrow \frac{x \partial \xi / \partial x}{r_x^2 + \xi} + \frac{y \partial \xi / \partial y}{r_y^2 + \xi} = 0$$

$$\Rightarrow I_x(\xi=0) = \cancel{I_y(\xi=0)} = \frac{z}{(r_x + r_y) r_x} \quad \text{and} \quad I_y(\xi=0) = \frac{z}{(r_x + r_y) r_y}$$

Using these results:

$$\left( \frac{\partial^2}{\partial x^2} + \frac{\partial^2}{\partial y^2} \right) \phi = -\frac{\lambda}{2\pi\epsilon_0} \left\{ \frac{z}{r_x r_y} - 0 \right\} = -\frac{\lambda}{\epsilon_0 \pi r_x r_y} = -\frac{q \hat{n}}{\epsilon_0} \quad \checkmark$$

Finally, check the limiting form outside the beam for  $r$  large  $\Rightarrow \xi$  large.

$$-\frac{\partial \phi}{\partial x} = \frac{\lambda}{2\pi\epsilon_0} x I_x(\xi) \quad \lim_{r \rightarrow \infty} I_x(\xi) = \frac{1}{\xi} = \frac{1}{r^2}$$

$$-\frac{\partial \phi}{\partial y} = \frac{\lambda}{2\pi\epsilon_0} y I_y(\xi) \quad \lim_{r \rightarrow \infty} I_y(\xi) = \frac{1}{\xi} = \frac{1}{r^2}$$

Thus:

$$\lim_{r \rightarrow \infty} \frac{-\partial \phi}{\partial x} = \frac{\lambda}{2\pi\epsilon_0} \frac{x}{r^2} \checkmark = \frac{\lambda}{2\pi\epsilon_0} \frac{x}{r^2}$$

$$\lim_{r \rightarrow \infty} \frac{-\partial \phi}{\partial y} = \frac{\lambda}{2\pi\epsilon_0} \frac{y}{r^2} \checkmark = \frac{\lambda}{2\pi\epsilon_0} \frac{y}{r^2}$$

These have the correct limiting forms for a line charge at the origin. Completing the verification of the general formula.

In the beam ( $x^2/r_x^2 + y^2/r_y^2 < 1$ ,  $\xi = 0$ ), the formula reduces to:

$$\begin{aligned} \phi &= -\frac{\lambda}{4\pi\epsilon_0} \left\{ x^2 I_x(\xi=0) + y^2 I_y(\xi=0) \right\} + \text{const.} \\ &= -\frac{\lambda}{4\pi\epsilon_0} \left\{ \frac{2x^2}{r_x(r_x+y)} + \frac{2y^2}{r_y(r_x+y)} \right\} + \text{const.} \end{aligned}$$

$$\phi = -\frac{\lambda}{2\pi\epsilon_0} \left\{ \frac{x^2}{r_x(r_x+y)} + \frac{y^2}{r_y(r_x+y)} \right\} + \text{const.}$$

The case of an axisymmetric beam with

$$r_x = r_y = r_0$$

is easy to construct explicitly and is included in the homework problems.

There is also an alternative way to do this field calculation, that is less direct but more efficient. We carry out this proof now since steps involved are useful for other <sup>15</sup> purposes.

A density profile with elliptic symmetry can be expressed as:

$$n(x, y) = n\left(\frac{x^2}{r_x^2} + \frac{y^2}{r_y^2}\right)$$

Here we do not assume a specific uniform density profile and we leave  $n(x^2/r_x^2 + y^2/r_y^2)$  arbitrary outside of having elliptic symmetry. The solution to the 2D Poisson equation in free-space

$$\left(\frac{\partial^2}{\partial x^2} + \frac{\partial^2}{\partial y^2}\right)\phi = -\frac{q n}{\epsilon_0}$$

is then given by

$$\phi = -\frac{q r_x r_y}{4\epsilon_0} \int_0^\infty \frac{d\xi \eta(\mathcal{Z})}{\sqrt{r_x^2 + \xi} \sqrt{r_y^2 + \xi}}$$

$$\mathcal{Z} \equiv \frac{x^2}{r_x^2 + \xi} + \frac{y^2}{r_y^2 + \xi}$$

where  $\eta(\mathcal{Z})$  is a function defined such that:

$$n(x, y) = \left. \frac{d\eta(\mathcal{Z})}{d\mathcal{Z}} \right|_{\mathcal{Z}=0}$$

This choice for  $\eta(\mathcal{Z})$  can always be made.



We first prove that this solution is valid by direct substitution:

$$\mathcal{U} = \frac{x^2}{r_x^2 + \xi} + \frac{y^2}{r_y^2 + \xi} \Rightarrow \frac{\partial \mathcal{U}}{\partial x} = \frac{2x}{r_x^2 + \xi}; \quad \frac{\partial^2 \mathcal{U}}{\partial x^2} = \frac{2}{r_x^2 + \xi}$$

$$\frac{\partial \mathcal{U}}{\partial y} = \frac{2y}{r_y^2 + \xi}; \quad \frac{\partial^2 \mathcal{U}}{\partial y^2} = \frac{2}{r_y^2 + \xi}$$

Substitute in Poisson's equation and use the chain rule and results above:

$$\left( \frac{\partial^2}{\partial x^2} + \frac{\partial^2}{\partial y^2} \right) \phi = -\frac{g(x,y)}{4\epsilon_0} \int_0^\infty d\xi \left( \frac{d^2 \eta}{d\xi^2} \right) \left( \frac{4x^2}{(r_x^2 + \xi)^2} + \frac{4y^2}{(r_y^2 + \xi)^2} \right) + \left( \frac{d\eta}{d\xi} \right) \left( \frac{2}{r_x^2 + \xi} + \frac{2}{r_y^2 + \xi} \right)$$

$$\text{Note: } d\mathcal{U} = - \left[ \frac{x^2}{(r_x^2 + \xi)^2} + \frac{y^2}{(r_y^2 + \xi)^2} \right] d\xi$$

so the first integral can be simplified by partial integration:

$$\int_0^\infty d\xi \left( \frac{d^2 \eta}{d\xi^2} \right) \left( \frac{4x^2}{(r_x^2 + \xi)^2} + \frac{4y^2}{(r_y^2 + \xi)^2} \right) = -4 \int_0^\infty d\xi \frac{d^2 \eta}{d\xi^2} \frac{d\mathcal{U}}{d\xi}$$

$$= -4 \int_0^\infty d\xi \frac{d}{d\xi} \left( \frac{d\eta}{d\xi} \right) \frac{1}{\sqrt{r_x^2 + \xi} \sqrt{r_y^2 + \xi}} = -4 \int_0^\infty d\xi \frac{d}{d\xi} \left[ \frac{d\eta}{d\xi} \frac{1}{\sqrt{r_x^2 + \xi} \sqrt{r_y^2 + \xi}} \right] + 4 \int_0^\infty d\xi \frac{d\eta}{d\xi} \frac{d}{d\xi} \frac{1}{\sqrt{r_x^2 + \xi} \sqrt{r_y^2 + \xi}}$$

$$= -4 \frac{d\eta}{d\xi} \frac{1}{\sqrt{r_x^2 + \xi} \sqrt{r_y^2 + \xi}} \Big|_{\xi=0}^{\xi \rightarrow \infty} - 2 \int_0^\infty d\xi \frac{d\eta}{d\xi} \left( \frac{1}{r_x^2 + \xi} + \frac{1}{r_y^2 + \xi} \right) \frac{1}{\sqrt{r_x^2 + \xi} \sqrt{r_y^2 + \xi}}$$

$$= \frac{4}{r_x r_y} \frac{d\eta}{d\mathcal{U}} \Big|_{\xi=0} - 2 \int_0^\infty d\xi \frac{d\eta}{d\mathcal{U}} \left( \frac{1}{r_x^2 + \xi} + \frac{1}{r_y^2 + \xi} \right) \frac{1}{\sqrt{r_x^2 + \xi} \sqrt{r_y^2 + \xi}}$$

term will cancel 2nd Integral

Thus:

$$\left(\frac{\partial^2}{\partial x^2} + \frac{\partial^2}{\partial y^2}\right)\phi = -\frac{g(x,y)}{4\epsilon_0} \frac{d\eta(z)}{dz} \Big|_{z=0}$$

But  $\frac{d\eta(z)}{dz} \Big|_{z=0} = n(x,y)$  by definition.

$$\Rightarrow \left(\frac{\partial^2}{\partial x^2} + \frac{\partial^2}{\partial y^2}\right)\phi = -\frac{g(x,y)}{\epsilon_0} \quad \text{verifying the result.}$$

1) For a uniform density ellipse we take:

$$\eta(z) = \frac{\lambda}{g\pi R_y} \begin{cases} z & ; z < 1 \\ 1 & ; z > 1 \end{cases} \Rightarrow \frac{d\eta(z)}{dz} = \begin{cases} \frac{\lambda}{g\pi R_y} & ; z < 1 \\ 0 & ; z > 1 \end{cases}$$

Thus

$$\frac{d\eta(z)}{dz} \Big|_{z=0} = \begin{cases} \frac{\lambda}{g\pi R_y} & ; z|_{z=0} < 1 \\ 0 & ; z|_{z=0} > 1 \end{cases} = \begin{cases} \frac{\lambda}{g\pi R_y} & ; \frac{x^2}{R_x^2} + \frac{y^2}{R_y^2} < 1 \\ 0 & ; \frac{x^2}{R_x^2} + \frac{y^2}{R_y^2} > 1 \end{cases}$$

$$\therefore \frac{d\eta(z)}{dz} \Big|_{z=0} = n(x,y) \quad \text{for a uniform density}$$

Apply these results to calculate  $\phi$  interior to a uniform density elliptical beam. with radii  $(R_x, R_y)$  and density  $\lambda/(g\pi R_y)$ .

$$\phi = -\frac{g(x,y)}{4\epsilon_0} \int_0^{\infty} \frac{d\eta(z)}{\sqrt{R_x^2 + \xi} \sqrt{R_y^2 + \xi}}$$

$$z = \frac{x^2}{R_x^2 + \xi} + \frac{y^2}{R_y^2 + \xi}$$

$$\text{if } \frac{x^2}{R_x^2} + \frac{y^2}{R_y^2} < 1, \text{ then}$$

$$z = \frac{x^2}{R_x^2 + \xi} + \frac{y^2}{R_y^2 + \xi} < 1 \quad \text{for all } 0 \leq \xi < \infty$$

Using this and the result above:

for  $\eta(z)$ ,  $\phi$  inside the elliptical beam is:

$$\phi = -\frac{g(x,y)}{4\epsilon_0} \int_0^{\infty} \frac{d\xi}{\xi} \frac{\lambda}{g\pi R_y} \left[ \frac{x^2}{(R_x^2 + \xi)^{3/2} (R_y^2 + \xi)^{1/2}} + \frac{y^2}{(R_x^2 + \xi)^{1/2} (R_y^2 + \xi)^{3/2}} \right]$$

$$\phi = \frac{-\lambda}{4\pi\epsilon_0} \left\{ x^2 \int_0^\infty \frac{ds}{(r_x^2+s)^{3/2} (r_y^2+s)^{1/2}} + y^2 \int_0^\infty \frac{ds}{(r_x^2+s)^{1/2} (r_y^2+s)^{3/2}} \right\}$$

Using Mathematica or Integral tables:

$$\int_0^\infty \frac{ds}{(r_x^2+s)^{3/2} (r_y^2+s)^{1/2}} = \frac{2}{r_x(r_x+r_y)}$$

$$\int_0^\infty \frac{ds}{(r_x^2+s)^{1/2} (r_y^2+s)^{3/2}} = \frac{2}{r_y(r_x+r_y)}$$

Hence

$$\phi = \frac{-\lambda}{2\pi\epsilon_0} \left\{ \frac{x^2}{r_x(r_x+r_y)} + \frac{y^2}{r_y(r_x+r_y)} \right\} + \text{const} \quad \checkmark$$

since an overall constant can always be added to  $\phi$   
(The integral has a reference choice  $\phi(x=y=0) = 0$  built in.)

The steps introduced in this proof can also be used to show that:

$$\left\langle x \frac{\partial \phi}{\partial x} \right\rangle_{\perp} = \frac{-\lambda}{4\pi\epsilon_0} \frac{r_x}{r_x+r_y}$$

$$\left\langle y \frac{\partial \phi}{\partial y} \right\rangle_{\perp} = \frac{-\lambda}{4\pi\epsilon_0} \frac{r_y}{r_x+r_y}$$

$$\lambda = \int d^2x n$$

$$r_x \equiv 2\langle x^2 \rangle^{1/2}$$

$$r_y \equiv 2\langle y^2 \rangle^{1/2}$$

for any elliptic symmetry density profile

$n(x,y) = n(x^2/r_x^2 + y^2/r_y^2)$ . In the intro. lectures these

results were employed to show that the KV envelope

equations with evolving emittances can be applied to

elliptic symmetry beams. This result was first demonstrate

by Sacherer: [IEEE Trans Nucl. Sci. 18, 1105 (1971)]

Canonical Transformation of the ICV Distribution

The single-particle equations of motion can be derived from the Hamiltonian;  $\left( \frac{d\vec{x}_i}{ds} = \frac{\partial H}{\partial \vec{x}_i'}, \frac{d\vec{x}_i'}{ds} = -\frac{\partial H}{\partial \vec{x}_i} \right)$

$$H_{\perp}(x, y, x', y', s) = \frac{1}{2} x'^2 + \left[ R_x(s) - \frac{ZQ}{R_x(s)[R_x(s)+R_y(s)]} \right] \frac{x^2}{2} + \frac{1}{2} y'^2 + \left[ R_y(s) - \frac{ZQ}{R_y(s)[R_x(s)+R_y(s)]} \right] \frac{y^2}{2}$$

Perform a canonical transform to new variables  $X, Y, X', Y'$  using the generating function

$$F_2(x, y, X', Y') = \frac{x}{w_x} \left[ X' + \frac{x w_x'}{2} \right] + \frac{y}{w_y} \left[ Y' + \frac{y w_y'}{2} \right]$$

Then:

$$X = \frac{\partial F_2}{\partial X'} = \frac{x}{w_x}$$

$$Y = \frac{\partial F_2}{\partial Y'} = \frac{y}{w_y}$$

Ref:

R.C. Davidson,  
 "Physics of Nonneutral Plasmas"  
 Addison-Wesley, 1990

Comment!

Here,  $X' \neq \frac{d}{ds} X$ ,  $X'$  merely denotes the conjugate variable to  $X$   
 Also,  $X, X'$  both have dim: meters<sup>1/2</sup>

$$x' = \frac{\partial F_2}{\partial x} = \frac{1}{w_x} (X' + x w_x')$$

$$y' = \frac{\partial F_2}{\partial y} = \frac{1}{w_y} (Y' + y w_y')$$

and solving for  $X', Y'$ :

$$X' = w_x x' - x w_x'$$

$$Y' = w_y y' - y w_y'$$

The Courant-Snyder invariants are then simply expressed:

$$C_x = X^2 + X'^2 = \text{const}$$

$$C_y = Y^2 + Y'^2 = \text{const}$$

One can show from the transformations that:

$$dx dy = w_x w_y dX dY$$

$$dx' dy' = \frac{dX' dY'}{w_x w_y}$$

$$dx dy dx' dy' = dX dY dX' dY' *$$

\* Property of canonical transforms in general. — Results from structure of Generating Function

Therefore, the distribution in transformed phase space variables is the same as for the original variables:

$$f_{\perp}(X, Y, X', Y', s) = f_{\perp}(x, y, x', y', s)$$

$$= \frac{\lambda}{2\pi^2 \epsilon_x \epsilon_y} \delta \left[ \frac{X^2 + X'^2}{\epsilon_x} + \frac{Y^2 + Y'^2}{\epsilon_y} - 1 \right]$$

Now examine the density:

$$n(x, y) = \int dx' dy' f_{\perp} = \int \frac{dX' dY'}{w_x w_y} f_{\perp} =$$

$$U_x = X' / \sqrt{\epsilon_x}, \quad U_y = Y' / \sqrt{\epsilon_y}$$

$$r_x = \sqrt{\epsilon_x} w_x, \quad r_y = \sqrt{\epsilon_y} w_y$$

$$dU_x dU_y = \frac{dX' dY'}{\sqrt{\epsilon_x \epsilon_y}}$$

$$n = \frac{\lambda}{2\pi^2 \epsilon_x \epsilon_y} \int dU_x dU_y \delta \left[ U_x^2 + U_y^2 - \left( 1 - \frac{X^2}{\epsilon_x} - \frac{Y^2}{\epsilon_y} \right) \right]$$

Exploit the cylindrical symmetry:

$$U_{\perp}^2 = U_x^2 + U_y^2$$

$$dU_x dU_y = d\psi U_{\perp} dU_{\perp} = d\psi \frac{dU_{\perp}^2}{2}$$

$$n(x,y) = \frac{\lambda}{g\pi r_x r_y} \int_0^{2\pi} d\psi \int_0^{\infty} \frac{dU_{\perp}^2}{2} \delta \left[ U_{\perp}^2 - \left( 1 - \frac{x^2}{r_x^2} - \frac{y^2}{r_y^2} \right) \right]$$

Thus:

$$n(x,y) = \frac{\lambda}{g\pi r_x r_y} \int_0^{\infty} dU_{\perp}^2 \delta \left[ U_{\perp}^2 - \left( 1 - \frac{x^2}{r_x^2} - \frac{y^2}{r_y^2} \right) \right]$$

$$= \begin{cases} \frac{\lambda}{g\pi r_x r_y} = \hat{n} & ; \frac{x^2}{r_x^2} + \frac{y^2}{r_y^2} < 1 \\ 0 & ; \frac{x^2}{r_x^2} + \frac{y^2}{r_y^2} > 1 \end{cases}$$

Showing that the singular kv distribution yields the required uniform density beam of elliptical cross-section.

Note

$$\hat{n} = \frac{\lambda}{g\pi r_x r_y}$$

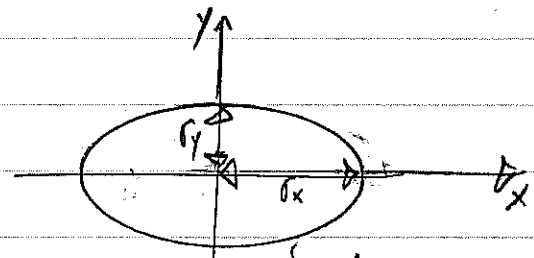

$$\lambda = g\hat{n}\pi r_x r_y$$

for uniform density.

An interesting footnote to this appendix is that an intensity of generating functions can be used to transform the KV distribution in standard quadratic form:

$$f_c \sim \delta [X'^2 + Y'^2 + \bar{X}^2 + \bar{Y}^2 - \text{const}]$$

to other sets of variables. This will generate other distributions with KV form for skew coupling and other effects. It would not be logical to label such distributions as "new" as has been done in the literature. However, identifying physically relevant transforms has practical value.

Inverse transform:

$$x = w_x \bar{x}$$

$$w_x x' = \bar{x}' + x w_x' \Rightarrow x' = \frac{\bar{x}'}{w_x} + w_x' \bar{x}$$

$x = w_x \bar{x}$	$x' = \frac{\bar{x}'}{w_x} + w_x' \bar{x}$
$y = w_y \bar{y}$	$y' = \frac{\bar{y}'}{w_y} + w_y' \bar{y}$

Next,

$$\frac{d}{ds} \bar{x} = \frac{x'}{w_x} - \frac{x w_x'}{w_x^2}$$

$$= \frac{\bar{x}'}{w_x^2} + \frac{w_x' \bar{x}}{w_x} - \frac{w_x' \bar{x}}{w_x} = \frac{\bar{x}'}{w_x^2}$$

Thus,

$\frac{d}{ds} \bar{x} = \frac{\bar{x}'}{w_x^2}$
$\frac{d}{ds} \bar{y} = \frac{\bar{y}'}{w_y^2}$

$$\frac{d}{ds} \bar{x}' = \frac{w_x' \bar{x}'}{w_x^2} + w_x \bar{x}'' - \frac{w_x' \bar{x}'}{w_x} + x w_x''$$

$$\Rightarrow \begin{cases} x'' = \frac{\frac{d}{ds} \bar{x}'}{w_x} + w_x'' \bar{x} \\ y'' = \frac{\frac{d}{ds} \bar{y}'}{w_y} + w_y'' \bar{y} \end{cases}$$



Apply in Eqn of motion:

$$X'' + R_x X - \frac{ZQX}{(R_x + R_y) \Gamma_x} = 0$$

$$\frac{d}{ds} \frac{X'}{W_x} + W_x'' X + R_x W_x X - \frac{ZQ W_x X}{(R_x + R_y) \Gamma_x} = 0$$

$$\frac{d}{ds} X' + W_x \left( W_x'' + R_x W_x - \frac{ZQ W_x}{(R_x + R_y) \Gamma_x} \right) X = 0$$

"  $\frac{1}{W_x^2}$  from  $W_x$  eqn

$$\boxed{\begin{aligned} \frac{d}{ds} \frac{X'}{W_x} + \frac{1}{W_x^2} X &= 0, & \frac{d}{ds} X &= \frac{X'}{W_x} \\ \frac{d}{ds} \frac{Y'}{W_y} + \frac{1}{W_y^2} Y &= 0, & \frac{d}{ds} Y &= \frac{Y'}{W_y} \end{aligned}}$$

Following Davidson, these eqns can be solved using the method of variation of constants.

$$X(s) = X_p \cos \Psi_x(s) + X_p' \sin \Psi_x(s)$$

$$\Psi_x(s) = \int_{s_1}^s \frac{ds'}{W_x^2(s')} \quad ; \quad \Psi_x'(s) = \frac{1}{W_x^2(s)}$$

etc. = This also demonstrates explicitly the C.C.S. invariant

$$X^2 + X'^2 = \text{const.}$$

Note:

$$\frac{d}{ds} X = \frac{X'}{W_x^2}$$

Transformed Hamiltonian:

$$\begin{aligned} \frac{dX}{ds} &= \frac{\partial \tilde{H}}{\partial X'} = \frac{X'}{w_x^2} \\ \frac{dY}{ds} &= \frac{\partial \tilde{H}}{\partial Y'} = \frac{Y'}{w_y^2} \\ \frac{dX'}{ds} &= -\frac{\partial \tilde{H}}{\partial X} = -\frac{1}{w_x^2} X \\ \frac{dY'}{ds} &= -\frac{\partial \tilde{H}}{\partial Y} = -\frac{1}{w_y^2} Y \end{aligned}$$

$$\tilde{H} = \tilde{H}(X, Y, X', Y')$$

Transformed Hamiltonian

$$\Rightarrow \tilde{H} = \frac{1}{2w_x^2} X'^2 + \frac{1}{2w_y^2} Y'^2 + \frac{1}{2w_x^2} X^2 + \frac{1}{2w_y^2} Y^2 + \text{const.}$$

Note that  $\tilde{H}$  is still explicitly  $s$ -dependent based on  $w_x$  and  $w_y$  lattice functions.

This Hamiltonian can also be found using results from the theory of canonical transforms.

$$\Rightarrow \tilde{H} = H + \frac{\partial F}{\partial s}$$

and the coordinate transform expressions.

# Particle Resonances with Application to Circular Accelerators\*

Steven M. Lund

Lawrence Livermore National Laboratory (LLNL)

Steven M. Lund and John J. Barnard

“Beam Physics with Intense Space-Charge”

US Particle Accelerator School

University of Maryland, held at Annapolis, MD

16-27 June, 2008

(Version 20080613)

\* Research supported by the US Dept. of Energy at LLNL and LBNL under contract Nos. DE-AC52-07NA27344 and DE-AC02-05CH11231.

SM Lund, USPAS, June 2008

Particle Resonances

1

## Particle Resonances: Outline

Overview

Floquet Coordinates and Hill's Equation

Perturbed Hill's Equation in Floquet Coordinates

Sources of and Forms of Perturbation Terms

Solution of the Perturbed Hill's Equation: Resonances

Tune Restrictions Resulting from Resonances and Machine Operating Points

Space-Charge Effects

References

SM Lund, USPAS, June 2008

Particle Resonances

2

## Particle Resonances: Detailed Outline

### 1) Overview

Hill's Equation Review: Betatron Form of Phase-Amplitude Solution  
Transform Approach

Random and Systematic Perturbations Acting on Orbits

### 2) Floquet Coordinates and Hill's Equation

Transformation of Hill's Equation

Phase-Space Structure of Solution

Expression of the Courant-Snyder Invariant

Phase-Space Area Transform

### 3) Perturbed Hill's Equation in Floquet Coordinates

Transformation Result for  $x$ -Equation

### 4) Sources of and Forms of Perturbation Terms

Power Series Expansion of Perturbations

Connection to Multipole Field Errors

SM Lund, USPAS, June 2008

Particle Resonances

3

## Particle Resonances: Detailed Outline - 2

### 5) Solution of the Perturbed Hill's Equation: Resonances

Fourier Expansion of Perturbations and Resonance Terms  
Resonance Conditions

### 6) Machine Operating Points: Tune Restrictions Resulting from Resonances

Tune Restrictions from Low Order Resonances

### 7) Space-Charge Effects

Coherent and Incoherent Tune Shifts

Laslett Limit

Contact Information

References

Acknowledgments

SM Lund, USPAS, June 2008

Particle Resonances

4

## SI: Overview

In our treatment of single particle orbits of lattices with s-varying focusing, we found that [Hill's Equation](#) describes the orbits to leading-order approximation:

$$\begin{aligned} x''(s) + \kappa_x(s)x(s) &= 0 \\ y''(s) + \kappa_y(s)y(s) &= 0 \end{aligned}$$

where  $\kappa_x(s)$ ,  $\kappa_y(s)$

are functions that describe the linear applied focusing fields of the lattice

- ▶ Focusing functions can also incorporate linear space-charge forces

- Self-consistent for special case of a KV distribution

In analyzing Hill's equations we employed phase-amplitude methods

- ▶ See: S.M. Lund lectures on [Transverse Particle Equations, S8](#), on the betatron form of the solution

$$\begin{aligned} x(s) &= A_{xi} \sqrt{\beta_x(s)} \cos \psi_x(s) & A_{xi} &= \text{const} \\ \frac{1}{2} \beta_x(s) \beta_x''(s) - \frac{1}{4} \beta_x^2(s) + \kappa_x(s) \beta_x^2(s) &= 1 & \psi_x(s) &= \psi_{xi} + \int_{s_i}^s \frac{d\bar{s}}{\beta_x(\bar{s})} \\ \beta_x(s + L_p) &= \beta_x(s) \end{aligned}$$

SM Lund, USPAS, June 2008

Particle Resonances

5

These transforms will help us more simply understand the action of perturbations (from applied field nonlinearities, ....) acting on the particle orbits:

$$\begin{aligned} x''(s) + \kappa_x(s)x(s) &= \mathcal{P}_x(s; \mathbf{x}_\perp, \mathbf{x}'_\perp, \bar{\delta}) \\ y''(s) + \kappa_y(s)y(s) &= \mathcal{P}_y(s; \mathbf{x}_\perp, \mathbf{x}'_\perp, \bar{\delta}) \end{aligned}$$

$\mathcal{P}_x, \mathcal{P}_y$  = Perturbations

$\bar{\delta}$  = Extra Coupling Variables

For simplicity, we restrict analysis to:

- $\gamma_b \beta_b = \text{const}$       No Acceleration
- $\delta = 0$                       No Axial Momentum Spread
- $\phi = 0$                       Neglect Space-Charge

- ▶ Comments on space-charge effects will be made in [S7](#)

We also take the applied focusing lattice to be periodic with:

$$\begin{aligned} \kappa_x(s + L_p) &= \kappa_x(s) & L_p &= \text{Lattice Period} \\ \kappa_y(s + L_p) &= \kappa_y(s) \end{aligned}$$

SM Lund, USPAS, June 2008

Particle Resonances

7

This formulation helped to simply identify the Courant-Snyder invariant:

$$\left( \frac{x}{w_x} \right)^2 + (w_x x' - w_x' x)^2 = A_x^2 = \text{const} \quad w_x = \sqrt{\beta_x}$$

which helped to interpret the dynamics.

We will now exploit this formulation to better ([analytically!](#)) understand resonant instabilities in periodic focusing lattices. This is done by choosing coordinates such that stable unperturbed orbits described by Hill's equation:

$$x''(s) + \kappa_x(s)x(s) = 0$$

are mapped to a continuous oscillator

$$\begin{aligned} \tilde{x}''(\tilde{s}) + \tilde{k}_{\beta 0}^2 \tilde{x}(\tilde{s}) &= 0 \\ \tilde{k}_{\beta 0}^2 &= \text{const} > 0 \end{aligned}$$

$\tilde{\cdot} \dots$  = Transformed Coordinate

SM Lund, USPAS, June 2008

Particle Resonances

6

For a ring we also have the superperiodicity condition:

$$\mathcal{P}_x(s + C; \mathbf{x}_\perp, \mathbf{x}'_\perp, \bar{\delta}) = \mathcal{P}_x(s; \mathbf{x}_\perp, \mathbf{x}'_\perp, \bar{\delta})$$

$$\mathcal{P}_y(s + C; \mathbf{x}_\perp, \mathbf{x}'_\perp, \bar{\delta}) = \mathcal{P}_y(s; \mathbf{x}_\perp, \mathbf{x}'_\perp, \bar{\delta})$$

$C = \mathcal{N}L_p = \text{Circumference Ring}$

$\mathcal{N} \equiv \text{Superperiodicity}$

Perturbations can be [Random](#) and/or [Systematic](#):

[Random Errors](#) in a ring will be felt once per particle lap in the ring rather than every lattice period

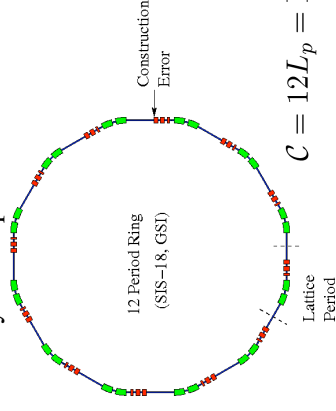

[Random Error Sources](#):

- ▶ Fabrication
- ▶ Assembly/Construction
- ▶ Material Defects
- ▶ ....

$C = 12L_p = \text{Ring Circumference}$

SM Lund, USPAS, June 2008

Particle Resonances

8

Systematic Errors can occur in both linear machines and rings and effect every lattice period in the same manner.

Example: FODO Lattice with the same error in each dipole of pair

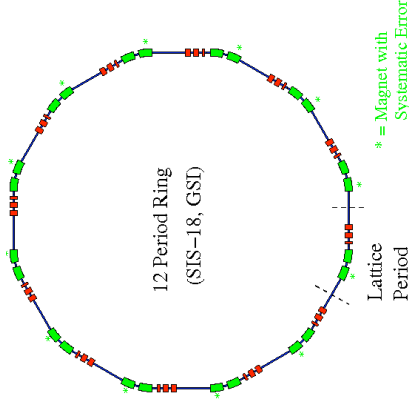

**Systematic Error Sources:**

- ◆ Design Flaw/Limit/Ideal
- ◆ Repeated Construction
- ◆ or Material Error
- ◆ ....

We will find that perturbations arising from both random and systematic error can drive resonance phenomena that destabilize particle orbits and limit machine performance

**S2: Floquet Coordinates and Hill's Equation**

Define for a stable solution to Hill's Equation

- ◆ Drop x subscripts and only analyze x-orbit for now to simplify

“Radial” Coordinate:  $u \equiv \frac{x}{\sqrt{\beta}}$  (dimensionless)

“Angle” Coordinate:  $\varphi \equiv \frac{1}{\nu_0} \int_{s_i}^{s} \frac{d\bar{s}}{\beta(\bar{s})} \equiv \frac{\Delta\psi(s)}{\nu_0}$  (dimensionless, normalized)

where

$\beta = w^2 =$  Betatron Amplitude Function

$\nu_0 \equiv \frac{\Delta\psi(\mathcal{N}L_p)}{2\pi} =$  Number undepressed particle oscillations in ring ( $\mathcal{N} =$  Superperiod Number)

$\psi =$  Phase of x-orbit

$\Delta\psi(s) = \psi(s) - \psi(s_i)$

- ◆ Can also take  $\mathcal{N} = 1$  and then  $\nu_0$  is the number (usually fraction thereof) of undepressed particle oscillations in one lattice period

**Comment:**

$\varphi$  can be interpreted as a normalized angle measured in the particle betatron phase advance:

- Ring:**  $\implies \varphi$  advances by  $2\pi$  on one transit around ring for analysis of Random Errors ( $\mathcal{N} =$  Superperiod #)
- Linac or Ring:**  $\implies \varphi$  advances by  $2\pi$  on transit through one lattice period for analysis of Systematic Errors in a ring or linac ( $\mathcal{N} = 1$ )

Take  $\varphi$  as the independent coordinate:

$u = u(\varphi)$

$\dot{u} \equiv \frac{du}{d\varphi}$

and define a new “momentum” phase-space coordinate

$\cdot \equiv \frac{d}{d\varphi}$

These new variables will be applied to express Hill's equation in simpler form

**From the definition**

$u \equiv \frac{x}{\sqrt{\beta}}$

we have

$x = \sqrt{\beta}u$

$x' = \frac{\beta'}{2\sqrt{\beta}}u + \sqrt{\beta} \frac{du}{d\varphi} \frac{d\varphi}{ds}$

From:

$\frac{d\varphi}{ds} = \frac{1}{\nu_0\beta}$

we obtain

$x' = \frac{\beta'}{2\sqrt{\beta}}u + \frac{1}{\nu_0\sqrt{\beta}}\dot{u}$

$x'' = \frac{d}{ds}x' = \frac{\beta''}{2\sqrt{\beta}}u - \frac{\beta'^2}{4\beta^{3/2}}u - \frac{\beta'}{2\nu_0\beta^{3/2}}\dot{u} + \frac{1}{2\nu_0\beta^{3/2}}\ddot{u}$

0 (cancels)

Summary:

$$x' = \frac{\beta'}{2\sqrt{\beta}}u + \frac{1}{\nu_0\sqrt{\beta}}\dot{u}$$

$$x'' = \frac{\beta''}{2\sqrt{\beta}}u - \frac{\beta'^2}{4\beta^{3/2}}u + \frac{1}{\nu_0^2\beta^{3/2}}\ddot{u}$$

Using these results, Hill's equation:

$$x''(s) + \kappa_x(s)x(s) = 0$$

becomes

$$\ddot{u} + \nu_0^2 \left[ \frac{\beta\beta''}{2} - \frac{\beta'^2}{4} + \kappa\beta^2 \right] u = 0$$

But the betatron amplitude equation satisfies:

$$\frac{\beta\beta''}{2} - \frac{\beta'^2}{4} + \kappa\beta^2 = 1 \quad \beta(s + L_p) = \beta(s)$$

Thus the terms in [...] = 1 and Hill's equation reduces to simple harmonic oscillator form:

$$\ddot{u} + \nu_0^2 u = 0 \quad \nu_0^2 = \text{const} > 0$$

Transform has mapped a stable, time dependent solution to Hill's equation to a simple harmonic oscillator!

SM Lund, USPAS, June 2008

Particle Resonances

13

Unperturbed phase-space ellipse:

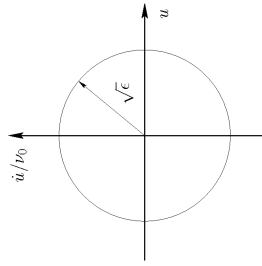

This simple structure will also allow more simple visualization of perturbations:

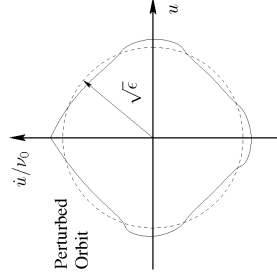

SM Lund, USPAS, June 2008

Particle Resonances

15

The general solution to the simple harmonic oscillator equation can be expressed as:

$$u(\varphi) = u_i \cos(\nu_0\varphi) + \frac{\dot{u}_i}{\nu_0} \sin(\nu_0\varphi)$$

$$\dot{u}(\varphi) = -u_i\nu_0 \sin(\nu_0\varphi) + \dot{u}_i \cos(\nu_0\varphi)$$

$$u(\varphi = 0) = u_i = \text{const}$$

$$\dot{u}(\varphi = 0) = \dot{u}_i = \text{const}$$

$u_i$  and  $\dot{u}_i$  set by initial conditions at  $s = s_i$  (phase choice  $\varphi = 0$  at  $s = s_i$ )

The Floquet representation also simplifies the interpretation of the Courant-Snyder invariant:

$$u^2 + \left( \frac{\dot{u}}{\nu_0} \right)^2 = u_i^2 + \left( \frac{\dot{u}_i}{\nu_0} \right)^2 \equiv \epsilon = \text{const}$$

→ Unperturbed phase-space in  $u - \dot{u}/\nu_0$  is a unit circle!

SM Lund, USPAS, June 2008

Particle Resonances

14

The  $u - \dot{u}/\nu_0$  variables also preserve phase-space area

→ Feature of the transform being symplectic (Hamiltonian Dynamics)

From previous results:

$$x = \sqrt{\beta}u$$

$$x' = \frac{\beta'}{2\sqrt{\beta}}u + \sqrt{\beta} \frac{d\varphi}{ds} \dot{u} = \frac{\beta'}{2\sqrt{\beta}}u + \frac{1}{\nu_0\sqrt{\beta}}\dot{u}$$

$$\frac{d\varphi}{ds} = \frac{1}{\nu_0\beta}$$

Transform area elements by calculating the Jacobian:

$$dx \otimes dx' = |J| du \otimes \dot{u}$$

$$J = \det \begin{vmatrix} \frac{\partial x}{\partial u} & \frac{\partial x}{\partial \dot{u}} \\ \frac{\partial x'}{\partial u} & \frac{\partial x'}{\partial \dot{u}} \end{vmatrix} = \det \begin{vmatrix} \sqrt{\beta} & 0 \\ \frac{\beta'}{2\sqrt{\beta}} & \frac{1}{\nu_0\sqrt{\beta}} \end{vmatrix} = \frac{1}{\nu_0}$$

$$dx \otimes dx' = du \otimes \frac{d\dot{u}}{\nu_0}$$

Thus the Courant-Snyder invariant  $\epsilon$  is the usual single particle emittance

SM Lund, USPAS, June 2008

Particle Resonances

16

### S3: Perturbed Hill's Equation in Floquet Coordinates

Return to the perturbed Hill's equation in S1:

$$\ddot{x}''(s) + \kappa_x(s)x(s) = \mathcal{P}_x(s; \mathbf{x}_\perp, \mathbf{x}'_\perp, \vec{\delta})$$

$$\ddot{y}''(s) + \kappa_y(s)y(s) = \mathcal{P}_y(s; \mathbf{x}_\perp, \mathbf{x}'_\perp, \vec{\delta})$$

$\mathcal{P}_x, \mathcal{P}_y$  = Perturbations

$\vec{\delta}$  = Extra Coupling Variables

Drop the extra coupling variables and apply the Floquet transform in S2:

→ Examine only  $x$ -equation,  $y$ -equation analogous

$$\ddot{u} + \nu_0^2 u = \nu_0^2 \beta^3 / 2 \mathcal{P}_x$$

Here,

$$\mathcal{P}_x = \mathcal{P}(s(\varphi), \sqrt{\beta}u, y, \vec{\delta})$$

↑ Transform  $y$  similarly to  $x$

See Handwritten Notes From pg 12 Onward

### S4: Sources and Forms of Perturbation Terms

### S6: Solution of the Perturbed Hill's Equation: Resonances

## S7: Machine Operating Points: Tune Restrictions Resulting from Resonances

SM Lund, USPAS, June 2008

Particle Resonances

21

## S8: Space-Charge and Other Effects Altering Resonances

Ring operating points are generally chosen to be far from low-order resonance lines in  $x$ - $y$  tune space. Processes that act to shift resonances closer towards the low-order lines can prove problematic:

- ▶ Oscillation amplitudes increase (spoiling beam quality and control)
- ▶ Particles can be lost

Tune shift limits of machine operation are often named “Laslett Limits” in honor of Jackson Laslett who first calculated tune shift limits for many processes:

- ▶ Image charges
- ▶ Image currents
- ▶ KV model self-fields internal to the beam
- ▶ ...

SM Lund, USPAS, June 2008

Particle Resonances

22

Processes shifting resonances can be grouped into two broad categories:

- |                   |   |
|-------------------|---|
| <b>Coherent</b>   | <b>Same for every particle</b> in distribution <ul style="list-style-type: none"><li>▶ Usually most dangerous</li></ul>                       |
| <b>Incoherent</b> | <b>Different for particles</b> in separate parts of the distribution <ul style="list-style-type: none"><li>▶ Usually less dangerous</li></ul> |

SM Lund, USPAS, June 2008

Particle Resonances

23

These slides will be corrected and expanded for reference and any future editions of the US Particle Accelerator School class:

*Beam Physics with Intense Space Charge*, by J.J. Barnard and S.M. Lund

Corrections and suggestions are welcome. Contact:

Steven M. Lund  
Lawrence Berkeley National Laboratory  
BLDG 47 R 0112  
1 Cyclotron Road  
Berkeley, CA 94720-8201

[SMLund@lbl.gov](mailto:SMLund@lbl.gov)  
(510) 486 – 6936

Please do not remove author credits in any redistributions of class material.

SM Lund, USPAS, June 2008

Particle Resonances

24



## References: For more information see:

- E.D. Courant and H.S. Snyder, *Theory of the Alternating Gradient Synchrotron*, Annals of Physics **3**, 1 (1993).
- A. Dragt, "Lectures on Nonlinear Orbit Dynamics," in *Physics of High Energy Accelerators*, edited by R.A. Carrigan, F.R. Hudson, and M. Month (AIP Conf. Proc. No. 87, 1982) p. 147.
- D.A. Edwards and M.J. Syphers, *An Introduction to the Physics of High Energy Accelerators*, Wiley (1993).
- M. Reiser, *Theory and Design of Charged Particle Beams*, Wiley (1994, 2008)
- F. Sacherer, *Transverse Space-Charge Effects in Circular Accelerators*, Univ. of California Berkeley, Ph.D Thesis (1968)
- H. Wiedemann, *Particle Accelerator Physics, Basic Principles and Linear Beam Dynamics*, Springer-Verlag (1993).
- H. Wiedemann, *Particle Accelerator Physics II, Nonlinear and Higher-Order Beam Dynamics*, Springer-Verlag (1995).

SM Lund, USPAS, June 2008

Particle Resonances

25

## Acknowledgments:

Considerable help was provided by Giuliano Franchetti (GSI) in educating one of the authors (S.M. Lund) in methods described in this lecture.

SM Lund, USPAS, June 2008

Particle Resonances

26

We now analyze the effects of perturbations on the dynamics

$$\ddot{U} + \gamma_0^2 U = \gamma_0^2 \beta^{3/2} P(x, y, s) \quad *$$

Expand the perturbation in a power series

• Can always be done for all physical applied field perturbations.

$$P(x, y, s) = P_0(y, s) + P_1(y, s)x + P_2(y, s)x^2 + \dots$$

$$= \sum_{n=0}^{\infty} P_n(y, s) x^n$$

and take

$$x = \sqrt{\beta} U$$

to obtain

$$\ddot{U} + \gamma_0^2 U = \gamma_0^2 \sum_{n=0}^{\infty} \beta^{\frac{n+3}{2}} P_n(y, s) U^n$$

\* P represents a perturbation due to:  
- Systematic or random field errors in magnets etc.  
- Alignment error induced field terms etc.

To more simply illustrate resonances we will take the particle to move in the x-plane only ( $y=0$  for all  $s$ ). If this is not the case the formalism can be generalized by expanding the  $P_n(y, s)$  in a power series in  $y$  and generalizing the notation for the Floquet coordinates to distinguish between the x- and y-planes, etc. The essential character of the more general analysis is illustrated by this simple case.

$$y(s) \equiv_{T_0} 0 \quad \text{to simplify picture}$$

In this special case ( $y=0$ ) we expand each coefficient in the power series in a Fourier series as:

Here I implicitly assume a ring and keep  $\varphi$  as a  $2\pi$  "phase" path variable in the ring for both systematic and random errors.

$$P_n(y=0, s) \beta^{\frac{n+3}{2}} = \sum_{k=-\infty}^{\infty} C_{n,k} e^{i k \varphi}$$

$$P = \begin{cases} 1 & \text{- A random perturbation (once in ring)} \\ P & \text{- A periodic perturbation (every period)} \end{cases}$$

$$C_{n,k} = \int_{-\pi/P}^{\pi/P} \frac{d\varphi}{2\pi P} P_n(y=0, s) \beta^{\frac{n+3}{2}}$$

$$s = s(\varphi) ; \varphi = \int_{s_0}^s \frac{ds}{\omega_0 \beta(s)}$$

Then the perturbed equation of motion becomes:

$$\ddot{U} + \omega_0^2 U = \omega_0^2 \sum_{n=0}^{\infty} \sum_{k=-\infty}^{\infty} C_{n,k} e^{i k \varphi} U^n$$

For the case of small amplitude perturbations this equation can be analyzed perturbatively to linear order, as:

$$U = U_0 + \delta U ; |U_0| \gg |\delta U|$$

where!

Simple Harmonic Oscillator  $\rightarrow$

$$\ddot{U}_0 + \omega_0^2 U_0 = 0$$

put unperturbed solution in perturbation  
 $\downarrow$

Simple Harmonic Oscillator  $\rightarrow$

$$\ddot{\delta U} + \omega_0^2 \delta U \approx \omega_0^2 \sum_{n=0}^{\infty} \sum_{k=-\infty}^{\infty} C_{n,k} e^{i k \varphi} U_0^n$$

with driving terms.

$U_0$  represents the unperturbed particle orbit.  
The general solution to the equation for  $U_0$  can be expressed as:

$$U_0 = U_{0i} \cos(\gamma_0 \varphi + \psi_i)$$

$U_{0i}, \psi_i$  initial conditions (constants)

Then,

$$U_0^n = U_{0i}^n \left( \frac{e^{i(\gamma_0 \varphi + \psi_i)} + e^{-i(\gamma_0 \varphi + \psi_i)}}{2} \right)^n$$

$$= \frac{U_{0i}^n}{2^n} \sum_{m=0}^n \binom{n}{m} e^{i(n-m)(\gamma_0 \varphi + \psi_i)} e^{-im(\gamma_0 \varphi + \psi_i)}$$

Here,  $\binom{n}{m} \equiv \frac{n!}{m!(n-m)!}$  is a binomial coefficient.

$$= \frac{U_{0i}^n}{2^n} \sum_{m=0}^n \binom{n}{m} e^{i(n-2m)\gamma_0 \varphi} e^{i(n-2m)\psi_i}$$

and the perturbed equation becomes:

$$\delta \ddot{U} + \gamma_0^2 \delta U \approx \gamma_0^2 \sum_{n=0}^{\infty} \sum_{k=-\infty}^{\infty} \sum_{m=0}^n \binom{n}{m} C_{n,k} e^{i[(n-2m)\gamma_0 \varphi + k\psi_i]} \times e^{i(n-2m)\psi_i}$$

In general, can take  $\delta U = \delta U_h + \delta U_p$  where  $\delta \ddot{U}_h + \gamma_0^2 \delta U_h = 0$  but in this case we can take  $\delta U_h = 0$  since this part of the perturbative solution is contained in  $U_0$ . Thus only the particular solution need be found. From the properties of a driven harmonic oscillator, we know that no stable solution exists

whenever the the frequency of the driving force equals that of the restoring force (resonant exchange). Thus we have the resonance condition: ← see Homework!

$$(n - 2m) \omega_0 + pk = \pm \omega_0$$

$$n = 1, 2, 3, \dots; \quad m = 0, 1, 2, \dots, n$$

$$k = -\infty, \dots, 0, \dots, \infty$$

$$p = \begin{cases} 1 & \text{A random perturbation (once per ring)} \\ \mathcal{N} & \text{A periodic perturbation (every lattice period)} \end{cases}$$

For  $\omega_0$  satisfying this condition the perturbation will grow in amplitude. If the growth rate is sufficiently large, such tunes will be unreliable operating points of the machine and the corresponding perturbation must be corrected. Since this is a linear analysis, the perturbations may be analyzed in turn:

Examples:

$n=0$  (Dipole Perturbation)

$n=0 \Rightarrow m=0$  and the resonance condition becomes:

$$\omega_0 = \pm pk \quad p \cdot k = \text{integer}$$

Therefore:

$$p = \begin{cases} 1 & \text{random pert} \\ & \text{in ring} \\ \mathcal{N} & \text{periodic} \\ & \text{perturbation in} \\ & \text{lattice.} \end{cases}$$

$$\omega_0 \neq \text{integer} = |p \cdot k| \quad \text{for dipole (n=0)} \\ = p_1, p+1, \dots \quad \text{perturbations}$$

$p=1$  Note: Random error in ring (once per lap)

$$\omega_0 \neq 1, 2, 3, \dots$$

$$\omega_0 \neq \mathcal{N}, 2\mathcal{N}, \dots$$

$p=\mathcal{N}$ : Systematic error (every lattice period)

$$\omega_0 \neq \mathcal{N}, 2\mathcal{N}, 3\mathcal{N}, \dots$$

$$\omega_0 \neq \mathcal{N}, 2\mathcal{N}, \dots$$

Systematic errors less restrictive.

$n=1$  Quadrupole Perturbation

The resonance conditions give:  $\Rightarrow n=1, m=0, 1$

$$\omega_0 + pk = \pm \omega_0 \quad (n=1, m=0)$$

$$-\omega_0 + pk = \pm \omega_0 \quad (n=1, m=1)$$

$pk + \omega_0 = \omega_0$  represents a special case that can be eliminated by "renormalizing" the driving force of the oscillator and  $pk = 2\omega_0$  implies that:

$p = \begin{cases} 1: & \text{random} \\ & \text{pert. in ring} \\ \omega_0: & \text{periodic} \\ & \text{pert. in} \\ & \text{lattice} \end{cases}$

$\omega_0 \neq \text{half-integer} = |pk/2|$  for quadrupole ( $n=1$ ) perturbations.

 $n=2$  Sextupole Perturbations  $\Rightarrow n=3, m=0, 1, 2$ 

The resonance conditions give:

$$2\omega_0 + pk = \pm \omega_0$$

$$pk = \pm \omega_0$$

$$-2\omega_0 + pk = \pm \omega_0$$

These conditions are equivalent to:

$p = \begin{cases} 1: & \text{random} \\ & \text{pert. in} \\ & \text{ring} \\ \omega_0: & \text{periodic} \\ & \text{pert. in} \\ & \text{lattice} \end{cases}$

$\omega_0 \neq \begin{cases} \text{integer } (pk) & \text{for sextupole} \\ \text{half-integer } (pk/2) & (n=3) \text{ perturbations} \\ \text{3rd-integer } (pk/3) \end{cases}$

The integer and half-integer restrictions were already obtained with respect to the dipole and quadrupole cases. The 3rd integer is a new restriction.

Other cases similar

Aside Interpretation of low-order resonance conditions:

Dipole Errors

Consider a ring with 1 dipole error along the azimuth of a ring:

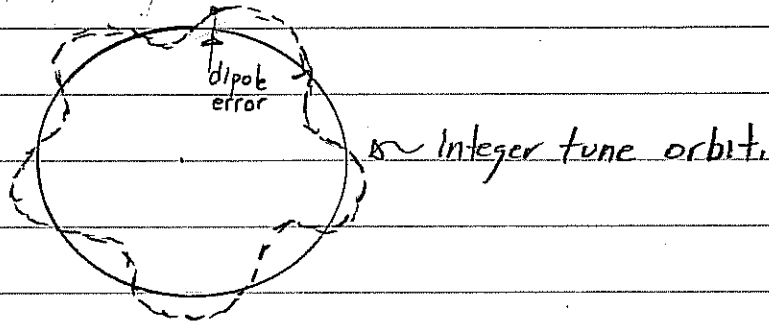

If the particle is oscillating with integer tune, then the particle will experience the error each time with the same phase <sup>of oscillation</sup> and the particle trajectory will "walk-off" lap to lap in phase space. Since the machine aperture is finite the particle will be lost.

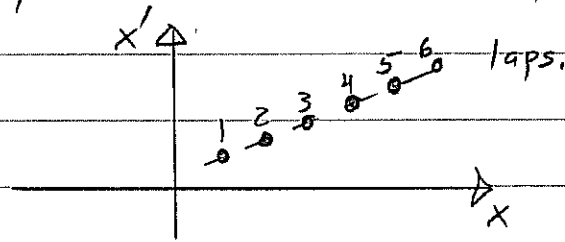

Quadrupole Errors

For a single quadrupole error along the azimuth of a ring, a similar qualitative argument leads one to conclude that if the particle oscillates with  $1/2$  integer tune that the orbit can "walk-off" lap-to-lap in phase space patterns as shown here:

phase space patterns as shown here:

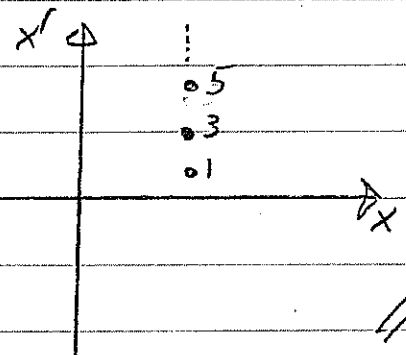

The general resonance condition for x-plane motion can be summarized as:

$$M \nu_0 = N$$

$M, N$  integers of the same sign.

$M =$  order resonance

Generally higher order numbers are less dangerous.

• Longer coherence path for validity of theory and coefficients generally smaller; higher order can "wash" out.

In the general case particle motion is not restricted to the x-plane ( $y \neq 0$ ) and a more general resonance analysis shows that:

$$M_x \nu_{0x} + M_y \nu_{0y} = N$$

$\nu_{0x} =$  x-plane tune

$\nu_{0y} =$  y-plane tune

$M_x, M_y, N$  integers of the same sign.

∴  $|M_x| + |M_y| =$  order resonance.

These restrictions are plotted order-by-order in  $\nu_x - \nu_y$  plots to find allowed tunes where the machine can safely operate. Generally, lower order resonances are more dangerous, since small effects can invalidate the ideal analysis and "wash out" higher order resonances.



Typical tune plots for up to 3rd order resonances!  
 $N=1$  Superperiodicity

Machine operating point is chosen to avoid resonance lines.

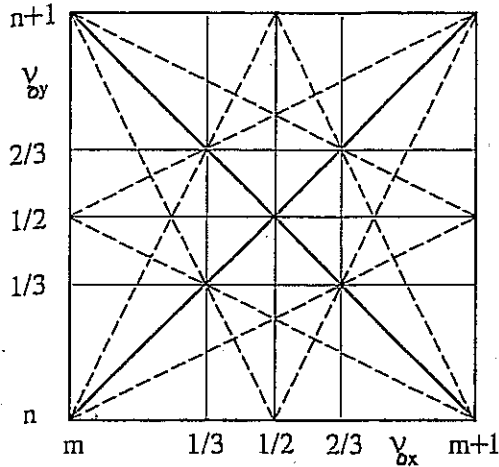

Applicable to field errors from random construction errors.

From Wiedemann

$N=4$  Superperiodicity

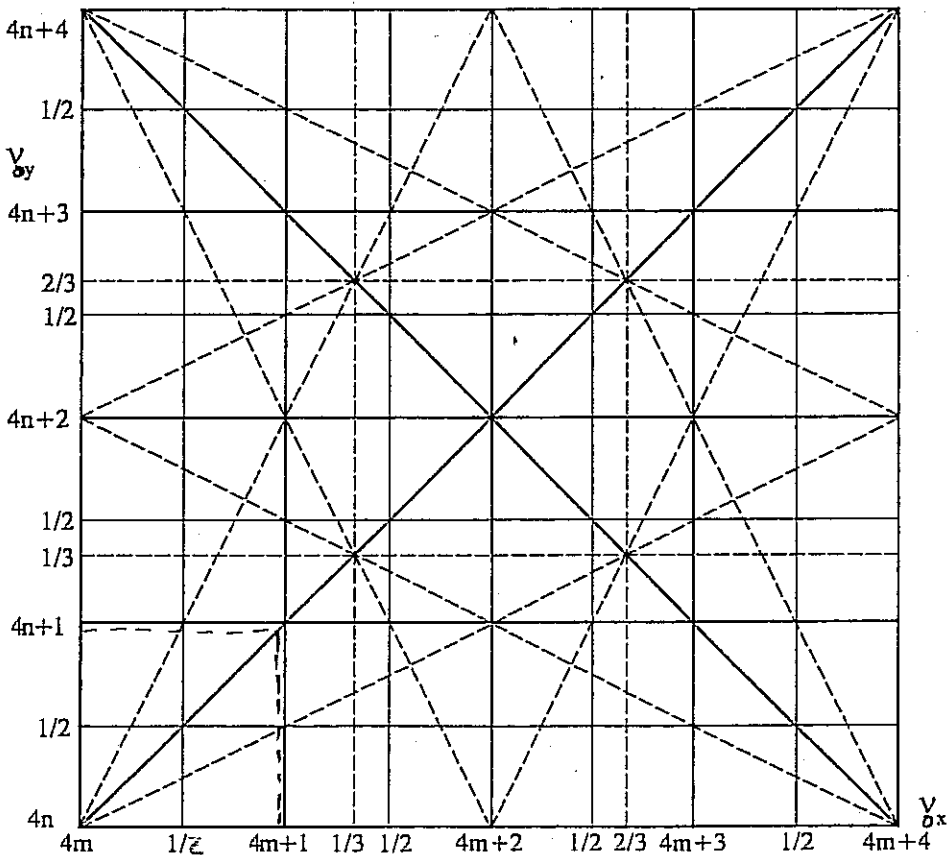

Applicable to systematic lattice field errors in a 4-period ring.

Note lesser density of resonance lines than in the  $N=1$  case.

Distinguishing between field errors from random construction ( $p=1$ ) and systematic errors on the lattice ( $p=N$ ) is important.

### Random errors ( $p=1$ )

- Errors always present and can give low order resonances.
- Usually have weak amplitude coefficients and may be corrected.

### Systematic errors ( $p=N$ )

- Lead to higher order resonances for large  $N$  and a lower density of resonance lines
  - Large symmetric rings ( $N$  large) have lesser restrictions from systematic errors
  - Practical issues such as construction cost and getting the beam into and out of the ring lead to smaller  $N$
- Amplitude coefficients can be large and the systematic resonances can be strong and thus can be dangerous.

In practice, resonances higher than 3rd order need rarely be considered.

- Effects outside model tend to wash out higher order resonances.

The influence of periodic errors is an active area of research. See Lund and Lindberg.

## Effects of Space Charge on Resonances

Machine operating points are generally chosen far from low-order resonance lines. Coherent processes that shift tune values towards a low-order resonance are dangerous.

Coherent - same for each particle in the ~~beam~~ distribution.

incoherent - different (random) for each particle in distribution.

Tune shift limits are often called "Laslett Limits" because he <sup>first</sup> calculated such limits for many processes

- image charges
- image currents
- space charge

⋮

For space-charge, the so-called Laslett limit is taken as:

$$\nu_0 - \nu = \Delta\nu < 1/4$$

$\nu_0$  = tune at zero space charge

$\nu$  = kv distribution tune

This is probably over idealized and restrictive but is widely used to set ring current limits.

The Laslett condition is probably overly restrictive:

- Real space-charge is not coherent like a KV model
  - spectrum of  $\beta$ -tunes,
  - no equilibrium beam and oscillations may crack resonances.
- Simulations indicate that 10's  $\rightarrow$  100's of laps may pose little problems for strong space charge.
  - Univ. Maryland Ring may soon ( $\sim 2007+$ ) operate in such regime to test in the lab.

This could be a good research area with new physics.

John Barnard  
Steven Lund  
USPAS  
June 2008

## Injectors and longitudinal physics -- I

1. Child-Langmuir Law  
(Reiser 2.5.2, Appendix 1)
2. Pierce electrodes
3. Transients in injectors
4. Injector choices

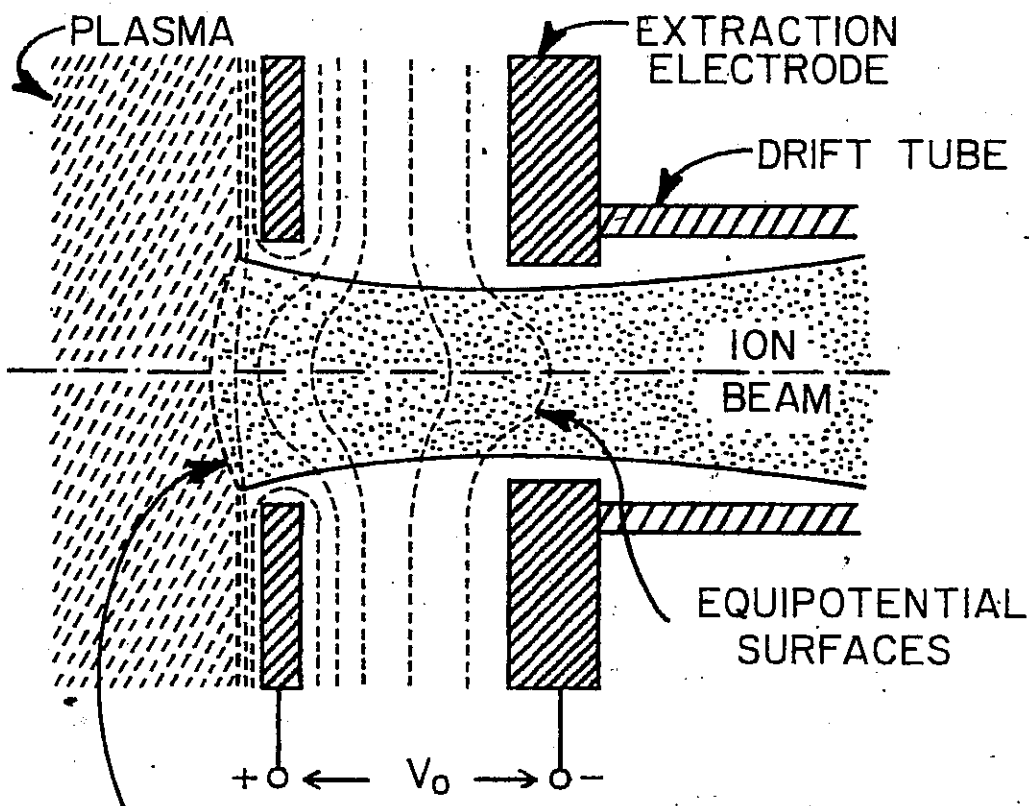

EMITTING SURFACE  
 (PLASMA "SHEATH" OR "MENISCUS")  
 OR "HOT PLATE"  
 REISER, FIGURE 1.2  
 - DOPED TUNGSTEN  
 - ALUMINO-SILICATE

# I CHILD-LANGMUIR EMISSION

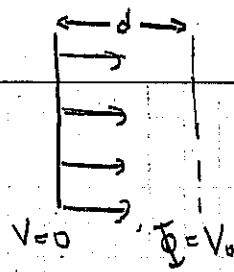

ASSUME EMISSION IS PLANAR 1-D:

$$J = \rho v_z \quad (1)$$

$$\frac{1}{2} m v_z^2 = -q \Phi$$

$$(2) \Rightarrow v_z = \left( \frac{-2q\Phi}{m} \right)^{1/2}$$

$$\frac{J^2 \Phi}{J^2 z^2} = \frac{\rho}{\epsilon_0}$$

$$(3) \text{ (NOTE } \Phi = -\phi \text{ ACTUAL E.I. potential)}$$

CONTINUITY EQUATION  $\frac{\partial \rho}{\partial t} + \frac{\partial}{\partial z} \rho v_z = 0$   
(1-D)

for time steady emission  $\rho v_z = \text{constant} = J$

$$\Rightarrow \frac{J^2 \Phi}{J^2 z^2} = \frac{J}{\epsilon_0 v_z} = \frac{J}{\epsilon_0 \left( \frac{-2q\Phi}{m} \right)^{1/2}}$$

MULTIPLYING BY  $\frac{d\Phi}{dz}$  AND INTEGRATING:

$$\frac{\Phi^{3/2}}{z} = \frac{J m^{1/2}}{\epsilon_0 (2q)^{1/2}} z^{1/2} + \text{const}$$

Assume  $\Phi' = 0$  at  $z=0$  (Space-charge limited emission)

$$\Phi = 0 \text{ at } z=0 \Rightarrow \text{const} = 0$$

$$\frac{d\Phi}{dz} = \left( \frac{4J}{\epsilon_0} \right)^{1/2} \left( \frac{m\Phi}{2q} \right)^{1/4}$$

$$\Rightarrow \frac{4}{3} J^{3/4} \Phi^{3/4} = \left( \frac{4J}{\epsilon_0} \right)^{1/2} \left( \frac{m}{2q} \right)^{1/4} z \Rightarrow \Phi(z) = \left( \frac{3}{4} \right)^{4/3} \left( \frac{4J}{\epsilon_0} \right)^{2/3} \left( \frac{m}{2q} \right)^{1/3} z^{4/3}$$

If  $\Phi = V_0$  at  $z = d \Rightarrow \Phi = V_0 \left(\frac{z}{d}\right)^{4/3}$

$\Rightarrow V_0 = \left(\frac{3}{4}\right)^{3/4} \left(\frac{4J}{\epsilon_0}\right)^{3/4} \left(\frac{m}{2q}\right)^{1/3} d^{4/3}$

$q J = \frac{4}{9} \epsilon_0 \left(\frac{2q}{m}\right)^{1/2} \frac{V_0^{3/2}}{d^2}$

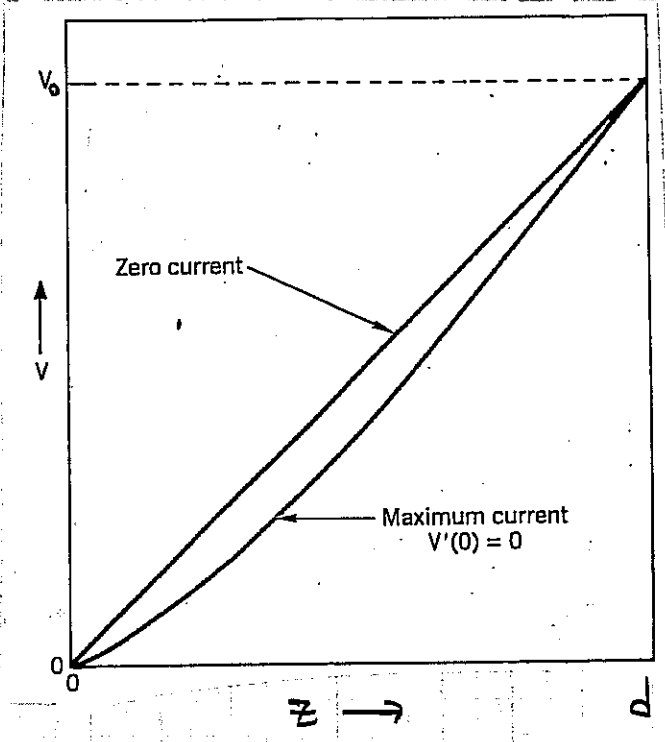

NOTE THAT IF WE MULTIPLY  $J$  BY THE BEAM AREA  $\pi r_b^2$ , AND DIVIDE BY  $v = \left(\frac{2qV_0}{m}\right)^{1/2}$

$\Rightarrow \lambda = \frac{4\pi\epsilon_0 V}{9} \left(\frac{r_b^2}{d^2}\right)$

RECALL  $Q \equiv \frac{\lambda}{4\pi\epsilon_0 V}$  (NON-RELAT.)

$\Rightarrow Q = \frac{1}{9} \left(\frac{r_b^2}{d^2}\right)$  or as a function of  $z$ :  $Q(z) = \frac{1}{9} \left(\frac{r_b^2}{z^2}\right)$

REFERENCE

50% RECYCLED PAPER, 50% RECYCLED FIBER, 50% RECYCLED GLASS, 50% RECYCLED PLASTIC, 50% RECYCLED METAL, 50% RECYCLED WHITE, 50% RECYCLED COLOR. MADE IN U.S.A.



# PIERCE COLUMN

V.  $\sim 24/5$

E  $\sim 2/3$

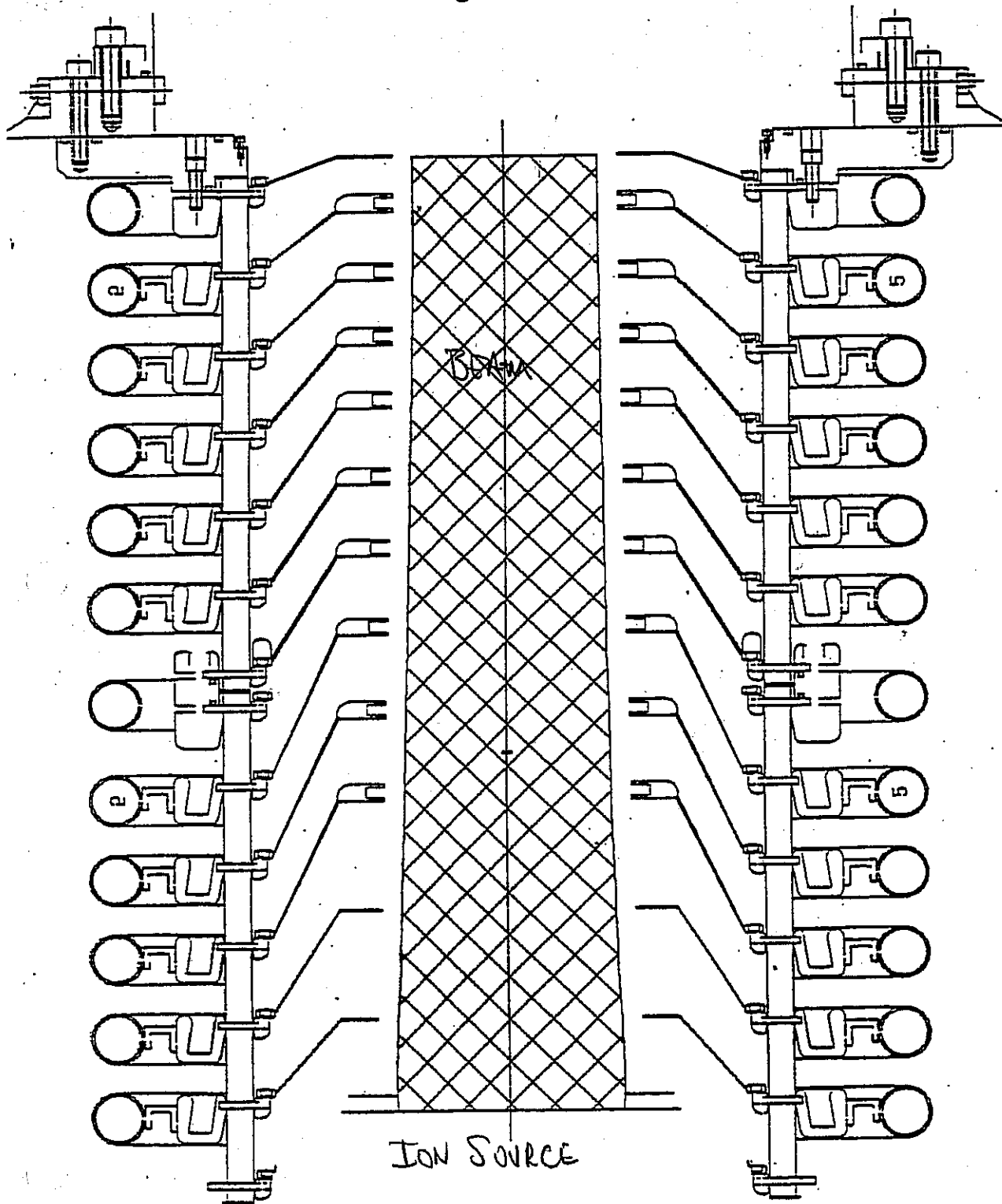

~~DELIVERED~~ WE HAVE THE PARAXIAL RAY EQUATION FOR PARTICLES IN AXISYMMETRIC SYSTEMS:

$$r'' + \underbrace{\frac{\gamma'}{\beta^2 \gamma}}_{\text{INERTIAL}} r' + \underbrace{\frac{\gamma''}{2\beta^2 \gamma}}_{E_r} r + \underbrace{\left(\frac{\omega_c}{2\gamma\beta c}\right)^2}_{V_0 B_z - \text{CENTRIFUGAL}} r - \underbrace{\left(\frac{p_0}{\gamma\beta m c}\right)^2 \frac{1}{v^3}}_{\text{CENTRIFUGAL}} - \underbrace{\frac{q}{\gamma^3 m v^2} \frac{\lambda(r)}{2\beta^2 \gamma}}_{\text{SELF-FIELD}} = 1$$

$$\theta' = \frac{p_0}{\gamma m v^2 \beta c} - \frac{\omega_c}{2\gamma\beta c} \quad \leftarrow \text{CONSTANCY \& DEFINITION OF CANONICAL MOMENTUM}$$

ENVELOPE EQUATION FOR AXISYMMETRIC BETA

$$r_b'' + \frac{\gamma' r_b'}{\beta^2 \gamma} + \frac{\gamma''}{2\beta^2 \gamma} r_b + \left(\frac{\omega_c}{2\gamma\beta c}\right)^2 r_b - \frac{4\langle v_0 \rangle^2}{(\gamma\beta c)^2 \beta^3} - \frac{E_r^2}{v_b^3} - \frac{Q}{r_b} = 0$$

$$E_r^2 \equiv 4(\langle r^2 \rangle \langle v^2 \rangle - \langle r v \rangle^2 + \langle v^2 \rangle \langle \theta'^2 \rangle - \langle r' \theta' \rangle^2)$$

(7)

## RETURNING TO PARAXIAL ENVELOPE EQUATION:

$$\text{For } \beta \ll 1 \quad v_b'' + \frac{\beta'}{\beta} v_b' + \left[ \frac{1}{2} \frac{\beta''}{\beta^2} + \frac{1}{2} \frac{\beta''}{\beta} \right] v_b - \frac{Q}{v_b} = 0$$

$$\text{For } v_b'' = \frac{\beta'}{\beta} v_b' = 0$$

$$\text{If } \Phi = v_b \left( \frac{z}{d} \right)^{1/3}$$

$$v = C z^{2/3}$$

$$v' = \frac{2}{3} C z^{-1/3}$$

$$v'' = -\frac{2}{9} C z^{-4/3}$$

$$\Rightarrow \left[ \frac{1}{2} \frac{\beta''}{\beta^2} + \frac{1}{2} \frac{\beta''}{\beta} \right] v_b^2 = Q$$

$$\left[ \frac{2}{9} \frac{1}{z^2} \quad -\frac{1}{9} \frac{1}{z^2} \right]$$

$$\Rightarrow Q(z=1) = \frac{1}{9} \frac{v_b^2}{z^2}$$

So Child-Langmuir flow satisfies the

PARAXIAL ENVELOPE EQUATION FOR

A CONSTANT BEAM RADIUS (AS IT SHOULD!)

# PIERCE'S ELECTRODES: GOING BEYOND PARAXIAL APPROXIMATION

CONSIDER THE CASE A BEAM WHICH FILLS THE LOWER HALF-SPACE.

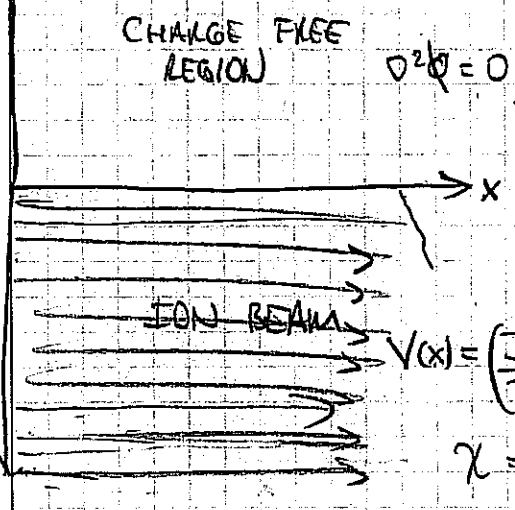

$$\frac{\partial^2 \phi}{\partial x^2} + \frac{\partial^2 \phi}{\partial y^2} = 0$$

FIND SOLUTION SUCH THAT

$\frac{\partial \phi}{\partial y}(x, y=0) = 0$

$\phi(x, y=0) = V(x)$

PIERCE'S SOLUTION: LET THE POTENTIAL BE THE REAL PART OF

$$\phi + iW = V(x+iy) \equiv V(z) \quad z = x+iy$$

NOTE THAT FOR ANY  $V(z)$  WITH DERIVATIVES THAT EXIST INDEPENDENT OF DIRECTION (ANALYTIC) THE REAL PART OF  $V(z)$  SATISFIES LAPLACE'S EQUATION:

$$\frac{\partial^2 \text{Re}[V]}{\partial x^2} + \frac{\partial^2 \text{Re}[V]}{\partial y^2} = 0$$

$$\frac{\partial \phi}{\partial x} = \text{Re} \left[ \frac{\partial V}{\partial z} \right] \quad \frac{\partial \phi}{\partial y} = \text{Re} \left[ i \frac{\partial V}{\partial z} \right]$$

$$\frac{\partial^2 \phi}{\partial x^2} = \text{Re} \left[ \frac{\partial^2 V}{\partial z^2} \right] \quad \frac{\partial^2 \phi}{\partial y^2} = -\text{Re} \left[ \frac{\partial^2 V}{\partial z^2} \right] \Rightarrow \frac{\partial^2 \phi}{\partial x^2} + \frac{\partial^2 \phi}{\partial y^2} = \text{Re} \left[ \frac{\partial^2 V}{\partial z^2} \right] - \text{Re} \left[ \frac{\partial^2 V}{\partial z^2} \right] = 0$$

CHOOSE  $V(z) = \left(\frac{J}{\lambda}\right)^{2/3} (x+iy)^{4/3}$

By construction  $\phi(x, y=0) = V(x)$  ✓

$$\begin{aligned}\phi &= \operatorname{Re} \left[ \left(\frac{J}{\lambda}\right)^{2/3} (x+iy)^{4/3} \right] \\ &= \left(\frac{J}{\lambda}\right)^{2/3} (x^2+y^2)^{2/3} \operatorname{Re} \left[ \exp \left[ i \frac{4}{3} \tan^{-1} \left( \frac{y}{x} \right) \right] \right]\end{aligned}$$

Let  $x+iy = r \exp[i\theta]$   
 $(x+iy)^{4/3} = r^{4/3} \exp \left[ i \frac{4\theta}{3} \right]$

$$\phi(x,y) = \left(\frac{J}{\lambda}\right)^{2/3} (x^2+y^2)^{2/3} \cos \left[ \frac{4}{3} \tan^{-1} \left( \frac{y}{x} \right) \right]$$

Note that  $\phi(x,y) = \phi(x,-y) \Rightarrow \frac{\partial \phi}{\partial y}(x,y=0) = 0$

$\phi = 0$  EQUIPOTENTIAL:

$$\Rightarrow 0 = \cos \left[ \frac{4}{3} \tan^{-1} \left( \frac{y}{x} \right) \right]$$

$$\Rightarrow \tan^{-1} \left( \frac{y}{x} \right) = \frac{3}{4} \left( \frac{\pi}{2} \right) = 67.5^\circ$$

FOR A GENERAL EQUIPOTENTIAL PASSING THROUGH  $x_0$ :

$$x_0^{4/3} = (x^2+y^2)^{2/3} \cos \left[ \frac{4}{3} \tan^{-1} \left( \frac{y}{x} \right) \right]$$





TRANSIENTS IN INJECTORS (LAMPET & TIEFENBACK, APPL. PHYS. LETT, 43, 57, 1983)

DURING TURN-ON THERE IS NO SPACE CHARGE IN FRONT OF BEAM, SO FIELDS MAY NOT BE GIVEN BY CHILD-LANGMUIR LAW.  $\Rightarrow$  CURRENT SPIKES POSSIBLE  $\Rightarrow$  ADVERSE TRANSVERSE COUPLING.

SOLUTION: ADJUST VOLTAGE ON DIODE SUCH THAT C-L FIELD OCCURS EVERYWHERE THERE IS BEAM.

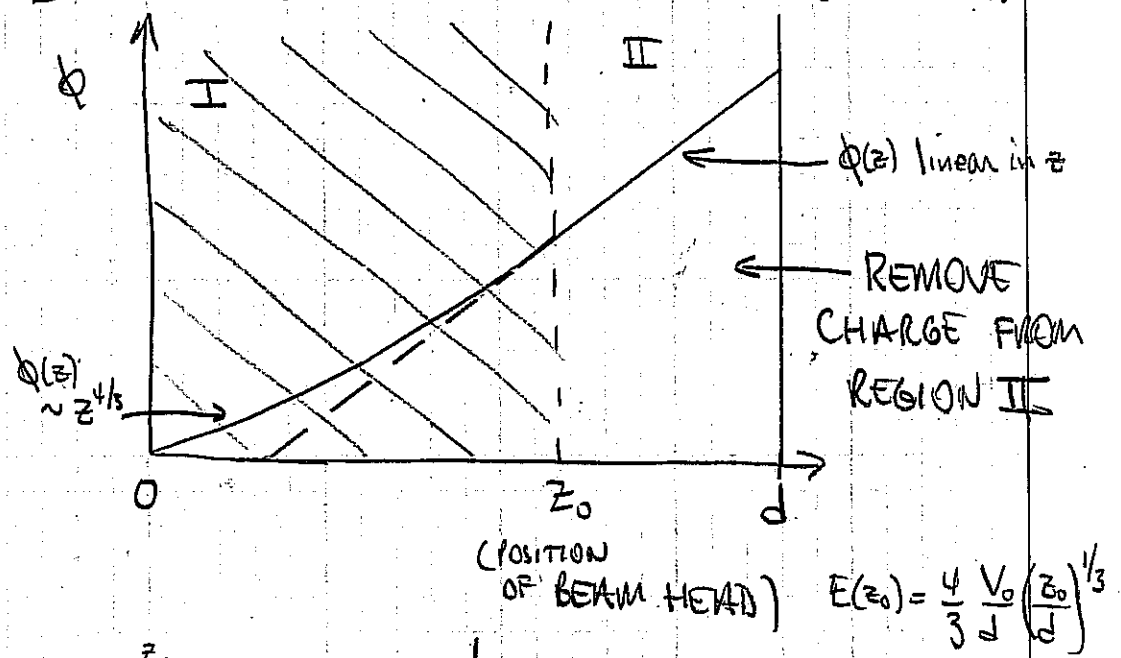

$$\begin{aligned} \Phi(d) &= \int_0^{z_0} E(z) dz + \int_{z_0}^d E(z) dz \\ &= V_0 \left(\frac{z_0}{d}\right)^{4/3} + \frac{4}{3} \frac{V_0}{d} \left(\frac{z_0}{d}\right)^{1/3} (d - z_0) \\ &= V_0 \left[ \frac{4}{3} \left(\frac{z_0}{d}\right)^{1/3} - \frac{1}{3} \left(\frac{z_0}{d}\right)^{4/3} \right] \end{aligned}$$

(NOTE  $V_0$  IS THE DESIRED STEADY STATE VOLTAGE ACROSS DIODE)



So if we know  $z_0(t)$  we can determine  $\Phi(t)$ .

$$\frac{1}{2} m \dot{z}_0^2 = qV_0 \left(\frac{z_0}{d}\right)^{4/3}$$

(SINCE BY CONSTRUCTION,  
HEAD OF BEAM TRAVELS  
AT CHILD-LANGMUIR VELOCITY  
LIKE ALL PARTICLES),

$$\dot{z}_0 = \left(\frac{2qV_0}{m}\right)^{1/2} \left(\frac{z_0}{d}\right)^{2/3}$$

$$\frac{dz_0}{z_0^{2/3}} = \left(\frac{2qV_0}{m}\right)^{1/2} \frac{dt}{d^{2/3}}$$

$$\Rightarrow 3z_0^{1/3} = \left(\frac{2qV_0}{m}\right)^{1/2} \frac{t}{d^{2/3}} \Rightarrow t = \frac{3(z_0 d^2)^{1/3}}{\left(\frac{2qV_0}{m}\right)^{1/2}}$$

Let  $\uparrow = \frac{3d}{\left(\frac{2qV_0}{m}\right)^{1/2}} =$  transit time across diode

$$\Rightarrow \frac{t}{\uparrow} = \left(\frac{z_0}{d}\right)^{1/3}$$

$$\Phi(d, z_0) = V_0 \left[ \frac{4}{3} \left(\frac{z_0}{d}\right)^{1/3} - \frac{1}{3} \left(\frac{z_0}{d}\right)^{4/3} \right]$$

$$\Rightarrow \Phi(d, t) = \begin{cases} V_0 \left[ \frac{4}{3} \left(\frac{t}{\uparrow}\right) - \frac{1}{3} \left(\frac{t}{\uparrow}\right)^4 \right] & \text{for } 0 < t < \uparrow \\ V_0 & \text{for } t > \uparrow \end{cases}$$

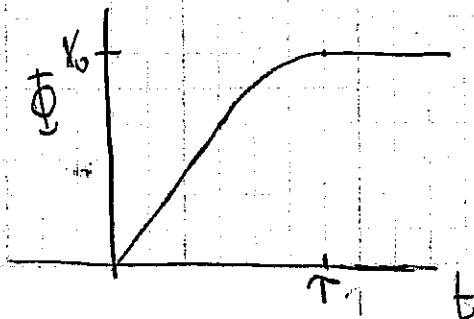

# INJECTOR CHOICES (cf. Kwan et al, NIMPR464, 379 (2001))

CHILD-LANGMUIR  $\Rightarrow J = \chi \frac{V^{3/2}}{d^2}$

where  $\chi = \frac{4}{9} \epsilon_0 \left(\frac{2q}{m}\right)^{1/2}$

SOME CONSTRAINTS:

## (1) VOLTAGE BREAKDOWN

EMPIRICALLY  $V \leq \sim 100 \text{ kV} \begin{cases} \left(\frac{d}{1 \text{ cm}}\right) & \text{for } d \leq 1 \text{ cm} \\ \left(\frac{d}{1 \text{ cm}}\right)^{1/2} & \text{for } d \gg 1 \text{ cm} \end{cases}$

(2) BEAM OPTICS ABERRATIONS:  $d \geq \sim \frac{3}{4} r_p$  (TYPICALLY)

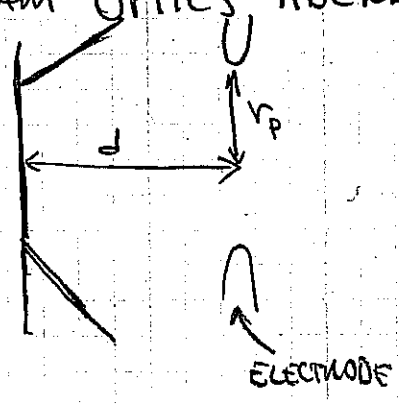

NOTE THAT

$J \sim \frac{V^{3/2}}{d^2} \sim \begin{cases} V^{-1/2} & \leftarrow d < 1 \text{ cm} \\ V^{-3/2} & \leftarrow d > 1 \text{ cm} \end{cases} \quad I \sim \pi r_p^2 J \sim \begin{cases} V^{3/2} \end{cases}$

Thus current density decreases with size and voltage, but I increases.

$V = \frac{A \cdot V}{24 \cdot 54 \cdot 75}$

from A. Fultner:

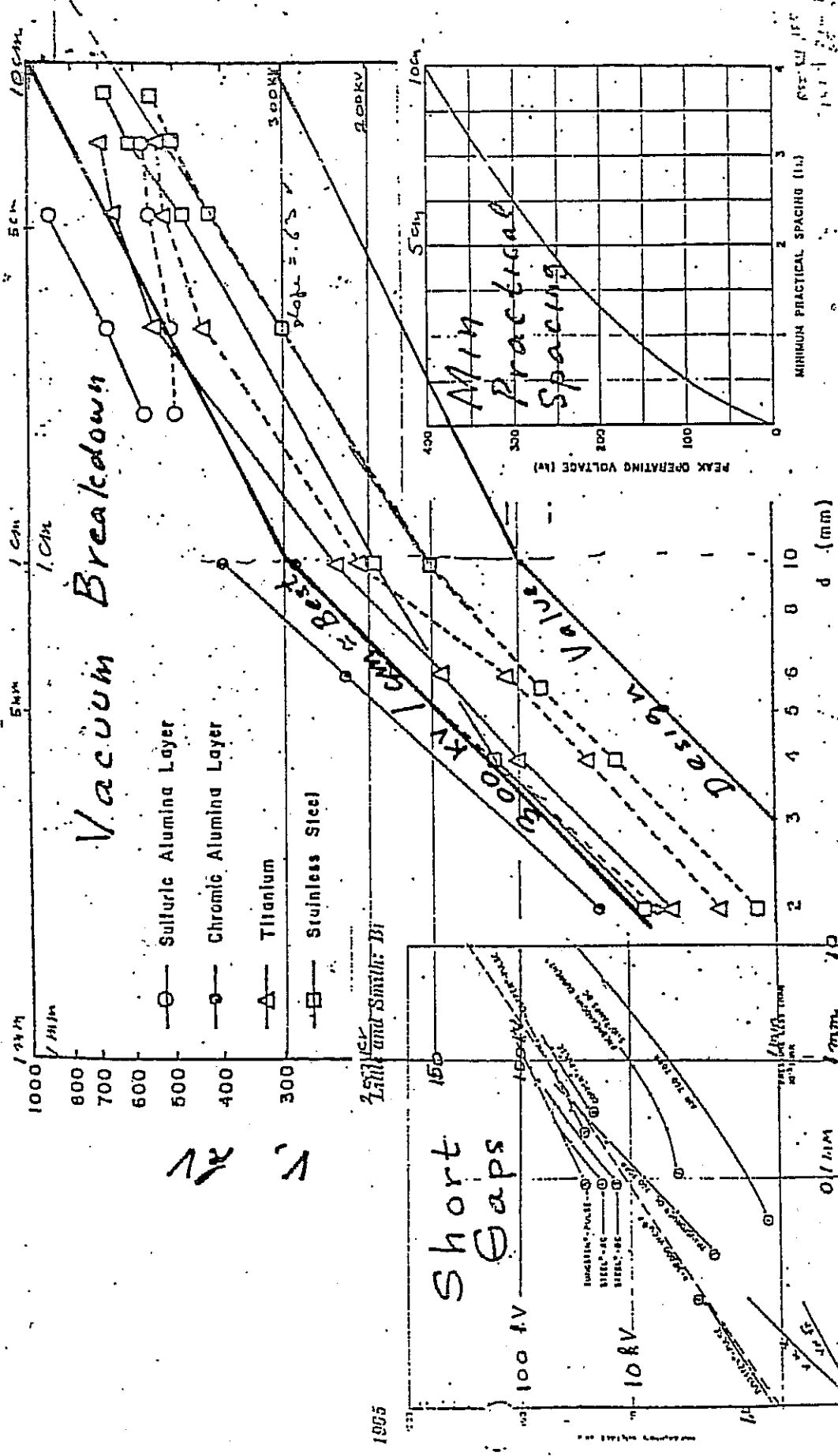
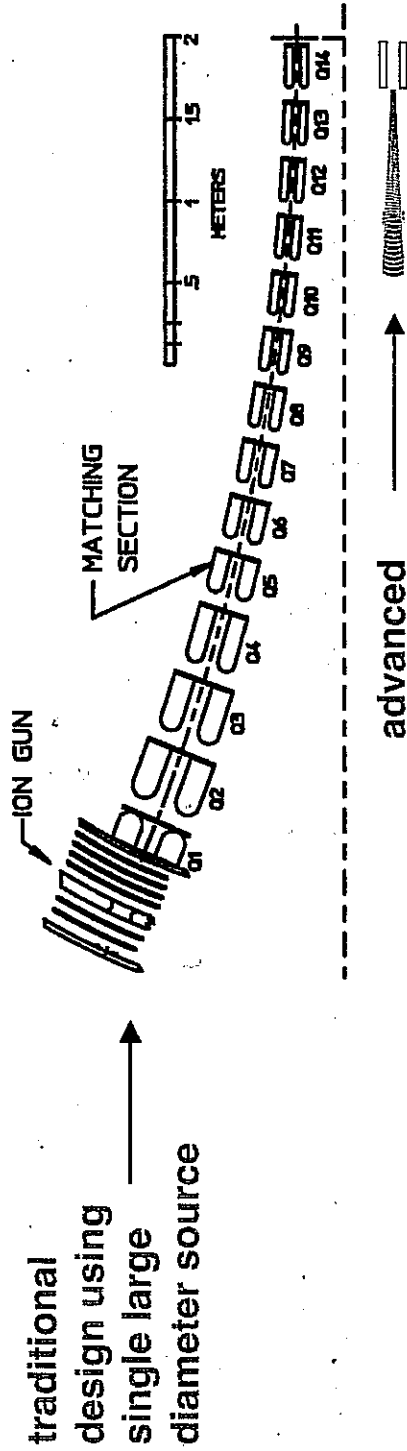

Figure 7.13 Log U - log d plot.

Fig. 1. Breakdown voltage-vs-gap length for uniform-field and non-uniform-field geometries. Numbers on curves indicate the

15  
 1000  
 800  
 700  
 600  
 500  
 400  
 300  
 200  
 100  
 0  
 1 2 3 4  
 MINIMUM PRACTICAL SPACING (in)

MULTIPLE BEAMLET INJECTORS CAN HAVE HIGHER CURRENT DENSITY  
 DECREASING SIZE OF INJECTOR



Each beamlet carries higher current density; But merging beamlets increases thermal spread.

**Child-Langmuir**  $J_{CL} \propto \frac{V^{3/2}}{d^2}$

$J \propto V^{-1/2 \text{ to } -5/2} \propto d^{-1/2 \text{ to } -5/4}$

**Breakdown limit**  $V \propto d^{1.0 \text{ to } 0.5}$

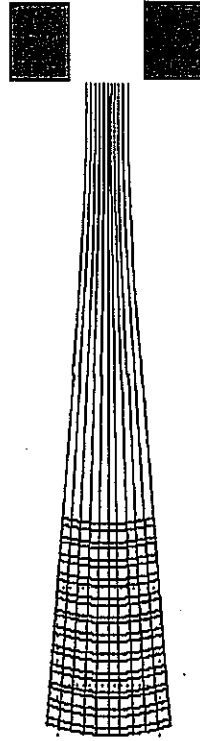

Merge and match beamlets into an ESQ channel



The Heavy Ion Fusion Virtual National Laboratory

# Simulations of merging-beamlet injector

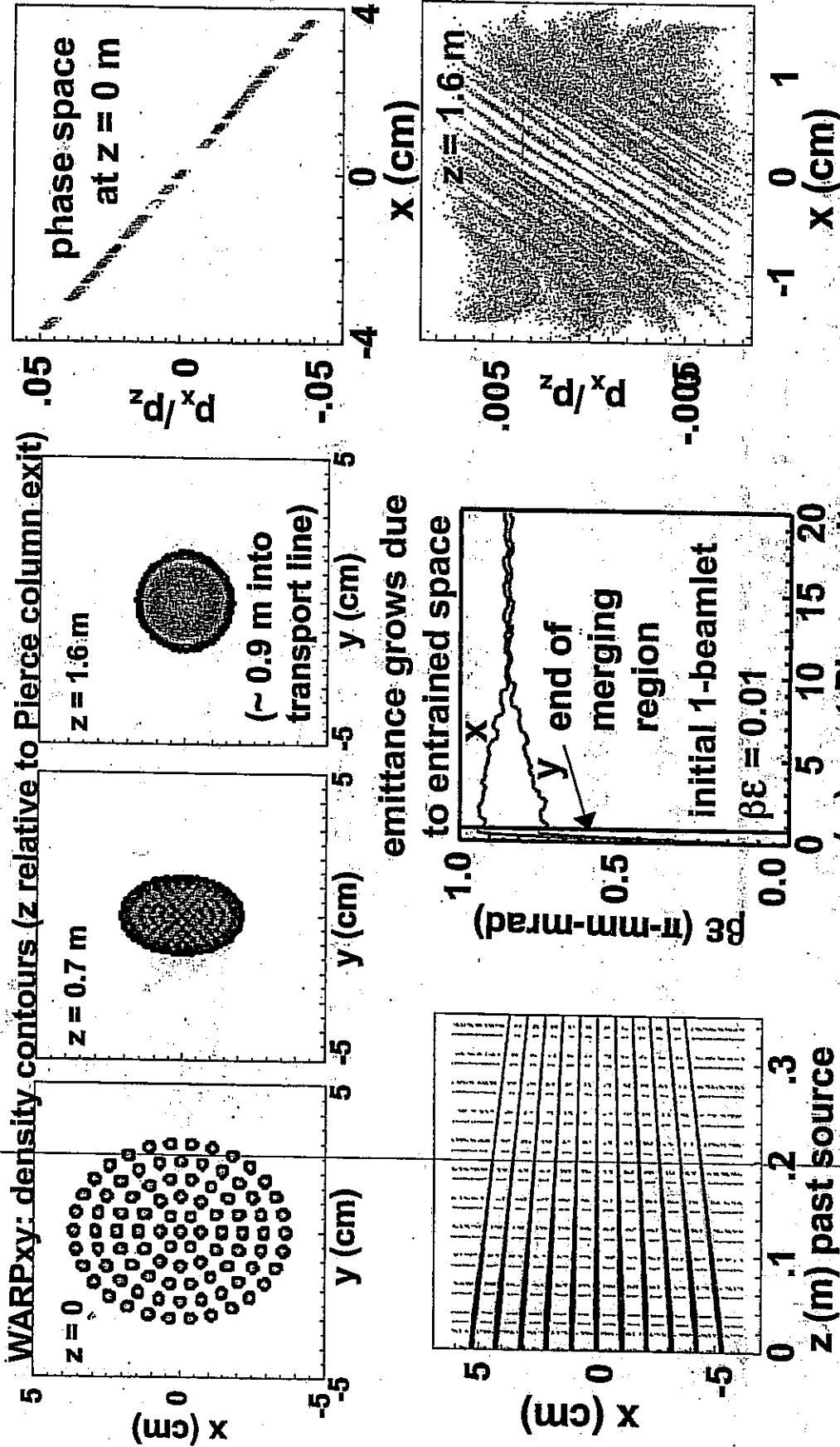

from P. HENESTROZA AND J. W. KUAN, "DESIGN & SIMULATION OF THE MULTIBEAMLET INJECTOR FOR A HEAVY ION ACCELERATOR", SUBMITTED TO NUCLEAR INSTRUMENTS & METHODS

The Heavy Ion Fusion Virtual National Laboratory

PPPL  
PRINCETON PLASMA PHYSICS LABORATORY  
PRINCETON UNIVERSITY

(5)



# 0.8 Ampere, 2 MV $K^+$ Injector produced a $\lambda=0.25\mu C/m$ beam

Electrostatic Quadrupole Accelerator for simultaneous  
focusing and acceleration of ion beams to 2 MV.

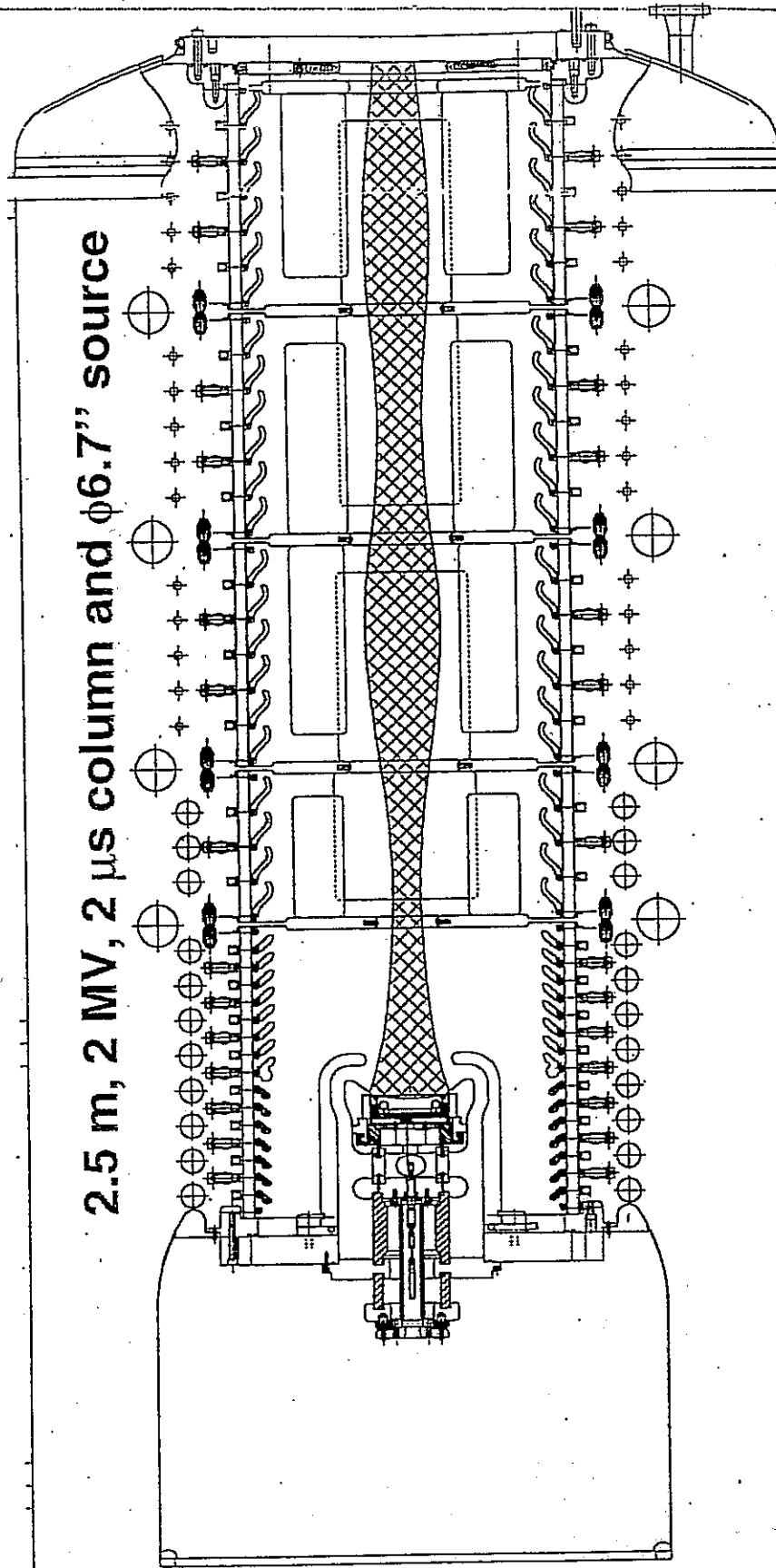

2.5 m, 2 MV, 2  $\mu s$  column and  $\phi 6.7''$  source

LAWRENCE BERKELEY NATIONAL LABORATORY

Figure 10 for e308 of 15/5/74/14P

### SCALING OF BRIGHTNESS IN INJECTORS

$$G_N = 4 \rho \langle x^2 \rangle^{1/2} \langle x'^2 \rangle^{1/2} = \frac{4}{c} \left( \frac{v_b}{2} \right) \langle v_x^2 \rangle^{1/2}$$

$$G_{11} = 2 \rho_b \sqrt{\frac{kT}{mc^2}}$$

$$\frac{1}{2} m v_x^2 = \frac{1}{2} kT$$

$$\Rightarrow B = \frac{I}{\epsilon_N^2} = \frac{\pi J}{4(kT/mc^2)} \sim \frac{J}{T}$$

⇒ FOR HIGH BRIGHTNESS & HIGH CURRENT  
 MAY WISH TO ACCELERATE MANY BEAMLETS  
 AND THEN MERGE TO FORM SINGLE BEAM.

MANY ISSUES NOT DISCUSSED HERE!

---

- SOURCES
- ELECTRON TRAPPING
- CONVERGING BEAMS
- MATCHING TO AN ESQ (e.g.)
- rf
- ...



John Barnard  
Steven Lund  
USPAS  
June 2008

## Injectors and longitudinal physics -- II

1. Acceleration - introduction
2. Space charge of short bunches (rf)
3. Space charge of long bunches
4. Longitudinal space charge waves
5. Longitudinal rarefaction waves and bunch ends

# ACCELERATION

rf (radio-frequency)

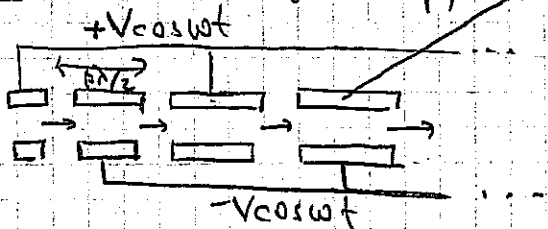

TUBES SHIELDS BEAM

(Wideroe Linac)

LOW FREQUENCIES (< 100 MHz)

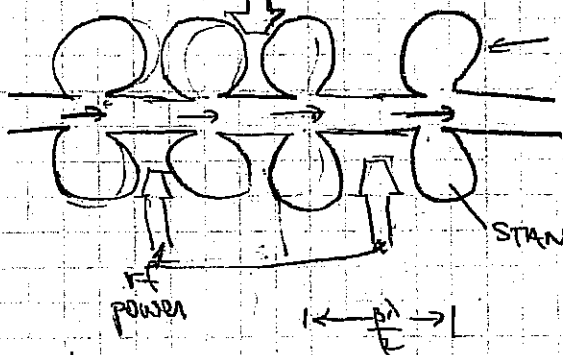

(COUPLED CAVITY Linac)

$0.4 < \beta < 1.0$

FREQUENCIES ~ 100'S MHz - ~ GHz

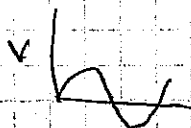

IN EACH GAP  $E = E_m \sin \omega t$

## Induction acceleration

PULSED POWER

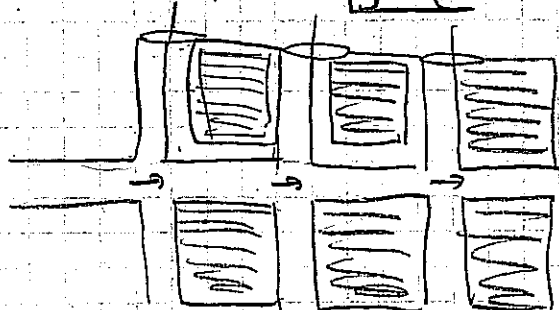

(INDUCTION LINAC)

$\nabla \times E = -\partial B / \partial t$

IN EACH GAP  $E = \text{CONSTANT}$

(OR SOME PRESCRIBED FUNCTION)

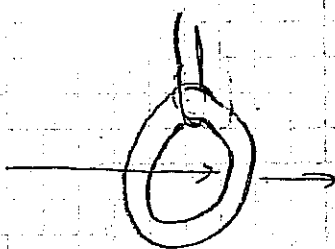

RF longitudinal equation of motion

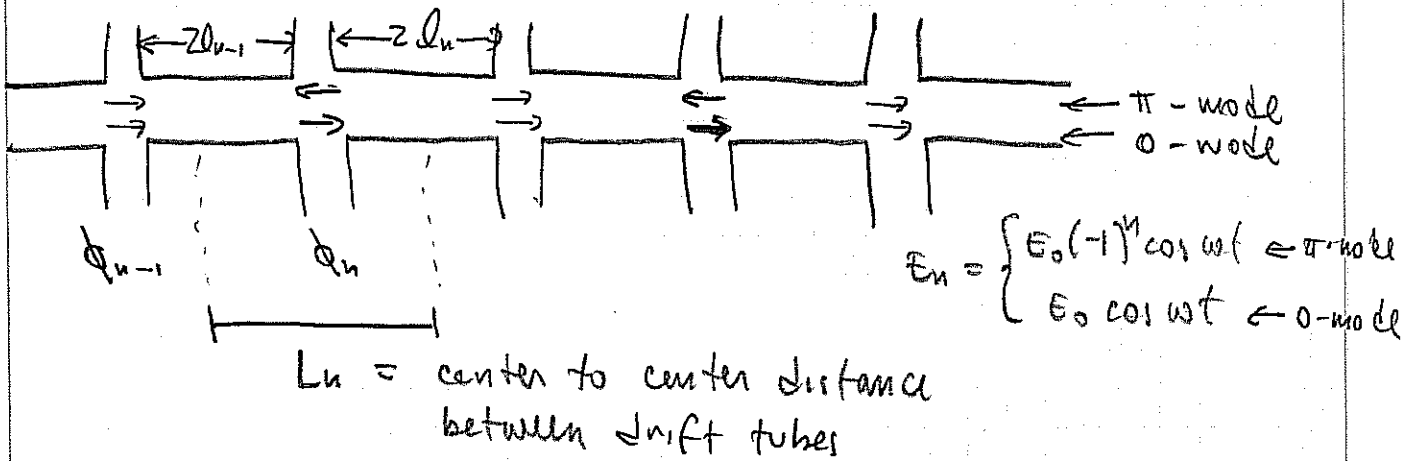

$E_z = E_0 \cos(\phi_s)$  ← synchronous particle enters each gap at same phase

RESONANCE CONDITION ON SYNCHRONOUS PARTICLE:

$$L_{n-1} = \frac{\beta_s \lambda}{2} \begin{cases} \frac{1}{2} & \pi\text{-mode} \\ 1 & 0\text{-mode} \end{cases}$$

$\lambda = \frac{2\pi c}{\omega} =$  light travel distance in one cycle of oscillation

(IT TAKES  $\frac{1}{2}$  OSCILLATION PERIOD TO TRAVEL BETWEEN GAPS).

$\beta_s = \frac{v_s}{c} =$  velocity of synchronous particle

PARTICLE PHASE RELATIVE TO  $\omega t$  at the  $n^{\text{th}}$  gap:

$$\phi_n = \phi_{n-1} + \omega \frac{2L_{n-1}}{\beta_{n-1} c} + \begin{cases} \pi & \pi\text{-mode} \\ 0 & 0\text{-mode} \end{cases}$$

$$\Delta(\phi - \phi_s)_n = 2\pi \beta_{s,n-1} \left( \frac{1}{\beta_{n-1}} - \frac{1}{\beta_{s,n-1}} \right) \begin{cases} \frac{1}{2} & \pi\text{-mode} \\ 1 & 0\text{-mode} \end{cases}$$

$$\approx -2\pi \frac{\delta\beta}{\beta_{s,n-1}} \begin{cases} \frac{1}{2} \\ 1 \end{cases}$$

A VELOCITY DIFFERENCE LEADS TO A PHASE DIFFERENCE!!

$$\Delta(\phi - \phi_s)_n \approx -2\pi \frac{W_{n-1} - W_{s,n-1}}{m c^2 \beta_{s,n-1}^3 \beta_{s,n-1}^2} \begin{cases} \frac{1}{2} \\ 1 \end{cases}$$

$$W = (\gamma - 1) m c^2$$

$$\frac{1}{\beta} - \frac{1}{\beta_s} \approx -\frac{\delta\beta}{\beta_s^2}$$

$$\delta W = \gamma_s^3 \beta_s m c^2 \delta\beta$$

SIMILARLY, A. PHASE DIFFERENCE PRODUCTS

AND ENERGY CHANGE (RELATIVE TO SYNCHRONOUS PARTICLES)

$$\Delta(W - W_s)_n = q E_0 L_n (\cos \psi_n - \cos \psi_{s,n})$$

$$L_n = \frac{(\beta_{s,n-1} + \beta_{s,n}) \lambda}{2} \left\{ \begin{matrix} 1/2 \\ 1 \end{matrix} \right\} =$$

CENTER-TO-CENTER  
DISTANCE  
BETWEEN  
DRIFT SECTIONS

$$(\Delta W_s = q E_0 L_n \cos \psi_s)$$

CAMPAL

CONVERTING TO A CONTINUOUS VARIABLE:

$$\Delta(\phi - \phi_s) \rightarrow \frac{d\Delta\phi}{dn} \quad \Delta(W - W_s) \rightarrow \frac{d\Delta W}{dn}$$

$$\gamma_s^3 \beta_s^3 \frac{d\Delta\phi}{ds} = -2\pi \frac{\Delta W}{mc^2 \lambda}$$

$$\frac{d\Delta W}{ds} = qE_0 (\cos \phi - \cos \phi_s)$$

$dn = \frac{ds}{\beta_s \lambda} \left\{ \begin{matrix} 2 \\ 1 \end{matrix} \right\}$

$$\frac{d}{ds} \left[ \gamma_s^3 \beta_s \frac{d\Delta\phi}{ds} \right] = -2\pi \frac{qE_0}{mc^2 \lambda} [\cos \phi - \cos \phi_s] \quad (I)$$

NOW THE SPATIAL SEPARATION IS GIVEN BY:

$$\Delta z \equiv z - z_s = -\frac{\beta_s \lambda}{2\pi} \Delta\phi$$

$$\Rightarrow \frac{d}{ds} [\cos \phi - \cos \phi_s] \approx -\sin \phi_s \frac{d\phi}{ds} \quad \left[ \text{for } \frac{2\pi \Delta z}{\beta_s \lambda} = \Delta\phi \ll 1 \right]$$

$$\Rightarrow \frac{d}{ds} \left[ \gamma_s^3 \beta_s \frac{d}{ds} \left( \frac{\Delta z}{\beta_s} \right) \right] \approx -\frac{2\pi}{\lambda} \frac{qE_0}{mc^2} \sin \phi_s \frac{\Delta z}{\beta_s}$$

WHEN THE ACCELERATION RATE IS SMALL

$$\Rightarrow \frac{d^2}{ds^2} \Delta z \approx -\frac{2\pi}{\lambda} \frac{qE_0 \sin \phi_s}{\gamma_s^3 \beta_s mc^2} \Delta z$$

$$\equiv -k_{s0}^2 \Delta z \quad (\text{synchrotron oscillations})$$

6

RETURNING TO  $\Delta W - \phi$  NOTATION

$$\text{Let } w = \frac{\Delta W}{mc^2}$$

$$A = \frac{2\pi}{\beta_s^2 \gamma_s^3 \lambda}$$

$$B = \frac{q E_0}{mc^2}$$

$$\Rightarrow w' = B(\cos \phi - \cos \phi_s)$$

$$\phi' = -Aw$$

$$\phi'' = -AB(\cos \phi - \cos \phi_s)$$

MULTIPLYING BY  $\phi'$  AND INTEGRATING:

$$\frac{\phi'^2}{2} = -AB(\sin \phi - \phi \cos \phi_s) + \text{const}$$

Using  $\phi' = -Aw$  (dividing by A)

$$\Rightarrow \frac{Aw^2}{2} + B(\sin \phi - \phi \cos \phi_s) = \text{const.}$$

kinetic energy

potential energy

$$\frac{dW_s}{ds} \sim qE_0 \cos \phi_s$$

$$V(\phi) = B(\sin \phi - \phi \cos \phi_s)$$

$$\frac{dV}{d\phi} = B(\cos \phi - \cos \phi_s)$$

$$\frac{d^2V}{d\phi^2} = -B \sin \phi$$

$$> 0 \Rightarrow -\pi < \phi_s < 0$$

FOR LONGITUDINAL FOCUSING

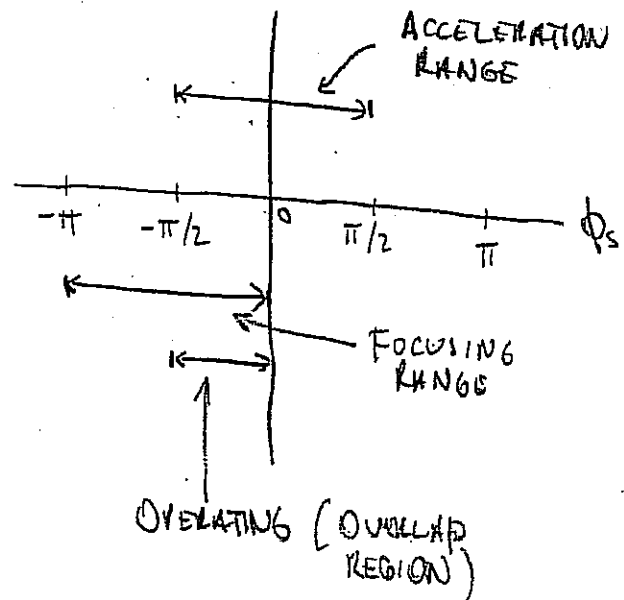

LONGITUDINAL MOTION WHEN ACCELERATION RATE IS SMALL

simultaneous acceleration and a potential well when  $-\pi/2 \leq \phi_s \leq 0$ . The stable region for the phase motion extends from  $\phi_2 < \phi < -\phi_s$ , where the lower phase limit  $\phi_2$  can be obtained numerically by solving for  $\phi_2$  using  $H_\phi(\phi_2) = H_\phi(-\phi_s)$ . Figure 6.3 shows longitudinal phase space and the longitudinal potential well. At the potential maximum, where  $\phi = -\phi_s$ , we

from  
T. Wangler's  
"PRINCIPLES  
of  
RF LINEAR  
ACCELERATORS"

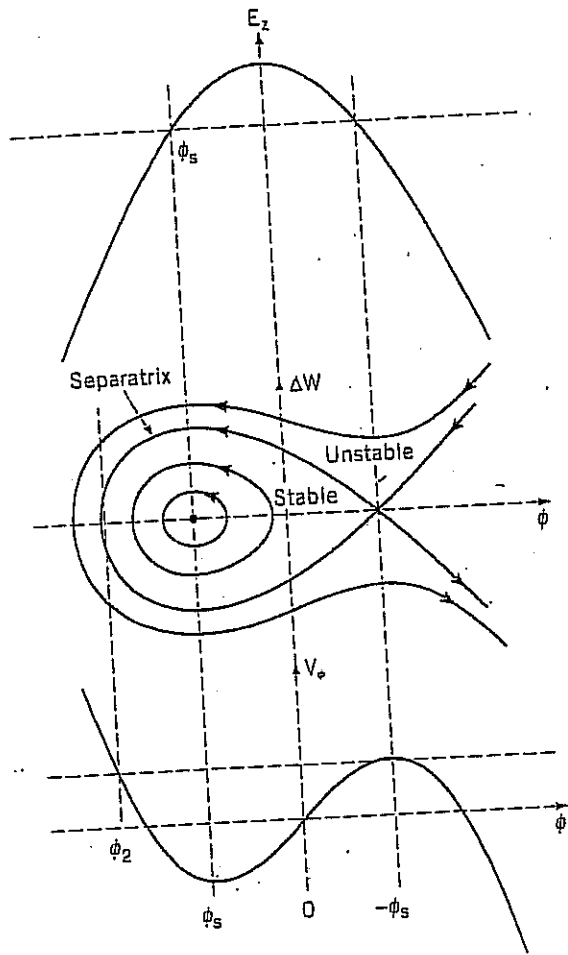
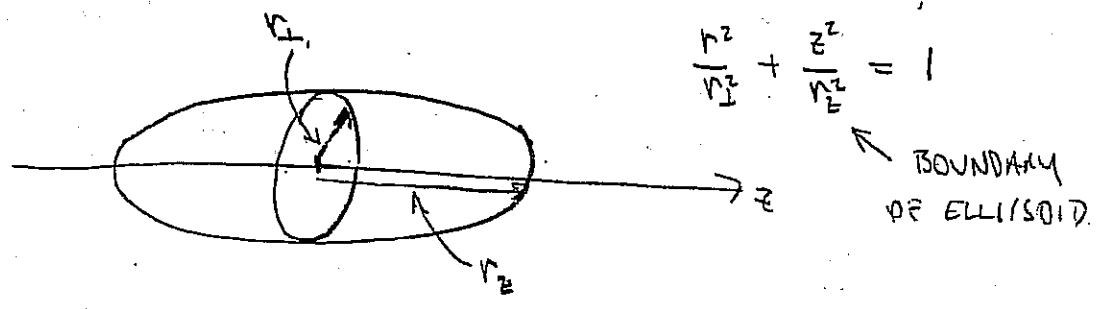

Figure 6.3. At the top, the accelerating field is shown as a cosine function of the phase; the synchronous phase  $\phi_s$  is shown as a negative number, which lies earlier than the crest where the field is rising in time. The middle plot shows some longitudinal phase-space trajectories, including the separatrix, the limiting stable trajectory, which passes through the unstable fixed point at  $\Delta W = 0$ , and  $\phi = -\phi_s$ . The stable fixed point lies at  $\Delta W = 0$  and  $\phi = \phi_s$ , where the longitudinal potential well has its minimum, as shown in the bottom plot.

SPACE-CHARGE FIELD OF BUNCHED BEAMS



THE POTENTIAL OF A UNIFORM DENSITY BUNCH IN FREE SPACE  
(A MACLAURIN SPHEROID) IS GIVEN BY:

(cf Landau & Lifshitz, Classical Theory of Fields, p 297)

$$\phi = \frac{\rho}{4\epsilon_0} (\alpha_{\perp} r_{\perp}^2 + \alpha_{\parallel} z^2 - \delta)$$

where  $\alpha_{\perp} = r_{\perp}^2 r_z \int_0^{\infty} \frac{ds}{(r_{\perp}^2 + s) \Delta}$

$$\alpha_{\parallel} = r_{\perp}^2 r_z \int_0^{\infty} \frac{ds}{(r_z^2 + s) \Delta}$$

$$\delta = r_{\perp}^2 r_z \int_0^{\infty} \frac{ds}{\Delta}$$

where  $\Delta^2 = (r_{\perp}^2 + s)^2 (r_z^2 + s)$

FOR NON-RELATIVISTIC BEAM:

$$E_z = -\frac{\partial \phi}{\partial z} = f \frac{\rho}{\epsilon_0} z$$

$$E_r = -\frac{\partial \phi}{\partial r} = \frac{(1-f)}{2} \frac{\rho}{\epsilon_0} r$$

$$f = f(\alpha) = \begin{cases} \frac{\alpha^2}{1-\alpha^2} \left[ \frac{1}{\sqrt{1-\alpha^2}} \tanh^{-1} \sqrt{1-\alpha^2} - 1 \right] & \alpha < 1 \\ \frac{1}{3} & \alpha = 1 \\ \frac{\alpha^2}{\alpha^2-1} \left[ 1 - \frac{1}{\sqrt{\alpha^2-1}} \tanh^{-1} \sqrt{\alpha^2-1} \right] & \alpha > 1 \end{cases} \quad \alpha \equiv \frac{r_z}{r_{\perp}}$$



## FOR RELATIVISTIC BEAM

(cf. LUND & BARNARD 1997)  
PAC 97 CONF PROCEEDINGS

$$\frac{d^2 x_L}{ds^2} = \frac{F_L}{\gamma_s^3 \beta_s^2 m c^2}$$

$$F_{Ls} = -\frac{q}{\gamma_s^2} \frac{\partial \phi}{\partial x_L} = \frac{q\rho}{2\gamma_s^2 \epsilon_0} [1 - f(\alpha)] x_L$$

$$\frac{d^2 \Delta z}{ds^2} = \frac{F_z}{\gamma_s^3 \beta_s^2 m c^2}$$

$$F_{zs} = -\frac{q}{\gamma_s^2} \frac{\partial \phi}{\partial z} = \frac{q\rho}{\epsilon_0} f(\alpha) \Delta z$$

$$\alpha = \frac{r_L}{\gamma_s v_z}$$

$$\left[ \alpha = \frac{r_L}{(v_z \text{ in COMOVING FRAME})} \right]$$

## COMBINING FOCUSING + SELF FIELDS

$$\frac{d^2 \Delta z}{ds^2} = -k_{s0} \Delta z + \frac{q\rho f(\alpha)}{\gamma_s^3 \beta_s^2 m c^2 \epsilon_0} \Delta z$$

(LINEAR  
RF)



# Total field seen by particle is sum of rf and spacecharge

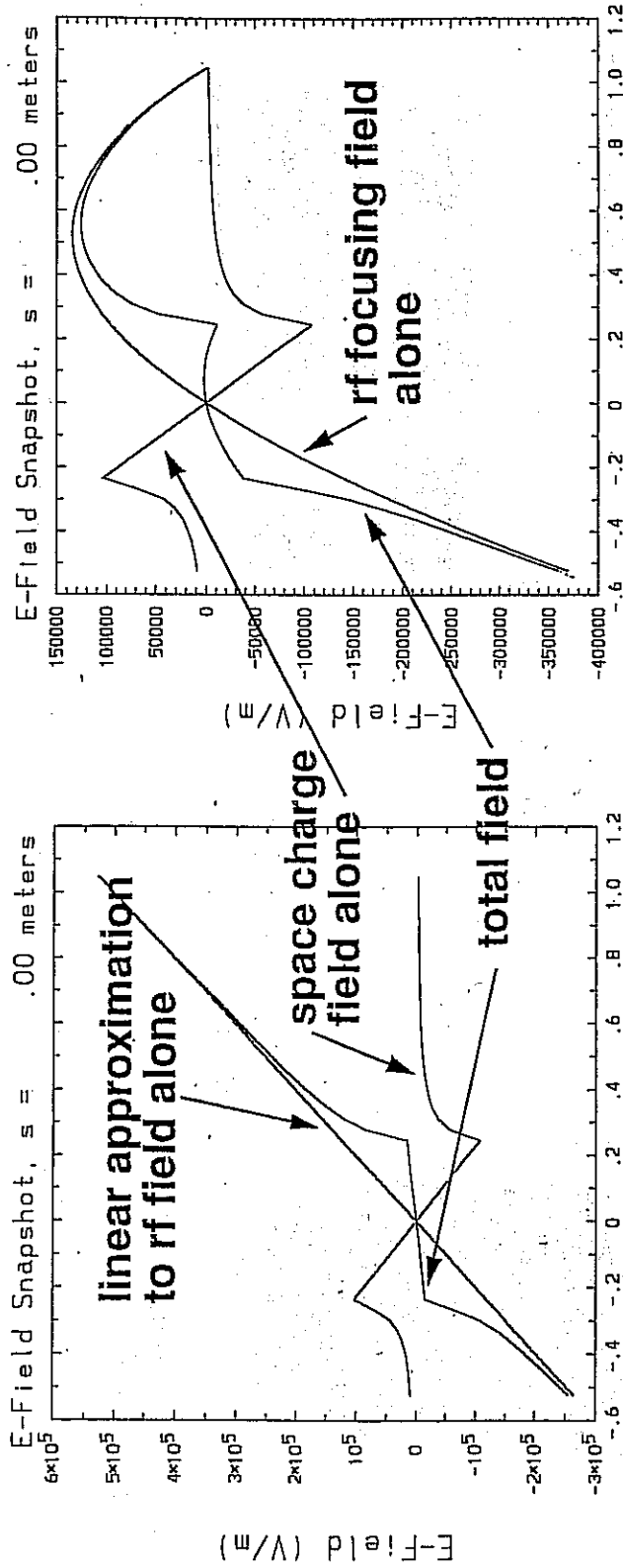

$\phi - \phi_s$  (rad)

$\phi - \phi_s$  (rad)

here  $\phi - \phi_s = - (2 \pi / \beta_s \lambda) \Delta z$ , where  $\beta_s c$  is the longitudinal velocity of the synchronous particle and  $\lambda = c/v$  is the rf vacuum wavelength



# Induction acceleration

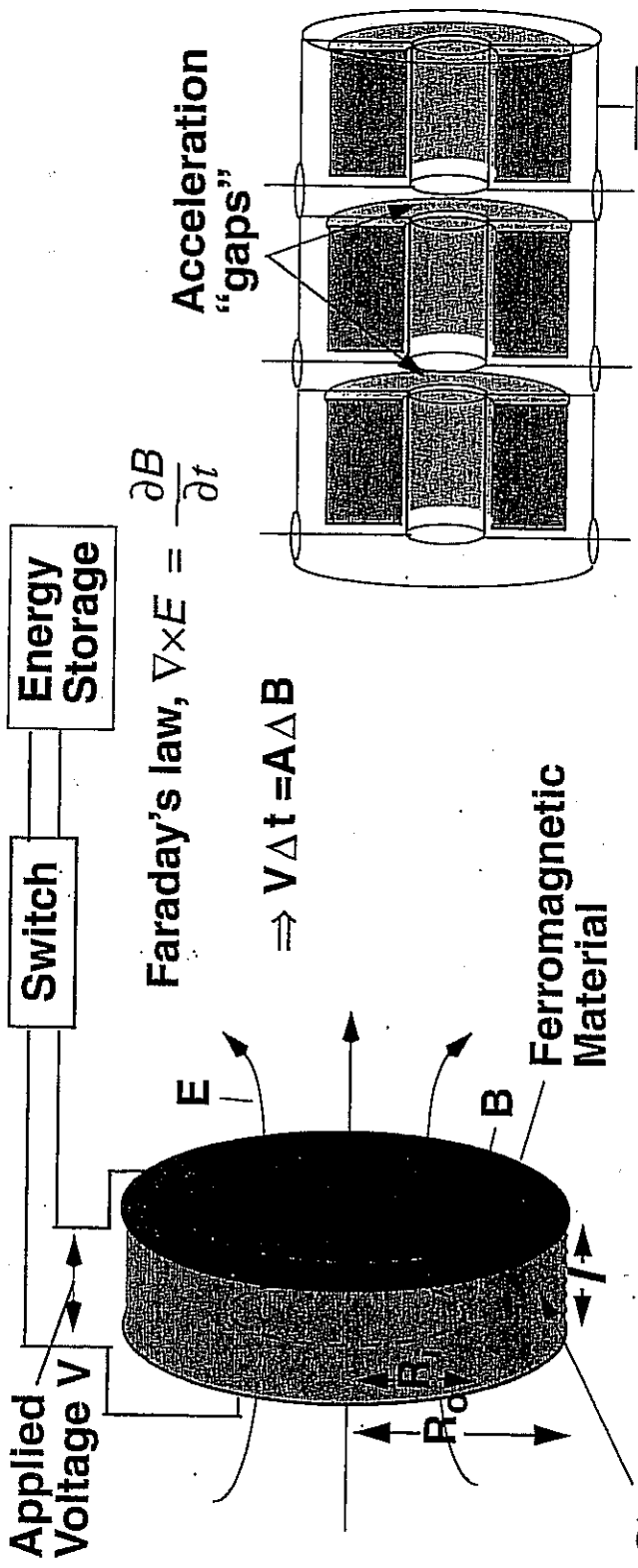
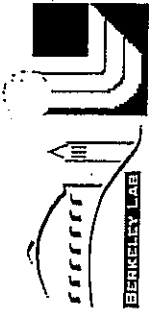

Faraday's law,  $\nabla \times E = \frac{\partial B}{\partial t}$   
 $\Rightarrow V \Delta t = A \Delta B$

Cross-sectional area A  
 $A = (R_o - R_i) l$

Volt-seconds per m:  $(dV/dz) \Delta t = (R_o - R_i) \Delta B$  f radial f longit.  
 $\sim 1 \text{ m} \sim 2.5 \text{ T} \sim 0.8 \sim 0.8$

$(dV/dz) \Delta t < \sim 1.6 \text{ V-s/m}$

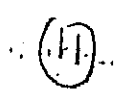

Several types of waveform are needed to accelerate, compress, and confine the beam

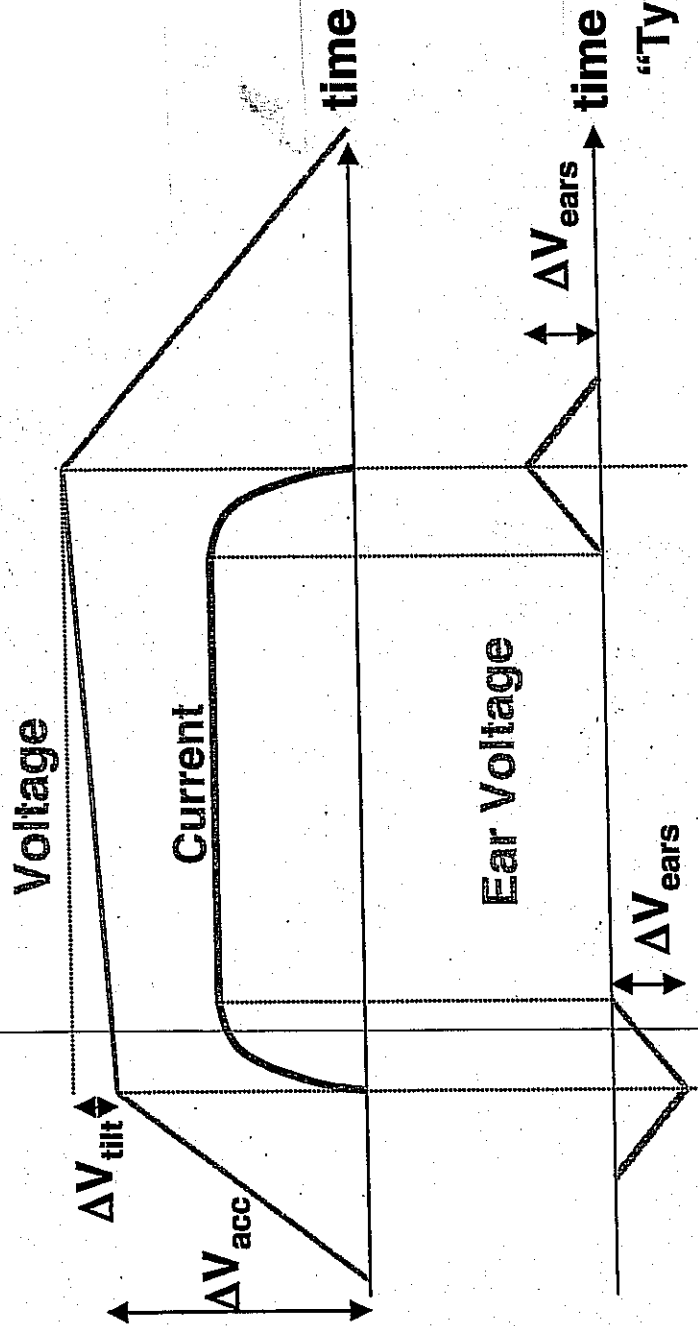

“Typical” numbers:

- $\Delta V_{tilt} \sim 1 \text{ kV}$
- $\Delta V_{ears} \sim 14 \text{ kV}$
- $\Delta V_{acc} \sim 100 \text{ kV}$



The Heavy Ion Fusion Virtual National Laboratory



# COORDINATE SYSTEM

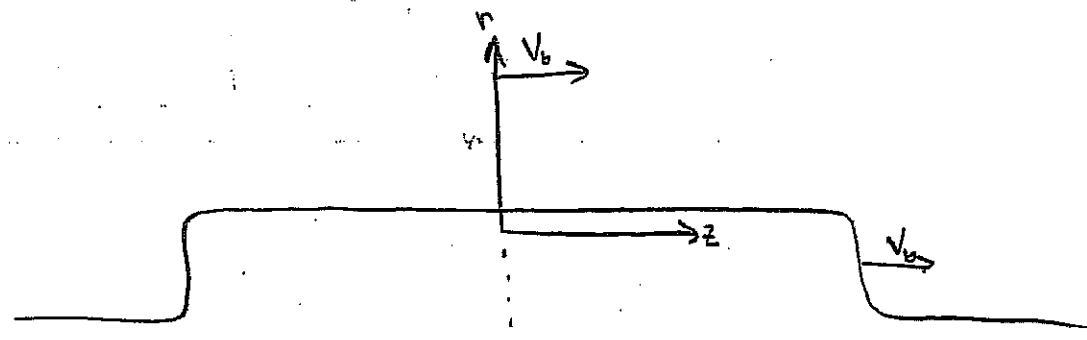

42-102 100 SHEETS  
National Brand  
Made in U.S.A.

$s=0$

$s = \beta_0 c t$  for drifting beam  
= position of beam center in lab frame

$s \leftrightarrow t$  are related by  $\beta_0 c$  for drifting beam

$z$  = longitudinal coordinate in beam frame ( $z=0$  = beam center)

$r$  = radial coordinate in beam frame (or lab frame).

(This class will assume non-relativistic dynamics)

These are ions with  $\beta < 0.2$ .

LONGITUDINAL PHYSICS OF LONG PULSES (BUNCH LENGTH  $\gg r_{pipe}$ )

"g-factor" model

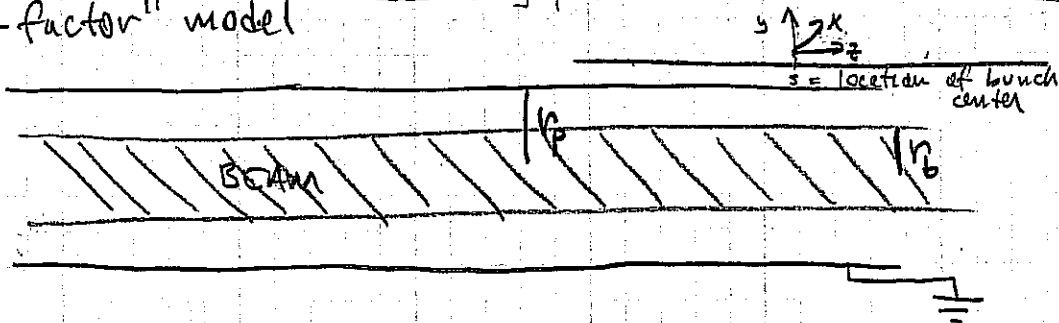

If  $\frac{\partial^2 \phi}{\partial z^2} \ll \frac{1}{r} \left( \frac{\partial}{\partial r} r \frac{\partial \phi}{\partial r} \right) \Rightarrow \frac{\partial \phi}{\partial r} = \frac{-\lambda(r)}{2\pi\epsilon_0 r}$

Let  $\rho = \begin{cases} \rho_0 & 0 < r < r_b \\ 0 & r_b < r < r_p \end{cases} \Rightarrow \lambda = \lambda_0 \left( \frac{r}{r_b} \right)^2$

$\phi = \int \frac{\partial \phi}{\partial r} dr = \begin{cases} \frac{\lambda}{2\pi\epsilon_0} \left[ \frac{1}{2} \left( 1 - \frac{r^2}{r_b^2} \right) + \ln \frac{r_p}{r_b} \right] & 0 < r < r_b \\ \frac{\lambda}{2\pi\epsilon_0} \ln \left( \frac{r_p}{r} \right) & r_b < r < r_p \end{cases}$

$\frac{\partial \phi}{\partial z} = \frac{1}{2\pi\epsilon_0} \left[ \frac{1}{2} \left( 1 - \frac{r^2}{r_b^2} \right) + \ln \frac{r_p}{r_b} \right] \frac{\partial \lambda}{\partial z} - \frac{1}{2\pi\epsilon_0} \left[ 1 - \frac{r^2}{r_b^2} \right] \frac{\lambda}{r_b} \frac{\partial r_b}{\partial z}$

If  $\rho = \text{const} \Rightarrow \frac{\lambda}{r_b^2} = \text{const} \Rightarrow \frac{\partial \lambda}{\partial z} = -\frac{2\lambda}{r_b} \frac{\partial r_b}{\partial z}$

$\Rightarrow \frac{\partial \phi}{\partial z} = \frac{1}{2\pi\epsilon_0} \ln \left( \frac{r_p}{r_b} \right) \frac{\partial \lambda}{\partial z}$

$E_z = \frac{-g}{4\pi\epsilon_0} \frac{\partial \lambda}{\partial z}$

where  $g = 2 \ln \left( \frac{r_p}{r_b} \right)$

[SPACE-CHARGE DOMINATED BEAM]

[Example of  $\rho = \text{const}$ .  
Magnetic Quad focusing  
 $\frac{\lambda}{4\pi\epsilon_0 Va} \approx k_{p0}^2 a$   
 $\Rightarrow \rho \sim V k_{p0}^2 \approx \text{const}$ ]

(for space-charge dominated beam)

FOR EMITTANCE DOMINATED BEAMS:

RADIUS NOT DETERMINED BY  $\lambda$

$$\text{SO } \frac{\delta r_b}{\delta \lambda} \approx 0$$

$$\left\langle \frac{\partial \phi}{\partial z} \right\rangle = \frac{1}{2\pi\epsilon_0} \left[ \frac{1}{z} \left( 1 - \left\langle \frac{v_z^2}{v_b^2} \right\rangle \right) + \ln \frac{r_p}{r_b} \right] \frac{\partial \lambda}{\partial z}$$

$$\Rightarrow g = 2 \ln \left( \frac{r_p}{r_b} \right) + \frac{1}{2} \quad (\text{EMITTANCE DOMINATED BEAMS})$$

(SEE REISER, SECTION 6.3 FOR DISCUSSION ON g-FACTOR).









# BEAM ENDS & RAREFACTION WAVES

(FALTINGS & LEE,  
J. APPL. PHYS. 61, 5214)  
(ALSO LANDAU & LIFSHITZ,  
FLUID MECHANICS)

SUPPOSE YOU START WITH A PULSE THAT ENDS WITH A STEP FUNCTION IN  $\lambda$ . WHAT HAPPENS TO THE END?

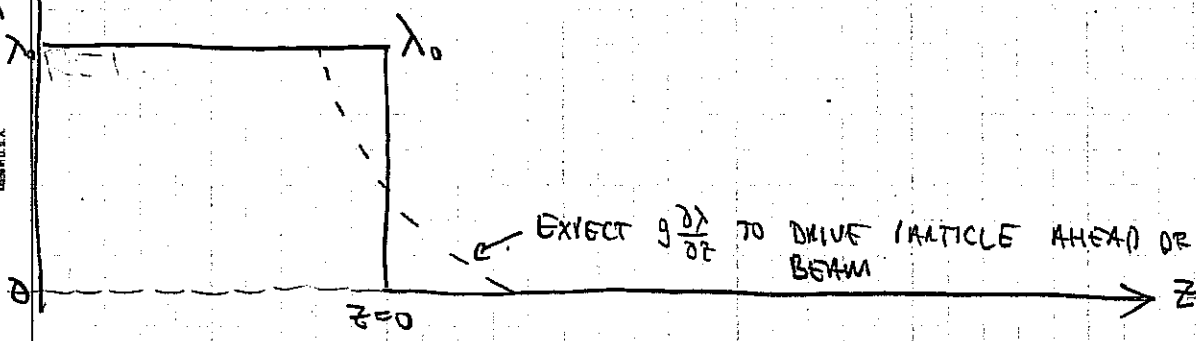

TO ANALYZE: RETURN TO NON-LINEAR FLUID EQUATIONS (SINCE  $\delta\lambda \sim \lambda_0$ ) (91):

$$\frac{\partial \lambda}{\partial s} + \lambda \frac{\partial \bar{z}'}{\partial z} + \bar{z}' \frac{\partial \lambda}{\partial z} = 0 \quad (\text{CONTINUITY})$$

$$\frac{\partial \bar{z}'}{\partial s} + \bar{z}' \frac{\partial \bar{z}'}{\partial z} + \frac{c^2}{\lambda_0 v_0^2} \lambda \frac{\partial \lambda}{\partial z} = 0 \quad (\text{MOMENTUM})$$

1ST IT IS CONVENIENT TO DEFINE:  $\Lambda \equiv \lambda / \lambda_0$

$$V \equiv \frac{v_0}{c_s} \bar{z}'$$

$$\zeta \equiv \frac{v_0}{c_s} z$$

$$(c_s^2 \equiv \frac{g \lambda_0}{m 4\pi \epsilon_0})$$

$$\Rightarrow \frac{\partial \Lambda}{\partial s} + \Lambda \frac{\partial V}{\partial \zeta} + V \frac{\partial \Lambda}{\partial \zeta} = 0 \quad (\text{CONTINUITY})$$

$$\frac{\partial V}{\partial s} + V \frac{\partial V}{\partial \zeta} + \frac{\partial \Lambda}{\partial \zeta} = 0 \quad (\text{r1})$$

(momentum)

TRY A SIMILARITY SOLUTION:  $\Lambda = \Lambda(x)$  &  $V = V(x)$

WHERE  $X = \frac{z}{s} = \left( \frac{v_0 z}{c_s s} \right)$

$\frac{\partial X}{\partial s} = -\frac{X}{s}$

$\frac{\partial X}{\partial z} = \frac{X}{z}$

$\frac{\partial \Lambda}{\partial s} = -\frac{\Lambda}{s} \frac{X}{s}$

$\frac{\partial \Lambda}{\partial z} = \frac{\Lambda}{z} \frac{X}{z}$

$\frac{\partial V}{\partial s} = -\frac{V}{s} \frac{X}{s}$

$\frac{\partial V}{\partial z} = \frac{V}{z} \frac{X}{z}$

$\left[ -\frac{\Lambda}{s} \frac{X}{s} + \Lambda \frac{dV}{dx} \frac{X}{z} + V \frac{d\Lambda}{dx} \frac{X}{z} \right] = 0$

(CONTINUITY)

$\left[ -\frac{dV}{dx} \frac{X}{s} + V \frac{dV}{dx} \frac{X}{z} + \frac{d\Lambda}{dx} \frac{X}{z} \right] = 0$

(MOMENTUM)

MULTIPLY BY  $z/s$  & gather terms:

$\Rightarrow \begin{bmatrix} V - X & \Lambda \\ 1 & V - X \end{bmatrix} \begin{bmatrix} d\Lambda/dx \\ dV/dx \end{bmatrix} = 0$

FOR NON-TRIVIAL SOLUTION DETERMINANT MUST VANISH:

$\Lambda = [V - X]^2$

$\Rightarrow \frac{d\Lambda}{dx} = 2[V - X] \left[ \frac{dV}{dx} - 1 \right]$  &  $\frac{d\Lambda}{dx} = -[V - X] \frac{dV}{dx}$

$\Rightarrow -\frac{dV}{dx} = 2 \frac{dV}{dx} - 2 \Rightarrow \frac{dV}{dx} = \frac{2}{3}$

$\Rightarrow \begin{bmatrix} V = \frac{2}{3}X + C \\ \Lambda = \left[ -\frac{1}{3}X + C \right]^2 \end{bmatrix}$



SNAPSHOTS OF  $\lambda/\lambda_0$  VS  $z$  AT VARIOUS  $s$

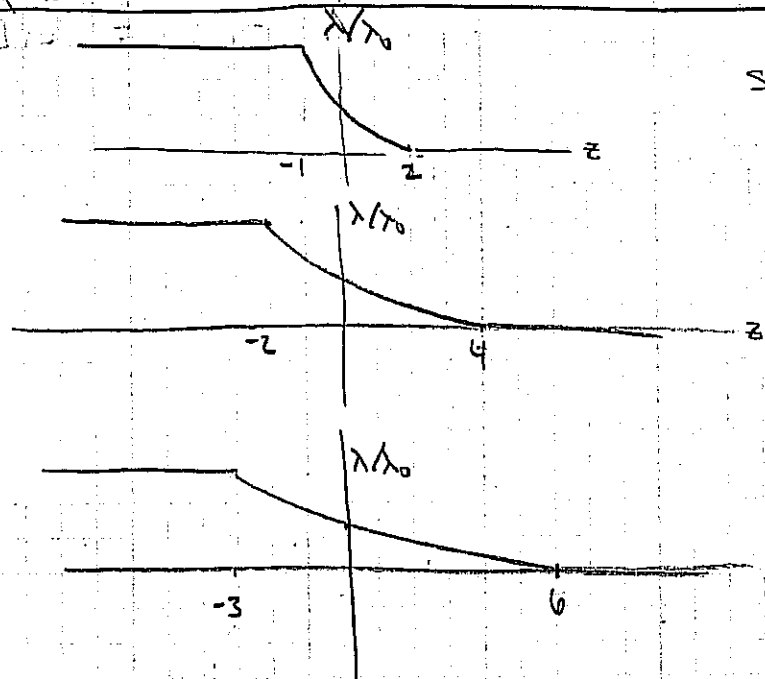

$s = 1 v_0/c_s$

$s = 2 v_0/c_s$

$s = 3 v_0/c_s$

HOW DOES ONE PREVENT "END EROSION"?

APPLY EAR PULSES AT END OF BEAM:

$$V \sim E_z = \frac{1}{4\pi\epsilon_0} \frac{\partial \lambda}{\partial z}$$

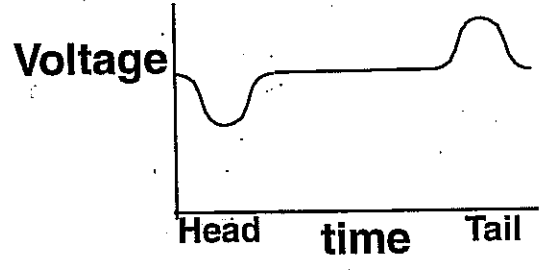
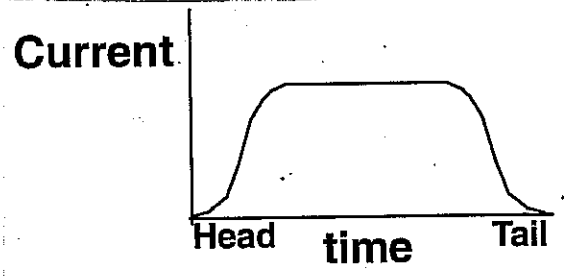

CHAPTER 6. INTERMITTENTLY-APPLIED AXIAL CONFINING FIELDS 98

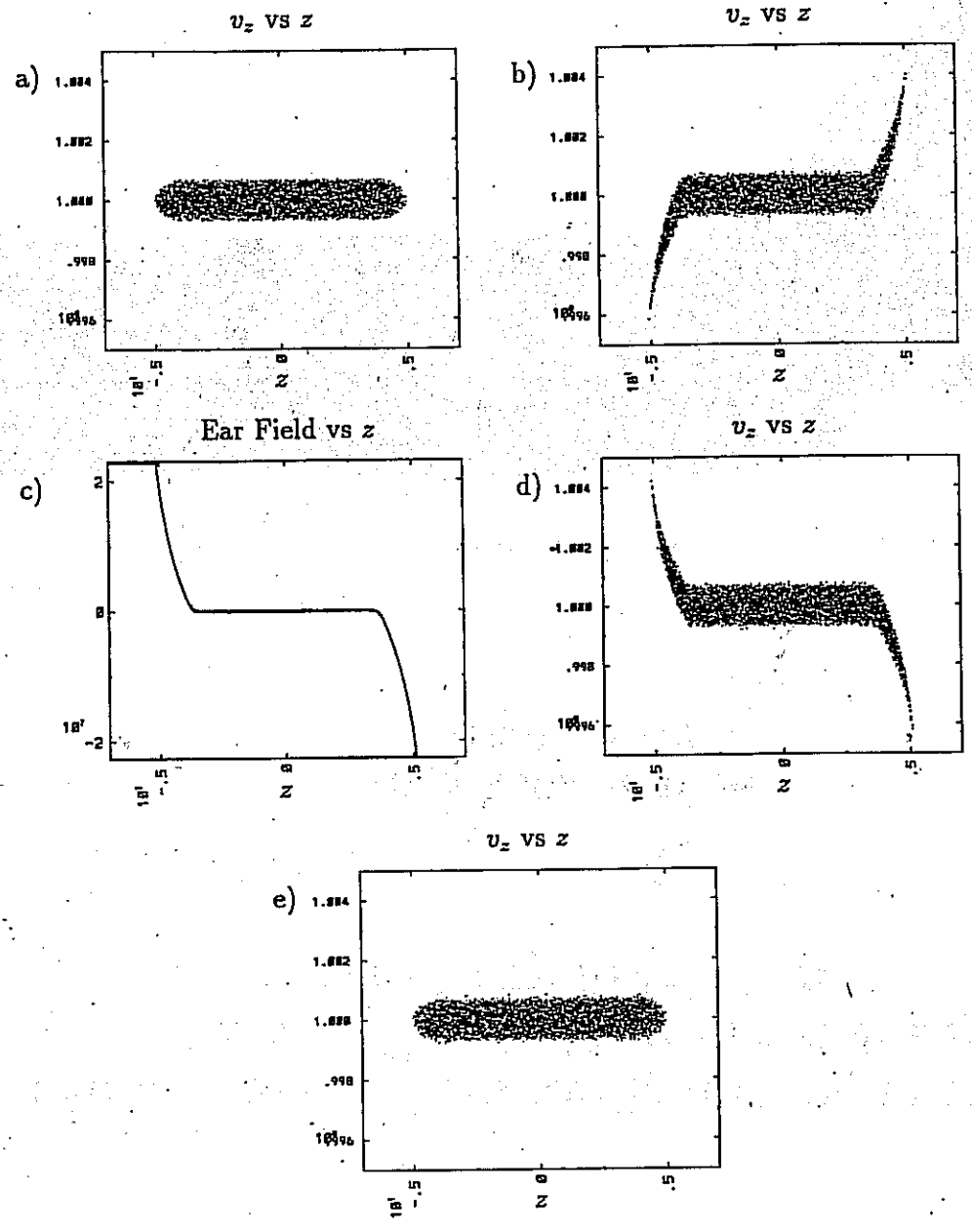

Figure 6.4: One cycle of intermittently-applied ears. (a) Initial phase space (b) Beam expands (c) Ear Field is applied (d) Beam is compressed (e) Beam expands back to its initial state

from D. Callahan Miller  
PhD thesis, U.C. Davis, 1994.

John Barnard  
Steven Lund  
USPAS  
June 2008

## Injectors and longitudinal physics -- III

1. Longitudinal cooling from acceleration
2. Longitudinal instability
3. Bunch compression
4. Neuffer distribution



# LONGITUDINAL COOLING

1. DURING INJECTION BEAM UNDERGOES LARGE LONGITUDINAL EXPANSION
2.  $T_{\perp 0} = T_{\perp 10}$  AT SOURCE, BUT  $T_{\perp 1} \neq T_{\perp 11}$  AFTER ACCELERATION
3. IMPLICATIONS FOR BEAM STABILITY AND EMITTANCE EVOLUTION

CONSIDER 1D DIODE:

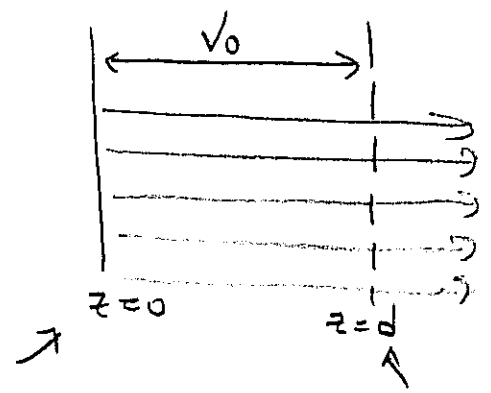

AT SOURCE

$$E_0 = \frac{p_{z0}^2}{2m}$$

$$\Delta E_{\perp 0} \equiv \frac{\langle p_{z0}^2 \rangle}{2m} = \frac{1}{2} kT_{\perp 0}$$

AT END OF DIODE

$$E_f = qV_0 + \frac{p_{zf}^2}{2m} = \frac{p_{zf}^2}{2m}$$

$$\Delta E_{\perp f} = \Delta E_{\perp 0} \neq \frac{1}{2} kT_f$$

SINCE  $E_{\parallel} = \frac{p_z^2}{2m} \Rightarrow \Delta E_{\parallel} = \frac{2p_z \Delta p_z}{2m}$

$$\frac{\Delta E}{E} = \frac{2\Delta p_z}{p_z}$$

$$\frac{1}{2} kT_f \approx \frac{\Delta p_{zf}^2}{2m} = \left( \frac{p_{zf} \Delta E_f}{2E_f} \right)^2 \frac{1}{2m} = \frac{\Delta E_f^2}{4E_f} = \frac{kT_0}{2} \left[ \frac{1}{2} \frac{kT_0}{qV_0} \right]$$

$$\Rightarrow \boxed{kT_f = \frac{1}{2} kT_0 \left[ \frac{kT_0}{qV_0} \right]}$$

$$kT_f = \frac{1}{2} kT_0 \left[ \frac{kT_0}{qV_0} \right] \ll 1$$

EXAMPLE 1000°C  $\Leftrightarrow$  0.1 eV

FOR  $V_0 = 1$  MeV

$kT_0 = 0.1$  eV

$kT_f = 5 \times 10^{-9}$  eV

How CAN  $kT_f \ll kT_0$  BUT  $\Delta E_f = \Delta E_0$ ?

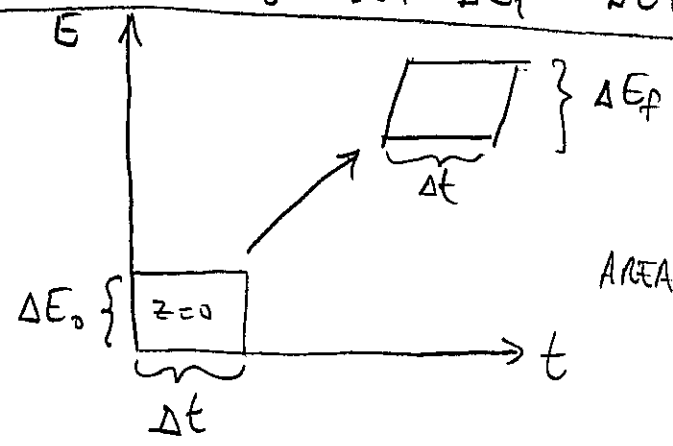

AREA IS CONSERVED  
(PULSE DURATION STAYS THE SAME.)

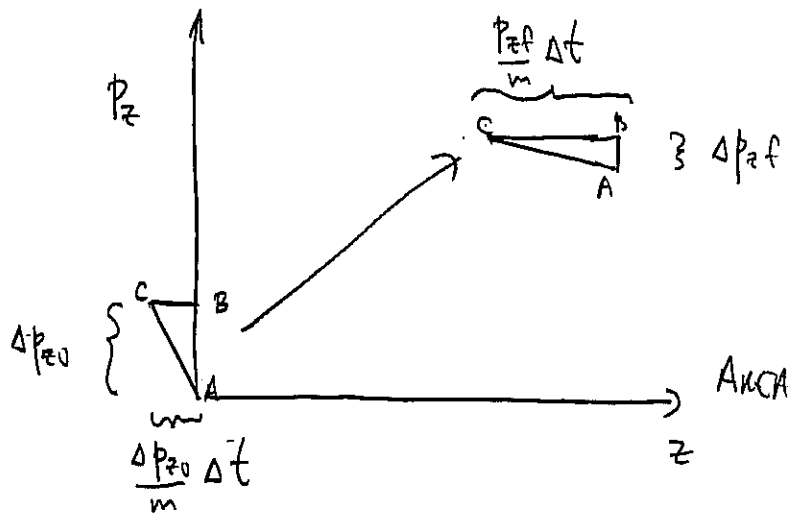

(BUNCH LENGTH GROWS)  
AREA IS CONSERVED

$$\frac{1}{2} \frac{\Delta p_{z0}^2}{m} \Delta t = \frac{1}{2} \Delta p_{zf} \left( \frac{p_{zf}}{m} \right) \Delta t$$

$$\Rightarrow \Delta p_{zf} = \frac{\Delta p_{z0}^2}{p_{zf}}$$

$$\Rightarrow kT_f \approx \frac{1}{2} kT_0 \left( \frac{kT_0}{qV_0} \right)$$

# CHANGE IN NOTATION

④

NOTE:  $\bar{z}' \equiv \left\langle \frac{dz}{ds} \right\rangle$ ;  $s = v_0 t$

Let  $u = \left\langle \frac{dz}{dt} \right\rangle$ ; then  $u = v_0 \bar{z}'$   
 = fluid velocity in comoving frame

$s_0$

$$\frac{\partial \lambda}{\partial s} + \frac{\partial}{\partial z} (\lambda \bar{z}') = 0 \quad \Rightarrow \quad \boxed{\frac{\partial \lambda}{\partial t} + \frac{\partial}{\partial z} (\lambda u) = 0}$$

$$\frac{\partial \bar{z}'}{\partial s} + \bar{z}' \frac{\partial}{\partial z} \bar{z}' + \frac{1}{\lambda} \frac{\partial}{\partial z} (\lambda \Delta z'^2) = \ddot{z}'$$

$$\Rightarrow \frac{\partial u}{\partial t} + u \frac{\partial u}{\partial z} + \frac{1}{\lambda} \frac{\partial}{\partial z} (\lambda [\langle v_z^2 \rangle - u^2]) = \ddot{z}'$$

Since  $p_z = m \int_{-\infty}^{\infty} n [v_z^2 - u^2] dv_z =$  where  $n = \frac{\lambda}{\pi v_0^2}$

$$\Rightarrow \boxed{\frac{\partial u}{\partial t} + u \frac{\partial u}{\partial z} + \frac{\pi n_0^2}{m \lambda} \frac{\partial}{\partial z} p_z = \ddot{z}'}$$

where  $\ddot{z}' = \frac{d^2 z'}{dt^2} = \frac{F_z}{m}$

"LONGITUDINAL" OR "RESISTIVE WALL" INSTABILITY

Let us return to the 1-D FLUID EQUATIONS

$$\frac{\partial \lambda}{\partial t} + \frac{\partial}{\partial z} \lambda u = 0$$

$$\frac{\partial u}{\partial t} + u \frac{\partial u}{\partial z} + \frac{1}{\rho} \frac{\partial p_e}{\partial z} = \frac{-g \rho}{4\pi \epsilon_0 m v_0^2} \frac{\partial \lambda}{\partial z} + \frac{\rho E_z}{m}$$

↑  
IGNORE  
AGAIN

↑  
EXTERNALLY  
GENERATED

SEE  
REISER 6.3.2.  
CALLAHAN-MILLER, PH.D. DISSERTATION,  
U.C. DAVIS, 1994

AS BEAM PASSES CONDUCTING SURFACE IMAGE CHARGE AND CURRENT INTERACTS WITH BEAM. HIGHLY GEOMETRY DEPENDENT.

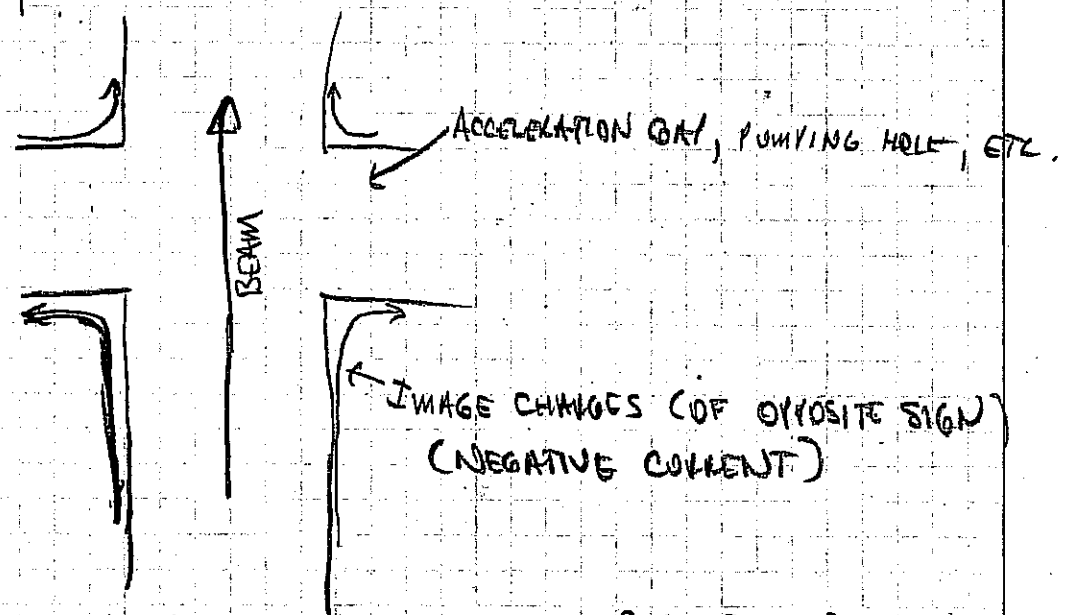

CAN BE CALCULATED APPROXIMATELY USING CIRCUIT MODEL.

RESISTIVITY IN WALL, AND COMPLICATED ELECTRON FLOW PATTERNS CREATE A RETARDING ELECTRIC FIELD ON BEAM.

# MODEL OF IMPEDANCE (IN LONG WAVELENGTH REGIME) (6)

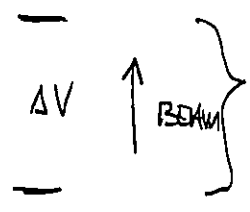
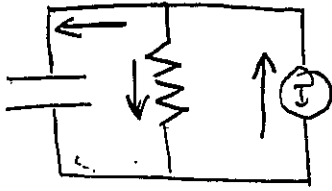

ONE MODULE OF MANY, EACH SEPARATED BY DISTANCE L

$$I = C \frac{d\Delta V}{dt} + \frac{\Delta V}{R}$$

$$I = [CL] \frac{d\Delta V/L}{dt} + \frac{\Delta V/L}{R/L}$$

$$E = -\frac{\Delta V}{L}$$

$$C^* = CL$$

$$R^* = \frac{R}{L}$$

LET  $I = I_0 + I_1 e^{-i\omega t}$

$E = E_0 + E_1 e^{-i\omega t}$

$$I_1 = i\omega C^* E_1 - \frac{E_1}{R^*}$$

$$\Rightarrow E_1 = \frac{-R^*}{1 - i\omega C^* R^*} I_1$$

$$Z^* \equiv \frac{-E_1}{I_1} = \frac{R^*}{1 - i\omega C^* R^*}$$

## RETURNING TO THE 1D FLUID EQUATIONS

$$\frac{\partial \lambda}{\partial t} + \frac{\partial}{\partial z} \lambda v = 0$$

$$\frac{\partial u}{\partial t} + u \frac{\partial u}{\partial z} = \frac{-\rho g}{4\pi\epsilon_0 m} \frac{\partial \lambda}{\partial z} + \frac{\rho E_0}{m}$$

Let  $\lambda = \lambda_0 + \lambda_1 \exp[i(kz - \omega t)]$

$u = v_0 + u_1 \exp[i(kz - \omega t)]$

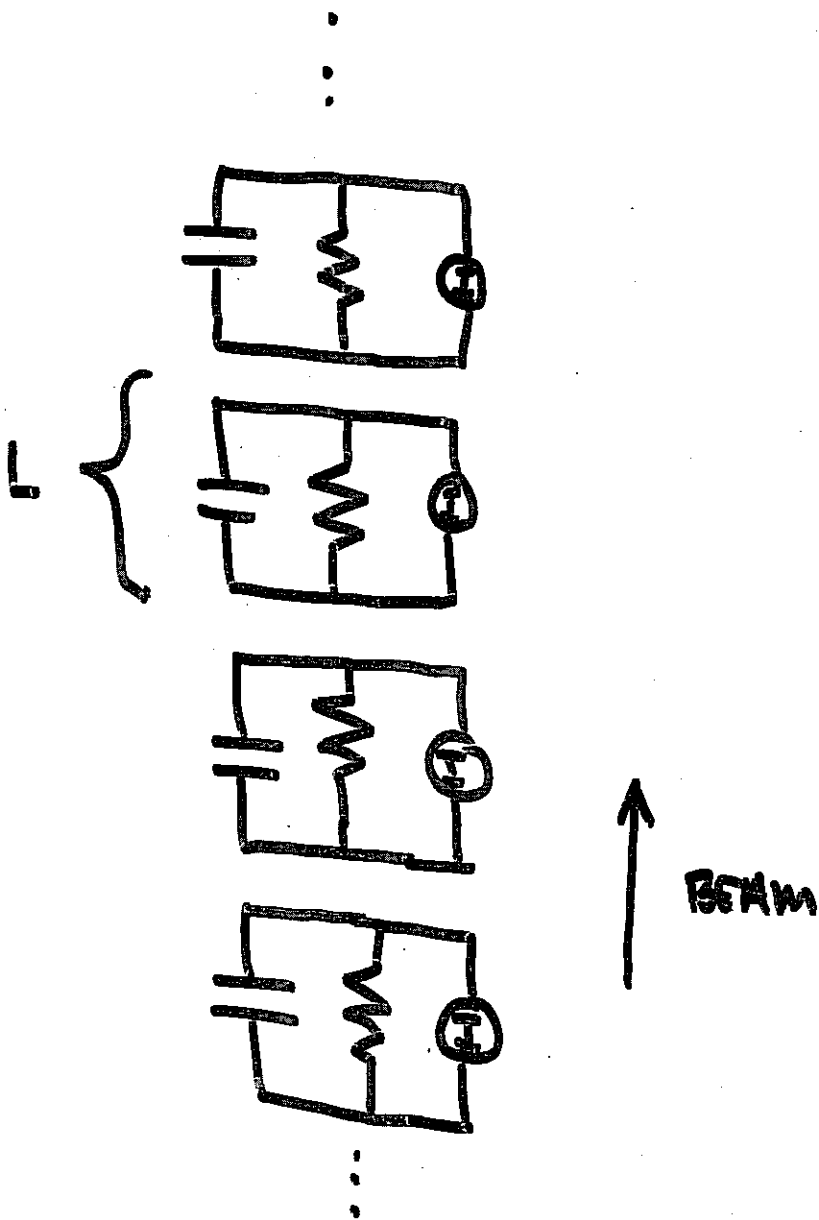

CONTINUOUS LIMIT :

$$R^* = R/L$$

$$C^* = CL$$

$$E = \frac{\Delta V}{L}$$

Resistance per unit length  
 $C^*$  per unit length

AVERAGE ELECTRIC  
 FIELD

$$-i\omega\lambda_1 + ik\lambda_0 u_1 + ikv_0\lambda_1 = 0$$

$$-i\omega u_1 + ikv_0 u_1 + \underbrace{\frac{ikqg\lambda_1}{4\pi\epsilon_0 m}}_{= \frac{ikc_s^2}{\lambda_0} \lambda_1} + \frac{q}{m} z^* \underbrace{(\lambda_0 v_1 + v_0 \lambda_1)}_{= I_1} = 0$$

$$\begin{bmatrix} \omega - kv_0 & -k\lambda_0 \\ -\frac{c_s^2 k}{\lambda_0} + \frac{iq}{m} z^* v_0 & \omega - kv_0 + \frac{iq}{m} z^* \lambda_0 \end{bmatrix} \begin{bmatrix} \lambda_1 \\ u_1 \end{bmatrix} = 0$$

THE DETERMINANT OF THE ABOVE MATRIX MUST VANISH:

$$(\omega - kv_0)^2 + \frac{iq}{m} z^* \lambda_0 (\omega - kv_0) - c_s^2 k^2 + \frac{iq}{m} z^* \lambda_0 v_0 k = 0$$

$$\boxed{(\omega - kv_0)^2 - c_s^2 k^2 + \frac{iq z^* \lambda_0 \omega}{m} = 0} \quad (\text{LAB FRAME})$$

Using a Galilean transformation, in the beam frame:

$$\omega' = \omega - kv_0$$

$$k' = k$$

' denotes beam frame

$$\boxed{\omega'^2 - c_s^2 k'^2 + \frac{iq z^*(\omega') \lambda_0 (\omega' + kv_0)}{m} = 0} \quad (\text{BEAM FRAME})$$

NOTE  $z^*(\omega') = z^*(\omega = \omega' + kv_0)$

CASE I PURE RESISTIVE IMPEDANCE  $Z^* = R^*$  (REAL)

$$\omega' = \pm c_s k' \sqrt{1 - i R^* \frac{g \lambda_0}{\omega} \frac{(\omega' + k' v_0)}{c_s^2 k'^2}}$$

Using  $c_s^2 = \frac{g \lambda_0}{4\pi \epsilon_0 \omega}$  and  $\frac{\omega'}{k'} \sim c_s \ll v_0$

$$\omega' = \pm c_s k' \sqrt{1 - i R^* \left(\frac{4\pi \epsilon_0}{g}\right) \frac{v_0}{k'}}$$

$$\approx \pm \left[ c_s k' - i \frac{c_s v_0}{2} \left(\frac{4\pi \epsilon_0}{g}\right) R^* \right]$$

Since  $\lambda_1, E_1 \sim \exp [i(kz' - \omega t')]$

Choosing "+" (Re  $\omega' > 0$ )  $\Rightarrow z' = c_s t'$  line of const phase  $\Rightarrow$  Forward propagating

(Im  $\omega' < 0$ )  $\Rightarrow \lambda_1 \sim \exp \left[ -\frac{c_s v_0}{2} \left(\frac{4\pi \epsilon_0}{g}\right) R^* t' \right] \Rightarrow$  DECAYING PERTURBATION

Choosing "-"

(Re  $\omega' < 0$ )  $\Rightarrow z' = -c_s t'$  is line of constant phase

$\Rightarrow$  BACKWARD PROPAGATING

$$\Rightarrow \lambda_1 \sim \exp \left[ \underbrace{\frac{c_s v_0}{2} \left(\frac{4\pi \epsilon_0}{g}\right) R^* t'}_G \right]$$

INSTABILITY!



$$\lambda_1 \approx \lambda_{i0} \exp[G]$$

(9)

$$G = \left[ \frac{C_s V_0}{2} \left( \frac{4\pi\epsilon_0}{g} \right) R^2 t \right] = \begin{matrix} \text{LOGARITHMIC} \\ \text{GAIN} \\ \text{OF} \\ \text{INSTABILITY} \end{matrix} = \ln \left( \frac{\lambda_{\text{final}}}{\lambda_{\text{initial}}} \right)$$

Now  $t_{\text{max}} = \begin{cases} \min \left\{ \begin{matrix} l_b / c_s \\ t_{\text{residence}} \end{matrix} \right. \end{cases}$

TRANSIT TIME FOR PERTURBATION TO TRAVEL FROM HEAD TO TAIL

RESIDENCE TIME WITHIN ACCELERATOR

IF upper condition holds

$$G \sim \frac{V_0^2}{2} \left( \frac{4\pi\epsilon_0}{g} \right) R^2 \Delta t$$

IF lower condition holds

$$G \sim \sqrt{\lambda}$$

$$E = QV$$

(10)

$$I \sim \frac{Q \cdot W \cdot J}{4 \text{ GeV} \cdot 200 \text{ ns}} \sim \frac{QV}{V \Delta t} \\ \sim 7.5 \text{ kA}$$

EXAMPLE:

FOR MATCHED BEAM IMPEDANCE

$$R^* = \frac{\Delta V / \Delta s}{I} \sim \frac{10^6 \text{ V/m}}{10 \text{ kA}} \sim 100 \text{ } \Omega / \text{m}$$

$$v_0 \sim 0.2c$$

$$\Delta t \sim 200 \text{ ns}$$

$$G \sim \frac{v_0^2}{2} \left( \frac{4\pi\epsilon_0}{j} \right) R^* \Delta t$$

$$\sim 3.6$$

( AN EARLY CONCERN  
FOR HEAVY ION FUSION )

$$R^* = 100 \Omega/m$$

11

CHAPTER 4. SIMULATIONS WITH MODULE IMPEDANCE

63

FOR ALL  
SIMULATIONS  
(p 11-15)

$$V_0 = C/3$$

$$I = 3 \text{ kA}$$

$$l_b = 10 \text{ m}$$

$$\frac{r_b}{r_p} = 0.4$$

$$kT_{\perp} = kT_{\parallel} = 10 \text{ keV}$$

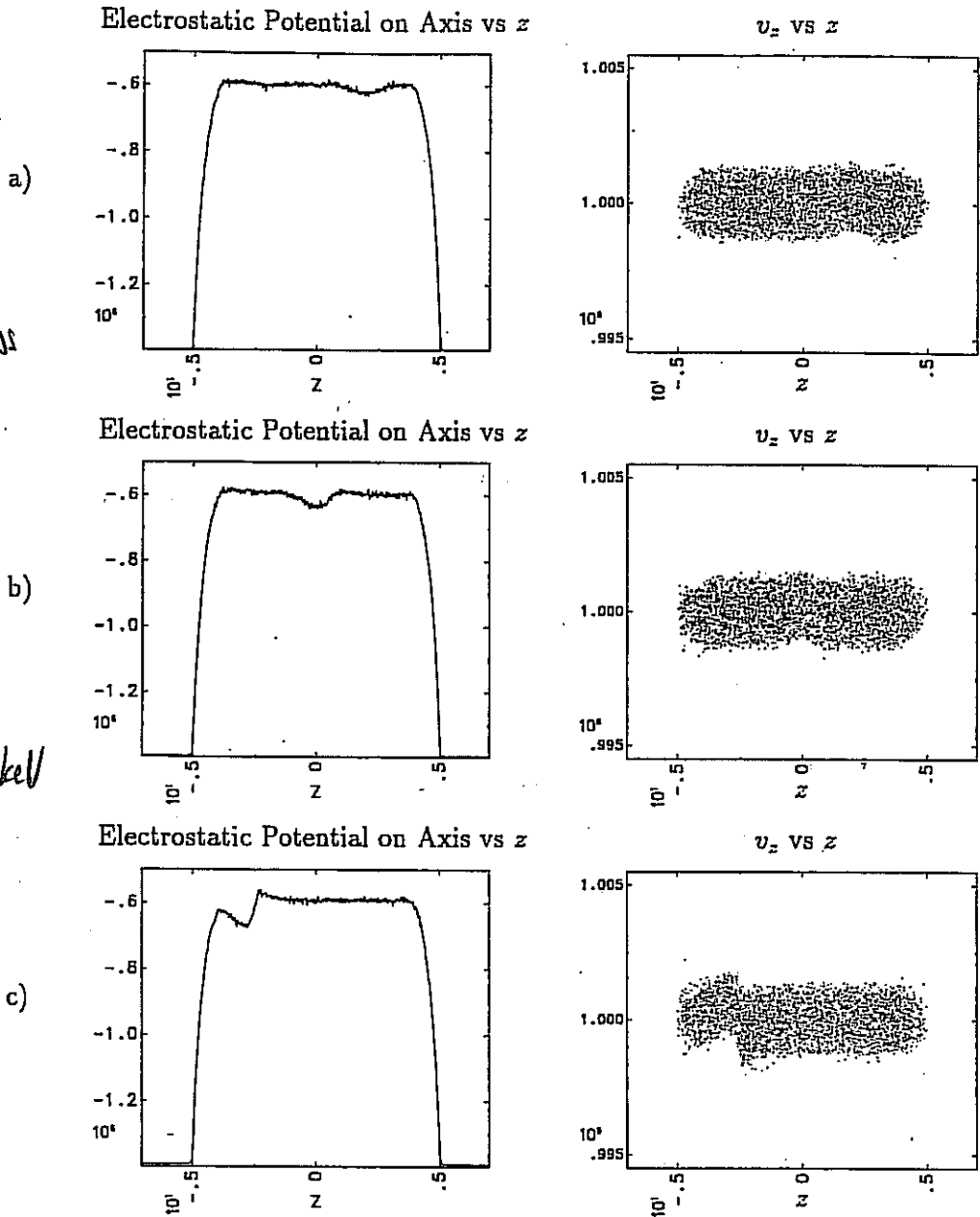

Figure 4.2: A simulation with 100  $\Omega/m$  resistance shows moderate growth. (a) 6.6  $\mu\text{s}$ , (b) 10.9  $\mu\text{s}$ , (c) 17.5  $\mu\text{s}$

from D.A. Callahan Miller, Ph.D. Thesis  
U.C. Davis, 1994

$$R^* = 100 \Omega/m$$

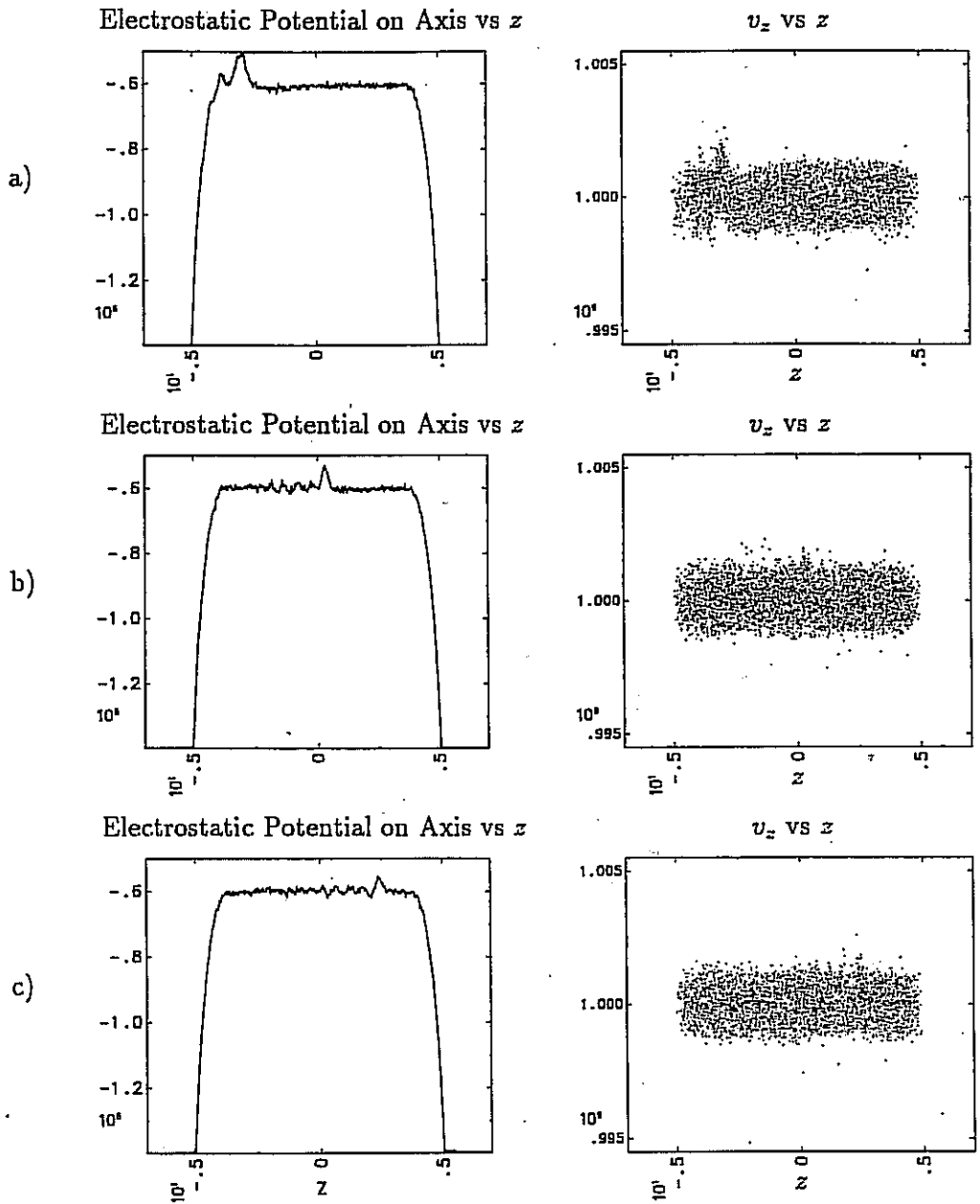

Figure 4.3: The perturbation reflects off the beam end and decays as it travels forward. (a) 28.4  $\mu$ s, (b) 35.0  $\mu$ s, (c) 39.4  $\mu$ s

from D.A. Callahan Miller, Ph.D. Thesis  
U.C. Davis, 1994  
(FORWARD WAVE)

$$R^* = 200 \Omega/m$$

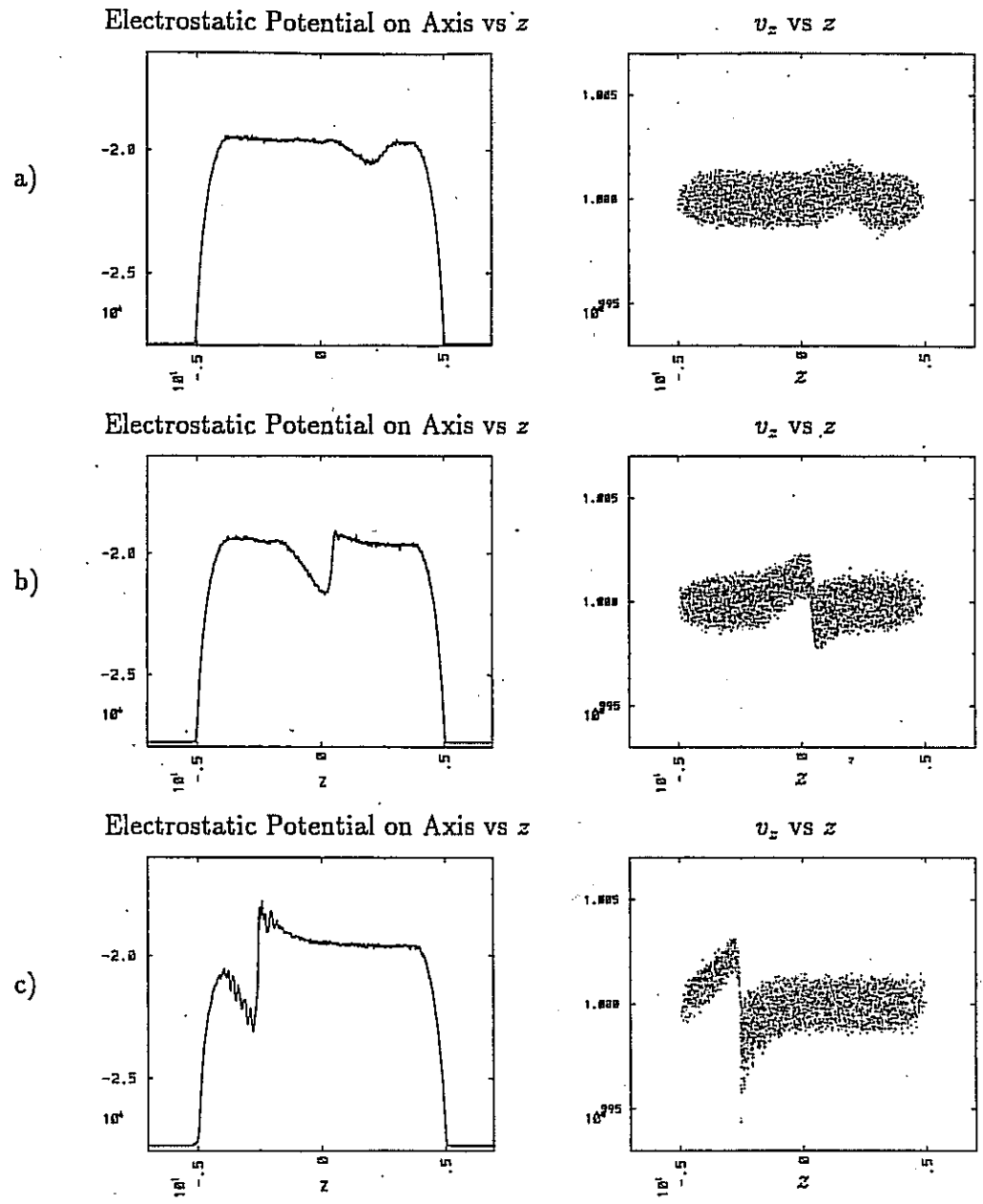

Figure 4.1: A simulation with 200  $\Omega/m$  resistance shows large amounts of growth. (a) 6.6  $\mu s$ , (b) 10.9  $\mu s$ , (c) 17.5  $\mu s$

From D.A. Callahan Miller, Ph.D. Thesis  
U.C. Davis, 1994

## CASE II RESISTIVE + CAPACITIVE IMPEDANCE

$$Z^* = \frac{R^*}{1 - i\omega C^+ R^*} = \frac{R^* + i\omega C^+ R^{*2}}{1 + \omega^2 C^{+2} R^{*2}}$$

GOING BACK TO (10) 7:

IN LAB FRAME:

$$(\omega - kv_0)^2 - c_s^2 k^2 + \frac{i q R^* \lambda_0 \omega}{m(1 + \omega^2 C^{+2} R^{*2})} - \frac{q \omega^2 C^+ R^{*2} \lambda_0}{m(1 + \omega^2 C^{+2} R^{*2})} = 0$$

$$(\omega - kv_0)^2 - c_s^2 k^2 - \frac{4\pi\epsilon_0 \omega^2 C^+ R^{*2} c_s^2}{g(1 + \omega^2 C^{+2} R^{*2})} + \frac{i 4\pi\epsilon_0 c_s^2 R_x^* \omega}{g(1 + \omega^2 C^{+2} R^{*2})}$$

IN BEAM FRAME:

$$\omega'^2 - c_s^2 k^2 - \frac{4\pi\epsilon_0 (\omega' + kv_0)^2 C^+ R^{*2} c_s^2}{g(1 + (\omega' + kv_0)^2 C^{+2} R^{*2})} + \frac{i 4\pi\epsilon_0 c_s^2 R_x^* (\omega' + kv_0)}{g(1 + \omega'^2 C^{+2} R^{*2})}$$

So if one takes limit  $C \rightarrow \infty$  the final two terms tend to zero. Thus capacitance has reduced the instability growth rate.

$$RC^* = 2 \times 10^{-8} \text{ s}$$

$$R^* = 100 \Omega/\text{m}$$

15

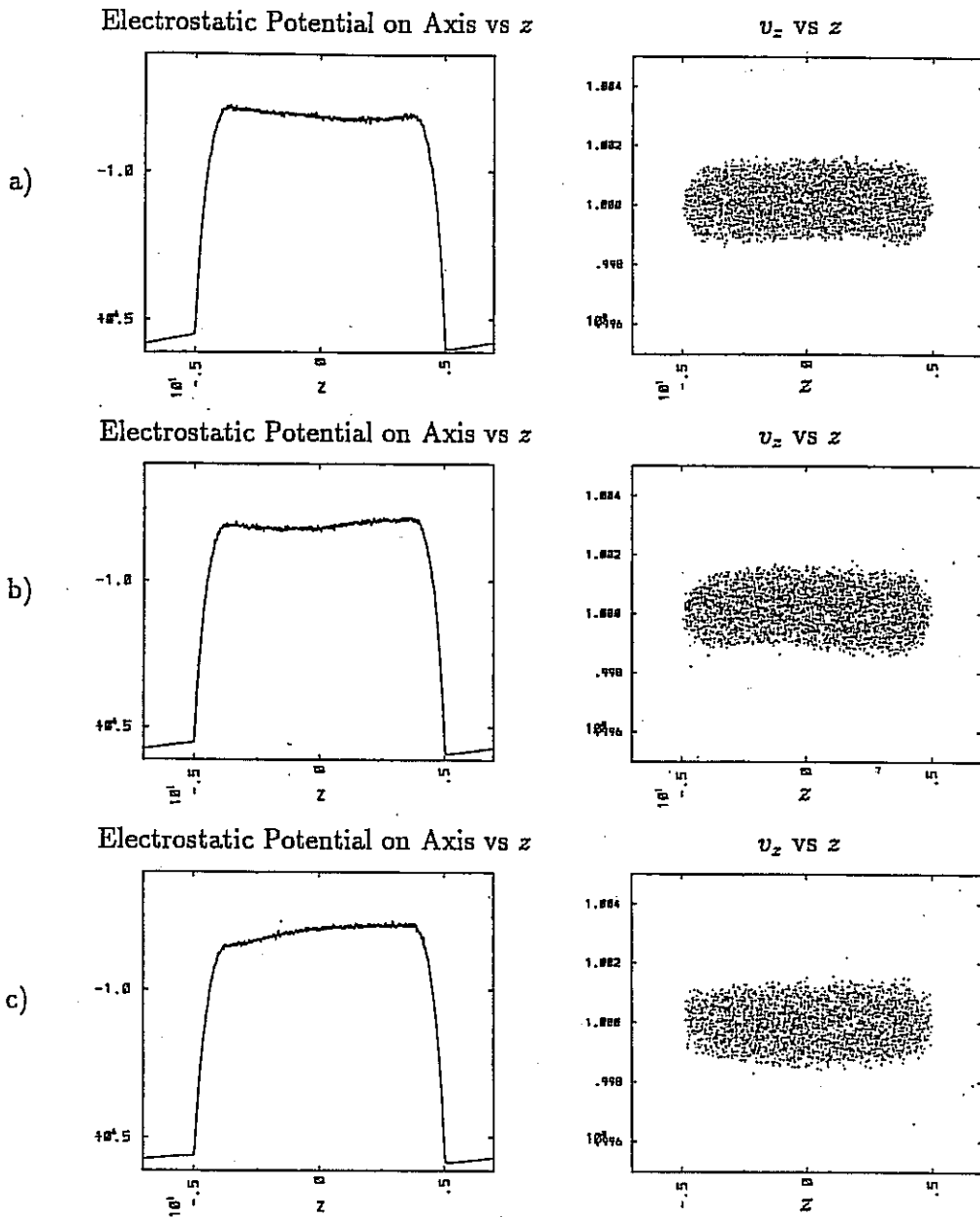

Figure 4.6: When capacitance is added to the system, a larger perturbation is launched, but little growth occurs (a) 6.6 μs, (b) 10.9 μs, (c) 17.5 μs

from D.A. Callahan Miller, Ph.D. Thesis,  
U.C. Davis, 1994

SUMMARY OF LONGITUDINAL INSTABILITY

"RESISTIVE WALL" OR "LONGITUDINAL" INSTABILITY HAS POTENTIAL TO DEGRADE LONGITUDINAL EMITTANCE IN HIGH CURRENT ACCELERATORS.

HOWEVER, CAPACITANCE (e.g. FROM ACCELERATING GRAYS) DECREASES GROWTH CAN MITIGATE INSTABILITY,

NOT DISCUSSED:

1. LONGITUDINAL TEMPERATURE DRIFTS INSTABILITY (C.F. KEISER 6.3.3)
2. FEED BACK HAS BEEN PROPOSED TO CONTROL INSTABILITY IF NEEDED

42-182 100 SHEETS  
Made in U.S.A.  
National Brand



## DRIFT COMPRESSION

OBJECTS :

APPLY A HEAD-TO-TAIL VELOCITY TILT TO  
INCREASE CURRENT BY DECREASING PULSE DURATION

DURING COMPRESSION "TAILS" ARE NOT REQUIRED

AT END OF DRIFT COMPRESSION, VELOCITY "TILT"  
SHOULD BE MINIMIZED, SO THAT CHROMATIC  
ABERRATIONS IN FINAL FOCUS ARE MINIMIZED.

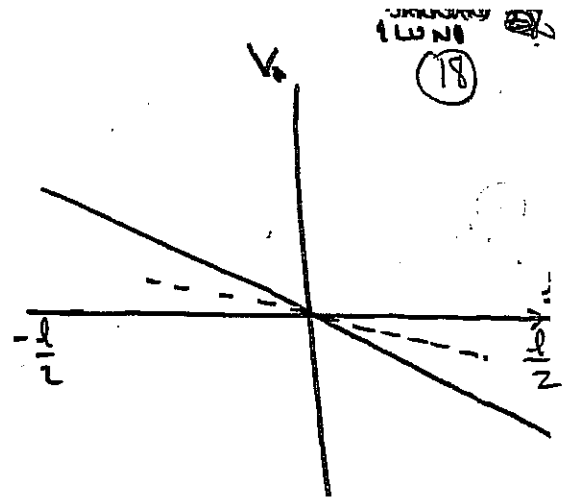
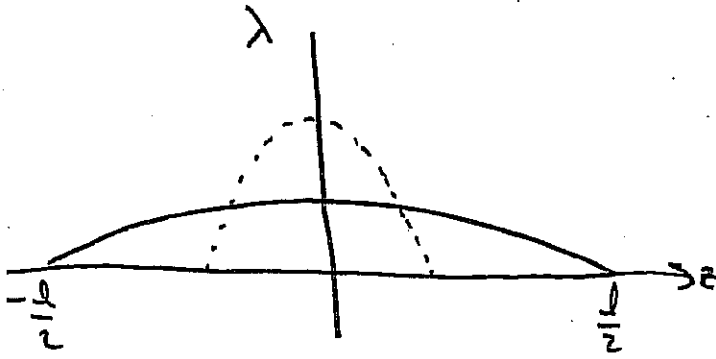

$$\frac{\partial \lambda}{\partial t} + \frac{\partial}{\partial z} \lambda v = 0$$

CONTINUITY EQUATION

$$\frac{\partial v}{\partial t} + v \frac{\partial v}{\partial z} = -\frac{\rho g}{4\pi\epsilon_0} \frac{\partial \lambda}{\partial z}$$

MOMENTUM EQUATION

LET  $\lambda = \lambda_0(t) \left(1 - \frac{4z^2}{l^2(t)}\right)$

← PARABOLIC LINE CHARGE PROFILE

$$v = -\Delta V(t) \frac{z}{l(t)}$$

← LINEAR VELOCITY PROFILE

① MASS conservation:

$$Q_c = \int_{-l/2}^{l/2} \lambda dz = \lambda_0 \int_{-l/2}^{l/2} \left(1 - \frac{4z^2}{l^2}\right) dz = \frac{2}{3} \lambda_0 l = \text{constant}$$

(but  
 $\lambda_0 = \lambda_0(t)$   
 $l = l(t)$ )

# CALCULATING PARTIAL DERIVATIVES:

CHAPTER 19

$$\frac{\partial \lambda}{\partial t} = \dot{\lambda}_0 \left(1 - \frac{4z^2}{l^2}\right) + 2\lambda_0 \left(\frac{4z}{l^2}\right) \dot{z}$$

$$\frac{\partial \lambda}{\partial z} = -\frac{8z}{l^2} \lambda_0$$

$$\frac{\partial V}{\partial t} = -\dot{\Delta V} \left(\frac{z}{l}\right) + \frac{\Delta V z}{l^2} \dot{z}$$

FROM DEFINITION OF  $\Delta V$  &  $\dot{z}$ :  
 $\Delta V = -\dot{z}$

$$\frac{\partial V}{\partial z} = -\frac{\Delta V}{l}$$

② CONTINUITY EQUATION  $\Rightarrow \left(1 - \frac{4z^2}{l^2}\right) \left(\dot{\lambda}_0 - \frac{\Delta V \lambda_0}{l}\right) = 0$

③ MOMENTUM EQUATION  $\Rightarrow \left(\frac{z}{l}\right) \left[-\dot{\Delta V} + \frac{\dot{z} \Delta V}{l} + \frac{\Delta V^2}{l} + \frac{8z}{4\pi\epsilon_0} \frac{\lambda_0}{l}\right] = 0$

① & ②  $\Rightarrow \frac{\dot{\lambda}_0}{\lambda_0} = \frac{\Delta V}{l} = -\frac{\dot{z}}{l}$  ④

③ & ④  $\Rightarrow \ddot{z} - \frac{12z}{4\pi\epsilon_0 M} \frac{Q_c}{l^2} = 0$

where  $Q_c = \frac{2}{3} \lambda_0 l = \text{const.}$   
!!!  
CHANGE IN LENGTH (NOT PERIOD)

LONGITUDINAL "ENVELOPE" EQUATION  
(WITHOUT EMITTANCE)

MULTIPLY BY  $\dot{l}$  & INTEGRATE:

$$\frac{\dot{l}^2}{2} + \frac{1299}{4\pi\epsilon_0 m} \frac{Q_c}{l} = \frac{\dot{l}_f^2}{2} + \frac{1299}{4\pi\epsilon_0 m} \frac{Q_c}{l_f}$$

HERE SUBSCRIPT "f"  
= "final"

& subscript "o"  
= original or initial

$$\Rightarrow \dot{l}_o = \sqrt{\frac{1699}{4\pi\epsilon_0 m} \lambda_f \left[ 1 - \frac{l_f}{l_o} \right]}$$

Now  $Q_f = \frac{\lambda_f}{4\pi\epsilon_0 V_f}$  = FINAL PERVEANCE  
AT CENTER OF  
PARABOLIC TULSE

(NOTE  $Q_c = \frac{2}{3} \lambda_o l$   
= CHARGE

whereas  $Q_f =$  PERVEANCE  
DIMENSIONLESS

$C =$  COMPRESSION RATIO  $= \frac{l_o}{l_f}$

$\frac{\Delta V}{V_o} =$  velocity tilt  $= \frac{|\dot{l}|}{V_o}$

$$\rightarrow \frac{\Delta V}{V} = \sqrt{89 Q_f \left[ 1 - \frac{1}{C} \right]}$$

for  $Q_f = 10^{-4}$   
 $g = 1.1$   
 $C = 20$

$$\Rightarrow \frac{\Delta V}{V} = 0.029$$

$$\text{DLIFT LENGTH} \approx \frac{l}{\Delta V} V_o = \frac{l}{\Delta V/V} = 345 \text{ m for } l = 10 \text{ m}$$

Vlasov - equation for a drifting beam:

$$\frac{\partial f}{\partial s} + x' \frac{\partial f}{\partial x} + x'' \frac{\partial f}{\partial x'} + y' \frac{\partial f}{\partial y} + y'' \frac{\partial f}{\partial y'} + z' \frac{\partial f}{\partial z} + z'' \frac{\partial f}{\partial z'} = 0$$

$$\text{Let } \tilde{f}(z, z', s) \equiv \iiint f \, dx \, dx' \, dy \, dy'$$

INTEGRATING VLASOV EQUATION:

If  $z'' \neq f(x, x', y, y')$ :

$$\Rightarrow \frac{\partial \tilde{f}}{\partial s} + \iiint x' \frac{\partial f}{\partial x} \, dx \, dx' \, dy \, dy' + \dots + z' \frac{\partial \tilde{f}}{\partial z} + z'' \frac{\partial \tilde{f}}{\partial z'} = 0$$

$$\Rightarrow \boxed{\frac{\partial \tilde{f}}{\partial s} + z' \frac{\partial \tilde{f}}{\partial z} + z'' \frac{\partial \tilde{f}}{\partial z'} = 0} \quad \text{1D Vlasov}$$

Now let  $\lambda \equiv q \int \tilde{f} \, dz'$ ;  $\lambda \bar{z}' = \int \tilde{f} z' \, dz'$ ;  $\lambda \bar{z}'^2 = \int \tilde{f} z'^2 \, dz'$

Also, let  $\Delta z'^2 \equiv \bar{z}'^2 - (\bar{z}')^2$

FLUID EQUATIONS

INTEGRATING 1D VLASOV OVER  $z'$ :

$$\boxed{\frac{\partial \lambda}{\partial s} + \frac{\partial (\lambda \bar{z}')}{\partial z} = 0} \quad \text{(CONTINUITY EQUATION)}$$

MULTIPLYING BY  $z'$  & INTEGRATING VLASOV OVER  $z'$ :

$$\frac{\partial \lambda \bar{z}'}{\partial s} + \frac{\partial \lambda \bar{z}'^2}{\partial z} - \lambda z'' = 0$$

DIVIDING BY  $\lambda$ , USING CONTINUITY EQUATION & DEFINITION OF  $\Delta z'^2$ :

$$\boxed{\underbrace{\frac{\partial \bar{z}'}{\partial s} + \bar{z}' \frac{\partial \bar{z}'}{\partial z}}_{\text{INERTIAL}} + \underbrace{\frac{1}{\lambda} \frac{\partial (\lambda \Delta z'^2)}{\partial z}}_{\text{PRESSURE TERM}} = \underbrace{z''}_{\text{FORCE}}} \quad \text{(MOMENTUM EQUATION)}$$

13-702  
42-301  
42-302  
42-303  
42-304  
42-305  
42-306  
42-307  
42-308  
42-309  
42-310  
42-311  
42-312  
42-313  
42-314  
42-315  
42-316  
42-317  
42-318  
42-319  
42-320  
42-321  
42-322  
42-323  
42-324  
42-325  
42-326  
42-327  
42-328  
42-329  
42-330  
42-331  
42-332  
42-333  
42-334  
42-335  
42-336  
42-337  
42-338  
42-339  
42-340  
42-341  
42-342  
42-343  
42-344  
42-345  
42-346  
42-347  
42-348  
42-349  
42-350  
42-351  
42-352  
42-353  
42-354  
42-355  
42-356  
42-357  
42-358  
42-359  
42-360  
42-361  
42-362  
42-363  
42-364  
42-365  
42-366  
42-367  
42-368  
42-369  
42-370  
42-371  
42-372  
42-373  
42-374  
42-375  
42-376  
42-377  
42-378  
42-379  
42-380  
42-381  
42-382  
42-383  
42-384  
42-385  
42-386  
42-387  
42-388  
42-389  
42-390  
42-391  
42-392  
42-393  
42-394  
42-395  
42-396  
42-397  
42-398  
42-399  
42-400  
42-401  
42-402  
42-403  
42-404  
42-405  
42-406  
42-407  
42-408  
42-409  
42-410  
42-411  
42-412  
42-413  
42-414  
42-415  
42-416  
42-417  
42-418  
42-419  
42-420  
42-421  
42-422  
42-423  
42-424  
42-425  
42-426  
42-427  
42-428  
42-429  
42-430  
42-431  
42-432  
42-433  
42-434  
42-435  
42-436  
42-437  
42-438  
42-439  
42-440  
42-441  
42-442  
42-443  
42-444  
42-445  
42-446  
42-447  
42-448  
42-449  
42-450  
42-451  
42-452  
42-453  
42-454  
42-455  
42-456  
42-457  
42-458  
42-459  
42-460  
42-461  
42-462  
42-463  
42-464  
42-465  
42-466  
42-467  
42-468  
42-469  
42-470  
42-471  
42-472  
42-473  
42-474  
42-475  
42-476  
42-477  
42-478  
42-479  
42-480  
42-481  
42-482  
42-483  
42-484  
42-485  
42-486  
42-487  
42-488  
42-489  
42-490  
42-491  
42-492  
42-493  
42-494  
42-495  
42-496  
42-497  
42-498  
42-499  
42-500  
42-501  
42-502  
42-503  
42-504  
42-505  
42-506  
42-507  
42-508  
42-509  
42-510  
42-511  
42-512  
42-513  
42-514  
42-515  
42-516  
42-517  
42-518  
42-519  
42-520  
42-521  
42-522  
42-523  
42-524  
42-525  
42-526  
42-527  
42-528  
42-529  
42-530  
42-531  
42-532  
42-533  
42-534  
42-535  
42-536  
42-537  
42-538  
42-539  
42-540  
42-541  
42-542  
42-543  
42-544  
42-545  
42-546  
42-547  
42-548  
42-549  
42-550  
42-551  
42-552  
42-553  
42-554  
42-555  
42-556  
42-557  
42-558  
42-559  
42-560  
42-561  
42-562  
42-563  
42-564  
42-565  
42-566  
42-567  
42-568  
42-569  
42-570  
42-571  
42-572  
42-573  
42-574  
42-575  
42-576  
42-577  
42-578  
42-579  
42-580  
42-581  
42-582  
42-583  
42-584  
42-585  
42-586  
42-587  
42-588  
42-589  
42-590  
42-591  
42-592  
42-593  
42-594  
42-595  
42-596  
42-597  
42-598  
42-599  
42-600  
42-601  
42-602  
42-603  
42-604  
42-605  
42-606  
42-607  
42-608  
42-609  
42-610  
42-611  
42-612  
42-613  
42-614  
42-615  
42-616  
42-617  
42-618  
42-619  
42-620  
42-621  
42-622  
42-623  
42-624  
42-625  
42-626  
42-627  
42-628  
42-629  
42-630  
42-631  
42-632  
42-633  
42-634  
42-635  
42-636  
42-637  
42-638  
42-639  
42-640  
42-641  
42-642  
42-643  
42-644  
42-645  
42-646  
42-647  
42-648  
42-649  
42-650  
42-651  
42-652  
42-653  
42-654  
42-655  
42-656  
42-657  
42-658  
42-659  
42-660  
42-661  
42-662  
42-663  
42-664  
42-665  
42-666  
42-667  
42-668  
42-669  
42-670  
42-671  
42-672  
42-673  
42-674  
42-675  
42-676  
42-677  
42-678  
42-679  
42-680  
42-681  
42-682  
42-683  
42-684  
42-685  
42-686  
42-687  
42-688  
42-689  
42-690  
42-691  
42-692  
42-693  
42-694  
42-695  
42-696  
42-697  
42-698  
42-699  
42-700  
42-701  
42-702  
42-703  
42-704  
42-705  
42-706  
42-707  
42-708  
42-709  
42-710  
42-711  
42-712  
42-713  
42-714  
42-715  
42-716  
42-717  
42-718  
42-719  
42-720  
42-721  
42-722  
42-723  
42-724  
42-725  
42-726  
42-727  
42-728  
42-729  
42-730  
42-731  
42-732  
42-733  
42-734  
42-735  
42-736  
42-737  
42-738  
42-739  
42-740  
42-741  
42-742  
42-743  
42-744  
42-745  
42-746  
42-747  
42-748  
42-749  
42-750  
42-751  
42-752  
42-753  
42-754  
42-755  
42-756  
42-757  
42-758  
42-759  
42-760  
42-761  
42-762  
42-763  
42-764  
42-765  
42-766  
42-767  
42-768  
42-769  
42-770  
42-771  
42-772  
42-773  
42-774  
42-775  
42-776  
42-777  
42-778  
42-779  
42-780  
42-781  
42-782  
42-783  
42-784  
42-785  
42-786  
42-787  
42-788  
42-789  
42-790  
42-791  
42-792  
42-793  
42-794  
42-795  
42-796  
42-797  
42-798  
42-799  
42-800  
42-801  
42-802  
42-803  
42-804  
42-805  
42-806  
42-807  
42-808  
42-809  
42-810  
42-811  
42-812  
42-813  
42-814  
42-815  
42-816  
42-817  
42-818  
42-819  
42-820  
42-821  
42-822  
42-823  
42-824  
42-825  
42-826  
42-827  
42-828  
42-829  
42-830  
42-831  
42-832  
42-833  
42-834  
42-835  
42-836  
42-837  
42-838  
42-839  
42-840  
42-841  
42-842  
42-843  
42-844  
42-845  
42-846  
42-847  
42-848  
42-849  
42-850  
42-851  
42-852  
42-853  
42-854  
42-855  
42-856  
42-857  
42-858  
42-859  
42-860  
42-861  
42-862  
42-863  
42-864  
42-865  
42-866  
42-867  
42-868  
42-869  
42-870  
42-871  
42-872  
42-873  
42-874  
42-875  
42-876  
42-877  
42-878  
42-879  
42-880  
42-881  
42-882  
42-883  
42-884  
42-885  
42-886  
42-887  
42-888  
42-889  
42-890  
42-891  
42-892  
42-893  
42-894  
42-895  
42-896  
42-897  
42-898  
42-899  
42-900  
42-901  
42-902  
42-903  
42-904  
42-905  
42-906  
42-907  
42-908  
42-909  
42-910  
42-911  
42-912  
42-913  
42-914  
42-915  
42-916  
42-917  
42-918  
42-919  
42-920  
42-921  
42-922  
42-923  
42-924  
42-925  
42-926  
42-927  
42-928  
42-929  
42-930  
42-931  
42-932  
42-933  
42-934  
42-935  
42-936  
42-937  
42-938  
42-939  
42-940  
42-941  
42-942  
42-943  
42-944  
42-945  
42-946  
42-947  
42-948  
42-949  
42-950  
42-951  
42-952  
42-953  
42-954  
42-955  
42-956  
42-957  
42-958  
42-959  
42-960  
42-961  
42-962  
42-963  
42-964  
42-965  
42-966  
42-967  
42-968  
42-969  
42-970  
42-971  
42-972  
42-973  
42-974  
42-975  
42-976  
42-977  
42-978  
42-979  
42-980  
42-981  
42-982  
42-983  
42-984  
42-985  
42-986  
42-987  
42-988  
42-989  
42-990  
42-991  
42-992  
42-993  
42-994  
42-995  
42-996  
42-997  
42-998  
42-999  
42-1000

### LONGITUDINAL ENVELOPE EQUATION

$$\frac{\partial^2 z}{\partial s^2} + z' \frac{\partial^2 z}{\partial z^2} + z'' \frac{\partial^2 z}{\partial z'^2} = 0$$

$Q_c = \text{total charge in bunch}$

$$\text{If } z'' = -K(s)z + \frac{gg}{4\pi\epsilon_0 m v^2} \left( \frac{12Q_c}{L^3} \right) z$$

$$\Rightarrow \frac{\partial}{\partial s} \langle z^2 \rangle = 2 \langle z z' \rangle$$

$$\frac{\partial}{\partial s} \langle z z' \rangle = \langle z'^2 \rangle + \frac{gg}{4\pi\epsilon_0 m v^2} \left( \frac{12Q_c}{L^3} \right) \langle z^2 \rangle - K(s) \langle z^2 \rangle$$

$$\frac{\partial}{\partial s} \langle z'^2 \rangle = 2 \left( \frac{gg}{4\pi\epsilon_0 m v^2} \right) \left( \frac{12Q_c}{L^3} \right) \langle z z' \rangle - 2K(s) \langle z z' \rangle$$

NOTE  $\langle z^2 \rangle = \frac{1}{Q_c} \int_{-L}^0 \int_{-L/2}^{L/2} z^2 f(z, z') dz dz' = \frac{1}{20} L^2$

$$\epsilon_z^2 = 25 [ \langle z^2 \rangle \langle z'^2 \rangle - \langle z z' \rangle^2 ]$$

$$\Rightarrow \frac{d^2 L}{ds^2} = \frac{16 \epsilon_z^2}{L^3} + \frac{12 gg Q_c}{4\pi\epsilon_0 m v^2 L^2} - K(s) L$$

Let  $v_z = L/2$

$$\Rightarrow \frac{d^2 v_z}{ds^2} = \frac{\epsilon_z^2}{v_z^3} + \frac{3}{2} \frac{gg Q_c}{4\pi\epsilon_0 m v^2} \frac{1}{v_z^2} - K(s) v_z$$

# SELF-CONSISTENT LONGITUDINAL DISTRIBUTION:

## NEUFFER DISTRIBUTION

D. NEUFFER, PARTICLE ACCELERATORS,  
Vol II, p 23 (1980)

RETURNING TO THE 1D VLASOV EQUATION:

$$\frac{\partial f}{\partial s} + z' \frac{\partial f}{\partial z} + z'' \frac{\partial f}{\partial z'} = 0$$

$$\text{If } z'' = -A \frac{\partial \lambda}{\partial z} - K(s) z$$

THEN,

$$f(z, z', s) = \frac{3N}{2\pi \epsilon_z} \sqrt{1 - \frac{z^2}{v_z^2} - \frac{v_z^2 (z' - v_z' z / v_z)^2}{\epsilon_z^2}}$$

$$f_0 \quad -v_z < z < v_z$$

$$v_z' z - \frac{\epsilon_z}{v_z} \sqrt{1 - \frac{z^2}{v_z^2}} \leq z' \leq \frac{v_z' z}{v_z} + \frac{\epsilon_z}{v_z} \sqrt{1 - \frac{z^2}{v_z^2}}$$

is a solution to the 1D Vlasov equation.

$$\text{HERE } \epsilon_z^2 = 25 [ \langle z^2 \rangle \langle z'^2 \rangle - \langle z z' \rangle^2 ] = \text{CONSTANT}$$

$N$  = total number of particles in bunch

$v_z$  = hand edge of bunch

$$\text{NOTE THAT } \lambda(z) = \frac{3}{4} \frac{N}{v_z} \left( 1 - \frac{z^2}{v_z^2} \right) = \int_{-v_z}^{v_z} f(z, z', s) dz'$$

$$\Rightarrow \frac{\partial \lambda}{\partial z} \propto z \Rightarrow \text{LINEAR SPACE CHARGE FIELD}$$

# Neuffer Distribution Function

$$f[z, z'] = \frac{3N}{2\pi\epsilon_z} \sqrt{1 - \frac{z^2}{r_z^2} - \frac{r_z^2(z' - r_z z / r_z)^2}{\epsilon_z^2}}$$

for:

$$-r_z \leq z \leq r_z$$

$$\frac{r_z z}{r_z} - \frac{\epsilon_z}{r_z} \sqrt{1 - \frac{z^2}{r_z^2}} \leq z' \leq \frac{r_z z}{r_z} + \frac{\epsilon_z}{r_z} \sqrt{1 - \frac{z^2}{r_z^2}}$$

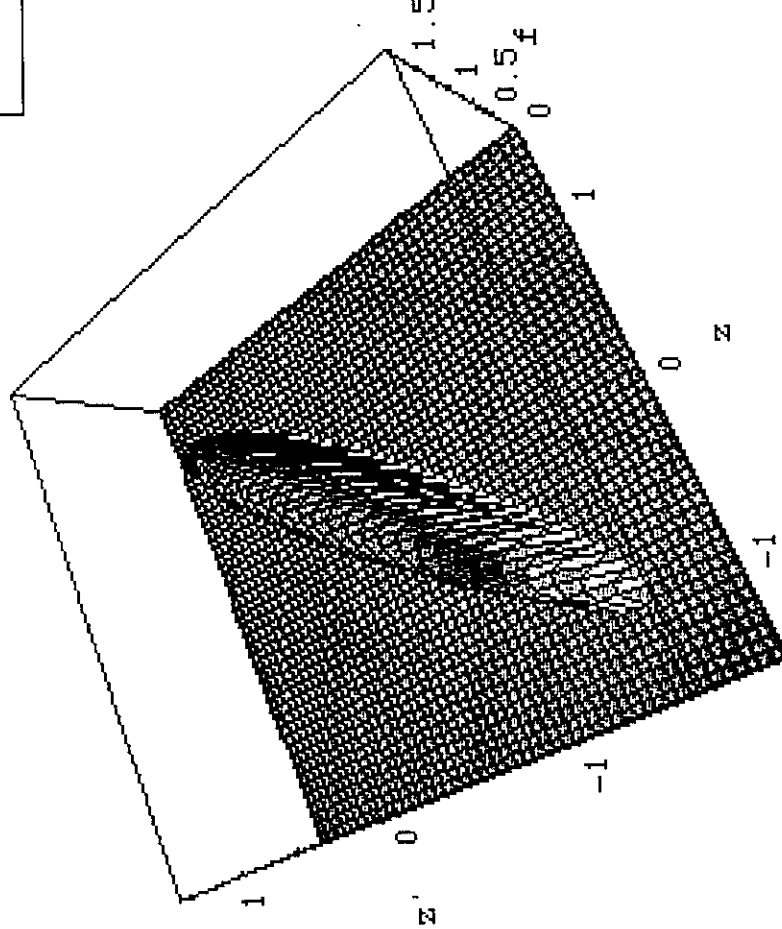

Neuffer Distribution Function

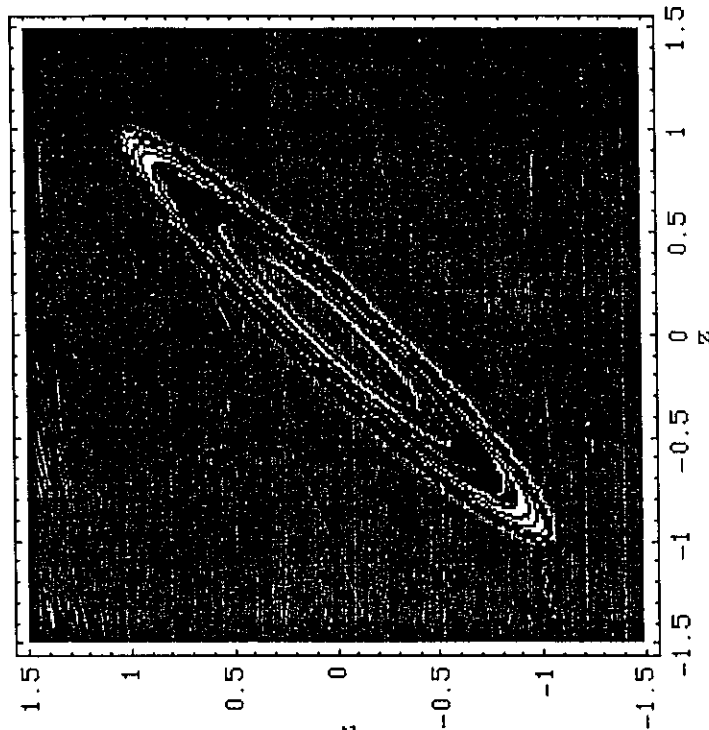

Here  $N=r_z=r_z'=1$ ;  $\epsilon_z=0.3$



NOTE:

- DISTRIBUTION FUNCTION HAS ELLIPTICAL BOUNDARY IN  $z-z'$  PHASE SPACE
- $\pi E_z$  IS AREA OF ELLIPSE AND  $K$  CONSTANT
- ANALOGOUS TO K-V DISTRIBUTION WITH LINEAR SPACE CHARGE FORCE AND SECOND ORDER ENVELOPE EQUATION TO DESCRIBE THE MOTION OF THE DISTRIBUTION:

$$\frac{d^2 r_z}{ds^2} = \frac{E_z^2}{r_z^3} + \frac{3}{2} \frac{AN}{r_z^2} - K(s) r_z$$

NOTE ALSO THAT NEUFFER FUNCTION CAN BE USED FOR BUNCHED BEAMS IN WHICH  $E_z \propto z$ , AS IN A UNIFORM DENSITY ELLIPSOID.

Summary

1D VLACON EQUATION

g-factor model

$$\frac{\partial f}{\partial s} + z' \frac{\partial f}{\partial z} + z'' \frac{\partial f}{\partial z'} = 0$$

$$z'' = \frac{-g}{4\pi\epsilon_0 m v_z^2} \frac{\partial \lambda}{\partial z}$$

Leads to fluid equations:

$$\frac{\partial \lambda}{\partial s} + \frac{\partial}{\partial z} (\lambda \bar{z}') = 0$$

$$\frac{\partial \bar{z}'}{\partial s} + \bar{z}' \frac{\partial \bar{z}'}{\partial z} + \frac{1}{\lambda} \frac{\partial}{\partial z} (\lambda \bar{z}'^2) + \frac{c_s^2}{\lambda_0 v_0^2} \frac{\partial \lambda}{\partial z} = 0$$

⇒ SPACE CHARGE WAVES

↳ LONGITUDINAL OR RESISTIVE WAVE INSTABILITY

⇒ SPACE CHARGE LATERALION WAVES

⇒ PARABOLIC BUNCH COMPRESSION  $\frac{\partial \lambda}{\partial z} \propto z$

VLACON EQUATION ALSO ⇒ ENVELOPE EQUATION

$$\frac{d^2 r_z}{ds^2} = \frac{E_z}{V_z^3} + \frac{3}{2} \frac{g g_0 c}{4\pi\epsilon_0 m v_z^2} \frac{1}{V_z^2} - K(s) r_z$$

KINETIC SOLUTION TO VLACON EQUATION SATISFYING VMC ENVELOPE EQUATION IS "MUFFET DISTRIBUTION" (ANALOGOUS TO KV).

$$f(z, z') = \frac{3N}{2\pi E_z} \sqrt{1 - \frac{z^2}{V_z^2} - \frac{r_z^2 (z' - v_z'/v_z)^2}{E_z^2}}$$

# Transverse Centroid and Envelope Descriptions of Beam Evolution\*

Steven M. Lund

Lawrence Livermore National Laboratory (LLNL)

Steven M. Lund and John J. Barnard

“Beam Physics with Intense Space-Charge”

US Particle Accelerator School

University of Maryland, held at Annapolis, MD

16-27 June, 2008

(Version 20080624)

\* Research supported by the US Dept. of Energy at LLNL and LBNL under contract Nos. DE-AC52-07NA27344 and DE-AC02-05CH11231.

SM Lund, USPAS, June 2008 Transverse Centroid and Envelope Descriptions of Beam Evolution 1

## Transverse Centroid and Envelope Model: Outline

Overview

Derivation of Centroid and Envelope Equations of Motion

Centroid Equations of Motion

Envelope Equations of Motion

Matched Envelope Solutions

Envelope Perturbations

Envelope Modes in Continuous Focusing

Envelope Modes in Periodic Focusing

Transport Limit Scaling Based on Envelope Models

Centroid and Envelope Descriptions via 1<sup>st</sup> order Coupled Moment Equations

Comments:

◆ Some of this material related to J.J. Barnard lectures:

- Transport limit discussions (**Introduction**)
  - Transverse envelope modes (**Continuous Focusing Envelope Modes and Halo**)
  - Longitudinal envelope evolution (**Longitudinal Beam Physics III**)
  - 3D Envelope Modes in a Bunched Beam (**Cont. Focusing Envelope Modes and Halo**)
- ◆ Specific topics will be covered in more detail here

SM Lund, USPAS, June 2008 Transverse Centroid and Envelope Descriptions of Beam Evolution 2

## Transverse Centroid and Envelope Model: Detailed Outline

1) Overview

2) Derivation of Centroid and Envelope Equations of Motion

Statistical Averages

Particle Equations of Motion

Distribution Assumptions

Self-Field Calculation: Direct and Image

Coupled Centroid and Envelope Equations of Motion

3) Centroid Equations of Motion

Single Particle Limit: Oscillation and Stability Properties

Effect of Driving Errors

Effect of Image Charges

4) Envelope Equations of Motion

KV Envelope Equations

Applicability of Model

Properties of Terms

5) Matched Envelope Solution

Construction of Matched Solution

Symmetries of Matched Envelope: Interpretation via KV Envelope Equations

Examples

SM Lund, USPAS, June 2008 Transverse Centroid and Envelope Descriptions of Beam Evolution 3

## Detailed Outline - 2

6) Envelope Perturbations

Perturbed Equations

Matrix Form: Stability and Mode Symmetries

Decoupled Modes

General Mode Limits

7) Envelope Modes in Continuous Focusing

Normal Modes: Breathing and Quadrupole Modes

Driven Modes

8) Envelope Modes in Periodic Focusing

Solenoidal Focusing

Quadrupole Focusing

Launching Conditions

9) Transport Limit Scaling Based on Envelope Models

Overview

Example for a Periodic Quadrupole FODO Lattice

Discussion and Application of Formulas in Design

Results of More Detailed Models

SM Lund, USPAS, June 2008 Transverse Centroid and Envelope Descriptions of Beam Evolution 4

## Detailed Outline - 3

### 10) Centroid and Envelope Descriptions via 1<sup>st</sup> Order Coupled Moment

#### Equations

#### Formulation

Example Illustration -- Familiar KV Envelope Model

#### Contact Information

#### References

### Oscillations in the statistical beam centroid and envelope radii are the

#### lowest-order collective responses of the beam

**Centroid Oscillations:** Associated with errors and are purposefully suppressed to the level possible

#### Error Sources:

- Beam distribution asymmetries
- Dipole bending terms from applied field optics
- Imperfect mechanical alignment

Exception: When the beam is kicked (insertion or extraction) into or out of a transport channel as is often done in rings

#### Envelope Oscillations: Can have two components in periodic focusing lattices

- 1) **Matched Envelope:** Periodic "flutter" synchronized to period of focusing lattice to yield net focusing
- 2) **Mismatched Envelope:** Excursions deviate from matched flutter motion and are seeded/driven by errors

Limiting maximum beam-edge excursions is desired for economical transport

- Reduces cost by Limiting material volume needed to transport an intense beam

## S1: Overview

Analyze transverse centroid and envelope properties of an unbunched ( $\partial/\partial z = 0$ ) beam

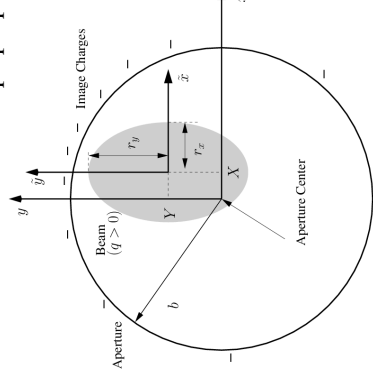

Transverse averages:

$$\langle \dots \rangle_{\perp} \equiv \frac{\int d^2 x_{\perp} \int d^2 x'_{\perp} \dots f_{\perp}}{\int d^2 x_{\perp} \int d^2 x'_{\perp} f_{\perp}}$$

#### Centroid:

$$\begin{aligned} X &= \langle x \rangle_{\perp} \\ Y &= \langle y \rangle_{\perp} \end{aligned}$$

x- and y-coordinates of beam center of mass

#### Envelope: (edge measure)

$$\begin{aligned} r_x &= 2 \sqrt{\langle (x - X)^2 \rangle_{\perp}} \\ r_y &= 2 \sqrt{\langle (y - Y)^2 \rangle_{\perp}} \end{aligned}$$

x- and y-principal axis radii of an elliptical beam envelope

Apply to general  $f$  but base on uniform density  $f$

Mismatched beams have larger envelope excursions and have more stability problems since mismatch adds another source of free energy that can drive statistical increases in particle amplitudes (see: J.J. Barnard lectures on **Envelopes and Halo**)

### Example: FODO Quadrupole Transport Channel

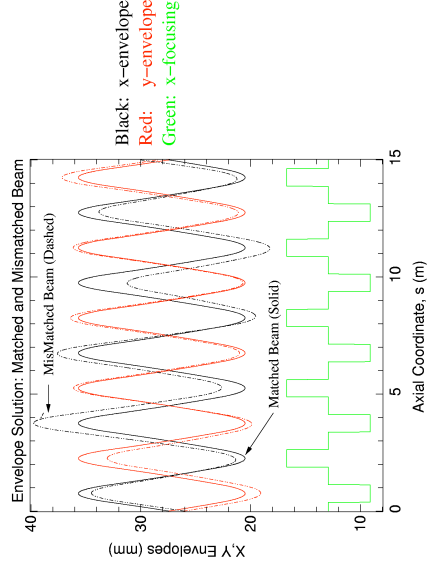

Larger machine aperture is needed to confine a mismatched beam

## Centroid and Envelope oscillations are the most important collective modes of an intense beam

- Force balances based on matched beam envelope equation predict scaling of transportable beam parameters
  - Used to design transport lattices
- Instabilities in beam centroid and/or envelope oscillations prevent reliable transport
  - Parameter locations of instability regions should be understood and avoided in machine design/operation

Although it is *necessary* to design to avoid envelope and centroid instabilities, it is not alone *sufficient* for effective machine operation

- Higher-order kinetic and fluid instabilities not expressed in the low-order envelope models can degrade beam quality and control and must also be evaluated

- To be covered (see: S.M. Lund, lectures on **Kinetic Stability**)

## S2: Derivation of Transverse Centroid and Envelope Equations of Motion

Analyze centroid and envelope properties of an unbunched ( $\partial/\partial z = 0$ ) beam  
 Transverse Statistical Averages:

Let  $N$  be the number of particles in a thin axial slice of the beam at axial coordinate  $s$ .

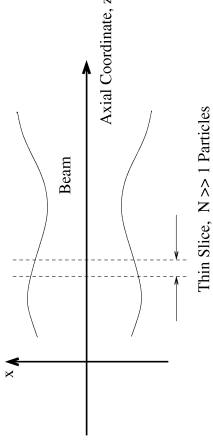

Equivalent averages can be defined in terms of the particles or the transverse Vlasov distribution function:

$$\begin{aligned} \langle \dots \rangle_{\perp} &\equiv \frac{1}{N} \sum_{i=1}^N \dots \\ \text{particles:} & \\ \langle \dots \rangle_{\perp} &\equiv \frac{\int d^2 x_{\perp} \int d^2 x'_{\perp} \dots f_{\perp}}{\int d^2 x_{\perp} \int d^2 x'_{\perp} f_{\perp}} \\ \text{distribution:} & \end{aligned}$$

→ Averages can be generalized to include axial momentum spread

## Transverse Particle Equations of Motion

Consistent with earlier analysis, take:

$$\begin{aligned} x'' + \frac{(\gamma_b \beta_b)'}{(\gamma_b \beta_b)} x' + \kappa_x x &= -\frac{q}{m \gamma_b^3 \beta_b^2 c^2} \frac{\partial \phi}{\partial x} \\ y'' + \frac{(\gamma_b \beta_b)'}{(\gamma_b \beta_b)} y' + \kappa_y y &= -\frac{q}{m \gamma_b^3 \beta_b^2 c^2} \frac{\partial \phi}{\partial y} \\ \nabla_{\perp}^2 \phi &= \left( \frac{\partial^2}{\partial x^2} + \frac{\partial^2}{\partial y^2} \right) \phi = -\frac{\rho}{\epsilon_0} \\ \rho &= q \int d^2 x'_{\perp} f_{\perp} \quad \phi|_{\text{aperture}} = 0 \end{aligned}$$

Assume:

- Unbunched beam
- No axial momentum spread
- Linear applied focusing fields described by  $\kappa_x, \kappa_y$
- Possible acceleration  $\gamma_b \beta_b$  need not be constant

Various apertures are possible. Some simple examples:

### Round Pipe

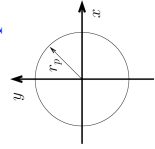

### Hyperbolic Sections

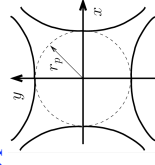

### Elliptical Pipe

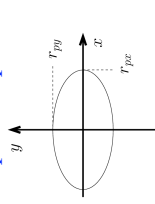

Linear magnetic quadrupoles, acceleration cells, ...  
 In rings with dispersion: in drifts, magnetic optics, ...

## Review: Focusing lattices we will take in examples: Continuous and piecewise constant periodic solenoid and quadrupole doublet

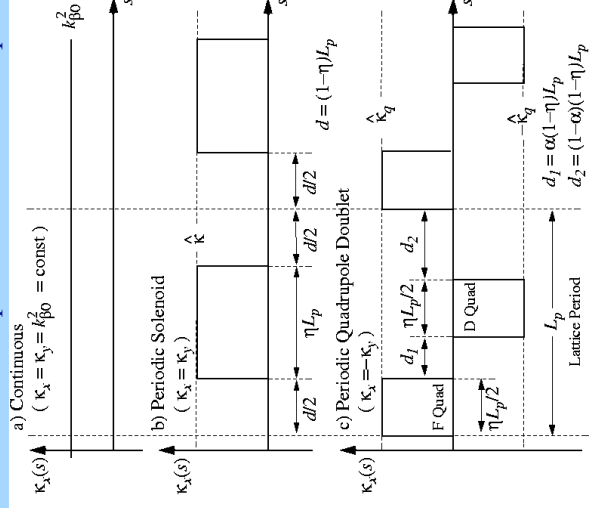

Lattice Period  $L_p$

Occupancy  $\eta$   
 $\eta \in [0, 1]$

Solenoid description carried out implicitly in Larmor frame

[see: S.M. Lund lectures on **Transverse Particle Equations**]

Syncopation Factor  $\alpha$

$$\alpha \in [0, \frac{1}{2}]$$

$$\alpha = \frac{1}{2} \implies FODO$$

## Distribution Assumptions

To lowest order, linearly focused intense beams are expected to be nearly uniform in density within the core of the beam out to an edge where the density falls rapidly to zero

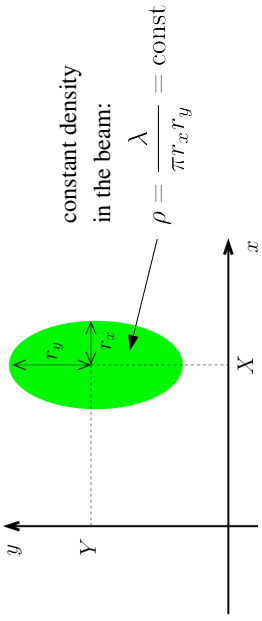

→ Expected for near equilibrium structure for strong space-charge due to Debye screening (see: S.M. Lund, lectures on **Transverse Equilibrium Distributions**)

→ Observed in simulations of stable non-equilibrium beams

$$\rho(x, y) = q \int d^2 x'_\perp f_\perp \simeq \begin{cases} \frac{\lambda}{\pi r_x r_y}, & (x-X)^2/r_x^2 + (y-Y)^2/r_y^2 < 1 \\ 0, & (x-X)^2/r_x^2 + (y-Y)^2/r_y^2 > 1 \end{cases}$$

$$\lambda = q \int d^2 x'_\perp \int d^2 x''_\perp f_\perp = \int d^2 x \rho$$

## Self-Field Calculation

Temporarily, we will consider an arbitrary beam charge distribution within an arbitrary aperture to formulate the problem.

Electrostatic field of a line charge in free-space

$$\mathbf{E}_\perp = \frac{\lambda_0}{2\pi\epsilon_0} \frac{(\mathbf{x}_\perp - \tilde{\mathbf{x}})}{|\mathbf{x}_\perp - \tilde{\mathbf{x}}|^2}$$

$\lambda_0 =$  line charge  
 $\mathbf{x}_\perp = \tilde{\mathbf{x}} =$  coordinate of charge

Resolve the field of the beam into direct (free space) and image terms:

$$\mathbf{E}_\perp^s = -\frac{\partial\phi}{\partial\mathbf{x}_\perp} = \mathbf{E}_\perp^d + \mathbf{E}_\perp^i$$

and superimpose free-space solutions for direct and image contributions

**Direct Field**

$$\mathbf{E}_\perp^d(\mathbf{x}_\perp) = \frac{1}{2\pi\epsilon_0} \int d^2 \tilde{x}_\perp \frac{\rho(\tilde{\mathbf{x}}_\perp)(\mathbf{x}_\perp - \tilde{\mathbf{x}}_\perp)}{|\mathbf{x}_\perp - \tilde{\mathbf{x}}_\perp|^2}$$

$\rho(\mathbf{x}) =$  beam charge density

**Image Field**

$$\mathbf{E}_\perp^i(\mathbf{x}_\perp) = \frac{1}{2\pi\epsilon_0} \int d^2 \tilde{x}_\perp \frac{\rho^i(\tilde{\mathbf{x}}_\perp)(\mathbf{x}_\perp - \tilde{\mathbf{x}}_\perp)}{|\mathbf{x}_\perp - \tilde{\mathbf{x}}_\perp|^2}$$

$\rho^i(\mathbf{x}) =$  beam image charge density induced on aperture

## Distribution Assumptions

To lowest order, linearly focused intense beams are expected to be nearly uniform in density within the core of the beam out to an edge where the density falls rapidly to zero

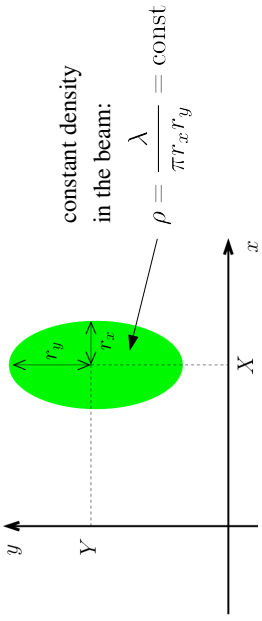

→ Expected for near equilibrium structure for strong space-charge due to Debye screening (see: S.M. Lund, lectures on **Transverse Equilibrium Distributions**)

→ Observed in simulations of stable non-equilibrium beams

$$\rho(x, y) = q \int d^2 x'_\perp f_\perp \simeq \begin{cases} \frac{\lambda}{\pi r_x r_y}, & (x-X)^2/r_x^2 + (y-Y)^2/r_y^2 < 1 \\ 0, & (x-X)^2/r_x^2 + (y-Y)^2/r_y^2 > 1 \end{cases}$$

$$\lambda = q \int d^2 x'_\perp \int d^2 x''_\perp f_\perp = \int d^2 x \rho$$

## Direct Field:

The direct field solution for a uniform density beam in free-space was calculated for the KV equilibrium distribution

- see: S.M. Lund, lectures on **Transverse Equilibrium Distributions**

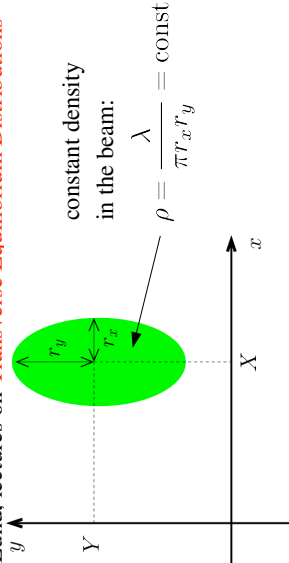

$$E_x^d = \frac{\lambda}{\pi\epsilon_0} \frac{x-X}{(r_x+r_y)r_x}$$

$$E_y^d = \frac{\lambda}{\pi\epsilon_0} \frac{y-Y}{(r_x+r_y)r_y}$$

Expressions are valid only within the elliptical density beam -- where they will be applied in taking averages

## Image Field:

Image structure depends on the aperture. Assume a round pipe (most common case) for simplicity.

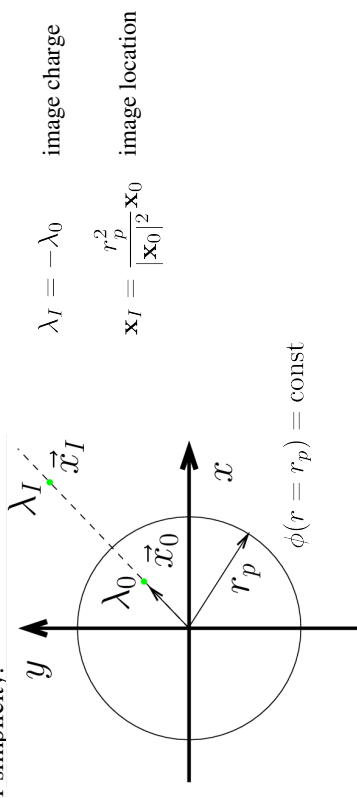

superimpose all images of beam:

$$\mathbf{E}_\perp^i(\mathbf{x}_\perp) = -\frac{1}{2\pi\epsilon_0} \int_{\text{pipe}} d^2 \tilde{x}_\perp \frac{\rho(\tilde{\mathbf{x}}_\perp)(\mathbf{x}_\perp - r_p^2 \tilde{\mathbf{x}}_\perp / |\tilde{\mathbf{x}}_\perp|^2)}{|\mathbf{x}_\perp - r_p^2 \tilde{\mathbf{x}}_\perp / |\tilde{\mathbf{x}}_\perp|^2|^2}$$

→ Difficult to calculate even for  $\rho$  corresponding to a uniform density beam

Examine limits of the image field to build intuition on the range of properties:

1) On-axis line charge:  $\rho(\mathbf{x}_\perp) = \lambda \delta(\mathbf{x}_\perp - X\hat{\mathbf{x}})$

$$\mathbf{E}_\perp^i(\hat{\mathbf{x}}_\perp = X\hat{\mathbf{x}}) = \frac{\lambda}{2\pi\epsilon_0(r_p^2/X - X)}\hat{\mathbf{x}}$$

- Generates nonlinear field at position of direct charge
- Field creates attractive force between direct and image charge

2) Centered, uniform density elliptical beam:

Expand using complex coordinates starting from the general image expression:

$$E_y^i + iE_x^i = \sum_{n=2,4,\dots}^{\infty} c_n z^{n-1} \quad c_n = \frac{i}{2\pi\epsilon_0} \int_{\text{pipe}} d^2x_\perp \rho(\mathbf{x}_\perp) \frac{(x-iy)^n}{r_p^{2n}}$$

$$z = x + iy \quad = \frac{i\lambda n!}{2\pi\epsilon_0 2^n (n/2 + 1)!(n/2)!} \left( \frac{r_x^2 - r_y^2}{r_p^4} \right)^{n/2}$$

$$i = \sqrt{-1}$$

The linear (n = 2) components of this expansion give:

$$E_x^i = \frac{\lambda}{8\pi\epsilon_0} \frac{r_x^2 - r_y^2}{r_p^4} x, \quad E_y^i = -\frac{\lambda}{8\pi\epsilon_0} \frac{r_x^2 - r_y^2}{r_p^4} y$$

- Rapidly vanish (higher order terms more rapid) as beam becomes more round

3) Uniform density elliptical beam with a small displacement along the x-axis:

$$Y = 0 \quad |X|/r_p \ll 1$$

Expand using complex coordinates starting from the general image expression:

- Use complex coordinates to simplify calculation

E.P. Lee, E. Close, and L. Smith, Nuclear Instruments and Methods, 1126 (1987)

- Expressions become even more complicated with simultaneous x- and y-displacements and more complicated aperture geometries

Leading Order Image Fields

$$E_x^i = \frac{\lambda}{2\pi\epsilon_0 r_p^2} [f(x - X) + gX] + \Theta\left(\frac{X}{r_p}\right)^3$$

$$E_y^i = -\frac{\lambda}{2\pi\epsilon_0 r_p^2} fy + \Theta\left(\frac{X}{r_p}\right)^3$$

$$f = \frac{r_x^2 - r_y^2}{4r_p^2} + \frac{X^2}{r_p^2} \left[ 1 + \frac{3}{2} \left( \frac{r_x^2 - r_y^2}{r_p^2} \right) + \frac{3}{8} \left( \frac{r_x^2 - r_y^2}{r_p^2} \right)^2 \right]$$

$$g = 1 + \frac{r_x^2 - r_y^2}{4r_p^2} + \frac{X^2}{r_p^2} \left[ 1 + \frac{3}{4} \left( \frac{r_x^2 - r_y^2}{r_p^2} \right) + \frac{1}{8} \left( \frac{r_x^2 - r_y^2}{r_p^2} \right)^2 \right]$$

Comments on images:

- Sign is generally such that it will tend to increase beam displacements
- Also (usually) weak linear focusing corrections for an elliptical beam
- Can be very difficult to calculate explicitly
  - Even for simple case of circular pipe
  - Special cases of simple geometry formulas can give idea on scaling
  - Generally suppress just by making the beam small relative to characteristic aperture dimensions and keeping the beam steered near-axis
- Depend strongly on the aperture geometry
  - Generally varies as a function of  $s$  in the machine aperture changes and/or beam symmetries evolve

Round Pipe

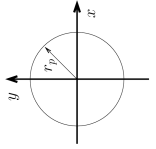

Elliptical Pipe

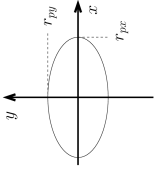

Hyperbolic Sections

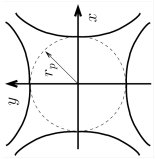

Coupled centroid and envelope equations of motion

Consistent with the assumed structure of the distribution (uniform density elliptical beam), denote:

Beam Centroid:

$$X \equiv \langle x \rangle_\perp \quad X' \equiv \langle x' \rangle_\perp$$

$$Y \equiv \langle y \rangle_\perp \quad Y' \equiv \langle y' \rangle_\perp$$

Coordinates with respect to centroid:

$$\tilde{x} \equiv x - X \quad \tilde{x}' \equiv x' - X'$$

$$\tilde{y} \equiv y - Y \quad \tilde{y}' \equiv y' - Y'$$

Envelope Edge Radii:

$$r_x \equiv 2\sqrt{\langle \tilde{x}^2 \rangle_\perp} \quad r'_x \equiv \langle \tilde{x}\tilde{x}' \rangle_\perp / r_x$$

$$r_y \equiv 2\sqrt{\langle \tilde{y}^2 \rangle_\perp} \quad r'_y \equiv \langle \tilde{y}\tilde{y}' \rangle_\perp / r_y$$

With the assumed uniform elliptical beam, all moments can be calculated in terms of:  $X, Y, X', Y', r_x, r_y$

- Such truncations follow whenever the form of the distribution is "frozen"



Derive centroid equations: First use the self-field resolution for a uniform density beam, then the equations of motion for a particle within the beam are:

$$x'' + \frac{(\gamma_b \beta_b)'}{(\gamma_b \beta_b)} x' + \kappa_x x - \frac{2Q}{(r_x + r_y)r_x} (x - X) = \frac{q}{m\gamma_b^3 \beta_b^2 c^2} E_x^i$$

$$y'' + \frac{(\gamma_b \beta_b)'}{(\gamma_b \beta_b)} y' + \kappa_y y - \frac{2Q}{(r_x + r_y)r_y} (y - Y) = \frac{q}{m\gamma_b^3 \beta_b^2 c^2} E_y^i$$

Direct Terms Image Terms

Perveance:

$$Q \equiv \frac{q\lambda}{2\pi\epsilon_0 m\gamma_b^3 \beta_b^2 c^2}$$

(not necessarily constant if beam accelerates)

average equations using:  $\langle x' \rangle_{\perp} = \langle x' \rangle'_{\perp} = X'$  etc., to obtain:

**Centroid Equations:**

$$X'' + \frac{(\gamma_b \beta_b)'}{(\gamma_b \beta_b)} X' + \kappa_x X = Q \left[ \frac{2\pi\epsilon_0}{\lambda} \langle E_x^i \rangle_{\perp} \right]$$

$$Y'' + \frac{(\gamma_b \beta_b)'}{(\gamma_b \beta_b)} Y' + \kappa_y Y = Q \left[ \frac{2\pi\epsilon_0}{\lambda} \langle E_y^i \rangle_{\perp} \right]$$

◆  $\langle E_x^i \rangle_{\perp}$  will generally depend on:  $X$ ,  $Y$  and  $r_x$ ,  $r_y$

Note: the electric image field will cancel the coefficient  $2\pi\epsilon_0/\lambda$

To derive equations of motion for the envelope radii, first subtract the centroid equations from the particle equations of motion ( $\tilde{x} \equiv x - X$ ) to obtain:

$$\tilde{x}'' + \frac{(\gamma_b \beta_b)'}{(\gamma_b \beta_b)} \tilde{x}' + \kappa_x \tilde{x} - \frac{2Q\tilde{x}}{(r_x + r_y)r_x} = \frac{q}{m\gamma_b^3 \beta_b^2 c^2} [E_x^i - \langle E_x^i \rangle_{\perp}]$$

$$\tilde{y}'' + \frac{(\gamma_b \beta_b)'}{(\gamma_b \beta_b)} \tilde{y}' + \kappa_y \tilde{y} - \frac{2Q\tilde{y}}{(r_x + r_y)r_x} = \frac{q}{m\gamma_b^3 \beta_b^2 c^2} [E_y^i - \langle E_y^i \rangle_{\perp}]$$

Differentiate the equation for the envelope radius (y-equations analogous):

$$r_x = 2\langle \tilde{x}^2 \rangle_{\perp}^{1/2} \longrightarrow r_x' = \frac{2\langle \tilde{x}\tilde{x}' \rangle_{\perp}}{\langle \tilde{x}^2 \rangle_{\perp}} = \frac{4\langle \tilde{x}\tilde{x}' \rangle_{\perp}}{r_x}$$

Define (motivated the KV equilibrium results) a statistical rms edge emittance:

$$\varepsilon_x \equiv 4\epsilon_{x,\text{rms}} \equiv 4 \left[ \langle \tilde{x}^2 \rangle_{\perp} \langle \tilde{x}'^2 \rangle_{\perp} - \langle \tilde{x}\tilde{x}' \rangle_{\perp}^2 \right]^{1/2}$$

Differentiate the equation for  $r_x$  again and use the emittance definition:

$$r_x'' = 4 \frac{\langle \tilde{x}\tilde{x}'' \rangle_{\perp}}{r_x} + \frac{16 \left[ \langle \tilde{x}^2 \rangle_{\perp} \langle \tilde{x}'^2 \rangle_{\perp} - \langle \tilde{x}\tilde{x}' \rangle_{\perp}^2 \right]}{r_x^3}$$

$$= 4 \frac{\langle \tilde{x}\tilde{x}'' \rangle_{\perp}}{r_x} + \frac{\varepsilon_x^2}{r_x^3}$$

and then employ the equations of motion to eliminate  $\tilde{x}''$  in  $\langle \tilde{x}\tilde{x}'' \rangle_{\perp}$  to obtain:

**Envelope Equations:**

$$r_x'' + \frac{(\gamma_b \beta_b)'}{(\gamma_b \beta_b)} r_x' + \kappa_x r_x - \frac{2Q}{r_x + r_y} \frac{\varepsilon_x^2}{r_x} = 8Q \left[ \frac{\pi\epsilon_0}{\lambda} \langle \tilde{x} E_x^i \rangle_{\perp} \right]$$

$$r_y'' + \frac{(\gamma_b \beta_b)'}{(\gamma_b \beta_b)} r_y' + \kappa_y r_y - \frac{2Q}{r_x + r_y} \frac{\varepsilon_y^2}{r_y} = 8Q \left[ \frac{\pi\epsilon_0}{\lambda} \langle \tilde{y} E_y^i \rangle_{\perp} \right]$$

◆  $\langle \tilde{x} E_x^i \rangle_{\perp}$  will generally depend on:  $X$ ,  $Y$  and  $r_x$ ,  $r_y$

**Comments on Centroid/Envelope equations:**

- ◆ Centroid and envelope equations are coupled and must be solved simultaneously when image terms on the RHS cannot be neglected
- ◆ Image terms contain nonlinear terms that can be difficult to evaluate explicitly
  - Aperture geometry changes image correction
- ◆ The formulation is not self-consistent because a frozen form (uniform density) charge profile is assumed
  - Uniform density choice motivated by KV results and Debye screening
- see: S.M. Lund, lectures on **Transverse Equilibrium Distributions**
- The assumed distribution form not evolving represents a fluid model closure

**Comments on Centroid/Envelope equations (Continued):**

- ◆ Constant (normalized when accelerating) emittances are generally assumed
- See: S.M. Lund, lectures on **Transverse Particle Equations**

$\beta_b$ ,  $\gamma_b$ ,  $\lambda$  s-variation set by acceleration schedule

$\varepsilon_{nx} = \gamma_b \beta_b \varepsilon_x = \text{const} \longrightarrow$  used to calculate  $\varepsilon_x$ ,  $\varepsilon_y$   
 $\varepsilon_{ny} = \gamma_b \beta_b \varepsilon_y = \text{const}$

$$Q = \frac{q\lambda}{2\pi m\epsilon_0 \gamma_b^3 \beta_b^2 c^2}$$



### S3: Centroid Equations of Motion

#### Single Particle Limit: Oscillation and Stability Properties

Neglect image charge terms, then the centroid equation of motion becomes:

$$X'' + \frac{(\gamma_b \beta_b)'}{(\gamma_b \beta_b)} X' + \kappa_x X = 0$$

$$Y'' + \frac{(\gamma_b \beta_b)'}{(\gamma_b \beta_b)} Y' + \kappa_y Y = 0$$

- ◆ Usual Hill's equation with generalized acceleration term
- ◆ Single particle form. Apply results from S.M. Lund lectures on **Transverse Particle Equations**: phase amplitude methods, Courant-Snyder invariants, and stability bounds, ...

Assume that applied lattice focusing is tuned for constant phase advances and/or that acceleration is weak and can be neglected. Then single particle stability results give immediately:

$$\sigma_{0x} < 180^\circ$$

$$\sigma_{0y} < 180^\circ$$

**centroid stability, 1<sup>st</sup> stability condition**

#### /// Example: FODO channel centroid evolution

lattice/beam parameters:  
 $\beta_b = \text{const}$   
 $\sigma_{0x} = 80^\circ$   
 $L_p = 0.5 \text{ m}$   
 $\eta = 0.5$

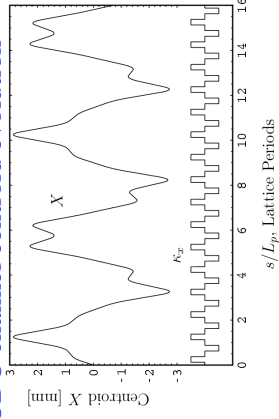

Mid-drift launch:  
 $X(0) = 1 \text{ mm}$   
 $X'(0) = 1 \text{ mrad}$

- ◆ Centroid exhibits expected characteristic stable betatron oscillations

///

#### Effect of Driving Errors

The reference orbit is ideally tuned for zero centroid excursions. But there will *always* be driving errors that can cause the centroid oscillations to accumulate with beam propagation distance:

$$X'' + \frac{(\gamma_b \beta_b)'}{(\gamma_b \beta_b)} X' + \frac{G_n}{G_0} \kappa_q(s) X = \frac{G_n}{G_0} \kappa_q(s) \Delta_{xn}$$

$\frac{G_n}{G_0} = n$ th quadrupole gradient error (unity for no error;  $s$ -varying)

$\Delta_{xn} = n$ th quadrupole transverse displacement error ( $s$ -varying)

/// Example: FODO channel centroid with quadrupole displacement errors

$\frac{G_n}{G_0} = 1$   
 $\Delta_{xn} = [-0.5, 0.5] \text{ mm}$   
 (uniform dist)

same lattice as previous

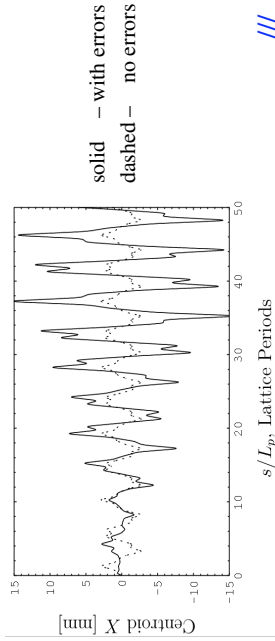

///

Errors will result in a **characteristic random walk** increase in oscillation amplitude due to the (generally random) driving terms.

**Control by:**

- ◆ Synthesize small applied dipole fields to regularly steer the centroid back on-axis to the reference trajectory:  $X = 0 = Y, X' = 0 = Y'$
- ◆ Fabricate and align focusing elements with higher precision
- ◆ Employ a sufficiently large aperture to contain the oscillations and limit detrimental nonlinear image charge effects

**Economics dictates the optimal strategy**

## Effects of Image Charges

Model the beam as a displaced line-charge in a circular aperture. Then using the previously derived image charge field, the equations of motion reduce to:

$$X'' + \frac{(\gamma_b \beta_b)'}{(\gamma_b \beta_b)} X' + \kappa_x X = \frac{QX}{r_p^2 - X^2}$$

examine oscillation along x-axis

$$\frac{QX}{r_p^2 - X^2} \approx \frac{Q}{r_p^2} X + \frac{Q}{r_p^4} X^3$$

linear correction

Nonlinear correction (smaller)

### Example: FODO channel centroid with image charge corrections

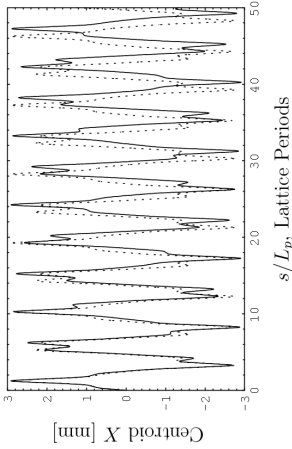

$r_p = 30 \text{ mm}$

$Q = 2 \times 10^{-4}$

same lattice as previous

solid – with images  
dashed – no images

Main effect of images appears to be an accumulated phase error of the centroid orbit since, generally the centroid error oscillations are not “matched” orbits. This will complicate extrapolations of errors over many lattice periods

### Control by:

- Keeping centroid displacements X, Y small by correcting
- Make aperture (pipe radius) larger

### General Comments:

- Images contributions to centroid excursions generally less problematic than misalignment errors in focusing elements
- More detailed analyses show that the coupling of the envelope radii  $r_x, r_y$  to the centroid evolution in X, Y is often weak
- Fringe fields are more important for accurate calculation of centroid orbits since orbits are not part of a matched lattice
  - Nonideal orbits are poorly tuned to lattice and become more sensitive to the precise phase of impulses
- Over long path lengths many nonlinear terms can influence results
- Lattice errors are not often known so one must often analyze characteristic error distributions to see if centroids measured are consistent with expectations

## S4: Envelope Equations of Motion

**Overview:** Reduce equations of motion for  $r_x, r_y$

- Generally found that couplings to centroid coordinates X Y are weak
  - Centroid ideally zero
- Envelope eqns are most important in designing transverse focusing systems
  - Expresses average radial force balance (see following discussion)
  - Can be difficult to analyze analytically for scaling properties
  - “Systems” codes generally written using envelope equations, stability criteria, and practical engineering constraints
- Instabilities of the envelope equations in periodic focusing lattices must be avoided in machine operation
  - Instabilities are strong and real: not washed out with realistic distributions without frozen form
  - Represent lowest order “KV” modes of a full kinetic theory
- Previous derivation of envelope equations relied on Courant-Snyder invariants in linear applied and self-fields. Analysis shows that the same force balances result for a uniform elliptical beam with no image couplings.
  - Debye screening arguments suggest assumed uniform density model taken should be a good approximation for intense space-charge

## KV/rms Envelope Equations: Properties of Terms

The envelope equation reflects low-order force balances:

$$r_x'' + \frac{(\gamma_b \beta_b)'}{(\gamma_b \beta_b)} r_x' + \kappa_x r_x - \frac{2Q}{r_x + r_y} = \frac{\varepsilon_x^2}{r_x^3} = 0$$

$$r_y'' + \frac{(\gamma_b \beta_b)'}{(\gamma_b \beta_b)} r_y' + \kappa_y r_y - \frac{2Q}{r_x + r_y} = \frac{\varepsilon_y^2}{r_y^3} = 0$$

**Terms:** Applied Acceleration Lattice Space-Charge Focusing Defocusing Thermal

The “acceleration schedule” specifies both  $\gamma_b \beta_b$  and  $\lambda$  then the equations are integrated with:

$$\gamma_b \beta_b \varepsilon_x = \text{const}$$

$$\gamma_b \beta_b \varepsilon_y = \text{const}$$

normalized emittance conservation

$$Q = \frac{q\lambda}{2\pi\epsilon_0 m^3 \beta_b^2 c^2}$$

specified perveance

**Reminder:** It was shown for a coasting beam that the envelope equations remain valid for elliptic charge densities suggesting more general validity [Sacherer, IEEE Trans. Nucl. Sci. 18, 1101 (1971), J.J. Barnard, **Intro. Lectures**]

For any beam with **elliptic symmetry** charge density in each transverse slice:

Based on:  

$$\langle r \frac{\partial \phi}{\partial x} \rangle_{\perp} = -\frac{\lambda}{4\pi\epsilon_0} \frac{r_x}{r_x + r_y}$$
 see J.J. Barnard, **Intro. Lectures**

the KV envelope equations

$$r_x''(s) + \kappa_x(s)r_x(s) - \frac{2Q}{r_x(s) + r_y(s)} - \frac{\epsilon_x^2(s)}{r_x^3(s)} = 0$$

$$r_y''(s) + \kappa_y(s)r_y(s) - \frac{2Q}{r_x(s) + r_y(s)} - \frac{\epsilon_y^2(s)}{r_y^3(s)} = 0$$

remain valid when (averages taken with the full distribution):

$$Q = \frac{q\lambda}{2\pi\epsilon_0 m \gamma_b^3 \beta_b^2 c^2} = \text{const} \quad \lambda = q \int d^2x_{\perp} \rho = \text{const}$$

$$r_x = 2 \langle x^2 \rangle_{\perp}^{1/2} \quad \epsilon_x = 4 [\langle x^2 \rangle_{\perp} \langle x'^2 \rangle_{\perp} - \langle x x' \rangle_{\perp}^2]^{1/2}$$

$$r_y = 2 \langle y^2 \rangle_{\perp}^{1/2} \quad \epsilon_y = 4 [\langle y^2 \rangle_{\perp} \langle y'^2 \rangle_{\perp} - \langle y y' \rangle_{\perp}^2]^{1/2}$$

♦ Evolution changes often small in  $\epsilon_x, \epsilon_y$

**Properties of Envelope Equation Terms:**

**Applied Focusing:**  $\kappa_x r_x, \kappa_y r_y$  and **Acceleration:**  $\frac{(\gamma_b \beta_b)'}{(\gamma_b \beta_b)} r_x', \frac{(\gamma_b \beta_b)'}{(\gamma_b \beta_b)} r_y'$

- ♦ Analogous to single particle orbit terms
- ♦ Contributions to beam envelope essentially the same as in single particle case
- ♦ Have strong  $s$  dependence, can be both focusing and defocusing
  - Act only in focusing elements and acceleration gaps

**Perveance:**  $\frac{2Q}{r_x + r_y}$

- ♦ Acts continuously in  $s$ , always defocusing
- ♦ Becomes stronger (relatively to other terms) when the beam expands in cross-sectional area

**Emittance:**  $\frac{\epsilon_x^2}{r_x^3}, \frac{\epsilon_y^2}{r_y^3}$

- ♦ Acts continuously in  $s$ , always defocusing
- ♦ Becomes stronger (relatively to other terms) when the beam becomes small in cross-sectional area
- ♦ Scaling makes clear why it is necessary to inhibit emittance growth for applications where small spots are desired on target

**As the beam expands, the perveance term will eventually dominate:**

[see: S.M. Lund and B. Bukh, PRSTAB 7, 024801 (2004)]

Free expansion ( $\kappa_x = \kappa_y = 0$ )

**Initial conditions:**

$$r_x(s_i) = r_y(s_i) \quad Q = \frac{\epsilon_x^2}{r_x(s_i) + r_y(s_i)} = \frac{\epsilon_x^2}{2r_x(s_i)}$$

$$r_x'(s_i) = r_y'(s_i) = 0 \quad \text{Emittance Dominated: } Q = 0$$

$$Q = \frac{\epsilon_x^2}{r_x^2(s_i)} = 10^{-3}$$

**Cases:**

Space-Charge Dominated:  $\epsilon_x = 0$

Emittance Dominated:  $Q = 0$

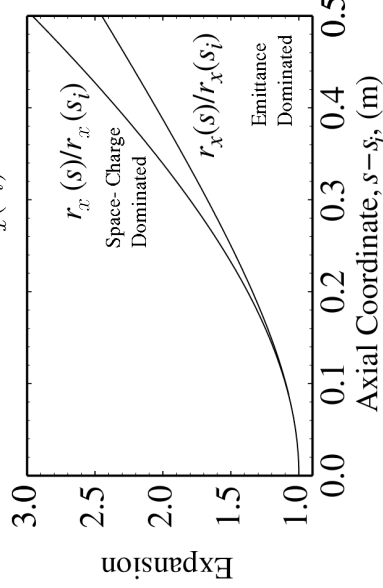

See PRSTAB article: solution is analytical in bounding limits shown

Parameters are chosen such that initial defocusing forces in two limits are equal

**S5: Matched Envelope Solution:**

Neglect acceleration ( $\gamma_b \beta_b = \text{const}$ ) or use transformed variables:

$$r_x''(s) + \kappa_x(s)r_x(s) - \frac{2Q}{r_x(s) + r_y(s)} - \frac{\epsilon_x^2}{r_x^3(s)} = 0$$

$$r_y''(s) + \kappa_y(s)r_y(s) - \frac{2Q}{r_x(s) + r_y(s)} - \frac{\epsilon_y^2}{r_y^3(s)} = 0$$

$$r_x(s + L_p) = r_x(s) \quad r_x(s) > 0$$

$$r_y(s + L_p) = r_y(s) \quad r_y(s) > 0$$

Matching involves finding specific initial conditions for the envelope to have the **periodicity of the lattice:**

**Find Values of:**

$$r_x(s_i) \quad r_x'(s_i)$$

$$r_y(s_i) \quad r_y'(s_i)$$

**Such That:**

$$r_x(s_i + L_p) = r_x(s_i) \quad r_x'(s_i + L_p) = r_x'(s_i)$$

$$r_y(s_i + L_p) = r_y(s_i) \quad r_y'(s_i + L_p) = r_y'(s_i)$$

- ♦ Typically constructed with numerical root finding from estimated/guessed values
  - Can be surprisingly difficult for complicated lattices and/or strong space-charge
- ♦ Iterative technique developed to numerically calculate without root finding

[S.M. Lund, S. Chilton and E.P. Lee, PRSTAB 9, 064201 (2006)]

### Typical Matched vs Mismatched solution for FODO channel:

#### Matched

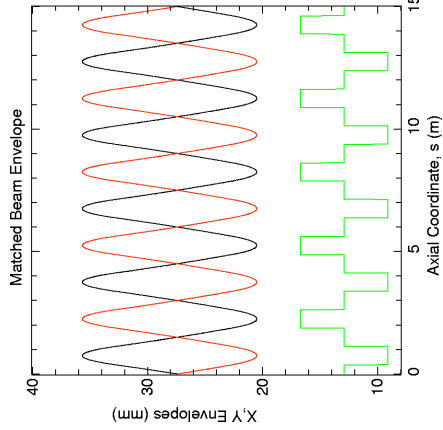

#### Mismatched

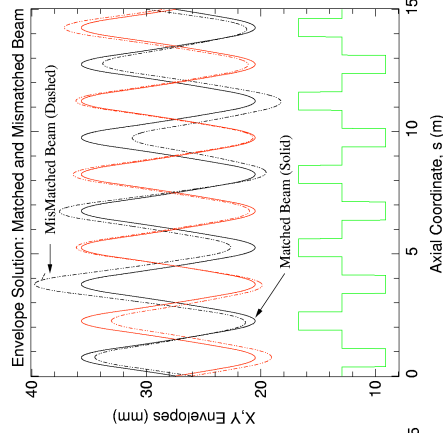

The matched beam is the most radially compact solution to the envelope equations rendering it highly important for beam transport

→ Matching tends to exploit optics most efficiently to maintain confinement

The matched solution to the KV envelope equations reflects the symmetry of the focusing lattice and must in general be calculated numerically

#### Parameters

$$L_p = 0.5 \text{ m}, \quad \sigma_0 = 80^\circ, \quad \eta = 0.5$$

$$\varepsilon_x = 50 \text{ mm-mrad}$$

$$\sigma/\sigma_0 = 0.2$$

#### Solenoidal Focusing

$$(Q = 6.6986 \times 10^{-4})$$

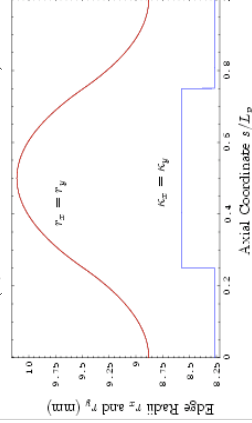

#### FODO Quadrupole Focusing

$$(Q = 6.5614 \times 10^{-4})$$

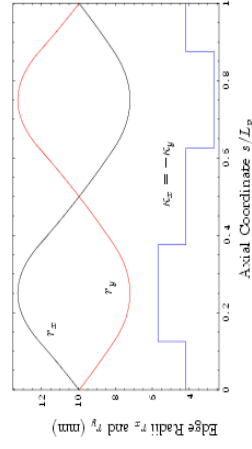

Symmetries of a matched beam are interpreted in terms of a local rms equivalent KV beam and moments/projections of the KV distribution

[see: S.M. Lund, lectures on [Transverse Equilibrium Distributions](#)]

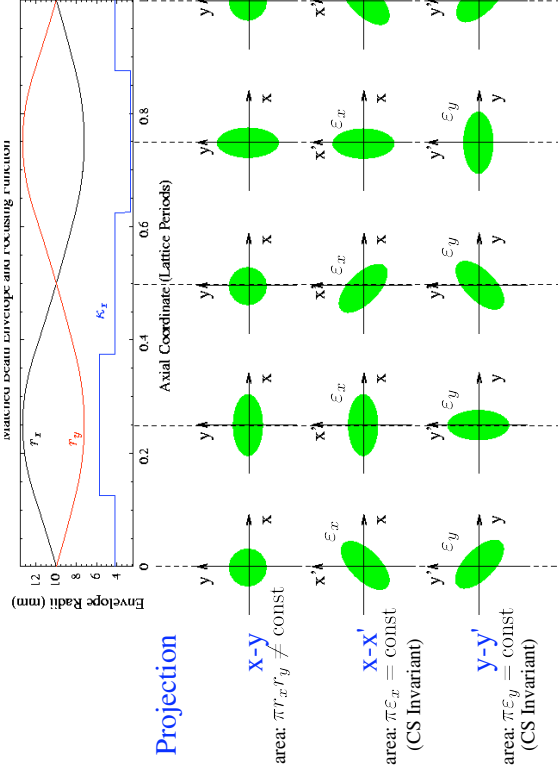

#### Projection

$$\text{area: } \pi \varepsilon_x \varepsilon_y = \text{const}$$

(CS Invariant)

$$\text{area: } \pi \varepsilon_x' \varepsilon_y' = \text{const}$$

(CS Invariant)

$$\text{area: } \pi \varepsilon_x'' \varepsilon_y'' = \text{const}$$

(CS Invariant)

#### S6: Envelope Perturbations:

An extensive review article is available that both reviews/extends many aspects of envelope modes in periodic lattices covered in S6-S8: see S.M. Lund and B. Bukh, PRSTAB 024801 (2004) [henceforth denoted: PRSTAB Review]

In the envelope equations set:

#### Envelope Perturbations:

$$r_x(s) = r_{xm}(s) + \delta r_x(s)$$

$$r_y(s) = r_{ym}(s) + \delta r_y(s)$$

Matched Envelope Perturbations

$$r_{xm}(s + L_p) = r_{xm}(s) \quad r_{xm}(s) > 0$$

$$r_{ym}(s + L_p) = r_{ym}(s) \quad r_{ym}(s) > 0$$

$$r_{xm}(s) \gg |\delta r_{xm}(s)|$$

$$r_{ym}(s) \gg |\delta r_{ym}(s)|$$

#### Driving Perturbations:

$$k_x(s) \rightarrow k_x(s) + \delta k_x(s) \quad \text{Focus}$$

$$k_y(s) \rightarrow k_y(s) + \delta k_y(s) \quad \text{Pervance}$$

$$Q \rightarrow Q + \delta Q(s) \quad \text{Emittance}$$

$$\varepsilon_x \rightarrow \varepsilon_x + \delta \varepsilon_x(s)$$

$$\varepsilon_y \rightarrow \varepsilon_y + \delta \varepsilon_y(s)$$

Amplitudes defined in terms of producing small envelope perturbations

→ Driving terms and distribution errors drive envelope perturbations

- Arise from many sources: focusing errors, lost particles, emittance growth, ....

The **matched solution** satisfies:

- ◆ Add subscript  $m$  to denote matched to distinguish from other solutions

$r_x \rightarrow r_{xm}$  For matched beam envelope  
 $r_y \rightarrow r_{ym}$  with periodicity of lattice

$$\begin{aligned} r_{xm}''(s) + \kappa_x(s)r_{xm}(s) - \frac{2Q}{r_{xm}(s) + r_{ym}(s)} - \frac{\varepsilon_x^2}{r_{xm}^3(s)} &= 0 \\ r_{ym}''(s) + \kappa_y(s)r_{ym}(s) - \frac{2Q}{r_{xm}(s) + r_{ym}(s)} - \frac{\varepsilon_y^2}{r_{ym}^3(s)} &= 0 \\ r_{xm}(s) + L_p &= r_{xm}(s) & r_{xm}(s) &> 0 \\ r_{ym}(s) + L_p &= r_{ym}(s) & r_{ym}(s) &> 0 \end{aligned}$$

**Martix Form of the Linearized Perturbed Envelope Equations:**

$$\frac{d}{ds} \delta \mathbf{R} + \mathbf{K} \cdot \delta \mathbf{R} = \delta \mathbf{P}$$

$\delta \mathbf{R} \equiv \begin{pmatrix} \delta r_x \\ \delta r_x' \\ \delta r_y \\ \delta r_y' \end{pmatrix}$  Coordinate vector

$\mathbf{K} \equiv \begin{pmatrix} 0 & -1 & 0 & 0 \\ k_{xm} & 0 & k_{0m} & 0 \\ 0 & 0 & 0 & -1 \\ k_{ym} & 0 & k_{jm} & 0 \end{pmatrix}$  Coefficient matrix Has periodicity of the lattice period

$k_{0m} = \frac{2Q}{(r_{xm} + r_{ym})^2}$   
 $k_{jm} = \kappa_j + 3\frac{\varepsilon_j^2}{r_{jm}^4} + k_{0m} \quad j = x, y$

$\delta \mathbf{P} \equiv \begin{pmatrix} 0 \\ -\delta \kappa_x + 2\frac{\delta Q}{r_{xm} + r_{ym}} + 2\frac{\varepsilon_x \delta \varepsilon_x}{r_{xm}^3} \\ 0 \\ -\delta \kappa_y + 2\frac{\delta Q}{r_{xm} + r_{ym}} + 2\frac{\varepsilon_y \delta \varepsilon_y}{r_{ym}^3} \end{pmatrix}$  Driving perturbation vector

Expand solution into **homogeneous** and **particular** parts:

$$\begin{aligned} \delta \mathbf{R} &= \delta \mathbf{R}_h + \delta \mathbf{R}_p & \delta \mathbf{R}_h &= \text{homogeneous solution} \\ & & \delta \mathbf{R}_p &= \text{particular solution} \\ \frac{d}{ds} \delta \mathbf{R}_h + \mathbf{K} \cdot \delta \mathbf{R}_h &= 0 & \frac{d}{ds} \delta \mathbf{R}_p + \mathbf{K} \cdot \delta \mathbf{R}_p &= \delta \mathbf{P} \end{aligned}$$

**Linearized Perturbed Envelope Equations:**

- ◆ Neglect all terms of order  $\delta^2$  and higher:  $(\delta r_x)^2$ ,  $\delta r_x \delta r_y$ ,  $\delta Q \delta r_x$ , ...

$$\begin{aligned} \delta r_x'' + \kappa_x \delta r_x + \frac{2Q}{(r_{xm} + r_{ym})^2} (\delta r_x + \delta r_y) + \frac{3\varepsilon_x^2}{r_{xm}^4} \delta r_x &= -r_{xm} \delta \kappa_x + \frac{2}{r_{xm} + r_{ym}} \delta Q + \frac{2\varepsilon_x^2}{r_{xm}^3} \delta \varepsilon_x \\ \delta r_y'' + \kappa_y \delta r_y + \frac{2Q}{(r_{xm} + r_{ym})^2} (\delta r_x + \delta r_y) + \frac{3\varepsilon_y^2}{r_{ym}^4} \delta r_y &= -r_{ym} \delta \kappa_y + \frac{2}{r_{xm} + r_{ym}} \delta Q + \frac{2\varepsilon_y^2}{r_{ym}^3} \delta \varepsilon_y \end{aligned}$$

**Homogeneous Equations:**

- ◆ Linearized envelope equations with driving terms set to zero

$$\begin{aligned} \delta r_x'' + \kappa_x \delta r_x + \frac{2Q}{(r_{xm} + r_{ym})^2} (\delta r_x + \delta r_y) + \frac{3\varepsilon_x^2}{r_{xm}^4} \delta r_x &= 0 \\ \delta r_y'' + \kappa_y \delta r_y + \frac{2Q}{(r_{xm} + r_{ym})^2} (\delta r_x + \delta r_y) + \frac{3\varepsilon_y^2}{r_{ym}^4} \delta r_y &= 0 \end{aligned}$$

**Homogeneous Solution: Normal Modes**

- ◆ Describes normal mode oscillations
  - ◆ Original analysis by Struckmeier and Reiser [Part. Accel. 14, 227 (1984)]
- Particular Solution: Driven Modes**
- ◆ Describes action of driving terms
  - ◆ Characterize in terms of projections on homogeneous response (on normal modes)
- Homogeneous solution expressible as a map:**

$$\begin{aligned} \delta \mathbf{R}(s) &= \mathbf{M}_e(s|s_i) \cdot \delta \mathbf{R}(s_i) \\ \delta \mathbf{R}(s) &= (\delta r_x, \delta r_x', \delta r_y, \delta r_y') \\ \mathbf{M}_e(s|s_i) &= 4 \times 4 \text{ transfer map} \end{aligned}$$

Now 4x4 system, but analogous to the 2x2 analysis of Hill's equation via transfer matrices: see S.M. Lund lectures on **Transverse Particle Equations**

**Eigenvalues and eigenvectors** of map through one period characterize normal modes and stability properties:

$$\mathbf{M}_e(s_i + L_p | s_i) \cdot \mathbf{E}_n(s_i) = \lambda_n \mathbf{E}_n(s_i)$$

**Stability**

$$\begin{aligned} \lambda_n = \gamma_n e^{i\sigma_n} & \quad \sigma_n \rightarrow \text{mode phase advance (real)} \\ \gamma_n & \quad \gamma_n \rightarrow \text{mode growth/damp factor (real)} \end{aligned}$$

**Mode Expansion/Launching**

$$\delta \mathbf{R}(s_i) = \sum_{n=1}^4 \alpha_n \mathbf{E}_n(s_i) \quad \alpha_n = \text{const (complex)}$$



## Eigenvalue/Eigenvector Symmetry Classes:

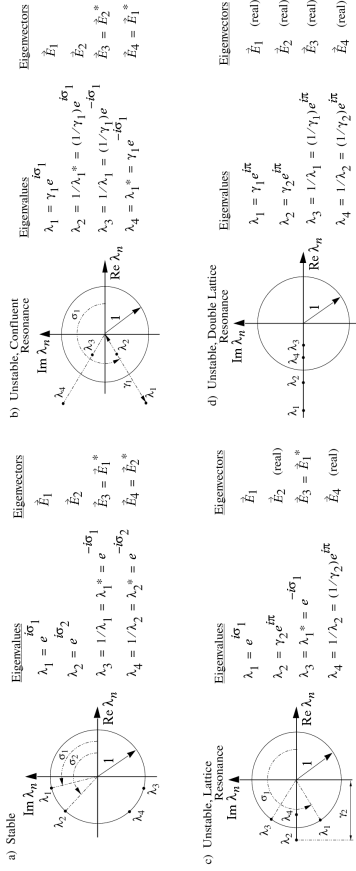

### Symmetry classes of eigenvalues/eigenvectors:

- ◆ Determine normal mode symmetries
- ◆ See A. Dragt, Lectures on Nonlinear Orbit Dynamics, in Physics of High Energy Particle Accelerators, (AIP Conf. Proc. No. 87, 1982, p. 147)
- ◆ Envelope mode symmetries discussed fully in PRSTAB review
- ◆ Caution: Textbook by Reiser makes errors in mode symmetries and mislabels/identifies dispersion characteristics

## Decoupled Modes

In a continuous or periodic solenoidal focusing channel

$$\kappa_x(s) = \kappa_y(s) = \kappa(s)$$

with a round matched-beam solution

$$\varepsilon_x = \varepsilon_y \equiv \varepsilon = \text{const}$$

$$r_{x\text{m}}(s) = r_{y\text{m}}(s) \equiv r_m(s)$$

envelope perturbations are simply decoupled with:

$$\text{Breathing Mode: } \delta r_+ \equiv \frac{\delta r_x + \delta r_y}{2}$$

$$\text{Quadrupole Mode: } \delta r_- \equiv \frac{\delta r_x - \delta r_y}{2}$$

The resulting decoupled envelope equations are:

$$\text{Breathing Mode: } \delta r_+'' + \kappa \delta r_+ + \frac{2Q}{r_m^2} \delta r_+ = -r_m \left( \frac{\delta \kappa_x + \delta \kappa_y}{2} \right) + \frac{1}{r_m} \delta Q + \frac{2\varepsilon^2}{r_m^3} \left( \frac{\delta \varepsilon_x + \delta \varepsilon_y}{2} \right)$$

$$\text{Quadrupole Mode: } \delta r_-'' + \kappa \delta r_- + \frac{3\varepsilon^2}{r_m^4} \delta r_- = -r_m \left( \frac{\delta \kappa_x - \delta \kappa_y}{2} \right) + \frac{2\varepsilon^2}{r_m^3} \left( \frac{\delta \varepsilon_x - \delta \varepsilon_y}{2} \right)$$

## Pure mode launching conditions:

Launching conditions for distinct normal modes corresponding to the eigenvalue classes illustrated:

$$A_\ell = \text{mode amplitude (real)} \quad \ell = \text{mode index}$$

$$\psi_\ell = \text{mode launch phase (real)}$$

Case	Mode	Launching Condition	Lattice Period Advance
(a) Stable	1 - Stable Osc.	$\delta \mathbf{R}_1 = A_1 e^{i\psi_1} \mathbf{E}_1 + \text{C.C.}$	$\mathbf{M}_e \delta \mathbf{R}_1(\psi_1) = \delta \mathbf{R}_1(\psi_1 + \sigma_1)$
	2 - Stable Osc.	$\delta \mathbf{R}_2 = A_2 e^{i\psi_2} \mathbf{E}_2 + \text{C.C.}$	$\mathbf{M}_e \delta \mathbf{R}_2(\psi_2) = \delta \mathbf{R}_2(\psi_2 + \sigma_2)$
(b) Unstable	1 - Exp. Growth	$\delta \mathbf{R}_1 = A_1 e^{i\psi_1} \mathbf{E}_1 + \text{C.C.}$	$\mathbf{M}_e \delta \mathbf{R}_1(\psi_1) = \gamma_1 \delta \mathbf{R}_1(\psi_1 + \sigma_1)$
Confluent Res.	2 - Exp. Damping	$\delta \mathbf{R}_2 = A_2 e^{i\psi_2} \mathbf{E}_2 + \text{C.C.}$	$\mathbf{M}_e \delta \mathbf{R}_2(\psi_2) = (1/\gamma_1) \delta \mathbf{R}_2(\psi_2 + \sigma_1)$
(c) Unstable	1 - Stable Osc.	$\delta \mathbf{R}_1 = A_1 e^{i\psi_1} \mathbf{E}_1 + \text{C.C.}$	$\mathbf{M}_e \delta \mathbf{R}_1(\psi_1) = \delta \mathbf{R}_1(\psi_1 + \sigma_1)$
Lattice Res.	2 - Exp. Growth	$\delta \mathbf{R}_2 = A_2 \mathbf{E}_2$	$\mathbf{M}_e \delta \mathbf{R}_2 = -\gamma_2 \delta \mathbf{R}_2$
	3 - Exp. Damping	$\delta \mathbf{R}_3 = A_3 \mathbf{E}_4$	$\mathbf{M}_e \delta \mathbf{R}_3 = -(1/\gamma_2) \delta \mathbf{R}_3$
(d) Unstable	1 - Exp. Growth	$\delta \mathbf{R}_1 = A_1 \mathbf{E}_1$	$\mathbf{M}_e \delta \mathbf{R}_1 = -\gamma_1 \delta \mathbf{R}_1$
Double Lattice	2 - Exp. Growth	$\delta \mathbf{R}_2 = A_2 \mathbf{E}_2$	$\mathbf{M}_e \delta \mathbf{R}_2 = -\gamma_2 \delta \mathbf{R}_2$
Resonance	3 - Exp. Damping	$\delta \mathbf{R}_3 = A_3 \mathbf{E}_3$	$\mathbf{M}_e \delta \mathbf{R}_3 = -(1/\gamma_1) \delta \mathbf{R}_3$
	4 - Exp. Damping	$\delta \mathbf{R}_4 = A_4 \mathbf{E}_4$	$\mathbf{M}_e \delta \mathbf{R}_4 = -(1/\gamma_2) \delta \mathbf{R}_4$

$$\delta \mathbf{R}_\ell \equiv \delta \mathbf{R}_\ell(s_i) \quad \mathbf{E}_\ell \equiv \mathbf{E}_\ell(s_i) \quad \mathbf{M}_e \equiv \mathbf{M}_e(s_i + L_p |s_i)$$

$$\delta \mathbf{R}(s) = \begin{cases} A_1 [\mathbf{E}_1(s) e^{i\psi_1(s)} + \mathbf{E}_1^*(s) e^{-i\psi_1(s)}] + A_2 [\mathbf{E}_2(s) e^{i\psi_2(s)} + \mathbf{E}_2^*(s) e^{-i\psi_2(s)}], & \text{cases (a) and (b)} \\ A_1 [\mathbf{E}_1(s) e^{i\psi_1(s)} + \mathbf{E}_1^*(s) e^{-i\psi_1(s)}] + A_2 \mathbf{E}_2(s) + A_3 \mathbf{E}_4(s), & \text{case (c)} \\ A_1 \mathbf{E}_1(s) + A_2 \mathbf{E}_2(s) + A_3 \mathbf{E}_3(s) + A_4 \mathbf{E}_4(s), & \text{case (d)} \end{cases}$$

## Graphical interpretation of mode symmetries:

$$\text{Breathing Mode: } \delta r_+ = \frac{\delta r_x + \delta r_y}{2}$$

### Quadrupole Mode:

$$\delta r_- = \frac{\delta r_x - \delta r_y}{2}$$

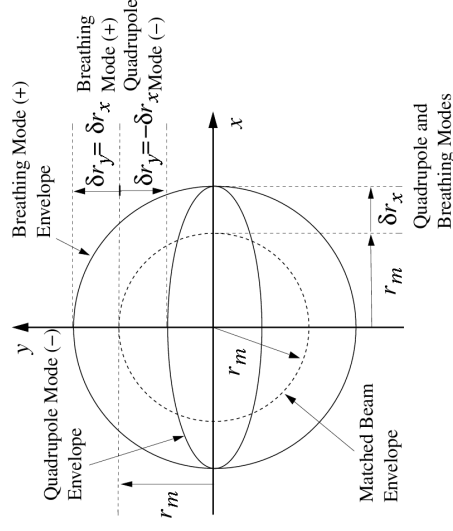

### Decoupled Mode Properties:

Space charge terms  $\sim Q$  only directly expressed in equation for  $\delta r_+(s)$

- Indirectly present in both equations from matched envelope  $r_m(s)$

### Homogeneous Solution:

- Restoring term for  $\delta r_+(s)$  larger than for  $\delta r_-(s)$ 
  - Breathing mode should oscillate faster than the quadrupole mode

### Particular Solution:

- Misbalances in focusing and emittance driving terms can project onto either mode
  - nonzero perturbed  $\kappa_x(s) + \kappa_y(s)$  and  $\epsilon_x(s) + \epsilon_y(s)$  project onto breathing mode
  - nonzero perturbed  $\kappa_x(s) - \kappa_y(s)$  and  $\epsilon_x(s) - \epsilon_y(s)$  project onto quadrupole mode
- Perveance driving perturbations project *only* on breathing mode

### Previous symmetry classes greatly reduce for decoupled modes:

Previous homogeneous 4x4 solution map:

$$\begin{aligned} \delta \mathbf{R}(s) &= \mathbf{M}_e(s|s_i) \cdot \delta \mathbf{R}(s_i) \\ \delta \mathbf{R}(s) &= (\delta r_x, \delta r'_x, \delta r_y, \delta r'_y) \\ \mathbf{M}_e(s|s_i) &= 4 \times 4 \text{ transfer map} \end{aligned}$$

reduces to two independent 2x2 maps with greatly simplified symmetries:

$$\delta \mathbf{R} \equiv (\delta r_+, \delta r'_+, \delta r_-, \delta r'_-) \quad \mathbf{M}_e(s_i + L_p|s_i) = \begin{bmatrix} \mathbf{M}_+(s_i + L_p|s_i) & 0 \\ 0 & \mathbf{M}_-(s_i + L_p|s_i) \end{bmatrix}$$

with corresponding eigenvalue problems:

$$\mathbf{M}_\pm(s_i + L_p|s_i) \cdot \mathbf{E}_n(s_i) = \lambda_\pm \mathbf{E}_n(s_i)$$

Many familiar results from analysis of Hill's equation (see: S.M. Lund lectures on **Transverse Particle Equations**) can be immediately applied to the decoupled case, for example:

$$\frac{1}{2} |\text{Tr} \mathbf{M}_\pm(s_i + L_p|s_i)| < 1 \longrightarrow \text{mode stability}$$

### Eigenvalue symmetries and launching conditions simplify for decoupled modes

#### Eigenvalue Symmetry 1:

Stable

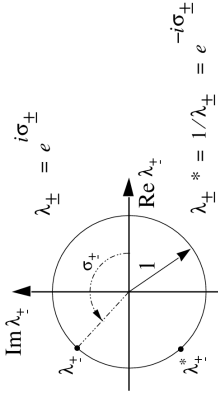

#### Launching Condition / Projections

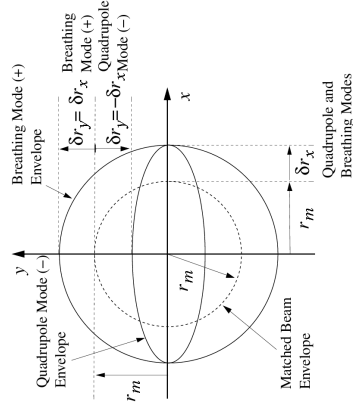

#### Eigenvalue Symmetry 2:

Unstable, Lattice Resonance

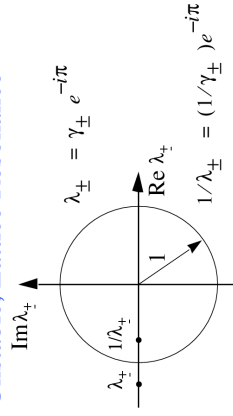

### General Mode Limits

Using phase-amplitude analysis can show for any linear focusing lattice:

- Phase advance of any normal mode satisfies the zero space-charge limit:

$$\lim_{Q \rightarrow 0} \sigma_\ell = 2\sigma_0$$

- Pure normal modes evolve with a quadratic phase-space

(Courant-Snyder) invariant in the normal coordinates of the mode

Simply expressed for decoupled modes with  $\kappa_x = \kappa_y$ ,  $\epsilon_x = \epsilon_y$

$$\left[ \frac{\delta r_\pm(s)}{w_\pm(s)} \right]^2 + [w'_\pm(s)\delta r_\pm(s) - w_\pm(s)\delta r'_\pm(s)]^2 = \text{const}$$

where

$$\begin{aligned} w''_+ + \kappa w_+ + \frac{2Q}{r^2} w_+ + \frac{3\epsilon^2}{r^4 m^2} w_+ - \frac{1}{w^3} &= 0 \\ w''_- + \kappa w_- + \frac{4}{r^4} w_- + \frac{1}{w^3} &= 0 \end{aligned}$$

$$w_\pm(s + L_p) = w_\pm(s)$$

Analogous results for coupled modes [See Edwards and Teng, IEEE Trans Nuc. Sci. **20**, 885 (1973)]

- More complex expression due to coupling

## S7: Envelope Modes in Continuous Focusing

**Focusing:**

$$\kappa_x(s) = \kappa_y(s) = k_{\beta 0}^2 = \left(\frac{\sigma_0}{L_p}\right)^2 = \text{const}$$

**Matched beam:**

$$\begin{aligned} \varepsilon_x = \varepsilon_y = \varepsilon = \text{const} \\ r_{xm}(s) = r_{ym}(s) = r_m = \text{const} \end{aligned}$$

symmetric beam:

$$k_{\beta 0}^2 r_m - \frac{Q}{r_m} - \frac{\varepsilon^2}{r_m^3} = 0$$

matched envelope:

$$\text{depressed phase advance: } \sigma = \sqrt{\sigma_0^2 - \frac{Q}{(r_m/L_p)^2}} = \frac{\varepsilon L_p}{r_m}$$

$$\text{one parameter needed for scaled solution: } \frac{k_{\beta 0}^2 \varepsilon^2}{Q^2} = \frac{\sigma_0^2 \varepsilon^2}{Q^2 L_p^2} = \frac{(\sigma/\sigma_0)^2}{[1 - (\sigma/\sigma_0)^2]^2}$$

**Decoupled Modes:**

$$\delta r_{\pm}(s) = \frac{\delta r_x(s) \pm \delta r_y(s)}{2}$$

Envelope equations of motion become:

$$\begin{aligned} L_p^2 \frac{d^2}{ds^2} \left( \frac{\delta r_+}{r_m} \right) + \sigma_+^2 \left( \frac{\delta r_+}{r_m} \right) &= -\frac{\sigma_0^2}{2} \left( \frac{\delta \kappa_x}{k_{\beta 0}^2} + \frac{\delta \kappa_y}{k_{\beta 0}^2} \right) + (\sigma_0^2 - \sigma^2) \frac{\delta Q}{Q} + \sigma^2 \left( \frac{\delta \varepsilon_x}{\varepsilon} + \frac{\delta \varepsilon_y}{\varepsilon} \right) \\ L_p^2 \frac{d^2}{ds^2} \left( \frac{\delta r_-}{r_m} \right) + \sigma_-^2 \left( \frac{\delta r_-}{r_m} \right) &= -\frac{\sigma_0^2}{2} \left( \frac{\delta \kappa_x}{k_{\beta 0}^2} - \frac{\delta \kappa_y}{k_{\beta 0}^2} \right) + \sigma^2 \left( \frac{\delta \varepsilon_x}{\varepsilon} - \frac{\delta \varepsilon_y}{\varepsilon} \right) \end{aligned}$$

$$\sigma_+ \equiv \sqrt{2\sigma_0^2 + 2\sigma^2} \quad \text{“breathing” mode phase advance}$$

$$\sigma_- \equiv \sqrt{\sigma_0^2 + 3\sigma^2} \quad \text{“quadrupole” mode phase advance}$$

Homogeneous equations for normal modes:

$$\frac{d^2}{ds^2} \delta r_{\pm} + \left( \frac{\sigma_{\pm}}{L_p} \right)^2 \delta r_{\pm} = 0$$

Simple harmonic oscillator equation

Homogeneous Solution (normal modes):

$$\delta r_{\pm}(s) = \delta r_{\pm}(s_i) \cos\left(\frac{s-s_i}{L_p}\right) + \frac{\delta r'_{\pm}(s_i)}{\sigma_{\pm}/L_p} \sin\left(\frac{s-s_i}{L_p}\right)$$

$\delta r_{\pm}(s_i)$ ,  $\delta r'_{\pm}(s_i)$  mode initial conditions

Properties of continuous focusing homogeneous solution: Normal Modes

**Mode Phase Advances**

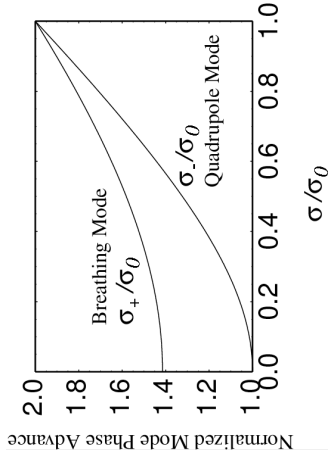

**Mode Projections**

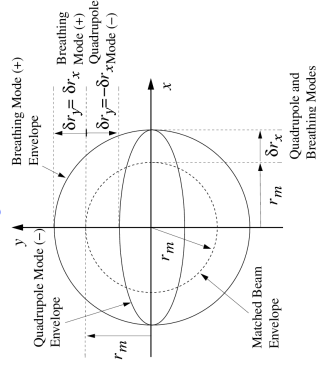

$$\text{Breathing Mode: } \delta r_+ \equiv \frac{\delta r_x + \delta r_y}{2}$$

$$\text{Quadrupole Mode: } \delta r_- \equiv \frac{\delta r_x - \delta r_y}{2}$$

Particular Solution (driving perturbations):

Green's function form of solution derived using projections onto normal modes see PRSTAB Review

$$\begin{aligned} \frac{\delta r_{\pm}(s)}{r_m} &= \frac{1}{L_p^2} \int_{s_i}^s ds G_{\pm}(s, \tilde{s}) \delta p_{\pm}(\tilde{s}) \\ \delta p_+(s) &= -\frac{\sigma_0^2}{2} \left[ \frac{\delta \kappa_x(s)}{k_{\beta 0}^2} + \frac{\delta \kappa_y(s)}{k_{\beta 0}^2} \right] + (\sigma_0^2 - \sigma^2) \frac{\delta Q(s)}{Q} + \sigma^2 \left[ \frac{\delta \varepsilon_x(s)}{\varepsilon} + \frac{\delta \varepsilon_y(s)}{\varepsilon} \right] \\ \delta p_-(s) &= -\frac{\sigma_0^2}{2} \left[ \frac{\delta \kappa_x(s)}{k_{\beta 0}^2} - \frac{\delta \kappa_y(s)}{k_{\beta 0}^2} \right] + \sigma^2 \left[ \frac{\delta \varepsilon_x(s)}{\varepsilon} - \frac{\delta \varepsilon_y(s)}{\varepsilon} \right] \\ G_{\pm}(s, \tilde{s}) &= \frac{1}{\sigma_{\pm}/L_p} \sin\left(\sigma_{\pm} \frac{s-\tilde{s}}{L_p}\right) \end{aligned}$$

Green's function solution is *fully general*. Insight gained from simplified solutions for specific classes of driving perturbations:

- Adiabatic covered here
- Sudden covered here
- Ramped covered in PRSTAB Review article
- Harmonic covered in PRSTAB Review article



## Continuous Focusing – adiabatic particular solution

For driving perturbations  $\delta p_{\pm}(s)$  and  $\delta p(s)$  slow on quadrupole mode (slower mode) wavelength  $\sim 2\pi L_p/\sigma_{\pm}$  the solution is:

$$\begin{aligned} \frac{\delta r_{\pm}(s)}{r_m} &= \frac{\delta p_{\pm}(s)}{\sigma_{\pm}^2} \\ &= - \left[ \frac{1}{2} \frac{1}{1 + (\sigma/\sigma_0)^2} \right] \frac{1}{2} \left( \frac{\delta \kappa_x(s)}{k_{\beta 0}^2} + \frac{\delta \kappa_y(s)}{k_{\beta 0}^2} \right) + \left[ \frac{1}{2} \frac{1 - (\sigma/\sigma_0)^2}{1 + (\sigma/\sigma_0)^2} \right] \frac{\delta Q(s)}{Q} \\ &\quad + \left[ \frac{1}{2} \frac{(\sigma/\sigma_0)^2}{1 + (\sigma/\sigma_0)^2} \right] \frac{1}{2} \left( \frac{\delta \varepsilon_x(s)}{\varepsilon} + \frac{\delta \varepsilon_y(s)}{\varepsilon} \right), \\ \frac{\delta r_{-}(s)}{r_m} &= \frac{\delta p_{-}(s)}{\sigma_{-}^2} \\ &= - \left[ \frac{1}{1 + 3(\sigma/\sigma_0)^2} \right] \frac{1}{2} \left( \frac{\delta \kappa_x(s)}{k_{\beta 0}^2} - \frac{\delta \kappa_y(s)}{k_{\beta 0}^2} \right) \\ &\quad + \left[ \frac{2(\sigma/\sigma_0)^2}{1 + 3(\sigma/\sigma_0)^2} \right] \frac{1}{2} \left( \frac{\delta \varepsilon_x(s)}{\varepsilon} - \frac{\delta \varepsilon_y(s)}{\varepsilon} \right). \end{aligned}$$

Focusing

Perveance

Emittance

Coefficients of adiabatic terms in square brackets: [ ]

Emittance

## Continuous Focusing – adiabatic solution coefficients

a)  $\delta r_{+} = (\delta r_x + \delta r_y)/2$  Breathing Mode Projection

Relative strength of:

- Space-Charge (Perveance)
- Applied Focusing
- Emittance

terms vary with space-charge depression ( $\sigma/\sigma_0$ ) for both breathing and quadrupole mode projections

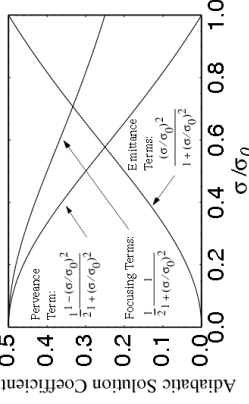

b)  $\delta r_{-} = (\delta r_x - \delta r_y)/2$  Quadrupole Mode Projection

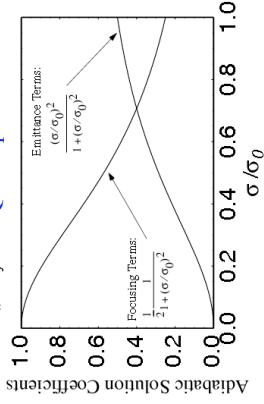

Plots allow one to read off the relative importance of various contributions to beam mismatch as a function of space-charge strength

## Continuous Focusing – sudden particular solution

For step function driving perturbations of form:

$$\delta p_{\pm}(s) = \widehat{\delta p}_{\pm} \Theta(s - s_p)$$

Hat quantities are constant amplitudes

$s = s_p$  axial coordinate perturbation applied

with amplitudes:

$$\begin{aligned} \widehat{\delta p}_{+} &= -\frac{\sigma_0^2}{2} \left[ \frac{\widehat{\delta \kappa}_x}{k_{\beta 0}^2} + \frac{\widehat{\delta \kappa}_y}{k_{\beta 0}^2} \right] + (\sigma_0^2 - \sigma^2) \frac{\widehat{\delta Q}}{Q} + \sigma^2 \left[ \frac{\widehat{\delta \varepsilon}_x}{\varepsilon} + \frac{\widehat{\delta \varepsilon}_y}{\varepsilon} \right] = \text{const} \\ \widehat{\delta p}_{-} &= -\frac{\sigma_0^2}{2} \left[ \frac{\widehat{\delta \kappa}_x}{k_{\beta 0}^2} - \frac{\widehat{\delta \kappa}_y}{k_{\beta 0}^2} \right] + \sigma^2 \left[ \frac{\widehat{\delta \varepsilon}_x}{\varepsilon} - \frac{\widehat{\delta \varepsilon}_y}{\varepsilon} \right] = \text{const} \end{aligned}$$

The solution is given by the substitution in the expression for the adiabatic solution:

$$\delta p_{\pm}(s) \rightarrow \widehat{\delta p}_{\pm} \left[ 1 - \cos \left( \sigma_{\pm} \frac{s - s_p}{L_p} \right) \right] \Theta(s - s_p)$$

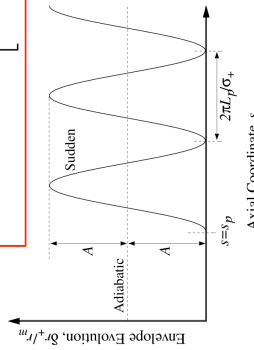

For the same amplitude of total driving perturbations, sudden perturbations result in 2x the envelope excursion that adiabatic perturbations produce.

Adiabatic Excursion

2x Excursion

## S8: Envelope Modes in Periodic Focusing Channels

### Overview

- Much more complicated the continuous limit results
  - Lattice can couple to oscillations and destabilize the system
  - Broad parametric instability bands can result
- Instability bands calculated will exclude wide ranges of parameter space from machine operation
  - Exclusion region depends on focusing type
  - Will find that alternating gradient quadrupole focusing tends to have more instability than high occupancy solenoidal focusing due to larger envelope flutter driving stronger, broader instability
- Results in this section are calculated numerically and summarized parametrically to illustrate the full range of mode characteristics
  - Results presented in terms of phase advances and normalized space-charge strength to allow broad applicability
  - Coupled 4x4 eigenvalue problem and mode symmetries identified in S6 are solved numerically and analytical limits are verified
- More information on results presented can be found in the PRSTAB Review

## Solenoidal Focusing – Matched Envelope Solution

a)  $\sigma_y = 80^\circ$  and  $\eta = 0.75$  High Occupancy

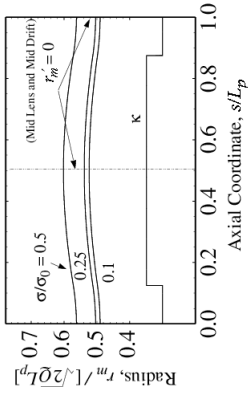

b)  $\sigma_y = 80^\circ$  and  $\eta = 0.25$  Low Occupancy

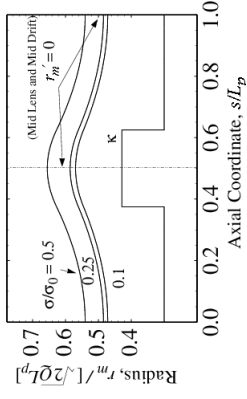

Focusing:

$$\kappa_x(s) = \kappa_y(s) = \kappa(s)$$

$$\kappa(s + L_p) = \kappa(s)$$

Matched Beam:

$$\varepsilon_x = \varepsilon_y = \varepsilon = \text{const}$$

$$r_{xm}(s) = r_{ym}(s) = r_m(s)$$

$$r_m(s + L_p) = r_m(s)$$

Comments:

- Envelope flutter a strong function of occupancy  $\eta$
- Space-charge expands envelope but does not strongly modify periodic flutter

Solenoidal Focusing – parametric plots of breathing and quadrupole envelope mode phase advances two values of undepressed phase advance

a)  $\eta = 0.25, \sigma_0 = 80^\circ$

+ Stable - Stable

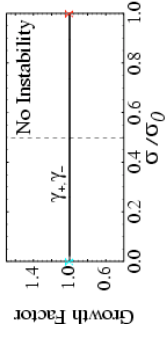
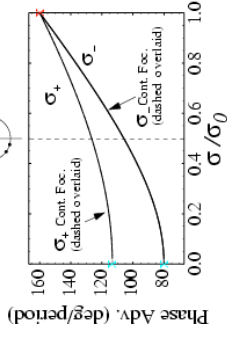

b)  $\eta = 0.25, \sigma_0 = 115^\circ$

+ Stable + Lattice Resonance - Stable - Stable

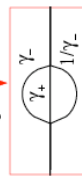
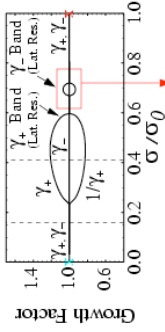
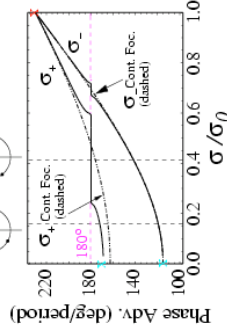

Using a transfer matrix approach on undepressed single-particle orbits set the strength of the focusing function for specified undepressed particle phase advance by solving:

See: S.M. Lund, lectures on **Transverse Particle Equations**

Solenoidal Focusing - piecewise constant focusing lattice

$$\cos \sigma_0 = \cos(2\Theta) - \frac{1-\eta}{\eta} \Theta \sin(2\Theta) \quad \Theta \equiv \frac{\sqrt{\hat{\kappa}} L_p}{2}$$

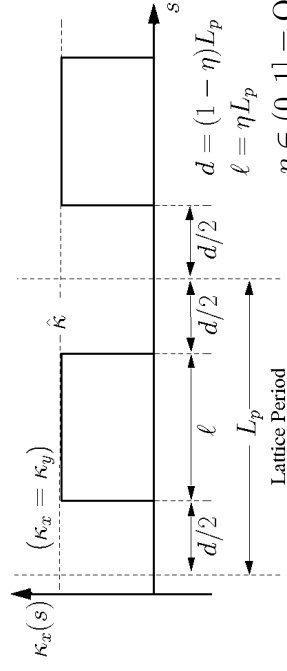

$\eta \in (0, 1] = \text{Occupancy}$

Solenoidal Focusing – mode instability bands become wider and stronger for smaller occupancy

$$\eta = \begin{cases} 0.75 & \text{(Blue)} \\ 0.25 & \text{(Green)} \\ 0.10 & \text{(Red)} \end{cases} \quad \sigma_0 = 115^\circ$$

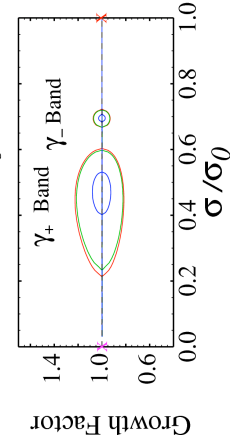
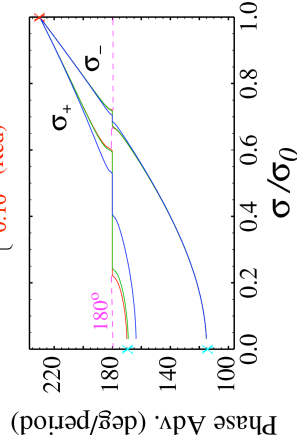

Comments:

- Phase advance in instability band 180 deg.
- Significant deviations from continuous model even outside the band of instability when space-charge strong
- Instability band becomes stronger for low occupancy

Solenoidal Focusing – broad ranges of parametric instability are found for the breathing and quadrupole bands that must be avoided in machine operation

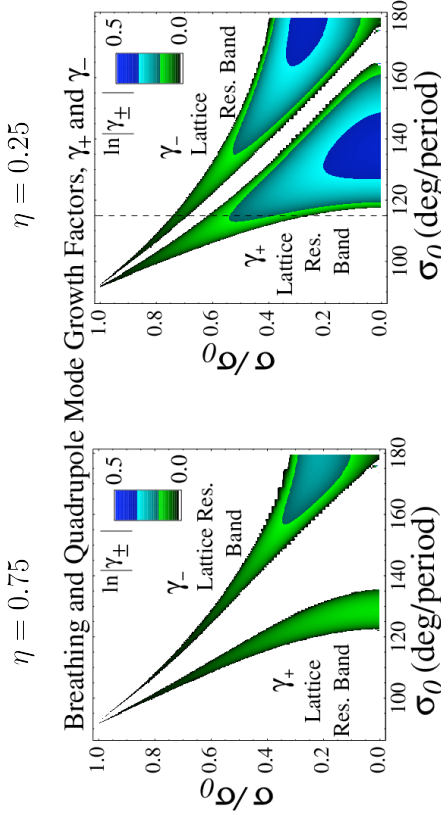

Solenoidal Focusing – parametric mode properties of band oscillations

a)  $\eta = 0.75$

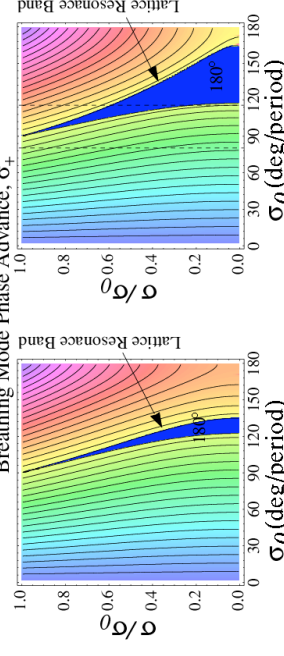

b)  $\eta = 0.25$

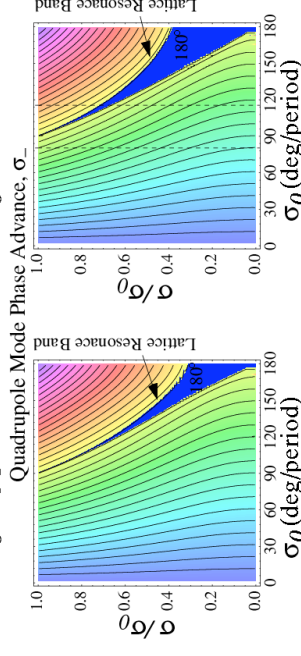

## Quadrupole Doublet Focusing – Matched Envelope Solution

FODO and Syncopated Lattices

a)  $\sigma_0 = 80^\circ$ ,  $\eta = 0.6949$ , and  $\alpha = 1/2$  FODO

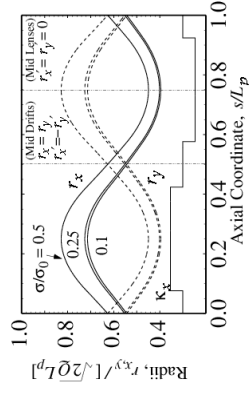

b)  $\sigma_0 = 80^\circ$ ,  $\eta = 0.6949$ , and  $\alpha = 0.1$  Syncopated

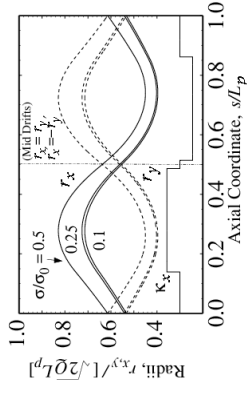

Focusing:

$$\kappa_x(s) = -\kappa_y(s) = \kappa(s)$$

$$\kappa(s + L_p) = \kappa(s)$$

Matched Beam:

$$\varepsilon_x = \varepsilon_y = \varepsilon = \text{const}$$

$$r_{xm}(s + L_p) = r_{xm}(s)$$

$$r_{ym}(s + L_p) = r_{ym}(s)$$

Comments:

- Envelope flutter a weak function of occupancy  $\eta$
- Syncopation factors  $\alpha \neq 1/2$  reduce envelope symmetry and can drive more instabilities
- Space-charge expands envelope

Using a transfer matrix approach on undepressed single-particle orbits set the strength of the focusing function for specified undepressed particle phase advance by solving:

See: S.M. Lund, lectures on **Transverse Particle Equations**

**Quadrupole Doublet Focusing - piecewise constant focusing lattice**

$$\cos \sigma_0 = \cos \Theta \cosh \Theta + \frac{1-\eta}{\eta} \theta (\cos \Theta \sinh \Theta - \sin \Theta \cosh \Theta) - 2\alpha(1-\alpha) \frac{(1-\eta)^2}{\eta^2} \Theta^2 \sin \Theta \sinh \Theta \quad \Theta \equiv \frac{\sqrt{|\hat{k}|} L_p}{2}$$

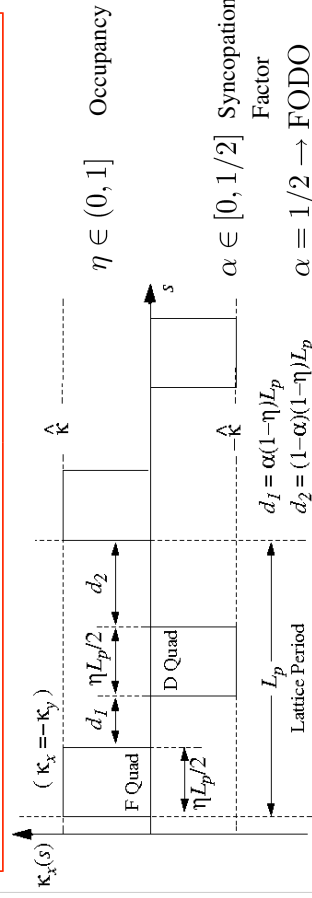

**Quadrupole Focusing – parametric plots of breathing and quadrupole envelope mode phase advances two values of undepressed phase advance**

a)  $\eta = 0.6949, \alpha = 0.1, \sigma_0 = 80^\circ$  **FODO** Syncopated

b)  $\eta = 0.6949, \alpha = 0.1, \sigma_0 = 115^\circ$  **FODO** Syncopated

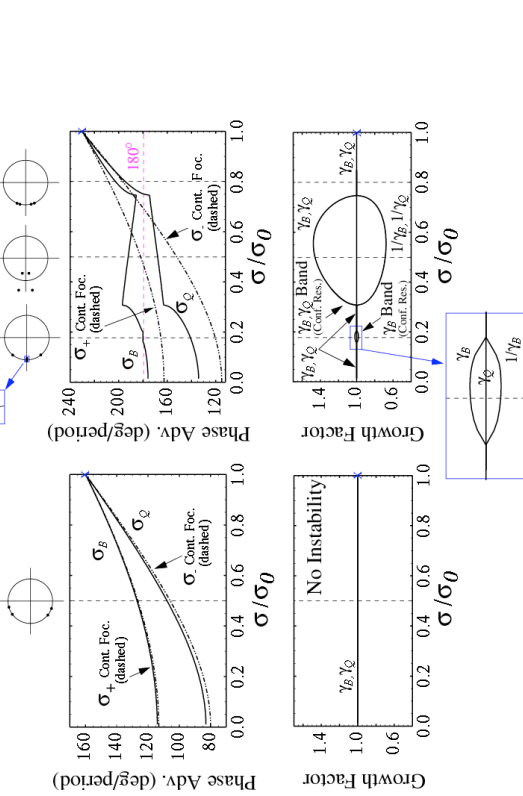

**Quadrupole Focusing – mode instability bands vary little/strongly with occupancy for FODO/syncopated lattices**

a)  $\alpha = 1/2$  (FODO),  $\sigma_0 = 115^\circ$  **FODO**

b)  $\alpha = 0.1, \sigma_0 = 115^\circ$  **Syncopated**

$\eta = \begin{cases} 0.90 & \text{(Blue)} \\ 0.6949 & \text{(Black)} \\ 0.25 & \text{(Green)} \\ 0.10 & \text{(Red)} \end{cases}$

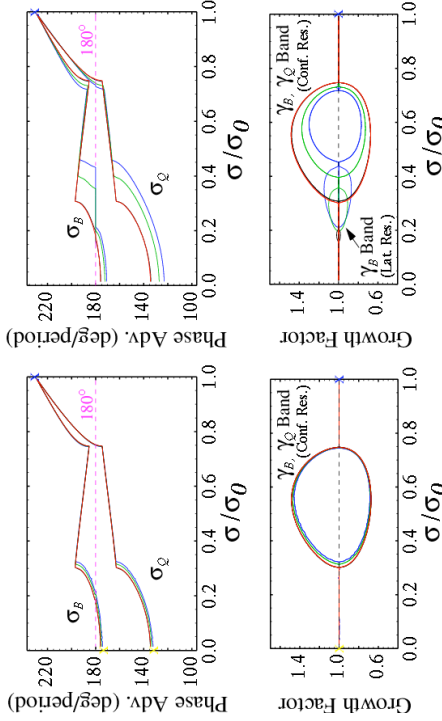

**Quadrupole Focusing – broad ranges of parametric instability are found for the breathing and quadrupole bands that must be avoided in machine operation**

**FODO Lattice**  $\eta = 0.6949, \alpha = 1/2$

**Syncopated Lattice**  $\eta = 0.6949, \alpha = 0.1$

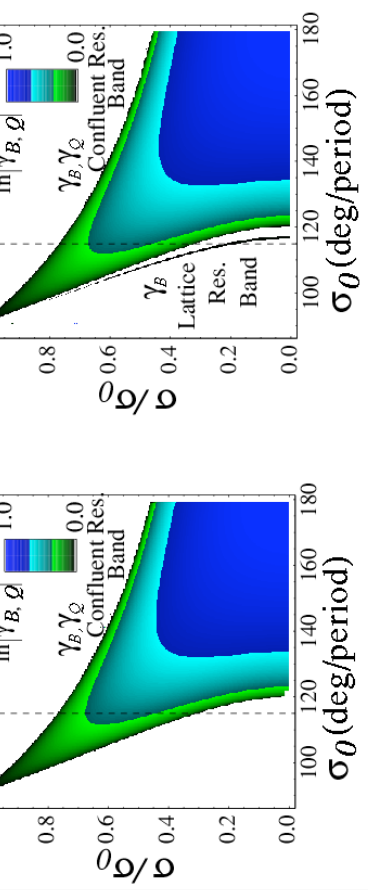

**Quadrupole Focusing – parametric mode properties of band oscillations**

a)  $\eta = 0.6949, \alpha = 1/2$  **FODO** **Breathing Mode Phase Advance,  $\sigma_B$**

b)  $\eta = 0.6949, \alpha = 0.1$  **Syncopated** **Quadrupole Mode Phase Advance,  $\sigma_Q$**

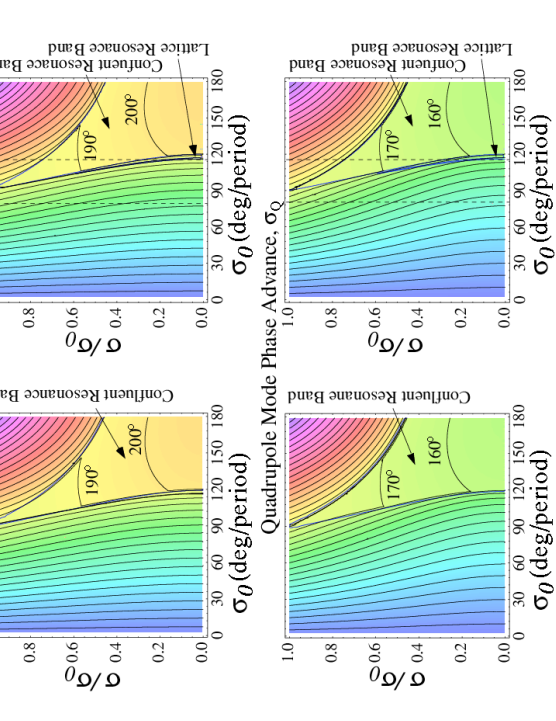



**Quadrupole Focusing – mode structure varies strongly with mode phase and the location in the lattice (FODO example)**

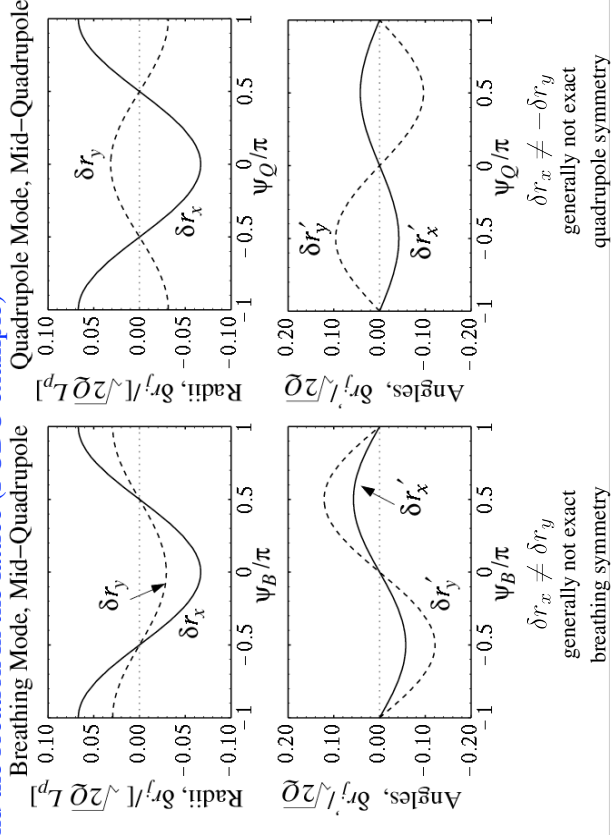

**Summary: Envelope band instabilities and growth rates for periodic solenoidal and quadrupole doublet focusing lattices**

Envelope Mode Instability Growth Rates

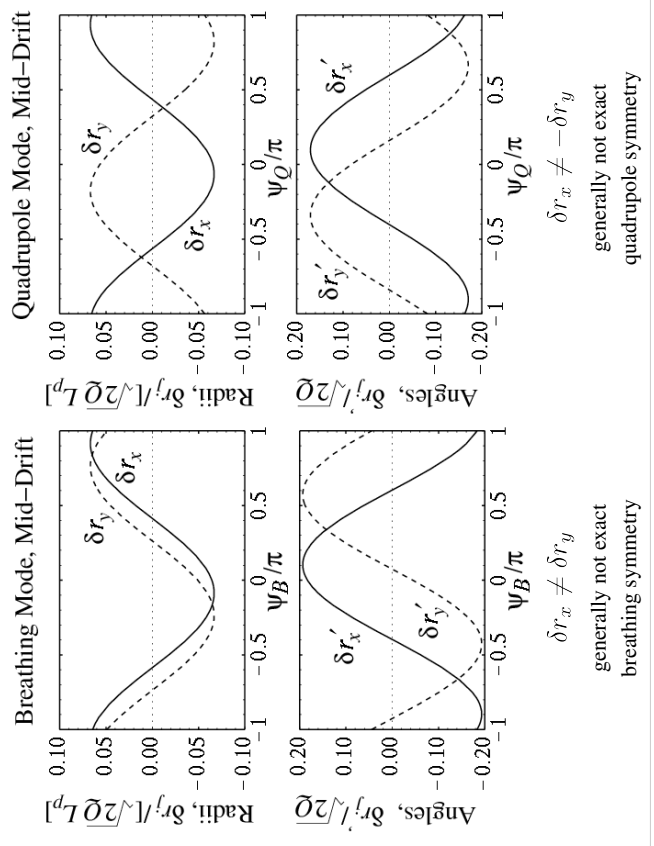
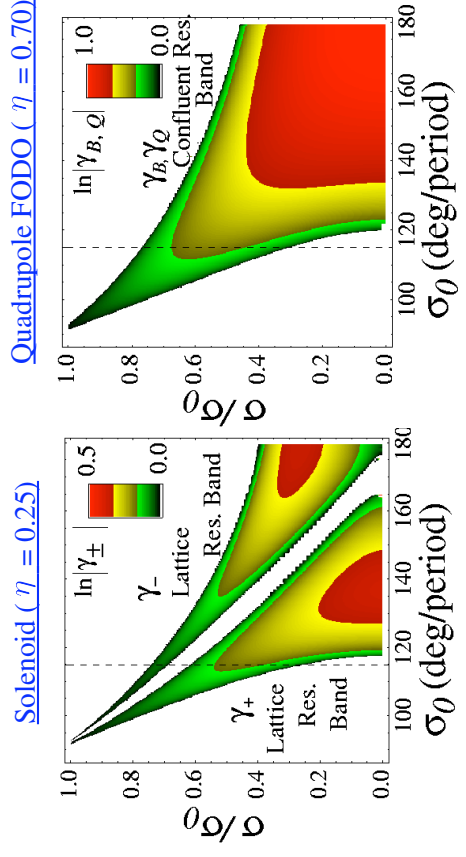

**S9: Transport Limit Scaling Based on Envelope Models**

See Handwritten Notes from 2006 USPAS

- ♦ Will attempt to convert to slides in future versions of the class

## S8: Centroid and Envelope Descriptions via 1<sup>st</sup> Order Coupled Moment Equations

When constructing centroid and moment models, it can be efficient to simply write moments, differentiate them, and then apply the equation of motion. Generally, this results in lower order moments coupling to higher order ones and an infinite chain of equations. But the hierarchy can be truncated by:

- Assuming a fixed functional form of the distribution in terms of moments
- Neglecting coupling to higher order terms

Resulting first order moment equations can be expressed in terms of a closed set of moments and advanced in  $s$  or  $t$  using simple (ODE based) numerical codes. This approach can prove simpler to include effects where invariants are not easily extracted to reduce the form of the equations (as when solving the KV envelope equations in the usual form).

Examples of effects that might be more readily analyzed:

- Skew coupling in quadrupoles See: references at end of notes
- Chromatic effects in final focus J.J. Barnard, lecture on **Heavy-Ion Fusion and Final Focusing**
- Dispersion in bends

SM Lund, USPAS, June 2008 Transverse Centroid and Envelope Descriptions of Beam Evolution 77

When simplifying the results, if the distribution form is frozen in terms of moments (Example: assume uniform density elliptical beam) then we use constructs like:

$$n = \int d^2x_{\perp} f_{\perp} = n(\mathbf{M})$$

to simplify the resulting equations and express the RHS in terms of elements of  $\mathbf{M}$

1<sup>st</sup> order moments:

$$\begin{aligned} \mathbf{X}_{\perp} &= \langle \mathbf{x}_{\perp} \rangle_{\perp} && \text{Centroid coordinate} \\ \mathbf{X}'_{\perp} &= \langle \mathbf{x}'_{\perp} \rangle_{\perp} && \text{Centroid angle} \\ &+ \text{possible others if more variables. Example} \\ \Delta &= \langle \frac{\delta p_s}{p_s} \rangle = \langle \delta \rangle && \text{Centroid off-momentum} \\ &: && \\ &: && \end{aligned}$$

SM Lund, USPAS, June 2008 Transverse Centroid and Envelope Descriptions of Beam Evolution 79

Resulting form of coupled moment equations:

$$\frac{d}{ds} \mathbf{M} = \mathbf{F}(\mathbf{M})$$

- $\mathbf{M}$  = vector of moments, generally infinite
- $\mathbf{F}$  = vector function of  $\mathbf{M}$ , generally nonlinear
- System advanced from a specified initial condition (initial value of  $\mathbf{M}$ )

Transverse moment definition:

$$\langle \dots \rangle_{\perp} \equiv \frac{\int d^2x_{\perp} \int d^2x'_{\perp} \dots f_{\perp}}{\int d^2x_{\perp} \int d^2x'_{\perp} f_{\perp}}$$

Can be generalized if other variables such as off momentum are included in  $f$

Differentiate moments and apply equations of motion:

$$\frac{d}{ds} \langle \dots \rangle_{\perp} \equiv \frac{\int d^2x_{\perp} \int d^2x'_{\perp} \left[ \frac{d}{ds} \dots \right] f_{\perp}}{\int d^2x_{\perp} \int d^2x'_{\perp} f_{\perp}}$$

+ apply equations of motion to simplify  $\frac{d}{ds} \dots$

SM Lund, USPAS, June 2008 Transverse Centroid and Envelope Descriptions of Beam Evolution 78

2<sup>nd</sup> order moments:

It is typically convenient to subtract centroid from higher-order moments

$$\begin{aligned} \tilde{x} &\equiv x - X && \tilde{x}' \equiv x' - X' \\ \tilde{y} &\equiv y - Y && \tilde{y}' \equiv y' - Y' \\ \tilde{\delta} &\equiv \delta - \Delta \end{aligned}$$

$$\begin{array}{lll} \text{x-moments} & \text{y-moments} & \text{x-y cross moments} & \text{dispersive moments} \\ \langle \tilde{x}^2 \rangle_{\perp} & \langle \tilde{y}^2 \rangle_{\perp} & \langle \tilde{x}\tilde{y} \rangle_{\perp} & \langle \tilde{x}\tilde{\delta} \rangle, \langle \tilde{y}\tilde{\delta} \rangle \\ \langle \tilde{x}\tilde{x}' \rangle_{\perp} & \langle \tilde{y}\tilde{y}' \rangle_{\perp} & \langle \tilde{x}'\tilde{y} \rangle_{\perp}, \langle \tilde{x}\tilde{y}' \rangle_{\perp} & \langle \tilde{x}'\tilde{\delta} \rangle, \langle \tilde{y}'\tilde{\delta} \rangle \\ \langle \tilde{x}'^2 \rangle_{\perp} & \langle \tilde{y}'^2 \rangle_{\perp} & \langle \tilde{x}'\tilde{y}' \rangle_{\perp} & \langle \tilde{\delta}^2 \rangle \end{array}$$

3<sup>rd</sup> order moments: Analogous to 2<sup>nd</sup> order case, but more for each order

$$\langle \tilde{x}^3 \rangle_{\perp}, \langle \tilde{x}^2\tilde{y} \rangle_{\perp}, \dots$$

SM Lund, USPAS, June 2008 Transverse Centroid and Envelope Descriptions of Beam Evolution 80

Many quantities of physical interest are expressed in transport can then be expressed in terms of moments calculated when the equations are numerically advanced in  $s$  and their evolutions plotted to understand behavior

- Many quantities of physical interest are expressible in terms of 1st and 2nd order moments

Example moments often projected:

Statistical beam size:

(rms edge measure)

$$r_x = 2 \langle \tilde{x}^2 \rangle_{\perp}^{1/2}$$

$$r_y = 2 \langle \tilde{y}^2 \rangle_{\perp}^{1/2}$$

Statistical emittances:

(rms edge measure)

$$\varepsilon_x = 4 \left[ \langle \tilde{x}^2 \rangle_{\perp} \langle \tilde{x}'^2 \rangle_{\perp} - \langle \tilde{x} \tilde{x}' \rangle_{\perp}^2 \right]^{1/2}$$

$$\varepsilon_y = 4 \left[ \langle \tilde{y}^2 \rangle_{\perp} \langle \tilde{y}'^2 \rangle_{\perp} - \langle \tilde{y} \tilde{y}' \rangle_{\perp}^2 \right]^{1/2}$$

Kinetic longitudinal temperature:

(rms measure)

$$T_s = \text{const} \times \langle \tilde{\delta}^2 \rangle$$

## Illustrate approach with the familiar KV model

Truncation assumption: unbunched uniform density elliptical beam in free space

- $\delta = 0$ , no axial velocity spread

- All cross moments zero, i.e.  $\langle \tilde{x} \tilde{y} \rangle_{\perp} = 0$

$$\frac{d}{ds} \langle x \rangle_{\perp} = \langle x' \rangle_{\perp}$$

$$\frac{d}{ds} \langle x^2 \rangle_{\perp} = 2 \langle x x' \rangle_{\perp}$$

$$\frac{d}{ds} \langle x' \rangle_{\perp} = \langle x'' \rangle_{\perp}$$

$$\frac{d}{ds} \langle x'^2 \rangle_{\perp} = 2 \langle x' x'' \rangle_{\perp}$$

$\vdots$

$\vdots$

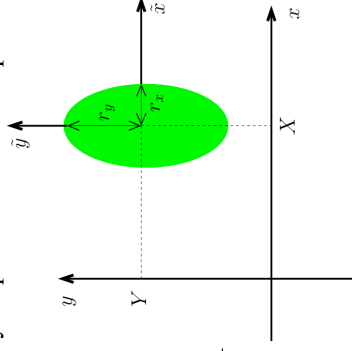

Use particle equations of motion within beam, neglect images, and simplify

- Apply equations in S2 with  $\mathbf{E}_{\perp}^i = 0$

$$x'' + \frac{(\gamma_b \beta_b)'}{(\gamma_b \beta_b)} x' + \kappa_x x - \frac{2Q}{(r_x + r_y) r_x} (x - \langle x \rangle_{\perp}) = 0$$

$$y'' + \frac{(\gamma_b \beta_b)'}{(\gamma_b \beta_b)} y' + \kappa_y y - \frac{2Q}{(r_x + r_y) r_y} (y - \langle y \rangle_{\perp}) = 0$$

Using 2<sup>nd</sup> order moment equations we can show that

$$\frac{d}{ds} \varepsilon_x^2 = 0 = \frac{d}{ds} \varepsilon_y^2$$

$$\varepsilon_x^2 = 16 \left[ \langle x^2 \rangle_{\perp} \langle x'^2 \rangle_{\perp} - \langle x x' \rangle_{\perp}^2 \right] = \text{const}$$

$$\varepsilon_y^2 = 16 \left[ \langle y^2 \rangle_{\perp} \langle y'^2 \rangle_{\perp} - \langle y y' \rangle_{\perp}^2 \right] = \text{const}$$

Using this, the 2<sup>nd</sup> order moment equations can be equivalently expressed in the standard KV envelope form:

$$\frac{dr_x}{ds} = r_x'; \quad \frac{d}{ds} r_x' + \kappa_x r_x - \frac{2Q}{r_x + r_y} - \frac{\varepsilon_x^2}{r_x^3} = 0$$

$$\frac{dr_y}{ds} = r_y'; \quad \frac{d}{ds} r_y' + \kappa_y r_y - \frac{2Q}{r_x + r_y} - \frac{\varepsilon_y^2}{r_y^3} = 0$$

- Moment form fully consistent with usual KV model .... as it must be
- Moment form generally easier to put in additional effects that would violate the usual emittance invariants

## Resulting system of 1st and 2nd order moments

1<sup>st</sup> order moments:

$$\frac{d}{ds} \begin{bmatrix} \langle x \rangle_{\perp} \\ \langle x' \rangle_{\perp} \\ \langle y \rangle_{\perp} \\ \langle y' \rangle_{\perp} \end{bmatrix} = \begin{bmatrix} \langle x' \rangle_{\perp} \\ -\kappa_x(s) \langle x \rangle_{\perp} \\ \langle y' \rangle_{\perp} \\ -\kappa_y(s) \langle y \rangle_{\perp} \end{bmatrix}$$

2<sup>nd</sup> order moments:

$$\frac{d}{ds} \begin{bmatrix} \langle \tilde{x}^2 \rangle_{\perp} \\ \langle \tilde{x} \tilde{x}' \rangle_{\perp} \\ \langle \tilde{x}'^2 \rangle_{\perp} \\ \langle \tilde{y}^2 \rangle_{\perp} \\ \langle \tilde{y} \tilde{y}' \rangle_{\perp} \\ \langle \tilde{y}'^2 \rangle_{\perp} \end{bmatrix} = \begin{bmatrix} 2 \langle \tilde{x} \tilde{x}' \rangle_{\perp} \\ \langle \tilde{x}'^2 \rangle_{\perp} - \kappa_x(s) \langle \tilde{x}^2 \rangle_{\perp} + \frac{Q \langle \tilde{x}'^2 \rangle_{\perp}}{[4 \langle \tilde{x}^2 \rangle_{\perp}^{1/2} \langle \tilde{x}'^2 \rangle_{\perp}^{1/2} + \langle \tilde{y}^2 \rangle_{\perp}^{1/2}]} \\ -2 \kappa_x(s) \langle \tilde{x} \tilde{x}' \rangle_{\perp} + \frac{2Q \langle \tilde{x} \tilde{x}' \rangle_{\perp}}{[4 \langle \tilde{x}^2 \rangle_{\perp}^{1/2} \langle \tilde{x}'^2 \rangle_{\perp}^{1/2} + \langle \tilde{y}^2 \rangle_{\perp}^{1/2}]} \\ 2 \langle \tilde{y} \tilde{y}' \rangle_{\perp} \\ \langle \tilde{y}'^2 \rangle_{\perp} - \kappa_y(s) \langle \tilde{y}^2 \rangle_{\perp} + \frac{Q \langle \tilde{y}'^2 \rangle_{\perp}}{[4 \langle \tilde{y}^2 \rangle_{\perp}^{1/2} \langle \tilde{x}^2 \rangle_{\perp}^{1/2} + \langle \tilde{y}^2 \rangle_{\perp}^{1/2}]} \\ -2 \kappa_y(s) \langle \tilde{y} \tilde{y}' \rangle_{\perp} + \frac{2Q \langle \tilde{y} \tilde{y}' \rangle_{\perp}}{[4 \langle \tilde{y}^2 \rangle_{\perp}^{1/2} \langle \tilde{x}^2 \rangle_{\perp}^{1/2} + \langle \tilde{y}^2 \rangle_{\perp}^{1/2}]} \end{bmatrix}$$

- Express 1st and 2nd order moments separately in this case since uncoupled
- Form truncates due to frozen distribution form: all moments on LHS on RHS
- Integrate from initial moments values of  $s$  and project out desired quantities

Relative advantages of the use of coupled matrix form versus reduced equations can depend on the problem/situation

[Coupled Matrix Equations](#)

$$\frac{d}{ds} \mathbf{M} = \mathbf{F}$$

$\mathbf{M}$  = Moment Vector  
 $\mathbf{F}$  = Force Vector

- ◆ Easy to formulate
- Straightforward to incorporate additional effects
- ◆ Natural fit to numerical routine
- Easy to code

[Reduced Equations](#)

$$X'' + \kappa_x X = 0$$

$$r_x'' + \kappa_x r_x - \frac{2Q}{r_x + r_y} \frac{\epsilon_x^2}{r_x^3} = 0$$

etc.

- Reduction based on identifying invariants such as
- $\epsilon_x^2 = 16 \left[ \langle \tilde{x}^2 \rangle_{\perp} \langle \tilde{x}'^2 \rangle_{\perp} - \langle \tilde{x} \tilde{x}' \rangle_{\perp}^2 \right]$  helps understand solutions
- ◆ Compact expressions

**References:** For more information see:

Image charge couplings:

E.P. Lee, E. Close, and L. Smith, Nuc. Inst. And Methods, 1126 (1987)

**Seminal work on envelope modes:**

J. Struckmeier and M. Reiser, *Theoretical Studies of Envelope Oscillations and Instabilities of Mismatched Intense Charged-Particle Beams in Periodic Focusing Channels*, Part. Accel. **14**, 227 (1984)

M. Reiser, *Theory and Design of Charged Particle Beams* (John Wiley, 1994, 2008)

**Extensive review on envelope instabilities:**

S.M. Lund and B. Bukh, *Stability Properties of the KV Envelope Equations Describing Intense Ion Beam Transport*, PRSTAB **7** 024801 (2004)

**Efficient, Fail-Safe Generation of Matched Envelope Solutions:**

S.M. Lund and S.H. Chilton, and E.P. Lee, *Efficient Computation of Matched Solutions of the KV Envelope Equations*, PRSTAB **9** 064201 (2006)

These slides will be corrected and expanded for reference and any future editions of the US Particle Accelerator School class: *Beam Physics with Intense Space Charge*, by J.J. Barnard and S.M. Lund

Corrections and suggestions are welcome. Contact:

Steven M. Lund  
 Lawrence Berkeley National Laboratory  
 BLDG 47 R 0112  
 1 Cyclotron Road  
 Berkeley, CA 94720-8201

[SMLund@lbl.gov](mailto:SMLund@lbl.gov)  
 (510) 486 – 6936

Please do not remove author credits in any redistributions of class material.

**KV results:**

F. Sacherer, *Transverse Space-Charge Effects in Circular Accelerators*, Univ. of California Berkeley, Ph.D Thesis (1968)

I. Kaphinskij and V. Vladimirkij, in *Proc. Of the Int. Conf. On High Energy Accel. and Instrumentation* (CERN Scientific Info. Service, Geneva, 1959) p. 274

**Symmetries and phase-amplitude methods:**

A. Dragt, *Lectures on Nonlinear Orbit Dynamics in Physics of High Energy Particle Accelerators*, (American Institute of Physics, 1982), AIP Conf. Proc. No. 87, p. 147

E. D. Courant and H. S. Snyder, *Theory of the Alternating-Gradient Synchrotron*, Annals of Physics **3**, 1 (1958)

**Analytical analysis of matched envelope solutions and transport scaling:**

E. P. Lee, *Precision matched solution of the coupled beam envelope equations for a periodic quadrupole lattice with space-charge*, Phys. Plasmas **9**, 4301 (2005)

O.A. Anderson, *Accurate Iterative Analytic Solution of the KV Envelope Equations for a Matched Beam*, PRSTAB, **10** 034202 (2006)



### Coupled Moment Formulations of Centroid and Envelope Evolution:

- J.J. Barnard, H.D. Shay, S.S. Yu, A. Friedman, and D.P. Grote, *Emittance Growth in Heavy-Ion Recirculators*, 1992 PAC Proceedings, Ontario, Canada, p. 229
- J.J. Barnard, J. Miller, I. Haber, *Emittance Growth in Displaced Space Charge Dominated Beams with Energy Spread*, 1993 PAC Proceedings, Washington, p. 3612 (1993)
- J.J. Barnard, *Emittance Growth from Rotated Quadrupoles in Heavy Ion Accelerators*, 1995 PAC Proceedings, Dallas, p. 3241 (1995)
- R.A. Kishek, J.J. Barnard, and D.P. Grote, *Effects of Quadrupole Rotations on the Transport of Space-Charge-Dominated Beams: Theory and Simulations Comparing Linacs with Circular Machines*, 1999 PAC Proceedings, New York, TUP119, p. 1761 (1999)
- J.J. Barnard, R.O. Bangerter, E. Henestroza, I.D. Kaganovich, E.P. Lee, B.G. Logan, W.R. Meier, D. Rose, P. Santhanam, W.M. Sharp, D.R. Welch, and S.S. Yu, *A Final Focus Model for Heavy Ion Fusion System Codes*, NIMA **544** 243-254 (2005).
- J.J. Barnard and B. Losic, *Envelope Modes of Beams with Angular Momentum*, Proc. 20th LINAC Conf., Monterey, MOE12 (2000)

§9

Transport Limit Scaling Based on the  
Matched Beam Envelope Equations  
for Periodic Focusing Channels

The scaling of the maximum beam current, or equivalently, the maximum perveance  $Q$  that can be transported at a given energy, with a specified focusing technology and lattice is of critical importance in designing optimal transport and acceleration channels. Needed equations can be derived from approximate analytical solutions to the matched beam envelope equations for a given lattice.

Alternatively, numerical solutions of the envelope equations can be evaluated. But analytical solutions are preferable to understand scaling and enable rapid evaluation of design tradeoffs.

As a practical matter, equations derived must be applied to regimes where technology is feasible.

- Magnet Field Limits
- Electron breakdown
- Vacuum

!

Transport limits are inextricably linked to technology. Moreover, higher order stability constraints etc. must also be respected. Treatments of these topics are beyond the scope of this class. Here we present simplified treatments to<sup>274</sup> highlight issues and methods.

First review an example sketched by J.J. Barnard in the Intro. lectures.

### Transport Limits of a Periodic FODO Quadrupole Transport Channel

$$x_m'' + \frac{(\delta_b \beta_b)'}{(\delta_b \beta_b)} x_m' + K_x x_m - \frac{2Q}{x_m + y_m} - \frac{E_x^2}{x_m^3} = 0$$

$$y_m'' + \frac{(\delta_b \beta_b)'}{(\delta_b \beta_b)} y_m' - K_x y_m - \frac{2Q}{x_m + y_m} - \frac{E_y^2}{y_m^3} = 0$$

$$x_m(s+L_p) = x_m(s) \quad ; \quad y_m(s+L_p) = y_m(s)$$

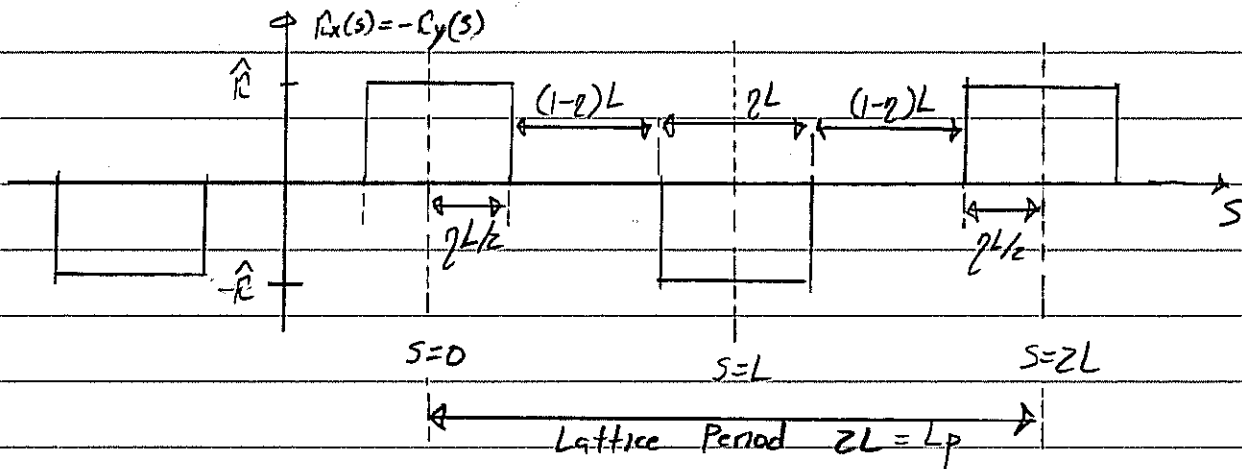

$L = \text{Half-Period} \quad L = L_p/2$

$\eta = \text{Quadrupole "occupancy"} \quad 0 < \eta \leq 1$

$K = \text{Focus strength}$

$$K = \begin{cases} \frac{qE'_1(s)}{m\delta_b\beta_b c^2} ; \text{Electric} \\ \frac{qB'_1(s)}{m\delta_b\beta_b c} ; \text{Magnetic} \end{cases}$$

Expand  $K_x(s)$  as a Fourier Series:

$$K_x(s) = \sum_{n=1}^{\infty} K_n \cos\left(\frac{n\pi s}{L}\right)$$

$$K_n = \frac{1}{L} \int_0^{2L} K_x(s) \cos\left(\frac{n\pi s}{L}\right) ds = \frac{2\hat{K}}{n\pi} \left[ 1 - (-1)^n \right] \sin\left(\frac{n\pi\eta}{2}\right)$$

And expand the periodic matched beam envelope by:

$$r_{xm} = r_b \left[ 1 + \Delta \cos\left(\frac{n\pi s}{L}\right) \right] + \sum_{n=2}^{\infty} \Delta_{xn} \cos\left(\frac{n\pi s}{L}\right)$$

$$r_{ym} = r_b \left[ 1 - \Delta \cos\left(\frac{n\pi s}{L}\right) \right] + \sum_{n=2}^{\infty} \Delta_{yn} \cos\left(\frac{n\pi s}{L}\right)$$

$$r_b = \text{const} = \text{avg. beam radius.}$$

$$|\Delta| = \text{const} \ll 1$$

$$\Delta_{xn} \text{ constants with } |\Delta_{xn}| \ll |\Delta|$$

Take!

$$\bullet (y_b \beta_b)' = 0 \Rightarrow \text{coasting beam}$$

$$\bullet \varepsilon_x = \varepsilon_y = \varepsilon \Rightarrow \text{isotropic beam}$$

and insert these expansions in the envelope equations.

Neglect:

$$\bullet \text{All terms } \mathcal{O}(\Delta^2) \text{ and higher}$$

$$\bullet \text{Fast oscillation terms } \sim \cos\left(\frac{n\pi s}{L}\right) \text{ with } n \geq 2.$$

to obtain two independent constraint equations:

$$\text{Avg (const)}: \frac{2\Delta \hat{K}}{\pi} r_b \sin\left(\frac{\pi \eta}{2L}\right) - \frac{Q}{r_b} - \frac{\varepsilon^2}{r_b^3} = 0$$

Fundamental

$$\text{at } \cos\left(\frac{\pi s}{L}\right): -\Delta \left(\frac{\pi r}{L}\right)^2 r_b + \frac{4\hat{K}}{\pi} r_b \sin\left(\frac{\pi \eta}{2L}\right) + \frac{3\Delta \varepsilon^2}{r_b^3} = 0$$

These equations can be solved to express the maximum beam edge excursion as

$$\text{Max}[r_{xm}] = \text{Max}[r_{ym}] \approx r_b(1+|\Delta|) = r_b \left\{ 1 + \frac{4|\hat{K}|L^2 \sin\left(\frac{\pi Q}{2L}\right)}{\pi^3 \left(1 - \frac{3L^2 \epsilon^2}{\pi^2 r_b^4}\right)} \right\}$$

and the beam Perveance as:

$$Q = 2 \left[ \frac{\sin\left(\frac{\pi Q}{2L}\right)}{\left(\frac{\pi Q}{2L}\right)} \right]^2 \frac{\hat{K}^2 L^2 r_b^2}{\left(1 - \frac{3L^2 \epsilon^2}{\pi^2 r_b^4}\right)} - \frac{\epsilon^2}{r_b^2}$$

### Design Strategy:

- 1) Choose a lattice period  $2L$ , quadrupole occupancy  $\hat{K}$ , and clear machine "pipe" radius  $r_b$  consistent with focusing technology employed.
- 2) Choose the largest possible focus strength  $\hat{K}$  (quadrupole current or voltage excitation) for beam energy with undepressed particle phase advance:

$$\Delta \lesssim 80^\circ / \text{period.} \quad \text{"Tiefenback Limit"}$$

- Larger phase advances correspond to stronger focus and smaller beam cross-sections/area for given values of  $Q, \epsilon$ .

- Weaker phase advance suppresses various particle, envelope, and collective instabilities for reliable transport: [Ref: M.G. Tiefenback, "Space-Charge Limits on the Transport of Ion Beams," UC Berkeley PhD Thesis, 1986 LBL-22465]

- 3) Choose a suitable beam-edge to aperture clearance factor:

$$\Gamma_p = \text{Max}[\Gamma_{xm}] + \Delta_p$$

$$\Delta_p = \text{Clearance.}$$

to allow for misalignments, limit scraping of halo particles outside the beam core, reduce image charges, gas propagation times from the aperture to the beam, and other nonideal effects.

- 4) Evaluate choices made using higher-order theory, numerical simulations etc., Iterate choices made to reoptimize when evaluating cost.

Effective application of this formulation requires extensive practical knowledge:

- Nonideal effects: collective instabilities, halo, electron and gas interactions (species contamination), .....
- Technology limits: Voltage breakdown, vacuum, superconducting magnets, .....

In practice, for intense beam transport, the emittance terms  $\epsilon_x, \epsilon_y$  can often be neglected for the purpose of obtaining simpler scaling relations that are more easily understood.

$$\lim_{\epsilon_x \rightarrow 0} \delta_x = 0$$

$\Rightarrow$  Full space charge

$$\lim_{\epsilon_y \rightarrow 0} \delta_y = 0$$

depression

In this limit  $Q \rightarrow Q_{\max}$ , the maximum transportable perveance.

For our previous example for FODO quadrupoles) the  $\epsilon \rightarrow 0$  limit obtains:

$$\lim_{\epsilon \rightarrow 0} \text{Max}[\Gamma_{\text{km}}] = \Gamma_b \left\{ 1 + \frac{4|\hat{K}|L^2}{\pi^3} \sin\left(\frac{\pi\eta}{2}\right) \right\}$$

$$\lim_{\epsilon \rightarrow 0} Q = Q_{\max} = \frac{2}{\pi^2} \left[ \frac{\sin\left(\frac{\pi\eta}{2}\right)^2}{\left(\frac{\pi\eta}{2}\right)} \right] \eta^2 \hat{K}^2 L \Gamma_b^2$$

Unfortunately, the method introduced before are inadequate for lattices with lesser degrees of symmetry such as syncopated quadrupole doublet lattices. However, methods introduced by Lee [E.P. Lee, Physics of Plasmas 9; 4301 (2002)], can be applied in this situation and also obtain more accurate results. It is beyond the scope of this class to carry out derivations with these methods, but we summarize results derived.

### Quadrupole Doublet Lattice

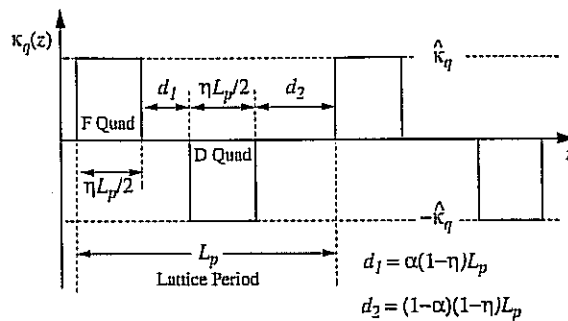

Denote:

$$\text{Avg Radius: } \bar{r}_m = \int_0^{L_p} \frac{ds}{L_p} r_{xm}(s) = \int_0^{L_p} \frac{ds}{L_p} r_{ym}(s)$$

$$\text{Max Excursion: } \text{Max}[\bar{r}_m] \equiv \text{Max}[r_{xm}, r_{ym}]$$

in period



# Phase Advance

S.M. Lund

8/

$$\cos \sigma_0 = 1 - \frac{(\eta \hat{k}_q L_p^2)^2}{32} \left[ \left(1 - \frac{2}{3}\eta\right) - 4\left(\alpha - \frac{1}{2}\right)^2 (1 - \eta)^2 \right]$$

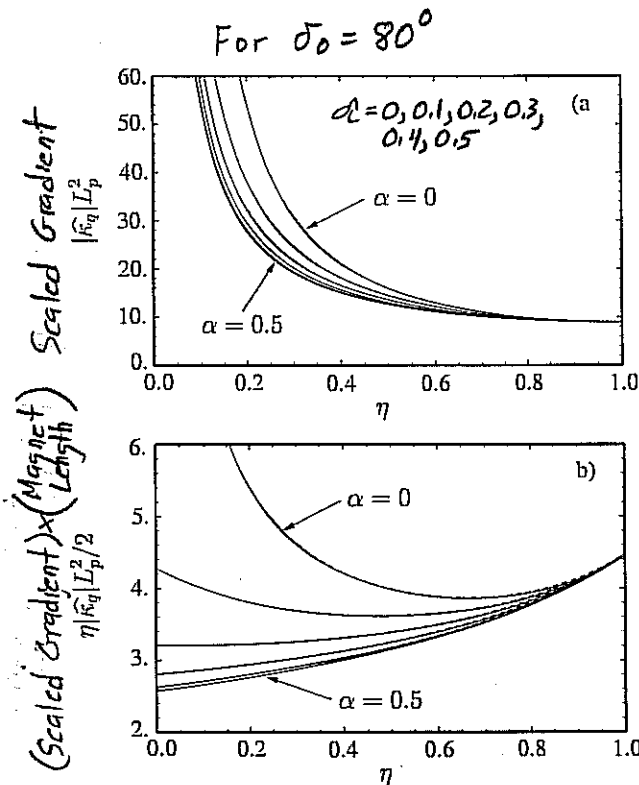

# Envelope Flutter

$$\frac{\text{Max}[r_m]}{\bar{r}_m} - 1 = \frac{(1 - \cos \sigma_0)^{1/2} (1 - \eta/2) [1 - 4(\alpha - 1/2)^2 (1 - \eta)^2]}{2^{3/2} [(1 - 2\eta/3) - 4(\alpha - 1/2)^2 (1 - \eta)^2]^{1/2}}$$

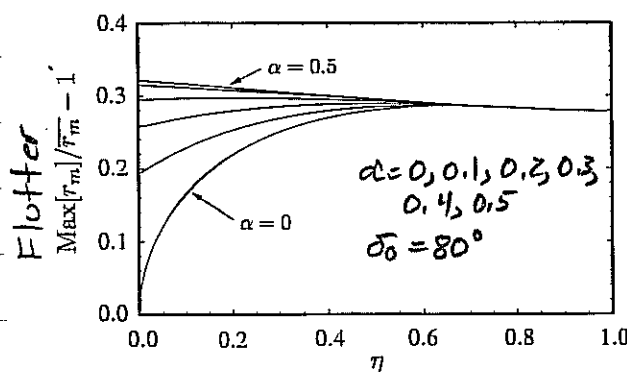

## Relations Connecting Max Transportable Perveance $Q_{\max}$ and Lattice Parameters

$$Q_{\max} = \frac{(1 - \cos \sigma_0)^{1/2} \eta [(1 - 2\eta/3) - 4(\alpha - 1/2)^2 (1 - \eta)^2]^{1/2}}{2^{3/2} (\text{Max}[r_m]/\bar{r}_m)^2} |\widehat{\kappa}_q| \text{Max}[r_m]^2$$

$$= \frac{(1 - \cos \sigma_0)^{1/2} \eta [(1 - 2\eta/3) - 4(\alpha - 1/2)^2 (1 - \eta)^2]^{1/2}}{2^{3/2} \left\{ 1 + \frac{(1 - \cos \sigma_0)^{1/2} (1 - \eta/2) [1 - 4(\alpha - 1/2)^2 (1 - \eta)^2]}{2^{3/2} [(1 - 2\eta/3) - 4(\alpha - 1/2)^2 (1 - \eta)^2]^{1/2}} \right\}^2} |\widehat{\kappa}_q| \text{Max}[r_m]^2.$$

$$\frac{\text{Max}[r_m]}{L_p} = \sqrt{\frac{Q_{\max}}{2(1 - \cos \sigma_0)}} \left( \frac{\text{Max}[r_m]}{\bar{r}_m} \right)$$

$$= \sqrt{\frac{Q_{\max}}{2(1 - \cos \sigma_0)}} \left\{ 1 + \frac{(1 - \cos \sigma_0)^{1/2} (1 - \eta/2) [1 - 4(\alpha - 1/2)^2 (1 - \eta)^2]}{2^{3/2} [(1 - 2\eta/3) - 4(\alpha - 1/2)^2 (1 - \eta)^2]^{1/2}} \right\},$$

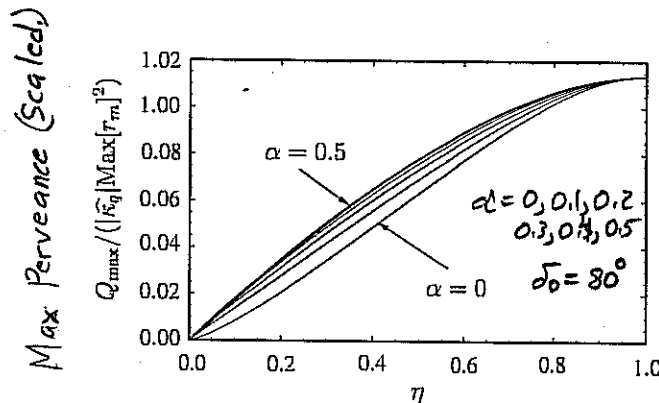

Derivation and application of scaling relations can be complicated. They are often applied in systems codes to generate plots that can be interpreted more readily.

John Barnard  
Steven Lund  
USPAS  
June 2008

## Mismatched Beams and Beam Halo

Envelope modes of beams in continuous focusing

Envelope modes of bunched beams in continuous focusing

Halos from mismatched beams

## SMOOTH FOCUSING ENVELOPE MODES

• If  $\frac{d}{ds} \gamma \beta = 0$  &  $K(s) = k_{p0}^2 = \text{constant}$  &  $\epsilon_x = \epsilon_y$

$$\Rightarrow v_x'' + k_{p0}^2 v_x - \frac{2Q}{v_x + v_y} - \frac{\epsilon^2}{v_x^3} = 0 \quad (s1)$$

$$v_y'' + k_{p0}^2 v_y - \frac{2Q}{v_x + v_y} - \frac{\epsilon^2}{v_y^3} = 0$$

THE EQUILIBRIUM OCCURS WHEN  $v_x'' = v_y'' = 0$   
&  $v_x = v_y = v_b$

$$\Rightarrow k_{p0}^2 v_b - \frac{Q}{v_b} - \frac{\epsilon^2}{v_b^3} = 0$$

THIS IS EASILY SOLVED FOR  $v_b$ :

$$v_b = \frac{Q^{1/2}}{k_{p0}} \left[ \frac{1}{2} + \frac{1}{2} \sqrt{1 + 4k_{p0}^2 \epsilon^2 / Q^2} \right]^{1/2} \rightarrow \begin{cases} \frac{Q^{1/2}}{k_{p0}} ; & 2k_{p0}\epsilon \ll 1 \\ \frac{\epsilon^{1/2}}{k_{p0}^{1/2}} ; & 2k_{p0}\epsilon \gg 1 \end{cases}$$

Let  $v_x = v_b + \xi(s)$

$v_y = v_b + \eta(s)$

LINEARIZING (S1)

$$(S1) \Rightarrow 0 = \xi'' + k_{p0}^2 (v_b + \xi) - \frac{2Q}{2v_b} \left(1 - \frac{\xi}{2v_b} - \frac{\eta}{2v_b}\right) - \frac{\epsilon^2}{v_b^3} \left(1 - \frac{3\xi}{v_b}\right)$$

$$\& 0 = \eta'' + k_{p0}^2 (v_b + \eta) - \frac{2Q}{2v_b} \left(1 - \frac{\xi}{2v_b} - \frac{\eta}{2v_b}\right) - \frac{\epsilon^2}{v_b^3} \left(1 - \frac{3\eta}{v_b}\right)$$

SUBTRACTING THE EQUILIBRIUM:

$$\xi'' + \left(k_{p0}^2 + \frac{Q}{2v_b^2} + \frac{3\epsilon^2}{v_b^4}\right)\xi + \frac{Q}{2v_b^2}\eta = 0$$

$$\eta'' + \left(k_{p0}^2 + \frac{Q}{2v_b^2} + \frac{3\epsilon^2}{v_b^4}\right)\eta + \frac{Q}{2v_b^2}\xi = 0$$

Using  $k_p^2 = k_{p0}^2 - \frac{Q}{v_b^2} = \frac{\epsilon^2}{v_b^4}$

$$\Rightarrow \xi'' + \left(\frac{3}{2}k_{p0}^2 + \frac{5}{2}k_p^2\right)\xi + \left(\frac{1}{2}k_{p0}^2 - \frac{1}{2}k_p^2\right)\eta = 0 \quad (A)$$

$$\eta'' + \left(\frac{3}{2}k_{p0}^2 + \frac{5}{2}k_p^2\right)\eta + \left(\frac{1}{2}k_{p0}^2 - \frac{1}{2}k_p^2\right)\xi = 0 \quad (B)$$

LET  $y_1 = \xi - \eta$       SUBTRACTING (B) FROM (A):

$$y_1'' + k_1^2 y_1 = 0$$

where  $k_1^2 = \left(\frac{3}{2}k_{p0}^2 + \frac{5}{2}k_p^2 - \frac{1}{2}k_{p0}^2 + \frac{1}{2}k_p^2\right) = k_{p0}^2 + 3k_p^2$

LET  $y_2 = \xi + \eta$       ADDING (A) & (B):

$$y_2'' + k_2^2 y_2 = 0$$

where  $k_2^2 = \left(\frac{3}{2}k_{p0}^2 + \frac{5}{2}k_p^2 + \frac{1}{2}k_{p0}^2 - \frac{1}{2}k_p^2\right) = 2k_{p0}^2 + 2k_p^2$

Letting  $\xi = \xi_0 e^{ik_1 s}$   $\eta = \eta_0 e^{ik_2 s}$  where  $k_1^2 = k_{p0}^2 + 3k_p^2$  (3.5)

(A)  $\Rightarrow$

$$-(k_{p0}^2 + 3k_p^2) \xi_0 + \left(\frac{3}{2}k_{p0}^2 + \frac{5}{2}k_p^2\right) \xi_0 + \left(\frac{1}{2}k_{p0}^2 - \frac{1}{2}k_p^2\right) \eta_0 = 0$$

$$\Rightarrow \frac{1}{2}(k_{p0}^2 - k_p^2) [\xi_0 + \eta_0] = 0 \quad (A')$$

(B)  $-(k_{p0}^2 + 3k_p^2) \eta_0 + \left(\frac{3}{2}k_{p0}^2 + \frac{5}{2}k_p^2\right) \eta_0 + \left(\frac{1}{2}k_{p0}^2 - \frac{1}{2}k_p^2\right) \xi_0 = 0$

$$\Rightarrow \frac{1}{2}(k_{p0}^2 - k_p^2) [\xi_0 + \eta_0] = 0 \quad (B')$$

Similarly for  $\xi = \xi_0 e^{ik_1 s}$  and  $\eta = \eta_0 e^{ik_2 s}$

(A)  $\Rightarrow$

$$-(2k_{p0}^2 + 2k_p^2) \xi_0 + \left(\frac{3}{2}k_{p0}^2 + \frac{5}{2}k_p^2\right) \xi_0 + \left(\frac{1}{2}k_{p0}^2 - \frac{1}{2}k_p^2\right) \eta_0 = 0$$

$$\Rightarrow \frac{1}{2}(k_{p0}^2 - k_p^2) [-\xi_0 + \eta_0] = 0 \quad (A'')$$

(B)  $\Rightarrow$

$$-(2k_{p0}^2 + 2k_p^2) \eta_0 + \left(\frac{3}{2}k_{p0}^2 + \frac{5}{2}k_p^2\right) \eta_0 + \left(\frac{1}{2}k_{p0}^2 - \frac{1}{2}k_p^2\right) \xi_0 = 0$$

$$\frac{1}{2}(k_{p0}^2 - k_p^2) [-\eta_0 + \xi_0] = 0 \quad (B'')$$

THE SOLUTIONS ARE:

$$y_1 \sim e^{ik_1 s} \Rightarrow \xi \neq \eta \sim e^{ik_1 s}$$

EQUATIONS (A') & (B') CAN BE WRITTEN

$$\begin{pmatrix} 1 & 1 \\ 1 & 1 \end{pmatrix} \begin{pmatrix} \xi \\ \eta \end{pmatrix} = 0 \Rightarrow \xi = -\eta \Rightarrow \text{"QUADRUPOLE MODE"}$$

FOR  $y_2 \sim e^{ik_2 s}$  THE MATRIX EQUATIONS (A') & (B') BECOMES:

$$\begin{pmatrix} -1 & 1 \\ 1 & -1 \end{pmatrix} \begin{pmatrix} \xi \\ \eta \end{pmatrix} = 0 \Rightarrow \xi = \eta \Rightarrow \text{"BREATHING MODE"}$$

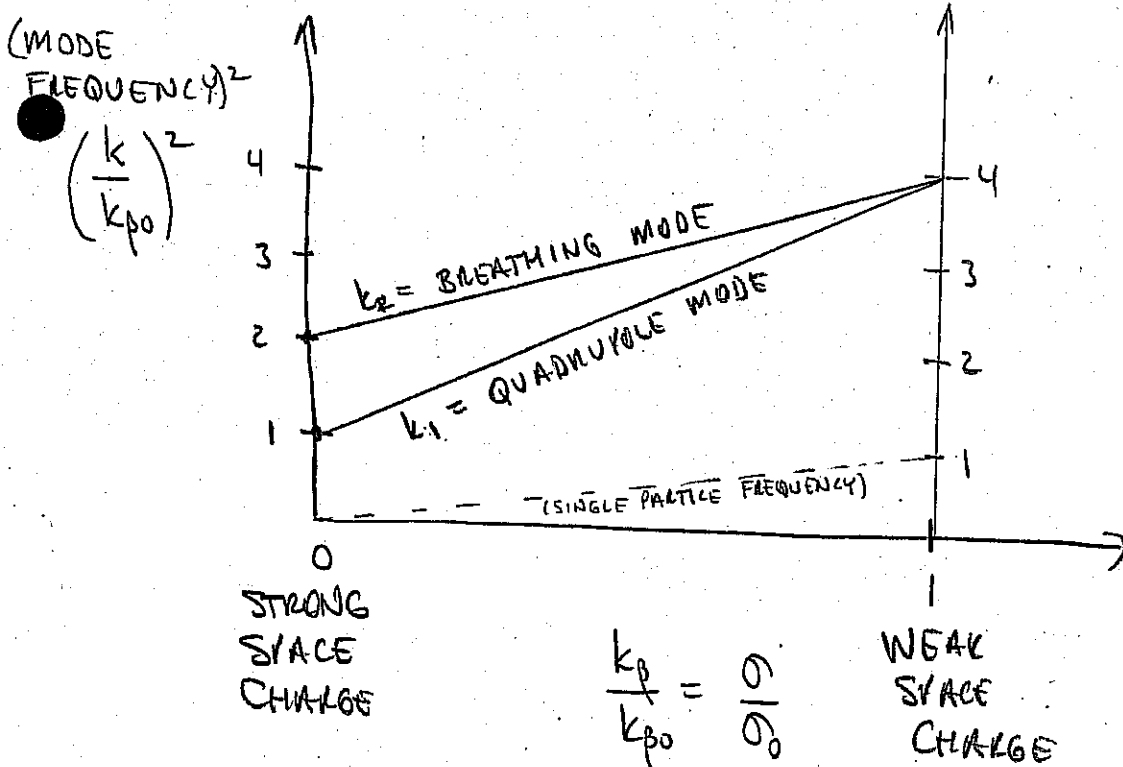

$$k_1^2 = k_{p0}^2 + 3k_p^2$$

$$k_2^2 = 2k_{p0}^2 + 2k_p^2$$

$$k_p^2 = k_{p0}^2 - \frac{Q}{287 \frac{v^2}{b}}$$

← MODE FREQUENCY

← SINGLE PARTICLE FREQUENCY

# Smooth focusing: breathing mode and quadrupole mode

Breathing mode:

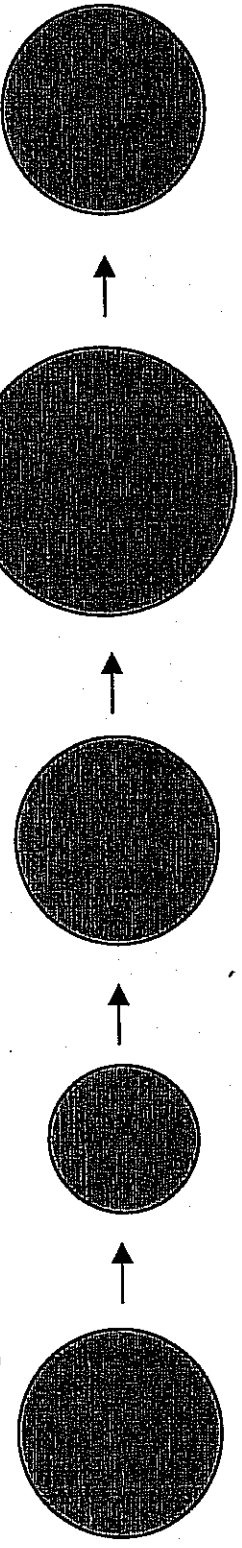

Quadrupole mode:

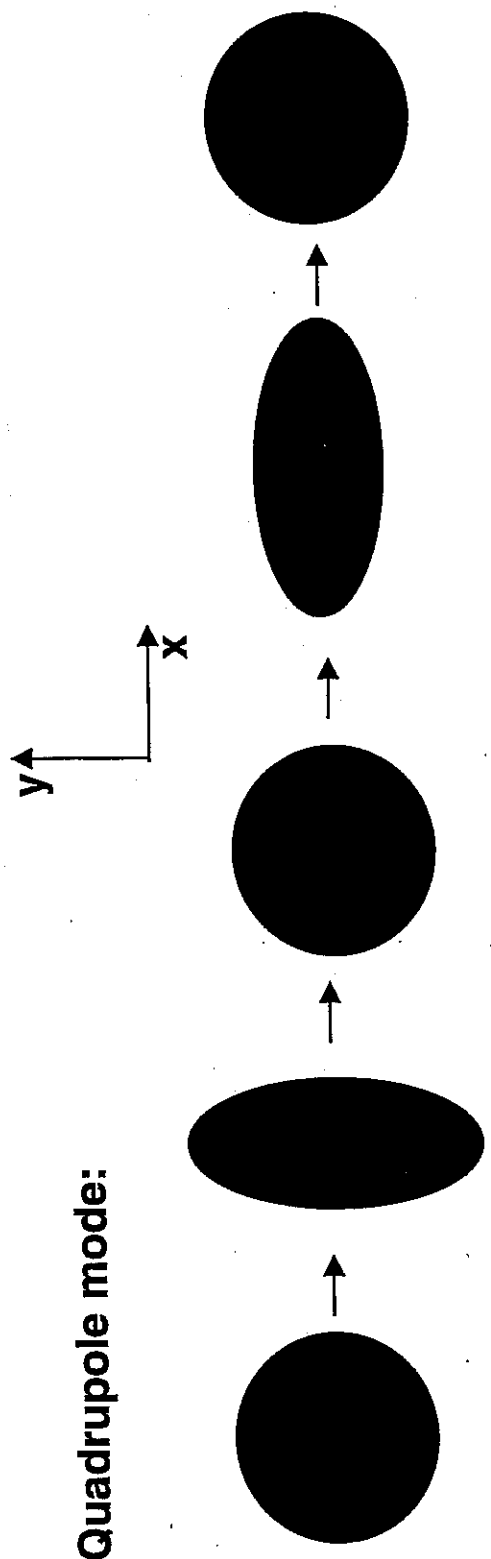

Note that in the quadrupole mode the beam area is nearly constant, whereas in the breathing mode, density increases increasing restoring force; hence breathing mode has the higher frequency of the two modes.



JOHN BALUND  
+ STEVEN LUND  
USIAS  
JANUARY 2004



### III ENVELOPE MODES OF BUNCHED BEAMS IN CONTINUOUS FOCUSING CHANNELS

# Total field seen by particle is sum of rf and spacecharge

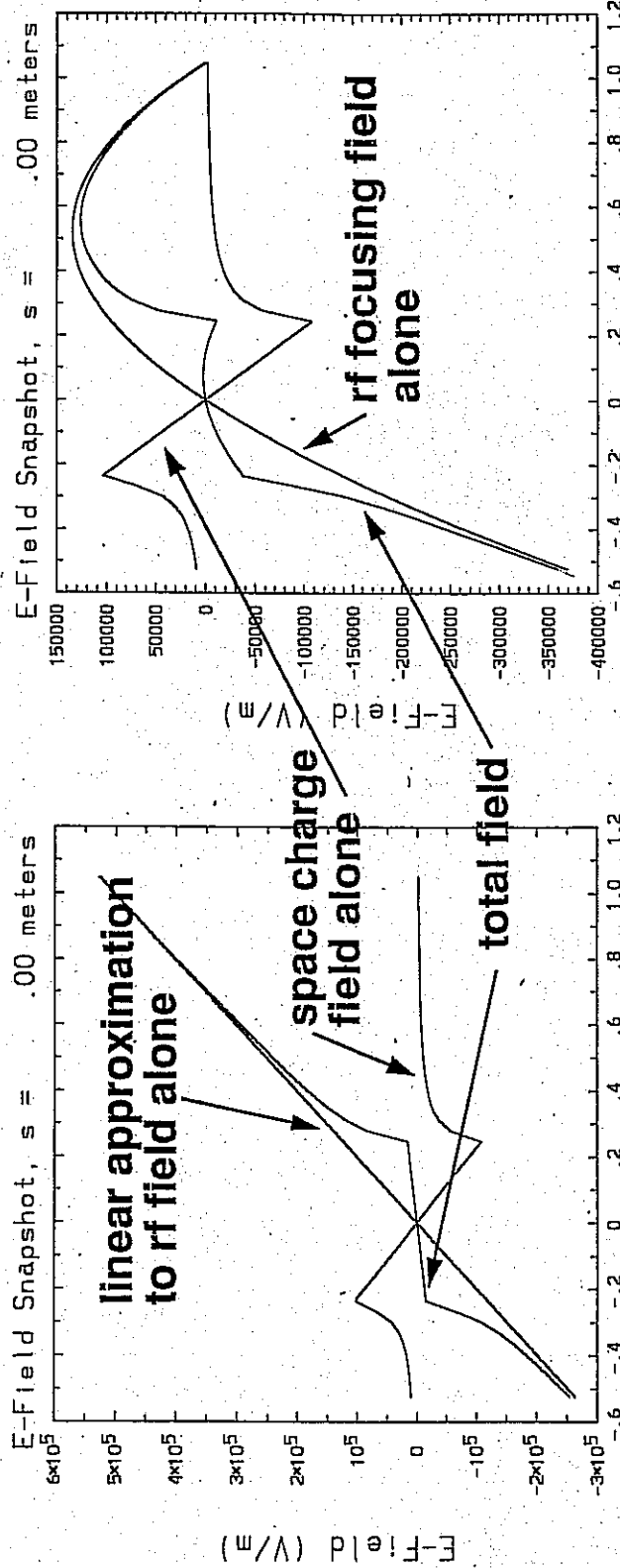

$\phi - \phi_s$  (rad)

$\phi - \phi_s$  (rad)

here  $\phi - \phi_s = - (2 \pi / \beta_s \lambda) \Delta z$ , where  $\beta_s c$  is the longitudinal velocity of the synchronous particle and  $\lambda = c/v$  is the rf vacuum wavelength

SPACE-CHARGE FIELD OF BUNCHED BEAMS

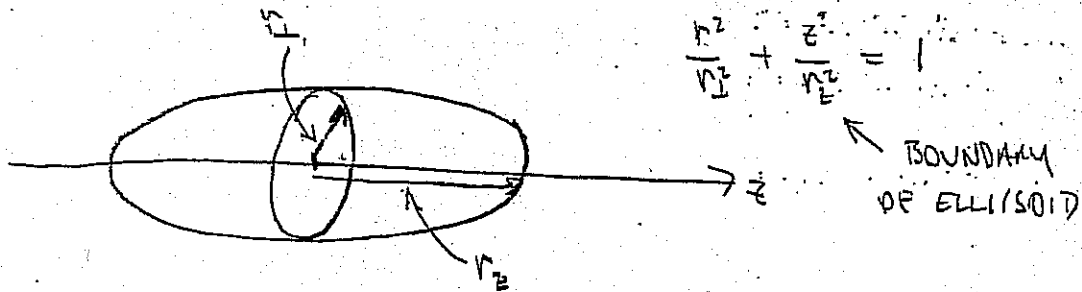

THE POTENTIAL OF A UNIFORM DENSITY BUNCH IN FREE SPACE  
(A MACLAURIN SPHEROID) IS GIVEN BY:

(cf Landau & Lifshitz, Classical Theory of ~~Fields~~, p. 297)

$$\phi = \frac{\rho}{4\epsilon_0} (\alpha_{\perp} r^2 + \alpha_{\parallel} z^2 - \delta)$$

where  $\alpha_{\perp} = r_{\perp}^2 r_z \int_0^{\infty} \frac{ds}{(r_{\perp}^2 + s) \Delta}$

$$\alpha_{\parallel} = r_{\perp}^2 r_z \int_0^{\infty} \frac{ds}{(r_z^2 + s) \Delta}$$

$$\delta = r_{\perp}^2 r_z \int_0^{\infty} \frac{ds}{\Delta}$$

where  $\Delta^2 = (r_{\perp}^2 + s)^2 (r_z^2 + s)$

FOR NON-RELATIVISTIC BEAM:

$$E_z = -\frac{\partial \phi}{\partial z} = f \frac{\rho}{\epsilon_0} z$$

$$E_r = -\frac{\partial \phi}{\partial r} = \frac{(1-f)}{2} \frac{\rho}{\epsilon_0} r$$

$$f = f(\alpha) = \begin{cases} \frac{\alpha^2}{1-\alpha^2} \left[ \frac{1}{\sqrt{1-\alpha^2}} \tanh^{-1} \sqrt{1-\alpha^2} - 1 \right] & \alpha < 1 \\ \frac{1}{3} & \alpha = 1 \\ \frac{\alpha^2}{\alpha^2-1} \left[ 1 - \frac{1}{\sqrt{\alpha^2-1}} \tanh^{-1} \sqrt{\alpha^2-1} \right] & \alpha > 1 \end{cases} \quad \alpha \equiv \frac{r_{\perp}}{r_z}$$

FOR RELATIVISTIC BEAM

(cf. LUND & BARNARD 1997)  
PAC97 Conf. Proceedings, Vancouver

$$\frac{d^2 X_L}{ds^2} = \frac{F_L}{\gamma_s^3 \beta_s^2 mc^2}$$

$$F_{Ls} = -\frac{q}{\gamma_s^2} \frac{\partial \phi}{\partial X_L} = \frac{q\rho}{2\gamma_s^2 \epsilon_0} [1 - f(\alpha)] X_L$$

$$\frac{d^2 \Delta z}{ds^2} = \frac{F_z}{\gamma_s^3 \beta_s^2 mc^2}$$

$$F_{zs} = -\frac{q}{\gamma_s^2} \frac{\partial \phi}{\partial z} = \frac{q\rho}{\epsilon_0} f(\alpha) \Delta z$$

$$\alpha = \frac{r_L}{\gamma v_z} \quad \left[ \alpha = \frac{r_L}{(v_z \text{ in comoving frame})} \right]$$

COMBINING FOCUSING + SELF FIELDS

$$\frac{d^2}{ds^2} \Delta z = -k_{s0}^2 \Delta z + \frac{q\rho f(\alpha)}{\gamma_s^3 \beta_s^2 mc^2 \epsilon_0} \Delta z \quad \text{(LINEAR)}$$

$$\frac{d^2}{ds^2} X_L = -k_{p0}^2 X_L + \frac{q\rho [1 - f(\alpha)]}{2\gamma_s^3 \beta_s^2 mc^2 \epsilon_0} X_L$$

$$\rho = \frac{3I \lambda_{rf}}{4\pi r_L^2 r_z c}$$

where  $\lambda_{rf} = \frac{2\pi c}{\omega}$

# Envelope Equations for an Unaccelerated Ellipsoidal Beam Bunch with Uniform Space-Charge



$$\frac{d^2 r_{\perp}}{ds^2} + k_{\beta 0}^2 r_{\perp} - \frac{K_{3D}[1 - f(\alpha)]}{2r_{\perp} r_z} - \frac{\epsilon_x^2}{r_{\perp}^3} = 0$$

$$\frac{d^2 r_z}{ds^2} + f_{nl}(\zeta) k_{s0}^2 r_z - \frac{K_{3D} f(\alpha)}{r_{\perp}^2} - \frac{\epsilon_z^2}{r_z^3} = 0$$

$$\alpha = \frac{v_{\perp}}{\delta v_z}$$

$$f_{nl}(\zeta) = (15/\zeta^5)[(3 - \zeta^2) \sin \zeta - 3\zeta \cos \zeta]$$

$$\text{Let } \zeta = (2\pi/\beta_s \lambda) r_z$$

$k_{\beta 0}^2$

Undepressed Transverse Betatron Wavenumber-Squared

$k_{s0}^2$

Undepressed Longitudinal Synchrotron Wavenumber-Squared

$$K_{3D} = 3qI\lambda/4\pi\epsilon_0\gamma_s^3\beta_s^3 mc^3$$

3D Space-Charge Parameter (dimension of length)

$$\epsilon_x^2 = 25[\langle x^2 \rangle \langle x'^2 \rangle - \langle xx' \rangle^2]$$

3D Bunched Beam Transverse Emittance-Squared

$$\epsilon_z^2 = 25[\langle \Delta z^2 \rangle \langle \Delta z'^2 \rangle - \langle \Delta z \Delta z' \rangle^2]$$

3D Bunched Beam Longitudinal Emittance-Squared

$f_{nl}$

Accounts for Nonlinear rf Focusing,  $f_{nl}(\zeta) \rightarrow 1$  when  $\zeta \rightarrow 0$

- Envelope equations couple the transverse and longitudinal single-particle motion
- Bunch acceleration results in additional terms
- Linear rf envelope equations presented in Wangler, "Intro. to Linear Accelerators"

Envelope Equations will be used to:

- Calculate equilibrium values of the envelope widths  $r_z$  and  $r_{\perp}$
- Calculate properties of mismatch eigenmodes
  - Mode wavenumber
  - Relative amplitude of transverse and longitudinal mismatch

$$\lambda_{rf}^2 = \frac{2\pi c}{\omega} = \text{rf wavelength}$$

$$I \equiv \frac{qNc}{\lambda_{rf}} = \text{average current}$$

$$K_{3D} = \frac{3Q}{2} \lambda_{rf}$$

## Perturbed Envelope Equations Yield Linear Eigenmode for a Mismatched Ellipsoidal Beam Bunch



Assume small-amplitude perturbations ( $|\delta r_{\perp}|/r_{\perp 0} \ll 1$  and  $|\delta r_z|/r_{z0} \ll 1$ ):

$$\begin{aligned} r_{\perp} &= r_{\perp 0} + \delta r_{\perp} \exp(iks) \\ r_z &= r_{z0} + \delta r_z \exp(iks) \end{aligned}$$

SEE  
BARNARD & LUND  
LUND & BARNARD  
PAC 97 VAN COUVENTER  
CONF. PROCEEDINGS

To obtain coupled linear mode equations:

$$\begin{pmatrix} -k^2 + K_{11} & K_{12} \\ K_{21} & -k^2 + K_{22} \end{pmatrix} \begin{pmatrix} \delta r_{\perp}/r_{\perp 0} \\ \delta r_z/r_{z0} \end{pmatrix} = 0$$

$$\begin{aligned} K_{11} &= 4k_{\beta}^2 - \frac{K_{3D}}{r_{\perp 0}^2 r_{z0}} \left[ 1 - f(\alpha) - \frac{\alpha}{2} \frac{df(\alpha)}{d\alpha} \right]_{r_{\perp}=r_{\perp 0}, r_z=r_{z0}} \\ K_{22} &= 4k_{s0}^2 \left[ f_{nl}(\zeta) + \frac{\zeta}{4} \frac{df_{nl}(\zeta)}{d\zeta} \right]_{r_{\perp}=r_{\perp 0}, r_z=r_{z0}} - \frac{3K_{3D}}{r_{\perp 0}^2 r_{z0}} \left[ f(\alpha) - \frac{\alpha}{3} \frac{df(\alpha)}{d\alpha} \right]_{r_{\perp}=r_{\perp 0}, r_z=r_{z0}} \\ K_{12} &= \frac{K_{3D}}{2r_{\perp 0}^2 r_{z0}} \left[ 1 - f(\alpha) - \alpha \frac{df(\alpha)}{d\alpha} \right]_{r_{\perp}=r_{\perp 0}, r_z=r_{z0}} \\ K_{21} &= \frac{K_{3D}}{r_{\perp 0}^2 r_{z0}} \left[ 2f(\alpha) - \alpha \frac{df(\alpha)}{d\alpha} \right]_{r_{\perp}=r_{\perp 0}, r_z=r_{z0}} \end{aligned}$$

Solution of the quartic dispersion relation characterizes the envelope mismatch modes  
Spatial Frequencies:

$$\begin{aligned} \text{High Frequency Mode: } k^2 &= k_H^2 = \frac{1}{2}(K_{11} + K_{22}) + \frac{1}{2}\sqrt{(K_{11} - K_{22})^2 + 4K_{12}K_{21}} \\ \text{Low Frequency Mode: } k^2 &= k_L^2 = \frac{1}{2}(K_{11} + K_{22}) - \frac{1}{2}\sqrt{(K_{11} - K_{22})^2 + 4K_{12}K_{21}} \end{aligned}$$

Relative Amplitude of Transverse and Longitudinal Oscillations:

$$\frac{\delta r_{\perp}/r_{\perp 0}}{\delta r_z/r_{z0}} = \frac{K_{12}}{k^2 - K_{11}}$$

BARNARD 21



# Envelope equations yield equilibrium beam parameters and eigenfrequencies and modes of mismatched beam

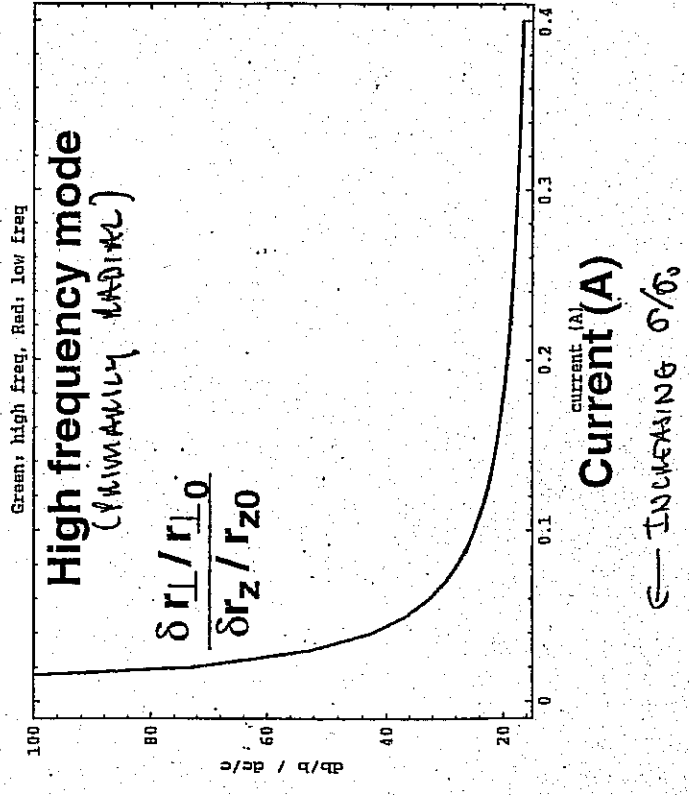
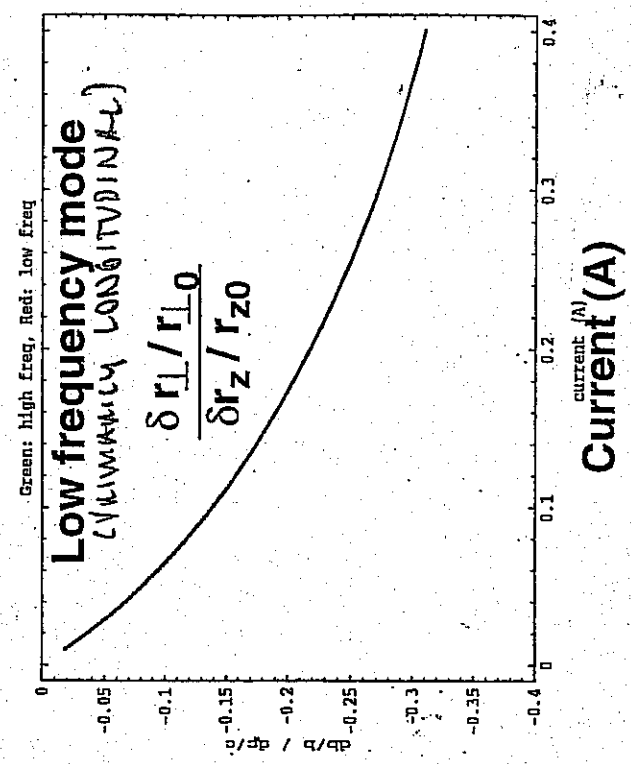
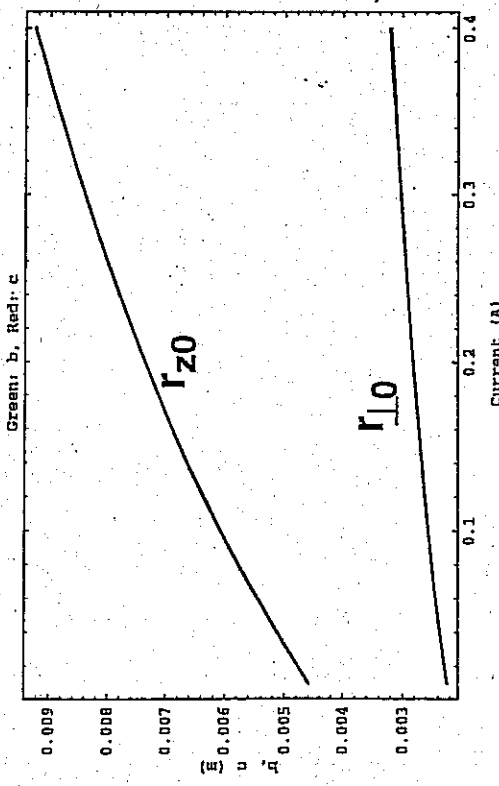
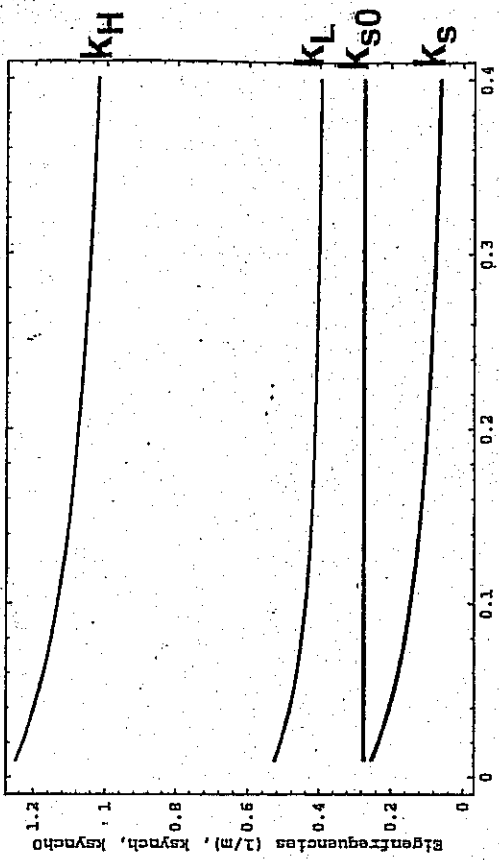

JOHN BARNARD  
& STEVEN LUND  
USPAS JANUARY 2004

III HALOS

1. WHAT IS HALO? WHY DO WE CARE?
2. QUALITATIVE PICTURE OF HALO FORMATION:  
MISMATCHES RESONANTLY DRIVE PARTICLES TO LARGE AMPLITUDE
3. CORE/PARTICLE MODELS
4. AMPLITUDE/PHASE ANALYSIS



BRANKEN (14)

FULLY SELF-CONSISTENT  
PIC CODE RESULTS

FROM  
"BEAM LOSS & BEAM  
HALO STUDIES"  
ROBERT RYNE, 1995

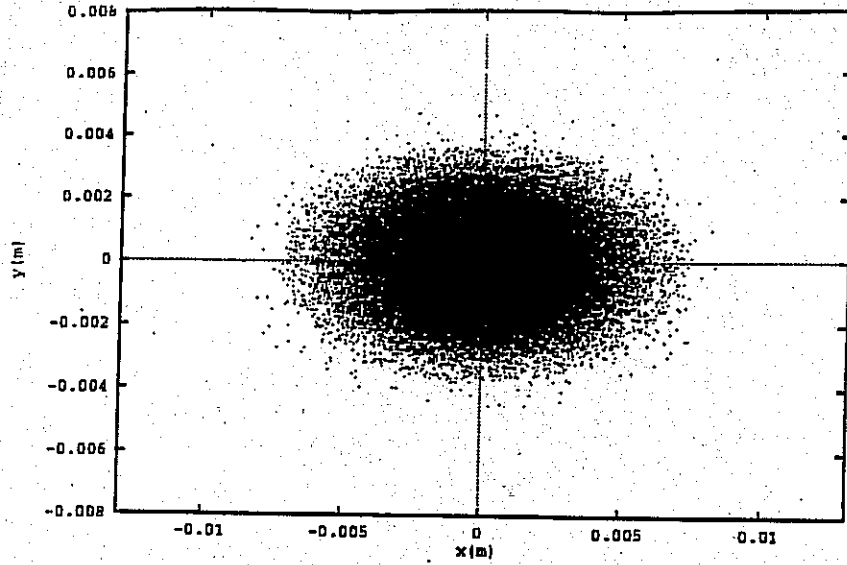

MATCHED  
BEAM

Figure 5: Beam halo after 22 focusing periods in a FODO channel. The initial distribution is an *rms* matched Gaussian beam. ( $\sigma_0 = 70$  deg,  $\sigma = 35$  deg)

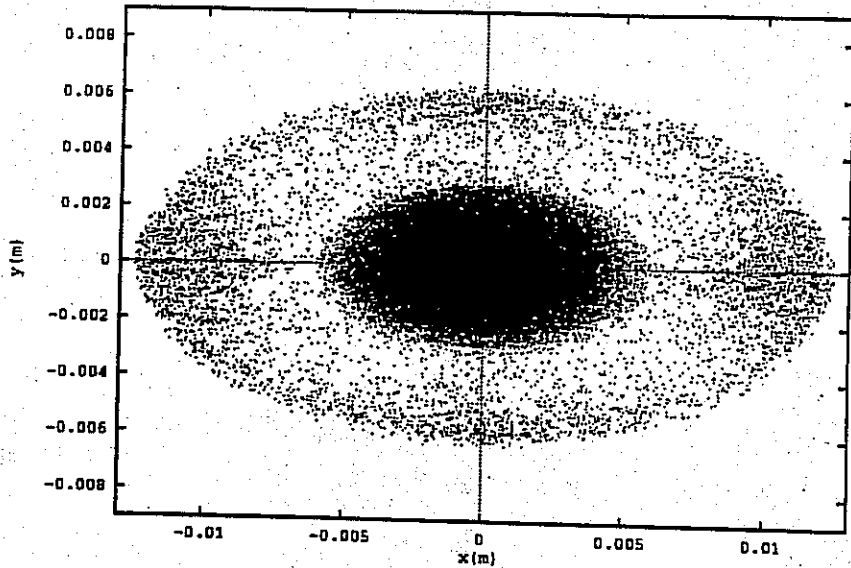

MISMATCHED  
BEAM

Figure 6: Beam halo after 22 focusing periods in a FODO channel. The initial distribution is an *rms* mismatched Gaussian beam. ( $\sigma_0 = 70$  deg,  $\sigma = 35$  deg)

WHY DO WE CARE?1). BEAM LOSS OF HIGH ENERGY PARTICLES  
⇒ ACCELERATOR ACTIVATION

EXAMPLE: FOR THE 1 GeV, 100 mA ACCELERATOR  
PRODUCTION OF TRITIUM (APT) PARAMETERS

1 nA/m OF BEAM LOSS ALLOWED FOR

"HANDS ON" MAINTENANCE (FOR  $E > 1$  GeV)

( $\frac{1 \text{ nA}}{\text{m}} \times 1000 \text{ m} \Rightarrow 10^{-6} \text{ A loss allowed}$ )

⇒  $\frac{10^{-6} \text{ A}}{0.1 \text{ A}} \Leftrightarrow 10^{-5}$  fractional beam loss  
allowed !!

2). BEAM LOSS ON WALLS

⇒ ELECTION / GAS EMISSION FROM WALLS

FOR LONG PULSE OR DC MACHINES, OR STORAGE  
RINGS, WHERE ELECTRONS CAN BE DRAWN INTO  
BEAM AND ACCUMULATION ⇒ INSTABILITIES AND  
NON-LINEAR FIELDS COULD DESTROY BEAM EMITTANCE  
OR EVEN DISRUPT BEAM.

3). INCREASE IN EMITTANCE

MAY REDUCE FOCUSABILITY FOR APPLICATIONS REQUIRING  
A SMALL BEAM SPOT.

WHAT IS THE BASIC PHYSICS?

RECALL DISPERSION RELATION FOR ENVELOPE MODES:

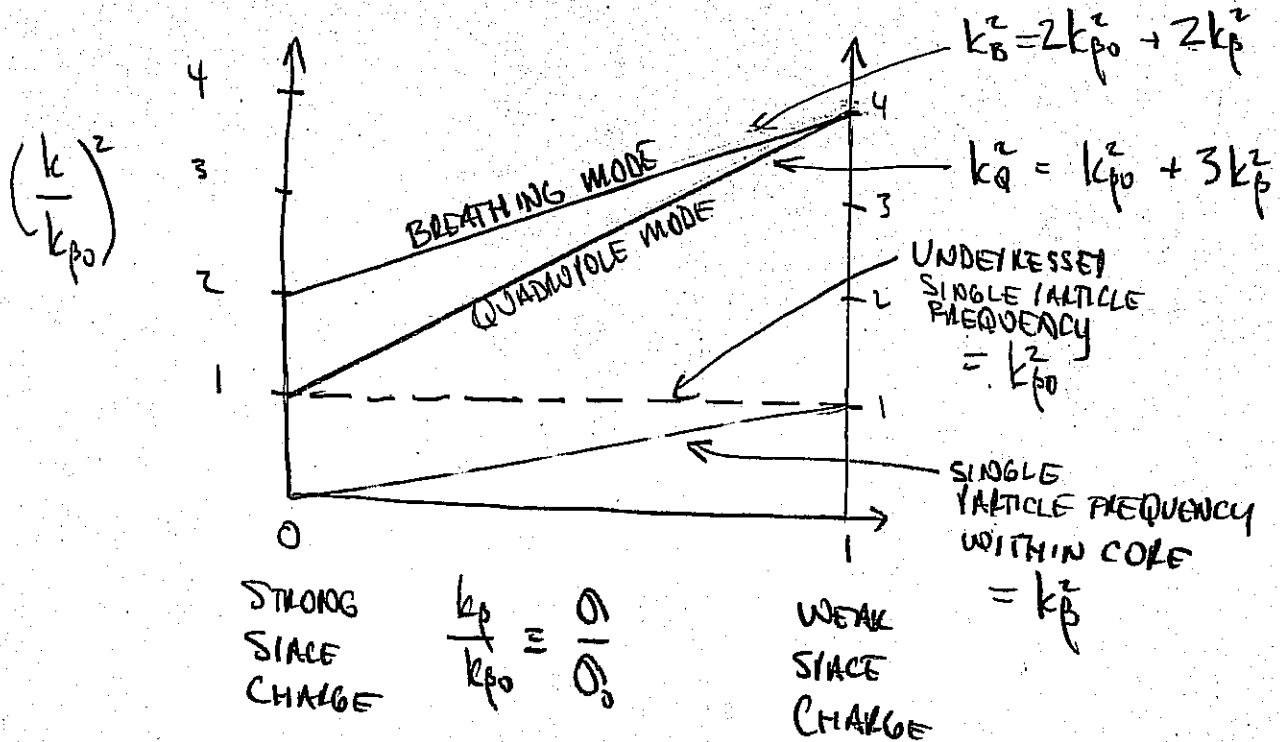

CONSIDER DIAGRAM FOR  $\frac{k_B}{2}$  AND  $\frac{k_Q}{2}$ :

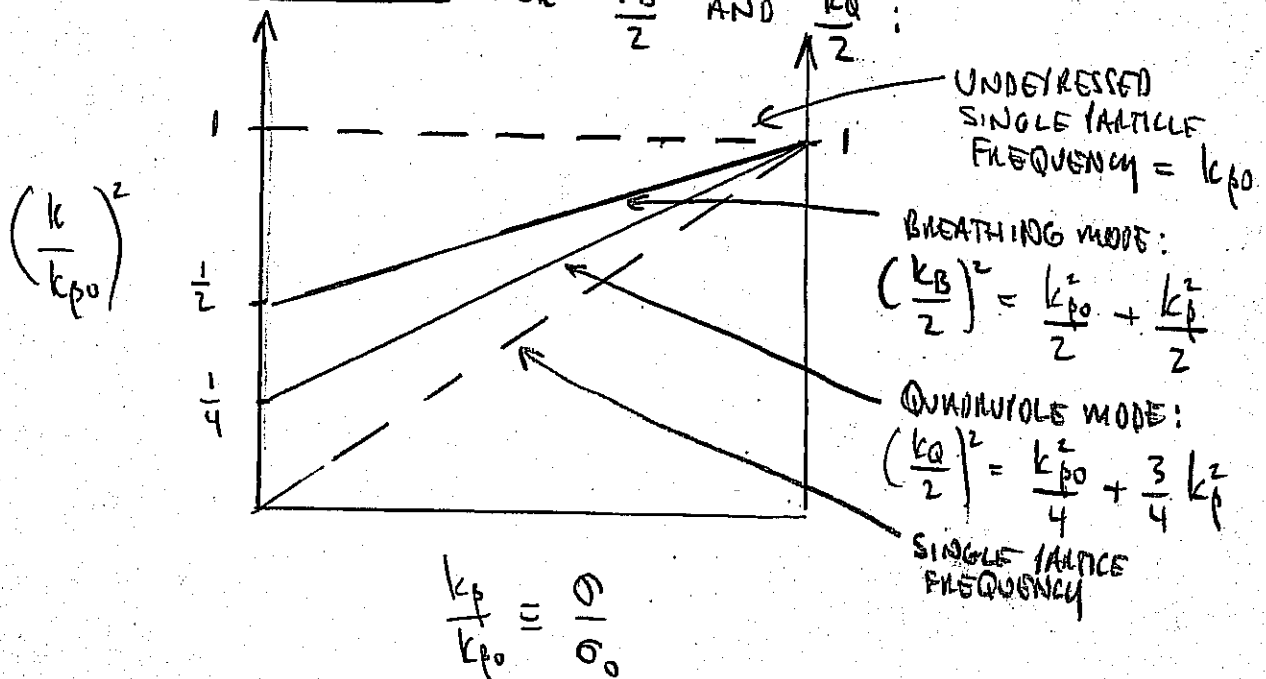

PARTICLES IN ORBITS FAR FROM CORE OSCILLATE AT FREQUENCY  $k_{\phi 0}$ , WHEREAS THOSE WITHIN CORE OSCILLATE AT FREQUENCY  $k_{\phi}$ .

AT INTERMEDIATE RADII, PARTICLE FREQUENCY  
= ENVELOPE FREQUENCY / 2

⇒ POSSIBILITY OF RESONANCE

⇒ MISMATCHES (EXCITATION OF ENVELOPE MODES) TOGETHER WITH COMMENSURATE PARTICLE FREQUENCY AND ENVELOPE HALF-FREQUENCY ARE THE SOURCE OF HALO.

SUGGESTS USING A CORE / TEST PARTICLE MODE  
TO EXPLORE THESE EFFECTS (O'CONNEL, WANGLEL,  
JAMESON, RYNE, ...)

ASSUME KV ENVELOPE, OSCILLATING AT A MODE  
FREQUENCY.

USE KNOWN ANALYTIC FORMULAS INTERIOR AND  
EXTERIOR TO BEAM.

FOR EXAMPLE, FOR CIRCULAR BEAM

$$x'' = \begin{cases} -\left[k_{p0}^2 - \frac{Q}{r_b^2}\right] x & \text{for } r < r_b \\ -\left[k_{p0}^2 - \frac{Q}{r^2}\right] x & \text{for } r > r_b \end{cases}$$

Similarly for y.

$$r_b = r_{b0} + \delta r_b \cos(k_{BS} + \phi)$$

↑ BREATHING MODE  $k_B$

DISTRIBUTE TEST PARTICLES IN PHASE SPACE  
AND FOLLOW EVOLUTION OF ORBITS. ALLOWS  
PHYSICS STUDIES, WHICH CAN BE FOLLOWED UP  
WITH SELF-CONSISTENT PIC RUNS.

NOTE THAT THE SAME TYPE OF RESONANCES OCCUR LONGITUDINALLY, IN BUNCHED BEAMS.

BETATON FREQUENCY  $\rightarrow$  SYNCHROTRON FREQUENCY

$$k_{\beta 0} \rightarrow k_{s 0}$$

$$k_{\beta} \rightarrow k_s \text{ (DEPRESSED SYNCHROTRON FREQUENCY)}$$

BREATHING  
MODE

$$k_B \rightarrow k_L \text{ LOW FREQUENCY MODE}$$

RESONANCE CONDITION

$$k_{\beta} < \frac{k_B}{2} < k_{\beta 0} \quad \rightarrow \quad k_s < \frac{k_L}{2} < k_{s 0}$$

NL  $\rightarrow$

ADDITIONAL COMPLICATION:

INTRINSIC NON-LINEARITY  
OF RF BUCKET

# Stroboscopic Map (The Peanut Diagram)

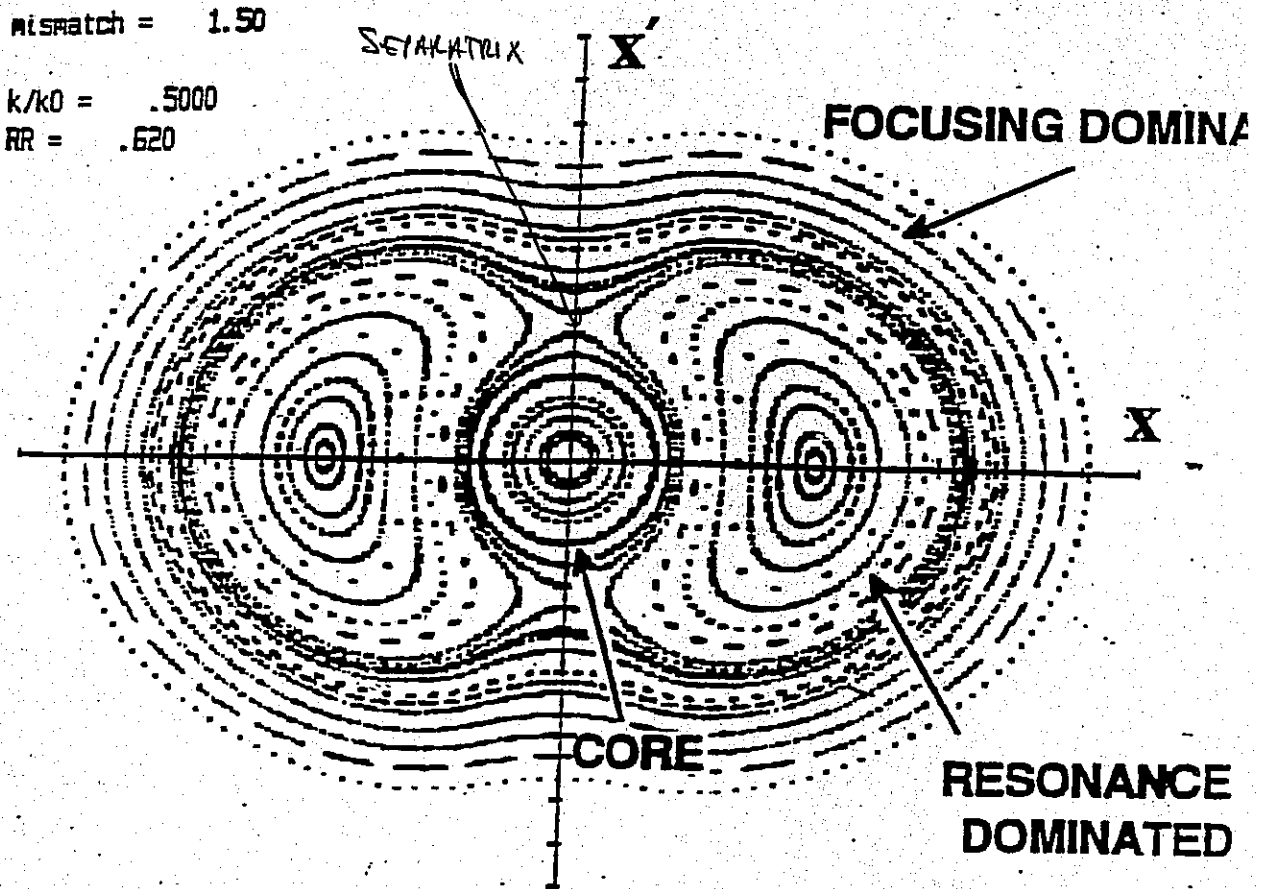

- Accumulate Many Snapshots of Phase Space Taken at Minimum Amplitude of Core Oscillation. (OF ANY PARTICULAR PHASE)
- Follow an Array of Particles to Obtain a "Trajectory Field".
- Regular Trajectories Appear as Smooth Curves.
- Chaotic Trajectories Appear as Stochastic Scatter.

• INITIAL POSITIONS OF PARTICLES IN PHASE SPACE WERE EQUALLY SPACED ALONG X & X' AXES.

Orbits of resonant particles have amplitudes which are highly varying compared to non-resonant particles

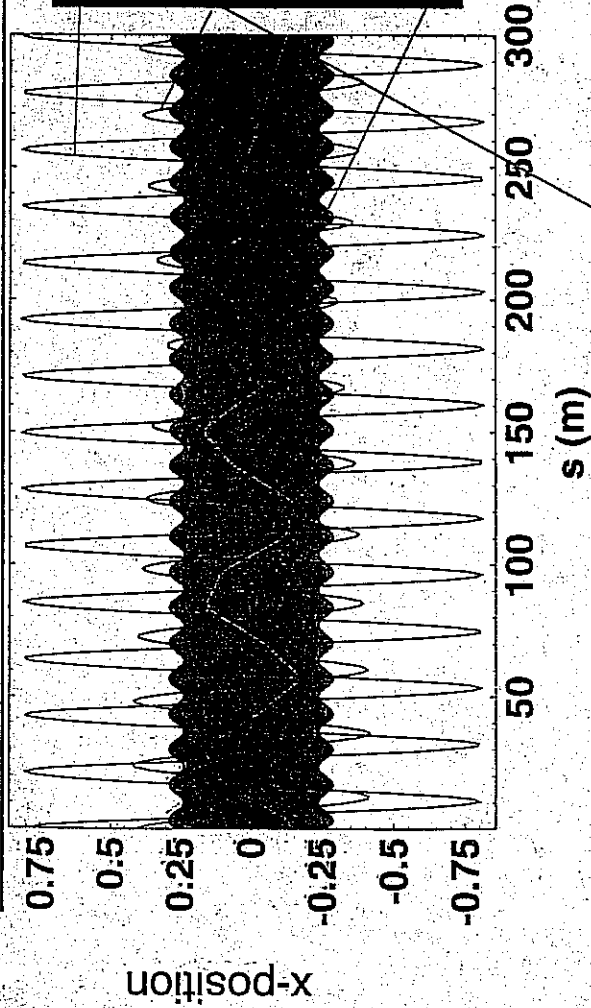

Oscillation frequency UNDER (RESONANT)  $< k\beta_0$  (PARTICLE OUTSIDE CONE)  
 $\sim k_{env}/2$  (RESONANT)  $\approx kR/2$  (NON-RESONANT)  
 $\sim k\beta$  (RESONANT) (PARTICLE IN CONE)  
 $k_{env} - \beta_{RESONANT} \text{ MODE}$

Poincare plot strobos phase space each envelope oscillation

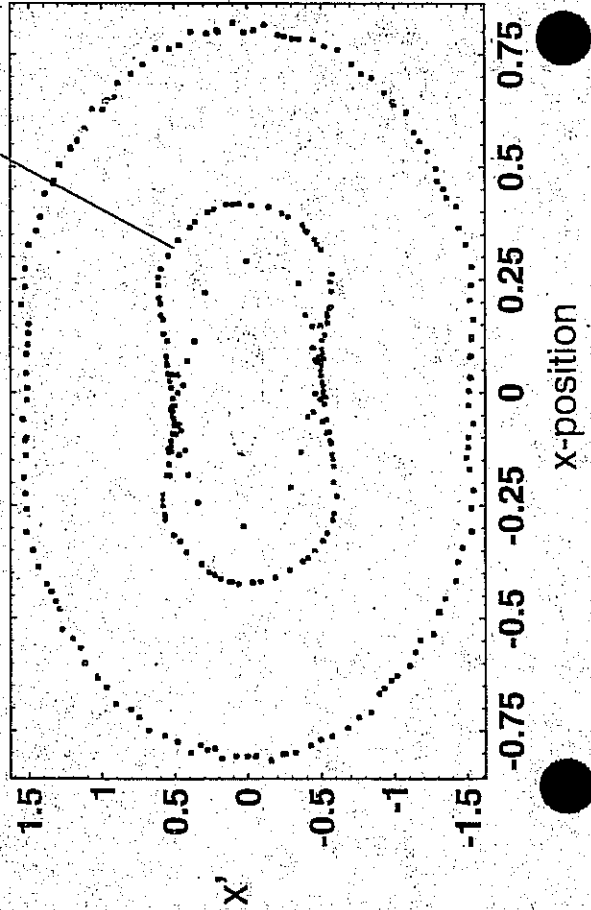

Note that resonant particle undergoes 11 oscillation periods, half of the 22 periods of the envelope. (The two non-resonant particles undergo 14 and 2 oscillation periods.)

Non-resonant large and small amplitude particles have regular orbits whereas resonant particles have varying amplitudes



# Changing Poincare phase rotates diagram as expected



$k_L s = 0$

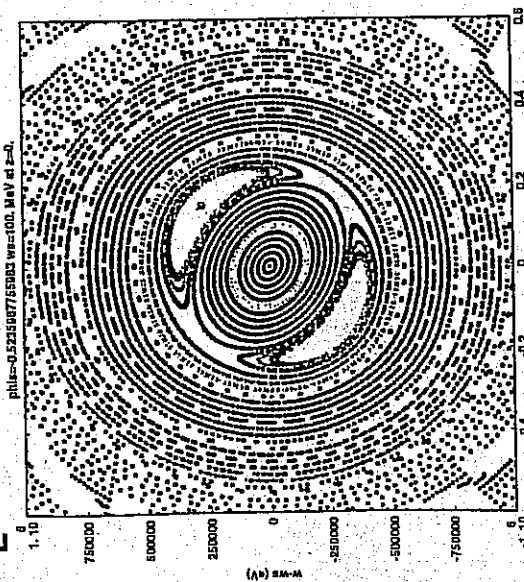

$k_L s = \pi/6$

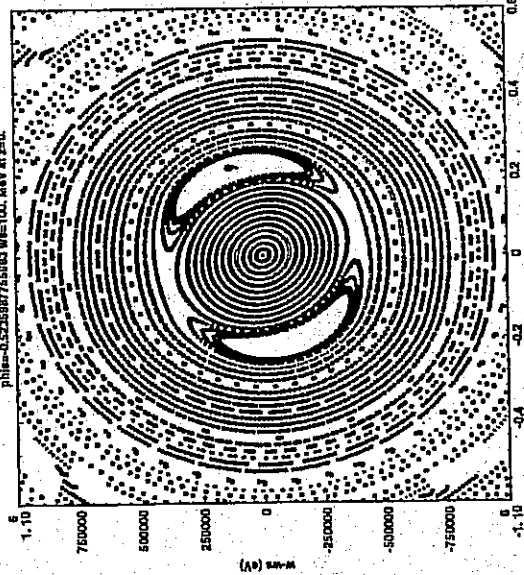

$k_L s = \pi/3$

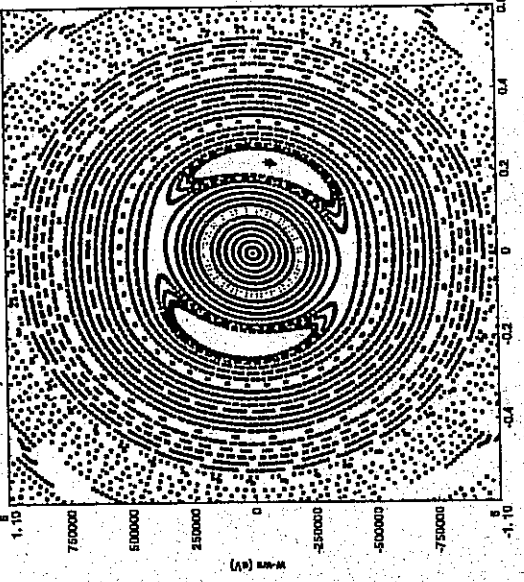

$k_L s = \pi/2$

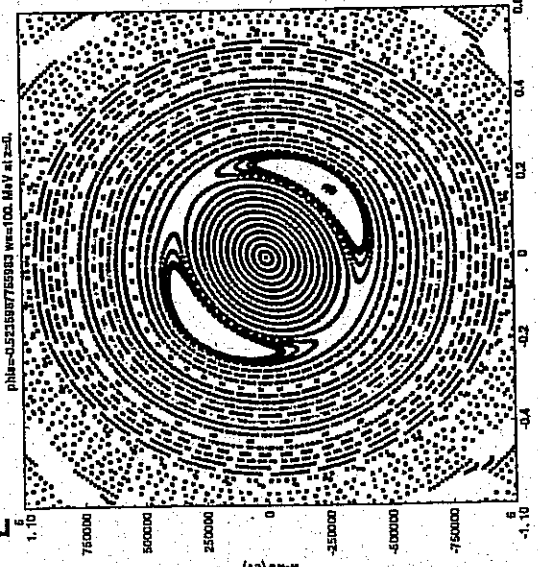

$k_L s = 2\pi/3$

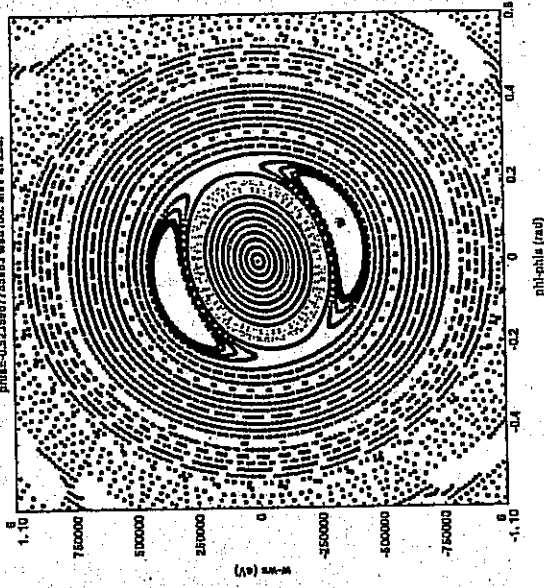

$k_L s = 5\pi/6$

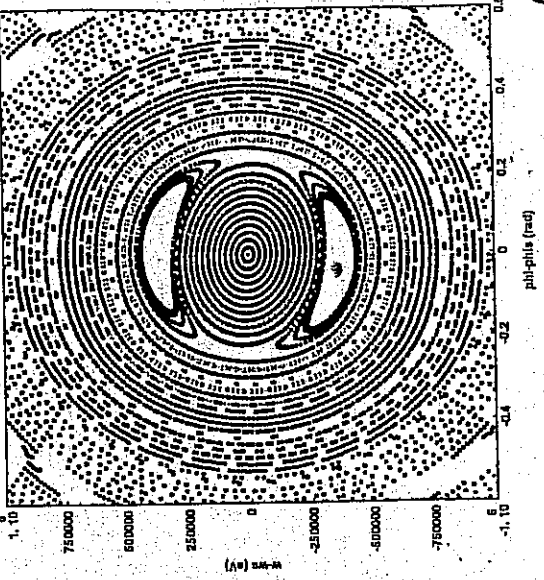

22

(CHANGING  $k_L s$  BY  $\pi$  ROTATES POINCARÉ PLOT BY  $\pi$ .)

$k_b^2/k_0^2 = 3 + \eta^2$  for the spherical bunch.

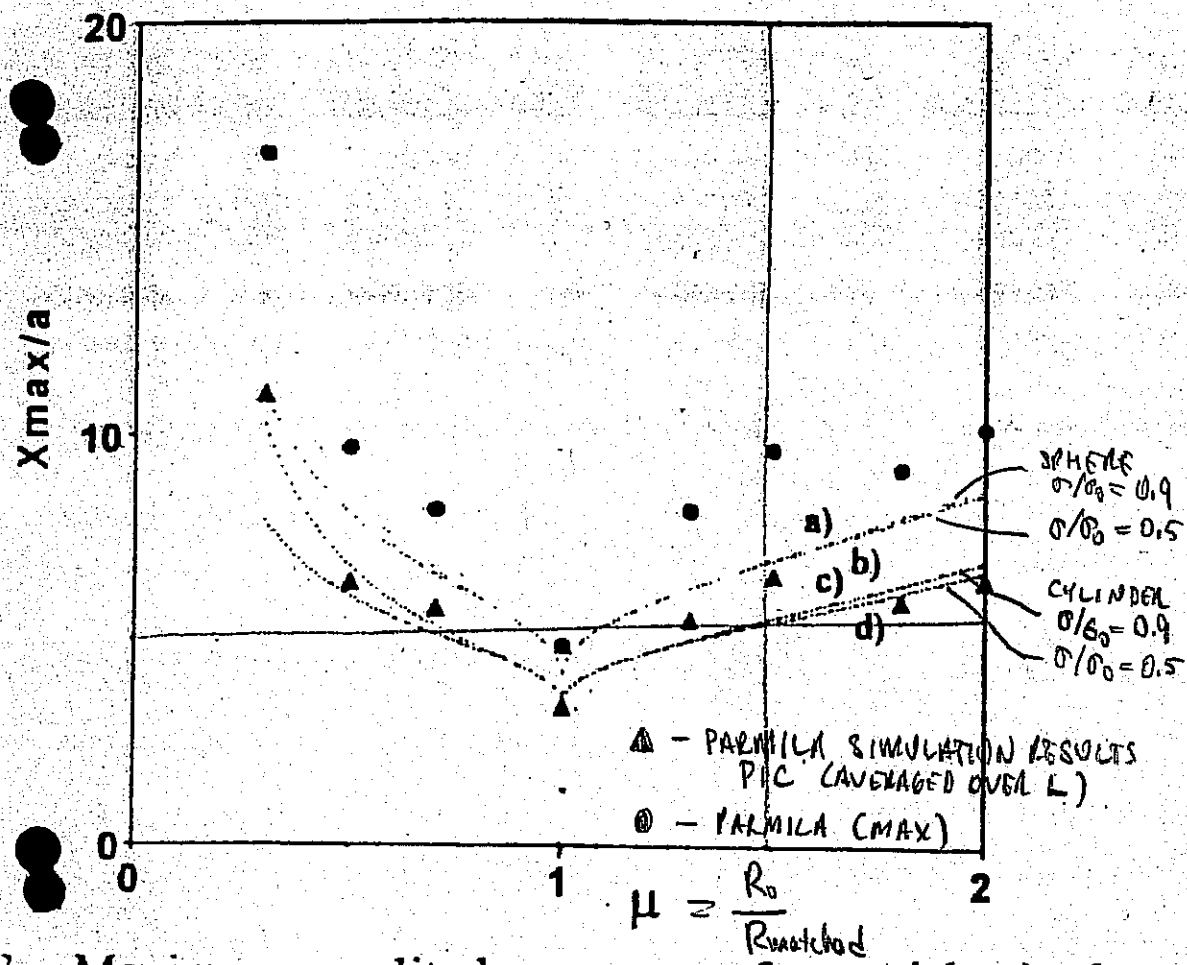

note that the mesh to enc simulations

Work du that beam 1 the new li mainly resp models to n formed. Th and one for limited to a the strengt predictions bounds of th a linac. Sin produce sn consistent v that the brea the halo. To as well as j keeping  $\epsilon$  si can contribi beam-residu However, th than beam n

3. Maximum amplitudes versus  $\mu$  for particles in the nance regions for the cylinder, and sphere models: a) re,  $\eta = 0.9$ , b) sphere,  $\eta = 0.5$ , c) cylinder,  $\eta = 0.9$ , and d) nder,  $\eta = 0.5$ . The triangles represent the smoothed MILA simulation results for comparison with the els, and the dots represent the maximum amplitudes ding quadrupole flutter.

a real linac, additional effects that are not included in the cle-core model, must be accounted for, such as beam- ope flutter associated with a quadrupole focusing system, eration, and the influence of other modes of the ashed beam. We have conducted a test of the predictions e particle-core model, by carrying out PARMILA ations, using an r-z space-charge mesh with individual y 105 particles

The author Gluckstem a

\* Work sunn

FROM WANGLER et al  
XVIII Int'l LINAC CONF.  
GENEVA, SWITZERLAND,  
AUG. 26-30, 1996

### WANGLER'S CORE/TEST PARTICLE RESULTS

$$\frac{x_{max}}{\langle x^2 \rangle^{1/2}} = A + B | \mu \mu |$$

$$\mu = \left( \frac{r_{bi}}{r_{b0}} \right)$$

= INITIAL BEAM RADIUS  
MATCHED BEAM RADIUS

FOR	$\sigma/\sigma_0$	A	B
CYLINDER	0.5	3.97	3.83
CYLINDER	0.9	3.91	4.25
SPHERE	0.5	4.87	5.30
SPHERE	0.9	4.81	5.56

# Numerical Validation of 1D particle-core model

- Maximum beam size in large scale simulations found to be in excellent agreement with “peanut diagram” of particle-core model

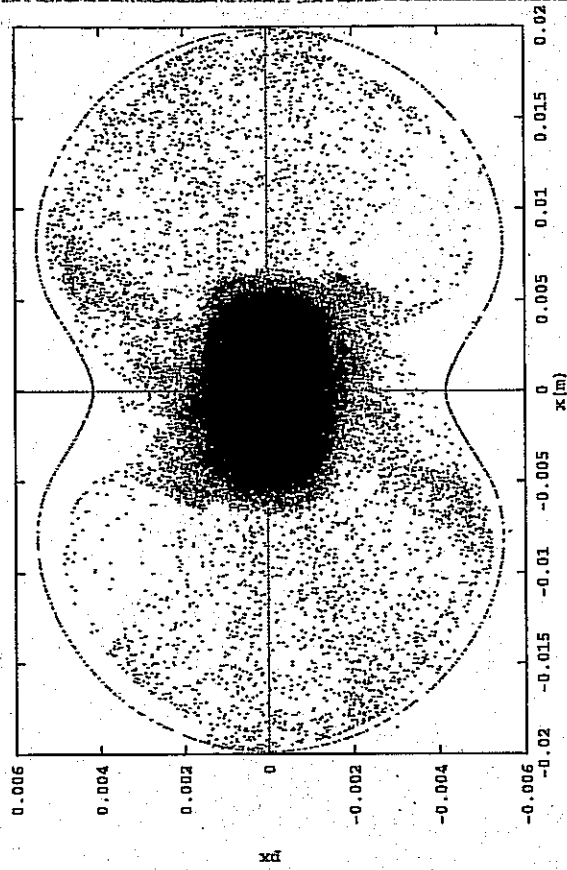
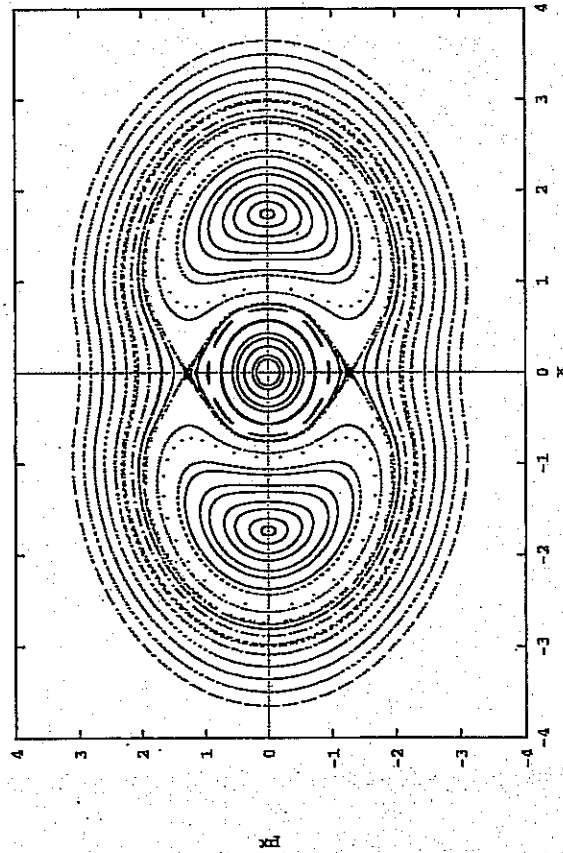

# Longitudinal Particle-Core Model w/ RF Nonlinearity

- Core-Test-Particle (CTP) code exhibits asymmetry in peanut diagram also observed in simulations with HALO3D PIC code
- 200 mA simulation:

CTP test particles

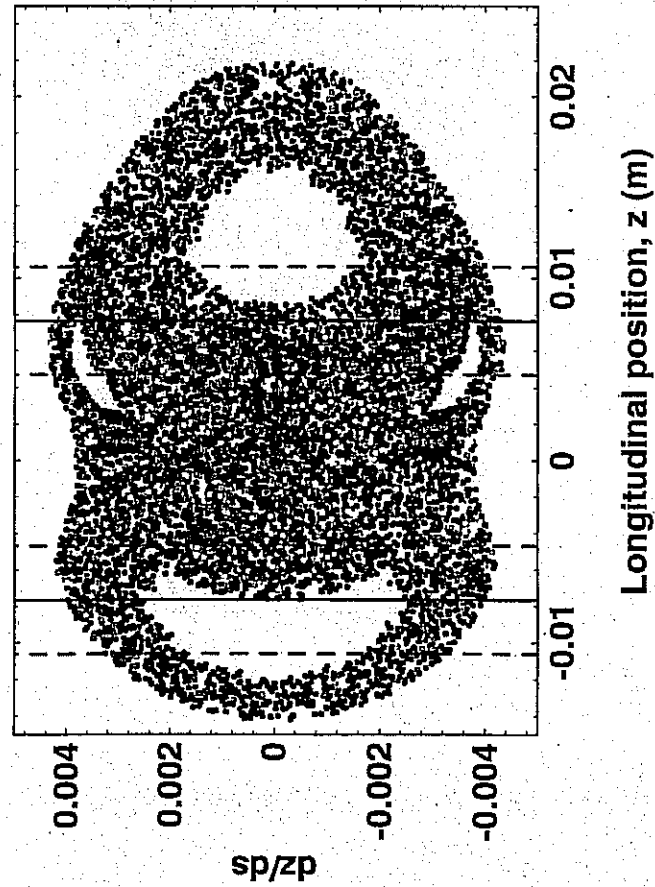

HALO3D beam particles

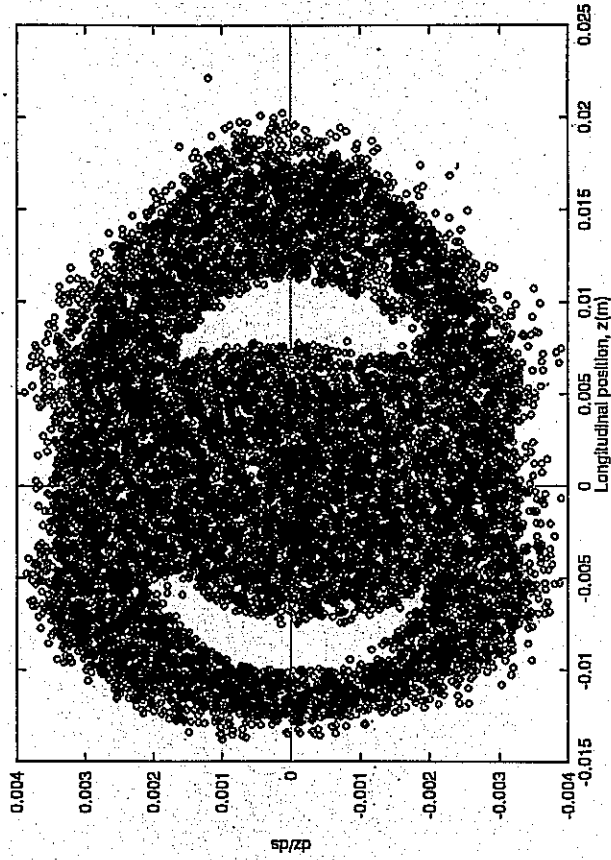

# Longitudinal Particle-Core Model w/ RF Nonlinearity

- Absence of  $k_{\perp}/2$  resonance (and associated halo) predicted by CTP analysis confirmed in HALO3D simulations
- 5 mA simulation:

CTP test particles

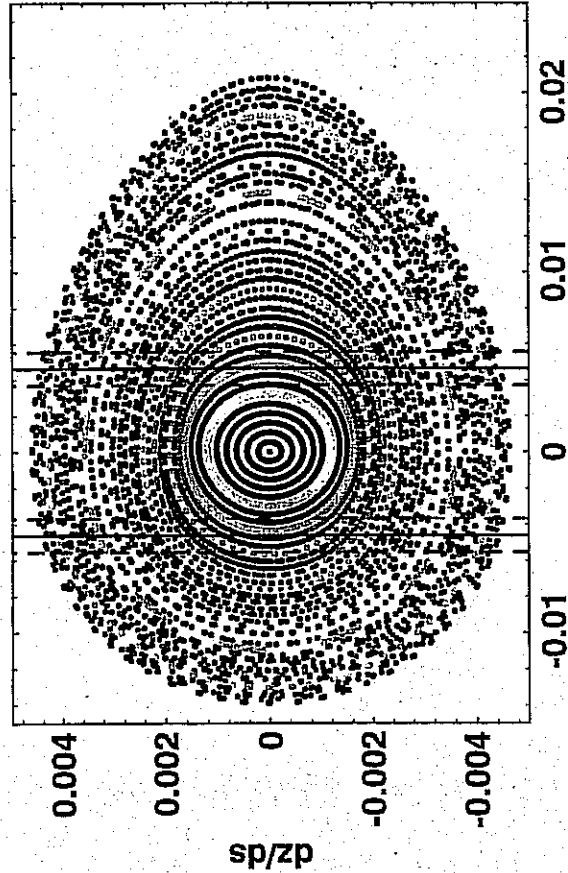

HALO3D test particles

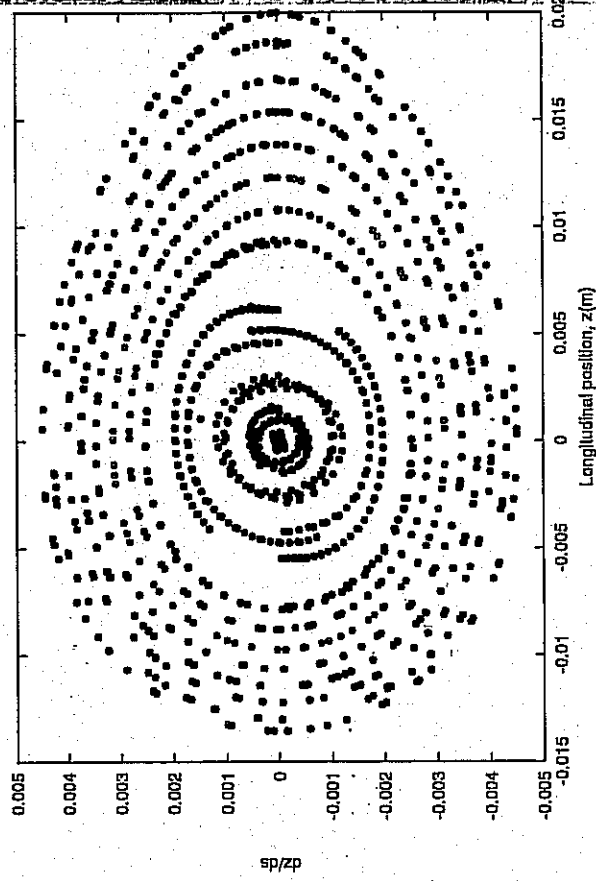

Longitudinal position, z (m)

## Model w/out RF Nonlinearity

- $k_L/2$  resonance present in 5 mA CTP run when nonlinearity is turned off. Also observed in HALO3D.

CTP test particles

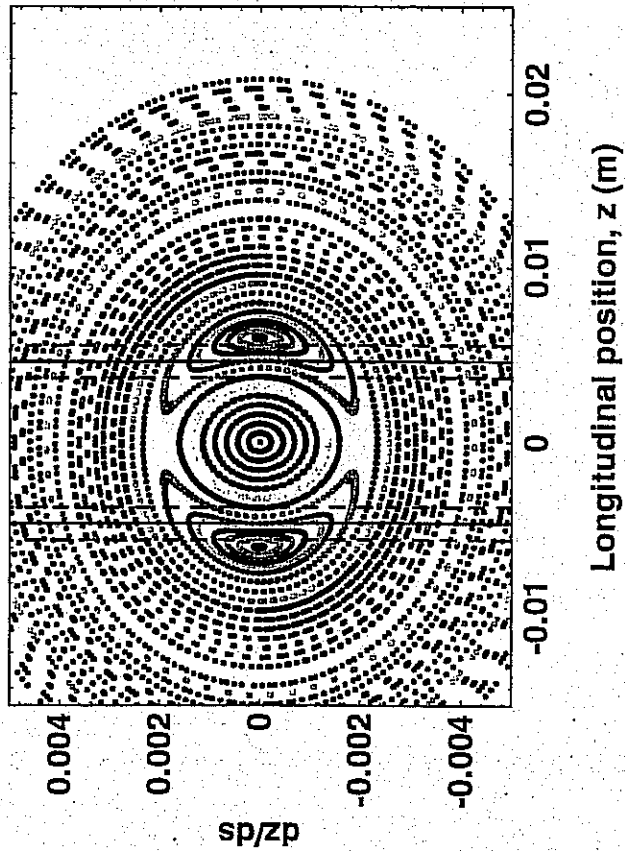

HALO3D test particles

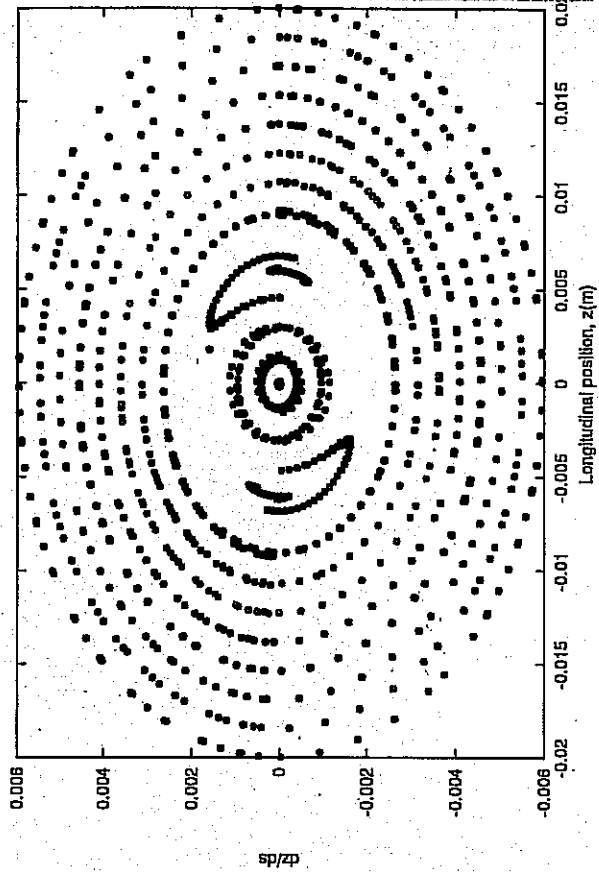

Longitudinal position, z (m)

# Numerically determined frequency and amplitude of particle oscillations: non-linear rf focusing

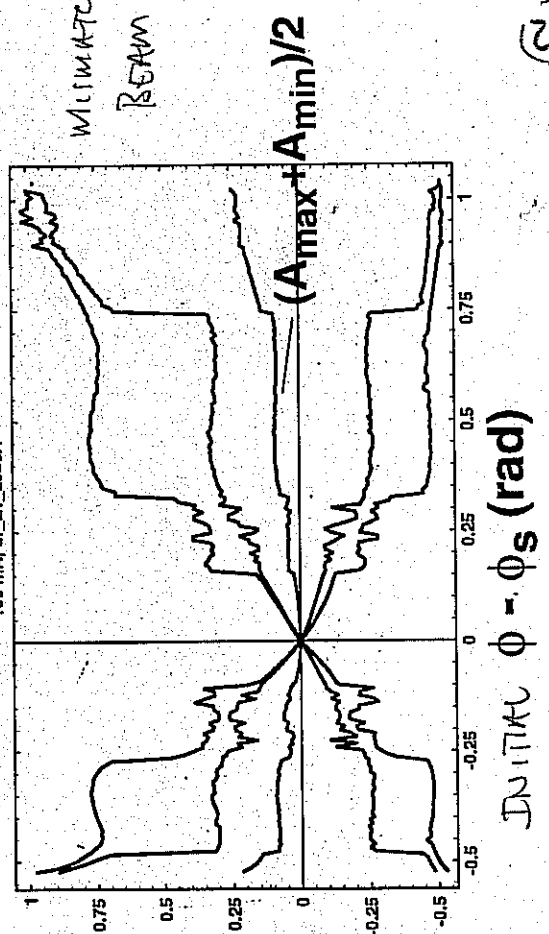
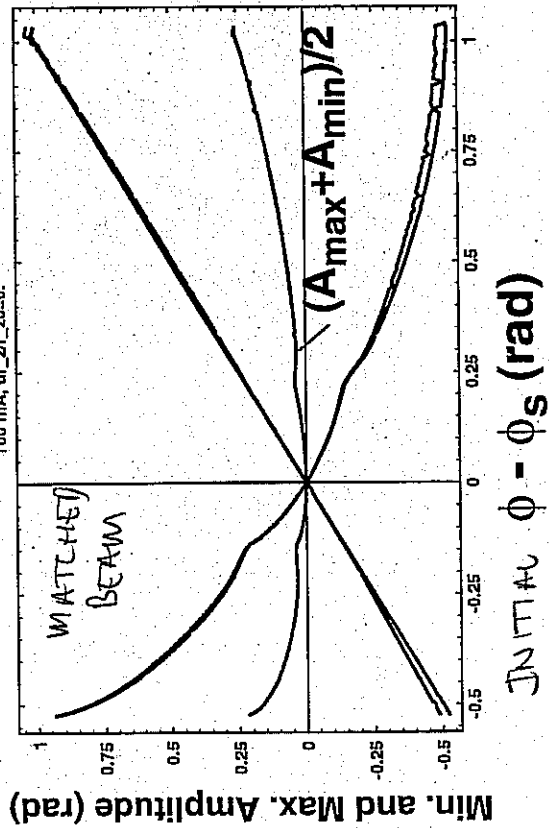
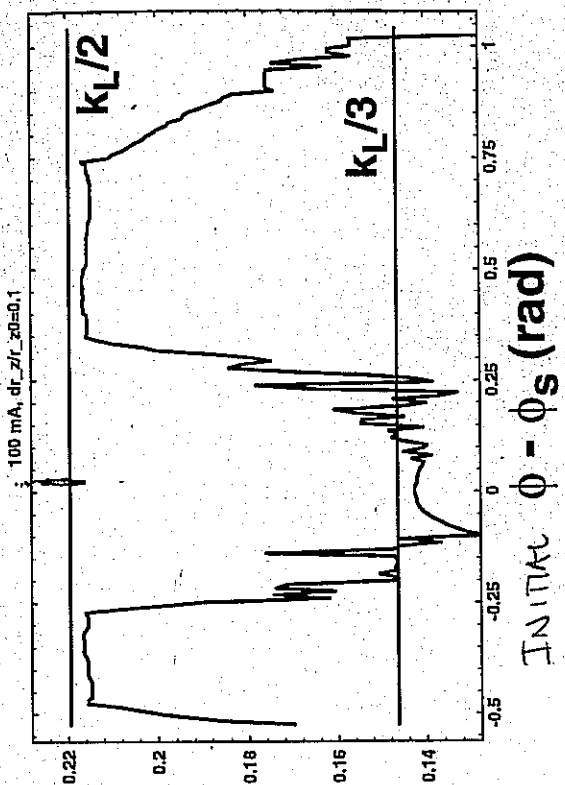
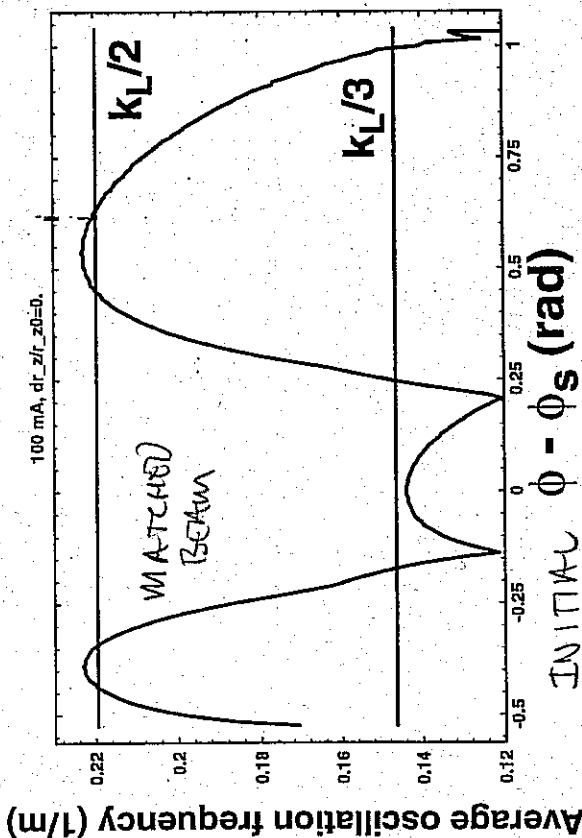

(92)



For non-linear rf,  $k_L/2$  resonance occurs only over a range of current

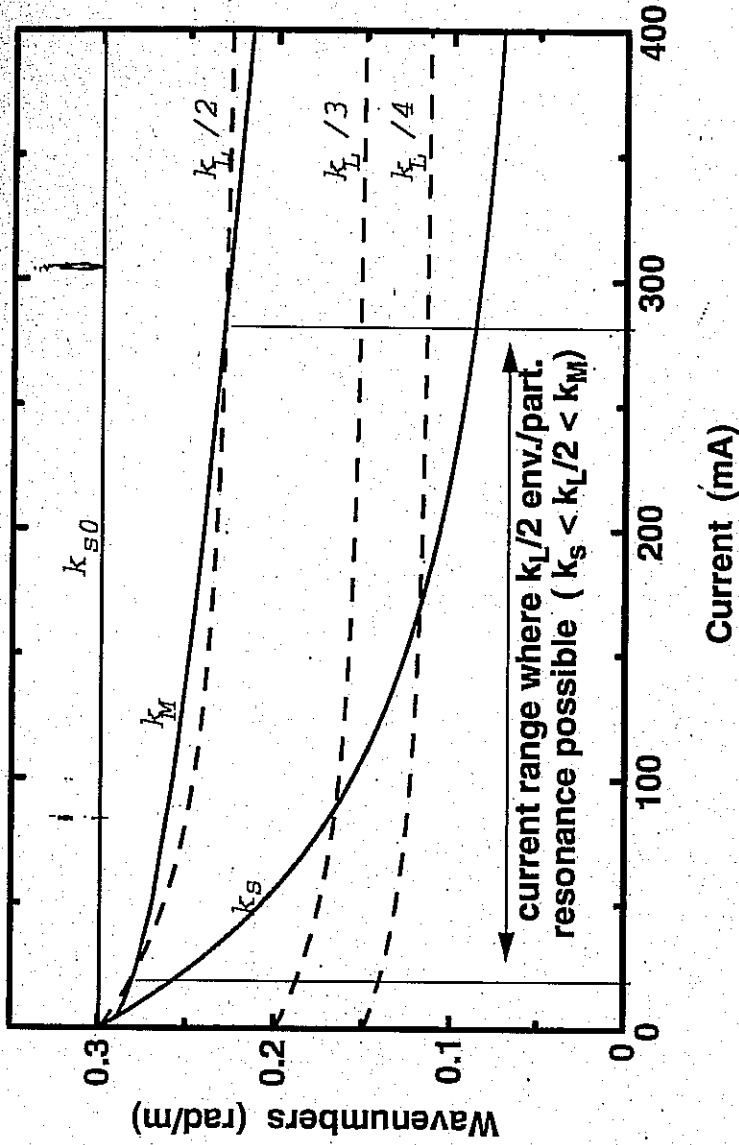

$k_{s0}$  = single particle frequency

$k_S$  = space-charge depressed synchrotron frequency

$k_M$  = maximum particle oscillation frequency

$k_L$  = longitudinal envelope oscillation frequency

# AMPLITUDE PHASE ANALYSIS

GLUCKSTERN, PHYS. REV. LETTERS  
73, 1247, 1994

$$x'' + k_p^2 x = \begin{cases} \frac{Q}{v_b^2} x & \text{for } r < r_b \\ \frac{Q}{v^2} x & \text{for } r > r_b \end{cases}$$

Assume  $v_b = v_{b0} + i \epsilon \cos(k_B s)$

$$x'' + k_p^2 x = \underbrace{-\frac{Q}{v_{b0}^2} x \left(1 - \frac{v_{b0}^2}{v^2}\right)}_{\text{EXTENSION}} \Theta(r - r_{b0}) + \underbrace{\frac{2\epsilon Q}{v_{b0}^2} x \cos k_B s}_{\text{INTERIOR}} \Theta(r_{b0} - r)$$

$$\Theta(x) = \begin{cases} 1 & x > 0 \\ 0 & x < 0 \end{cases}$$

NON-LINEAR TERM MAKES AMPLITUDE DEPENDENT FREQUENCY

ARISING SOLELY FROM ENVELOPE PERTURBATION; ALLOWS TRANSFER FROM CORE

$$k_p^2 = k_{p0}^2 - \frac{Q}{v_{b0}^2}$$

GLUCKSTERN TREATED GENERAL CASE OF ARBITRARILY ANGLE MOMENTUM. FOR ILLUSTRATION

USE PHASE AMPLITUDE METHOD

HERE I SET ANG. MOM = 0.  $\Rightarrow x = r$

$$\frac{x}{v_{b0}} \equiv A(s) \sin \Psi(s)$$

$$\Psi \equiv k_p s + \alpha(s)$$

$$\frac{x'}{v_{b0}} \equiv k_p A(s) \cos \Psi(s)$$

OSCILLATION AT DELETED TIME ADVANCE

SLOWLY CHANGING PHASE

Let  $x'' + k_p^2 x = f(x, s)$   
 $= f(A, \Psi, k_B s)$

NOTE  $\left. \begin{aligned} \frac{x'}{v_{b0}} &= A' \sin \Psi + (k_p + \alpha') A \cos \Psi \\ &= k_p A \cos \Psi \end{aligned} \right\} \Rightarrow A' \sin \Psi + \alpha' A \cos \Psi = 0$

$\frac{d^2}{dt^2} A \sin \alpha$  CAN BE EXPRESSED IN TERMS OF  $f$

$$x'' = k_p r_{b0} A' \cos \psi - k_p r_{b0} A \sin \psi (\underbrace{k_1 + \alpha'}_{\psi'})$$

$$+ k_p^2 x = k_p^2 r_{b0} A \sin \psi$$

$$x'' + k_p^2 x = k_p r_{b0} A' \cos \psi - k_p r_{b0} A \sin \psi \alpha' = f(x, \dot{x})$$

$$A \sin \psi + A \cos \psi \alpha' = 0$$

$$\begin{bmatrix} k_p r_{b0} \cos \psi & -k_p r_{b0} \sin \psi \\ \sin \psi & A \cos \psi \end{bmatrix} \begin{bmatrix} A' \\ \alpha' \end{bmatrix} = \begin{bmatrix} f \\ 0 \end{bmatrix}$$

INVERTING MATRIX:

$$\begin{bmatrix} A' \\ \alpha' \end{bmatrix} = \frac{1}{A' k_p r_{b0}} \begin{bmatrix} A \cos \psi & k_p r_{b0} \sin \psi \\ -\sin \psi & k_p r_{b0} \cos \psi \end{bmatrix} \begin{bmatrix} f \\ 0 \end{bmatrix}$$

$$A' = \frac{\cos \psi}{k_p r_{b0}} f$$

$$\alpha' = \frac{-\sin \psi}{k_p r_{b0} A} f$$

USING THESE DEFINITIONS THE EQUATION OF MOTION CAN BE EXPRESSED AS:

$$A' = \frac{1}{k_p r_{b0}} f(A, \psi, k_B s) \cos \psi$$

$$\alpha' = -\frac{1}{k_p A r_{b0}} f(A, \psi, k_B s) \sin \psi$$

At resonance we expect  $2k_p - k_B \sim 0$ ,

so define  $\Psi = 2\psi - k_B s = (2k_p - k_B)s + 2\alpha$

$$\Rightarrow \Psi' = (2k_p - k_B) + 2\alpha'$$

ELIMINATE  $k_B s$  IN  $f(A, \psi, k_B s)$  USING

$$k_B s = 2\psi - \Psi$$

AVERAGE OVER ALL NON-RESONANT FREQUENCY COMPONENTS, FOR RESONANT PARTICLE EQUATIONS OF MOTION:

$$A'_r = \frac{1}{k_p r_{b0}} \int_{-\pi}^{\pi} \frac{d\psi}{2\pi} f(A_r, \Psi_r, \psi) \cos \psi$$

$$\alpha'_r = -\frac{1}{r_{b0} k_p A_r} \int_{-\pi}^{\pi} \frac{d\psi}{2\pi} f(A_r, \Psi_r, \psi) \sin \psi$$

$A_r$  &  $\Psi_r = (2k_p - k_B)s + 2\alpha$  are held fixed during integration.

THE RESULT IS

$$A_r' = F_1(A_r, \Psi_r)$$

$$\Psi_r' = (2k\beta - k\alpha) + 2F_2(A_r, \Psi_r)$$

where  $F_1$  &  $F_2$  are explicit functions of  $A_r$  and  $\Psi_r$

Let  $\omega = A_r^2$

$$\omega' = 2A_r A_r' = 2A_r F_1(A_r, \Psi_r) = 2\omega^{1/2} F_1(\omega^{1/2}, \Psi_r)$$

$$\Psi_r' = (2k\beta - k\alpha) + 2F_2(A_r, \Psi_r)$$

$\omega$  &  $\Psi$  are conjugate variables, and the resonant particle equation of motion can be derived from an  $s$ -independent Hamiltonian  $H$  as:

$$\omega' = \frac{\partial H}{\partial \Psi} \quad \Psi' = -\frac{\partial H}{\partial \omega}$$

GLUCKSTEIN FOUND A CONSTANT OF THE MOTION  $H_r(\omega, \Psi)$  which satisfies Hamilton's EQUATIONS.

RESONANT PARTICLE WOULD STAY ON LINES OF CONSTANT  $H$ .

# GLUCKSTEIN'S SIMPLIFIED EXAMPLE

$$x'' + k_p^2 x = -\frac{Q}{V_{b0}^4} x^3 + \frac{zeQ}{V_{b0}^2} x \cos k_B s$$

↑  
NON-LINEAR FORCE

↑  
OSCILLATING CORE

This example:

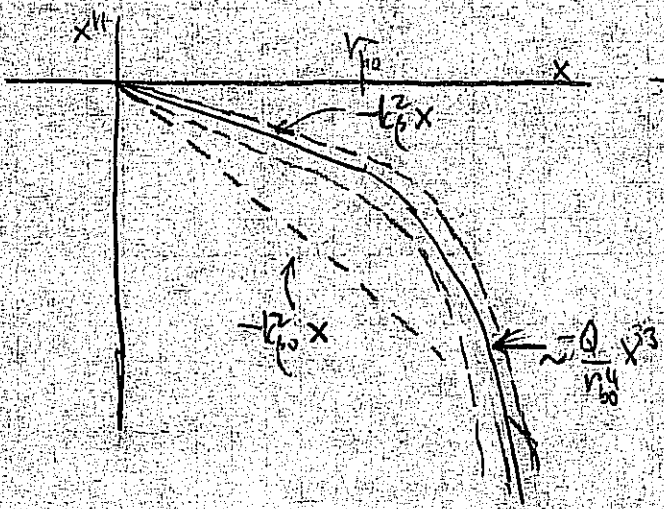

ACTUAL MODEL OF BREATHING BEAM

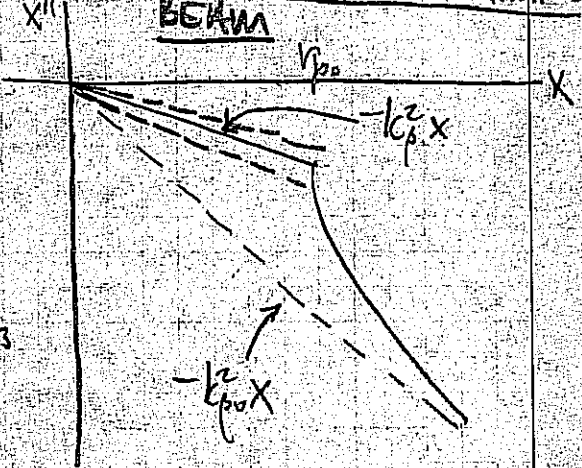

42-182-100 SHEETS  
National Brand  
Made in U.S.A.

$$x'' + k_p^2 x = -\frac{Q}{r_{b0}^4} x^3 + \frac{2\epsilon Q}{r_{b0}^2} x \cos k_B s$$

$$\equiv f(x, s)$$

$$\equiv -\frac{Q}{r_{b0}^4} A^3 \sin^3 \psi + \frac{2\epsilon Q}{r_{b0}^2} A \sin \psi \cos k_B s$$

(when  $\frac{x}{r_{b0}} \equiv A \sin \psi$  &  $\frac{x'}{r_{b0}} \equiv k_p A \cos \psi$ )

$$\Rightarrow A' = \frac{\cos \psi}{k_p r_{b0}} f = -\frac{Q}{k_p r_{b0}^4} A^3 \sin^3 \psi \cos \psi + \frac{\epsilon Q}{k_p r_{b0}^2} A \sin^2 \psi \cos k_B s$$

$$\alpha' = \frac{-\sin \psi}{k_p r_{b0} A} f = \frac{Q}{k_p r_{b0}^4} A^2 \sin^4 \psi + \frac{2\epsilon Q}{k_p r_{b0}^2} \sin^2 \psi \cos k_B s$$

Using  $\psi \equiv 2\psi - k_B s \Rightarrow \cos k_B s = \cos[2\psi - \psi]$   
 $= \cos[2\psi] \cos[\psi] + \sin[2\psi] \sin[\psi]$

TRIG IDENTITIES:

$$\sin 2\psi \cos k_B s = \frac{1}{2} \sin \psi - \frac{1}{2} \cos 4\psi \sin \psi + \frac{1}{2} \sin 4\psi \cos \psi$$

$$\sin^4 \psi = \frac{3}{8} - \frac{1}{2} \cos 2\psi - \frac{1}{8} \cos 4\psi$$

$$\sin^2 \psi \cos k_B s = \cos \psi \left[ -\frac{1}{4} + \frac{1}{2} \cos 2\psi - \frac{1}{4} \cos 4\psi \right] + \sin \psi \left[ \frac{1}{2} \sin 2\psi - \frac{1}{4} \sin 4\psi \right]$$

$$\sin^3 \psi \cos \psi = \frac{1}{4} \sin 2\psi - \frac{1}{8} \sin 4\psi$$

42-182-100 SHEETS  
 Made in U.S.A.



$$\Rightarrow A_r' = \frac{\epsilon Q}{2k_p r_{b0}^2} A_r \sin \Psi_r$$

$$\Psi_r' = (2k_p - k_B) + 2\alpha_r'$$

$$= (2k_p - k_B) + \frac{3Q}{4k_p r_{b0}^2} A_r^2 + \frac{\epsilon Q}{k_p r_{b0}^2} \cos \Psi$$

DEFINE  $w = A_r^2$

$$w' = 2A_r A_r' = \frac{\epsilon Q}{k_p r_{b0}^2} w \sin \Psi_r$$

$$\Psi_r' = (2k_p - k_B) + \frac{3Q}{4k_p r_{b0}^2} w + \frac{\epsilon Q}{k_p r_{b0}^2} \cos \Psi$$

A Hamiltonian can be found satisfying Ham. (ton's equations:

$$H = (2k_p - k_B) w + \frac{3}{8} \frac{Q}{k_p r_{b0}^2} w^2 + \frac{\epsilon Q}{k_p r_{b0}^2} w \cos \Psi$$

THIS CAN BE EXPRESSED AS:

$$\epsilon \cos \Psi = \Delta - \frac{3}{8} w - \frac{Q}{w}$$

where  $C$  is determined by initial conditions and:

$$\Delta = k_p (k_B - 2k_p) r_{b0}^2 / Q$$

(NOTE:  $k_B^2 = 4k_p^2 + 2Q/r_{b0}^2$  for breathing mode).



(2.4) and (2.5)

$$[\cos p z], \quad (2.5)$$

$$] \quad (2.6)$$

oscillatory terms  
number  $2q - p$

$$(2.7)$$

$$\cos \Psi, \quad (2.8)$$

of this resonant  
al of the motion

$$(2.9)$$

and where the  
he initial values  
pe equation we  
breathing mode,

$$(2.10)$$

d by the space

Guided by the parametrization of the  $x$  and  $y$  separately, the amplitude-phase parametrization of a two-dimensional oscillation is written as

$$s = \frac{w^2 + L^2}{2w} - \frac{w^2 - L^2}{2w} \cos(2qz + \gamma).$$

Here  $w$  and  $\gamma$  are slowly varying amplitude parameters which would be constant if the right-hand side of Eq. (2.11) vanished. We now write

$$s' = q \frac{w^2 - L^2}{w} \sin(2qz + \gamma)$$

and use Eq. (2.11) and the required connection between  $w'$  and  $\gamma'$  implied by Eq. (2.13) to obtain explicit expressions for  $w'$  and  $\gamma'$ . We then average over oscillations

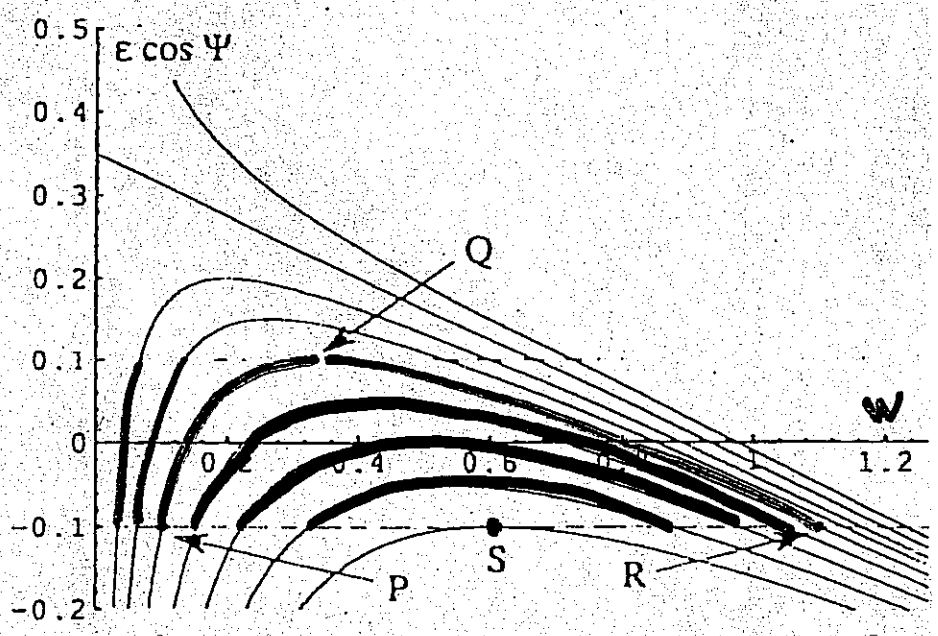

FIG. 1. Plot of  $\epsilon \cos \Psi$  vs  $w$  for the simplified model with  $\Delta = 0.35$ .

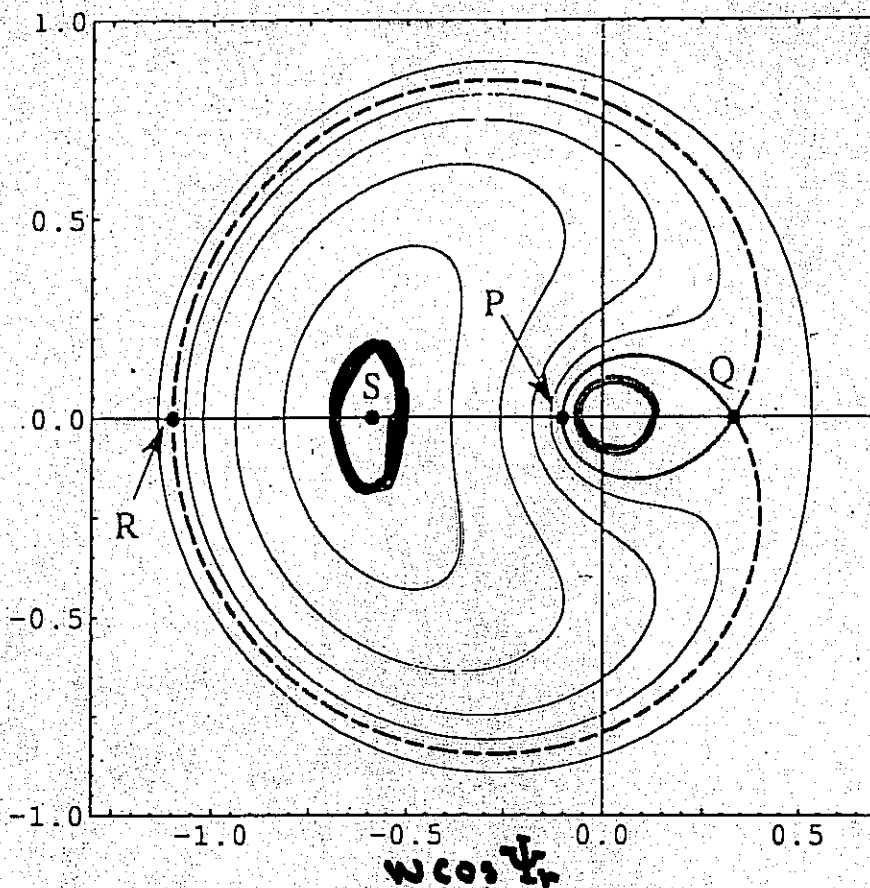

FIG. 2. Polar plot of  $w$  vs  $\Psi$  for the trajectories corresponding to the parametric resonance using  $\Delta = 0.35$ ,  $\epsilon = 0.1$ , and the simplified model.

all wave numbers except  $2q - p$ , being careful to include the step functions as we obtain these averages. The final equations for  $w'$  and  $\Psi'$  [ $\Psi = (2q - p)z + \gamma$ ] are similar to Eqs. (2.7) and (2.8) and again lead to an integral of the motion, which now is

$$g(1 - h)\epsilon \cos \Psi = f\Delta - t - C, \quad (2.14)$$

where  $f(w) = (w^2 + L^2)/2w$ ,  $g(w) = (w^2 - L^2)/2w$ .

(2.15)

Therefore the distribution in  $L$  for a K-V beam is uniform from  $L = -1/2$  to  $L = 1/2$  and vanishes for  $|L| > 1/2$

Also

(2.16)

IV. Implications of the model. — Since the breather K-V beam is a solution of the Vlasov equation, particles within the core will continue to remain there, even in the presence of the resonant interaction. If however

The arc-quadrant dependence expression for Eq. (2.6)

effect when through the  $\Delta = 0.35$  very similar Fig. 4 for the model in scale for  $w$  ranging with  $\epsilon$  given by the

am. — The to

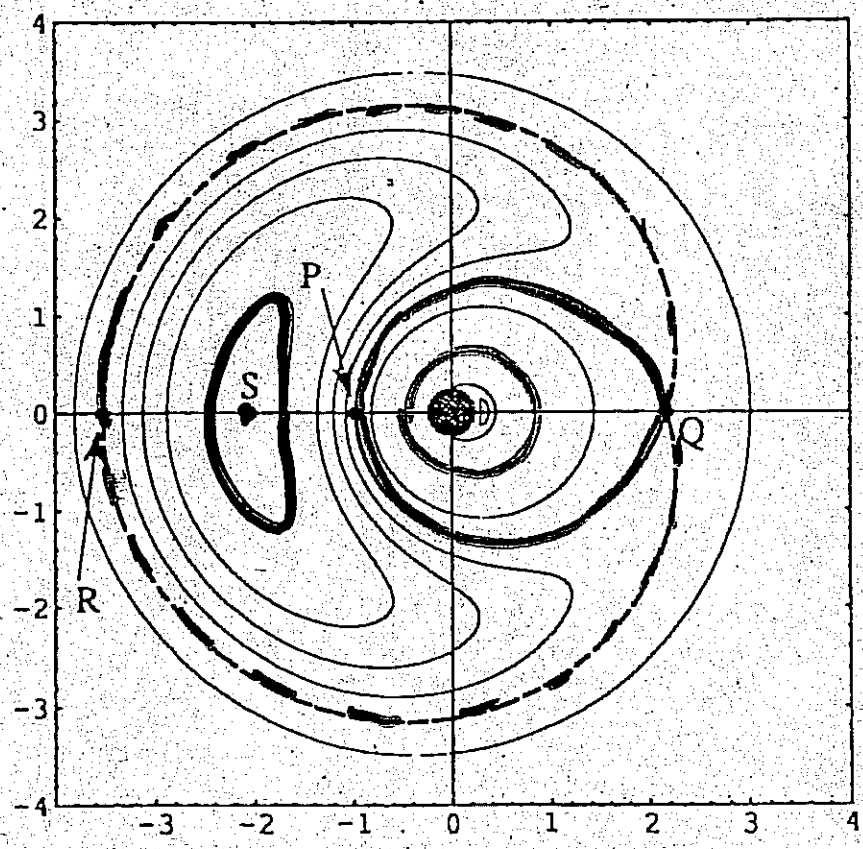
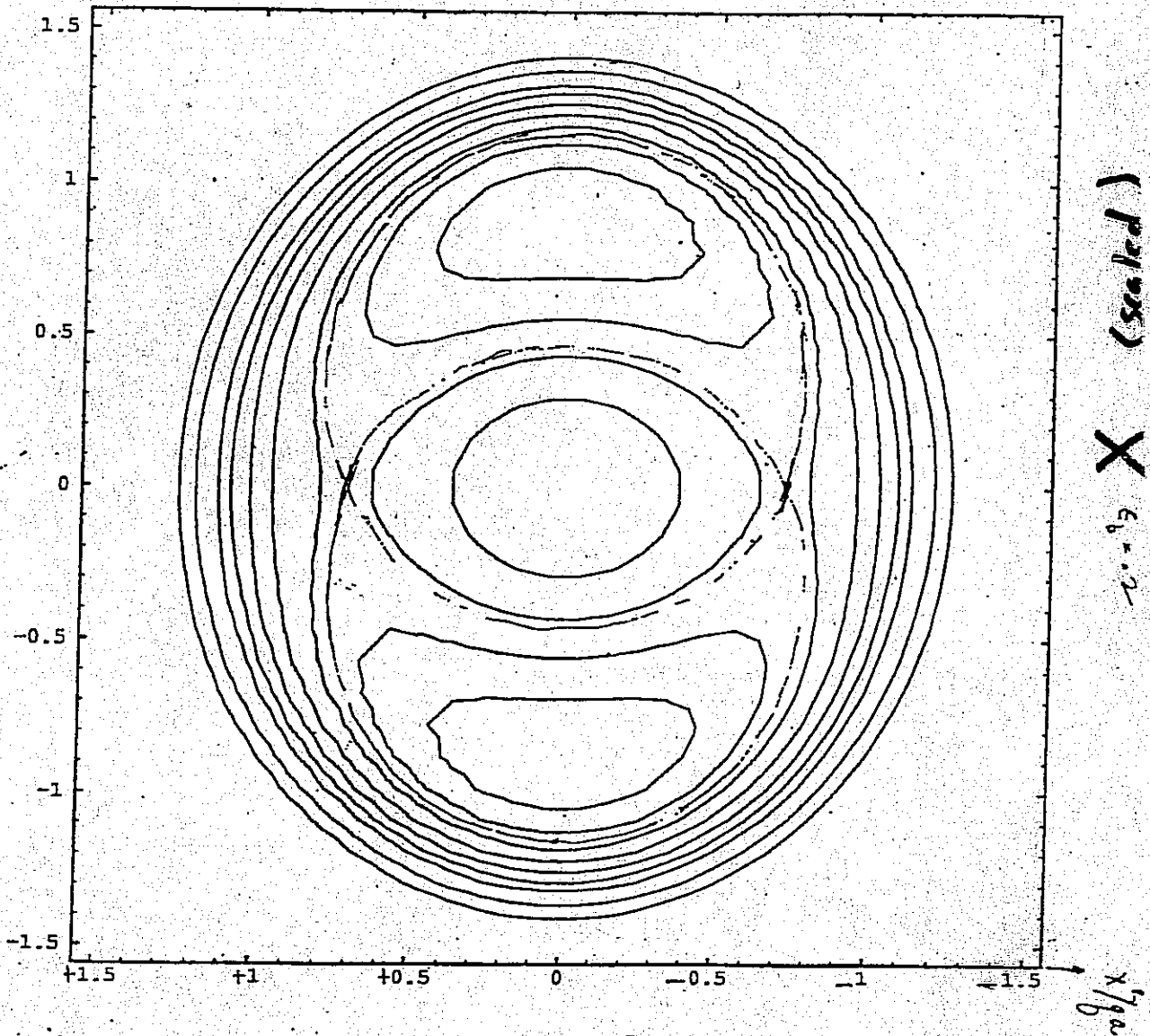

FIG. 4. Polar plot of  $w$  vs  $\Psi$  for the trajectories corresponding to the parametric resonance using  $\Delta = 0.35$ ,  $L = 0$ ,  $\epsilon =$  and the exact model.

Bob Gluckstern  
Univ. of Maryland.

$$X = \pm \sqrt{\frac{1}{2} \left( \frac{1}{\mu} + \frac{1}{\nu} \right)} \sin \left[ \frac{1}{2} \left( \frac{1}{\mu} + \frac{1}{\nu} \right) t \right]$$

$$X' = \pm \sqrt{\frac{1}{2} \left( \frac{1}{\mu} + \frac{1}{\nu} \right)} \cos \left[ \frac{1}{2} \left( \frac{1}{\mu} + \frac{1}{\nu} \right) t \right]$$



X' (scaled)

Fig. 3

# Stroboscopic Map (The Peanut Diagram)

misratch = 1.50  
k/k0 = .5000  
RR = .620

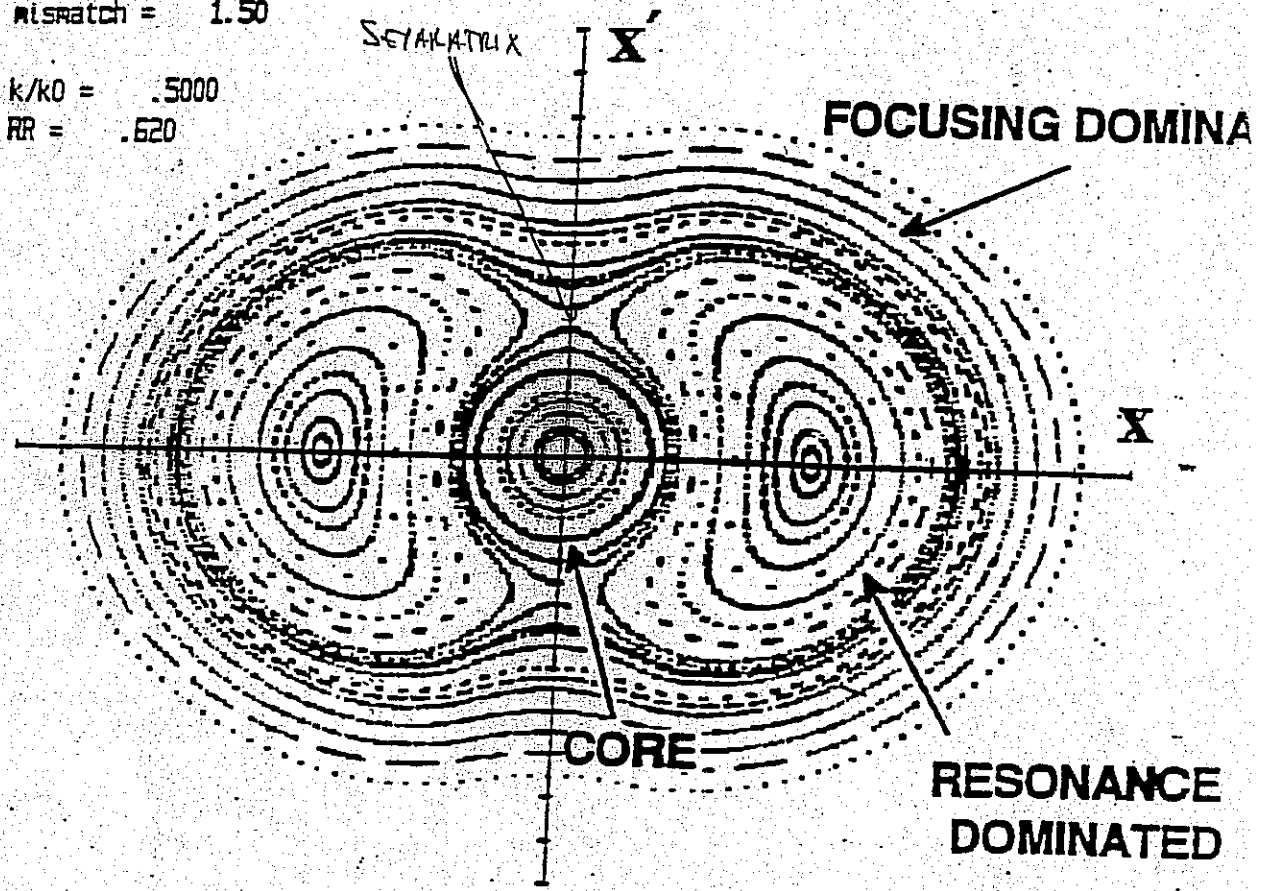

- Accumulate **Many Snapshots of Phase Space Taken at Minimum Amplitude of Core Oscillation.** (OR ANY PARTICULAR PHASE)
- Follow an Array of Particles to Obtain a "Trajectory Field".
- Regular Trajectories Appear as Smooth Curves.
- Chaotic Trajectories Appear as Stochastic Scatter.
- INITIAL POSITIONS OF PARTICLES IN PHASE SPACE WERE EQUALLY SPACED ALONG X & X' AXES.

994  
908  
pin,  
and  
Opt.  
Rev.  
den,  
90);  
and  
hys.  
lett.  
ght-  
(but  
tion  
W.  
lora,  
248  
H. J.  
cen,  
3. P.  
W.  
taev  
der  
11  
(63);  
Rev.  
gen,  
E. I.  
ight  
tion,  
(1) is  
even  
the  
sica  
A. P.  
v. A  
near  
rag,  
2ω<sub>0</sub>  
(tent  
rate  
Rev.  
lited  
ress,

### Analytic Model for Halo Formation in High Current Ion Linacs

Robert L. Gluckstern

Physics Department, University of Maryland, College Park, Maryland 20742

(Received 8 March 1994)

We construct an azimuthally symmetric 2D model for halo formation in high current ion linacs. The driving term, a "breathing" oscillation caused by a transverse mismatch along the linac, leads to growth of ion amplitudes in the core through the parametric resonance. As the ion amplitude grows, its wave number increases, enhancing the resonance. This leads to the formation of a halo surrounding the core. We explore the dependence of this mechanism on the tune depression and the size of the mismatch. The model agrees well with simulations at Los Alamos, but does not yet include the effects of chaos observed in the simulations as the tune depression becomes severe.

PACS numbers: 41.85.-p, 29.17.+w, 29.27.Bd

**I. Introduction.**—High current, high duty factor ion linacs have become increasingly attractive in recent years. Among possible applications are heavy ion drivers for thermonuclear energy production, production of tritium, transmutation of radioactive wastes, and production of radioactive isotopes for medical use.

Obviously, it is desirable to accelerate the maximum possible current in such linacs. Much work has been done to explore the optimum transverse phase space distribution in such beams. In particular, the Kapchinsky-Vladimirsky (K-V) distribution [1] is simplest to analyze, since this projection into real space has a uniform density and therefore linear space charge forces. The stability of the K-V distribution has been analyzed and approximately confirmed by numerical simulations. Nevertheless it appears that, particularly at high currents, the K-V and other equilibrium distributions evolve to ones with rounded edges and tails. In many cases involving high peak current, the distribution spins off a cluster of particles in the form of a halo surrounding a dense core. This halo is seen in simulations as well as in actual linacs, such as LAMPF [2]. And efforts to remove the halo by collimation have been largely unsuccessful since the halos almost always regenerate.

It is clear that the halos will produce unacceptably high levels of radioactivity in high current, high duty factor linacs. For this reason considerable effort has recently been devoted to exploring their detailed structure and understanding the mechanism or mechanisms by which the halos are produced [3-6]. What has been learned is that halos are most likely to be produced at transition locations, such as where there are discontinuities in frequency, structure geometry, transverse focusing pattern, accelerating gradient and phase, etc.

In the present paper, we propose an analytic model for halo formation which appears to reproduce the main features seen in simulations and in actual linacs. In particular we consider a circular cw beam with a K-V core distribution and explore the motion of individual ions passing through the core. Since energy transfer between ions and the core can take place only if the core has a time

dependent behavior, we consider the driving mechanism to be a "breathing" oscillation of the core. We then explore the resonant (parametric) interaction between the breathing core and the ions oscillating about and through the core. Of particular importance is the dependence of the frequency of each oscillating ion on its amplitude, which is related to the fraction of the oscillation for which the ion is within the core.

In spite of the fact that the actual distribution will have nonlinear fields, the use of a K-V distribution for the analysis leads us to a very likely mechanism for the development of the halo. In particular, the results provide an explanation for the low density region around the core which is surrounded by a somewhat higher density halo ring. This explanation will probably still apply for other self-consistent distributions.

**II. Model.**—We consider an azimuthally symmetric K-V core of radius  $a$  for which the equation of motion of an ion is

$$x'' + k^2 x = x \begin{cases} \kappa/a^2, & r \leq a \\ \kappa/r^2, & r \geq a \end{cases} \quad (2.1)$$

where the prime stands for  $d/dz$ , and  $k$  is the wave number of the transverse motion in the absence of space charge. The perveance of the beam,  $\kappa = eI/2\pi\epsilon_0 m v^3$ , is a dimensionless parameter proportional to the current  $I$ , where  $e$ ,  $m$ , and  $v$  are the charge, mass, and ion velocity, and  $\epsilon_0$  is the permittivity of free space. The equation for  $y$  is identical to Eq. (2.1).

We now assume a core oscillation of wave number  $p$  of the form  $a \rightarrow a(1 - \epsilon \cos pz)$  and expand  $a^{-2}$  in Eq. (2.1) to first order in  $\epsilon$ , the relative oscillation amplitude. After some algebra, Eq. (2.1) can be written as

$$x'' + q^2 x = -\frac{\kappa}{a^2} x \left(1 - \frac{a^2}{r^2}\right) \Theta(r - a) + \frac{2\epsilon\kappa}{a^2} x \cos pz \Theta(a - r), \quad (2.2)$$

where  $\Theta(u) = 1, 0$  for  $u > 0, u < 0$  and where  $q = \sqrt{k^2 - \kappa/a^2}$  is the wave number of oscillations within the core.



With the radial forces of Eq. (2.2), we see that the angular momentum  $Lqa^2 \equiv xy' - x'y = r^2\psi'$  is constant. The equation for radial motion then becomes

$$r'' + q^2 \left( r - \frac{L^2 a^4}{r^3} \right) = -\frac{\kappa}{a^2} r \left( 1 - \frac{a^2}{r^2} \right) \Theta(r - a) + 2 \frac{\epsilon \kappa}{a^2} r \cos pz \Theta(a - r). \quad (2.3)$$

The first term on the right makes the oscillation wave number depend on amplitude and the second allows for energy transfer between the core and the oscillating ion.

In order to understand the role of the different terms in Eq. (2.3), we construct a simplified model by setting  $L = 0$  and invoking a pendulum model for the first term on the right side of Eq. (2.3) by replacing  $r(1 - a^2/r^2)\Theta(r - a)$  by  $r^3/a^2$ , corresponding to the cubic nonlinear term for a pendulum. (However, its sign is opposite from the conventional pendulum since, in our model, the wave number *increases* with increasing amplitude.) In addition, we extend the driving term to all values of  $r$ . The simplified equation for  $x$  is therefore

$$x'' + q^2 x = -\frac{\kappa}{a^2} \frac{x^3}{a^2} + 2 \frac{\epsilon \kappa}{a^2} x \cos pz. \quad (2.4)$$

We now use the phase-amplitude method by writing  $x/a = A \sin \psi$ ,  $x'/a = qA \cos \psi$ , where  $\psi = qz + \alpha$ , implying  $A' \sin \psi + A\alpha' \cos \psi = 0$ . Here  $A$  and  $\alpha$  are taken to be the slowly varying amplitude and phase parameters of the ion oscillation. Substituting into Eq. (2.4) and solving for  $A'$  and  $\alpha'$  we obtain

$$A' = -\frac{\kappa A}{qa^4} [A^2 \sin^3 \psi \cos \psi - \epsilon a^2 \sin 2\psi \cos pz], \quad (2.5)$$

$$\alpha' = \frac{\kappa}{qa^4} [A^2 \sin^4 \psi - 2\epsilon a^2 \sin^2 \psi \cos pz]. \quad (2.6)$$

We now average over all rapidly varying oscillatory terms with the exception of the one with wave number  $2q - p$  (the parametric resonance) and obtain

$$A' = \frac{\epsilon \kappa}{2qa^2} A \sin \Psi, \quad (2.7)$$

$$\Psi' = (2q - p) + \frac{3\kappa}{4qa^4} A^2 + \frac{\epsilon \kappa}{qa^2} \cos \Psi, \quad (2.8)$$

where  $\Psi = (2q - p)z + 2\alpha$  is the phase of this resonant interaction. One then finds that an integral of the motion exists, enabling us to write [7]

$$\epsilon \cos \Psi = \Delta - \frac{3}{8} w - \frac{C}{w}, \quad (2.9)$$

where  $w = A^2/a^2$ ,  $\Delta = q(p - 2q)a^2/\kappa$ , and where the integration constant  $C$  is determined by the initial values of  $w$  and  $2\alpha$ . By resorting to the envelope equation we can show that  $p^2 = 4q^2 + 2\kappa/a^2$  for the breathing mode, so that

$$\Delta = \frac{1}{1 + \sqrt{(1 + \kappa^2/q^2)/2}}, \quad (2.10)$$

where  $q/k$  is the tune depression caused by the space

charge. In Fig. 1 we plot  $\epsilon \cos \Psi$  vs  $w$  for  $q/k = 0.412$ ,  $\Delta = 0.35$ , and various values of  $C$ . For  $\epsilon = 0.1$ , the polar plot of  $w$  vs  $\Psi$  is shown in Fig. 2. It is clear that  $Q$  is an unstable fixed point and that the origin and  $S$  are stable fixed points. Figure 2 is equivalent to a "second order stroboscopic plot" for integral values of  $pz/2\pi$ , and contains the main features of the resonant interaction. Specifically, all trajectories starting within the inner separatrix (thick solid curve) bounded by  $P$  and  $Q$  oscillate in stable orbits while any trajectory starting just outside will travel along the outer separatrix (thick dashed curve). For these particles, as the amplitude of motion grows the true oscillation wave number increases, enhancing the resonant term and *locking in* to the resonance. And the presence of a thin distribution of trajectories near the outer separatrix has the appearance of a halo in  $x - y$  space at the radius corresponding to  $R$  in Figs. 1 and 2.

We now drop the simplified model and return to Eq. (2.3). Although the algebra is far more complicated we eventually obtain a more accurate version of Eq. (2.9) with a very similar set of curves to those in Figs. 1 and 2. First we rewrite Eq. (2.3) for the variable  $s = r^2/a^2$ , obtaining

$$s'' - \frac{(s')^2}{2s} + 2q^2 \left( s - \frac{L^2}{s} \right) = -\frac{2\kappa}{a^2} (s - 1) \Theta(s - 1) + 4 \frac{\epsilon \kappa}{a^2} s \cos pz \Theta(1 - s). \quad (2.11)$$

Guided by the parametrization of the  $x$  and  $y$  motions separately, the amplitude-phase parametrization of the two-dimensional oscillation is written as

$$s = \frac{w^2 + L^2}{2w} - \frac{w^2 - L^2}{2w} \cos(2qz + \gamma). \quad (2.12)$$

Here  $w$  and  $\gamma$  are slowly varying amplitude and phase parameters which would be constant if the right side of Eq. (2.11) vanished. We now write

$$s' = q \frac{w^2 - L^2}{w} \sin(2qz + \gamma) \quad (2.13)$$

and use Eq. (2.11) and the required connection between  $w'$  and  $\gamma'$  implied by Eq. (2.13) to obtain explicit expressions for  $w'$  and  $\gamma'$ . We then average over oscillations at

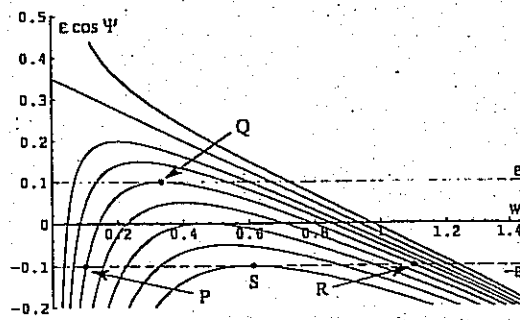

FIG. 1. Plot of  $\epsilon \cos \Psi$  vs  $w$  for the simplified model with  $\Delta = 0.35$ .

FIG. to simp

all v the : equ lar t the

wher Her

for

for tang The of t b(w with S L = cor and to t ε = Fig is a amj 3/8 I dist

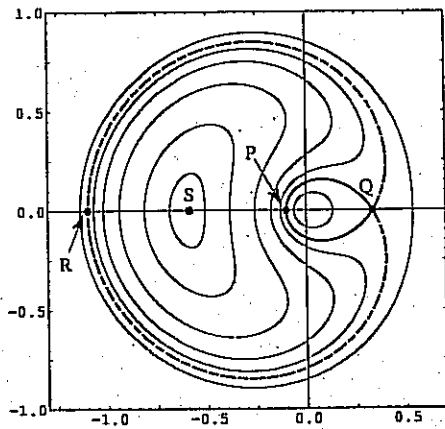

FIG. 2. Polar plot of  $w$  vs  $\Psi$  for the trajectories corresponding to the parametric resonance using  $\Delta = 0.35$ ,  $\epsilon = 0.1$ , and the simplified model.

all wave numbers except  $2q - p$ , being careful to include the step functions as we obtain these averages. The final equations for  $w'$  and  $\Psi'$  [ $\Psi' = (2q - p)z + \gamma$ ] are similar to Eqs. (2.7) and (2.8) and again lead to an integral of the motion, which now is

$$g(1 - h)\epsilon \cos \Psi' = f\Delta - t - C, \quad (2.14)$$

where  $f(w) = (w^2 + L^2)/2w$ ,  $g(w) = (w^2 - L^2)/2w$ . Here

$$\pi h(w) = \tan^{-1}[\ell/(1 - f)] + \ell(1 - f)/2g^2 \quad (2.15)$$

for  $w \geq 1$  and  $\ell(w) = \sqrt{(w - 1)(w - L^2)}/w$ . Also

$$t(w) = \frac{1}{\pi} \int_1^w \frac{dw}{wg} \left[ (g^2 - f) \tan^{-1} \left( \frac{\ell}{1 - f} \right) + f\ell + L \tan^{-1} \left( \frac{2L\ell}{f - L^2} \right) \right], \quad (2.16)$$

for  $w \geq 1$ , and  $h(w) = t(w) = 0$  for  $w \leq 1$ . The arctangents are taken to be in the first or second quadrant. The term in  $b(w)$  comes from the amplitude dependence of the ion wave number. A more accurate expression for  $b(w)$  can be obtained, if necessary, by solving Eq. (2.6) with  $\epsilon = 0$ .

Since the resonance will have its greatest effect when  $L = 0$ , corresponding to ion orbits which pass through the core center, we present a plot of  $\epsilon \cos \Psi$  vs  $w$  for  $\Delta = 0.35$  and  $L = 0$  in Fig. 3. The pattern of curves is very similar to that in Fig. 1, and the  $w, \Psi$  polar plot in Fig. 4 for  $\epsilon = 0.1$  has the same topology as for the simple model in Fig. 2, as is also the case for  $L \neq 0$ . But the scale for  $w$  is about 7 times larger, corresponding to a detuning with amplitude about 7 times smaller than that given by the 3/8 factor in Eq. (2.14).

III. Distribution of  $L$  in a symmetric K-V beam.—The distribution in  $L$  for a K-V beam is proportional to

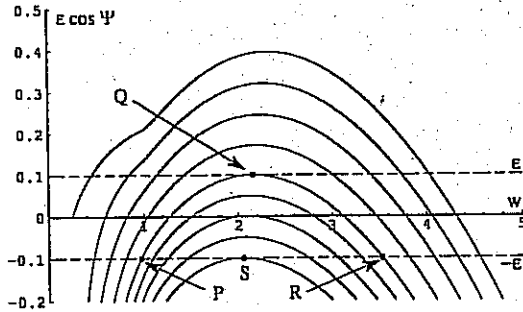

FIG. 3. Plot of  $\epsilon \cos \Psi$  vs  $w$  for the exact model with  $\Delta = 0.35$ ,  $L = 0$ .

$$f(L) \sim \int \int \int \int dx dy dx' dy' \delta(x^2 + y^2 + \frac{(x')^2}{q^2} + \frac{(y')^2}{q^2} - a^2) \delta(x'y - xy' - Lqa^2). \quad (3.1)$$

We first do  $45^\circ$  rotations from the  $x/a, y'/qa$  space to the  $u, u'$  space and from the  $y/a, x'/qa$  space to the  $v, v'$  space and follow this by integrating over the polar angles in the  $uv'$  and  $vu'$  spaces. This leads to

$$f(L) \sim \int_0^\infty ds \int_0^\infty dt \delta(s + t - 1) \delta\left(\frac{s - t}{2} - L\right) = \begin{cases} 1, & 2|L| < 1 \\ 0, & 2|L| > 1 \end{cases} \quad (3.2)$$

where  $s = u^2 + (v')^2$  and  $t = v^2 + (u')^2$  are both positive. Therefore the distribution in  $L$  for a K-V beam is uniform from  $L = -1/2$  to  $L = 1/2$  and vanishes for  $|L| > 1/2$ .

IV. Implications of the model.—Since the breathing K-V beam is a solution of the Vlasov equation, particles within the core will continue to remain there, even in the presence of the resonant interaction. If however,

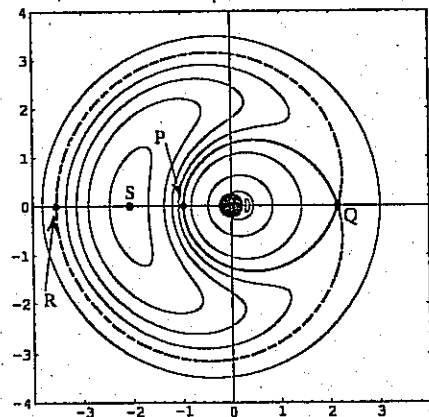

FIG. 4. Polar plot of  $w$  vs  $\Psi$  for the trajectories corresponding to the parametric resonance using  $\Delta = 0.35$ ,  $L = 0$ ,  $\epsilon = 0.1$ , and the exact model.



some other mechanism moves the particle outside the core, particularly to an oscillation amplitude exceeding that corresponding to the points  $P$  or  $Q$  in the figures, a halo will develop at a radius corresponding to point  $R$  in the figures. The most likely mechanism to do this is an instability associated with a nonlinear density perturbation. In addition, simulations show that chaotic motion develops near point  $Q$  in the figures for a large amplitude breathing mode at high current, enabling particles in the core to populate the halo.

*V. Summary and discussion.*—We considered a symmetric K-V beam undergoing a breathing mode and found that the parametric resonance ( $2q = p$ ) is a vehicle for particles to leave the core of the beam and perform excursions to large amplitude, forming a distribution in real space in the form of a halo. In this calculation, we neglected the effect of high frequency terms, and the effect of other possible resonances and driving oscillations. Thus our model, which successfully describes a mechanism by which halos can and probably do form, is only an approximation to a much more complicated situation.

We have compared our predictions with some preliminary simulations performed for  $L = 0$  by Wangler [8], and find that, for tune depressions from  $q/k = 1$  to 0.6, the topology of the stroboscopic plot resembles Figs. 2 and 4 very closely. For tune depressions below 0.6, the stroboscopic plot shows the onset of chaotic behavior in an ever widening band near the inner separatrix as the tune depression deepens. Particles inside but near to the inner separatrix are then able to move outside the inner separatrix and participate more easily in the development of the halo.

Wangler's simulations using a K-V beam [8] confirm that core ions always remain within the inner separatrix. It is quite possible for core ions to lie outside the equivalent inner separatrix for nonuniform equilibrium charge density distributions. We therefore expect the halo mechanisms in the present model to apply to non-K-V beams as well. Lagniel's simulations [6] give similar results, showing the onset of chaos for high space charge as well as the similarity with the three-body astronomical problem.

Our present model is unable to describe either diffusion or chaos in the  $w, \Psi$  phase space. If we were to try to do so we would have to include the neglected high frequency terms, as well as resonances other than the one corresponding to the parametric resonance. Integrals of the motion corresponding to Eq. (2.14) would no longer be valid. Descriptions of the growth of halos including the effects of chaos and diffusion will require further analysis and/or extensive numerical simulations.

The author would like to thank Alex Dragt, Bob Jameson, Pierre Lapostolle, Ron Ruth, Rob Ryne, Fred Skiff, and Tom Wangler for several helpful comments. He is also indebted to Dan Abell for performing the calculations leading to Figs. 1-4.

- [1] See I.M. Kapchinsky, *Theory of Resonance Linear Accelerators* (Harford Academic Press, New York, 1985), p. 247ff.
- [2] R.A. Jameson, Los Alamos Report No. LA-UR-93-1209 (unpublished). Jameson describes the early observations of emittance growth and halo production, with particular reference to LAMPF simulations and observations.
- [3] M. Reiser, in Proceedings of the 1991 Particle Accelerator Conference, San Francisco, California, (unpublished), p. 2497.
- [4] A. Cucchietti, M. Reiser, and T. Wangler, in Proceedings of the 1991 Particle Accelerator Conference (Ref. [3]), p. 251.
- [5] J.S. O'Connell, T.P. Wangler, R.S. Mills, and K.R. Crandall, in Proceedings of the 1993 Particle Accelerator Conference, Washington, D.C. (unpublished), p. 3657.
- [6] J.M. Lagniel, Nucl. Instrum. Methods Phys. Res., Sect. A 345, 46 (1994).
- [7] This result can also be obtained using a contact transformation, followed by neglecting rapidly oscillating terms. In fact, the transformed Hamiltonian in the canonical variables  $w$  and  $\Psi$  is  $H = (\kappa/qa^2)[w\epsilon \cos\Psi - \Delta w + 3w^2/8]$ .
- [8] Tom Wangler (private communication).

The  
ions ar  
such c  
flares,  
the rat  
release  
well th  
of ma  
theore  
In  
constr  
dimen  
Incom  
outflo  
 $v_i \sim$   
width  
is lin  
curre  
Dreie  
(MHI  
collis  
be rel  
the et  
altho  
2D in  
Oh  
is ac  
ment  
The i  
the s  
[6].  
and )  
[5,7]  
layer  
tive  
layer  
very  
scrib  
In th  
curr  
skin

# Transverse Kinetic Stability\*

Steven M. Lund

Lawrence Livermore National Laboratory (LLNL)

Steven M. Lund and John J. Barnard  
“Beam Physics with Intense Space-Charge”

US Particle Accelerator School

University of Maryland, held at Annapolis, MD  
16-27 June, 2008  
(Version 20080625)

\* Research supported by the US Dept. of Energy at LLNL and LBNL under contract Nos. DE-AC52-07NA27344 and DE-AC02-05CH11231.

SM Lund, USPAS, June 2008

Transverse Kinetic Stability

1

## Transverse Kinetic Stability: Outline

Overview: Machine Operating Points  
Overview: Collective Modes and Transverse Kinetic Stability  
Linearized Vlasov Equation  
Collective Modes on a KV Equilibrium Beam  
Global Conservation Constraints  
Kinetic Stability Theorem  
rms Emittance Growth and Nonlinear Fields  
rms Emittance Growth and Nonlinear Space-Charge Fields  
Uniform Density Beams and Extreme Energy States  
Collective Relaxation and rms Emittance Growth  
Halo Induced Mechanism of Higher Order Instability  
Phase Mixing and Landau Damping in Beams  
References

SM Lund, USPAS, June 2008

Transverse Kinetic Stability

2

## Transverse Kinetic Stability: Detailed Outline

- 1) **Overview: Machine Operating Points**  
Notions of Beam Stability  
Tiefenback's Experimental Results for Quadrupole Transport
- 2) **Overview: Collective Modes and Transverse Kinetic Stability**  
Possibility of Collective Internal Modes  
Vlasov Model Review  
Plasma Physics Approach to Understanding Higher Order Instability
- 3) **The Linearized Vlasov Equation**  
Equilibrium and Perturbations  
Linear Vlasov Equation  
Method of Characteristics  
Discussion
- 4) **Collective Modes on a KV Equilibrium Beam**  
KV Equilibrium  
Linearized Equations of Motion  
Solution of Equations  
Mode Properties  
Physical Mode Components Based on Fluid Model  
Periodic Focusing Results

SM Lund, USPAS, June 2008

Transverse Kinetic Stability

3

## Detailed Outline - 2

- 5) **Global Conservation Constraints**  
Conserved Quantities  
Implications
- 6) **Kinetic Stability Theorem**  
Effective Free Energy  
Free Energy Expansion in Perturbations  
Perturbation Bound and Sufficient Condition for Stability  
Interpretation and Example Applications
- 7) **rms Emittance Growth and Nonlinear Forces**  
Equations of Motion  
Coupling of Nonlinear Forces to rms Emittance Evolution
- 8) **rms Emittance Growth and Nonlinear Space-Charge Forces**  
Self-Field Energy  
rms Equivalent Beam Forms  
Wangler's Theorem

SM Lund, USPAS, June 2008

Transverse Kinetic Stability

4

## Detailed Outline - 3

- 9) **Uniform Density Beams and Extreme Energy States**  
Variational Formulation  
Self-Field Energy Minimization
- 10) **Collective Relaxation and rms Emittance Growth**  
Conservation Constraints  
Relaxation Processes  
Emittance Growth Bounds from Space-Charge Nonuniformities
- 11) **Halo Induced Mechanism of Higher Order Instability**  
Halo Model for an Elliptical Beam  
Pumping Mechanism  
Stability Properties
- 12) **Phase Mixing and Landau Damping in Beams**  
(to be added, future editions)

### Contact Information

### References

SM Lund, USPAS, June 2008

Transverse Kinetic Stability

5

## S1: Overview: Machine Operating Points

Good transport of a single component beam with intense space-charge described by a Vlasov-Poisson type model requires:

### 1. Lowest Order:

Stable single-particle centroid:  $\sigma_0 < 180^\circ$  see: [Transverse Particle Eqns, Transverse Centroid and Env.](#)

### 2. Next Order:

Stable rms envelope:  $\sigma_0, \sigma/\sigma_0$  both outside of envelope bands see: [Transverse Centroid and Envelope Descriptions](#)

### 3. Higher Order:

“Stable” Vlasov description: **To be covered these lectures**

Transport of a relatively smooth initial beam distribution can fail or become “unstable” within the Vlasov model for several reasons:

- Collective modes internal to beam become unstable and grow
  - Large amplitudes can lead to statistical (rms) beam emittance growth
- Excessive halo generated
- Increased statistical beam emittance and particle losses
- Combined processes above

SM Lund, USPAS, June 2008

Transverse Kinetic Stability

6

Transport limits in periodic (FODO) quadrupole lattices that result from higher order processes have been measured in the SBTE experiment. These results had only limited theoretical understanding over 20+ years

### Experimental limits on beam stability in terms of $\sigma$ and $\sigma_0$

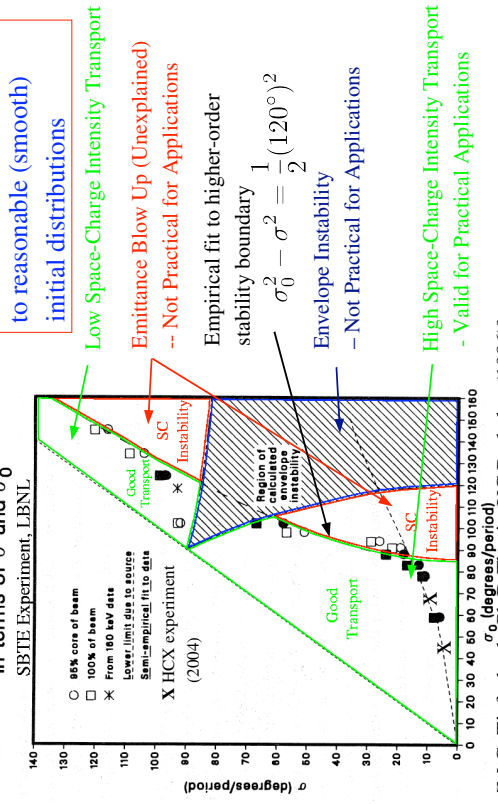

[M.G. Tiefenback, Ph.D Thesis, UC Berkeley (1986)]

SM Lund, USPAS, June 2008

Transverse Kinetic Stability

7

Summary of beam stability with intense space-charge in a quadrupole transport lattice: centroid, envelope, and theory boundary based on higher order emittance growth/particle losses

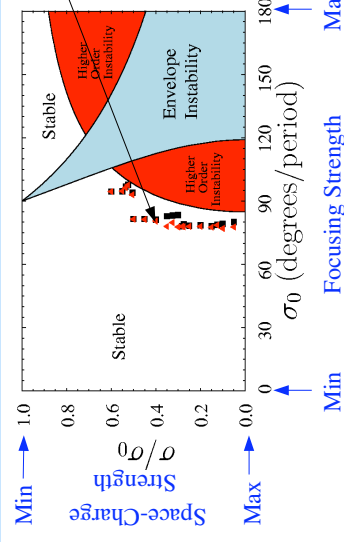

Recent theory analyzes AG transport limits without equilibria

- Suggests near core, chaotic halo resonances driven by matched beam envelope flutter can drive strong emittance growth and particle losses
- Results checked with fully self-consistent simulations

Analogous results (with less “instability”) exist for solenoidal transport

SM Lund, USPAS, June 2008

Transverse Kinetic Stability

8

## S2: Overview: Collective Modes and Transverse Kinetic Stability

In discussion of transverse beam physics we have focused on:

### Equilibrium

- Used to estimate balance of space-charge and focusing forces
  - KV model for periodic focusing
  - Continuous focusing equilibria for qualitative guide on space-charge effects such as Debye screening and nonlinear equilibrium self-field effects

### Centroid/Envelope Modes and Stability

- Lowest order collective oscillations of the beam
  - Analyzed assuming fixed internal form of the distribution
- Model only exactly correct for KV equilibrium distribution
  - Should hold in a leading-order sense for a wide variety of real beams
- Predictions of instability regions are well verified by experiment
  - Significantly restricts allowed system parameters for periodic focusing lattices

Reminder (lecture on *Centroid and Envelope Descriptions of Beams*): Instability bands of the KV envelope equation are well understood in periodic focusing channels

### Envelope Mode Instability Growth Rates

#### Solenoid ( $\eta = 0.25$ )

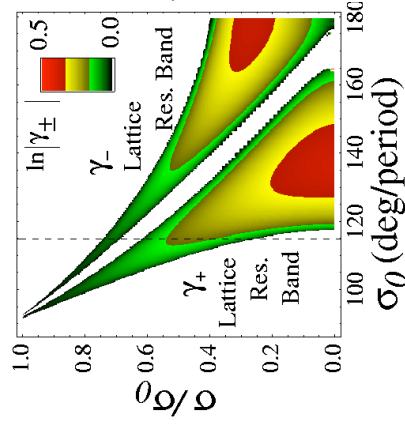

#### Quadrupole FODO ( $\eta = 0.70$ )

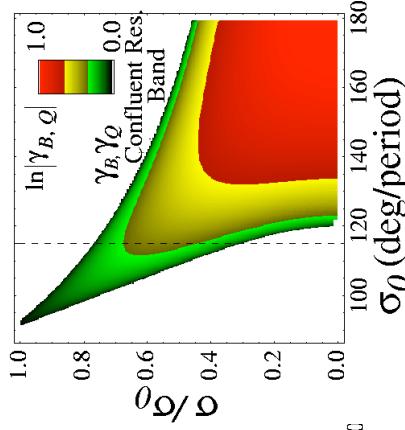

## Example – Envelope Modes on a Round, Continuously Focused Beam

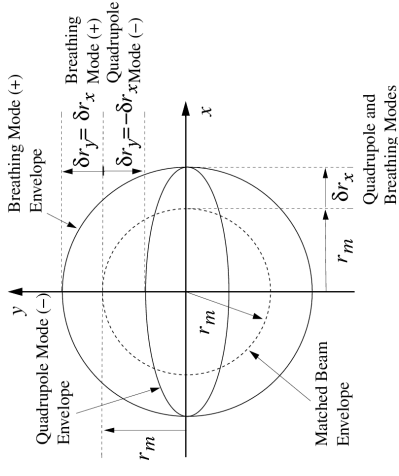

The analog of these modes in a periodic focusing lattice can be destabilized

- Constrains system parameters to avoid band (parametric) regions of instability

More instabilities are possible than can be described by statistical (moment/envelope) equations. Look at a more complete, Vlasov based kinetic theory including self-consistent space-charge:

### Higher-order Collective (internal) Mode Stability

- Perturbations will generally drive nonlinear space-charge forces
- Evolution of such perturbations can change the beam rms emittance
- Many possible internal modes of oscillation should be possible
  - Frequencies can differ significantly from envelope modes
  - Creates more possibilities for resonant exchanges with a periodic focusing lattice and various beam characteristic responses opening many possibilities for system destabilization

### KV Envelope Mode (breathing)

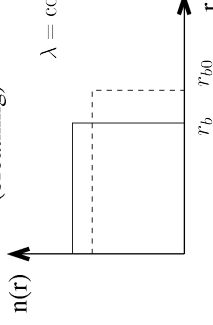

### Higher Order Mode

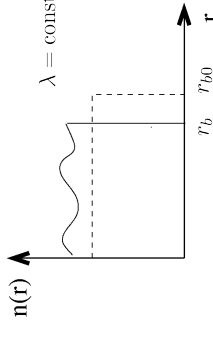

## Plasma physics approach to beam physics:

Resolve:

$$f(\mathbf{x}_\perp, \mathbf{x}'_\perp, s) = f_\perp(\{C_i\}) + \delta f_\perp(\mathbf{x}_\perp, \mathbf{x}'_\perp, s)$$

↙ equilibrium
↘ perturbation

$$f_\perp \gg |\delta f_\perp|$$

and carry out equilibrium + stability analysis

Comments:

- ◆ Attraction is to parallel the impressive successes of plasma physics
  - Gain insight into preferred state of nature
- ◆ Beams are born off a source and may not be close to an equilibrium condition
  - Appropriate single particle constants of the motion unknown for periodic focusing lattices other than the KV distribution
- ◆ Intense beam self-fields and finite radial extent vastly complicate equilibrium description and analysis of perturbations

Review: Transverse Vlasov-Poisson Model: for a coasting, single species beam with electrostatic self-fields propagating in a linear focusing lattice:

$\mathbf{x}_\perp, \mathbf{x}'_\perp$  transverse particle coordinate, angle  
 $q, m$  charge, mass  
 $\gamma_b, \beta_b$  axial relativistic factors  
 Vlasov Equation (see J.J. Barnard, **Introductory Lectures**):

$$\frac{d}{ds} f_\perp = \frac{\partial f_\perp}{\partial s} + \frac{d\mathbf{x}_\perp}{ds} \cdot \frac{\partial f_\perp}{\partial \mathbf{x}_\perp} + \frac{d\mathbf{x}'_\perp}{ds} \cdot \frac{\partial f_\perp}{\partial \mathbf{x}'_\perp} = 0$$

Particle Equations of Motion:

$$\frac{d}{ds} \mathbf{x}_\perp = \frac{\partial H_\perp}{\partial \mathbf{x}'_\perp} \quad \frac{d}{ds} \mathbf{x}'_\perp = - \frac{\partial H_\perp}{\partial \mathbf{x}_\perp}$$

Hamiltonian (see: S.M. Lund, lectures on **Transverse Equilibrium Distributions**):

$$H_\perp = \frac{1}{2} \mathbf{x}'_\perp \cdot \mathbf{x}'_\perp + \frac{1}{2} \kappa_x(s) x^2 + \frac{1}{2} \kappa_y(s) y^2 + \frac{q}{m\gamma_b^3 \beta_b^2 c^2} \phi$$

Poisson Equation:

$$\left( \frac{\partial^2}{\partial x^2} + \frac{\partial^2}{\partial y^2} \right) \phi = - \frac{q}{\epsilon_0} \int d^2 \mathbf{x}'_\perp f_\perp$$

+ boundary conditions on  $\phi$

## Review: Focusing lattices, continuous and periodic (simple piecewise constant):

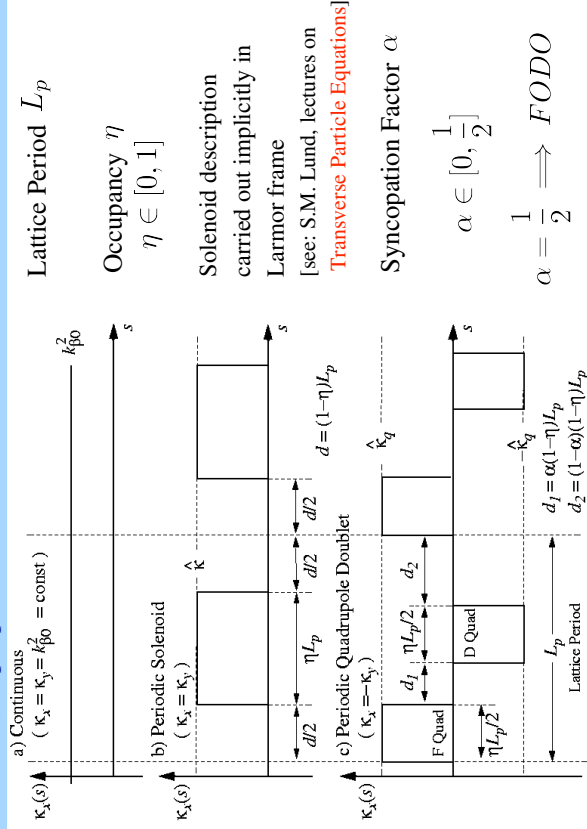

Continuous Focusing:  $\kappa_x = \kappa_y = k_{\beta 0}^2 = \text{const}$

$$H_\perp = \frac{1}{2} \mathbf{x}'_\perp \cdot \mathbf{x}'_\perp + \frac{1}{2} k_{\beta 0}^2 \mathbf{x}_\perp \cdot \mathbf{x}_\perp + \frac{q}{m\gamma_b^3 \beta_b^2 c^2} \phi$$

Solenoidal Focusing (in Larmor frame variables):  $\kappa_x = \kappa_y = \kappa(s)$

$$H_\perp = \frac{1}{2} \mathbf{x}'_\perp \cdot \mathbf{x}'_\perp + \frac{1}{2} \kappa \mathbf{x}_\perp \cdot \mathbf{x}_\perp + \frac{q}{m\gamma_b^3 \beta_b^2 c^2} \phi$$

Quadrupole Focusing:  $\kappa_x = -\kappa_y = \kappa_q(s)$

$$H_\perp = \frac{1}{2} \mathbf{x}'_\perp \cdot \mathbf{x}'_\perp + \frac{1}{2} \kappa_q x^2 - \frac{1}{2} \kappa_q y^2 + \frac{q}{m\gamma_b^3 \beta_b^2 c^2} \phi$$

We will concentrate on the continuous focusing model in these lectures

- ◆ Kinetic theory is notoriously complicated even in this (simple) case
- ◆ By analogy with envelope mode results expect that kinetic theory of periodic focusing systems to have more instabilities
- ◆ As in equilibrium analysis the continuous model can give simplified insight on a range of relevant kinetic stability considerations



### S3: Linearized Vlasov Equation

Because of the complexity of kinetic theory, we will limit discussion to a simple continuous focusing model Vlasov-Poisson system for a coasting beam within a round pipe

$$\frac{df_{\perp}}{ds} = \left\{ \frac{\partial}{\partial s} + \mathbf{x}'_{\perp} \cdot \frac{\partial}{\partial \mathbf{x}_{\perp}} - \left( k_{\beta 0}^2 \mathbf{x}_{\perp} + \frac{q}{m\gamma_b^3 \beta_b^2 c^2} \frac{\partial \phi}{\partial \mathbf{x}_{\perp}} \right) \cdot \frac{\partial}{\partial \mathbf{x}'_{\perp}} \right\} f_{\perp}(\mathbf{x}_{\perp}, \mathbf{x}'_{\perp}, s) = 0$$

$$\nabla_{\perp}^2 \phi(\mathbf{x}_{\perp}, s) = -\frac{q}{\epsilon_0} \int d^2 x'_{\perp} f_{\perp}(\mathbf{x}_{\perp}, \mathbf{x}'_{\perp}, s)$$

$$\phi(|\mathbf{x}_{\perp}| = r_p, s) = \text{const}$$

Then expand the distribution and field as:

$$f_{\perp} = \underbrace{f_0(H_0)}_{\text{equilibrium}} + \underbrace{\delta f_{\perp}}_{\text{perturbation}}$$

$$\phi = \underbrace{\phi_0}_{\text{equilibrium}} + \underbrace{\delta \phi}_{\text{perturbation}}$$

**Comment:**

The Poisson equation connects  $f_{\perp}$  and  $\phi$  so,  $\delta f_{\perp}$  and  $\delta \phi$  cannot be independently specified. We quantify the connection shortly.

At present, there is *no assumption* that the perturbations are small.

Insert the perturbations in Vlasov's equation and expand terms:

$$\left\{ \frac{\partial}{\partial s} + \mathbf{x}'_{\perp} \cdot \frac{\partial}{\partial \mathbf{x}_{\perp}} - \left( k_{\beta 0}^2 \mathbf{x}_{\perp} + \frac{q}{m\gamma_b^3 \beta_b^2 c^2} \frac{\partial \phi_0}{\partial \mathbf{x}_{\perp}} \right) \cdot \frac{\partial}{\partial \mathbf{x}'_{\perp}} \right\} f_0(H_0) \quad \text{equilibrium term}$$

$$+ \left\{ \frac{\partial}{\partial s} + \mathbf{x}'_{\perp} \cdot \frac{\partial}{\partial \mathbf{x}_{\perp}} - \left( k_{\beta 0}^2 \mathbf{x}_{\perp} + \frac{q}{m\gamma_b^3 \beta_b^2 c^2} \frac{\partial \phi_0}{\partial \mathbf{x}_{\perp}} \right) \cdot \frac{\partial}{\partial \mathbf{x}'_{\perp}} \right\} \delta f_{\perp}$$

$$= \frac{q}{m\gamma_b^3 \beta_b^2 c^2} \frac{\partial}{\partial \mathbf{x}_{\perp}} \cdot \frac{\partial}{\partial \mathbf{x}'_{\perp}} \delta \phi + \frac{q}{m\gamma_b^3 \beta_b^2 c^2} \frac{\partial \delta \phi}{\partial \mathbf{x}_{\perp}} \cdot \frac{\partial}{\partial \mathbf{x}'_{\perp}} \delta f_{\perp}$$

perturbed field                      nonlinear term

linear correction term

Take the perturbations to be small-amplitude:

$$f_0(H_0) \gg |\delta f_{\perp}|$$

$$\phi_0 \gg \delta \phi$$

and neglect the nonlinear terms to obtain the linearized Vlasov-Poisson system: <--- follows automatically from distribution/Poisson Eqn

$$\left\{ \frac{\partial}{\partial s} + \mathbf{x}'_{\perp} \cdot \frac{\partial}{\partial \mathbf{x}_{\perp}} - \left( k_{\beta 0}^2 \mathbf{x}_{\perp} + \frac{q}{m\gamma_b^3 \beta_b^2 c^2} \frac{\partial \phi_0}{\partial \mathbf{x}_{\perp}} \right) \cdot \frac{\partial}{\partial \mathbf{x}'_{\perp}} \right\} \delta f_{\perp}(\mathbf{x}_{\perp}, \mathbf{x}'_{\perp}, s)$$

$$= \frac{q}{m\gamma_b^3 \beta_b^2 c^2} \frac{\partial \delta \phi(\mathbf{x}_{\perp}, s)}{\partial \mathbf{x}_{\perp}} \cdot \frac{\partial}{\partial \mathbf{x}'_{\perp}} f_0(H_0)$$

$$\nabla_{\perp}^2 \delta \phi(\mathbf{x}_{\perp}, s) = -\frac{q}{\epsilon_0} \int d^2 x'_{\perp} \delta f_{\perp}(\mathbf{x}_{\perp}, \mathbf{x}'_{\perp}, s) \quad \delta \phi(|\mathbf{x}_{\perp}| = r_p, s) = \text{const}$$

The equilibrium satisfies:

(see: S.M. Lund, lectures on **Transverse Equilibrium Distributions**)

$$H_0 = \frac{1}{2} \mathbf{x}'_{\perp}{}^2 + \frac{1}{2} k_{\beta 0}^2 \mathbf{x}_{\perp}^2 + \frac{q}{m\gamma_b^3 \beta_b^2 c^2} \phi_0$$

$$f_0(H_0) = \text{any non-negative function}$$

$$\frac{1}{r} \frac{\partial}{\partial r} \left( r \frac{\partial \phi_0}{\partial r} \right) = -\frac{q}{\epsilon_0} \int d^2 x'_{\perp} f_0(H_0)$$

The unperturbed distribution must then satisfy the equilibrium Vlasov equation:

$$\left\{ \frac{\partial}{\partial s} + \mathbf{x}'_{\perp} \cdot \frac{\partial}{\partial \mathbf{x}_{\perp}} - \left( k_{\beta 0}^2 \mathbf{x}_{\perp} + \frac{q}{m\gamma_b^3 \beta_b^2 c^2} \frac{\partial \phi_0}{\partial \mathbf{x}_{\perp}} \right) \cdot \frac{\partial}{\partial \mathbf{x}'_{\perp}} \right\} f_0(H_0) = 0$$

Because the Poisson equation is linear:

$$\nabla_{\perp}^2 \delta \phi(\mathbf{x}_{\perp}, s) = -\frac{q}{\epsilon_0} \int d^2 x'_{\perp} \delta f_{\perp}(\mathbf{x}_{\perp}, \mathbf{x}'_{\perp}, s)$$

$$\delta \phi(|\mathbf{x}_{\perp}| = r_p, s) = \text{const}$$

### Solution of the Linearized Vlasov Equation, the method of characteristics

The linearized Vlasov equation is an integral-partial differential equation system

- Highly nontrivial to solve
- Method of characteristics can be employed to simplify analysis due to the structure of the equation

Note that the equilibrium Vlasov equation is:

$$\left\{ \frac{\partial}{\partial s} + \mathbf{x}'_{\perp} \cdot \frac{\partial}{\partial \mathbf{x}_{\perp}} - \left( k_{\beta 0}^2 \mathbf{x}_{\perp} + \frac{q}{m\gamma_b^3 \beta_b^2 c^2} \frac{\partial \phi_0}{\partial \mathbf{x}_{\perp}} \right) \cdot \frac{\partial}{\partial \mathbf{x}'_{\perp}} \right\} f_0 = 0$$

Interpret:  $\left. \frac{d}{ds} \right|_{\text{eq. orbit}} f_0 = 0$

$$\left\{ \frac{\partial}{\partial s} + \mathbf{x}'_{\perp} \cdot \frac{\partial}{\partial \mathbf{x}_{\perp}} - \left( k_{\beta 0}^2 \mathbf{x}_{\perp} + \frac{q}{m\gamma_b^3 \beta_b^2 c^2} \frac{\partial \phi_0}{\partial \mathbf{x}_{\perp}} \right) \cdot \frac{\partial}{\partial \mathbf{x}'_{\perp}} \right\} = \left. \frac{d}{ds} \right|_{\text{eq. orbit}}$$

as a total derivative evaluated along an equilibrium particle orbit. This suggests employing the method of characteristics.

## Method of Characteristics:

Equilibrium orbit:

$$\begin{aligned} \frac{d}{d\tilde{s}} \mathbf{x}_\perp(\tilde{s}) &= \mathbf{x}'_\perp(\tilde{s}) \\ \frac{d}{d\tilde{s}} \mathbf{x}'_\perp(\tilde{s}) &= -k_{\beta 0}^2 \mathbf{x}_\perp(\tilde{s}) - \frac{q}{m\gamma_b^3 \beta_b^2 c^2} \frac{\partial \phi_0(\mathbf{x}_\perp(\tilde{s}))}{\partial \mathbf{x}_\perp(\tilde{s})} \end{aligned}$$

“Initial” conditions of characteristic orbit:

$$\begin{aligned} \mathbf{x}_\perp(\tilde{s} = s) &= \mathbf{x}_\perp \\ \mathbf{x}'_\perp(\tilde{s} = s) &= \mathbf{x}'_\perp \end{aligned}$$

Then the linearized Vlasov equation can be expressed as:

$$\frac{d}{d\tilde{s}} \delta f_\perp(\mathbf{x}_\perp(\tilde{s}), \mathbf{x}'_\perp(\tilde{s}), \tilde{s}) = \frac{q}{m\gamma_b^3 \beta_b^2 c^2} \frac{\partial \delta \phi(\mathbf{x}_\perp(\tilde{s}))}{\partial \mathbf{x}_\perp(\tilde{s})} \cdot \frac{\partial}{\partial \mathbf{x}'_\perp} f_0(H_0(\mathbf{x}_\perp(\tilde{s}), \mathbf{x}'_\perp(\tilde{s})))$$

This is a total derivative and can be integrated:

- ◆ To analyze instabilities assume growing perturbations that grow in  $s$
- ◆ Neglect initial conditions at  $\tilde{s} \rightarrow -\infty$  and integrate

$$\delta f_\perp(\mathbf{x}_\perp, \mathbf{x}'_\perp, s) = \frac{q}{m\gamma_b^3 \beta_b^2 c^2} \int_{-\infty}^s d\tilde{s} \frac{\partial \delta \phi(\mathbf{x}_\perp(\tilde{s}))}{\partial \mathbf{x}_\perp(\tilde{s})} \cdot \frac{\partial}{\partial \mathbf{x}'_\perp} f_0(H_0(\mathbf{x}_\perp(\tilde{s}), \mathbf{x}'_\perp(\tilde{s})))$$

$$\nabla_\perp^2 \delta \phi(\mathbf{x}_\perp, s) = -\frac{q}{\epsilon_0} \int d^2 x'_\perp \delta f_\perp(\mathbf{x}_\perp, \mathbf{x}'_\perp, s)$$

$$\delta \phi(\mathbf{x}_\perp) = r_p, s) = \text{const}$$

Gives the self-consistent evolution of the perturbations

- ◆ Similar statement for nonlinear perturbations (Homework problem)

Effectively restates the Poisson equation as a differential-integral equation that is solved to understand the evolution of perturbations

- ◆ Simpler to work with but still very complicated

## S4: Collective Modes on a KV Equilibrium Beam

Unfortunately, calculation of normal modes is generally complicated even in continuous focusing. Nevertheless, the normal modes of the KV distribution can be analytically calculated and give insight on the expected collective response of a beam with intense space-charge.

Review: Continuous Focusing KV Equilibrium

$$f_\perp(H_\perp) = \frac{\hat{n}}{2\pi} \delta\left(H_\perp - \frac{\epsilon^2}{2r_b^2}\right)$$

$$r_b = \left( \frac{Q + \sqrt{4k_{\beta 0}^2 \epsilon^2 + Q^2}}{2k_{\beta 0}^2} \right)^{1/2} = \text{const}$$

Undepressed

$k_{\beta 0}$  = betatron wavenumber

$r_b$  = Beam edge radius

$\hat{n}$  = Beam number density

$Q$  = Dimensionless perveance

$\epsilon$  = rms edge emittance

## Further comments on the KV equilibrium: Distribution Structure

Equilibrium distribution:

$$f_\perp \sim \delta[\text{Courant-Snyder invariants}]$$

Forms a highly singular hyper-shell in 4D phase-space

Schematic:

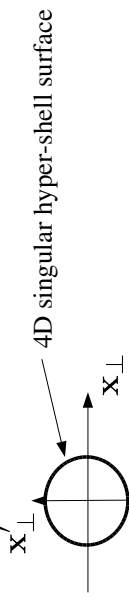

- ◆ Singular distribution has large “Free-Energy” to drive many instabilities

- Low order envelope modes are physical and highly important

(see: S.M. Lund, lectures on **Centroid and Envelope Descriptions of Beams**)

- ◆ Perturbative analysis shows strong collective instabilities

- Hofmann, Laslett, Smith, and Haber, Part. Accel. **13**, 145 (1983)

- Higher order instabilities (collective modes) have unphysical aspects due to (delta-function) structure of distribution and must be applied with care (see following lecture material)

- Instabilities can cause problems if the KV distribution is employed as an initial beam state in self-consistent simulations

A full kinetic stability analysis of the KV equilibrium distribution is complicated and uncovers many strong instabilities

[I. Hofmann, J.L. Laslett, L. Smith, and I. Haber, Particle Accel. 13, 145 (1983); R. Gluckstern, Proc. 1970 Proton Linac Conf., Batavia 811 (1971)]

Expand Vlasov's equation to linear order with:

$$f_{\perp} \rightarrow f_{\perp}(\text{C.S. Invariant}) + \delta f_{\perp}$$

$f_{\perp}$  (C.S. Invariant) = equilibrium

$\delta f_{\perp}$  = perturbation

Solve the Poisson equation:

$$\nabla_{\perp}^2 \delta\phi = -\frac{q}{\epsilon_0} \int d^2x' \delta f_{\perp}$$

using truncated polynomials for  $\delta\phi$  internal to the beam to represent a

“normal mode” with pure harmonic variation, i.e.,  $\delta\phi \sim \text{func}(x, y)e^{-iks}$

$$\delta\phi = \sum_{m=0}^n A_m^{(0)}(s)x^{n-m}y^m + \sum_{m=0}^{n-2} A_m^{(1)}(s)x^{n-m-2}y^m + \dots$$

$k = \text{const}$   
 $i = \sqrt{-1}$

$n = 2, 3, 4, \dots$  “order” of mode

$m$  can be restricted to even or odd terms

Truncated polynomials can meet all boundary conditions

Eigenvalues of a Floquet form transfer matrix analyzed for stability properties

- Lowest order results reproduce KV envelope instabilities

- Higher order results manifest many strong instabilities

The continuous focusing limit can be analyzed to better understand properties of internal modes on a KV beam (1)

[S. Lund and R. Davidson, Physics of Plasmas 5, 3028 (1998); see Appendix B, C]

Continuous focusing, symmetric beam:

$$\kappa_x(s) = \kappa_y(s) = k_{\beta 0}^2 = \text{const}$$

$$\epsilon_x = \epsilon_y \equiv \epsilon$$

$$r_x = r_y \equiv r_b$$

Mode eigenfunction (2n “order” in the sense of Hoffman et. al.):

$$\delta\phi_n = \begin{cases} \frac{A_n}{2} \left[ P_{n-1} \left( 1 - 2\frac{r^2}{r_b^2} \right) + P_n \left( 1 - 2\frac{r^2}{r_b^2} \right) \right], & 0 \leq r \leq r_b \\ 0, & r_b < r \end{cases}$$

$A_n = \text{const}$

$n = 1, 2, 3, \dots$   $P_n(x) = n^{\text{th}}$  order Legendre polynomial

**Potential** ( $\delta n_n = \epsilon_0 \nabla_{\perp}^2 \delta\phi_n / q$ )

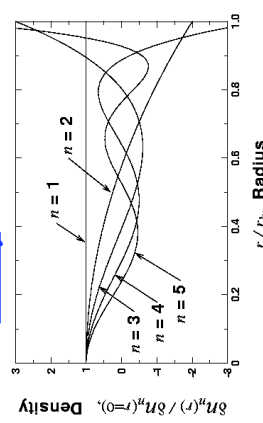
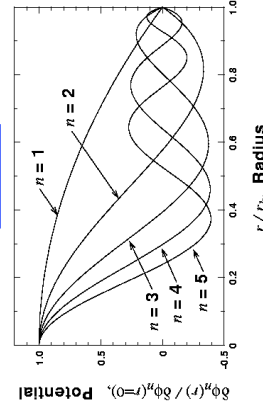

Higher order kinetic instabilities of the KV equilibrium are strong and cover a wide parameter range for periodic focusing lattices

Example: FODO Quadrupole Stability

4<sup>th</sup> order ( $n = 4$ ) even mode

[Hofmann et. al, Particle Accel. 13, 145 (1983)]

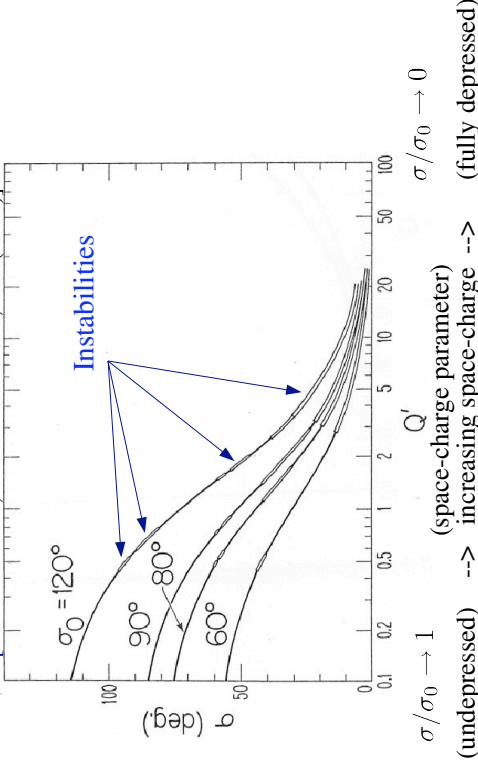

$\sigma/\sigma_0 \rightarrow 1$  (space-charge parameter)  $\sigma/\sigma_0 \rightarrow 0$

(undepressed)  $\rightarrow$  increasing space-charge  $\rightarrow$  (fully depressed)

The continuous focusing limit can be analyzed to better understand properties of internal modes on a KV beam (2)

Mode dispersion relation for  $e^{-iks}$  variations:

$$2n + \frac{1 - \sigma/\sigma_0}{(\sigma/\sigma_0)^2} \left[ B_{n-1} \left( \frac{k/k_{\beta 0}}{\sigma/\sigma_0} \right) - B_n \left( \frac{k/k_{\beta 0}}{\sigma/\sigma_0} \right) \right] = 0$$

where:  $B_j(\alpha) \equiv \begin{cases} 1, & j = 0 \\ \frac{(\alpha/2)^2 - 0^2}{(\alpha/2)^2 - 1^2} \frac{(\alpha/2)^2 - 2^2}{(\alpha/2)^2 - 3^2} \dots \frac{(\alpha/2)^2 - (j-1)^2}{(\alpha/2)^2 - j^2}, & j = 1, 3, 5, \dots \\ \frac{(\alpha/2)^2 - 2^2}{(\alpha/2)^2 - 2^2} \frac{(\alpha/2)^2 - 4^2}{(\alpha/2)^2 - 4^2} \dots \frac{(\alpha/2)^2 - (j-1)^2}{(\alpha/2)^2 - j^2}, & j = 2, 4, 6, \dots \end{cases}$

Eigenfunction structure suggestive of wave perturbations often observed internal to the beam in simulations for a variety of beam distributions

n distinct branches for 2n order (real coefficient) polynomial dispersion relation

Some range of  $\sigma/\sigma_0$  will be unstable for all  $n > 1$

- Instability exists for some n for  $\sigma/\sigma_0 < 0.3985$

- Growth rates are strong



### Continuous focusing limit dispersion relation results for KV beam stability

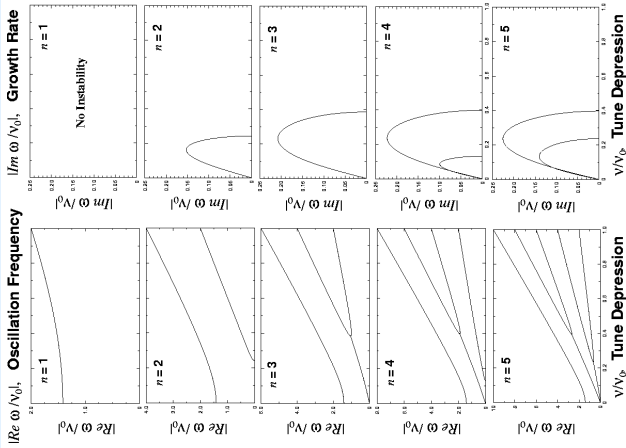

Notation Change:

$$k/k_{\beta 0} \equiv \omega/\nu_0$$

$$\sigma/\sigma_0 \equiv \nu/\nu_0$$

[S. Lund and R. Davidson, Physics of Plasmas **5**, 3028 (1998): see Appendix B, C]

For continuous focusing, fluid theory shows that some branches of the KV dispersion relation *are* physical

[S. Lund and R. Davidson, Physics of Plasmas **5**, 3028 (1998)]

Fluid theory:

- ◆ KV equilibrium distribution is reasonable in fluid theory
  - No singularities
  - Flat density and parabolic radial temperature profiles
- ◆ Theory truncated by assuming zero heat flow

Mode eigenfunctions:

**Exactly the same as derived under kinetic theory!**

Mode dispersion relation:

$$\frac{k}{k_{\beta 0}} = \sqrt{2 + 2 \left( \frac{\sigma}{\sigma_0} \right)^2 (2n^2 - 1)}$$

$n = 1, 2, 3, \dots$

◆ Single, stable branch

- Agrees well with high frequency branch from kinetic theory
- Results show that aspects of higher-order KV internal modes are physical!**

### Continuous focusing limit dispersion relation results for KV beam stability

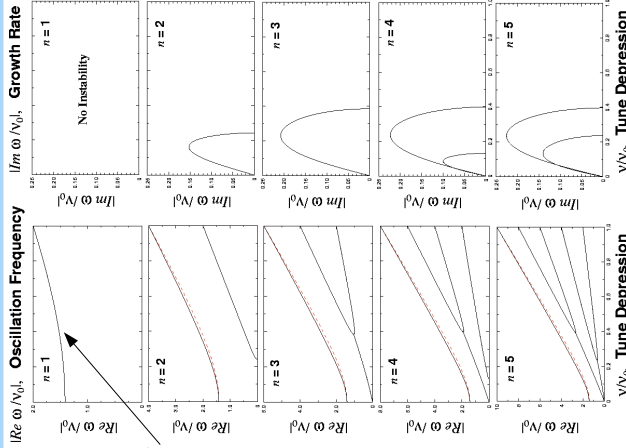

Notation Change:

$$k/k_{\beta 0} \equiv \omega/\nu_0$$

$$\sigma/\sigma_0 \equiv \nu/\nu_0$$

**Red: Fluid Theory**  
(no instability)

**Black: Kinetic Theory**  
(unstable branches)

[S. Lund and R. Davidson, Physics of Plasmas **5**, 3028 (1998)]

### S5: Global Conservation Constraints

Apply for any initial distribution, equilibrium or not.

- ◆ Strongly constrain nonlinear evolution of the system.
- ◆ Valid even with a beam pipe provided that particles are not lost from the system and that symmetries are respected.
- ◆ Useful to bound perturbations, but yields no information on evolution timescales.

1) Generalized Entropy

$$U_G = \int d^2x_{\perp} \int d^2x'_{\perp} G(f_{\perp}) = \text{const}$$

$$G(f_{\perp}) = \text{Any differentiable functions satisfying } G(f_{\perp} \rightarrow 0) = 0$$

◆ Applies to all Vlasov evolutions.

// Examples

Line-charge:  $G(f_{\perp}) = qf_{\perp} \rightarrow \lambda = q \int d^2x \int d^2x' f_{\perp} = \text{const}$

Entropy:  $G(f_{\perp}) = -\frac{f_{\perp}}{A} \ln \left( \frac{f_{\perp}}{f_0} \right) \rightarrow S = - \int \frac{d^2x}{A} \int d^2x' f_{\perp} \ln \left( \frac{f_{\perp}}{f_0} \right) = \text{const}$

$A, f_0$  constants



**Comments on applications of the global conservation constraints:**

Global invariants strongly constrain the nonlinear evolution of the system

- Only evolutions consistent with Vlasov's equation are physical
- Constraints consistent with the model can bound kinematically accessible evolutions

Application of the invariants does not require (difficult to derive) normal mode descriptions

- But cannot, by itself, provide information on evolution timescales

Use of global constraints to bound perturbations has appeal since distributions in real machines may be far from an equilibrium. Used to:

- Derive sufficient conditions for stability
- Bound particle losses [O'Neil, Phys. Fluids **23**, 2216 (1980) ]
- Bound changes of system moments (for example the rms emittance) under assumed relaxation processes

The perturbed potential satisfies:

$$\delta\phi \equiv \phi - \phi_0 \quad \nabla_{\perp}^2 \delta\phi = -\frac{q}{\epsilon_0} \int d^2x_{\perp} \delta f_{\perp}$$

Take  $|\delta f_{\perp}| \ll f_0$  and Taylor expand to 2<sup>nd</sup> order

$$G(f_0 + \delta f_{\perp}) = G(f_0) + \frac{dG(f_0)}{df_0} \delta f_{\perp} + \frac{d^2G(f_0)}{df_0^2} \frac{(\delta f_{\perp})^2}{2} + \Theta(\delta^3)$$

Without loss of generality, choose:

$$\frac{dG(f_0)}{df_0} = -H_0 = -\left( \frac{1}{2} \mathbf{x}_{\perp}^2 + \frac{1}{2} k_{\beta 0}^2 \mathbf{x}_{\perp}^2 + \frac{q\phi}{m\gamma_b^3 \beta_b^2 c^2} \right)$$

◆ This choice can *always* be realized

Then 
$$\frac{d^2G(f_0)}{df_0^2} = -\frac{\partial H_0}{\partial f_0} = \frac{-1}{\partial f_0(H_0)/\partial H_0}$$

Some steps (few lines using partial integration) yields:

$$F = \int d^2x_{\perp} \left\{ \frac{\epsilon_0 |\nabla_{\perp} \delta\phi|^2}{2m\gamma_b^3 \beta_b^2 c^2} - \int d^2x'_{\perp} \frac{(\delta f_{\perp})^2}{\partial f_0(H_0)/\partial H_0} \right\} + \Theta(\delta^3) = \text{const}$$

◆ If  $\partial f_0(H_0)/\partial H_0 < 0$  then  $F$  is a sum of two positive definite terms and perturbations are bounded by  $F = \text{const}$ .

**S6: Kinetic Stability Theorem** for continuous focusing equilibria

[Fowler, J. Math Phys. **4**, 559 (1963); Gardner, Phys. Fluids **6**, 839 (1963);

R. Davidson, Physics of Nonneutral Plasmas, Addison-Wesley (1990)]

Resolve:

$$\begin{aligned} f_{\perp} &= f_0(H_0) + \delta f_{\perp} \\ f_0(H_0) &= \text{Equilibrium (subscript 0) distribution} \\ \delta f_{\perp} &= \text{Perturbation about equilibrium} \end{aligned}$$

Employ generalized entropy and transverse energy global constraints (S5):

$$U_G = \int d^2x_{\perp} \int d^2x'_{\perp} G(f_{\perp}) = \text{const}$$

$$U_{\mathcal{E}} = \int d^2x'_{\perp} \int d^2x_{\perp} \left\{ \frac{1}{2} \mathbf{x}_{\perp}^2 + \frac{1}{2} k_{\beta 0}^2 \mathbf{x}_{\perp}^2 \right\} f_{\perp} + \int d^2x_{\perp} \frac{\epsilon_0 |\nabla_{\perp} \phi|^2}{2m\gamma_b^3 \beta_b^2 c^2} = \text{const}$$

Apply to equilibrium and full distribution to form an effective “free-energy”:

$$\Delta U_G = U_G - U_{G0} = \text{const} \quad \Delta U_{\mathcal{E}} = U_{\mathcal{E}} - U_{\mathcal{E}0} = \text{const}$$

$$F = \Delta U_{\mathcal{E}} - \Delta U_G$$

$$\begin{aligned} &= \int d^2x'_{\perp} \int d^2x_{\perp} \left\{ \frac{1}{2} \mathbf{x}_{\perp}^2 + \frac{1}{2} k_{\beta 0}^2 \mathbf{x}_{\perp}^2 \right\} \delta f_{\perp} + \int d^2x_{\perp} \frac{\epsilon_0 |\nabla_{\perp} \phi|^2}{2m\gamma_b^3 \beta_b^2 c^2} \\ &\quad + \int d^2x_{\perp} \int d^2x'_{\perp} [G(f_{\perp}) - G(f_0)] = \text{const} \end{aligned}$$

$$F = \int d^2x_{\perp} \left\{ \frac{|\nabla_{\perp} \delta\phi|^2}{2m\gamma_b^3 \beta_b^2 c^2} - \int d^2x'_{\perp} \frac{(\delta f_{\perp})^2}{\partial f_0(H_0)/\partial H_0} \right\} = \text{const}$$

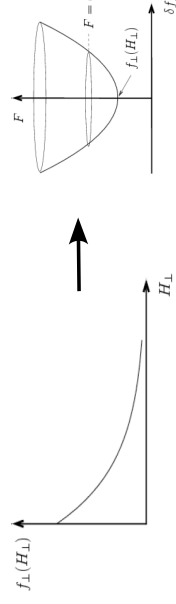

Drop zero subscripts in stability statement:

**Kinetic Stability Theorem**

If  $f_{\perp}(H_{\perp})$  is a monotonic decreasing function of  $H_{\perp}$  with  $\partial f_{\perp}(H_{\perp})/\partial H_{\perp} < 0$  then the equilibrium defined by  $f_{\perp}(H_{\perp})$  is stable to arbitrary small-amplitude perturbations.

- ◆ Is a sufficient condition for stability
- Equilibria that violate the theorem may or may not be stable
- ◆ Mean value theorem can be used to generalize conclusions for arbitrary amplitude
- R. Davidson proof

### // Example Applications of Kinetic Stability Theorem

#### KV Equilibrium:

$$f_{\perp}(H_{\perp}) = \frac{\hat{n}}{2\pi} \delta(H_{\perp} - H_{\perp b})$$

changes sign

$$\partial f_{\perp} / \partial H_{\perp} \text{ inconclusive stability by theorem}$$

- Full normal mode analysis in Kinetic theory shows strong instabilities when space-charge becomes strong
- Not surprising, delta function represents a highly inverted population in phase-space with “free-energy” to drive instabilities

#### Waterbag Equilibrium:

$$f_{\perp}(H_{\perp}) = f_0 \Theta(H_{\perp b} - H_{\perp})$$

$$\partial f_{\perp} / \partial H_{\perp} = f_0 \delta(H_{\perp} - H_{\perp b}) \leq 0$$

monotonic decreasing, stable by theorem

#### Thermal Equilibrium:

$$f_{\perp}(H_{\perp}) = f_0 \exp(-\beta H_{\perp}),$$

$$\partial f_{\perp} / \partial H_{\perp} = -f_0 \beta \exp(-\beta H_{\perp}) \leq 0$$

monotonic decreasing, stable by theorem

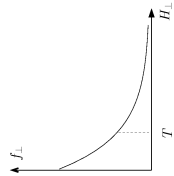
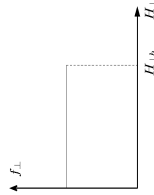
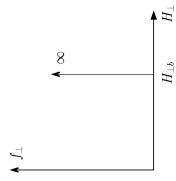

- Add material to discuss combined application of the density inversion theorem and the kinetic stability theorem
- Monotonic decreasing radial density profile  $n(r)$  gives monotonic decreasing distribution  $f(H)$
- Stability of radial density profiles follows for continuous focusing
- Extent this can be generalized to periodic focusing?

### S7: rms Emittance Growth and Nonlinear Forces

Fundamental theme of beam physics is to minimize statistical beam emittance growth in transport to preserve focusability on target

Return to the full transverse beam model with:

$$x'' + \kappa_x x = -\frac{q}{m\gamma_b^3 \beta_b^2 c^2} \frac{\partial \phi}{\partial x} + \text{Applied Nonlinear Field Terms}$$

and express as:

$$x''(s) + \kappa_x(s)x(s) = f_x^L(s)x(s) + F_x^{NL}(x, y, s)$$

$$f_x^L(s) = \text{Linear Space-Charge Coefficient}$$

$$F_x^{NL}(x, y, s) = \text{Nonlinear Forces + Linear Skew Coupled Forces (Applied and Space-Charge)}$$

#### // Examples:

$$f_x^L(s) = \frac{Q}{r_b(s)} \quad \text{Self-field forces within an axisymmetric (mismatched) KV beam core in a continuous focusing model}$$

$$F_x^{NL}(x, y, s) = \text{Im} \left[ \frac{b_3}{r_p} \left( \frac{x + iy}{r_p} \right)^2 \right] \quad \text{Electric (with normal and skew components) sextupole optic based on multipole expansions (see: lectures on Particle Equations of Motion)}$$

From the definition of the statistical (rms) emittance:

$$\varepsilon_x \equiv 4 [\langle x^2 \rangle_{\perp} \langle x'^2 \rangle_{\perp} - \langle xx' \rangle_{\perp}^2]^{1/2}$$

Differentiate the squared emittance and apply the chain rule:

$$\begin{aligned} \frac{d}{ds} \varepsilon_x^2 &\equiv 32 [\langle xx' \rangle_{\perp} \langle x'^2 \rangle_{\perp} + \langle x^2 \rangle_{\perp} \langle x' x'' \rangle_{\perp} - \langle xx' \rangle_{\perp} \langle x'^2 \rangle_{\perp} - \langle xx' \rangle_{\perp} \langle x x'' \rangle_{\perp}] \\ &= 32 [\langle x^2 \rangle_{\perp} \langle x' x'' \rangle_{\perp} - \langle xx' \rangle_{\perp} \langle x x'' \rangle_{\perp}] \end{aligned}$$

Insert the equations of motion:

$$x'' + \kappa_x x = f_x^L x + F_x^{NL}$$

The linear terms cancel to show for any beam distribution that:

$$\frac{d}{ds} \varepsilon_x^2 = 32 [\langle x^2 \rangle_{\perp} \langle x' F_x^{NL} \rangle_{\perp} - \langle xx' \rangle_{\perp} \langle x F_x^{NL} \rangle_{\perp}]$$

Implications of:

$$\frac{d}{ds} \varepsilon_x^2 = 32 \left[ \langle x^2 \rangle_{\perp} \langle x' F_x^{NL} \rangle_{\perp} - \langle x x' \rangle_{\perp} \langle x F_x^{NL} \rangle_{\perp} \right]$$

- Emittance evolution/growth is driven by nonlinear or skew coupling forces
- Nonlinear terms can result from applied or space-charge fields
- More detailed analysis shows that skew coupled forces cause x-y plane transfer oscillations but there is still a 4D quadratic invariant
- Minimize nonlinear forces to preserve emittance and maintain focusability
- This result (essentially) has already been demonstrated in the problem sets for the **Introductory Lectures**

If the beam is accelerating, the equations of motion become:

$$x'' + \frac{(\gamma_b \beta_b)'}{\gamma_b \beta_b} x' + \kappa_x x = f_x^L + F_x^{NL}$$

and this result can be generalized (see homework problems) using the normalized emittance:

$$\varepsilon_{nx} \equiv \gamma_b \beta_b \varepsilon_x$$

$$\frac{d}{ds} \varepsilon_{nx}^2 = 32 (\gamma_b \beta_b)^2 \left[ \langle x^2 \rangle_{\perp} \langle x' F_x^{NL} \rangle_{\perp} - \langle x x' \rangle_{\perp} \langle x F_x^{NL} \rangle_{\perp} \right]$$

**S8: rms Emittance Growth and Nonlinear Space-Charge Forces**

[Wangler et. al, IEEE Trans. Nuc. Sci. 32, 2196 (1985), Reiser, *Charged Particle Beams*, (1994)]

In continuous focusing all nonlinear force terms are from space-charge, giving:

$$\frac{d}{ds} \varepsilon_x^2 = - \frac{32q}{m \gamma_b^3 \beta_b^2 c^2} \left[ \langle x^2 \rangle_{\perp} \langle x' \frac{\partial \phi}{\partial x} \rangle_{\perp} - \langle x x' \rangle_{\perp} \langle x \frac{\partial \phi}{\partial x} \rangle_{\perp} \right]$$

For any axisymmetric beam it can be shown that:

$$\langle x \frac{\partial \phi}{\partial x} \rangle_{\perp} = \frac{1}{2} \lambda \frac{\partial \phi}{\partial r} \Big|_{\perp} = - \frac{\lambda}{8\pi \epsilon_0}$$

$$\langle x' \frac{\partial \phi}{\partial x} \rangle_{\perp} = \frac{1}{2} \langle r' \frac{\partial \phi}{\partial x} \rangle_{\perp} = \frac{1}{8\pi \epsilon_0 \lambda} \frac{dW}{ds}$$

$$W = \frac{\epsilon_0}{2} \int d^2x_{\perp} |\nabla_{\perp} \phi|^2 = \text{self-field energy (per unit axial length)}$$

For any axisymmetric beam it can also be shown that:

$$\langle x x' \rangle_{\perp} = \frac{1}{2} \langle r r' \rangle_{\perp} = - \frac{\langle x^2 \rangle_{\perp} dW_u}{\lambda^2 ds}$$

$$W_u = W \text{ for an rms equivalent uniform density beam}$$

These results give (Wangler, Lapostolle):

$$\frac{d}{ds} \varepsilon_x^2 = -4Q \langle x^2 \rangle_{\perp} \frac{d}{ds} \left( \frac{W - W_u}{\lambda^2} \right)$$

- Applies to both radially bounded and radially infinite systems
- Result does not require an equilibrium for validity – only axisymmetry
- For a beam with s-variation, this result suggests that *only* the (mismatched) KV equilibrium can subsequently evolve with no change in rms emittance
- Result can be partially generalizable [J. Struckmeier and I. Hofmann, Part. Accel. **39**, 219 (1992)] to an unbunched elliptical beam
- Result may have implications to existence/nonexistence of nonuniform density Vlasov equilibria in periodic focusing channels

If the rms beam radius does not change much in the beam evolution:

$$r_b^2 = 2 \langle x^2 \rangle_{\perp} \simeq \text{const}$$

Then the equation can be trivially integrated to show that:

$$\Delta_{f_i}(\varepsilon_x^2) = -4Q r_b^2 \Delta_{f_i} \left( \frac{W - W_u}{\lambda^2} \right)$$

$$\Delta_{f_i}(\dots) \equiv \text{Final State Value} - \text{Initial State Value}$$

Consider the rms envelope equation to better understand what is required for  $r_b^2 = \text{const}$

$$r_b'' + k_{\beta 0}^2 r_b - \frac{Q}{r_b} - \frac{\varepsilon_x^2}{r_b^3} = 0$$

- Valid in an rms equivalent sense with  $\varepsilon \neq \text{const}$  for a non-KV beam

If the emittance term is small relative to the perveance term and the initial beam starts out as matched we can approximate the equation as

$$k_{\beta 0}^2 r_b - \frac{Q}{r_b} - \frac{\varepsilon_x^2}{r_b^3} = 0$$

and it is reasonable to expect the beam radius to remain nearly constant under modest changes in emittance. This ordering must be checked after estimating the emittance change based the final to initial state energy differences. See **S9** and **S10** analysis for a better understanding on how this can be valid.



### S9: Uniform Density Beams and Extreme Energy States

Construct minima of the self-field energy per unit axial length:

$$W = \frac{\epsilon_0}{2} \int d^2x_{\perp} |\nabla_{\perp} \phi|^2$$

subject to:  $\lambda = \text{const}$  ... fixed line-charge

$r_b = \sqrt{2\langle r^2 \rangle_{\perp}} = \text{const}$  ... fixed rms equivalent beam radius  
Using the method of Lagrange multipliers, vary (Helmholtz free energy):

$$F = W - \mu(\lambda/q)\langle r^2 \rangle_{\perp} = \int d^2x_{\perp} \left\{ \epsilon_0 \frac{|\nabla_{\perp} \phi|^2}{2} - \mu r^2 n \right\} \quad \mu = \text{const}$$

and require that variations satisfy the Poisson equation and conserve charge

$$\nabla_{\perp}^2 \delta\phi = -\frac{q}{\epsilon_0} \delta n \quad \delta\phi|_{\text{boundary}} = 0 \quad \int d^2x_{\perp} \delta n = 0$$

Then variations terminate at 2<sup>nd</sup> order giving:

$$\delta F = - \int d^2x_{\perp} \{ \mu r^2 + \text{const} \} \delta n + \epsilon_0 \int d^2x_{\perp} \nabla_{\perp} \phi \cdot \nabla_{\perp} \delta\phi + \frac{\epsilon_0}{2} \int d^2x_{\perp} |\nabla_{\perp} \delta\phi|^2$$

Integrating the 2<sup>nd</sup> term by parts and employing the Poisson equation then gives:

The result:

At fixed line charge and rms radius, a uniform density beam minimizes the electrostatic self-field energy

combined with Wangler's Theorem:

$$\frac{d}{ds} \epsilon_x^2 = -Q \langle x^2 \rangle_{\perp} \frac{d}{ds} \left( \frac{W - W_u}{\lambda^2} \right)$$

shows that:

- Self-field energy changes from beam nonuniformity drives emittance evolution
- Expect the following trends in an evolving beam density profile
  - Nonuniform density => more uniform density <=> local emittance growth
  - Uniform density => more nonuniform density <=> local emittance reduction
- Should attempt to maintain beam density uniformity to preserve beam emittance and focusability

Results can be partially generalized to 2D elliptical beams

[J. Struckmeier and I. Hofmann, Part Accel. **39**, 219 (1992)]

$$\delta F = \int d^2x_{\perp} \{ q\phi - \mu r^2 - \text{const} \} \delta n + \frac{\epsilon_0}{2} \int d^2x_{\perp} |\nabla_{\perp} \delta\phi|^2$$

For an extremum, the first order term must vanish, giving within the beam:

$$q\phi = \mu r^2 + \text{const}$$

From Poisson's equation:

$$\frac{1}{r} \left( r \frac{\partial \phi}{\partial r} \right) \phi = \text{const}$$

This is the density of a uniform, axisymmetric beam, which implies that a uniform density axisymmetric beam results in an extremum. This extremum is also a global maximum since all variations about it (2nd term of boxed equation above) are positive definite.

Result:

At fixed line charge and rms radius, a uniform density beam minimizes the electrostatic self-field energy

### S10: Collective Relaxation and rms Emittance Growth

The space-charge profile of intense beams can be born highly nonuniform out of nonideal (real) injectors or become nonuniform due to a variety of (error) processes. Also, low-order envelope matching of the beam may be incorrect due to focusing and/or distribution errors.

How much emittance growth and changes in other characteristic parameters may be induced by relaxation of characteristic perturbations?

- Employ Global Conservation Constraints of system to bound possible changes
- Assume full relaxation to a final, uniform density state for simplicity

What is the mechanism for the assumed relaxation?

- Collective modes launched by errors will have a broad spectrum
  - Phase mixing can smooth nonuniformities – mode frequencies incommensurate
- Nonlinear interactions, Landau damping, interaction with external errors, ...
- Certain errors more/less likely to relax:
  - Internal wave perturbations expected to relax due to many interactions
  - Envelope mismatch will not (coherent mode) unless amplitudes are very large producing copious halo and nonlinear interactions

### Example: Relaxation of nonlinear space-charge waves

#### Nonuniform Initial Beam

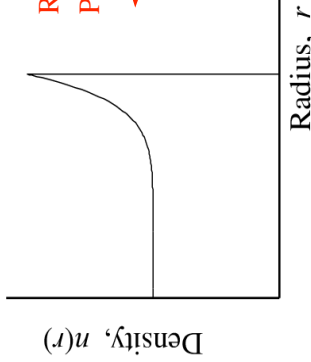

#### Uniform Final Beam

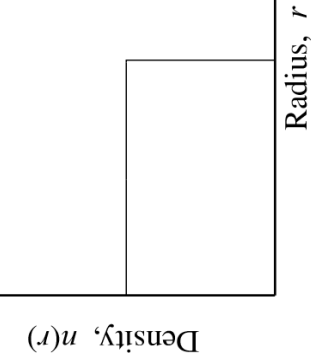

Relaxation Processes



Reference: High resolution self-consistent PIC simulations shown in class

- Continuous focusing and a more realistic FODO transport lattice
- Relaxation more complete in real lattice due to a richer frequency spectrum
- Relaxations surprisingly rapid: few undepressed betatron wavelengths observed in simulations

### Initial Nonuniform Beam Parameterization

$h$  = hollowing parameter  
 $= n(r=0)/n(r=r_e)$   
 $n(r) = \begin{cases} \hat{n} \left[ 1 + \frac{1-h}{h} \left( \frac{r}{r_e} \right)^p \right], & 0 \leq r \leq r_e \\ 0, & r_e < r \leq r_p \end{cases}$   
 $p$  = radial index  
 $r_e$  = edge radius

$$\lambda = \int d^2x_{\perp} n = \pi q \hat{n} r_e^2 \left[ \frac{(ph+2)}{(p+2)h} \right]$$

$$r_b = 2(x^2)_{\perp}^{1/2} = \sqrt{\frac{(p+2)(ph+4)}{(p+4)(ph+2)}} r_e$$

Normalize profiles to compare common rms radius ( $r_b$ ) and total charge ( $\lambda$ )

#### Hollowed Initial Density

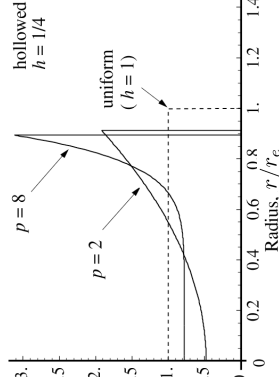

#### Peaked Initial Density

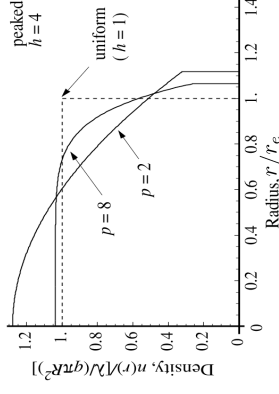

Analogous definitions are made for the radial temperature profile of the beam

### Example Simulation, Initial Nonuniform Beam

$\sigma/\sigma_0 = 0.2$  Initial density:  $h=1/4, p=8$  Initial Temp:  $h = \text{infinity}, p=2$

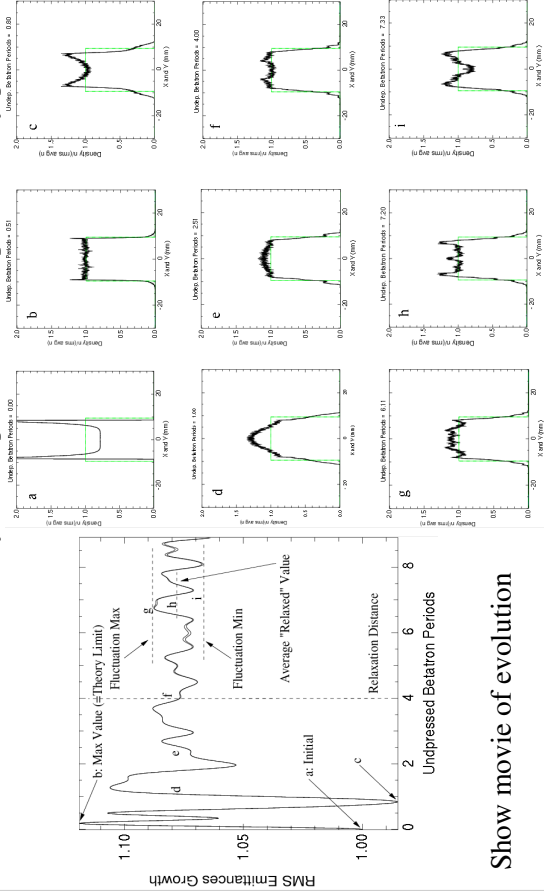

Show movie of evolution

### Simulation results for a broad range of strong space-charge

Initial beam		Relaxed and transient beam					
$\sigma_i/\sigma_0$	Density	Temperature	Emittance growth				
$h$	$p$	$h$	$p$				
0.1	0.25	4	1	arb.	1.57	1.42 (1.57, 1.31-1.52)	3.5
		$\infty$	2	2	1.43	1.45 (1.57, 1.38-1.52)	3.0
	0.25	8	1	arb.		1.41 (1.57, 1.30-1.52)	3.0
		$\infty$	2	2		1.33 (1.43, 1.28-1.38)	3.5
		0.25	4	1	arb.	1.35 (1.43, 1.30-1.40)	4.5
		$\infty$	2	2		1.52 (1.43, 1.26-1.38)	4.0
0.20	0.25	4	1	arb.	1.17	1.11 (1.16, 1.09-1.13)	4.5
		$\infty$	2	2		1.12 (1.16, 1.10-1.13)	3.0
	0.25	8	1	arb.	1.12	1.11 (1.16, 1.09-1.13)	4.0
		$\infty$	2	2		1.08 (1.12, 1.06-1.09)	5.5
		0.25	4	1	arb.	1.08 (1.12, 1.07-1.09)	4.0
		$\infty$	2	2		1.08 (1.12, 1.06-1.09)	4.5

Theory results based on conservation of system charge and energy used to calculate the change in rms edge radius between initial ( $i$ ) and final ( $f$ ) matched beam states

$$\frac{(r_{bf}/r_{bi})^2 - 1}{1 - (\sigma_i/\sigma_0)^2} + \frac{p(1-h)[4+p+(3+p)h]}{(p+2)(p+4)(2+ph)^2} - \ln \left[ \sqrt{\frac{(p+2)(ph+4)}{(p+4)(ph+2)}} \frac{r_{bf}}{r_{bi}} \right] = 0$$

Ratios of final to initial emittance are then obtainable from the matched envelope eqns:

$$\frac{\mathcal{E}_{xf}}{\mathcal{E}_{xi}} = \frac{r_{bf}}{r_{bi}} \sqrt{\frac{(r_{bf}/r_{bi})^2 - [1 - (\sigma_i/\sigma_0)^2]}{(\sigma_i/\sigma_0)^2}}$$

Theory estimates from global conservation constraints work well. What changes if the beam relaxes to a smooth thermal equilibrium instead? -- Very little change

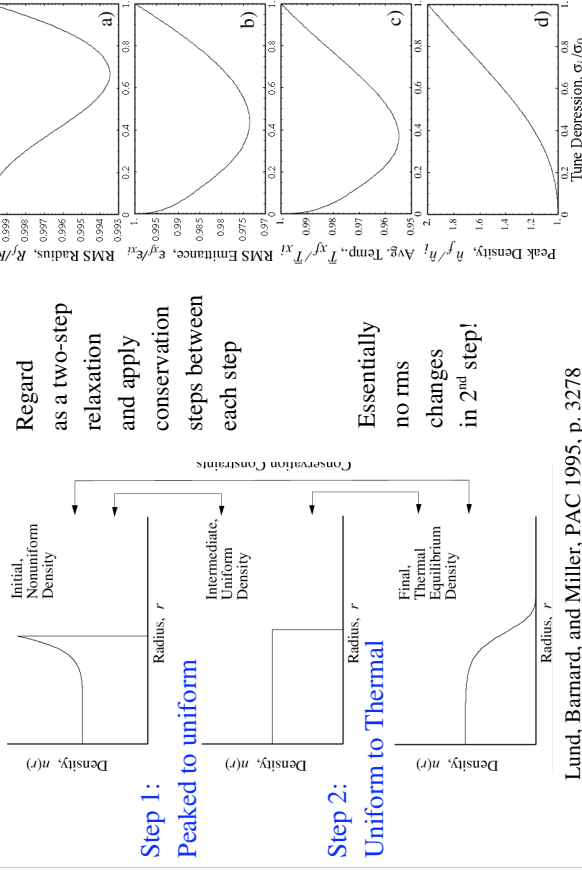

Lund, Barnard, and Miller, PAC 1995, p. 3278

SM Lund, USPAS, June 2008

Transverse Kinetic Stability 57

Self consistent Vlasov stability simulations were carried out to better quantify characteristics of instability

- 2D  $x$ - $y$  slice simulations advanced in  $s$
- Initial distributions: semi-Gaussian, a smooth equilibrium-like, and KV
- Carried out using the WARP PIC code

More Details:

Lund and Chawla, "Space-charge transport limits of ion beams in periodic quadrupole focusing channels," *Nuc. Instr. Meth. A* **561**, 203 (2006)

SM Lund, USPAS, June 2008

Transverse Kinetic Stability 59

### S11: Halo Induced Mechanism of Higher Order Instability

In periodic focusing with alternating gradient quadrupole focusing (most common case), it has been observed in simulations and the laboratory that good transport in terms of **little lost particles or emittance growth** is obtained when the applied focusing strength satisfies:

$$\sigma_0 \lesssim 85^\circ$$

little dependence on  $\sigma/\sigma_0$

It has been a 40+ year unsolved problem by what primary mechanism this limit comes about. It was long thought that collective modes coupled to the lattice were responsible. However:

- Modes carry little free energy (see S10) to drive strong emittance growth
- Particle losses and strong halo observed when stability criterion is violated
- Collective internal modes likely also pumped but hard to explain with KV

Recent progress helps clarify how this limit comes about via a strong halo-like resonance mechanism affecting near edge particles

- Does *not* require an equilibrium core beam

SM Lund, USPAS, June 2008

Transverse Kinetic Stability 58

Parametric PIC simulations of quadrupole transport agree with experimental observations and show that large rms emittance growth can occur rapidly

Parameters:  $\sigma_0 = 110^\circ$ ,  $\sigma/\sigma_0 = 0.2$  ( $L_p = 0.5$  m,  $\eta = 0.5$ )

for initial semi-Gaussian distribution

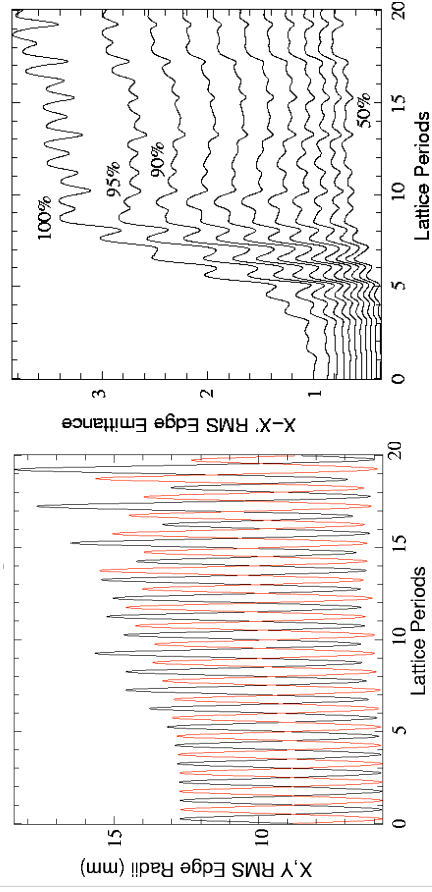

Higher  $\sigma_0 \lesssim 85^\circ$  makes the onset of emittance growth larger and more rapid

SM Lund, USPAS, June 2008

Transverse Kinetic Stability 60



Simulations suggest that transport limits observed are relatively insensitive to the structure of the initial distribution

Parameters:  $\sigma_0 = 110^\circ$ ,  $\sigma/\sigma_0 = 0.2$  ( $L_p = 0.5$  m,  $\eta = 0.5$ )

- Wide class of initial distributions probed – little difference in  $x$ - $y$  plane averages which help average over initial phase choices associated with launching conditions
- Growth becomes larger and faster with increasing  $\sigma_0$

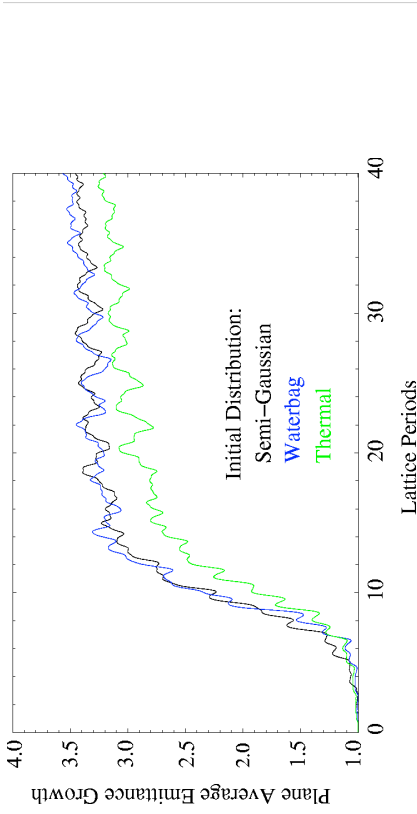

SM Lund, USPAS, June 2008

Transverse Kinetic Stability

61

An essential feature is that particles evolve outside the core of the beam

Take an instantaneous, rms equivalent measure of the core of the beam and “tag” particles that evolve outside the core:

$$r_x = 2 \langle x^2 \rangle^{1/2}$$

$$r_y = 2 \langle y^2 \rangle^{1/2}$$

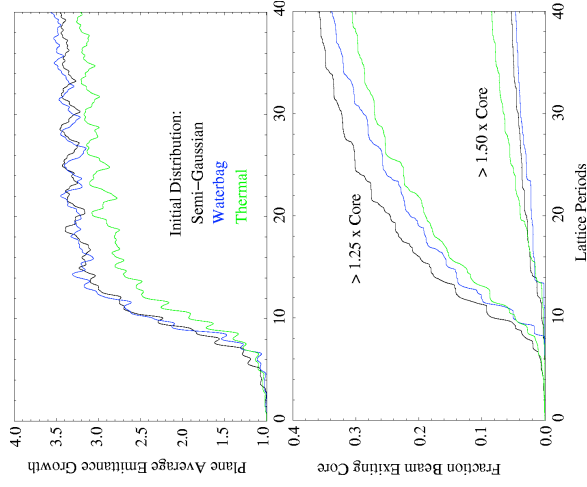
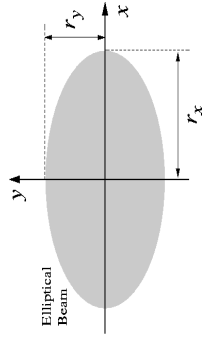

SM Lund, USPAS, June 2008

Transverse Kinetic Stability

62

Poincare plots generated from different initial distributions agree qualitatively in areas of strong instability and show large oscillation amplitude particle are halo like with resonant structure

Lattice period Poincare strobe

$$\sigma_0 = 110^\circ \quad \sigma/\sigma_0 = 0.2$$

Semi-Gaussian

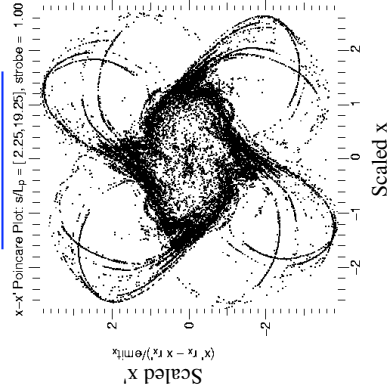

Thermal Equilibrium

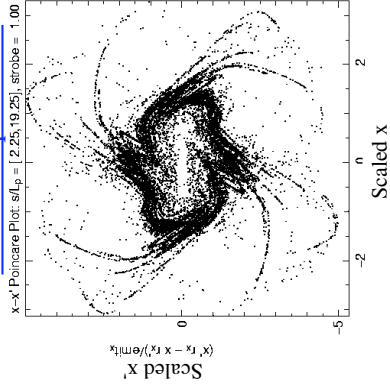

- Particles evolving along  $x$ -axis particles accumulated to generate clearer picture
- Including off axis particles does *not* change basic conclusions

SM Lund, USPAS, June 2008

Transverse Kinetic Stability

63

Extensive simulations were carried out to better understand the parametric nature of the emittance growth

- All simulations carried out 6 underpressed betatron periods
  - Enough to resolve transition boundary: transition growth can be larger if run longer
- Strong growth regions of initial distributions all similar (threshold can vary)
  - Irregular grid contouring with ~200 points (dots) to thoroughly probe possible instabilities

initial semi-Gaussian

- Initial thermal equilibrium almost identical

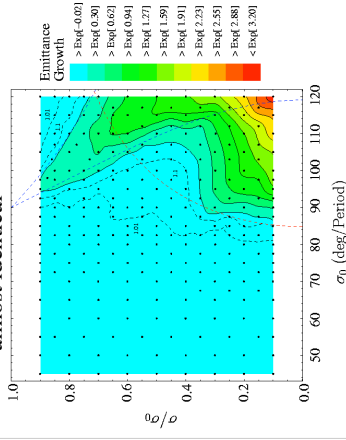

- Initial KV similar but does not excite envelope band

SM Lund, USPAS, June 2008

Transverse Kinetic Stability

64

**Core-Particle Model** --- Transverse particle equations of motion for a test particle moving inside and outside a uniform density elliptical beam envelope

$$x'' + \kappa_x x = \frac{2QF_x}{(r_x + r_y)r_x} x$$

$$y'' + \kappa_y y = \frac{2QF_y}{(r_x + r_y)r_y} y$$

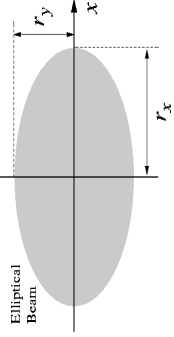

$$Q = \frac{q\lambda}{2\pi\epsilon_0 m \gamma_b^2 \beta_b^2 c^2} \dots \text{dimensionless perveance}$$

Where: inside the beam

$$F_x = 1$$

$$F_y = 1$$

outside the beam:

$$F_x = (r_x + r_y) \frac{r_x}{x} \text{Re}[\tilde{S}]$$

$$F_y = -(r_x + r_y) \frac{r_y}{y} \text{Im}[\tilde{S}]$$

with

$$\tilde{S} \equiv \frac{\tilde{z}}{r_x^2 - r_y^2} \left[ 1 - \sqrt{1 - \frac{(r_x^2 - r_y^2)}{\tilde{z}^2}} \right]$$

$$= \frac{1}{2\tilde{z}} \left[ \frac{1}{1 + \frac{r_x^2 - r_y^2}{\tilde{z}^2}} + \frac{1}{1 + \frac{r_x^2 - r_y^2}{\tilde{z}^4}} + \dots \right]$$

$$\tilde{z} = x + iy$$

$$i = \sqrt{-1}$$

Particles oscillating radially outside the beam envelope will experience oscillating nonlinear forces that vary with space-charge intensity and can drive resonances

Continuous Focusing Axisymmetric Beam Radial Force

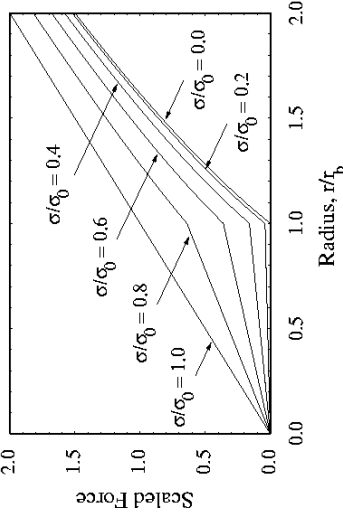

- ◆ Nonlinear force transition at beam edge larger for strong space-charge
- ◆ Edge oscillations of matched beam enhance nonlinear effects acting on particles moving outside the envelope
- ◆ In AG focusing envelope oscillation amplitude scales strongly with

**Core-particle simulations:** Poincare plots illustrate resonances associated with higher-order halo production near the beam edge for FODO quadrupole transport

- ◆ High order resonances near the core are strongly expressed
- ◆ Resonances stronger for higher  $\sigma_0$  and stronger space-charge
- ◆ Can overlap and break-up (strong chaotic transition) allowing particles launched near the core to rapidly increase in oscillation amplitude

**Lattice Period Poincare Strobe**, particles launched [1.1,1.2] times core radius

Stable  $\sigma_0 = 95^\circ$ ,  $\sigma/\sigma_0 = 0.67$  Unstable  $\sigma_0 = 110^\circ$ ,  $\sigma/\sigma_0 = 0.1$

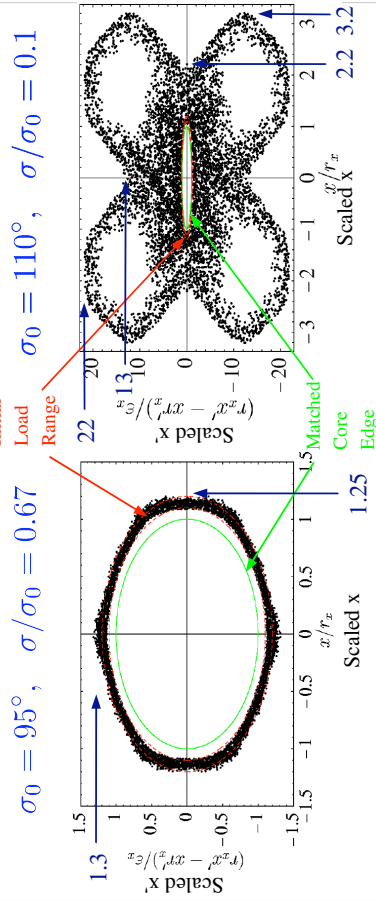

**Core-particle simulations:** Amplitude pumping of characteristic “unstable” phase-space structures is typically rapid and saturates whereas stable cases experience little or no growth

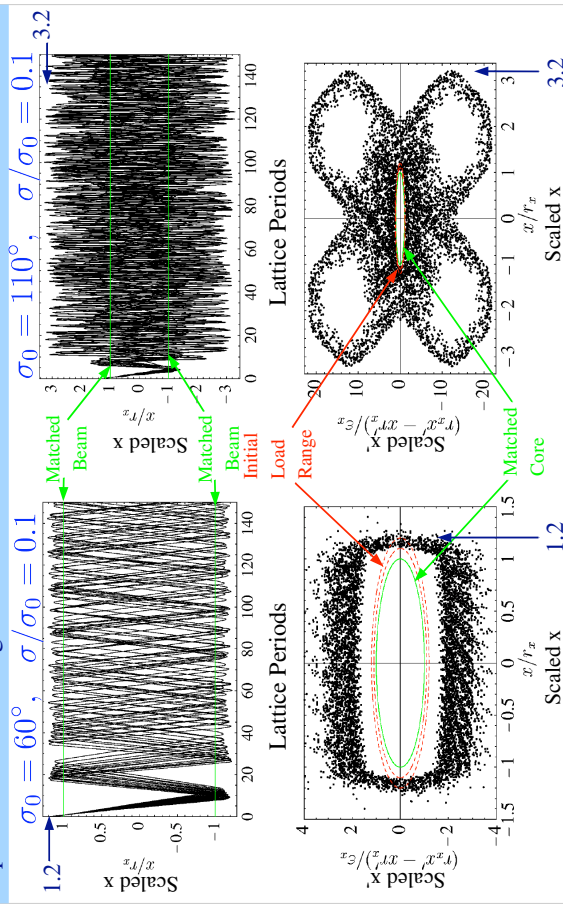

**Core particle simulations:** Stability boundary data from a “halo” stability criterion agree with experimental data for quadrupole transport limits

- Start at a point  $(\sigma_0, \sigma)$  deep within the stable region
- While increasing  $\sigma_0$  vary  $\sigma$  to find a point (if it exists) where initial launch groups [1.05, 1.10] outside the matched beam envelope are pumped to max amplitudes of 1.5 times the matched envelope
  - Boundary position relatively insensitive to specific group and amplitude growth choices

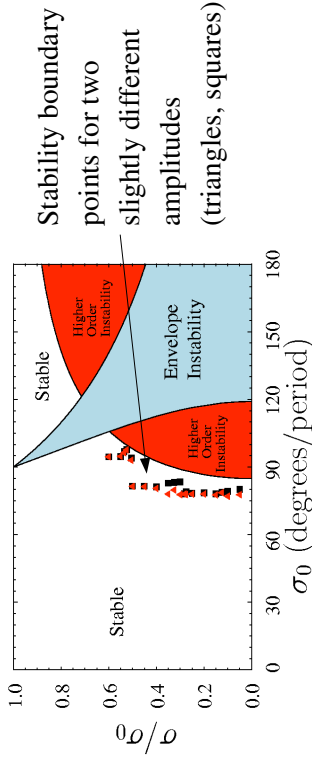

Other halo analyses of transport limits conclude overly restrictive limits: [Lagniel, Nuc. Instr. Meth. A **345**, 405 (1994)]

**Conclusions**

High-order space-charge related emittance growth has long been observed in intense beam transport in quadrupole focusing channels with  $\sigma_0 \gtrsim 85^\circ$  :

- SBTE Experiment at LBNL [M.G. Tiefenback, Ph.D Thesis, UC Berkeley (1986)]
- Simulations

A core-particle model has been developed that suggests observed transport limits result from a halo like mechanism:

- Near edge particles feel strong, rapidly oscillating nonlinear forces when moving just outside the matched beam envelope
- Drives a strongly chaotic resonance chain that limits at large amplitude resulting in a distorted beam and large statistical rms emittance growth
- Lack of core equilibrium provides a natural pump of significant numbers of particles outside the statistical beam edge and increase in oscillation amplitude

**Instability mechanism expected to explain other features**

- Stronger with envelope mismatch: consistent with observation that mismatched beams more unstable
- Weaker for focusing without much envelope fluctuation: high occupancy solenoids

Contours of maximum particle amplitudes obtained in the core particle model are strongly suggestive of trends observed in self-consistent simulation and experimental data

Max amplitudes achieved for particles launched [1.05, 1.1] times the core radius:

- Variation with small changes in launch position small

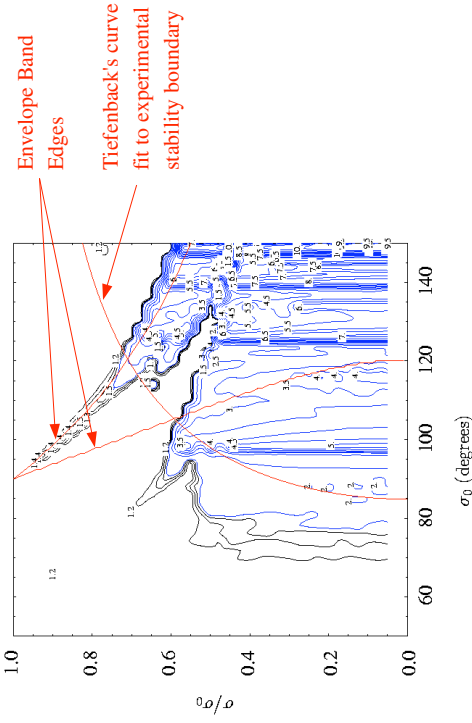

**More Details:**

Lund and Chawla, *Space-charge transport limits of ion beams in periodic quadrupole focusing channels*, Nuc. Instr. Meth. A **561**, 203 (2006)

Lund, Barnard, Bukh, Chawla, and Chilton, *A core-particle model for periodically focused ion beams with intense space-charge*, Nuc. Instr. Meth. A **577**, 173 (2006)

Lund, Kikuchi, and Davidson, *Generation of initial kinetic distributions for simulation of long-pulse charged particle beams with high space-charge intensity*, submitted to PRSTAB

## S12: Phase Mixing and Landau Damping in Beams

To be covered in future editions of class notes

- ♦ Likely inadequate time in lectures

## References: For more information see:

- M. Reiser, *Theory and Design of Charged Particle Beams*, Wiley (1994)
- R. Davidson, *Theory of Nonneutral Plasmas*, Addison-Wesley (1989)
- R. Davidson and H. Qin, *Physics of Intense Charged Particle Beams in High Energy Accelerators*, World Scientific (2001)
- F. Sacherer, *Transverse Space-Charge Effects in Circular Accelerators*, Univ. of California Berkeley, Ph.D Thesis (1968)
- S. Lund and B. Bukh, Review Article: *Stability Properties of the Transverse Envelope Equations Describing Intense Beam Transport*, PRST-Accel. and Beams 7, 024801 (2004)
- S. Lund and R. Davidson, *Warm Fluid Description of Intense Beam Equilibrium and Electrostatic Stability Properties*, Phys. Plasmas 5, 3028 (1998)
- D. Nicholson, *Introduction to Plasma Theory*, Wiley (1983)

These slides will be corrected and expanded for reference and any future editions of the US Particle Accelerator School class:

*Beam Physics with Intense Space Charge*, by J.J. Barnard and S.M. Lund

Corrections and suggestions are welcome. Contact:

Steven M. Lund  
Lawrence Berkeley National Laboratory  
BLDG 47 R 0112  
1 Cyclotron Road  
Berkeley, CA 94720-8201

[SMLund@lbl.gov](mailto:SMLund@lbl.gov)  
(510) 486 – 6936

Please do not remove author credits in any redistributions of class material.

## References (2)

- Lund and Chawla, *Space-charge transport limits of ion beams in periodic quadrupole focusing channels*, Nuc. Instr. Meth. A **561**, 203 (2006)
- Lund, Barnard, Bukh, Chawla, and Chilton, *A core-particle model for periodically focused ion beams with intense space-charge*, Nuc. Instr. Meth. A **577**, 173 (2006)

94 Collective Modes on a KV<sub>3</sub> Equilibrium Beam

Here we take a KV equilibrium distribution with

$$f_0(H_0) = \frac{\hat{n}}{2\pi} \delta\left[H_0 - \frac{E_x^2}{2\Gamma_b^2}\right]$$

$\hat{n}$  = constant density of KV equilibrium

$E_x^2$  = x-emittance.

$\Gamma_b$  = equilibrium beam radius.

$$k_{\beta 0}^2 \Gamma_b - \frac{Q}{\Gamma_b} - \frac{E_x^2}{\Gamma_b^3} = 0$$

$$H_0 = \frac{1}{2} \vec{x}_\perp'^2 + \frac{k_{\beta 0}^2}{2} \vec{x}_\perp'^2 + \frac{q}{m\delta b^3 \beta_b^2 c^2} \phi_0$$

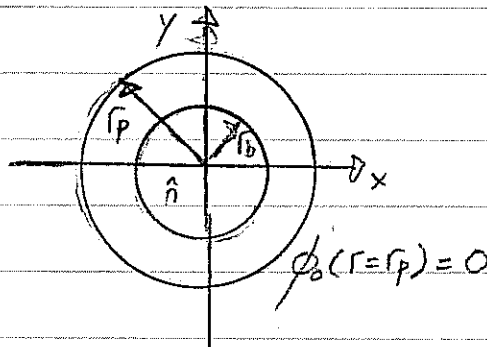

and assume small-amplitude axisymmetric ( $\partial/\partial\theta=0$ ) perturbations with normal mode form:

$$\delta f(\vec{x}_\perp, \vec{x}_\perp', s) = \delta f(r, \vec{x}_\perp', k) e^{-iks}$$

$$\delta \phi(\vec{x}_\perp, s) = \delta \phi(r, k) e^{-iks}$$

$k = \text{const}$  (mode eigenfrequency)

The equilibrium characteristics in the core of the kv beam can be expressed as:

$$r^2(\tilde{s}) = r^2 \cos^2[k_p(\tilde{s}-s)] + \frac{r r'}{k_p} \cos \Psi \sin[2k_p(\tilde{s}-s)] + \frac{r'^2}{k_p^2} \sin^2[k_p(\tilde{s}-s)]$$

$$\begin{aligned} x(\tilde{s}=s) &= r \cos \theta & ; & \quad x'(\tilde{s}=s) = r' \cos \theta_p \\ y(\tilde{s}=s) &= r \sin \theta & ; & \quad y'(\tilde{s}=s) = r' \sin \theta_p \end{aligned}$$

$$\Psi = \theta - \theta_p$$

$$k_p = \left( k_{p0}^2 - \frac{Q}{r_b^2} \right)^{1/2} = \frac{E_x}{r_b^2} \quad \text{Depressed B-tron wavenumber of particle oscillations}$$

These results can be inserted into the characteristic equation

$$\delta f(\vec{x}_1, \vec{x}_1', s) = \frac{-q}{m \gamma_0^3 \beta_0^2 c^2} \int_{-\infty}^s d\tilde{s} \frac{\partial \delta \phi(\vec{x}_1(\tilde{s}))}{\partial \vec{x}_1(\tilde{s})} \cdot \frac{\partial}{\partial \vec{x}_1'(\tilde{s})} f_0(H_0(\vec{x}_1(\tilde{s}), \vec{x}_1'(\tilde{s})))$$

to derive an expression for  $\delta f(r, \vec{x}_1')$ . This expression can then be inserted into the Poisson equation

$$\frac{1}{r} \frac{\partial}{\partial r} \left( r \frac{\partial \delta \phi(r)}{\partial r} \right) = -\frac{q}{\epsilon_0} \int d^2 x' \delta f(r, \vec{x}_1')$$

to derive a linear eigenvalue equation for  $\delta \phi(r)$ :



A significant amount of manipulation obtains the following form for the eigenvalue equation:

$$\left( \frac{\partial^2}{\partial r^2} + \frac{1}{r} \frac{\partial}{\partial r} \right) \delta\phi(r) = \frac{\hat{\omega}_p^2}{\gamma_b \beta_b^2 c^2} \Theta(r_b - r) \frac{1}{r_1'} \frac{\partial}{\partial r_1'} I_{orb}(r, r_1', k) \quad \textcircled{1}$$

$$+ \frac{\hat{\omega}_p^2 / (\gamma_b \beta_b^2 c^2)}{E_x^2 / r_b^2} \delta(r - r_b) \left[ \delta\phi + I_{orb}(r, r_1', k) \right] \quad \textcircled{2}$$

$r_1'^2 = \frac{E_x^2}{r_b^2} \left( 1 - \frac{r^2}{r_b^2} \right)$   
 $r_1' = 0$

Subject to:  $\delta\phi(r=r_b) = 0$ ,  $\hat{\omega}_p^2 = \frac{q^2 \hat{n}}{\epsilon_{0m}} = \text{Plasma Freq. Squared.}$

where:

$$\Theta(r_b - r) \equiv \begin{cases} 1 & r_b > r \\ 0 & r_b < r \end{cases} \quad \begin{array}{l} \text{Heaviside} \\ \text{Step function} \end{array}$$

$$I_{orb}(r, r_1', k) = ik \int_{-\pi}^{\pi} \frac{d\psi}{2\pi} \int_{-\infty}^s d\tilde{s} \delta\phi(r(\tilde{s}), k) e^{-i k(\tilde{s} - s)}$$

Orbit integral.

Note:

- Term ① of  $\Theta(r_b - r)$  is a body-wave perturbation existing only in the core ( $r < r_b$ ) of the equilibrium beam.
- Term ② of  $\delta(r - r_b)$  is a surface-wave perturbation existing only at the edge ( $r = r_b$ ) of the equilibrium beam.
- The orbit integral  $I_{orb}(r, r_1', k)$  depends on both  $\delta\phi$  and the eigenfrequency  $k$ .

The Poisson equation has become a linear integro-differential eigenvalue equation fixing the mode perturbed potential  $\delta\phi$  and eigenfrequency  $k$ .

## Gluckstern Mode Solution S.M. Lund 4/

This eigenvalue equation is difficult, but it has been solved analytically

- A finite polynomial in  $r^2$  expansion of  $\delta\phi$  for  $r \leq r_b$  can satisfy the equation (terms truncate)
- Expansions are inserted into the characteristic integrals and coefficients are identified power-by-power in  $r^2$ , and assembled.

Eigenfunction:                      Solution (after much analysis)

$$\delta\phi_n(r) = \begin{cases} \frac{A_n}{2} \left[ P_{n-1}(1 - 2r^2/r_b^2) + P_n(1 - 2r^2/r_b^2) \right]; & 0 \leq r < r_b \\ 0 & ; r_b < r \leq r_p \end{cases}$$

$n = 1, 2, 3, \dots$

radial mode index

$A_n = \text{const.}$

linear mode amplitude.

$P_n(x)$

$n$ 'th order Legendre Polynomial

Dispersion Relation:

Each  $n$ -labeled eigenfunction has  $2n$  (degenerate) "eigenfrequencies" & satisfying an  $n$ th degree polynomial in  $k^2$  dispersion relation.

$$2n + \frac{1 - (\sigma/\sigma_0)^2}{(\sigma/\sigma_0)^2} \left[ B_{n-1} \left( \frac{k/k_{p0}}{\sigma/\sigma_0} \right) - B_n \left( \frac{k/k_{p0}}{\sigma/\sigma_0} \right) \right] = 0$$

where:  $\frac{\sigma}{\sigma_0} = \frac{k_p}{k_{p0}} = \frac{(k_{p0}^2 - Q/r_b^2)^{1/2}}{k_{p0}}$

and

$$B_n(\alpha) \equiv \begin{cases} 1 & n=0 \\ \frac{[(\alpha/r)^2 - 0^2] \cdot [(\alpha/r)^2 - 2^2] \cdot \dots \cdot [(\alpha/r)^2 - (n-1)^2]}{[(\alpha/r)^2 - 1^2] \cdot [(\alpha/r)^2 - 3^2] \cdot \dots \cdot [(\alpha/r)^2 - n^2]} & n=1, 3, 5, \dots \\ \frac{[(\alpha/r)^2 - 1^2] \cdot [(\alpha/r)^2 - 3^2] \cdot \dots \cdot [(\alpha/r)^2 - (n-1)^2]}{[(\alpha/r)^2 - 2^2] \cdot [(\alpha/r)^2 - 4^2] \cdot \dots \cdot [(\alpha/r)^2 - n^2]} & n=2, 4, 6, \dots \end{cases}$$



Properties:

Radial Eigenfunction:

- Vanishes outside the equilibrium beam edge ( $r > r_b$ ).
- Has  $n-1$  nodes with  $\delta\phi=0$  within the equilibrium beam ( $r < r_b$ ).
- Each  $n$  labeled eigenfunction has  $2n$  distinct frequencies

Corresponding perturbed density can be calculated from Poisson's equation:

$$\delta n_n = \delta n_n(r) e^{-i\omega t}$$

$$\delta n_n(r) = -\frac{\epsilon_0}{q} \frac{1}{r} \frac{\partial}{\partial r} \left( r \frac{\partial \delta\phi_n}{\partial r} \right)$$

- Find that the perturbed density of the mode is more larger near the outer ( $r \approx r_b$ ) edge of the beam for larger  $n$ .

Eigenfunction Form

Mode number $n$	$\delta\phi_n/A_n$ (potential)	$\delta n_n$ (density, scaled units)
1	$1 - \tilde{r}^2$	1
2	$1 - 4\tilde{r}^2 + 3\tilde{r}^4$	$4(1 - 3\tilde{r}^2)$
3	$1 - 9\tilde{r}^2 + 18\tilde{r}^4 - 10\tilde{r}^6$	$9(1 - 8\tilde{r}^2 + 10\tilde{r}^4)$
4	$1 - 16\tilde{r}^2 + 60\tilde{r}^4 - 80\tilde{r}^6 + 35\tilde{r}^8$	$16(1 - 15\tilde{r}^2 + 45\tilde{r}^4 - 35\tilde{r}^6)$
⋮	⋮	⋮

$$\tilde{r} \equiv r/r_b$$

# Radial Eigenfunction

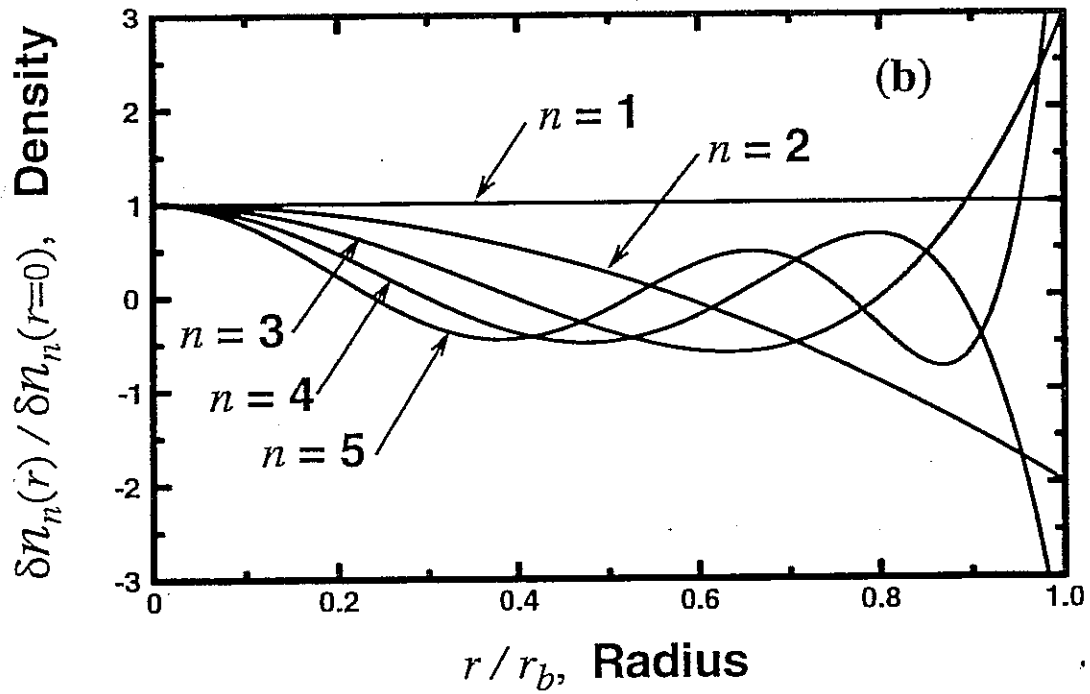
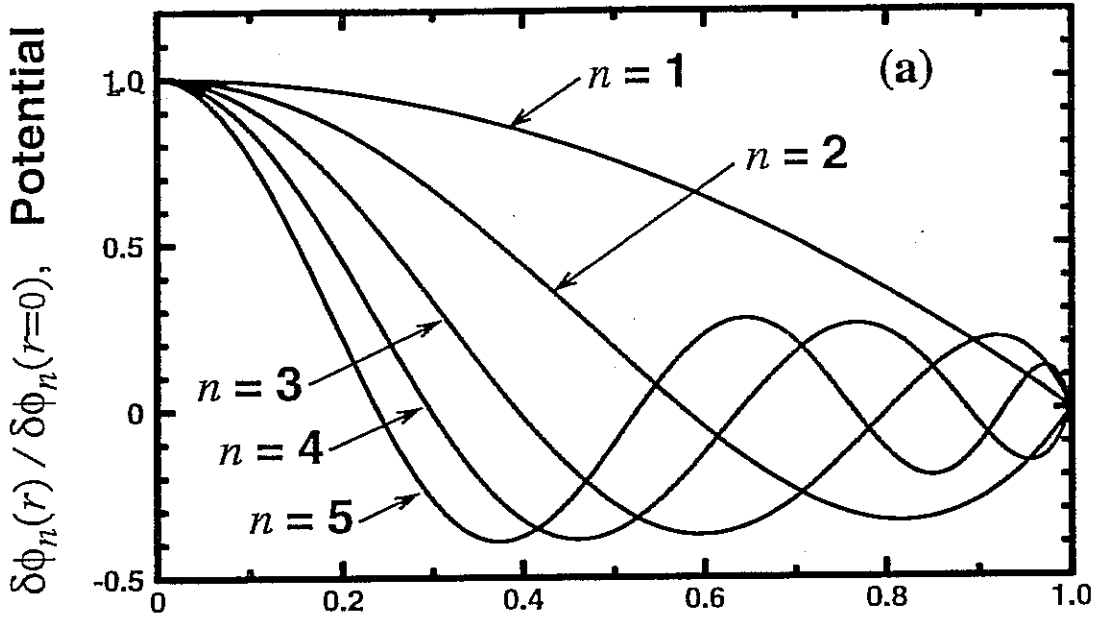

Perturbations should introduce no net charge into the system:

$$2\pi \int_0^{r_p} dr r \delta n(r) = 0$$

The  $r < r_b$  component of the perturbations are not the only terms present. For the  $r < r_b$  eigenfunctions calculated  $\int_0^{r_b} dr r \delta n_n(r) \neq 0$ . A more detailed analysis shows that:

$$\delta n_n(r) = \delta n_n(r) \Big|_{\text{body}} \Theta(r_b - r) + \delta n_n \Big|_{\text{surface}} \frac{r_b^2}{r} \delta(r - r_b)$$

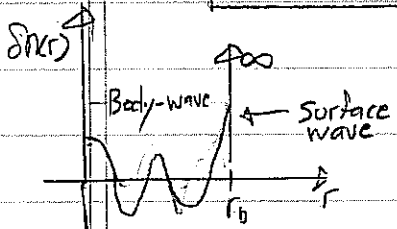

body-wave perturbation in core of equilibrium

singular charge conserving beam edge adjustment at  $r=r_b$

where:

$$\delta n_n \Big|_{\text{body}} = \frac{-\epsilon_0}{\epsilon} \frac{1}{r} \frac{\partial}{\partial r} \left( r \frac{\partial \delta \phi_n}{\partial r} \right)$$

$$\delta n_n \Big|_{\text{surface}} = \text{const} \times (-1)^n n A_n$$

To linear order this is equivalent to:

$$n(r) = \left[ \hat{n} + \delta n_n(r) \Big|_{\text{body}} \right] \Theta [r_b + \delta r_b - r]$$

$$\delta r_b = \text{const} \times (-1)^n n A_n \quad \text{readjustment of beam edge radius.}$$

Dispersion Relation

- Polynomial in  $k^2 \Rightarrow \pm k$  solutions. and therefore there will be unstable growing perturbations if  $k$  is complex:

$$\delta\phi \sim \delta\phi_n(r) e^{-ikt}$$

$$k = k_r \pm ik_i \quad k_r = \text{real part}$$

$$k_i = \text{imaginary part}$$

For the unstable branch:

$$\delta\phi \sim \delta\phi_n(r) e^{-ik_r t} \cdot e^{|k_i| t} \Rightarrow \text{exponential growth.}$$

- $|k|$  is a function of  $n$  and  $\sigma/\sigma_0$  only.

$$0 \leq \sigma/\sigma_0 \leq 1$$

↑  
strongest possible space charge.

↑  
zero space-charge.

- Instabilities will occur over a range of  $\sigma/\sigma_0$  and will turn off for  $\sigma/\sigma_0$  large enough (weak space-charge).  
KV beam is always stable for zero space-charge since orbits are stable.

Dispersion Relations:

Mode number $n$	Dispersion relation
1	$(k/k_{po})^2 - 2(1 + \sigma^2/\sigma_0^2) = 0$
2	$(k/k_{po})^4 - 2(1 + 9\sigma^2/\sigma_0^2)(k/k_{po})^2 - 4(\sigma^2/\sigma_0^2)(1 - 17\sigma^2/\sigma_0^2) = 0$
⋮	⋮
⋮	Rapidly more complicated!

$\frac{|\text{Re } \omega / v_0|}{|\text{Re } k / k_{po}|}$

# Oscillation Frequency

$\frac{|\text{Im } \omega / v_0|}{|\text{Im } k / k_{po}|}$

# Growth Rate

9/

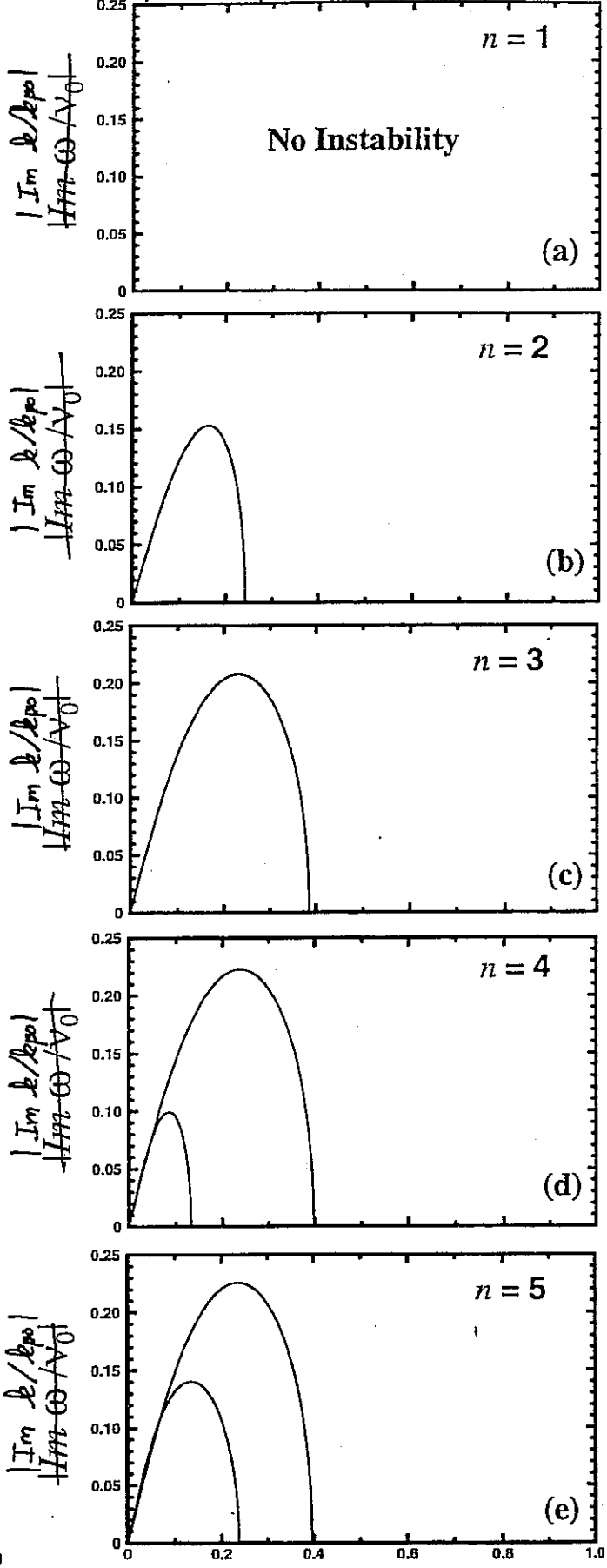
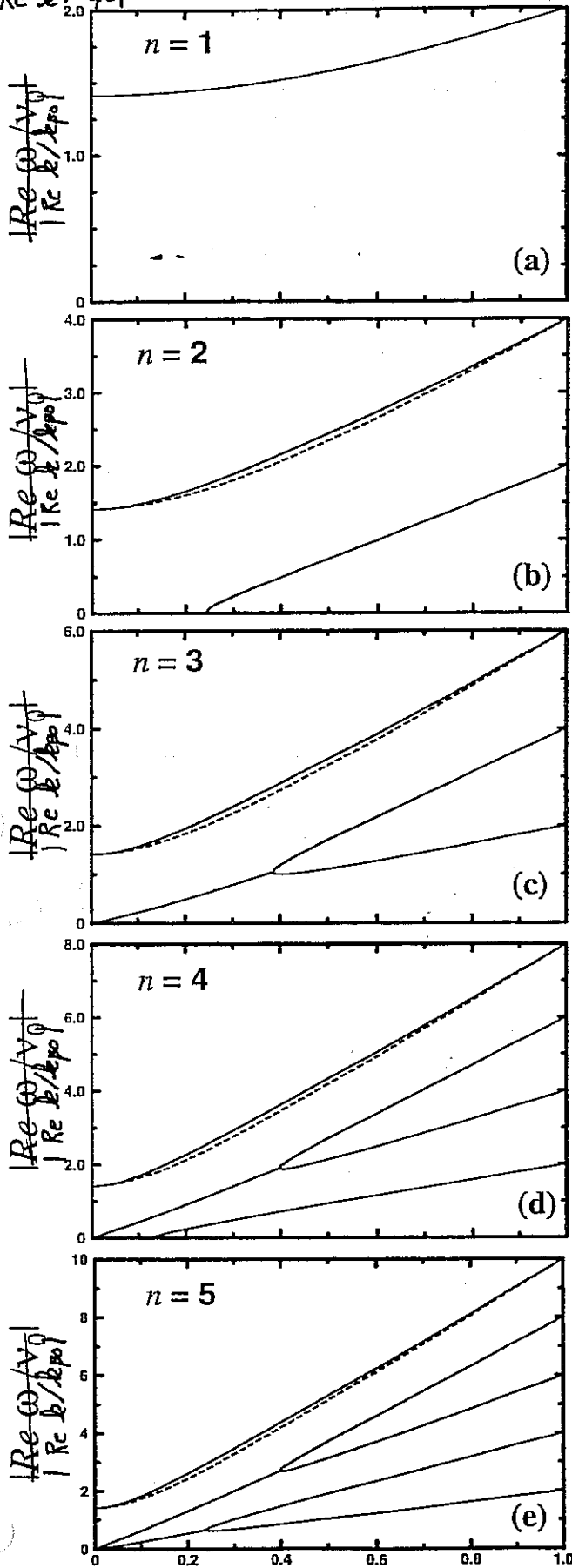

$\frac{v/v_0 - 1}{\delta}$  Tune Depression

$\frac{v/v_0 - 1}{\delta}$  Tune Depression

Fig. 8

# Kinetic Theory – Transverse Gluckstern Modes (6)



Example:  $n = 1$ , Envelope Mode

$$\delta\phi_1 = \begin{cases} A_1[1 - (r/r_b)^2], & 0 \leq r \leq r_b, \\ 0, & r_b \leq r \leq r_p, \end{cases}$$

$$(\omega/\omega_{p0})^2 = 2 + 2(\sigma/\sigma_0)^2$$

$n = 1$  Dispersion Relation

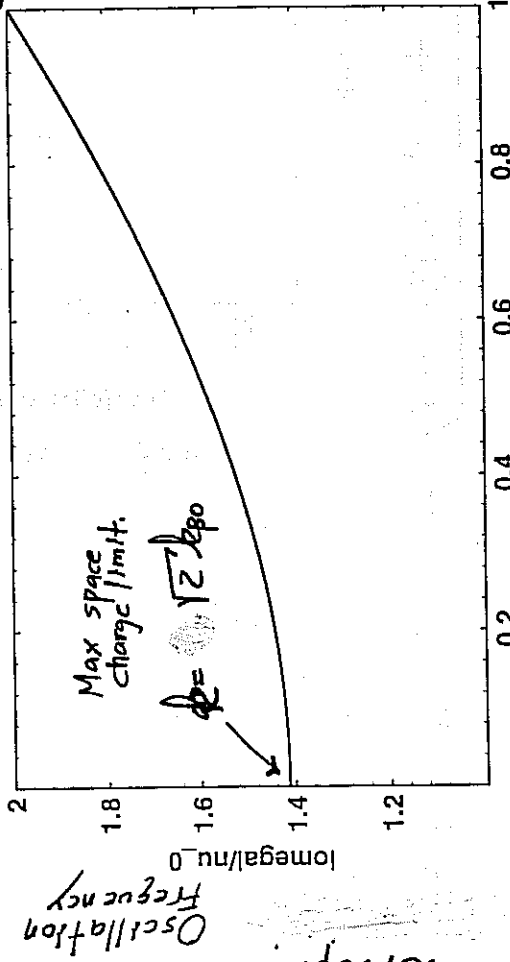

The  $n=1$  mode will be shown (homework) to be the usual envelope mode

$\sigma/\sigma_0$ , Tune Depression

Oscillation Frequency

# Kinetic Theory – Transverse Gluckstern Modes (7)



Example:  $n = 2$  Mode

$$\delta\phi_2 = \begin{cases} A_2 [1 - 4(r/r_b)^2 + 3(r/r_b)^4], & 0 \leq r \leq r_b, \\ 0, & r_b \leq r \leq r_p, \end{cases}$$

$$(\omega/\nu_0)^2 = 1 + 9(\nu/\nu_0)^2 \pm \sqrt{1 + 22(\nu/\nu_0)^2 + 13(\nu/\nu_0)^4}$$

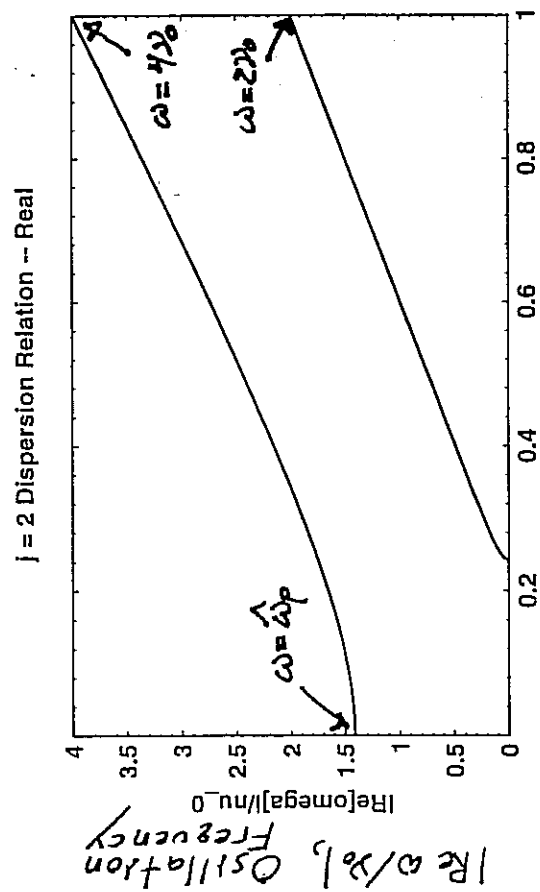

$\gg \nu_0$ , Tune Depression

Oscillation Frequency

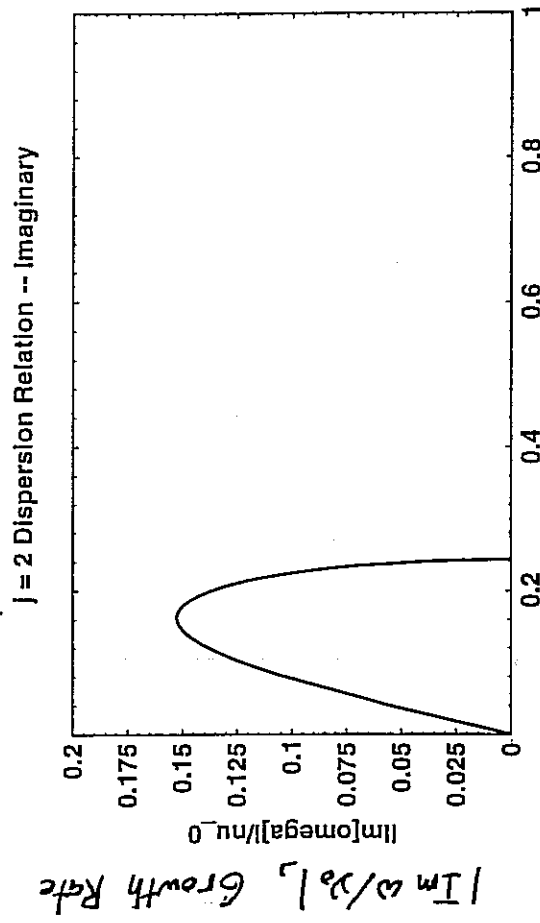

$\gg \nu_0$ , Tune Depression

Growth Rate

## Discussion:

S. M. Lund 12/

As might be expected on physical grounds, the singular KV distribution drives numerous, strong, collective instabilities. This implies that the KV model is suspect since real beams are often transported where the KV model would predict strong instability. However:

- Low-order KV features (envelope modes) are correct and well verified.
- Higher order collective modes observed on intense beam cores often look similar to the KV model predictions in density/potential etc, but are not unstable.

How is this situation resolved? A partial answer was suggested by a fluid model developed by Lund and Davidson. In this model:

- Density and temperature profiles (i.e., low order features) of the KV model were preserved.
- The singular phase-space structures were eliminated.

A stability analysis obtained:

$$\text{Mode Eigenfunction: } \delta\phi_n = \frac{A_n}{z} \left[ P_{n-1} \left( 1 - 2 \frac{r^2}{r_b^2} \right) + P_n \left( 1 - 2 \frac{r^2}{r_b^2} \right) \right] \quad (r < r_b)$$

$$\text{Mode Dispersion: } \left( \frac{\omega}{\omega_0} \right)^2 = z + z \left( \frac{\omega}{\omega_0} \right)^2 (2n^2 - 1)$$

$$n = 1, 2, 3, \dots$$



## Features of fluid model:

S.M. Lund 13/

- Identical radial eigenfunction to the full kinetic theory
- Fluid mode dispersion relation predicts stability for all modes and closely tracks the (stable) high frequency branch of the KV dispersion relation for the full range of space charge strength  $0 \leq \sigma/\sigma_0 \leq 1$ 
  - Fluid mode dispersion relation plotted dashed on KV mode plots.
  - The  $n=1$  fluid envelope mode is identical to the KV envelope mode.

Since the fluid model reproduces the coarse macroscopic features of the KV model - which can be a good approximation at high space-charge intensities, this implies:

- KV model mode eigenfunctions should roughly model those of intense beams with smooth distributions.
- Oscillation frequencies may be close to the (stable) high frequency KV mode branch
  - May be other lower frequency branches that are also physical.
- Many high-order KV instabilities may be of little relevance to real beams.
  - Low order (envelope and maybe others) can be relevant.

The real issue for high intensity collective modes may not be higher order KV instabilities but if low-order collective modes can:

- Be driven unstable by periodic (s-varying) focusing structures in machine lattices, errors in rings, etc.
- Drive the production of beam halo, etc.

### References:

Material on the kinetic stability of KV beams is found mostly in journals.

#### Original references

Gluckstern, Proc. 1970 Proton Linac Conference, Nat. Accel. Lab., pg. 811 - First KV mode analysis.

T.F. Wang and L. Smith, Part. Accel. 12, 247 (1982). - Simplified (closed form) mode eigenfunction and dispersion relation.

Interpretation of Branches, Mode Structure, KV Fluid Stability  
S.M. Lund and R.C. Davidson, Physics of Plasmas 5, 3028 (1998). Detailed analysis of eigenfunctions, dispersion relations, etc. in appendices. Fluid mode analysis and interpretations of KV modes.

Other papers by Hoffmann, Gluckstern, and others. Hoffmann et al. analyzed KV in periodic focusing lattices.

John Barnard  
Steven Lund  
USPAS  
June 2008

Intrabeam collisions, gas and electron  
effects in intense beams

1. Beam/beam coulomb collisions
2. Beam/gas scattering
3. Charge changing processes
4. Gas pressure instability
5. Electron cloud processes
6. Electron-ion instability

## Gas and electron effects

-Effects are quite different depending on q, m of species being accelerated

-Circular accelerators vs. Linacs  
( $t_{\text{residence}} \sim \text{ms to days vs. } 10\text{'s of } \mu\text{s}$ )

-Long pulse vs. short pulse  
( $t_{\text{pulse}} \sim 10\text{'s of } \mu\text{s vs. } 10\text{'s of ns}$ )



Processes:

1. Coulomb collisions (intra-beam)

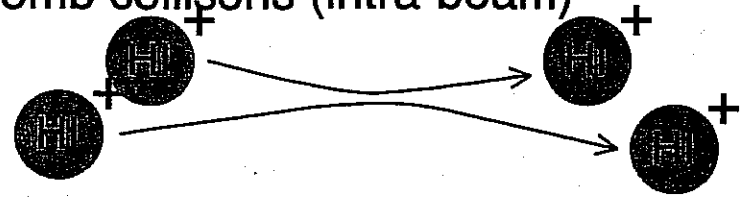

2. Coulomb collisions with residual gas

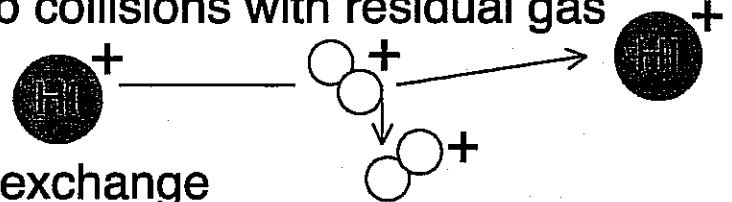

3. Charge exchange

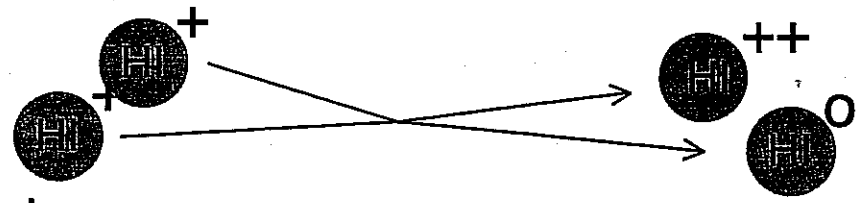

4. Stripping

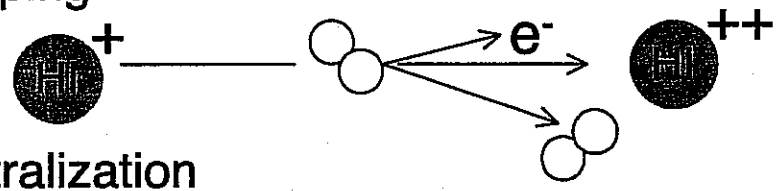

5. Neutralization

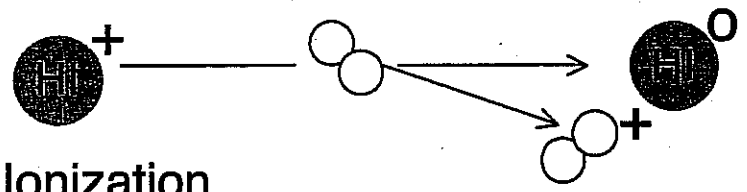

6. Gas Ionization

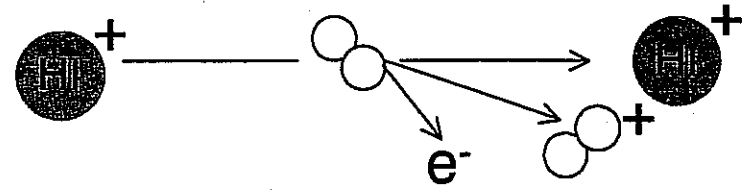

# 7. Wall interactions

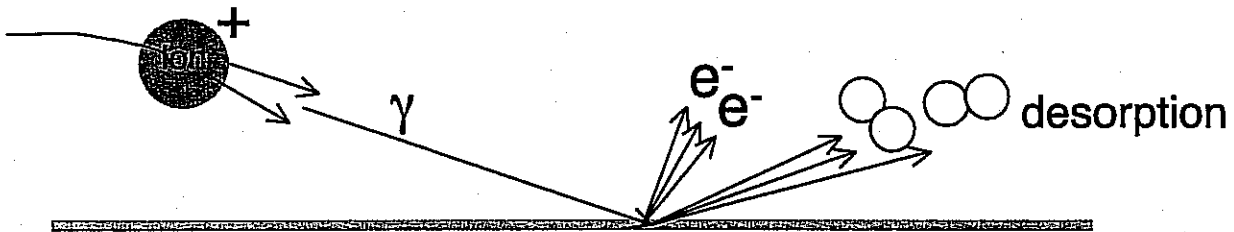
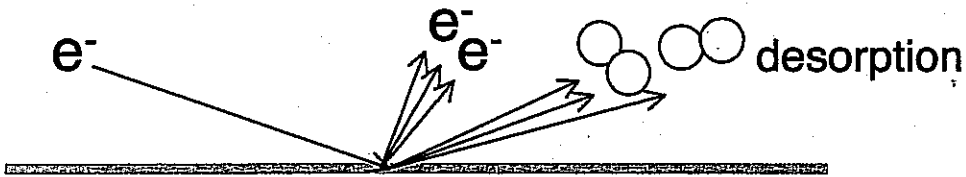
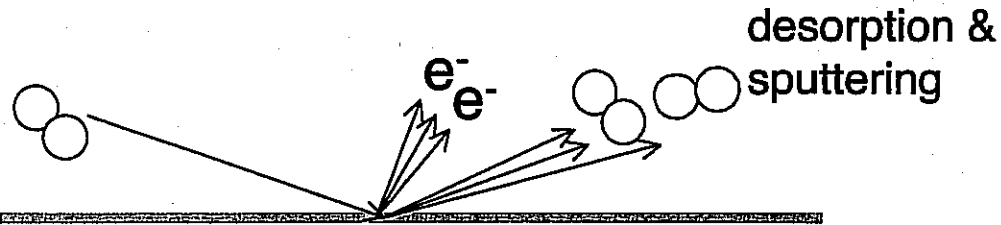
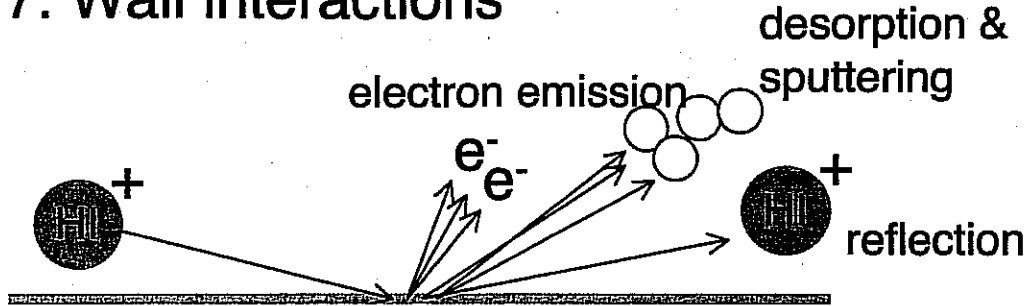

$\gamma$	synchrotron photon
----------	--------------------

# 1. COLLISIONS WITHIN BEAM REISER 6.4

CONSIDER EFFECTS OF COULOMB COLLISIONS  
IN A CONTINUOUS BEAM PROPAGATING THROUGH  
A SMOOTH FOCUSING CHANNEL WITH  $T_{\perp 0} \neq T_{\parallel 0}$

(IF  $T_{\perp 0} = T_{\parallel 0} \Rightarrow$  BEAM ALREADY KEUKED)

FROM ICHIMARU & ROSENBLUTH, PHYS FLUIDS 13, 2718, (1970):

$$\frac{dT_{\perp}}{dt} = -\frac{1}{2} \frac{dT_{\parallel}}{dt} = \frac{-(T_{\perp} - T_{\parallel})}{\tau}$$

(SINCE  $T_x = T_y = T_{\perp}$ ,  $T_{\parallel}$  CHANGES AT TWICE THE RATE OF  $T_{\perp}$ )  
(SINCE  $2k_B T_{\perp} + k_B T_{\parallel} = \text{const}$ )

$\tau$  = RELAXATION TIME

$$\tau = \frac{15 (k_B T_{\text{eff}} / m c^2)^{3/2} (4\pi \epsilon_0)^2 m^2 c^3}{8\pi^{1/2} q^4 \ln \Lambda n} = \left( \frac{15 \pi^{1/2}}{8 \ln \Lambda} \right) v_c^{-1}$$

$$\ln \Lambda = \begin{cases} \ln \left( \frac{\epsilon_0 k T_{\perp}}{q^3 v^2} \right) 12\pi & \text{for } \lambda_D < r_D \\ \ln \left( \frac{12\pi \epsilon_0 k T_{\text{eff}} r_D}{q^2} \right) & \text{for } \lambda_D > r_D \end{cases}$$

COULOMB COLLISION APPROXIMATE  
RATE FOR LARGE ANGLES  
(PAGE 9 OF INTRODUCTION  
NOTES)

$$T_{\text{eff}} = T_{\perp} \left[ \frac{15}{4} \int_{-1}^1 \frac{\mu^2 (1 - \mu^2) d\mu}{[(1 - \mu^2) + \mu^2 (T_{\parallel} / T_{\perp})]^{3/2}} \right]^{-2/3}$$

$T_{\text{eff}}$  is an appropriate average of  $T_{\perp}$  &  $T_{\parallel}$

Teff/Tperp vs. Tpar/Tperp

$\frac{T_{eff}}{T_{\perp}}$

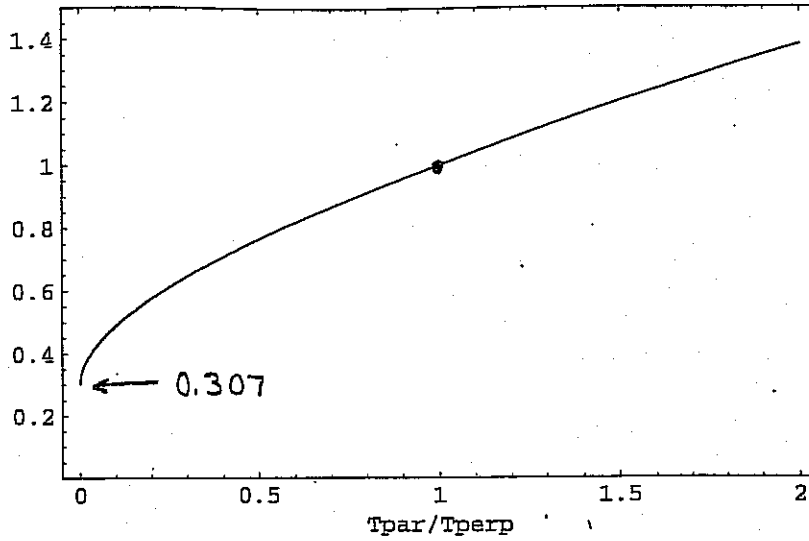

For  $T_{||} = 0$

$$T_{\perp} = \frac{2}{3} T_{\perp 0} \left( 1 + \frac{1}{2} e^{-3t/\tau_{eff}} \right), \quad (6.156a)$$

$$T_{||} = \frac{2}{3} T_{\perp 0} (1 - e^{-3t/\tau_{eff}}), \quad (6.156b)$$

(APPROXIMATE SOLUTIONS)

$$\tau_{eff} = 0.42 \tau_{eq}$$

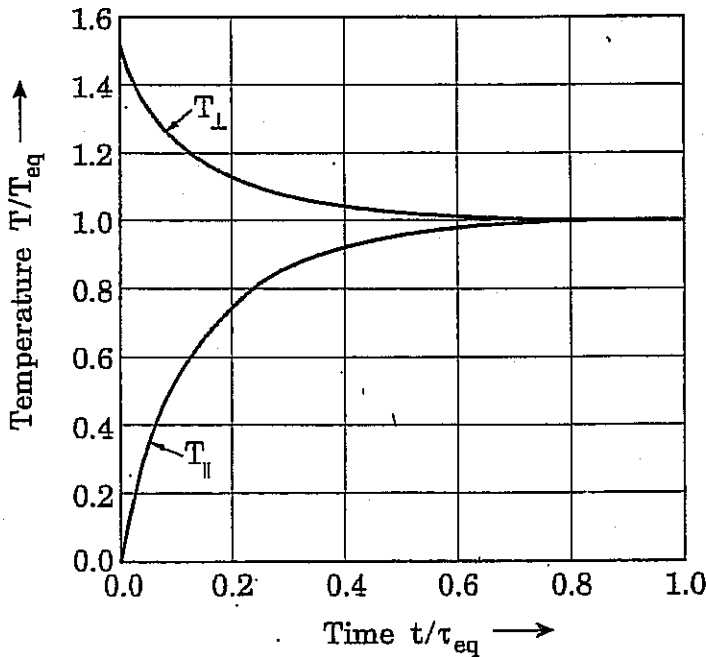

FROM REISER p. 527

$$\tau_{eq} = \tau(T_{eq})$$



BOERSCH EFFECT

ARENT COLLISIONS NEGLIGIBLE? (NOT ALWAYS)

PUTTING IN NUMBERS:

FOR IONS:

$$\tau_{\text{eff}} = 4.3 \cdot 10^{-4} \text{ s} \frac{(A^{1/2})}{Z^4} \left( \frac{kT_{\text{eff}}}{1 \text{ eV}} \right)^{3/2} \left( \frac{15}{\ln \lambda} \right) \left( \frac{10^{10} \text{ cm}^{-3}}{n} \right)$$

$$\ln \lambda = \ln \left[ \frac{1.5 \cdot 10^5 (kT/1 \text{ eV})^{3/2}}{Z^3 (n/10^{10} \text{ cm}^{-3})} \right]$$

EXAMPLE: 2 MeV INJECTOR

$$\tau_{\text{eff}} \approx 8.8 \cdot 10^{-4} \text{ s} \quad \text{for } A=39 \quad kT_{\text{eff}} = 0.3 \text{ eV}$$

$$Z=1 \quad \ln \lambda = 8.5$$

$$n = 10^{10} \text{ cm}^{-3}$$

$$t_{\text{transit}} \approx \frac{Zd}{V} \approx \frac{Z(2 \text{ m})}{(0.1) 3 \cdot 10^8} = 1.3 \mu\text{s}$$

So  $\tau_{\text{eff}} \gg t_{\text{transit}} \Rightarrow$  collisions are rare BUT

$$T_{\text{cool}}^{\text{accel}} = \frac{1}{Z} \left( \frac{kT_0}{qV} \right) kT_0 = 2.5 \cdot 10^{-9} \text{ eV} \quad \text{for } kT_0 = 0.1 \text{ eV}$$

$$qV = 2 \text{ MeV}$$

$$T_{\text{collisions}} \approx \frac{2}{3} T_{10} (1 - \exp(-3t/\tau_{\text{eff}})) \approx 2T_{10} \left( \frac{t_{\text{transit}}}{\tau_{\text{eff}}} \right) = .006 \text{ eV}$$

$$\text{for } T_{10} = 1 \text{ eV}$$

8

So  $T_H$  FROM "BOERSCH EFFECT"

>>  $T_L$  FROM LONGITUDINAL COOLING

100 SHEETS  
J.S.A.



COULOMB COLLISIONS IN RESIDUAL GAS (REISER 6.4.3)

JACKSON CHAPTER 13

(RUTHERFORD SCATTERING)

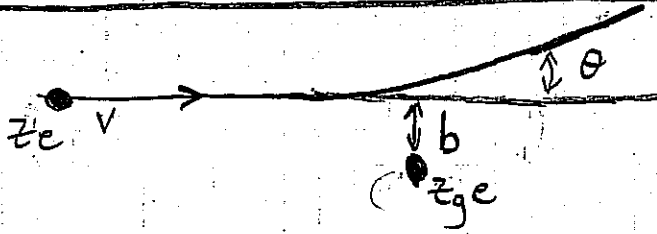

$$\frac{dp}{dt} = \frac{z z_g e^2}{4\pi\epsilon_0 r^2} \frac{b}{r} \Rightarrow \Delta p = \int_{-\infty}^{\infty} \frac{dp_x}{dt} \frac{dt}{dz} dz$$

$$= \frac{z z_g e^2 b}{4\pi\epsilon_0 v} \int_{-\infty}^{\infty} \frac{dz}{(z^2 + b^2)^{3/2}}$$

$$= \frac{z z_g e^2}{4\pi\epsilon_0 v b}$$

$$\frac{\Delta p}{p} \theta \approx \frac{\Delta p}{p} = \frac{z z_g e^2}{4\pi\epsilon_0 p v b} \Rightarrow \frac{db}{d\theta} \sim \frac{1}{\theta^2}$$

DIFFERENTIAL CROSS SECTION FOR SCATTERING WITH IMPACT

PARAMETER  $b$  INTO SOLID ANGLE  $d\Omega$  AT ANGLE  $\theta$  SATISFIES

$$\underbrace{2\pi b db}_{\text{AREA}} = \underbrace{\frac{d\Omega}{d\Omega} 2\pi \sin\theta d\theta}_{\text{SOLID ANGLE}}$$

$$\Rightarrow \frac{d\Omega}{d\Omega} = \frac{b}{\sin\theta} \left| \frac{db}{d\theta} \right| = \left( \frac{z z_g e^2}{4\pi\epsilon_0 p v} \right)^2 \frac{1}{\theta^4}$$

ELECTRON SCREENING PUTS CUTOFF AT SMALL  $\theta$  (LARGE  $b$ ) SO BETTER TO USE

$$\frac{d\Omega}{d\Omega} = \left( \frac{z z_g e^2}{4\pi\epsilon_0 p v} \right)^2 \frac{1}{(\theta^2 + \theta_{min}^2)^2}$$

AVERAGE ANGLE SQUARED FOR A SINGLE SCATTERING IS:

$$\bar{\theta}^2 = \frac{\int \theta^2 \frac{d\sigma}{d\Omega} 2\pi \sin\theta d\theta}{\int \frac{d\sigma}{d\Omega} 2\pi \sin\theta d\theta} \approx \frac{\int_0^{\theta_{max}} \frac{\theta^3}{(\theta^2 + \theta_{min}^2)^2} d\theta}{\int_0^{\theta_{max}} \frac{\theta}{(\theta^2 + \theta_{min}^2)^2} d\theta}$$

$$\approx 2 \theta_{min}^2 \ln\left(\frac{\theta_{max}}{\theta_{min}}\right)$$

ASSUMES  $\theta_{max}^2 \gg \theta_{min}^2$   
 &  $\ln\left(\frac{\theta_{max}}{\theta_{min}}\right) \gg 1$

MULTIPLE COLLISIONS

AFTER TRAVERSING DISTANCE  $s$ ,  
 AND UNDERGOING  $N_s$  COLLISIONS, THE  
 MEAN SQUARE ANGLE  $\overline{(\theta)}^2$

$$\overline{(\theta)}^2 = N_s \bar{\theta}^2 = n_0 \sigma_s s \bar{\theta}^2$$

$$= 16 \pi n_0 \left( \frac{z z_0 e^2}{4 \pi \epsilon_0 m c^2 \gamma \beta^2} \right)^2 \ln\left(\frac{\theta_{max}}{\theta_{min}}\right) s$$

$$\left[ \sigma_s = \pi \left( \frac{z z_0 e^2}{4 \pi \epsilon_0 p v} \right)^2 \theta_{min}^2 \right]$$

JACKSON ARGUES  $\theta_{max}$  ARISES FROM DISTRIBUTED  
 NATURE OF NUCLEUS (NOT POINT CHARGE)  
 AND  $\theta_{min}$  ARISES FROM SCREENING OF ELECTRONS  
 OR UNCERTAINTY PRINCIPLE

$$\ln \frac{\theta_{max}}{\theta_{min}} \approx \ln(204 z_0^{-1/3})$$

$$\Delta \langle x'^2 \rangle = \frac{1}{2} \overline{(\Delta)^2} \quad \left[ \text{since } \Delta \langle x'^2 \rangle + \Delta \langle y'^2 \rangle = \Delta \overline{(\Delta)^2} \right]$$

$$\epsilon = 4 \sqrt{\langle x^2 \rangle \langle x'^2 \rangle} - \langle x x' \rangle^2$$

FOR A MATCHED BEAM

$$k_p^2 \langle x^2 \rangle = \langle x'^2 \rangle$$

where  $k_p =$  depressed betatron wavenumber

$$\Rightarrow \epsilon = \frac{4 \langle x'^2 \rangle}{k_p}$$

$$\Delta \epsilon = \frac{4 \Delta \langle x'^2 \rangle}{k_p} = \frac{2 \overline{(\Delta)^2}}{k_p}$$

$$\Rightarrow \frac{d\epsilon}{ds} = \frac{32\pi}{k_p} n_g \left( \frac{z z_g e^2}{4\pi \epsilon_0 m c^2 \rho} \right)^2 \ln(204 z_g^{-1/3})$$

IN TERMS OF NORMALIZED EMITTANCES:  $(5 \times 10^{-11})^2 \text{ cm}^3$

$$\frac{d\epsilon_N}{ds} = \frac{32\pi}{k_p} n_g \left( \frac{z z_g e^2}{4\pi \epsilon_0 m c^2} \right)^2 \frac{1}{\gamma \beta^3} \ln(204 z_g^{-1/3})$$

Example:  $n_g = 10^{-7} \text{ Torr} = 3.5 \cdot 10^9 \text{ cm}^{-3} = 3.5 \cdot 10^{15} \text{ m}^{-3}$

$k_{p0} = 2.5 \text{ m}^{-1} \quad k_p = 0.25 \text{ m}^{-1}$

$z_g = 7, z = 19, A = 39, \rho = 0.01, \epsilon_N = 1 \cdot 10^{-6} \text{ m-rad}$

$\Rightarrow \frac{d\epsilon_N}{ds} = 3.7 \cdot 10^{-11} \text{ m}^{-1} \Rightarrow$  Need 27 km to equal original emittance!  
(But more important for rings & low mass!)



If we take  $n_b \approx \text{constant}$

then we may express gas evolution equation as:

$$\frac{d\bar{n}}{dt} = \frac{\bar{n}}{\tau} + q_{\text{eff}}$$

with solution:

$$\bar{n} = (\bar{n}_0 + \tau q_{\text{eff}}) \exp[t/\tau] - \tau q_{\text{eff}}$$

$$\text{HERE } \tau = \frac{1}{(\eta_g \sigma_i + \eta_{HI} \sigma_s) \left(\frac{V_{\text{beam}}}{V_{\text{pipe}}}\right) n_b V_i - S/A_p}$$

$$q_{\text{eff}} = q + \eta_{HI} \sigma_{CE} V_{\text{cm}} n_b^2 \left(\frac{V_{\text{beam}}}{V_{\text{pipe}}}\right)$$

EQUILIBRIUM REACHED IF  $\tau < 0$  (i.e. pumping exceeds desorption).

$$\Rightarrow \bar{n} = -\tau q_{\text{eff}} = \frac{q + \eta_{HI} \sigma_{CE} V_{\text{cm}} n_b^2 \left(\frac{V_{\text{beam}}}{V_{\text{pipe}}}\right)}{S/A_p - (\eta_g \sigma_i + \eta_{HI} \sigma_s) \left(\frac{V_{\text{beam}}}{V_{\text{pipe}}}\right) n_b V_i}$$

INSTABILITY IF

$$n_b V_i \gg \frac{S \left(\frac{V_{\text{pipe}}}{V_{\text{beam}}}\right)}{\eta_g \sigma_i + \eta_{HI} \sigma_s}$$

Instability first observed on the ISR proton storage ring, limiting current in rings, in 1970's.

$$I_{\text{beam}} = I_{\text{pipe}}$$

INSTABILITY CRITERION MAY BE WRITTEN

$$I > \frac{zeS}{\eta_g Q_i + \eta_{HI} Q_s}$$

EXAMPLE:

$$\text{IF } S = 100 \text{ } \mu\text{s}^{-1}\text{m}^{-1} = 0.1 \text{ m}^3 \text{ s}^{-1} \text{ m}^{-1}$$

ISR

$$\eta_g = 4$$

$$Q_i = 10^{-22} \text{ m}^2 = 10^{-16} \text{ cm}^2; \quad Q_s = 0$$

$$z = 1 \quad (\text{protons})$$

$$\Rightarrow I \leq 40 \text{ Amperes}$$

(PRESSURE RUNAWAYS WERE OBSERVED ON THE ISR AT 14-18A,  
(BENVENUTI et al, IEEE Trans. on Nuc. Sci. NS-24, 1773, 1977)

SEE "BEAM INDUCED PRESSURE RISE IN RINGS"

13th ICFA BEAM DYNAMICS MINI WORKSHOP, BNL, Dec. 9-12, 2003.

WEBSITE: <http://www.c-ad.bnl.gov/icfa>



# "ELECTRON CLOUD EFFECTS"

REFERENCE: CERN e-CLOUD WORKSHOP

<http://wwwslap.cern.ch/collective/ecloudp2/>

→ [proceedings.html](#)

## BASIC IDEA

IN ION STORAGE RINGS OR COLLIDER RINGS:

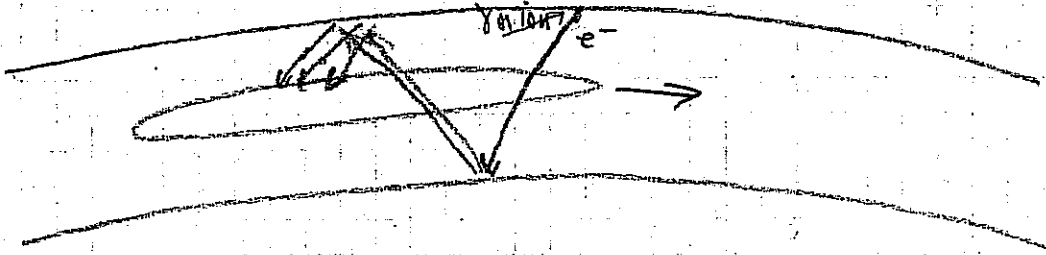

ELECTRONS ARE ATTRACTED TO POSITIVE POTENTIAL OF BEAM & ACCUMULATE

### SOME SYMPTOMS:

1. BEAM LOSS & PRESSURE RISE
2. HIGH FREQUENCY CENTROID OSCILLATIONS

### SOME ACCELERATORS WHICH SHOW EVIDENCE OF e<sup>-</sup> EFFECTS

1. LANL PSR
2. CERN PS & SPS
3. BNL RHIC

### COULD LIMIT PLANNED / UNDER CONSTRUCTION:

1. SNS ACCUMULATOR RING
2. LHC

cf. "Electron-cloud effects in HIGH INTENSITY PROTON ACCELERATORS" J. Wei & R. Maccek, CERN

BEAM INDUCED MULTIFACTING

a) MULTI-BUNCH

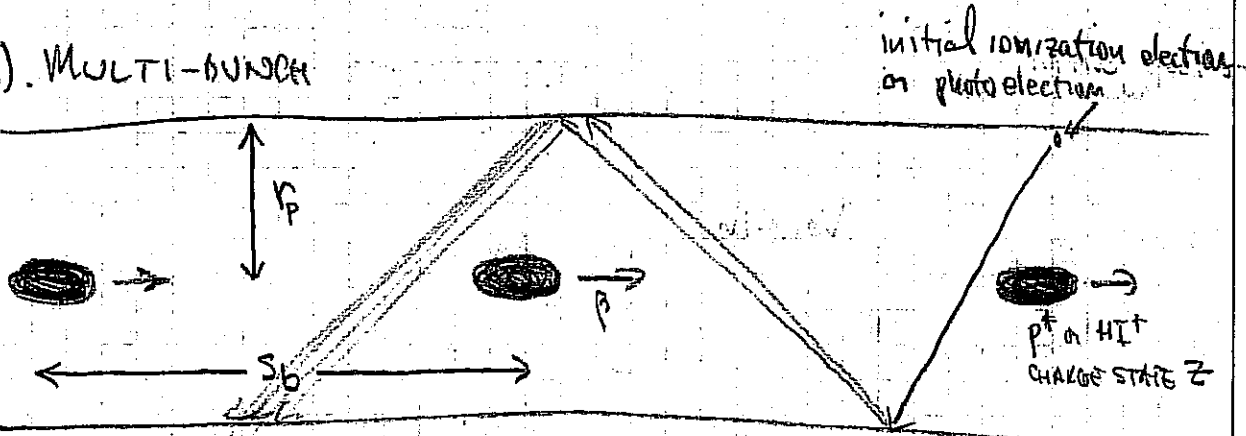

Using COULOMB COLLISION FORMULA FROM PAGE 9:

$$\Delta p_x \approx \frac{2ZN_b e^2}{4\pi\epsilon_0 v r_p}$$

$N_b$  = Number of ions of charge  $Z$  in bunch

$$\Delta E_e = m_e c^2 \left[ \sqrt{\frac{\Delta p_x^2}{m_e^2 c^2} + 1} - 1 \right] = m_e c^2 \left[ \sqrt{\left( \frac{2Zv_e Z N_b}{\beta r_p} \right)^2 + 1} - 1 \right]$$

(where  $v_e = \frac{e^2}{4\pi\epsilon_0 m_e c^2} \approx 2.8 \times 10^{-15} \text{ m}$ )

$$\approx 2v_e^2 m_e c^2 \frac{Z^2 N_b^2}{\beta^2 r_p^2} \quad \text{for } \Delta E_e \ll m_e c^2 \quad \left( \text{or } \frac{2Zv_e Z N_b}{\beta r_p} \ll 1 \right)$$

DEFINE A MULTIFACTING PARAMETER  $J_m$

$$J_m = \frac{\text{TIME FOR ELECTRON TO CROSS PIPE}}{\text{TIME BETWEEN BUNCHES}} = \frac{2r_p}{s_b} \frac{\beta}{\beta_e}$$

$$\approx \frac{\beta^2 r_p^2}{Z N_b v_e s_b}$$

RESONANCE CONDITION:

$$J_m = 1$$

$s_b$  = distance between bunches

b). SINGLE-BUNCH BEAM-INDUCED MULTIPLYING

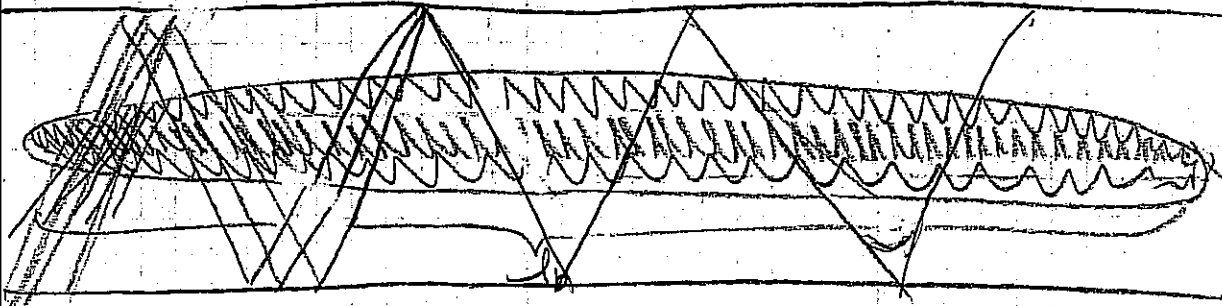

$$J_s = \frac{r_p \beta}{l_b \rho_e} = \frac{\text{time for electrons to cross pipe}}{\text{passage time for half of the bunch}}$$

Recall:

$$\psi = \begin{cases} \frac{\lambda}{2\pi\epsilon_0} \left[ \frac{1}{2} \left( 1 - \frac{v^2}{v_b^2} \right) + \ln \frac{r}{r_b} \right] & 0 < r < r_b \\ \frac{\lambda}{2\pi\epsilon_0} \left[ \ln \frac{r}{r} \right] & r_b < r < r_p \end{cases}$$

$$\frac{1}{2} m_e v_e^2 + q\psi \approx \text{const} \approx 0$$

(AVERAGE  
e- VELOCITY)

$$\beta_0 \sim \frac{1}{2} \sqrt{\frac{z q \psi}{m_e c^2}} \sim \sqrt{\frac{N_0 z e z}{l_b 4\pi\epsilon_0 m_e c^2}} \sim \sqrt{\frac{z v_e N_0}{l_b}}$$

$$\Rightarrow J_s = \frac{\beta v_r}{\sqrt{v_e l_b N_0 z}}$$

THE ENERGY GAIN OF THE ELECTRON, RELIES ON THE DENSITY CHANGING OVER THE COURSE OF THE BUNCH.

$$\begin{aligned} \Delta E_e &\sim \frac{m_e c^2}{z} \left[ \frac{z v_e N_0(z)}{l_b} \right] - \frac{m_e c^2}{z} \left[ \frac{z v_e N_0(z+\Delta z)}{l_b} \right] \\ &\sim \frac{m_e c^2}{z} \left( \frac{\partial N_0}{\partial z} \Delta z \right) \left( \frac{z v_e}{l_b} \right) \end{aligned}$$

$$\Delta E_e \sim \frac{m_e c^2}{2} \left( \frac{\partial N_0}{\partial z} \Delta z \right) \left( \frac{z v_e}{l_b} \right)$$

$$\Delta z = \frac{v_p}{v_e} \rho_e = \beta r_p \sqrt{\frac{l_b}{z v_e N_0}}; \quad \frac{\partial N_0}{\partial z} \sim \frac{N_0}{l_b}$$

$$\text{So } \Delta E_e \sim m_e c^2 \left( \frac{z N_0 v_e}{l_b^3} \right)^{1/2} \beta r_p$$

Condition  $\gamma \leq 1 \Rightarrow$  Election build up possible within bunch

WHAT IS STEADY STATE ELECTRON DENSITY?

Elections can build up until  $E_r$  at pipe  $\sim 0$ .

$$\Rightarrow \lambda_e = \lambda_J$$

$$\pi r_p^2 n_e = \pi v_b^2 z n_i$$

$$n_e = \left( \frac{v_b}{r_p} \right)^2 z n_i$$

# ELECTRON-ION INSTABILITY

(SEE ALSO R.C. DAVIDSON & H. QIN, Physics of Zeta wave charged particle beams in High Energy Accelerators, p. 503 FOR KINETIC TREATMENT)

CONSIDER A UNIFORM DISTRIBUTION OF ELECTRONS (AT REST) WHICH HAS THE SAME RADIUS (OR SLIGHTLY SMALLER RADIUS) AS A UNIFORM DENSITY ION BEAM, THAT IS MOVING AT VELOCITY  $v_z$  (OUT OF THE PLANE OF THE PAPER).

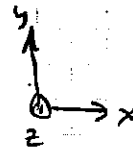
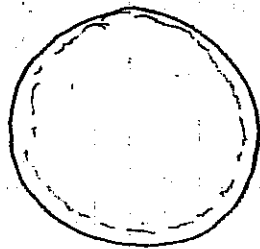

$$E_x = \frac{\lambda_i(r)(x-x_i)}{2\pi\epsilon_0 v_0 r} = \frac{\rho_i(x-x_i)}{2\epsilon_0}$$

THE EQUATION OF MOTION FOR THE CENTROID OF THE ELECTRONS IS OBTAINED FROM

$$m_e \ddot{x} = -\frac{e\rho_i}{2\epsilon_0}(x-x_i) + \frac{e\rho_e}{2\epsilon_0}(x-x_e)$$

$$\text{or } \frac{d^2 x_e}{dt^2} = -\frac{\omega_{pi}^2}{2} \left( \frac{m_i}{q} \frac{e}{m_e} \right) (x_e - x_i)$$

$$\text{here } \omega_{pi}^2 = \frac{q^2 n_i}{\epsilon_0 m_i} = \frac{q\rho_i}{\epsilon_0 m_i}$$

(THE CENTER OF OSCILLATION FOR THE ELECTRONS IS THE CENTER OF THE ION BEAM).

$x_e$  = centroid of electron beam

$x_i$  = centroid of ion beam

THE EQUATION OF MOTION FOR THE CENTROID OF THE IONS IS GIVEN BY

$$\frac{d^2 x_i}{dt^2} = -\omega_{p0}^2 x_i - \left[ \frac{m_e N_e}{m_i N_i} \right] \left( \frac{\omega_{pi}^2}{2} \frac{m_i}{q} \frac{e}{m_e} \right) (x_i - x_e)$$

↑  
THE TOTAL MOMENTUM  
KICK TO EACH SPECIES  
MUST BE EQUAL & OPPOSITE

$$\Rightarrow \frac{d^2 x_i}{dt^2} = -\omega_{p0}^2 x_i - f \frac{\omega_{pi}^2}{2} (x_i - x_e)$$

HERE  $f \equiv \frac{e N_e}{q N_i} = \text{fractional neutralization}$

Now  $\frac{d}{dt} = \text{total derivative} = \frac{\partial}{\partial t} + v_z \frac{\partial}{\partial z}$

⇒ THE ION & ELECTRON EQUATIONS MAY BE WRITTEN

$$\left( \frac{\partial}{\partial t} + v_z \frac{\partial}{\partial z} \right)^2 x_i = -\omega_{p0}^2 x_i - f \frac{\omega_{pi}^2}{2} (x_i - x_e)$$

$$\frac{\partial^2}{\partial t^2} x_e = -\frac{\omega_{pe}^2}{2} \left( \frac{m_i}{q} \frac{e}{m_e} \right) (x_e - x_i)$$

Now let  $X_e = X_e \exp[i(\omega t - kz)]$ ;  $X_i = X_i \exp[i(\omega t - kz)]$

$$\Rightarrow (-\omega^2 + 2\omega kv_z - k^2 v_z^2) X_i = -\omega_{pi}^2 X_i - f \frac{\omega_{pi}^2}{2} (X_i - X_e)$$

$$-\omega^2 X_e = -\frac{\omega_{pi}^2}{2} \left( \frac{m_i}{m_e} \frac{e}{q} \right) (X_e - X_i)$$

$$\Rightarrow \left[ (\omega - kv_z)^2 - \omega_{po}^2 - f \frac{\omega_{pi}^2}{2} \right] X_i = -\frac{f \omega_{pi}^2}{2} X_e$$

$$\left[ \omega^2 - \frac{\omega_{pi}^2}{2} \left( \frac{m_i}{m_e} \frac{e}{q} \right) \right] X_e = -\frac{\omega_{pi}^2}{2} \left( \frac{m_i}{m_e} \frac{e}{q} \right) X_i$$

Multiplying the above equations and dividing by  $X_e X_i$ , yields the dispersion relation:

$$\underbrace{\left[ (\omega - kv_z)^2 - \omega_{po}^2 - f \frac{\omega_{pi}^2}{2} \right]}_{\text{ION BETATRON FREQUENCY (INCREASED BY SIGN CHANGE OF ELECTRON)}} \underbrace{\left[ \omega^2 - \frac{\omega_{pi}^2}{2} \left( \frac{m_i}{m_e} \frac{e}{q} \right) \right]}_{\text{ELECTRON OSCILLATING IN POTENTIAL WELL OF ION}} = \underbrace{+ \frac{f \omega_{pi}^4}{4} \left( \frac{m_i}{m_e} \frac{e}{q} \right)}_{\text{COUPLING}}$$

ION BETATRON FREQUENCY (INCREASED BY SIGN CHANGE OF ELECTRON)

ELECTRON OSCILLATING IN POTENTIAL WELL OF ION

COUPLING

So a beam with high spatial frequency undergoing betatron oscillations in the coupling frame,  $kv_z - \omega \approx \sqrt{\omega_{po}^2 + f \frac{\omega_{pi}^2}{2}}$

will resonate with electrons oscillating in the ion well if

$$\omega \approx \frac{\omega_{pi}}{\sqrt{2}} \sqrt{\frac{m_i}{m_e} \frac{e}{q}}$$

Giving rise to instability!

FROM DAVIDSON & QIN (22)  
 PHYSICS OF INTENSE CHARGED  
 MULTIPLE BEAMS, 2001, 513

10.4] Instability in Intense Particle Beams

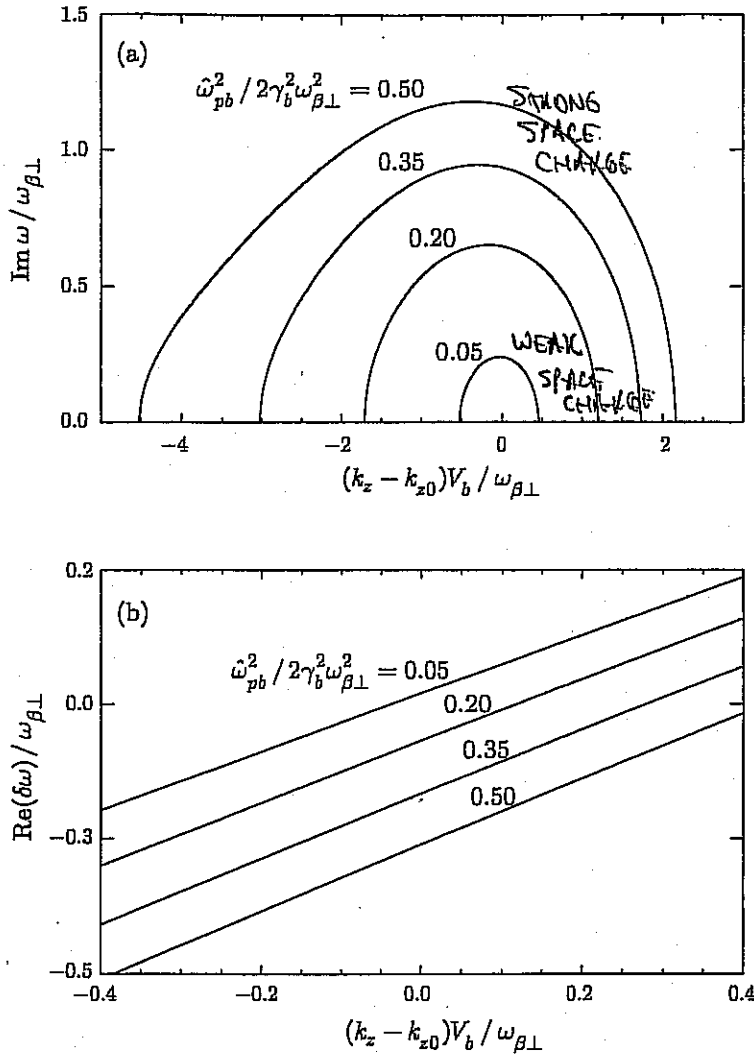

$\omega_{p\perp}^2 \equiv \omega_{pb}^2$

$\frac{\omega_{pb}^2}{2\gamma_b^2\omega_{\beta\perp}^2} \approx 1$   
 $(1 - \beta_{\parallel}^2)$

Figure 10.11. Plots of (a) normalized growth rate ( $Im\omega/\omega_{\beta\perp}$ ), and (b) normalized real frequency ( $Re\omega - \omega_e)/\omega_{\beta\perp}$  versus shifted axial wavenumber  $(k_z - k_{z0})V_b/\omega_{\beta\perp}$  obtained from the dispersion relation (10.103) for the unstable branch with positive real frequency. System parameters correspond to  $v_{T\parallel b} = 0 = v_{T\parallel e}$ ,  $m_b/m_e = 1836$  (protons),  $(\gamma_b - 1)m_b c^2 = 800$  MeV,  $r_b/r_w = 0.5$ , and  $f = 0.1$ . Curves are shown for several values of normalized beam intensity  $\hat{\omega}_{pb}^2/2\gamma_b^2\omega_{\beta\perp}^2$  ranging from 0.05 to 0.5.

$k_{z0} V_z \approx \omega \mp \sqrt{\omega_{p0}^2 + f\omega_i^2/2}$ ;  $\omega = \frac{\omega_{pe}}{2} \sqrt{\frac{\omega_i}{m_e q}}$



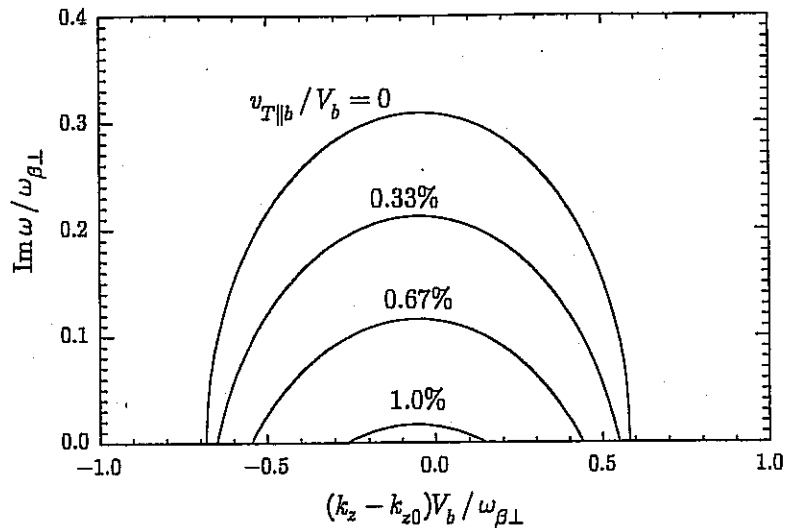

Figure 10.12. Plot of normalized growth rate ( $Im\omega/\omega_{\beta\perp}$ ), and normalized real frequency  $(Re\omega - \omega_e)/\omega_{\beta\perp}$  versus positive real frequency. System parameters correspond to  $\tilde{\omega}_{pb}^2/2\gamma_b^2\omega_{\beta\perp}^2 = 0.07$ ,  $v_{T||e} = v_{T||b}$ ,  $m_b/m_e = 1836$  (protons),  $(\gamma_b - 1)m_b c^2 = 800$  MeV,  $r_b/r_w = 0.5$ , and  $f = 0.1$ . Curves are shown for several values of normalized ion thermal spread  $v_{T||b}/V_b$  ranging from 0 to 0.01.

velocity  $V_b$  [Eq. (10.105)], it is expected that Landau damping by parallel ion kinetic effects can have a strong stabilizing influence at modest values of  $v_{T||b}/V_b$ . That this is indeed the case is evident from Fig. 10.12, which shows a substantial reduction in maximum growth rate and eradication of the instability over the instability bandwidth as  $v_{T||b}/V_b$  is increased from 0 to 0.01.

We now make use of the nonlinear particle perturbative simulation method [60, 61] described in Sec. 8.5 to illustrate several important properties of the two-stream instability in intense beam systems (Sec. 10.4.2).

PREVENTIVE MEASURES (from J. Weid & Meek, GENN electron cloud workshop 2003)

- SUPPRESS ELECTRON GENERATION

- SURFACE TREATMENT OF THE VACUUM PIPE
- KICKER MAGNETS IN GRIS
- VACUUM VOLTS SCREENED TO REDUCE E-ADD
- CLEANING ELECTRODES
- HIGH VACUUM
- SOLENOIDS - TO REDUCE MULTIPACTING

# SUMMARY OF ELECTRON, GAS, PRESSURE, & SCATTERING EFFECTS

1. COULOMB COLLISIONS WITHIN BEAM CAN TRANSFER ENERGY FROM I TO II AND PROVIDE LOWER LIMIT ON  $T_{II}$ , HIGHER THAN FLOW ACCELERATIVE COOLING.
2. COULOMB INTERACTIONS WITH RESIDUAL GAS NUCLEI PROVIDE A SOURCE OF EMITTANCE GROWTH (BUT NOT IMPORTANT FOR HIGH CURRENT AND LONG RESIDENCE TIMES).
3. PRESSURE INSTABILITY FROM DESORPTION OF RESIDUAL GAS BY STRUCK BEAM IONS HITTING WALL OR BEAM-IONIZED RESIDUAL GAS ATOMS, FORCED TO WALL BY E-FIELD OF BEAM. LIMITS CURRENT IN RINGS OR HIGH VELOCITY LINAC.
4. ELECTRONS CAN CASCADE AND REACH A "QUASI" EQUILIBRIUM POPULATION OF SIMILAR LINE CHARGE TO THE ION BEAM. ELECTRON-ION TWO STREAM INSTABILITY IS UNSTABLE, AND CAN LEAD TO TRANSVERSE INSTABILITY, SIMILAR TO WHAT IS OBSERVED IN SOME PROTON RINGS.



John Barnard  
Steven Lund  
USPAS  
June 2008

An application of intense beams

- 1. Heavy-ion fusion
  - A. Requirements
  - B. Targets for ICF
  - C. Accelerator
  - D. Drift compression
  - E. Final focus
  - F. Experiments

**Inertial Fusion Energy (IFE) power plants of the future will consist of four parts**

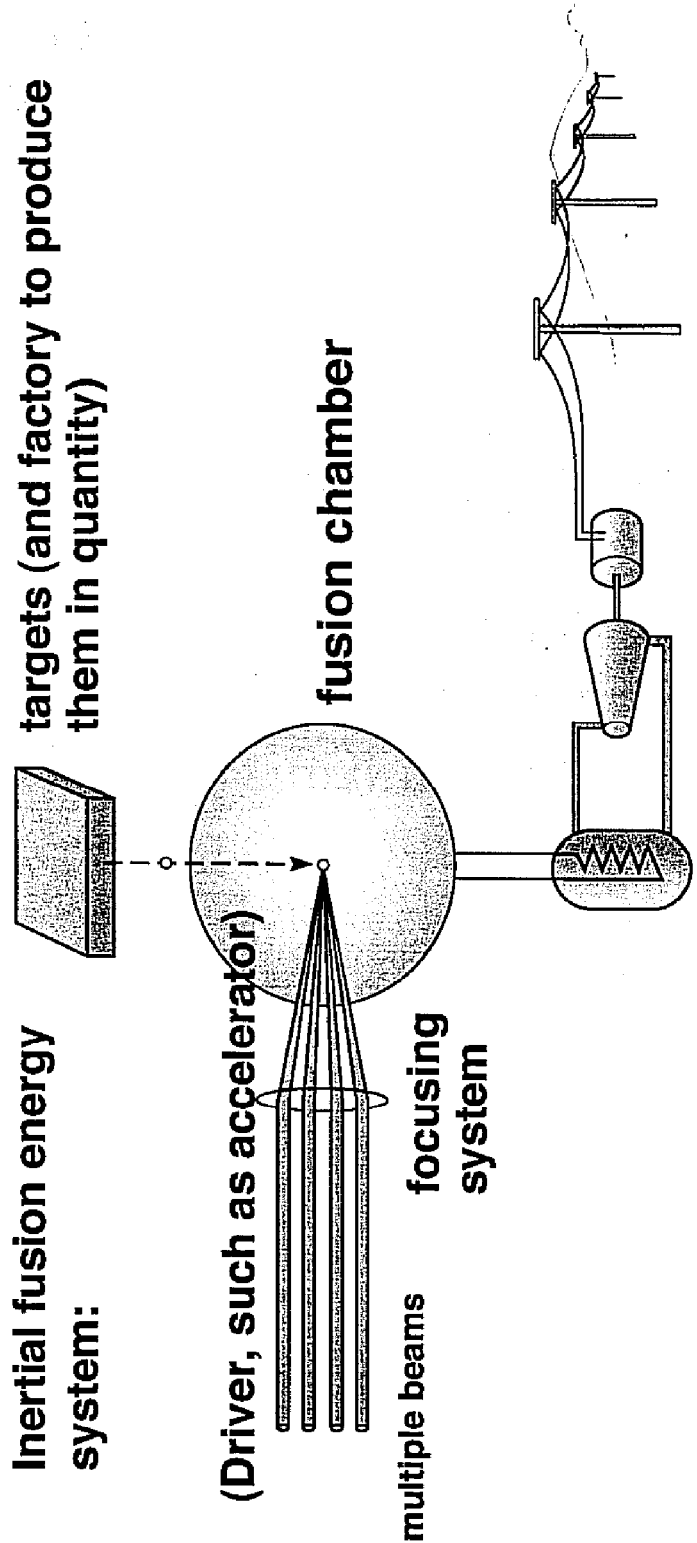

**heat exchange/steam turbine for electricity production**



## Heavy Ion Fusion provides an attractive approach to long term energy production



Fusion offers an inexhaustible, long term solution to the problem of future energy supplies free from long-lived radioactive by-products and greenhouse CO<sub>2</sub>.

Inertial Confinement Fusion (ICF) uses laser or particle beams to implode a target, raising the temperature and density of the fuel, creating the conditions necessary for the following reaction:



Heavy ion accelerators are a strong candidate for inertial fusion energy production (IFE) because of:

- High efficiency
- High repetition rate
- Survivability of final lens
- Favorable target illumination geometry

# National Ignition Facility has 192 beams of 40-cm aperture arranged in four beam clusters

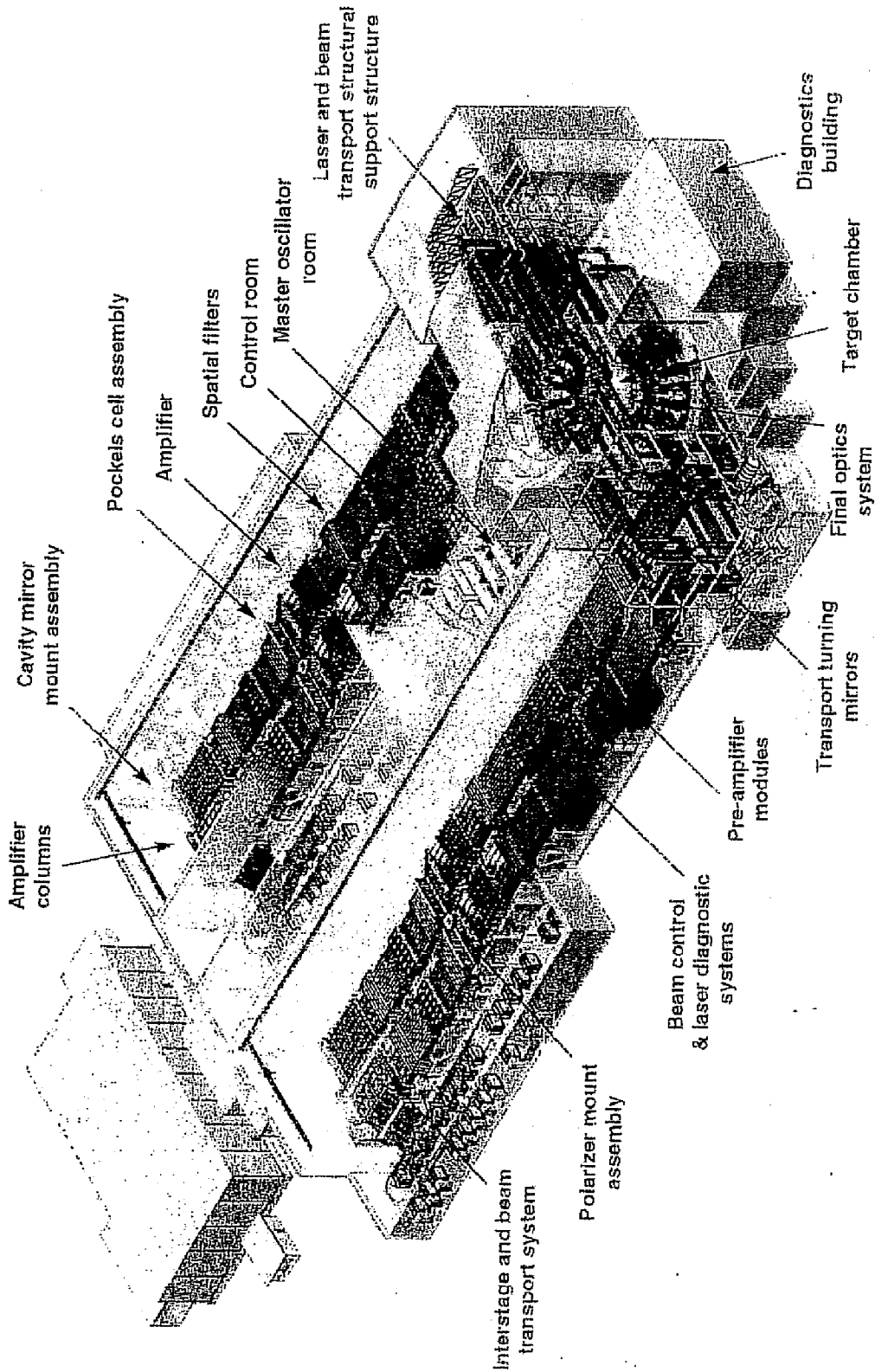

**NIF illustrates many of the features of IFE development and will play a critical role in addressing IFE feasibility**

40-00-0996-2100YA  
03GAC/9sh

5/1/98  
ENCLOS



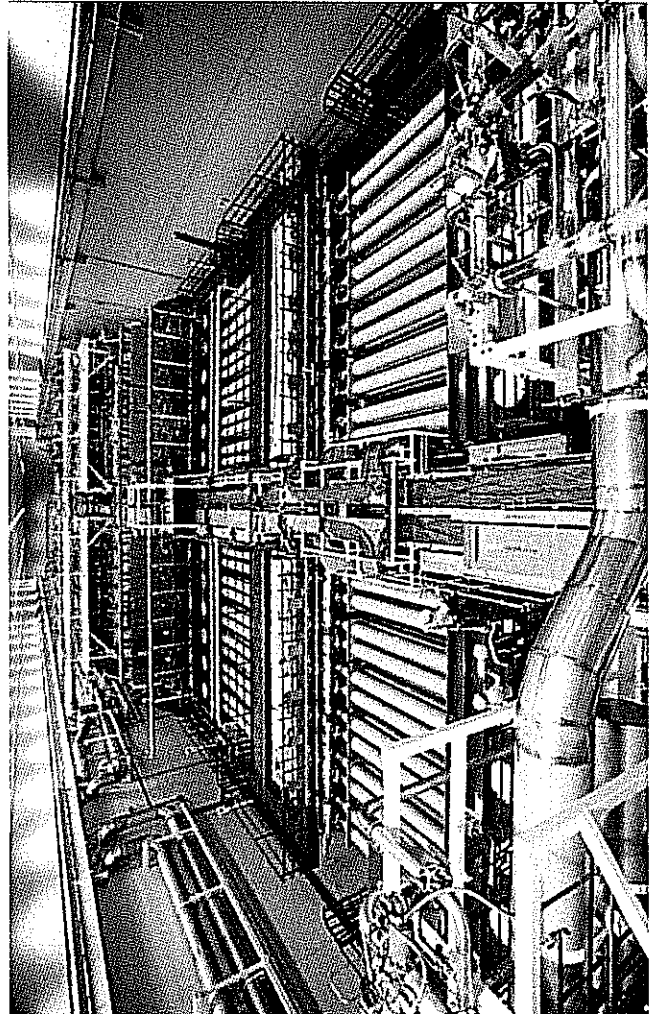
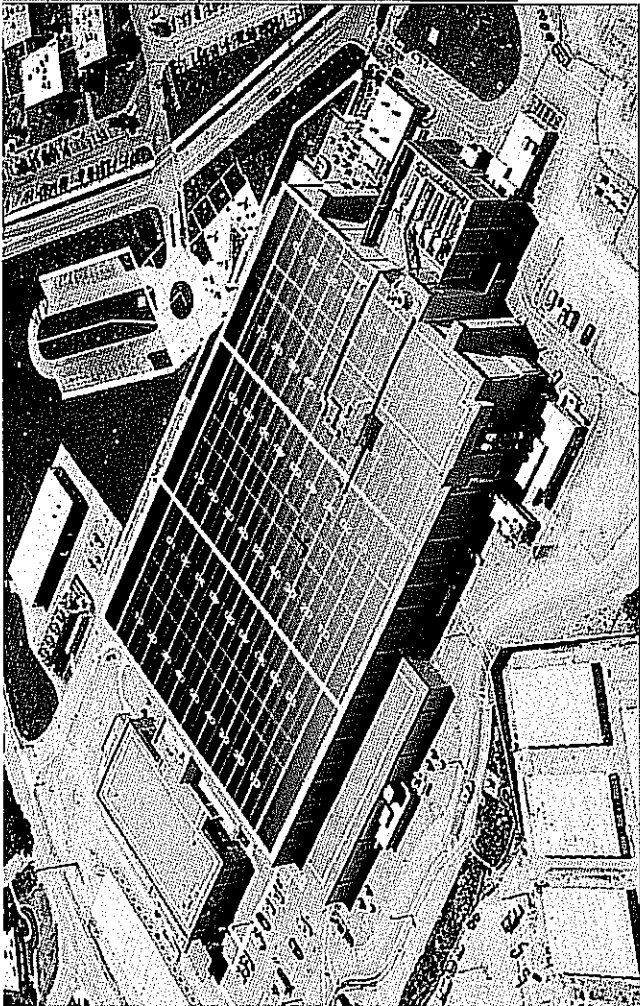
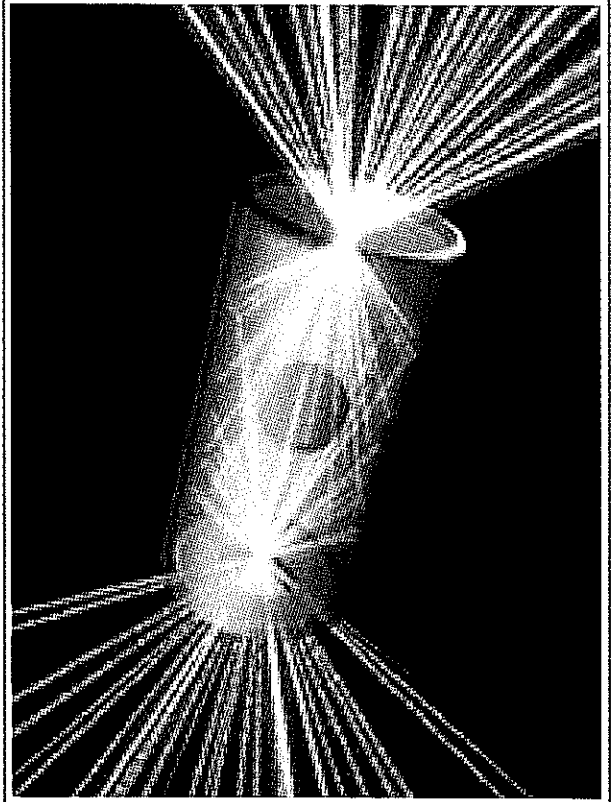
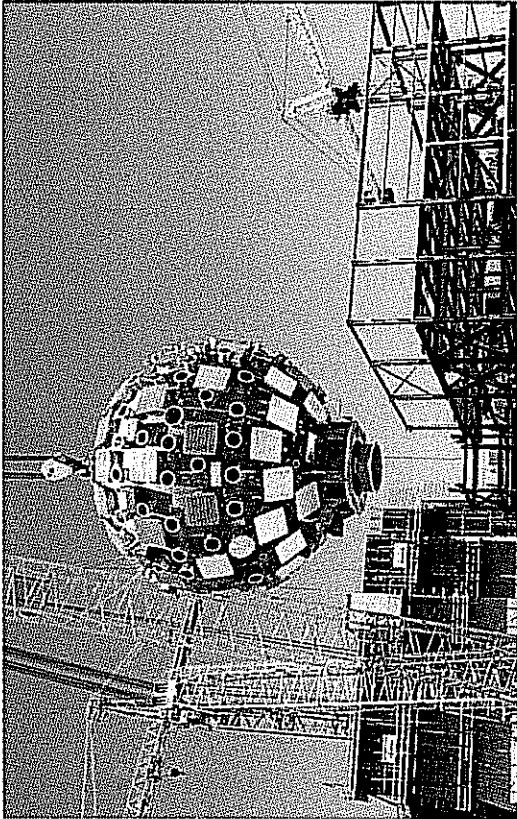

# The two principal approaches to ICF are direct drive and indirect drive

## Two types of targets:

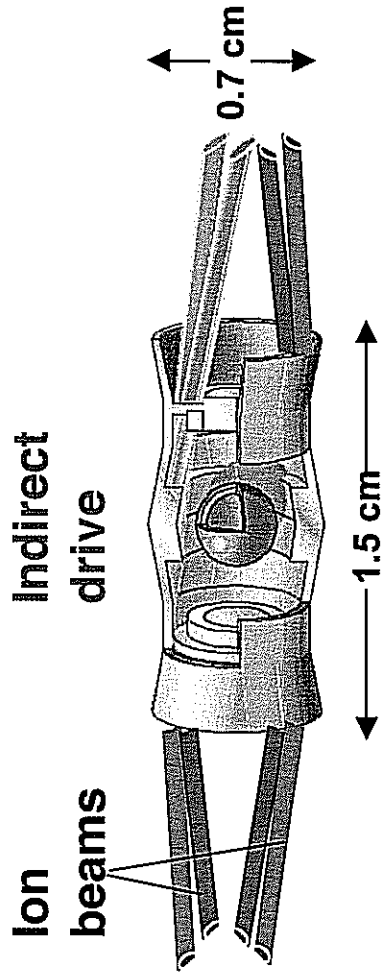
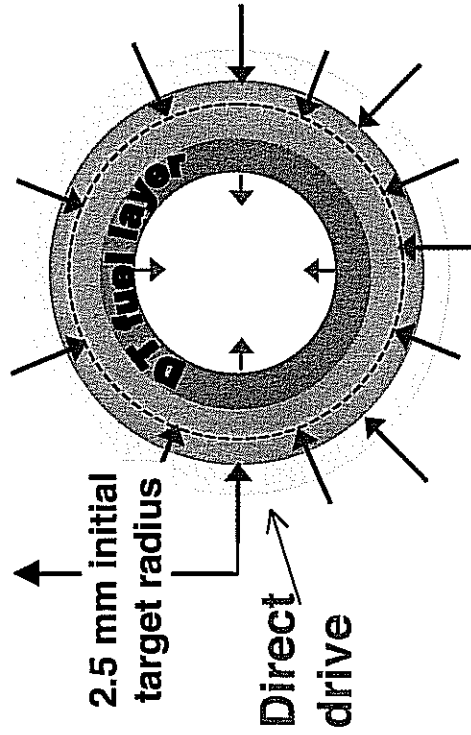

**Indirect drive advantages:**

- Relaxed beam uniformity (reduced hydro instability)**
- Significant commonality for lasers and ion beams**
- Significant simplification of chamber geometry**

**Direct drive advantages:**

- Higher coupling efficiency with potential for higher gain**

# The two principal approaches to ICF are direct drive and indirect drive

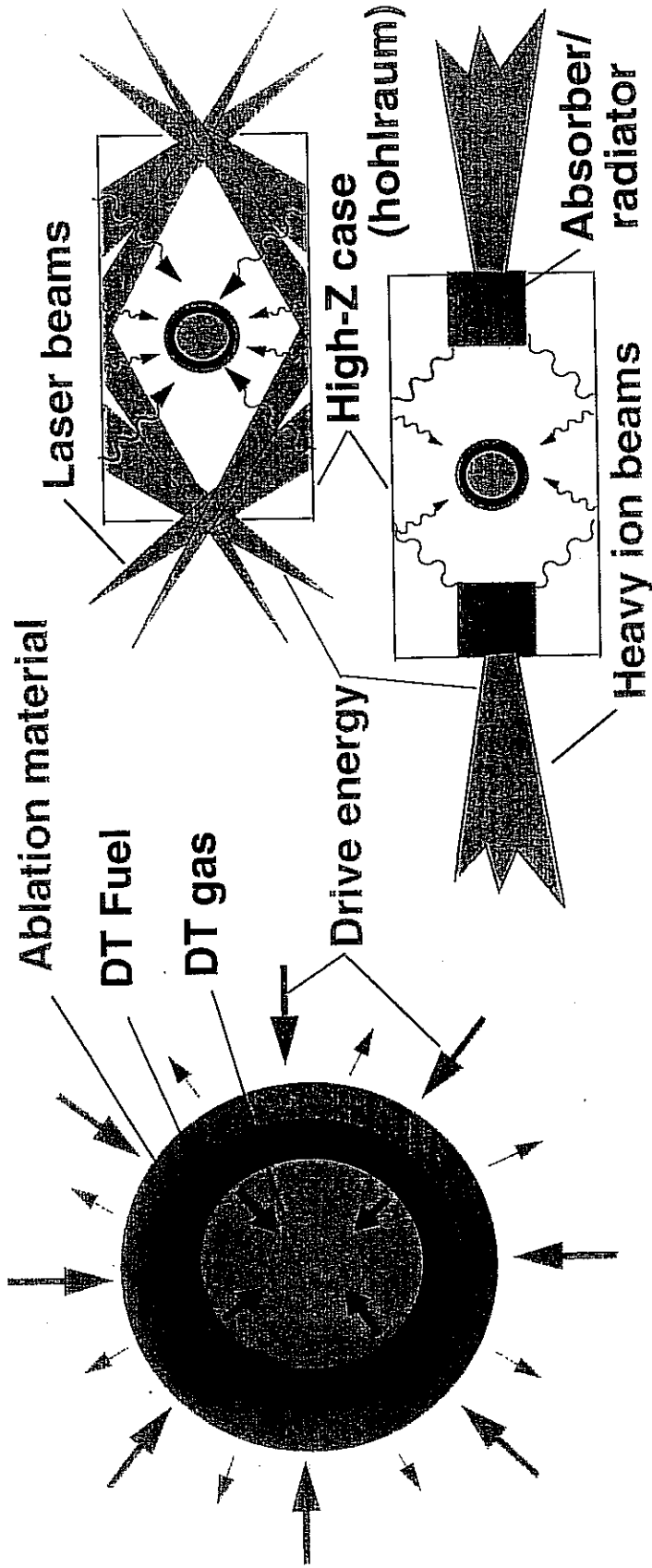

## Direct drive:

### Advantage:

Higher coupling efficiency  
(with potential for higher gain)

## Indirect drive:

### Advantages:

Relaxed beam uniformity  
(reduced hydro instability)  
Significant commonality for lasers and ion beams  
Significant simplification of chamber geometry

"FAST IGNITION" IS AN ALTERNATIVE TO "HOT SPOT" IGNITION

- CAPSULE IS COMPLETED ON LOW ADIABAT
- SECOND "IGNITION" PULSE STARTS IGNITION PHASE

COMPRESSION PULSE  $E \sim 200 \text{ kJ} - 1 \text{ MJ}$

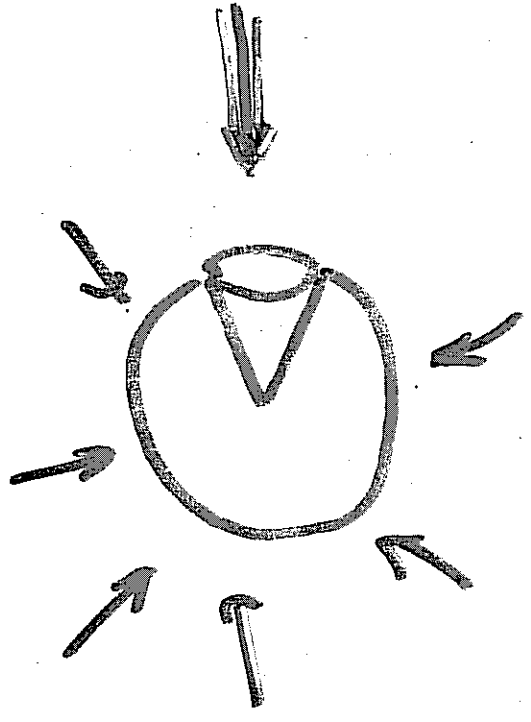

IGNITION PULSE

$E \sim 20 \text{ kJ}$

$\lambda \sim 20 \mu\text{s}$

$\nu \sim 20 \mu\text{s}$

( CAPSULE  
PULSED BY  
100% BEAM )

A "DISTRIBUTED RADIATOR" TARGET PRODUCES HIGH GAIN ION RADIATION - HYDRODYNAMIC SIMULATIONS

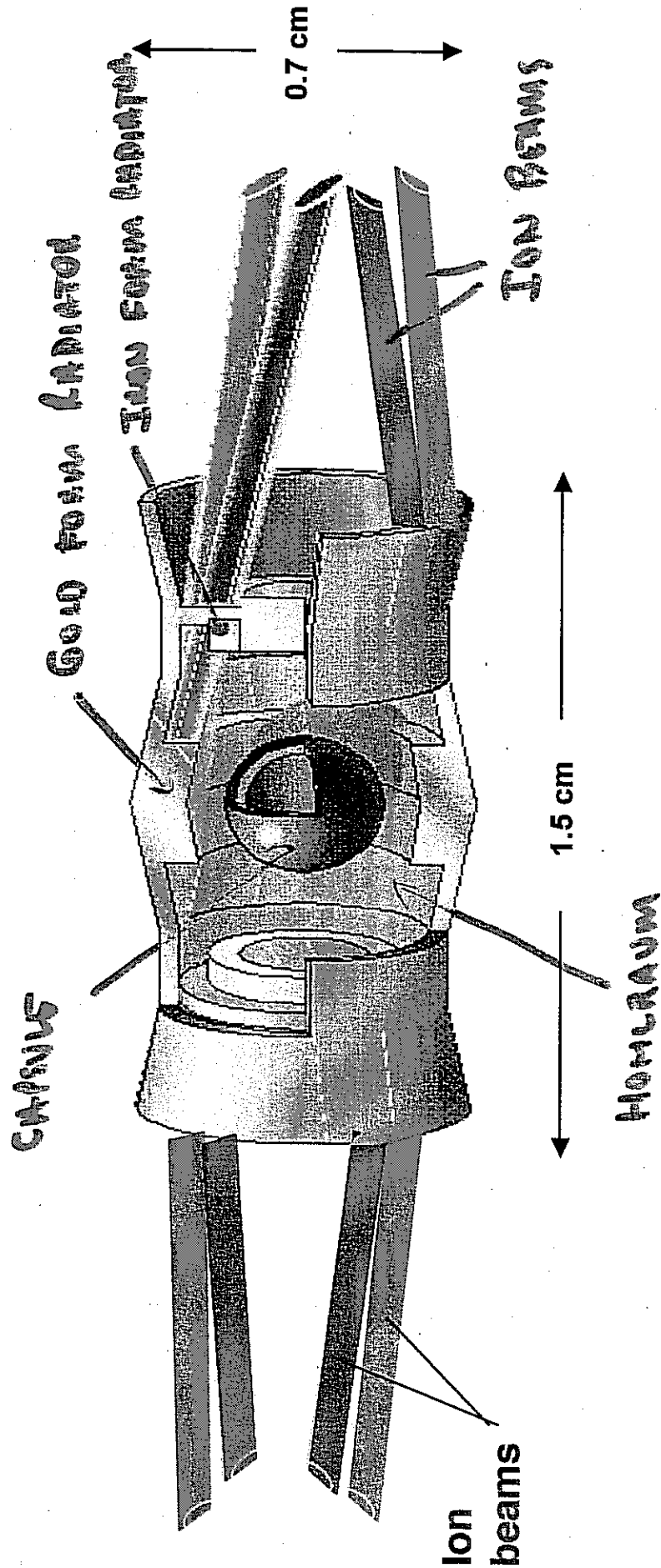

# Ion current profile and radiation temperature

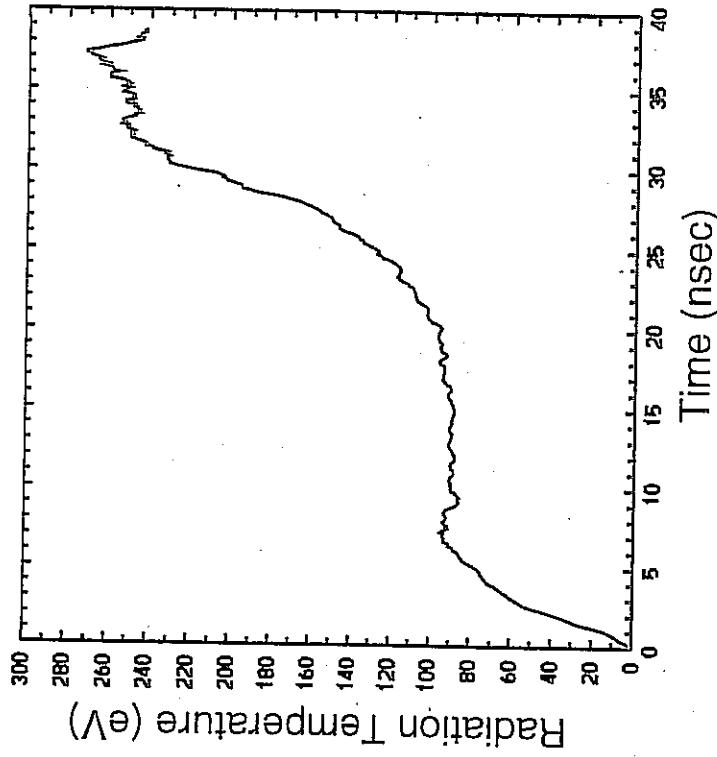
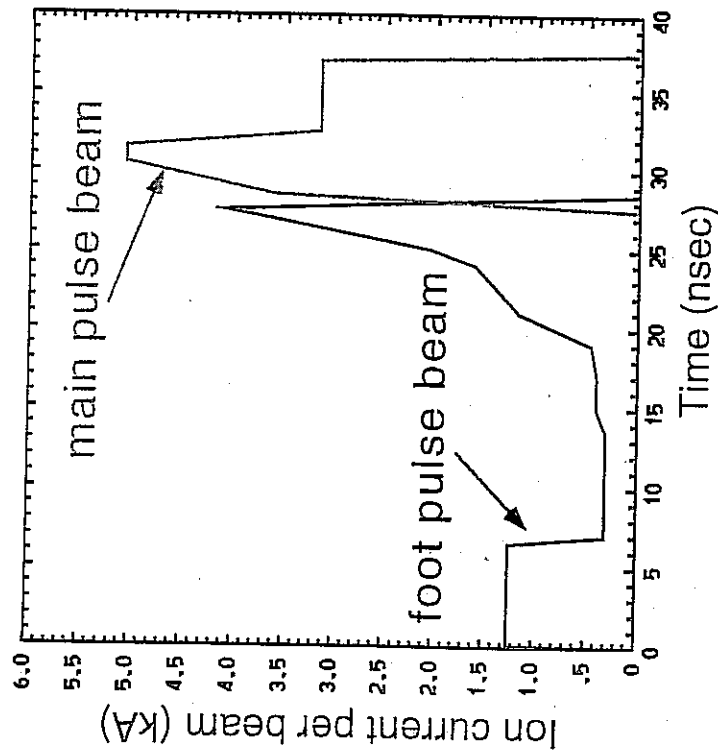

Current assumes 16 beams in foot pulse  
32 beams in main pulse

# Overlapping Gaussian, elliptical beams are focused at the end of the target



Each beam is an ellipse

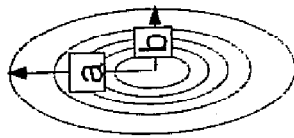

$a = 4.15 \text{ mm}$

$b = 1.8 \text{ mm}$

effective  $r = 2.7 \text{ mm}$

95% of charge inside

8 beams overlap in the foot pulse

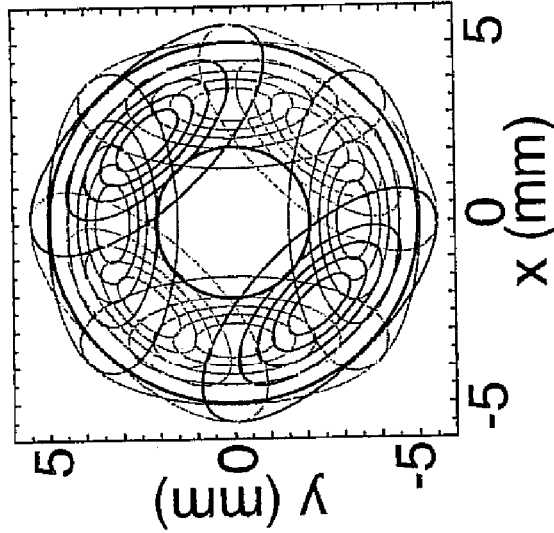

Sum of 8 foot pulse beams

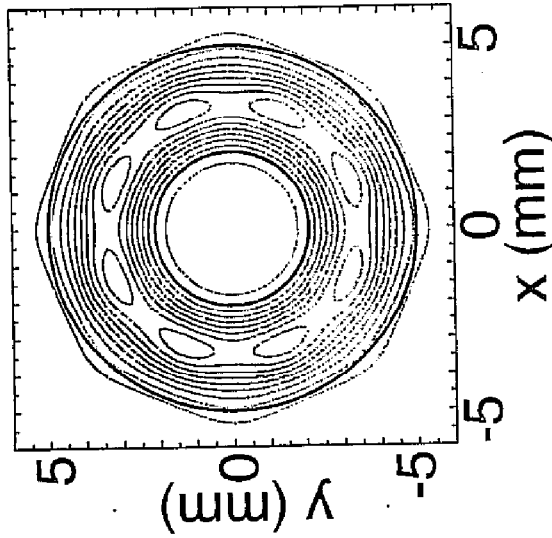

Azimuthal asymmetry:

foot pulse: -1.6% in  $m=8$

main pulse: 0.06% in  $m=16$

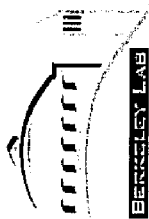

# Why Heavy Ions?

## Target requires:

3.5 - 6 MJ in ~ 10 ns  $\Rightarrow$  ~ 500 TW

Range ~ 0.02 - .2 g/cm<sup>2</sup>

Range requirement



Higher mass  $\leftrightarrow$  higher kinetic energy

Power Requirement



Current  $\propto \frac{1}{\text{kinetic energy}}$



**Higher mass requires lower current (easier to focus).**



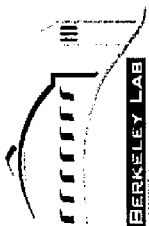

# Heavier Ions $\Rightarrow$ Higher Kinetic Energy

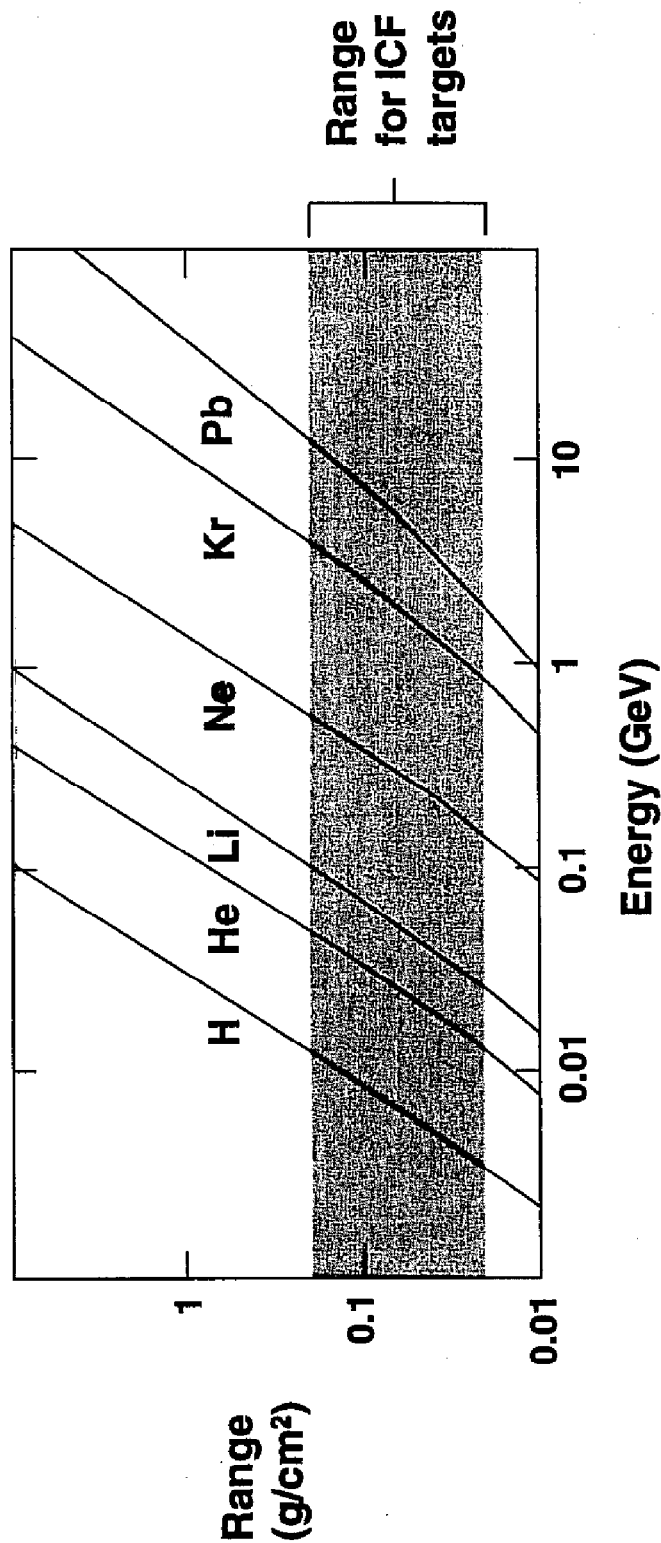

**Targets require high power (kinetic energy x current).**

- Light Ion Fusion requires high-current, unconventional accelerators (Sandia 1970s).
- Heavy Ion Fusion requires lower currents enabling the use of more conventional high energy accelerators (Maschke ~ 1974).



# There are two principle methods of acceleration

## 1. r.f. acceleration (Approach in Europe and Japan)

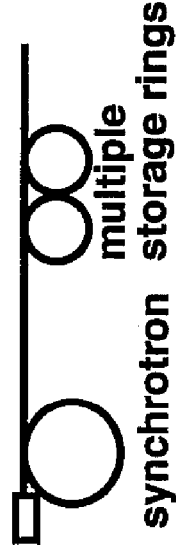
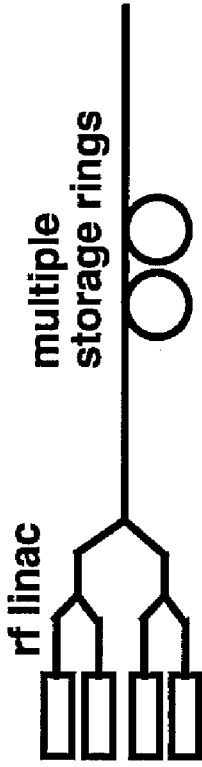
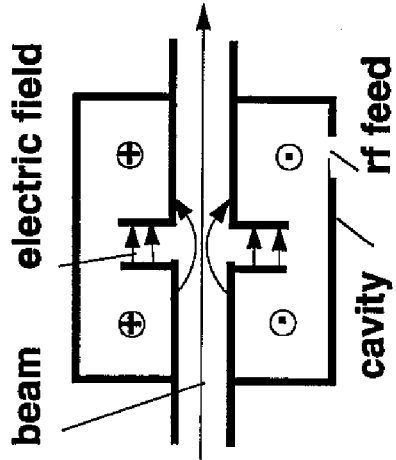

## 2. Induction acceleration (U.S. approach)

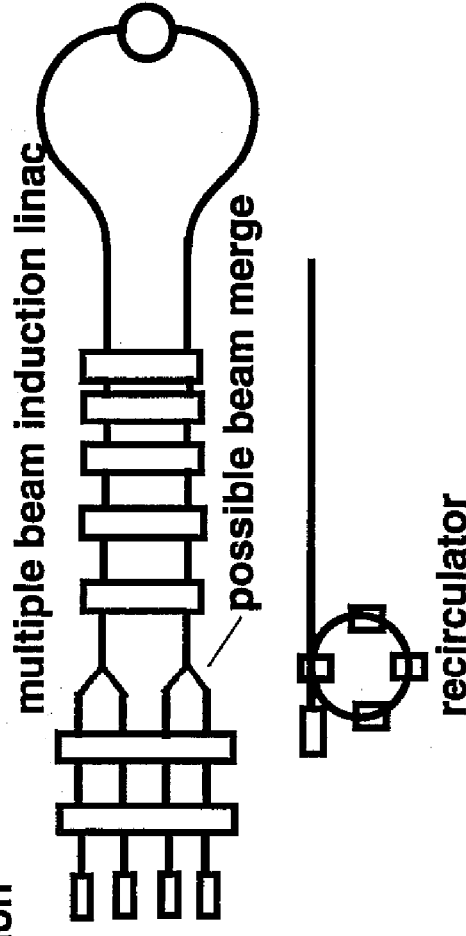

# Induction acceleration for HIF consists of several subsystems and a variety of beam manipulations

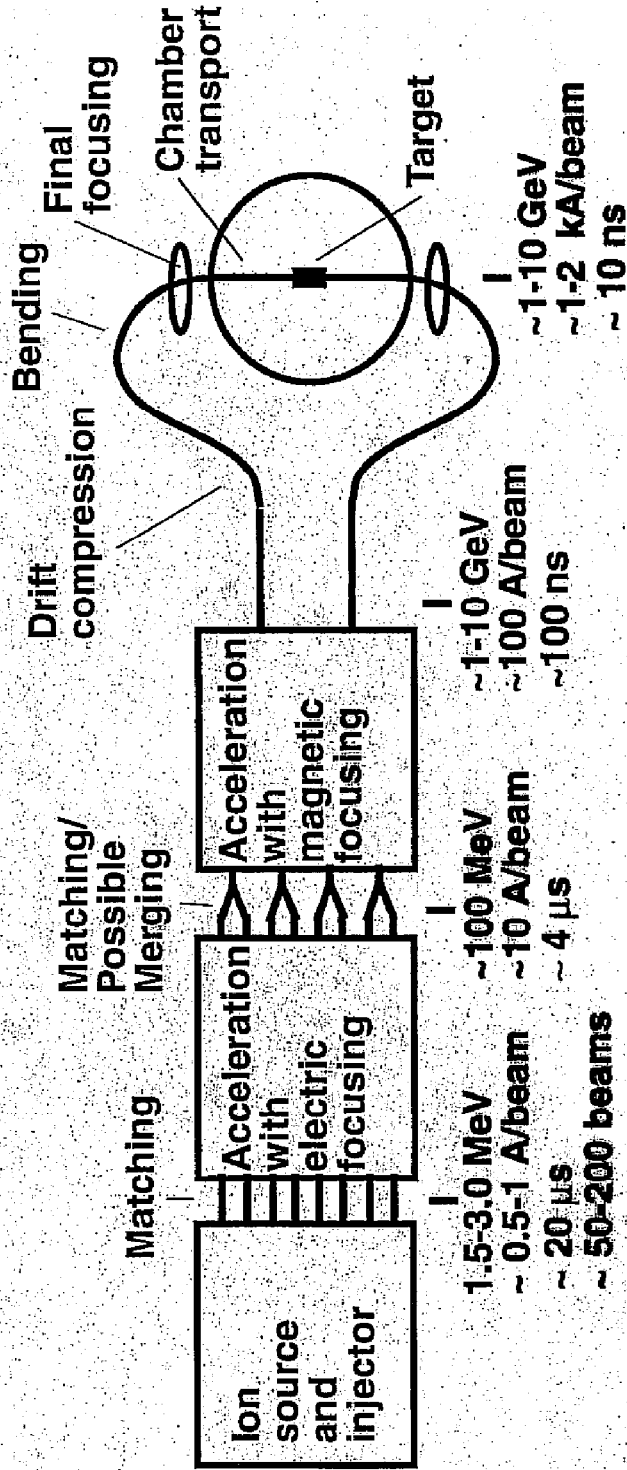

# A Robust Point Design study established a baseline for a multiple-beam quadrupole induction linac HIF driver

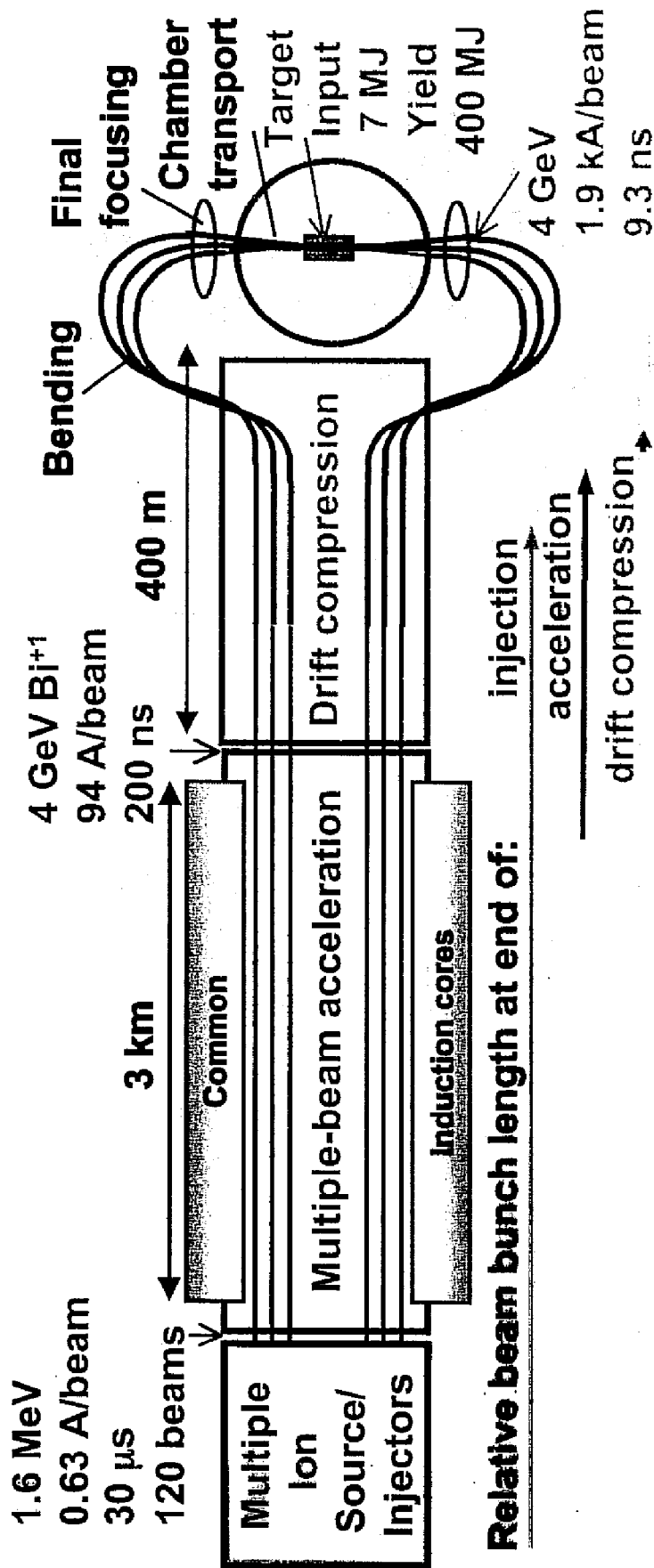

# A solenoid focus option leads to a low V, high current modular driver with advantageous development path

Pulse energy ~ 6.7 MJ

V ~ 200-300 MV: T ~ 2.5 GeV Xe<sup>8+</sup> ions or T ~ 200 MeV for Ne<sup>11</sup>

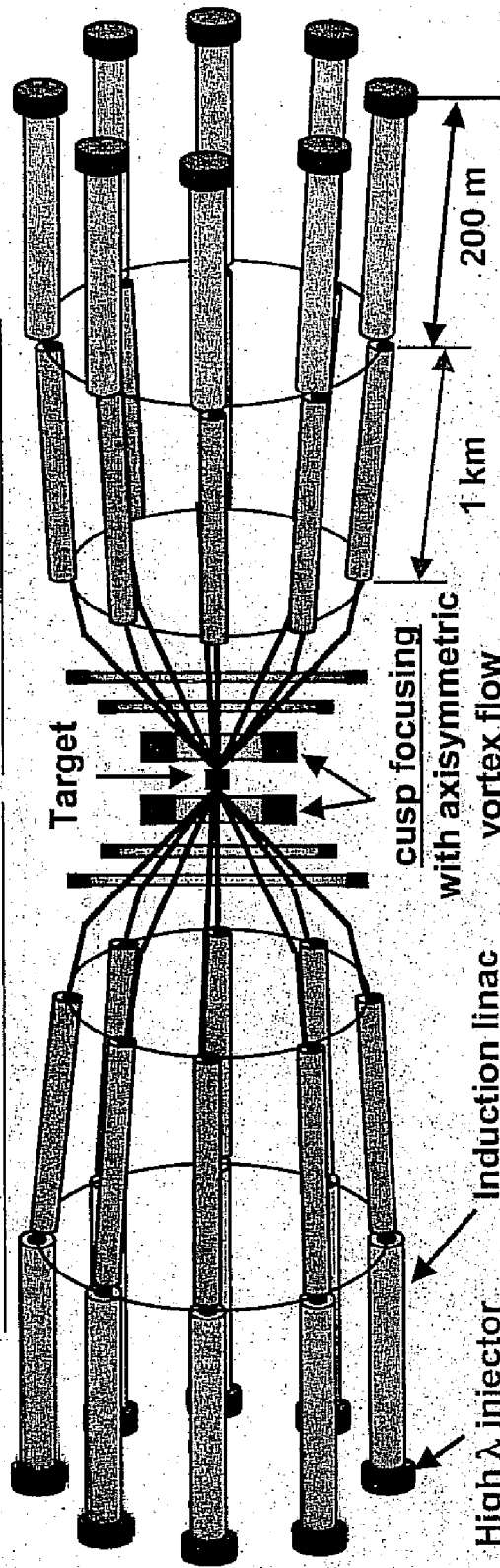

High  $\lambda$  injector  
Merging beamlet source/injector

or  
accel/decel injector

Induction linac  
single beams  
 $r_p \sim 15$  cm  
 $B_s \sim 9$  T  
 $I \sim 6.7$  kA

T ~ 2.5 GeV  
 $\Delta t \sim 100$  ns

double pulsed for foot and main pulses

cusp focusing with axisymmetric vortex flow

or

adiabatic plasma  
lense assisted pinch with cross-jet flow. liquid walls

Neutralized drift compression

$\Delta v/v \sim 0.01$

(no space charge stagnation)

# Summary of Current Limits from Different Focusing Methods

## EINZEL LENS

$$Q_{max} \approx \frac{3\pi^2}{8} \left( \frac{q\beta_0}{m\beta_0^2} \right)^2 \left( \frac{V_0}{L} \right)^2$$

## SOLENOIDS

$$Q_{max} = \left( \frac{\omega_c V_0}{2\gamma\beta c} \right)^2$$

## QUADRUPOLE FOCUSING

$$Q_{max} \approx \frac{\eta Q_0}{2\pi} \left( \frac{\sin \frac{\pi}{2}}{\frac{\pi}{2}} \right)$$

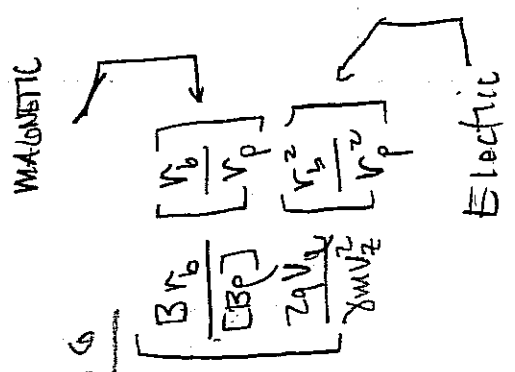

## FOR NON-RELATIVISTIC BEAMS

$$\lambda_{max} \propto \frac{Q_0^2}{V}$$

$$\lambda_{max} \propto \frac{q}{m} B^2 r_p^2$$

$$\left\{ \begin{array}{l} B_1 V^{1/2} r_p \\ N_q \end{array} \right.$$

NOTE

- $Q_0$  = Voltage between Einzel lenses
- $V_q$  = Voltage on a quad relative to ground
- $V$  = particle energy /  $q$



# Major components of an induction linac

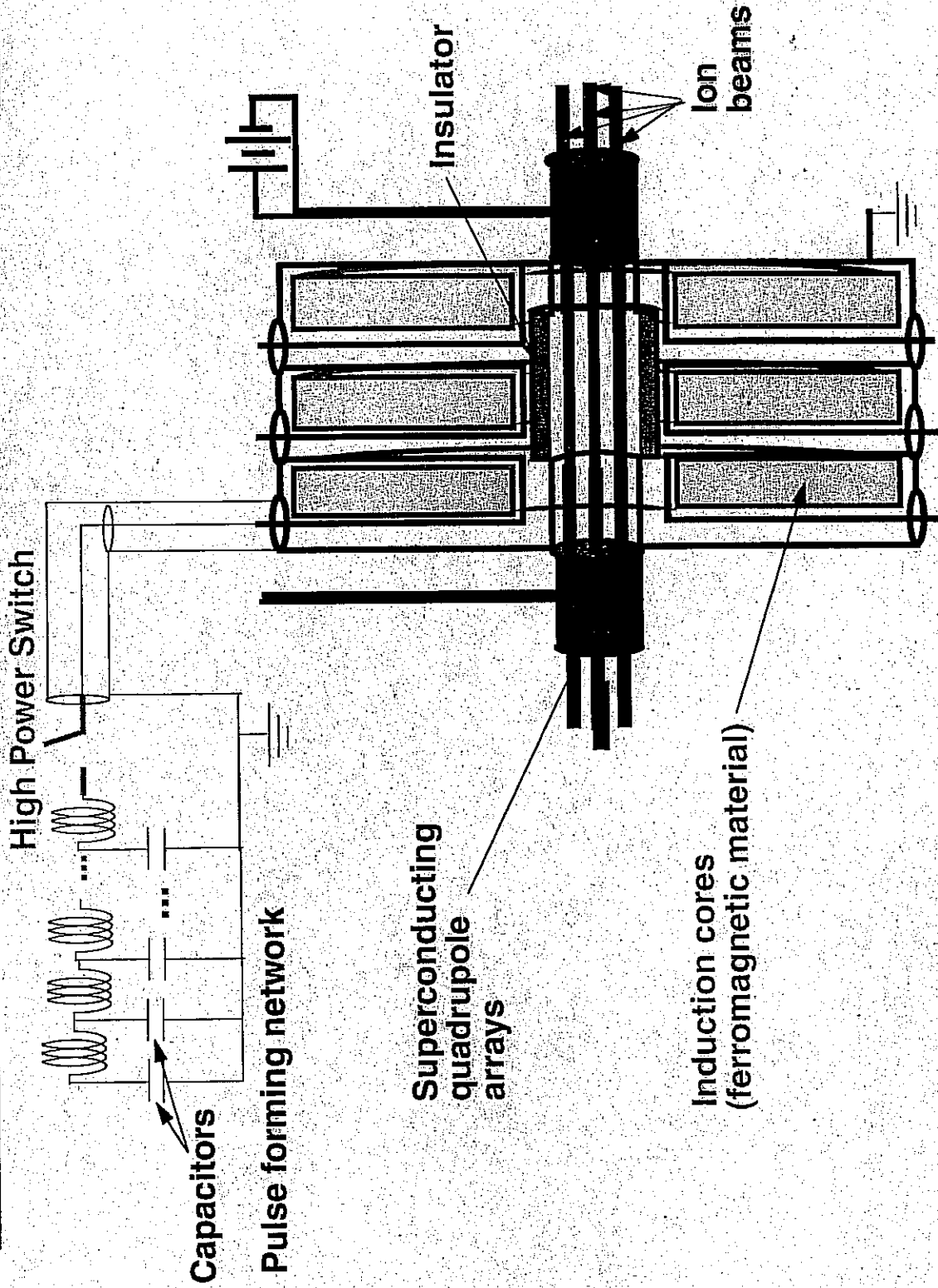

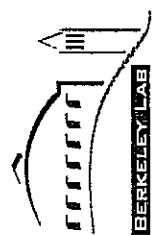

# An Induction Core

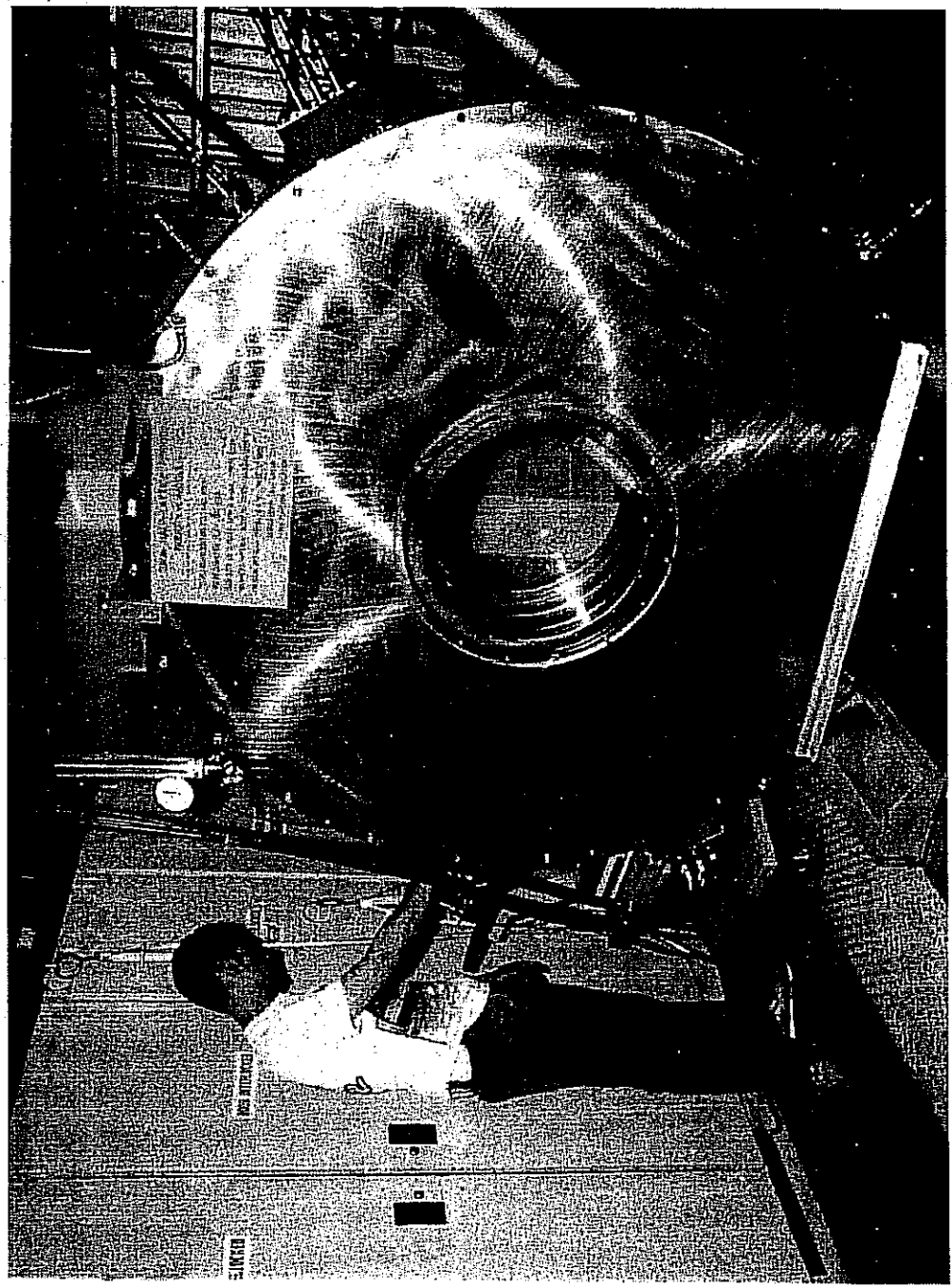



An array of small beamlets increases the total beam current through the core.



From class:

$$Q = \left( \frac{dI}{I} \right) \frac{a}{L}$$

$$Q \approx \frac{N_b I_b}{I} \frac{a}{L}$$

$$I \approx \frac{I_b N_b a}{L} \approx \frac{I_b N_b a}{L} \frac{1}{r_p}$$

Core (radius =  $R_{\text{core}}$ )

Multibeam quad array

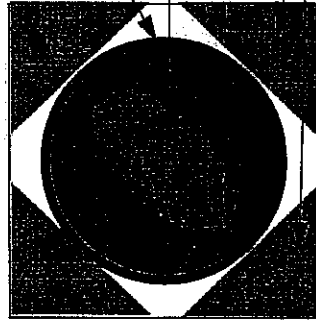
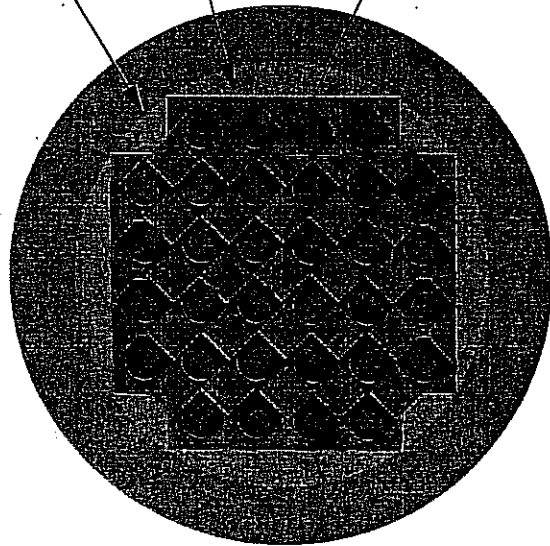

beam pipe (radius =  $r_p$ )

beam (radius =  $a$ )

quadrupole magnet winding

Current per beam =  $I_b \sim a^2 B \beta^2 / r_p$

$r_p \sim a$  (until misalignments require minimum size--better:  $r_p = c_1 a + c_2$ )

so  $I_b \sim a$ ;  $N_b$  = number of beams in array  $\sim R_{\text{core}}^2 / a^2$

Total current through core =  $I_{\text{tot}} = N_b I_b \sim R_{\text{core}}^2 / a$  (until misalignments dominate scaling)



# A Typical driver has about 2000 individual modules

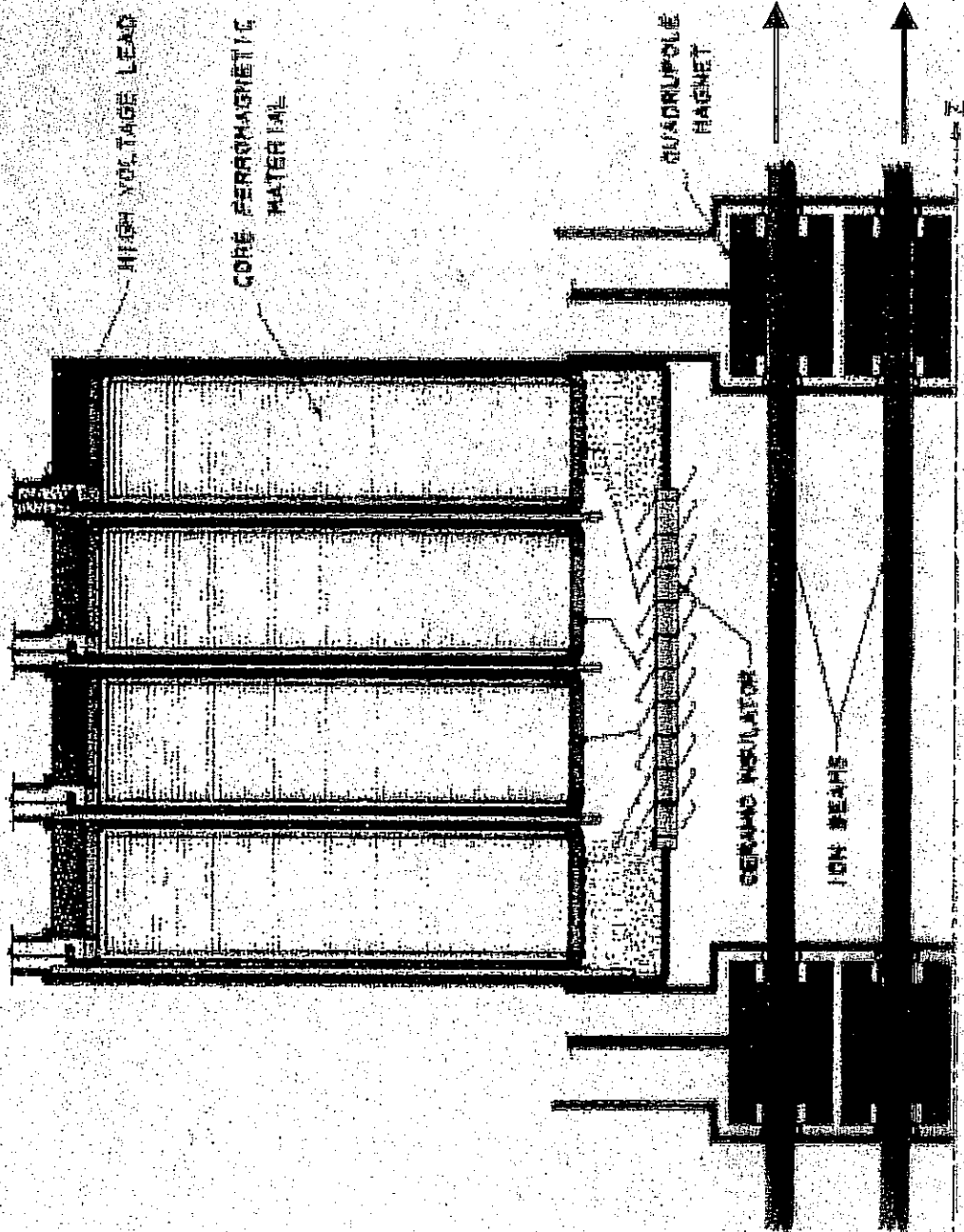

BRUKER LAB

18

# Focusability at the target is key scientific issue



Conditions of beam at target are set by hohlraum and implosion physics



Energy in pulse: ~ 3 to 6 MJ

Duration of main pulse: ~ 8 to 10 ns

Duration of foot pulse: ~ 30 ns

Spot radius: ~ 1.5 to 3 mm

Transverse and longitudinal compression are required to meet target  
y z specifications.



Radius of beam at source ~ 1-3 cm

At target ~ 1.5-3 mm

Compression factors of 10 to 50 in both longitudinal and transverse directions are required.

## In an induction linac, certain limits constrain design

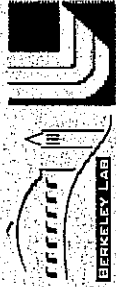

Phase advance per lattice period  $\sigma_0 < \sim 85^\circ$  (to avoid envelope/lattice instabilities)  $\uparrow$  emittance growth).

Space charge is limited by external focusing  $K < (\sigma_0 a / 2L)^2$  where  $K$  is the perveance (proportional to line charge density over beam Voltage),  $a$  is the average beam radius and  $L$  is the half-lattice period.

Velocity tilt  $\Delta v/v < \sim 0.3$  for electrostatic quads (larger for magnetic quads) to avoid mismatches at head and tail of beam, and to ensure tail radius within pipe and head  $\sigma_0$  within limit)

Volt-seconds per meter  $(dV/ds) l/v_0 < \sim 1.5-2.0$  V-s/m (for "reasonable" core sizes)

Voltage gradient  $dV/ds < \sim 1-2$  MV/m (to avoid breakdown in gaps)

## **Sources of non-linearity and mismatch are well defined**

---



### **Sources of non-linearities**

- External focusing magnets**
- Space-charge**
- Multiple-beam effects**

### **Sources of mismatch**

- Accelerator imperfections**
  - Quad strength and placement errors**
  - Acceleration waveform errors**
  - Bend strength errors**
- Velocity tilt**

**Simulations give reliable and definitive tolerances on each source**

## Several potential instabilities have been investigated in HIF drivers



### Temperature anisotropy instability

After acceleration  $T_{\parallel} \ll T_{\perp}$ , internal beam modes are unstable; saturation occurs when  $T_{\parallel} \sim T_{\perp}/3$

### Longitudinal resistive instability

Module impedance interacts with beam, amplifying space-charge waves that are backward propagating in beam frame

### Beam break-up (BBU) instability

High frequency waves in induction module cavities interact transversely with beam

### Beam-plasma instability

Beam interacts with residual gas in target chamber

All of these instabilities have known analytic linear growth rates, which constrain the accelerator design (to ensure minimal growth or benign saturation).

**M. de Hoon studied a final current pulse that is flat with parabolic ends using the HERMES code**

15 ns final pulse duration

The initial tilt on the beam is about 4% (compare to ~30% at the beginning of the accelerator)

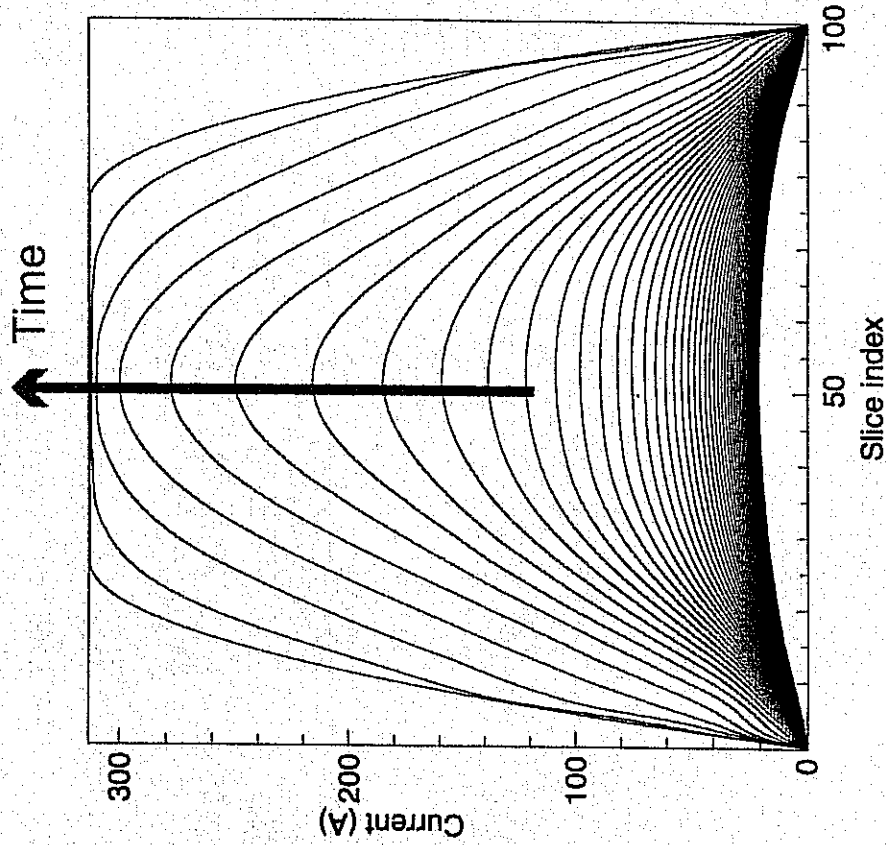
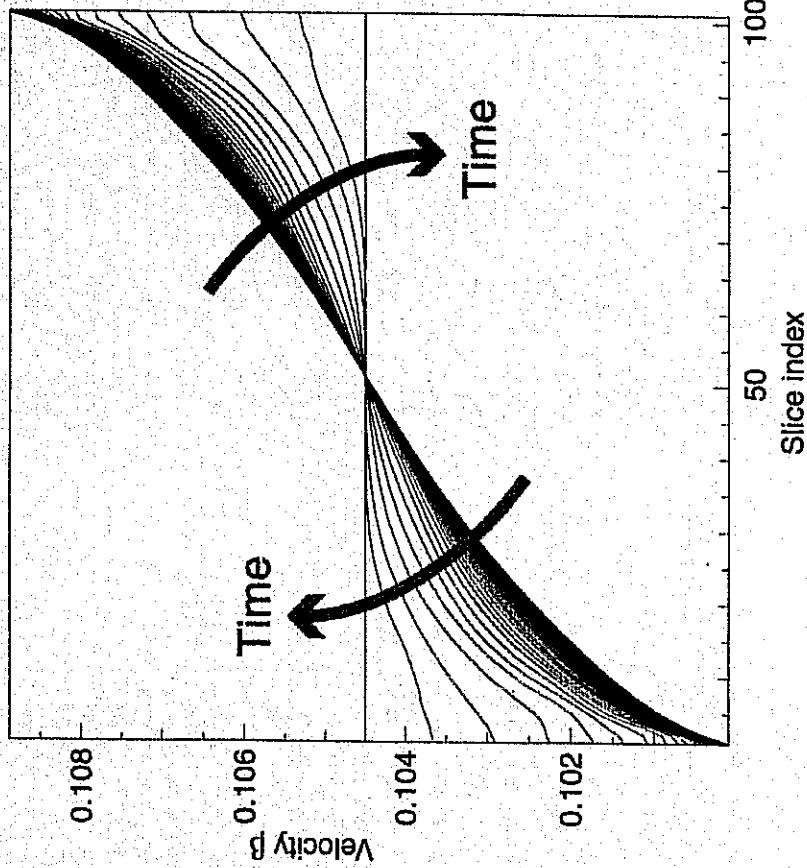

Although the final beam profile is flat, it is parabolic for most of the drift compression



The Heavy Ion Fusion Virtual National Laboratory

**Drift compression section is designed by running code first backwards from target, then forwards after rematching**

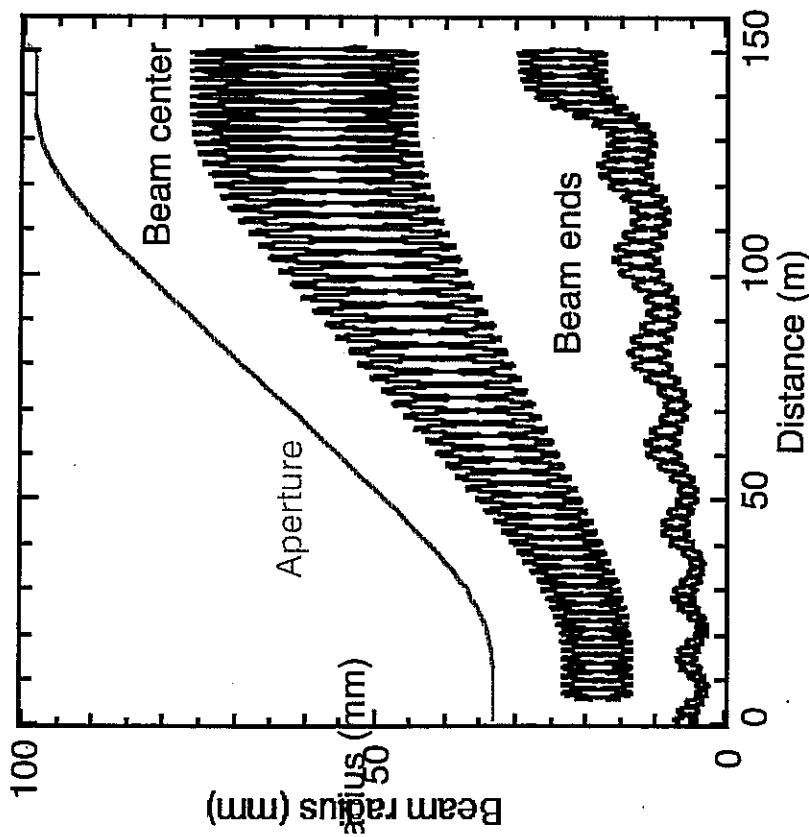

**Begin with a desired 20ns, constant-energy pulse at end of compression, track backwards, design lattice for central slice; beam end becomes mismatched early on**

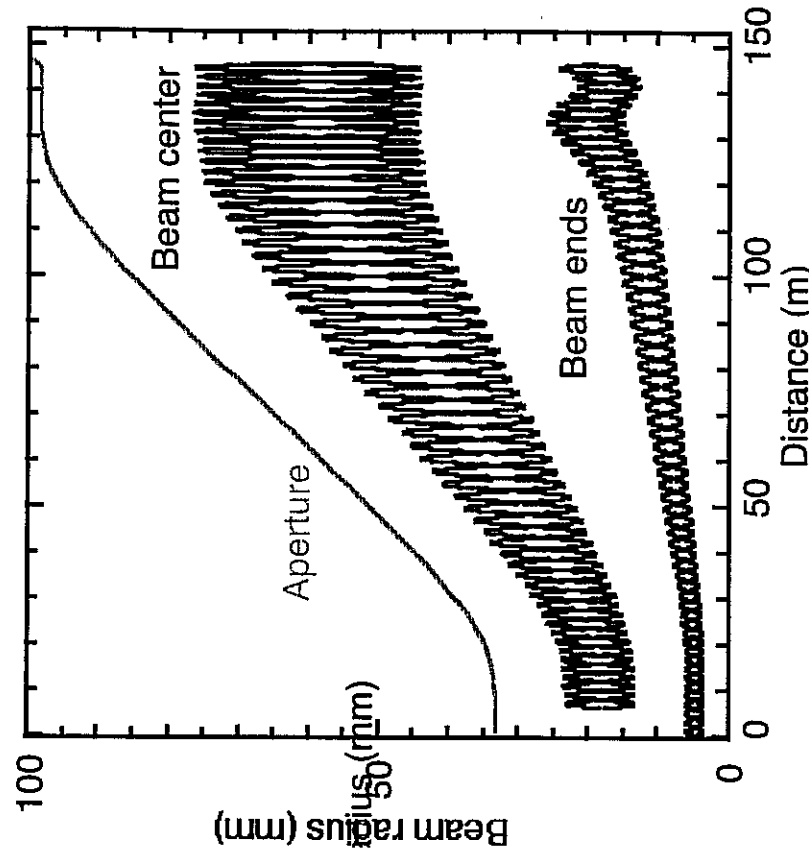

**“Rematch” at entrance to compression section, by adjusting a,a’,b,b’; then track forward**



# The HYLIFE-II ion beam-driven power plant is shown with a two-end target, illustrated from two sides and a linear heavy-ion induction driver



The liquid wall protection including beam ports is provided by pumping molten salt (Flibe) through the chamber

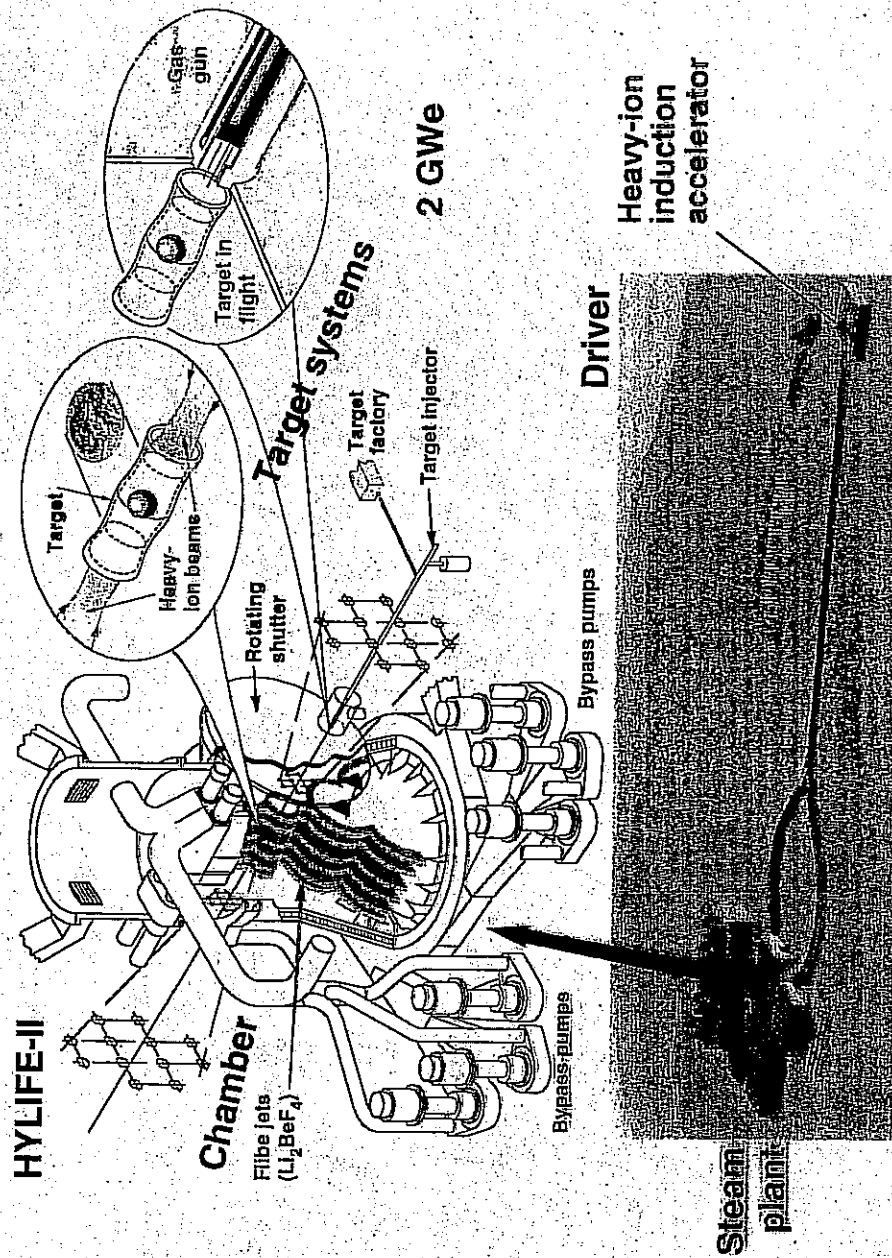

Liquid-jet protected fusion chambers for long lifetime, low cost, and low environmental impact

# The First Wall Protected by Neutron-thick Molten Salt FLiBe, FLiBe is a low Z salt $\Rightarrow$ low activation $\Rightarrow$ Green fusion energy

(One Half Cut Away)

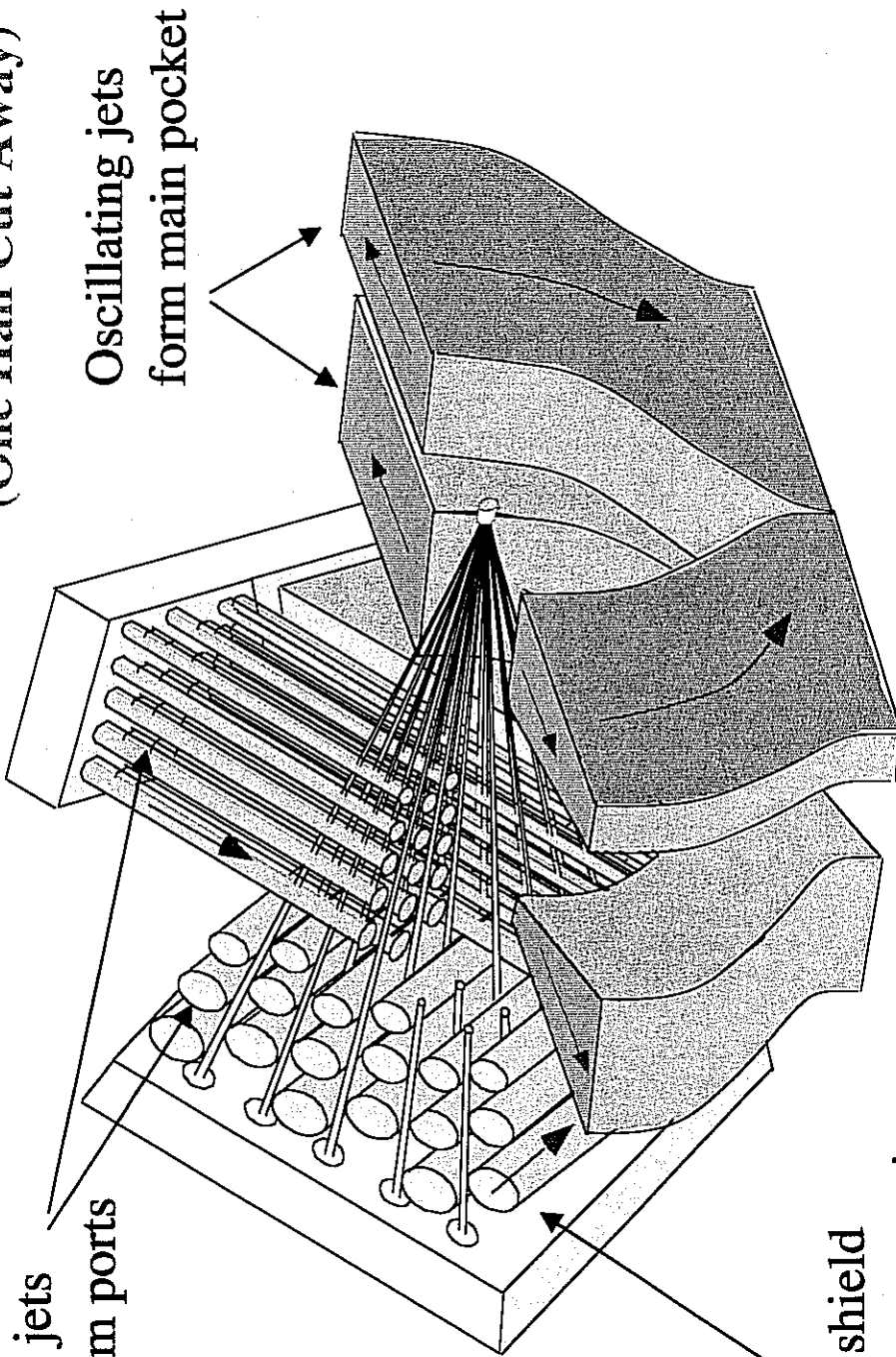

Crossing jets form beam ports

Vortices shield beamline penetrations

# A number of final focus options are being considered for HIF applications

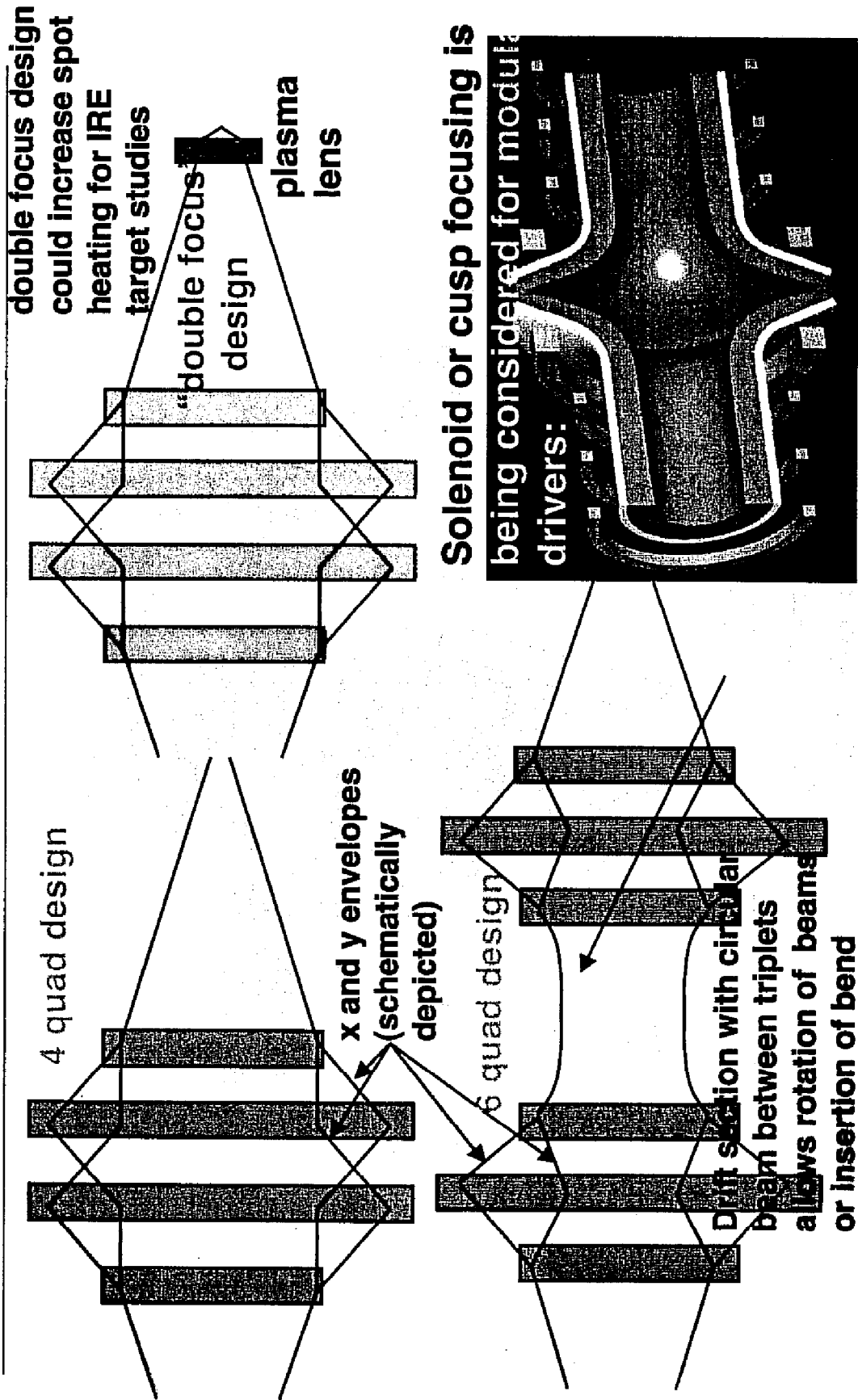

The Heavy Ion Fusion Virtual National Laboratory



# ESTIMATING SPOT SIZE

$$r_x'' + \frac{(\gamma_b \beta_b)'}{\gamma_b \beta_b} r_x + k_x r_x - \frac{zQ}{r_x + r_y} - \frac{E_x^2}{v_x^3} = 0$$

$$r_y'' + \frac{(\gamma_b \beta_b)'}{\gamma_b \beta_b} r_y + k_y r_y - \frac{zQ}{r_x + r_y} - \frac{E_y^2}{v_y^3} = 0$$

IN CHAMBER: NO EXTERNAL FOCUSING, NO ACCELERATION  
AND BEAM IS OFTEN CIRCULAR (BY DESIGN)

$$\Rightarrow k_x = k_y = (\gamma_b \beta_b)' = 0 \quad \& \quad v_x = v_y = v_b$$

$\Rightarrow$  ENVELOPE EQUATION IS:

$$r_b'' = \frac{Q}{r_b} + \frac{E^2}{v_b^3}$$

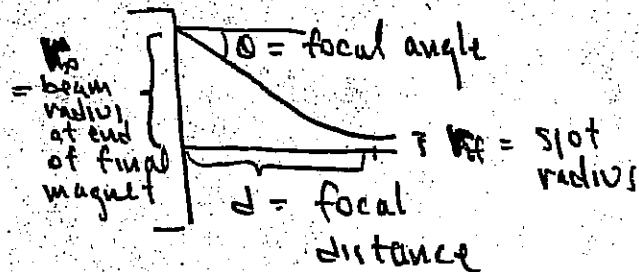

MULTIPLYING BY  $r_b'$  & INTEGRATING  $\Rightarrow$

$$\frac{r_{bf}^2}{2} - \frac{r_{b0}^2}{2} = Q \ln \frac{r_{bf}}{r_{b0}} + \frac{E^2}{2v_{b0}^3} - \frac{E^2}{2v_{bf}^3}$$

Now  $r_{b0}' \approx \theta$        $r_{bf}$  = spot radius       $r_{bf} \ll r_{b0}$   
 $r_{bf}' = 0$        $r_{b0} \approx d\theta$

$$\Rightarrow \theta^2 \approx \frac{2Q}{d} \ln \left( \frac{d}{r_{bf}} \right) + \frac{E^2}{r_{bf}^3}$$

FOR EMITTANCE DOMINATED SPOT:  $r_{bf} = \frac{E}{\theta}$

"CHROMATIC ABERRATIONS" TEND TO BROADEN SPOT

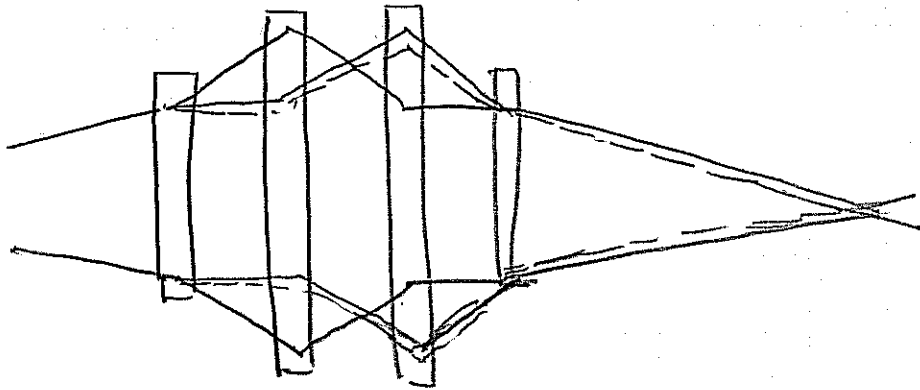

SINCE QUADRUPOLE MAGNET FOCUSING  $\propto \frac{1}{V_z}$

(i.e.,  $x'' = \frac{qB'}{\gamma m v_z} x$ ) A SPREAD IN LONGITUDINAL VELOCITY GIVES RISE TO A BROADENING OF FINAL SPOT.

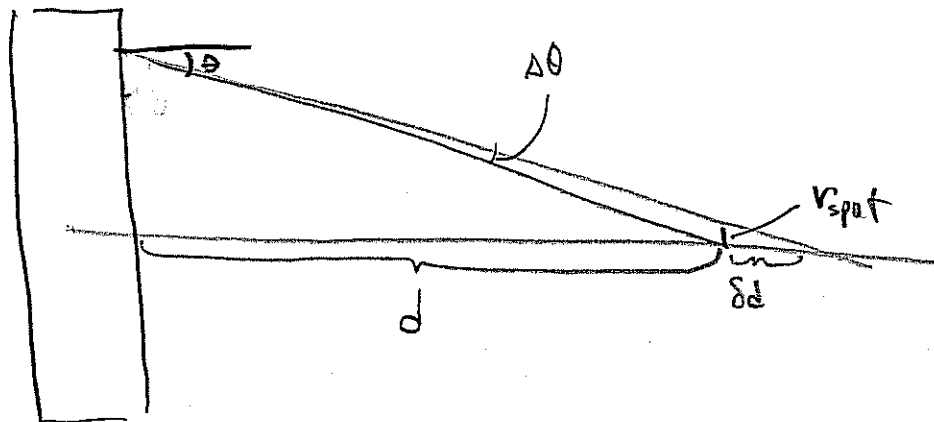

$$\begin{aligned}
 v_{spot} &= \theta \delta d \\
 &= \theta \frac{\partial d}{\partial \theta} \frac{\partial \theta}{\partial v} \delta v \\
 &= \alpha \theta d \left( \frac{\delta v}{v} \right)
 \end{aligned}$$

$\alpha =$  some constant depending on focal system

HEURISTICALLY THE CONTRIBUTION FROM CHROMATIC  
ABERRATIONS CAN BE WRITTEN

$$v_{\text{chrom}}^2 = \alpha^2 f^2 \left( \frac{\delta n}{n} \right)^2 \theta^2$$

where  $\alpha$  depends  
on system,  
typically 4-8

$$v_{\text{spot}}^2 = v_{\text{bf}}^2 + v_{\text{chrom}}^2$$

DETAILED SIMULATIONS OR MOMENT CODE RESULTS  
REQUIRED TO FIX  $\alpha$ .

We constructed moment models to study chromatic effects (through 2nd order) in final focus system

$$\frac{dp_x}{dt} = q(E_x + v_z B_y - v_y B_z)$$

Expand through 2nd order in  $x', y', k_{\beta 0} x, k_{\beta 0} y, \delta p/p$

$$x'' + \left( \frac{1}{\gamma v_{z0}} \frac{d}{dz} (\gamma v_z) \right) x' = \frac{qB'}{\gamma m v_{z0}^2} x \left( 1 - \frac{\Phi}{p} \right) + \frac{q\lambda}{4\pi\epsilon_0 m v_{z0}^2} \frac{2\Phi}{p} (x - \bar{x}) \left( 1 - \frac{2\Phi}{p} \right) + \frac{q\lambda}{4\pi\epsilon_0 m v_{z0}^2} \frac{2\Phi}{p} (\Delta x^2 + [\Delta x^2 \Delta y^2]^{1/2})$$

The equation of motions can be written (where  $\delta = \delta p/p$ ):

$$x'' = K_{xx} x + K_{x\delta} x \delta \quad y'' = K_{yy} y + K_{y\delta} y \delta$$

Here:

$$K_{xx} = \frac{B'}{[B\rho]_0} + \frac{Q}{2(\Delta x^2 + [\Delta x^2 \Delta y^2]^{1/2})} \quad K_{yy} = \frac{-B'}{[B\rho]_0} + \frac{Q}{2(\Delta y^2 + [\Delta x^2 \Delta y^2]^{1/2})}$$

$$K_{x\delta} = - \left[ \frac{B'}{[B\rho]_0} + \frac{2Q}{2(\Delta x^2 + [\Delta x^2 \Delta y^2]^{1/2})} \right] \quad K_{y\delta} = - \left[ \frac{-B'}{[B\rho]_0} + \frac{2Q}{2(\Delta y^2 + [\Delta x^2 \Delta y^2]^{1/2})} \right]$$

$$B' = \text{quadrupole gradient}; \quad [B\rho] = \text{ion rigidity} = p/q; \quad Q = \text{perveance} = \frac{q\lambda}{2\pi\epsilon_0 \gamma_0^3 m v_{z0}^2}$$

We take averages of 2nd, 3rd, ... order quantities, forming infinite set of 1st order ode's

$$\begin{aligned} \frac{d}{ds} \langle x^2 \rangle &= 2 \langle xx' \rangle \\ \frac{d}{ds} \langle xx' \rangle &= \langle x'^2 \rangle + \langle xx'' \rangle \\ &= \langle x'^2 \rangle + K_{xx} \langle x^2 \rangle + K_{xx1} \langle x^2 \delta \rangle \\ \frac{d}{ds} \langle x'^2 \rangle &= 2 \langle x'x'' \rangle \\ &= 2 K_{x'x'} \langle xx' \rangle + 2 K_{x'x1} \langle xx' \delta \rangle \end{aligned}$$

$$\begin{aligned} \frac{d}{ds} \langle x^2 \delta^n \rangle &= 2 \langle xx' \delta^n \rangle \\ \frac{d}{ds} \langle xx' \delta^n \rangle &= \langle x'^2 \delta^n \rangle + \langle xx'' \delta^n \rangle \\ &= \langle x'^2 \delta^n \rangle + K_{x'x'} \langle x^2 \delta^n \rangle + K_{x'x1} \langle x^2 \delta^{n+1} \rangle \\ \frac{d}{ds} \langle x'^2 \delta^n \rangle &= 2 \langle x'x'' \delta^n \rangle \\ &= 2 K_{x'x'} \langle xx' \delta^n \rangle + 2 K_{x'x1} \langle xx' \delta^{n+1} \rangle \end{aligned}$$

—  $\Rightarrow$  term higher order by one



**Infinite set of equations can be truncated, but are reliable over only finite distances**

**Two equivalent methods of truncation have been employed:**

1.  $\langle x^2 \delta^2 \rangle \sim \langle x^2 \rangle \langle \delta^2 \rangle$  and  $\langle xx' \delta^2 \rangle \sim \langle xx' \rangle \langle \delta^2 \rangle$ ; or
2. Noticing that  $\frac{1}{1+\delta} = 1 - \delta + \delta^2 + \dots$  and  $\frac{1}{1-\delta} = 1 + \delta + \delta^2 + \dots$  thus,

$$\frac{1}{1-\delta} - \frac{1}{1+\delta} = 2\delta + 2\delta^3 + \dots \quad \text{also} \quad \frac{\delta}{1+\delta} = 1 - \frac{1}{1+\delta}$$

**so that we may, to good approximation, write**

$$\frac{d}{ds} \langle x^2 \rangle = 2 \langle xx' \rangle \quad \frac{d}{ds} \langle xx' \rangle = \langle x'^2 \rangle + K_{xx} \langle x^2 \rangle + K_{xx1} \left[ \left\langle \frac{x^2}{1-\delta} \right\rangle - \left\langle \frac{x^2}{1+\delta} \right\rangle \right] + O(x^2 \delta^3)$$

$$\frac{d}{ds} \langle x'^2 \rangle = 2K_{xx} \langle xx' \rangle + K_{xx1} \left[ \left\langle \frac{xx'}{1-\delta} \right\rangle - \left\langle \frac{xx'}{1+\delta} \right\rangle \right] + O(xx' \delta^3)$$

$$\frac{d}{ds} \left\langle \frac{xx'}{1+\delta} \right\rangle - \left\langle \frac{x'^2}{1+\delta} \right\rangle + K_{xx} \left\langle \frac{x^2}{1+\delta} \right\rangle - K_{xx1} \left\langle \frac{x^2}{1+\delta} \right\rangle + K_{xx1} \langle x^2 \rangle \quad \frac{d}{ds} \left\langle \frac{x^2}{1+\delta} \right\rangle = 2 \left\langle \frac{xx'}{1+\delta} \right\rangle$$

$$\frac{d}{ds} \left\langle \frac{x'^2}{1+\delta} \right\rangle = 2K_{xx} \left\langle \frac{xx'}{1+\delta} \right\rangle + 2K_{xx1} \left\langle \frac{xx'}{1+\delta} \right\rangle - 2K_{xx1} \left\langle \frac{xx'}{1+\delta} \right\rangle$$

**Truncated set of equations forms closed set.**

**both methods give nearly identical results for  $\langle \delta^2 \rangle$  in the regime of interest; similar equations for  $\langle x^2/(1-\delta) \rangle$ ,  $\langle xx'/(1-\delta) \rangle$ ,  $\langle x'^2/(1-\delta) \rangle$ , and the same set for  $\gamma$ ; 18 equations total.**



# Comparison of moment equations with Particle-in-Cell (WARP<sup>1</sup>) simulations (1% velocity spread)

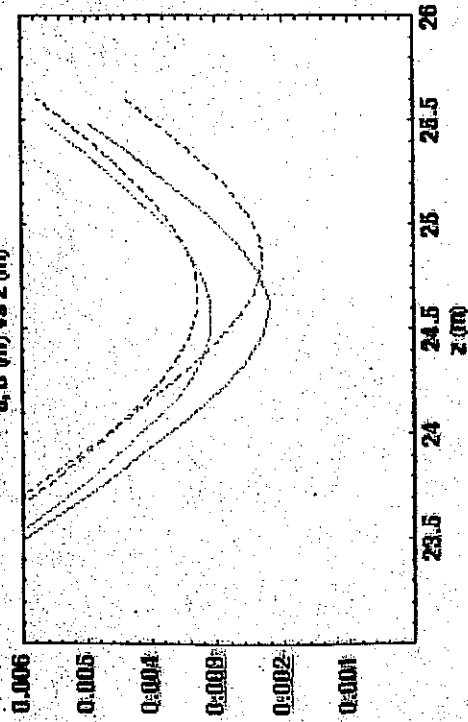
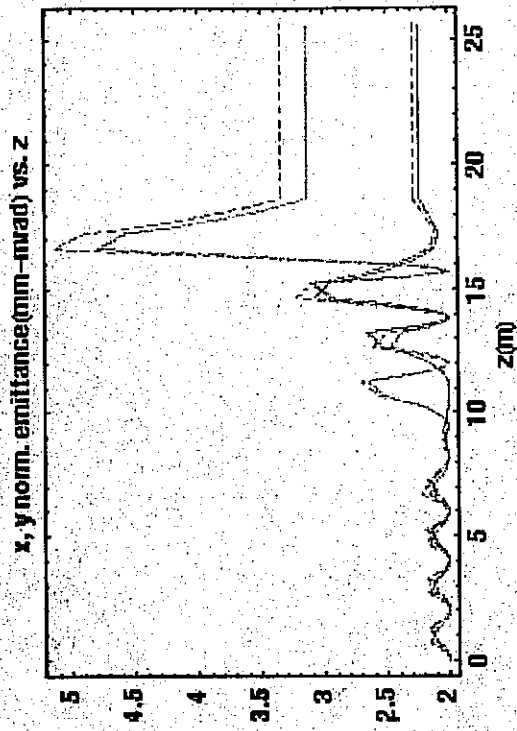
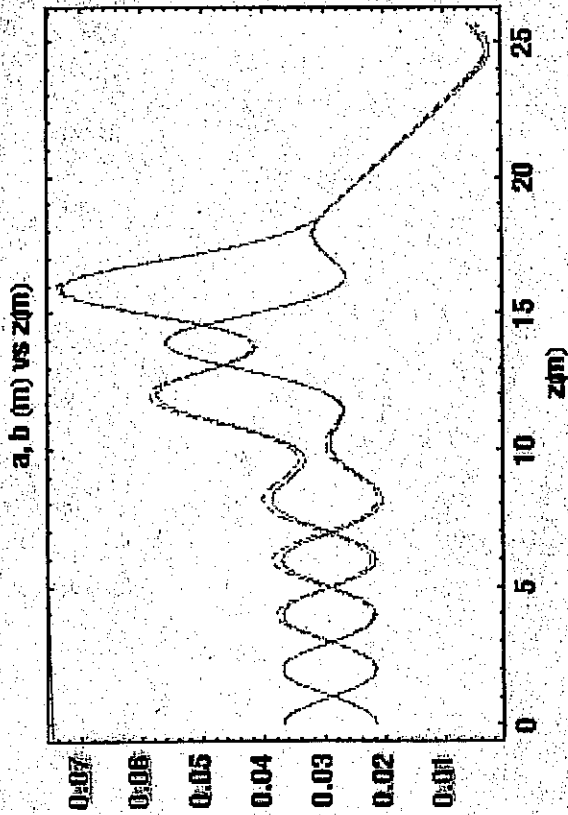

**Particle simulations:**  
 Dashed, red (x) and blue (y)  
 Initial distribution: KV

**Moment calculations:**  
 Solid, magenta (x), and aqua (y)



# Comparison of moment equations with PIC simulations (WARP) -- no velocity spread

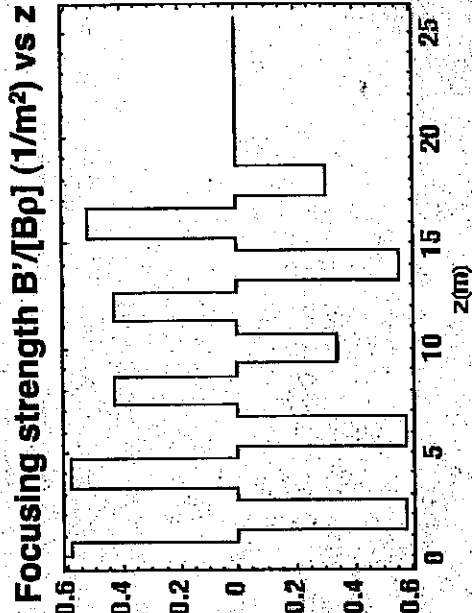
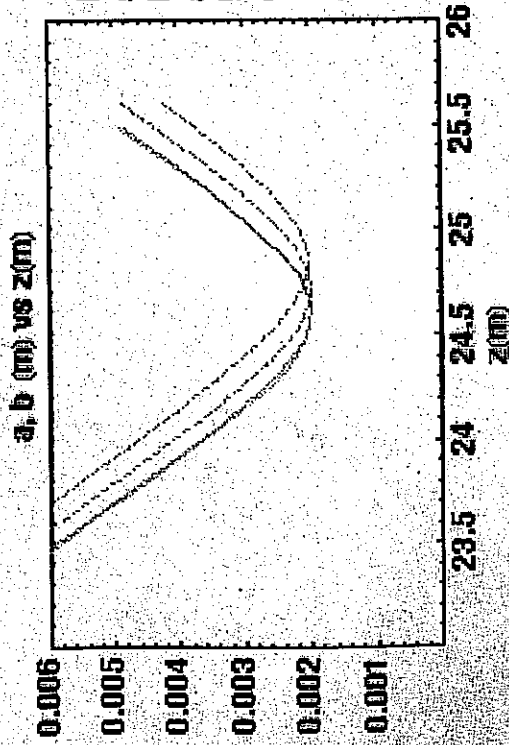
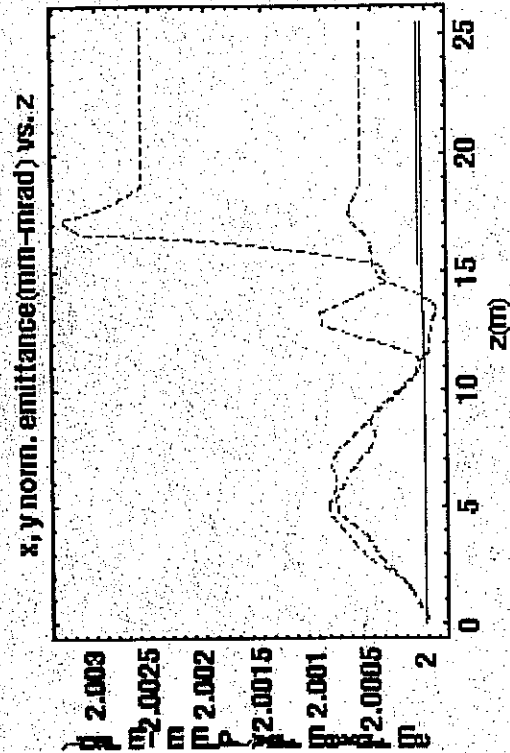
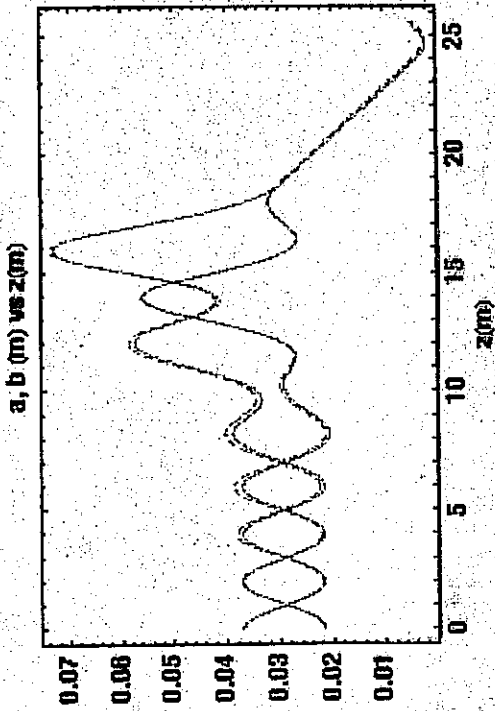

Particle simulations:  
 Dashed, red (x) and blue (y)  
 Initial distribution: KV  
 Moment calculations: Solid, magenta (x), and aqua (y)



**The HIFS VNL has two ongoing experiments, and a long range plan for HEDP studies and Heavy Ion Fusion**

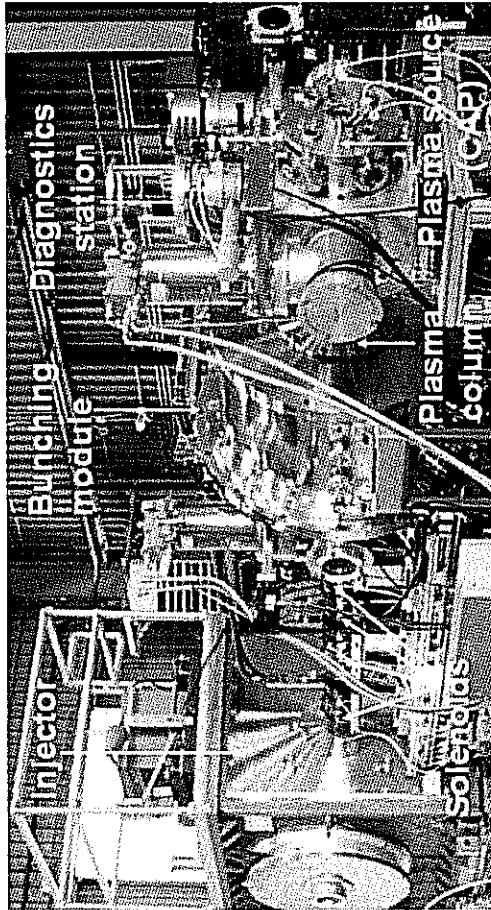

Today: ↙

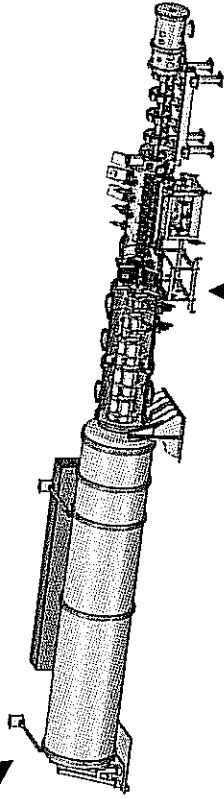

HCX ↑

← NDCX I

1.7 MeV, ~0.025 μC

0.4 MeV, 0.003 μC

NDCX II 3 - 6 MeV, 0.03 μC

~2009

IB-HEDPX (with CD0)

5 - 15 year goal

20 - 40 MeV, 0.3 - 1.0 μC

WDM User facility

10 kJ Machine for HIF

10 - 20 year goal

Target implosion physics

Future ↗ ↘

Soon →

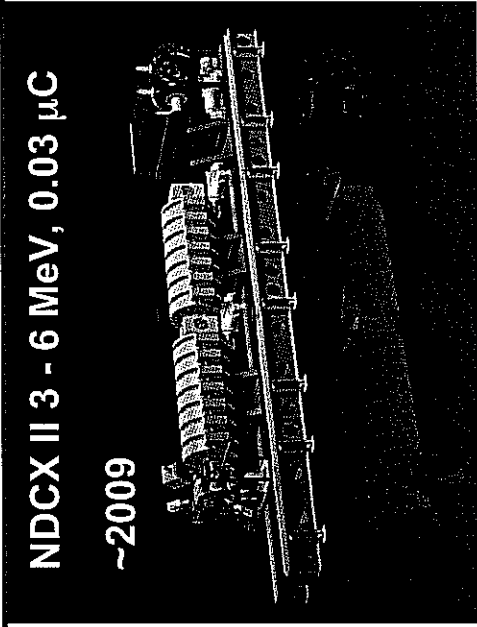

The Heavy Ion Fusion Science Virtual National Laboratory



**HIF/WDM beam science: neutralized focusing and drift compression are now being tested for use in WDM and HIF**

**Both techniques virtually eliminate the repulsive effects of space charge on transverse and longitudinal compression**

**Transverse compression (= focusing the beam to a small spot, raising the watts/cm<sup>2</sup>): Recent VNL experiments, eg. scaled final focus experiment, (MacLaren et al 2002), NTX (Roy et al 2004), and current NDCX-1 have demonstrated benefits of neutralization by plasmas, also required for HIF.**

**Longitudinal compression (= raising the watts): WDM experiments require very short, intense pulses (<~ 1 ns) (shorter than needed for HIF). Neutralization allows high current/high power beams. Modular HIF concept also pushes limit of high current.**

# NDCX-1 has demonstrated > factor 70 pulse compression, and simultaneous transverse and longitudinal focusing

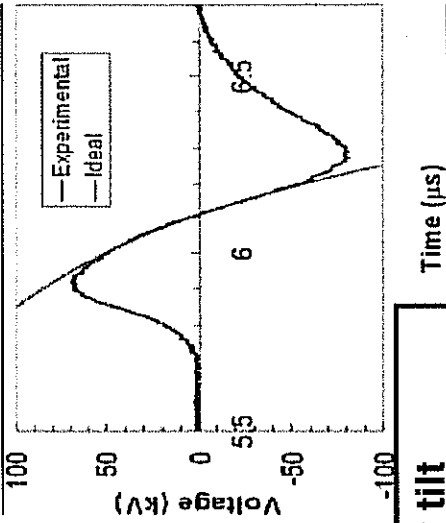
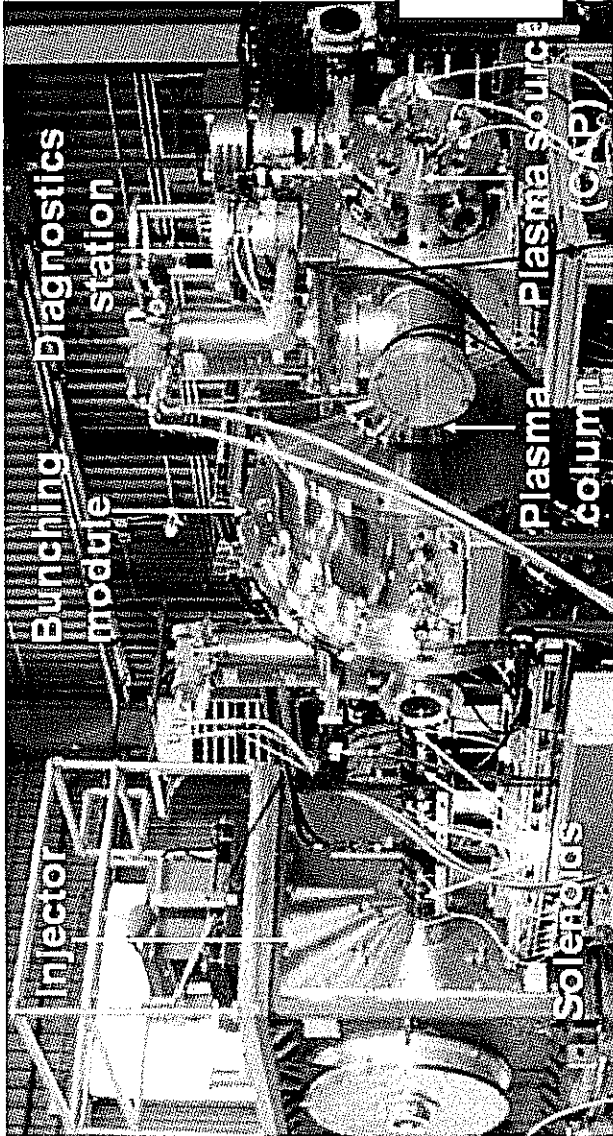

Velocity tilt, accelerates tail, decelerates head

(Like chirped pulse compression)

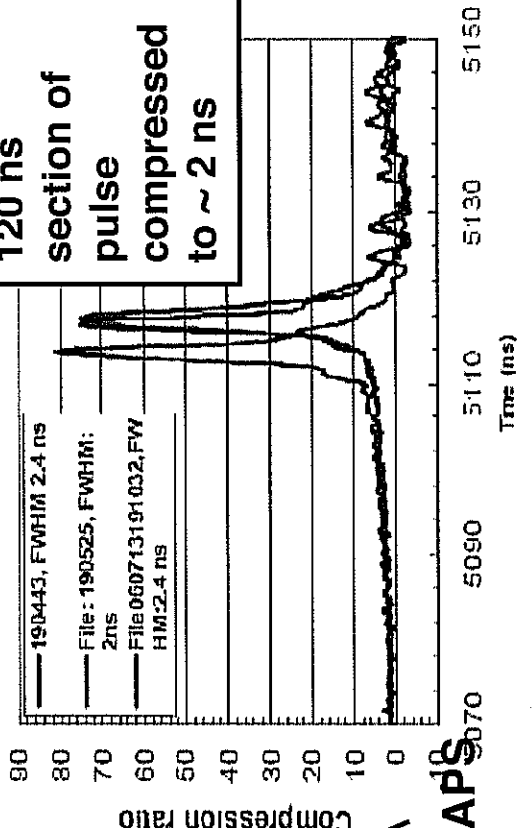
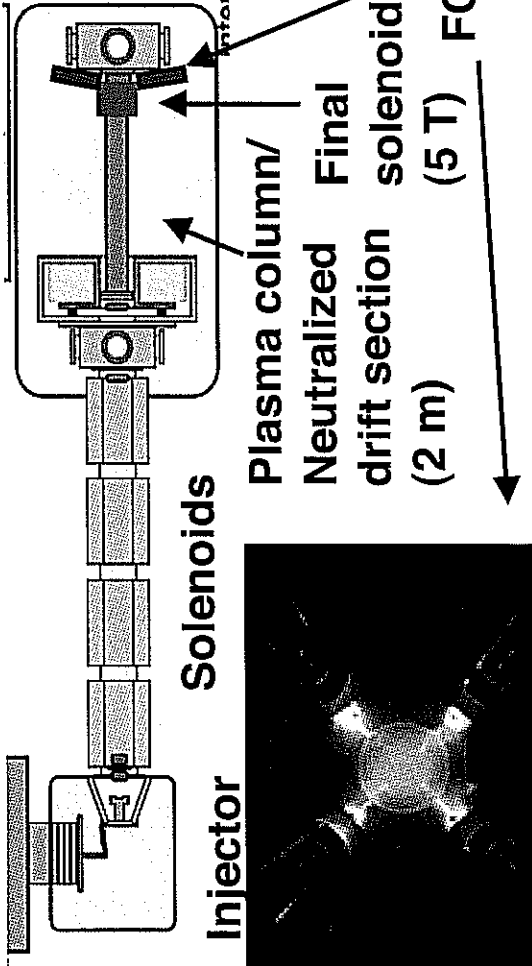

120 ns section of pulse compressed to ~ 2 ns

# Artist's Conception of an HIF Power Plant on a few km<sup>2</sup> site

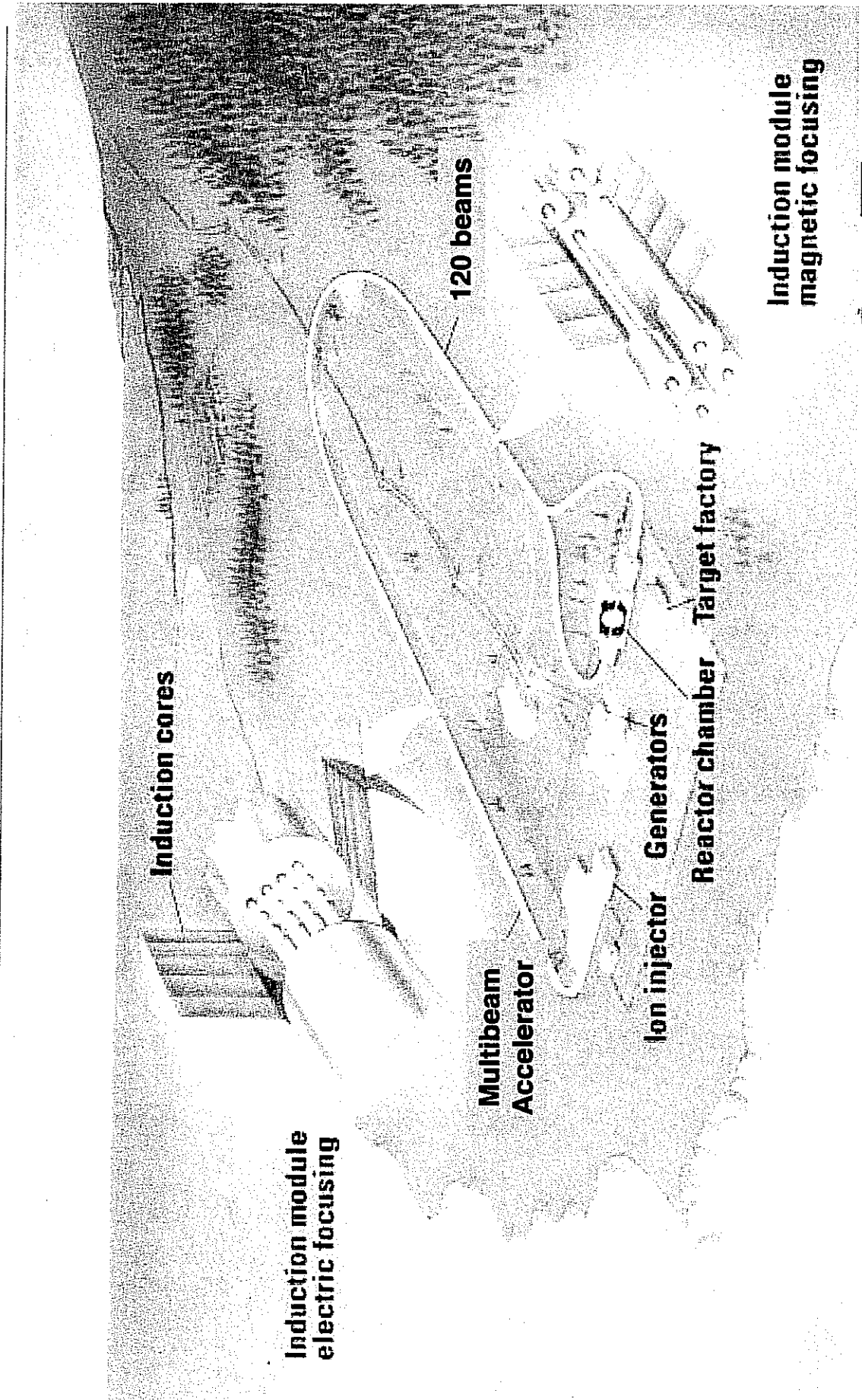

Molvik, BNL-1203, 4

The Heavy Ion Fusion Virtual National Laboratory



# Simulation Techniques for Intense Beams\*

Steven M. Lund

Lawrence Livermore National Laboratory (LLNL)

Steven M. Lund and John J. Barnard

“Beam Physics with Intense Space-Charge”

US Particle Accelerator School

University of Maryland, held at Annapolis, MD

16-27 June, 2008

(Version 20080622)

\* Research supported by the US Dept. of Energy at LLNL and LBNL under contract Nos. DE-AC52-07NA27344 and DE-AC02-05CH11231.

# Simulation Techniques for Intense Beams: Outline

- Why Numerical Simulation
- Classes of Intense Beam Simulations
- Overview of Basic Numerical Methods
- Numerical Methods for Particle and Distribution Methods
- Diagnostics
- Initial Distributions and Particle Loading
- Numerical Convergence
- Practical Considerations
- Overview of the WARP Code
- Example Simulations
- References

# Simulation Techniques for Intense Beams: Detailed Outline

- 1) Why Numerical Simulation?
- 2) Classes of Intense Beam Simulations
  - A. Overview
  - B. Particle Methods
  - C. Distribution Methods
  - D. Moment Methods
  - E. Hybrid Methods
- 3) Overview of Basic Numerical Methods
  - A. Discretization
  - B. Discrete Numerical Operations
    - Derivatives
    - Quadrature
    - Irregular Grids and Axisymmetric Systems
  - C. Time Advance
    - Overview
    - Euler and Runge-Kutta Advances
    - Solution of Moment Methods

# Detailed Outline - 2

## 4) Numerical Methods for Particle and Distribution Methods

- A. Overview
- B. Integration of Equations of Motion
  - Leapfrog Advance for Electric Forces
  - Leapfrog Advance for Electric and Magnetic Forces
  - Numerical Errors and Stability of the Leapfrog Method
  - Illustrative Examples
- C. Field Solution
  - Electrostatic Overview
  - Green's Function Approach
  - Gridded Solution: Poisson Equation and Boundary Conditions
  - Methods of Gridded Field Solution
  - Spectral Methods and the FFT
- D. Weighting: Depositing Particles on the Field Mesh and Interpolating Gridded Fields to Particles
  - Overview of Approaches
  - Approaches: Nearest Grid Point, Cloud in Cell, Area, Splines
- E. Computational Cycle for Particle in Cell Simulations



## Detailed Outline - 3

- 5) Diagnostics
- 6) Initial Distributions and Particle Loading
- 7) Numerical Convergence
- 8) Practical Considerations
  - A. Overview
  - B. Fast Memory
  - C. Run Time
  - D. Machine Architectures
- 9) Overview of the WARP Code
- 10) Example Simulations
  - A. ESQ Injector
  - B. ....

Contact Information  
Acknowledgments  
References

## S1: Why Numerical Simulation?

- Builds intuition of intense beam physics
- ◆ “The purpose of computation is insight, not numbers”  
Richard Hamming, chief mathematician of the Manhattan Project and Turing Award recipient
  - ◆ Advantages over laboratory experiments:
    - Full noninvasive beam diagnostics are possible
    - Effects can be turned on and off

Allows analysis of more realistic situations than analytically tractable

- ◆ Realistic geometries
- ◆ Non-ideal distributions
- ◆ Combined effects
- ◆ Large amplitude (nonlinear) effects

Insight obtained can motivate analytical theories

- ◆ Suggest and test approximations and models to most simply express relevant effects

## Why Numerical Simulation? (2)

Can quantify expected performance of specific machines

- ◆ Machines and facilities expensive – important to have high confidence that systems will work as intended

Computers and numerical methods/libraries are becoming more powerful

Enables both analysis of more realistic problems and/or better numerical convergence

- ◆ **Bigger and faster hardware**
  - Processor speed increasing
  - Parallel machine architectures
  - Greater memory
- ◆ **More developed software**
  - Improved numerical methods
  - Libraries of debugged code modules
  - Graphics and visualization tools

## Why Numerical Simulation? (3)

Simulations are increasingly powerful and valuable in the analysis of intense beams, but should not be used to exclusion

- ◆ Parametric scaling is very important in machine design
  - Often it is hardest to understand what specific choices should be made in physical aperture sizes, etc.
  - Although scaling can be explored with simulation, analytical theory often best illustrates the trade-offs, sensitivities, and relevant combinations of parameters
- ◆ Concepts often fail due to limits of technology (e.g., fabrication tolerances, material failures, and unanticipated properties) and hence full laboratory testing is vital
  - Many understood classes of errors can be probed with simulation.
  - Unanticipated error sources are most dangerous
- ◆ Economic realities often severely limit what can be constructed
  - Simulating something unattainable may serve little purpose

## Why Numerical Simulation? (4)

The highest understanding and confidence is achieved when results from analytic theory, numerical simulation, and experiment all converge

- ◆ Motivates model simplifications and identification of relevant sensitivities
- Numerical simulation skills are highly sought in many areas of accelerator and beam physics

- ◆ Specialists readily employable
  - ◆ Skills transfer easily to many fields of physics and engineering
- Numerous programming languages are employed in numerical simulations of intense beams
- ◆ Most common today: Fortran, Fortran 90, C, C++, Java, ...
  - ◆ Strengths and weaknesses depend on application, preferences, and history (legacy code)

Results are analyzed with a variety of graphics packages:

- ◆ Commonly used: NCAR, Gist, Gnuplot, IDL, Narcisse...
- ◆ Plot frames combine into movies
- ◆ Use can greatly simplify construction of beam visualization diagnostics

SM Lund, USPAS, June 2008

Simulation Techniques

9

34

## Why Numerical Simulation? (5)

A modern and flexible way to construct simulation packages is to link routines in fast, compiled code with an interactive interpreter such as:

- ◆ Examples: Python, Basis, Yorick, ...

Advantages of using interactive interpreters:

- ◆ Allows routines to be coded in mixed languages
  - Renders choice of programming languages less important
- ◆ Flexible reconfiguration of code modules possible to adapt for specific, unanticipated needs
  - Reduces need for recompilation and cumbersome structures for special uses
  - Aids cross-checking problems and debugging
- ◆ “Steering” of code during runs to address unanticipated side effects
- ◆ In the case of Python, facilitates modern, object-oriented structure

SM Lund, USPAS, June 2008

Simulation Techniques

10

## Why Numerical Simulation? (6)

Discussing particular programming languages and graphics packages is beyond the scope of this class. Here our goal is to survey numerical simulation methods employed without presenting details of specific implementations.

However, we will show examples based on the “WARP” particle-in-cell code developed for intense beam simulation at LLNL and LBNL

- ◆ WARP is so named since it works on a “warped” Cartesian mesh with bends
- ◆ WARP is a family of particle-in-cell code tools built around a common Python interpreter for flexible operation
- ◆ Optimized for the simulation of intense beams with self-consistent electrostatic space-charge forces
- ◆ Actively maintained and extended:
  - Diagnostics
  - E-cloud
  - Electromagnetic effects and dense plasmas
  - ...

More on WARP later after discussion of methods, etc.

SM Lund, USPAS, June 2008

Simulation Techniques

11

## S2: Classes of Intense Beam Simulations

### S2A: Overview

There are three distinct classes of modeling of intense ion beams applicable to numerical simulation

- 1) Particle methods (see: S2B)
- 2) Distribution methods (see: S2C)
- 3) Moment methods (see: S2D)

All of these draw heavily on methods developed for the simulation of neutral plasmas. The main differences are:

- ◆ Lack of overall charge neutrality
  - Single species typical, though electron + ion simulations are common too
- ◆ Directed motion of the beam along accelerator axis
- ◆ Applied field descriptions of the lattice
  - Optical focusing elements
  - Accelerating structures

We will review and contrast these methods before discussing specific numerical implementations

SM Lund, USPAS, June 2008

Simulation Techniques

12



## S2C: Distribution Methods: Vlasov Equation

The Vlasov Equation is essentially a continuity equation for an incompressible “fluid” in 6D phase-space. To see this, note that

$$\frac{\partial}{\partial \mathbf{p}} \cdot \mathbf{v} \times \mathbf{B} = 0$$

The Vlasov Equation can be expressed as

$$\begin{aligned} \frac{\partial f}{\partial t} + \frac{\partial}{\partial \mathbf{x}} \cdot (\mathbf{v}f) + \frac{\partial}{\partial \mathbf{p}} \cdot (q[\mathbf{E} + \mathbf{v} \times \mathbf{B}]f) &= 0 \\ \Rightarrow \frac{\partial f}{\partial t} + \frac{\partial}{\partial \mathbf{x}} \cdot \left( \frac{d\mathbf{x}}{dt} \bigg|_{\text{orbit}} f \right) + \frac{\partial}{\partial \mathbf{p}} \cdot \left( \frac{d\mathbf{p}}{dt} \bigg|_{\text{orbit}} f \right) &= 0 \end{aligned}$$

which is manifestly the form of a continuity equation in 6D phase-space, i.e., probability is not created or destroyed

## S2C: Distribution Methods: Collision Corrections

The effect of collisions can be included by adding a collision operator:

$$\left\{ \frac{\partial}{\partial t} + \mathbf{v} \cdot \frac{\partial}{\partial \mathbf{x}} + \frac{\partial}{\partial \mathbf{p}} \cdot (q[\mathbf{E} + \mathbf{v} \times \mathbf{B}]) \right\} f = \frac{\partial f}{\partial t} \Big|_{\text{coll}}$$

For most applications in beam physics,  $\frac{\partial f}{\partial t} \Big|_{\text{coll}}$  can be neglected.

♦ See: estimates in J.J. Barnard, [Intro Lectures](#)

For exceptional cases, specific forms of collisions terms can be found in Nicholson, *Intro to Plasma Theory*, Wiley 1983, and similar plasma physics texts

## S2C: Distribution Methods: Comment on the PIC Method

The common Particle-in-Cell (PIC) method is *not* really a particle method, but rather a distribution method that uses a collection of smoothed “macro” particles to simulate Vlasov’s Equation. This can be understood roughly by noting that Vlasov’s Equation can be interpreted as

$$\frac{d}{dt} f(\mathbf{x}, \mathbf{p}, t) = 0$$

Total derivative along a test particle’s path

⇒ Advance particles in a continuous field “fluid” to eliminate particle collisions

Important Point:

**PIC is a method to solve Vlasov’s Equation, *not* a discrete particle method**

This will become clear after these lectures

## S2C: Distribution Methods: Multispecies Generalizations

Subscript species with  $j$ . Then in the Vlasov equation replace:

$$\begin{aligned} f &\longrightarrow f_j \\ m &\longrightarrow m_j \\ q &\longrightarrow q_j \end{aligned}$$

and there is a separate Vlasov equation for each of the  $j$  species.

Replace the charge and current density couplings in the Maxwell Equations with and appropriate form to include charge and current contributions from all species:

$$\begin{aligned} \rho(\mathbf{x}, t) &= \rho_{\text{ext}}(\mathbf{x}, t) + \sum_j q_j \int d^3 p f_j(\mathbf{x}, \mathbf{p}, t) \\ \mathbf{J}(\mathbf{x}, t) &= \mathbf{J}_{\text{ext}}(\mathbf{x}, t) + \sum_j q_j \int d^3 p \mathbf{v} f_j(\mathbf{x}, \mathbf{p}, t) \end{aligned}$$

Also, if collisions are included the collision operator should be generalized to include collisions between species as well as collisions of a species with itself

## S2C: Fluid Models

### Fluid Models

- Obtained from further averages of kinetic model
- Described in terms of “macroscopic” variables (density, flow velocity, pressure...) that vary in  $\mathbf{x}$  and  $t$
- Models must be closed (truncated) at some order via physically motivated assumptions (cold, negligible heat flow, ...)

### Moments:

$$\text{Density} \quad n : \quad n(\mathbf{x}, t) = \int d^3p f(\mathbf{x}, \mathbf{p}, t)$$

$$\text{Flow velocity} \quad \mathbf{V} : \quad n\mathbf{V}(\mathbf{x}, t) = \int d^3p \mathbf{v} f(\mathbf{x}, \mathbf{p}, t)$$

$$\text{Flow momentum} \quad \mathbf{P} : \quad n\mathbf{P}(\mathbf{x}, t) = \int d^3p \mathbf{p} f(\mathbf{x}, \mathbf{p}, t)$$

$$\text{Pressure tensor} \quad \mathcal{P}_{ij} : \quad n\mathcal{P}_{ij}(\mathbf{x}, t) = \int d^3p [p_i - P_i(\mathbf{x}, t)] \\ \times [v_j - V_j(\mathbf{x}, t)] f(\mathbf{x}, \mathbf{p}, t)$$

Higher rank objects  $\vdots$

SM Lund, USPAS, June 2008

Simulation Techniques 21

437

## S2C: Fluid Models: Equations of Motion

### Equations of Motion (Eulerian approach)

### Continuity:

$$\frac{\partial n}{\partial t} + \frac{\partial}{\partial \mathbf{x}} \cdot [n\mathbf{V}] = 0$$

### Force: ith component

$$n \left( \frac{\partial}{\partial t} + \mathbf{V} \cdot \frac{\partial}{\partial \mathbf{x}} \right) P_i + \sum_j \frac{\partial}{\partial x_j} \mathcal{P}_{ij} = qn[\mathbf{E} + \mathbf{V} \times \mathbf{B}]_i$$

### Field:

Maxwell Equations with charge and current density coupling to fluid variables given by:

$$\rho(\mathbf{x}, t) = \rho_{\text{ext}}(\mathbf{x}, t) + qn(\mathbf{x}, t)$$

$$\mathbf{J}(\mathbf{x}, t) = \mathbf{J}_{\text{ext}}(\mathbf{x}, t) + qn(\mathbf{x}, t)\mathbf{V}(\mathbf{x}, t)$$

SM Lund, USPAS, June 2008

Simulation Techniques 22

## S2C: Fluid Model: Multispecies Generalization

Subscript species with  $j$ . Then in the continuity, force, pressure, ... equations replace

Particle Properties

$$m \longrightarrow m_j$$

$$q \longrightarrow q_j$$

Moments

$$n \longrightarrow n_j$$

$$\mathbf{V} \longrightarrow \mathbf{V}_j$$

$\vdots$

Replace the charge and current density couplings in the Maxwell Equations with

$$\rho(\mathbf{x}, t) = \rho_{\text{ext}}(\mathbf{x}, t) + \sum_j q_j n_j(\mathbf{x}, t)$$

$$\mathbf{J}(\mathbf{x}, t) = \mathbf{J}_{\text{ext}}(\mathbf{x}, t) + \sum_j q_j n_j(\mathbf{x}, t) \mathbf{V}_j(\mathbf{x}, t)$$

SM Lund, USPAS, June 2008

Simulation Techniques 23

## S2C: Lagrangian Formulation of Distribution Methods

In kinetic and especially fluid models it can be convenient to adopt *Lagrangian* methods. For fluid models these can be distinguished as follows:

### Eulerian Fluid Model:

Flow quantities are functions of space ( $\mathbf{x}$ ) and evolve in time ( $t$ )

- Example: density  $n(\mathbf{x}, t)$  and flow velocity  $\mathbf{V}(\mathbf{x}, t)$

### Lagrangian Fluid Model:

Identify parts of evolution (flow) with objects (material elements) and follow the flow in time ( $t$ )

- Shape and position of elements must generally evolve to represent flow
- Example: envelope model edge radii  $r_x(s), r_y(s)$

Many distribution methods for Vlasov's Equation are hybrid Lagrangian methods

- Macro particle “shapes” in PIC (Particle in Cell) method to be covered can be thought of as Lagrangian elements representing a Vlasov flow

SM Lund, USPAS, June 2008

Simulation Techniques 24

## S2C: Example Lagrangian Fluid Model

- 1D Lagrangian model of the longitudinal evolution of a cold beam
- Discretize fluid into longitudinal elements with boundaries
- Derive equations of motion for elements

Coordinates:	$Z_0$	$Z_1$	$Z_2$	$Z_3$	$Z_4$	$\dots$	$Z_N$
Charges:	$Q_{1/2}$	$Q_{3/2}$	$Q_{5/2}$	$Q_{7/2}$	$Q_{9/2}$	$\dots$	$Q_{N-1/2}$
Masses:	$m_{1/2}$	$m_{3/2}$	$m_{5/2}$	$m_{7/2}$	$m_{9/2}$	$\dots$	$m_{N-1/2}$
Velocities:	$V_0$	$V_1$	$V_2$	$V_3$	$V_4$	$\dots$	$V_N$

$z = Z_i$  slice boundaries       $Q_{i+1/2}$  fixed       $\frac{q}{m} = \text{const}$   
 $\frac{dZ_i}{dt} = V_i$  velocities of slice       $m_{i+1/2}$  fixed      for single species  
 boundaries      (set initial coordinates)

## Example Lagrangian Fluid Model, Continued (2)

Solve the equations of motion

$$\frac{dZ_i(t)}{dt} = V_i(t)$$

$$\frac{dV_i(t)}{dt} = \frac{q}{m} E_z(Z_i, t)$$

for all the slice boundaries. Several methods might be used to calculate  $E_z$ :

- 1) Take “slices” to have some radial extent modeled by a perpendicular envelope etc. and deposit the  $Q_{i+1/2}$  onto a grid and solve:

$$\nabla^2 \phi = -\frac{\rho}{\epsilon_0} \quad E_z = -\frac{\partial \phi}{\partial z}$$

subject to  $E_z \rightarrow 0$  as  $|z| \rightarrow \infty$

- 2) Employ a “g-factor” model

$$E_z = -\frac{g}{4\pi\epsilon_0} \frac{\partial \lambda}{\partial z}$$

$\lambda$  calculated from  $Q_{i+1/2}$  and radial extent of the elements etc.

- 3) Pure 1D model using Gauss' Law

## S2D: Moment Methods

### Moment Methods

- Most reduced description of an intense beam
  - Often employed in lattice designs
- Beam represented by a finite (closed and truncated) set of moments that are advanced from initial values
  - Here by moments, we mean functions of a single variable  $s$  or  $t$
- Such models are not generally self-consistent
  - Some special cases such as a stable transverse KV equilibrium distribution (see: S.M. Lund lectures on **Transverse Equilibrium Distributions**) are consistent with truncated moment description (rms envelope equation)
  - Typically derived from assumed distributions with self-similar evolution
- See: S.M. Lund lectures on **Transverse Equilibrium Distributions** for more details on moment methods

## S2D: Moment Methods: 1<sup>st</sup> Order Moments

Many moment models exist. Illustrate with examples for transverse beam evolution

Moment definition:

$$\langle \dots \rangle_{\perp} \equiv \frac{\int d^2 x_{\perp} \int d^2 x'_{\perp} \dots f}{\int d^2 x_{\perp} \int d^2 x'_{\perp} f}$$

1<sup>st</sup> order moments:

$$\begin{aligned} \mathbf{X} &= \langle \mathbf{x} \rangle_{\perp} && \text{Centroid coordinate} \\ \mathbf{X}' &= \langle \mathbf{x}' \rangle_{\perp} && \text{Centroid angle} \\ \Delta &= \left\langle \frac{\delta p_s}{p_s} \right\rangle_{\perp} \equiv \langle \delta \rangle_{\perp} && \text{Off momentum} \\ & \vdots && \vdots \\ & \vdots && \vdots \end{aligned}$$



## S2D: Moment Methods: 2<sup>nd</sup> and Higher Order Moments

2<sup>nd</sup> order moments:

x moments	y moments	x-y cross moments	dispersive moments
$\langle x^2 \rangle_{\perp}$	$\langle y^2 \rangle_{\perp}$	$\langle xy \rangle_{\perp}$	$\langle x\delta \rangle_{\perp}, \langle y\delta \rangle_{\perp}$
$\langle x'x \rangle_{\perp}$	$\langle y'y \rangle_{\perp}$	$\langle x'y \rangle_{\perp}, \langle xy' \rangle_{\perp}$	$\langle x'\delta \rangle_{\perp}, \langle y'\delta \rangle_{\perp}$
$\langle x'^2 \rangle_{\perp}$	$\langle y'^2 \rangle_{\perp}$	$\langle x'y' \rangle_{\perp}$	$\langle \delta^2 \rangle_{\perp}$

It is typically convenient to subtract centroid from higher-order moments

$$\tilde{x} \equiv x - X \quad \tilde{x}' \equiv x' - X'$$

$$\tilde{y} \equiv y - Y \quad \tilde{y}' \equiv y' - Y'$$

$$\langle \tilde{x}^2 \rangle_{\perp} = \langle (x - X)^2 \rangle_{\perp} = \langle x^2 \rangle_{\perp} - X^2, \text{ etc.}$$

3<sup>rd</sup> order moments: Analogous to 2<sup>nd</sup> order case, but more for each order

$$\langle x^3 \rangle_{\perp}, \langle x^2 y \rangle_{\perp}, \dots$$

## S2D: Moment Methods: Common 2<sup>nd</sup> Order Moments

Many quantities of physical interest are expressed in terms of moments

Statistical beam size: (rms edge measure)

$$r_x = 2 \langle \tilde{x}^2 \rangle_{\perp}^{1/2}$$

$$r_y = 2 \langle \tilde{y}^2 \rangle_{\perp}^{1/2}$$

Statistical emittances: (rms edge measure)

$$\varepsilon_x = 4 \left[ \langle \tilde{x}^2 \rangle_{\perp} \langle \tilde{x}'^2 \rangle_{\perp} - \langle \tilde{x}\tilde{x}' \rangle_{\perp}^2 \right]^{1/2}$$

$$\varepsilon_y = 4 \left[ \langle \tilde{y}^2 \rangle_{\perp} \langle \tilde{y}'^2 \rangle_{\perp} - \langle \tilde{y}\tilde{y}' \rangle_{\perp}^2 \right]^{1/2}$$

## S2D: Moment Methods: Equations of Motion

Equations of Motion

- Can be expressed in terms of moments of combinations of moments that are of physical interest
- Moments are advanced from specified initial conditions

Form equations:

$$\frac{d}{ds} \mathbf{M} = \mathbf{F}(\mathbf{M})$$

$\mathbf{M}$  = vector of moments, generally infinite

$\mathbf{F}$  = vector function of  $\mathbf{M}$ , generally nonlinear

Moment methods generally form an infinite chain of equations that do *not* truncate. To be useful the system must be truncated. Truncations are usually carried out by assuming a specific form of the distribution that can be described by a finite set of moments

- Self-similar evolution: form of distribution assumed not to change
  - Analytical solutions often employed
- Neglect of terms

A simple example will be employed to illustrate these points

## S2D: Moment Methods: Example: Transverse Envelope Eqns.

Truncation assumption: unbunched uniform density elliptical beam in free space

- $\delta = 0$ , no axial velocity spread
- All cross moments zero, i.e.  $\langle \tilde{x}\tilde{y} \rangle_{\perp} = 0$

Centroid:  $X = \langle x \rangle_{\perp}$   
 $Y = \langle y \rangle_{\perp}$

Envelope:  $r_x = 2 \langle \tilde{x}^2 \rangle_{\perp}^{1/2}$   
 $r_y = 2 \langle \tilde{y}^2 \rangle_{\perp}^{1/2}$

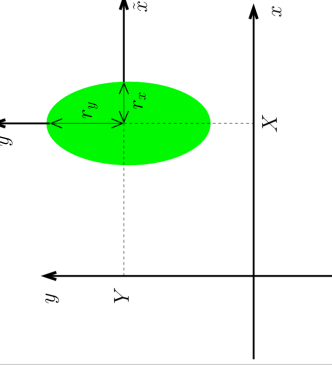

For:  $\frac{\tilde{x}^2}{r_x^2} + \frac{\tilde{y}^2}{r_y^2} < 1$

$$E_{\tilde{x}} = \frac{\tilde{x}}{\pi \epsilon_0 (r_x + r_y) r_x}$$

$$E_{\tilde{y}} = \frac{\tilde{y}}{\pi \epsilon_0 (r_x + r_y) r_y}$$

$\lambda$  = line charge density

These results are employed to derive the moment equations of motion (See S.M. Lund lectures on Transverse Centroid and Envelope Models)

## Example Continued (2) - Equations of Motion in Matrix Form

$$\frac{d}{ds} \begin{bmatrix} X \\ X' \\ Y \\ Y' \end{bmatrix} = \begin{bmatrix} X' \\ -\kappa_x(s)X \\ Y' \\ -\kappa_y(s)Y \end{bmatrix}$$

$$\frac{d}{ds} \begin{bmatrix} \langle \tilde{x}^2 \rangle_{\perp} \\ \langle \tilde{x}\tilde{x}' \rangle_{\perp} \\ \langle \tilde{x}'^2 \rangle_{\perp} \\ \langle \tilde{y}^2 \rangle_{\perp} \\ \langle \tilde{y}\tilde{y}' \rangle_{\perp} \\ \langle \tilde{y}'^2 \rangle_{\perp} \end{bmatrix} = \begin{bmatrix} 2 \langle \tilde{x}\tilde{x}' \rangle_{\perp} & Q \langle \tilde{x}'^2 \rangle_{\perp} \\ \langle \tilde{x}'^2 \rangle_{\perp} - \kappa_x(s) \langle \tilde{x}^2 \rangle_{\perp} + \frac{Q \langle \tilde{x}'^2 \rangle_{\perp}}{[4 \langle \tilde{x}^2 \rangle_{\perp}^{1/2} (\langle \tilde{x}^2 \rangle_{\perp}^{1/2} + \langle \tilde{y}^2 \rangle_{\perp}^{1/2})]} & \\ -2\kappa_x(s) \langle \tilde{x}\tilde{x}' \rangle_{\perp} + \frac{2Q \langle \tilde{x}\tilde{x}' \rangle_{\perp}}{[4 \langle \tilde{x}^2 \rangle_{\perp}^{1/2} (\langle \tilde{x}^2 \rangle_{\perp}^{1/2} + \langle \tilde{y}^2 \rangle_{\perp}^{1/2})]} & \\ 2 \langle \tilde{y}\tilde{y}' \rangle_{\perp} & Q \langle \tilde{y}'^2 \rangle_{\perp} \\ \langle \tilde{y}'^2 \rangle_{\perp} - \kappa_y(s) \langle \tilde{y}^2 \rangle_{\perp} + \frac{Q \langle \tilde{y}'^2 \rangle_{\perp}}{[4 \langle \tilde{y}^2 \rangle_{\perp}^{1/2} (\langle \tilde{x}^2 \rangle_{\perp}^{1/2} + \langle \tilde{y}^2 \rangle_{\perp}^{1/2})]} & \\ -2\kappa_y(s) \langle \tilde{y}\tilde{y}' \rangle_{\perp} + \frac{2Q \langle \tilde{y}\tilde{y}' \rangle_{\perp}}{[4 \langle \tilde{y}^2 \rangle_{\perp}^{1/2} (\langle \tilde{x}^2 \rangle_{\perp}^{1/2} + \langle \tilde{y}^2 \rangle_{\perp}^{1/2})]} & \end{bmatrix}$$

- Form truncates due to assumed distribution form
- Self-consistent with the KV distribution. See: S.M. Lund lectures on **Transverse Equilibrium Distributions**

SM Lund, USPAS, June 2008

Simulation Techniques

33

Simulation Techniques

34

## Example Continued (3) - Reduced Form Equations of Motion

Using 2<sup>nd</sup> order moment equations we can show that

$$\frac{d}{ds} \varepsilon_x^2 = 0 = \frac{d}{ds} \varepsilon_y^2$$

$$\Rightarrow \begin{cases} \varepsilon_x^2 = 16 \left[ \langle x^2 \rangle_{\perp} \langle x'^2 \rangle_{\perp} - \langle xx' \rangle_{\perp}^2 \right] = \text{const} \\ \varepsilon_y^2 = 16 \left[ \langle y^2 \rangle_{\perp} \langle y'^2 \rangle_{\perp} - \langle yy' \rangle_{\perp}^2 \right] = \text{const} \end{cases}$$

The 2<sup>nd</sup> order moment equations can be equivalently expressed as

$$\begin{cases} \frac{dr_x}{ds} = r'_x ; & \frac{d}{ds} r'_x + \kappa_x r_x - \frac{2Q}{r_x + r_y} - \frac{2Q}{r_x} - \frac{\varepsilon_x^2}{r_x^3} = 0 \\ \frac{dr_y}{ds} = r'_y ; & \frac{d}{ds} r'_y + \kappa_y r_y - \frac{2Q}{r_x + r_y} - \frac{2Q}{r_y} - \frac{\varepsilon_y^2}{r_y^3} = 0 \end{cases}$$

SM Lund, USPAS, June 2008

Simulation Techniques

34

## Example Continued (4) : Contrast Form of Matrix and Reduced Form Moment Equations

Relative advantages of the use of coupled matrix form versus reduced equations can depend on the problem/situation

### Coupled Matrix Equations

$$\frac{d}{ds} \mathbf{M} = \mathbf{F}$$

**M** = Moment Vector

**F** = Force Vector

- Easy to formulate
- Straightforward to incorporate additional effects
- Natural fit to numerical routine
- Easy to code

### Reduced Equations

$$X'' + \kappa_x X = 0$$

$$r''_x + \kappa_x r_x - \frac{2Q}{r_x + r_y} - \frac{\varepsilon_x^2}{r_x^3} = 0$$

etc.

- Reduction based on identifying invariants such as
- $\varepsilon_x^2 = 16 \left[ \langle \tilde{x}^2 \rangle_{\perp} \langle \tilde{x}'^2 \rangle_{\perp} - \langle \tilde{x}\tilde{x}' \rangle_{\perp}^2 \right]$  helps understand solutions
- Compact expressions

440

## S2E: Hybrid Methods

Beyond the three levels of modeling outlined earlier:

- Particle methods
- Distribution methods
- Moment methods

there exist numerous “hybrid” methods that combine features of several methods.

Examples:

- Particle-in-Cell (PIC) models with shaped particles
- Gyro-kinetic models
  - Average over fast gyro motion in magnetic fields: common in plasma physics
- Delta-f models
  - Evolve perturbed distribution with marker particles
- ⋮
- ⋮

SM Lund, USPAS, June 2008

Simulation Techniques

35

Simulation Techniques

36



## Hybrid Methods Continued (2)

### General comments:

- ◆ Particle and distribution methods are appropriate for higher levels of detail
- ◆ Moment methods are used for rapid iteration of machine design
  - Moments also typically calculated as diagnostics in particle and distribution methods
- ◆ Even within one (e.g. particle) there are many levels of description:
  - Electromagnetic and electrostatic, with many field solution methods
    - 1D, 2D, 3D
    - ⋮
- ◆ Employing a hierarchy of models with full diagnostics allows cross-checking (both in numerics and physics) and aids understanding
  - No single method is best in all cases

## S3: Overview of Basic Numerical Methods

### S3A: Discretizations

General approach is to discretize independent variables in each of the methods and solve for dependent variables which in some cases may be discretized as well  
time (or  $s$ )

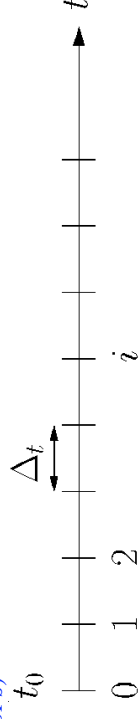

$$t = t_0 + i\Delta t; \quad i = 0, 1, 2, 3, \dots$$

- ◆ Nonuniform meshes also possible
  - Can add resolution where needed
  - Increases complexity

In typical applications may apply these descriptions in a variety of ways

- ◆ Move a transverse thin slice of a beam...

## Transverse Coordinate Discretization

### Spatial Coordinates (transverse)

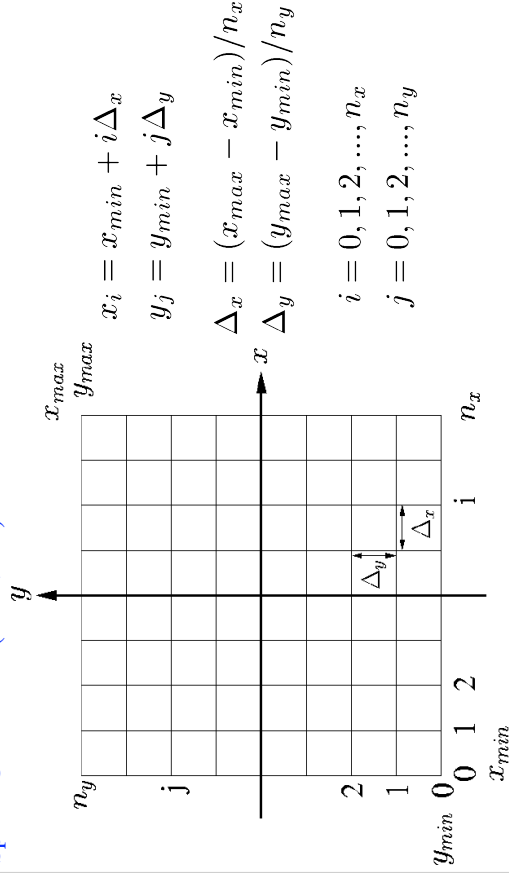

Analogous for 3D, momentum coordinates, etc.

## Transverse Coordinate Discretization – Applications

In typical applications may apply these discretizations in a variety of ways:

### Transverse Slice Simulation:

- ◆ Move a transverse thin “slice” of beam along the axial coordinate  $s$  of a reference particle

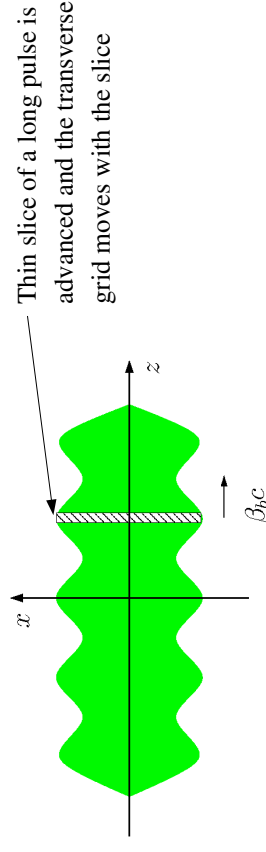

### Limitations:

- This “unbunched” approximation is not always possible
- 3D effect can matter, e.g. in short pulses and/or beams ends

## Transverse Coordinate Discretization – Applications (2)

### Steady State Simulation:

- Simulate the middle of a long pulse where a time stationary beam fills the grid

Example: [Mid-Pulse Diode](#)

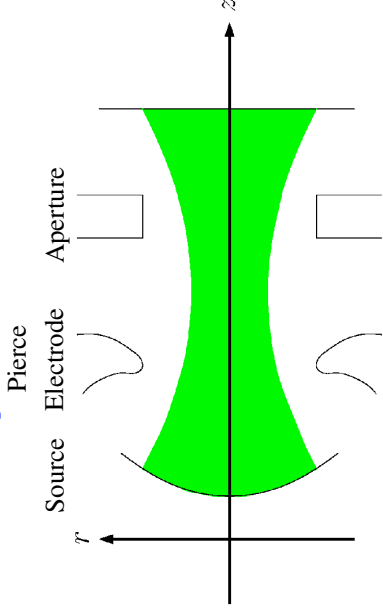

- Mesh is stationary, leading to limitations
  - Beam pulse always has ends: see J.J. Barnard lectures on **Longitudinal Physics**
  - Assumes that the mid-pulse in nearly time-independent in structure

SM Lund, USPAS, June 2008

Simulation Techniques

41

442

## Transverse Coordinate Discretization – Applications (3)

### Full 3D Simulation

- Simulate a 3D beam with a moving mesh that follows a reference particle (possibly beam centroid).

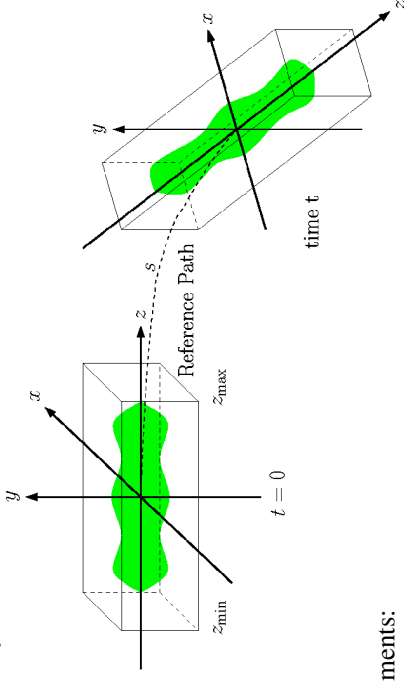

- Comments:
  - Most realistic level of modeling, but also most numerically intensive
  - Grid can be moved in discretized jumps so that applied fields maintain alignment with the grid

SM Lund, USPAS, June 2008

Simulation Techniques

42

## S3B: Discrete Numerical Operations

Let  $x$  represent a spatial coordinate and  $f(x)$  some continuous function of  $x$

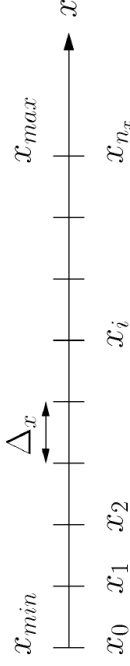

$$x_i = x_{min} + i\Delta_x; \quad \Delta_x = (x_{max} - x_{min})/n_x$$

$$i = 0, 1, 2, \dots, n_x$$

Denote  $f_i \equiv f(x_i)$ , etc. and Taylor expand one grid point forward and backward about  $x = x_i$

$$f_{i+1} = f_i + \frac{\partial f}{\partial x} \Big|_i \Delta_x + \frac{1}{2!} \frac{\partial^2 f}{\partial x^2} \Big|_i \Delta_x^2 + \frac{1}{3!} \frac{\partial^3 f}{\partial x^3} \Big|_i \Delta_x^3 + \dots$$

$$f_{i-1} = f_i - \frac{\partial f}{\partial x} \Big|_i \Delta_x + \frac{1}{2!} \frac{\partial^2 f}{\partial x^2} \Big|_i \Delta_x^2 - \frac{1}{3!} \frac{\partial^3 f}{\partial x^3} \Big|_i \Delta_x^3 + \dots$$

The same methodology can be applied to other spatial ( $x, y$ , etc.), axial ( $s$ ), and temporal ( $t$ ) coordinates

SM Lund, USPAS, June 2008

Simulation Techniques

43

## Discrete Numerical Operations: Derivatives

Simple, but inaccurate expressions for 1<sup>st</sup> order derivatives follow immediately from the forward and backward expansions

$$\frac{\partial f}{\partial x} \Big|_i = \frac{f_{i+1} - f_i}{\Delta_x} + \mathcal{O}(\Delta_x)$$

Forward:

$$\frac{\partial f}{\partial x} \Big|_i = \frac{f_i - f_{i-1}}{\Delta_x} + \mathcal{O}(\Delta_x)$$

Backward:

2 point:

(non-centered)

A more accurate, centered discretization for a 1<sup>st</sup> order derivative is obtained by subtracting the two expansions.

$$\frac{\partial f}{\partial x} \Big|_i = \frac{f_{i+1} - f_{i-1}}{2\Delta_x} + \mathcal{O}(\Delta_x^2)$$

3 point:

(centered)

- More accuracy generally will require the use of more function points

SM Lund, USPAS, June 2008

Simulation Techniques

44

## Discrete Numerical Operations: Derivatives (2)

The expansions can be relabeled ( $i \rightarrow i+1$ , etc.) and the resulting set of equations can be manipulated to obtain 5-point and other higher-order forms with higher accuracy:

$$\text{5 point: (centered)} \quad \left. \frac{\partial f}{\partial x} \right|_i = \frac{f_{i-2} - 8f_{i-1} + 8f_{i+1} - f_{i+2}}{12\Delta x} + \mathcal{O}(\Delta x^4)$$

Still higher order, and more accurate, forms are possible but rapidly become cumbersome and require more points.

Similar methods can be employed to obtain discretizations of higher order derivatives. For example,

$$\text{3 point: (centered)} \quad \left. \frac{\partial^2 f}{\partial x^2} \right|_i = \frac{f_{i+1} - 2f_i + f_{i-1}}{\Delta x^2} + \mathcal{O}(\Delta x^2)$$

## Discrete Numerical Operations: Integrals/Quadrature

Take  $n_x$  even, then  $\int_{x_{min}}^{x_{max}} d\tilde{x} f(\tilde{x})$  can be composed as sub-integrals of the form

$$\int_{x_{i-1}}^{x_{i+1}} d\tilde{x} f(\tilde{x})$$

Using a linear approximation (Trapezoidal Rule):

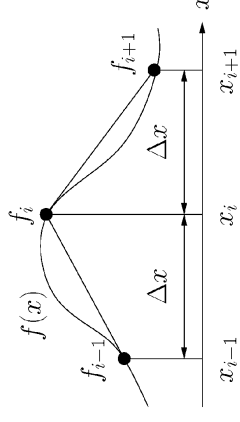

$$\int_{x_{i-1}}^{x_{i+1}} dx f(x) = \frac{f_{i-1} + 2f_i + f_{i+1}}{2} \Delta x + \mathcal{O}(\Delta x^3)$$

## Discrete Numerical Operations: Integrals/Quadrature (2)

Better approximations can be found (e.g., Simpson's Rule) using Taylor series expansions and the previous discrete derivatives:

$$f(x) = f_i + \frac{f_{i+1} - f_{i-1}}{2\Delta x} x + \frac{f_{i+1} - f_i + f_{i-1}}{\Delta x^2} x^2 + \dots$$

giving:

$$\int_{x_{i-1}}^{x_{i+1}} dx f(x) = \frac{f_{i-1} + 4f_i + f_{i+1}}{3} \Delta x + \mathcal{O}(\Delta x^5)$$

In the examples given, uniform grids have been employed and the formulas presented for derivatives and integrals are readily generalized to multiple dimensions.

## Discrete Numerical Operations: Irregular Grids

Nonuniform grids can be used to effectively concentrate resolution where it is needed

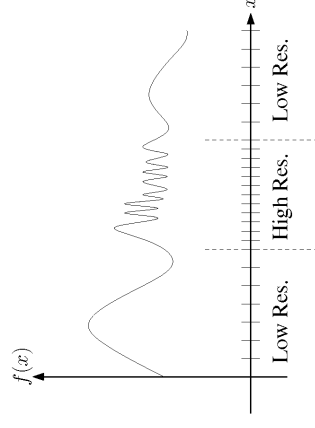

- ♦ Can be used most effectively when high resolution is needed only in limited regions and simulation domains are large
- ♦ Nonuniform grids make discretized formulas more complicated, particularly with respect to ordering errors
  - A simple example of nonuniform derivative calculation is included in the homework to illustrate methods

### Discrete Numerical Operations: Axisymmetric Systems

To be added: Slide to discuss how to solve cylindrically symmetric problems pointing out origin problems. Suggest that it is often better to simply do in 2D x-y geometry and use conserved angular momentum.

### S3C: Numerical Solution of Moment Methods – Time Advance

We now have the tools to numerically solve moment methods. The moment equations may always be written as an N-dimensional set of coupled 1<sup>st</sup> order ODEs (see: S2C and S.M. Lund lectures on **Transpose Envelope Equations**):

$$\mathbf{M} = (\langle x \rangle_{\perp}, \dots, \langle x^2 \rangle_{\perp}, \dots) \quad \text{N-dim vector of moments}$$

$$\frac{d\mathbf{M}}{ds} = \mathbf{F}(\mathbf{M}, s) \quad \text{vector equation of motion}$$

- Methods developed to advance moments can also be used for advances in particle and distribution methods

/// Example: Axisymmetric envelope equation for a continuously focused beam

$$\frac{d^2 R}{ds^2} + k_{\beta 0}^2 R - \frac{Q}{R} - \frac{\varepsilon_x^2}{R^3} = 0 \quad R = 2\sqrt{\langle x^2 \rangle_{\perp}}$$

$$\frac{d}{ds} \begin{bmatrix} R \\ R' \end{bmatrix} = \begin{bmatrix} R' \\ -k_{\beta 0}^2 R + \frac{Q}{R} + \frac{\varepsilon_x^2}{R^3} \end{bmatrix} \quad k_{\beta 0}^2, Q, \varepsilon_x^2, \text{ constants}$$

///

### S3C: Numerical Solution of Moment Methods – Euler Advance

Euler's Method:

Apply the forward difference formula

$$\left. \frac{d\mathbf{M}}{ds} \right|_i = \frac{\mathbf{M}_{i+1} - \mathbf{M}_i}{\Delta_s} + \mathcal{O}(\Delta_s) = \mathbf{F}(\mathbf{M}_i, s_i)$$

Rearrange to obtain 1<sup>st</sup> order Euler advance:

$$\mathbf{M}_{i+1} = \mathbf{M}_i + \mathbf{F}(\mathbf{M}_i, s_i)\Delta_s + \mathcal{O}(\Delta_s^2)$$

- Moments advanced in discrete steps in s from initial values
- Note that  $N_s$  steps will lead to a total error

$$\text{error} \sim N_s \cdot \mathcal{O}(\Delta_s^2) \sim \frac{s_{max} - s_{min}}{\Delta_s} \mathcal{O}(\Delta_s^2) \sim \mathcal{O}(\Delta_s)$$

- Error decreases only linearly with step size
- Numerical work for each step is only one evaluation of  $\mathbf{F}$

### S3C: Numerical Solution of Moment Methods – Order Advance

Definition:

A discrete advance with error  $\mathcal{O}(\Delta_s^n)$  is an (n-1)th order method

- Euler's method is a 1<sup>st</sup> order method
- Higher order methods are generally used for ODE's in moment methods
  - Cheap to evaluate  $\mathbf{F}$
- Low order methods are generally used for particle and distribution methods
  - Expensive to evaluate  $\mathbf{F}$

### S3C: Numerical Solution of Moment Methods – Runge-Kutta Advance

Runge-Kutta Method:

Integrate from  $s_i$  to  $s_{i+1}$ :

$$\frac{d\mathbf{M}}{ds} = \mathbf{F}(\mathbf{M}, s)$$

$$\mathbf{M}_{i+1} = \mathbf{M}_i + \int_{s_i}^{s_{i+1}} ds \mathbf{F}(\mathbf{M}, s)$$

Approximate  $\mathbf{F}$  with a Taylor expansion through the midpoint of the step,  $s_{i=1/2}$

$$\mathbf{F}(\mathbf{M}, s) = \mathbf{F}(\mathbf{M}_{i+1/2}, s_{i+1/2}) + \frac{\partial \mathbf{F}}{\partial s} \Big|_{s_{i+1/2}} (s - s_{i-1/2}) + \dots$$

The linear term integrates to zero, leaving

$$\Rightarrow \mathbf{M}_{i+1} = \mathbf{M}_i + \mathbf{F}(\mathbf{M}_{i+1/2}, s_{i+1/2}) \cdot \Delta_s + \mathcal{O}(\Delta_s^3)$$

### Runge-Kutta Advance (2)

Note: only need  $\mathbf{M}_{i+1/2}$  to  $\mathcal{O}(\Delta_s^2)$  for  $\mathcal{O}(\Delta_s^3)$  accuracy  
Apply Euler's method for the two-step procedure:

2<sup>nd</sup> Order Runge-Kutta Method:

$$\text{Step 1: } \mathbf{K} = \mathbf{F}(\mathbf{M}_i, s_i) \Delta_s$$

$$\text{Step 2: } \mathbf{M}_{i+1} = \mathbf{M}_i + \mathbf{F} \left( \mathbf{M}_i + \frac{\mathbf{K}}{2}, s_i + \frac{\Delta_s}{2} \right) \Delta_s + \mathcal{O}(\Delta_s^3)$$

- ◆ Requires two evaluations of  $\mathbf{F}$  per advance
- ◆ 2<sup>nd</sup> order accurate in  $\Delta_s$

Higher order Runge-Kutta schemes are derived analogously from various quadrature formulas. Such formulas are found in standard numerical methods texts

- ◆ Typically, methods with error  $\mathcal{O}(\Delta_s^{N+1})$  will require  $N$  evaluations of  $\mathbf{F}$

### S3C: Numerical Solutions of Moment Methods

Many methods are employed to advance moments and particle orbits.

A general survey of these methods is beyond the scope of this lecture. But some general comments can be made:

- ◆ Many higher-order methods with adaptive step sizes exist that refine accuracy to specified tolerances and are optimized for specific classes of equations
- ◆ Choice of numerical method often relates to numerical work and stability considerations
- ◆ Certain methods can be formulated to exactly preserve relevant single-particle invariants
  - “Symplectic” methods preserve Hamiltonian structure of dynamics
- ◆ Accelerator problems can be demanding due to multiple frequency scales and long tracking times/distances
  - Hamiltonian dynamics; phase space volume does not decay

### S3C: Numerical Solutions of Moment Methods – Numerical Stability

“Numerical Reversibility” test of stability:

In this method, the final value of an advance is used as an initial condition. Then the problem is run backwards to the original starting point and deviations from the initial conditions taken in the original advance are analyzed.

- ◆ Often a simple, but stringent test of accuracy
- ◆ Will ultimately fail due to roundoff errors and cases where there is a sensitive dependence on initial conditions
- ◆ Orbits can be wrong but qualitatively right. We will quantify this notion better later. So lack of full convergence does not necessarily mean that useless results will be obtained.

We will now briefly overview an application of moment equations, namely the KV envelope equations, to a practical high current transport lattice that was designed for Heavy Ion Fusion applications at Lawrence Berkeley National Laboratory.

### S3C: Moment Equation Application: Perp. KV Envelope Eqns

Neglect image charges and nonlinear self-fields (emittance constant) to obtain moment equations for the evolution of the beam envelope radii

$$\frac{d^2 r_x}{ds^2} + \kappa_x q r_x - \frac{2Q}{r_x + r_y} \frac{\varepsilon_x^2}{r_x^3} - \frac{\varepsilon_x^2}{r_x^3} = 0 \quad r_x = 2\sqrt{\langle x^2 \rangle_{\perp}}$$

$$\frac{d^2 r_y}{ds^2} - \kappa_y q r_y - \frac{2Q}{r_x + r_y} \frac{\varepsilon_y^2}{r_y^3} - \frac{\varepsilon_y^2}{r_y^3} = 0 \quad r_y = 2\sqrt{\langle y^2 \rangle_{\perp}}$$

$$Q = \frac{qI}{2\pi\epsilon_0 m c^3 \gamma_b^3 \beta_b^3}$$

$$\varepsilon_x = 4 \left[ \langle x^2 \rangle_{\perp} \langle x'^2 \rangle_{\perp} - \langle x x' \rangle_{\perp}^2 \right]^{1/2}$$

( $\varepsilon_{xn} = \gamma_b \beta_b \varepsilon_x$  normalized)

Dimensionless Perveance  
measures space-charge strength  
RMS Edge Emittance  
measures x-x' phase-space area  
~(beam size)sqrt(thermal temp.)

The matched beam solution together with parametric constraints from engineering, higher-order theory, and simulations are used to design the lattice.

### Application Example Continued (2) – Focusing Lattice

Take an alternating gradient FODO doublet lattice

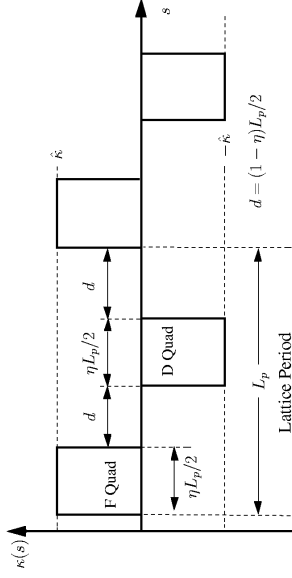

$$d = (1 - \eta) \frac{L_p}{2} \quad \eta = \text{Quadrupole Occupancy } (0 < \eta \leq 1)$$

Focusing Strength

$$\hat{\kappa} = \begin{cases} \frac{1}{[B\rho]} \left| \frac{dB_x}{dy} \right|, & \text{Magnetic Quadrupole} \\ \frac{1}{[B\rho]\beta_b c} \left| \frac{dE_x}{dy} \right|, & \text{Electric Quadrupole} \end{cases}$$

Rigidity

$$[B\rho] = m\gamma_b\beta_b c/q$$

### Application Example Contd. (3) – Matched Envelope Properties

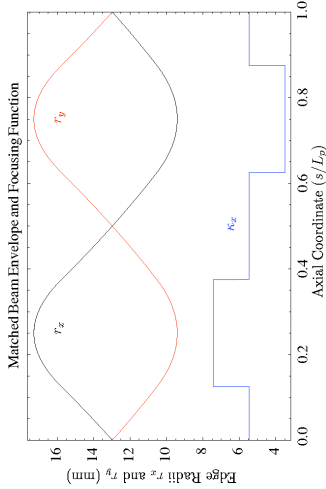

Ion  
 $K^+$ ,  $E = 2 \text{ MeV}$   
Current  
 $I = 800 \text{ mA}$   
Lattice  
 $L_p = 0.5 \text{ m}$   
 $\eta = 1/2$   
 $\sigma_0 = 80^\circ / \text{Lattice Period}$

Envelope Properties:

- 1) Low Emittance Case:  $\varepsilon_x = \varepsilon_y = 50 \text{ mm-mrad}$ ;  $\sigma = 9.42^\circ / \text{Lattice Period}$   
 $\text{Max}[r_x] = \text{Max}[r_y] = 17.3 \text{ mm}$      $\text{Max}[r'_x] = -\text{Min}[r'_y] = 47.5 \text{ mrad}$   
 $\text{Min}[r_x] = \text{Min}[r_y] = 9.41 \text{ mm}$      $\text{Max}[r'_y] = -\text{Min}[r'_x] = 47.5 \text{ mrad}$
- 2) High Emittance Case:  $\varepsilon_x = \varepsilon_y = 200 \text{ mm-mrad}$ ;  $\sigma = 32.13^\circ / \text{Lattice Period}$   
 $\text{Max}[r_x] = \text{Max}[r_y] = 18.9 \text{ mm}$      $\text{Max}[r'_x] = -\text{Min}[r'_y] = 52.4 \text{ mrad}$   
 $\text{Min}[r_x] = \text{Min}[r_y] = 10.1 \text{ mm}$      $\text{Max}[r'_y] = -\text{Min}[r'_x] = 52.4 \text{ mrad}$

### S4: Numerical Solution of Particle and Distribution Methods

#### S4A: Overview

Particle Methods – Generally not used at high space-charge intensity  
Distribution Methods – Preferred (especially PIC) for high space-charge.

We will motivate why now.

Why are direct particle methods are not a good choice for typical beams?

- $N$  particle coordinates  $\{x_i, p_i\}$
- Physical beam (typical)  $N \sim 10^{10} - 10^{14}$  particles

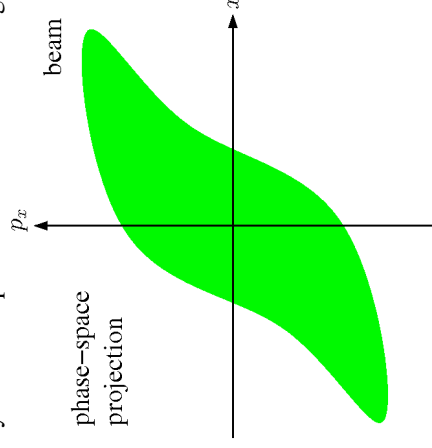

Although larger problems are possible every year with more powerful computers, current processor speeds and memory limit us to  $N \lesssim 10^8$  particles



## Numerical Solution of Particle and Distribution Methods (2)

Represent the beam by Lagrangian “macroparticles” advanced in time

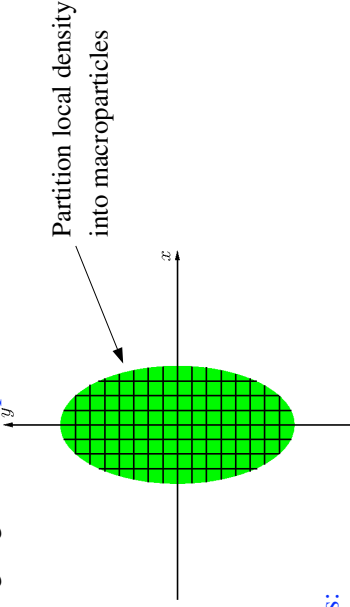

### Macroparticle Properties:

- ◆ Same  $q/m$  ratio as real particle
- Gives same single particle dynamics in the applied field
- ◆ More collisions due to macroparticles having more close approaches
- Enhanced collisionality is unphysical
- Controlled by smoothing the macroparticle interaction with the self-field. More on this later.

SM Lund, USPAS, June 2008

Simulation Techniques 61

447

## Numerical Solution of Particle and Distribution Methods (3)

Direct Vlasov as an example:

Discretize grid points  $\{x_i, p_j\}$

Advance distribution  $f(x, p, t)$  at discrete grid points in time

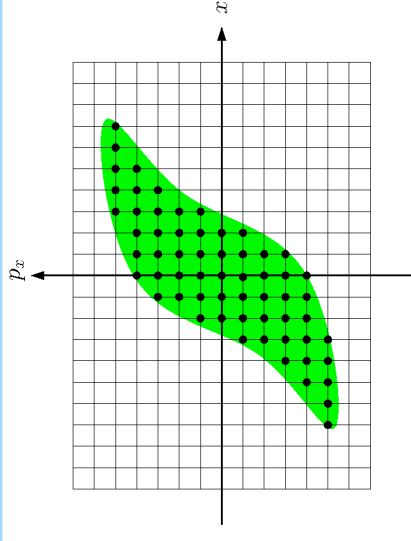

- ◆ Continuum distribution advanced on a discrete phase-space mesh
  - Extreme memory for high resolution. Example: for 4D  $x-p_x, y-p_y$  with  $10^8$  mesh points on each axis  $\rightarrow 100^4 = 10^8$  values to store in fast memory (RAM)
- ◆ Discretization errors can lead to aliasing and unphysical behavior (negative probability, etc.)

SM Lund, USPAS, June 2008

Simulation Techniques 62

## Numerical Solution of Particle and Distribution Methods (4)

Both particle and distribution methods can be broken up into two basic parts:

- 1) Moving particles or distribution evaluated at grid points through a finite time (or axial space) step
  - 2) Calculation of beam self-fields consistently with the distribution of particles
- In both methods, significant fractions of run time may be devoted to diagnostics
- ◆ Moment calculations can be computationally intensive and may be “gathered” frequently for evolution “histories”
  - ◆ Phase space projections (“snapshot” in time)
  - ◆ Fields (snapshot in time)

Diagnostics are also critical!

- ◆ Without appropriate diagnostics runs are useless, even if correct
- ◆ Must accumulate and analyze/present large amounts of data in an understandable format

Significant code development time may also be devoted to creating (loading) the initial distribution of particles to simulate

- ◆ Loading will usually only take a small fraction of total run time

SM Lund, USPAS, June 2008

Simulation Techniques 63

## S4B: Integration of Equations of Motion

Higher order methods require more storage and numerical work per time step

- ◆ Fieldsolves are expensive, especially in 3D, and several fieldsolves per step can be necessary for higher order accuracy

Therefore, low-order methods are typically used for self-consistent space-charge.

The “leapfrog” method is most common

- ◆ Only need to store prior position and velocity
- ◆ One fieldsolve per time step

Illustrate the leapfrog method for non-relativistic particle equations of motion:

- ◆ Develop methods for particles but can be applied to moments, distributions,...

$$m \frac{d\mathbf{v}}{dt} = \mathbf{F} = q(\mathbf{E} + \mathbf{v} \times \mathbf{B})$$

$$\frac{d\mathbf{x}}{dt} = \mathbf{v}$$

SM Lund, USPAS, June 2008

Simulation Techniques 64

## Leapfrog Method for Electric Forces

Leapfrog Method: for *velocity independent* (Electric) forces

Leapfrog Advance (time centered): Advance velocity and position out of phase

$$1) \quad m \frac{\mathbf{v}_{i+1/2} - \mathbf{v}_{i-1/2}}{\Delta t} = \mathbf{F}_i \quad \mathbf{F} = \mathbf{F}(\mathbf{x})$$

$$2) \quad \frac{\mathbf{x}_{i+1} - \mathbf{x}_i}{\Delta t} = \mathbf{v}_{i+1/2}$$

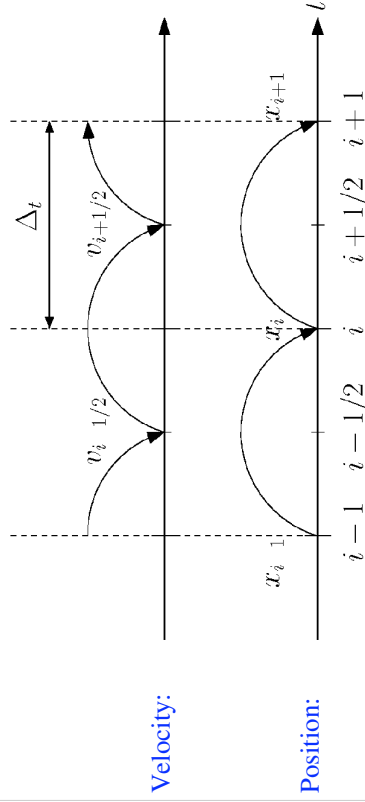

Velocity:

Position:

SM Lund, USPAS, June 2008

Simulation Techniques

65

448

## Leapfrog Method: Order

To analyze the properties of the leapfrog method it is convenient to write the map in an alternative form:

$$i \rightarrow i + 1 : \begin{cases} \frac{\mathbf{x}_{i+1} - \mathbf{x}_i}{\Delta t} = \mathbf{v}_{i+1/2} \\ \frac{\mathbf{x}_i - \mathbf{x}_{i-1}}{\Delta t} = \mathbf{v}_{i-1/2} \end{cases}$$

Subtract the two equations above and apply the other leapfrog advance formula:

$$\Rightarrow m \frac{\mathbf{v}_{i+1/2} - \mathbf{v}_{i-1/2}}{\Delta t} = \frac{\mathbf{x}_{i+1} - 2\mathbf{x}_i + \mathbf{x}_{i-1}}{\Delta t^2} = \mathbf{F}_i$$

Note correspondence of formula to discretized derivative:

$$\left. \frac{\partial^2 f}{\partial x^2} \right|_i = \frac{f_{i+1} - 2f_i + f_{i-1}}{\Delta x^2} + \mathcal{O}(\Delta x^2)$$

- ◆  $\mathbf{x}_{i+1}$  fixed from  $\mathbf{x}_i, \mathbf{x}_{i-1}, \mathbf{F}_i$  to  $\mathcal{O}(\Delta t^4)$
- ◆ Leapfrog method is 2<sup>nd</sup> order accurate

SM Lund, USPAS, June 2008

Simulation Techniques

66

## Initial conditions must be desynchronized in leapfrog method

Leapfrog Method: Synchronization

Since  $\mathbf{x}$  and  $\mathbf{v}$  are not evaluated at the same time in the leapfrog method

synchronization is necessary both to start the advance cycle and for diagnostics

- ◆ Initial conditions: typically,  $\mathbf{v}$  is pushed back half a cycle

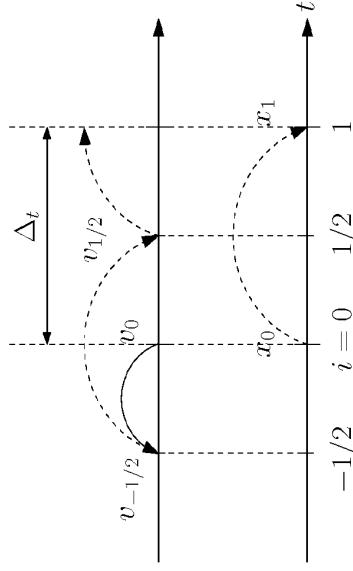

- ◆ When evaluating diagnostic quantities such as moments the particle coordinates and velocities should first be synchronized analogously to above

SM Lund, USPAS, June 2008

Simulation Techniques

67

## Leapfrog Method for Magnetic and Electric Forces --

### The Boris Method

Velocity Dependent Forces

Another complication in the evolution ensues when the force has velocity dependence, as occurs with magnetic forces. This complication results because  $\mathbf{x}$  and  $\mathbf{v}$  are advanced out of phase in the leapfrog method

$$\mathbf{F} = q\mathbf{E} + q\mathbf{v} \times \mathbf{B}$$

velocity term

- ◆ Electric field  $\mathbf{E}$  accelerates
- ◆ Magnetic field  $\mathbf{B}$  bends particle trajectory without change in speed  $|\mathbf{v}|$

A commonly implemented time centered scheme for magnetic forces is the following 3-step "Boris" method:

J. Boris, in *Proceedings of the 4<sup>th</sup> Conference on the Numerical Simulation of Plasmas* (Naval Research Lab, Washington DC 1970)

SM Lund, USPAS, June 2008

Simulation Techniques

68



## The Boris Advance

Boris Advance: 3-step, time-centered

1) Half-step acceleration in electric field

$$\mathbf{v}_{i+1/2}^{(1)} = \mathbf{v}_{i-1/2} + \frac{q}{m} \mathbf{E}_i \frac{\Delta t}{2}$$

2) Rotation in magnetic field. Here choose coordinates so that

$$\mathbf{B}_i = B_i \hat{z}, \omega_{ci} = \frac{qB_i}{m}$$

$$\parallel \mathbf{B}_i : v_{z_{i+1/2}}^{(2)} = v_{z_{i+1/2}}^{(1)}$$

$$\perp \mathbf{B}_i : \begin{bmatrix} v_{z_{i+1/2}}^{(2)} \\ v_{z_{i+1/2}}^{(1)} \end{bmatrix} = \begin{bmatrix} \cos(\omega_{ci} \Delta t) & \sin(\omega_{ci} \Delta t) \\ -\sin(\omega_{ci} \Delta t) & \cos(\omega_{ci} \Delta t) \end{bmatrix} \begin{bmatrix} v_{z_{i+1/2}}^{(2)} \\ v_{z_{i+1/2}}^{(1)} \end{bmatrix}$$

3) Half-step acceleration in electric field

$$\mathbf{v}_{i+1/2} = \mathbf{v}_{i+1/2}^{(3)} = \mathbf{v}_{i+1/2}^{(2)} + \frac{q}{m} \mathbf{E}_i \frac{\Delta t}{2}$$

## Boris Advance Continued (2)

Complication: on startup, how does one generate the out-of-phase  $\mathbf{x}$ ,  $\mathbf{v}$  advance from the initial conditions?

- ◆ Calculate  $\mathbf{E}$ ,  $\mathbf{B}$  with initial conditions
- ◆ Move  $\mathbf{v}$  backward half a time step
  - Rotate with  $\mathbf{B}$  a half-step
  - Decelerate a half-step in  $\mathbf{E}$

Similar comments hold for synchronization of  $\mathbf{x}$ ,  $\mathbf{v}$  for diagnostic accumulation

Now we will look at the numerical properties of the leapfrog advance cycle

- ◆ Only use a simple “electric” force example to illustrate issues

## Leapfrog Advance: Errors and Numerical Stability

To better understand the leapfrog method consider the simple harmonic oscillator:

$$\frac{d^2 x}{dt^2} = -\omega^2 x, \omega = \text{const} \implies \begin{aligned} x &= C_0 \cos \omega t + C_1 \sin \omega t \\ &= x_0 \cos(\omega t + \psi_0) \end{aligned}$$

Discretized equation of motion

$$\frac{x_{i+1} - 2x_i + x_{i-1}}{\Delta t^2} = -\omega^2 x_i$$

Try a solution of the form  $x_i = c e^{j\tilde{\omega} i \Delta t}$ ,  $j \equiv \sqrt{-1}$

$$\implies e^{j\tilde{\omega} \Delta t} - 2 + e^{-j\tilde{\omega} \Delta t} = -\omega^2 \Delta t^2$$

$$2 - 2 \cos(\tilde{\omega} \Delta t) = \omega^2 \Delta t^2$$

$$\sin^2 \left( \frac{\tilde{\omega} \Delta t}{2} \right) = \frac{\omega^2 \Delta t^2}{4}$$

$$\implies \sin \left( \frac{\tilde{\omega} \Delta t}{2} \right) = \frac{\omega \Delta t}{2}$$

This has solutions for  $\omega \Delta t < 2$  and it is straightforward to show via expansion that for small  $\omega \Delta t$

$$\omega \Delta t = \tilde{\omega} \Delta t + \frac{(\tilde{\omega} \Delta t)^3}{24} + \mathcal{O} [(\tilde{\omega} \Delta t)^5]$$

## Leapfrog Errors and Numerical Stability Continued (2)

It follows for the leapfrog method applied to a simple harmonic oscillator:

- ◆ For  $\omega \Delta t < 2$  the method is stable
- ◆ There is  $n\theta$  amplitude error in the integration
- ◆ For  $\omega \Delta t \ll 1$  the phase error is
  - Actual phase:  $\psi \equiv \omega \Delta t i$

$$\text{Simulated phase: } \tilde{\psi} \equiv \tilde{\omega} \Delta t i \approx \omega \Delta t i + \frac{(\omega \Delta t)^3}{24} i$$

$$\text{Error phase: } \Delta \psi \equiv \tilde{\psi} - \psi \approx \frac{(\omega \Delta t)^3}{24} i$$

Note:  $i$  to get to a fixed time  $\sim \Delta t^{-1}$  and therefore phase errors decrease as  $\mathcal{O}(\Delta t^2)$   
 // Example:  $\omega = 2\pi/\tau$

Time step	Steps for a $\pi$ phase error
$\Delta t = 0.1\tau$	$24\pi / (0.1 \cdot 2\pi)^3 \approx 3 \times 10^2$
$\Delta t = 0.01\tau$	$24\pi / (0.01 \cdot 2\pi)^3 \approx 3 \times 10^5$

### Leapfrog Errors and Numerical Stability Continued (3)

Contrast: Numerical and Actual Orbit: Simple Harmonic Oscillator

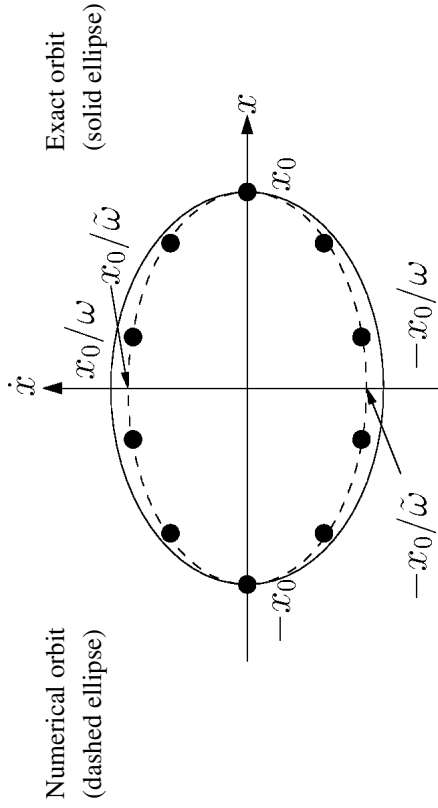

Emittance = (Phase Space Area)/ $\pi$

Exact:  $\varepsilon = x_0^2/\omega$        $\tilde{\varepsilon} \approx 1 - \frac{(\omega\Delta t)^2}{24}$

Numerical:  $\tilde{\varepsilon} = x_0^2/\tilde{\omega}$

### Leapfrog Errors and Numerical Stability Continued (4)

The numerical orbit conserves phase space area regardless of the number of steps taken! The slight differences between the numerical and actual orbits can be removed by rescaling the angular frequency to account for the discrete step

- ◆ More general analysis of the leapfrog method shows it has “symplectic” structure, meaning it preserves the Hamiltonian nature of the dynamics
- ◆ Symplectic methods are important for long tracking problems (typical in accelerators) to obtain the right orbit structure
  - Runge-Kutta methods are not symplectic and can result in artificial numerical damping in long tracking problems

### Example: Contrast of Non-Symplectic and Symplectic Advances

Contrast: Numerical and Actual Orbit for a Simple Harmonic Oscillator use scaled coordinates (max extents unity for analytical solution)

**Symplectic Leapfrog Advance:** 5 steps per period, 100 periods

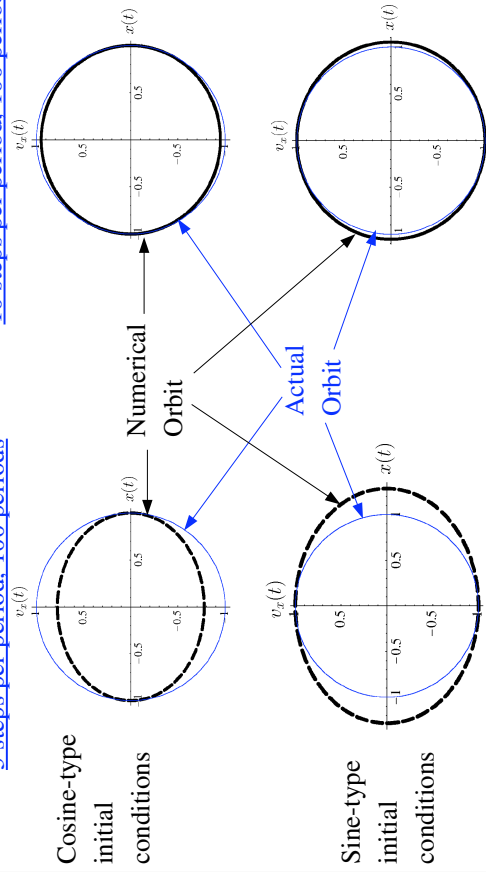

### Example: Contrast of Non-Symplectic and Symplectic Advances (2)

Contrast: Numerical and Actual Orbit for a Simple Harmonic Oscillator

**Non-Symplectic 2<sup>nd</sup> Order Runge-Kutta Advance:** (see earlier notes on RK advance) 6 steps per period, 10 periods

**20 steps per period, 50 periods**

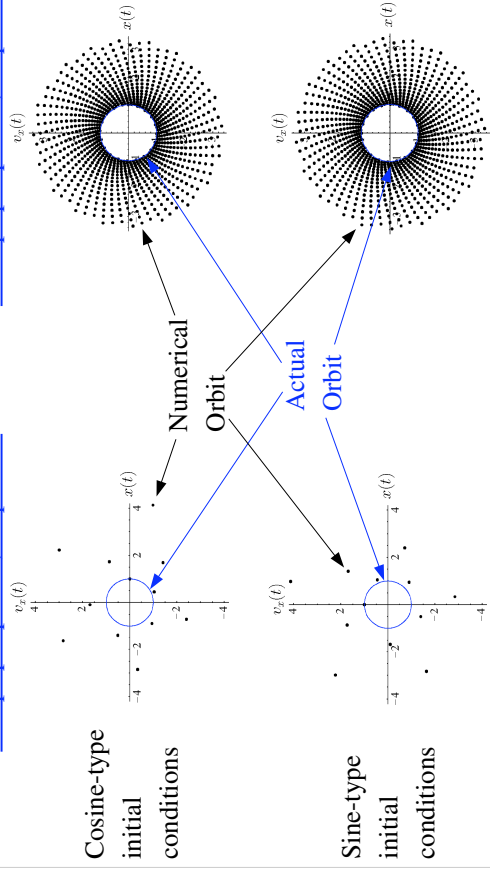

### Example: Contrast of Non-Symplectic and Symplectic Advances (3)

Contrast: Numerical and Actual Orbit for a Simple Harmonic Oscillator

**Non-Symplectic 4<sup>th</sup> Order Runge-Kutta Advance:** (analog to notes on 2<sup>nd</sup> order RK adv)

5 steps per period, 20 periods      10 steps per period, 200 periods

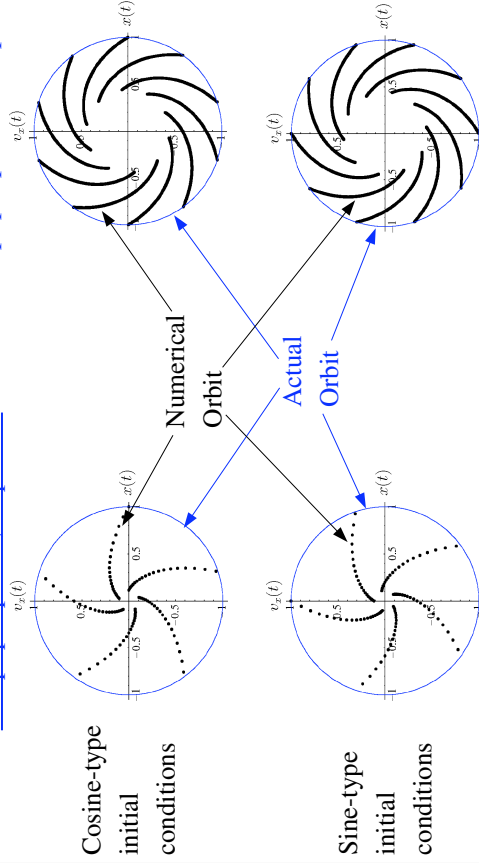

### Example: Leapfrog Stability Applied to the Nonlinear Envelope Equation in a Continuous Focusing Lattice

For linear equations of motion, numerical stability requires:

$$k\Delta_s < 2$$

Here,  $k$  is the wave number of the phase advance of the quantity evolving under the linear force. The continuous focusing envelope equation is nonlinear:

$$\frac{d^2 r_x}{ds^2} + k_{\beta 0}^2 r_x - \frac{2Q}{r_x + r_y} - \frac{\epsilon_x^2}{r_x^3} = 0$$

$$\frac{d^2 r_y}{ds^2} + k_{\beta 0}^2 r_y - \frac{2Q}{r_x + r_y} - \frac{\epsilon_y^2}{r_y^3} = 0$$

Several wavenumbers  $k$  can be expressed in the envelope evolution:

$$k_{\beta} = \sigma / L_p \quad \dots \text{Depressed Particle Betatron Motion}$$

$$k_{\beta 0} = \sigma_0 / L_p \quad \dots \text{Undepressed Particle Betatron Motion}$$

$$k_Q \equiv \sqrt{k_{\beta 0}^2 + 3k_{\beta}^2} \quad \dots \text{Quadrupole Envelope Mode}$$

$$k_B \equiv \sqrt{2k_{\beta 0}^2 + 2k_{\beta}^2} \quad \dots \text{Breathing Envelope Mode}$$

### Example: Leapfrog Stability and the Continuous Foc. Envelope Equation (2)

Expect that  $k_{\beta 0} \Delta_s < 2$  for the fastest (largest  $k$ ) component determines stability.

Numerical simulations for an initially matched envelope with:  $\sigma / \sigma_0 = 1/2$

$k_{\beta} \Delta_s$	$k_{\beta 0} \Delta_s$	$k_Q \Delta_s$	$k_B \Delta_s$	Stable?
0.500	1.00	1.32	1.58	Yes
0.600	1.20	1.59	1.90	Yes
0.630	1.26	1.67	1.99	Yes
0.635	1.27	1.68	2.01	No
0.640	1.28	1.69	2.02	No

The highest  $k$ -mode, the breathing mode, appears to determine stability, i.e.  $k_B \Delta_s < 2$  is the stability criterion. Other values of  $\sigma / \sigma_0$  produce results in agreement with this conclusion.

### Example: Leapfrog Stability and the Continuous Foc. Envelope Equation (3)

Numerical simulations an initially matched envelope with:  $\sigma_0 = 80^\circ$ ,  $\sigma / \sigma_0 = 1/2$   
Note that numerical errors seed small amplitude mismatch and that the plot scale to the left is  $\sim 10^{-13}$ , corresponding to numerical errors.

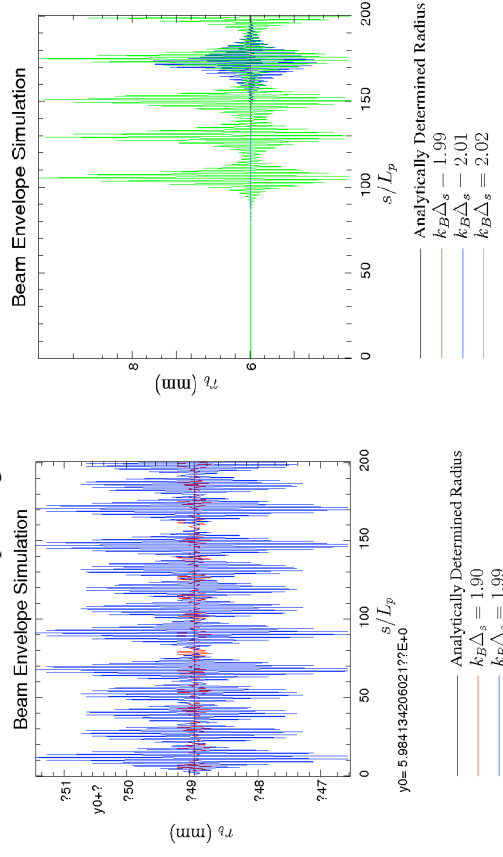

## Comments of 2D and 3D Axisymmetric Particle Moves

To be added:

Comments on moving ring particles:

- 3D axisymmetry => particles rings, 3D axisymmetry => particles are infinite cylindrical shells.
- Angular momentum will be conserved for such particles (can rotate)
- Easier to do in many cases using x-y movers

## S4C: Field Solution

The self-consistent calculation of beam-produced self-fields is vital to accurately simulate forces acting on particles in intense beams

$$\mathbf{F} = q(\mathbf{E} + \mathbf{v} \times \mathbf{B})$$

- Techniques outlined here are also applicable to distribution methods
- Fields can be resolved into externally applied and self (beam generated) components

$$\mathbf{E} = \mathbf{E}_a + \mathbf{E}_s$$

$$\mathbf{B} = \mathbf{B}_a + \mathbf{B}_s$$

$\mathbf{E}_a, \mathbf{B}_a$  applied fields generated by magnets and electrodes

- Sometimes calculated at high resolution in external codes and imported or specified via analytic formulas
- Sometimes calculated from code fieldsolve via applied charges and currents and boundary conditions
- $\mathbf{E}_s, \mathbf{B}_s$  self fields generated by beam charges and currents
- At high beam intensities can be a large fraction (on average) of applied fields
- Important to calculate with realistic boundary conditions

## Electrostatic Field Solution

For simplicity, we restrict analysis to electrostatic problems to illustrate methods:

$\mathbf{B} = \mathbf{B}_a$   $\mathbf{B}_a$  specified via another code or theory

$\mathbf{E} = \mathbf{E}_a + \mathbf{E}_s$   $\mathbf{E}_a$  due to biased electrodes and  $\mathbf{E}_s$  due to beam space-charge

The Maxwell equations to be solved for  $\mathbf{E}$  are

$$\begin{aligned} \nabla \cdot \mathbf{E} &= \frac{\rho}{\epsilon_0} & + \text{boundary conditions on } \mathbf{E} \\ \nabla \times \mathbf{E} &= 0 \end{aligned}$$

$\nabla \times \mathbf{E} = 0$  implies that we can always take  $\mathbf{E} = -\nabla\phi$  and so

$$\begin{aligned} \nabla^2\phi &= -\frac{\rho}{\epsilon_0} & + \text{boundary conditions on } \phi \\ \mathbf{E} &= -\nabla\phi \end{aligned}$$

## Electrostatic Field Solution: Typical Problem

As an example, it might be necessary to solve (2D) fields of a beam within an electric quadrupole assembly.

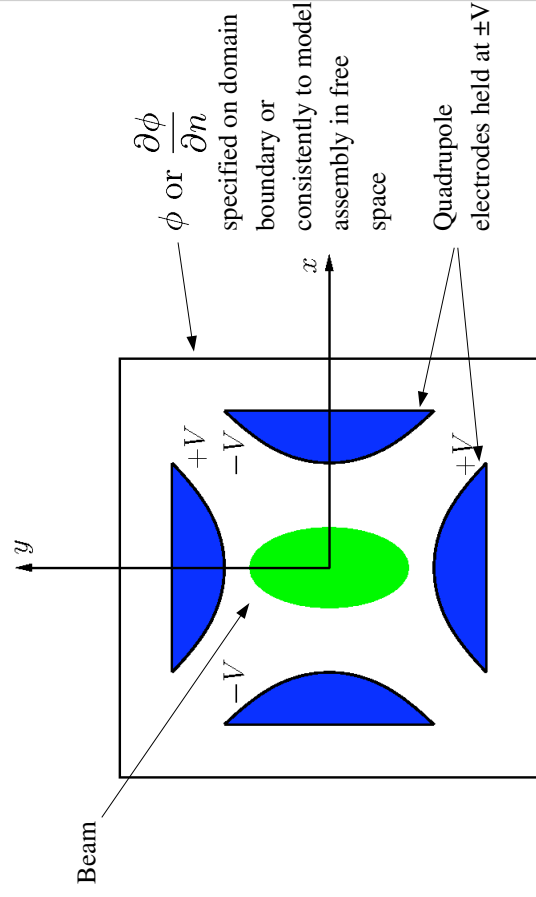

## Electrostatic Field Solution by Green's Function

Formally, the solution to  $\phi$  can be constructed with a Green's function, illustrated here with Dirichlet boundary conditions:

$$\nabla^2 G(\mathbf{x}, \mathbf{x}') = -4\pi\delta(\mathbf{x} - \mathbf{x}')$$

$$G(\mathbf{x}, \mathbf{x}')|_{\mathbf{x}'_b} = 0$$

$\mathbf{x}'_b \equiv \mathbf{x}'$  on boundaries

$$\frac{\partial}{\partial n} \equiv \hat{\mathbf{n}} \cdot \frac{\partial}{\partial \mathbf{x}}$$

$\hat{\mathbf{n}} \equiv$  Unit normal vector to boundary surface

This yields

$$\phi(\mathbf{x}) = \frac{1}{4\pi\epsilon_0} \int_V d^3x' \rho(\mathbf{x}') G(\mathbf{x}, \mathbf{x}') - \frac{1}{4\pi} \oint_S d^2x' \phi(\mathbf{x}') \frac{\partial G(\mathbf{x}, \mathbf{x}')}{\partial n'} \quad \uparrow$$

Self-field component

$$\begin{aligned} &\equiv \phi_s \\ \mathbf{E}_s &= -\frac{\partial \phi_s}{\partial \mathbf{x}} \end{aligned}$$

Applied field from electrode potentials

$$\begin{aligned} &\equiv \phi_a \\ \mathbf{E}_a &= -\frac{\partial \phi_a}{\partial \mathbf{x}} \end{aligned}$$

## Electrostatic Field Solution by Green's Function (2)

Applied Field:

$\phi_a$  can be calculated in advance and need not be recalculated if transverse geometry does not change

- Can be analytical in simple situations

Self Field:

Let:  $q_M, \mathbf{x}_i =$  Macro-particle charge and coordinate

$N_p =$  Macro-particle number

$$\phi_s = \frac{1}{4\pi\epsilon_0} \int d^3x' \rho(\mathbf{x}') G(\mathbf{x}, \mathbf{x}') = \frac{q_M}{4\pi\epsilon_0} \sum_{i=1}^{N_p} \int d^3x' \delta(\mathbf{x}' - \mathbf{x}_i) G(\mathbf{x}, \mathbf{x}')$$

$$\phi_s = \frac{q_M}{4\pi\epsilon_0} \sum_{i=1}^{N_p} G(\mathbf{x}, \mathbf{x}_i)$$

Then the field at the  $i$ th macro-particle is (self-field term removed):

$$\mathbf{E}_{si} = \frac{\partial \phi_s}{\partial \mathbf{x}} \Big|_{\mathbf{x}=\mathbf{x}_i} = \frac{q_M}{4\pi\epsilon_0} \sum_{\substack{j=1 \\ j \neq i}}^{N_p} \frac{\partial G(\mathbf{x}, \mathbf{x}_j)}{\partial \mathbf{x}} \Big|_{\mathbf{x}=\mathbf{x}_i}$$

## Electrostatic Field Solution by Green's Function (3)

The Green's Function expression for  $\phi_a$  will, in general, be a numerically intensive expression to evaluate at *each* macroparticle

- $N_p(N_p - 1)$  terms to evaluate and **G itself will in general be complicated** and may require many costly numerical operations for each term, limiting  $N_p$
- Small  $N_p$  for which this procedure is practical will result in a noisy field
  - Enhanced, unphysically high, close approaches (collisions) with poor statistics can change the physics
- Special "fast multipole" methods based on Green's functions can reduce the scaling to  $\sim N_p$  or  $\sim N_p \ln(N_p)$ .
- Coefficient is large and smoothing is not easily implemented, often rendering such methods inferior to gridded methods to be covered shortly

// Example: Self fields in free space

$$G(\mathbf{x}, \mathbf{x}') = \frac{1}{|\mathbf{x} - \mathbf{x}'|}; \quad \mathbf{E}_{si} = \frac{q_M}{4\pi\epsilon_0} \sum_{\substack{j=1 \\ j \neq i}}^{N_p} \frac{(\mathbf{x}_i - \mathbf{x}_j)}{|\mathbf{x}_i - \mathbf{x}_j|^3} \quad //$$

## Field Solution on a Discrete Grid

An alternative procedure is needed to

- Calculate fields efficiently by discretization of the Maxwell equations
  - Smooth interactions to compensate for limited particle numbers
- Approach: Solve the Maxwell Equations on a discrete spatial grid and then smooth the interactions calculated from the gridded field.

**Discretization:** 2D uniform grid (1D and 3D analogs)

$$\begin{aligned} x_i &= x_{min} + i\Delta_x & \Delta_x &= (x_{max} - x_{min})/n_x & i &= 0, 1, 2, \dots, n_x \\ y_j &= y_{min} + j\Delta_y & \Delta_y &= (y_{max} - y_{min})/n_y & j &= 0, 1, 2, \dots, n_y \end{aligned}$$

$$\left. \begin{aligned} \mathbf{E}_{ij} &= \mathbf{E}(x_i, y_j) \\ \phi_{ij} &= \phi(x_i, y_j) \\ \rho_{ij} &= \rho(x_i, y_j) \end{aligned} \right\} \begin{array}{l} \text{Field components, potential,} \\ \text{and charge are gridded} \end{array}$$

Comments:

- $\rho_{ij}$  must be calculated from macro-particles, not necessarily on grid points
- Fields will ultimately be needed at macro-particle coordinates, not on grid. These issues will be covered later under "particle weighting"

## Field Solution on a Discrete Grid: Example Problem, Beam in an Electric Quadrupole

Beam in an electric quadrupole lattice ( $2D$ )

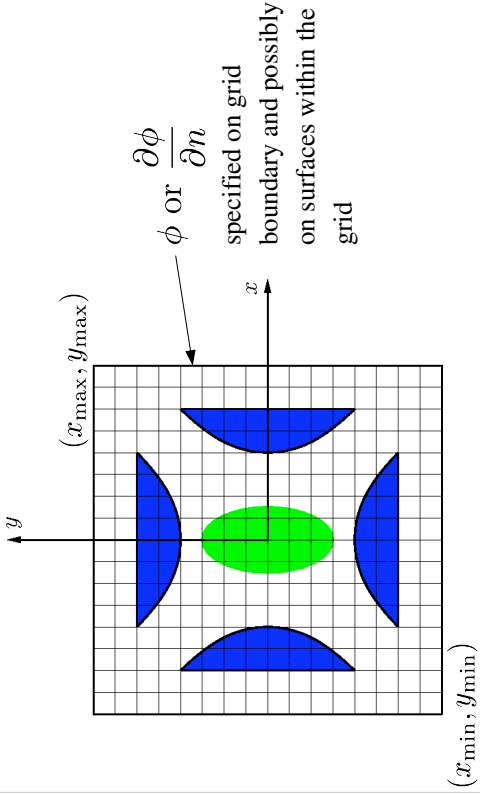

## Gridded Field Solution: Discretized Poisson Eqn.

For low order differencing, the Poisson Equation becomes

$$\frac{\phi_{i+1,j} - 2\phi_{i,j} + \phi_{i-1,j}}{\Delta x^2} + \frac{\phi_{i,j+1} - 2\phi_{i,j} + \phi_{i,j-1}}{\Delta y^2} = -\frac{\rho_{i,j}}{\epsilon_0}$$

with the gridded field components calculated as

$$E_{xij} = \frac{\phi_{i+1,j} - \phi_{i-1,j}}{2\Delta x}$$

$$E_{yij} = \frac{\phi_{i,j+1} - \phi_{i,j-1}}{2\Delta y}$$

Boundary conditions must also be incorporated as constraint equations

**Dirichlet Conditions:**  $\phi$  specified on surfaces

**Neumann Conditions:**  $\frac{\partial \phi}{\partial n}$  specified on surfaces

## Gridded Field Solution: Discretized Dirichlet Boundary Cond

**Dirichlet Conditions:**  $\phi$  specified on surface  
Example:  $\phi = V = \text{const}$  at right grid edge

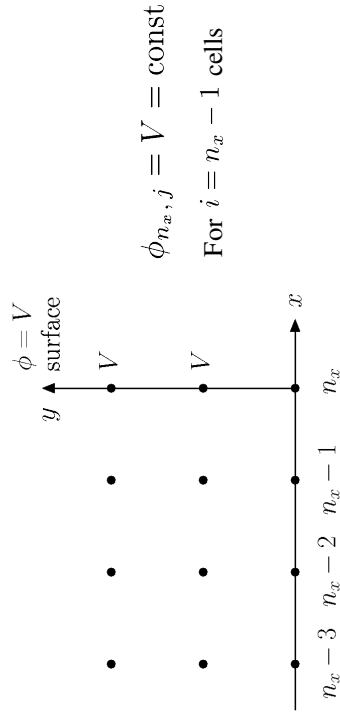

$$\frac{V - 2\phi_{n_x-1,j} + \phi_{n_x-2,j}}{\Delta x^2} + \frac{\phi_{n_x-1,j+1} - 2\phi_{n_x-1,j} + \phi_{n_x-1,j-1}}{\Delta y^2} = -\frac{\rho_{n_x-1,j}}{\epsilon_0}$$

## Gridded Field Solution: Discretized Neumann Boundary Cond

**Neumann Conditions:**  $\frac{\partial \phi}{\partial n}$  specified on surfaces

Example:  $\frac{\partial \phi}{\partial n} = G = \text{const}$  at right grid edge

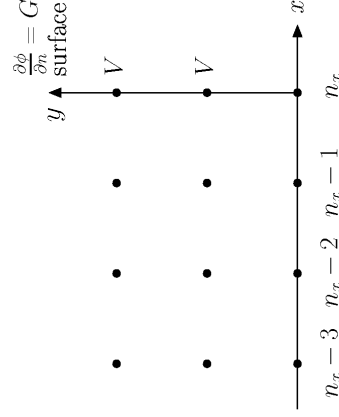

$$\frac{\phi_{n_x-1,j} - \phi_{n_x,j}}{\Delta x} = G$$





## Field Solution Methods on Grid Continued (2)

Sometimes methods in these three classes are combined. For example, one might employ spectral methods transversely and invert the tri-diagonal matrix longitudinally.

Other discretization procedures are also widely employed, giving rise to other classes of field solutions such as:

- ◆ Finite elements
- ◆ Variational
- ◆ Monte Carlo

Methods of field solution are central to the efficient numerical solution of intense beam problems. It is not possible to review them all here. But before discussing particle weighting, we will first overview the important spectral methods and FFT's

## Spectral Methods and the FFT

The spectral approach combined with numerically efficient Fast Fourier Transforms (FFT's) is commonly used to efficiently solve the Poisson Equation on a discrete spatial grid

- ◆ Approach provides spectral information on fields that can be used to smooth the interactions
- ◆ Efficiency of method enabled progress in early simulations
  - Computers had very limited memory and speed
- ◆ Method remains important and can be augmented in various ways to implement needed boundary conditions
  - Simple to code with numerical libraries
  - Efficiency still important ... especially in 3D geometries

## Spectral Method: Discrete Fourier Transform

Illustrate in 1D for simplicity (multidimensional case analogous)

$$\frac{d^2 \phi}{dx^2} = -\frac{\rho}{\epsilon_0}$$

Continuous Fourier Transforms (Reminder)

$$\begin{aligned} \tilde{\phi}(k) &= \int_{-\infty}^{\infty} dx e^{ikx} \phi(x) & \tilde{\rho}(k) &= \int_{-\infty}^{\infty} dx e^{ikx} \rho(x) \\ \phi(x) &= \int_{-\infty}^{\infty} \frac{dk}{2\pi} e^{-ikx} \tilde{\phi}(k) & \rho(x) &= \int_{-\infty}^{\infty} \frac{dk}{2\pi} e^{-ikx} \tilde{\rho}(k) \end{aligned}$$

Transform Poisson Equation:  $k^2 \tilde{\phi}(k) = \frac{\tilde{\rho}(k)}{\epsilon_0}$

$$\phi(x) = \int_{-\infty}^{\infty} \frac{dk}{2\pi} e^{-ikx} \frac{\tilde{\rho}(k)}{\epsilon_0 k^2}$$

Similar procedures work to calculate the field on a finite, discrete spatial grid

- ◆ Develop by analogy to continuous transforms

## Discrete Fourier Transform (2)

Discretize the problem as follows:

$$x_j = x_{min} + j\Delta_x; \quad \Delta_x = \frac{x_{max} - x_{min}}{n_x}; \quad j = 0, 1, 2, \dots, n_x$$

$$\phi_j \equiv \phi(x_j)$$

$n_x + 1$  grid points  
 $n_x$  distinct values  
(periodic)

$$k_n \equiv \frac{2\pi n}{n_x \Delta_x} \quad n = -\frac{n_x}{2}, \dots, 0, \dots, \frac{n_x}{2}$$

The discrete transform is defined by analogy to the continuous transform by:

$$\begin{aligned} \tilde{\phi}(k_n) &= \int_{-\infty}^{\infty} dx e^{ik_n x} \phi(x) \iff \tilde{\phi}_n \equiv \Delta_x \sum_{j=0}^{n_x} e^{ik_n(x_j - x_{min})} \phi_j \\ &= \Delta_x \sum_{j=0}^{n_x} \exp\left(\frac{i2\pi n j}{n_x}\right) \phi_j \end{aligned}$$



### Discrete Fourier Transform (3)

$$\underbrace{\text{Grid}}_{\phi_j} \longleftrightarrow \underbrace{\text{Transform}}_{\tilde{\phi}_n} \quad (n_x + 1 \text{ values}) \quad (n_x + 1 \text{ complex values})$$

Note that  $\tilde{\phi}_n$  is periodic in  $n$  with period  $n_x$

$$\tilde{\phi}_{-n} = \tilde{\phi}_{n_x - n}$$

- Let  $n = 0, 1, 2, \dots, n_x$  so  $n$  and  $j$  have the same ranges

Then an inverse transform can be constructed *exactly*:

$$\phi_j = \frac{1}{n_x \Delta_x} \sum_{n=0}^{n_x} \exp\left(-\frac{i2\pi nj}{n_x}\right) \tilde{\phi}_n$$

- This exact inversion is proved in the problems by summing a geometric series

### Discrete Transform Formulas

Application of the Discrete Fourier Transform to solve Poisson's Equation:

$$E_x = -\frac{d\phi}{dx} \longleftrightarrow E_{xj} = -\frac{\phi_{j+1} - \phi_{j-1}}{2\Delta_x}$$

$$\frac{d^2\phi}{dx^2} = -\frac{\rho}{\epsilon_0} \longleftrightarrow \frac{\phi_{j+1} - 2\phi_j + \phi_{j-1}}{\Delta_x^2} = -\frac{\rho}{\epsilon_0}$$

Applying the discrete transform yields:

$$\tilde{E}_{xn} = ik_n \tilde{\phi}_n \quad k_n = k_n \left[ \frac{\sin(k_n \Delta_x)}{k_n \Delta_x} \right] \quad k_n \equiv \frac{2\pi n}{(n_x + 1)\Delta_x}$$

$$\equiv k_n \text{dif}(k_n \Delta_x)$$

Poisson's Equation becomes:

$$\tilde{\phi}_n = \frac{\tilde{\rho}_n}{\epsilon_0 K_n^2}; \quad K_n^2 \equiv k_n^2 \text{dif}^2(k_n \Delta_x/2) = k_n^2 \left[ \frac{\sin(k_n \Delta_x/2)}{k_n \Delta_x/2} \right]^2$$

Note: factors of  $K_n^2$  need only be calculated once per simulation (store values)

### Spectral Methods: Aliasing

The discrete transform describes a periodic problem if indices are extended

- Discretization errors (aliasing) can occur

Figure to be edited:  $\lim_{x \rightarrow \pm\infty} \phi(x) = 0$

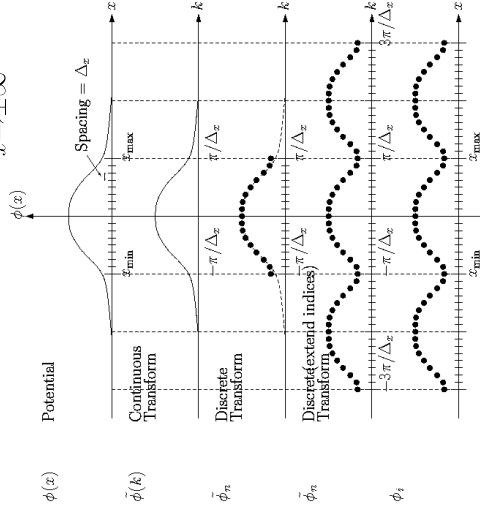

Plots will be replaced with real transforms based on a Gaussian distribution in future versions of the notes

### Derivation of Discrete Transform Eqns.

Example Derivation of a formula for the discrete transformed E-field:

$$\text{Discretized E-field} \quad E_{xj} = -\frac{\phi_{j+1} - \phi_{j-1}}{2\Delta_x}$$

$$\phi_j = \frac{1}{(n_x + 1)\Delta_x} \sum_{n=0}^{n_x} \exp\left(-\frac{i2\pi nj}{n_x + 1}\right) \tilde{\phi}_n$$

$$\text{Transforms} \quad E_{xj} = \frac{1}{(n_x + 1)\Delta_x} \sum_{n=0}^{n_x} \exp\left(-\frac{i2\pi nj}{n_x + 1}\right) \tilde{E}_{xn}$$

Substitute transforms into difference formula:

$$2\Delta_x \sum_{n=0}^{n_x} \exp\left(-\frac{i2\pi nj}{n_x + 1}\right) \tilde{E}_{xn}$$

$$= -\sum_{n=0}^{n_x} \exp\left(-\frac{i2\pi nj}{n_x + 1}\right) \tilde{\phi}_n \left\{ \exp\left(-\frac{i2\pi n}{n_x + 1}\right) - \exp\left(\frac{i2\pi n}{n_x + 1}\right) \right\}$$

$$= \Delta_x \sum_{n=0}^{n_x} \exp\left(-\frac{i2\pi nj}{n_x + 1}\right) \tilde{E}_{xn} = i \sum_{n=0}^{n_x} \exp\left(-\frac{i2\pi nj}{n_x + 1}\right) \tilde{\phi}_n$$

$$\Delta_x \sum_{n=0}^{n_x} \exp\left(-\frac{i2\pi nj}{n_x+1}\right) \tilde{E}_{x,n} = i \sum_{n=0}^{n_x} \exp\left(-\frac{i2\pi nj}{n_x+1}\right) \sin\left(\frac{2\pi n}{n_x+1}\right) \tilde{\phi}_n$$

This equation must hold true for each term in the sum proportional to

$$\exp\left(-\frac{i2\pi nj}{n_x+1}\right) \text{ to be valid for a general } j.$$

$$\Rightarrow \tilde{E}_{x,n} = \frac{i}{\Delta_x} \sin\left(\frac{2\pi n}{n_x+1}\right) \tilde{\phi}_n$$

$$k_n = \frac{2\pi n}{(n_x+1)\Delta_x}$$

$$\Rightarrow \tilde{E}_{x,n} = ik_n \left[ \frac{\sin(k_n \Delta_x)}{k_n \Delta_x} \right] \tilde{\phi}_n \\ = ik_n \text{dif}(k_n \Delta_x) \tilde{\phi}_n$$

///

## Spectral Methods: Discrete Transform Field Solution

Typical discrete Fourier transform field solution (not optimized)

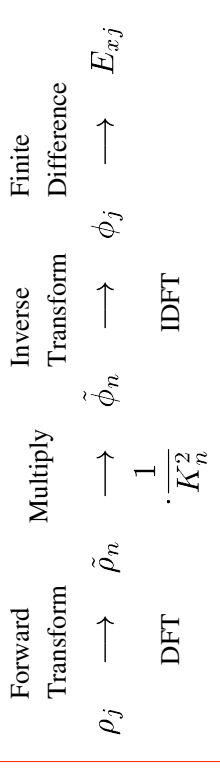

- $K_n^2$  factors can be calculated once and stored to increase numerical efficiency

## Discussion of Spectral Methods and the FFT

The Fast Fourier Transform (FFT) makes this procedure numerically efficient

- Discrete transform (no optimization),  $\sim (n_x + 1)^2$  complex operations
- FFT exploits symmetries to reduce needed operations to  $\sim (n_x + 1)/n_x(n_x + 1)$ 
  - Huge savings for large  $n_x$
- The needed symmetries exist only for certain numbers of grid points. In the simplest manifestations:  $n_x + 1 = 2^p$ ,  $p = 1, 2, 3, \dots$ 
  - Reduced gridding freedom
  - Other manifestations allow  $n_x + 1 = 2^p$  and products of prime numbers for more possibilities

The FFT can be combined with other procedures such as capacity matrices to implement boundary conditions for interior conductors, etc.

- This allows rapid field solutions in complicated geometries when capacity matrix elements can be pre-calculated and stored
- FFT is the fastest method for simple geometry
- Simple to code using typical numerical libraries for FFT's

## S4D: Weighting: Depositing Particles on the Field Mesh and Interpolating Gridded Fields to Particles

We have outlined methods to solve the electrostatic Maxwell's equations on a discrete spatial grid. To complete the description we must:

- Specify how to deposit macro-particle charges and current onto the grid
- Specify how to interpolate fields on the spatial grid points to the macro-particle coordinates (not generally on the grid) to apply in the particle advance
- Smooth interactions resulting from the small number of macro-particles to reduce artificial collisions resulting from the use of an unphysically small number of macro-particles needed for rapid simulation

This is called the *particle weighting problem*

## Weighting (2)

Particle weighting problem for electrostatic fields

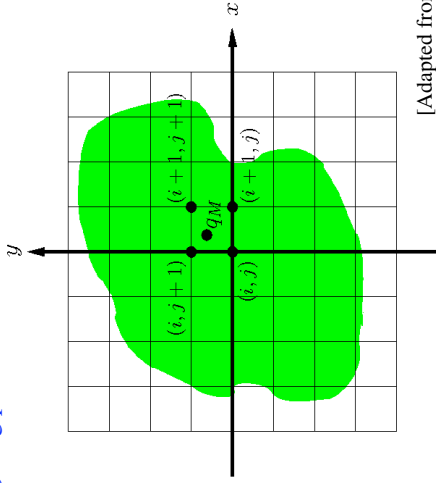

[Adapted from Birdsall and Langdon]

It is found that it is usually better to employ the same weighting schemes to deposit both the macro-particle charges and currents on the mesh and to extrapolate the fields at gridded points to the macro-particles

- Avoids unphysical self-forces where the particle accelerates itself

SM Lund, USPAS, June 2008

Simulation Techniques 109

## Weighting Methods

Many methods of particle weighting exist. They can be grouped into 4 categories:

- 1) Nearest Grid Point
- 2) Cloud in Cell (CIC)
  - Shaped particles
  - PIC method, linearly shaped particles
- 3) Multipole
  - Dipole, subtracted dipole, etc.
- 4) Higher order methods
  - Splines
  - $k$ -space cutoffs in discrete transforms
  - $\vdots$

Possible hybrid methods also exist. We will illustrate methods 1) and 2) for electrostatic problems. Descriptions of other methods can be found in the literature.

SM Lund, USPAS, June 2008

Simulation Techniques 110

## Weighting: Nearest Grid Point

1) Nearest Grid Point: Assign charges to the nearest grid cell

- Fast and simple: Show for 1D; 2D and 3D generalization straightforward
- Noisy

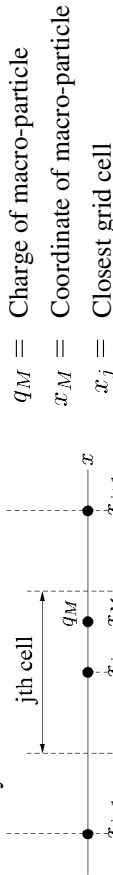

**Charge Deposition:**  
 $q_j = q_M$   
**Field "Interpolation":**  
 $E_x|_{x=x_M} = E_{x_j}$

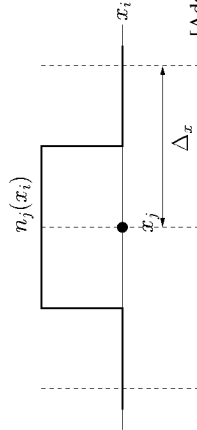

[Adapted from Birdsall and Langdon]

Comments:

- Currents can be interpolated to grid similarly for electromagnetic solving and/or diagnostics

SM Lund, USPAS, June 2008

Simulation Techniques 111

## Weighting : Cloud in Cell

2) Cloud in Cell: Shaped macro-particles pass freely through each other

- Smoother than Nearest Grid Point, but more numerical work
- For linear interpolation results in simple, commonly used "Particle in Cell" (PIC) method

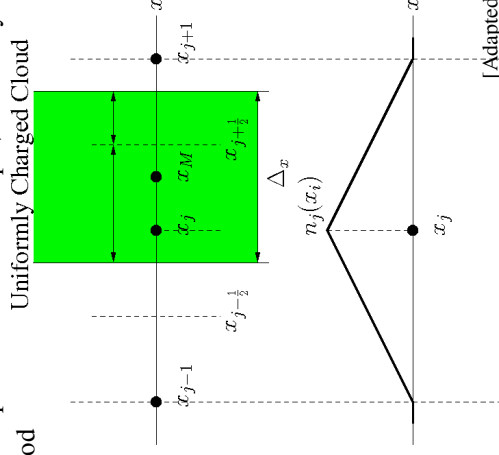

[Adapted from Birdsall and Langdon]

SM Lund, USPAS, June 2008

Simulation Techniques 112

## Cloud in Cell (2)

$q_M$ ,  $x_M$  = Charge and coordinate of macro-particle  
 $x_j$  = Closest grid cell

**Charge Deposition:**

$$q_j = q_M \left[ \frac{\Delta x - (x_M - x_j)}{\Delta x} \right] = q_M \frac{x_{j+1} - x_M}{\Delta x}$$

$$q_{j+1} = q_M \left[ \frac{x_M - x_j}{\Delta x} \right]$$

**Field Interpolation:**

$$E_x|_{x=x_M} = \left[ \frac{x_{j+1} - x_M}{\Delta x} \right] E_j + \left[ \frac{x_M - x_j}{\Delta x} \right] E_{j+1}$$

Comments:

- Linear interpolation results in triangularly shaped particles
- Shape smooths interactions reducing collisionality
  - Vlasov evolution with limited number of shaped particles
- Simple shape is fast to calculate numerically
- Currents can be interpolated to grid similarly for electromagnetic solving and/or diagnostics

SM Lund, USPAS, June 2008

Simulation Techniques 113

460

## Weighting: Area Weighting

In a 2D cloud-in-cell system, weighting is accomplished using rectangular “area weighting” to nearest grid points

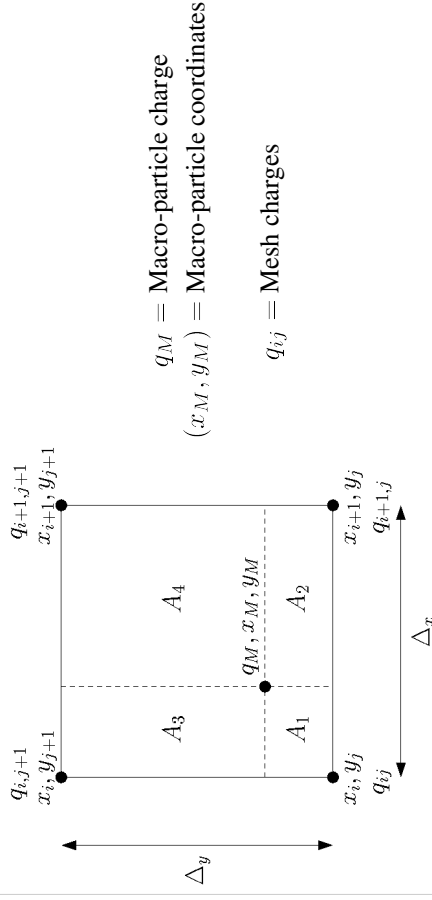

SM Lund, USPAS, June 2008

Simulation Techniques 114

## Area Weighting (2)

Charge Deposition:

$$q_{ij} = \left(1 - \frac{A_1}{\Delta x \Delta y}\right) q_M \quad A_1 = (x_M - x_i)(y_M - y_j)$$

$$q_{i+1,j} = \left(1 - \frac{A_2}{\Delta x \Delta y}\right) q_M \quad A_2 = (x_{i+1} - x_M)(y_M - y_j)$$

$$q_{i,j+1} = \left(1 - \frac{A_3}{\Delta x \Delta y}\right) q_M \quad A_3 = (x_M - x_i)(y_{j+1} - y_M)$$

$$q_{i+1,j+1} = \left(1 - \frac{A_4}{\Delta x \Delta y}\right) q_M \quad A_4 = (x_{i+1} - x_M)(y_{j+1} - y_M)$$

Field Interpolation:

$$\mathbf{E} = \frac{A_4}{\Delta x \Delta y} \mathbf{E}_{ij} + \frac{A_3}{\Delta x \Delta y} \mathbf{E}_{i+1,j} + \frac{A_2}{\Delta x \Delta y} \mathbf{E}_{i,j+1} + \frac{A_1}{\Delta x \Delta y} \mathbf{E}_{i+1,j+1}$$

Comments:

- Easily generalized to 3D using volumes
- Currents can be interpolated to grid similarly for electromagnetic solving and/or diagnostics

SM Lund, USPAS, June 2008

Simulation Techniques 115

## Higher Order Weighting: Splines

To be added: Slide on Splines to illustrate what is meant by higher order methods

Make Points:

- Requires more numerical work and harder to code
- Some schemes can introduce neg probability problems
- Should evaluate against simpler low order methods using same computer power to see which method wins.

SM Lund, USPAS, June 2008

Simulation Techniques 116

## S4E: Computational Cycle for Particle-In-Cell Simulations

We now have (simplified) notions of the parts that make up a Particle-In-Cell (PIC) simulation of Vlasov beam evolution

- 1) Particle Moving
- 2) Field Solver on a discrete grid
- 3) Weighting of particle and fields to and from the grid

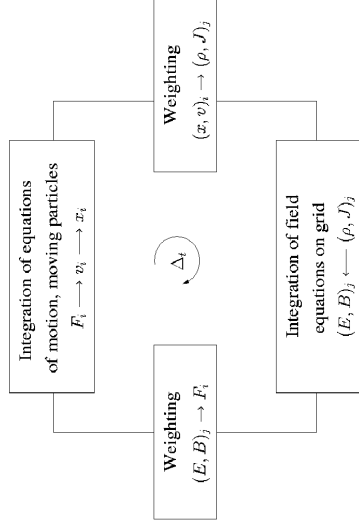

[Adapted from Birdsall and Langdon]

## Computational Cycle for Particle-In-Cell Simulations Contd.

Comments:

- ◆ Diagnostics must also be accumulated for useful runs (see S5)
  - Particles (coordinates and velocities) and fields will need to be synchronized (common time) when diagnostics are accumulated
- ◆ Initial conditions must be set (particle load, see S6)
  - Particle and field variables may need appropriate de-synchronization to initialize advance

## S5: Diagnostics

Diagnostics are *extremely* important. Without effective diagnostics even a correct and well converged simulation is useless. Diagnostics must be well formulated to display relevant quantities in a manner that increases physical understanding by highlighting important processes. This can be difficult since there can be a variety of issues and multiple effects taking place simultaneously.

Diagnostics can be grouped into two broad categories:

### 1) Snapshot Diagnostics

- ◆ Examples: Particle distribution projections at a particular values of  $s$  or  $t$
- ◆ Data can be saved to generate plots after the run or just the needed plots can be generated during the run using linked graphics packages etc.

### 2) History Diagnostics

- ◆ Examples: moments for the statistical beam centroid, envelope, and emittances
- ◆ Data for history plots must be accumulated and saved over several simulation advance steps

See handwritten notes from USPAS 06 for remaining diagnostics slides

- ◆ Will be updated in future versions of the notes

## S6: Initial Distributions and Particle Loading

To start the large particle or distribution simulations, the initial distribution function of the beam must be specified.

- ◆ For direct Vlasov simulations the distribution need simply be deposited on the phase-space grid

For PIC simulations, an appropriate distribution of macro-particle phase-space coordinates must be generated or “loaded” to represent the Vlasov distribution

### Discussion:

In realistic accelerators, focusing elements are  $s$ -varying. In such situations there are no known smooth equilibrium distributions.

- ◆ The KV distribution is an exact equilibrium for linear focusing fields, but has unphysical (singular) structure in 4-dimensional transverse phase-space
- Moreover, it is unclear in most cases if the beam is even best thought of as an equilibrium distribution as is typical in plasma physics. In accelerators, the beam in generally injected from a source and may only reside in the machine (especially for a linac) for a small number of characteristic oscillation periods and may not fully relax to an equilibrium like state within the machine.

## Initial Distributions: Source-to-Target Simulations

The lack of known, physically reasonable equilibria and the fact that the beams are injected from a source motivates so-called “source-to-target” simulations where particles are simulated off the source and tracked to the target. Such first principles simulations are most realistic if carried out with the actual focusing fields, accelerating waveforms, alignment errors, etc. Source-to-target simulations are highly valuable to measure expected machine performance. However, ideal source-to-target simulations can rarely be carried out due to:

- ◆ Source is often incompletely described
  - Example: important alignment and material errors may not be known
- ◆ Source may contain physics not adequately in imperfectly modeled
  - Example: plasma injectors with complicated material physics, etc.
- ◆ Computer limitations:
  - Memory required and simulation time
  - Convergence and accuracies
  - Limits of numerical methods applied

Ex: singular description needed for Child-Langmuir model of space-charge limited injection

## Initial Distributions: Types of Specified Loads

Due to the practical difficulty of always carrying out simulations off the source, two alternative methods are commonly applied:

- 1) Load an idealized initial distribution
  - ◆ Specify at some specific time
  - ◆ Based on physically reasonable theory assumptions
- 2) Load experimentally measured distribution
  - ◆ Construct/synthesize a distribution based on experimental measurements

### Discussion:

The 2<sup>nd</sup> option of generating a distribution from experimental measurements, unfortunately, often has practical difficulties:

- ◆ Real diagnostics often are far from ideal 6D snapshots of beam phase-space
  - Distribution must be reconstructed from partial data
  - Typically many assumptions must be made in the synthesis process
- ◆ Process of measuring the beam can itself change the beam
- ◆ It can sometimes be helpful to understand processes and limitations starting from cleaner, more idealized initial beam states

## Discussion Continued:

Because of the practical difficulties of loading a distribution based exclusively on experimental measurements, idealized distributions are often loaded:

- ◆ Employ distributions based on reasonable, physical ansatzes
  - ◆ Use limited experimental measures to initialize:
    - Energy, current, rms equivalent beam sizes and emittances
  - ◆ Simpler initial state can often aid insight:
    - Fewer simultaneous processes can allow one to more clearly understand how limits arise
    - Seed perturbations of relevance when analyzing resonance effects, instabilities, halo, etc.
- A significant complication is that there are no known exact smooth equilibrium distribution functions valid for periodic focusing channels:
- ◆ Approximate theories valid for low phase advances may exist
- Davidson, Struckmeier, and others

Formulate a simple approximate procedure to load an initial distribution that reflects features one would expect of an equilibrium



## Initial Distributions Based on Continuous Focusing Equilibria

Simple pseudo-equilibrium initial distribution:

- Use rms equivalent measures to specify the beam
    - Natural set of parameters for accelerator applications
  - Map rms equivalent beam to a smooth, continuous focused matched beam
    - Use smooth core models that are stable in continuous focusing:
      - Waterbag Equilibrium
      - Parabolic Equilibrium
      - Thermal Equilibrium
      - ⋮
  - Transform continuous focused beam for rms equivalency with original beam specification
    - Use KV transforms to preserve uniform beam Courant-Snyder invariants
- Procedure will apply to any s-varying focusing channel
- Focusing channel need not be periodic
  - Beam can be initially rms equivalent matched or mismatched if launched in a periodic transport channel
  - Can apply to both 2D transverse and 3D beams

SM Lund, USPAS, June 2008

Simulation Techniques 125

463

## Procedure for Initial Distribution Specification

Assume focusing lattice is given:

$$\kappa_x(s), \quad \kappa_y(s) \quad \text{specified}$$

Strength usually set by specifying undrpressed phase advances  $\sigma_{0x}, \quad \sigma_{0y}$

Step 1:

For each particle (3D) or slice (2D) specify 2<sup>nd</sup> order rms properties at axial coordinate  $s$

Envelope coordinates/angles:

$$r_x(s) = 2\langle x^2 \rangle_{\perp}^{1/2} \quad r'_x(s) = 2\langle xx' \rangle_{\perp} / \langle x^2 \rangle_{\perp}^{1/2}$$

$$r_y(s) = 2\langle y^2 \rangle_{\perp}^{1/2} \quad r'_y(s) = 2\langle yy' \rangle_{\perp} / \langle y^2 \rangle_{\perp}^{1/2}$$

Emitance:

$$\varepsilon_x(s) = 4[\langle x^2 \rangle_{\perp} \langle x'^2 \rangle_{\perp} - \langle xx' \rangle_{\perp}^2]^{1/2}$$

$$\varepsilon_y(s) = 4[\langle y^2 \rangle_{\perp} \langle y'^2 \rangle_{\perp} - \langle yy' \rangle_{\perp}^2]^{1/2}$$

Perveance:

$$Q = \frac{q\lambda(s)}{2\pi\epsilon_0 m\gamma_b^3(s)\beta_b^2(s)c^2}$$

SM Lund, USPAS, June 2008

Simulation Techniques 126

## Procedure for Initial Distribution Specification (2)

If the beam is rms matched, we take:

$$r_x'' + \kappa_x r_x - \frac{2Q}{r_x + r_y} \frac{\varepsilon_x^2}{r_x^3} = 0$$

$$r_y'' + \kappa_y r_y - \frac{2Q}{r_x + r_y} \frac{\varepsilon_y^2}{r_y^3} = 0$$

$$\kappa_x(s + L_p) = \kappa_x(s)$$

$$\kappa_y(s + L_p) = \kappa_y(s)$$

$$r_x(s + L_p) = r_x(s)$$

$$r_y(s + L_p) = r_y(s)$$

- Not necessary even for periodic lattices
  - Procedure applies to mismatched beams

SM Lund, USPAS, June 2008

Simulation Techniques 127

## Procedure for Initial Distribution Specification (3)

Step 2:

Define an rms matched, continuously focused beam in each transverse s-slice:

$$r_b(s) = \sqrt{r_x(s)r_y(s)}$$

$$\varepsilon_b(s) = \sqrt{\varepsilon_x(s)\varepsilon_y(s)}$$

$$Q(s) = Q(s)$$

Envelope Radius

Emitance

Perveance

Define a (local) matched beam focusing strength in continuous focusing:

$$r_b'' + k_{\beta 0}^2 r_b - \frac{Q}{r_b} \frac{\varepsilon_b^2}{r_b^2} = 0$$

$$k_{\beta 0}^2(s) = \frac{Q(s)}{r_b^2(s)} + \frac{\varepsilon_b^2(s)}{r_b^4(s)}$$

SM Lund, USPAS, June 2008

Simulation Techniques 128

## Procedure for Initial Distribution Specification (4)

### Step 3:

Specify an rms matched continuously focused equilibrium consistent with step 2:

Specify an equilibrium function:

$$f_{\perp}(x, y, x', y') = f_{\perp}(H_{\perp}) \quad H_{\perp} = \frac{1}{2} \mathbf{x}_{\perp}^2 + \frac{1}{2} k_{\beta 0}^2 \mathbf{x}_{\perp}^2 + \frac{q\phi}{m\gamma_b^3 \beta_b^2 c^2}$$

and constrain parameters used to define the equilibrium function with:

$$\lambda = q \int d^2x \int d^2x' f_{\perp}(H_{\perp}) \quad \text{Line Charge } \leftrightarrow \text{ Perveance}$$

$$r_b^2 = \frac{4 \int d^2x \int d^2x' x^2 f_{\perp}(H_{\perp})}{\int d^2x \int d^2x' f_{\perp}(H_{\perp})} \quad \text{rms edge radius}$$

$$\frac{\varepsilon_b^2}{r_b^2} = \frac{4 \int d^2x \int d^2x' x'^2 f_{\perp}(H_{\perp})}{\int d^2x \int d^2x' f_{\perp}(H_{\perp})} \quad \text{rms edge emittance}$$

- ◆ Constraint equations are generally highly nonlinear and must be solved numerically
  - Allows specification of beam with natural accelerations variables

## Procedure for Initial Distribution Specification (5)

Load N particles in x,y,x',y' phase space consistent with continuous focusing equilibrium distribution  $f_{\perp}(H_{\perp})$

### Step A (set particle coordinates):

Calculate beam radial number density  $n(r)$  by (generally numerically) solving the Poisson/stream equation and load particle x,y coordinates:

$$x = r \cos \theta$$

$$y = r \sin \theta$$

- Radial coordinates r: Set by transforming uniform deviates consistent with  $n(r)$
- Azimuthal angles  $\theta$ : Distribute randomly or space for low noise

### Step B (set particle angles):

Evaluate  $f_{\perp}(U, r)$  with  $U = \sqrt{x'^2 + y'^2}$  at the particle x, y coordinates loaded in step A to calculate the angle probability distribution function and load x', y' coordinates:

$$x' = U \cos \xi$$

$$y' = U \sin \xi$$

- Radial coordinate U: Set by transforming uniform deviates consistent with  $f_{\perp}(U, r)$
- Azimuthal coordinate  $\xi$ : Distribute randomly or space for low noise

## Procedure for Initial Distribution Specification (6)

### Step 4:

Transform continuous focused beam coordinates to rms equivalency in the system with s-varying focusing:

$$x = \frac{r_x}{r_b} x_i \quad y = \frac{r_y}{r_b} y_i$$

$$x' = \frac{\varepsilon_x}{\varepsilon_b} \frac{r_b}{r_x} x'_i + \frac{r'_x}{r_b} x_i \quad y' = \frac{\varepsilon_y}{\varepsilon_b} \frac{r_b}{r_y} y'_i + \frac{r'_y}{r_b} y_i$$

Here,  $\{x_i\}$ ,  $\{y_i\}$ ,  $\{x'_i\}$ ,  $\{y'_i\}$  are coordinates of the continuous equilibrium loaded

- ◆ Transform reflects structure of Courant-Snyder invariants

## Comments on Procedure for Initial Distribution Specification

- ◆ Applies to both 2D transverse and 3D beams
- ◆ Easy to generalize procedure for beams with centroid offsets
- ◆ Generates a charge distribution with elliptical symmetry
  - Sacherer's results on rms equivalency apply
  - Distribution will reflect self-consistent Debye screening
- ◆ Equilibria are only pseudo-equilibria since transforms are not exact
  - Nonuniform space-charge results in errors
  - Transform consistent with preserved Courant-Snyder invariants for uniform density beams
  - Errors largest near the beam edge - expect only small errors for very strong space charge where Debye screening leads to a flat density profile with rapid fall-off at beam edge
- ◆ Many researchers have presented or employed aspects of the improved loading prescription presented here, including:
  - I. Hofmann, GSI
  - M. Reiser, U. Maryland
  - M. Ikigami, KEK
  - E. Startsev, PPPL
  - Y. Batygin, SLAC



PIC simulations with the WARP code (see S9) were carried out to verify that the loading procedure results in less fluctuations and waves in self-consistent Vlasov evolutions from the load

Show evolutions from a matched load in a periodic FODO quadrupole transport lattice:

pseudo-thermal  
semi-Gaussian (for contrast)

- Find:
- Works well for  $\sigma_0 \lesssim 85^\circ$ 
    - Should not work where beam is unstable and all distributions are expected to become unstable for  $\sigma_0 > \sim 85^\circ$  see:
  - Experiment: Tiefenback, Ph.D. Thesis, U.C. Berkeley (1986)
  - Theory: Lund and Chawla, Proc. 2005 Part. Accel. Conf.
  - Works better when matched envelope has less "flutter"
    - Solenoids: larger lattice occupancy  $\eta$
    - Quadrupoles: smaller  $\sigma_0$
    - Not surprising since less flutter" corresponds to being closer to continuous focusing

### WARP PIC Simulation (see S9) Results – Pseudo Thermal Equilibrium

$\sigma_0 = 70^\circ$ ,  $L_p = 0.5$  m,  $\varepsilon_x = \varepsilon_y = 50$  mm-mrad  
 $\sigma/\sigma_0 = 0.2$

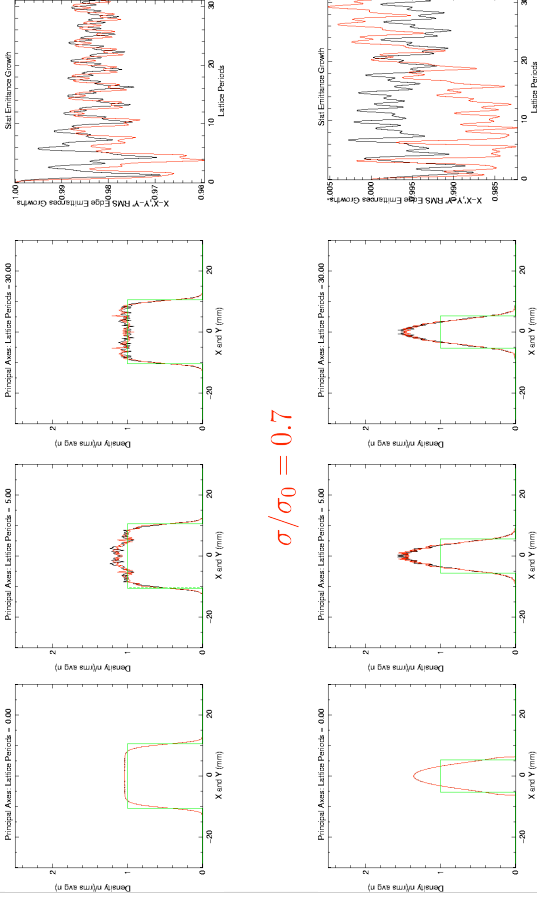

### WARP PIC Simulation (see S9) Results – Semi-Gaussian (for contrast)

$\sigma_0 = 70^\circ$ ,  $L_p = 0.5$  m,  $\varepsilon_x = \varepsilon_y = 50$  mm-mrad  
 $\sigma/\sigma_0 = 0.2$

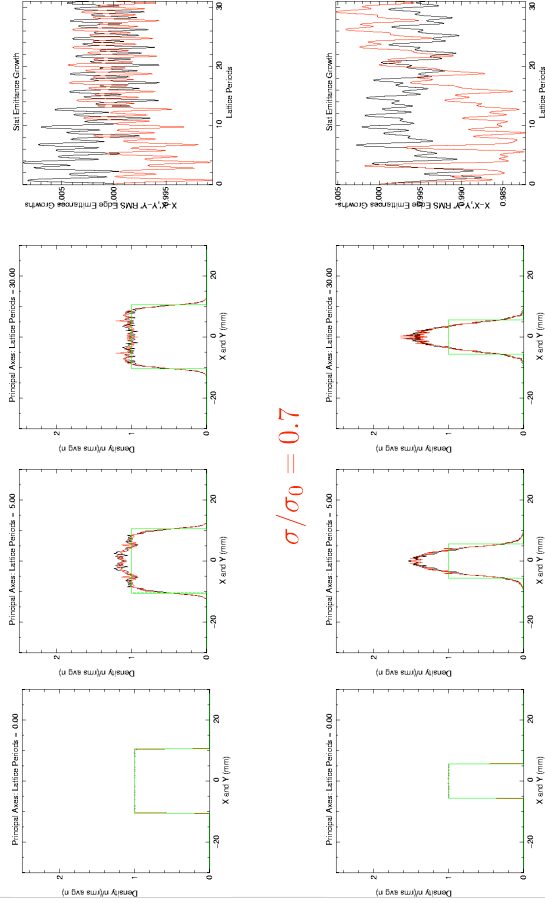

See handwritten notes from USPAS 06 for remaining distribution loading slides

- Will be updated in future versions of the notes

## Initial Loads: The Semi-Gaussian Distribution

See handwritten notes from USPAS 06

- ♦ Will be updated in future versions of the notes

## S7: Numerical Convergence

Numerical simulations must be checked for proper resolution and statistics to be confident that answers obtained are correct and physical:

### Resolution of discretized quantities

- ♦ Time  $t$  or axial  $s$  step of advance
- ♦ Spatial grid of fieldsolve
- ♦ For direct Vlasov: the phase-space grid

### Statistics for PIC

- ♦ Number of macroparticles used to represent Vlasov flow to control noise

Increased resolution and statistics generally require more computer resources (time and memory) to carry out the required simulation. It is usually desirable to carry out simulations with the minimum resources required to achieve correct, converged results that are being analyzed. Unfortunately, there are no set rules on adequate resolution and statistics. What is required generally depends on:

- ♦ What quantity is of interest
- ♦ How long an advance is required
- ♦ What numerical methods are being employed .....

## General Guidance on Numerical Convergence Issues

Although it is not possible to give detailed rules on numerical convergence issues, useful general guidance can be given:

- ♦ Find results from similar problems using similar methods when possible
- ♦ Analyze quantities that are easy to interpret and provide good measures of convergence for the use of the simulation

- Some moments like rms emittances:

$$\epsilon_x = 4 \left[ \langle \tilde{x}^2 \rangle_{\perp} \langle \tilde{x}'^2 \rangle_{\perp} - \langle \tilde{x} \tilde{x}' \rangle_{\perp}^2 \right]^{1/2}$$

can provide relatively sensitive and easy to interpret measures of relative phase-space variations induced by numerical effects when plotted as overlaid time (or  $s$ ) evolution “histories”

- ♦ Benchmark code against problems with known analytical solutions and properties
  - Apply a variety of numerical methods to judge which applies best
- ♦ Benchmark code against established, well verified simulation tools
  - Use different numerical methods expected to be more or less accurate

- ♦ Recheck convergence whenever runs differ significantly or when different quantities are analyzed

- What is adequate for one problem/measure may not be for another
- Ex: rms envelope evolution easier to converge than collective modes
- ♦ Although it is common to increase resolution and statistics till quantities do not vary, it is *also* useful to **purposefully analyze poor convergence** so characteristics of unphysical errors can be recognized

- Learn characteristic signature of failures to resolve effects so subtle onset issues can be recognized more easily

- ♦ Expect to make *many* setup, debugging, and convergence test runs for each useful series of simulations carried out

See handwritten notes from USPAS 06 for remaining slides

- ◆ Will be updated in future versions of the notes

## S8: Practical Considerations:

### A: Overview

Intense beam simulation problems can be highly demanding on computer resources – particularly for realistic higher dimensional models. The problem size that can be simulated is dictated by computer resources available in fast memory and the run time required to complete the simulation

- ◆ Fast Memory (RAM)
- ◆ Wall Clock Run Time (Computer Speed)

Both of these can depend strongly on the architecture of computer system that the problem is run on:

- ◆ Serial Machine
- ◆ Parallel Machine

can strongly influence the size of the problem that can be simulated. We will present rough estimates of the computer memory required for simulations and provide some guidance on how the total simulation time can scale on various computer systems. The discussion is limited to PIC and direct Vlasov simulations.

## S8B: Practical Considerations: Fast Memory

Fast computer memory (RAM) dictates how large a problem can be simulated

- ◆ If a problem will not fit into fast memory (RAM), computer performance will be severely compromised
- ◆ Writes to hard disks are slow

There are 3 main contributions to the problem size for typical PIC or direct Vlasov simulations:

- 1) Particle Phase Space Coordinates (PIC) or Discretized Distribution Function (Direct Vlasov)
- 2) Gridded Field
- 3) General Code Overhead

These three contributions to memory required are discussed in turn

Particle and field quantities are typically stored in double precision:

Representation	Digits (Floating Point)	Bytes Memory
Single Precision	8	4
Double Precision	16	8

Most problems

## Estimates of Required Fast Memory

### 1) Particle Phase Space Coordinates (PIC):

$B$  = bytes of floating point number (typically 8 for double precision)

$N_p$  = number macro particles (0 for direct Vlasov)

$D$  = dimension of variables characterizing particles

$$\text{Memory} = B * N_p * D \text{ Bytes}$$

The dimension  $D$  depends on the specific type of PIC simulation and methods employed

### /// Common Examples of $D$ :

$$3D \text{ PIC: } D = 7 \qquad 2D \text{ Transverse Slice PIC: } D = 5$$

$$x, y, z \qquad x, y$$

$$p_x, p_y, p_z, \gamma^{-1} \qquad p_x, p_y, \gamma^{-1} + p_z \quad (D=6) \text{ some models}$$

$\gamma^{-1}$  is often included often to optimize the mover

///

## Estimates of Required Fast Memory

### 1) Discretized Distribution Function (Direct Vlasov):

$B$  = bytes of floating point number (typically 8 for double precision)  
 $N_{pm}$  = number mesh points of grid describing the discretized particle phase space

$$\text{Memory} = B * N_{pm} \text{ Bytes}$$

The value of  $N_{pm}$  depends critically on the dimensionality of the phase space  
 // Examples of  $N_{pm}$  scaling for a uniform phase-space meshes:

Problem	Phase Space	$N_{pm}$	Scaling ( $n_x = n_{p_x} \equiv n$ etc)
1D	$z - p_z$	$n_z n_{p_z}$	$n^2$
2D ⊥ Slice	$x - p_x, y - p_y$	$n_x n_y n_{p_x} n_{p_y}$	$n^4$
2D Slice	$x - p_x, y - p_y, p_z$	$n_x n_y n_{p_x} n_{p_y} n_{p_z}$	$n^5$
3D	$x - p_x, y - p_y, z - p_z$	$n_x n_y n_{p_x} n_{p_y} n_{p_z}$	$n^6$

$n_x$  = number mesh points in  $x$  etc.

Rapid growth of  $N_{pm}$  with dimensionality severely limits tractability of problems

### 2) Gridded Field:

Required memory for a gridded field solve depends on the class of field solve (electrostatic, electromagnetic), mesh size, and numerical method employed. For a concrete illustration, consider *electrostatic* problems using a simple FFT field solve:

- Discrete Fourier Transform complex, but transform is of real functions. Proper optimization allows use of transforms using only real  $\phi$  and  $\rho$  arrays
- Electric field is typically not stored and is calculated for each particle only where it is needed. Spatial grid location need not be stored.
- Some methods store gridded E to optimize specific problems

$N_{fm}$  = number mesh points of field spatial grid

$$\text{Memory} = 2 * B * N_{fm} \text{ Bytes}$$

Factor of 2 for:  $\rho, \phi$

Memory required for a double precision ( $B = 8$ ) uniform phase-space grid with 100 zone discretization per degree of freedom:

$$n_x = n_{p_x} \equiv n = 100 \text{ etc.}$$

$D$  = dimension of phase-space

$$\text{Memory} = 8 * n^D \text{ Bytes}$$

Problem	$D$	Memory (Bytes) ( $n = 100$ )
1D	2	$80 \times 10^3 \sim 80 \text{ KB}$
2D ⊥ Slice	4	$80 \times 10^6 \sim 80 \text{ MB}$
2D Slice	5	$80 \times 10^9 \sim 80 \text{ GB}$
3D	6	$8 \times 10^{12} \sim 8000 \text{ GB}$

Rapidly increasing problem size with phase-space dimension  $D$  practically limits what can be simulated on direct Vlasov models with reasonable resolution even on large parallel computers:

- Irregular phase-space grids that place resolution where it is needed can partially alleviate scaling problem
- Optimal methods must also only grid minimal space exterior to the oscillating beam core in alternating gradient lattices

Number of mesh points  $N_{fm}$  depends strongly on the dimensionality of the field solve and the structure of the mesh

- Generally more critical to optimize storage and efficiency (see next section) of fieldsolvers in higher dimensions

Examples for uniform meshes:

$$\begin{aligned} N_{fm} &= n_z & 1D \text{ (Longitudinal)} \\ &= n_x n_y & 2D \text{ (Transverse Slice)} \\ &= n_x n_y n_z & 3D \end{aligned}$$

$n_x$  = number mesh points in  $x$  etc.

### 3) General Code Overhead:

System memory is also used for:

- ◆ Scratch arrays for various numerical methods (fieldsolvers, movers, etc.)
- ◆ History accumulations of diagnostic moments
- ◆ Diagnostic routines
- ◆ Graphics packages, external libraries, etc.
  - Graphics packages can be large!

$$\text{Memory} = M_{\text{overhead}} \text{ Bytes}$$

Characteristic of packages used, size of code, and methods employed. But typical numbers can range 1 MB – 20 MBytes

#### Summary: Total Memory Required:

For illustrative example, add contributions for electrostatic PIC

$$\text{PIC: Tot Memory} = B * (N_p * D + 2 * N_{jm}) + M_{\text{overhead}} \text{ Bytes}$$

$$\text{Direct Valsov: Tot Memory} = 2 * B * (N_{pm} + N_{jm}) + M_{\text{overhead}} \text{ Bytes}$$

Reminder: Machine fast memory (RAM) capacity *should not be exceeded*

- ◆ Storing data on disk and cycling to RAM generally too slow!

### S8C: Practical Considerations: Run Time

Run time can depend on many factors including:

- ◆ Type of problem
- ◆ Dimensionality of problem and number of particles and/or mesh points
- ◆ Numerical methods employed (particle moving, fieldsolve, ....)
- ◆ Moments and diagnostics accumulated
- ◆ Architecture/speed of computer system

It is not possible to give fully general guidance on estimating run times.

However, to better characterize the time required, it can be useful to benchmark the code on the computer to be employed in terms of:

$$t_{\text{step}} = \text{Time for an "ordinary" run step}$$

Generally, parts of the code that more time is spent in should be more carefully optimized to minimize total run time. Care should generally be applied with:

- ◆ Particle mover
- ◆ Field solver
- ◆ Frequent diagnostics such as moments

Diagnostics, loaders, problem setup routines, etc. can often be coded with less care for optimization since they are only executed infrequently. However:

- ◆ Diagnostics often take a large amount of development time
  - Often better to code as simply as possible!

Software profiling tools can be useful to best understand where “bottlenecks” occur so effort on optimization can be appropriately directed for significant returns.

### Dimensionality plays a strong role in required run time

Some general guidance for electrostatic PIC Simulations:

#### 1D: (Longitudinal typical)

Fieldsolve generally fast: small fraction of time compared to moving particles

- ◆ Green's function methods can be used (Gauss Law)

#### 2D: (Transverse slice typical)

Fieldsolve typically a small fraction of time relative to moving particles if fast gridded methods are applied (like FFT based methods)

- ◆ Special boundary conditions can increase the fraction

#### Method

FFT with Periodic BC

Small fraction of particle moving

FFT with Capacity Matrix

SOR

Green's Function

Dominates particle moving

### 3D:

Fieldsolve typically comparable in time or dominates time for particle moving even if fast, gridded methods are applied

- Fieldsolve efficiency of *critical* importance in 3D to optimize run time
- Whole classes can be taught just on methods of 3D electrostatic field solves for Poission's equation

### Some general guidance for Direct Vlasov Simulations:

The rapid growth of the problem size with the phase space-dimension and available fast computer memory can severely limit problem sizes that can be simulated:

- Numerical work can be significant to advance the discretized distribution over characteristics
- Size of gridded field arrays can be very large leading to slow advances
- Uniform mesh:  $D$

The type of computer system employed can also strongly influence run time

- Processor Speed
- Memory Speed
- RAM
- Fast, optimized cache memory
- System Architecture (see next section)
- Serial
- Parallel
- Library Optimization
- Especially for parallel machines

### S8D: Practical Considerations: Machine Architectures

Problems may be simulated on:

- 1) Serial Machines
  - Single processor or an independently run processor on a multi-processor machine (example: most present multi-“core” processors)
- 2) Parallel Machine
  - Multi-processors coordinated to work as a large single processor
  - Usually employ independent memory for each processor making up the machine but sometimes uses shared memory among processors

Serial machines represent traditional computers (PCs workstations, etc), whereas parallel machines are generally less familiar.

### Overview of parallel simulations:

In recent years parallel machines have significantly improved with libraries that allow more “natural” problem formulation with less effort and they are enabling significantly larger simulations to be carried out

- Several 100 million particles typically practical to simulate on large machines

### Typical Parallel Machine Architecture

Beam problems may often be conveniently partitioned among processors in terms of axial slices. Schematic example (5 processors):

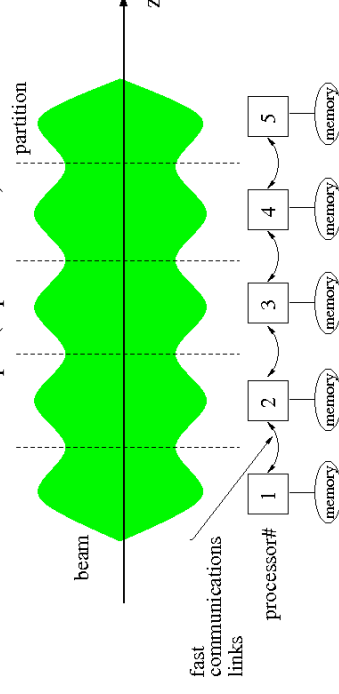

- Sharing of data at boundaries is necessary for fieldsolve
- Problems with axial velocity spread will generally require sorting of particles to maintain the load balance between processors
- Processors should ideally all perform an equal amount of work since the slowest will dictate the total time of the advance step



Ideal parallelization will result in a **linear speedup** with processor number

- ▶ Actual speedup less due to:
  - Overhead in data transfers
  - Lack of ideal load balance causing processors to wait on the slowest one that the problem is partitioned among

$$\tau_{\text{step}} = \text{Time "ordinary" step in computational cycle}$$
$$t_{\text{sim}} = \frac{\text{Simulation Time}}{\tau_{\text{step}}}$$

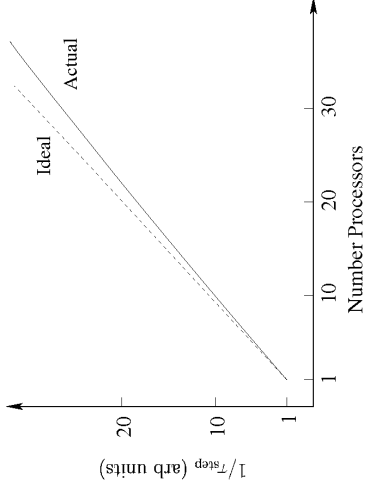

Even with the significant advances in problem size and speed promised by parallel computers, the solution of realistic 3D beam problems with direct (not gridded) fields remains far too large a problem to simulate with present computer systems. Thus, for detailed simulations, we often push computer resources to the maximum extent possible.

- ▶ Better numerical algorithms
- ▶ Parallelization
- ▶ ...

## S9: WARP Code Overview

See handwritten notes from USPAS 06 for remaining slides

- ▶ Will be updated in future versions of the notes

## S10: Example Simulations

Examples to this point have mostly been simply formulated to illustrate concepts. Here, we present results from more complex simulations carried out in support of experiments, theory, and for machine design. Simulations highlighted include:

- ▶ Electrostatic Quadrupole Injector
- ▶ Multi-beamlet Injector
- ▶ Collective Mode Effects
- ▶ Detailed Transport Lattice Design
- ▶ Transport Limits in Periodic Quadrupole Focusing Channels
- ▶ Electron Cloud Effects for Ion Beam Transport

All these simulations, as well as many of the preceding illustrations in the lecture notes, were produced with the WARP code described in **S9**. Only select issues from the problems are highlighted.

## Example: Electrostatic Quadrupole Injector

See handwritten notes from USPAS 06 for remaining slides

- ◆ Will be updated in future versions of the notes

These slides will be corrected and expanded for reference and any future editions of the US Particle Accelerator School class:

*Beam Physics with Intense Space Charge*, by J.J. Barnard and S.M. Lund

Corrections and suggestions are welcome. Contact:

Steven M. Lund  
Lawrence Berkeley National Laboratory  
BLDG 47 R 0112  
1 Cyclotron Road  
Berkeley, CA 94720-8201

[SMLund@lbl.gov](mailto:SMLund@lbl.gov)  
(510) 486 – 6936

Please do not remove author credits in any redistributions of class material.

## Acknowledgments

Sven Chilton (UCB, LLNL) assisted in the development of part of these lecture notes and in generating some of the numerical examples and figures

Special thanks are deserved for Alex Friedman, Dave Grote, and Jean-Luc Vay of the Lawrence Livermore and Lawrence Berkeley National Laboratories for help with these notes and extensively educating the authors in simulation methods.

Rami Kishek (UMD) assisted teaching a version of this class and contributed to the notes. Irving Haber (UMD), Christine Celata (LBL), and Bill Fawley (LBL) helped educate the authors on various simulation methods.

Michiel de Hoon helped with an early version of the lectures and with example Lagrangian methods.

## References: For more information see:

### Numerical Methods

Forman S. Acton, *Numerical Methods that Work*, Harper and Row Publishers, New York (1970)

Steven E. Koonin, *Computational Physics*, Addison-Wesley Publishing Company (1986)

W. Press, B. Flannery, S. Teukolsky, W. Vetterling, *Numerical Recipes in C: The Art of Scientific Computing*, Cambridge University Press (1992).

### Particle Methods

C.K. Birdsall and A.B. Langdon, *Plasma Physics via Computer Simulation*, McGraw-Hill Book Company (1985).

R.W. Hockney and J.W. Eastwood, *Computer Simulation using Particles*, Institute of Physics Publishing (1988).



§5

Diagnostics:

Depend on what is analyzed. Typical choices:

- Moments - statistical sums over the particle distribution (slices and full beam), often plotted as time histories as the beam evolves in the accelerator:

centroid:  $x_c = \langle x \rangle$  , , , , ,

RMS Widths: Beam Size  $\sigma_x = \sqrt{\langle (x-x_c)^2 \rangle}$  , , , , , etc.

Emittance:  $\epsilon_x = 16 \left[ \langle (x-x_c)^2 \rangle \langle (x'-x'_c)^2 \rangle - \langle (x-x_c)(x'-x'_c) \rangle^2 \right]^{1/2}$   
 etc. , , , , ,

Here:  $\langle \dots \rangle = \frac{1}{N_s} \sum_i^{slice} \{ \dots \}_i$  , , , , , etc.

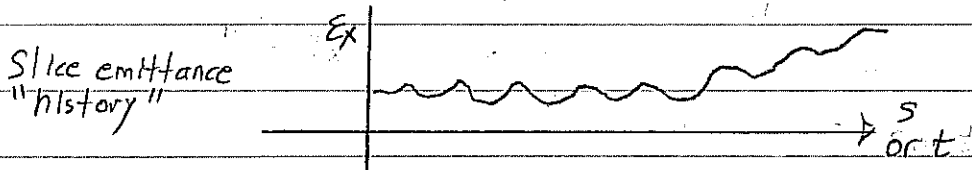

- Particle phase-space projections plotted as snapshots in time ( $x-x'$ ,  $y-y'$ ,  $x-y$ ,  $x'-y'$ , , , , , ).

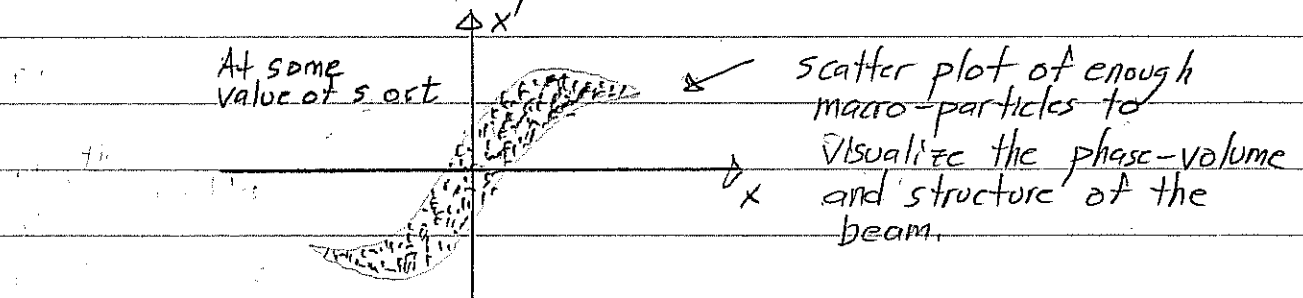

Plotting snapshots at periodic locations allows visualization of the evolution of beam distortions:

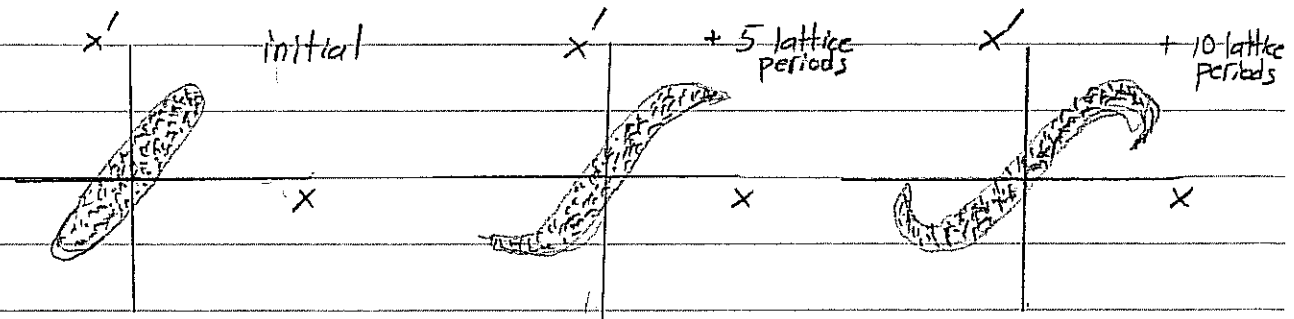

• Field Diagnostics:

Contours of self and applied fields illustrate field structure.

Examples:

- 1) Total potential contours of  $\phi$  (self and applied) of an elliptical beam in an electric quadrupole formed by 4 biased rods.

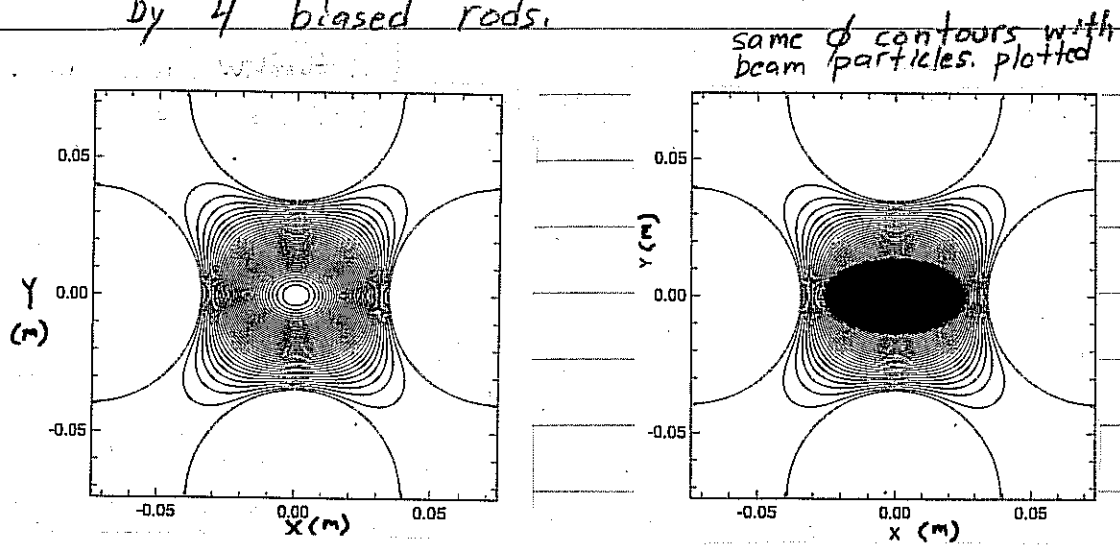

- 2) Applied Field Scalar magnetic potential contours of a permanent magnet lense illustrate the structure of applied field nonlinearities:

8 Block  
Permanent  
Magnet  
Quadrupole.

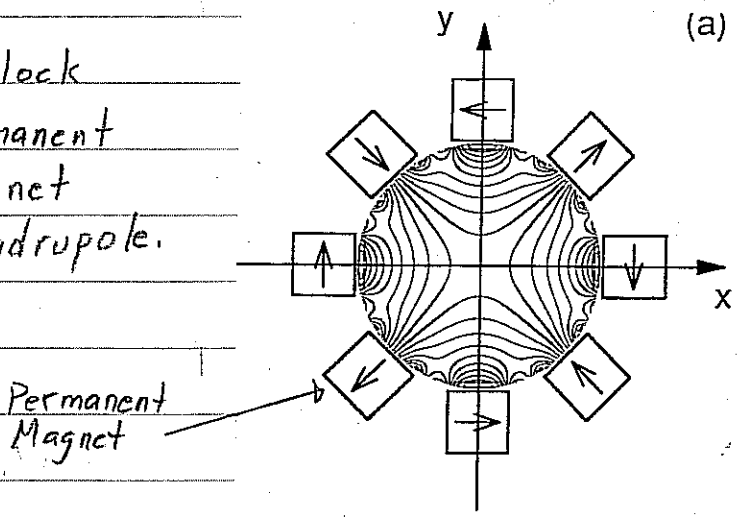

Note:  
Contours deviate  
from hyperbolic  
near aperture  
edge.

Numerous other field diagnostics are possible:

- Field energy, multipole moments,

## §6 Particle Loads

To start the simulation, one must specify and "load" the initial distribution function.

In realistic accelerators, focusing elements are  $s$ -varying. In such situations there are in general no known equilibrium distribution functions.

Moreover, it is unclear in most cases if the beam is even best thought of as an equilibrium + perturbations as is typical in plasma physics. Rather, in accelerators, the beam is injected from a source and may only reside in the machine (especially a linac) for a small number of characteristic oscillation periods and may not fully relax to an equilibrium-like state. In such situations, so-called "source-to-target" simulations where the particles are simulated off the source and tracked to the target can be most realistic if carried out with realistic focusing fields, accelerating waveforms, alignment errors, etc.

Unfortunately, such idealized source-to-target simulations can rarely be carried out due to computer limitations.

- Memory limits
- Numerical convergence and accuracy ....

Two ways around this limitation:

- 1) Load experimentally measured distribution at some point in the machine and advance as an initial condition.
- 2) Load an idealized initial distribution.

The 1st option can have practical difficulties:

- Diagnostics often are far from an ideal 6D "snapshot" of the beam phase-space.
  - Much information typically lost.
- Process of measuring the beam can itself change the beam.

Most commonly, some experimental measures such as:

- rms beam sizes  $\sigma_x, \sigma_y, \sigma_{x'}, \sigma_{y'}$
- rms emittances  $\epsilon_x, \epsilon_y$

are loaded in the form of idealized distributions.

It can be insightful to initialize the beam in a simplified manner

- Fewer simultaneous processes can allow one to more clearly see how limits arise.
- Seed perturbations of relevance when analyzing resonance effects, instabilities, halo, etc.

In these situations it is often useful to load a round, continuously focused distribution such as:

- Thermal Equilibrium
- Waterbag
- KV

and then transform the particle coordinates to "match" the local focusing structure of the lattice using a local KV envelope solution:

$$\frac{d^2}{ds^2} r_x(s) + K_x(s) r_x(s) - \frac{2Q(s)}{r_x(s) + r_y(s)} - \frac{E_x^2(s)}{r_x^3(s)} = 0$$

$$\frac{d^2}{ds^2} r_y(s) + K_y(s) r_y(s) - \frac{2Q(s)}{r_x(s) + r_y(s)} - \frac{E_y^2(s)}{r_y^3(s)} = 0$$

$K_x(s), K_y(s)$  = lattice focusing constants

$Q(s)$  = local perveance (specified)

$E_x(s), E_y(s)$  = local emittances (specified)

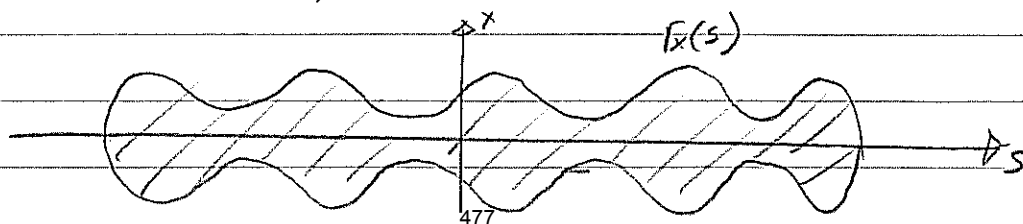

Procedure:

1st

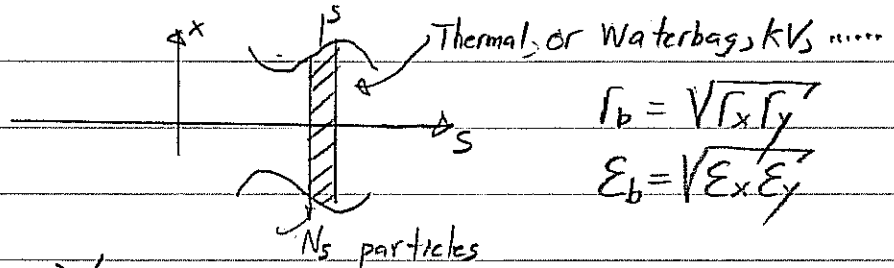
Load in each  $\perp$  slice found, continuous distribution:

$$\Gamma_b = \sqrt{\Gamma_x \Gamma_y}$$

$$\varepsilon_b = \sqrt{\varepsilon_x \varepsilon_y}$$

 $\Rightarrow \vec{X}_i, \vec{X}_i'$  specified

2nd

Transform the spatial coordinates to match the <sup>elliptical</sup> envelope structure

$$X_i \longrightarrow \frac{\Gamma_x}{\Gamma_b} X_i'$$

$$Y_i \longrightarrow \frac{\Gamma_y}{\Gamma_b} Y_i'$$

3rd

Transform the local thermal velocity spreads to obtain the right average thermal force.

$$X_i' \longrightarrow \frac{\varepsilon_x}{\varepsilon_b} \frac{\Gamma_b}{\Gamma_x} X_i'$$

$$Y_i' \longrightarrow \frac{\varepsilon_y}{\varepsilon_b} \frac{\Gamma_b}{\Gamma_y} Y_i'$$

4th

Add the correct coherent velocity to match the needed envelope angle.

$$X_i' \longrightarrow X_i' + \Gamma_x' \frac{X_i}{\Gamma_x}$$

$$Y_i' \longrightarrow Y_i' + \Gamma_y' \frac{Y_i}{\Gamma_y}$$

## // Aside - The semi-Gaussian Distribution

It is not necessary to always load something based on a transformation of an equilibrium distribution to get a good quiescent load. Note that for high space-charge intensities:

- Beam space charge will be more or less uniform out to the edge, where the density will rapidly fall to zero.
- If the beam is injected off a uniform temperature source or has relaxed, one expects roughly uniform thermal velocity spread across the cross-section of the beam.

This suggests the so-called "semi-Gaussian" load specified as follows:

- Uniform density within an elliptical beam envelope.

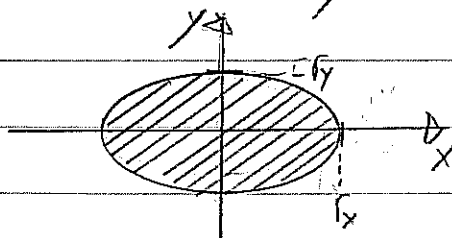

$x_i, y_i$  uniformly distributed for  $(x/r_x)^2 + (y/r_y)^2 \leq 1$ .

- Gaussian distributed thermal velocity spread with the correct coherent velocity to match the needed envelope angles

$$\begin{aligned} x_p' &= r_x' \frac{x_i}{r_x} + \frac{E_x}{2r_x} \tilde{r}_{x_i} \\ y_i' &= r_y' \frac{y_i}{r_y} + \frac{E_y}{2r_y} \tilde{r}_{y_i} \end{aligned} \quad \begin{array}{l} \tilde{r}_{x,y} \text{ Gaussian} \\ \text{distributed with unit} \\ \text{variance } \left( \frac{1}{N_s} \sum_i^{\text{slice}} \tilde{r}_{x,y_i}^2 = 1 \right) \end{array}$$

The semi-Gaussian load results in "squared" initial  $x-x'$  and  $y-y'$  phase space projections:

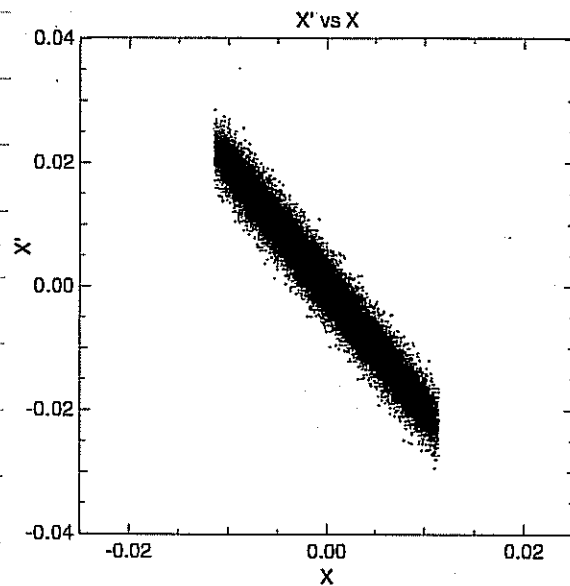

Initial load  
in a symmetric  
FODO AG  
Quadrupole  
transport lattice

The unphysical edges typically relax rapidly without perturbing the low order RMS structure of the beam (envelope match, emittance, etc.).

1 lattice period advance

4 lattice period advance

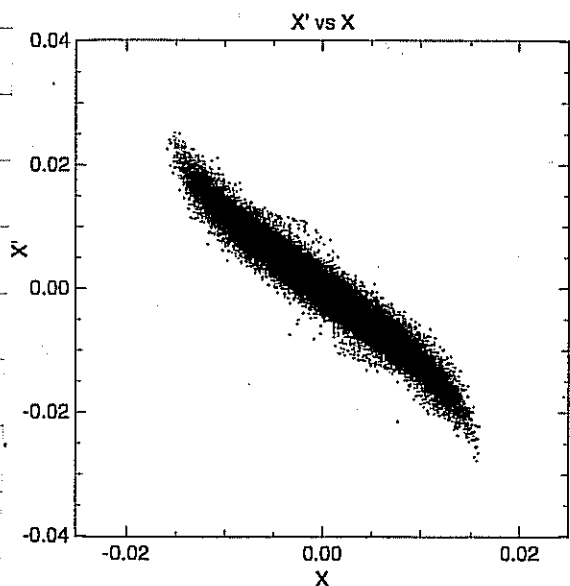
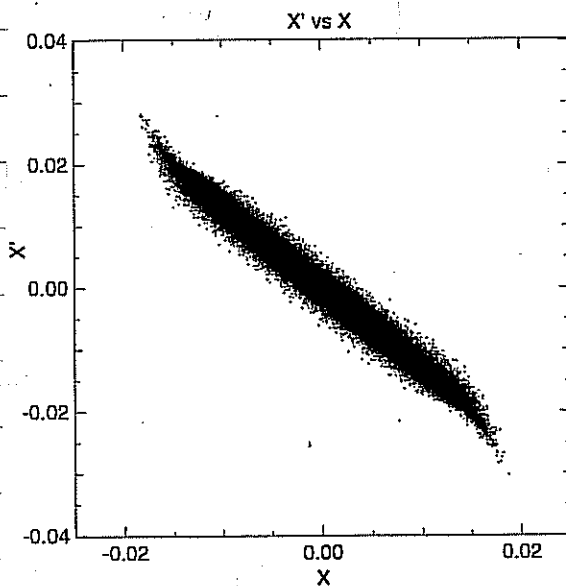

Numerous other loading techniques exist to address specific issues. //



## 7 Numerical Convergence

Numerical simulations must be checked for proper resolution and statistics to be confident that answers obtained are correct and physical.

### Resolution on discretized quantities

- Time step in particle advance
- Spatial grid for fields

• Statistics (number of macroparticles) to control noise.

More resolution and statistics require more computer time and memory. To be practical, one generally wishes to solve problems with the minimum resources required to achieve correct, converged answers. Unfortunately, there are no set rules on what resolution and statistics are required. This depends on what one is examining, how long the simulations are run, what numerical methods are employed, ....

### Some general guidance:

• The statistical rms emittances:

$$\epsilon_x = 4 \left[ \langle x^2 \rangle \langle x'^2 \rangle - \langle xx' \rangle^2 \right]^{1/2}$$

$$\epsilon_y = 4 \left[ \langle y^2 \rangle \langle y'^2 \rangle - \langle yy' \rangle^2 \right]^{1/2}$$

often prove to be sensitive <sup>and easy to interpret</sup> measures of numerical differences when plotted as overlaid time histories.

- picks up small phase space distortions induced by numerical errors.

## general guidance continued ....

- To get started, find results from similar problems using similar methods.
- Benchmark code and methods against problems with known analytical solutions, established codes using both similar and different numerical methods, ....
- Recheck numerical convergence whenever runs differ significantly or when differing quantities are analyzed.
  - What is adequate for one measure of the beam (say image charge structure) may not be for another (say collective modes).
- Although it is common to increase resolution and statistics till relevant quantities do not vary, it is also useful to purposefully analyze poor resolution and statistics regimes so the characteristics of unphysical numerical errors can be recognized.
- Expect to make many setups, convergence, and debugging runs for each useful series of simulations carried out.

Time Resolution.

These comments are applicable to both spatial or time steps of the particle advance. We will frame estimates in terms of timesteps.

- Particle coordinates should not move through more than one cell in a single step. This is a standard "Courant" condition:

$$\begin{aligned} v_x \Delta t &< \Delta x \\ v_y \Delta t &< \Delta y \\ v_z \Delta t &< \Delta z \end{aligned}$$

for all particles.

- Enough steps should be taken to resolve variations in applied field structures.

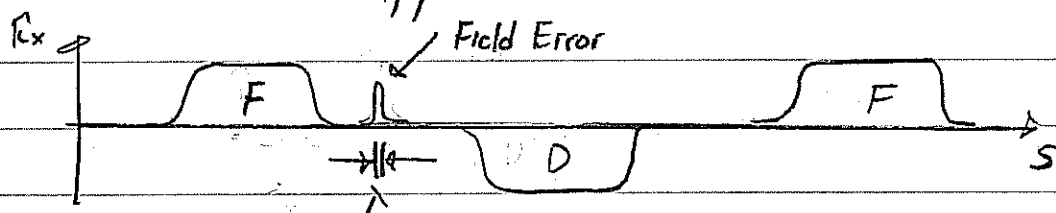

$$v_s \Delta t < \lambda \quad ; \quad \lambda = \text{shortest wavelength of field structures to be modeled}$$

- Phase variations in collective waves (if of interest) should be resolved. For a leap-frog mover this requires:

$$\frac{\omega \Delta t}{2\pi} < \frac{1}{2}$$

483

## Spatial Resolution

For cold beams the beam edge can be sharp  
for most reasonable distribution functions:

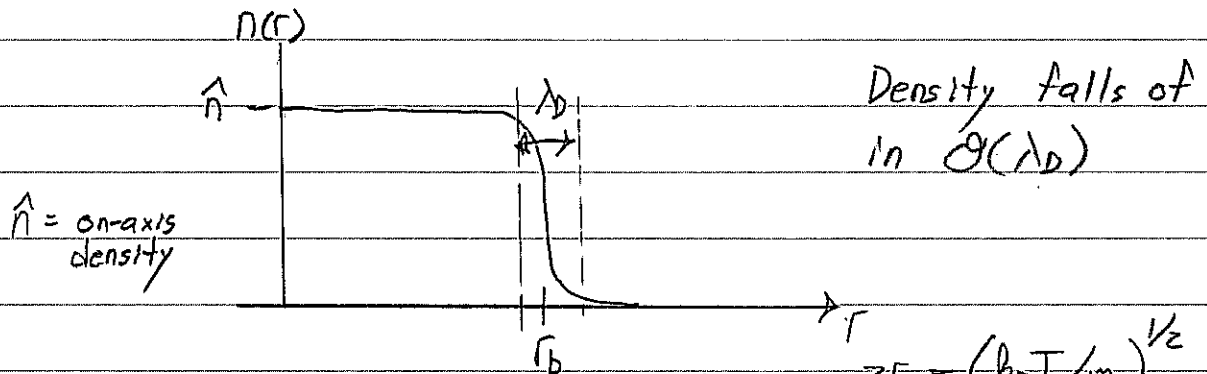

Debye length:  $\lambda_D = \frac{v_E}{\omega_p} = \left( \frac{\epsilon_0 k_B T}{\hat{n} q^2} \right)^{1/2}$

$$v_E = \left( \frac{k_B T}{m} \right)^{1/2}$$

$$\omega_p = \left( \frac{Z \hat{n}}{\epsilon_0 m} \right)^{1/2}$$

$$r_b = \sim 5 \lambda_D \rightarrow 30 \lambda_D \text{ typical.}$$

To resolve edge physics, the mesh should have several cells across the rapid density variation near the edge of the beam.

$$dx, dy < \frac{\lambda_{D,x,y}}{2}$$

$$\lambda_{D,x,y} = \left( \frac{k_B T_{x,y}}{m} \right)^{1/2}$$

$T_{x,y}$  = local kinetic temperature

The mesh should also resolve relevant spatial scales associated with processes of interest:

- If applied electrostatic fields are calculated from biased conductors, the mesh should resolve conductor structures or special corrections should be made.
- Self-field fluctuations induced by collective modes should be resolved.

Collective mode resolution: From Eigenfunctions to be presented later in the class:

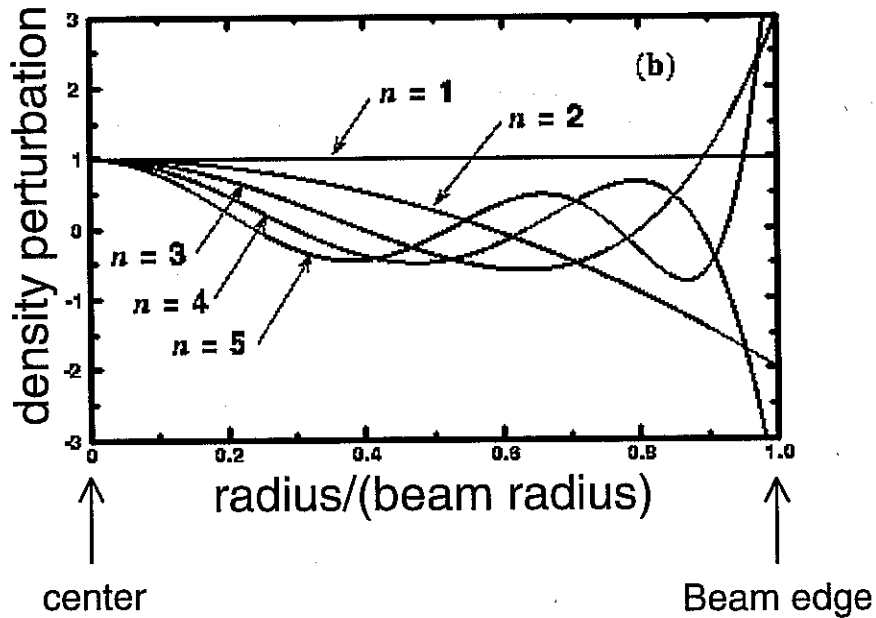

Collective mode  
density perturbations  
on a uniform  
density beam.

$\Rightarrow dx, dy < \lambda \sim$  shortest characteristic wavelength of modes of interest.

Note that higher order modes ( $n$  larger) will become hard to resolve. Moreover, such perturbations also oscillate rapidly making time ( $s$ ) stepsize resolution likewise difficult.

Statistics.

Collective effects typically require having a significant number of particles  $N_D$  within the characteristic screening radius characterized by the Debye length:

$$2D: \quad N_D = \sum_i \int_{\substack{\text{circle} \\ |\vec{x}| < \lambda_D}} d^2x \delta^{(2)}(\vec{x} - \vec{x}_i) \gg 1$$

$\vec{x}_i = \text{macro-particle coordinate.}$

$$3D: \quad N_D = \sum_i \int_{\substack{\text{sphere} \\ |\vec{x}| < \lambda_D}} d^3x \delta^{(3)}(\vec{x} - \vec{x}_i) \gg 1$$

where:

$$\lambda_D = \frac{v_{te}}{\omega_p} = \left( \frac{\epsilon_0 k_B T}{\hat{n} q^2} \right)^{1/2}$$

$$v_{te} = (k_B T / m)^{1/2}$$

$$\omega_p = \left( \frac{q^2 \hat{n}}{\epsilon_0 m} \right)^{1/2}$$

$\sum_i \Rightarrow$  sum over all macro particles.

In simulations of higher order collective modes it may also be necessary to have a significant number of particles per cell on a mesh that resolves the relevant spatial variations of mode induced self-field fluctuations.

$$2D: \quad N_{\text{cell}} = \sum_i \int_{\text{cell}} d^2x \delta^{(2)}(\vec{x} - \vec{x}_i) \gg 1$$

$$3D: \quad N_{\text{cell}} = \sum_i \int_{\text{cell}} d^3x \delta^{(3)}(\vec{x} - \vec{x}_i) \gg 1$$

- Larger  $N_{\text{cell}}$  prevents local self-fields from being noise dominated.
- Larger  $N_{\text{cell}}$  leads to larger  $N_D$  typically  $N_D > N_{\text{cell}}$  since  $\lambda_D$  must be resolved on the grid.

Good statistics are only needed in the beam core with the possible exception of certain beam-halo problems and near the beam edge.

- Most beams will only occupy a fraction of the full grid.

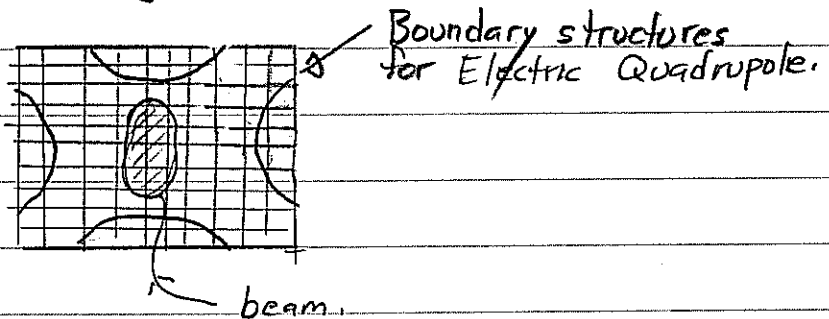

statistics should be evaluated in the cells that the beam occupies rather than average grid measures.

No comprehensive rules exist for how good the statistics must be. Individual problems must be checked and verified. Some general comments:

- What is adequate will typically depend on what is analyzed
  - Image fields may be resolved with few particles
  - Collective waves may take many particles if low noise (interpretable) diagnostic projections are needed.
- Longer runs generally require increased statistics
- Poor statistics result in unphysical collisionality that is often characterized by a linear rise in beam emittances with simulation time.

# Classes of Particle Simulations.

How important is smoothing?

3D Beam:  $N \sim 10^{10} - 10^{14}$  particles typical

Simulations:  $N \lesssim 10^8$  practical (modern parallel computers), typical  $10^3 - 10^6$

Each simulation particle may represent:  $10^3 \rightarrow 10^{11}$  particles in the real beam for 3D simulations.

- Smoothing involved with particle weightings are key to obtaining physical answers and limiting collisionality.

Is the situation really this bad?

- Lower dimensional models typically simulated.

## 3D Model

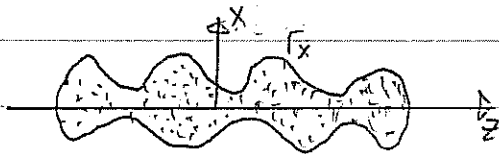

$N$  point particles with smoothed interactions

Phase Space:

Physical charge - point charges

$$\rho = \sum_i q \delta(x-x_i) \delta(y-y_i) \delta(z-z_i)$$

$$\left. \begin{array}{l} x, y, z \\ p_x, p_y, p_z \end{array} \right\} 6D$$

Smoothed charge

$$\rho = \sum_i q_M f(x-x_i, y-y_i, z-z_i)$$

$q_M$ : Macro particle charge  
 $f$ : smoothed shape function



2D  $\perp$  Thin Slice Model

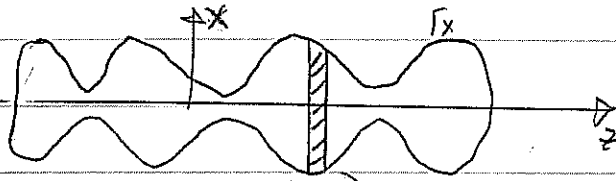

N line charges  
with smoothed interactions.

Thin slice

$$\frac{\partial \ll \nabla \perp}{\partial z}$$

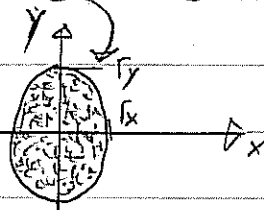

Phase Space:

$x, y$  } 4D + possible 1D  
 $p_x, p_y$  }  $p_z$   
4D or 5D

"Physical" charge - line charges

$$\rho = \sum_i \lambda_i \delta(x-x_i) \delta(y-y_i)$$

Smoothed charge -

$$\rho = \sum_i \lambda_{M_i} f(x-x_i, y-y_i)$$

$\lambda_M$  = Macro particle line charge

$f$  = smoothing function

The slice must be tracked in  $s$  with each particle moving the same increment in  $s$  with each step so that a slice maps to a slice.

- If  $p_z$  is included the velocity distribution must be assumed "frozen in".

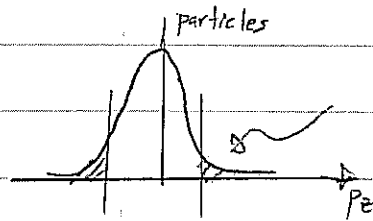

parts that would leave assumed replenished by particles from adjacent slices.

- Response to acceleration may be modeled with

- "Thick" slice models also possible with periodic boundary conditions, on the "slice" to try to recover some 3D effects of a long pulse in a periodic lattice.

2D r-z Model

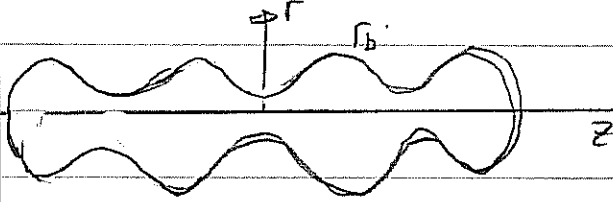

N charged Rings  
with smoothed interactions

$\frac{\partial}{\partial \theta} = 0$  Axisymmetric

Phase Space.

$r, z$  } 4D + possible 1D  
 $p_r, p_z$  }  $P_\theta$   
(angular mom.)

physical charge - cylindrical rings

$$\rho = \sum_i \frac{Q_i}{2\pi} \frac{\delta(r-r_i) \delta(z-z_i)}{r_i}$$

smoothed charge

$$\rho = \sum_i \frac{Q_M}{2\pi} \frac{f(r-r_i, z-z_i)}{r_i}$$

$Q_M$ : Macro particle charge  
 $f$ : Smoothing function.  
4D or 5D.

- Used to model solinoidal transport of an initial axisymmetric beam.
- Sometimes used to model AG beams with an approximately equivalent, s-dependant focusing force.  $\vec{X}_L'' = k_{p0}^2(s) \vec{X}_L + \dots$

1D Axisymmetric Model

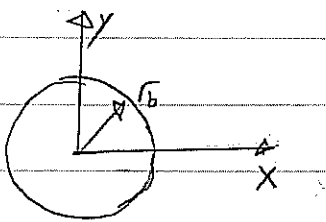

N charged cylinders with smoothed interactions

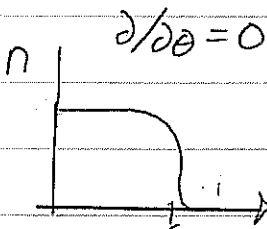

Phase - Space

$r$  } 2D + possible 1D  
 $p_r$  }  $P_\theta, p_z$   
2D to 4D

"physical" charge - cylindrical sheets

$$\rho = \sum_i \frac{Q_i}{2\pi} \frac{\delta(r-r_i)}{r_i}$$

smoothed charge

$$\rho = \sum_i \frac{Q_M}{2\pi} \frac{f(r-r_i)}{r_i}$$

$Q_M$ : Macro charge  
 $f$ : Smoothing function

- Simple model for continuously focused, axisymmetric beams

1D slab Model

N charged slabs with smoothed interactions.

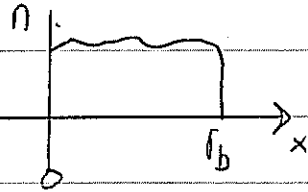
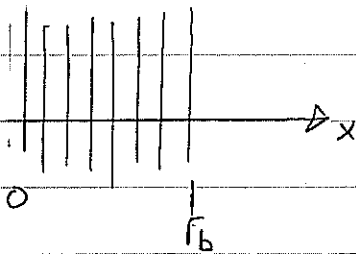

Phase-Space

$x$  } 2D + possible  
 $p_x$  }  $p_y, p_z$   
 2D to 4D

"physical" charge - sheets

$$\rho = \sum_i \sigma \delta(x-x_i)$$

smoothed charge

$$\rho = \sum_i \sigma_M f(x-x_i)$$

$\sigma_M$ : macro particle charge  
 $f$ : smoothing function

- Most simple model, but slab geometry is least physical.

It is not immediately clear how such different models can in many cases represent qualitatively similar collective interactions since force laws can change form with dimension. For example, in free space, we find that:

Model	Free space. Field due to ith "particle"	
3D	$\vec{E} = \frac{q_i (\vec{x} - \vec{x}_i)}{4\pi\epsilon_0  \vec{x} - \vec{x}_i ^3}$	
2D	$\vec{E} = \frac{\lambda_i (\vec{x} - \vec{x}_i)}{2\pi\epsilon_0  \vec{x} - \vec{x}_i ^2}$	$\lambda_i =$ line-charge "particle"
1D	$E_x = \frac{\sigma_i (x-x_i)}{2\epsilon_0  x-x_i }$	$\sigma_i =$ sheet charge "particle"

The reason these radically different interactions can give similar physics is that the screening associated with collective interactions is found to be similar:

- Debye screening has similar characteristics in each dimension.

showed 2D form, in class. Will show in final that the 3D scaling obtains the same Debye length definition.

$$\lambda_D = \frac{v_{\text{thermal}}}{\omega_p} = \left( \frac{\epsilon_0 k_B T}{\hat{n} q^2} \right)^{1/2} \quad v_{\text{th}} = \left( \frac{k_B T}{m} \right)^{1/2} \quad \omega_p = \left( \frac{q^2 \hat{n}}{\epsilon_0 m} \right)^{1/2}$$

- It is much easier to have a significant number of particles within the characteristic screening distances for lower dimensional problems.

- Lower dimensional simulations can more easily resolve collective effects! (Sometimes people run 3D simulations for collective modes and present garbage answers due to resolution difficulties)

Example

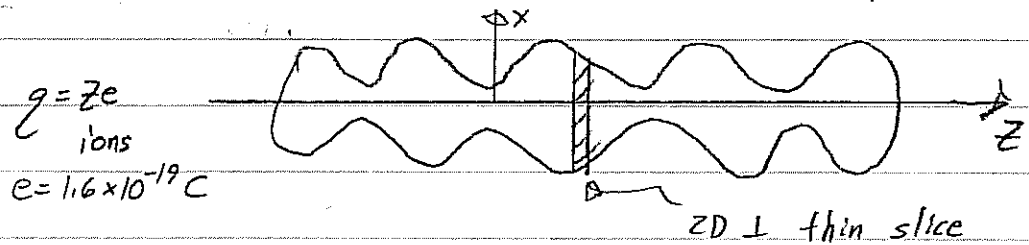

$\lambda \sim 10^{-13} \rightarrow 10^{-7} \text{ cm}$  typical for intense beams

$\# \text{ particles/cm} = \frac{\lambda}{ze \cdot 100} \sim \frac{10^4}{z} \rightarrow \frac{10^{10}}{z}$

$q = ze$   
charge state

- Smoothing still important in lower dimensions and real beam is 3D

~~89~~ 89WARP Code Overview

Electrostatic Multi-dimensional

PIC Code

WARP3d -  $x, y, z, p_x, p_y, p_z$   
Moves in tMany Fieldsolvers!  
SOR, Multigrids, FFT,  
FFT+Tridiag, FFT+Cap MaWARPxy -  $x, y, p_x, p_y, p_z$   
Moves in sWARPz -  $z, p_x, p_y, p_z, p_\theta$   
Moves in tWARPenv - envelope solver  
Used to seed/load PIC  
 $f_x, f_y, f_x', f_y'$   
Advances in sItermes - Fluid II + Bridged  
Space Charge Field

- Common diagnostic tools built around gist.  
graphics

- Run with python interpreter

Example Script

"ag-slice.py"

# 3D PIC simulations are being used to guide retrofits of an existing ESQ injector at LBL

1st principles, mid-pulse 3D simulations have been carried out to guide injector retrofits aimed at decreasing beam aberrations

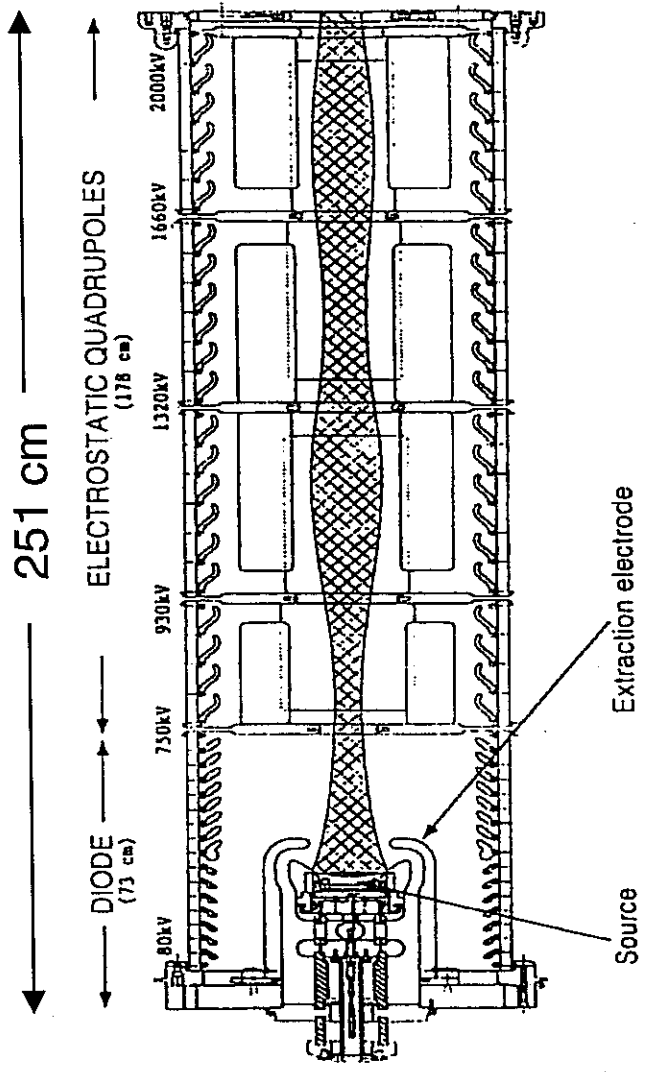
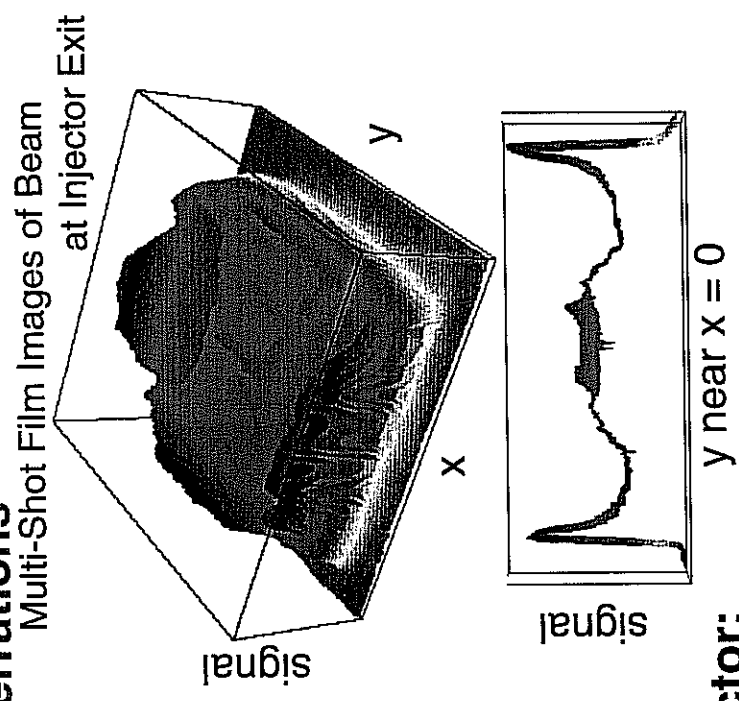

## Parameters expected at exit of retrofitted injector:

- Energy:  $E = 1.71 \text{ MeV}$
- Current:  $I = 692 \text{ mA, K}$
- Emittance:  $\epsilon_n = 1.1 \pi \text{ mm-mrad}$   
 $\sim 0.7 \pi \text{ mm-mrad}$       rms edge measure
- Envelope:  $r_x = 56.3 \text{ mm}$       measure eliminating empty entrained space  
 $r_y = 55.7 \text{ mm}$        $r_{x'} = 53.8 \text{ mrad}$   
 $r_{y'} = -44.8 \text{ mrad}$



The Heavy Ion Fusion Virtual National Laboratory

# HCX Injector: Simulations show distribution distortions in the retrofitted injector should be more modest

Mid-pulse distribution projections at exit plane of injector

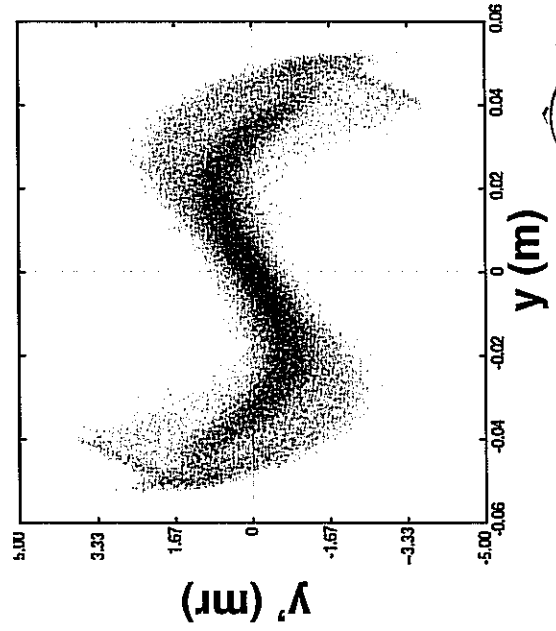
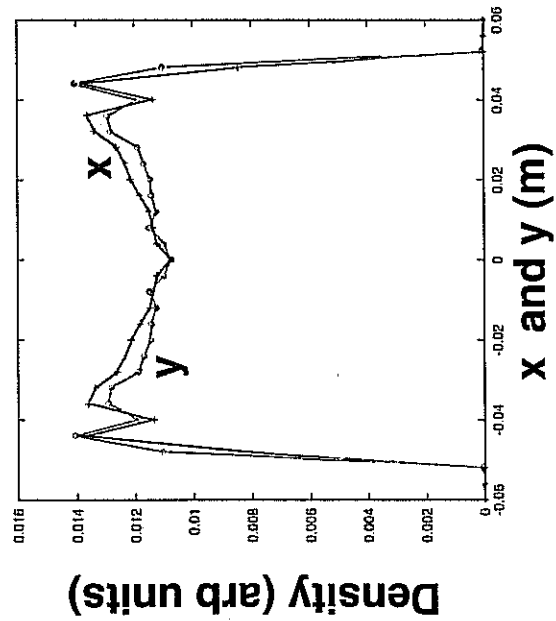
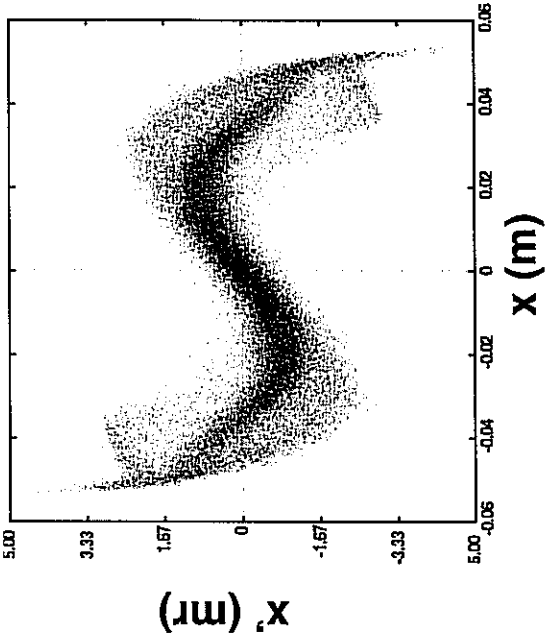
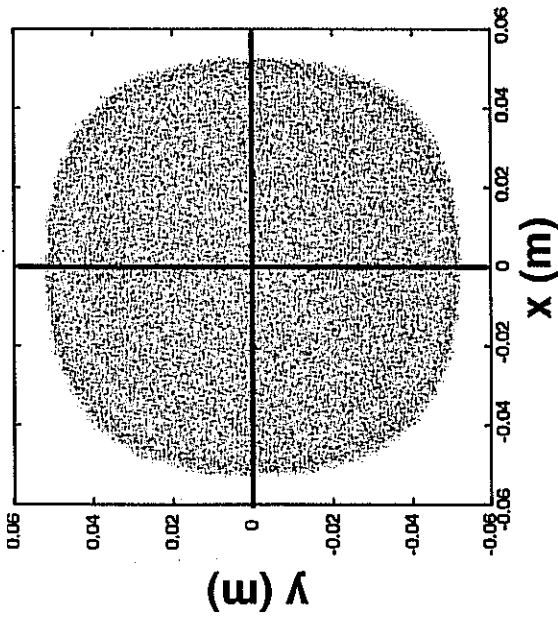

Overall convergence and divergence angles removed to illustrate distortions

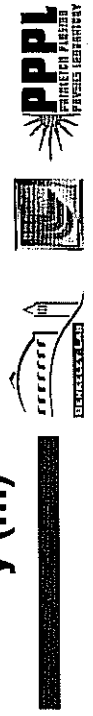

# Simulations show how waveform rise-time determines beam head mismatch

Tuned 1d diode voltage waveform rise-time is 400 ns -- deviations from this lead to significant mismatch effects in the beam head and particle loss with resultant worries about breakdown, electron effects, etc.

Rise-time  $\tau = 800$  ns  
beam head particle loss < 0.1%

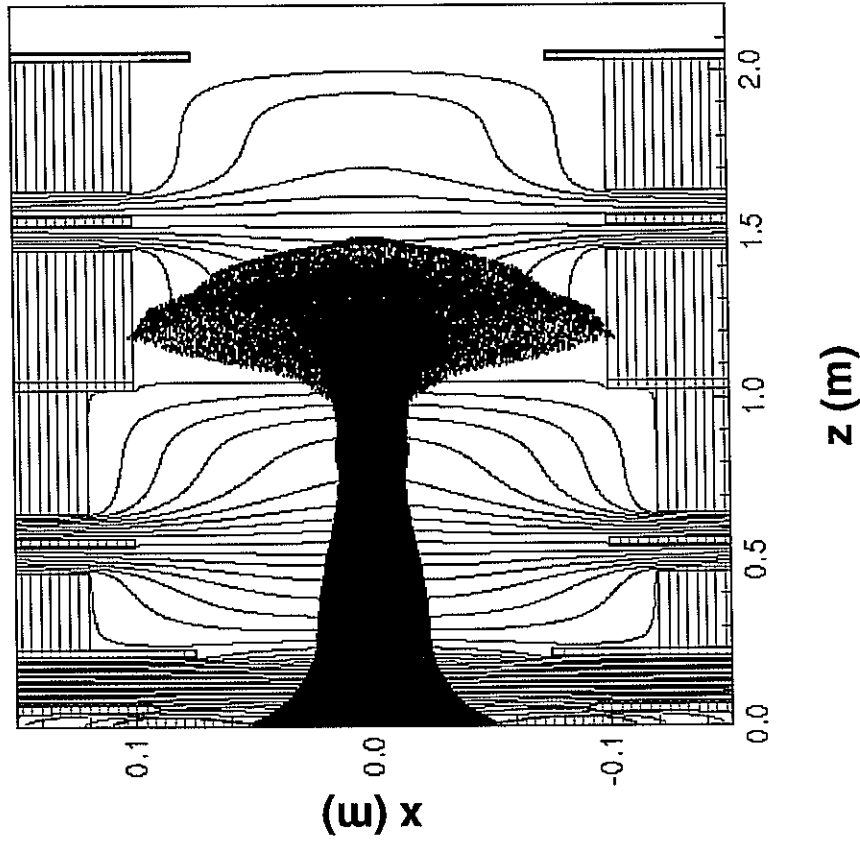

Rise-time  $\tau = 400$  ns  
zero beam head particle loss

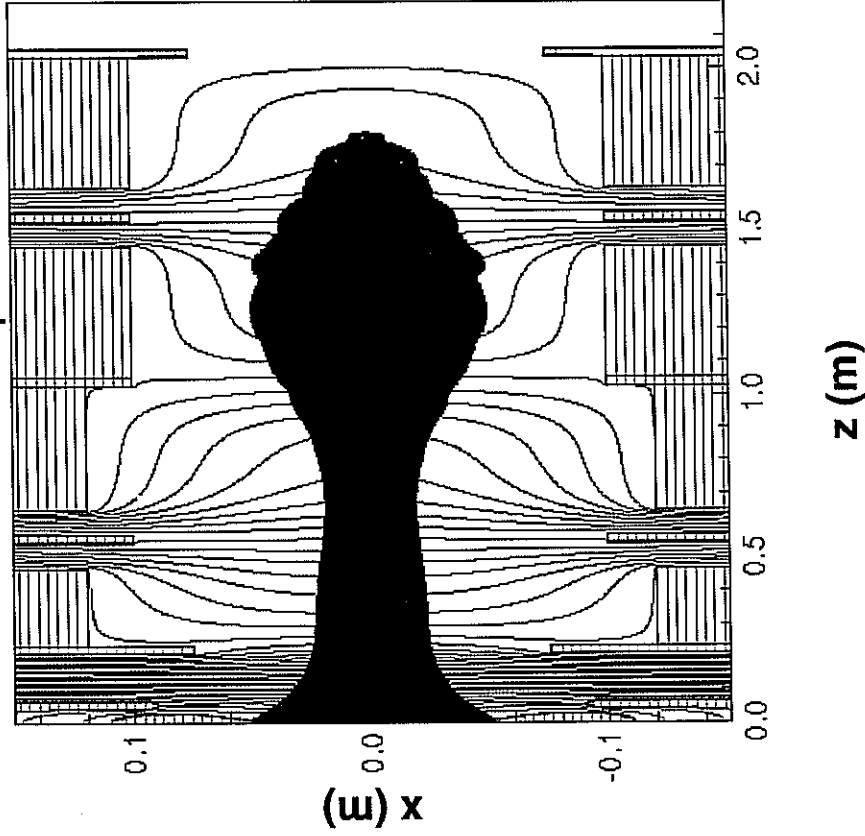



# Initial distribution distortions will launch a spectrum of collective mode perturbations that evolve

Kinetic and fluid theories have been employed to analyze perturbations on a uniform density intense-beam equilibrium [Lund and Davidson, Phys. Plasmas, 5 3028 (1998)]

## Small Amplitude Perturbations (arbitrary units, kinetic and fluid theory)

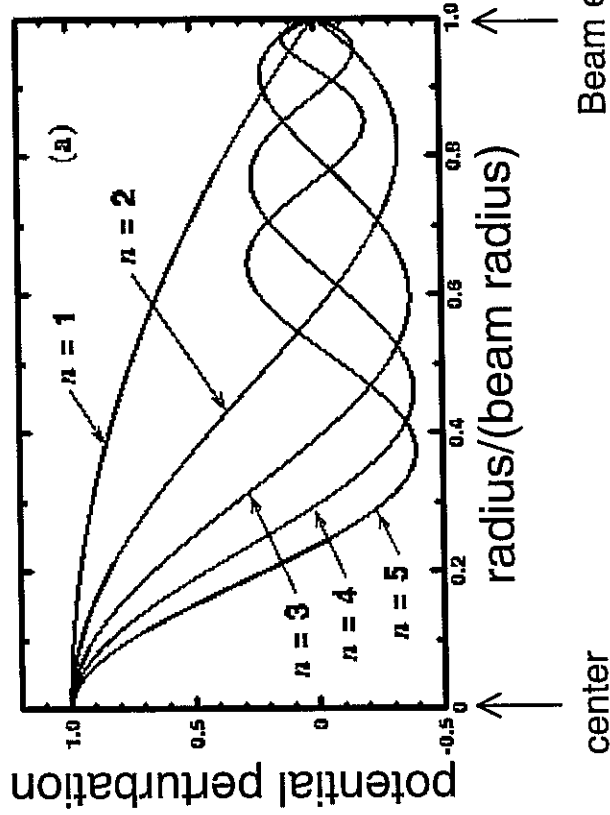
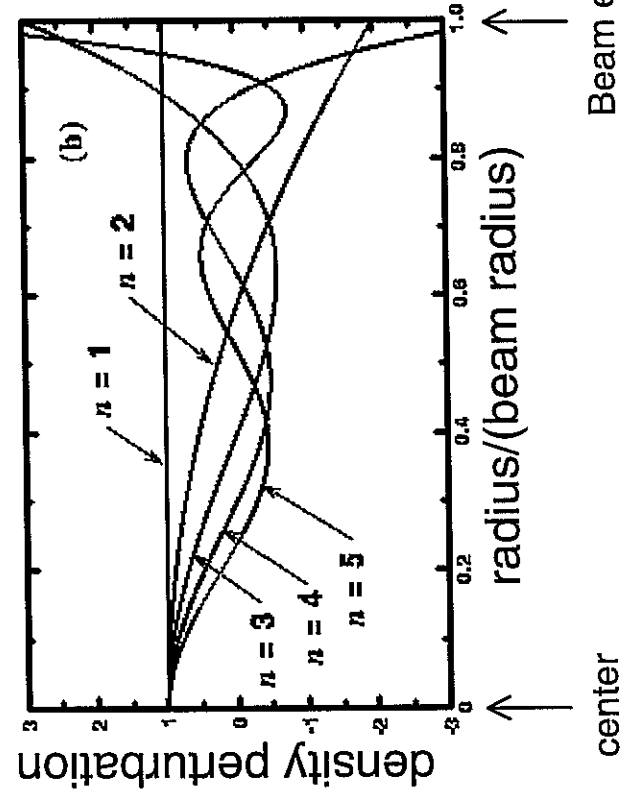

## Mode Dispersion Relation (fast branch, from fluid theory)

$$\frac{\sigma_n}{\sigma_0} = \sqrt{2 + 2\left(\frac{\sigma}{\sigma_0}\right)^2 (2n^2 - 1)}$$

$\sigma_n$  = mode phase advance  
 $n = 1, 2, 3, \dots$

Example:

$\sigma_0 = 80^\circ, \sigma / \sigma_0 = 0.2$   
 $\sigma_1 = 115^\circ, \sigma_5 = 182^\circ, \dots$



The Heavy Ion Fusion Virtual National Laboratory

# Perturbations launched by initial distribution nonuniformities can phase-mix to a more uniform profile with increased emittance

Mode spectrum launched can undergo a rapid cascade, settling to a smaller amplitude and lower order distortion

- Approximate conservation constraints employed to bound emittance increases resulting from full relaxation to a uniform profile [Lund, Lee, and Barnard, Proc. Linac 2000, pg. 290]
- How will such evolutions influence the range and interpretation of measurements

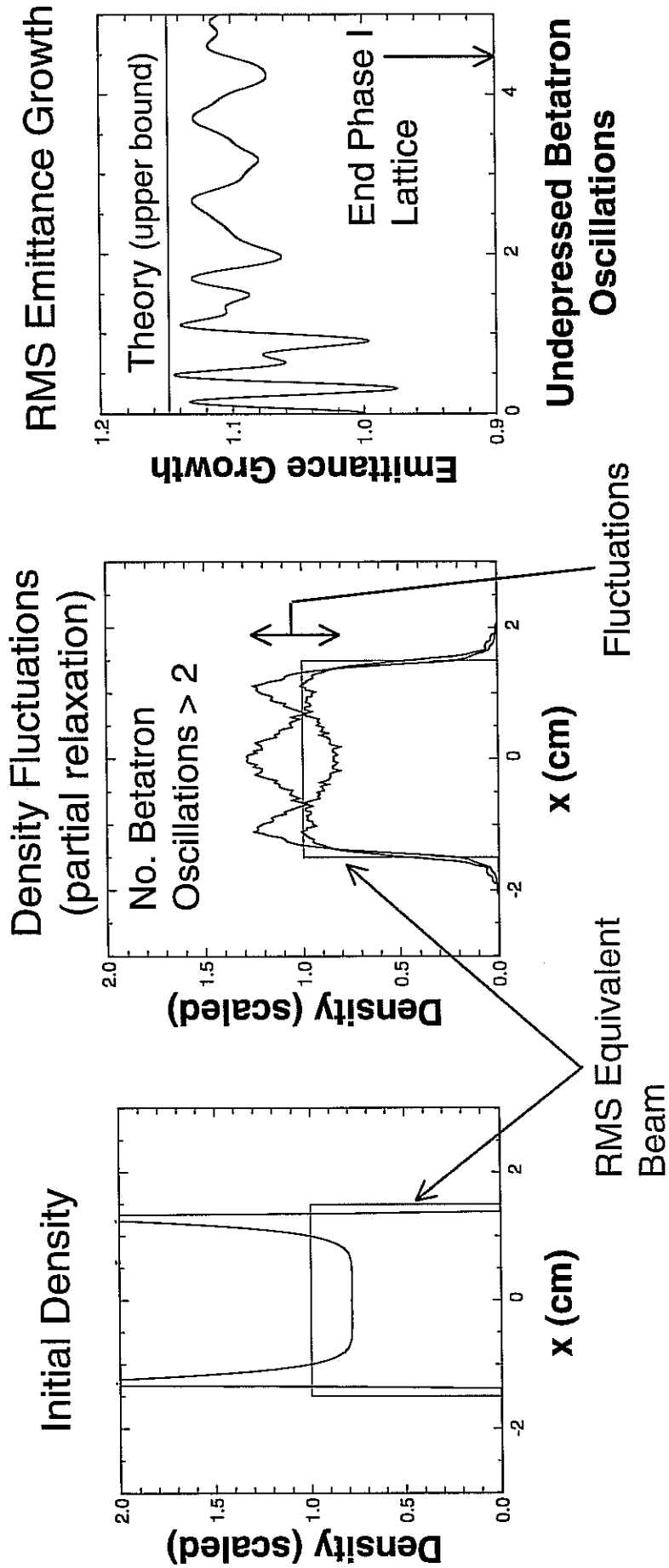

# Analytic theory has been used to parametrically bound emittance growth due to the relaxation of space-charge nonuniformities

Approximate conservation constraints can be employed to estimate maximal emittance increases resulting from the relaxation of an initial nonuniform density profile to a final, uniform profile [Lund, Lee, and Barnard, Proceedings Linac 2000, Monterey, CA, pg. 290]

## Initial Density

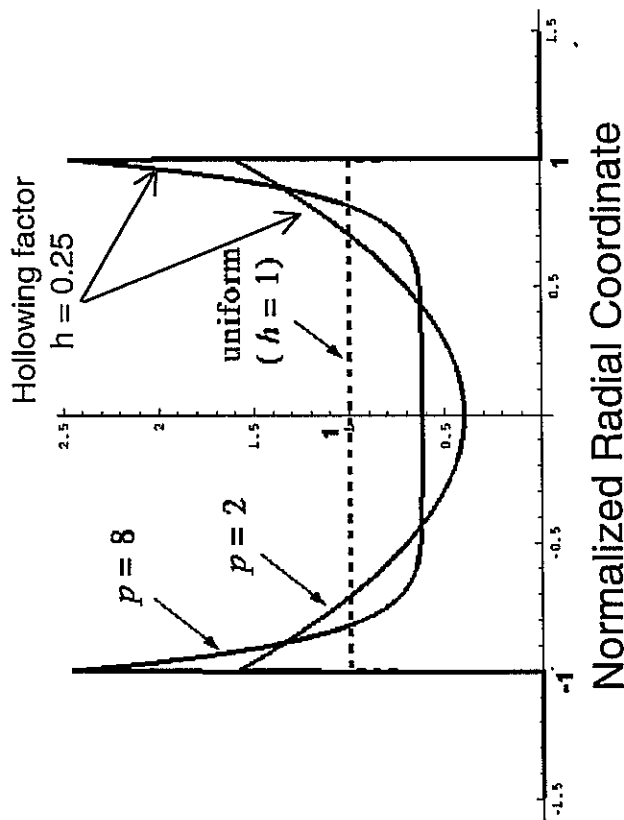

hollowing  $\sim r^p$

$h$  = ratio min to max density

## Emittance Growth on Relaxation

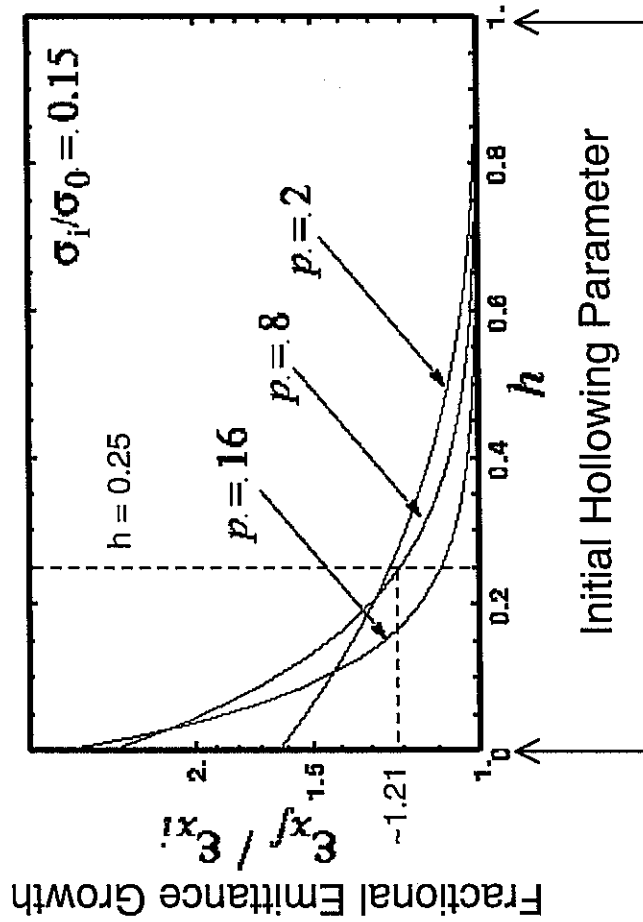

Extremely Hollowed

Initial Hollowing Parameter

Uniform

# HCX Phase II: A wide range of parametric simulations have been carried out with realistic magnetic transport lattices

A syncopated magnetic transport lattice of ~ 50 lattice periods has been designed

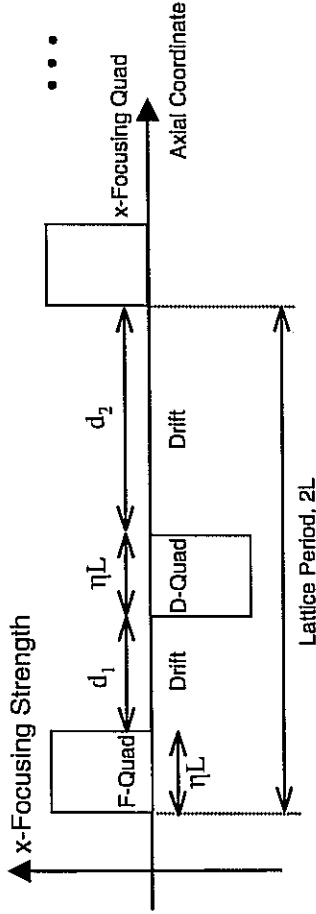

HCX:  
 $\eta = \text{Quadrupole Occupancy} \quad (0 < \eta < 1) \quad \eta = 0.453$   
 $\alpha = \text{Syncopation Factor} \quad (0 < \alpha < 1) \quad \alpha = 0.248$

Drifts:  
 $d_1 = \alpha(1-\eta)\eta L$   
 $d_2 = (1-\alpha)(1-\eta)\eta L$

## Superconducting magnetic quadrupoles have been designed and prototyped

$r_p = 29.5 \text{ mm}$        $B'_q = 104 \text{ T/m (max)}$        $B_q \sim 6 \text{ Tesla (wire)}$   
 $l = 136 \text{ mm}$        $l_{\text{eff}} = 101 \text{ mm}$       Integrated Field Error  $< 15 \times 10^{-3}$

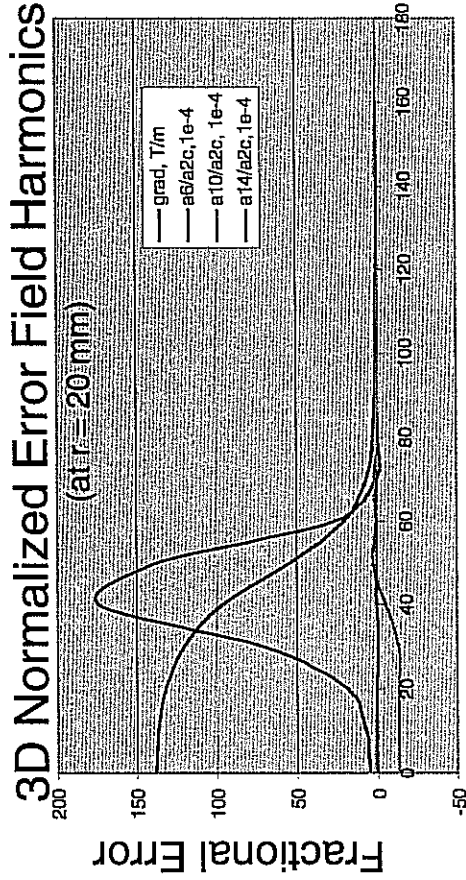

Distance from Median Plane, mm

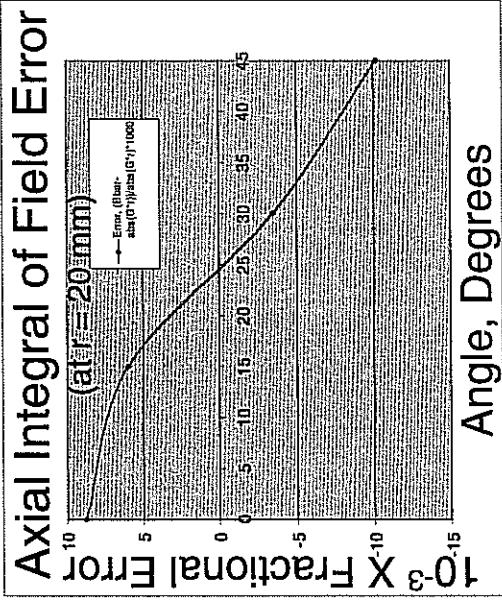

## HCX Phase II: Processes influencing beam quality and control have been explored --- Example: Nonlinear applied fields and beam quality

Full 3D magnetic field is resolved as:

$$\vec{B} = \vec{B}_{quad} + \delta\vec{B} \quad \delta\vec{B} \rightarrow s \cdot \delta\vec{B}$$

Very Strong Space Charge

( $\sigma/\sigma_0 = 0.086$ )

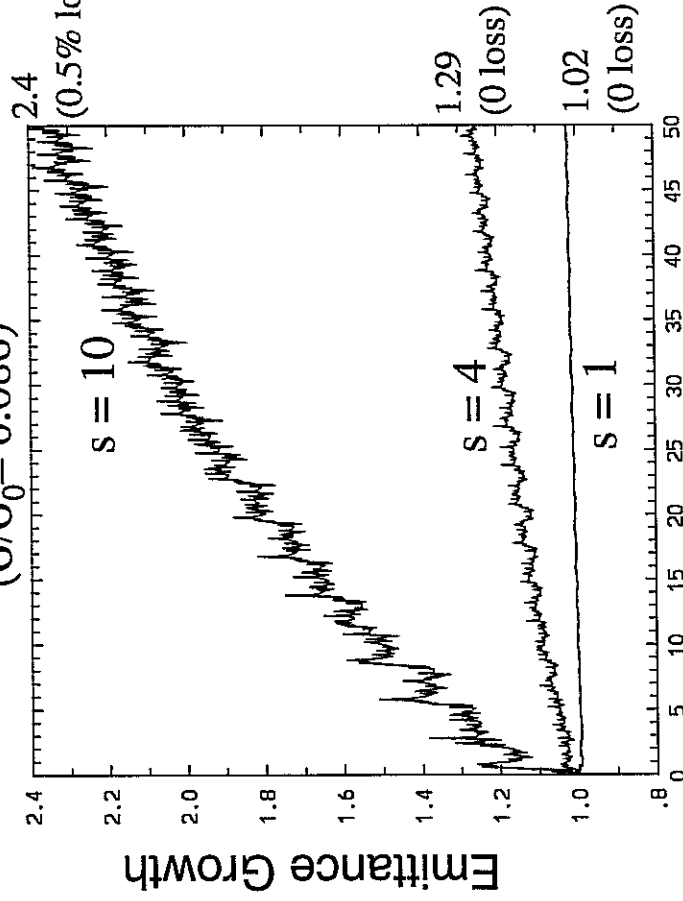

Lattice Periods

Intermediate Space Charge

( $\sigma/\sigma_0 = 0.248$ )

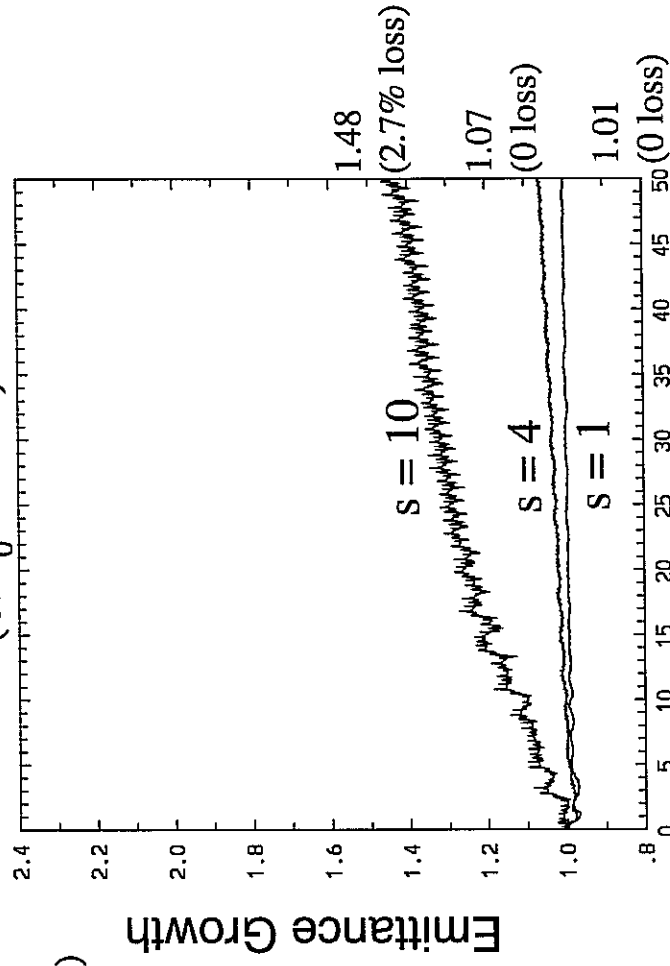

Lattice Periods

# Initial KV Distribution

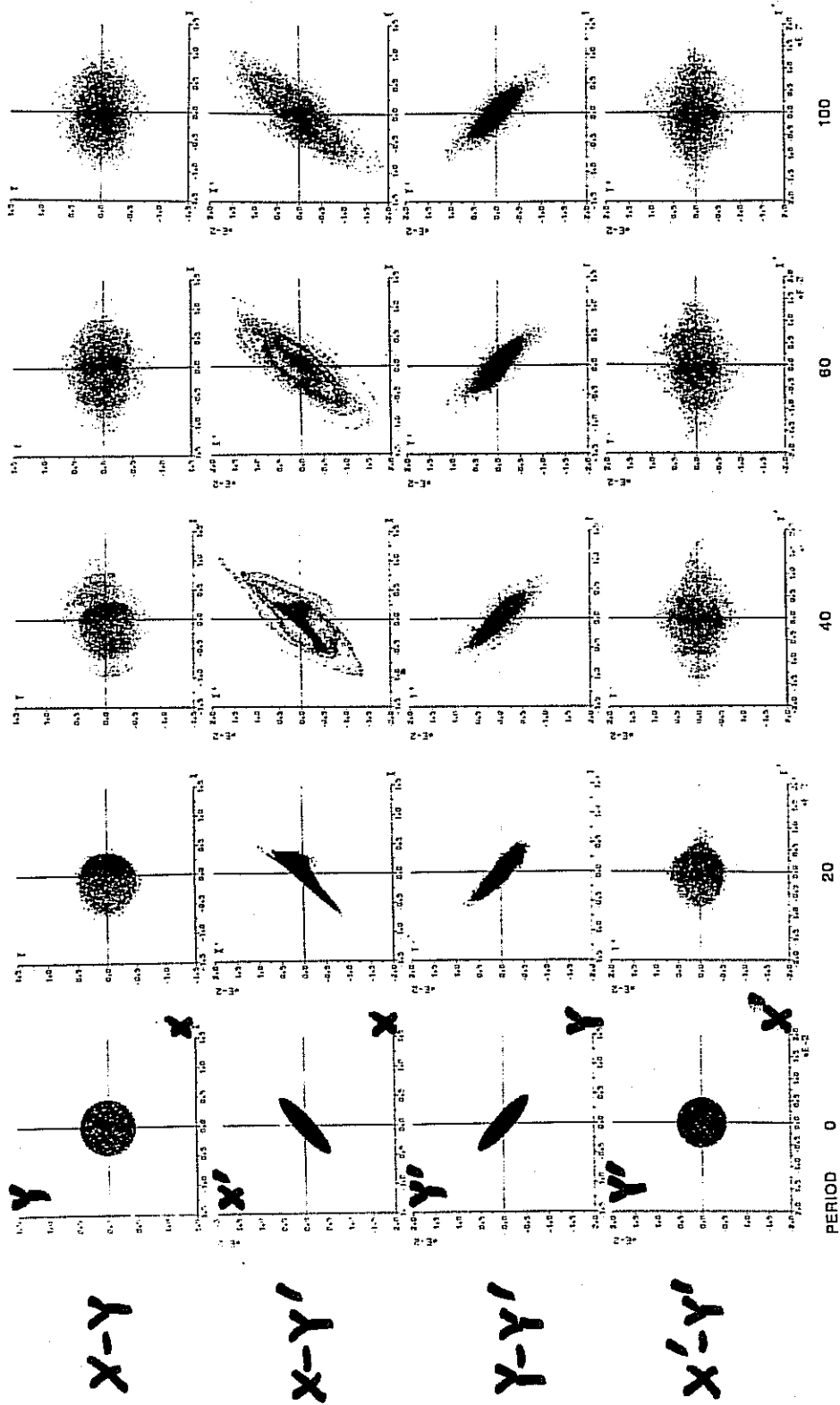

FIGURE 2 Transformation of an initial K-V distribution through the GSI FODO channel at  $\sigma_0 = 90^\circ$ ,  $\sigma = 4^\circ$ .

J. Struckmeier, J. Klabunde, and M. Reiser, Part. Accel. 15, 47 (1984).

See also Reiser Text, pg 495.

# Initial Gaussian Distribution

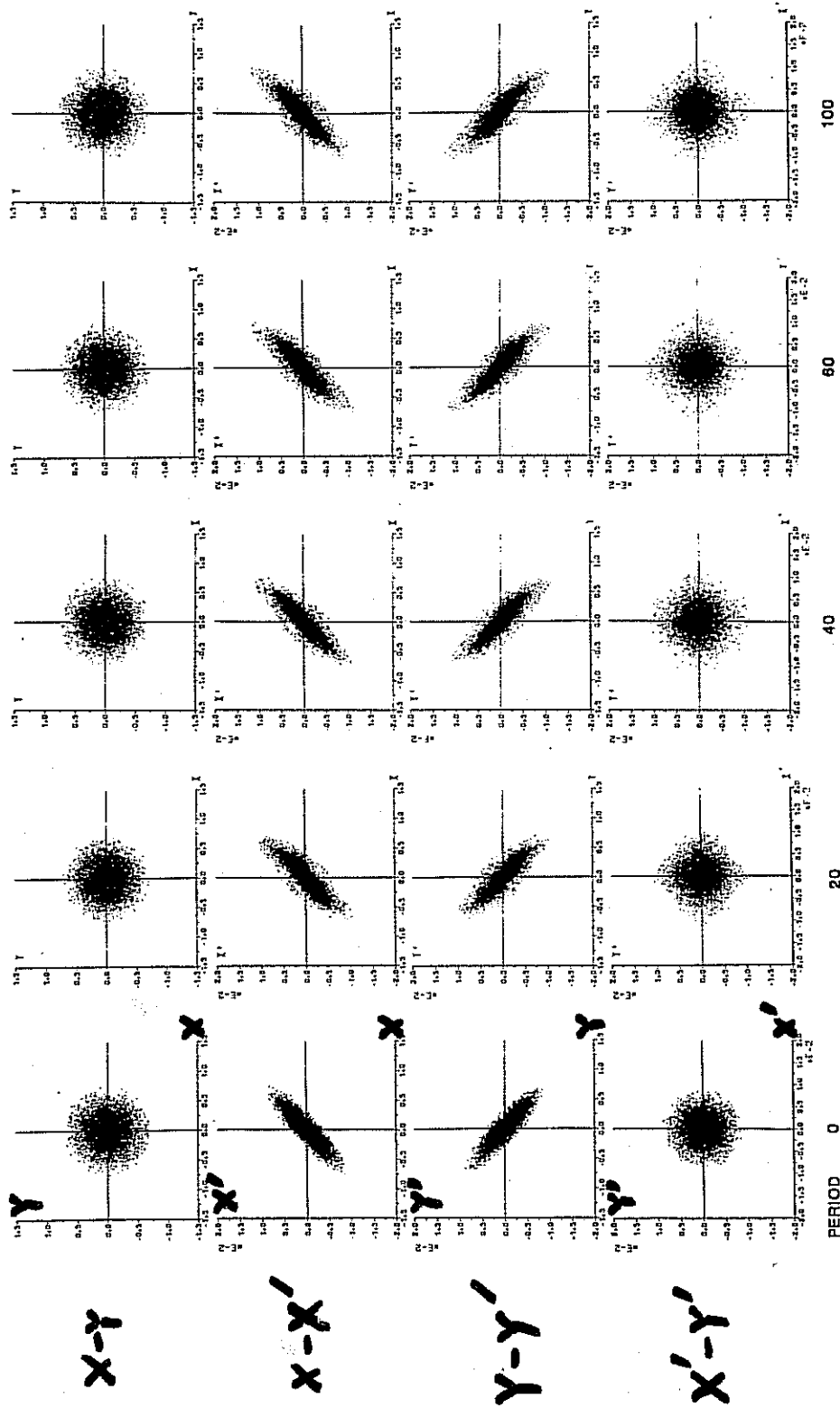

FIGURE 6 Transformation of an initial Gaussian distribution (rms-matched) through the GSI FODO channel at  $\sigma_0 = 90^\circ$ ,  $\sigma = 41^\circ$ .

J. Struckmeier, J. Klabunde and M. Reiser, Part. Accel. 15, 47 (1984)

GROWTH OF DIFFERENT DISTRIBUTIONS

61

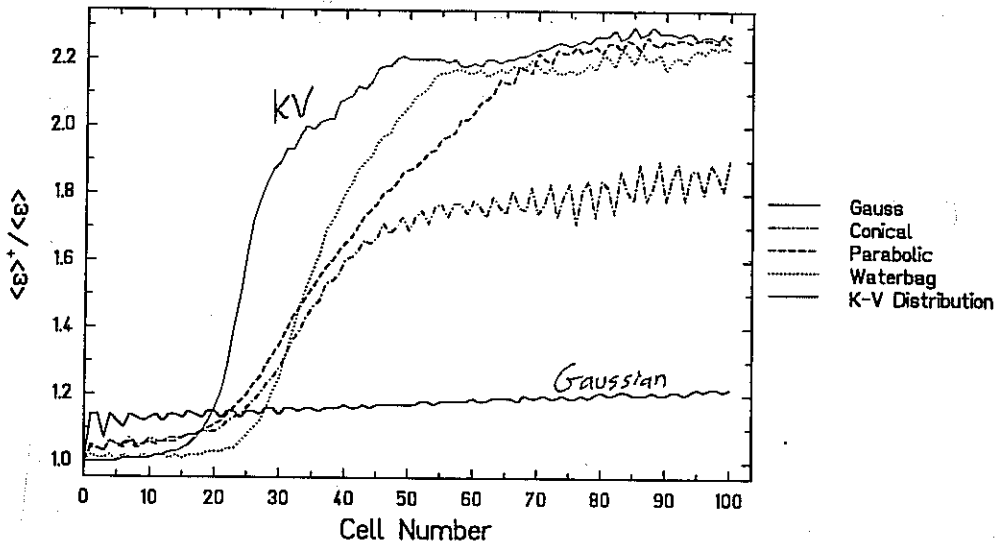

FIGURE 7 Emittance growth factors versus the number of cells obtained from particle simulations for initial K-V, waterbag, parabolic, conical and Gaussian distributions at  $\sigma_0 = 90^\circ$ ,  $\sigma = 41^\circ$ .

From J. Struckmeyer, J. Kabunde, and M. Reiser,  
Part. Accel. 15 47 (1984).



## Distribution Methods - Direct Gridded Solution of Vlasov's Equation.

Consider the Vlasov equation as an example.

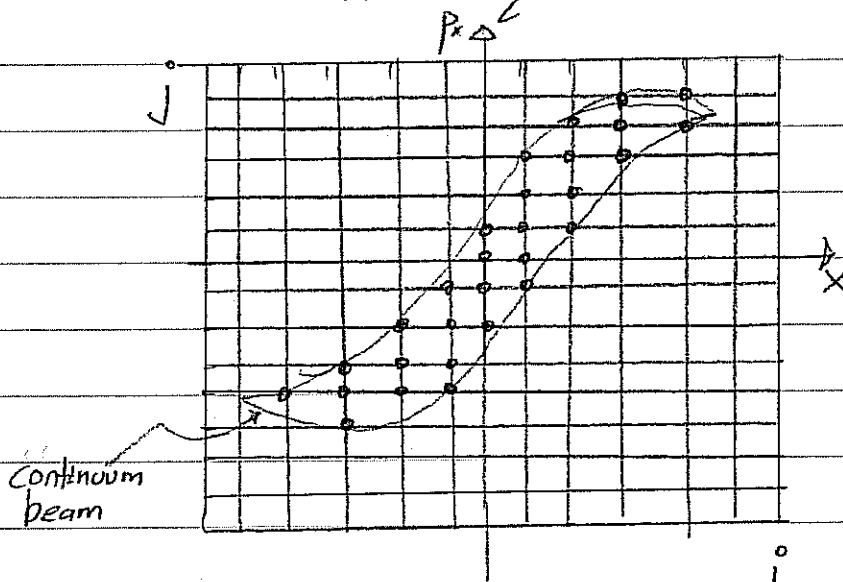

$$f(x_i, p_j, t) = f_{ij}(t)$$

The distribution is advanced at discrete grid points in time.

- Fields are typically solved using a discrete spatial mesh as for the particle methods described before.
  - Deposition on mesh is typically straightforward in Vlasov case (sum over momentum variables)
- The distribution advance cycle is different than for particle methods.
  - Numerical stability is key.
  - Characteristics and "semi-Lagrangian" methods can be employed.
  - Methods for solving for characteristics are familiar<sup>505</sup> from dynamics/plasma physics.

# Direct Vlasov Methods

S. M. Lund 66/

## "Pros"

Reasons for Vlasov simulations:

- Low noise - only discretization effects without statistical effects
- Allows clear analysis of collective effects and tenuous distribution components.

## "Cons"

Reasons why Vlasov simulations are presently employed less than PIC:

- Extreme memory requirements for needed grid resolution in multi-dimensional phase space.
  - Beams often have sharp edges in phase space that move in response to varying applied focusing forces.
- Numerical stability tends to be more difficult than in particle methods.

No time to illustrate Vlasov and other distribution methods in this introductory course. We hope to cover these methods and other numerical fieldsolve techniques in a later expanded version of this class.

However, it is easy to generalize from what we have learned.

John Barnard  
Steven Lund  
USPAS  
June 2008

Summary of JB lectures

START WITH MICROSCOPIC PHASE SPACE DENSITY

$$N(x, v, t) = \sum_{i=1}^N \delta(x - x_i(t)) \delta(v - v_i(t))$$

Klimontovich Density

$\frac{\partial N}{\partial t} + \text{CONSTANT EQUATIONS} \Rightarrow$  KLIMONTIVICH EQUATION:

$$\frac{\partial N}{\partial t} + v \cdot \nabla_x N(x, v, t) - \frac{q(E^m + v \times B^m)}{m} \cdot \nabla_v N(x, v, t) = 0$$

$$\text{or } \frac{dN(x, v, t)}{dt} = 0$$

Letting  $N = f + \delta f$      $f = \langle N \rangle$   
 $E^m = E + \delta E$      $E = \langle E^m \rangle$   
 $B^m = B + \delta B$      $B = \langle B^m \rangle$

$$f = \frac{\int N dx^3 dv^3}{\Delta x^3 \Delta v^3}$$

$n^{-1/3} \ll \Delta x \ll \lambda$

PERFORMING LOCAL AVERAGES TO OBTAIN SMOOTH & "LIKEY" QUANTITIES:

$$\frac{\partial f}{\partial t} + v \cdot \frac{\partial f}{\partial x} + \frac{dv}{dt} \cdot \frac{\partial f}{\partial v} = \frac{\partial f}{\partial t_c} \sim \frac{f}{\tau_c}$$

We estimated  $\frac{|\partial f / \partial t_c|}{|qE/m \cdot \partial f / \partial v|} \sim \frac{1}{16 \lambda_D^3 n_0} \ll 1$

$\lambda_D = v_{th} / \omega_p$      $v_{th} \equiv \sqrt{kT/m}$      $\omega_p \equiv \sqrt{\frac{q^2 n}{\epsilon_0 m}}$

$$\frac{\partial f}{\partial t} + v \cdot \frac{\partial f}{\partial x} + \frac{dv}{dt} \cdot \frac{\partial f}{\partial v} = 0 \quad ; \quad \dot{p} = -\frac{\partial H}{\partial x} \quad ; \quad \dot{x} = \frac{\partial H}{\partial p}$$

$$\frac{df}{dt} = 0$$

LIUVILLE'S EQUATION (INCOMPRESSIBILITY OF PHASE VOLUME)

CONJUGATE VARIABLES

DEFINE NORMALIZED EMITTANCES PROPORTIONAL TO  $\frac{\Delta p_x \Delta z}{\Delta v_x \Delta x} \propto \frac{\Delta E \Delta t}{\Delta p_y \Delta y}$

SO THAT

$$E_{N \times}^2 = \gamma^2 (\langle x^2 \rangle \langle x'^2 \rangle - \langle x x' \rangle^2)$$

$\Rightarrow$  CONSTANT IF FORCES ARE LINEAR IN  $x$  & FILAMENTATION IS ABSENT (LINEAR WITHOUT COUPLING TO  $z$ , OR  $y$ ).

WE DERIVED TWO SETS OF PARTICLE EQUATION OF MOTION:

AXIAL EQUATION (FOR AXISYMMETRIC SYSTEMS) ( $\frac{\partial}{\partial \theta} = 0$ )

STARTING WITH THE LORENZ FORCE EQUATION  $\frac{d\mathbf{L}}{dt} = q(\mathbf{E} + \mathbf{v} \times \mathbf{B})$  IN CYL. COORD.

$$\frac{d}{dt}(\gamma m \dot{r}) - \gamma m r \dot{\theta}^2 = q \left( \frac{V''}{z} r + r \dot{\theta} B \right) + q (E_r^{\text{self}} + v_z B_{\theta}^{\text{self}})$$

$\uparrow$                        $\uparrow$                        $\uparrow$                        $\uparrow$                        $\uparrow$                        $\uparrow$   
 INERTIAL              CENTRIFUGAL               $E_r$  external               $v_z B_z$                       SELF-FIELD

(DIVERGENCE OF  $E = 0$ )

$\dot{r} \equiv \frac{dr}{dt}; \quad v' = \frac{dr}{ds} = \frac{\dot{r}}{\beta c}$

$\theta$ -component:

$$p_{\theta} = \gamma m r^2 \dot{\theta} + \frac{q B(r) r z}{c} = \text{constant}$$

$$= \gamma m r^2 \beta c \theta' + \frac{q B r z}{c} = \text{constant}$$

$$r'' + \frac{\gamma'}{\beta^2 \gamma} r' + \frac{\gamma''}{2\beta^2 \gamma} r + \left( \frac{\omega_c}{2\gamma \beta c} \right)^2 r - \left( \frac{p_{\theta}}{\gamma \beta m c} \right)^2 \frac{1}{r} - \frac{q}{\gamma m v_z^2} \frac{\lambda(r)}{2\pi \epsilon_0 r} = 0$$

$\uparrow$                        $\uparrow$                        $\uparrow$                        $\uparrow$                        $\uparrow$                        $\uparrow$   
 INERTIAL              ACCELERATION               $E_r$                        $v_z B_z$                       CENTRIFUGAL                      CENTRIFUGAL                      SELF-FIELD  
 (INERTIAL)              (CONVERGENCE OF FIELD LINES)

STATISTICAL AVERAGE OF THIS EQUATION

$$r_b'' + \frac{\gamma'}{\beta^2 \gamma} r_b' + \frac{\gamma''}{2\beta^2 \gamma} r_b + \left( \frac{\omega_c}{2\gamma \beta c} \right)^2 r_b - \frac{4 \langle p_{\theta} \rangle^2}{(\gamma \beta m c)^2 r_b^3} - \frac{E_r^2}{r_b^3} - \frac{Q}{r_b} = 0$$

$$E_r^2 \equiv 4(\langle r^2 \rangle \langle v'^2 \rangle - \langle r v' \rangle^2 + \langle r^2 \rangle \langle v'^2 \theta'^2 \rangle - \langle r^2 \theta' \rangle^2); \quad Q = \frac{q \lambda}{2\pi \epsilon_0 \gamma^3 \beta^2 m c^2}$$

$$= E_x^2 - 4 \langle r^2 \theta'^2 \rangle^2 \quad (\text{if } p = p(r) \text{ only})$$

# CARTESIAN EQUATION OF MOTION

J BARON

(15)

EQUATION OF MOTION AGAIN STARTING WITH  $\frac{d\mathbf{p}}{dt} = q(\mathbf{E} + \mathbf{v} \times \mathbf{B})$

RETURN TO X, Y COORDINATES

$$x'' + \frac{1}{\gamma v_z} \frac{d}{ds} (\gamma v_z) x' = \frac{-q}{\gamma^3 m v_z^2} \frac{\partial \phi}{\partial x} \pm \begin{cases} \frac{q B'}{\gamma m v_z^2} x & \text{for magnetic quads} \\ \frac{q E'}{\gamma m v_z^2} x & \text{for electric quads} \end{cases}$$

Let  $\frac{\gamma m v_z^2}{q} = \frac{P}{q} \equiv [B'] \equiv \text{RIGIDITY}$

$$y'' + \frac{1}{\gamma v_z} \frac{d}{ds} (\gamma v_z) y' = \frac{-q}{\gamma^3 m v_z^2} \frac{\partial \phi}{\partial y} \mp \begin{cases} \frac{B'}{[B']} y & \text{magnetic} \\ \frac{q E'}{\gamma m v_z^2} y & \text{electric} \end{cases}$$

## ENVELOPE EQUATION

$$r_x^2 = 4 \langle x^2 \rangle; \quad r_y^2 = 4 \langle y^2 \rangle$$

$$r_x' = \frac{4 \langle x x' \rangle}{r_x}$$

$$r_x'' = \frac{4 \langle x x'' \rangle}{r_x} + \frac{E_x^2}{r_x^3}; \quad E_x^2 = 16 (\langle x^2 \rangle \langle x'^2 \rangle - \langle x x' \rangle^2)$$

$$r_y'' = \frac{4 \langle y y'' \rangle}{r_y} + \frac{E_y^2}{r_y^3}; \quad E_y^2 = 16 (\langle y^2 \rangle \langle y'^2 \rangle - \langle y y' \rangle^2)$$

for magnetic focusing:

$$r_x'' + \frac{1}{\gamma v_z} \frac{d}{ds} (\gamma v_z) r_x' + \frac{4q}{\gamma^3 m v_z^2} \left\langle x \frac{\partial \phi}{\partial x} \right\rangle \mp \frac{B'}{[B']} r_x - \frac{E_x^2}{r_x^3} = 0$$

$$r_y'' + \frac{1}{\gamma v_z} \frac{d}{ds} (\gamma v_z) r_y' + \frac{4q}{\gamma^3 m v_z^2} \left\langle y \frac{\partial \phi}{\partial y} \right\rangle \pm \frac{B'}{[B']} r_y - \frac{E_y^2}{r_y^3} = 0$$

(for electric focusing  $\frac{B'}{[B']} \rightarrow \frac{q E'}{\gamma m v_z^2}$ )

SPACE CHARGE TERM WITH ELLIPTICAL SYMMETRY

NOW DEFOCUSING IN ONE DIRECTION AND FOCUSING IN THE OTHER  $\Rightarrow$  RADIAL SYMMETRY SHOULD BE REPLACED BY ELLIPTICAL SYMMETRY:

$\rho = \rho \left( \frac{x^2}{r_x^2} + \frac{y^2}{r_y^2} \right)$

CAN BE SHOWN THAT  $\left\langle x \frac{\partial \phi}{\partial x} \right\rangle = \frac{-\lambda}{4\pi\epsilon_0} \frac{r_x}{r_x + r_y}$

$\left\langle y \frac{\partial \phi}{\partial y} \right\rangle = \frac{-\lambda}{4\pi\epsilon_0} \frac{r_y}{r_x + r_y}$

USE  $\phi(x,y) = \frac{-\lambda r_y}{4\epsilon_0} \int_0^{\infty} \frac{q(\chi) ds}{\sqrt{r_x^2+s} \sqrt{r_y^2+s}}$  to prove, where  $\hat{\rho}(\chi) = \frac{d^2 q}{ds^2}$

$\rho(x,y) = \hat{\rho}(\chi) |_{s=0}$   
 $\chi = \frac{x^2}{r_x^2+s} + \frac{y^2}{r_y^2+s}$

DEFINING  $Q = \frac{2\lambda q}{4\pi\epsilon_0 \gamma^3 m v_z^2}$

$r_x'' + \frac{1}{\gamma v_z} \frac{d}{ds} (\gamma v_z) r_x' - \frac{2Q}{r_x + r_y} = \frac{B'}{[B_0]} r_x - \frac{\epsilon_x^2}{r_x^2} = 0$

$r_y'' + \frac{1}{\gamma v_z} \frac{d}{ds} (\gamma v_z) r_y' - \frac{2Q}{r_x + r_y} = \frac{B'}{[B_0]} r_y - \frac{\epsilon_y^2}{r_y^2}$

(for Electric Focusing  $\frac{B'}{[B_0]} \rightarrow \frac{qE'}{\gamma m v_z^2}$ ).

(ANALOGUE TO CIRCULAR BEAM:

$\left\langle r \frac{\partial \phi}{\partial r} \right\rangle = \frac{-\lambda}{4\pi\epsilon_0}$  PROVED IN HOMEWORK)

## ENVELOPE EQUATIONS DERIVED

RMS (ENVELOPES DEFINED IN TERMS OF RMS QUANTITIES) (EMITTANCE NOT GUARANTEED TO BE CONSERVED).

1. PARAXIAL  $v_b$ ;  $\rho$  (NOT GUARANTEED TO BE CONSERVED).

2. ELLIPTICAL  $v_x, v_y$ ;  $\rho \left( \frac{x^2}{v_x^2} + \frac{y^2}{v_y^2} \right)$

3. LONGITUDINAL  $v_z$  FOR  $E_z = \frac{-q}{4\pi\epsilon_0} \frac{\partial \lambda}{\partial z} \propto z$ ;  $\left[ \lambda \propto (1 - 4z^2/v_z^2) \right]$   
 $v \propto (z/v_z)$

4. ELLIPSOIDAL w/ BUNCHES  $v_x, v_y, v_z$  (ALSO  $v_x, v_y, v_z$  c.f. Wangler, section 9.9).  
 $\rho$  (CONSTANT)

5. ELLIPTICAL WITH IMAGES  $v_x, v_y$   $\rho \left( \frac{x^2}{v_x^2} + \frac{y^2}{v_y^2} \right)$

6. LARMOR FRAME (PERIODIC SOLENOID) OR (CONTINUOUS FOCUSING)  $\tilde{v}_x, \tilde{v}_y$   $\rho$  (CONSTANT)

KINETIC ENVELOPE EQUATIONS (CONSTRAINT EQUATION ON A PARTICULAR DISTRIBUTION FUNCTION; EMITTANCE CONSERVED)

1. KV FOR ELLIPTICAL UNIFORM BEAMS  $f(x, x', y, y')$   
 [IDENTICAL TO #2 ABOVE]

2. NEUFER DISTRIBUTION FOR 1D  $f(z, z')$   
 [IDENTICAL TO #3 ABOVE]

## MOMENT EQUATIONS

1. TRANSVERSE WITH CHROMATIC EFFECTS

$$\langle x^2 \rangle, \langle x'^2 \rangle, \langle xx' \rangle, \langle x^2 \delta \rangle, \langle x'^2 \delta \rangle, \langle xx' \delta \rangle, \dots$$



# Summary of Current Limits from Different Focusing Methods

## EINZEL LENS

$$Q_{max} \approx \frac{3\pi^2}{8} \left( \frac{q\beta_0}{m\beta_0^2} \right)^2 \left( \frac{V_0}{L} \right)^2$$

## SOLENOIDS

$$Q_{max} = \left( \frac{\omega_c V_0}{2\gamma\beta c} \right)^2$$

## QUADRUPOLE FOCUSING

$$Q_{max} \approx \frac{1}{2\pi} \left( \frac{\sin \frac{\pi}{2}}{\frac{\pi}{2}} \right) \left[ \frac{B V_0}{\beta \beta_0} \right] \left[ \frac{2q V_0}{\gamma m \beta^2 c} \right]$$

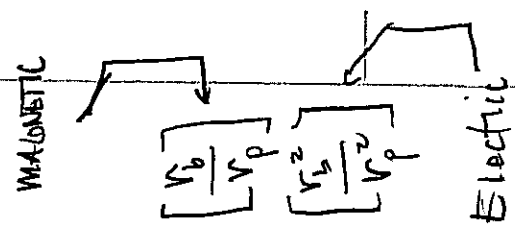

## FOR NON-RELATIVISTIC BEAMS

$$\lambda_{max} \propto \frac{Q_0^2}{V}$$

$$\lambda_{max} \propto \frac{1}{m} B^2 V_0^2$$

$$\lambda_{max} \propto \left\{ \begin{array}{l} B V_0^{1/2} r_p \\ V_0 \end{array} \right.$$

Note

- $Q_0$  = Voltage between Einzel lenses
- $V_0$  = Voltage on a quad relative to ground
- $V$  = particle energy /  $q$

Solenoids:  $\log\{\lambda[\text{Cm}^{-1}]\} = -7.0$

Electrostatic quads:  $\log\{\lambda[\text{Cm}^{-1}]\} = -5.8$

Magnetic quads:  $\log\{\lambda[\text{Cm}^{-1}]\} = -8.9 + \frac{1}{2} \log\{E_{\text{kin}}[\text{eV}]\}$

Einzel lenses:  $\log\{\lambda[\text{Cm}^{-1}]\} = 0.01 - \log\{E_{\text{kin}}[\text{eV}]\}$

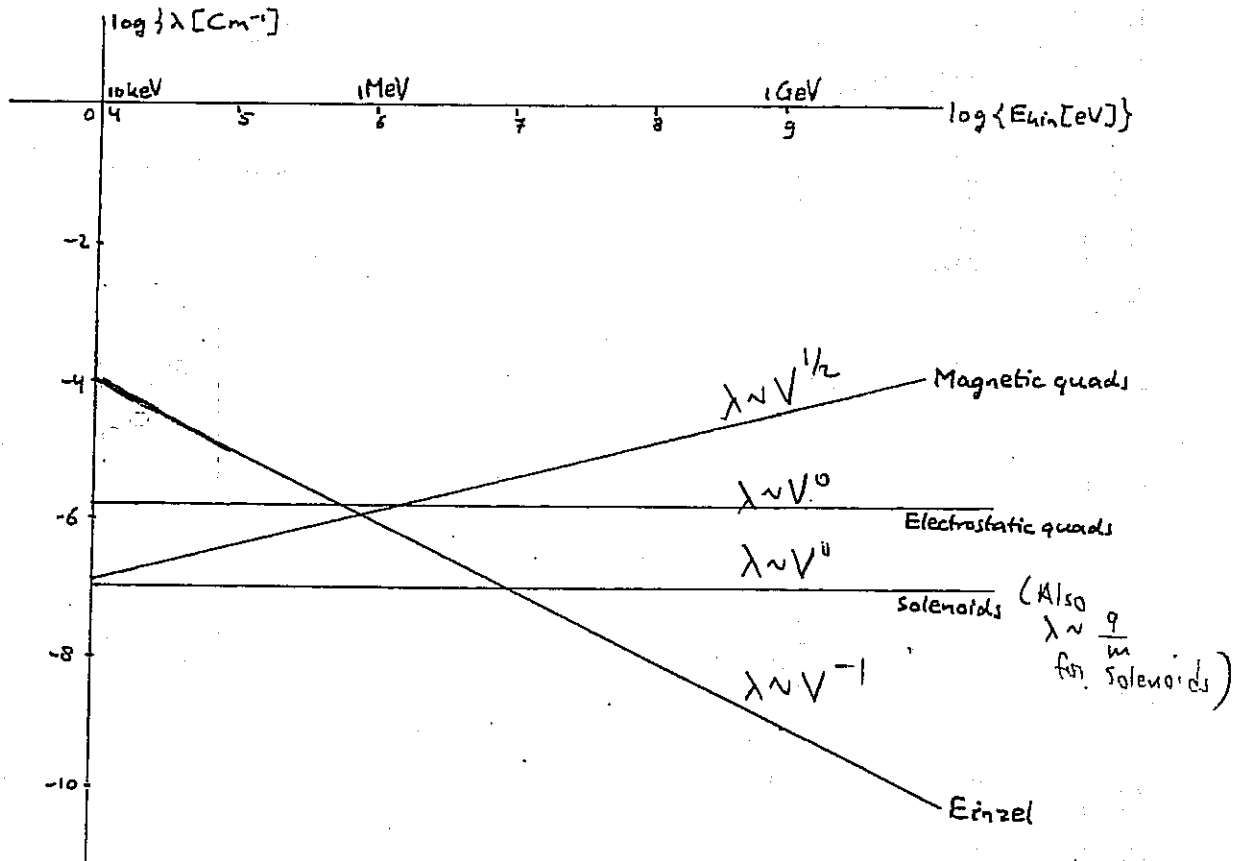

ESTIMATING SLOT SIZE

$$r_x'' + \frac{(Y_0 \beta_0)'}{Y_0 \beta_0} r_x + K_x r_x - \frac{zQ}{r_x + r_y} - \frac{E^2}{v_x^3} = 0$$

$$r_y'' + \frac{(Y_0 \beta_0)'}{Y_0 \beta_0} r_y + K_y r_y - \frac{zQ}{r_x + r_y} - \frac{E^2}{v_y^3} = 0$$

IN CHAMBER: NO EXTERNAL FOCUSING, NO ACCELERATION  
AND BEAM IS OFTEN CIRCULAR (BY DESIGN)

$$\Rightarrow K_x = K_y = (Y_0 \beta_0)' = 0 \quad \& \quad v_x = v_y = v_b$$

$\Rightarrow$  ENVELOPE EQUATION IS:

$$r_b'' = \frac{Q}{r_b} + \frac{E^2}{v_b^3}$$

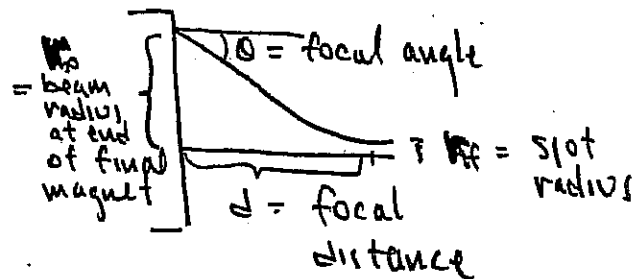

MULTIPLYING BY  $v_b'$  & INTEGRATING  $\Rightarrow$

$$\frac{v_{bf}^{1/2}}{2} - \frac{v_{b0}^{1/2}}{2} = Q \ln \frac{v_{bf}}{v_{b0}} + \frac{E^2}{2 v_{b0}^2} - \frac{E^2}{2 v_{bf}^2}$$

Now  $v_{b0}' \approx 0$        $v_{bf} = \text{spot radius}$

$v_{bf}' = 0$        $v_{b0} \approx d \theta$

$v_{bf} \ll v_{b0}$

WHEN  $\theta \ll 1$

$$r_{\text{spot}}^2 = \frac{E^2}{\theta^2} + r_{\text{CHROMATIC ABERRATION}}^2 + \dots$$

$$r_{\text{CHROMATIC}}^2 = K^2 d^2 \left(\frac{d\beta}{\beta}\right)^2 \theta^2$$

$\propto \theta^6$  (system dependent)

$$\Rightarrow \theta^2 \approx 2Q \ln \left( \frac{\theta d}{v_{bf}} \right) + \frac{E^2}{v_{bf}^2}$$

# LONGITUDINAL DYNAMICS SUMMARY

## 1D VLASOV EQUATION

$$\frac{\partial \tilde{f}}{\partial s} + z' \frac{\partial \tilde{f}}{\partial z} + z'' \frac{\partial \tilde{f}}{\partial z'} = 0$$

$$z'' = \frac{q E_z}{m v_0^2}$$

$$\frac{\partial^2 \phi}{\partial z^2} + \frac{1}{r} \frac{\partial}{\partial r} \left( r \frac{\partial \phi}{\partial r} \right) = - \frac{\rho}{\epsilon_0}$$

$$E_z = -\frac{q}{4\pi\epsilon_0} \frac{\partial \lambda}{\partial z}$$

"g-factor" model

CHILD-LANGMUIR IN 1-D PROBE

Ellipsoidal Bunch

## LEADS TO FLUID EQUATIONS

$\int (\text{Vlasov Equation}) dz'$

$$\frac{\partial \lambda}{\partial s} + \frac{\partial}{\partial z} (\lambda \bar{z}') = 0$$

$$\frac{\partial \bar{z}'}{\partial s} + \bar{z}' \frac{\partial \bar{z}'}{\partial z} + \frac{1}{\lambda} \frac{\partial}{\partial z} (\lambda \bar{z}'^2) = \frac{q E_z}{m v_0^2}$$

- 1D  $E_z$ :  $\Rightarrow$  CHILD LANGMUIR SOLUTION  $\leftarrow$  NON-LINEAR SOLUTION TO FLUID EQUATIONS
- g-factor:  $\Rightarrow$  SPACE-CHARGE WAVES  $\leftarrow$  NON-LINEAR SOLUTION TO FLUID EQNS.
- $\hookrightarrow$  LONGITUDINAL OR PERPENDICULAR WALL INSTABILITY (IF  $E_z = z' I_1$ )
- $\Rightarrow$  SPACE-CHARGE CATERPILLAR WAVES  $\leftarrow$  NON-LINEAR SOLUTION TO FLUID EQNS.
- $\Rightarrow$  VARIATIONAL BUNCH COMPRESSION  $\leftarrow$  NON-LINEAR SOLUTION TO FLUID EQUATIONS
- $\Rightarrow$  "EMK" FIELDS

2D PIRCE ELLIPSOID  
TIME DEPENDENT LAMBERT DIFFERENCE SOLUTION

VLASOV EQUATION ALSO  $\Rightarrow$  ENVELOPE EQUATION  $\int \int \text{Vlasov Equation } dz' dz''$

$$\frac{d^2 v_z}{ds^2} = \frac{E_z^2}{v_z^3} + \frac{3}{2} \frac{q q Q_c}{4\pi\epsilon_0 m v^2} \frac{1}{v_z^2} - K(r) v_z$$

KINETIC SOLUTION TO VLASOV EQUATION & SATISFYING KIN ENVELOPE EQUATION IS NEUBER DISTRIBUTION

$$f(z, z') = \frac{3N}{2\pi\epsilon_0} \sqrt{1 - \frac{z^2}{v_z^2} - \frac{v_z^2 (z' - v_z z / v_z)^2}{\epsilon_0^2}}$$

# NORMAL MODES

## LONGITUDINAL

### SPACE-CHARGE WAVES (FLUID)

$$\omega = \pm c_s k \quad [\text{IN COMOVING BEAM FRAME}]$$

$$c_s = \sqrt{\frac{q q \lambda_0}{4\pi \epsilon_0 m}} = \text{SPACE CHARGE WAVE SPEED}$$

## TRANSVERSE

### ENVELOPE MODES

CONTINUOUS FOCUSING (LONG BUNCHES)

BREATHING:  $k_B^2 = 2k_{p0}^2 + 2k_p^2$

QUADRUPOLE  $k_Q^2 = k_{p0}^2 + 3k_p^2$

(HERE  $k_p^2 \equiv k_{p0}^2 - \frac{Q}{f_s^2}$ )

(ANALOGOUS MODEL IN BUNCHED BEAMS)

STEPS LOOKED AT MODES IN PERIODIC SYSTEMS (CONTINUOUS FOCUSING)

+ KINETIC MODES (GLUCKSTERN MODES)

+ FLUID MODES

## INSTABILITIES

1. LONGITUDINAL (RESISTIVE WALL) INSTABILITY

(FLUID INSTABILITY)

2. ELECTRON-ION INSTABILITY

(CENTROID INSTABILITY)

STEVE TALKED ABOUT:

3. ENVELOPE INSTABILITIES

STEVE TALKED ABOUT:

4. KINETIC INSTABILITIES  
(DISTRIBUTION FUNCTION DEPENDENT)

5. SINGLE PARTICLE RESONANT INSTABILITIES

- HALO

- RING RESONANCES

HALL:

COVE TEST PARTICLE MODEL:

$$x'' = \begin{cases} -\left[k_{p0}^2 - \frac{Q}{v_b^2}\right]x & \text{for } v < v_b \\ -\left[k_{p0}^2 - \frac{Q}{v^2}\right]x & \text{for } v > v_b \end{cases}$$

$$v_b = v_{b0} + \delta r_b \cos(k_B s + \phi)$$

Gluckstein's phase-amplitude analysis:

$$x'' + \overbrace{\left[k_{p0}^2 - \frac{Q}{v_{b0}^2}\right]}^{k_p^2} x = f(x)$$

Non linear + forcing part

$$x = A \sin \psi \quad x' = k_p A \cos \psi \quad \leftarrow \text{PHASE/AMPLITUDE}$$

$$\psi = k_p s + \alpha \quad \text{If } f=0 \quad A \text{ \& } \alpha \text{ would be constant}$$

$$\Rightarrow A' = \frac{1}{k_p v_{b0}} f \cos \psi \quad \alpha' = -\frac{1}{k_p v_{b0} A} f \sin \psi$$

$$\text{DEFINE RESONANT PHASE: } \Phi_r = 2\psi - k_B s$$

AVERAGE OVER ALL NON-RESONANT FREQUENCIES

$$A_r' = \frac{1}{k_p v_{b0}} \int_{-\pi}^{\pi} f \cos \psi \frac{d\psi}{2\pi} \quad \alpha_r' = -\frac{1}{k_p A_r} \int_{-\pi}^{\pi} \frac{df}{2\pi} f \sin \psi$$

$$\rightarrow A_r', \Phi_r' \rightarrow \omega', \Phi_r' \rightarrow H(\omega', \Phi_r') \rightarrow \text{GIVE RESONANT PARTICLE TRAJECTORY}$$

§ SEPMATRIX

# Numerically determined frequency and amplitude of particle oscillations: linear rf focusing

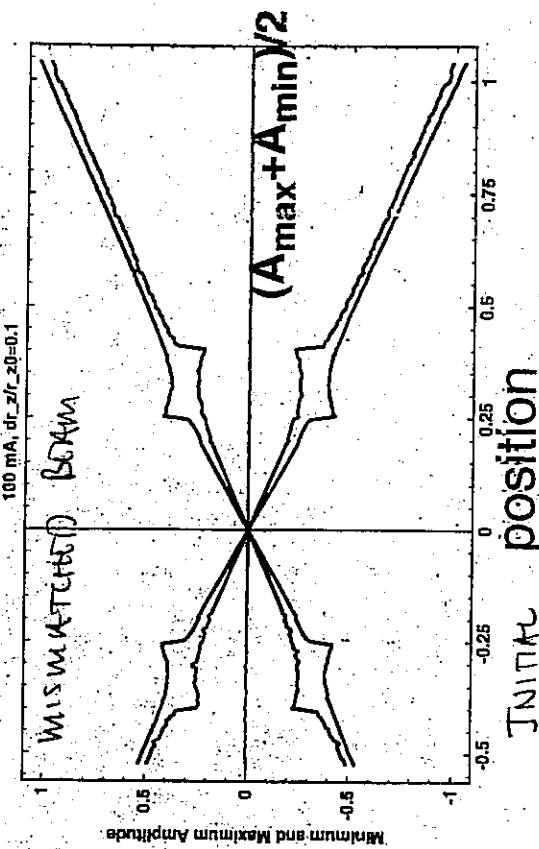
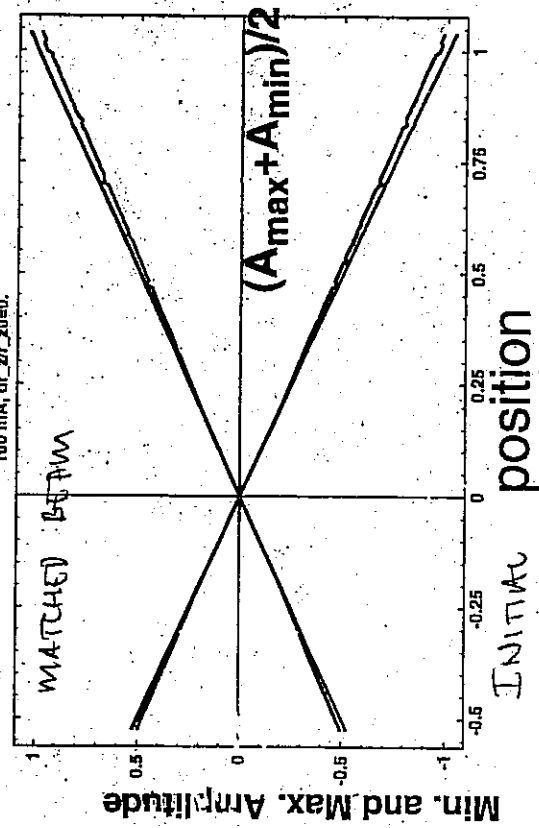
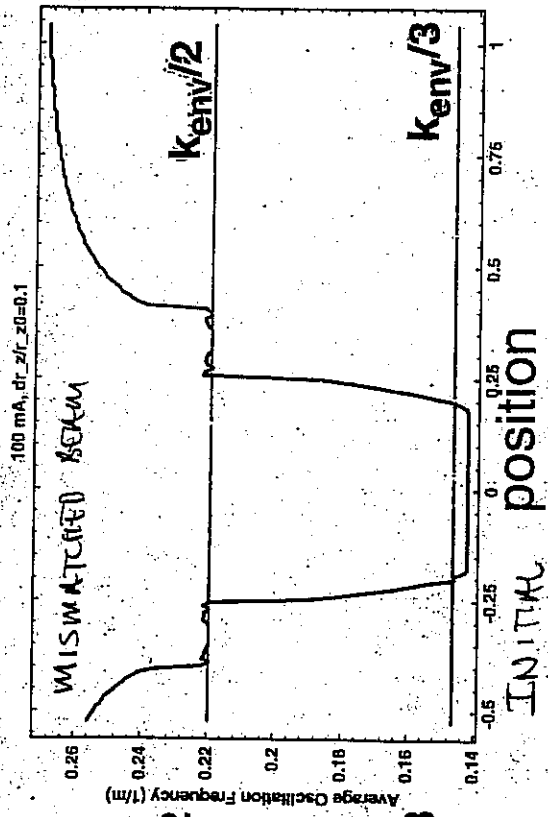
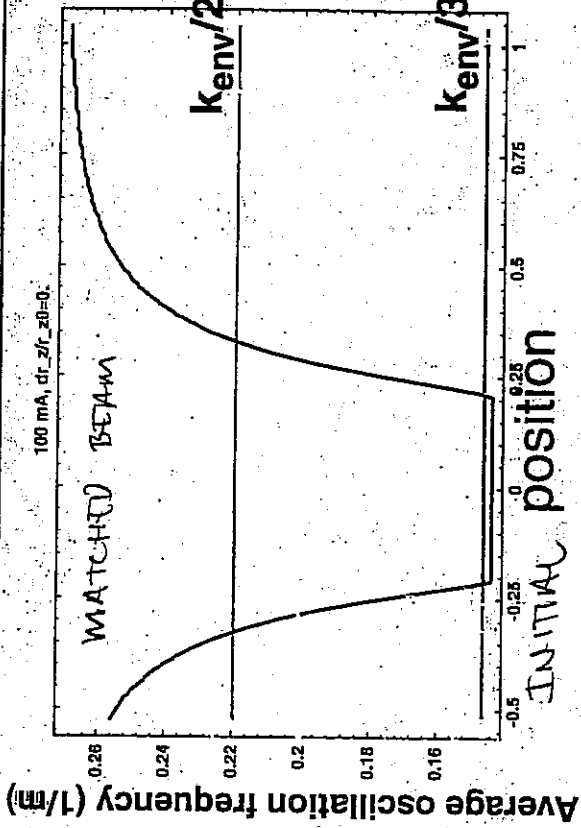



 Heavy ion	 Residual gas molecule	 electron
---	---	---

### Processes:

1. Coulomb collisions (intra-beam)

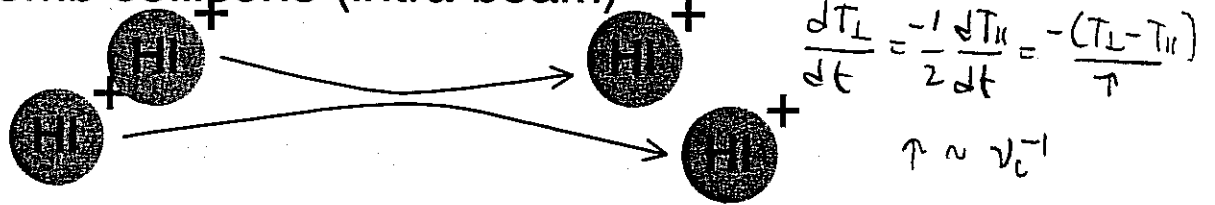

2. Coulomb collisions with residual gas

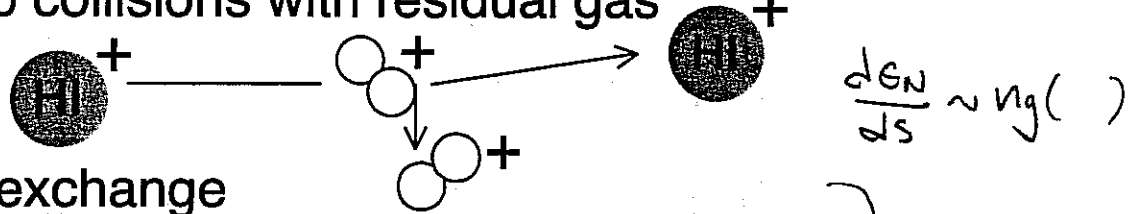

3. Charge exchange

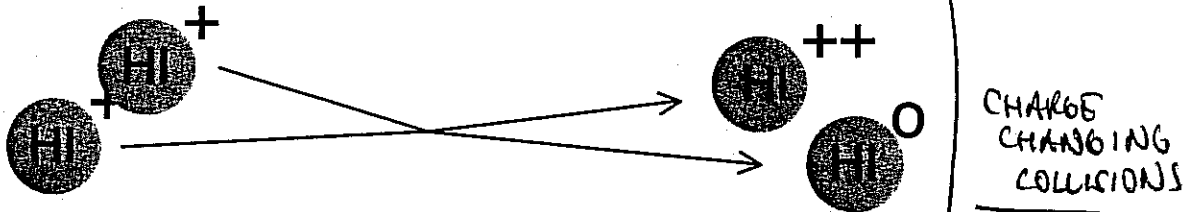

4. Stripping

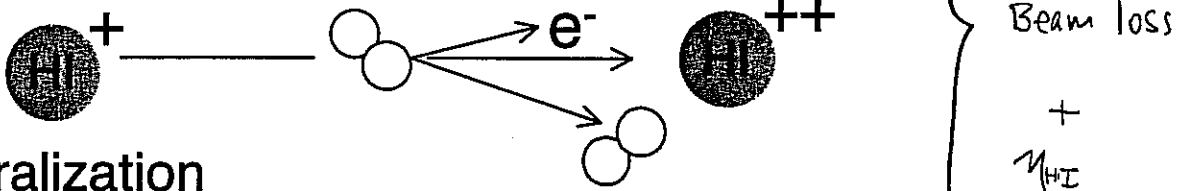

5. Neutralization

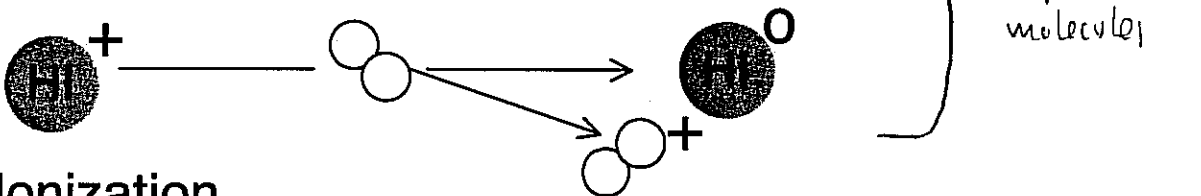

6. Gas Ionization

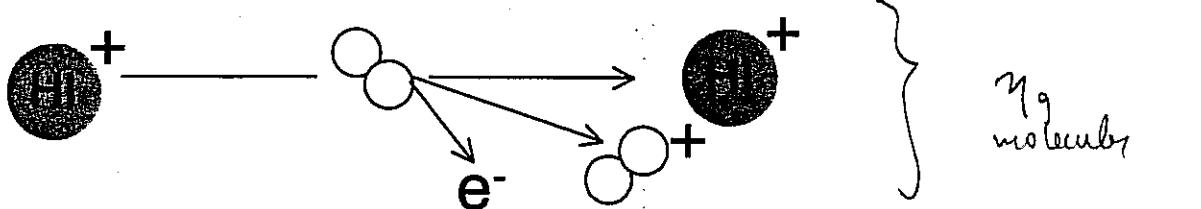

CHARGE CHANGING COLLISIONS

Beam loss

+  
n<sub>HI</sub> molecules

n<sub>g</sub> molecules

## SUMMARY OF ELECTRON, GAS, PRESSURE, & SCATTERING EFFECTS

1. COULOMB COLLISIONS WITHIN BEAM CAN TRANSPORT ENERGY FROM I TO II AND PROVIDE LOWER LIMIT ON  $T_{II}$ , HIGHER THAN FLOW ACCELERATIVE COOLING.
2. COULOMB INTERACTIONS WITH RESIDUAL GAS NUCLEI PROVIDE A SOURCE OF EMITTANCE GROWTH (BUT NOT IMPORTANT FOR HIGHER WALL AND LONG RESIDENCE TIMES).
3. PRESSURE INSTABILITY FROM DESORPTION OF RESIDUAL GAS BY STRIPPED BEAM IONS HITTING WALL OR BEAM-IONIZED RESIDUAL GAS ATOMS, FORCED TO WALL BY E-FIELD OF BEAM. LIMITS CURRENT IN RINGS OR HIGH VELOCITY LINAC.
4. ELECTRONS CAN CASCADE AND REACH A "QUIET" EQUILIBRIUM POPULATION OF SIMILAR LINE CHARGE TO THE ION BEAM. ELECTRON-ION TWO STREAM INSTABILITY IS UNSTABLE, AND CAN LEAD TO TRANSVERSE INSTABILITY, SIMILAR TO WHAT IS OBSERVED IN SOME PROTON RINGS.

**Inertial Fusion Energy (IFE) power plants of the future will consist of four parts**

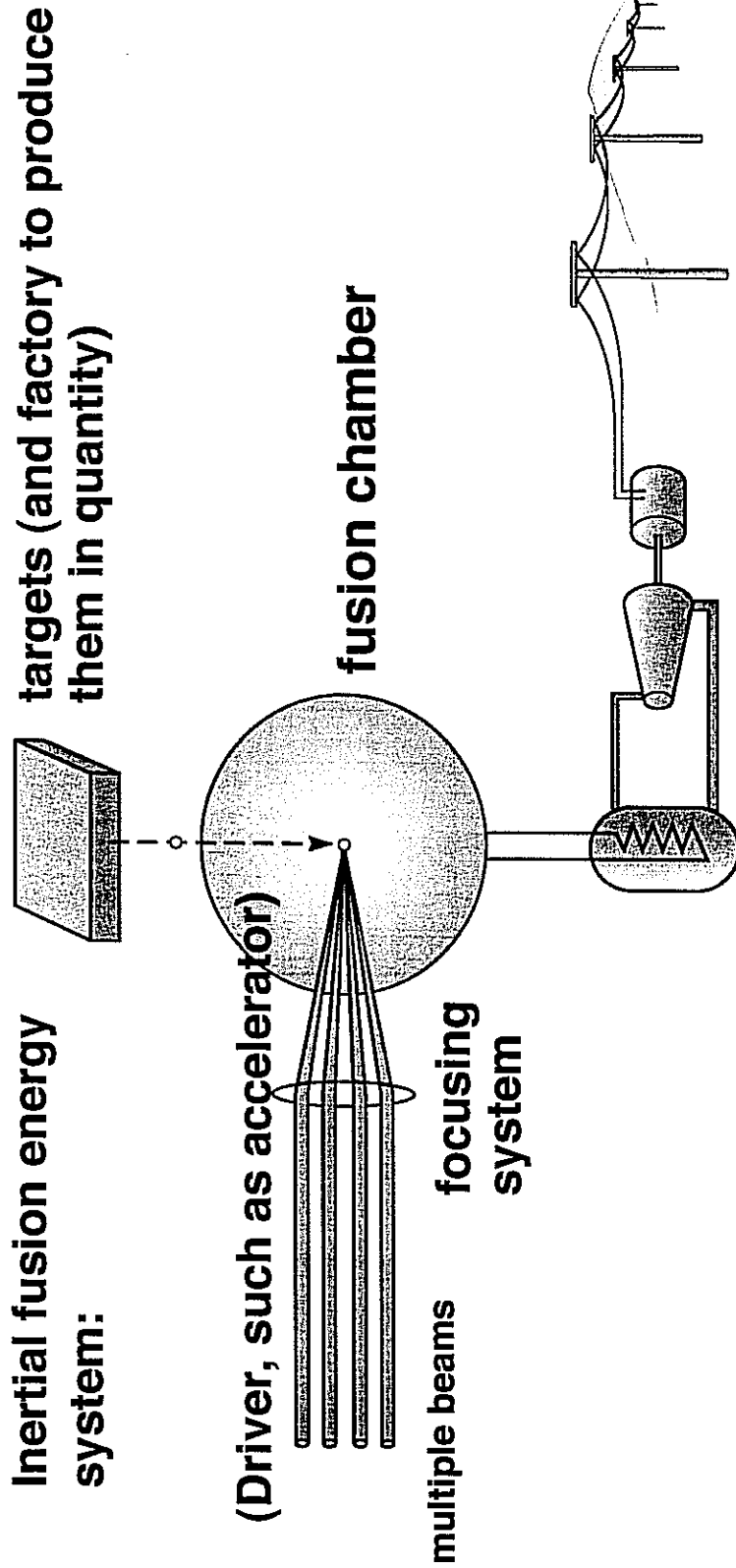

**heat exchange/steam turbine for electricity production**