

# Lawrence Berkeley National Laboratory

## LBL Publications

### Title

Magnetic Field in the SSC Arc Quad

### Permalink

<https://escholarship.org/uc/item/86s366jj>

### Authors

Caspi, S

Helm, M

Laslett, L J

### Publication Date

1991-04-01



# Lawrence Berkeley Laboratory

UNIVERSITY OF CALIFORNIA

## Accelerator & Fusion Research Division

### Magnetic Field in the SSC Arc Quad.

S. Caspi, M. Helm, and L.J. Laslett

April 1991

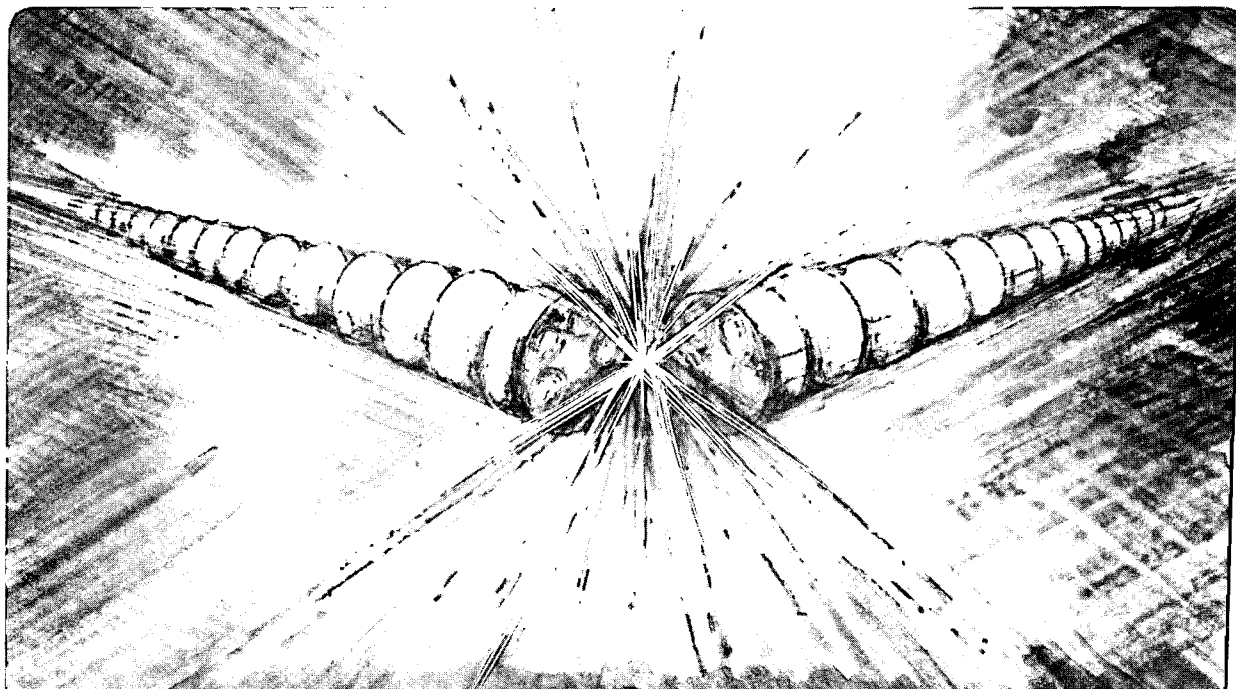

Prepared for the U.S. Department of Energy under Contract Number DE-AC03-76SF00098

LOAN COPY  
Circulates  
for 4 weeks  
Bldg. 50 Library.

LBL-30668

Copy 2

## **DISCLAIMER**

This document was prepared as an account of work sponsored by the United States Government. While this document is believed to contain correct information, neither the United States Government nor any agency thereof, nor the Regents of the University of California, nor any of their employees, makes any warranty, express or implied, or assumes any legal responsibility for the accuracy, completeness, or usefulness of any information, apparatus, product, or process disclosed, or represents that its use would not infringe privately owned rights. Reference herein to any specific commercial product, process, or service by its trade name, trademark, manufacturer, or otherwise, does not necessarily constitute or imply its endorsement, recommendation, or favoring by the United States Government or any agency thereof, or the Regents of the University of California. The views and opinions of authors expressed herein do not necessarily state or reflect those of the United States Government or any agency thereof or the Regents of the University of California.

SC-MAG-336  
LBL-30668

# Magnetic Field In the SSC Arc Quad.\*

S.Caspi, M.Helm and L.J. Laslett

Lawrence Berkeley Laboratory  
University Of California  
Berkeley, CA 94720

April 29, 1991

---

\* This was supported by the Director, Office of Energy Research, Office of High Energy and Nuclear Physics, High Energy Physics Division, U. S. Department of Energy, under Contract No. DE-AC03-76SF00098.

## Abstract

In part one we report on field calculations along the conductor in the end region of the SSC arc-quad. We have determined that the maximum field in the 2D section is 5.04 tesla located at the pole turn of the inner layer somewhere in the middle of the cable (strand 9) (fields are at 6500 A<sup>†</sup>). At the "end" the maximum field is slightly higher 5.09 tesla located at the overpass (strand 11). The iron contribution was included assuming infinite permeability. In part two we include results of a 3D representation of the magnetic field inside the bore. The complete analysis, for which a brief description has been included here, is described elsewhere<sup>‡</sup>. This form for presenting the field is suitable for interfacing with other codes that make use of the 3D field components (particle tracking and stability).

### Part 1 — maximum field at the conductor

The conductor geometry and fields are summarized in the following figures.

<sup>†</sup> The 40 mm SSC Arc Quadrupole – Magnetic Design — S.Caspi, M.Helm, and L.J. Laslett, SC-MAG-314, LBID—1677, November 1990.

<sup>‡</sup> 3D Field Harmonics — S.Caspi, M.Helm, and L.J. Laslett, SC-MAG-328, LBL-30313, March 1991.

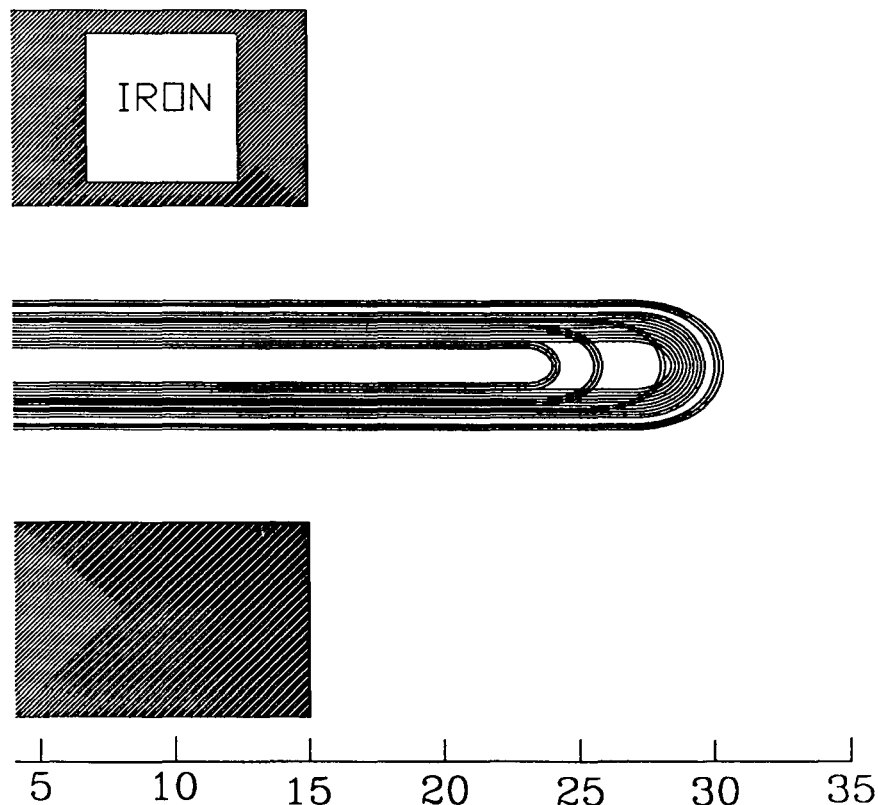

Figure 1 Coil schematic and IRON location in the end region.

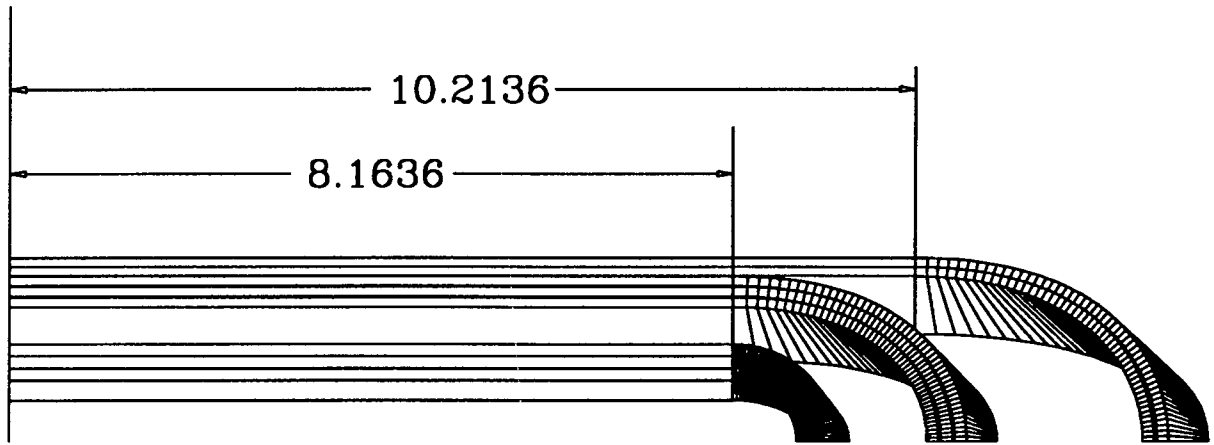

Figure 2 Conductor geometry in the end region of the SSC quad — LAYER-1 TOP.

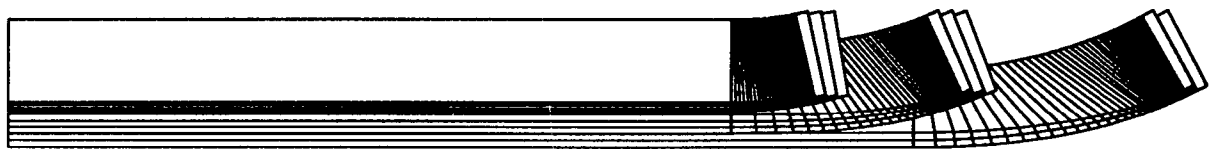

Figure 3 Conductor geometry in the end region of the SSC quad — LAYER-1 SIDE.

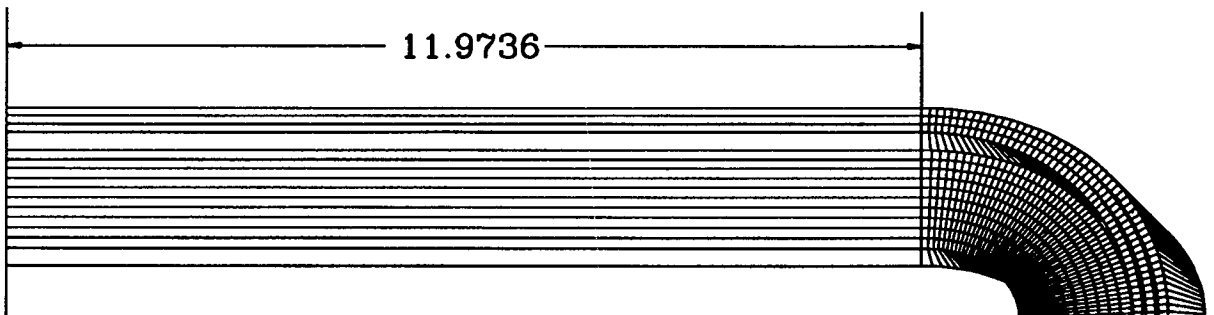

Figure 4 Conductor geometry in the end region of the SSC quad — LAYER-2 TOP.

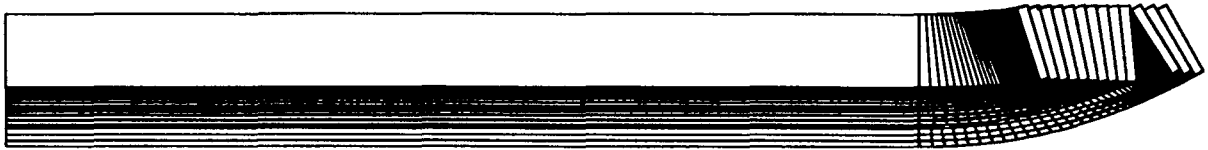

Figure 5 Conductor geometry in the end region of the SSC quad — LAYER-2 SIDE.

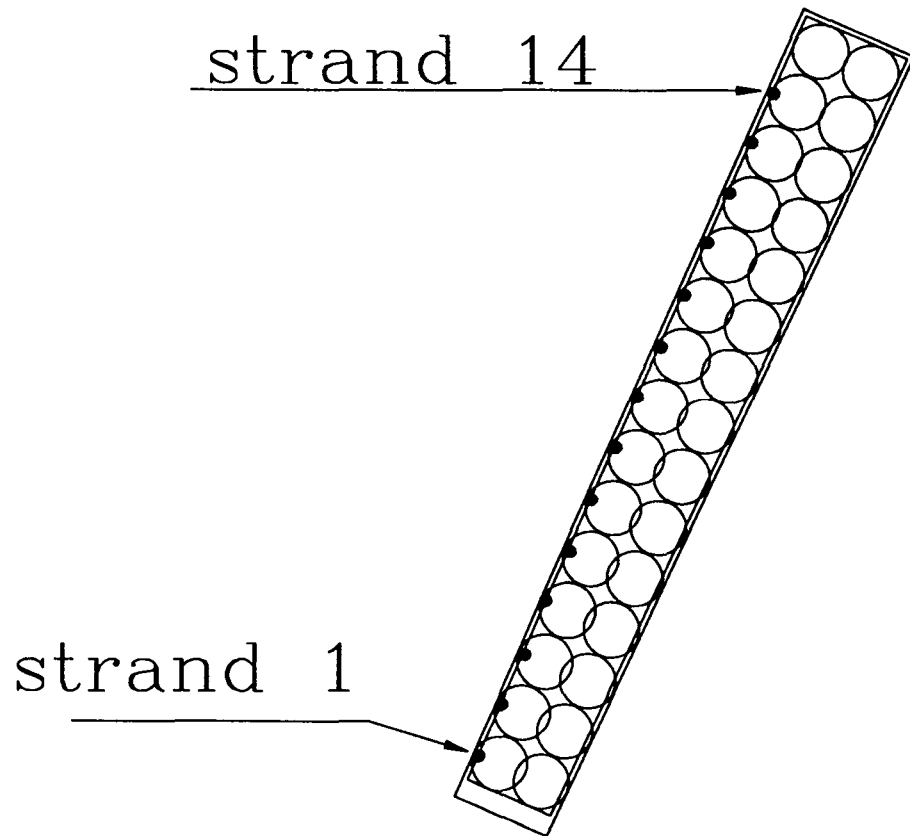

Figure 6 Strand number and location where fields have been calculated.

# SSC Arc - Quad

End Region - Conductor and Iron

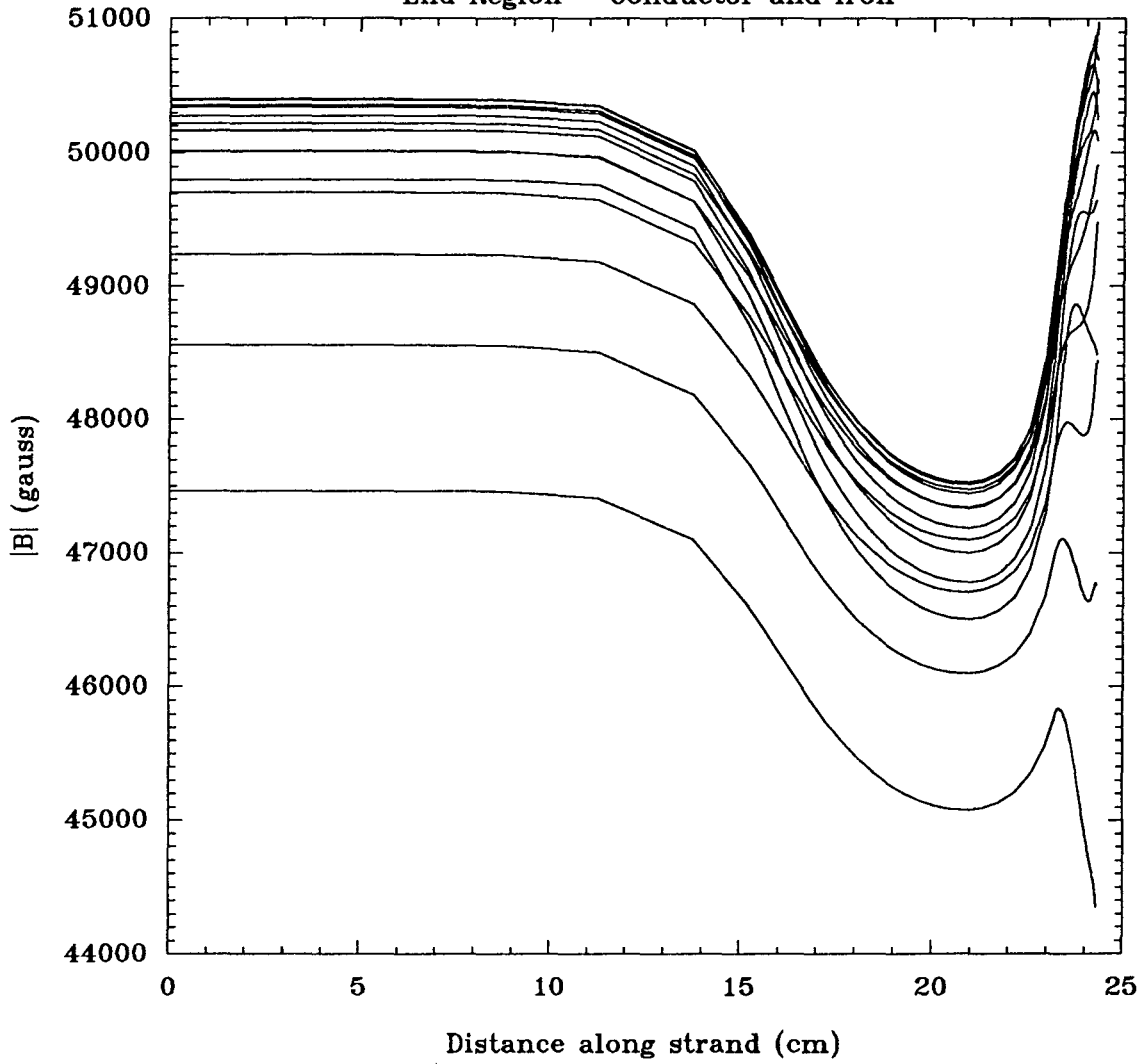

Figure 7 Absolute field along pole turn.



# SSC Arc - Quad

End Region - Conductor only

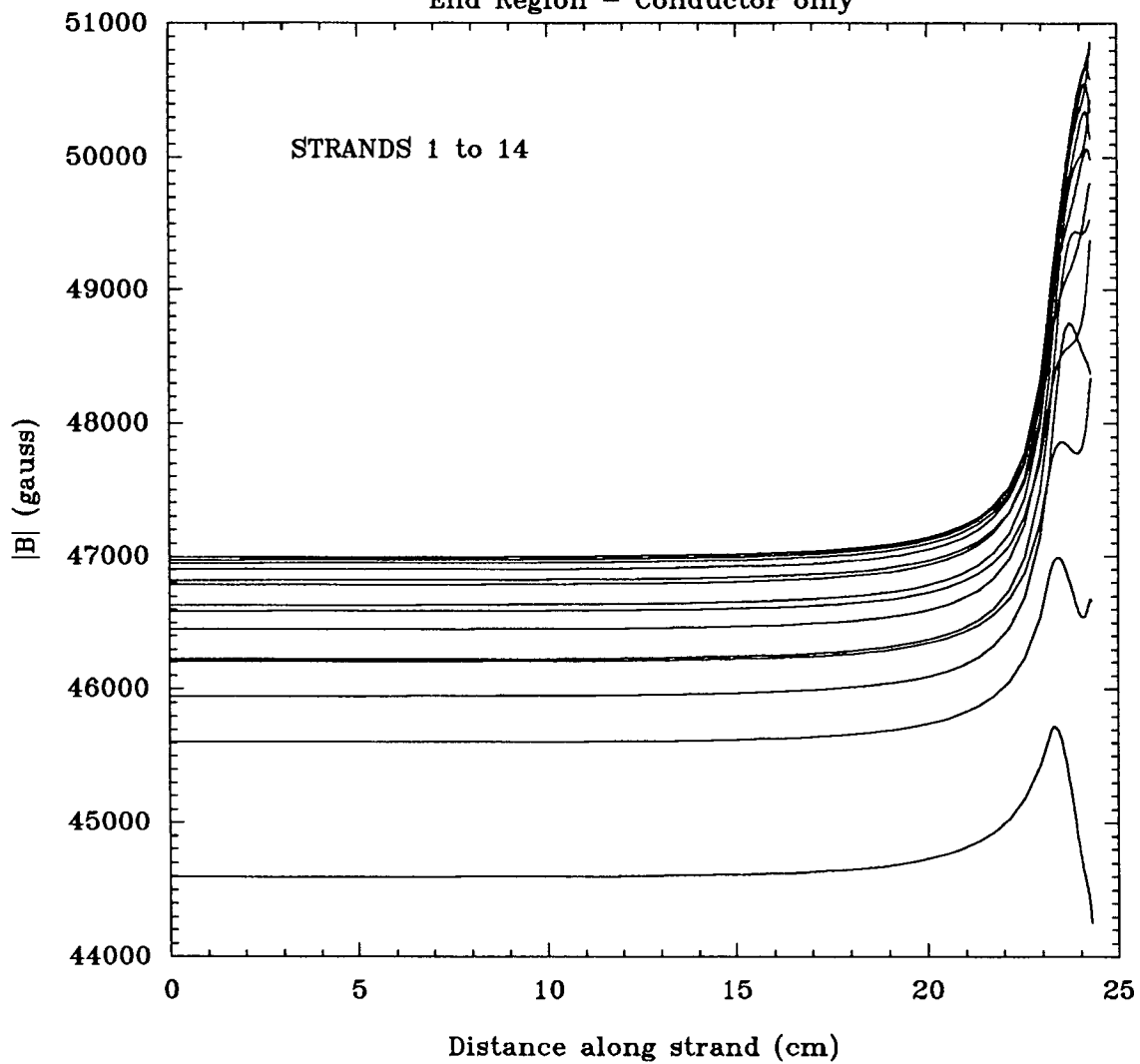

Figure 8 Absolute field along pole turn — CONDUCTOR ONLY.

# SSC Arc Quad

Iron contribution.

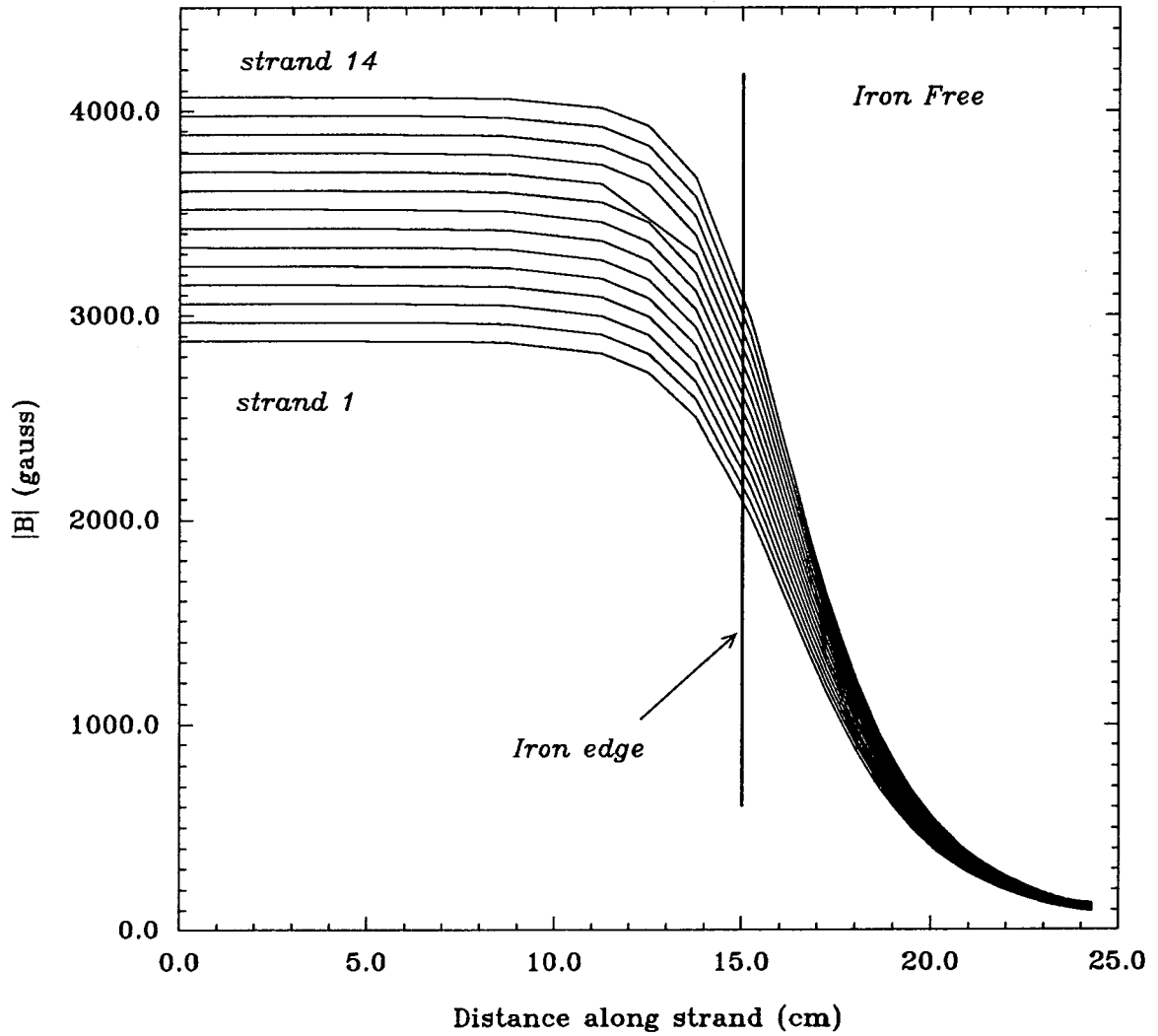

Figure 9 Absolute field along pole turn — IRON ONLY.

# SSC Arc-Quad

Absolute Field along STRAND 10

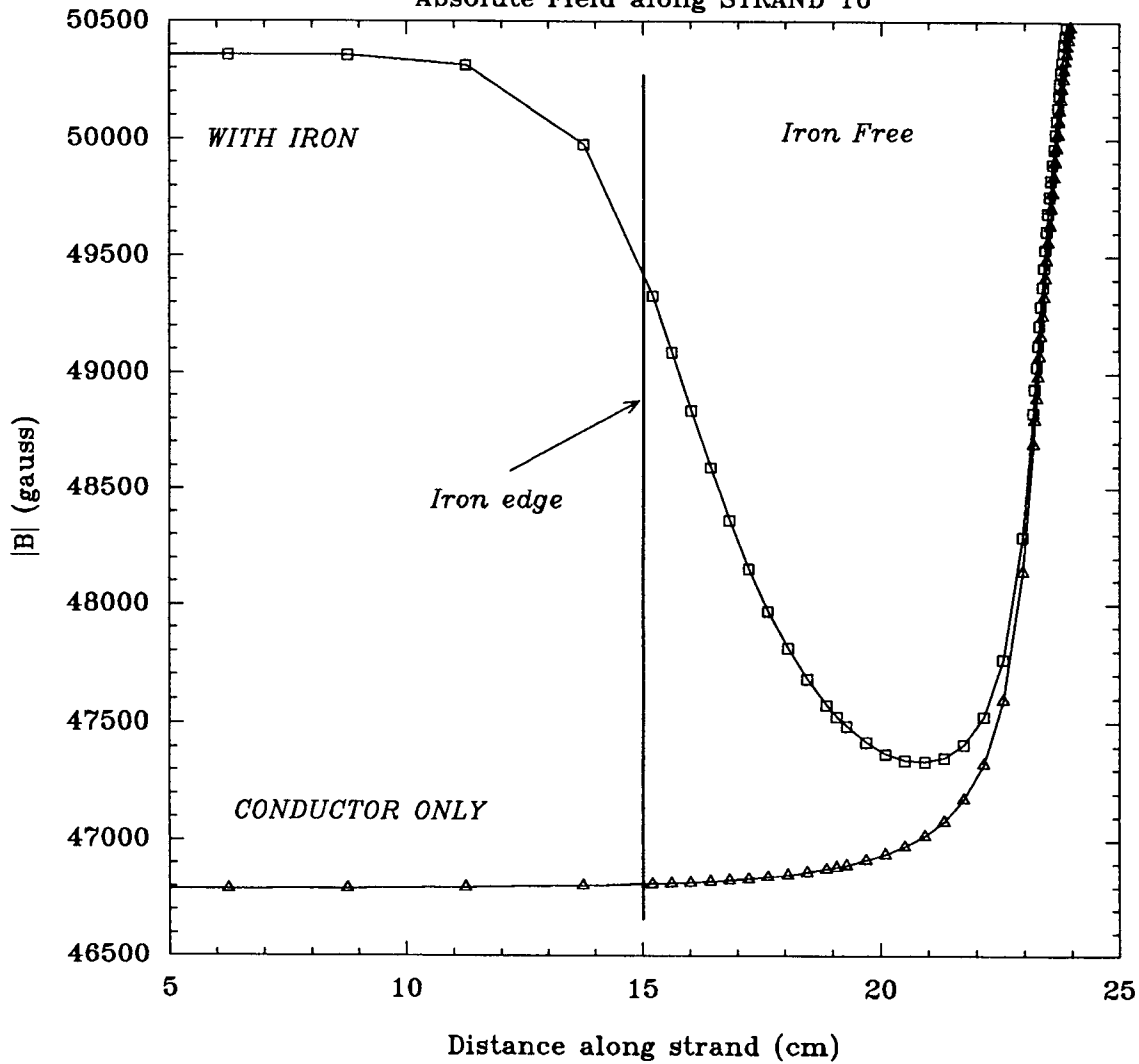

Figure 10 Absolute field along strand 10 — with and without iron.

# SSC Arc - Quad

End Region

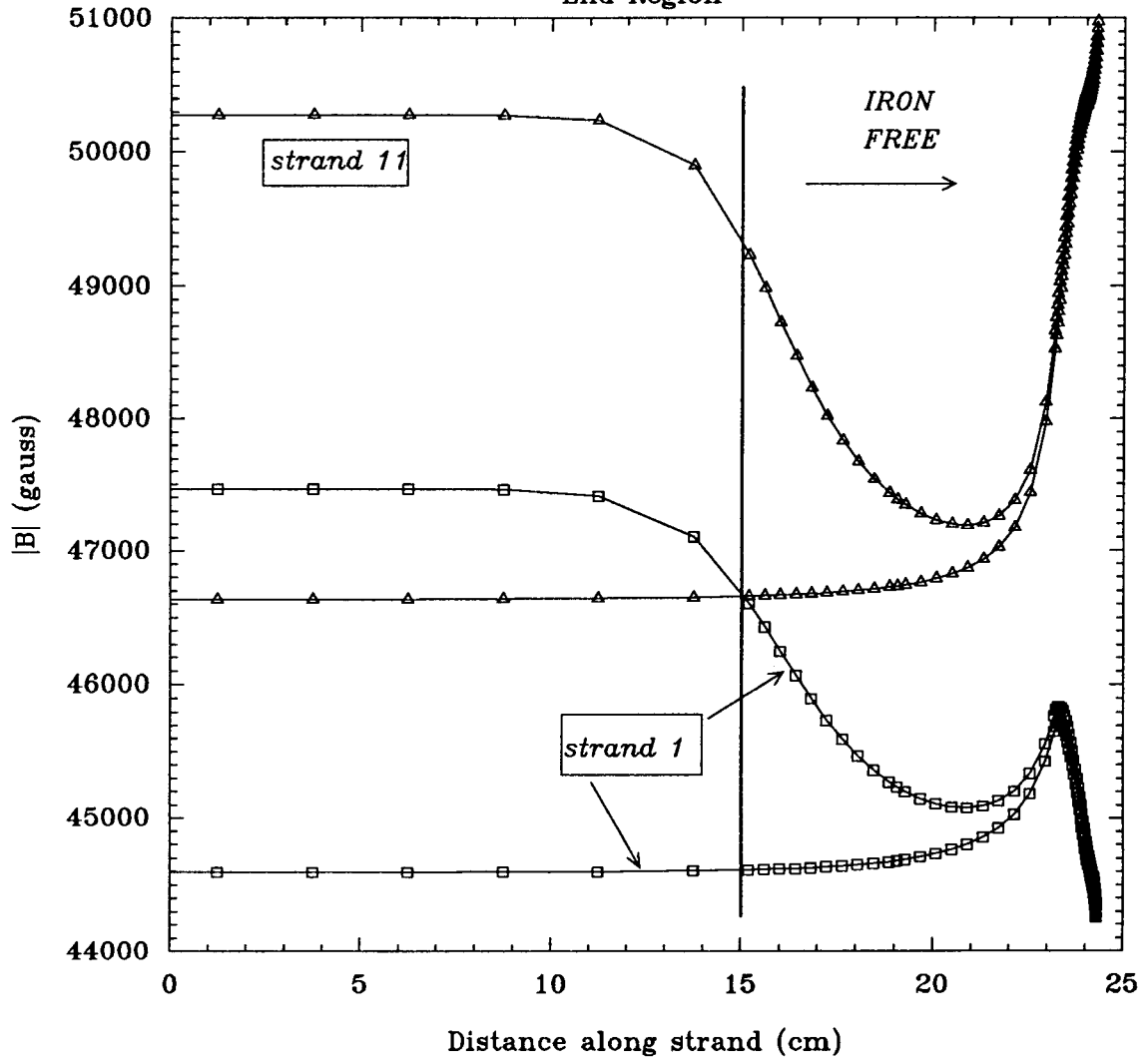

Figure 11 Absolute field along strands 1 and 11 — with and without iron.

# SSC Arc - Quad

End Region - Conductor only

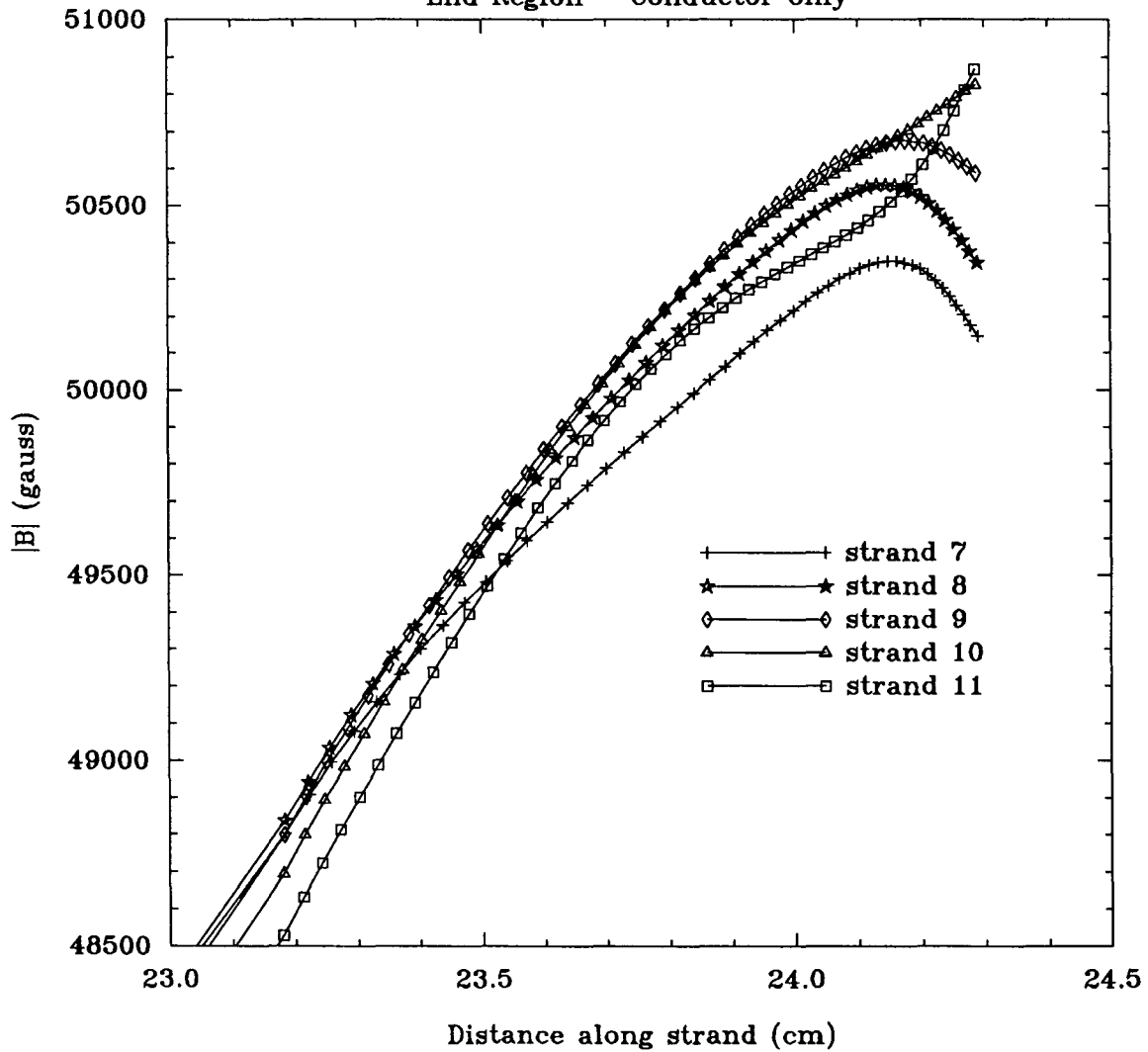

Figure 12 Absolute field at the end overpass.

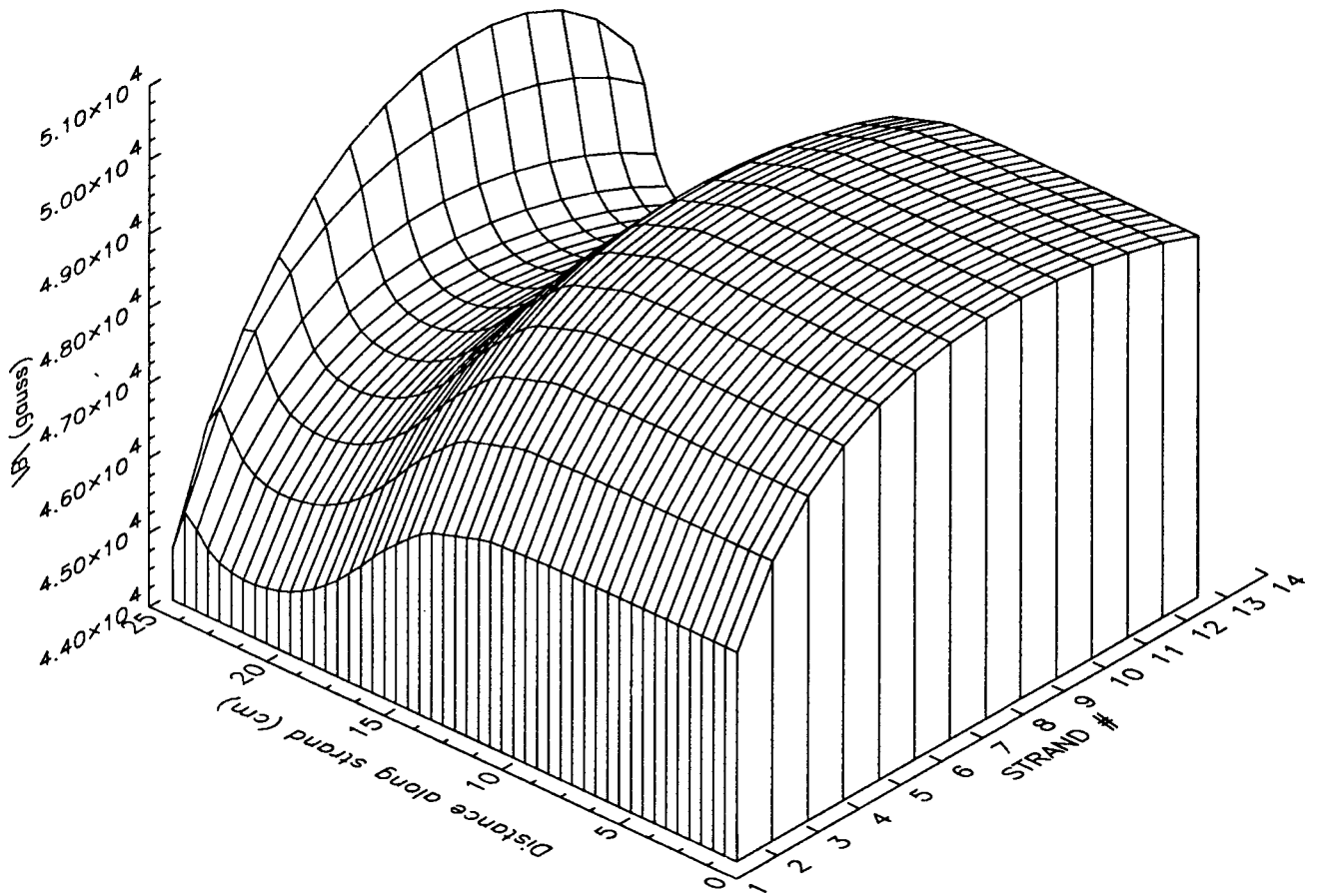

Figure 13 A 3 dimensional plot of the field magnitude as a function of strand number and position along the cable — view is from the straight section towards the “end”.

## Forces and Torque

We demonstrate a possible detailed calculation by producing the field around the strands of the pole turn of the inner layer in the straight section. The figure below shows the locations where the fields have been calculated. The next figure plots the absolute field at each location. The force on this turn was calculated to be  $F_x=131$  lb/inch ,  $F_y=-107$  lb/inch.

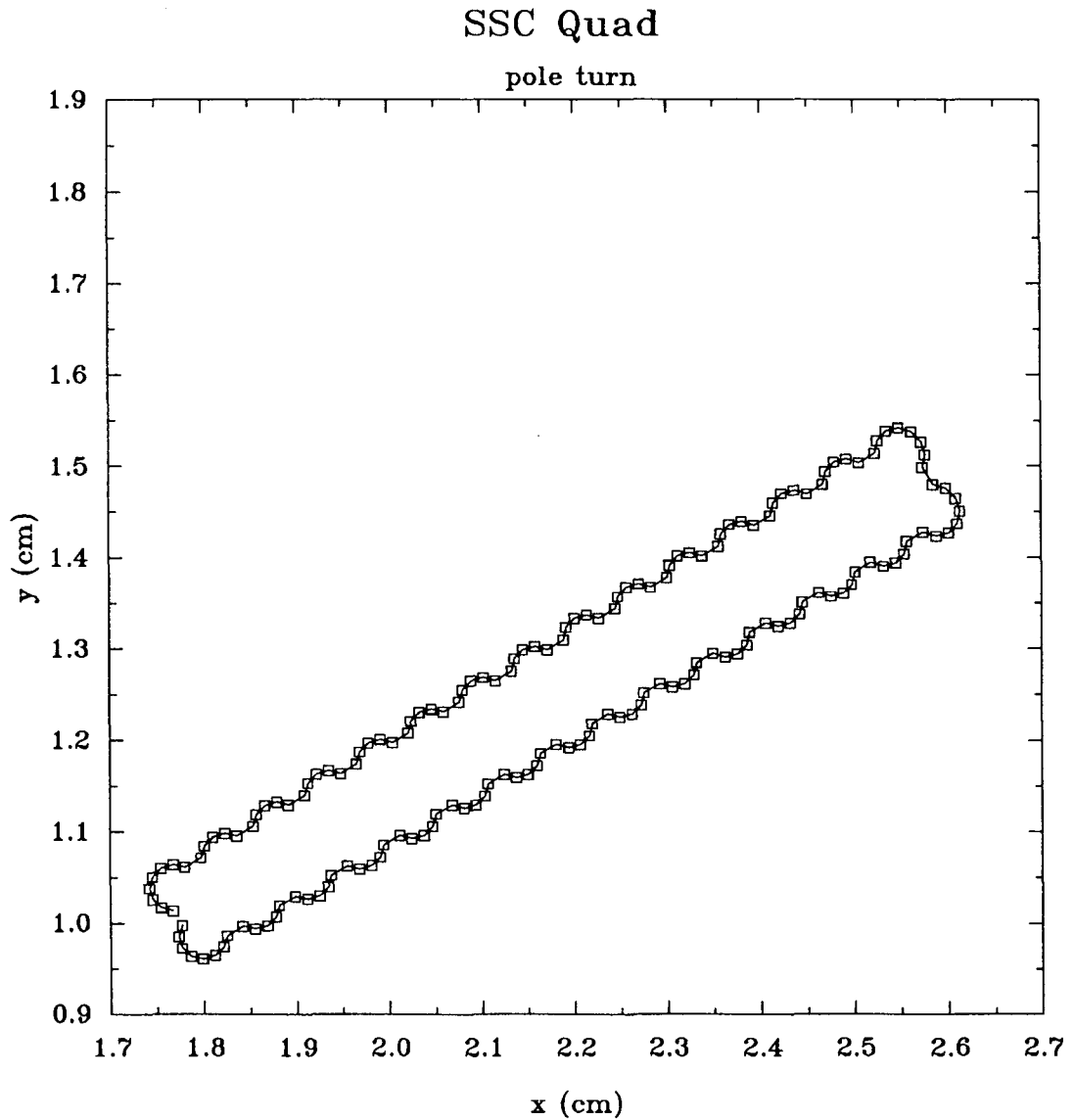

Figure 14 XY location around pole turn where field is calculated.

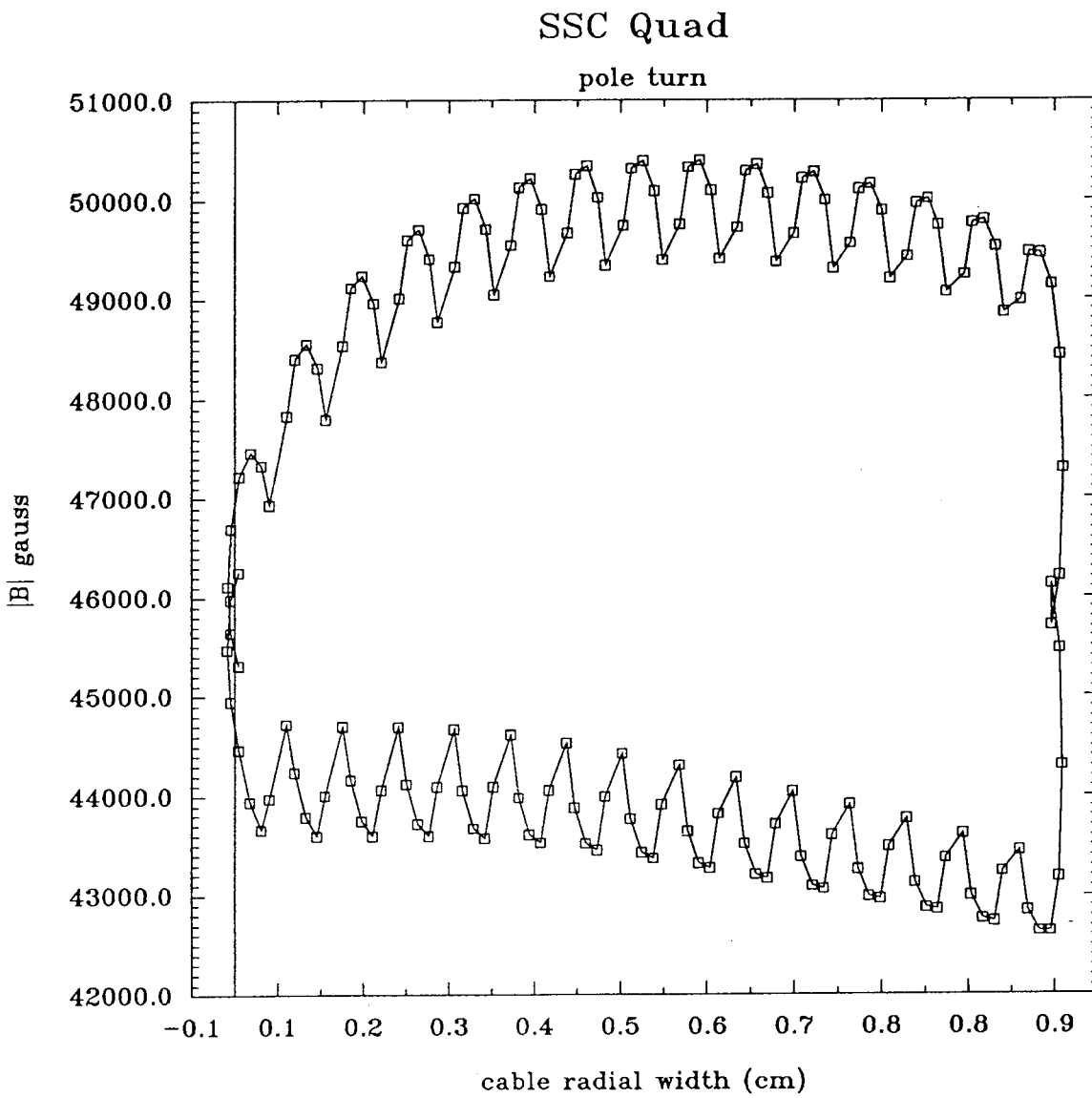

Figure 15 Absolute fields around cable.



## Part 2 — 3D Field Components inside the bore.

We note that in the curl-free divergence-free region near the axis  $r=0$  the field components may be expressed as given by  $\vec{B} = -\nabla V$  where  $V$  is a scalar potential function for which  $\nabla^2 V = 0$ . The proposed solution can be written in the form :

$$V = \sum_{n=1} V_n(r, z) \sin n\theta$$

with :

$$\frac{1}{r} \frac{\partial}{\partial r} \left( r \frac{\partial V_n}{\partial r} \right) + \frac{\partial^2 V_n}{\partial z^2} - \frac{n^2 V_n}{r^2} = 0 \quad (1)$$

We note that if  $V_n$  were to be free of any  $z$ -dependence, the acceptable solution for  $V_n$  near the axis would be expressed by a single term proportional to  $r^n$  (i.e., involving  $r$  raised to the positive power  $n$ ); more generally one would represent  $V_n$  by a power series involving factors  $r^{n+2k}$ , commencing with  $r^n$ , and employing  $z$ -dependent coefficients :

$$V_n = \sum_{k=0} C_{n,k}(z) r^{n+2k}$$

with  $C_{n,k}(z)$  satisfying the recursion relation

$$C_{n,k}(z) = -\frac{1}{4k(n+k)} \frac{d^2 C_{n,k-1}}{dz^2} \quad ; \quad k = 1, \dots \quad (2)$$

The magnetic field can be derived accordingly as :

$$\begin{aligned} B_{r,n} &= -\frac{\partial V_n}{\partial r} \sin n\theta = g_{rn} r^{n-1} \sin n\theta \\ B_{\theta,n} &= -\frac{n}{r} V_n \cos n\theta = g_{\theta n} r^{n-1} \cos n\theta \\ B_{z,n} &= -\frac{\partial V_n}{\partial z} \sin n\theta = g_{zn} r^n \sin n\theta \end{aligned} \quad (3)$$

In order that the series for  $V_n$  satisfy the differential equation written above we introduce  $A_n(z)$  and express the coefficients  $g_{rn}$ ,  $g_{\theta n}$  as general functions of  $r$  and  $z$  as shown below :

$$\begin{aligned} g_{rn}(r, z) &= \sum_{k=0} (-1)^{k+1} \frac{n!(n+2k)}{2^{2k} k!(n+k)!} A_n^{(2k)}(z) r^{2k} \\ g_{\theta n}(r, z) &= \sum_{k=0} (-1)^{k+1} \frac{n!n}{2^{2k} k!(n+k)!} A_n^{(2k)}(z) r^{2k} \end{aligned} \quad (4)$$

Explicitly we can write the above as :

$$\begin{aligned} g_{rn}(r, z) &= -n A_n(z) + \frac{n+2}{4(n+1)} A_n''(z) r^2 - \frac{n+4}{32(n+1)(n+2)} A_n''''(z) r^4 \\ &\quad + \frac{n+6}{384(n+1)(n+2)(n+3)} A_n''''''(z) r^6 - \dots \\ g_{\theta n}(r, z) &= -n A_n(z) + \frac{n}{4(n+1)} A_n''(z) r^2 - \frac{n}{32(n+1)(n+2)} A_n''''(z) r^4 \\ &\quad + \frac{n}{384(n+1)(n+2)(n+3)} A_n''''''(z) r^6 - \dots \end{aligned} \quad (5)$$

In analogy to Equations 4 and 5 we write :

$$g_{zn}(r, z) = \sum_{k=0}^{n-1} (-1)^{k+1} \frac{n!}{2^{2k} k! (n+k)!} A_n^{(2k+1)} r^{2k} \quad (6)$$

or explicitly :

$$g_{zn}(r, z) = -A'_n(z) + \frac{1}{4(n+1)} A_n'''(z) r^2 - \frac{1}{32(n+1)(n+2)} A_n''''(z) r^4 \dots \quad (7)$$

We have computed  $g_m$  ,  $g_{\theta_n}$  and  $g_{zn}$  from which the  $A(z)$  and its derivatives have been computed. In the following figures we show results for the  $A$ 's derived from the conductor only, the iron only, and both iron and conductor together. For the conductor alone the  $A$ 's have been computed up to  $\frac{\partial^4 A(z)}{\partial z^4}$  for  $n=2,6,10,14$  and 18. The quality of the iron contribution at the present time is limited and therefor the  $A$ 's for the iron have been computed only to  $\frac{\partial^2 A(z)}{\partial z^2}$  for  $n=2,6$  and 10. For the conductor+iron case we have carried the  $A$ 's up to  $n=14$ .

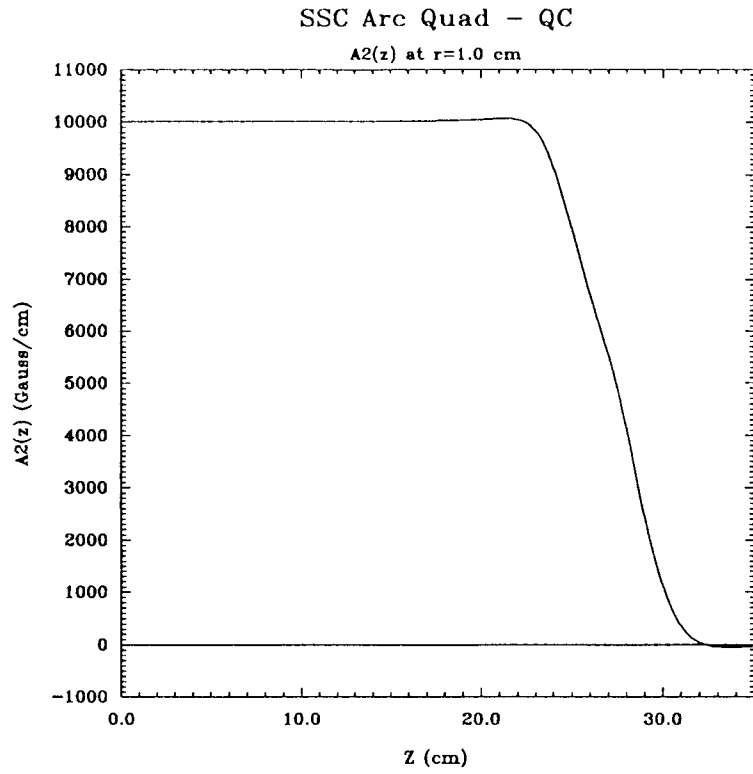

Figure 16 The quad function ( n=2 ) A2(z) — CONDUCTOR ONLY.

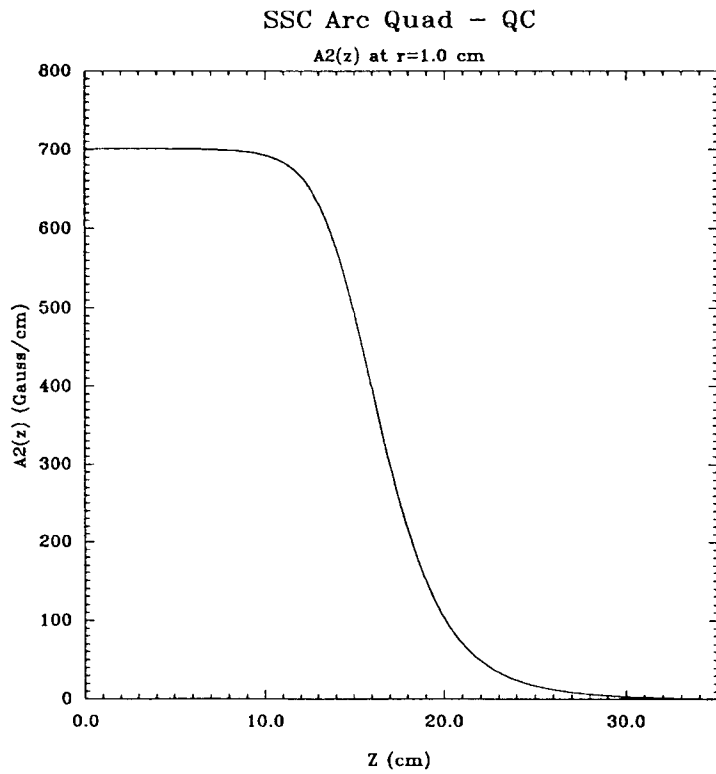

Figure 17 The quad function ( n=2 ) A2(z) — IRON ONLY.

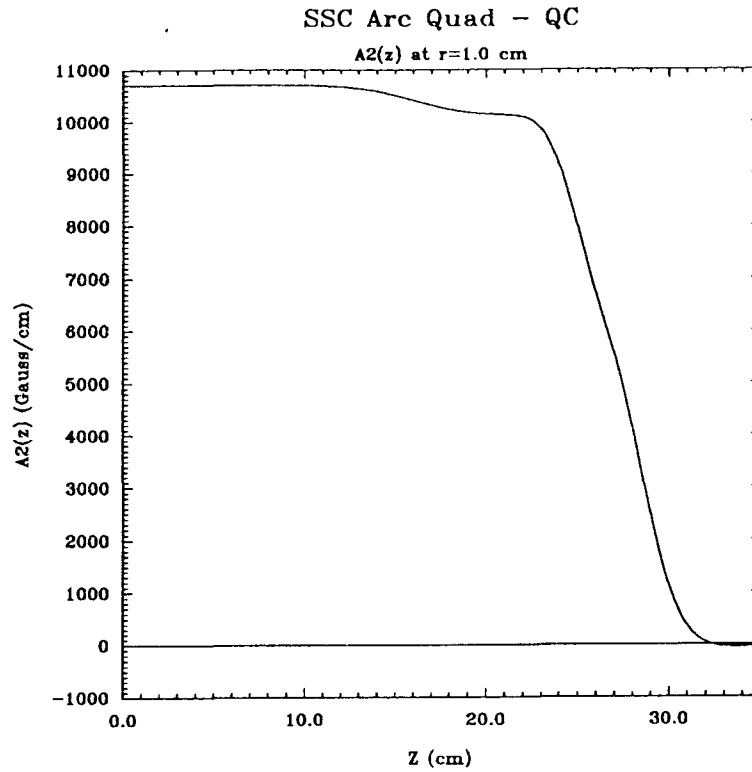

Figure 18 The quad function (  $n=2$  )  $A_2(z)$  — CONDUCTOR and IRON.

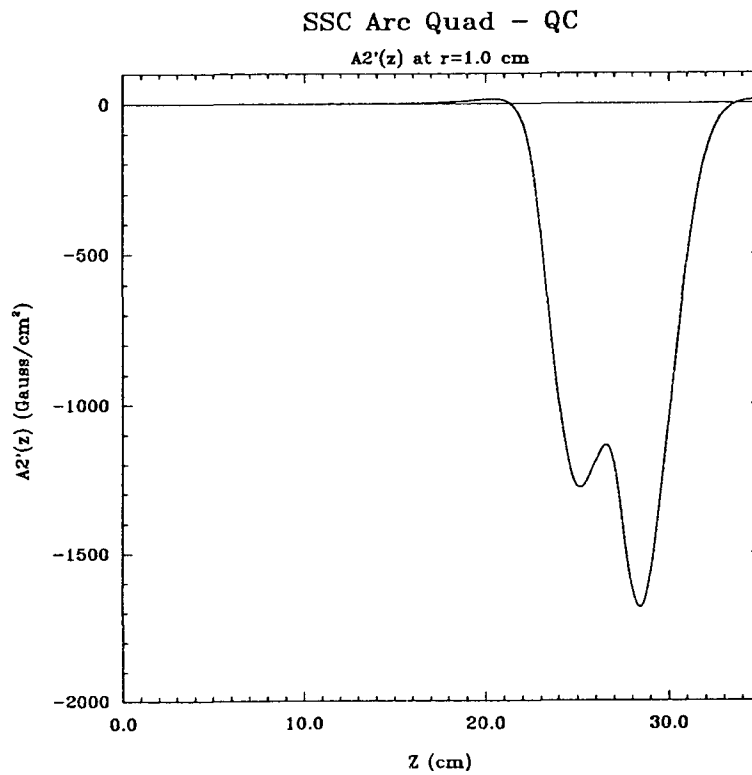

Figure 19 The first derivative function of  $n=2$  —  $A_2'(z)$  — CONDUCTOR ONLY.

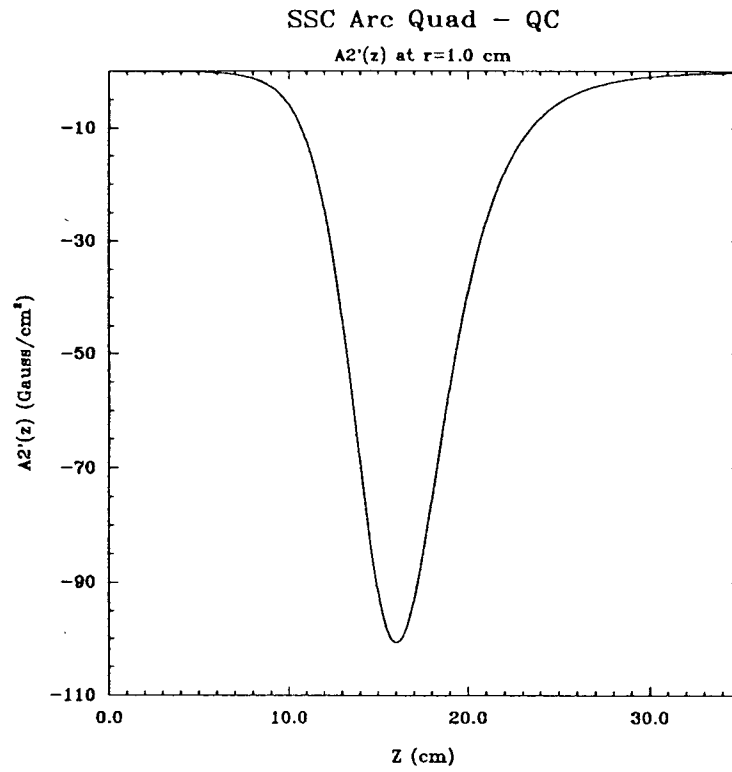

Figure 20 The first derivative function of  $n=2$  —  $A_2'(z)$  — IRON ONLY .

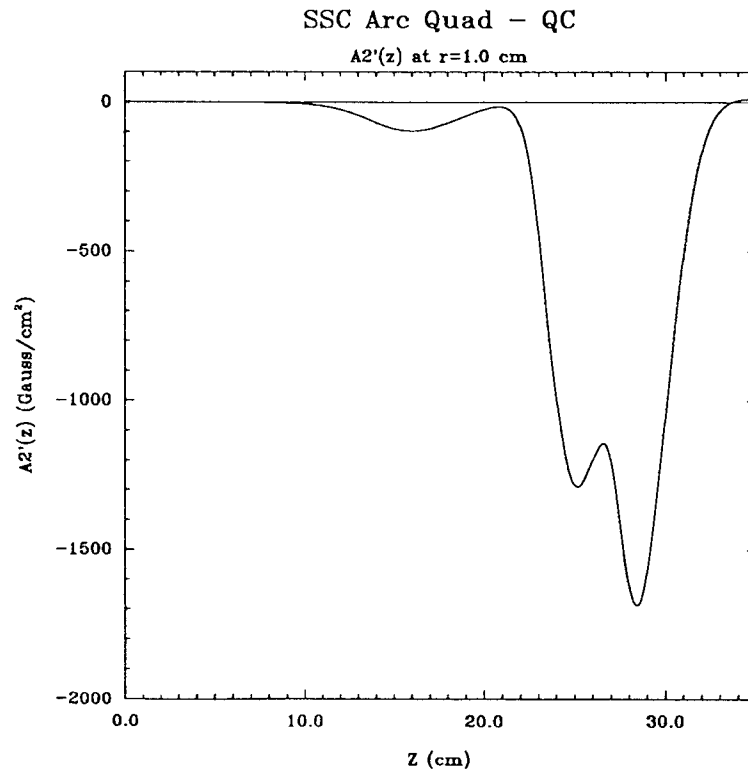

Figure 21 The first derivative function of  $n=2$  —  $A_2'(z)$  — CONDUCTOR and IRON.

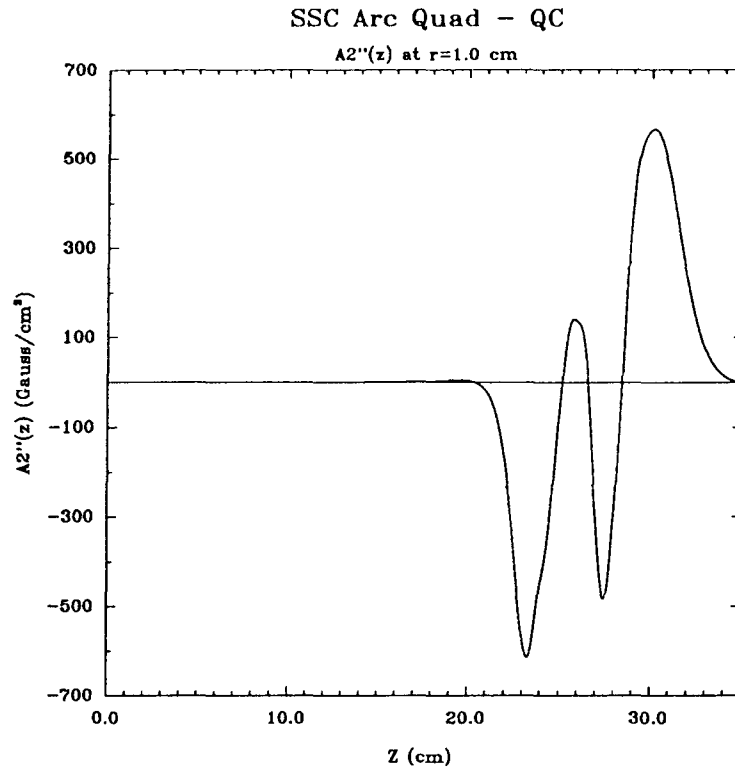

Figure 22 The second derivative function of  $n=2$  —  $A_2''(z)$  — CONDUCTOR ONLY.

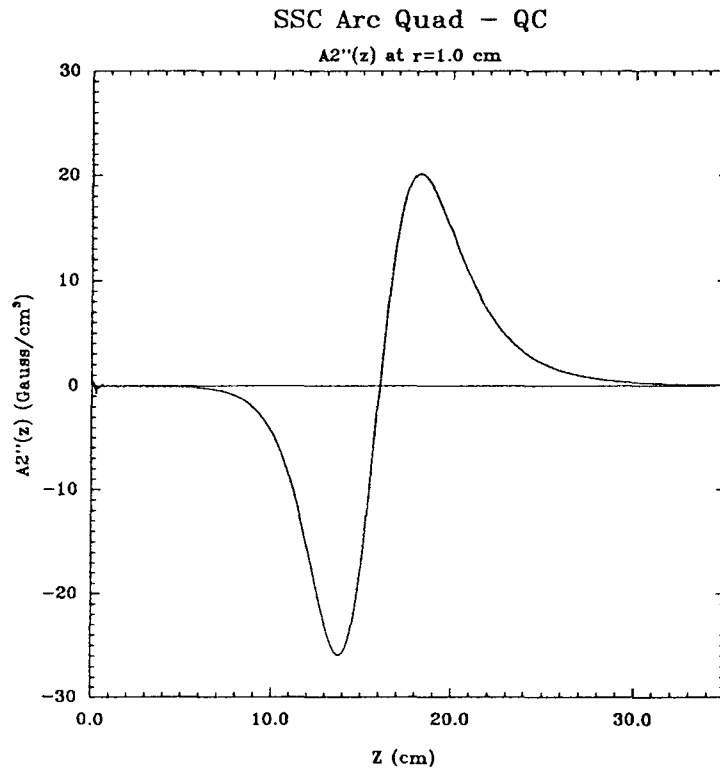

Figure 23 The second derivative function of  $n=2$  —  $A_2''(z)$  — IRON ONLY.

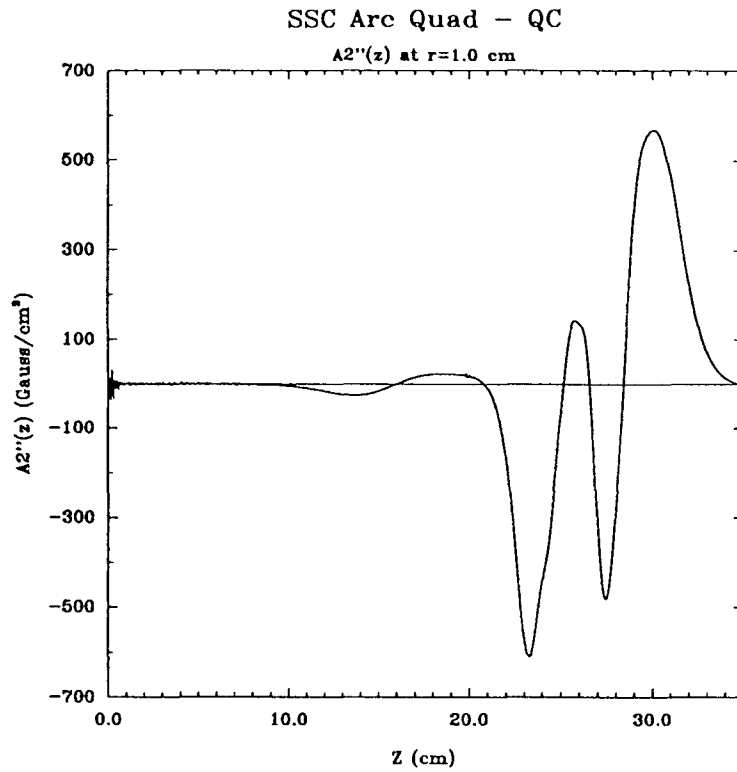

Figure 24 The second derivative function of  $n=2$  —  $A_2''(z)$  — CONDUCTOR and IRON.

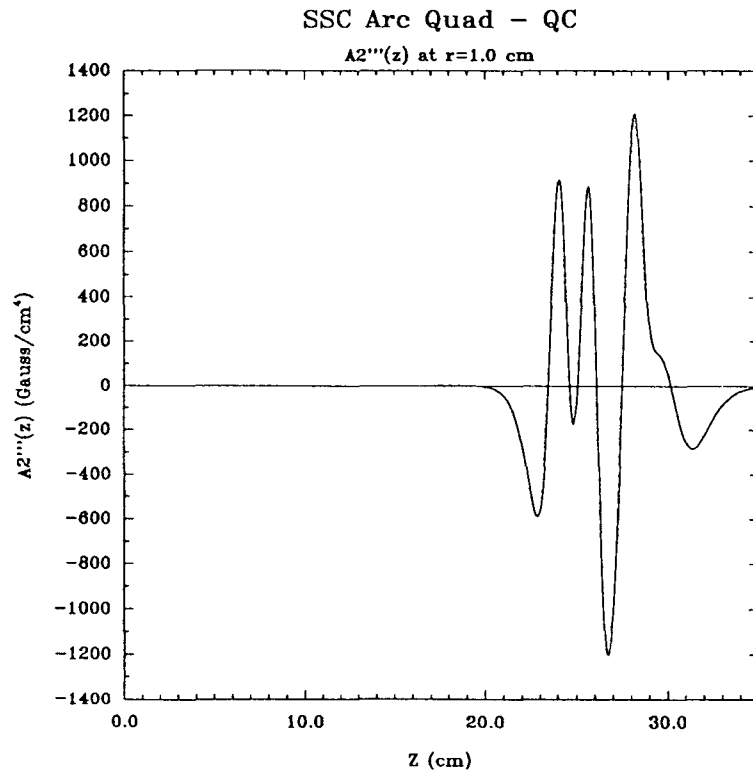

Figure 25 The 3-rd derivative function of  $n=2$  —  $A_2'''(z)$  — CONDUCTOR ONLY.

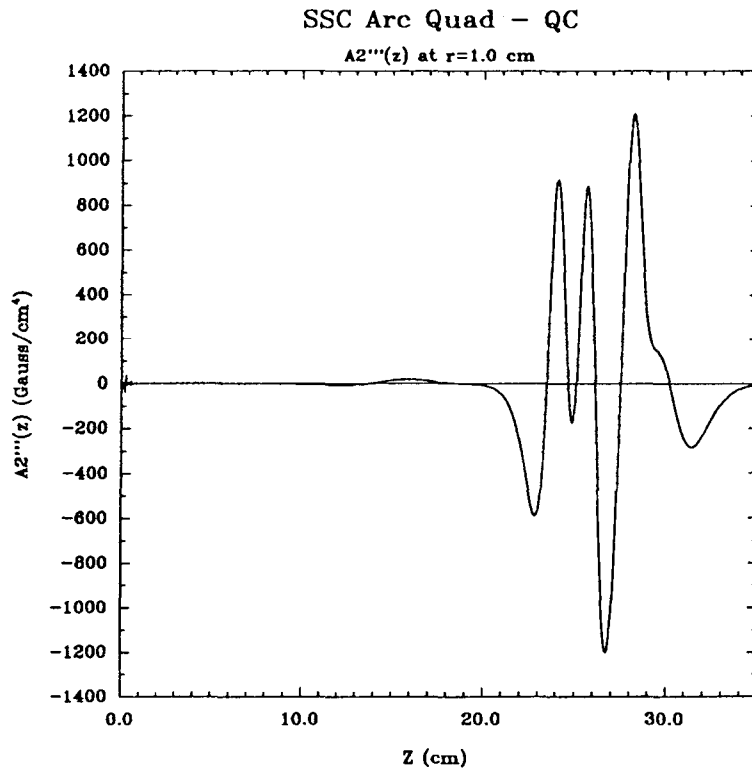

Figure 26 The 3-rd derivative function of  $n=2$  —  $A_2'''(z)$  — CONDUCTOR and IRON.

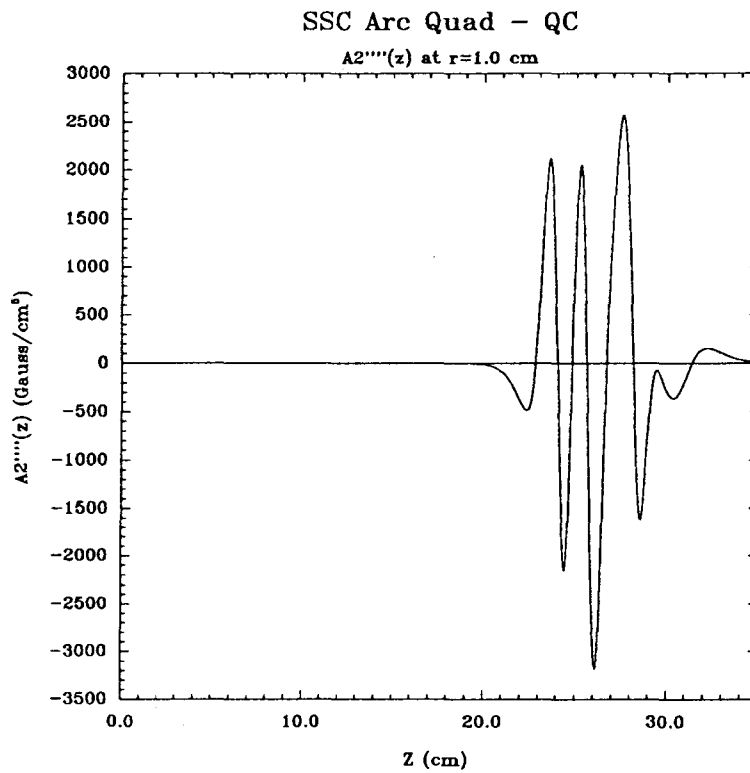

Figure 27 The fourth derivative function of  $n=2$  —  $A_2''''(z)$  — CONDUCTOR ONLY.



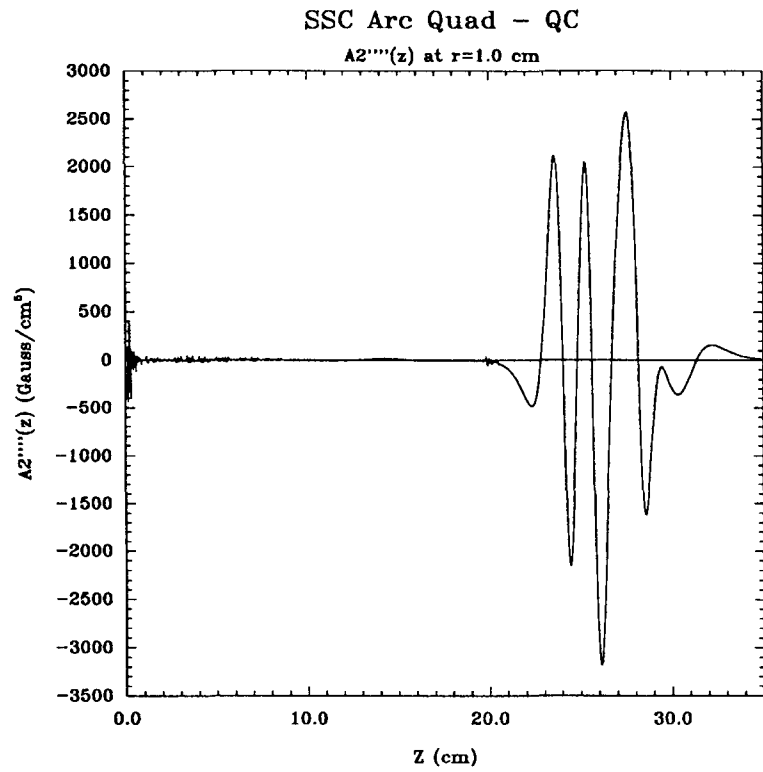

Figure 28 The fourth derivative function of  $n=2$  —  $A2''''(z)$  — CONDUCTOR and IRON.

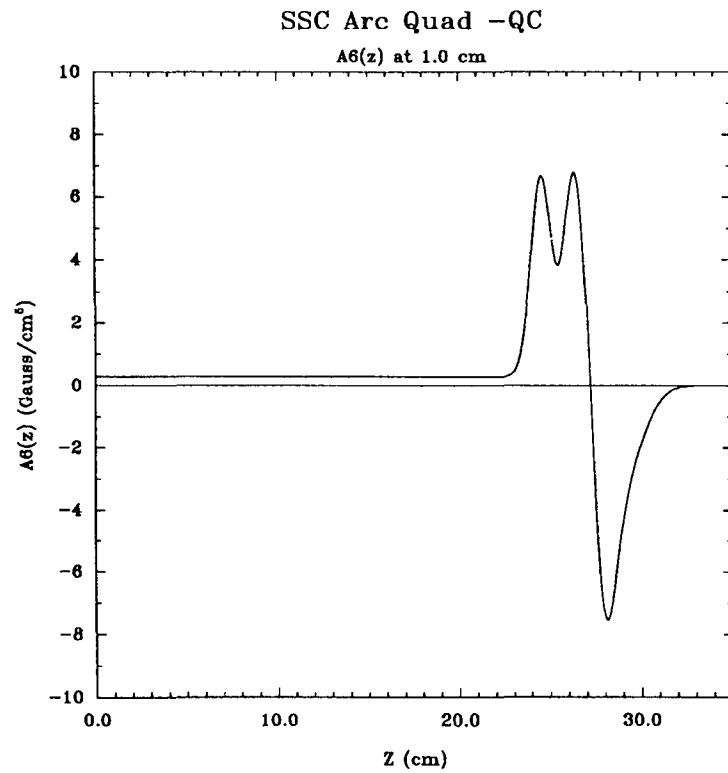

Figure 29 The dodecapole function  $A6(z)$  — CONDUCTOR ONLY.

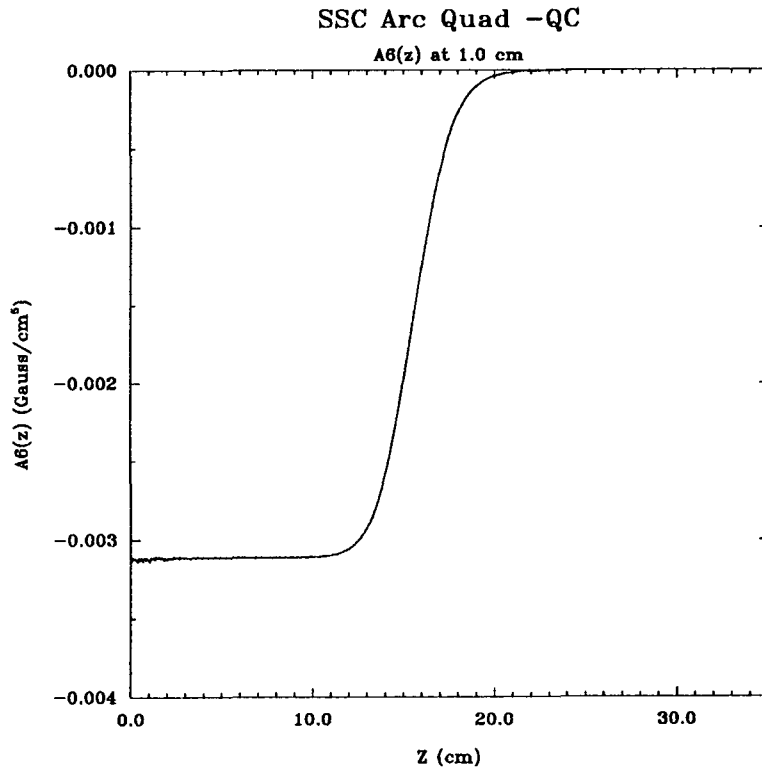

Figure 30 The dodecapole function A6(z) — IRON ONLY.

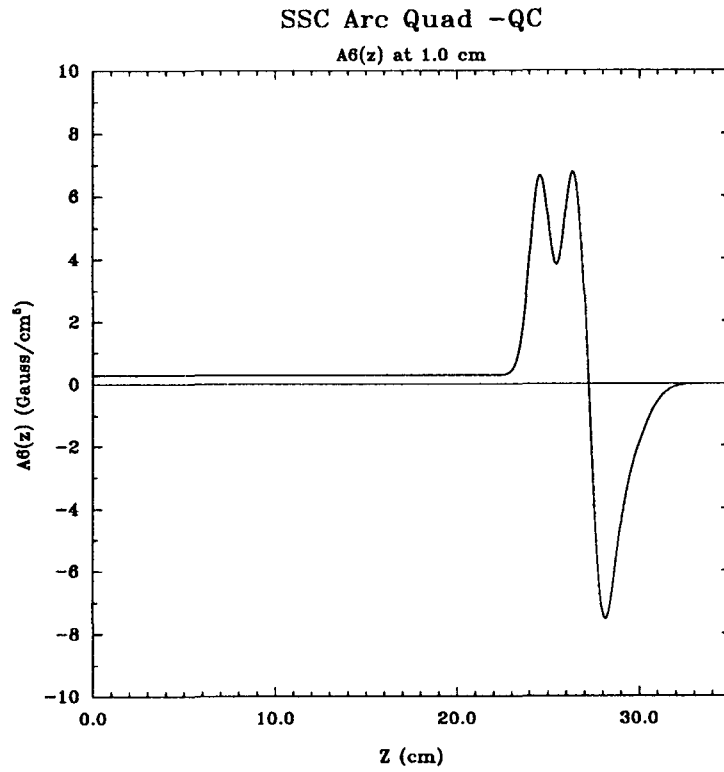

Figure 31 The dodecapole function A6(z) — CONDUCTOR and IRON.

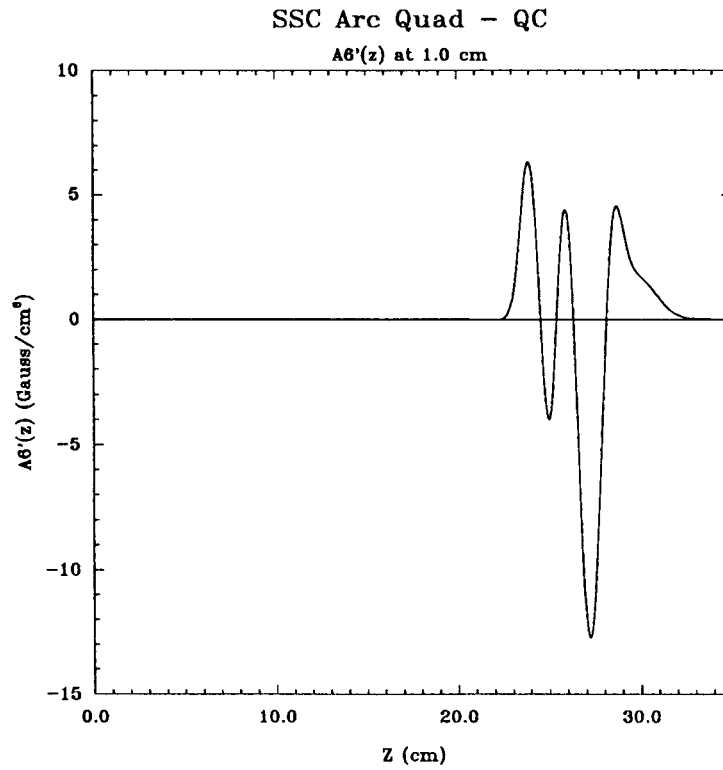

Figure 32 The first derivative function of  $n=6$  —  $A_6'(z)$  — CONDUCTOR ONLY.

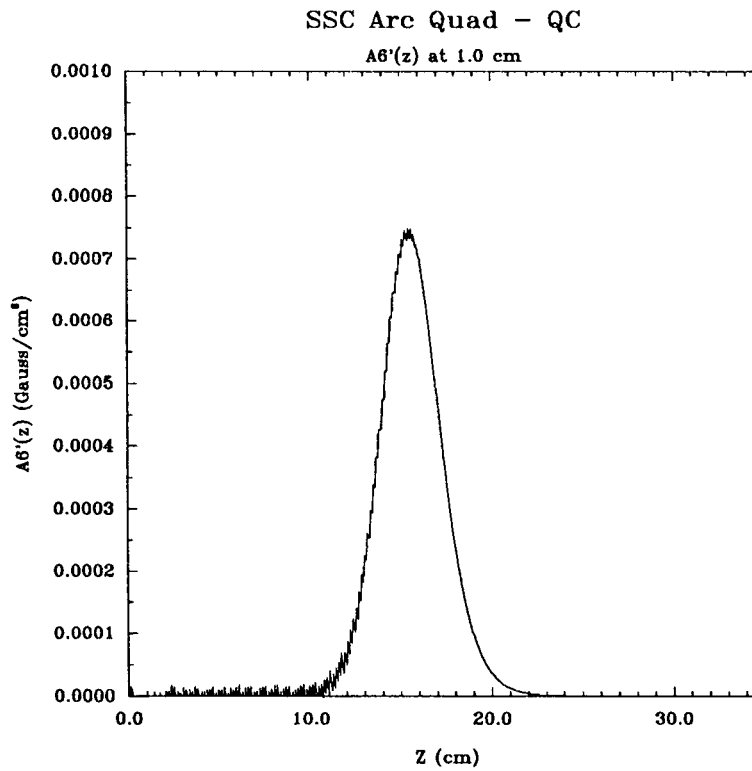

Figure 33 The first derivative function of  $n=6$  —  $A_6'(z)$  — IRON ONLY.

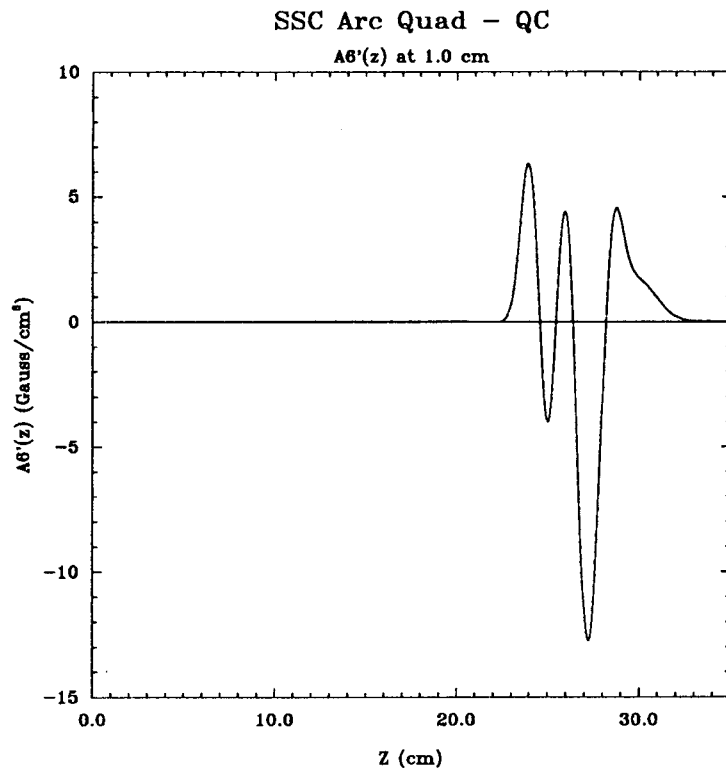

Figure 34 The first derivative function of  $n=6$  —  $A6'(z)$  — CONDUCTOR and IRON.

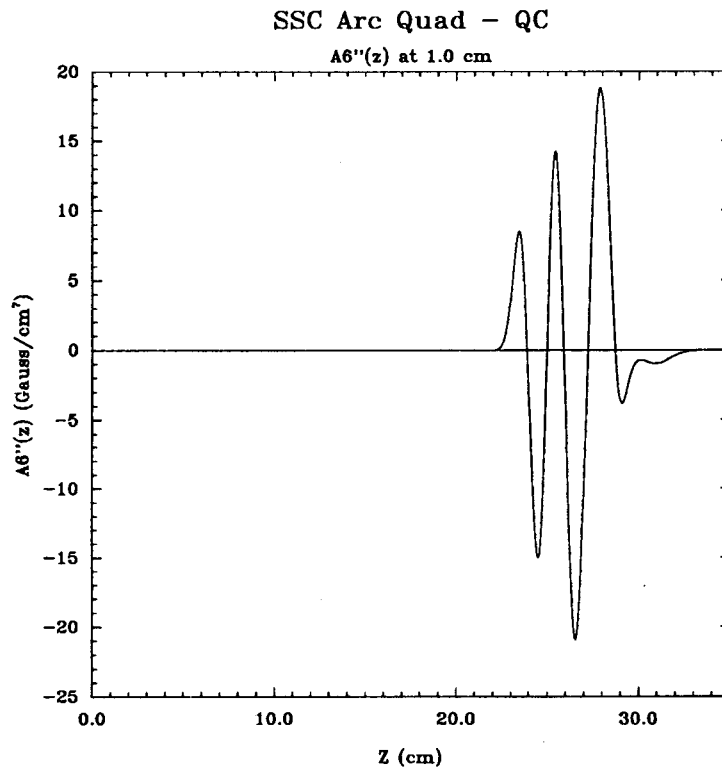

Figure 35 The second derivative function of  $n=6$  —  $A6''(z)$  — CONDUCTOR ONLY.

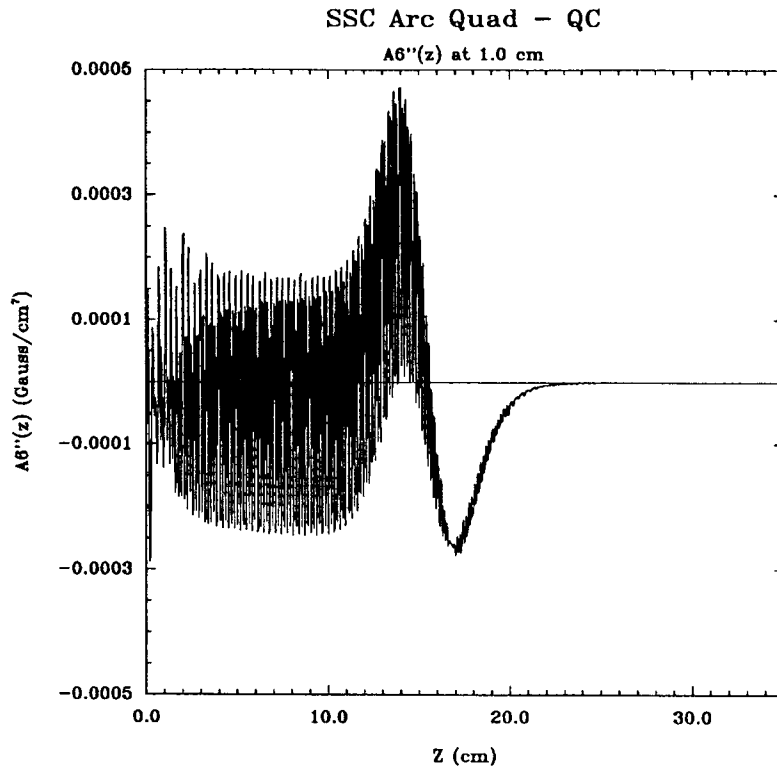

Figure 36 The second derivative function of  $n=6$  —  $A6''(z)$  — IRON ONLY.

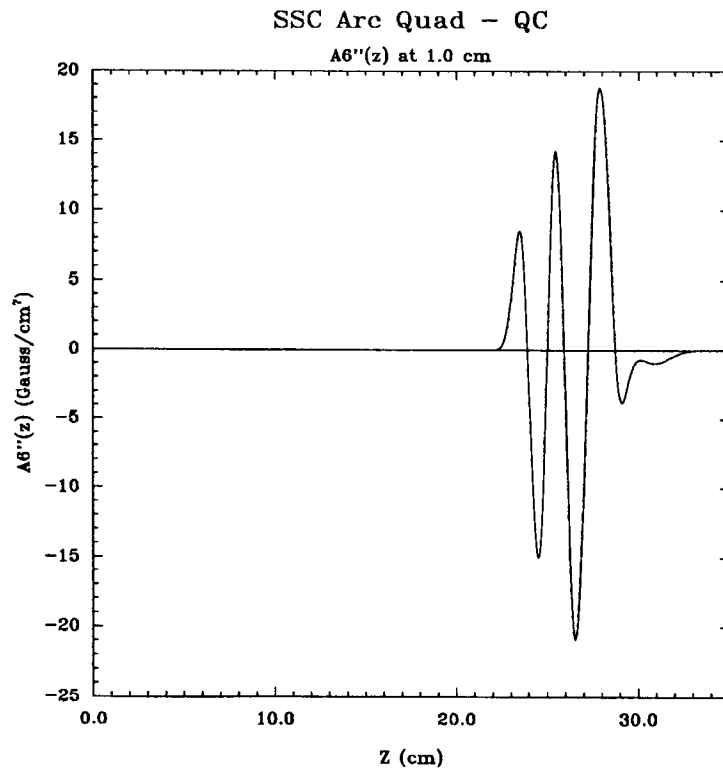

Figure 37 The second derivative function of  $n=6$  —  $A6''(z)$  — CONDUCTOR and IRON.

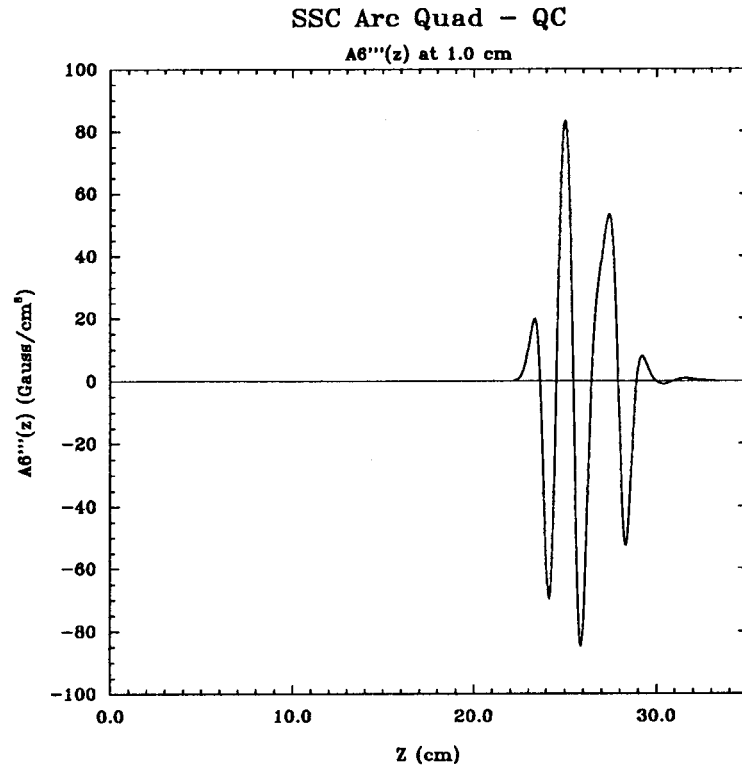

Figure 38 The 3-rd derivative function of n=6 — A6'''(z) — CONDUCTOR ONLY.

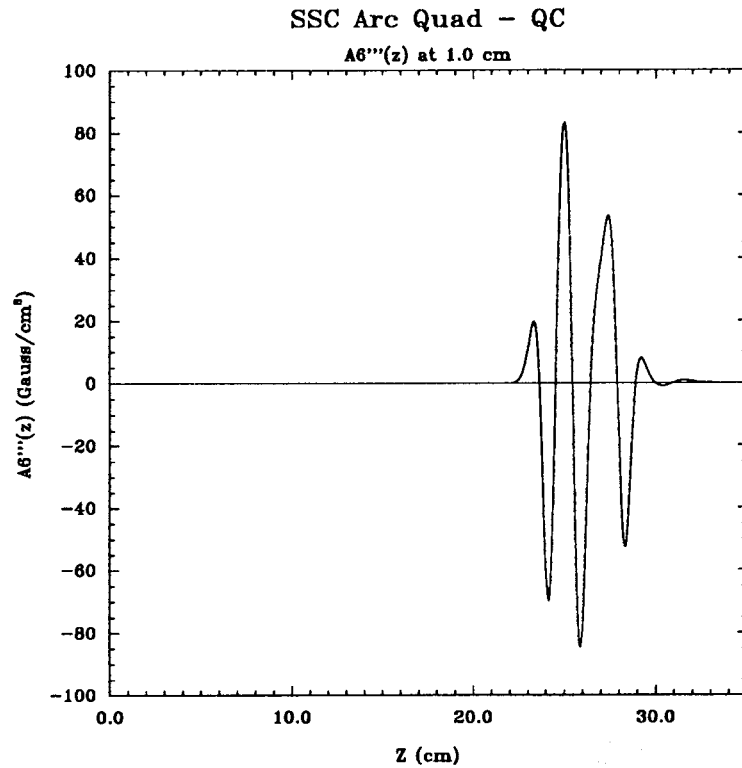

Figure 39 The 3-rd derivative function of n=6 — A6'''(z) — CONDUCTOR and IRON.

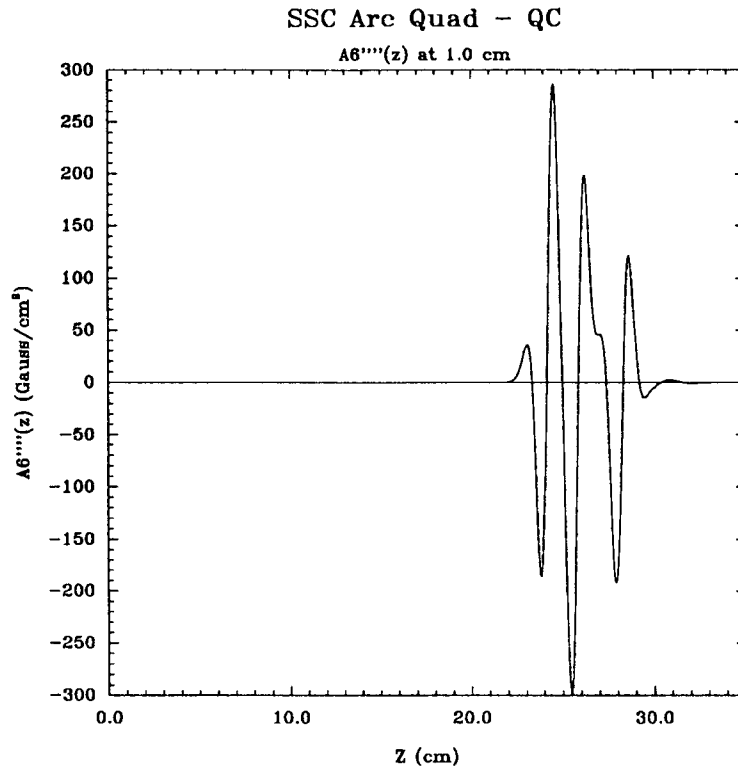

Figure 40 The fourth derivative function of  $n=6$ —  $A_6^{(4)}(z)$  — CONDUCTOR ONLY.

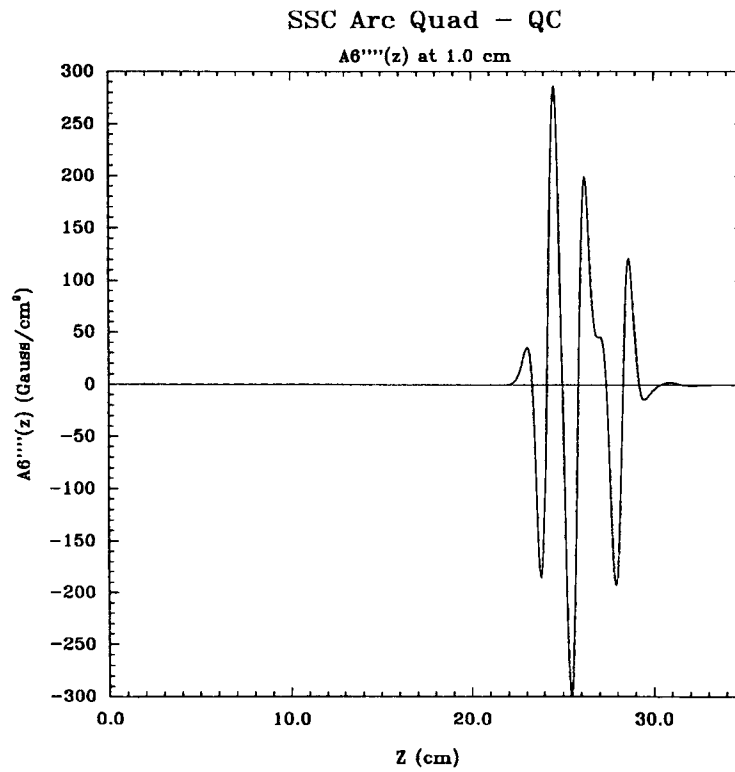

Figure 41 The fourth derivative function of  $n=6$ —  $A_6^{(4)}(z)$  — CONDUCTOR and IRON.

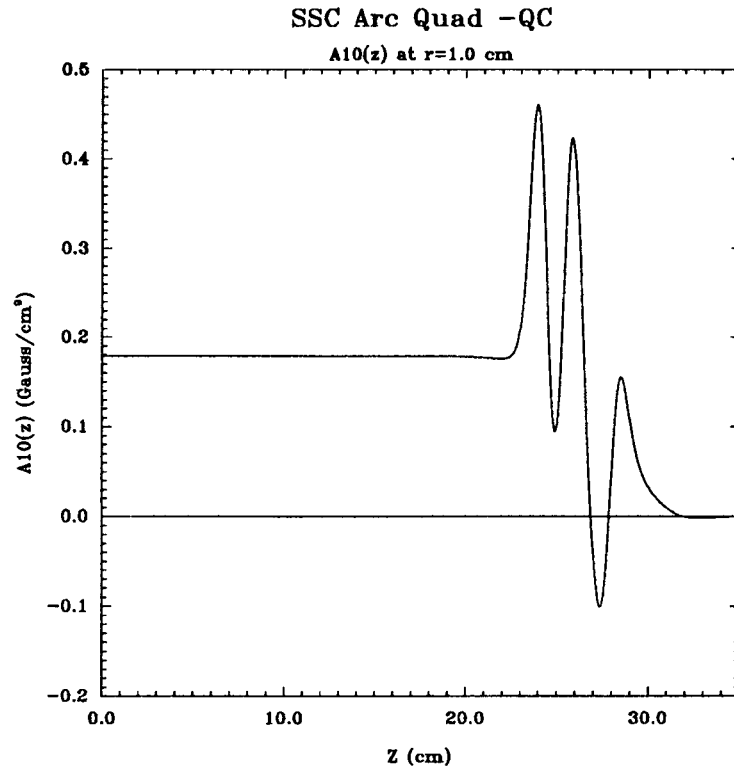

Figure 42 The 20 pole function  $A_{10}(z)$  — CONDUCTOR ONLY.

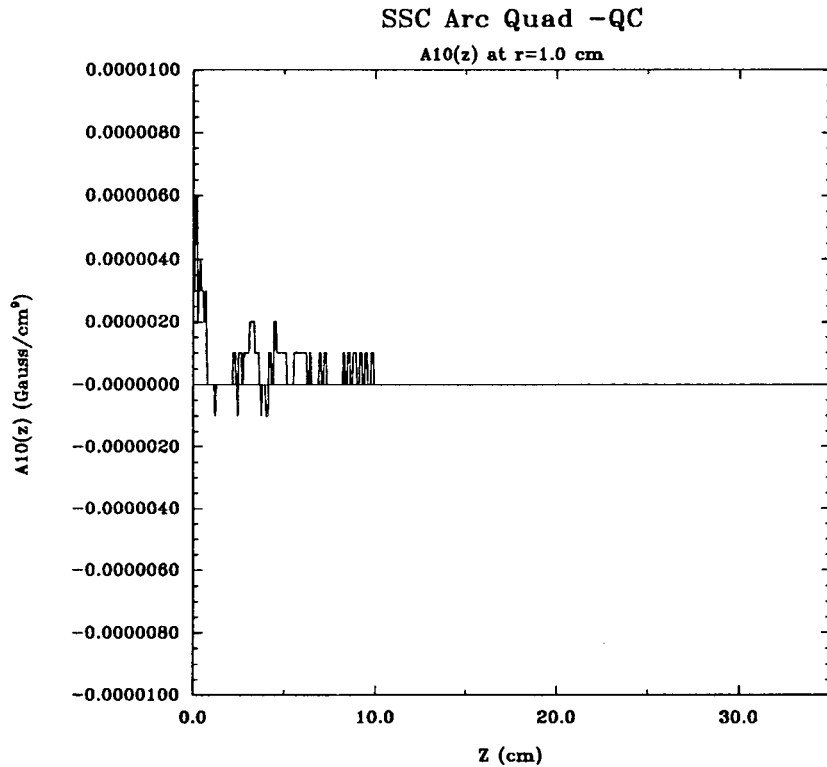

Figure 43 The 20 pole function  $A_{10}(z)$  — IRON ONLY.



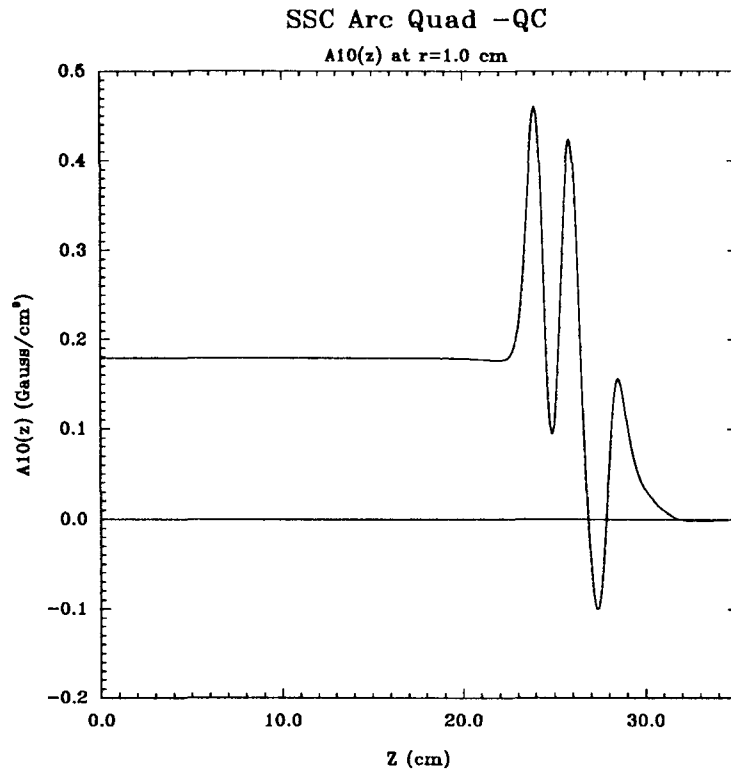

Figure 44 The 20 pole function A10(z) — CONDUCTOR and IRON.

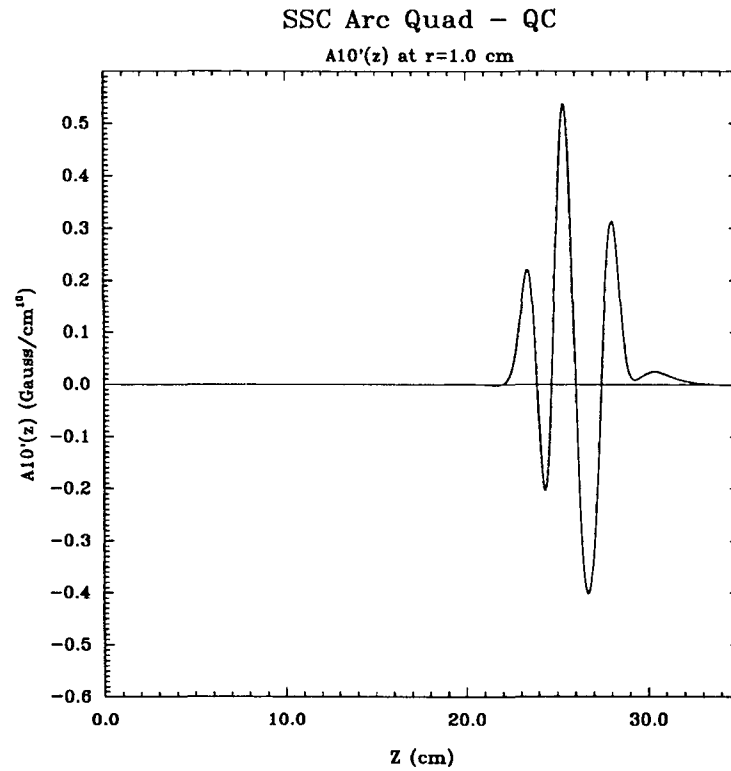

Figure 45 The first derivative function of n=10 — A10'(z) — CONDUCTOR ONLY.

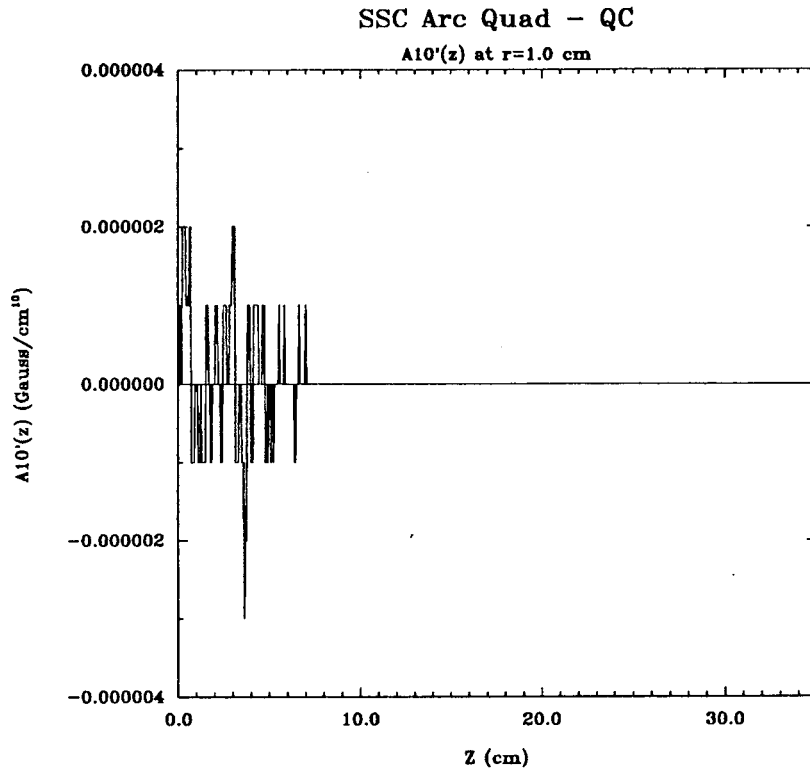

Figure 46 The first derivative function of  $n=10$  —  $A_{10}'(z)$  — IRON ONLY.

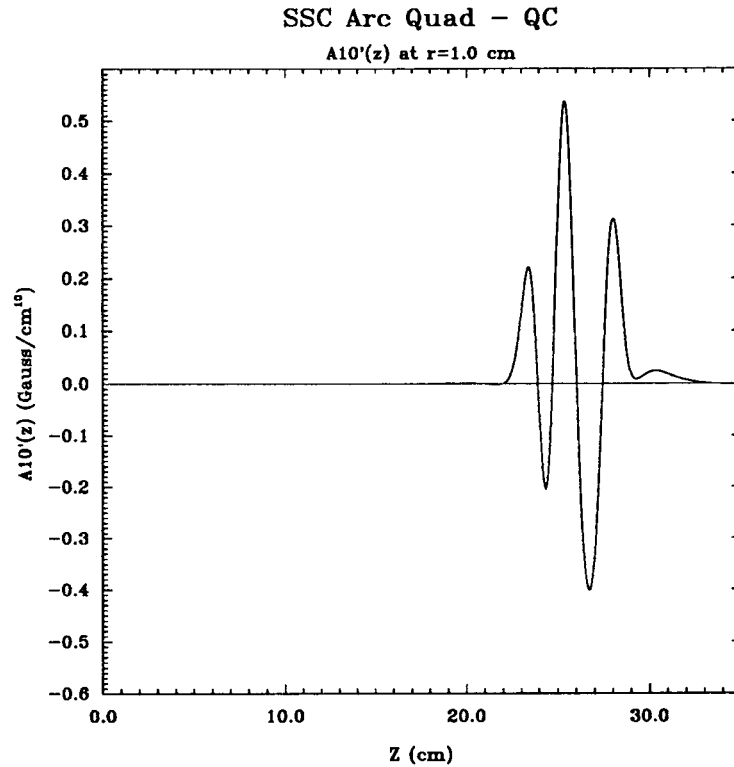

Figure 47 The first derivative function of  $n=10$  —  $A_{10}'(z)$  — CONDUCTOR and IRON.

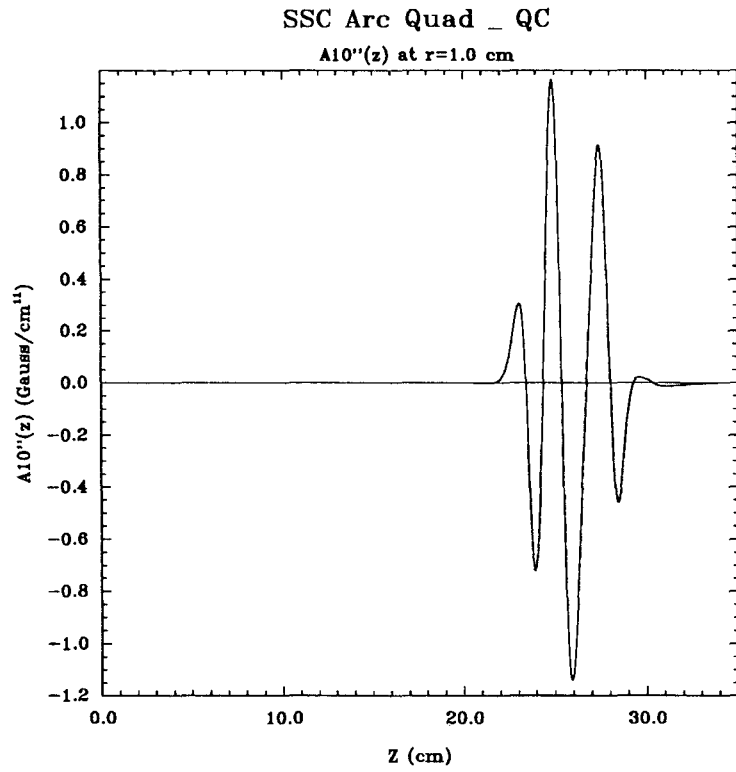

Figure 48 The second derivative function of n=10 — A10''(z) — CONDUCTOR ONLY.

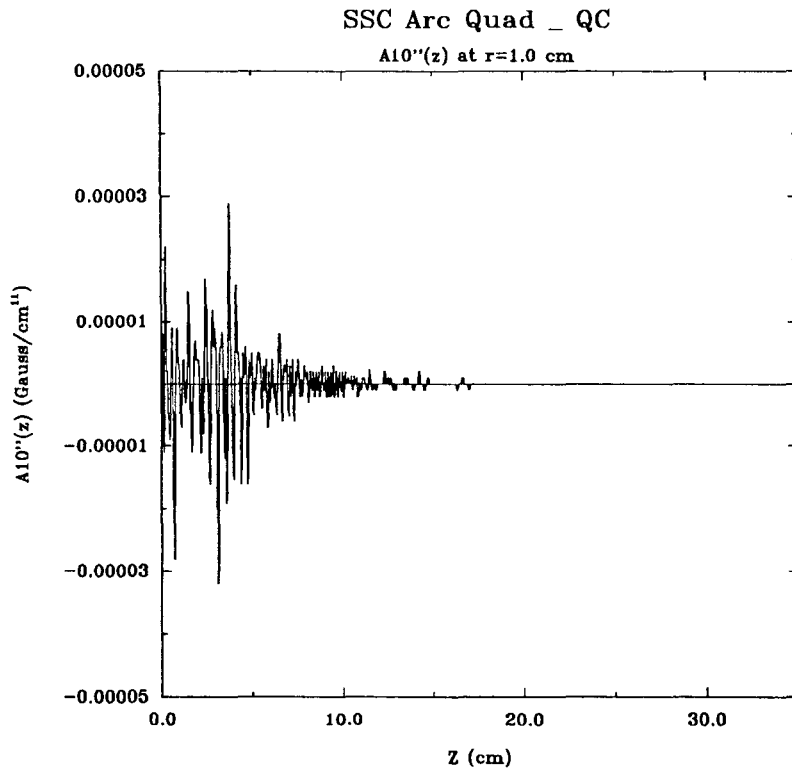

Figure 49 The second derivative function of n=10 — A10''(z) — IRON ONLY.

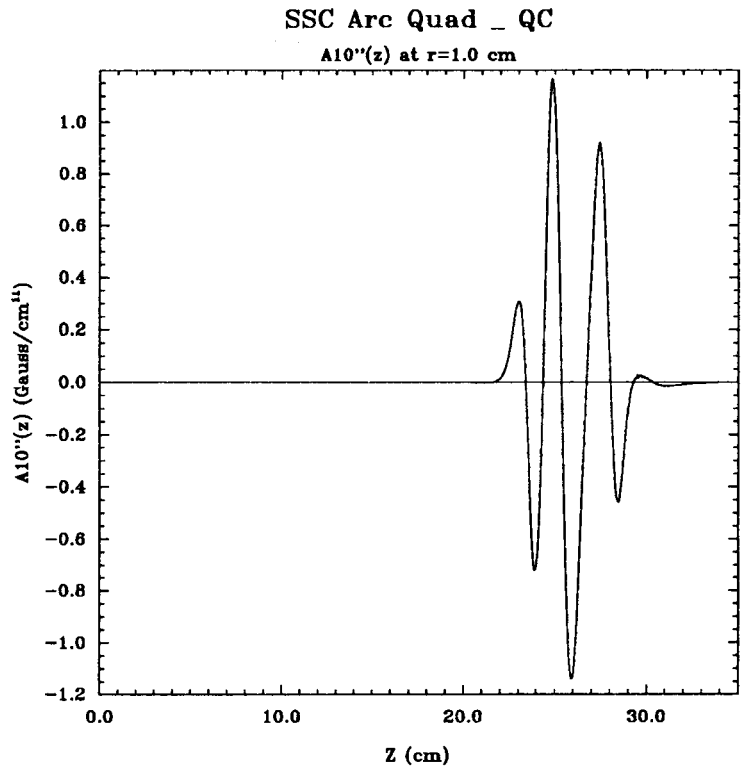

Figure 50 The second derivative function of n=10 — A10''(z) — CONDUCTOR and IRON.

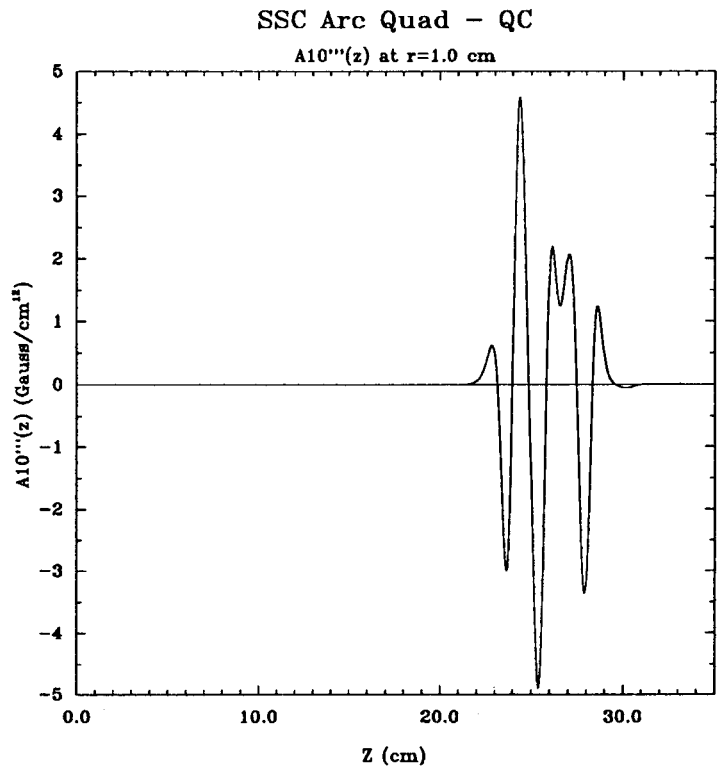

Figure 51 The 3-rd derivative function of n=10 — A10'''(z) — CONDUCTOR ONLY.

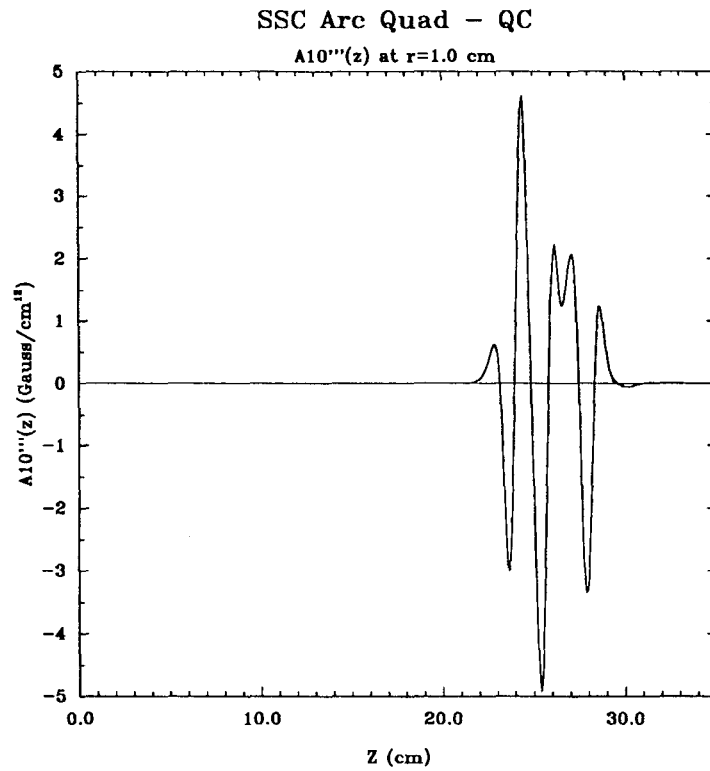

Figure 52 The 3-rd derivative function of n=10 —  $A_{10}'''(z)$  — CONDUCTOR and IRON.

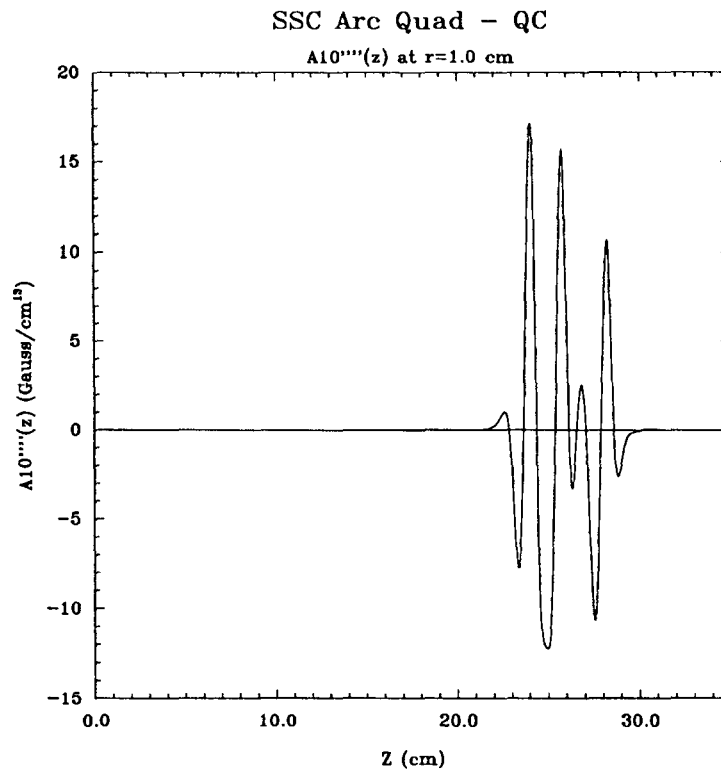

Figure 53 The fourth derivative function of n=10 —  $A_{10}''''(z)$  — CONDUCTOR ONLY.

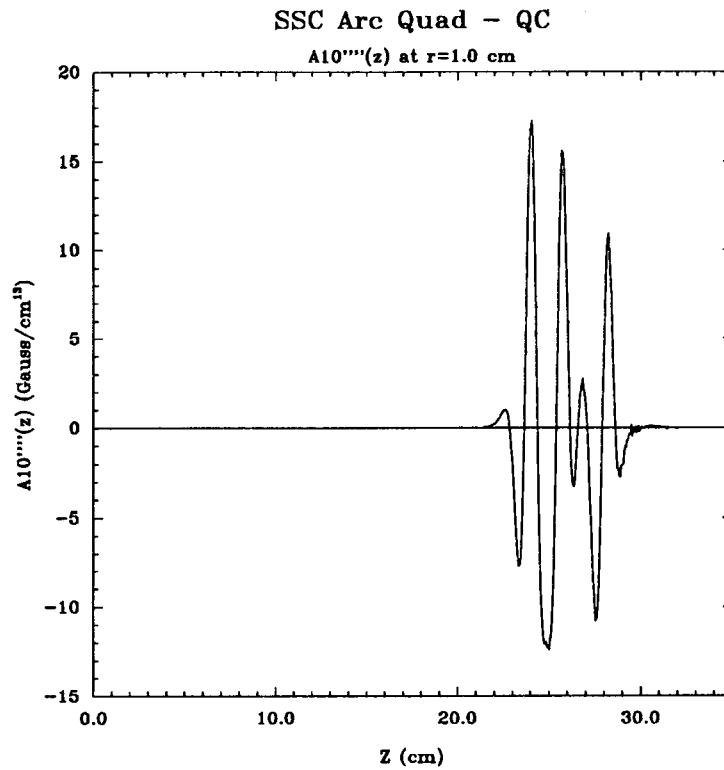

Figure 54 The fourth derivative function of  $n=10$  —  $A_{10}''''(z)$  — CONDUCTOR and IRON.

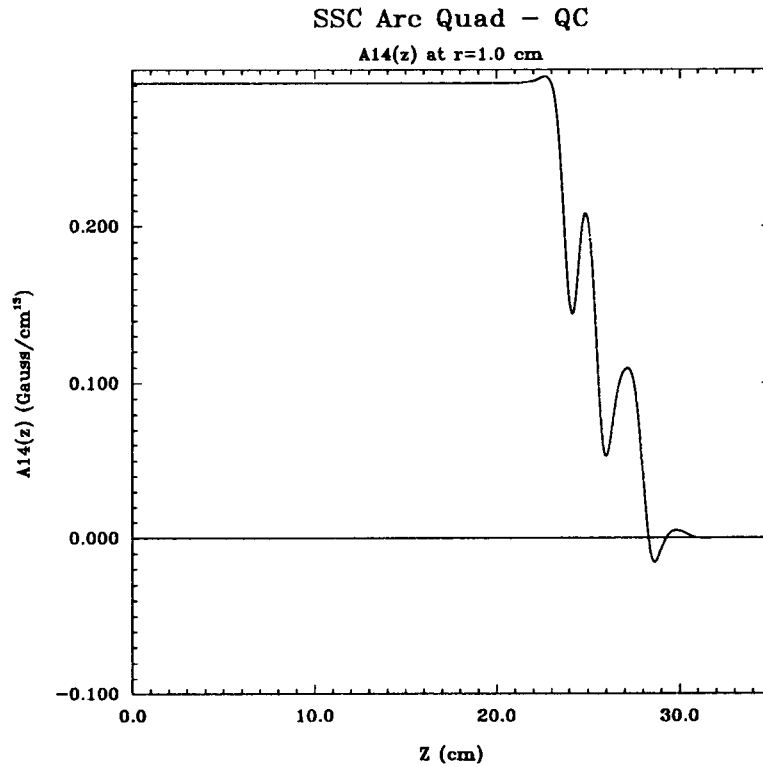

Figure 55 The 28 pole function  $A_{14}(z)$  — CONDUCTOR ONLY.

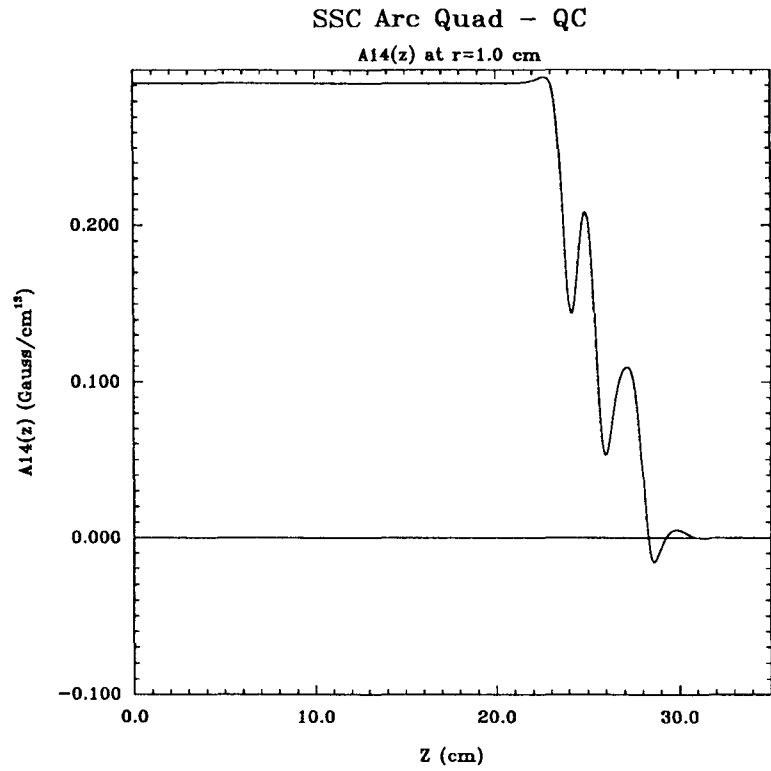

Figure 56 The 28 pole function  $A_{14}(z)$  — CONDUCTOR and IRON.

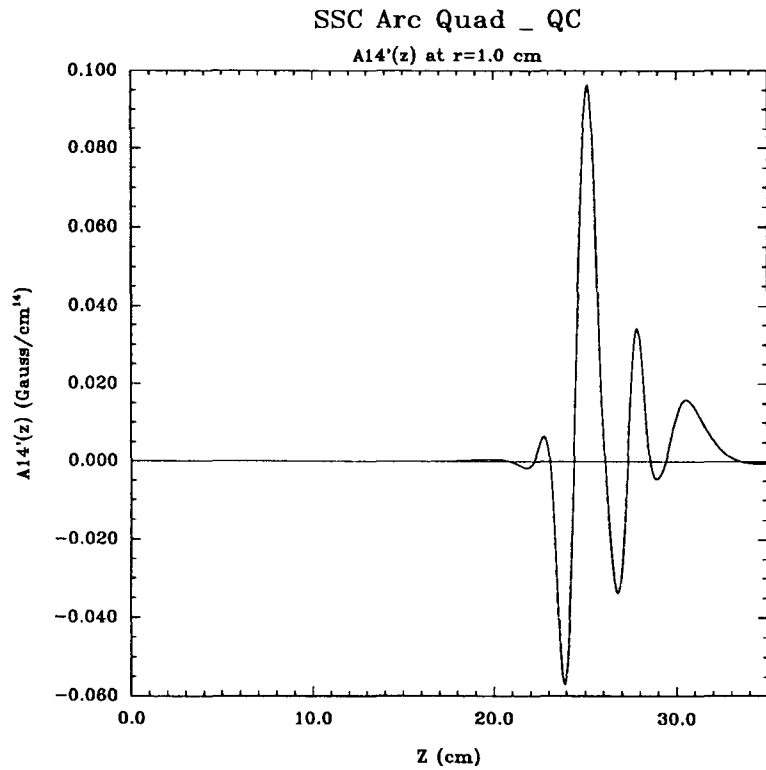

Figure 57 The first derivative function of  $n=14$  —  $A_{14}'(z)$  — CONDUCTOR ONLY.

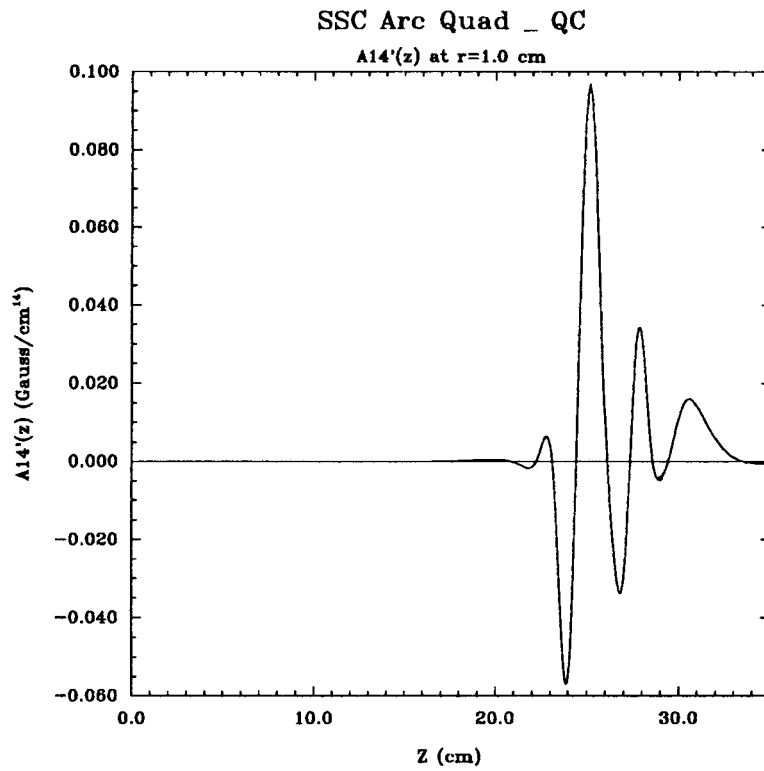

Figure 58 The first derivative function of n=14 —  $A_{14}'(z)$  — CONDUCTOR and IRON.

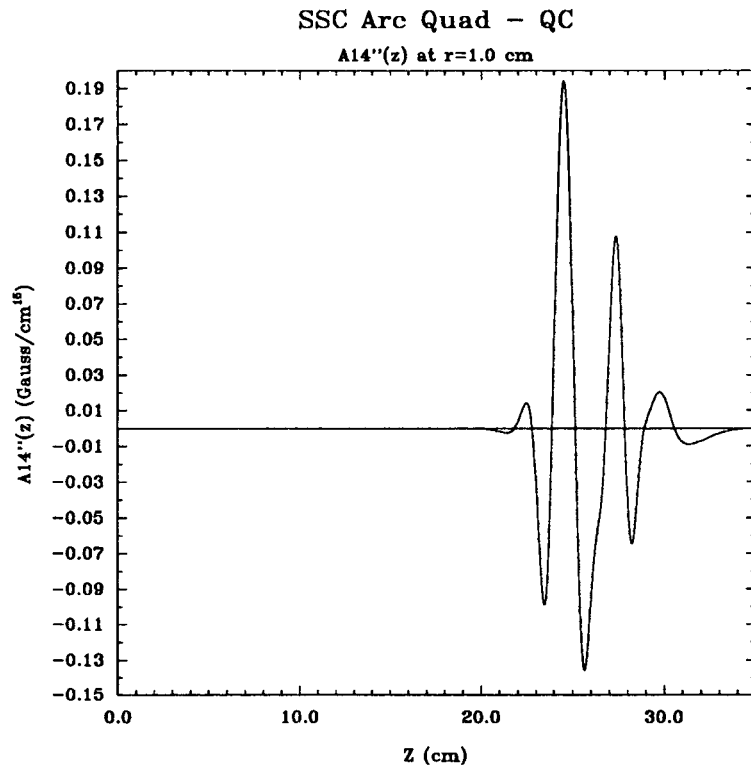

Figure 59 The second derivative function of n=14 —  $A_{14}''(z)$  — CONDUCTOR ONLY.



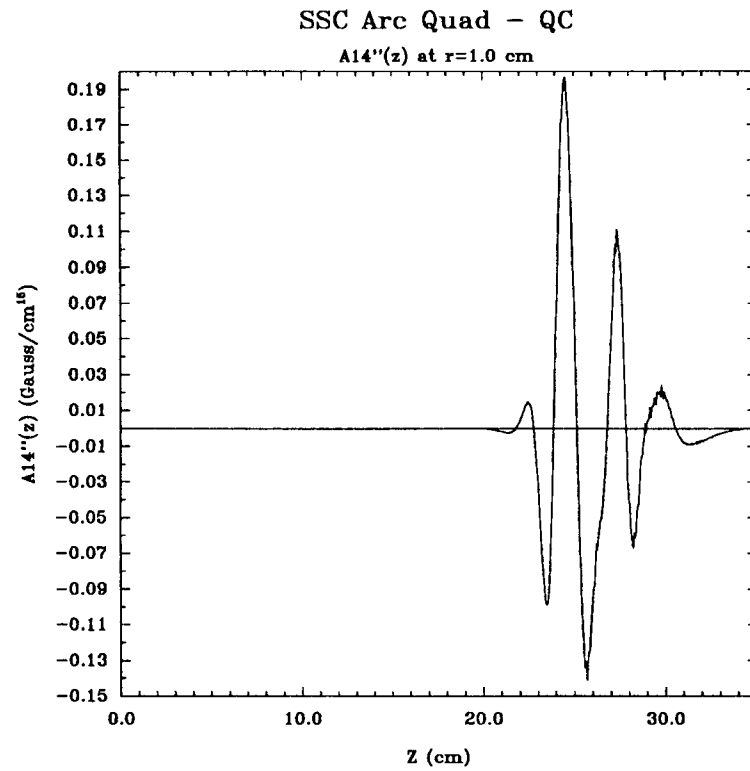

Figure 60 The second derivative function of n=14 —  $A_{14}''(z)$  — CONDUCTOR and IRON.

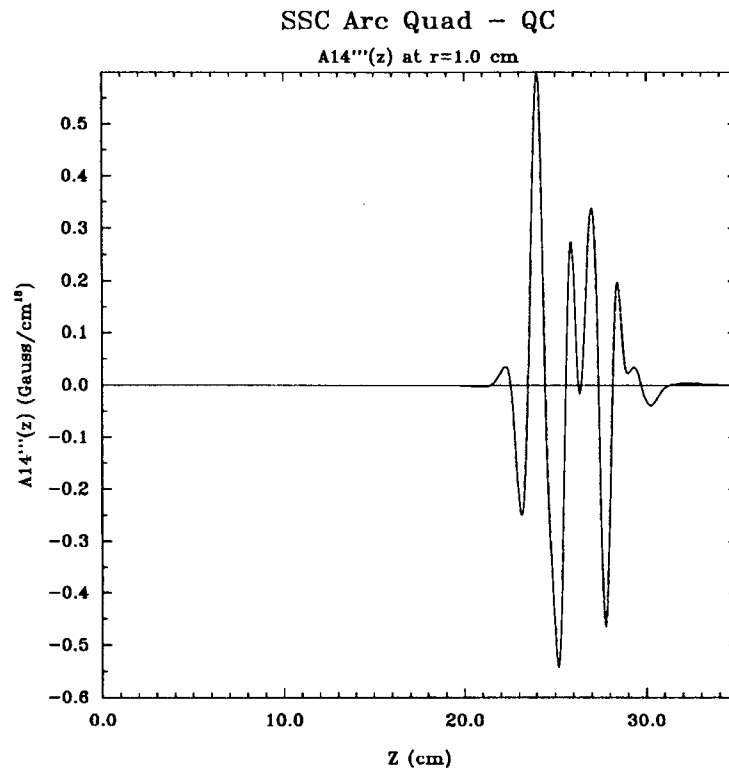

Figure 61 The 3-rd derivative function of n=14 —  $A_{14}'''(z)$  — CONDUCTOR ONLY.

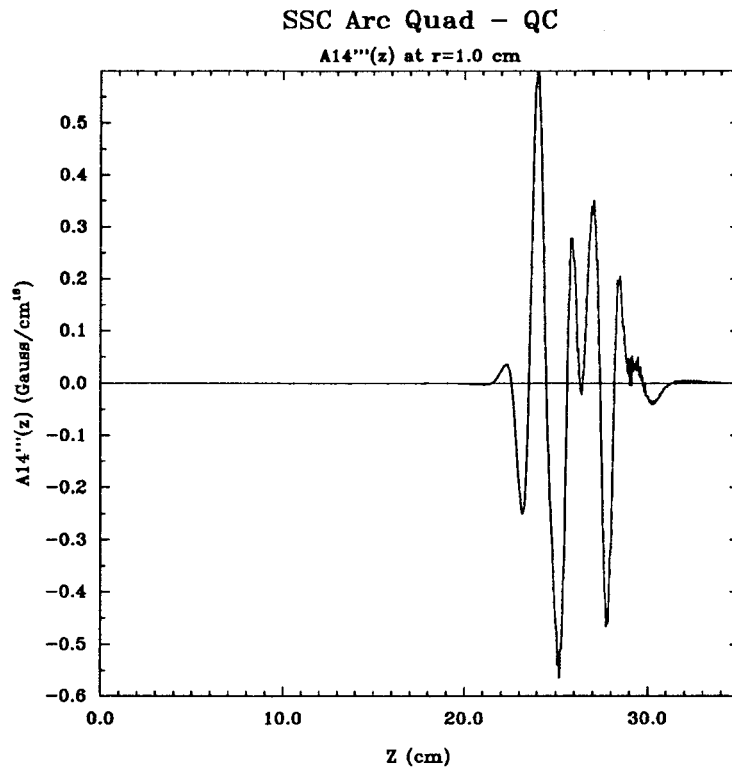

Figure 62 The 3-rd derivative function of n=14 — A14'''(z) — CONDUCTOR and IRON.

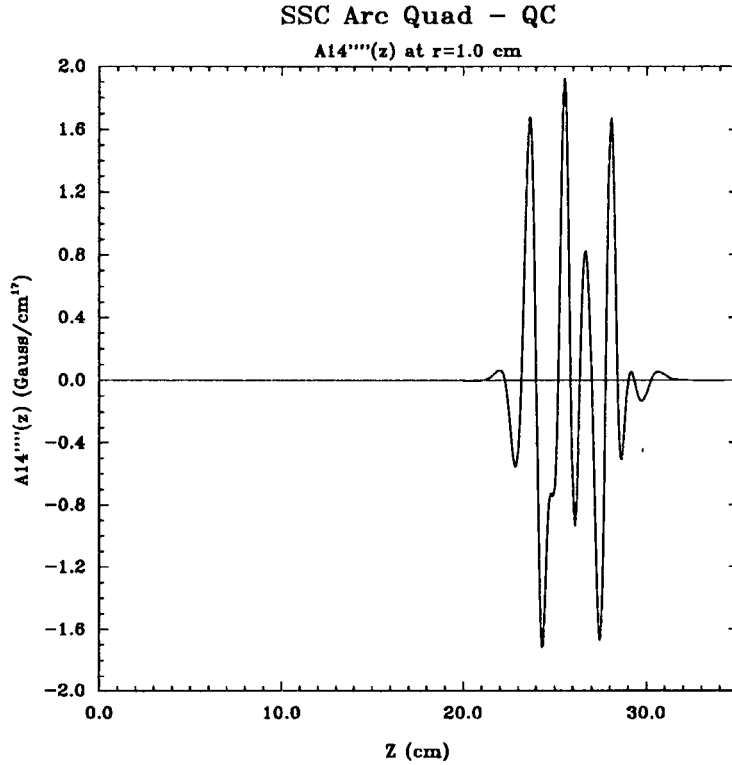

Figure 63 The fourth derivative function of n=14 — A14''''(z) — CONDUCTOR ONLY.

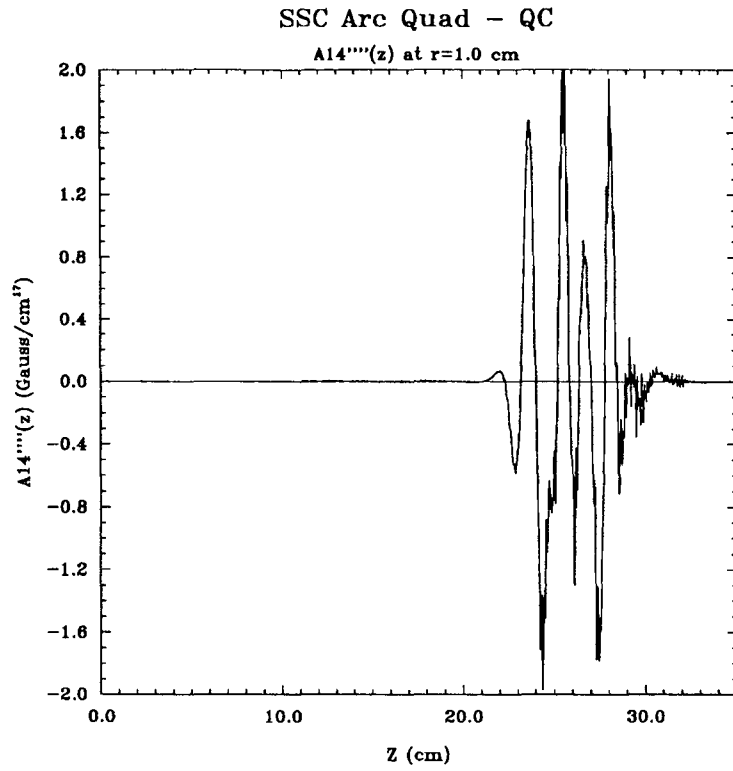

Figure 64 The fourth derivative function of  $n=14$  —  $A_{14}''''(z)$  — CONDUCTOR and IRON.

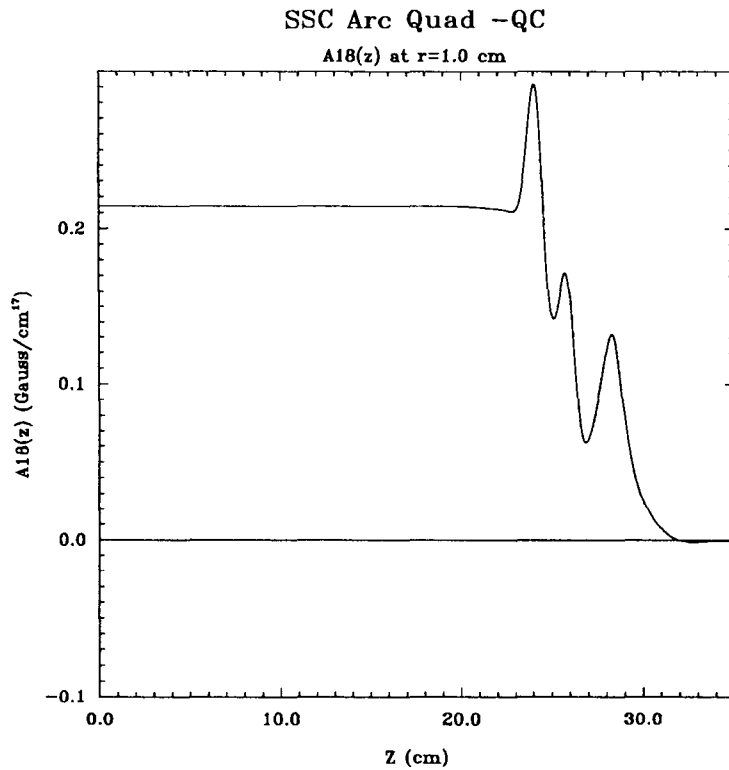

Figure 65 The 36 pole function  $A_{18}(z)$  — CONDUCTOR ONLY.

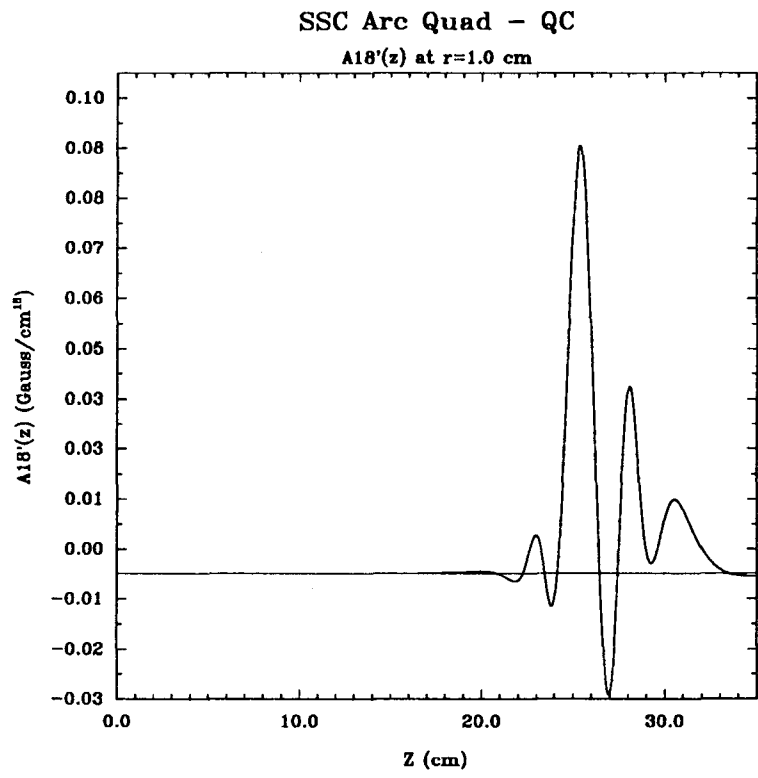

Figure 66 The first derivative function of n=18 — A18'(z) — CONDUCTOR ONLY.

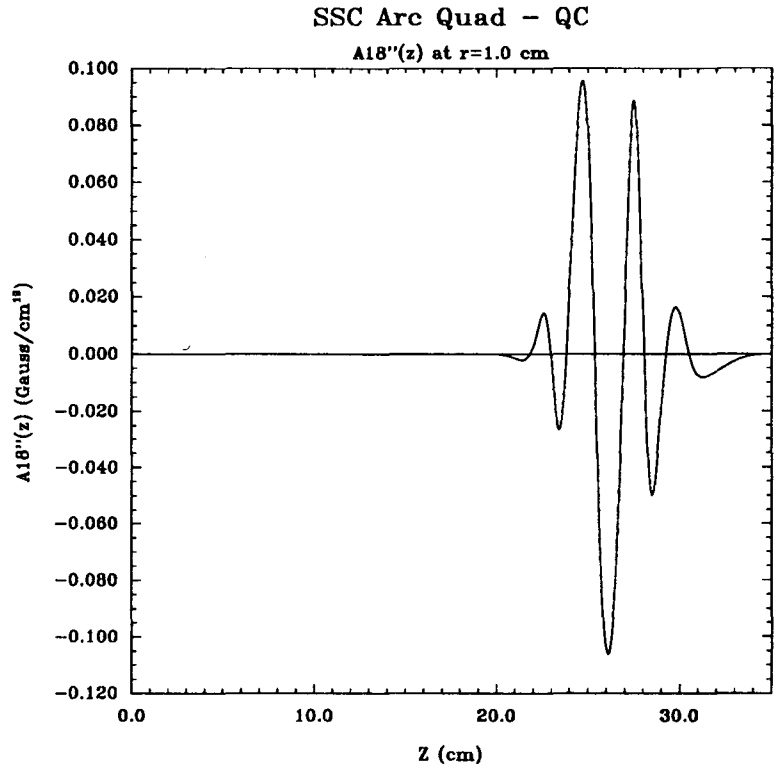

Figure 67 The second derivative function of n=18 — A18''(z) — CONDUCTOR ONLY.

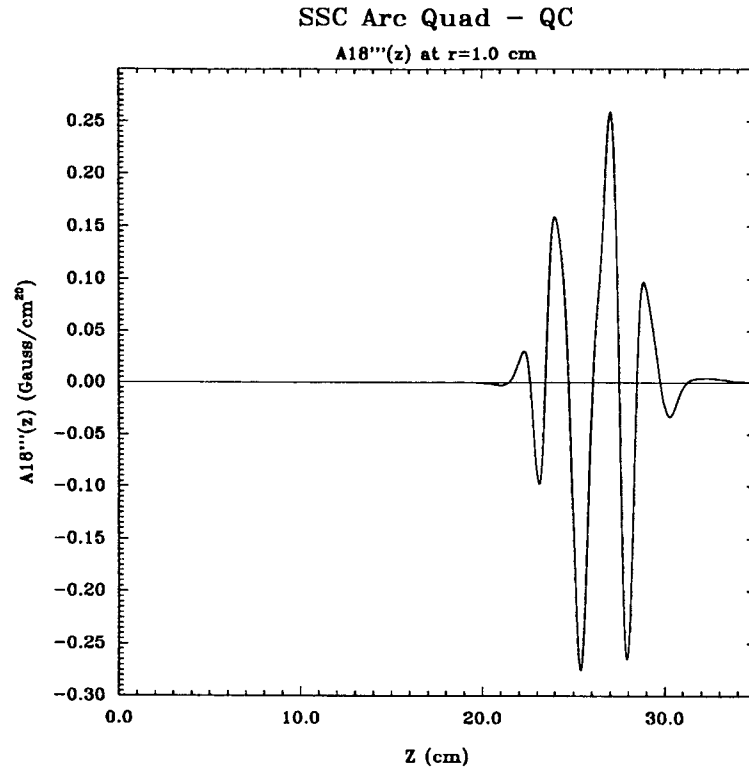

Figure 68 The 3-rd derivative function of n=18 —  $A18'''(z)$  — CONDUCTOR ONLY.

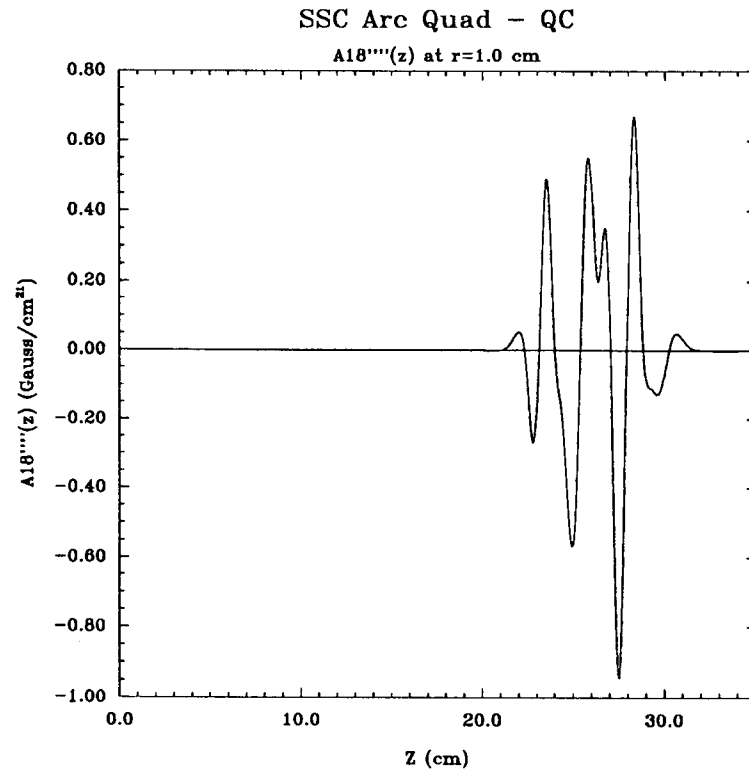

Figure 69 The fourth derivative function of n=18 —  $A18''''(z)$  — CONDUCTOR ONLY.

LAWRENCE BERKELEY LABORATORY  
UNIVERSITY OF CALIFORNIA  
INFORMATION RESOURCES DEPARTMENT  
BERKELEY, CALIFORNIA 94720