

# Lawrence Berkeley National Laboratory

## Lawrence Berkeley National Laboratory

### **Title**

Potential for reducing paper mill energy use and carbon dioxide emissions through plant-wide energy audits: A case study in China

### **Permalink**

<https://escholarship.org/uc/item/84x7n25s>

### **Author**

Kong, Lingbo

### **Publication Date**

2013-02-28

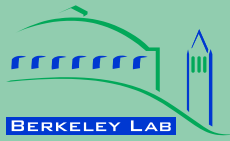

**ERNEST ORLANDO LAWRENCE**  
**BERKELEY NATIONAL LABORATORY**

---

# **Potential for reducing paper mill energy use and carbon dioxide emissions through plant-wide energy audits: A case study in China**

**Lingbo Kong, Lynn Price, Ali Hasanbeigi**

China Energy Group

Environmental Energy Technologies Division

Lawrence Berkeley National Laboratory

**Huanbin Liu, Jigeng Li**

State Key Laboratory of Pulp and Paper Engineering,

South China University of Technology

*Reprint version of journal article published in "Applied Energy",  
Volume 102, February 2013*

**March 2013**

This work was supported by the China Sustainable Energy Program of the Energy Foundation through the U.S. Department of Energy under Contract No. DE-AC02-05CH11231.

## Disclaimer

This document was prepared as an account of work sponsored by the United States Government. While this document is believed to contain correct information, neither the United States Government nor any agency thereof, nor The Regents of the University of California, nor any of their employees, makes any warranty, express or implied, or assumes any legal responsibility for the accuracy, completeness, or usefulness of any information, apparatus, product, or process disclosed, or represents that its use would not infringe privately owned rights. Reference herein to any specific commercial product, process, or service by its trade name, trademark, manufacturer, or otherwise, does not necessarily constitute or imply its endorsement, recommendation, or favoring by the United States Government or any agency thereof, or The Regents of the University of California. The views and opinions of authors expressed herein do not necessarily state or reflect those of the United States Government or any agency thereof, or The Regents of the University of California.

Ernest Orlando Lawrence Berkeley National Laboratory is an equal opportunity employer.

*NOTICE: this is the author’s version of a work that was accepted for publication in Applied Energy. Changes resulting from the publishing process, such as peer review, editing, corrections, structural formatting, and other quality control mechanisms may not be reflected in this document. Changes may have been made to this work since it was submitted for publication. A definitive version was subsequently published in Applied Energy, Volume 102, February 2013, Pages 1334-1342*

---

# **Potential for reducing paper mill energy use and carbon dioxide emissions through plant-wide energy audits: A case study in China**

**Lingbo Kong<sup>1,2</sup>, Lynn Price<sup>1</sup>, Ali Hasanbeigi<sup>1</sup>, Huanbin Liu<sup>2</sup>, Jigeng Li<sup>2</sup>**

<sup>1</sup>China Energy Group

Environmental Energy Technologies Division  
Lawrence Berkeley National Laboratory

<sup>2</sup>State Key Laboratory of Pulp and Paper Engineering  
South China University of Technology

## **Abstract**

The pulp and paper industry is one of the most energy-intensive industries worldwide. An energy audit is a primary step toward improving energy efficiency at the facility level. This paper describes a plant-wide energy audit aimed at identifying energy conservation and carbon dioxide (CO<sub>2</sub>) mitigation opportunities at a paper mill in Guangdong province, China. We describe the energy audit methods, relevant Chinese standards, methods of calculating energy and carbon indicators, baseline energy consumption and CO<sub>2</sub> emissions of the audited paper mill, and nine energy-efficiency improvement opportunities identified by the audit. For each of the nine options, we evaluate the energy conservation and associated CO<sub>2</sub> mitigation potential. The total technical energy conservation potential for these nine opportunities is 967.8 terajoules (TJ), and the total CO<sub>2</sub> mitigation potential is equal to 93,453 tonnes CO<sub>2</sub> annually, representing 14.4 percent and 14.7 percent, respectively, of the mill’s total energy consumption and CO<sub>2</sub> emissions during the audit period.

## **1. Introduction**

Energy efficiency is one of the most important and cost effective means for reducing industrial energy consumption and carbon dioxide (CO<sub>2</sub>) emissions, especially in the near and medium term (Metz, Davidson, Bosch, Dave, & Meyer, 2007; Worrell, Bernstein, Roy, Price, & Harnisch, 2009). Industrial

energy efficiency can be improved by various means, including management, technology, policy, and regulatory strategies (Abdelaziz, Saidur, & Mekhilef, 2011). For almost all energy-saving strategies, a first step is an energy audit that aims to improve energy efficiency without negatively affecting the facility's output (Lu & Price, 2011). Energy audits have contributed significantly to improving energy efficiency in China (Shen, Price, & Lu, 2012); energy-efficiency opportunities identified through energy audits and implemented by enterprises reduced China's energy intensity by 19.1 percent during the 11th five-year plan (2006-2010).

Energy audits have been carried out in many countries during recent years, and a number of recent publications support their value and popularity. For example, Schleich (2004) reports that energy audits could help overcome several barriers to improving energy efficiency in Germany, including providing missing information about energy consumption patterns and energy-saving measures. Lu and Price (2011) surveyed 22 industrial energy audit programs offered by governments in 15 countries worldwide and one region (the European Union) as the basis for recommendations for policy makers on establishing robust energy audit programs. Shen et al. (2012) studied China's national energy audit policies and guidelines and found that energy audits not only helped enterprises identify energy conservation opportunities but also helped them to improve their energy management structure. As of December 2011, the U.S. Industrial Assessment Centers had performed a cumulative total of 15,230 plant-wide assessments and made more than 114,227 recommendations for the U.S. industrial plants (DOE, 2011).

As the fourth largest industrial energy consumer worldwide, the pulp and paper industry consumed 6.87 exajoules (EJ) of final energy in 2007, which accounted for 5 percent of total global industrial energy consumption and 2 percent of global direct CO<sub>2</sub> emissions from the industrial sector in that year (Trudeau, Tam, Graczyk, & Taylor, 2011). China's pulp and paper industry alone used 0.75 EJ of final energy, which represented 11 percent of total final energy used in the global pulp and paper industry in that year (NBSC., 2010). Recent studies have examined opportunities to reduce the pulp and paper industry's energy consumption and CO<sub>2</sub> emissions. Klugman et al. (2007) audited a Scandinavian pulp mill and concluded that 22 percent of electricity and 1 percent of process heat could be saved per year, for overall energy savings of 113 gigawatt hours (GWh) per year. Gong et al. (2011) using Simprosys software carried out an energy audit on a paperboard drying line in Slovakia and found three possible ways to improve dryer energy performance: decreasing heat loss, effectively recovering waste heat, and shortening drying time. With a data-based energy audit operation in two UK paper machines, Afshar et al. (2012) found that improving drainage and eliminating over-drying of the sheet provided two important opportunities for thermal energy reduction in papermaking process. Hong et al. (2011) analyzed the energy flow of the pulp and paper industry in Taiwan and identified 3.2 petajoules (PJ) of total energy conservation potential per year, equal to 6.5 percent of Taiwanese pulp and paper industry energy consumption in 2009. Reese (2012) conducted performance and energy evaluations on more than 300 paper machines in North America and found that 25 percent of energy consumption in these paper machines could be reduced without significant capital expenditures.

To date, few analyses have been published on the potential to improve the energy efficiency and CO<sub>2</sub> emissions in China’s pulp and paper industry. This paper reports on an energy audit to identify energy conservation and CO<sub>2</sub> mitigation opportunities at a paper mill located in Guangdong province, South China. Nine energy-efficiency improvement opportunities were identified based on the audit results. The energy conservation and CO<sub>2</sub> mitigation potential of each measure was evaluated and an economic analysis was performed. For confidentiality reasons, the name and exact location of the mill are not identified.

## 2. Methodology

### 2.1. Energy Audit

The energy audit analyzed how energy is used within the mill and identified opportunities for reducing energy consumption and CO<sub>2</sub> emissions. In China, industrial energy audits are commonly performed in accordance with national standards (Table 1). These standards specify general principles for calculating or evaluating electricity, heat, and water use as well as comprehensive energy consumption. A Chinese industry standard (QB 1022-1991) also specifies the method for calculating the integrated energy consumption of pulp and papermaking enterprises (NDRC, 1991).

**Table 1. China national standards relevant to energy audits**

Standard No.	Standard Title
GB/T 2588-2000	The general principles for calculation of thermal efficiency of equipment
GB/T 2589-2008	General principles for calculation of the comprehensive energy consumption
GB/T 3485-1998	Technical guides for evaluating the rationality of electricity usage in industrial enterprise
GB/T 3486-1993	Technical guides for evaluating the rationality of heat usage in industrial enterprise
GB/T 6422-2009	Testing guide for energy consumption of equipment
GB/T 7119-2006	Evaluating guide for water saving enterprises
GB/T 13234-2009	Calculation methods of energy saved for enterprise
GB/T 15316-2009	General principles for monitoring and testing of energy conservation
GB/T 15587-2008	Guideline for energy management in industry enterprise
GB/T 17166-1997	General principle of energy audit on industrial and commercial enterprise
GB 17167-2006	General principle for equipping and managing of the measuring instrument of energy in organization of energy using

The paper mill audit was carried out from February 1, 2009 to January 31, 2010 and comprised the following steps: preparation, inventory and measurement of energy use, analysis of energy bills, benchmarking, analysis of energy-use patterns, identification of energy-efficiency opportunities, analysis of costs and benefits, preparation of energy audit reports, and post-audit activities. The Industrial Energy Audit Guidebook by Hasanbeigi and Price (2010) describes in detail the steps for conducting an energy audit in industrial facilities.

The data used in this audit came chiefly from the mill’s statistical report, plant energy bills, discussions with plant operators, and field measurements conducted at the mill. The best available technology (BAT) energy intensity values for different paper grades that we used for benchmarking were cited from a study by Jacobs Engineering and the Institute of Paper Science and Technology (2006) (Kinstrey & White). Considering the paper machines use the majority of energy at a paper mill, and some operational parameters for paper machines are not available, Kong et al. (2011) introduced a method of making field measurements to determine the energy performance of a papermaking process, which we used for this analysis.

## 2.2. Energy Intensity (EI)

The papermaking process mainly uses energy in the form of electricity and heat, so the energy intensity of the process is expressed using electricity intensity, thermal energy intensity, final energy intensity, and primary energy intensity (Eq. (1)). This energy intensity calculation can be used to benchmark any similar paper machine or mill.

$$EI_{PM,i} = \frac{\text{Energy consumption}_{PM,i} \text{ (kWh or GJ)}}{\text{Production}_{PM} \text{ (tonne paper)}} \quad (1)$$

Where  $EI_{PM,i}$  is the energy intensity of the paper machine or paper mill in the form of electricity, thermal energy, final energy, or primary energy (kilowatt hour [kWh] or gigajoule [GJ]/tonne paper).

A factor of 3.6 MJ/kWh is used to convert electricity to final energy. Primary energy is converted from final energy with related conversion factors. Note that the factor for converting electricity ( $CF_{elec}$ ) from final to primary energy might vary for different paper mills, because some mills only use self-generated electricity while others, especially small and medium paper mills, also use electricity purchased from the power grid. For the power purchased from the grid, a  $CF_{elec}$  of 2.97 can be used for China’s pulp and paper industry. This factor is calculated from the average net heat rates of coal-fired power plants and includes the transmission and distribution losses of China’s power grid (CEC & EDF 2011). For the portion of electricity that is self generated, the  $CF_{elec}$  is specific and depends on the net heat rate of supplied electricity in the mill. Because electricity is self generated in the paper mill studied here, a conversion factor of 3.17 is used in our analysis. This value is equivalent to the average net generation heat rate at the mill in 2009.

## 2.3. CO<sub>2</sub> Intensity

Emissions of CO<sub>2</sub> are expressed in tonnes. The basic equation for calculating CO<sub>2</sub> intensity is:

$$CO_2 \text{ intensity}_{PM} = \frac{CO_2 \text{ emissions}_{PM} \text{ (tonnes } CO_2 \text{)}}{\text{Production}_{PM} \text{ (tonne paper)}} \quad (2)$$

The overall CO<sub>2</sub> emissions from a paper mill or paper machine are calculated by multiplying the energy consumption of each type of fuel by the associated emission factor ( $EF_i$ ):

$$CO_2 \text{ emissions}_{PM} = \sum_i (EF_i \cdot \text{Energy consumption}_{PM,i}) \quad (3)$$

The emissions factors (*EF*) used for calculating CO<sub>2</sub> emissions from fossil fuel consumption are taken from the 2006 Intergovernmental Panel on Climate Change Guidelines for National Greenhouse Gas Inventories (IPCC, 2006). The power grid emissions factors vary for different regions in China and can be obtained from China’s Baseline Emission Factors for Regional Power Grids in 2009 (NDRC, 2009). For the South China Power Grid, the emissions factor was 0.788 kilograms (kg) CO<sub>2</sub>/kWh in 2009. This emission factor is specific for those paper mills that self-generate electricity.

## 2.4. Energy Intensity Index (EII)

We use the energy intensity index (*EII*) to benchmark actual energy performance of the paper machines. The EII indicates how much energy could be saved if BAT were applied to the machine. EII can be calculated from the ratio between the actual energy intensity ( $EI_{PM}$ ) and the benchmark energy intensity ( $EI_{BAT}$ ), as follows (Hasanbeigi, Price, Lu, & Wang, 2010; Phylipsen, Blok, Worrell, & Beer, 2002):

$$EII_{PM} = 100 \cdot \frac{EI_{PM}}{EI_{BAT}} = 100 \cdot \frac{\sum Energy\ consumption_{PM,i}}{Production_{PM} \cdot EI_{BAT}} \quad (4)$$

in which  $EII_{PM}$  is the energy intensity index of a paper machine,  $EI_{PM}$  is the actual energy intensity of a paper machine (GJ/tonne paper), and  $EI_{BAT}$  is the benchmark energy intensity of the similar paper machine with the unit of GJ/tonne paper.

The energy conservation potential can be estimated from Eq. (4). The *EII* would equal to 100 only if the paper machine used BAT. Actual paper machines will have an *EII* higher than 100. The gap between actual and benchmark intensities can be viewed as the energy-efficiency potential of the machine.

## 3. Overview of the Paper Mill

### 3.1. The Mill and Papermaking Process

The paper mill studied in this report is located in Guangdong province and is one of the Top-1,000 energy-consuming enterprises in China. It is a standalone paper mill. The raw material for papermaking is non-deinked pulp made from recycled waste paper. The mill has four paper production lines that manufactured corrugated medium and linerboard. Table 2 shows the details of each of the mill’s paper machine.



**Table 2. Details of the paper machines in the case mill**

Machine No.	Machine type	Hood type	Paper grade	Web width (meters)	Machine speed (meters/min)	Capacity (tonnes/day)
PM1	Foudriner	Semi-open	Corrugated medium	3.2	300	150
PM2	Gap PM	Semi-open	Linerboard	3.2	300	150
PM3	Gap PM	Closed	Linerboard	4.2	360-650	655
PM4	Twin-wire	Closed	Linerboard	5.5	700-1,100	1,000

PM 1 and PM2 were installed during the 1990s and have smaller capacities than PM3 and PM4. PM1 and PM2 have semi-open hoods and a production capacity of 150 tonnes per day. PM3 and PM4 have closed hoods and production capacities of 655 and 1,000 tonnes per day. Figure 1 shows the actual paper production of each machine during the audit period. The mill’s total paper production during the audit period was 610,819 tonnes. The production is relatively stable except during February and March of 2009, which could be an after effect of the global financial crisis. From March 2009 on, the four paper machines recovered to their normal capacity.

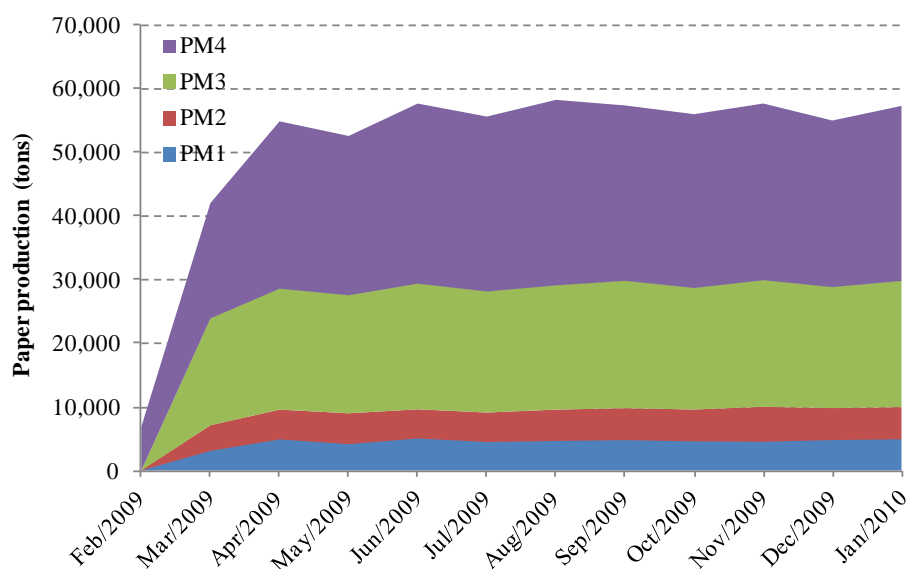

**Figure 1. Breakdown of paper production at the mill**

### 3.2. Energy System

The fossil fuels used at the paper mill are coal and diesel. Fossil fuel is converted through a combined heat and power (CHP) facility to electricity and steam, which are the final forms of energy used in the papermaking process. Figure 2 shows a simplified graphic rendering of the energy flow at the mill.

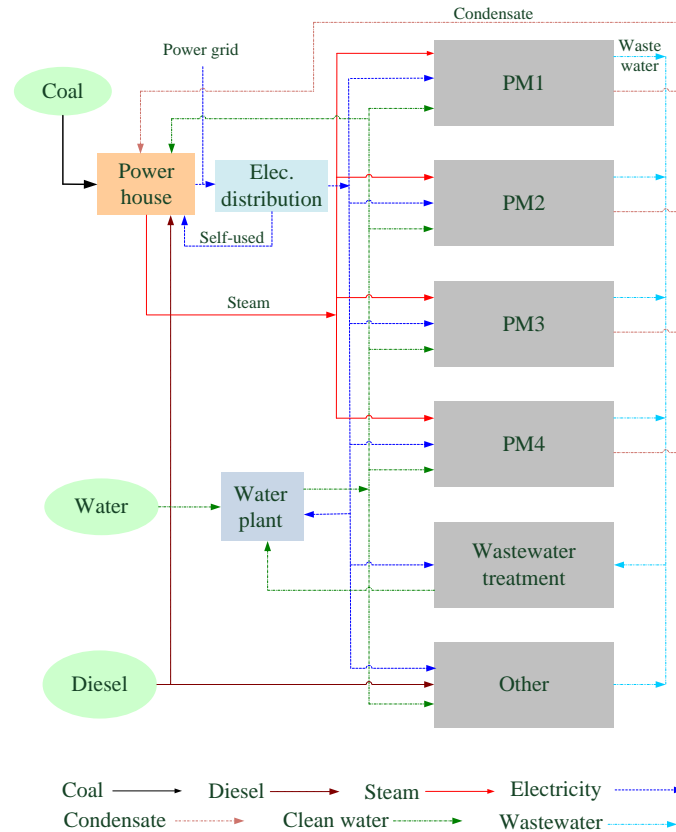

**Figure 2. Energy flow at the paper mill**

The four paper machines are the mill’s primary energy consumers. The paper machines used 68 percent of the electricity generated onsite and 90 percent of thermal energy during the audit period. The effluent exhausted from each paper machine is sent to a wastewater treatment plant that consumes only electricity. The auxiliary chemical preparation and compressed-air system only require a small amount of steam and electricity compared to that consumed by the paper machines.

## 4. Audit Results

### 4.1. Mill Energy Consumption and CO<sub>2</sub> Emissions

In 2009, the mill’s total consumption of primary energy in the form of raw coal and diesel was 6,733TJ, as shown in Table 3. Most of the consumed primary energy came from raw coal.

**Table 3. Breakdown of energy consumption and CO<sub>2</sub> emissions**

Month/Year	Primary energy (TJ)			CO <sub>2</sub> emissions (tonnes CO <sub>2</sub> )		
	Raw coal	Diesel	Total	Raw Coal	Diesel	Total
<b>Feb/2009</b>	135.11	3.76	138.87	12,769.46	278.72	13,048.18
<b>Mar/2009</b>	536.31	0.97	537.28	50,689.53	71.81	50,761.34
<b>Apr/2009</b>	569.32	0.31	569.63	53,808.85	22.99	53,831.84
<b>May/2009</b>	562.22	0.32	562.54	53,137.62	23.71	53,161.34
<b>Jun/2009</b>	587.49	0.20	587.70	55,526.84	15.08	55,541.92
<b>Jul/2009</b>	584.95	0.26	585.22	55,286.57	19.60	55,306.18
<b>Aug/2009</b>	607.89	0.04	607.93	57,454.72	3.02	57,457.73
<b>Sep/2009</b>	606.19	0.10	606.29	57,294.10	7.16	57,301.27
<b>Oct/2009</b>	645.56	0.04	645.60	61,014.93	2.62	61,017.56
<b>Nov/2009</b>	652.05	0.84	652.89	61,628.45	62.19	61,690.64
<b>Dec/2009</b>	611.75	0.03	611.78	57,819.37	2.26	57,821.63
<b>Jan/2010</b>	627.28	0.04	627.32	59,287.25	3.02	59,290.27
<b>Total</b>	6,726.12	6.92	6,733.04	635,717.69	512.19	636,229.88

Combustion of fossil fuel is the main source of CO<sub>2</sub> emissions from the mill. In 2009, a total of 636,230 tonnes energy-related CO<sub>2</sub> was emitted from the mill; 99 percent of these CO<sub>2</sub> emissions are attributed to burning of raw coal. Table 3 shows the breakdown of CO<sub>2</sub> emissions from the mill during the audit period.

#### 4.2. Mill Energy and CO<sub>2</sub> Intensity

From the energy use and overall paper production data presented above, we can obtain the primary energy intensity and CO<sub>2</sub> intensity of the mill using the calculation method described in Sections 2.2 and 2.3. Figure 3 shows the results of these calculations. The energy intensity of the mill ranged from 10.2 GJ/tonne paper in June, 2009 to 20.1 GJ/tonne paper in February, 2009, with an average value of 11.0 GJ/tonne paper. The CO<sub>2</sub> intensity ranged between 0.96 tonnes CO<sub>2</sub>/tonne paper in June and 1.87 tonnes CO<sub>2</sub>/tonne paper in February, 2009, with an average value of 1.04 tonnes CO<sub>2</sub>/tonne paper. From Figure 3, we can see that the effect of seasonal variations on energy consumption and associated CO<sub>2</sub> emissions are minor when only normal operation conditions are considered. Another key finding is that the energy and CO<sub>2</sub> intensities were higher when a machine was not operating close to its production capacity. This is the reason that the mill intensity is higher in February and March when the machines were operating at a lower capacity than is the case in other months.

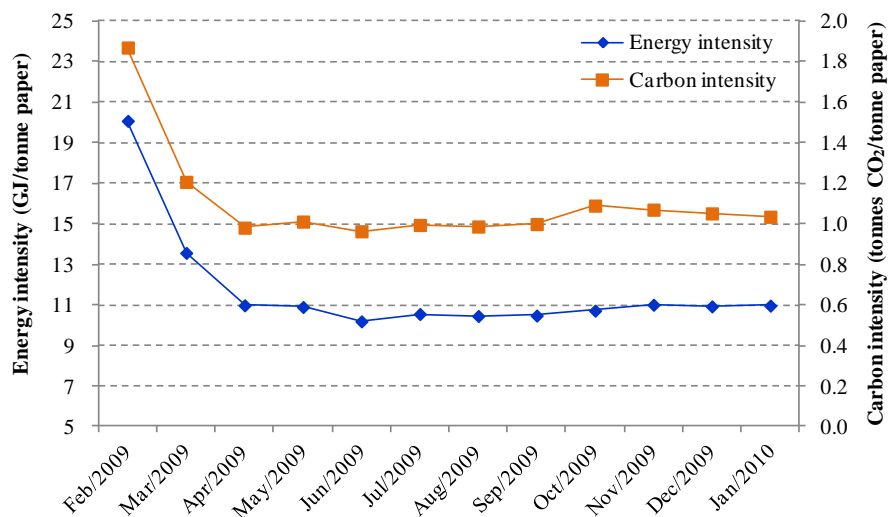

Figure 3. Primary energy and CO<sub>2</sub> intensity of the audited paper mill

### 4.3. Paper Machine Energy and CO<sub>2</sub> Intensity

We recorded separately the electricity and thermal energy consumption of the four paper machines at the mill. For simplicity and because of space constraints, we present here the energy and CO<sub>2</sub> intensity of only one paper machine, PM4.

As shown in Figure 4, the higher the electricity intensity, the lower the thermal energy intensity. Although the electricity and thermal energy intensity were somewhat variable during the audit period, the final energy intensity was relatively stable. The difference between the highest and the lowest final energy intensity is only 0.4 GJ/tonne paper. PM4 emitted 0.81 to 1.01 tonnes of energy-related CO<sub>2</sub> per tonne of paper produced.

Using similar methods, we can obtain the energy and CO<sub>2</sub> intensities of the other three paper machines. Figures 5-7 present the average energy intensities of all four paper machines at the mill.

Figure 5 shows the electricity intensity of the four paper machines in the mill during the audit period. Among the four paper machines, the electricity intensity varies ranges from 301 kWh/tonne paper to 494 kWh/tonne, with PM1 having the lowest electricity consumption. The electricity intensities of the other three machines are greater than 400 kWh/tonne paper; PM4's is close to 500 kWh/tonne paper.

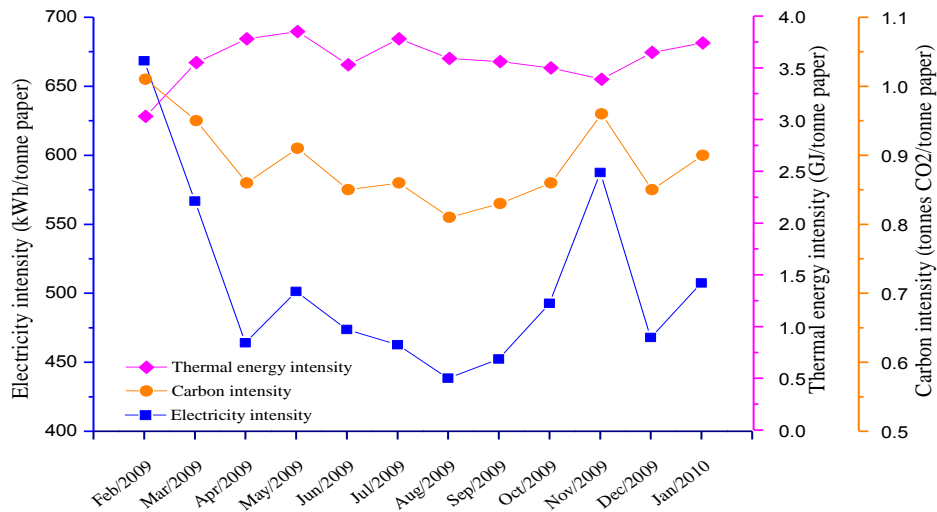

Figure 4. Energy and CO<sub>2</sub> intensity of the PM4

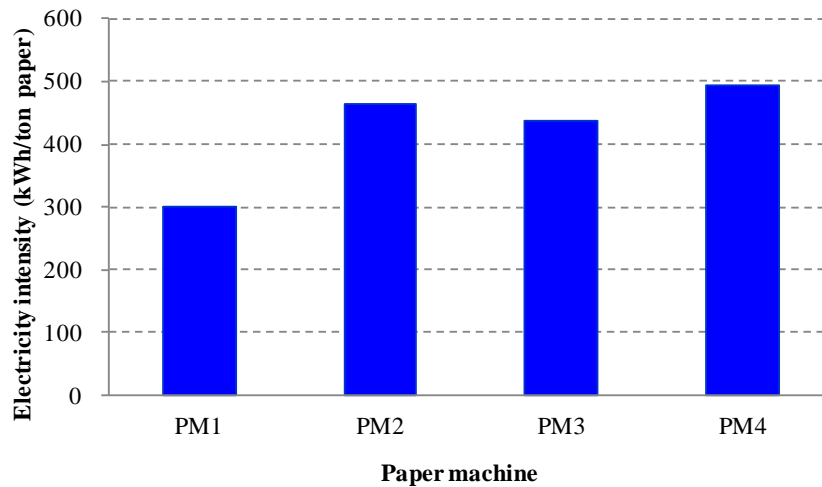
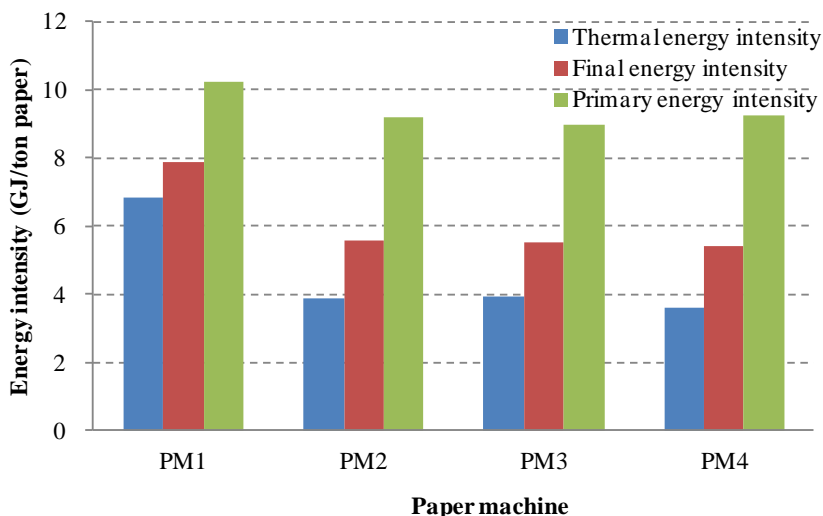

Figure 5. Electricity intensity of the paper machines during the audit period

Figure 6 shows the thermal energy, final energy, and primary energy intensity of the four paper machines during the audit period. The thermal energy intensities of the machines range between 3.61 and 6.82 GJ/tonne paper, which is much higher than the BAT intensity at 3.25 GJ/tonne paper. Although PM1 has the lowest electricity intensity (shown in Figure 5), its thermal energy intensity is the highest, with 6.82 GJ/tonne paper that is almost two times higher than the BAT thermal energy use. The difference in energy intensities among PM2, PM3, and PM4 is minimal.



**Figure 6. Energy intensity of the paper machines during the audit period**

Figure 7 shows CO<sub>2</sub> intensity of the four paper machines based on primary energy consumption over the audit period. PM1 had a carbon intensity of 0.97 tonnes CO<sub>2</sub>/tonne paper and emitted more CO<sub>2</sub> than the other paper machines. This is attributed to its higher energy intensities, shown above. The machine with the lowest CO<sub>2</sub> emissions was PM3, with an intensity of 0.85 tonnes CO<sub>2</sub>/tonne paper.

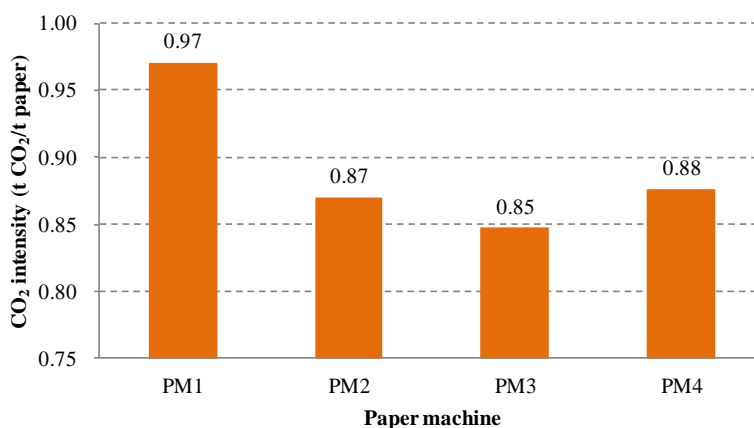
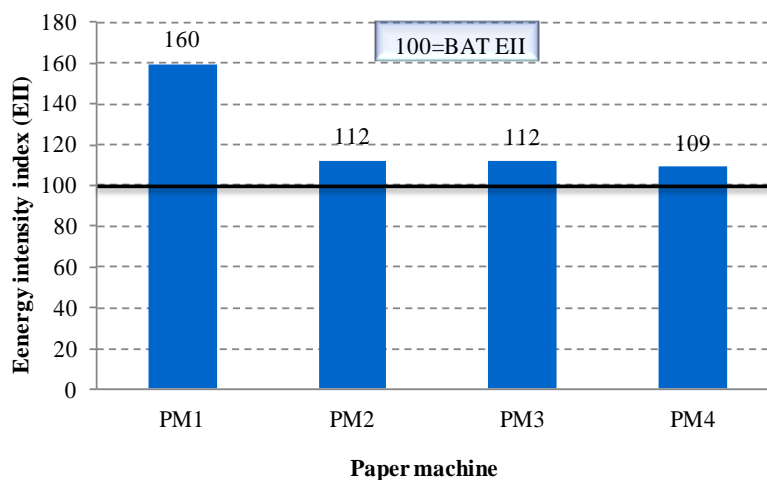

**Figure 7. CO<sub>2</sub> intensity of the paper machines during the audit period**

#### 4.4. Paper Machine EII

We calculated the EII of the paper machines using Eq. (4) based on the final energy intensities and related BAT values. The BAT value for both corrugated medium and linerboard are 4.95 GJ/tonne paper (Kinstrey & White). Using this BAT value and the final energy intensity shown in Figure 6, we calculated

the EII of the paper machines. As Figure 8 shows, the EII of all the paper machines at the mill is greater than 100. This is in line with our pre-audit estimate and indicates that the energy consumption in the paper production lines could be reduced if BAT were employed. Figure 8 also shows how each paper machine’s energy efficiency differs from that of a machine with BAT.



**Figure 8. Energy intensity index (EII) of the paper machines**

From the calculated EII, we can obtain the gross final energy conservation potential of each of the four paper machines: 37 percent, 11 percent, 11 percent, and 8 percent for PM1, PM2, PM3, and PM4, respectively. These potential values are only for the four paper machines, not the entire mill.

## 5. Energy-efficiency Improvement Opportunities and Potentials

The following subsections discuss energy-efficiency opportunities for both the entire paper mill and the paper machines. The first three energy-efficiency measures described below are for the entire mill; the remainder of the measures focuses on the paper machines. Energy-saving opportunities that could not be quantified are not included in this paper. Table 4 summarizes all of the energy-efficiency and CO<sub>2</sub> mitigation opportunities.

The overall technical primary energy-savings potential is 967.8 TJ annually, equivalent to 14.4 percent of total energy consumption in the mill during the audit period. The associated CO<sub>2</sub> mitigation potential is 93,454 tonnes CO<sub>2</sub>, equivalent to 14.7 percent of total CO<sub>2</sub> emissions from the mill during the same period. Although the simple payback periods for energy-efficiency measures EE-1 and EE-4 are more than 10 years, their energy-savings and CO<sub>2</sub> mitigation potential is large. Measure EE-4 would save 273.42 TJ of primary energy per year, and, of all of the measures, it has the highest CO<sub>2</sub> reduction potential, 28,732 tonnes CO<sub>2</sub> per year. Except for EE-1 and EE-4, the rest of the measures are cost

effective within a three-year simple payback period. For this reason, they are identified as priority energy-efficiency improvement opportunities that could be implemented at the mill in the near future.

**Table 4. Energy conservation and CO<sub>2</sub> emissions reduction opportunities**

Measure No.	Measure/Technology	Electricity savings (GWh/yr)	Fuel savings (TJ/yr)	Primary energy savings (TJ/yr)	CO <sub>2</sub> reduction <sup>b</sup> (tonnes/yr)	Investment cost (RMB <sup>c</sup> /tonne paper)	Simple payback period <sup>d</sup> (years)
EE-1	Retrofit low-efficiency boilers		274.49	274.49	25,967	136.0	12.3
EE-2	Implement anaerobic wastewater treatment		99.65	99.65	9,426	4.9	1.2
EE-3	Reuse sludge as boiler fuel		72.04	72.04	6,815	6.5	2.3
EE-4	Improve press performance by switching to shoe press	-9.77 <sup>a</sup>	385.12	273.42	28,732	174.0	15.8
EE-5	Enclose PM1&2 hood	2.05	73.63	97.04	8,579	83.2	2.7
EE-6	Implement heat recovery in PM3		114.34	114.34	10,816	9.5	0.7
EE-7	Implement exhaust humidity control in PM3&4	1.25	10.04	24.31	1,933	1.6	0.7
EE-8	Use heat pump to produce medium-pressure steam		5.79	5.79	547	0.4	1.8
EE-9	Insulate pipes and bare equipment		6.74	6.74	638	0.8	3.0
<b>Total</b>		-6.48	1,041.83	967.80	93,454	417.0	

<sup>a</sup>The negative electricity savings values mean that this measure (EE-4) will increase electricity consumption while saving thermal energy. However, the overall primary energy consumption resulting from this measure is positive.

<sup>b</sup>The CO<sub>2</sub> emission factors used for calculation in this case are 0.7880kg CO<sub>2</sub>/kWh for electricity and 94.60kg CO<sub>2</sub>/GJ for fuel.

<sup>c</sup>Renminbi (RMB)

<sup>d</sup>The primary energy price of 24.58 RMB/GJ is used in calculating the simple payback period for each measure.



### **5.1. Retrofit Low-efficiency Boilers (EE-1)**

The mill has six coal-fired steam boilers. Of these boilers, the original five boilers that were installed in 1990s are small middle-pressure and middle-temperature (3.82 MPa/450 °C) boilers with a steam load of 35 to 90 tonne/hour (h). The newest boiler was installed in 2002. It is a high-pressure and high-temperature boiler (9.80 MPa/540 °C) with 170 tonne/h of installation capacity.

Considering the higher efficiency of circulating fluidized-bed boilers (CFBs), the mill was already planning to install one new CFB to replace the original five low-efficiency and low-capacity boilers. The feasibility study performed by the mill prior to study shows that this retrofit could save 274.49 TJ of primary energy annually (includes an increase in self-generated electricity). Additionally, the retrofit will also reduce SO<sub>2</sub> emissions by 40 percent and CO<sub>2</sub> emissions by 4.1 percent for the mill.

### **5.2. Implement Anaerobic Wastewater Treatment (EE-2)**

Anaerobic wastewater treatment has many potential advantages compared with aerobic treatment. The advantages include using fewer chemicals, producing less sludge, and producing energy in the form of methane (Thompson, Swain, Kay, & Forster, 2001). Paper mill effluent contains abundant organic materials, so large amounts of methane gas (CH<sub>4</sub>) can be produced if the effluent is treated under anaerobic conditions. The CH<sub>4</sub> can be collected and burned in place of fossil fuel to generate electricity, either in the conventional CHP system or in a new biogas-based electricity generation system. A Biogas Utilization Clean Development Mechanism (CDM) Project conducted at Jingxing paper mill (another paper mill, located in Zhenjiang Province, China) showed that 39.29 TJ of final energy consumption can be avoided annually through the use of the biogas electricity generation system (UNFCCC, 2011).

The audited mill's existing wastewater treatment system has a capacity of 35,000 cubic meters (m<sup>3</sup>) per day. The CH<sub>4</sub> production potential from anaerobic treatment is estimated to be 14,000 m<sup>3</sup>/day, representing 99.65 TJ of primary energy. In addition to saving energy, the anaerobic system would mitigate greenhouse gas emissions because the small amount of CH<sub>4</sub> that is currently produced is released to the atmosphere directly rather than being recovered. The CO<sub>2</sub> mitigation potential from implementing anaerobic wastewater treatment is 1.5 percent of the total CO<sub>2</sub> emissions from the mill during the audited period.

### **5.3. Reuse Sludge as Boiler Fuel (EE-3)**

Sludge is a byproduct of the mill's wastewater treatment process. Traditionally, the paper mill's sludge has been disposed of at landfills, and the disposal costs account for 60 percent of wastewater treatment operating costs (Mahmood & Elliott, 2006). If the sludge were recovered and reused as fuel for the mill's steam-generating boilers, much of this cost could be reduced. Paper mill sludge consists mainly of fines and fillers from the papermaking process. The caloric value of dry solid can reach 11.5 MJ/kg. The primary investment for this measure would be the cost of sludge dehydration equipment. This measure

would reduce the fossil fuel used in boilers, thus mitigating the environmental impacts of obtaining the fuel as well as the emissions from burning it.

The mill's current sludge production is 100 tonnes per day, and the sludge water content is 75 to 80 percent. After the sludge is dehydrated to about 40 percent moisture, it can be mixed with fossil fuels and fed into boilers, resulting in 72.04 TJ of primary energy savings per year. Using sludge in the boilers will also reduce total CO<sub>2</sub> emissions from the mill by 1.1 percent with a payback period of only 2.3 years.

#### **5.4. Improve Press Performance by Switching to Shoe Press (EE-4)**

The papermaking process is essentially a massive dewatering process. Most of the water is removed in the wire section and press section of a paper machine; only about 1 percent of the original water content is removed in the dryer section (Kong & Liu, 2012). However, the dryer section is the largest energy user in terms of thermal energy utilization. Therefore, maximizing the performance of the press section is critical to minimizing the dryers' energy consumption (Reese, 2006). It is estimated that 3 to 8 percent of dryer steam can be reduced for every one-percent improvement in the solids content of web exiting the press section. The shoe press was developed to extend dwell time and thus improve mechanical dewatering in conventional roll presses. The web solids content leaving a shoe press can be as much as 50 to 55 percent, which will improve the overall energy efficiency despite even though a shoe press consumes more electricity than a conventional press does (Holik, 2006).

Table 5 shows the performance of the roll presses in the four paper machines at the mill. Even PM4, which has the highest-percentage exit solids (48 percent), has at least a two-percent dryness improvement potential. Assuming that retrofitting to a shoe press would result in exit solids of at least 50 percent, water evaporation in the dryer section would be reduced to 0.84 tonnes H<sub>2</sub>O/tonne paper. This would saving 8.4 and 29.4 percent of the steam required for the paper machines. Although electricity consumption would increase by 3.2 to 5.3 percent with the shoe press, this would be offset by the large thermal energy savings. The total energy-efficiency improvement potential from switching to shoe presses for the four paper machines is 4.06 percent, equivalent to 273.42 TJ/year. Although the simple payback period of this measure is longer than for some of the other measures, the measure will reduce annual CO<sub>2</sub> emissions from the mill by 28,732 tonnes.

**Table 5. Energy-efficiency potential of shoe press**

	PM1	PM2	PM3	PM4
<b>Solid content with current operations (%)<sup>a</sup></b>	42	42	46	48
<b>Optimized solid content with shoe press (%)<sup>b</sup></b>	50	50	50	50
<b>Current water evaporation in dryers (tonnes H<sub>2</sub>O/tonne paper)<sup>a</sup></b>	1.19	1.19	1.00	0.92
<b>Optimized water evaporation in dryers if shoe press is used (tonnes H<sub>2</sub>O/tonne paper)<sup>b</sup></b>	0.84	0.84	0.84	0.84
<b>Steam savings (%)</b>	29.4%	29.4%	16.0%	8.4%
<b>Electricity increase (%)</b>	5.3%	3.4%	3.7%	3.2%

<sup>a</sup> Current operation parameters with roll press

<sup>b</sup> Optimized operation parameters after retrofit from roll press to shoe press

### 5.5. Enclose Hoods in PM1&2 (EE-5)

The water evaporated during paper drying is captured and removed from the dryer by a hood air system. There are three types of paper machine hoods: open, semi-open, and closed. Open hoods are not used today, but semi-open hoods are still in use on some narrow paper machines. Modern paper machines are usually equipped with closed hoods, which are more energy efficient than other designs (Karlsson, 2000). A closed hood uses only one-third as much air as an open hood to remove the same amount of moisture (Kong, Li, et al., 2011). An estimated 15-20 percent reduction in steam can be achieved by replacing a semi-open hood with a closed hood. This, in turn, means a savings of about 40-50 percent of the electricity used by air-circulation fans. A closed hood reduces heat losses and allows recovery of more waste heat than is possible with a semi-open hood.

Both PM1 and PM2 have semi-open hoods. Based on the comparison shown in Table 6, we calculate that a 41 percent reduction in fan power requirements and an 11-percent steam savings for PM1 would result from retrofitting to a closed hood. The resulting overall energy savings for PM1 and PM2 would be 97.04 TJ/year, equivalent to 8,579 tonnes of energy-related CO<sub>2</sub> emissions per year.

**Table 6. Comparison of PM1 operation parameters with semi-open and closed hoods**

	Semi-open hood	Closed hood
<b>Air requirement (kg dry air/kg H<sub>2</sub>O)</b>	47.6	10.4
<b>Exhaust temperature (°C)</b>	45	80
<b>Exhaust humidity (grams H<sub>2</sub>O/kg dry air)</b>	45	120
<b>Dew point (°C)</b>	38	56
<b>Hood balance (%)</b>	30	80
<b>Supply air usage (kg dry air/kg H<sub>2</sub>O)</b>	14.3	8.3
<b>Supply air temperature (°C)</b>	32	95
<b>Supply air humidity (grams H<sub>2</sub>O/kg dry air)</b>	24	24

## **5.6. Implement Heat Recovery in PM3 (EE-6)**

A paper machine's heat recovery system is vital to the overall energy economy of the papermaking process (Sivill, Ahtila, & Taimisto, 2005). A large amount of the thermal energy used in the drying process ends up in the exhaust air. For a modern paper machine with an efficient heat recovery system, more than 60 percent of the exhaust heat from the dryer section can be recovered (Maltais, 1993; Pettersson & Söderman, 2007).

However, PM3 does not have a heat recovery system at all, and field testing documented that the temperature of PM3's exhaust was greater than 70°C. Thus, recovering the waste heat from PM3 could dramatically decrease the paper machine's energy consumption. We estimate that 114.34 TJ of thermal energy could be saved by installing a heat recovery system on PM3, which is equal to a reduction of 10,816 tonnes of energy-related CO<sub>2</sub> emissions. This measure is the most cost effective of all the measures identified, with a simple payback period of only 0.7 years.

## **5.7. Exhaust Humidity Control in PM3&4 (EE-7)**

The exhausted stream out of the paper machine hood is often used in place of fresh steam to heat different process streams, such as supply air, process water and circulation water (Kong, Liu, Li, & Tao, 2011). If the exhaust from the dryer section is not close to its moisture saturation point, energy will be wasted. Hood exhaust humidity control adjusts supply and exhaust air rates to ensure that the exhaust air moisture content remains close to the saturation point (Karlsson, 2000). Exhaust humidity control results in efficient drying performance and thus can reduce dryer thermal energy consumption as well as fan electricity consumption because the need for ventilation is reduced.

Neither PM3 nor PM4 has a humidity control system. As a result, ventilation is not being adjusted according to seasonal variations in environmental conditions. If exhaust humidity control were installed on PM3 and PM4, 1.25 GWh of electricity and 10.04 TJ of thermal energy could be saved annually. The associated carbon reduction potential is 1,933 tonnes CO<sub>2</sub> with only 0.7 years simple payback period.

## **5.8. Other measures (EE-8 & EE-9)**

Other energy-efficiency opportunities that would save less than 10 TJ/year of energy include EE-8, using a heat pump to produce medium-pressure steam instead of directly producing high-pressure steam, which would save 5.79 TJ/year of energy. EE-9, insulating steam pipes and other high-temperature equipment, would save 6.74 TJ/year of energy. The potential carbon reductions from EE-8 and EE-9 are 547 and 638 tonnes CO<sub>2</sub> per year, respectively.

## **6. Conclusions**

A plant-wide energy audit with the purpose of identifying energy conservation and CO<sub>2</sub> mitigation opportunities was implemented in a paper mill located in Guangdong province, China. The general energy audit methods and related Chinese national standards are illustrated. Also the calculation methods of energy and carbon indicators are introduced in this paper. The case study also demonstrates the significant energy savings potential that can be identified through plant-wide energy audits in paper mills.

As one of the Top-1000 energy-consuming enterprises in China, the studied paper mill produced 610,819 tonnes of paper products with 6,733 TJ of primary energy consumptions and 636,230 tonnes CO<sub>2</sub> emissions during the audit period. The average primary energy intensity of the paper mill was 11.0 GJ/tonne paper, and the CO<sub>2</sub> intensity was 1.04 tonnes CO<sub>2</sub>/tonne paper. The energy and CO<sub>2</sub> intensities of the four paper machines are also calculated respectively. The benchmarking of energy intensity index for the four paper machines shows that PM1 has the largest energy saving potential, representing 37 percent of energy consumption in PM1. The potentials for the other three machines vary between 8 percent and 11 percent.

Of the nine energy-efficiency improvement opportunities we identified based on an energy audit and calculation of energy and carbon indicators for a paper mill in Guangdong province, China, the top two measures for saving energy and reducing carbon emissions were retrofitting of a low-efficiency boiler and improving press performance by switching to a shoe press. The total technical energy savings potential for the paper mill is 967.8 TJ, which represents 14.4 percent of the mill's total energy consumption during the audit period. The associated CO<sub>2</sub> emissions reduction potential is 93,453 tonnes CO<sub>2</sub>, which represents 14.7 percent of the total CO<sub>2</sub> emissions from the mill during the audit period.

## **Acknowledgement**

The authors would like to thank the personnel at the paper mill where the energy audit was performed. Without their cooperation and support, this study would not been possible. The authors wish to thank the China Scholarship Council (CSC) for supporting one research team member's study at Berkeley Lab. We are also grateful to Nan Wishner for editing this paper.

## References

- Abdelaziz, E. A., Saidur, R., & Mekhilef, S. (2011). A review on energy saving strategies in industrial sector. *Renewable and Sustainable Energy Reviews*, 15(1), 150-168.
- Afshar, P., Brown, M., Austin, P., Wang, H., Breikin, T., & Maciejowski, J. (2012). Sequential modelling of thermal energy: New potential for energy optimisation in papermaking. *Applied Energy*, 89(1), 97-105.
- China Electricity Council (CEC) and U.S. Environmental Defense Fund (EDF). (2011). *The Current Status of Air Pollution Control for Coal-fired Power Plants in China*. Beijing: China Electric Power Press.
- U.S. Department of Energy (DOE). (2011). Industrial Assessment Center, December 31, 2011, from <http://iac.rutgers.edu/database>
- Gong, Z.-X., Stanovský, J., & Mujumdar, A. S. (2011). Energy audit of a fiberboard drying production line using simprosys software. *Drying Technology*, 29(4), 408-418.
- Hasanbeigi, A., & Price, L. (2010). *Industrial Energy Audit Guidebook: Guidelines for Conducting an Energy Audit in Industrial Facilities*. Berkeley (CA): Lawrence Berkeley National Laboratory, Environmental Energy Technologies Division; 2010 Oct. Report No.: LBNL-3991E.
- Hasanbeigi, A., Price, L., Lu, H., & Wang, L. (2010). Analysis of energy-efficiency opportunities for the cement industry in Shandong Province, China: A case study of 16 cement plants. *Energy*, 35(8), 3461-3473.
- Holik, H. (2006). *Handbook of Paper and Board*. Weinheim: WILEY-VCH Verlag GmbH & Co. KGaA.
- Hong, G.-B., Ma, C.-M., Chen, H.-W., Chuang, K.-J., Chang, C.-T., & Su, T.-L. (2011). Energy flow analysis in pulp and paper industry. *Energy*, 36(5), 3063-3068.
- Intergovernmental Panel on Climate Change (IPCC). (2006). *Intergovernmental Panel on Climate Change Guidelines for National Greenhouse Gas Inventories, Vol.2 Energy*.
- Karlsson, M. (2000). Papermaking Part 2, Drying. In J. Gullichsen & H. Paulapuro (Eds.), *Papermaking Science and Technology* (pp. 168-191). Helsinki, Finland: Fapet Oy.
- Kinstrey, R. B., & White, D. *Pulp and Paper Industry Energy Bandwidth Study*: Greenville (SC): Jacobs Engineering & Atlanta (GA): Institute of Paper Science and Technology (IPST) at Georgia Institute of Technology; 2006 Aug. Project Number: 16CX8700. Sponsored by the American Institute of Chemical Engineers (AIChE) and U.S. Department of Energy (DOE).
- Klugman, S., Karlsson, M., & Moshfegh, B. (2007). A Scandinavian chemical wood pulp mill. Part 1. Energy audit aiming at efficiency measures. *Applied Energy*, 84(3), 326-339.
- Kong, L., Li, J., Liu, H., & Yin, Y. (2011). *Survey of Paper Machine Dryer System - A Method to Analysis Energy Efficiency for Corrugated Paper Drying Process*. Paper presented at the 7<sup>th</sup> Asia-Pacific Drying Conference (ADC2011), Tianjin, China.
- Kong, L., & Liu, H. (2012). A static energy model of conventional paper drying for multicylinder paper machines. *Drying Technology*, 30(3), 276-296.

- Kong, L., Liu, H., Li, J., & Tao, J. (2011). Waste heat integration of coating paper machine drying process. *Drying Technology*, 29(4), 442-450.
- Lu, H., & Price, L. (2011). *Industrial Energy Assessments: A Survey of Programs Around the World*. Paper presented at the 2011 ACEEE Summer Study on Energy Efficiency in Industry, Niagara Falls, New York. .
- Mahmood, T., & Elliott, A. (2006). A review of secondary sludge reduction technologies for the pulp and paper industry. *Water Research*, 40(11), 2093-2112.
- Maltais, D. (1993). Heat recovery on a paper machine hood. *Pulp and Paper Canada*, 94(12), 113-117.
- Metz, B., Davidson, O. R., Bosch, P. R., Dave, R., & Meyer, L. A. (2007). (Eds.), *Climate Change 2007: Mitigation. Contribution of Working Group III to the Fourth Assessment Report of the Intergovernmental Panel on Climate Change (IPCC)*. Cambridge University Press, Cambridge, United Kingdom and New York, NY, USA.
- National Bureau of Statistics of China (NBSC). (2010). *China Energy Statistical Yearbook 2009*. Beijing, China Statistic Press.
- National Development and Reform Commission (NDRC). (1991). Calculation method of integrated energy consumption of pulp and paper making enterprise (QB 1022-1991), Beijing.
- National Development and Reform Commission (NDRC). (2009). Baseline emission factors for China's regional power Grids in 2009, December 20, 2011, from [http://qhs.ndrc.gov.cn/qfzjz/t20090703\\_289357.htm](http://qhs.ndrc.gov.cn/qfzjz/t20090703_289357.htm)
- Pettersson, F., & Söderman, J. (2007). Design of robust heat recovery systems in paper machines. *Chemical Engineering and Processing*, 46(10), 910-917.
- Phylipsen, D., Blok, K., Worrell, E., & Beer, J. d. (2002). Benchmarking the energy efficiency of Dutch industry: an assessment of the expected effect on energy consumption and CO<sub>2</sub> emissions. *Energy Policy*, 30(8), 663-679.
- Reese, D. (2006). Save energy by optimizing paper machine clothing. *Solutions - for People, Processes and Paper*, 89(4), 21-29.
- Reese, D. (2012). Improve Paper Machine Energy Performance. Dick Reese and Associates Inc. Personal communication.
- Schleich, J. (2004). Do energy audits help reduce barriers to energy efficiency? An empirical analysis for Germany. *International Journal of Energy Technology and Policy*, 2(3), 226-239.
- State Electricity Regulatory Commission (SERC). (2011). Power generation business briefing of China in 2010, December 20, 2011, from [http://www.serc.gov.cn/zwgk/jggg/201109/t20110901\\_15293.htm](http://www.serc.gov.cn/zwgk/jggg/201109/t20110901_15293.htm)
- Shen, B., Price, L., & Lu, H. (2012). Energy audit practices in China: National and local experiences and issues. *Energy Policy*, 46(0), 346-358.
- Sivill, L., Ahtila, P., & Taimisto, M. (2005). Thermodynamic simulation of dryer section heat recovery in paper machines. *Applied Thermal Engineering*, 25(8-9), 1273-1292.
- Thompson, G., Swain, J., Kay, M., & Forster, C. F. (2001). The treatment of pulp and paper mill effluent: a review. *Bioresource Technology*, 77(3), 275-286.

Trudeau, N., Tam, C., Graczyk, D., & Taylor, P. (2011). *Energy Transition for Industry: India and the Global Context*. Paris, France: International Energy Agency (IEA), Energy Technology Policy Division.

United Nations Framework Convention on Climate Change (UNFCCC). (2011). Biogas Utilization Project in Zhejiang Jingxing Paper Joint Stock Co. Ltd. CDM project design document (Version 2.2).

Worrell, E., Bernstein, L., Roy, J., Price, L., & Harnisch, J. (2009). Industrial energy efficiency and climate change mitigation. *Energy Efficiency*, 2(2), 109-123.