

UC Irvine

UC Irvine Previously Published Works

Title

Regulation of Chlamydia Gene Expression by Tandem Promoters with Different Temporal Patterns

Permalink

<https://escholarship.org/uc/item/7h22p61d>

Journal

Journal of Bacteriology, 198(2)

ISSN

0021-9193

Authors

Rosario, Christopher J
Tan, Ming

Publication Date

2016-01-15

DOI

10.1128/jb.00859-15

Peer reviewed

Regulation of *Chlamydia* Gene Expression by Tandem Promoters with Different Temporal Patterns

Christopher J. Rosario,^a Ming Tan^{a,b}

Department of Microbiology and Molecular Genetics^a and Department of Medicine,^b University of California, Irvine, California, USA

ABSTRACT

Chlamydia is a genus of pathogenic bacteria with an unusual intracellular developmental cycle marked by temporal waves of gene expression. The three main temporal groups of chlamydial genes are proposed to be controlled by separate mechanisms of transcriptional regulation. However, we have noted genes with discrepancies, such as the early gene *dnaK* and the midcycle genes *bioY* and *pgk*, which have promoters controlled by the late transcriptional regulators EUO and σ^{28} . To resolve this issue, we analyzed the promoters of these three genes *in vitro* and in *Chlamydia trachomatis* bacteria grown in cell culture. Transcripts from the σ^{28} -dependent promoter of each gene were detected only at late times in the intracellular infection, bolstering the role of σ^{28} RNA polymerase in late gene expression. In each case, however, expression prior to late times was due to a second promoter that was transcribed by σ^{66} RNA polymerase, which is the major form of chlamydial polymerase. These results demonstrate that chlamydial genes can be transcribed from tandem promoters with different temporal profiles, leading to a composite expression pattern that differs from the expression profile of a single promoter. In addition, tandem promoters allow a gene to be regulated by multiple mechanisms of transcriptional regulation, such as DNA supercoiling or late regulation by EUO and σ^{28} . We discuss how tandem promoters broaden the repertoire of temporal gene expression patterns in the chlamydial developmental cycle and can be used to fine-tune the expression of specific genes.

IMPORTANCE

Chlamydia is a pathogenic bacterium that is responsible for the majority of infectious disease cases reported to the CDC each year. It causes an intracellular infection that is characterized by coordinated expression of chlamydial genes in temporal waves. Chlamydial transcription has been shown to be regulated by DNA supercoiling, alternative forms of RNA polymerase, and transcription factors, but the number of transcription factors found in *Chlamydia* is far fewer than the number found in most bacteria. This report describes the use of tandem promoters that allow the temporal expression of a gene or operon to be controlled by more than one regulatory mechanism. This combinatorial strategy expands the range of expression patterns that are available to regulate chlamydial genes.

A defining feature of the pathogenic bacterium *Chlamydia* is an unusual intracellular developmental cycle with three main stages (1). During the early stage, an extracellular form of chlamydiae, called the elementary body (EB), enters the host eukaryotic cell and differentiates into a reticulate body (RB), which is the metabolically active but noninfectious form. During the midstage, the RB replicates via multiple rounds of binary fission. Finally, in the late stage, RBs convert back into infectious EBs. This developmental cycle lasts 48 to 72 h and ends with the release of EBs to infect a new host cell. These fundamental steps of the developmental cycle are conserved among species of the genus *Chlamydia*, even though members of this genus cause different infections ranging from sexually transmitted disease to infectious blindness and pneumonia (2).

Another characteristic feature of the intracellular *Chlamydia* infection is the temporal expression of chlamydial genes in three main classes that correspond to these three stages of the developmental cycle (3–5). Early genes are transcribed within 1 to 3 h of chlamydial entry, when the EB is beginning to convert into an RB. Midcycle genes, which make up the large majority of chlamydial genes, are first expressed during RB replication. Late genes, many of which have important roles in RB-to-EB conversion or EB function, are first transcribed or upregulated at late times.

The temporal classes of chlamydial genes are differentially regulated by specific mechanisms (6). DNA supercoiling, which

peaks in midcycle, is proposed to regulate genes with supercoiling-responsive promoters, which include midcycle genes and a subset of early genes (7, 8). Late genes consist of two subsets that are transcribed by either the major chlamydial RNA polymerase, which contains the sigma factor σ^{66} , or an alternative RNA polymerase containing σ^{28} (7, 9–11). Both subsets of late genes, however, are negatively regulated by the same transcription factor, EUO, which appears to be the master regulator of late gene expression (12, 13). It is hypothesized that EUO prevents the premature expression of late genes, thereby delaying RB-to-EB conversion until after there has been sufficient RB replication (12).

Even though σ^{28} regulates a subset of late genes, there are questions about its temporal role in the developmental cycle. Three of the six known σ^{28} -dependent promoters in *Chlamydia trachoma-*

Received 21 October 2015 Accepted 24 October 2015

Accepted manuscript posted online 2 November 2015

Citation Rosario CJ, Tan M. 2016. Regulation of *Chlamydia* gene expression by tandem promoters with different temporal patterns. *J Bacteriol* 198:363–369. doi:10.1128/JB.00859-15.

Editor: R. L. Gourse

Address correspondence to Ming Tan, mingt@uci.edu.

Copyright © 2015, American Society for Microbiology. All Rights Reserved.

TABLE 1 *C. trachomatis* transcription templates used in this study

Plasmid	Promoter ^a	Reference or source
pMT1150	<i>omcAB</i> promoter region from -122 to +5	14
pMT1234	<i>pgk</i> promoter region from -266 to +5	Hilda Yu (unpublished data)
pMT1456	<i>bioY</i> P2 promoter region from -219 to +5	10
pMT1457	<i>dnaK</i> P2 promoter region from -269 to +5	10
pMT1662	<i>dnaK</i> P1 promoter region from -55 to +5	This work
pMT1663	<i>bioY</i> P1 promoter region from -55 to +5	This work

^a Nucleotide positions relative to the transcription start site at position +1.

tis control late genes (*hctB*, *tsp*, and *tlyC_1*). However, σ^{28} RNA polymerase also transcribes promoters for an early gene (*dnaK*) and two midcycle genes (*bioY* and *pgk*) (4, 10). Unexpectedly, we recently found that all six σ^{28} promoters are bound and repressed by EUO *in vitro* (13). Thus, σ^{28} -regulated genes appear to share a potential mechanism of late gene regulation, even though they have different temporal expression patterns.

To resolve this issue, we examined if the three genes with a σ^{28} -dependent promoter but a non-late expression profile can be regulated by additional mechanisms. In each case, the σ^{28} -dependent promoter was transcribed only at late times, but the gene was transcribed at earlier times from a second promoter. These tandem promoters allow the gene to be differentially regulated by two forms of chlamydial RNA polymerase and to have an overall expression pattern that differs from the temporal expression pattern of a single promoter.

MATERIALS AND METHODS

Construction of *in vitro* transcription plasmids. Promoter sequences were amplified from *C. trachomatis* serovar D UW-3/Cx genomic DNA by PCR or produced by annealing complementary oligonucleotides. Each promoter sequence was cloned upstream of the promoterless G-less cassette transcription template pMT1125 as previously described (14). All constructs were verified by sequencing (Genewiz). The plasmids used in this study are listed in Table 1.

Purification of recombinant EUO and σ^{28} proteins. Recombinant His-tagged *C. trachomatis* serovar L2 EUO (rEUO) was purified by nickel chromatography as previously described (9, 12). Purified rEUO was dialyzed in storage buffer (10 mM Tris HCl [pH 8.0], 10 mM MgCl₂, 0.1 mM EDTA, 100 mM NaCl, 10 mM 2-mercaptoethanol, 30% [vol/vol] glycerol) and stored at -70°C.

Overexpression of recombinant His-tagged *C. trachomatis* serovar L2 σ^{28} was performed as previously described (9), with slight modifications. The protein was purified by nickel chromatography under denaturing conditions. Protein lysate was prepared in buffer N (10 mM Tris, pH 8.0, 0.3 M NaCl, 10 mM β -mercaptoethanol) containing 20 mM imidazole and 6 M urea and incubated with Ni-nitrilotriacetic acid beads. Bound protein was successively washed with 25 ml buffer N containing 20 mM imidazole with 6, 3, 1, and 0 M urea. His-tagged protein was eluted with buffer N containing 250 mM imidazole. The protein was then dialyzed in storage buffer and stored at -70°C.

EMSAs. Electrophoretic mobility shift assays (EMSAs) were performed as previously described (12). Labeled 60-bp DNA probes were incubated with 160 nM rEUO at room temperature for 20 min. Samples were electrophoresed on a 6% EMSA polyacrylamide gel. The gel was dried and exposed to a phosphorimager screen. The screen was scanned on a Bio-Rad Personal FX scanner.

Preparation of supercoiling and relaxed plasmid DNA templates. Plasmid DNA was first isolated from *Escherichia coli* using a Macherey-Nagel NucleoBond Xtra midprep kit. Plasmid DNA was further purified on a CsCl gradient by ultracentrifugation in TE buffer (10 mM Tris [pH 8.0], 1 mM EDTA) containing 5.9 M CsCl and 0.9 mg/ml ethidium bro-

midine in a Beckman NVT80 rotor at 58,000 rpm for 18 h at 20°C. The band corresponding to the supercoiled plasmid DNA was removed, cleaned with isopropanol to remove the ethidium bromide, and recovered by ethanol precipitation.

To relax the plasmid DNA, 10 μ g of CsCl gradient-purified plasmid DNA was treated with wheat germ topoisomerase I (Promega) as previously described (7). DNA relaxation was verified by electrophoresis on a 1% agarose gel in 1 \times TAE buffer (0.01 M Tris-acetate, 1 mM EDTA). The DNA concentration was measured using a NanoDrop ND1000 spectrophotometer.

***In vitro* transcription assays.** *In vitro* transcription of σ^{28} -dependent and σ^{66} -dependent promoters was performed as previously described (12, 13). Supercoiled or relaxed plasmid DNA (13 nM) containing the transcription template was transcribed by σ^{28} RNA polymerase, reconstituted from 1 μ l *C. trachomatis* recombinant His-tagged σ^{28} and 0.4 U *E. coli* RNA polymerase core enzyme (Epicentre), or 0.4 U *E. coli* σ^{70} RNA polymerase holoenzyme (Epicentre). rEUO (2.5 μ M) was added to some reaction mixtures where indicated. Transcripts were resolved on an 8 M urea-6% polyacrylamide gel and quantified with a Bio-Rad Personal FX scanner and Quantity One software (Bio-Rad). The effect of EUO was measured by normalizing the transcript levels in the presence of EUO to the levels in the absence of EUO, and the results are reported as a percentage. For each plasmid, transcription assays were performed as a minimum of three independent experiments, and values are reported as the mean of the repression + standard deviation.

RNA preparation. Mouse fibroblast L929 cells were infected with *C. trachomatis* lymphogranuloma venereum serovar L2 EBs at a multiplicity of infection of 3 in a 6-well plate. Total RNA was harvested from the infected cells with RNA STAT-60 (Tel Test) according to the manufacturer's directions. In brief, cells were resuspended in 1 ml RNA STAT, and the RNA in the aqueous layer was precipitated with isopropanol and resuspended in diethyl pyrocarbonate-treated water. DNA-free RNA was prepared by treating approximately 10 μ g RNA with 10 U RQ1 DNase (Promega) at 37°C for 2 h, and the absence of genomic DNA was verified by PCR.

5' RACE. Approximately 5 μ g DNA-free RNA was used for 5' rapid amplification of cDNA end (RACE) reactions with a First Choice RLM-RACE kit (Ambion) per the manufacturer's directions. RNA was modified at the 5' end by removal of the pyrophosphate with tobacco acid pyrophosphatase, followed by ligation of a DNA-specific sequence (Ambion). Reverse transcription (RT) was performed with Moloney murine leukemia virus reverse transcriptase in the presence of 250 ng random primers. Approximately 2 μ l of a cDNA preparation was used for PCR with a primer specific for the 5' ligated DNA sequence and a gene-specific primer. A second round of PCR was performed using the products from the first PCR together with a primer specific for a sequence on the 5' ligated DNA fragment and a gene-specific primer. PCR products were separated by electrophoresis on a 2% agarose gel and visualized by ethidium bromide staining. We verified that the PCR products corresponded to the chlamydial genes (promoters) under study by excising each PCR product from the gel using a Macherey-Nagel gel extraction kit, cloning it into the pGEM-T vector (Promega), and determining its DNA sequence (Genewiz).

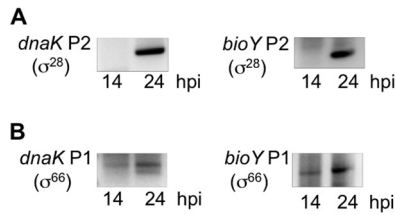

FIG 1 Temporal regulation of the σ^{28} - and σ^{66} -dependent promoters of *dnaK* and *bioY*. 5' RACE analysis of transcription from the σ^{28} -dependent P2 promoter (A) and σ^{66} -dependent P1 promoter (B) of *dnaK* and *bioY* performed on RNA extracted from *C. trachomatis*-infected cells at 14 and 24 hpi. Promoter-specific PCR products were resolved on a 2% agarose gel. Each band was excised and sequenced to confirm that the PCR product originated from the chlamydial promoter.

RT-PCR. RT was performed with approximately 2 μ g DNA-free RNA with 20 U avian myeloblastosis virus (AMV) reverse transcriptase (Promega) in the presence of 250 ng random primers (Invitrogen), 1 mM deoxynucleoside triphosphates, and 40 U RNasin (Promega) at 42°C for 50 min. The reactions were terminated by incubation at 70°C for 10 min. Approximately 2 μ l of the RT reaction mixture was used for PCR with gene-specific primers. PCR products were separated by electrophoresis on a 2% agarose gel and visualized by ethidium bromide staining.

qRT-PCR. Quantitative RT-PCR (qRT-PCR) was used to quantify the *bioY* transcripts at selected times in the chlamydial developmental cycle. cDNA was first generated using approximately 2 μ l DNA-free RNA (which is equivalent to 0.04% of the total amount of RNA in the sample), 20 U AMV reverse transcriptase (Promega), and a primer specific for the *bioY* gene. Real-time quantitative PCR (qPCR) was performed with a Bio-Rad iCycler iQ instrument, using the Bio-Rad iQ SYBR green master mix. Transcripts solely from *bioY* P1 were measured with one set of primers, while a second set of primers was used to measure the total transcripts from *bioY* P1 and P2. To normalize the results, genomic DNA was extracted from *Chlamydia*-infected L929 cells at each time point using a Qiagen DNeasy blood and tissue kit, and the number of genome copies was determined by qPCR using the same primer pairs. Expression at each time point was reported as the number of transcripts per genome. The standard deviation was determined for triplicate samples.

RESULTS

To understand the role of σ^{28} in *Chlamydia* temporal regulation, we first examined two chlamydial genes that are transcribed prior to late times, even though they each have a σ^{28} -dependent promoter controlled by the late regulator EUO (13). *C. trachomatis dnaK* and *bioY* have been classified as early and midcycle genes, respectively, in *Chlamydia* transcriptional profiling studies (4). However, this expression profiling was based on transcript levels for each gene and did not examine promoter-specific transcription. Using 5' RACE to examine promoter-specific transcripts from *C. trachomatis*-infected cells, we detected transcripts only from the σ^{28} -dependent promoters of *dnaK* and *bioY* at 24 h postinfection (hpi), which is late in the chlamydial developmental cycle, but not at 14 hpi, which corresponds to midcycle (Fig. 1A). Thus, these σ^{28} -dependent promoters are late promoters that cannot account for the expression of *dnaK* as an early gene and *bioY* as a midcycle gene.

We examined if the early onset of *dnaK* transcription (4) was due to a second *dnaK* promoter. In addition to its own σ^{28} -dependent promoter, *dnaK* is transcribed as part of an operon from a σ^{66} -dependent promoter (*dnaK* P1) upstream of *hrcA* (Fig. 2) (15). We detected transcription from *dnaK* P1 at both 14 and 24

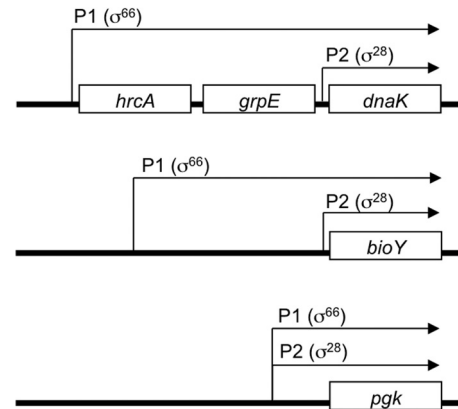

FIG 2 Diagram of tandem promoters for the *dnaK* operon, *bioY*, and *pgk* of *C. trachomatis*. The relative positions of the σ^{66} -dependent P1 promoters and σ^{28} -dependent P2 promoters are marked (the diagram is not to scale). Transcripts are indicated by arrows.

hpi, consistent with expression from midcycle or earlier (Fig. 1B). Thus, *dnaK* is transcribed from two promoters, with initial transcription from σ^{66} -dependent *dnaK* P1 taking place at early times and additional transcription from σ^{28} -dependent *dnaK* P2 taking place at late times.

These findings prompted us to examine if the biotin transporter gene *bioY* (16) also has a second promoter to account for its expression as a midcycle gene (4). Only a single σ^{28} -dependent *bioY* promoter has been reported to date (10). However, we noted that another transcription start site was mapped upstream of this *bioY* promoter in a *C. trachomatis* genome-wide deep sequencing study (17). By inspection, we identified sequences resembling the sequence of the optimal chlamydial σ^{66} promoter (18, 19) immediately upstream of this transcription start site (Fig. 3A). We tested

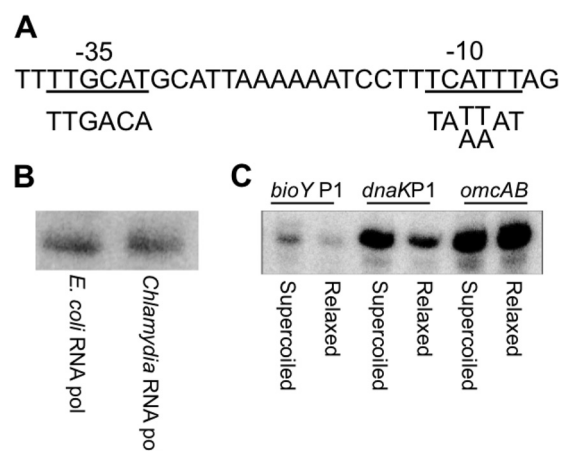

FIG 3 The *bioY* P1 promoter is transcriptionally active and supercoiling dependent. (A) Sequence of *bioY* P1. The predicted -35 and -10 elements are underlined, and the preferred *C. trachomatis* σ^{66} promoter sequences are shown below for comparison. (B) *In vitro* transcription of *bioY* P1 by *E. coli* RNA polymerase σ^{70} holoenzyme and partially purified *C. trachomatis* σ^{66} RNA polymerase, as indicated. *bioY* P1 was present on a supercoiled transcription template. (C) Comparison of *bioY* P1 transcription from supercoiled and relaxed plasmid templates. As controls, a supercoiling-independent promoter (*omcAB*) and a supercoiling-dependent promoter (*dnaK* P1) were also tested. Transcription reactions were performed with *E. coli* σ^{70} RNA polymerase.

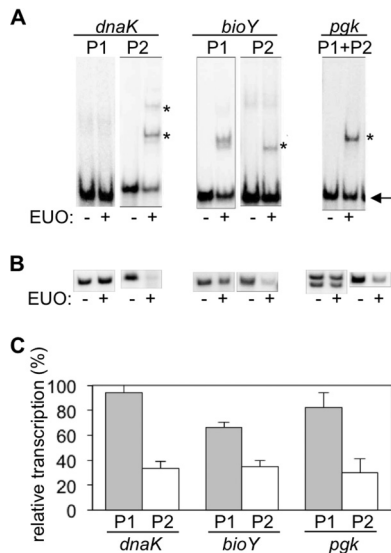

FIG 4 Promoter-specific binding and repression by the late regulator EUO. (A) EMSAs with the P1 (σ^{66}) or P2 (σ^{28}) promoter regions of *dnaK*, *bioY*, and *pgk*, performed in the absence or presence of 160 nM rEUO. Each promoter was present on a 60-bp DNA probe. Bands corresponding to the bound probes are represented by an asterisk, and the free probe is indicated with an arrow. (B) Representative *in vitro* transcription assays measuring the effect of EUO on these six promoters. The σ^{66} -dependent promoters were transcribed by *E. coli* σ^{70} RNA polymerase, and the σ^{28} -dependent promoters were transcribed with σ^{28} RNA polymerase reconstituted from *E. coli* core enzyme and recombinant *C. trachomatis* σ^{28} . Each assay was performed in the absence or presence of 2.5 μ M rEUO. (C) Graph showing the effect of EUO on the transcriptional activity of each promoter. For each promoter, transcription in the presence of EUO is reported as a percentage of the baseline level of transcription in the absence of EUO. Values are averages from at least 3 independent experiments with standard deviations (indicated by error bars).

this candidate *bioY* promoter in an *in vitro* transcription assay and found that it was transcribed by σ^{66} RNA polymerase (Fig. 3B) but not by σ^{28} RNA polymerase (data not shown). The σ^{66} -dependent *bioY* promoter was transcribed at a higher level from a supercoiled DNA template than from a relaxed template (Fig. 3C), demonstrating supercoiling-dependent promoter activity that is characteristic of chlamydial midcycle genes (7, 11). We propose to call this new σ^{66} promoter *bioY* P1 and to call the original σ^{28} promoter *bioY* P2, reflecting the location of P1 upstream of P2 (Fig. 2).

We used a promoter-specific 5' RACE analysis of *C. trachomatis*-infected cells to examine the temporal expression of *bioY* P1 and P2. σ^{66} -dependent *bioY* P1 was detected at 14 hpi (midcycle) and 24 hpi (late in the cycle), but σ^{28} -dependent *bioY* P2 was detected only at 24 hpi (Fig. 1). *bioY* thus provides another example of a gene that is first transcribed from a σ^{66} promoter before being expressed from a σ^{28} -dependent promoter at late times.

We next investigated if this differential control of tandem promoters is due to the temporal regulator EUO. EUO represses σ^{66} -dependent promoters of late genes (12), as well as all six known σ^{28} -dependent promoters (13). In EMSAs, recombinant *C. trachomatis* EUO produced a gel shift with DNA fragments containing *dnaK* P2 but not *dnaK* P1 (Fig. 4A). EUO also inhibited *dnaK* P2 but not *dnaK* P1 in an *in vitro* transcription assay (Fig. 4B and C), verifying that only σ^{28} -dependent *dnaK* P2 is an EUO target. EUO bound both *bioY* promoters (Fig. 4A), and it repressed σ^{28} -

dependent *bioY* P2 and caused modest inhibition of σ^{66} -dependent *bioY* P1 (Fig. 4B and C).

We then examined a third chlamydial gene that is transcribed prior to late times, even though it has a σ^{28} -dependent promoter. The phosphoglycerate kinase gene *pgk* is a midcycle gene (4) that has overlapping σ^{66} and σ^{28} promoters which initiate from the same transcription start site (Fig. 2) (10). In EMSAs, EUO bound to *pgk* (Fig. 4A), but we could not distinguish between binding to its σ^{66} and σ^{28} promoters since they overlap. Intriguingly, however, EUO inhibited transcription only of σ^{28} -dependent *pgk* P2 and not of σ^{66} -dependent *pgk* P1 (Fig. 4B and C). Thus, we found a consistent pattern in which EUO regulated the σ^{28} promoter of three tandem promoter pairs. EUO may also regulate *bioY* P1, although the modest inhibition suggests that EUO may cause only partial repression of this promoter.

We used qRT-PCR to determine the relative contributions of the tandem *bioY* promoters to overall expression of this gene over the course of the chlamydial developmental cycle. Using specific primers, we measured transcripts from *bioY* P1 alone and total transcripts from *bioY* P1 and *bioY* P2 (Fig. 5A). We could not directly measure P2-only transcript levels, because this promoter is downstream of P1 and there is no P2-specific mRNA sequence, but we were able to calculate P2 transcript levels by subtraction. At 8 and 16 hpi, the levels of total transcripts (P1 plus P2) were similar to P1 transcript levels (Fig. 5B). At 24 hpi, total transcript levels were modestly higher than those at 16 hpi, but levels from *bioY* P1 were only 34% of the total levels, implying that the majority of transcripts were now from P2. Total transcript levels were much lower at 32 hpi, but P1-only transcript levels were 42% of the total, again indicating more transcription from P2. The transcript levels measured from σ^{66} -dependent *bioY* P1 and the transcript levels calculated from σ^{28} -dependent *bioY* P2 are shown in Fig. 5C. These results indicate that P1 by itself can account for *bioY* transcription during midcycle, when there is no significant transcription from *bioY* P2. However, at late times in the developmental cycle, σ^{28} -dependent *bioY* P2 becomes active, and there is an additive effect of transcription from the tandem *bioY* promoters.

To identify additional temporally regulated tandem promoters, we used a bioinformatics approach to identify chlamydial genes with more than one promoter and then analyzed the expression pattern of each promoter during an intracellular chlamydial infection. We first examined the results from a genome-wide analysis of *C. trachomatis* transcripts for genes with more than one transcription start site (17). We next predicted the promoters for each transcription start site, based on sequence similarity to the optimal chlamydial σ^{66} and σ^{28} promoters (10, 18, 19). We then analyzed promoter-specific transcripts in *C. trachomatis*-infected cells at 12 hpi (midcycle) and 24 hpi (late in the cycle). With this approach, we identified a candidate σ^{28} promoter (P1) upstream of a predicted σ^{66} promoter (P2) for *ct415*, a gene of unknown function (Fig. 6A). Using RT-PCR, we detected a *ct415* P1-specific transcript only at 24 hpi, while a region of the transcript common to *ct415* P1 and P2 was detected at both 12 and 24 hpi (Fig. 6B). We then used 5' RACE to detect promoter-specific transcripts and found that σ^{66} -dependent P2 was transcribed only at 12 hpi, while σ^{28} -dependent P1 was expressed only at 24 hpi (Fig. 6C). *ct415* thus provides another example of a chlamydial gene with tandem promoters that have different temporal expression patterns and different mechanisms of regulation. The σ^{28} -dependent promoter

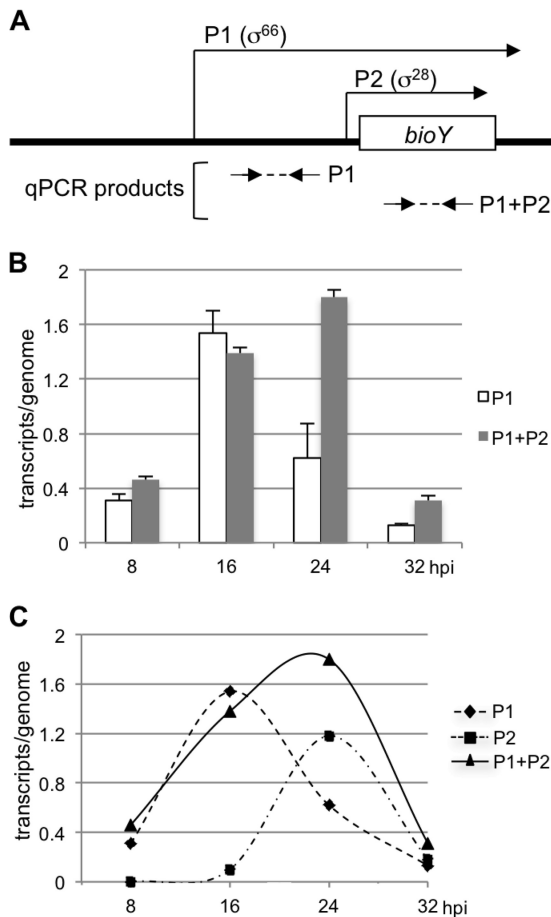

of *ct415* was similar to the other σ^{28} promoters in having a late transcriptional pattern.

DISCUSSION

This study describes a new mechanism of temporal regulation in *Chlamydia* in which genes are transcribed from tandem promoters that have different temporal expression profiles. Prior to this study, tandem promoters had been noted for a few chlamydial genes (19, 20), but they were not known to have a role in temporal gene regulation. We identified four *C. trachomatis* genes that each has a σ^{66} promoter which is transcribed prior to late times and a σ^{28} promoter that is expressed only late in the developmental cycle.

The four tandem promoter pairs that we studied showed dif-

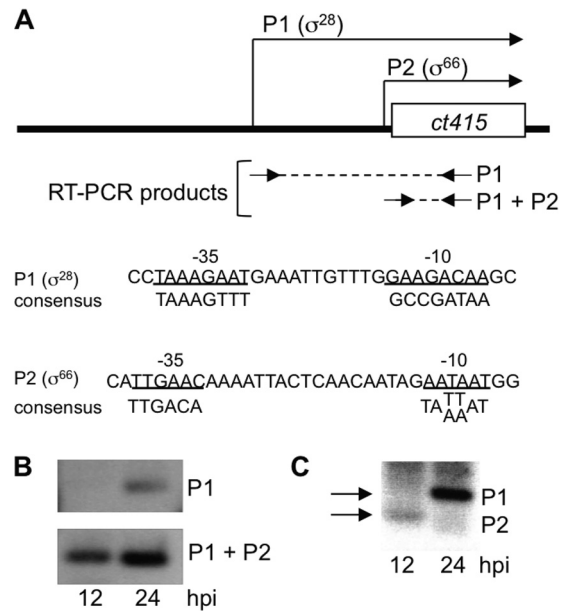

ferences in promoter organization (Fig. 2 and 6). *bioY* and *ct415* have a straightforward promoter arrangement in which a single gene is transcribed from two promoters, although with a different order of σ^{66} and σ^{28} promoters upstream of the gene. The tandem promoters of *pgk* overlap and initiate transcription from the same start site. *dnaK* has a more complicated configuration in which the gene is transcribed as part of an operon, while it also has its own internal promoter. In each case, however, one promoter was expressed prior to late times and the second promoter was detected during late development, suggesting that the order of the tandem promoters relative to the gene is not critical.

These findings highlight the key role of the promoter in allowing a chlamydial gene to be temporally regulated by a specific form of RNA polymerase and by different mechanisms of transcriptional control (6). For example, chlamydial genes with supercoiling-responsive promoters have been proposed to be upregulated in midcycle by increased chlamydial DNA supercoiling levels at this stage of the developmental cycle (7, 8, 11). In contrast, late genes have been proposed to be repressed during early times and midcycle by the transcription factor EUO, until this repression is relieved at late times by an as-yet-undefined mechanism (12, 13). This study makes a conceptual advance by demonstrating that a chlamydial gene can be regulated by more than one of these temporal mechanisms by having more than one promoter. However, it also shows the limitations of trying to predict the mechanism of transcriptional regulation from the temporal expression pattern

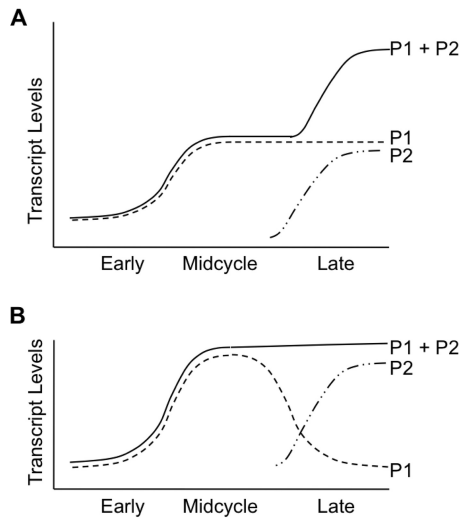

FIG 7 Graphs showing models for the effect of tandem promoters on the temporal expression of a gene. In both models, supercoiling-dependent transcription from P1 is upregulated in midcycle, when chlamydial DNA supercoiling levels are the highest, and transcription from P2 is repressed until late times by the transcription factor EUO. (A) Additive effect in which supercoiling-dependent transcription from P1 during midcycle is supplemented at late times by additional transcription from the late P2 promoter, leading to higher overall transcription of the gene (P1 + P2). (B) Alternative compensatory model in which P1 transcription decreases at late times in response to lower supercoiling levels but is replaced by late P2 transcription, which maintains overall transcription (P1 + P2).

of a chlamydial gene unless it is known that the gene is transcribed only from a single promoter.

Our qRT-PCR analysis of *bioY* transcription demonstrates how tandem promoters can contribute together to the overall expression of a chlamydial gene. Our approach allowed us to calculate the relative transcription from *bioYP1* and *bioYP2* at different times in the intracellular infection. In the midcycle stage, transcription was solely from σ^{66} -dependent *bioYP1*. However, when σ^{28} -dependent *bioYP2* was turned on at late times, transcription from the tandem promoters had an additive effect, resulting in higher overall transcript levels at 24 hpi (Fig. 5C). Thus, an additional late promoter provides a mechanism to boost transcription at late times (Fig. 7A).

Intriguingly, our four tandem promoters appear to have a similar architecture with a supercoiling-dependent, early or midcycle promoter paired with a late σ^{28} -dependent promoter. The supercoiling responsiveness of *dnaK* P1, *pgk* P1 (7), and *bioY* P1 (Fig. 3C) have been experimentally confirmed. *ct415* P2 is also predicted to be supercoiling dependent because *ct415* is a midcycle gene (4), but we have not analyzed this promoter because of its weak *in vitro* activity (data not shown). Changes in DNA supercoiling during the chlamydial developmental cycle have been examined by measuring the superhelical density of the plasmid, which is a commonly used surrogate marker of chromosomal DNA supercoiling in bacteria (21). This approach has shown that chlamydial DNA supercoiling levels are the highest in midcycle, with lower levels being found early and late in the intracellular infection (7). This temporal pattern predicts that supercoiling-dependent promoters have a low level of initial transcription that increases in midcycle and then decreases at late times, which is the transcriptional profile that we determined for supercoiling-de-

pendent *bioYP1* (Fig. 5C). Tandem promoters may then represent a compensatory mechanism in which decreased transcription from a supercoiling-dependent promoter at late times is offset by transcription from the late promoter (Fig. 7B).

Our study focused on understanding why some genes controlled by late regulators have a non-late expression pattern and thus may have been biased toward identifying the combination of a supercoiling-dependent, non-late promoter and a late promoter. We anticipate that there are likely to be additional combinations of temporal promoters in *Chlamydia*, leading to a wider repertoire of transcriptional profiles beyond the three main temporal classes of early, midcycle, and late genes that have been described.

Tandem promoters also make it more difficult to study chlamydial transcriptional regulators because they obscure the contribution of an individual promoter to the temporal expression pattern of the gene. For example, the temporal role of σ^{28} has been ambiguous because σ^{28} RNA polymerase transcribes genes with different temporal patterns, ranging from early to midcycle to late expression (10). The late expression pattern of three of these σ^{28} -dependent genes (*hctB*, *tsp*, and *tlyC_1*) was apparent because these genes are transcribed only from a single σ^{28} -dependent promoter (9, 10). However, we now know that late expression from the σ^{28} -dependent promoters of *dnaK*, *bioY*, *pgk*, and *ct415* was not obvious from transcriptional profiling studies (4) because each of these genes is transcribed from earlier times by a second promoter. Analyses at the promoter level have been necessary to reveal that these σ^{28} -dependent promoters share a consistent pattern of late temporal expression (13; this study). These findings clarify the role of σ^{28} RNA polymerase as an alternative chlamydial RNA polymerase that transcribes late promoters.

Tandem promoters also provide an explanation for why the late regulator EUO is able to bind and repress promoters for the non-late genes *dnaK*, *bioY*, and *pgk* (13). We showed that each of these three genes has a late promoter that is regulated by σ^{28} and EUO, but the late transcriptional pattern was not apparent because of a second promoter. We have also made an interesting observation that EUO appears to repress the σ^{28} promoter and not the σ^{66} promoter of *pgk*, even though these promoters overlap. How EUO selectively regulates the σ^{28} promoter is not known, but we speculate that EUO-operator binding may cause greater steric hindrance of σ^{28} RNA polymerase-promoter binding than σ^{66} RNA polymerase-promoter binding. Alternatively, EUO-operator binding may selectively affect other steps in σ^{28} RNA polymerase-dependent transcription initiation, such as isomerization or promoter clearance. These findings affirm the role of EUO as a critical regulator of late chlamydial genes. They also emphasize that a transcriptional regulator controls the temporal expression of its target promoter but not necessarily that of its gene.

In summary, we describe how a *Chlamydia* gene can be controlled by two promoters, each with its own temporal pattern due to transcription by a specific form of RNA polymerase and regulation by different mechanisms. This strategy allows a chlamydial gene to be controlled by multiple regulatory signals and to have a hybrid temporal expression pattern that may not be possible with a single promoter. *Chlamydia* has a limited means to differentially regulate its genes because it has only about a dozen transcription factors (6, 19, 22–24). Tandem promoters provide a relatively simple approach to fine-tune the expression of a chlamydial gene by using existing mechanisms of temporal regula-

tion. This combinatorial approach also broadens the repertoire of temporal expression patterns that are available to regulate chlamydial genes.

ACKNOWLEDGMENTS

We thank Brett Hanson, Kirsten Johnson, Jennifer Lee, and Emilie Orillard for critical reading of the manuscript.

FUNDING INFORMATION

HHS | National Institutes of Health (NIH) provided funding to Ming Tan under grant number AI44198.

REFERENCES

- Moulder JW. 1991. Interaction of chlamydiae and host cells *in vitro*. *Microbiol Rev* 55:143–190.
- Batteiger BE, Tan M. 2014. *Chlamydia trachomatis* (trachoma, genital infections, perinatal infections, and lymphogranuloma venereum), p 2154–2170. In Bennett JE, Dolin R, Mandell GL (ed), Mandell, Douglas, and Bennett's principles and practice of infectious diseases, 8th ed. Elsevier Inc., Philadelphia, PA.
- Shaw EI, Dooley CA, Fischer ER, Scidmore MA, Fields KA, Hackstadt T. 2000. Three temporal classes of gene expression during the *Chlamydia trachomatis* developmental cycle. *Mol Microbiol* 37:913–925. <http://dx.doi.org/10.1046/j.1365-2958.2000.02057.x>.
- Belland RJ, Zhong G, Crane DD, Hogan D, Sturdevant D, Sharma J, Beatty WL, Caldwell HD. 2003. Genomic transcriptional profiling of the developmental cycle of *Chlamydia trachomatis*. *Proc Natl Acad Sci U S A* 100:8478–8483. <http://dx.doi.org/10.1073/pnas.1331135100>.
- Nicholson TL, Olinger L, Chong K, Schoolnik G, Stephens RS. 2003. Global stage-specific gene regulation during the developmental cycle of *Chlamydia trachomatis*. *J Bacteriol* 185:3179–3189. <http://dx.doi.org/10.1128/JB.185.10.3179-3189.2003>.
- Tan M. 2012. Temporal gene regulation during the chlamydial development cycle, p 149–169. In Tan M, Bavoil PM (ed), *Intracellular pathogens I: Chlamydiales*. ASM Press, Washington, DC.
- Niehus E, Cheng E, Tan M. 2008. DNA supercoiling-dependent gene regulation in *Chlamydia*. *J Bacteriol* 190:6419–6427. <http://dx.doi.org/10.1128/JB.00431-08>.
- Cheng E, Tan M. 2012. Differential effects of DNA supercoiling on *Chlamydia* early promoters correlate with expression patterns in midcycle. *J Bacteriol* 194:3109–3115. <http://dx.doi.org/10.1128/JB.00242-12>.
- Yu HHY, Tan M. 2003. Sigma 28 RNA polymerase regulates *hctB*, a late developmental gene in *Chlamydia*. *Mol Microbiol* 50:577–584. <http://dx.doi.org/10.1046/j.1365-2958.2003.03708.x>.
- Yu HHY, Kibler D, Tan M. 2006. *In silico* prediction and functional validation of sigma 28-regulated genes in *Chlamydia* and *Escherichia coli*. *J Bacteriol* 188:8206–8212. <http://dx.doi.org/10.1128/JB.01082-06>.
- Case ED, Peterson EM, Tan M. 2010. Promoters for *Chlamydia* type III secretion genes show a differential response to DNA supercoiling that correlates with temporal expression pattern. *J Bacteriol* 192:2569–2574. <http://dx.doi.org/10.1128/JB.00068-10>.
- Rosario CJ, Tan M. 2012. The early gene product EUO is a transcriptional repressor that selectively regulates promoters of *Chlamydia* late genes. *Mol Microbiol* 84:1097–1107. <http://dx.doi.org/10.1111/j.1365-2958.2012.08077.x>.
- Rosario CJ, Hanson BR, Tan M. 2014. The transcriptional repressor EUO regulates both subsets of *Chlamydia* late genes. *Mol Microbiol* 94:888–897. <http://dx.doi.org/10.1111/mmi.12804>.
- Wilson AC, Tan M. 2002. Functional analysis of the heat shock regulator HrcA of *Chlamydia trachomatis*. *J Bacteriol* 184:6566–6571. <http://dx.doi.org/10.1128/JB.184.23.6566-6571.2002>.
- Tan M, Wong B, Engel JN. 1996. Transcriptional organization and regulation of the *dnaK* and *groE* operons of *Chlamydia trachomatis*. *J Bacteriol* 178:6983–6990.
- Fisher DJ, Fernandez RE, Adams NE, Maurelli AT. 2012. Uptake of biotin by *Chlamydia* spp. through the use of a bacterial transporter (BioY) and a host-cell transporter (SMVT). *PLoS One* 7:e46052. <http://dx.doi.org/10.1371/journal.pone.0046052>.
- Albrecht M, Sharma CM, Reinhardt R, Vogel J, Rudel T. 2010. Deep sequencing-based discovery of the *Chlamydia trachomatis* transcriptome. *Nucleic Acids Res* 38:868–877. <http://dx.doi.org/10.1093/nar/gkp1032>.
- Schaumburg CS, Tan M. 2003. Mutational analysis of the *Chlamydia trachomatis* *dnaK* promoter defines the optimal –35 promoter element. *Nucleic Acids Res* 31:551–555. <http://dx.doi.org/10.1093/nar/gkg150>.
- Tan M. 2006. Regulation of gene expression, p 103–131. In Bavoil PM, Wyrick PB (ed), *Chlamydia: genomics and pathogenesis*. Horizon Bioscience, Wymondham, United Kingdom.
- Shen L, Shi Y, Douglas AL, Hatch TP, O'Connell CM, Chen JM, Zhang YX. 2000. Identification and characterization of promoters regulating *tuf* expression in *Chlamydia trachomatis* serovar F. *Arch Biochem Biophys* 379:46–56. <http://dx.doi.org/10.1006/abbi.2000.1854>.
- Peter BJ, Arsuaga J, Breier AM, Khodursky AB, Brown PO, Cozzarelli NR. 2004. Genomic transcriptional response to loss of chromosomal supercoiling in *Escherichia coli*. *Genome Biol* 5:R87. <http://dx.doi.org/10.1186/gb-2004-5-11-r87>.
- Bao X, Nickels BE, Fan H. 2012. *Chlamydia trachomatis* protein GrgA activates transcription by contacting the nonconserved region of sigma66. *Proc Natl Acad Sci U S A* 109:16870–16875. <http://dx.doi.org/10.1073/pnas.1207300109>.
- Song L, Carlson JH, Whitmire WM, Kari L, Virtaneva K, Sturdevant DE, Watkins H, Zhou B, Sturdevant GL, Porcella SF, McClarty G, Caldwell HD. 2013. *Chlamydia trachomatis* plasmid-encoded Pgp4 is a transcriptional regulator of virulence-associated genes. *Infect Immun* 81:636–644. <http://dx.doi.org/10.1128/IAI.01305-12>.
- Domman D, Horn M. 30 September 2015. Following the footsteps of chlamydial gene regulation. *Mol Biol Evol*. <http://dx.doi.org/10.1093/molbev/msv193>.