

# UC Berkeley

## UC Berkeley Electronic Theses and Dissertations

### Title

Nuclear Quality Assurance in University Research with Control System Design as a Case Study

### Permalink

<https://escholarship.org/uc/item/7936z4xq>

### Author

Kendrick, James Cunningham

### Publication Date

2019

Peer reviewed|Thesis/dissertation

Nuclear Quality Assurance in University Research with Control System Design as a Case Study

By

James Cunningham Kendrick

A dissertation submitted in partial satisfaction of the

requirements for the degree of

Doctor of Philosophy

in

Engineering – Nuclear Engineering

in the

Graduate Division

of the

University of California, Berkeley

Committee in charge:

Professor Per F. Peterson, Chair

Professor David M. Auslander

Professor Massimiliano Fratoni

Fall 2019



## Abstract

### Nuclear Quality Assurance in University Research with Control System Design as a Case Study

By

James Cunningham Kendrick

Doctor of Philosophy in Nuclear Engineering

University of California, Berkeley

Professor Per F. Peterson, Chair

This dissertation is focused on understanding the relationship between university research and commercial applications in the nuclear energy field, specifically through quality assurance in experimental nuclear engineering research in the Thermal Hydraulics Laboratory at the University of California, Berkeley. This dissertation includes the development of a novel control system for the Compact Integral Effects Test (CIET) Facility, including testing to demonstrate and validate the new design and implementation, which serves as a case study for the quality assurance approach developed here. Reproducibility, a necessary aspect of scientific investigation, and community, the relationships between the people and organizations involved in nuclear engineering research, are important themes that run throughout this dissertation.

Quality assurance practices are required in commercial nuclear energy applications and provide helpful guidance for achieving safe, reliable, and efficient utilization of nuclear energy and management and processing of radioactive materials. These practices may also be applied through a graded approach in research settings to support good scientific research, including reproducibility. Essential elements from the ASME NQA-1 nuclear quality assurance standard used in industry and from existing quality assurance practices in research environments are distilled and integrated into a new quality assurance program for the CIET Research Program within the Thermal Hydraulics Laboratory. A primary goal for this quality assurance program and all related implementation documentation is that they are applicable to a general set of university nuclear engineering research programs. The CIET quality assurance program can then be used to create a template for a quality assurance program useful for nuclear engineering research at universities, called the University Nuclear Quality Assurance (UNQA) Program. A wide adoption of the UNQA Program may lead to a broad community of university nuclear engineering laboratories and research groups that have chosen to implement quality assurance practices through the UNQA Program and who are committed to quality assurance in their research.

In this study of quality assurance in commercial and academic settings, the control system for a large, complex thermal hydraulics experimental facility, the CIET Facility, is designed, developed, tested, and used as a case study for the application of quality assurance practices in a university research setting. The major functions of the CIET control system are to collect and

communicate data from instrumentation and system operation, control the heat input into the facility, control the fluid flow in the facility, control the heat extracted from the facility, and to allow an operator to control the facility in real time. These major functions are directly mapped to the major elements of the control system. A modular structure, task and state organization, and principles from object-oriented design are used in this dissertation to create a modular control system that is flexible for the end user, extensible for future development and expansion, and maintainable with the least effort (or cost) needed from students who are most likely not experts in the hardware and software used. To realize the CIET control system, the programming software LabVIEW is used in combination with hardware from the same parent company, National Instruments. The design and implementation of the CIET control system, both the hardware and LabVIEW code, are documented through two procedures designed to provide a record of the design process within the CIET quality assurance program. This research and thorough quality assurance integration for the CIET control system lays the foundation for its conversion into an advanced reactor test bed.

The CIET quality assurance program that will serve as the prototype for the UNQA Program, including the community of nuclear engineering research developed alongside it, and the foundational development of a control system needed for the conversion of the CIET Facility into an advanced reactor test bed are the primary goals of the research presented in this dissertation. An advanced reactor testbed is an excellent exploratory research and development tool for the university environment to test new ideas and concepts not ready for industrial development. A quality assurance program ensures this research and development both adheres to good scientific practices and is readily usable in more regulated spaces, such as national laboratories and in industry, and in other university research environments who wish to pursue similar goals.

*To my grandparents, Mrs. Joyce and Dr. Bart Kendrick,  
My Nina and Big Daddy*

# Table of Contents

Table of Contents.....	ii
List of Figures.....	v
List of Tables .....	vii
Acknowledgements.....	viii
1 Introduction .....	1
1.1 The Fluoride-Salt-Cooled High-Temperature Reactor .....	1
1.1.1 FHR Class Description .....	1
1.1.2 Integrated Research Projects.....	3
1.1.3 The Compact Integral Effects Test Facility and Research Program.....	4
1.2 Design and Role of Integral Effects Tests in Reactor Development and Licensing .....	7
2 Nuclear Quality Assurance and Reproducibility .....	10
2.1 Introduction .....	10
2.1.1 Reproducibility and Replicability.....	11
2.1.2 Regulatory Basis for Quality Assurance.....	13
2.1.3 ASME NQA-1 .....	17
2.2 Application of Quality Assurance in Universities.....	24
2.2.1 Definition and Purpose .....	24
2.2.2 Best Practices in Research and Development.....	28
2.3 Social Impact.....	35
2.3.1 Definition of Community.....	36
2.3.2 Community Development through Quality Assurance.....	37
2.4 Discussion Synthesis .....	39
3 The University Nuclear Quality Assurance Program .....	41
3.1 Challenges to Quality Assurance .....	41
3.1.1 Challenge Area: Conflicting Goals.....	42
3.1.2 Challenge Area: University Research Structure .....	44
3.1.3 Three Implementation Challenges .....	45
3.2 Quality Assurance Integration.....	47
3.2.1 Alignment of Goals.....	47
3.2.2 Alignment of Structures.....	50
3.2.3 Three Implementation Solutions.....	52

3.3	Implementation of the New Quality Assurance Program .....	54
3.3.1	Program Description .....	55
3.3.2	Specific Areas of Interest.....	57
3.3.3	NQA-1 Audits.....	60
3.4	Impact on Reproducibility.....	61
3.5	Future Work .....	62
3.5.1	UNQA Template Series .....	62
3.5.2	Creating the Quality Assurance Community .....	63
3.5.3	Call to Action.....	65
4	CIET Control System Design.....	67
4.1	Introduction .....	67
4.1.1	CIET Major Systems and Components.....	68
4.1.2	CIET Instrumentation and Control Hardware and Software .....	71
4.1.3	High-Level Architecture .....	77
4.1.4	Task and State Organization and Object-Oriented Design.....	80
4.2	Design of Control System Elements .....	82
4.2.1	Data Acquisition .....	83
4.2.2	Heater.....	90
4.2.3	Rotating Equipment .....	94
4.2.4	User Interface.....	99
4.2.5	Unique Aspects of LabVIEW .....	112
4.3	Future Work .....	113
5	Quality Assurance Case Study .....	115
5.1	Boeing 737 MAX Mini-Case Study.....	116
5.2	Design Procedure for Instrumentation and Control Hardware.....	118
5.2.1	Designer Instructions .....	118
5.2.2	Verifier Instructions .....	124
5.3	Software Design Procedure for Control System .....	125
5.3.1	Designer Instructions .....	126
5.3.2	Verifier Instructions .....	130
5.4	Application in Integral Effects Tests.....	131
5.5	Future Work .....	133



6	Summary and Final Words .....	134
6.1	Quality Assurance and Reproducibility in Research.....	134
6.2	The University Nuclear Quality Assurance Program.....	137
6.3	CIET Control System Development .....	140
6.4	Integral Effects Test Expansion .....	142
7	References .....	144
8	Appendices .....	152
8.1	CIET Test Procedure Template.....	153
8.2	PXIe System Control Hardware.....	173

## List of Figures

Figure 1.1. 3-dimensional rendering of the CIET Facility with the main components identified (left) and a picture of the facility in reality (right).....	5
Figure 1.2. Simplified CIET piping and instrumentation diagram. ....	6
Figure 1.3. Elements of the EMDAP [16]. ....	8
Figure 4.1. Piping and instrumentation diagram for the CIET Facility. ....	69
Figure 4.2. Thermocouple and Coriolis mass flow meter signals and channels in the PXIe system. ....	73
Figure 4.3. Control hardware included in the PXIe system for the CIET Facility; image captured in National Instruments Measurement and Automation Explorer (NI MAX). ....	75
Figure 4.4. CIET control system high-level structure.....	79
Figure 4.5. State transition diagram for data acquisition and communication VI (DAQ.vi).....	84
Figure 4.6. Initialization of data acquisition control module (DAQ.vi). ....	86
Figure 4.7. Data collection and organization in the data acquisition control module (DAQ.vi)..	87
Figure 4.8. Data communication in the data acquisition control module (DAQ.vi). ....	88
Figure 4.9. Termination of data acquisition control module (DAQ.vi) upon closing. ....	89
Figure 4.10. Front panel for the data acquisition control module (DAQ.vi). ....	90
Figure 4.11. State transition diagram for power supply/heater control VI (Core.vi).....	91
Figure 4.12. Heater control module (Core.vi) with the default state of digital control, resistance feedback shown.....	93
Figure 4.13. State transition diagram for rotating component control using VFDs (VFD.vi).....	95
Figure 4.14. Initialization of the rotating equipment control module (VFD.vi). ....	96
Figure 4.15. Control state of the rotating equipment control module (VFD.vi). ....	97
Figure 4.16. Termination state of the rotating equipment control module (VFD.vi). ....	98
Figure 4.17. Front panel of the rotating equipment control module (VFD.vi). ....	99
Figure 4.18. State transition diagram for primary user interface VI.....	101
Figure 4.19. State transition diagram for secondary user interface VI(s). ....	102
Figure 4.20. Initialization structure of the user interface control module (System_Host.vi). ....	103
Figure 4.21. Code to display system data and communicate user inputs to other control modules within the user interface control module (System_Host.vi). ....	105
Figure 4.22. Termination state for the user interface control module (System_Host.vi). ....	106

Figure 4.23. Front Panel of the user interface control module (System_Host.vi) showing the user inputs available to the operator. ....	107
Figure 4.24. Front Panel of the user interface control module (System_Host.vi) showing the system data displayed for the operator's reference. ....	110
Figure 4.25. LabVIEW project item tree for the CIET control system. ....	111
Figure 6.1. CIET control system high-level structure (reproduction of Figure 4.4).....	140
Figure 8.1. Copy of Figure 4.3; Control hardware included in the PXIe system for the CIET Facility; image captured in National Instruments Measurement and Automation Explorer (NI MAX).....	173

## List of Tables

Table 2.1. Timeline and description of quality management system (QMS) development, implementation, and accreditation for two laboratories in Brazil (LACOR and LAPOR) [51]... 30	
Table 2.2. Essential elements and their descriptions for quality assurance programs designed for and implemented in research and development environments. .... 34	
Table 3.1. Comparison of the essential quality assurance elements distilled from reviewing best practices in other research and development (R&D) environments and from the NQA-1 standard. .... 47	
Table 3.2. CIET organizational roles and functional responsibilities ..... 53	
Table 6.1. Essential elements and their descriptions for quality assurance programs designed for and implemented in research and development environments (reproduction of Table 2.2). ..... 135	
Table 6.2. Comparison of the essential quality assurance elements distilled from reviewing best practices in other research and development (R&D) environments and from the NQA-1 standard (reproduction of Table 3.1). .... 136	

## Acknowledgements

People are what make life so special. My time at the University of California, Berkeley has been filled with brilliant, kind, and hardworking people who have shaped my experience and affected me deeply. It's impossible to recognize all the people who make this place, and my experience here, so special and rewarding, but I do want to take this opportunity to acknowledge some who have had an oversized and direct impact on me and the research presented here.

The graduate students who welcomed me into the Thermal Hydraulics Lab were Harry Andreades, Grant Buster, Andrew Greenop, Nils Haneklaus, Lakshana Huddar, Xin Wang, Nicolas Zweibaum, and our post-doc, Mike Laufer. The undergraduate students I worked with when I first came to Berkeley who showed me the ropes were Alan Yamanaka, Rohit Upadhyaya, and Eric Yehl. The graduate students that have joined the Thermal Hydraulics Lab during my time here that have made it wonderfully special include Clara Alivisatos, Omar Alzaabi, Dane de Wet, Shane Gallagher, Brian He, Ishak Johnson, April Novak, Theodore Ong, Chris Poresky, and Harry Andreades who decided to stick around for a post-doc. Undergraduate students I've worked with since starting here that continually impressed me and were excellent partners in research include AJ Albaaj, Jason Anderson, Matthew Clavelli, Joe Corvino, Sruthi Davuluri, Michael Jagadpramana, Brandon Kuhnert, Raleigh Lukas, and Sala Tiemann. For me, these will always be the students of the Thermal Hydraulics Lab. Professor Per Peterson has been a constant source of inspiration and encouragement and has always made himself available to meet and talk – the Thermal Hydraulics Lab has done amazing things under his leadership and it has been an honor and joy to be a small part of such an amazing group.

The Nuclear Engineering Department has been a home on campus for me and there are several people here who truly make it what it is for me. Professors who I gratefully consider friends are Peter Hosemann, Max Fratoni, and Rachel Slaybaugh. The staff who truly run the department and who have always been more than helpful are Brandon Anguiano-Andrade, Jeff Bickel, Alan Bolind, Christina Castellanos, AJ Gubser, Kirsten Wimple Hall, Sara Harmon, Hanna Loricca, and Lydia Liu. Other staff and professors who have added to my work in ways not often seen but deeply appreciated are Professor David Auslander, Professor George Anwar, and Tom Clark. Daren Jensen from the Idaho National Laboratory has also been an important resource for this work, good friend, and constant source of encouragement.

Outside of the extraordinary people on campus, my family have always been my supporters, encouragers, providers, and, well, my family – starting long before they road-tripped halfway across the U.S. with me and all my stuff in tow. My dad, Bret, my mom, Julia, and my brother, Reed, are simply my family and I wouldn't have made it this far without them. I can say the exact same for my grandparents, Bart and Joyce (Big Daddy and Nina), who've brought me so much joy and love.

Sanctuary Berkeley, the church that I've attended in Berkeley for most of my time here, has been and continues to be my constant home and where I've grown the most as a person. My family there include Alan Bolind; Brandon Borders; Luis and Saharai Caldera; David, Corynne, Elliott, and Caiden Escalante; Kayli Martinez; Aqshems Nichols; and Wesley and Jing Wu. Past family from Sanctuary who have left for other adventures with the Lord and who've made an impact on

my time in Berkeley include Brenda Gutierrez, Natalie Guzikowski, Kristen Lee, Olivia Lee, and Mayra Luna. I am so thankful for the hope and love that I share with all of my family at Sanctuary – Berkeley would not be my home and I would not be who I am now without them. However, I am unashamed to give all credit, honor, and glory for any good in me to the resurrecting power of Jesus Christ in my life.

People have been so important for my experience at Berkeley and have given me so much joy and so many wonderful opportunities. However, what is most special about every person is the image that we all bear. Each person I've met in my life bears the mark of their Creator and is wonderfully beautiful and beyond valuable because of Him – I'm sure, because of who He is, that this is true for everyone I haven't met as well. It is my sincere joy and thanksgiving that this work, as all my life, is for the glory of Jesus Christ our Savior.

*Soli Deo gloria*

# 1 Introduction

This dissertation is focused on understanding the relationship between university research and commercial applications in the nuclear energy field, specifically through quality assurance in experimental nuclear engineering research in the Thermal Hydraulics Laboratory at the University of California, Berkeley. This interest and exploration have been driven through the rich history of advanced nuclear power research in the Thermal Hydraulics Laboratory which most recently has focused on the fluoride-salt-cooled high-temperature reactor, an advanced nuclear fission reactor that shows promise for near-term commercial deployment in the U.S. and abroad. In this study of quality assurance in commercial and academic settings, the control system for a large, complex thermal hydraulics experimental facility is used as a case study for the application of quality assurance practices in a university research setting. Before exploring quality assurance and control systems, this chapter further introduces and discusses the fluoride-salt-cooled high-temperature reactor and its research and development progress in the Thermal Hydraulics Laboratory at the University of California, Berkeley. The thermal hydraulics experimental facility used in this dissertation is also discussed and its precedence and context within nuclear reactor research and development is defined.

## 1.1 The Fluoride-Salt-Cooled High-Temperature Reactor

The fluoride-salt-cooled high-temperature reactor (FHR) is a unique class of nuclear reactor that combines several favorable features of other nuclear reactor classes in a way that has made the FHR interesting both in research communities and, more recently, in industry. This section discusses the FHR class in general and the research and development, particularly at the University of California, Berkeley, that has supported and championed the FHR to be a reactor class of interest and significance.

### 1.1.1 FHR Class Description

The FHR is a unique combination of characteristics from the molten salt reactor (MSR), high-temperature gas-cooled reactor (HTGR), and sodium-cooled fast reactor (SFR). The two primary characteristics of the FHR are [1]:

1. *High-temperature, low-pressure molten-fluoride-salt coolant.* As the name suggests, the FHR takes its coolant-of-choice from the MSR. The most typical fluoride salt discussed for use in reactors is flibe ( $\text{Li}_2\text{BeF}_4$ ), often written FLiBe, a eutectic mixture of lithium- and beryllium-fluoride.
2. *Coated-particle graphite-matrix fuel.* The FHR uses TRISO particles (tristructural-isotropic particles composed of a fuel kernel of a uranium ceramic surrounded by four layers: porous buffer graphite, pyrolytic carbon, silicon carbide, and pyrolytic carbon) embedded in a graphite matrix as its fuel form, taken from HTGR research and development. The TRISO particle-laden graphite matrix can take several geometrical forms and sizes including cylindrical compacts, spherical pebbles, and prismatic plates.

Two important consequences of these characteristics are increased value from high-temperature heating and several improvements to system safety. High outlet temperatures increase the thermal efficiency (i.e. Carnot efficiency) of the system and are more valuable generally for

high-temperature chemical processing, such as those found in the petrochemical industry, some forms of water desalination, and those needed for the high-temperature production of hydrogen. Further, high outlet temperatures allow FHRs to take advantage of the Brayton power conversion cycle and thus significant advancement in gas turbine technologies and improved power conversion efficiency.

There are several improvements to system safety from the combination of a high-temperature, low-pressure molten salt and coated-particle graphite matrix fuel. Like sodium and other liquid metals, molten salts allow for near-ambient system pressures, reducing the stored energy in the fluid that is able to be released in a leak or similar accident. Low pressures also make pool-type configurations of the primary system feasible, where the reactor core is located within a larger pool of coolant as opposed to a loop-type design where the reactor core is located in series with the other major components of the primary system in a single or multiple coolant flow loops. Pool-type designs take advantage of the large thermal inertia around the core and provide the potential for natural circulation circuits within the reactor vessel, thus enhancing the safety of the system. Unlike sodium, fluoride salts are not violently reactive with air or water (specifically the oxygen therein). Fluoride salts also have large thermal margins between typical operating temperatures and boiling temperatures; flibe has a boiling temperature near 1400°C, significantly higher than normal maximum operating temperatures (generally between 600°C and 700°C).

A significant benefit of molten salts in FHRs is their ability to use natural circulation for the removal of decay heat in accident scenarios. Safety systems designed to take advantage of this include the DRACS (direct reactor auxiliary cooling system) and the RVACS (reactor vessel auxiliary cooling system). The ability to passively remove decay heat from a reactor, without the need for onsite power or operator intervention, is a key safety criterion of most advanced reactors and greatly increases their safety and simplicity by removing the need for complex layers of active safety systems necessary in traditional light-water-cooled reactors.

Altogether, these are compelling advantages of the FHR, but the reactor class has its challenges that must be addressed before commercialization and broad adoption. The primary challenges associated with this reactor design, as with most advanced reactors, stem from the choice of coolant and fuel. The molten salt coolant is challenging to produce, both because of hazardous constituents such as beryllium and enriched lithium-7, and because there is no developed supply chain necessary for fleet-scale quantities of coolant. The molten salt is also chemically corrosive, although corrosion is able to be limited (including corrosion of stainless steel 316, a common structural material) if the salt chemistry is held to strict specifications [2]. The use of flibe in particular brings the challenge of tritium management in the system as well due to the presence of lithium-6 and beryllium [3]. Challenges related to fuel are primarily related to fabrication, both fabrication of the high-assay low-enriched uranium (HALEU) and of the TRISO fuel particles and fuel form (e.g. compacts, pebbles, plates, etc.). The fuel, including all of its components, have been theoretically proven and demonstrated at test scales but there are no established supply chains that have demonstrated the scale and cost of production necessary for a fleet of FHRs.

TRISO-based fuels bring advantages and complications to nuclear waste generated by advanced reactors. TRISO particles and the graphite matrix they reside in present a very robust fuel form



and thus are resistant to chemical decomposition – an advantage for nonproliferation and a challenge for reprocessing. There are no significant advantages or disadvantages for TRISO-based fuel compared to traditional light water reactor fuel in the disposition of spent nuclear fuel. As TRISO-based fuel usage becomes more common there are myriad opportunities for optimization of this technology for reprocessing and disposition [4].

Given the strengths of FHR technology as well as cross-cutting challenges that are common to reactors and technologies beyond the FHR, the FHR has been the subject of significant research and development. The genesis of the FHR and the first major research efforts stemmed from academia and are discussed in the following section.

### 1.1.2 Integrated Research Projects

The FHR has generated significant interest in both academic and industrial settings. However, this reactor class was first studied in depth in academia, specifically through a research collaboration between universities and outside partners. This research collaboration was initially organized through a three-year Integrated Research Project (IRP) through the Department of Energy's Nuclear Energy University Programs (DOE NEUP) in 2011 [5]. This FHR IRP consisted of researchers from the Massachusetts Institute of Technology (MIT), the University of California at Berkeley (UCB), and the University of Wisconsin at Madison (UW) and included Westinghouse Electric Company as an industrial partner. The purpose of the IRP was to, “develop a path forward to a commercially viable salt-cooled solid-fuel high-temperature reactor with superior economic, safety, waste, nonproliferation, and physical security characteristics compared to light-water reactors,” [5]. Three integrating activities with experimental support were undertaken to meet this goal:

1. Commercial Basis: The commercial basis for an FHR with an air-Brayton combined cycle coupled with high-temperature heat storage was developed by MIT [6].
2. FHR Point Design: A detailed point design of a modular FHR, the “Mark 1” Pebble-Bed FHR, was developed by UCB to provide a credible design and define the major technical challenges [7].
3. Test Reactor: A preconceptual design of a fluoride-salt-cooled high-temperature test reactor (FHTR) and a test reactor strategy was developed by MIT [8].

Three major experimental programs, one at each university, were developed and performed to support the activities above. The experimental programs were:

1. Thermal Hydraulics Tests (UCB): UCB built large-scale thermal hydraulic loops using simulant fluids to provide experimental data for reactor design and code validation. The Compact Integral Effects Test (CIET) Facility was the primary outcome from this program and is discussed in more detail in the following section.
2. Materials Testing (UW): UW built and operated systems to purify the fluoride salts required for the FHR. These salts were then used in corrosion tests at prototypical temperatures for materials compatibility testing.
3. Materials Irradiations (MIT): MIT developed, built, and operated tests using prototypical FHR materials at prototypical temperatures in the MIT reactor under prototypical irradiation conditions expected in the FHR.

A series of workshops with subject matter experts from industry, academia, and national laboratories were held during the IRP to review technical and licensing challenges for FHRs. These workshops generated four white papers that summarize their discussions and conclusions which were invaluable for the research efforts of the IRP and continue to be key collections of research and discussion to support future research [9]-[12].

The success of this original FHR IRP led to two consecutive, independent FHR IRPs, one as a continuation of the original MIT-led IRP with the addition of the University of New Mexico, and the second as an independent FHR IRP led by the Georgia Institute of Technology (Georgia Tech or more simply GT) that included the University of Michigan, the Virginia Polytechnic Institute and State University (Virginia Tech), Texas A&M University at College Station, and Texas A&M University at Kingsville, with industry, national laboratory, and international research organization partners as well. The second MIT-led IRP continued the research and development from the previous three years' effort, allowing research to focus on technical challenges that are most important to FHR development and commercialization. These technical challenge areas included tritium control, corrosion control with redox control, impurity control, and materials selection; experiments and modeling for thermal hydraulics, neutronics, and structural mechanics; the design, performance, and evaluation of a benchmarking and validation campaign for FHR modeling and simulation tools; the design of a subcritical driven facility to be coupled to an existing test reactor; and further development of the commercialization basis for FHRs [13]. The GT-led FHR IRP, during the same time period, studied several key areas necessary for FHR development, some that constructively overlapped with the research in the MIT-led IRP and several unique research efforts. Research performed within the GT-led IRP included the study of the radiation environment for tritium management; liquid salt impurity removal and redox and corrosion control; identification and prioritization of verification and validation (V&V) needs through the use of PIRT (Phenomena Identification and Ranking Table) panels; development and demonstration of instrumentation systems for high-temperature liquid salt environments; qualification of alloys for structural applications; design, fabrication, testing, demonstration, and modeling of novel heat exchangers for FHRs; and V&V of neutronics and thermal hydraulics tools and methodologies to support licensing [14]. Both of these IRPs continued to further research and development of FHR technologies and led to the current research within the Thermal Hydraulics Laboratory at UCB.

### 1.1.3 The Compact Integral Effects Test Facility and Research Program

Initiated during the first FHR IRP, the Compact Integral Effects Test (CIET) Facility was designed to provide data on integral transient thermal hydraulic response of FHRs under forced and natural circulation, particularly startup and shutdown transients, loss of forced cooling (LOFC) and loss of heat sink (LOHS) accident transients, and passive, buoyant shutdown rod insertion during transients [15]. CIET has two coupled flow circuits that replicate the primary coolant flow circuit in FHRs, including bypass flow, and the DRACS flow circuit, a natural-circulation-driven loop designed to passively remove decay heat from the FHR core and reject it to the environment through a thermosyphon-cooled heat exchanger (TCHX). Figure 1.1 shows a computer aided design (CAD) image of the CIET Facility with the major components identified as well as the front of the facility in real life. Figure 1.2 is a simplified piping and instrumentation diagram for the facility where major components are identified and the coupled-

two-loop structure is clearly shown (in Figure 1.1 and Figure 1.2, CTAH is the coiled tube air heater, DHX the DRACS heat exchanger, DRACS the direct reactor auxiliary cooling system, and TCHX the thermosyphon-cooled heat exchanger). As an integral effects test (IET), the driving purpose of the CIET Facility was to provide validation data for evaluation models of FHR thermal hydraulic systems, such as RELAP5-3D, so that the evaluation models may be used to provide a licensing basis for advanced FHR designs. The historical significance and purpose of IETs is discussed in more detail in Section 1.2.

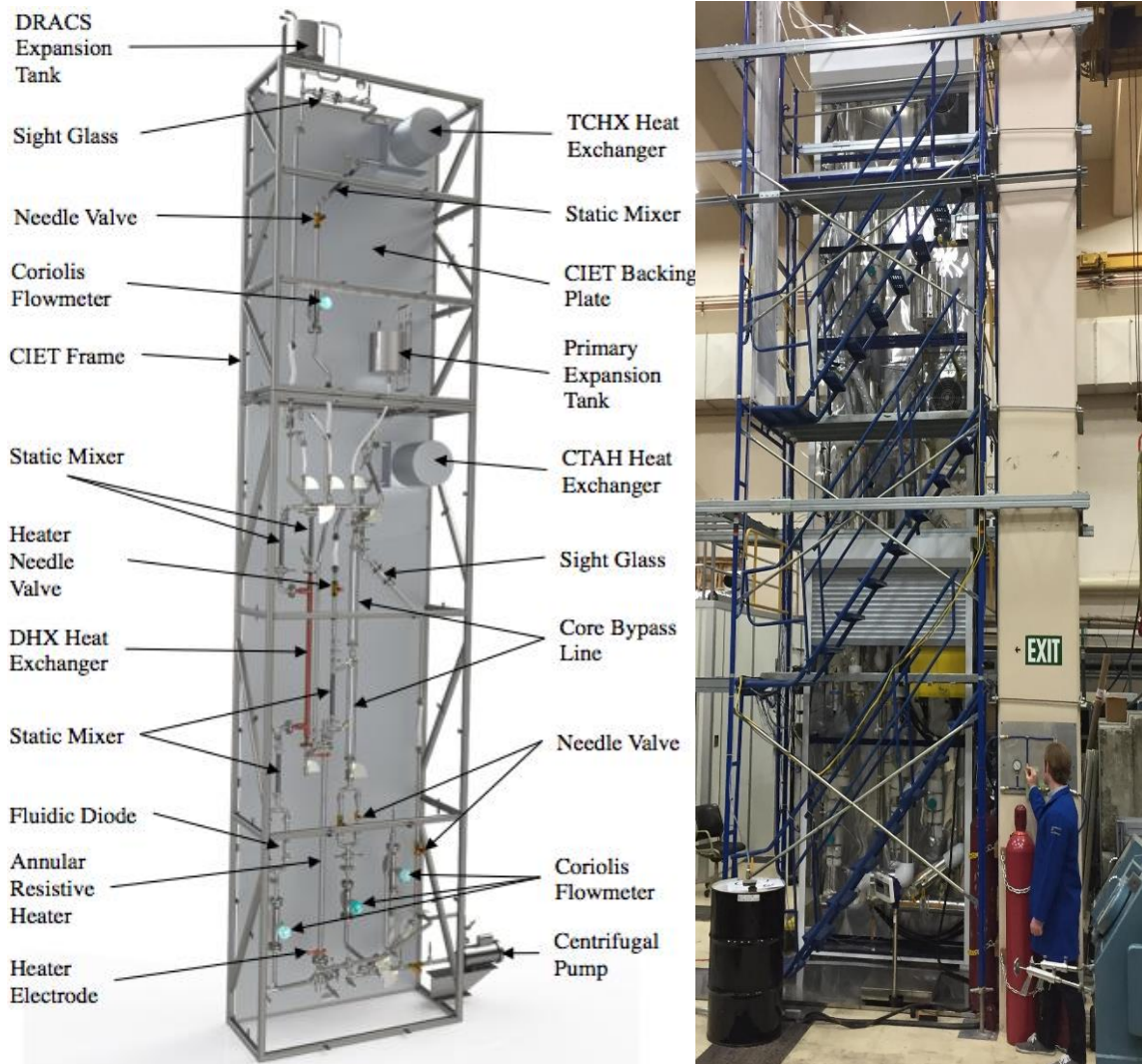

Figure 1.1. 3-dimensional rendering of the CIET Facility with the main components identified (left) and a picture of the facility in reality (right).

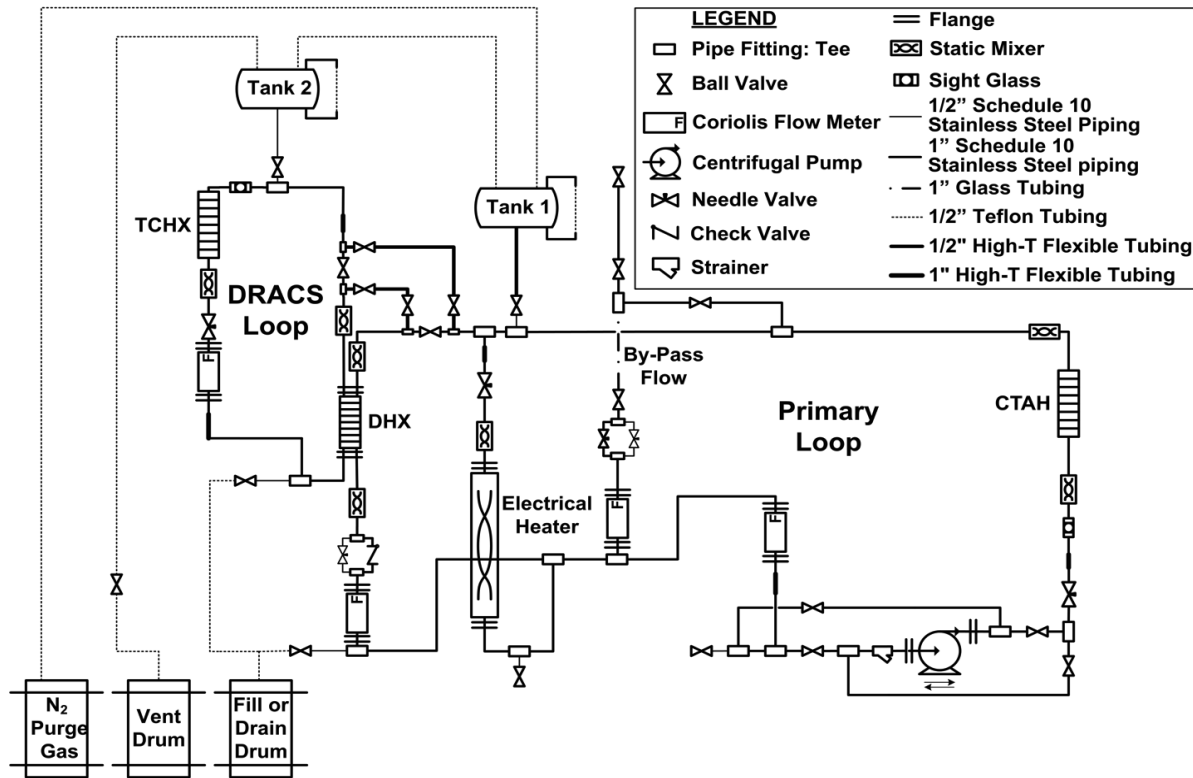

Figure 1.2. Simplified CIET piping and instrumentation diagram.

The original research plan for the CIET Facility was as follows:

1. *Isothermal forced circulation flow around the loop, with pressure data collection to determine friction losses in the system:* CIET-specific friction loss correlations were compared with handbook values, and empirically measured values were implemented in the system codes that were validated by data from CIET.
2. *Steady-state forced and coupled natural circulation in the primary loop and the DRACS loop:* collected data was compared to predicted performance and forms the validation basis for best estimate steady-state models.
3. *Thermal transients, including startup, shutdown, loss of forced circulation (LOFC) with scram and loss of heat sink (LOHS) with scram:* the set of collected data was meant to serve the double purpose of confirming strategies for operation of FHRs, and validating best estimate transient models.

The initial two tasks in the research plan were primarily for system characterization. CIET-specific pressure drop correlations for all parts of the flow paths in the facility were developed through isothermal forced circulation tests, while simple heated tests helped begin characterization of the performance of the system heat structures (electrical heater, CTAH, DHX, TCHX, and insulation) and the system thermal inertias. These correlations and insights were implemented in the systems analysis code, RELAP5-3D, to build a more accurate model of the CIET Facility to aid in validation activities of this widely accepted and industry standard evaluation model of reactor safety for severe accidents [15]. Within the third task, startup and shutdown tests are performed during every experiment and thus there is significant experience with these regimes of operation. However, a detailed analysis of startup and shutdown strategies

for FHRs has not been developed, thus the startup and shutdown routines for CIET are rudimentary and only meant to condition the system for testing and return the system to a cold, safe state following the test sequence. Minor experience has been gained with LOFC and LOHS with scram experiments, although thorough data analysis has not been performed. It was these tests, meant to study reactor-specific behavior, that revealed the need for more rigorous understanding and implementation of FHR behavior and operation within the CIET Facility. This need sparked the current interest in operating the CIET Facility as an advanced reactor test bed – this is the ongoing pursuit of the research around the CIET Facility. This body of research, with the CIET Facility at its center, is now named the CIET Research Program. The primary missions of the CIET Research Program are:

1. To develop best practices for designing and operating scaled IETs and developing impactful experimental/modeling programs.
2. To serve as an advanced reactor test bed for research in areas such as advanced reactor control strategies, cyber security strategy, human-machine interface development, and fault detection methodology and tool development.
3. To provide a high-quality user experience to train operators, designers, and regulators on the safe construction and operation of FHRs.

These missions continue to guide the CIET Research Program in its current research as new students have brought their unique perspectives and interests to the research topics covered by the CIET Research Program, leading its research to become significantly more varied over time.

## 1.2 Design and Role of Integral Effects Tests in Reactor Development and Licensing

Before moving into the body of this dissertation, it is important to understand the context and precedence in the nuclear engineering field that the CIET Facility was originally designed within and where it still finds itself. The CIET Facility, as the name suggests, is an integral effects test (IET) facility (also commonly referred to as an integral test facility (ITF)) which is a class of experiment specifically meant to be used in evaluation model development as defined by the U.S. Nuclear Regulatory Commission in their Evaluation Model Development and Assessment Process (EMDAP) [16]. Earlier use of IETs for evaluation model development for use in nuclear reactor design and analysis include the use of IETs within Zuber's hierarchical two-tiered scaling methodology (H2TS) [17] and within the code scaling, applicability, and uncertainty (CSAU) evaluation methodology [18]. In each of these methods, IETs are used as scaled experiments to provide data to validate evaluation models for a pre-defined use. The use of IETs in this way must be very intentionally done, where the evaluation model developer has already established all requirements for the evaluation model, has specified the objectives for the assessment data base, has performed and understands the necessary scaling analysis and has identified similarity criteria, and carefully evaluates scaling distortions and scaling and experimental uncertainties. Figure 1.3 shows the purpose of IETs within the overall EMDAP process.

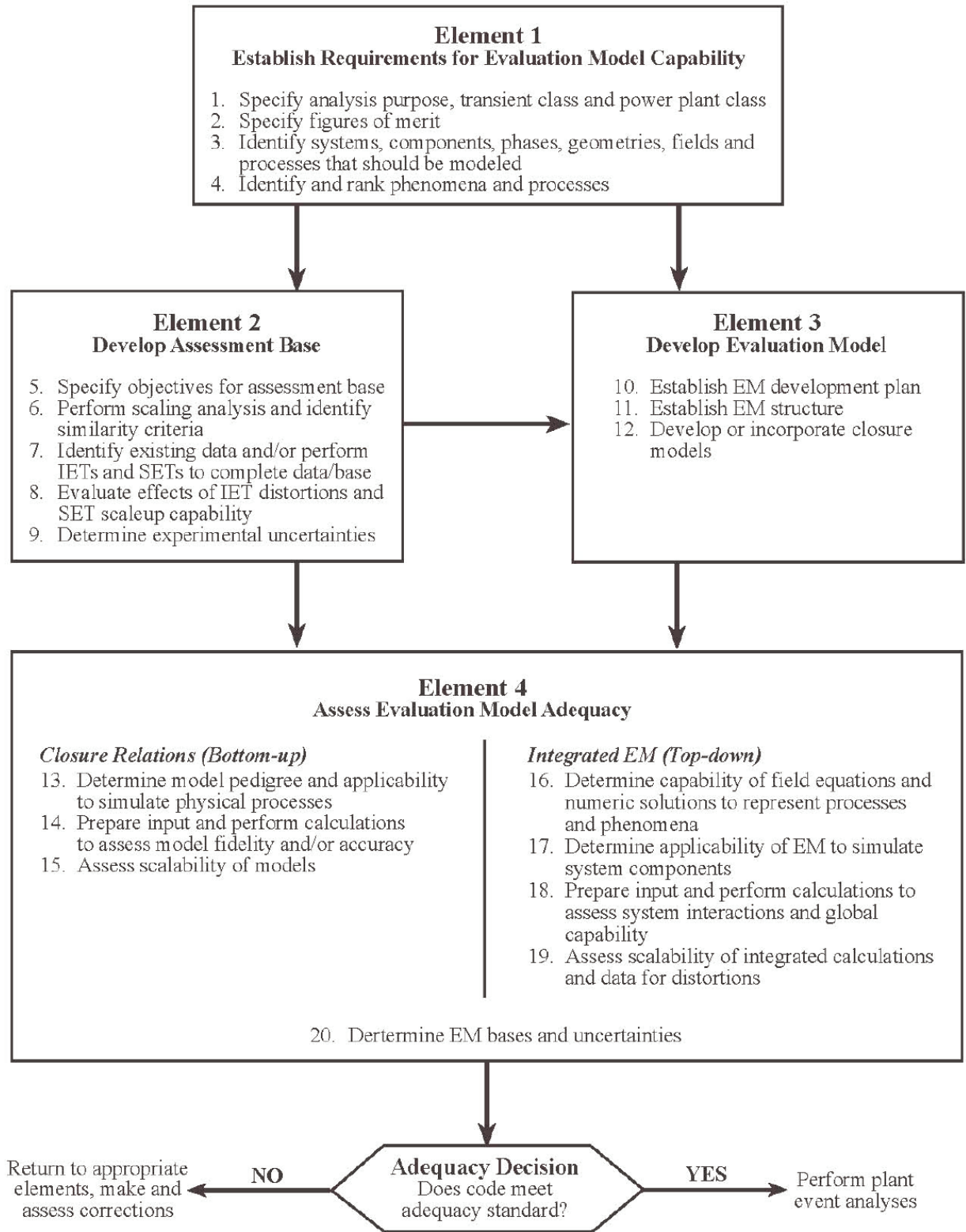

Figure 1.3. Elements of the EMDAP [16].

Important examples of IETs include the PKL Facility in Germany [19], the Semiscale Facility at the Idaho National Laboratory in the U.S. [20], and the APEX Facility [21] and the MASLWR Facility [22] at the Oregon State University in the U.S. These facilities have all been used for many purposes for the understanding and development of light-water nuclear reactors including to better understand accident scenarios and safety margins, to further validate thermal hydraulic system codes, for the verification and extension of operating manuals and procedures in nuclear power plants, for operator training, for exploratory research, as experimental test beds for safety technologies, to provide licensing basis for novel systems, and to develop and demonstrate new technologies and designs.

The CIET Research Program is intended for the basic purpose of IETs, to provide validation data for the development of evaluation models, but it is also capable of a much broader scope and impact on advanced reactor development – the example IET facilities listed here show that broader impacts are not only possible but desirable. IETs are generally large and expensive facilities requiring significant investment and support to operate for extended experimental campaigns. Therefore, there is clear motivation to use IETs for as much as possible – within reason and where careful analysis and study support extended applications. The missions of the CIET Research Program, defined in the previous section, reflect the desire to explore the boundaries of application for the CIET Facility and future advanced reactor IETs like it.

In order to use IETs and other research tools effectively, both for scientific progress and for nuclear reactor research and development, quality assurance is a key tool that must be considered. Chapter 2 addresses the relationship between quality assurance and reproducibility in research and how quality assurance practices standard in industry may be applicable to the university research environment. Chapter 3 builds upon this discussion by exploring the design and implementation of a quality assurance program that is compliant to the industry standard quality assurance requirements as well as fit-for-purpose for the university research environment and the unique challenges therein. Chapter 4 shifts focus to the control system design for the CIET Facility, an integral component that enables the mission of the CIET Research Program. This chapter discusses in more detail the major systems and components within the CIET Facility that are most relevant to the control system and then how the control system is designed to connect these systems and components to the facility operator. Chapter 5 then connects the development of the CIET control system to the CIET quality assurance program by showing how the control system is designed using quality assurance documents designed and created for this purpose. Chapter 6 is the final chapter in this dissertation and summarizes the major conclusions.



## 2 Nuclear Quality Assurance and Reproducibility

The capability to reproduce the results of experiments, modeling and simulation, and analysis is essential to academic scholarship and underpins requirements for the licensing and operation of nuclear energy technologies. Over the last decade, reproducibility has emerged as a key field of academic research due to shocking problems that have been identified in some peer reviewed archival journal publications, particularly within specific fields of scholarship where substantial fractions of published scholarship have been found to be unreproducible [23]-[27].

In contrast to some of the problematic scholarship practices that are now understood to occur with unacceptable frequency, regulated technologies have much stricter practices that include external audits that verify that results used to make regulatory decisions meet strict standards for reproducibility. The specific example of nuclear quality assurance, as is required by regulations of commercial nuclear facilities by the U.S. Nuclear Regulatory Commission (NRC), is used as an example in this dissertation.

Generally, the staffing, record keeping, formalized training, and external audits required to maintain a fully compliant nuclear quality assurance program exceed the capabilities of university research programs. A key goal of this dissertation is to review these requirements and recommend how the most important elements can be implemented in university-based research programs to assure that academic scholarship meets appropriate standards for reproducibility.

In reviewing the essential elements from the nuclear power industry's standard quality assurance requirements, there are several elements that are good practices in academic research particularly as they address challenges of reproducibility. These essential quality assurance practices include: applying a graded approach to quality practices that reflect the item or activity's significance, complexity, and importance to safety; keeping thorough and transparent documentation and record management; clearly defining the responsibility of all personnel for quality-related activities; including independent review and approval throughout all activities; thorough understanding of the as-built configuration of the system, including on-going inspections to ensure continued performance; and applying corrective action consistently and effectively. The distillation of these practices from the industrial quality assurance standard used in the nuclear field, their relationship to reproducibility, and how they may be incorporated in university research programs through a graded approach are explored in this chapter.

A primary outcome of this work is to develop a university-applicable version of a quality assurance program that is compliant with industry-standard quality assurance requirements, the University Nuclear Quality Assurance (UNQA) Program. The UNQA Program may then be used in other nuclear engineering university research programs to quickly and effectively implement quality assurance practices and significantly improve research reproducibility. The UNQA Program is discussed in detail in the next chapter.

### 2.1 Introduction

This chapter starts with a review of some of the challenges that have been found in reproducibility in academic research and the role that structured quality assurance procedures



and practices can play in enabling high-quality academic scholarship – a fundamental motivation for this dissertation. To provide context for the use of quality assurance to provide for reproducibility, the discussion turns to the distinct regulatory bases for quality assurance for commercial nuclear power plants and Department of Energy nuclear facilities. Next, this chapter introduces the ASME NQA-1 quality assurance standard, the nuclear quality assurance standard that is commonly adopted in the commercial nuclear power industry in the U.S. and in Department of Energy nuclear facilities.

### 2.1.1 Reproducibility and Replicability

Science fundamentally relies on replication and cumulative knowledge generation [26]. Most fundamentally, scientific investigation is summarized as [25]:

Scientists attempt to transparently describe the methodology and resulting evidence used to support their claims. Other scientists agree or disagree whether the evidence supports the claims, citing theoretical or methodological reasons or by collecting new evidence.

However, if this evidence is not reproducible, any following debate is meaningless. Reproducibility may be degraded through random and systematic error in research as well as bias introduced in the research or in its selection for publication (i.e. publication, selection, and reporting biases).

There is no agreed upon definition of reproducibility in the literature, currently. There is also confusion between reproducibility and replicability and often the two are used interchangeably. One definition of replication is, “the attempt to recreate the conditions believed sufficient for obtaining a previously observed finding and is the means of establishing reproducibility of a finding with new data,” [25]. Another reference defines replication as, “obtaining consistent results across different studies that have separate data sets,” and reproduction as, “independently deriving a study’s quantitative results from its original data set,” [24]. There is clearly nuance in these terms: replication is important for supporting a scientific finding with additional evidence whereas reproducibility is important for confirming a single study’s methodology and analyses are correctly performed. This discussion focuses on reproducibility as it is most concerned with the quality of individual studies, primarily consisting of their transparency of design, methodology, and analyses, not whether their findings can be confirmed through independent research using alternative means of investigation. A helpful example in the nuclear context is the Three Mile Island accident, for which a reoccurrence should be strongly avoided much less repeated to show replicability. However, much can and should be learned from this accident, necessitating reproducible research through many independent studies using the available data from the accident.

It is important to also make clear that high quality in research, provided by formal quality assurance processes, does not necessarily ensure reproducibility and vice versa. Instead, quality assurance practices seek to identify and provide sufficient detail for the minimum set of conditions necessary to successfully repeat actions (rephrased later in this dissertation as *the set of things done to provide confidence that a goal will be achieved*). Key questions here are: is it possible to identify the minimum set of conditions necessary for reproducibility? Can this set be

generalized for any research endeavor? For any activity more generally? As fascinating as that discussion may be, this dissertation will focus on the minimum set of conditions necessary for reproducibility within nuclear engineering research and the overlap of quality assurance practices.

Research by Freedman et al. [26] has attempted to identify root causes of the problem of irreproducibility, estimate direct costs of irreproducible research, and develop a framework to address the highest priorities identified. In their study, the authors are careful to note that proving perfect reproducibility is not desirable as this drives up costs and drives down productivity in producing new research. From their study, the authors identified an overarching inefficiency in assuring reproducibility in research: the responsibility of reproducibility is placed on the researcher although the most significant costs of poor reproducibility are borne by downstream organizations that use this research in products or other applications. In essence, although the responsibility for reproducibility is firmly on the researcher, there is little to no accountability because the consequences are born primarily by downstream organizations. A question to keep in mind: is it possible to move these costs or otherwise hold researchers accountable for the reproducibility of their work?

As this discussion continues to consider the minimum set of conditions necessary for reproducibility and who should bear the costs for assuring reproducibility, the application of standards for research is a natural consideration. As discussed, the standard chosen in this research is the ASME NQA-1 standard because of its wide acceptance in the field of nuclear engineering and its rigor and emphasis of safety. The Global Biological Standards Institute (GBSI), in their summary report, “The Case for Standards in Life Science Research,” [28] identified the broad use of standards as a critical tool in addressing reproducibility in life sciences research. Their claim is that standards, “provide an effective and feasible solution to problems stemming from uncontrolled variation,” and they “successfully reduce variability and improve quality and outcomes” when used in other fields. Therefore, the NQA-1 standard may be used in nuclear engineering research for the same purposes, including to improve reproducibility and the overall quality of research.

As fundamental to scientific progress as reproducibility is, it must always be in balance with innovation [25]:

Innovation is the engine of discovery and is vital for a productive, effective scientific enterprise. However, innovative ideas become old news fast. Journal reviewers and editors may dismiss a new test of a published idea as unoriginal. The claim that “we already know this” belies the uncertainty of scientific evidence. Deciding the ideal balance of resourcing innovation versus verification is a question of research efficiency. How can we maximize the rate of research progress? Innovation points out paths that are possible; replication points out paths that are likely; progress relies on both. The ideal balance is a topic for investigation itself. Scientific incentives—funding, publication, or awards—can be tuned to encourage an optimal balance in the collective effort of discovery.

As this discussion moves forward to the application of quality assurance in universities, it is important to keep this balance in mind. Any quality assurance program designed for and implemented in a university research environment must respect this balance and seek to benefit the research environment it is used in. Petit [29] notes this balance or tension and suggests quality approaches (or more generally *the* quality approach) should be integrated into fundamental research practices rather than fitting fundamental research into a highly formalized quality structure. Fundamental research should be kept as flexible as possible to provide space for improvisation and discovery within science and to provide space for researchers themselves to take the initiative for this purpose.

### 2.1.2 Regulatory Basis for Quality Assurance

Quality assurance is required for many applications through specific regulations. Commercial nuclear power plants are regulated by the NRC primarily under two specific parts of the Code of Federal Regulations (CFR). Department of Energy nuclear facilities are self-regulated by the Department of Energy following regulations primarily under a separate part of the CFR from the regulations for commercial nuclear power plants. Both distinct sets of regulations include specific quality assurance requirements for these facilities that can be satisfied through compliance with the ASME NQA-1 standard, a key common element which this dissertation focuses on. This section specifically points to the regulations for quality assurance in these applications.

#### 2.1.2.1 Commercial Nuclear Power Plants

In the United States, commercial nuclear power plants are required to maintain quality standards and records by the Code of Federal Regulations in Title 10, Part 50, Appendix A (10 CFR 50 Appendix A, “General Design Criteria”), with more detailed requirements found in Appendix B, “Quality Assurance Criteria for Nuclear Power Plants and Fuel Reprocessing Plants”. There are several other sub-sections within 10 CFR 50 and 52, although these are additions to and clarifications of the primary requirements in 10 CFR 50 Appendix B. The NRC is responsible for maintaining and enforcing these regulations. The NRC was established through a reorganization of the Atomic Energy Commission through the aptly named Energy Reorganization Act of 1974 [30]. This Act also created the Energy Research and Development Administration which later was consolidated with the Federal Energy Administration and programs of various other agencies to become the Department of Energy by The Department of Energy Organization Act of 1977 [31].

The requirements in 10 CFR 50 Appendix B do not call for the use of a specific quality assurance standard [32]. However, the NRC has endorsed, with certain clarifications and regulatory positions, the use of various versions of the NQA-1 standard and continues to update its endorsement to include recent versions of the standard as the NRC finds appropriate; the most recent version endorsed is from 2015 [33]. More discussion of the NQA-1 standard is found in Section 2.1.3.

In the adolescent years of the U.S. commercial nuclear industry, shortly after the Three Mile Island accident, quality assurance was identified as a critical component to challenges in nuclear

plant construction. Problems related to quality slowly became apparent in plant construction projects and caused significant concern from Congress, leading to an in-depth study of these problems and identification of potential solutions. The study describes quality assurance in the following manner [34]:

In any complex endeavor, some errors will be made. The more complex the endeavor, the greater the chance of errors. If some risk is associated with the endeavor, measures must be taken to provide assurance that errors are found, corrected, and do not pose an undue threat to public health-and safety. Construction of nuclear power plants is a very complex endeavor, and uncorrected errors in construction may seriously threaten public health and safety when operation begins. The primary measure used by the nuclear industry to provide assurance that construction errors are found and corrected is a quality assurance (QA) program. As used by the NRC, "quality assurance" comprises all those planned and systematic actions necessary to provide adequate confidence that a structure, system or component will perform satisfactorily in service. Quality assurance includes "quality control, which comprises those quality assurance actions related to the physical characteristics of a material, structure, component or system which provide a means to control the quality of the material, structure, component or system to predetermined requirements."

This description shows the essential nature of quality assurance not only in design and construction but in every part of commercial nuclear power plant ownership. Today, as advanced nuclear reactor designs leverage modern technologies and advanced coolants, fuels, and construction materials and processes, quality assurance remains a foundational element of good design, construction, and operation.

#### 2.1.2.2 Department of Energy Facilities

Quality assurance requirements for the Department of Energy (DOE) are found in 10 CFR 830, Subpart A, and DOE Order (O) 414.1D. 10 CFR 830, Subpart A, "Quality Assurance Requirements," often referred to as the Rule, are specific for activities performed by DOE personnel, contractors, and other persons conducting activities that affect, or may affect, the safety of DOE nuclear facilities. DOE O 414.1D, "Quality Assurance," often referred to as the Order, provides requirements for all other activities. Requirements in both the Rule and Order are applicable to DOE nuclear facilities and activities whereas for all other DOE facilities and activities only the requirements in the Order are applicable.

Here again, the quality assurance requirements in the Rule and Order do not specifically endorse a quality assurance standard. Instead, the Rule requires the reference to and use of voluntary consensus standards in the development and implementation of the quality assurance program [35]. The Order requires the reference to and use of appropriate national or international consensus standards in whole or in part, consistent with regulatory requirements and Secretarial Officer direction, to satisfy quality assurance requirements and gives ASME NQA-1 as an example of a currently acceptable standard [36]. Guidance documents from the Department of Energy on the Order also include the NQA-1 standard as an appropriate example of an applicable standard [37].

It is interesting to note that DOE's Office of Environment, Health, Safety, and Security describes their quality assurance program as the following [38]:

When properly implemented, the principles and requirements form a management system to plan, perform, assess, and improve work. The requirements are performance oriented and offer implementation flexibility. The DOE quality management system moves beyond the traditional quality assurance requirements that had become narrowly focused on compliance, and inspections. The management system is designed to link with an organization's strategic plan to support mission achievement and the delivery of products and services that meet customer expectations. The Department's commitment to environment, safety, and health also relies, upon work being conducted within an effective management system. DOE line managers and contracting officers must understand these two fundamental purposes for the Quality Assurance (QA) requirements and ensure the QA Order and QA Rule are specified in each major contract.

This is a great example of an organization seeing quality assurance as a valuable tool for achieving their mission and therefore making quality assurance an important part of their strategy for achieving this mission. Quality assurance in this context is focused on achieving desired results ("performance oriented") in a way that best suits the organization ("implementation flexibility").

#### 2.1.2.3 DOE Nuclear Engineering University Program

The Department of Energy provides significant funding to nuclear engineering research at universities through their Nuclear Energy University Program (NEUP). NEUP is a primary funding source within the TH Laboratory for both research projects and students through fellowships; NEUP provided the initial funding for the CIET Research Program and continues to support its research.

Through their research and development funding process, DOE NEUP expects grant recipients to follow applicable quality assurance requirements contained in their NEUP QA Requirements Worksheet when conducting research and development activities by including this worksheet as part of the contractual requirements of research grants [39]. DOE NEUP expects grant applicants to include the implementation of QA requirements in their proposal strategy and to include compliance costs as part of their research proposals; the specific language from the most recent funding opportunity announcement (FOA), under pre-application agreement requirements (Section IV.C.2.5), is as follows [40]:

Institutions will be expected to follow quality assurance (QA) principles and requirements in conducting R&D activities. The integrity of R&D products and their usability by NE is predicated on meeting QA requirements as they apply to a specific scope of work and associated deliverables if the application is successful. Further, each institution serving as a team member to the proposed project shall be identified in the pre-application, with their commitment made to collaborate in the FOA process.

In the FOA, the words “QA requirements” in the above paragraph are hyperlinked to the NEUP’s informational webpage on related documents, which contains a link to the Quality Assurance Requirements Worksheet referred to above. The FOA includes further discussion of quality assurance expectations and guidelines in Section VI.B.2, Special Terms and Conditions and National Policy Requirements. These guidelines include test planning, implementation, and documentation (research planning); equipment calibration and documentation; procurement document control; training and personnel qualification; records; data acquisition/collection and analysis; and peer review. Finally, in the project proposals within the FOA, several refer directly to the need for quality assurance in the research project, specifically the need for a quality assurance plan and peer-review of data, designs, experimental plans, and analyses. In addition to this specific language found in NEUP FOAs, the NEUP website contains a page on quality assurance requirements for principal investigators who lead NEUP research projects [41]. This webpage again references the NEUP QA Requirements Worksheet as the reference for quality assurance requirements.

The NEUP QA Requirements Worksheet contains eleven requirements that are derived from the quality assurance requirements in DOE O 414.1D with specific application to university research, such as the use of lab notebooks, the use of a Test/Research Plan, and the use of journal peer review requirements. These requirements, like their parent requirements in the Order, do not require compliance with ASME NQA-1. Unlike the Order, the NEUP QA Requirement Worksheet does not reference the use of national or international consensus standards apart from their use in instrumentation calibration. The NEUP QA Requirements Worksheet thus represents a flow-down of requirements by DOE NEUP to ensure all university work performed with their support meets the quality assurance requirements they are beholden to. The Quality Assurance Requirements webpage does however contain several guidance documents, including templates, for satisfying these requirements. The lack of reference to the ASME NQA-1 standard in NEUP documents and resources most likely stems from their view of NQA-1 as inappropriate for university research. This may either be because of NQA-1’s high degree of rigor and the challenge of applying an appropriate graded approach or because NEUP does not expect university research projects to be able to adhere to the requirements in the NQA-1 standard. In practice however, there has been very little to no rigorous enforcement of these requirements; instead, the peer review process for journal articles is typically counted on to provide adequate quality assurance. However, peer review in medical journal applications has been shown to be insufficient in most cases to satisfy basic requirements of scientific integrity [42]. Given this evidence, in combination with challenges to reproducibility in scientific publishing, it is questionable that peer review should be relied upon to perform a quality assurance role in journal publications. Where the results from research may affect the safety of nuclear facilities, materials, and activities, more rigorous quality assurance practices should be applied and enforced. More discussion on the links between quality assurance, university research, and scientific integrity is presented in Section 2.2.2.

The following section discusses in more detail the ASME NQA-1 standard that has been referenced several times so far. This is an important standard in the national and international nuclear power communities and is a central focus of this dissertation as this research seeks to apply industry-specific quality assurance practices to university research to improve overall research quality as well as reproducibility in research.

### 2.1.3 ASME NQA-1

The Nuclear Quality Assurance (NQA-1) standard is a quality assurance standard for nuclear facilities. The CIET Research Program references ASME NQA-1-2008/1a-2009 as the reference standard for its quality assurance program and refers to ASME NQA-1-2015, the most recently NRC-approved revision, for additional guidance [43], [44]. The NQA-1 standard is maintained and periodically updated by the American Society of Mechanical Engineers (ASME) through their codes and standards organizations, specifically the Standards Committee on Nuclear Quality Assurance. This standards committee is one of several committees under the ASME Board on Nuclear Codes and Standards, which is again is one of many boards that oversee the ASME codes and standards. NQA-1 has been popularized primarily through endorsements/adoption within the ASME Boiler and Pressure Vessel (BPV) Code, governmental regulatory bodies, national and international standards, and contracts between organizations. In the U.S., the NQA-1 standard is recognized as an acceptable way to meet federal regulation for quality assurance requirements in commercial and Department of Energy (DOE) nuclear facilities [33], [36]. NQA-1 has also found application outside of nuclear facilities in projects and industries with high hazards where the health and safety of the public are primary concerns [45]. Because of its acceptance by the U.S. NRC, the NQA-1 standard is also widely referred to internationally for guidance and best practice.

From its inception, the CIET Research Program has chosen to use the requirements in the ASME NQA-1 standard as the basis for the design and implementation of its quality assurance program because of the standard's use in the U.S. and international commercial nuclear power industries and its use in DOE facilities including national laboratories like the Idaho National Laboratory. The CIET Research Program's commitment to the NQA-1 standard reflects its commitment to supporting these communities and their common goals. To have its research be useful in these communities and to have the ability to participate in these communities, it is important that the research within the CIET Research Program essentially "speak the same language" in terms of quality assurance. Therefore, if the CIET Research Program is working with the Idaho National Laboratory on a research project and researchers from the Idaho National Laboratory refer to a specific requirement within NQA-1 that isn't being fully met by the CIET Research Program (or vice versa), there is a common understanding and both organizations can move toward a solution together. Other quality assurance standards have been considered, such as the ISO 9001 Quality Management System, but none have been found to be as appropriate to nuclear engineering research as the NQA-1 standard [46]. Further, the NQA-1 standard includes significant guidance for implementing a "graded approach" to applying the requirements in the standard [43]. Using a graded approach allows the CIET Research Program to apply only the requirements of the NQA-1 standard that are applicable to its research and apply them in a way that is commensurate with the scope, complexity, and importance of its research.

Now discussion will focus on the eighteen requirements in Part I of the NQA-1 standard that form its structure and then will extract the core quality assurance principles that define quality assurance as it is applied within NQA-1. In the NQA-1 standard, Part I contains eighteen requirements for developing and implementing a quality assurance program for nuclear facility applications. Part II contains additional requirements for the planning and performance of

specific activities under the quality assurance program developed under Part I. Parts III and IV contain guidance (non-mandatory) for implementing requirements, for application of the standard, and for comparing the NQA-1 standard with other quality assurance requirements.

In developing the Quality Assurance Program for the CIET Research Program, the ASME NQA-1-2008/1a-2009 version of the standard was used as it was the most recent, endorsed version of the standard when the CIET Research Program began. The subsequent revisions of the standard (1b-2011, 2012, 2015, and most recently 2017) do not contain significant changes that affect the types of research performed within the CIET Research Program. However, the latest endorsed version (ASME NQA-1-2015) is used for guidance and reference in writings related to this research, here and elsewhere. When and where possible, as this research moves forward it will be good practice to update the quality assurance program to be consistent with the most recent, endorsed revision of the standard. This reflects the CIET Research Program's commitment to cutting-edge research and active involvement in the communities engaged in quality assurance within the nuclear field.

The eighteen requirements in Part I each include many sub-requirements that provide more definition to the requirement and help define the specific expectations each major requirement entails. The eighteen Part I requirements with short descriptions and commentary on their applicability to university research are as follows:

1. Organization

This requirement concerns the quality assurance program's definition and implementation and is particularly concerned with the personnel and reporting structures supporting it. This requirement includes specific sub-requirements for the organizational structure, functional responsibilities, levels of authority, and lines of communication expected within the organization implementing the NQA-1 standard.

This requirement emphasizes the role of the individual and management personnel in the implementation and sustainment of quality, a hallmark of this standard and of the quality assurance in the nuclear industry in the U.S. [47]. This requirement establishes the expectations of independence and sufficient authority for those personnel verifying work and assuring the completion of activities. Both of these qualities are essential to quality assurance and must be preserved in applying the NQA-1 standard to a university research program.

2. Quality Assurance Program

This requirement builds upon the previous requirement by describing the planning, implementation, maintenance, and documentation of the quality assurance program. Sub-requirements include the program's scope, requisite controls, indoctrination and training for personnel, and management oversight. Sub-requirements in this requirement also give qualification requirements needed for specific activities, including for nondestructive examination (NDE), inspection and test activities, audits, and activities requiring technical specialists.



Applying this requirement to a university research program is challenging because of the mismatch in personnel expectations – the personnel within the CIET Research Program, the majority of whom are students, take on many varied roles and responsibilities throughout their time in the CIET Research Program and then leave once they graduate, creating frequent shifts in roles and responsibilities and high turnover not generally accounted for in the NQA-1 standard. It’s important to carefully apply a graded approach here so that the intention of this requirement is satisfied in a sustainable manner – more discussion on this challenge is found in Chapter 3.

### 3. Design Control

This requirement is for the design of any system, structure, or component included in the overall facility and includes sub-requirements that cover the design process, including design inputs, the design process itself, design analyses, design verification, change control, interface control, and documentation. Sub-requirements particular for software design control are given in Part II, Subpart 2.7, “Quality Assurance Requirements for Computer Software for Nuclear Facility Applications”.

This requirement is directly relevant to experimental research and special consideration should be made to this when this requirement is applied to university research. In the university setting, a balance must be struck between applying this requirement rigorously to experiments and using a graded approach to make its application appropriate for university research, with a key goal being to document analysis and assumptions made in design of experimental systems and facilities.

### 4. Procurement Document Control

This requirement governs the procurement of items and services to ensure applicable design bases and other requirements necessary for quality are considered. Sub-requirements focus on the content in, review of, and subsequent changes to procurement documents.

Items and services used in university research range from highly specialized research equipment to common tools and parts found at hardware stores. Therefore, the application of this requirement must be flexible to accommodate this wide range of items and services used in the university research environment, with the key goal being to correctly document and verify relevant information about items and services used in research so they are traceable.

### 5. Instructions, Procedures, and Drawings

This requirement is relatively short as more specific requirements for specific procedures are given elsewhere. The sub-requirements here ensure that all activities affecting quality and services refer to documented instructions, procedures, and/or drawings that include acceptance criteria.

Although relatively short, this requirement is important in that it defines the need for instructions, procedures, and drawings within the quality assurance program. These types of documents are the primary document types used day-to-day by personnel to implement the quality assurance program. Instructions, procedures, and drawings are therefore primarily used to satisfy the other requirements within the NQA-1 standard. These documents play a major role in assuring the reproducibility of research work.

#### 6. Document Control

This requirement builds upon the previous requirement for instructions, procedures, and drawings by providing sub-requirements for document preparation, issue, and change control.

Document control is a fundamental requirement within the NQA-1 standard as it applies to every document and record used. Combined with the previous requirement, these two requirements represent comprehensive control of the primary documents used within the quality assurance program and should be integrated into any quality assurance program used within a university research setting.

#### 7. Control of Purchased Items and Services

This requirement defines the controls needed when purchasing items or services within the quality assurance program to ensure required performance. Sub-requirements include topics of supplier evaluation and selection, bid evaluation, control of supplier-generated documents, the acceptance of the item or service, control of supplier nonconformances, commercial grade items and services, and records.

Where Requirement 4, "Procurement Document Control," mainly covers the requirements for the procurement documents themselves, this requirement defines controls for the procurement process itself, including how to handle nonconformances. These two requirements should be considered together when procuring items and services within the quality assurance program. From the discussion of Requirement 4, it follows that the application of this requirement must be flexible as well in order to accommodate this wide range of items and services used in the university research environment, while assuring that important information about items and services is collected, verified, and retained.

#### 8. Identification and Control of Items

This requirement builds upon the previous requirement for the control of purchased items by assuring only correct and accepted items are used or installed. Sub-requirements cover identification methods and more specific requirements for the control of items.

Similar to the application of requirements four and seven which cover the procurement of items and services and the controls needed within procurement documents, flexibility in

the application of this requirement is necessary in the university research environment.

## 9. Control of Special Processes

This requirement is for activities that are outside the scope of the normal activities within the quality assurance program but that are used to control or verify quality; examples given include welding, heat treating, and nondestructive examination. Sub-requirements provide that only qualified personnel using qualified procedures with special requirements perform these processes and that clear records are maintained.

Special processes that are not routinely performed are relatively common within university research. This requirement provides standard controls for these non-standard processes which is very helpful for providing structure and clarity to university research to assure reproducibility, although flexibility is needed in applying this requirement due to the usually wide range of special processes.

## 10. Inspection

This requirement is for inspection activities to verify quality within the program. The sub-requirements in this requirement cover the important aspects of planning and executing inspections, including defining characteristics to be inspected (acceptance criteria), inspection methods, inspector qualifications, and inspection records handling. This requirement also covers inspections during operations, or in-service inspections, to ensure continued performance of structures, systems, and components.

Inspections of varying scope and rigor should be incorporated into university research generally, for the purpose of confirming as-built conditions, confirming environmental conditions, for understanding the operation of experiments, and for the education of students. Inspection documents should therefore be flexible or multiple versions should be made for their many uses within the research program.

## 11. Test Control

This requirement provides controls for tests/experiments and includes sub-requirements that cover the important aspects of experiments and testing, including test requirements, procedures, results, and records. Sub-requirements particular for software design control are given in Part II, Subpart 2.7, "Quality Assurance Requirements for Computer Software for Nuclear Facility Applications".

Similar to the requirement for design control, this requirement is directly relevant to assuring the reproducibility of experimental research and special consideration should be made to this when this requirement is applied to university research. In the university setting, a balance must be struck between applying this requirement rigorously to experiments and using a graded approach to make its application appropriate for research.

## 12. Control of Measuring and Test Equipment

This requirement covers how to handle instrumentation and other measuring and test equipment and includes sub-requirements for the selection, calibration and control, and record keeping of measuring and test equipment.

Similar to the previous requirement, this requirement is directly relevant to the reproducibility of experimental research and special consideration should be made to this when this requirement is applied to university research.

## 13. Handling, Storage, and Shipping

This requirement includes sub-requirements for the handling, storage, cleaning, packaging, shipping, and preservation of items to prevent damage or excessive deterioration. This requirement provides special consideration for the handling of items within the quality assurance program.

This requirement is helpful for high-value and/or high-importance items but should be applied only where appropriate using a graded approach.

## 14. Inspection, Test, and Operating Status

This requirement includes sub-requirements to identify the status of items to prevent inappropriate use.

Similar to the previous requirement, this requirement is helpful for high-value and/or high-importance items (including items that are components within larger structures/facilities) but should be applied only where appropriate using a graded approach.

## 15. Control of Nonconforming Items

This requirement is for the control of items that do not conform to their specified requirement and includes sub-requirements to prevent their misuse. Sub-requirements include those for identification of nonconformance, segregation of nonconforming items, and their ultimate disposition, whether that is use-as-is, reject, repair, or rework.

In research environments, nonconformance is not uncommon as items and processes are used in novel (experimental) ways. Although nonconformance is more common in research environments, these environments are typically more flexible and able to handle nonconformance. However, nonconformance is never ideal and therefore this requirement should be applied but, as always, using a graded approach to accommodate the unique environment and needs within university research environments.

## 16. Corrective Action

This requirement defines the process of correcting problems and includes sub-requirements for the identification and correction of conditions adverse to quality. Identification of a condition adverse to quality includes identification of the cause of the condition, and correction includes corrective action to preclude recurrence. Sub-requirements for verification of the corrective action and documentation are included as well.

Having a systematic process to identify and document corrective actions is critical for the continual maintenance and improvement of the system or facility as well as the quality assurance program itself. The process of identifying, correcting, and documenting conditions adverse to quality is essential to identifying and correcting problems and preventing the repetition of errors.

## 17. Quality Assurance Records

This requirement defines the control and management of records within the quality assurance program and includes sub-requirements for the generation of records, the authentication of records, records classification (specifically relating to the record's lifetime), the receipt control of records, records storage, records retention, and the maintenance of records.

In university research programs, record keeping is essential to document research that has been done and to serve as a knowledge repository. This requirement is important to carefully consider and apply as thoroughly as possible but in a way that is transparent and easy to use. Records may become even more important to manage well as journals are beginning to allow supplemental electronic material to become part of the archival record of a journal article [48].

## 18. Audits

This requirement defines the scope and process of performing internal and external audits of the quality assurance program and includes sub-requirements for scheduling, preparation, performance, reporting, response, follow-up action, and records. The two kinds of audits defined here are internal audits (including prior to facility operation, during facility operation, and of suppliers and other nuclear support organizations) and external audits.

Internal and external audits of the quality assurance program or specific sections therein are important for maintaining an open and transparent quality assurance program and for seeking further development and growth through review. This is another hallmark of the NQA-1 standard and an essential element of reproducibility of a research program.

The term “graded approach”, found within the NQA-1 standard, is used consistently throughout the discussion above when considering the application of these requirements to a university

research program. According to the standard, a graded approach should be used to apply requirements to the specific type of facility, items, or services involved in a manner consistent with the nature, scope, and relative importance of the activity or item. In applying the requirements within the NQA-1 standard to the CIET Research Program, defining the graded approach taken will be critical to ensure all requirements, and most important their intentions, are systematically met by the research program.

In reviewing the quality assurance requirements within the NQA-1 standard, the following essential elements are found: the application of a graded approach; thorough and transparent documentation and record keeping; the clear responsibility of all personnel for quality-related activities; the need for independent review and approvals; thorough understanding of the as-built configuration of the system, including on-going inspections to ensure continued performance; and corrective action. However the NQA-1 standard is applied, these elements should be present in the resulting quality assurance program for it to comply with the requirements and their intentions.

## 2.2 Application of Quality Assurance in Universities

This section in this chapter connects commercial nuclear quality assurance, specifically the ASME NQA-1 standard, to nuclear power research in universities. Before specifically examining the application of NQA-1 to the CIET Research Program, an overview of quality assurance in other research and development environments is presented and best practices are highlighted. A university-applicable version of an NQA-1-compliant quality assurance program, the University Nuclear Quality Assurance (UNQA) Program, is then introduced through discussing the integration of the NQA-1 standard to university research and the details of the CIET Research Program's quality assurance program. Finally, the social impact of integrating a quality assurance program into a university setting is considered and discussed.

### 2.2.1 Definition and Purpose

Given the regulatory basis established above, it is important to step back and consider the definition and application of quality assurance particularly considering its application to university research. The definition of quality assurance applied to nuclear facilities from the Code of Federal Regulation that the U.S. NRC uses is as follows (emphasis added):

All planned and systematic actions that are necessary to *provide adequate confidence* that a structure, system, or component will *perform satisfactorily in service*.

In this definition, the two primary components of quality assurance are emphasized: “provide adequate confidence,” or what this application of quality assurance is trying to show, and “perform satisfactorily in service,” or the goal of this application of quality assurance. “All planned and systematic actions that are necessary” are then defined in relation to these two primary components which is why this part of the above statement is not included as a primary component. Generalizing these two primary components of nuclear quality assurance, quality assurance in any application is defined as:

The set of things done to *show* that the desired *goal* is or will be achieved.

A defined goal, an audience to show, and a set of actions that connect these together are the three components of any quality assurance program. Again, the “goal” and “show” components determine the set of actions needed and are thus the two primary components of quality assurance. This “goal/show” quality assurance framework can be applied to almost every area of life, including personal goals. An example of quality assurance in life outside of nuclear engineering is in improving a skill, for example playing a musical instrument. Most often in practicing an instrument, the goal is to perform a specific musical piece for a concert, audition, or simply for a lesson with a music teacher. The person or people that quality assurance is trying to “show” and give confidence to in this case is not the final listener of the piece, but rather the musician themselves as they practice and learn to play the piece as they would like. In this example, quality assurance could be defined as:

The preparation means or practice tools needed to give confidence to the musician that the piece of music will be performed satisfactorily.

The application of quality assurance, here primarily through the “preparation means” or practice tools, could be a practice plan and practice log, essentially a testing plan, to divide the music into sections or to set smaller goals or milestones that can be achieved between starting to work on the music and the final performance. More detailed preparation may include plans (i.e. procedures) to use a metronome to practice at different speeds, plans to use a tuner to make sure the instrument and performer are consistently in tune (i.e. calibrated to an accepted standard or reference), the use of scales and scale studies to reinforce the fundamental ability to play music scales, the use of other technical studies specific to the instrument or music piece, listening to recordings of the piece (i.e. training), playing for family or friends to practice performing (i.e. audits), etc. Practicing is also an apt use of corrective action – as problems are found during a practice session they are noted, included in the practice plan, and focused on in subsequent practice sessions to eliminate the problem and prevent recurrence during the final performance. The practice plan used with the practice log and these detailed preparation practices then provides confidence to the musician that they have understood what is needed to perform the piece as they would like, and that they are putting in the work needed to accomplish this plan over the timeframe they have. An experienced musician may not need this detailed and defined structure as they practice because of habits and routines developed and reinforced over years of effort, although these specific practice elements are still used, but for a beginning musician this framework is invaluable. This systematic way of approaching and reaching a goal through necessary confidence building means is found everywhere in our personal and professional lives, from practicing a piece of music to making a grocery list to balancing a budget to designing a nuclear reactor. Ultimately, we constantly practice some level of quality assurance in nearly every area of our lives.

Bringing quality assurance back to nuclear engineering, it is clear from the regulatory basis defined and discussed in Section 2.1.2 that quality assurance requirements are unavoidable while working within the nuclear science and engineering field in some form or fashion. Further, it should be clear that quality assurance pervades nearly every area of life, particularly in the research lab in the form of procedures, trainings, the use of PPE (personal protective equipment),

reproducible data analysis, etc. So, the questions become: should a research program implement a quality assurance program, and if so, how? What are the goals of the research program, who is the audience of the quality assurance program (who is being shown quality assurance actions), and what exactly should the set of things be that are done to instill confidence and gain approval by the audience? Given the background and context presented in the first chapter of this dissertation as well as the beginning of this chapter, the following thesis as these questions apply to the CIET Research Program at UCB is:

If the CIET Research Program is to participate in licensing and regulatory decisions through its research, quality assurance is a critical tool for performing research that satisfies regulatory standards and that proves to CIET's "customers" that its research is useful and that it itself is a valuable member of these communities.

To set this thesis statement in the quality assurance framework discussed above, the goal of the CIET Research Program is to perform research with deeper impact and influence in regulated communities as a participant rather than an outside contributor, and the audience, or who the CIET Research Program is trying to show that its research can achieve this, are the regulated communities themselves. These regulated communities are the "customers" of CIET's research, including national laboratories, nuclear reactor and technology vendors, policy makers, etc. who not only benefit from CIET's research but who also help to inform the direction and focus of its research. To be clear, research from CIET and other university research programs is generally inherently valuable as basic research and ultimately serves to advance human understanding of complex subjects. However, to engage and participate in regulated communities, the application of quality assurance not only increases the value of research through expanded utility within these communities but implicitly claims that the research program more broadly is a valuable member of these communities. The research done to design and implement a university quality assurance program using the CIET Research Program as a specific example can then be generalized to the UNQA Program.

Here it is generally assumed that participation in regulated communities beyond the level of outside contributor is desirable to the point of benefiting from the application of the additional demands of a rigorous quality assurance program. There is strong argument to support this assumption in the context of the CIET Research Program's work, namely the importance of integral effects tests in the development and understanding of nuclear reactors and the need for the reduction of regulatory risk in the advanced reactor development process. This basic assumption is not necessarily true otherwise, even though the application of quality assurance practices with some degree of formality or rigor to a university research effort is a valuable proposition on its face. Unfortunately, the benefit of the application of a quality assurance program and the subsequent improvement in reproducibility is very difficult to quantify, which has made it a hard sell for the majority of university research programs where quality assurance requirements are not enforced. This challenge holds true for identifying, quantifying, and attributing the costs of reproducibility in research and the organization bearing this cost. Possible metrics could be: project funding rate/amount, acceptance rate to high-quality journals, number of citations from national labs and other regulated community members, amount of discussion with the NRC/IAEA, etc., and number of significant safety problems, but all of these are hard to



quantify without a long and detailed historical record on either side of implementing a quality assurance program.

Despite challenges around quantifying benefit and value, there are several intangible goals associated with the application of quality assurance to nuclear engineering research that are important to emphasize. First, as is clear in the thesis of this discussion, quality assurance promises to give the CIET Research Program greater participation and thus influence in communities that value and implement quality assurance practices. Greater participation may lead to new research opportunities and the credibility to participate in important decisions in national laboratory research, regulatory decisions, and even policy directives. Successfully taking on the additional responsibilities and the challenge of implementing a quality assurance program indicates to these communities that the CIET Research Program values its research and has important contributions to make. Second, the students and members of the CIET Research Program have greater participation and influence in communities that value and implement quality assurance practices themselves. Quality assurance is ubiquitous in the nuclear engineering field, making this a worthwhile goal for students and professionals wanting to stay engaged in the field or engage at a deeper level. Quality assurance training and experience will better prepare students for careers in nuclear engineering as well as provide nuclear engineers to companies, laboratories, and organizations that are better prepared to work under quality assurance requirements so that these organizations succeed in their missions. Third, and most intangible of all, implementing a quality assurance program helps to create a community within the CIET Research Program itself that values these goals and is committed to excellence in research and study. The social benefits of community are the most foreign to an engineering dissertation such as this one, albeit too valuable to not study and reflect upon further. Section 2.3 contains further discussion.

These intangible goals also touch back upon one of the original goals of improving reproducibility in research discussed in Section 2.1.1: shifting the costs of irreproducibility in research from downstream users to the research organizations themselves [26]. The basic rationale follows that as research organizations like university research laboratories apply quality assurance practices and improve the reproducibility of their research, the downstream organizations that use this research (national laboratories, reactor design companies, etc.) reduce their own research and development costs. The connection with the above intangible benefits are that (1) as research organizations prove themselves in these regulated communities where the downstream research users are, more important research can be entrusted to them, further reducing research costs; (2) as the students and personnel in research organizations become experienced with quality assurance practices and adept at producing reproducible research, many move into the organizations that make up the downstream research users after they graduate, reducing training costs and improving the effectiveness of these organizations; and (3) these new quality-embracing and reproducibility-supporting communities that are nurtured in research organizations are carried into the downstream organizations by the movement of personnel, bringing their benefits along with them and fostering additional communities that should improve the downstream organizations as well. Again, these are intangible goals and challenging to describe well much less quantify and attribute. However, because the logic is sound and the benefit clear, these are goals that make supporting the application of quality assurance practices worthwhile.

## 2.2.2 Best Practices in Research and Development

Experiences from other university and research organizations that have implemented quality assurance into their research and development are reviewed here. The goal in this section is to draw out best practices that can be applied generally in the following sections.

In biomedical research at the University of Minnesota, an internal quality assurance consulting group advocates for “voluntary quality assurance” to strengthen research and improve reproducibility [49]. Quality assurance practices applied there, although not following a specific standard or set of guidelines, still helped reduce questions on how experiments were done and where data is stored. The author specifically notes that while more formal standards and guidelines such as Good Clinical Practice, Good Manufacturing Practice, and Good Laboratory Practice standards and quality assurance guidelines from the World Health Organization and the British Association of Research Quality Assurance (now simply RQA) exist, most researchers are not aware of them and instead, if quality assurance practices are implemented, the practices are ad hoc rather than compliant with specific standards or guidelines. The researchers and consulting group have found that data produced under these basic quality assurance practices can withstand criticism more effectively. Quality assurance practices made it so that, “data sections in papers practically write themselves,” and more time can be spent on scientific explanations of results – the primary aim of research. In this setting, quality assurance professionals in the consulting group act like partners, not dictators, emphasizing that quality assurance is not punitive or guilt inspiring. The quality assurance consultants help the scientists take the lead on choosing and implementing the quality assurance elements that they incorporate in their research. The consultants’ role then is to explain the reasoning behind quality assurance practices and to reinforce good practices already in place.

In a review paper of quality practices in university research, the authors considered two approaches to quality assurance in research laboratories [50]:

1. Research is a logical extension of testing and therefore one can assume that testing standards can be applied methodically to each step in a research project.
2. A flexible approach to applying quality assurance practices is taken, with research-specific criteria used to assess quality.

The conclusion of this study was that a general quality management approach, encompassed by the ISO 9000 set of quality management and quality assurance standards that emphasize customer satisfaction and, “fitness for purpose,” is suitable for implementing quality assurance in research laboratories. The authors noted that the hardest challenge to overcome when implementing quality assurance practices was establishing full commitment on the part of the researchers themselves to the implementation of quality assurance. Therefore, it is vital to establish the “right” standards for each type of research activity and to avoid the application of quality assurance requirements for measures that do not affect quality. The critical factors identified for successful implementation were: (1) quality assurance documentation should be as simple and flexible as possible, (2) the quality assurance system/program should be modular and non-redundant, (3) the system/program must be sustainable (need for continuity particularly when staff are short-term), and (4) the quality assurance system/program must provide added

value to the organization. In addition to these critical factors for successful implementation, the authors identified three guiding principles to implementing quality assurance practices in research:

1. Quality assurance must be integrated into the research group's management, research practices, and their scientific culture.
2. Integration of quality assurance practices into research must take into account the concrete reality of the researcher's profession – current practices that act as inherent quality controls should be identified and included.
3. Constraints on the researchers should be minimized and where applied should be adapted to the nature and impact of the research.

In another review paper, the authors reviewed implementation of a quality management system (QMS) and associated quality manual (QM; equivalent to Quality Assurance Plan in this dissertation) for two laboratories in Brazil and compared their findings with other published studies in the same topic [51]. The authors found that the critical factors for successful quality management system implementation, in the two Brazilian labs and elsewhere, include:

1. Each team member involved in using the quality management system must accept and commit to apply it well (this also helps create an organization-wide culture that embraces quality, similar to a “safety culture”).
2. The quality management system, particularly its documentation, should be simple and flexible in its application. Ideally, the personnel using the documentation (e.g. procedures) should be involved in its design and implementation.
3. The quality system must include functions to maintain permanent team knowledge within the organization.
4. Annual customer satisfaction (in this case, the satisfaction of the customers of the lab's offered technical services, including testing services and specialized consultancy) surveys provide valuable feedback to evaluate the performance of the organization and to identify opportunities for improvement.

The authors also found that creating and implementing a quality management system that follows a rigorous standard for testing and calibration laboratories (in this case, ISO/IEC 17025) required some elements not common to all research laboratories. Critical to their reviewed programs' success were to have some long-term personnel who have quality responsibilities within their role, such as professors and technical staff, and outside help generally from consultants to help setup the quality management system within the organization. With all of these critical factors in place, the process of creating and implementing a quality system in a university research organization is a long process; Table 2.1 shows that the two Brazilian labs in this review required six years for full implementation and accreditation.

Table 2.1. Timeline and description of quality management system (QMS) development, implementation, and accreditation for two laboratories in Brazil (LACOR and LAPOR) [51].

Year	Activity
2001	Employment and training of a professional
2002	Lecture to “sensibilize” the staff at the laboratories Survey of tests and other activities, of adequate standards and methodologies, and of conditions of the equipment Definitions of area, scope, and structure of the QMS, of the organization structure, of functions and responsibilities, of the structure of documentation, and of QMS policy and objectives Preliminary outline of QM
2003	Acquisition of measurement standards and reference materials Performance of calibrations Acquisition of written standards Initial non-conformities recorded Beginning of participation in interlaboratory programs Preparation of procedures and test controls, instructions for equipment use and operation, main technical and management documents, and the complete version of the QM
2004	Finish the writing of technical and managerial documents
2005	Change of location and performing various adaptation Performing of the first customer satisfaction survey
2006	Adaptations for ISO/IEC 17025 version 2005 Preparation of the procedure to determine uncertainties First internal audit
2007	Accreditation according to NBR ISO/IEC 17025:2005 in the Metrological Network of RS

In Table 2.1, QMS is quality management system and LACOR and LAPOL are the two laboratories at the Federal University of Rio Grande do Sul in Brazil that serve as the primary university research organizations of interest in the review paper. This is clearly a long process with many moving parts, including the employment and training of a professional (2001), interlaboratory programs (2003), customer satisfaction surveys (2005), an internal audit (2006), and finally accreditation according to a professional standard through a regional accreditation board (2007). These are not all activities that all university research organizations would desire or be expected to perform but are more or less representative of the process of implementing a quality system in a university research laboratory.

Vermaercke et al. provide a good example of implementing a quality assurance program in a research and development setting. This is a particularly fitting example as it is implemented at the Belgian Nuclear Research Center, SCK-CEN [52]. Within their quality system, the authors show that their document management system contains more formality through five distinct levels, considering requirements for non-redundancy and modularity. The levels cover the whole organization starting at the top with a quality manual that provides a general description of “what” is done without providing any technical detail, all the way to the bottom of the organization with operating instructions that include technical details that provide for consistent technical competence. The authors report that their biggest achievement in implementing their quality system is the implementation of a horizontally oriented communication structure that provides open, unbiased discussion between laboratories at SCK-CEN. Consistent, clear, and open communication is fundamental to collaborative research and provides a means for feedback and group learning.

In their work, Krapp discusses the challenges of applying quality assurance to research and development and suggests ways to address these challenges without hampering the flexibility and creativity in research and development [53]. Two terms that are important in this work are traceability and trackability; Krapp defines traceability as the relation of data to stated references with stated uncertainties providing an unbroken chain of comparisons, and trackability as essentially traceability of data to a specific sample rather than references. Both traceability and trackability are essential for achieving consistency in results and achieving transparency of research. Krapp suggests using the following tools to apply quality in research and development:

1. Quality related training for staff and allocating part of the research budget for undirected experimentation (e.g. 15% of time allocated for undirected research) are important tools for achieving desired flexibility in research. Krapp goes so far as to assert that quality related training of staff is the most important step in establishing and maintaining quality assurance in research and development.
2. A well-organized and easy-to-use quality information database for all staff to use is important for achieving transparency internal and external to the quality assurance program.
3. Peer review of publications, conference papers and presentations, etc.; internal and external audits; and accreditation of laboratory personnel all serve to improve monitoring and assessing within the quality assurance program. These actions serve the dual role of providing accountability and review to the research within the organization as well as providing learning opportunities for staff, both to share information within the organization and to bring in fresh information (e.g. best practices) from other communities.

Petit presents the quality approach in fundamental research, specifically within the French Atomic Energy Commission (CEA), in two articles that form a two-part examination. The first article examines, in theory, the applicability of the quality approach to fundamental research [29] and the second article examines the synergies between quality practices and fundamental research and specifies practical proposals for adapting quality practices for fundamental research [54]. In Petit’s first article, they present three core quality concepts that are applicable to every situation within research and development:

1. Conformity with a reference: Defining a reference or standard and following what it prescribes is necessary for implementing a quality program and performing research in general. In science, however, understanding when and why deviations from accepted values and concepts (the reference or standard) happen is important – deviations are normal in research and important for capturing “science in action”.
2. Satisfaction of a requirement and/or adaptation to use: Defining the purpose of research and development and the resulting requirements is necessary. Two questions to ask are: Who are the customers of the research? What does “usefulness” mean in this context? It is critical to determine whether research and development will be used solely for internal purposes, will be presented to a larger scientific community, or will be used in society at large.
3. Planning and formalization: Research projects should define their objective at the outset, but their success should not be judged on consistent agreement between the objective and actual results. Fundamental research must be given flexibility for discovery and improvisation. Therefore, formalized planning should be performed carefully and only when necessary and all anomalies and deviations must be recorded, reviewed, and judged to be beneficial or in need of correction.

In their second article, Petit applies these concepts by suggesting practical proposals for applying the quality approach to fundamental research, distinguishing the three major steps of a research program, and encouraging of feedback from experience. Petit’s three guiding principles for applying the quality approach to fundamental research are listed below along with their practical implementation suggestions:

1. Integrating the quality approach in fundamental research requires a global management approach that is adapted to the culture of the scientific community. Therefore, specific criteria of quality and associated critical points should be defined for each stage of the research project – this is a responsibility for the high-level management of the project.
2. The concrete reality of the researchers’ experience and “profession” should be considered. This means that changes should generally be made gradually and incrementally, based on acquired data and experience. Further, researchers must be helped to see the importance of quality in their work and to adopt a continuous improvement approach.
3. The design of quality measures must try to minimize constraints on researchers. Practically, appropriate measures to satisfy the criteria of quality identified above should be determined by team leaders rather than overall project management and practical solutions should be determined within the teams themselves. This provides the researchers autonomy and flexibility while satisfying the overall project objectives, while specifying the personnel responsible provides accountability.

Petit also suggests feedback should be strongly encouraged, especially at the end of long, expensive, and/or significant projects. Rather than strictly define a research process, feedback should be used to develop intuition and communal knowledge in research. To effectively seek feedback, communication of results must be considered from the outset of the project (“popularization of the project”). Petit emphasizes that it is crucial to include, "explicit specification of the validity domain of these results [to] ensure that no abuse can be made that

involves the researchers' responsibilities," when effectively communicating research results to broader communities, especially to society at large.

Reproducibility is clearly a group-wide effort and it is critical to teach and demonstrate the importance of reproducibility and how it is managed as established members of the research group leave and new members enter. In one study, a lab took some time off from investigating new questions to solely focus on reproducibility through repeating some of their previously published work. This repetition showed the lab that some of its research protocols had slowly diverged and effort was needed to synchronize its practices. One researcher there noted that, "the lab saved money overall by getting synchronized instead of troubleshooting failed experiments piecemeal, but that it was a long-term investment," [23]. This experience underscores the need for strong institutional knowledge transfer mechanisms, particularly given high staff turnover, and is exactly what a strong training program seeks to address.

An important conclusion about the economics of reproducibility in research from Freedman et al. is [26]:

The economics literature on standardization posits that unless there is a clearly dominant platform leader willing to impose a solution, complex challenges such as irreproducibility that require a coordinated response are best solved by internally organized and driven, dynamic, and self-regulating collaborations of key stakeholders who establish and enforce their respective rules of engagement. What is needed is not another list of unfunded mandates, but rather community consensus on priorities for improvement and commitment for the additional funding for implementation. This includes training that focuses specifically on the importance of standards and best practices in basic research in graduate and postdoctoral programs, as well as quality management systems to ensure that best practices are implemented throughout the research process. No doubt that improving training and increasing quality control measures will add costs to the preclinical research enterprise. One estimate in a clinical setting suggests the adoption of mandated quality control procedures would increase costs to 15% to 25% above current spending levels. However, the societal benefits garnered from an increase in reproducible life science research far outweigh the cost. Assuming that we could recover even half of the approximately US\$28 billion annually spent on irreproducible preclinical research in the US alone by applying best practices and standards, the savings would be roughly US\$14B/year.

Although this study focuses on preclinical research, it is extensible to nuclear engineering research and to some degree to university research more broadly.

From this review of the best practices of quality assurance in other university and fundamental research environments, five elements essential to quality assurance in research and development settings are distilled; these elements are defined in Table 2.2.

Table 2.2. Essential elements and their descriptions for quality assurance programs designed for and implemented in research and development environments.

Element	Description
Personnel Commitment	Successful quality assurance programs depend on voluntary support and commitment from researchers that comes from understanding the need for and benefit from quality assurance practices in their research. All personnel within the research structure, including management, must have clear commitment to the quality assurance program – clear definitions of roles and responsibilities are necessary.
Modular Elements	A good quality assurance program should be flexible, modular, and non-redundant so that researchers choose and implement the parts that make sense and are beneficial. Document creation must directly involve relevant personnel, build upon good practices (and formalized instructions) that already exist, and should be careful not to unnecessarily expand the scope of the quality program.
Review	Review is a critical part of a quality assurance program, ensuring important planning is properly reviewed before being implemented. Further, structured review of results is critical as deviations and anomalies are expected in research and thorough review allows for discovery, corrective action as necessary, and progressive learning.
Knowledge Maintenance and Transfer	The quality program must include a permanent information/knowledge repository that is actively maintained and used in combination with a rigorous, quality-focused training program to continuously train new personnel, particularly students. This may be the most important element of the quality assurance program in a university research and development environment.
Communication	Consistent and clear communication is fundamental for collaboration within a research laboratory and for sharing knowledge with those outside of the laboratory. There must be clear structures within the research organization, both horizontal and vertical, to facilitate consistent communication including review of research (e.g. internal audits). There must also be clear means for sharing knowledge with the larger research community, which are generally carefully selected journal publications and conferences. Knowledge sharing should be in both directions, to and from the research laboratory.

The essential elements of quality assurance practices successfully applied in research organizations identified here are a key conclusion from this chapter. These essential elements are used in combination with the essential quality assurance elements in the ASME NQA-1 standard to create a quality assurance program fit for use in the university research environment that is adherent to the NQA-1 standard. With the experience from the CIET Research Program, these essential elements are the basis for the University Nuclear Quality Assurance Program discussed in the following chapter.

Before discussing the University Quality Assurance Program, this discussion will examine additional outcomes from the application of quality assurance practices in research. Quality



assurance is an important tool for shifting the costs of irreproducible research from downstream organizations that apply research in products or other applications back to the researchers themselves. However, quality assurance also has the potential to bring benefits to research beyond reproducibility – quality assurance improves research in general. Beyond the research itself, the application of quality assurance practices in the university research environment has the potential to bring significant social benefits, primarily through the development of community.

### 2.3 Social Impact

It is important to emphasize that the CIET Research Program should always be seeking not only to adhere to requirements in the ASME NQA-1 standard but to have a quality assurance program that best supports its research as well as the broader research community. The research explored and developed through this dissertation should not stop when the quality assurance program is complete and implemented but should continue to grow and improve with the life of the research program – continuous improvement is fundamental to quality assurance and scientific research in general. The goal of this work is rooted in seeking to establish and achieve standards of excellence over simple compliance. Given this larger, more enduring goal, the research presented here seeks to justify why a quality assurance program is important for the work in the CIET Research Project and how to make the program as impactful and enduring as possible.

In addition, a strong quality assurance program has the potential to build important elements of community into an academic research organization that enhances not only the quality of research but the experience and capabilities of students. A community of students in research should encourage commitment to the quality assurance program and to the research goals of the group, commitment to a high standard of ethical behavior in research, commitment to high technical standards of research for themselves and their fellow community members, and deeper satisfaction in their work.

A central premise in this research is that much of the success of the implementation of the CIET quality assurance program and later the UNQA Program is directly related to the strength of the laboratory community as the quality assurance program is ultimately community driven. This section will define “community” in this context along with important characteristics; why and how these characteristics are valuable for the laboratory community, specifically regarding the aims of the quality assurance program; and the elements of the quality assurance program that seek to build and strengthen these characteristics in a positive way. Final discussion on the broader university research community will be given including how this community relationship can be strengthened by a common commitment to quality assurance, including potential practices that the broader community could engage in to support each other as well as hold each other accountable to these higher standards (of excellence; an example of this is INPO (the Institute of Nuclear Power Operations) as a communitarian regulatory system).

As a general caveat for this section, the researcher responsible for this dissertation is a student, engineer, and relatively technically inexperienced outside of the field of nuclear engineering. Social theories, like those around community, are certainly fascinating and hold powerful promise for understanding and improving human experience not only for this work but for life in

general. However, without further study and outside perspectives, it is challenging to provide an adequate discussion and to fully sound the depths of this topic within this dissertation. Notwithstanding this inexperience and lack of technical background, this is a topic worth pursuing that may become the beginning of a much longer and deeper exploration of the importance of community here and elsewhere, at the very least for personal development.

### 2.3.1 Definition of Community

The definition of community is not easily pinned down, making this discussion and the connection between quality assurance and community challenging. Selznick distinguishes a community from a group in the following way [55]:

A group is a community to the extent that it encompasses a broad range of activities and interests, and to the extent that participation implicates whole persons rather than segmental interests or activities.

Selznick also notes that, “a framework of shared beliefs, interests, and commitments unites a set of *varied* groups and activities,” underscoring the connection across place and purpose, driven by this common framework. Nuclear engineering research laboratories, particularly those that share a common research field and common interests therein, meet this general concept of community through their common interests and mutual interdependence.

Individual research groups, such as the Thermal Hydraulics Laboratory, ideally meet this general definition of community. The Thermal Hydraulics Lab encompasses a broad range of activities and interests all centered around the FHR – frequency response testing methods, fault detection in reprocessing facilities, heat exchanger optimization and economics, conjugate heat transfer, thermal radiation, nondimensional scaling, human-machine interface study, and even quality assurance are bound together here. The members of the Thermal Hydraulics Lab are full time students, staff, and professors and thus are significantly involved, much closer to participating with their whole persons (time, interests, activities, social interactions, etc.) than not, especially as they naturally share interests being of similar age and of similar personality (it is a unique kind of person who pursues and obtains a Ph.D.). However, research can be solitary at times and not all research group members are as close as others, making this example imperfect even though it does point toward the ideal – research groups have the *potential* to be strong, cohesive communities.

Selznick goes on to clarify their understanding of community:

A common life is not a *fused* life: in a fused life there would be no need for regulation or governance, no need to take account of individual differences, no need for adjustment, reciprocity, or cooperation. The tacit assumption here is that people and groups participate in any community, large or small, as individuated and self-regarding entities. They are independent as well as interdependent.

The distinctive function of community, then, is the reconciliation of partial with general perspectives. A community must recognize the legitimacy of egoism as a basic aspect of

humanity and therefore as a necessary starting point for group life. If egoism did not persist there would be no need for community; if it had no moral and social worth, we might try to rid ourselves of it by repressive measures or by attempting to fashion a wholly altruistic self. But that is not the mission of community. Its true function is to regulate, discipline, and, especially, to channel self-regarding conduct, thereby binding it, so far as possible, to comprehensive interests and ideals.

What we prize in community is not unity of any sort, at any cost, but unity that preserves the integrity of persons, groups, and institutions. Thus understood, community is profoundly *federalist* in spirit and structure. It is a unity of unities.

The independence and self-regarding nature of the people that make up communities is vital to not only understand and account for but to productively celebrate and channel for the benefit of all in the community. The members of a community serve each other, are interdependent, and seek their common benefit. In the Thermal Hydraulics Lab, this looks like people reviewing each other's work, asking for and receiving help when they need it, celebrating each other's success and encouraging each other when struggling, participating in group experiments, giving guidance and advice on research, and generally giving their time and energy when needed. Here again, there must be a balance between people serving those around them and still having time to get their own work done. Individual success, such as publishing research in a high-profile journal, contributes to the overall success and reputation of the research group and thus all its members. This example of community is, again, the ideal and should be sought for while understanding there will always be things to improve upon.

### 2.3.2 Community Development through Quality Assurance

Community is certainly the ideal for a research group and brings significant benefit to research itself as well as the researchers. Quality assurance may foster community by providing structure and motivation for the research group to pursue community. There are evident shared values of clear and consistent communication, transparency of work, collaboration and mutual support, and individual responsibility to a larger organization. As personnel buy into the importance of quality assurance and commit to their responsibilities within the quality assurance program, they practically if not explicitly buy into the importance of and need for community.

Beyond creating the structure and formalization needed to define and support community within a research group, quality assurance training includes the important function of indoctrination. A general definition of indoctrination is the process of inculcating a person with ideas, attitudes, cognitive strategies, or professional methodologies. Indoctrination has a negative connotation associated with uncritical or blind acceptance of ideas that may be harmful, such as an authoritative government indoctrinating its citizens to support it without question, even in the face of harsh criticism from outside governments and organizations. Here, however, researchers seek indoctrination through critically examining the purpose and value of quality assurance. A significant function of the Training Procedure in the CIET Research Program's quality assurance program is to teach where quality assurance practices come from (the regulatory basis and the NQA-1 standard), what practices the CIET Research Program commits to and how these practices are implemented (the Quality Assurance Plan and implementation documents), and

why this is important and beneficial. As personnel within the CIET Research Program use these procedures and practice quality assurance, it is expected that they come to see the value of quality assurance, its benefit to their research, the importance of working together, and ultimately come to take ownership of the quality assurance program through review and maintenance of the quality assurance implementation documents. Indoctrination in this way is a slow process requiring consistent engagement with quality assurance, but it builds a lasting commitment and support rooted in experience and understanding.

Although the focus of this discussion has been on the importance of community within a research group and its relationship with quality assurance, community exists at many scales. In the literature there is a clear identification of the need for a broader community of the stakeholders in research to support the quality of research, including this dissertation's fundamental theme of reproducibility. The NIH (National Institutes of Health) has worked towards improving their community's commitment to reproducibility through (1) developing a training module to enhance reproducibility and transparency of research findings with an emphasis on good experimental design; (2) creating a checklist for grant evaluations for reviewers to ensure more systematic evaluation of grant applications; (3) developing ways for investigators to locate and access unpublished, primary data; and (4) developing an online community for open discourse about published articles [27]. The NIH recognizes that reproducibility is not a problem that it can tackle alone and is consequently reaching out broadly to stakeholders, including the research community, scientific publishers, universities, industry, professional organizations, and patient-advocacy groups to help reset the self-corrective process of scientific inquiry. This effort is an excellent example of community creation, engagement, and support to pursue not only reproducibility in their research but exemplary scientific practices more generally.

Freedman et al. concluded that community-developed best practices and standards must play a central role in improving reproducibility [26]. They give excellent examples in both the World Wide Web Consortium (W3C), an internally driven and self-regulating international consortium of public and private organizations, and the Internet Engineering Task Force (IETF), a not-for-profit nongovernmental organization with a large number of short-term working and informal discussion groups that work on specific, timely issues. Both W3C and IETF successfully guided the major stakeholders of the Internet toward common standards, requiring all to compromise and adapt in the short term but that clearly led to long-term benefit. Now, W3C and IETF continue to develop Web standards and maintain its interoperability as a universal space. This is a great example of communitarian regulation/regulators that were able to apply a common standard or practice across an industry for the betterment of all, even if there is not a direct financial benefit to themselves.

In the Global Biological Standards Institute's summary report, "The Case for Standards in Life Science Research," they assert that, through increasing reproducibility, standards, "can benefit all stakeholders, counteract quality challenges, and be a unifying driver of current and future life science research quality improvement efforts. Uniting diverse life science research stakeholders in a standardization effort will be challenging. Nonetheless, influential entities within the life sciences community can all join in a global initiative to exchange ideas, identify areas of greatest need, and advance the development and adoption of biological standards," [28]. This can be said

of the nuclear engineering research community as well, and the UNQA Program may be the appropriate starting tool for this effort.

There are clear relationships between quality assurance, reproducibility, and community that range from the laboratory scale all the way to broad research communities encompassing many stakeholders in many places.

## 2.4 Discussion Synthesis

This chapter has reviewed the important ideas of reproducibility in scientific research, quality assurance as a tool for excellence and reproducibility in research, and the social benefits applying this tool may have within and among research communities.

Reproducibility, defined by Thomas as “independently deriving a study’s quantitative results from its original data set,” [24] is fundamental to science and its progress. Unfortunately, poor reproducibility has become a challenge in many research fields. Quality assurance, defined within the commercial nuclear power industry as “all planned and systematic actions that are necessary to provide adequate confidence that a structure, system, or component will perform satisfactorily in service,” [32] if well applied, provides effective tools for improving reproducibility in science. Reviewing the nuclear energy industry-accepted quality assurance standard, the ASME NQA-1 standard, several key elements of quality assurance have been identified: the application of a graded approach; thorough and transparent documentation and record keeping; the clear responsibility of all personnel for quality-related activities; the need for independent review and approvals; thorough understanding of the as-built configuration of the system, including on-going inspections to ensure continued performance; and corrective action. These key elements compare well with key quality assurance elements identified through reviewing quality assurance experience within research organizations, which include: personnel commitment, modular elements, review, knowledge maintenance and transfer, and communication. These key quality assurance elements from the NQA-1 standard and from literature review are important lessons learned and inform the creation of a quality assurance program for the CIET Research Program.

This chapter also included brief discussion on the social benefits from quality assurance practices integrated into research environments. Research organizations such as university research laboratories are fundamentally communities of people with similar interests and goals and quality assurance provides a helpful structure for strengthening and spreading this community. The social benefits that quality assurance practices bring, although intangible and difficult to quantify and attribute, can improve the quality of research substantially through improving reproducibility and instilling the pursuit of excellence in all community members. These benefits can also shift costs of reproducible research to the researchers themselves as they take on the organization and structure of a quality assurance program, thus answering a fundamental challenge identified by Freedman et al. [26].

The following chapter will introduce challenges to quality assurance that have been seen in the CIET Research Program, how these challenges have been addressed, how quality assurance has been integrated into the CIET Research Program, and the design and implementation of the

quality assurance program for the CIET Research Program. The best practices from the NQA-1 standard and from quality assurance program experiences in other research environments identified in this chapter are again critical for addressing quality assurance challenges and designing and implementing a quality assurance program for university research that will be effective and long-lasting.

### 3 The University Nuclear Quality Assurance Program

The CIET Research Program, built upon previous research, was funded and initiated in the beginning of 2012 and began experimental testing at the end of 2014. The CIET Research Program used a quality assurance program throughout the design, construction, and initial testing of the facility. The quality assurance program was a requirement of the initial funding from the U.S. Department of Energy (DOE) and thus was carefully designed and implemented to meet applicable ASME NQA-1 requirements, as verified by annual audits from an NQA-1 specialist. However, in the years following the initial testing of the facility, the initial funding has expired, students and research staff have changed, and this original quality assurance program has not been adequately maintained due to these and other challenges, many of which are inherent to the university research environment. The cross-cutting nature of these challenges was confirmed through reviewing quality assurance best practices in research and development environments, discussed in the previous chapter. Given the benefits of good quality assurance practices and the reality of quality assurance requirements in commercial nuclear power plants in the United States and abroad, the research presented in this dissertation chapter aims to design a new quality assurance program that addresses the fundamental challenges of experimental research in the university setting while achieving the high standards of industrial nuclear quality assurance standards, namely ASME NQA-1. This new quality assurance program will also reinforce reproducibility within the CIET Research Program and instill its value within the organization.

The purpose of this work is to produce a Quality Assurance Plan and all necessary implementation documents, proven through consistent implementation, that satisfy the applicable requirements of Part I and Part II of ASME NQA-1-2008 and NQA-1a-2009 Addenda in a graded approach tailored for research and development in the Thermal Hydraulics Laboratory at UCB. Further, a primary goal for this quality assurance program and implementation documentation is that it is applicable to a general set of university nuclear engineering laboratories. Applicability will ideally be captured in a template series for the Quality Assurance Plan and all necessary implementation documents. This template series will be simply called the University Nuclear Quality Assurance Program, or the UNQA Program, that has only briefly been discussed up to this point within this dissertation. This work therefore has the potential to help extend good quality assurance practices to more fundamental and applied nuclear engineering research at university laboratories in the U.S. and aid in educating and training students that work in these laboratories. Quality assurance education and training will better prepare students to go on to work in the commercial nuclear power industry in the U.S. and elsewhere, potentially improving work there as well.

In this section, discussion will examine the challenges to quality assurance in the university research setting that have been faced in the context of the CIET Research Program, how these challenges are conceptually being addressed, and how the design and implementation of the CIET Research Program's new quality assurance program has begun to address them practically.

#### 3.1 Challenges to Quality Assurance

The university research environment presents many challenges to integrating quality assurance – from the experience in the CIET Research Program, the challenges are primarily in two areas: (1)

conflicting goals and (2) structural differences. These two areas also represent two perspectives from which to view challenges: a top-down perspective that considers the mission and strategy of the organization, and a bottom-up perspective that considers the way the organization is structured to support its mission and strategy. Quality assurance challenges in the university research environment will realistically often involve both conflicting goals and structural differences, although one more clearly than the other, which is why these are named “perspectives” as they are two ways of viewing the same challenge and should both be considered to fully appreciate the challenge and potential solutions.

Within these two challenge areas or perspectives, the CIET Research Program has faced three implementation challenges in particular: (1) roles and responsibilities, (2) program usability and transparency, and (3) training and indoctrination. This section will go through each challenge area in more detail as well as describe the three implementation challenges and how they fit into the above two challenge areas.

### 3.1.1 Challenge Area: Conflicting Goals

At first look, it is straightforward to see that a rigorous quality assurance program designed for nuclear facilities and a university research program have little overlap in practice as they have relatively disparate goals. Quality assurance in the commercial nuclear power industry, as embodied in the NQA-1 standard, has goals focused on ensuring operational safety, efficiency, and reliability; establishing and confirming as-built designs; keeping meticulous records of all actions; thorough training and indoctrination of staff into a culture of safety and consistently excellent operation; and supporting the ability to continue to meet these goals through the lifetime of the plant (including decommissioning and spent fuel disposition – easily a fifty-year endeavor and becoming considerably longer as plants are renewing their licenses for extended operations). In support of these goals, every organization responsible for the design and operation of the plant to some extent devotes several staff members working full-time and significant resources toward developing, implementing, and maintaining adequate quality assurance programs. The regulator is then responsible for inspecting and confirming that quality assurance requirements are being met by all associated quality assurance programs. The goals of quality assurance for the commercial nuclear power industry are essentially focused on nuclear power plants themselves, which have goals of safe, efficient, and reliable operation under all circumstances for their lifetime. Goals of innovation, flexibility, discovery, and thought leadership, essential to university research programs, are simply not the goals of nuclear power plants and their associated quality assurance programs.

University research in nuclear engineering has goals of making new and meaningful contributions to its related fields, requiring expert-level study and the development of novel concepts; teaching and training students for work and research in these fields; and leading its fields in desirable directions through research and discovery – more than discovering new things but defining and driving the conversation of why they are important and worthy of further pursuit. As noted above, these goals may be restated (more simply) as: innovation, flexibility, discovery, and thought leadership. University research programs, in the form of laboratories and groups comprised of faculty, staff, and students, are wholly devoted to these goals and all resources and personnel are ultimately responsible. In regard to confirming whether these goals



are met, there is no well-defined “enforcer” or regulator; rather, research communities made up of many research personnel and organizations are responsible for determining the value and importance of individual research efforts – essentially confirming or denying that these university research goals are being met. Research communities are generally established and communicate through conferences and publications (i.e. journals), and it is at these conferences and in these publications that the communities judge, critique, and refine their research as communities. In reflection, it is clear that university research is harder to clearly define and characterize as compared to a highly organized and structured organization like a nuclear power plant. University research is ever-changing based upon ever-changing interests and therefore funding, communities are continuously shifting as members join and leave, and even publications gain and lose reputation/credibility, thereby gaining or losing the power of their voices in these communities. It seems strange how volatile such important institutions are, particularly against such a striking foil as a nuclear power plant, but such is the fundamental nature of human discovery and invention.

Reproducibility is certainly a goal of both organizations, but the purpose of reproducibility in each organization is different. In nuclear power plants, a significant means of meeting its goals is to identify best practices and operations that provide for safe, efficient, and reliable operation under all circumstances for the plant’s lifetime and make those operations standard. Another way to say this is that nuclear power plants identify and reproduce excellent performance internally and within the U.S. fleet to maximally meet their goals [56]. Reproducibility in this setting is focused on internal performance and consistency in a set of operations that remain largely fixed across the lifetime of the plant (small operating power changes, startup and shutdown operations, maintenance periods, response to abnormal events, etc.). The same set of staff learn and practice these operations to develop deep experience and reproducibility in their performance, only adjusting their operations to increase efficiency in meeting the goals of the plant. A good example of this is that nuclear power plants typically use an outside contractor to help perform maintenance and inspection during planned plant outages. This contractor will go from plant to plant, performing maintenance and inspection activities when and where needed, thus gaining significant deep experience and maximizing their efficiency and effectiveness over time to help the plants meet their goals of maximal time online and producing power for the grid [57].

University research programs also value reproducibility, although in a different way and for a different purpose. Reproducibility in the university research environment is primarily achieved so that other research groups or organizations can reproduce and confirm their results, confirming research findings, and verifying that new discoveries have been made. As discussed in the previous chapter, reproducibility is a fundamental characteristic of good science and as such must be transparent and outward facing in the university research environment rather than only internal.

It is clear that the goals of nuclear power plants and university research programs are dissimilar and indeed may be seen as conflicting. Therefore, a quality assurance program designed for a nuclear power plant is generally inappropriate for university research. As discussed in Section 2.2.1 in the definition of quality assurance, quality assurance practices may be beneficial for university research programs, but practically they most likely will be very different from those practices in place at nuclear power plants embodied in their quality assurance programs even

though the high-level purpose of quality assurance (showing/proving that a desired goal is/will be achieved) is the same in both situations. This is the first challenge area: the goals of nuclear quality assurance, embodied in the NQA-1 standard, and university research are not only different but are often in opposition to each other. The challenge in this research is thus to design a university-specific quality assurance program that satisfies the fundamental quality assurance requirements in the ASME NQA-1 quality assurance standard.

### 3.1.2 Challenge Area: University Research Structure

The conflicting goals of nuclear power plants and nuclear engineering research in universities in many ways go hand-in-hand with differences in the way these organizations are generally structured. From the experience of the CIET Research Program and considering experience collaborating with other researchers in other institutions, nuclear engineering research in universities is typically structured as an academic department consisting of many research groups with more focused research interests/fields, such as thermal hydraulics, nuclear materials, radiation detection, and so on. Within these research groups, there is typically one professor (often called the Principal Investigator or PI), a dozen or so students (mostly graduate students but also including undergraduate students), and sometimes additional full- or part-time research staff. Professors generally spend full careers leading their research groups, although their interests often naturally change and develop over time. Graduate students, and even more so undergraduate students, are only in these research groups for a short time, typically four to six years (one to three years for undergraduate students), as they study, perform research, and complete the requirements for their degrees and ultimately graduate (a good thing!). Within their time in the research group, students often change research projects a few times. Full- and part-time research staff tend to be involved in these research groups to an extent somewhere in between professors and students, and often provide very specialized research roles such as experiment fabrication. Research groups are flexible as research interests, funding, and research projects all shift, change, and evolve over time (ideally in a coordinated way) which allows these groups to stay at the forefront of their research communities, taking on new and important challenges and questions in the field as they arise, leading to discovery and innovation. This flexibility in focus and emphasis on discovery and innovation leads research groups to act as thought leaders in their fields.

There are immediate and obvious differences between the university research environment and nuclear power plants, organizations focused on safe, efficient, and reliable operation of large, complex systems under all reasonable circumstances over many decades. University research groups naturally have small sizes and are comprised primarily of students who act as multipurpose research personnel, taking on the many roles and responsibilities within research projects (experiment design, literature review, item/service procurement, experiment fabrication, experiment operation, modeling and simulation, data analysis, scientific writing, etc.) over several years. This is excellent experience for forming engineers and scientists capable of expert-level work in challenging fields, but this creates high “turn-over” in staffing research projects within the group, makes institutional knowledge transfer difficult, and never allows deep practical experience to develop within the group, which are all important for sustained reliability and long-term improvement. To be clear, this is simply a contrast and is not meant to reflect negatively one way or the other – sustained reliability and long-term improvement are not goals

of university research programs in the same way that they are for nuclear power plants. As research within a group changes and research projects close and new projects start, there is less of a need for robust knowledge and skill transfer. Instead students and other personnel are expected to adapt and learn what is needed for the project, perform and publish research, and then move on to the next project or opportunity outside of the university. Because quality assurance would generally support goals of long-term/sustained reliability and improvement it therefore is traditionally not emphasized in university research programs, certainly not to the same extent as nuclear power plants.

Clearly these organizational structures are very different, and for good reason - the structures of each organization are meant to support the organization's goals. Challenges arise, however, when these goals shift. Research projects and associated experiments/infrastructure that have longer lifetimes – ten or more years, two or more generations of graduate students – require more dedicated knowledge transfer and quality assurance practices to maintain effective performance of the research project. Or, if the research in a group relies on a common methodology or technology (such as scaling and the use of fluid loops within the CIET Research Program and the Thermal Hydraulics Laboratory in general) and the research builds upon itself for several generations, knowledge transfer practices will be important to ensure reliability and continued improvement of these methodologies/technologies. Often the professor and any research staff help to maintain longer projects by performing knowledge transfer to new students and facilitating particular skills or special operations that require extensive experience beyond what students are expected to have, however there are generally no formal mechanisms for knowledge transfer (i.e. a dedicated training program for the specific work performed within a research group). A quality assurance program has the potential to hold institutional knowledge and provide knowledge transfer through a series of approved procedures, records of research performed (including data), and training and indoctrination, but again, this is typically not found in university research programs. There is traditionally very little need for formal or rigorous quality assurance to this extent and thus very little experience with quality assurance within these programs.

### 3.1.3 Three Implementation Challenges

The three major challenges faced by the CIET Research Program in implementing and maintaining its original quality assurance program are: roles and responsibilities, usability and transparency, and training and indoctrination – this section will discuss these challenges and expand on how these challenges fit into the primary challenge areas above.

Strictly defined roles and their responsibilities is helpful in ensuring all needs of an organization are covered and that responsible personnel know exactly what is expected of them. In the original quality assurance program for the CIET Research Program, specific roles and responsibilities were defined and the expectation was that these roles and responsibilities would be combined in the duties of specific research staff and students as there are less students/staff than the roles defined in the quality assurance program. As students come and go, these role assignments would change hands as well and a new set of personnel would continue to perform all necessary responsibilities. In practice, however, managing the assignment of numerous roles and responsibilities to changing research program personnel proved challenging, particularly as

project leadership and management roles are fluid and change hands often as well. This speaks to the inherent challenge at universities in managing research programs with long lifetimes that include multiple generations of graduate and undergraduate students, especially regarding the day-to-day leadership and management by the students themselves. Research programs like this must have strong institutional knowledge maintenance and transfer. This is challenging as the goals of university research programs are often aligned with more limited projects (i.e. single to a few students per project) with shorter project durations dictated by grant funding and student tenures. The challenge of defining roles and responsibilities within the quality assurance program, then, is a structural challenge resulting from small “staffs” in university research programs that wear many hats, change roles often, and leave the research program after only several years.

A second challenge found in using the original quality assurance program is the lack of transparency, intuitive organization, and ultimately, usability [58]. With a significant number of documents and records that are relevant to many personnel’s work, effective organization that allows for efficient work is important. The original quality assurance program included twenty-five quality assurance specific documents and a total of approximately 3,500 quality-related documents and records that were generated between starting research in 2012 through the beginning of the use of the new quality assurance program in 2019. The count of quality assurance specific documents and the total number of documents and records is included here not to make the argument that this is too much, too few, or somewhere in-between, but to emphasize the need for simplicity and clear organization for any single program user to navigate and use the quality assurance program effectively, efficiently, and in a satisfactory manner. This is particularly important for university students and research staff whose research is tangential to the CIET Research Program and who do not necessarily want to or need to spend the effort to become expert users of the quality assurance program itself. This challenge primarily comes from the conflicting goals of a rigorous, NQA-1-compliant quality assurance program and a university research program. Without personnel within the research program dedicated to the maintenance and use of the quality assurance program, the quality assurance program must be designed more simply and transparently to address the needed usability of personnel with goals unlike the personnel working at a nuclear power plant.

Training and indoctrination is the third primary challenge and it is closely related to the challenges above. Training and indoctrination in the quality assurance program is especially important in university research programs because of the related importance of training and education for students. This training was particularly challenging to implement well in the original quality assurance program due to changing leadership and lack of a regular, rigorous training program that is self-contained. Quality assurance in general is directly dependent on the commitment of the personnel, which requires rigorous and regular training and that the personnel receive a high degree of satisfaction from implementing the quality assurance program. A training and indoctrination program is a structural component of an organization which makes this a structural challenge. Further, the need for a rigorous training and indoctrination program in the university research setting is driven mainly by the high turnover of personnel and the lack of their deep experience, both fundamentally structural elements of university research. Ironically, training and indoctrination is a primary goal of university research programs as their primary

personnel are students who are there to learn and grow in their skills and knowledge within their research fields.

### 3.2 Quality Assurance Integration

The following sections address the two challenge areas and the three specific implementation challenges discussed above. The goal in these sections is to bring into alignment the use of the ASME NQA-1 standard and the quality assurance needs of university research.

#### 3.2.1 Alignment of Goals

From the discussion in Section 3.1.1 “Challenge Area: Conflicting Goals”, it is clear that the goals of quality assurance programs within nuclear power plants do not adequately align with university research programs in nuclear engineering. Reviewing Section 2.1.3, the essential quality assurance elements extracted from the NQA-1 standard are: the application of a graded approach; thorough and transparent documentation and record keeping; the clear responsibility of all personnel for quality-related activities; the need for independent review and approvals; thorough understanding of the as-built configuration of the system, including on-going inspections to ensure continued performance; and corrective action. All of these essential elements are reflected in the quality assurance best practices distilled from other disciplines, as shown in Table 3.1. Further discussion of the overlap of these elements is given below.

Table 3.1. Comparison of the essential quality assurance elements distilled from reviewing best practices in other research and development (R&D) environments and from the NQA-1 standard.

R&D Elements (Table 2.2)	NQA-1 Elements (Section 2.1.3)
Personnel Commitment	Clear responsibility of all personnel for quality-related activities
Modular Elements	Application of the graded approach
Review	Need for independent review and approvals; corrective action
Knowledge Maintenance and Transfer	Thorough and transparent documentation and record keeping; thorough understanding of the as-built configuration of the system, including on-going inspections to ensure continued performance
Communication	The need for independent review and approvals; thorough understanding of the as-built configuration of the system, including on-going inspections to ensure continued performance

The NQA-1 standard element of having clear responsibilities for all personnel for all quality-related activities overlaps well with the R&D element of Personnel Commitment. Commitment

to quality practices in research by all personnel within an organization should include their acceptance of responsibility for these practices. When clear responsibilities have been established, personnel will also be empowered to take ownership of their role within the organization. Clear delineation of roles and responsibilities also contributes to the transparency of the organization and thus accountability.

The application of the graded approach overlaps well with Modular Elements. Modular Elements speaks to the design and structure of the quality assurance program and the supporting documents and procedures within it. Applying the graded approach is meant to fit the intention of the requirements within the NQA-1 standard to the application and environment they are used in, in this case a university research program. Flexibility, modularity, and non-redundancy are all outcomes of applying the graded approach in this setting – none of the requirements within the standard are lost or changed, they are simply satisfied using this approach. Further, directly involving relevant personnel, building upon existing practices, and abiding by a strictly defined scope all are good examples of applying a graded approach so that the quality assurance program is fit for its purpose within the existing organization and project.

The need for independent review and approvals clearly overlaps with the R&D element of Review. The NQA-1 standard effectively formalizes the process of review within the research and development process and ensures that review is most effective by requiring independence of the reviewer. A second review, performed by an approval step from a second independent “approver”, is an additional review element. Careful application of the graded approach should be used here to ensure that independent review and approval does not add unnecessary constraint on the research and development process within the organization. Personnel constraints may make approval challenging if there are not several personnel with the necessary experience and knowledge available to perform both the review and approval steps. Corrective action overlaps with the Review R&D element as well in that corrective action should result from the review process when it is found necessary. Having a formal corrective action program is valuable for continued learning within the program and for continual improvement, an important value within research. Depending on the extent of the corrective action program, there may be overlaps with the Knowledge Maintenance and Transfer and Communication R&D elements as well. A corrective action program may be used to store and communicate lessons learned within the organization, improving institutional knowledge and improving the performance of research and development. Lessons learned may be communicated externally as well, either through an external-facing component of the corrective action program or through systematic communication through conference papers and journal publications.

Thorough and transparent documentation and record keeping as well as thorough understanding of the as-built configuration of the system<sup>1</sup>, including on-going inspections to ensure continued performance, are two NQA-1 elements that overlap with the Knowledge Maintenance and Transfer R&D element. Documentation and record keeping are essential for maintaining a clear

---

<sup>1</sup> “System” is a purposefully vague term here; a graded approach should be taken to understand the system referenced. If a quality assurance program is used across an organization, “system” correctly refers to not only the physical facilities owned by the organization but its human resources and other assets as well (e.g. its organization structure and communication paths should be understood as they practically exist). If the quality assurance program is limited to a specific research facility or experiment, the “system” then is the facility or experiment itself.

understanding of the organization and its research, including the as-built configurations of its important structures, including experiments and facilities. On-going inspections of items and facilities; internal audits of the performance of expected practices; and consistent review of designs, procedures, and results provide continuous understanding of the experiments, facilities, and research within the organization. This critical information is disseminated through the organization by documenting the outcomes of these actions and recording them in a common repository that is transparent and usable by all personnel. A rigorous, quality-focused training program then trains all personnel on how to use and maintain this information repository, maximizing its effectiveness. Beyond this one aspect, the training program also trains personnel on how and why the organization functions the way that it does, including common research practices such as which procedures to use in given situations and why. Training should be performed regularly to maintain best practices within the organization, especially if personnel change often as is the case with student involvement.

The Communication element overlaps in part with the discussion above: a thorough understanding of the as-built configuration of the system, including on-going inspections to ensure continued performance, in combination with robust and consistent training provides internal technical communication within the organization. As personnel participate in the training program, explore the information repository, and engage in internal audits and inspections, technical and organizational information is communicated. In a similar way, the independent review and approval process found in the NQA-1 standard allows personnel to communicate their planned and current research with other personnel, especially research relevant to the reviewer's as the reviewer and approver should be technically competent to provide appropriate review. These two elements of the NQA-1 standard help engage personnel with each other's research and the overall technical and organizational status of the program. However, there is still a need for structured communication, horizontally and vertically, within the organization. This communication should ideally take advantage of natural communication within research and development organizations, such as research group or team meetings, one-on-one meetings, project meetings, etc. External communication should also take advantage of the normal means of communication with the research community: conference presentations and journal publications. More specific external communication may be needed, such as quarterly reports or regular updates and corrective action summaries to specific interested parties such as the research's funding agency or collaborating organizations who will benefit from shared experience.

Given the clear alignment of the elements of the NQA-1 standard with established best practices from research and development environments, it should be possible to apply the NQA-1 standard to a university research setting to create a quality assurance program for a research project, such as the CIET Research Program. To go further than this, applying the NQA-1 standard to the CIET Research Program is also beneficial compared to applying other standards because of the nature of research within the CIET Research Program and the desire for the standard used to fit the function of the organization and project. Even though the goals of the CIET Research Program are very different from those of a nuclear power plant, the essential elements of the quality assurance standard used in nuclear power plants aligns well with best practices from other research and development disciplines that have successfully implemented quality assurance

programs. The NQA-1 standard not only will apply to the CIET Research Program but should support its goals well including reproducibility of its research.

Before moving forward, it is important to note here that there are no quality assurance measures in Part I of the NQA-1 standard that are unique to nuclear facilities and that are thus important to directly capture for application in nuclear engineering research. Part II of the NQA-1 standard includes requirements specific to nuclear facilities which thus are not invoked for the CIET Research Program. Caveats to this are that:

1. Application of the graded approach should consider the relative importance to nuclear safety. In research, the importance to nuclear safety should be considered yet balanced with the reality that the research itself, within the lab, has (in general) no impact on actual nuclear safety.
2. Requirements for software (found within Requirement 3, “Design Control” and Requirement 11, “Test Control”) refer to Subpart 2.7, “Quality Assurance Requirements for Computer Software for Nuclear Facility Applications,” which is not being invoked for the CIET Research Program’s quality assurance program. Subpart 2.7 is not invoked for simplicity, because the CIET Research Program is pursuing a graded approach to the design and implementation of the overall program, and because the current research does not have this need.

### 3.2.2 Alignment of Structures

The main differences in the structures of the university research program and a nuclear power plant are three-fold:

1. Small research group size vs. many personnel to fill a large organization with significant personnel structure within the organization
2. Multipurpose roles and responsibilities vs. well-defined and relatively fixed roles and responsibilities with sufficient redundancy
3. High personnel turnover vs. long-term careers within the organization

Structuring a university research program to resemble the organizational structure of a nuclear power plant, particularly given the irreconcilable size differences, is not the goal in this section. Instead, the aim is to design the structure of the quality assurance program to best suit the university research environment. First, there is a clear need for a strong training structure that can impart institutional knowledge to indoctrinate new personnel in the common research practices and get them active in research as soon as possible. This should maximize the effectiveness of research personnel as well as serve as a repository of sorts for institutional knowledge for the research program. A strong training program is further discussed as an implementation solution in the following section (Section 3.2.3). In addition to a structure specifically for training, special thought is given to how all implementation documents are designed. Implementation documents in the quality assurance program, such as procedures and templates, not only define how research should be performed but why research is performed in these specific ways. Including instructional material throughout the quality assurance program not only complements the training program, but also serves as institutional knowledge keeping and knowledge transfer. In the university research environment, it is just as important that students and personnel understand why they perform the actions they do as well as how to



perform these actions – this is essential for satisfaction-of-use, education in quality engineering, and allows students to continue to improve and adjust the quality assurance program to suit their particular needs and research. Using the quality assurance program should also result in significant records generation as research is performed. Records management, then, is critical to do well in order to promote ease-of-use and satisfaction-of-use. Clear records management provides history and context for the research performed which again facilitates institutional knowledge management. Records generated by the research program should be kept and managed for not only the lifetime of the specific research program but ideally for the lifetime of the research group so that future personnel may continue to learn and grow from past experience. Well managed records from past research projects will provide good examples of high-quality research and teach best practices which help to instill and carry forward excellent performance in the research program, even as the research itself changes over time. Beyond a robust training program, implementation documents designed to include instruction, and clear records management, longer-term research personnel such as professors and research staff ideally will facilitate and augment the knowledge keeping and transfer within the quality assurance program and within the research group more broadly. More important than knowledge transfer, it is recognized that culture and leadership in the research group is driven from the top down, and thus consistent and engaged management from professors and other research staff is critical [59]. Although graduate and undergraduate students continue to lead their own research and experiments and are responsible for day-to-day work as well as reaching milestones and creating deliverables (reports, presentations, posters, papers, etc.), the principle investigator of the project is responsible for establishing overall expectations for effective implementation of the quality assurance program and is responsible for obtaining the desired end result. The more this responsibility includes knowledge keeping and transfer, the better.

Training for the different functions and uses of the quality assurance program is also critical because of the small size of the research group and the multipurpose roles each member plays. Instead of having clearly defined roles and responsibilities, these roles and responsibilities are generalized into broader roles that match the natural structure of the research group. More discussion of these roles is found in the following section. The goal of this restructuring is to match responsibilities within the quality assurance program to the existing roles within the university research group and allow flexibility within these roles so that research group members may focus on responsibilities that make sense given the activities within the research group. Because these broader roles match the existing roles within the research group, there also does not need to be specific role and responsibility assignment. Instead, as research group members join the lab, complete the training for the quality assurance program, and begin their research, they naturally fall into their roles and take on the responsibilities that make sense for their research. The members of the research group and their roles are then tracked by the regular use of the training program for all personnel. This also helps to ensure all personnel are aware of their responsibilities and willing and able to perform them. Once personnel leave the research group, they stop participating in training, become ineligible for participation in the research project, and are no longer considered personnel within the quality assurance program.

### 3.2.3 Three Implementation Solutions

The first implementation challenge is addressed in the CIET Research Program's new quality assurance program by generalizing the quality assurance program roles and responsibilities to all program personnel, grouped into three roles in ascending responsibility: undergraduate students, graduate students/research staff, and the principal investigator. A fourth role, "Third Party Oversight," is included in order to include personnel outside of the CIET Research Program that must be included in order to perform critical responsibilities, such as annually auditing the quality assurance program to assure compliance to the NQA-1 standard. These roles and responsibilities (called functional requirements) are defined in Table 3.2.

Table 3.2. CIET organizational roles and functional responsibilities.

Role	Functional Requirements
<p>Principle Investigator (PI and/or Senior Management)</p>	<p>Establish overall expectations for effective implementation of the QAP (Quality Assurance Plan).            Coordinate CIET’s milestones and related schedules with CIET’s Sponsor (i.e. funding source) as needed.            Approve QA (quality assurance) documents, design documents, and changes thereto.            Adjudicate unresolved quality concerns.            Regularly performs management assessments of the adequacy and effective implementation of the quality assurance program.            Ensures the program is audited by a third party with appropriate qualifications.            Investigate adverse findings and assessment/audit findings.            Ensure corrective actions are addressed.</p>
<p>Graduate Students and Technical Staff (includes role of QA Manager)</p>	<p>Develop (prepare, review, approve) and maintain quality assurance program documents and records.            Qualify suppliers as needed or delegate this responsibility to qualified third-party personnel (i.e. personnel with auditor qualifications).            Take direction from the PI to implement the QAP.            Designate and/or ensure all project personnel are appropriately qualified for areas that require qualification, such as through a third party (e.g. ASQ, ASME, etc.).            Perform and/or oversee all research activities.            Ensure experiment design goals and system modeling goals align when necessary.            Create and/or review design changes.            Maintain and manage (includes inspecting and testing) all of CIET’s facilities and components, including instrument calibration.            Indoctrinate and train all personnel to the QAP and implementing procedures.            Assist Third Party Oversight personnel with logistics for QA audits.            Perform surveillance, inspection, and management assessment.</p>
<p>Undergraduate Students</p>	<p>Receive direction from the PI and graduate students to implement the QAP.            Perform work to QAP and implementing procedures.</p>
<p>Third Party Oversight</p>	<p>Perform annual QA audit and provide results to CIET.</p>

In this hierarchy, graduate students and research staff are the most active personnel in day-to-day research program work, while the principal investigator maintains final authority and responsibility for the research program as a whole. Undergraduates are an integral part of the CIET Research Program but are not generally given the authority and accompanying

responsibility for major decisions as compared to graduate students and research staff. Records of the names and active status of personnel are recorded and maintained through the training program rather than a separate roles and responsibilities record that then requires frequent updating. Generalizing project roles and responsibilities into three categories of research project personnel that exist naturally in the CIET Research Program is much simpler than the previous plan and works to align the structure of the quality assurance program to the existing structure of the university research group.

The second implementation challenge is addressed through a simpler and more transparent quality assurance program structure, described in Section 3.3.1 in more detail. Ideally, the quality assurance program structure is intuitive to use and reflects the requirements of the NQA-1 standard, allowing research program personnel as well as external quality assurance reviewers and auditors to use the program effectively and efficiently. Further, by emphasizing simplicity, the overall document overhead should be decreased and the number of documents per activity should be streamlined. This allows program personnel to identify and use the single or couple documents (most likely a procedure) as quickly and effectively as possible without the need for searching for several documents in several locations that may have overlapping functions/requirements. Streamlining the necessary document flow combined with effective documents that benefit research program work will also add to personnel satisfaction in the performance of their work, adding to the usability of the quality assurance program and the motivation of program personnel to continue to use the quality assurance program. Simplifying and streamlining the quality assurance workflow in a way that is intuitive and helpful is essentially creating a quality assurance program structure that best aligns with and complements the structure of the university research environment.

The third implementation challenge emphasizes the need for a rigorous and regular training program. Training and education are essential goals of the university research environment, therefore including training for quality assurance should be a natural extension of this environment. This addition to the university research experience is a welcome one for the purpose and benefit of the quality assurance program, research in the CIET Research Program, and even work in the commercial nuclear power sector. As students are trained in good quality assurance practices and graduate into this workforce, quality assurance will be the expected norm. Important qualities of training are that it rigorously includes training in quality assurance in general as well as the specific quality assurance program for the CIET Research Program, and that training occurs regularly so that there is no lapse in training, institutional knowledge transfer, and personnel leadership as personnel transition into and out of the research program. Structurally, the training program for the CIET Research Program is augmented to include quality assurance training alongside safety training and general technical training. The goal here is to take advantage of the structure of the university research lab (frequent trainings, emphasis on education) and to simply add quality assurance training to what already exists.

### 3.3 Implementation of the New Quality Assurance Program

The following sections describe the new quality assurance program used for the CIET Research Program and highlight specific areas of interest, including training and indoctrination, physical testing, and software design and testing.

### 3.3.1 Program Description

To address the challenges to quality assurance in research present in the CIET Research Program and to continue providing the benefits of good quality assurance practices, a new quality assurance program is under development. The new quality assurance program is being organized to closely match and meet the applicable requirements of Part I and Part II of ASME NQA-1-2008 with the NQA-1a-2009 Addenda. After meeting this first goal, additional quality assurance requirements will be considered, such as Department of Energy quality assurance requirements for research (i.e. 10 CFR 830, Subpart A: “Quality Assurance” and DOE O 414.1D). The new quality assurance program will follow the structure of the NQA-1 standard, with specific procedures implemented to meet the requirements for specific activities, for example: experiments, facility maintenance, buying new test equipment, designing new facility components, etc. The procedures will be as simple as possible while including all applicable requirements and instructions to reduce the number of documents needed for each activity and to provide the most guidance to personnel working on the activity. Emphasis is being placed on program effectiveness, efficiency, and personnel satisfaction in the performance of the program.

The primary document in the new quality assurance program is the Quality Assurance Plan. This is the top-level document that describes the quality assurance policy, applicable quality assurance requirements, assigns major functional responsibilities for CIET Research Program work activities conducted by or for the CIET Research Program, and describes the application of the graded approach for quality assurance requirements and implementing procedures. Describing the application of the graded approach is an important function of the Quality Assurance Plan and dedicated sections are included in each major piece of the plan, where relevant. The Quality Assurance Plan also includes the scope and applicability of the quality assurance program; the source requirements used for the Quality Assurance Plan, including regulatory documentation, consensus standards, and guides; and the quality program requirements satisfied by the quality assurance program. The Quality Assurance Plan most essentially defines the “what” of the quality assurance program while the implementation documents define the “who”, “how”, “when”, and “where”.

Section 5 of the Quality Assurance Plan, titled, “Quality Program Requirements,” is broken into eighteen sections, mirroring the eighteen requirements within the NQA-1 standard. Each of the eighteen sections defines the quality assurance practices that the CIET Research Program commits to based on the specific sub-requirements in each of the eighteen major requirement of Part I of the NQA-1 standard. Each of these sections also define the specific implementation documents that satisfy the quality assurance commitments made and define the application of the graded approach where applicable. The eighteen sections here mirror the eighteen requirements in Part I of the NQA-1 standard so that the relationship between the two is clear, there are no requirements missed, and experts in NQA-1 that are unfamiliar with this quality assurance program can quickly and effectively understand the program and its practices. Although this organization of the Quality Assurance Plan may not be as transparent as possible for the university research environment, it provides a clear relationship with the NQA-1 standard, benefits from industry practices learned from Kairos Power [60], [61], a commercial nuclear power plant design company designing an advanced nuclear reactor similar to the designs of

interest in the Thermal Hydraulics Laboratory, and helps students and other personnel learn more about and grow comfortable with nuclear quality assurance.

There are fourteen implementation documents in the new quality assurance program as well as two optional implementation documents that have been helpful in the initial design and implementation phase and that will continue to be helpful through the lifetime of the program. All sixteen documents are listed below; all documents are described in more detail within the Quality Assurance Plan. Further, each document includes specific instructions within itself regarding when and how to use the document, and often includes information on why the document is designed and used.

1. Calendar Procedure (used to create the CIET Calendar)
2. Information Repository Procedure (used to create the CIET Information Repository)
3. External Organization Interface Procedure
4. Training Procedure
5. Design Procedure
6. Software Design Procedure
7. Purchased Items and Services Procedure
8. Special Process Control Procedure
9. Inspection Procedure
10. Test Procedure Template
11. Software Test Procedure Template
12. Measuring and Test Equipment Selection Procedure
13. Corrective Action Procedure (Corrective Action Log)
14. Audit Procedure
15. Requirements Mapping Table (Optional)
16. Quality Improvement Plan (Optional)

The implementation documents are procedures and templates that guide personnel through the relevant process in a planned, reproducible manner. These documents are frequently revised and updated to reflect lessons learned as they are used to reflect changes in the activities within the CIET Research Program. These documents are also used as teaching tools as they contain information on why certain practices are performed and the practices themselves reflect the best practices used within the laboratory. Completed procedures and templates then serve as records of activities performed within the CIET Research Program and can be referenced in future work.

The two implementation documents that do not follow this format are the Requirements Mapping Table and the Quality Improvement Plan – the two optional documents. The Requirements Mapping Table is a helpful tool from Daren Jensen, the Quality Assurance Program Manager at the Idaho National Laboratory, that allows the user to map requirements from regulations (DOE Order 414.1D, 10 CFR 830 Subpart A, and 10 CFR Appendix B), to the requirements within the NQA-1 standard (specifically ASME NQA-1-2008/1a-2009), to the specific section within the Quality Assurance Plan that commits to meeting these requirements, and finally to the implementing procedure section and paragraph where the requirement is implemented. This allows the organization quality manager (or the personnel responsible for this function) to easily review whether all relevant requirements are implemented and where – this also allows a third-party quality assurance auditor to efficiently do the same. The Quality

Improvement Plan is similar to a GANTT chart where tasks and sub-tasks are scheduled and tracked over time. The purpose of this tool is to identify and plan for all work for the quality assurance program itself, such as routine review of documents, updating the Requirements Mapping Table, and reviewing requirements related to new research and development activities within the organization. The tasks are then viewed holistically over time to ensure consistent maintenance (and improvement where needed) is performed within an adequate time frame and that there is no interference or conflict between tasks. The Requirements Mapping Table is a helpful communication tool for the personnel responsible for these tasks and for communicating continued maintenance and improvement in the overall program to internal and external stakeholders such as management personnel, customers of the research, and external quality auditors.

### 3.3.2 Specific Areas of Interest

Three areas that are specifically of interest to the CIET Research Program are training and indoctrination, physical experiments, and software design and testing. These are areas that have either been challenging within the quality assurance program, are particularly important within the Thermal Hydraulics Laboratory, or are areas in which the CIET Research Program has had considerable experience.

#### *Training and Indoctrination*

As has been identified several times in discussing the application of quality assurance in universities, training is an essential component of a successful quality assurance program because of its combined purposes of institutional knowledge maintenance and transfer, improving the skills and abilities of students, and creating a supportive community within the laboratory. The communal aspect of training is related to indoctrination which has been discussed in detail in Section 2.3 in the previous chapter.

Training is a natural function of the university environment. Students, staff, and other personnel are routinely trained in safety and other research activities to facilitate safe and efficient conduct within laboratories. Quality assurance is fundamental to scientific research and should be as integral to research as safety is currently. Therefore, it follows that quality assurance training should be included in the standard set of training for all personnel. Further, training should occur routinely and often – within the CIET Research Program, a quality assurance training session, following the Training Procedure, is scheduled once per academic semester as this is when new students are onboarded and when research projects tend to begin. The Training Procedure includes review of the CIET Research Program’s regulatory commitments, applicable codes and standards, and at a high-level gives an overview of the Quality Assurance Plan and associated implementation documents. The Training Procedure goes into more detail for several of the most commonly used implementation documents, including demonstration from the Training Lead(s). These implementation documents include the Information Repository Procedure and CIET Information Repository, Calendar Procedure and CIET Calendar, Corrective Action Procedure and Corrective Action Log, and the Test Procedure Template. The CIET Information Repository and CIET Calendar are important items for communication and coordination and all CIET personnel are expected to actively use both. Corrective action is an essential element of quality

assurance and will be discussed in the following paragraph. The Test Procedure Template will be discussed below under *Physical Testing*.

The Corrective Action Program for the CIET Research Program is comprised of the Corrective Action Procedure, Corrective Action Log, records of completed Corrective Action Procedures, and communication through internal discussion, external presentations through conference presentations and journal publications, and through the Thermal Hydraulics Laboratory's public-facing website. From the CIET Research Program's Quality Assurance Plan:

A robust Corrective Action Program (constituted by the Corrective Action Procedure, Corrective Action Log, Corrective Action records (completed Procedures), all publicly accessible on CIET's website, and corrective action training in the Training Procedure for CIET) is an important component of a healthy organization. The Corrective Action Program promotes transparency, commitment to safety, community engagement, and public accountability. The Corrective Action Program is one of the most important tools within CIET and we believe it helps to show our commitment not only to high-quality research but to safety, investment in our organization, investment in community research, and our commitments to our research community and the general public.

Finally, the Training Procedure concludes with a general inspection of the CIET and ARCO Facilities, the primary experimental facilities within the CIET Research Program. The purpose of this inspection is to familiarize all personnel with the as-built and maintained condition of the facilities, verify their correct configurations, and to look for any out-of-place or mispositioned items that may lead to deteriorated or even dangerous performance without proper maintenance, such as loose power cables, missing items, or fluid leaks.

In addition to performing the Training Procedure, before personnel are considered "Trained" for the purpose of the quality assurance program, personnel are expected to assist or lead (if qualified already) an experiment using the CIET and ARCO Facilities to demonstrate operational competence. The Training Procedure in combination with practical testing experience qualifies CIET Research Program personnel for the general work within the program. This experience is expected as a fundamental proficiency, and further skills or knowledge needed is expected to be gained during research. Additional information relevant to quality assurance within the context of the CIET Research Program is included in the appendices of the Training Procedure.

### *Physical Testing*

Physical (as opposed to software) testing is a primary component within the CIET Research Program. Much of the experience within the CIET Research Program prior to designing and implementing this quality assurance program is with the operation and maintenance of the CIET Facility. The ARCO Facility is the primary means for operating the CIET Facility and has been used extensively for this purpose. The Test Procedure Template reflects this deep experience and continues to be revised and updated as personnel learn more about the facilities, streamline operations, and include additional features in the CIET and ARCO Facilities. The Test Procedure Template also functions as the standard operating procedure (SOP) for the CIET and ARCO Facilities and has been used in the research group's other experiments as an example of best



practice. The Test Procedure Template is included in Appendix 8.1, reproduced there as a series of pictures of the pages of the template to preserve the formatting of the document; the Test Procedure Template Microsoft Word document may be obtained from the this author or from the Thermal Hydraulics Laboratory at UC Berkeley.

### *Software Design and Testing*

Software design and testing, in their strictest definitions, are not primary components of the CIET Research Program. However, significant improvements have been made to the CIET control system hardware and design of the control system software using National Instruments' LabVIEW software. This experience is discussed as a case study for the application of the quality assurance program in Chapter 5 of this dissertation. In addition, the ARCO Facility primarily uses LabVIEW and significant software design has been performed for this facility and its ever-increasing applications.

The CIET Research Program is not developing software for application in nuclear power plants and does not have the experience and skillset required to do so. Instead, the research goals are to develop methods and tools that can be implemented in industrial software for plant operation. Thus, the software design and testing performed within the CIET Research Program does not fall under the purview of the NQA-1 standard. Therefore, a graded approach is applied by not invoking the requirements in Part II, Subpart 2.7, "Quality Assurance Requirements for Computer Software for Nuclear Facility Applications," from the NQA-1 standard. Instead, the relevant requirements from Part I of NQA-1-2009/1a-2009 are invoked and followed. This version of the NQA-1 standard includes specific requirements for Software Design Control in Requirement 3, Section 800, and specific requirements for Computer Program Test Procedures in Requirement 11, Section 400. In addition, there are general requirements for Design Control (Requirement 3) and Test Control (Requirement 11) that are used to support and guide software design and testing. It is important to note here that these software-specific requirements in NQA-1-2015 have been replaced entirely by the requirements of Part II, Subpart 2.7. Therefore, in the future, it is the aspiration of the CIET Research Program that all software related research and development will apply these requirements in a graded approach. It is important to invoke requirements carefully and to do so in a graded manner that best supports research and correctly reflects customer needs. In the future, it is the expectation of the CIET Research Program that as researchers foray further into software development, particularly software for direct application in industrial environments, they will take the responsibility upon themselves to modify the Software Design Procedure and Software Test Procedure (and/or Software Test Procedure Template) to reflect the more rigorous requirements in Part II, Subpart 2.7 and that are expected by the customers of their applications.

Although the current software design and testing work does not merit the full application of the NQA-1 standard, this research and development has been extremely helpful for the development of the quality assurance program. Particular challenges have been updating software, version control, managing collaboration between several personnel, and clear record keeping for the as-built configuration without being overly prescriptive.

### 3.3.3 NQA-1 Audits

External audits are a fundamental expectation in quality assurance programs and are required within the NQA-1 standard. The CIET Research Program has consistently had external audits of its quality assurance program from its inception. Since starting to redesign the quality assurance program, there have been two external audits.

At the end of 2017, the new quality assurance program for the CIET Research Program was audited by an NQA-1 specialist to assess its compliance with applicable requirements in ASME NQA-1-2008 and the NQA-1a-2009 Addenda. At that point, the new quality assurance program consisted of drafts of a Quality Assurance Plan and a set of implementation documents that would be used in the research program to satisfy quality assurance requirements. The rating from this audit was, “Marginally Effective/Meets Some Requirements,” because the new quality assurance program was still in draft form, did not address all the applicable requirements from the NQA-1 standard, and had not been implemented in the CIET Research Program. These were all correct findings and were as expected. To address these findings, the Quality Assurance Plan and several implementation documents were formalized with plans to formalize the full set of implementation documents as soon as possible, including thorough review and approval.

At the end of 2018, the CIET Research Program had a second external audit by the same NQA-1 specialist to continue to assess the new quality assurance program and its progress since the previous audit. The rating from the audit was, “Marginally Effective/Meets Some Requirements,” because the new quality assurance program was still in draft form, did not address all the applicable requirements from the NQA-1 standard, and had not been implemented in the CIET Research Program. This is the same outcome from the previous audit, although substantial effort had been made to formalize quality assurance documents. Important noteworthy practices identified in the audit include a “significantly improved” Quality Assurance Plan that addresses the NQA-1-2008/1a-2009 requirements and that the Test Procedure Template addresses NQA-1 test requirements much better than the previous procedure revision. It should also be noted that all operations in the previous two years continued to follow the previous quality assurance program, including the use of procedures for experiments and routine operations such as draining and filling the CIET Facility.

Since this audit, the CIET Research Program has approved and implemented the Quality Assurance Plan and the Test Procedure Template, which has seen significant use. Personnel also performed a training session using the Training Procedure for CIET and ARCO personnel that includes quality assurance training. The Training Procedure was not approved and formally implemented but was performed essentially as a practical review to determine its effectiveness and the best ways to improve the procedure. There are plans to have a third external audit by the same NQA-1 specialist later in 2019 and the plan is to have more implementation documents reviewed, approved, and in use as well as all personnel well-trained and knowledgeable about the role of quality assurance in their research.

### 3.4 Impact on Reproducibility

Before considering the impact of the CIET Research Program's quality assurance program on the reproducibility of its research, it is important to note that without transparency in research it is impossible to evaluate its reproducibility. Transparency is fundamental to quality assurance – to bring transparency to all practices important for achieving a goal in order to ensure/provide confidence the goal of the effort will be achieved. Therefore, transparency is required and inherent in good quality assurance practices. As was discussed in Section 2.1.3 in the previous chapter, transparency is a critical element of quality assurance within the NQA-1 standard and has been a special emphasis of the CIET Research Program's new quality assurance program.

An important question asked in the introduction to the previous chapter was: is it possible to identify the minimum set of conditions necessary for reproducibility in nuclear engineering research? Although discussion in the previous chapter as well as this chapter so far did not clearly define an answer, in the context of the CIET Research Program, the answer lies in balancing the requirements of the NQA-1 standard with actual research needs through applying a graded approach. The NQA-1 standard's requirements cover the scope of the activities within the CIET Research Program and are rigorous in including all details needed for reproducibility in an industrial setting. In the nuclear energy field, given the rigorous reputation of the U.S. NRC, it can be assumed that reproducibility in industry should also be sufficient for reproducibility in research, at least considering the major elements included in the NQA-1 standard such as change management, procedure requirements, record keeping, etc. Given the scope and rigor of the NQA-1 standard, applying the graded approach should be able to confine the application of its requirements to the minimum set necessary for reproducibility. Applying the graded approach is imperfect because there is no well-defined method as no two organizations are the same. Instead, the graded approach is defined by the research program invoking and implementing the requirements and thus requires honesty, transparency, and continuous review to strike the sufficient set of requirements needed for reproducibility. Therefore, this dissertation posits that there is no universal minimum set of conditions or requirements necessary for reproducibility, even restricted to the field of nuclear engineering research. Rather, this set of requirements is found through the judicious application of the graded approach to a quality assurance standard that is broad enough in scope and rigorous enough in its application to cover the minimal set of requirements for reproducibility in a wide range of quality assurance programs. In this case, the NQA-1 standard is the standard of choice for nuclear engineering research and the UNQA Program will tentatively be the best tool to use to jumpstart the graded approach needed to find the minimum set of requirements necessary for reproducibility within a university nuclear engineering research organization.

Ideally, when considering the impact of quality assurance on the reproducibility of research, it is desired to have well-defined, quantitative metrics to provide feedback. This is true not just for reproducibility but for understanding the impact of the quality assurance program more generally. Reproducibility is hard to determine without performing a dedicated reproducibility study, either by using the original raw data and analysis methods to try to reach the same conclusions or by performing identical experiments to generate new data and conclusions. However, the elements of research that most strongly contribute to reproducibility may be measured and understood. The best way to do this may be through regular customer satisfaction

surveys, such as were used in [51] to, “evaluate performance and to identify opportunities for improvement at the laboratories.” Although these surveys are specifically tuned to determine customer satisfaction, internal surveys could be used to query on items most closely related to reproducibility, such as the review process, transparency of research, understanding uncertainties, etc. In the case of the CIET Research Program, customers are the end users of its research, including NEUP as a research grant funding organization and national laboratories who are often research partners.

Other metrics important for quality assurance more generally could include: research funding (both the amount per grant and the total number of grants received), the acceptance rate to high-impact journals, the number of times research is cited/used in national laboratory research and by private companies, and the number of discussions and collaborations with organizations outside of the university. Data from metrics could give insight into the impact of the quality assurance program on the desirability of the research and how widely the research is being communicated and shared. Other metrics of importance could be more internally facing, such as the number of significant accidents/events. These are all challenging to collect and understand at present without a long history on either side of implementing the quality assurance program. Unfortunately, there is not a clear way of quickly showing the value of a quality assurance program in this setting, particularly given the limited time within this dissertation’s research. However, the need for metrics should be kept in mind as the CIET Research Program progresses in time – given the amount of data and information collected, the value of a well-designed quality assurance program should self-manifest over time.

In addition to continuing to consider appropriate metrics for judging the success of the quality assurance program in the CIET Research Program, there are several elements of future work that extend from the research presented here, primarily focused around the UNQA Program.

### 3.5 Future Work

The application of UNQA, using the CIET Research Program as a testbed, must be proven over time and thus will not be satisfactorily finished for several years, most likely about five years to allow for a full generation of graduate students to interact with and maintain the UNQA Program. However, much should be discussed regarding efforts to standardize the UNQA Program as official guidance for university nuclear engineering laboratories to follow in order to comply with the NQA-1 standard.

#### 3.5.1 UNQA Template Series

The new quality assurance program is being created and designed specifically for the CIET Research Program in the Nuclear Engineering Thermal Hydraulics Laboratory at the University of California, Berkeley. However, a primary goal of this work is to be as transparent and accessible to others as possible to allow and encourage other university nuclear engineering laboratories to implement similar quality assurance programs. Eventually this work should be generalized to be a generic quality assurance program template series that satisfies major requirements from ASME NQA-1-2008 with the NQA-1a-2009 Addenda for universities to implement, but that template series will require significant additional effort. The creation of a

generic university nuclear quality assurance template is an exciting idea and is certainly a significant goal of this work.

The UNQA Program will be the basis of a guide for other quality assurance programs for university nuclear engineering labs, much like NEI 11-04 is for industry [62]. The standards of excellence that define and set apart this quality assurance program and the resulting research should be extended to other groups as standards of university research in general. The more that the quality of university research is improved, and the more application to industrial and national laboratory research is possible, the better for all involved. Using the UNQA Program as a template for other research programs will also help the standards within to be embraced by a larger group, ideally forming a community that embraces these ideals and strives for high-quality research together. The more programs that implement the UNQA Program, the better the UNQA Program will become through feedback and maintenance, and the better all research in the field will become as reproducibility is increased and best scientific practices are followed. Ideally future discussion will include additional experience, such as from Prof. Wade Marcum from Oregon State University as his research group has extensive experience with quality assurance compliant with the NQA-1 standard.

Currently, the quality assurance program for the CIET Research Program is still being drafted and finalized; the major elements are in place but there are several implementation documents that must be drafted, reviewed, approved, and implemented before all requirements in ASME NQA-1-2008/1a-2009 are satisfied. Once the quality assurance program is complete and its design and implementation are formally audited, it will be ready to be transformed into a template series to create the UNQA Program. Additional documentation should also be created such as guidance on implementing the templates to create program-specific documents, best practices found from the CIET Research Program's use of its quality assurance program, and a formal structure for communication and collaboration for all research programs that choose to use the UNQA Program.

### 3.5.2 Creating the Quality Assurance Community

There are two primary ways to use the work done here and the eventual UNQA Program to create and encourage community around quality assurance in the nuclear engineering university research community. These ways are: (1) integrate the UNQA Program into the NQA-1 standard as guidance and include university participation in the ASME NQA-1 Standard Committee, and (2) create an inter-university organization that acts as a communitarian regulator to support and hold accountable those research groups and research projects that choose to implement the UNQA Program.

For broader adoption of UNQA as well as consistent upkeep and long-term commitment, integrating UNQA into the purview of the NQA-1 Standard Committee may be ideal, most likely in the form of students as non-voting members and the creation of a Working Group focused on the UNQA Program. After CIET Research Program personnel member attended a committee meeting and talked with several members, the NQA-1 Standard Committee sees the importance of quality assurance in universities. They certainly understand the importance of training students and young professionals in a way that clearly defines the importance of quality

assurance in the nuclear industry, far better than the students of the CIET Research Program do. In order for quality assurance to be well-maintained and updated as a practice in industry, it is vital to train students and young professionals to use quality assurance as an important engineering tool that should be maintained and further developed to best serve the industry and its stakeholders. This requires consistent engagement and support over time, and there is no expectation to see UNQA integrated into the NQA-1 standard in the near future, but it is nonetheless an important goal to strive for.

Communitarian regulation is a fascinating topic, and INPO presents a compelling example within the nuclear industry. Rees, from their study of INPO [56], defines communitarian regulation as having a well-defined industrial morality that is backed by enough communal pressure to institutionalize responsibility among its members. Three defining features of communitarian regulation are:

1. A well-defined industrial reality with codified standards of excellence
2. Sufficient communal pressure for the regulator to have influence
3. Institutionalized responsibility where each regulatee is formally beholden to the regulator

INPO uses lessons learned and best practices in the industry to calibrate its standards to be best-in-field and then continuously improves them as plants gain experience. In this way, INPO sets industry-wide expectations of excellence (as opposed to consensus standards) and communicates the ideal standard of behavior to all utilities involved. However, balancing continuous improvement against cost is challenging for nuclear plants, and it is critical for them to understand and properly value present investments on future operations. This is similar to challenges in implementing quality assurance requirements in research and finding the balance between those requirements and the research needs using the graded approach.

The legitimacy of INPO as a communitarian regulator is critical and yet was challenging in the beginning of its operation. However, the impact that INPO has had on the nuclear power industry in the U.S. after the Three Mile Island accident is undeniable and extraordinary. INPO has brought an industrial morality and professionalism that separated nuclear power from the other forms of electricity generation.

If this research is successful, sometime in the future, there may form a wider community of university nuclear engineering laboratories and research groups that have chosen to implement the UNQA Program and who are committed to quality assurance in their research. Creating a communitarian regulator, similar to INPO, could bring this community structure and direction; the function of identifying and codifying best practices as standards of excellence is especially compelling and would be a way to share and benefit from lessons learned within the community. Ideally this communitarian regulator would be integrated with the Working Group within the NQA-1 Standard Committee that officially oversees and maintains the UNQA Program. These two functions are mutually beneficial and there is no reason to separate these functions given limited resources.

### 3.5.3 Call to Action

A primary conclusion from this work is that quality assurance is an invaluable tool for university research that supports best practices for reproducibility in scientific research, lends credibility to research programs, and makes results more directly applicable to larger research and development programs at national laboratories and commercial companies – this conclusion is then a call to action to other university nuclear engineering research efforts. The research performed at UCB should raise the bar for university research broadly and encourage other research groups to make similar steps to improve the quality and applicability of their research. The UNQA Program will be a useful tool to begin this improvement and growth in nuclear engineering research.

From the review of the literature on reproducibility in research, several examples of the importance of community support of reproducibility and good scientific practice have been identified. There are many stakeholders in scientific research and development that should support good science, including reproducibility, performed in universities and other research organizations. These stakeholders form a community given their common values and interests and should support research as such. From the discussion and research in this dissertation, there is a clear argument for quality assurance as an appropriate tool to support the reproducibility and practice of good science in research and the following examples from the literature support this claim.

Institutions are an important stakeholder in the university research community and should play a supportive and engaging role. The central premise of a study by Begley et al. is that, “institutions must support and reward researchers who do solid — not just flashy — science and hold to account those whose methods are questionable,” [63]. They propose “Good Institutional Practice” certification that includes several measures including a standard reporting system (what would be described as a corrective action program in the context of this research), training and adoption of standards, records and quality management, and enforcement mechanisms. The purpose of these practices is not to prevent misconduct completely but to support good science performed by well-intentioned researchers. To promote good science, these measures aim to reduce waste from biased results and to relieve pressures that encourage flashy results.

Research institutions, particularly universities, are primary stakeholders in the research that they foster and must encourage and support best practices for reproducibility. University curricula for science and engineering disciplines for both undergraduate and graduate education should naturally include concepts that support reproducibility such as fundamentals of statistical analysis for data, fundamentals of experimental methodology, and fundamentals of technical communication and writing. In addition to including these concepts in lecture-based classes, laboratory or experimental classes should include these concepts as well to provide practical experience for students. Quality assurance practices, particularly in the laboratory setting, are a natural means of integrating these concepts into education, both theoretical and practical. Integrating quality assurance into education in these ways reflects modern industrial practice and connects university research to commercial use. This effectively emphasizes the importance of sound, reproducible science and research; prepares students for effective careers in industry or other research environments; and decreases the costs from irreproducible research, particularly

for down-stream users of university research such as commercial companies and national research laboratories.

Journals are another important stakeholder in the university research community. Journalology is defined as the science of publication practices and the study of these activities. According to Couzin-Frankel, journalology's goal is to improve the quality of at least a small part of the scientific record, in part by creating an evidence-based protocol for publishing studies, starting with their initial design [42]. Medical journals have taken the lead in this effort because of the significant consequence of medical research on human lives. Journalology seeks to influence journals to embrace and implement standards to improve reproducibility, transparency, and openness. Unfortunately, these goals see similar challenges as those that face quality assurance implementation in research: there is a significant lack of funding and support within the community for these standards and it is hard to quantitatively show the importance of these standards in the field.

The authors from the Open Science Collaboration who developed and managed the Reproducibility Project: Psychology also identified Transparency and Openness Promotion guidelines that help incentivize open research [48]. These guidelines were developed by the Transparency and Openness Promotion (TOP) Committee and are guidelines that journals may use to promote transparency, openness, and reproducibility in the articles that they accept and publish. There are eight standards and three levels to each standard in the TOP guidelines. The eight standards each move scientific communication toward greater openness and are modular, facilitating adoption in whole or in part. The three levels are meant to allow greater flexibility in application based on whether the standards are appropriate to the journal/discipline in consideration. The levels move from least barrier to implementation to greatest barrier to implementation, allowing journals to implement the standards progressively over time as openness becomes more and more of a community norm. These standards are a great example of a way to reform the way journals, important stakeholders in the university research community, review and accept research articles for publication. These standards encourage accountability within the community and seek to promote good science.

A primary point from Petit and Muret [64] as well as in Petit's other work reviewed here [29], [54] is that society is becoming increasingly more aware of and engaged with fundamental research in science, placing a burden of accountability on research organizations and personnel that has not existed before. This burden is well addressed through applying quality systems, or as Petit would argue, integrating the quality approach into fundamental research to provide for this accountability. The quality approach could increase confidence in research entities (particularly their reliability) by society, which Petit claims is fragile and in need of rebuilding.

Given this discussion, it is clear that there is a need for community support of good scientific practice in research from all involved stakeholders, and quality assurance has an important role to play in this.



## 4 CIET Control System Design

After the Compact Integral Effects Test (CIET) Facility itself, the control system is arguably the most important component within the CIET Research Program as all research conducted must interface with it in some fashion. Any data collected, any operation performed, any demonstration executed (with the exception of filling and draining the facility...) must include the CIET control system to some extent. Given its importance, significant thought has been given to the design and implementation of the control system.

This chapter discusses the major systems and components within the CIET Facility, including the instrumentation and control hardware and software that comprise the control system itself. The control system's high-level architecture is then discussed, including deeper discussion on the design and implementation of each major component within the control system. Throughout this discussion, consideration of long-term research direction is taken into account. The CIET Facility is a large, two-loop thermal hydraulics facility with a long future and rich testing program as a simulator for advanced nuclear reactors such as the FHR in its future. As such, the control system must be able to meet the demands of both fundamental thermal hydraulics research and advanced reactor operations research, all in a way that satisfies the quality assurance requirements that the CIET Research Program is committed to. The discussion in this chapter focuses on the technical aspects of the CIET control system whereas the following chapter shows how the quality assurance practices developed for the CIET Research Program are applied to the control system. However, the design of the CIET control system was not performed in a quality-vacuum and important quality assurance implications are considered throughout this chapter.

### 4.1 Introduction

This chapter introduces the control system for the CIET Facility. The first section reviews the major systems and components within the CIET Facility, narrows focus to the specific instrumentation and control hardware and software, and then discusses the high-level architecture of the control system as well as important organization and design considerations. The hood is then lifted on the control system to examine the functional and code design of the major elements of the control system. As is almost always the case, future work exists and is considered at the end of this chapter.

The control system discussed in this chapter was designed and implemented after significant experience with a previous control system. This previous control system laid the foundation for this work and enabled much of the early testing and experience gained with the CIET Facility. The design and implementation of this first control system is documented in [65], which also includes discussion of control algorithms and theories used, which is beyond the scope of the discussion presented in this chapter. It is the goal of this dissertation that the control system design developed here will provide a framework in which advanced control algorithms may be implemented seamlessly, which has already been the case in undergraduate researcher Jason Anderson's research with the CIET Research Program [66].

It should be noted at the beginning of this discussion that the CIET control system primarily uses the LabVIEW systems engineering software from National Instruments as its control system software of choice. LabVIEW is used to integrate all CIET's control system hardware and allows the facility operator to perform their desired actions. LabVIEW has been very beneficial for this research because of its basic ease-of-use and because of the instructional and support resources available to CIET personnel, especially students. In this environment where students are not experts in software design/engineering, especially for industrial control systems like those found in nuclear power plants, LabVIEW is a very appropriate tool. The research performed in this setting using LabVIEW is focused on methods development, proof-of-concept generation, and exploring new ideas not ready for industrial deployment. For use in actual industrial control systems, the research performed in the CIET Research Program must transition to industrial hardware and software as well as follow more rigorous software engineering practices. This follows a fit-for-function approach which allows this research to be as flexible and effective as possible given the environment and resources in the university research setting and still allows for significant influence in commercial applications, especially when this research is performed under an appropriate quality assurance program as discussed in previous chapters. Detailed discussion on the CIET Research Program's use of LabVIEW is in Section 4.2.5. In addition to LabVIEW, the CIET control system also uses a significant amount of National Instruments' hardware, including a PXIe system that acts as an embedded system that integrates with control hardware and LabVIEW.

#### 4.1.1 CIET Major Systems and Components

The CIET Facility is well-described by the piping and instrumentation diagram in Figure 4.1. This diagram may look cluttered at first, but it includes all locations for flow paths, major and minor components, and instrumentation.

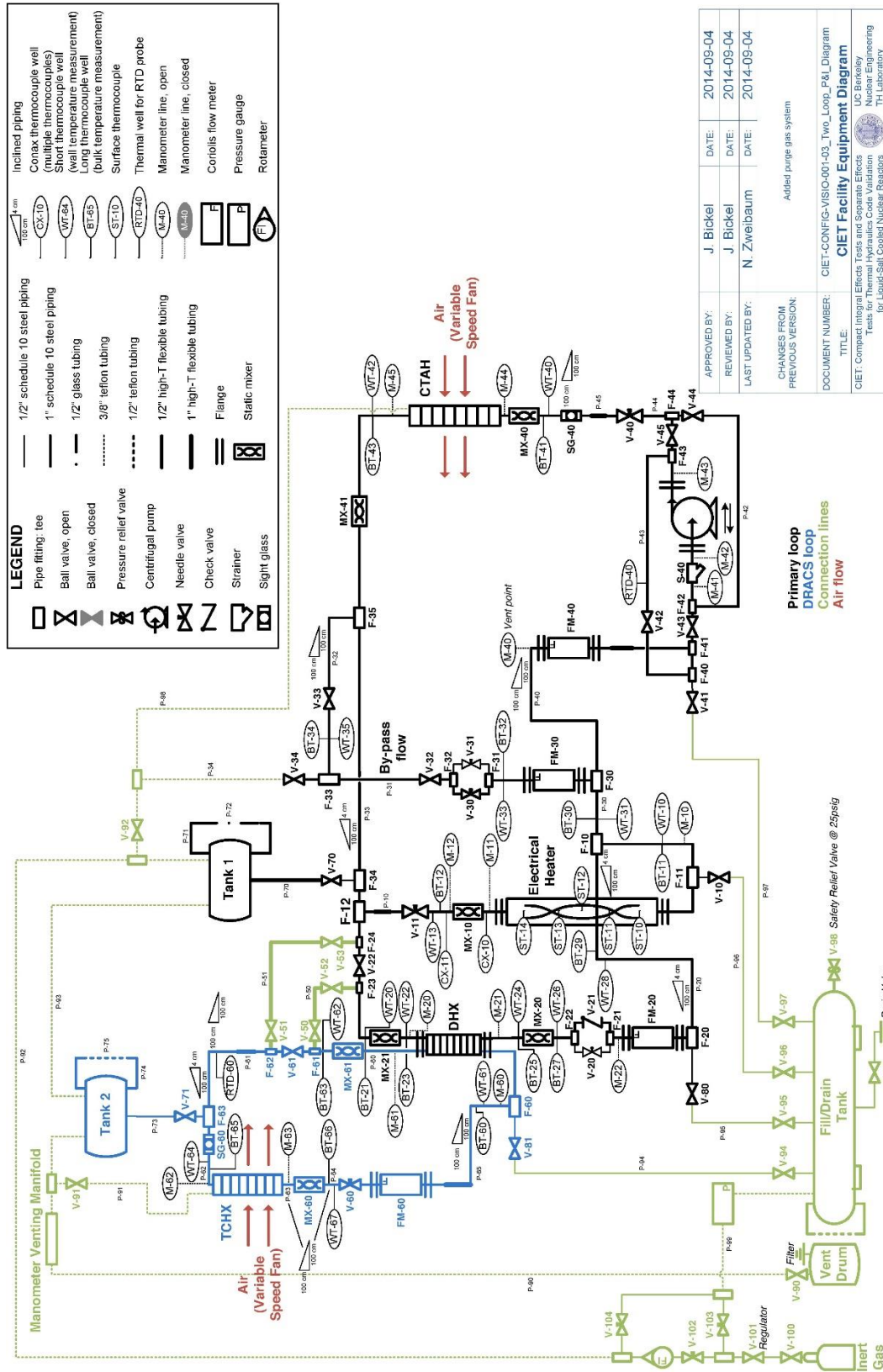

Figure 4.1. Piping and instrumentation diagram for the CIET Facility.

The flow paths shown in the piping and instrumentation diagram include, from left to right, the coiled tube air heater (CTAH) branch, the pump manifold, the bypass branch, the heater branch, the direct reactor auxiliary cooling system (DRACS) heat exchanger (DHX) branch, and the DRACS loop (in blue). The solid green piping indicates flow paths used in draining and filling the CIET Facility and the dashed green piping indicates cover gas flow paths. Depending on the valve positions, fluid may circulate through these flow paths for whatever purpose necessary.

To clarify the function and purpose of the DRACS loop, it is an independent fluid loop, separate from the primary loop (piping in black in Figure 4.1) that includes its own head tank. The DRACS loop does not contain a pump or other means of forcing circulation, but instead relies on natural circulation flow. The DRACS loop is thermally coupled to the primary loop through the DHX. Heat from the primary loop enters the DRACS through the DHX via conduction, heats the fluid in the DRACS which rises due to a decrease in density, and then leaves the facility through the thermosyphon-cooled heat exchanger (TCHX), cooling the fluid, decreasing its density, and causing the fluid to flow away from the TCHX and back to the DHX, thus driving natural circulation. The operation of the DRACS relies only on the amount of input heat from the primary loop, primarily controlled through valve alignment in the primary loop and thus the fluid flow and heat of the fluid through the DHX on the primary side, and the amount of heat rejected to the environment by the TCHX, primarily controlled through the TCHX's fan speed. The DRACS loop in the CIET Facility simulates passive removal of decay heat in fluoride-salt-cooled high-temperature reactors (FHRs). In off-normal conditions where heat in the reactor is not able to be removed through the primary heat exchanger, which is air-cooled, the DRACS removes heat from the reactor passively without the need for on-site power or operator action. This is a critical safety function during events where the reactor and power plant lose on-site power and thus normal means of cooling, such as happened during the Fukushima Daiichi nuclear power plant accident [67].

The major components included in the CIET Facility are a pump for forced circulation operation, a heater for heat addition to the fluid, two fan-cooled oil-to-air heat exchangers for heat rejection from the fluid, an oil-to-oil heat exchanger that thermally connects the primary and DRACS loops without allowing fluid exchange, fill and drain piping, and a cover gas system. Minor components include static mixers, two sight glasses, needle and check valves in parallel to allow local flow rate adjustment, and two head tanks to allow thermal expansion of the fluid in the system.

A common example configuration used in many experiments where the DRACS loop is active is forced circulation via the pump up through the bypass branch, heater branch, and DHX branch and then down through the CTAH. The DRACS loop is then allowed to circulate freely via natural convection, with fluid rising from the DHX and descending through the TCHX. This represents reactor coolant being forced up through the core (heater branch in combination with the bypass branch to represent a small fraction of flow bypassing the active core region through instrument channels, control rod guide tubes, in between structural graphite blocks, etc.) then down through the primary heat exchanger and back to the pump. In this configuration, a small amount of fluid flow in the primary (black) loop is allowed up through the DHX, representing a fraction of heat lost to the DRACS to keep it warm and operating. During an accident scenario where the ability to provide forced circulation via the pump is lost, fluid continues to rise

through the heater branch but then descends through the DHX branch due to natural convection. The check valve in the DHX branch restricts flow in the upward (forced circulation) direction but allows full flow in the downward (natural circulation) direction. No flow is present through the pump manifold and CTAH branch. The DRACS loop continues to operate at a higher flow speed due to larger amounts of heat being transferred from the primary loop, through the DHX, through the DRACS loop, and ultimately out of the TCHX.

The instrumentation identified in the piping and instrumentation diagram is discussed in more depth in the following section.

#### 4.1.2 CIET Instrumentation and Control Hardware and Software

Before exploring the control system which is the focus of this chapter, this section discusses the instrumentation hardware and control hardware and software in more depth. The intention of this section is to provide an overview of the instrumentation and control software and hardware with sufficient detail to fully understand and appreciate the requirements of the control system in the context of the CIET Research Program. The following section, Section 4.2, discusses the specific design of each major element of the control system, including LabVIEW code. The discussion in that section depends heavily on the understanding and appreciation developed here.

The control signals that are sent from the control system to hardware within the CIET Facility are: input power frequency for variable frequency drives (VFDs) that control the pump and the two fan-cooled oil-to-air heat exchangers and power input to the heater from two solid-state DC power supplies. The pump and fan-cooled heat exchangers are connected to VFDs which accept control signals from the control system using the MODBUS RTU communication protocol and adjust the rotational frequencies through varying the frequency of power supplied to these components. Therefore, the signal of interest in this case is input power frequency, and this is communicated via MODBUS RTU to three VFDs. The power supplies are controlled by one of two methods: digital communication, using an ethernet cable and software provided by the power supply manufacturer, or analog communication, through sending and receiving small voltage signals to and from the power supplies to control and measure output voltage and current. The control system in the CIET Facility is capable of both means of communication given some simple reconfiguration of hardware. The communication method employed is generally determined by the needs of the experiment, with the need for higher frequency control of the power supplies requiring analog control and low frequency (approaching steady-state) operation sufficiently handled through simpler digital control. A quirk in the hardware currently installed is that signals from the Coriolis mass flow meters cannot be read at the same time as voltage signals from the power supplies. Therefore, the analog means of communicating with the power supplies is used much less often and only in the case where mass flow rate data is not necessary to collect. A common control signal found in large experiments and facilities like the CIET Facility is the remote actuation of valves to control valve alignment and thus flow configuration. All valves in the CIET Facility are manually adjusted and thus the facility does not have the need to provide these control signals. Instead, valve alignment and thus flow path configuration is set before an experiment is started and simple changes may be made by personnel during the experiment at the direction of the test procedure used.

The instrumentation in the CIET Facility includes Type-T thermocouples and RTDs (resistance temperature detectors) that measure fluid, solid, and ambient air temperatures; Coriolis mass flow meters that measure the fluid mass flow rate in each branch of the facility; and a manometer array that shows the pressure differentials between points of interest across the system and which are recorded using remote-controlled digital cameras. Signals from the thermocouples and Coriolis mass flow meters are directly input into control hardware connected to the control system and therefore captured. Signals from the RTDs are measured by a handheld instrument and are recorded by hand; these signals are meant for in-situ temperature verification of thermocouples and therefore are not necessary to include within the design of the control system. The photographs of the system pressure differentials measured by the manometer system are captured manually as well. A full list of thermocouple and Coriolis mass flow signals and their channels used within the control system is included in Figure 4.2. These signals directly integrate into National Instruments hardware connected to a National Instruments PXIe system, which acts as an embedded system within the overall control system architecture – this is discussed in more detail later in this section.

Upper Thermocouple Rack: TC_1							
Heater Branch (12)		DHX Branch (10)		Bypass Branch (6)		CTAH Branch (4)	
Channel	Name	Channel	Name	Channel	Name	Channel	Name
TC0	WT-10	TC12	WT-20	TC22	BT-30	TC28	WT-40
TC1	BT-11	TC13	BT-21	TC23	WT-31	TC29	BT-41
TC2	CX-10-1	TC14	WT-22	TC24	BT-32	TC30	WT-42
TC3	CX-10-2	TC15	BT-23	TC25	WT-33	TC31	BT-43
TC4	CX-10-3	TC16	WT-24	TC26	BT-34		
TC5	CX-10-4	TC17	BT-25	TC27	WT-35		
TC6	CX-11-1	TC18	WT-26				
TC7	CX-11-2	TC19	BT-27				
TC8	CX-11-3	TC20	WT-28				
TC9	CX-11-4	TC21	BT-29				
TC10	BT-12						
TC11	WT-13						

Lower Thermocouple Rack: TC_2							
DRACS Loop (8)		Heater Surface (10)		Ambient (2)		Unused (12)	
Channel	Name	Channel	Name	Channel	Name	Channel	Name
TC0	BT-60	TC8	ST-10	TC23	AT-01	TC18	N/A
TC1	WT-61	TC9	ST-11	TC24	AT-02	TC19	
TC2	WT-62	TC10	ST-12-N			TC20	
TC3	BT-63	TC11	ST-12-SE			TC21	
TC4	WT-64	TC12	ST-12-SW			TC22	
TC5	BT-65	TC13	ST-13			TC23	
TC6	BT-66	TC14	ST-14-N			TC26	
TC7	WT-67	TC15	ST-14-E			TC27	
		TC16	ST-14-S			TC28	
		TC17	ST-14-W			TC29	
						TC30	
						TC31	

Analog Current Input	
Channel	Name
AI0	FM-20
AI2	FM-30
AI4	FM-40
AI6	FM-60

Figure 4.2. Thermocouple and Coriolis mass flow meter signals and channels in the PXIe system.

In Figure 4.2, “Upper Thermocouple Rack” and “Lower Thermocouple Rack” (also “TC\_1” and “TC\_2” as they are referred to within the PXIe system organization) refer to, as their names suggest, the upper and lower rows of thermocouple miniature connector ports that interface with

the CIET PXIe system. Each row contains thirty-two miniature connector ports as positions 0 through 31. The thermocouples are inserted in order of location in the CIET Facility starting with the heater branch and ending with the CTAH branch in the Upper Thermocouple Rack and starting with the DRACS loop and ending with the ambient thermocouples in the Lower Thermocouple Rack (unused thermocouple ports are listed for reference). The channel locations, named “TCX” where “X” is the channel number, are analog input channels specifically for thermocouples, thus the use of “TC” over the more traditional “AI” for analog input, although “AI” is used for the flow meter channels which accept electrical current signals. The names of the thermocouples and flow meters may all be found in Figure 4.1 with the exceptions of several of the surface thermocouples on the heater’s surface; several surface thermocouples were added in additional azimuthal locations with ST-12 and ST-14 since the piping and instrumentation diagram was finalized.

In addition to these signals, another useful signal captured during drain and fill operations for the CIET Facility is the change in weight of the fill/drain tank, which allows measurement of the inventory drained from the facility and the inventory that is refilled into the facility. The drain tank is used to collect fluid inventory and its weight is measured during drain and fill operations to provide this fluid inventory signal. Additional types of signals that could be included in the CIET Facility and integrated into the control system are other measures of fluid inventory such as level measurements in tanks, vibration signals, structure strain signals, fluid quality (void fraction) signals, and signals from visual and infrared photography. Although all of these additional signal types provide information of interest and may be helpful for monitoring and assessing system performance, none are used in the current research in the CIET Research Program. However, there are many non-traditional, data-based signals such as equipment health monitoring, personnel movements, signal metadata, plant performance metrics, and controls actuation that may provide additional insight into the operation and performance of the facility. In Poresky’s research with the CIET Facility [68], they seek to leverage all available data from many components including data-based signals to optimize the performance of the overall facility in a way that benefits the user, similar to what is done in “smart” homes and other smart systems. They analyze data about how the facility is used and the habits and patterns of operation in conjunction with the facility’s technical data to understand not only how the facility is performing but also why. They then use optimization methods to improve the facility’s operation to more effectively meet the user’s purpose of operation. In this way, many seemingly independent data streams are synthesized to provide a full picture of the facility, potentially revealing otherwise undetected behavior. Key questions in their work are how to determine what factors are important to optimize for and in what priority.

The control hardware for the CIET Facility is tied together by a National Instruments’ PXIe system, an embedded system that is designed to connect to control hardware and instrumentation and execute LabVIEW software in real time. Figure 4.3 is a snapshot of the National Instruments hardware that comprises the PXIe system.



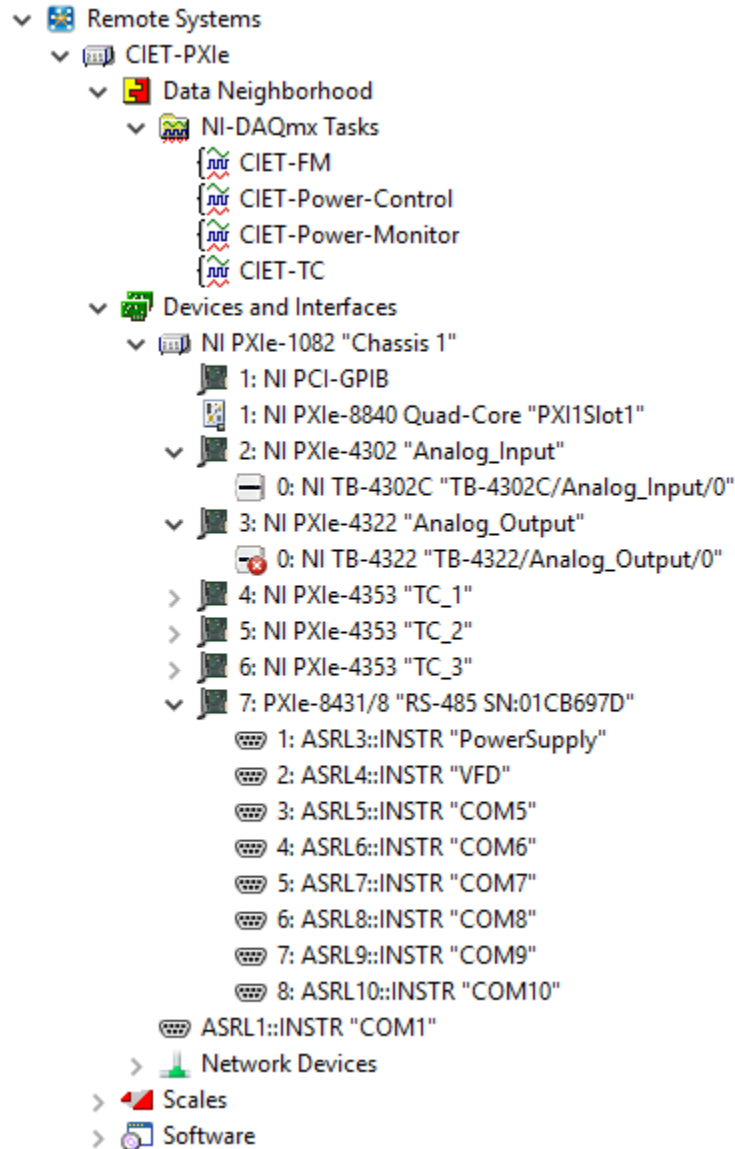

Figure 4.3. Control hardware included in the PXIe system for the CIET Facility; image captured in National Instruments Measurement and Automation Explorer (NI MAX).

Figure 4.3 shows that the PXIe system, labeled therein as “CIET-PXIe”, is a remote system accessible from a connected personal computer when connected via ethernet cable. As a remote or embedded system, programs are developed on the connected computer and “deployed” to the PXIe system to be run there. This is advantageous because the PXIe has specific hardware and software that allow it to operate in real time with high reliability. The two primary categories of interest here are “Data Neighborhood” and “Devices and Interfaces”. “Data Neighborhood” shows the specific “Tasks” that the PXIe system is regularly used for, which include all input and output signals necessary for those tasks. “CIET-FM” and “CIET-TC” contain lists of the instrument signals from the flow meters and thermocouples, respectively, that are routinely collected during experiments. “CIET-Power-Control” and “CIET-Power-Monitor” are the tasks used to send command signals and receive measurement signals from the power supplies and include the voltage output and voltage input signals necessary for these tasks. “Devices and

Interfaces” include all of the hardware associated with the PXIe system, which are included under NI PXIe-1082 “Chassis 1” which is the model and name of the chassis of this PXIe system that houses all of the interfacing hardware. More detailed description of this hardware and its function is included in Appendix 8.2.

In addition to the hardware directly connected to the PXIe system, there are three computers that interface with the PXIe system; one primary computer serves as the primary user interface while the other two computers serve as auxiliary control stations which may be given control functionality as well as monitoring functionality depending on the desired operation of the CIET Facility. Two large TV screens are also available for additional, large displays. The combination of these computers and displays, more accurately considered workstations, comprises the Advanced Reactor Control and Operations (ARCO) Facility. More detailed information on the ARCO Facility is included in the report from Poresky [68]. Because the ARCO Facility has taken over the user interface function of the control system, less emphasis and discussion are given here to the user interface in general.

The control software used for the implementation of the CIET control system is LabVIEW, a software developed by National Instruments for engineers and scientists whose research includes experiments requiring the integration of hardware and software but who are not computer scientists or programming experts themselves. LabVIEW is a visual programming language rather than a traditional line-by-line programming language. Section 4.2 shows and discusses code written in LabVIEW in more detail. The CIET control system currently uses LabVIEW 2017 (17.0.1), 32-bit, with the following additional software installed: Database Connectivity Toolkit, Datalogging and Supervisory Control, MathScript RT Module, Model Interface Toolkit, OPC UA Toolkit, and Real-Time Module. These additional software tools and modules were added during the control system development process as the needs arose and may not all be necessary as the function and mission of the CIET control system change over time. Additional software is installed on both the host PC and PXIe system, which is kept up to date with the latest versions compatible with the software listed above. All software can be found through NI MAX, a program from National Instruments that is invaluable when working with LabVIEW.

All of the information presented in this section must be well-documented to provide instruction and guidance to personnel reviewing the CIET control system as well as personnel who continue to advance this research. The P&I Diagram (Figure 4.1), instrumentation signals tables (Figure 4.2), and hardware configuration list (Figure 4.3) are good examples of such documentation and should be recorded and maintained for future reference. This is an important function of quality assurance and is discussed in more detail in the following chapter.

Before diving into the discussion of the software that has been written for the CIET control system, the next sections discuss the control system’s architecture as well as specific organization and design considerations.

### 4.1.3 High-Level Architecture

The control system for the CIET Facility operates the facility and collects data in real time. The architecture for the control system must be able to satisfy this basic requirement as well as satisfy three key goals:

1. *Provide flexibility through modularity to allow easy additions or replacements of existing components within the facility.*

Flexibility of software design, primarily through modularity, addresses important ideas of configurability, reusability, and extensibility. Configurability in software is the ability to change certain aspects of the software without having to significantly change the code itself. Configurable software is flexible, scalable, and can be modified as its use-cases and goals change. In this context, the opposite of configurable is customized. Customized software is designed for a single purpose and requires significant redesign to change the way it works. CIET's control system is desired to be highly configurable to allow for diverse research without the need to continuously redesign the control system itself. The control system must allow for highly flexible operation of the CIET Facility, and thus a highly flexible control system itself is of significant interest.

Reusability is a simpler concept but one that is extremely important in software development. Reusability is the ability to reuse a piece of code or element of software again within the overall software project. Generally, short and simple code that performs a specific function may be reused wherever that function is needed within the software design. Reusable software decreases development time and cost and increases the quality of software when each reusable element is itself high quality (i.e. follows quality assurance requirements and has been reviewed and approved as such). The opposite concept to reusability is leverage, which modifies instead of reuses existing software or code to meet desired purposes. CIET's control system is thus desired to include a significant amount of reusable code when possible to facilitate simplicity and quality software development.

Extensibility is the provision for future growth of the software, particularly through the addition of new functionality, without significant change to the existing structure and logic of the software. This is similar to configurability but speaks to the addition of functionality beyond options that exist within a pre-defined operational space. Here again, CIET's control system design is desired to be highly extensible, allowing for growth and further development as the research within the CIET Research Program develops and shifts focus over time.

Using these definitions, modularity has a clear impact on configurability, reusability, and extensibility. As each of these characteristics of software is desirable in the context of the CIET control system, it is desirable that the control system is highly modular. The CIET Research Program hopes to reduce the cost of ownership of the control system for its lifetime by focusing on these characteristics of design.

2. *Abstract the primary control and data signals for integration into data collection functions, user interface(s), and data processing algorithms.*

Abstraction is the separation of an object's essential functions, variables, and interfaces necessary for the developers' goals. This goal specifies that the control signals necessary for full operational control of the CIET Facility and all data signals from the facility must be abstracted from the hardware level of the facility and be made available at a high level of abstraction. This allows a developer to use these signals within the design of the user interface or in other high-level functions of the control system, such as collecting and writing data to a file and processing raw data to extract useful information. An intermediate level of abstraction is the control algorithm level, where data signals are analyzed to set control signals for hardware in the system to meet specific, user-defined goals. The user, at the highest abstraction level, would then choose which control algorithm to activate and when, if this amount of control is given to the user during an experiment with the CIET Facility.

Within the design of the control system itself, abstraction essentially allows the tasks within an operation to be hidden from the developer, simplifying their effort. It also specifically does not require the developer to program or otherwise work with hardware and software at lower abstraction levels (or higher levels) that they may be unfamiliar with, saving time and allowing division of work and delegated ownership of specific pieces of the software.

In the CIET control system, there are two main abstraction levels: (1) the hardware abstraction level which includes all software connected to physical devices and (2) the system application level which includes multiple applications that implement the "business" logic for various logical components. These two main levels each have abstraction levels within themselves as well, which further divides and simplifies the elements of the control system architecture.

3. *Provide for maintainability across the lifetime of the CIET Research Program, especially considering the university environment.*

Many of the same design principles in goal one (modularity) contribute to the reliability and maintainability of the software as well. As the software is made more modular, the overall complexity is reduced by encapsulating responsibilities, which significantly improves maintainability. As defined in the previous goal (abstraction), components do not expose their inner workings to other components and outside-facing interfaces are kept clean and intuitive. This allows developers to take ownership of single components without needing additional developers to understand how the component works "under the hood". This is critical for allowing multiple developers to work on the project together.

To summarize the discussion within the three goals above, the CIET control system is comprised of many levels of abstraction that contain modular software that encapsulates the specific objects and functions within each level. The important variables, functions, and interfaces within each

level are then shared with adjacent levels. The purpose of this architecture is to create a modular control system that is flexible for the end user, extensible for future development and expansion, and maintainable with the least effort (or cost) needed from students who are most likely not experts in the hardware and software used. This design also allows for these smaller modules of code to be developed, tested, and documented as part of the quality assurance program to ensure a high degree of quality throughout the control system. Figure 4.4 shows the high-level structure of the CIET control system, including levels of abstraction.

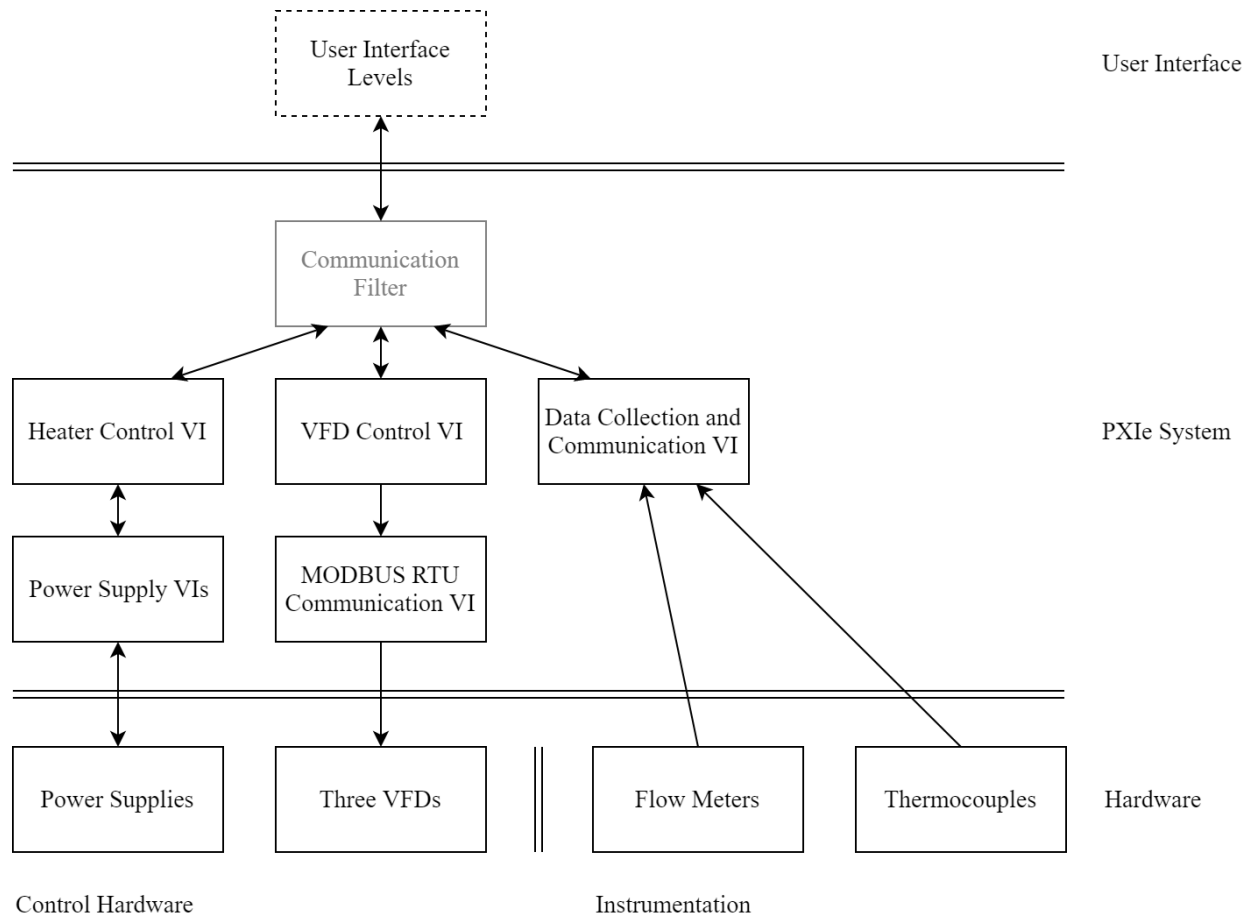

Figure 4.4. CIET control system high-level structure.

In Figure 4.4, VI is an acronym for virtual instrument, a program written in LabVIEW that performs a specific function. The lowest abstraction level included in Figure 4.4 contains the control hardware and instrumentation in the CIET Facility. The next level up is the first abstraction level within software which operates in the PXIe system. This level of software directly interfaces with the hardware and gives the developer access to the hardware's functionality without the developer needing an expert's knowledge of the hardware. The next abstraction level contains VI's that perform specific tasks using the hardware, in this case controlling the heater's power input, controlling the pump and two fan-cooled heat exchangers, and collecting and communicating data from the instrumentation. The final abstraction level within the PXIe acts as a buffer between the tasks performed within the PXIe that directly involve hardware and the user interface. This level allows specific limits and controls to be set

before operating to ensure safe operation by ensuring all communication passed to lower levels is within an expected range and in an expected format. This level is grayed out here as the CIET control system does not currently use this level. Instead, filters have been placed directly in the level below to protect the hardware. Although this works well in this application, if there was more hardware or more complex filters needed, it would be best to isolate these filters in a dedicated abstraction level. The final abstraction level exists on separate control computer(s) which act as user interfaces. This level may contain several abstraction levels itself, or may be a single interface – this is beyond the scope of this dissertation and is explored further in research from Poresky [68].

The next section discusses additional considerations for the design of the VI's within the abstraction levels and how control functionality has been defined and organized.

#### 4.1.4 Task and State Organization and Object-Oriented Design

The CIET control system architecture organizes the control functions of the system into tasks and states. Tasks and states are used to clearly define and organize the expected control capabilities of the system and to abstract the control of major components so that they are easily integrated into control algorithms and the user interface. The definitions and the discussion in this section are primarily taken from resources from Auslander et al. [69], [70] which were tremendously helpful resources in an area where this dissertation does not claim expertise.

Tasks represent units of work and are often matched to physical elements of the target system. Tasks break the system down along time scales and physical components or functions. In general, multiple tasks are often active at once, describing the inherent parallelism in physical systems. Examples of tasks include master control, operator interface, position control, set-point monitors, pump control, and heater control. It is best to include as many options and components as possible when first defining tasks for a control system – it is easy to simplify the system later but often challenging (and frustrating) to add features after design has begun. Organizing the control hierarchy into tasks helps to isolate levels of abstraction (how the system is viewed as a function of the particular activity). Crossing abstraction boundaries is typically expensive and complex in design and implementation.

Although tasks naturally operate in parallel, tasks are internally organized in strictly sequential fashion as states, where only one state is active at a time. A state is thus the particular aspect of activity that a task is engaged in at any moment in time. Typical state activities are moving (actuating), waiting, processing, computing, and measuring. Once states are known, state transition logic is then defined where individual states within each task and their relationships are specified. For each state, entry, action, and transition functions must be defined and related to other states within the task. Once these functions and relationships are known they are diagrammed using transition logic diagrams for clear communication. Using transition logic encourages modular software by associating most of the code with states. This achieves two important goals: (1) sections of code are directly connected to identifiable mechanical system operations and (2) individual functions are kept short and easily understood. The use of transition logic in real time systems is based on successful implementation of programmable logic controllers (PLCs), where

transition logic translates to each state taking on the role of a PLC. This greatly extends the scope of problems that can be solved with the PLC paradigm [70].

The task and state organization of the system is primarily an engineering design tool that provides detailed specification of the relationships between the control software and mechanical systems within the CIET Facility. Defining computational processes and threads is analogous to tasks and states but focuses on performance and computational cost constraints present in the system; processes and threads in the software design are not considered here for simplicity, expedience, and because the hardware and software used is assumed to be more than capable of exceeding performance requirements.

Task and state organization, especially state transition diagrams, in combination with limited supporting documentation should constitute complete engineering specification for the control of a system. Using task and state organization within the quality assurance program for the CIET Research Program ensures that good software design principles are used, thorough documentation is naturally generated, and all specifications needed for the design and implementation of the control system are established. Further, state transition logic is itself not dependent on the specific software language or software tools being used. Therefore, the state transition logic and much of the system specifications may be applied to other similar systems with relative ease or the control system design may be re-written in a new software language or environment as the need arises (e.g. during significant hardware/software upgrades or if applied to industrial environments using industrial hardware and software).

Careful thought should be given to inter-task communication. Where variables set within one task are used within another task and vice versa, these variables must be identified and carefully controlled such that each variable is set in only one place at one time to prevent race conditions and to ensure no data is lost or distorted. A good practice is to define all the variables used locally within the task and define separate communication variables that are used for inter-task communication. Each task will then have its own set of local and communication variables that are well defined and are only written to in one place.

In addition to organizing the CIET Facility's control system into tasks and states, the control system uses basic principles of object-oriented design. Object orientation is a programming style that defines a group of objects, their characteristics, and the actions that can be done to them.

More formal definitions that help to explain object-oriented programming include [71]:

1. *Class*: a template (type) for *objects* that defines *object fields* and *methods*
2. *Object*: an instance of a *class* that has *fields* and *methods* that are well-defined
3. *Field*: a variable defined for the *object(s)* within the *class* and bound to the namespaces of the *classes* and *objects*
  - a. *Object variable*: a *field* that belongs specifically to the *object* of the *class* – each *object* has its own copy of the *field*
  - b. *Class variable*: a *field* that belongs specifically to the *class* itself – shared by all *objects* of that *class*
4. *Method*: a function within a *class* performed by or with the *object(s)* in the class
5. *Attributes*: the *fields* and *methods* collectively of a *class*

Object-oriented programming has four principle attributes that show its usefulness in control system design [71]:

1. Encapsulation: Encapsulation is achieved when each object within a class keeps its state private, i.e. other objects do not have direct access to this state. Instead, objects can call a list of public functions (methods).
2. Abstraction: Abstraction occurs when objects only expose high-level mechanisms for using themselves to outside functions. These mechanisms are a small set of public methods which any other class can call without “knowing” how they work.
3. Inheritance: Inheritance is a product of designing a class hierarchy wherein child classes reuse all fields and methods of the parent class as well as implementing their own fields and methods.
4. Polymorphism: Polymorphism is the ability to use any child class in the same way you would use the parent class. The child classes may execute slightly differently depending on the child, but all are called in the same way as the parent.

Object-oriented design is therefore highly scalable and extensible, providing excellent maintainability of the software written using object-oriented programming. However, LabVIEW is not inherently an object-oriented software language, although it does include tools for the programmer to approximate object-oriented design through the LabVIEW Object-Oriented Programming (LVOOP) toolset [72]. This toolset was not used in the design and implementation of the control system for the CIET Facility. However, these principles from object-oriented design are taken and used in the control system design. The attributes of encapsulation and abstraction are particularly important to create modular elements of the control system that are used in abstraction levels, allowing many developers to work together at once and to maintain and expand the portions of the system relevant to their work.

The next section in this chapter discusses the design of the specific tasks and states within the control system and how the VI’s are designed.

## 4.2 Design of Control System Elements

The major functions of the CIET control system are to collect and communicate data from instrumentation and system operation, control the heat input into the facility through the heater, control the fluid flow in the facility using the pump, control the heat extracted from the facility through two fan-cooled oil-to-air heat exchangers, and to allow an operator to control the facility in real time. These major functions are directly mapped to the major elements of the control system, referred to here as modules. The following sections discuss the functional design of each major control module then show and discuss how these designs are implemented in LabVIEW.

All of the LabVIEW code discussed in this section is from a frozen version developed during the spring and summer of 2018. This code can be found on the primary CIET control system computer (the general account named “Mission Control”) at the following location:

```
C:\Transfer Between Accounts\Control System Versions\Frozen Copies\2018-06-01_CIET_Control_2-1-0
```



The control system has been developed further but is not in a finalized or “frozen” state – this is one of the future goals for this work. Thus, much of this further development will not be discussed in detail here, although it is referenced where appropriate to show how the control system has continued to evolve over time.

To preface discussion of LabVIEW code, it is important to know that LabVIEW is a visual programming language as opposed to a line-by-line programming language such as python or C. LabVIEW is a “data flow” language where blocks representing specific actions or functions are connected using wires which pass information between function blocks. The idea of a “wire” in this context may be misleading – wires show the passage of information between functions, generally in only one direction. Wires may contain simple data such as strings, numerical data, or Booleans, or wires may contain more complex information such as error signals, VISA information, or other communication information needed in specific functions within LabVIEW. LabVIEW also includes other structures such as while loops and for loops which are represented by boxes around the code which is meant to operate within the loop. For loops and other structures are not purely data flow in function but are necessary for more complex applications. It should always be kept in mind that LabVIEW is meant to be a tool for engineers and researchers who are not experts in computer science and programming and instead need a way to interface intuitively and efficiently with experimental hardware to collect and display data.

Admittedly, the figures of LabVIEW code in this chapter are small and difficult to read – although not impossible. However, to accommodate a larger readership who may not be familiar with LabVIEW, the discussion in this chapter will focus on how the code functions rather than specifics of the LabVIEW coding itself. Interesting nuances or quirks of LabVIEW are discussed in Section 4.2.5. LabVIEW’s graphical programming – a feature of the software – is also a weakness when it comes to documenting and reviewing code. Complex systems designed in LabVIEW are challenging to understand, especially when poor programming practices have been used such as “spaghetti coding” where the wires and blocks within LabVIEW are heavily cluttered. To adhere to quality assurance practices, it is essential that LabVIEW code design be as simple as possible, neatly organized, follow conventional practices where possible, and include comments throughout to aid developer/reviewer comprehension. This is especially important in the university setting where students are the primary developers and are often unavailable to work directly with code reviewers and future developers, often students themselves. The documentation provided by architecture diagrams presented in the previous section and state transition diagrams shown in this section are critical for understanding LabVIEW. Additional quality assurance documentation should serve to further clarify LabVIEW code for transparent use and review.

#### 4.2.1 Data Acquisition

Data acquisition, communication, and management is a primary mission within the CIET Research Program as data collected during experiments form the backbone of nearly all research therein – even modeling and simulation research relies on experimental data for model validation, a critical component of designing and ensuring a computational tool or model is able to produce meaningful results. In the CIET Facility, this data is collected in real time using the instrumentation previously discussed. The data is then communicated to the user(s) as an

important input into operational decision-making during experiments. This data is also managed and manipulated in real time in safety oversight functions, control algorithms for feedback control of major components, and for other on-line data analysis. Finally, this data is stored locally as a record of system performance and as input to off-line data analyses.

#### 4.2.1.1 Functional Design

The function of the data acquisition module of the control system is relatively straightforward. The essential goal of this module is to collect system data, including data from instrumentation as well as important data from other systems within the CIET Facility such as user set points and time information, to package this data in a usable form, and then to communicate this data in a way that can be used by all other control system modules. Figure 4.5 shows the state transition diagram that accomplishes this goal.

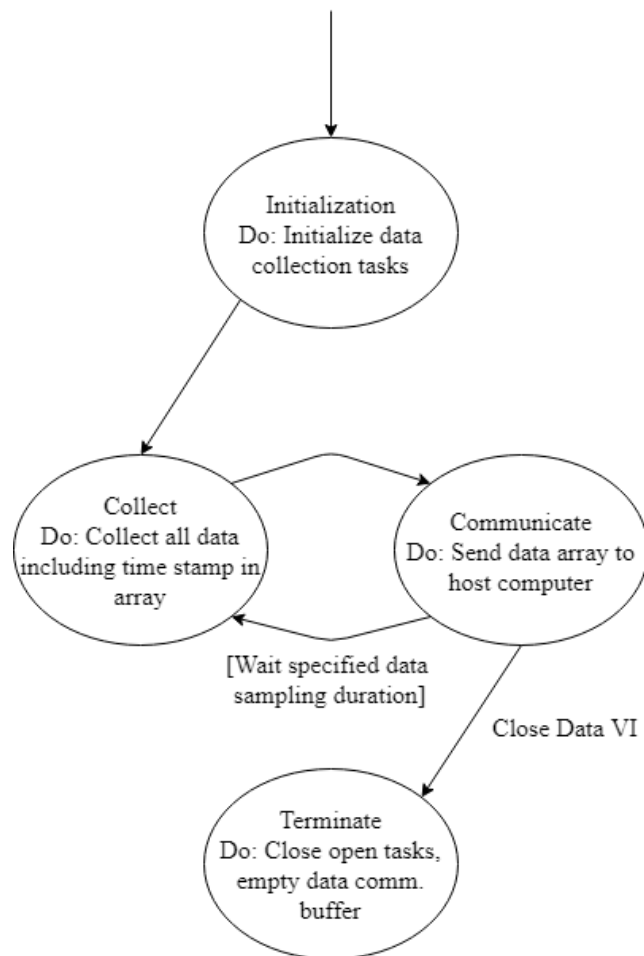

Figure 4.5. State transition diagram for data acquisition and communication VI (DAQ.vi).

When this module is first run, an initialization state is performed in order to initialize all data streams which are referred to as tasks within the LabVIEW data acquisition framework (seen under “Data Neighborhood” in Figure 4.3). Once the module is initialized, it enters a loop of collecting and communicating this data, which includes the important function of packaging the

data and including a time stamp for each iteration of this loop. The duration of each loop iteration is determined by the user. This process happens automatically whenever the control system is run so that the user never forgets to initialize data collection. Once the experiment is finished and the control system is ready to be shut down, this module is terminated. The termination state includes important functions of closing the open data acquisition tasks and emptying any data in the communication buffer so that no data is lost before it can be recorded and saved.

#### 4.2.1.2 Code Design

The data acquisition module VI has a relatively simple design that consists of code for initialization of the module, a timed loop (essentially a while loop with higher priority in LabVIEW's order of operations, ensuring deterministic operation) and a while loop that perform the major requirements of the module, and code to correctly terminate the operations within the module.

Figure 4.6 shows the initialization portion of the data acquisition module.

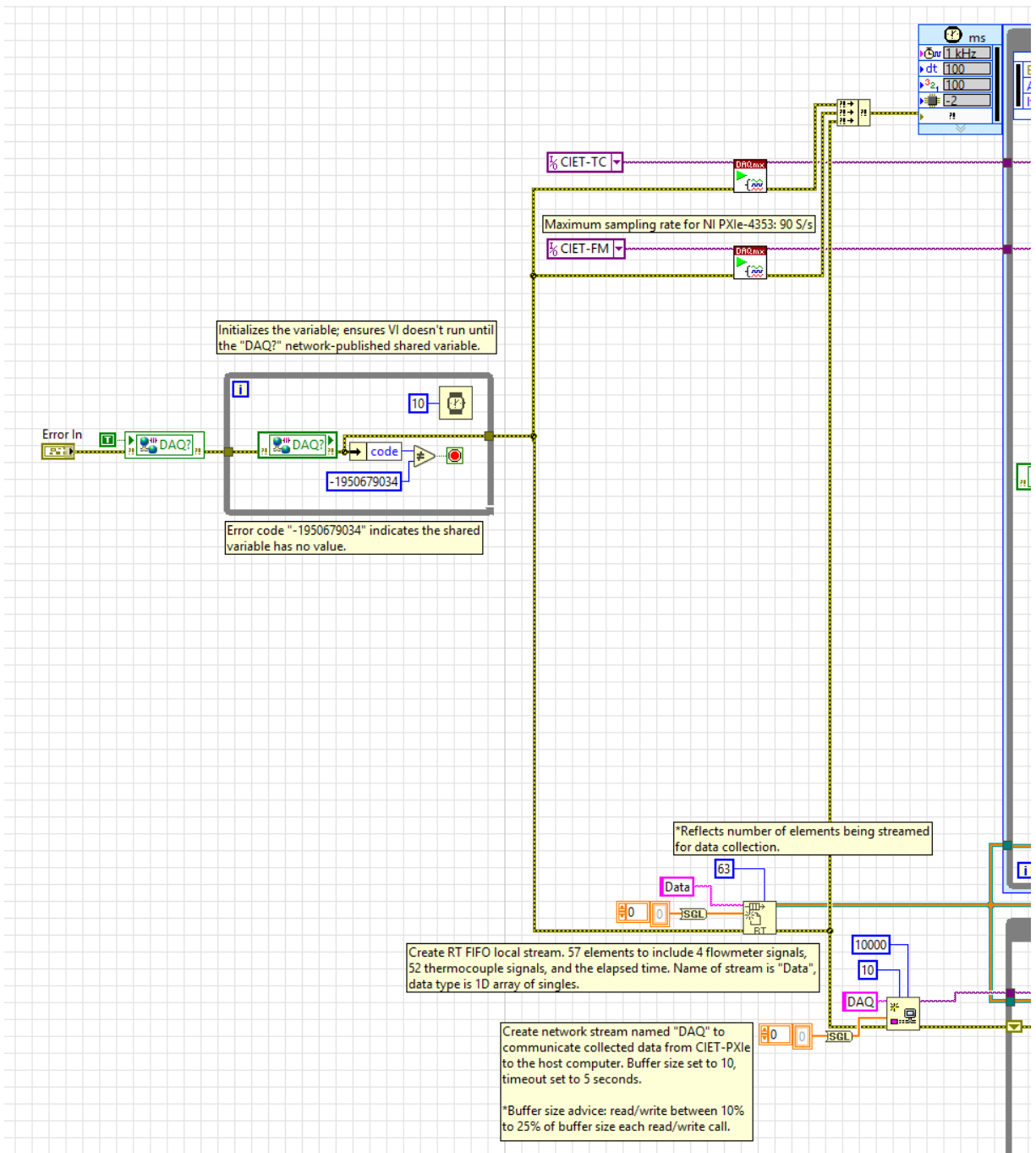

Figure 4.6. Initialization of data acquisition control module (DAQ.vi).

LabVIEW code is generally read and operates from left to right and top to bottom. This code design also passes errors from one function to the next (shown by the yellow and black striped lines or “wires” connected to the bottom of most of the blocks in Figure 4.6) which ensures the correct order of operations within the code and ensures no error from one function or code block is missed (i.e. not handled within the code’s operation). Figure 4.6 begins with an initialization of an empty error message that is input to a while loop that waits for a signal from the user interface that it is active and which then passes the error signal to two sections of code, one at the

top of Figure 4.6 and one at the bottom. The top section of code initializes the data collection tasks used in the PXIe system, in this case collection from the thermocouples (CIET-TC) and collection from the flow meters (CIET-FM). The bottom section of code initializes a network stream – a tool within LabVIEW used to continuously pass large amounts of data between a remote target, in this case the CIET PXIe system, and another computer within the network of the project, in this case the host computer where data is used by the user interface and is saved. Wires from these initializations are then sent into a timed loop on the top that collects all of the relevant data and a while loop on the bottom that communicates the data to the network; Figure 4.7 shows the data collection timed loop and Figure 4.8 shows the communication while loop.

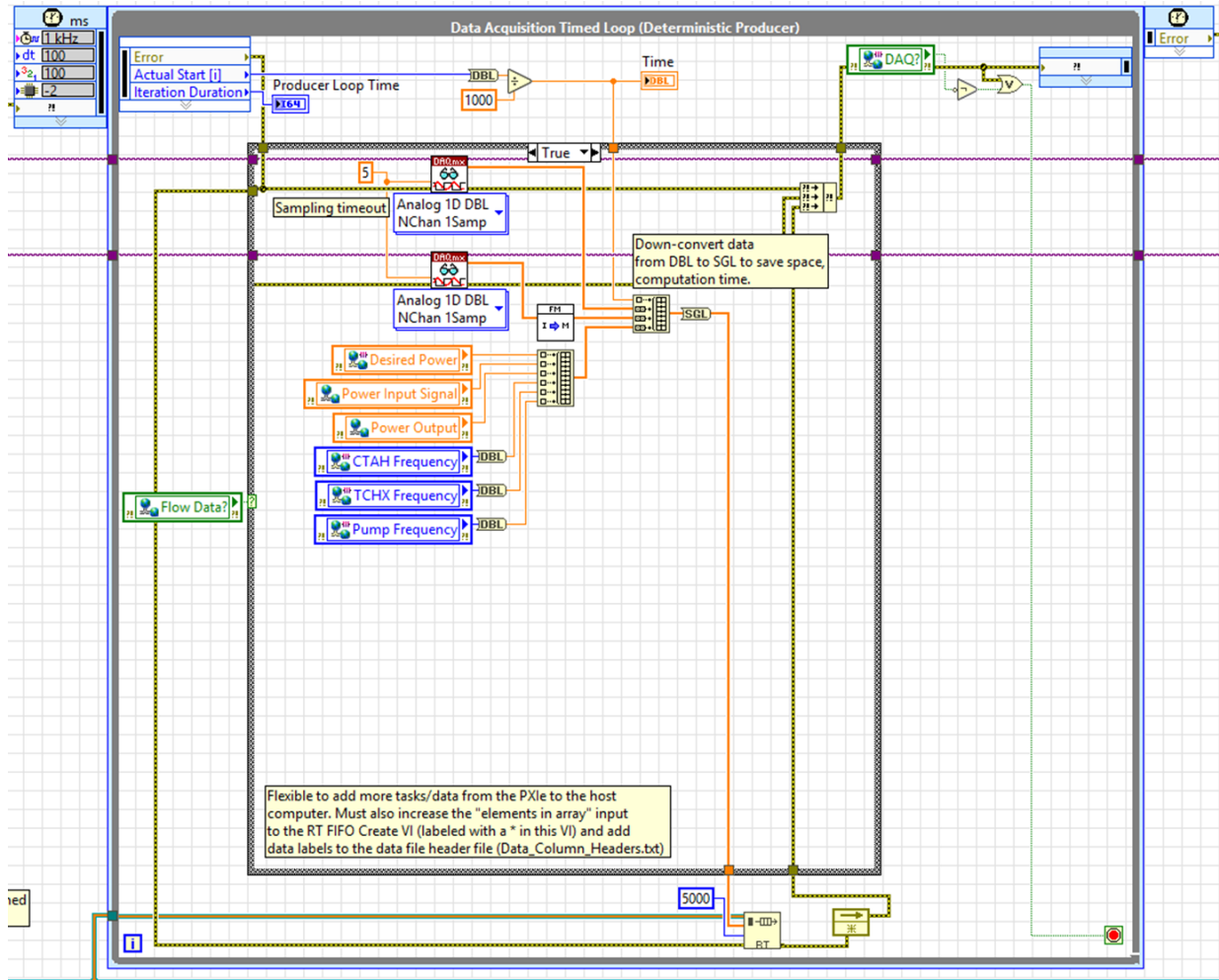

Figure 4.7. Data collection and organization in the data acquisition control module (DAQ.vi).

The primary actions taking place within Figure 4.7 are the collecting of instrumentation signals from the thermocouples and flow meters, collecting data signals from other parts of the control system, and organizing these signals into one vector (a one-dimensional array in LabVIEW) that may be easily handled and communicated. The data vector is then sent to an intra-VI communication tool called a queue in order to transfer this data to a separate loop to communicate the data to the broader network. The separation of data collection/organization from communication ensures only the actions that need deterministic timing precision are

included in the timed loop, thus not overwhelming the computational resources available. This structure is called a producer/consumer design in LabVIEW. An oddity to note in Figure 4.7 is the box within the timed loop – this is equivalent to an “if” statement and is a necessary albeit clunky inclusion to ensure that data collection, organization, and communication function correctly when analog voltage signals are used to control the power supplies. This is only necessary because of overlapping hardware for analog signal inputs, which the control system used for both the flow meters and for signals from the power supplies when controlling them using analog control.

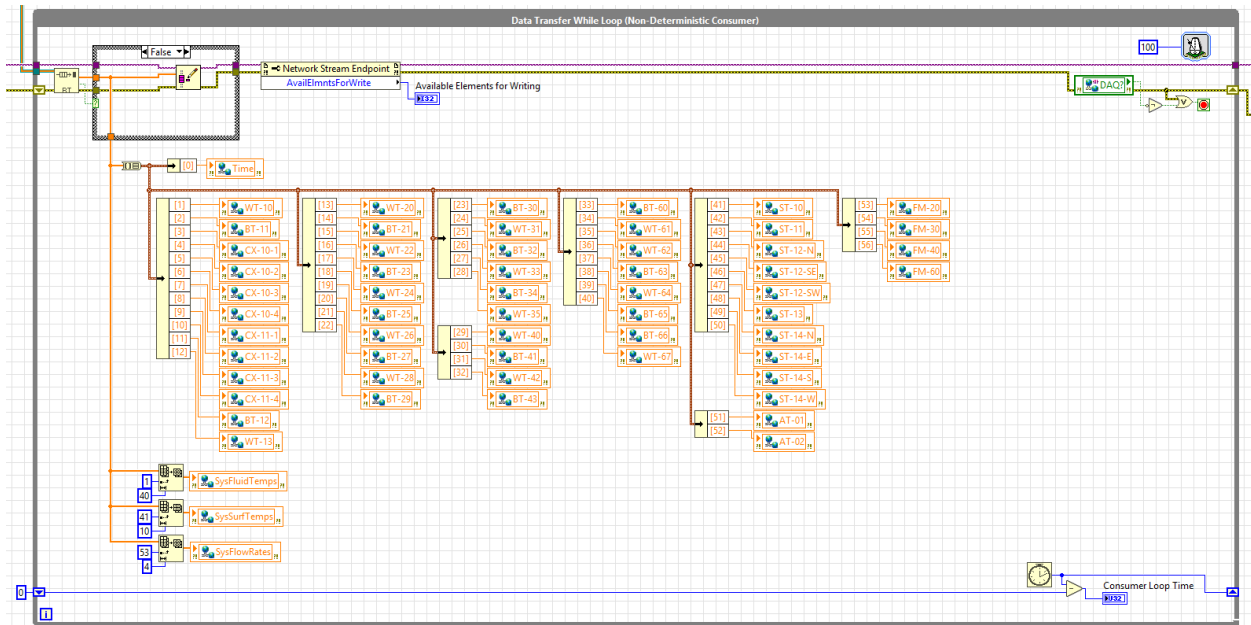

Figure 4.8. Data communication in the data acquisition control module (DAQ.vi).

Figure 4.8 shows the communication function of the data acquisition module. The data vector from the data collection and organization timed loop is passed to a network stream which then makes this data vector available to all computers on the same network. This communication loop also splits the data vector into its component parts and passes them to network-published shared variables (NPSVs in LabVIEW). Similar to the network stream, these NPSVs are available to any computer on the same network and make the use of single data signals (e.g. data from single thermocouple locations) much easier to work with. The next figure, Figure 4.9, shows the termination of the data acquisition module.

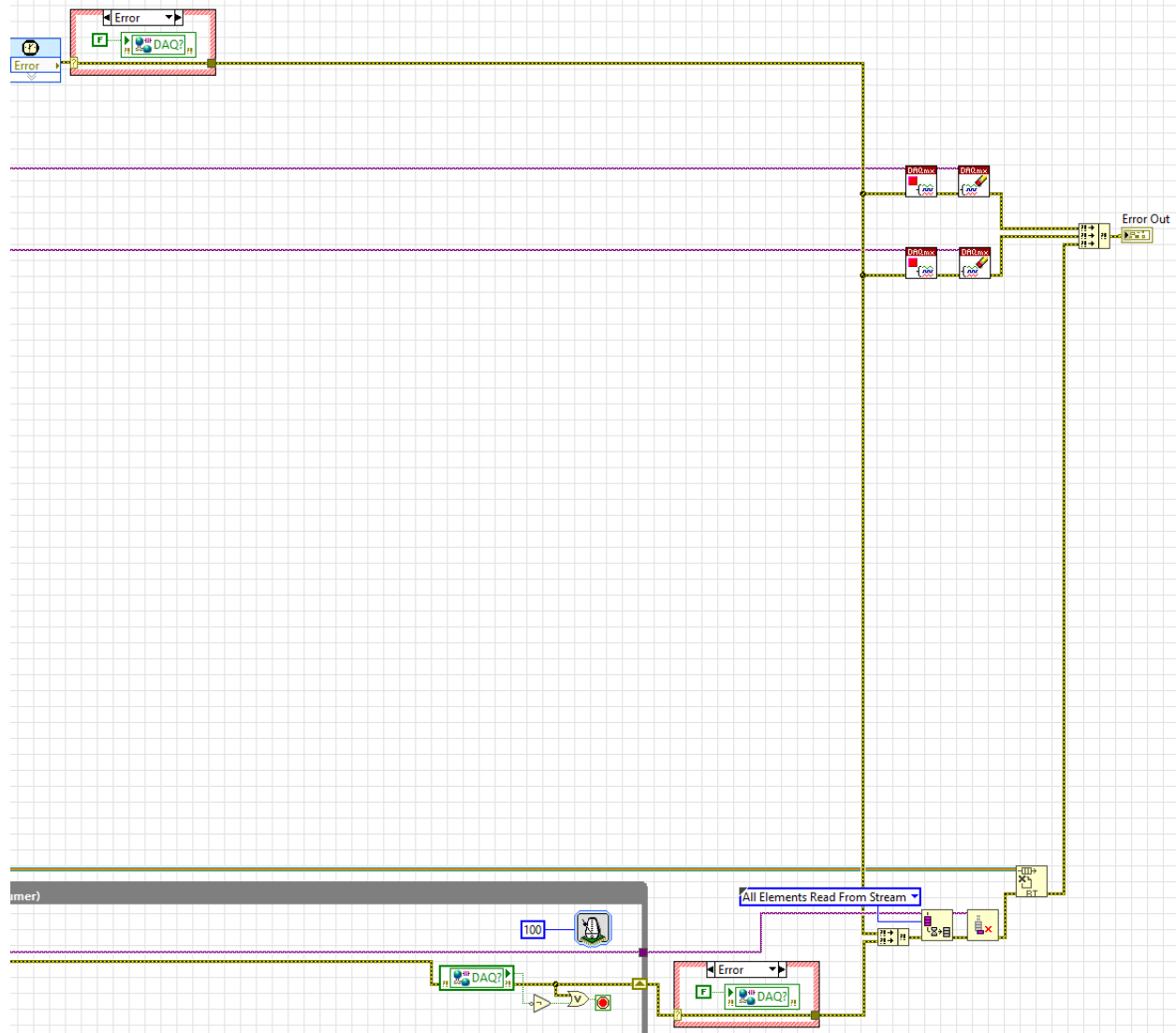

Figure 4.9. Termination of data acquisition control module (DAQ.vi) upon closing.

Figure 4.9 shows the error signals coming from the data collection and organization loop (top) and the data communication loop (bottom) going through functions to close the data collection tasks and network streams and finally to an error out display function. These closing operations are necessary to cleanly close all data collection and communication functions that were opened in this module so that no hardware or software is left running after this VI closes. This is not only good practice but necessary if this VI is to be run again before any of the hardware and software are restarted.

In LabVIEW, every VI has a front panel and block diagram. The front panel is essentially the user interface while the VI runs and the block panel is where the code itself is designed and built – the previous figures (Figure 4.6 through Figure 4.9) are snapshots of the block diagram for the data acquisition module which is a VI called “DAQ.vi”. Figure 4.10 shows the front panel for this VI.

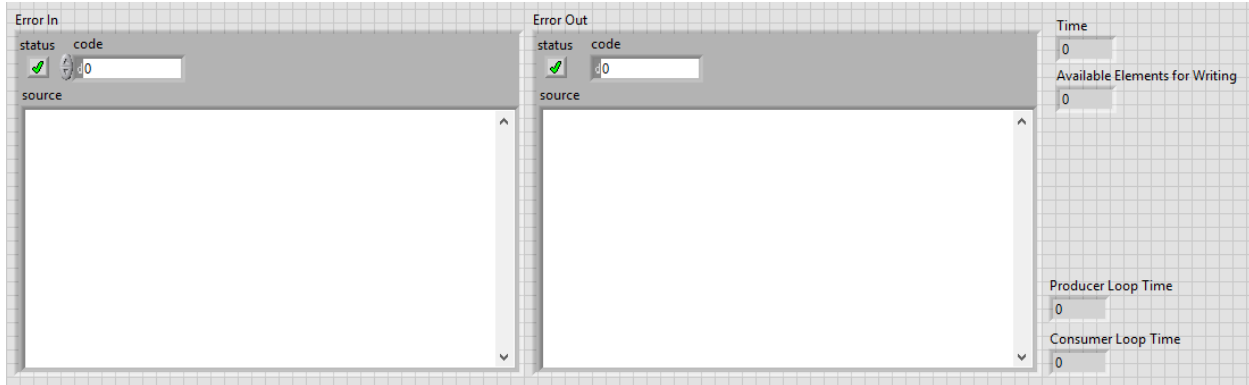

Figure 4.10. Front panel for the data acquisition control module (DAQ.vi).

The front panel for the data acquisition module, because it is not a module directly controlled by the user but instead interfaces with the user interface module, does not include any control elements or signals but does show important diagnostic values for the VI. Both the error input and error output are shown along with the total time of operation, “Time”; the number of data vectors in the network stream buffer, “Available Elements for Writing”; and the loop durations for both the data collection and organization loop and the data communication loop, “Producer Loop Time” and “Consumer Loop Time”, respectively. This front panel was important for testing when the VI was initially developed and integrated with the user interface module but is subsequently hardly used.

#### 4.2.2 Heater

A core component in a nuclear reactor is the core whose primary function is heat input into the system. In the CIET Facility, an electrically heated, thin-walled steel tube performs the same function. This heater is powered by two DC power supplies in series which are controlled by a user through the control system. The heater must be able to provide steady-state heat input to the system with reasonable accuracy and precision. In recent research, the heater is also operated dynamically to input dynamic power signals into the CIET Facility [73]. This dynamic operation requires the heater to provide sine wave inputs and other oscillating/dynamic signals with signal periods between 0.1 and 100 seconds (10 and 0.01 Hz). Therefore, the CIET Facility’s heater is expected to provide static and dynamic heat input to the facility with reasonable accuracy and precision. Safety is particularly important in the heater and therefore is an important consideration for this module and the control system in general.

##### 4.2.2.1 Functional Design

The functional design of the heater module for meeting the goals described above is relatively simple, even for both steady-state and dynamic power input operations. The complexity for accounting for both steady-state and dynamic operation is found, rather, in the LabVIEW code for this module, discussed in the following section. Figure 4.11 shows the state transition diagram for the power supply/heater control module.



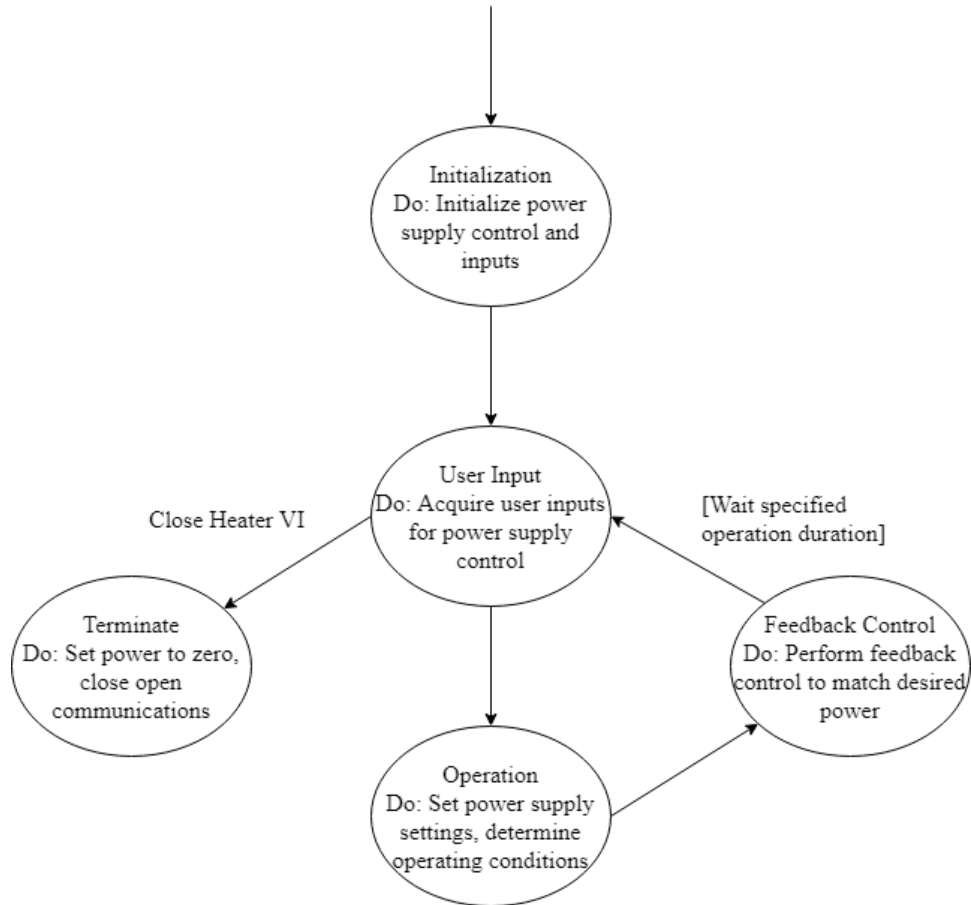

Figure 4.11. State transition diagram for power supply/heater control VI (Core.vi).

This state transition diagram design is simple yet highly flexible – it represents a general control module with initialization and termination states on either side of a loop of states that includes user input, actuation, and observation of system performance for feedback control, if included. In this specific application for the heater in the CIET Facility, when the user is operating the heater at steady-state values, simple feedback control is used by calculating the resistance of the heater element and using this calculated resistance value in the subsequent determination of the needed voltage and current from the power supplies in order to match a user-defined power input to the system. When the user is operating the heater by inputting a dynamic signal such as a sine wave, the user input is a table of input power values with a predefined time period between each value (e.g. 0.1 seconds) and if the control loop has an operating period less than this predefined dynamic input time period then resistance feedback is also used to improve accuracy. Dynamic signal inputs are generally only used with the analog control method where the operating period is 0.01 seconds, allowing fast and accurate control of the power supplies.

Not included in this design is a protective function for the control of the power supplies. The heater’s maximum operating temperature (the maximum temperature of the thin stainless steel tube that is heated via resistance heating) is 250°C due to the use of Teflon in the heater design, which has a typical maximum operating temperature of 260°C and a melting point of 335°C [74]. The power supplies themselves have maximum power outputs of 10 kW each, making a total maximum power output of 20 kW. For safety, the control of the power supplies includes a

limit on the total maximum power output of 10 kW as this is typically a maximum amount of power able to be input to the heater without exceeding the heater's maximum operating temperature (250°C) under full power operating conditions (pump providing a mass flow rate of 0.18 kg/s through the pump manifold and the CTAH cooling the fluid entering the heater to 80°C). This maximum power output limit is hard coded into the heater control module design. However, there may still be scenarios where the maximum temperature limit is reached without exceeding 10 kW of input power, such as when there is low flow in the system or when the CTAH is not removing sufficient heat. In this case, there is a protective function built into the user interface module that will set the power output to 0 W if the heater's maximum operating temperature is exceeded. This protective function is discussed further in the section on the user interface module, Section 4.2.4. This protective functionality is included in the user interface module instead of this module for simplicity – if this control system design became more complex, it would be good practice to include protective functions or safety states within the design of the relevant control system modules.

#### 4.2.2.2 Code Design

The LabVIEW code for the heater control module is different in structure and purpose compared to the code for the data acquisition module. The design structure used here is called a state machine, which is a particularly powerful design within the LabVIEW design space. Figure 4.12 shows the code for the heater control module in the heater VI, “Core.vi”.



After the initialization of the module, which is primarily an initialization of the hardware using digital communication methods supplied by the manufacturer of the power supplies that have been wrapped into a custom sub-VI, the main structure is a while loop. Within the while loop there is a box which is a case structure – depending on user selected input, the case structure can contain several unique states with unique code that is actuated when the user selects the specific case to use. The default case, shown here, contains a timed loop with code inside that allows digital control of the power supplies and thus the heater power. The user is able to turn the power supplies off and on and set the desired power of the power supplies. The power supplies return data signals for their output voltages and currents, the total power output, and the power input signal they received from the user. All of these data signals are made available to the user in the user interface through NPSVs. Locally, the electrical resistance of the heater is calculated and used to perform feedback control of the power supplies output power. The heater’s electrical resistance is used in all of the heater’s operating states to allow for feedback control and thus more accurate control of the output power from the power supplies.

Other cases included in the heater control module are digital control, power profile input; analog control, resistance feedback; and analog control, power profile input. Power profile input refers to the user’s ability to input a complex power output profile that they desire to have the heater input into the system. These two cases use a for loop to take desired power output values from a list of power outputs that the user has defined and outputs each power output value to the heater. The power output values in the input power profile are separated in time by the duration of a wait function block which is set to 1 second and 0.01 seconds for the digital and analog versions of this case, respectively. Additional cases may be added easily because of the design of the case structure, making this design incredibly useful and powerful within the LabVIEW development environment. As demonstrated in the heater module, the LabVIEW state machine is a powerful tool to implement state transition logic for the module in code as discussed in Section 4.1.4.

### 4.2.3 Rotating Equipment

Rotating equipment is used within the centrifugal pump and both fan-cooled heat exchangers in the CIET Facility. Because these components all use identical VFDs for their control, the control system interfaces with all three components very similarly which simplifies this component of the control system. Requirements here are similar to the heater discussed above – the rotating components must be able to be controlled in steady-state and dynamic operating regimes and must be able to be controlled by feedback controllers to accomplish more complex control tasks, such as holding heat exchanger outlet fluid temperatures constant while the heat input is changing. Safety is important for the rotating equipment and the rotating equipment control module includes hard coded operating limits for each rotating equipment.

#### 4.2.3.1 Functional Design

The functional design for the control system module for the rotating components, or more directly the VFDs, is essentially identical to the design for the heater module because of the similar functional requirements. Figure 4.13 shows the state transition diagram for the VFD control system module.

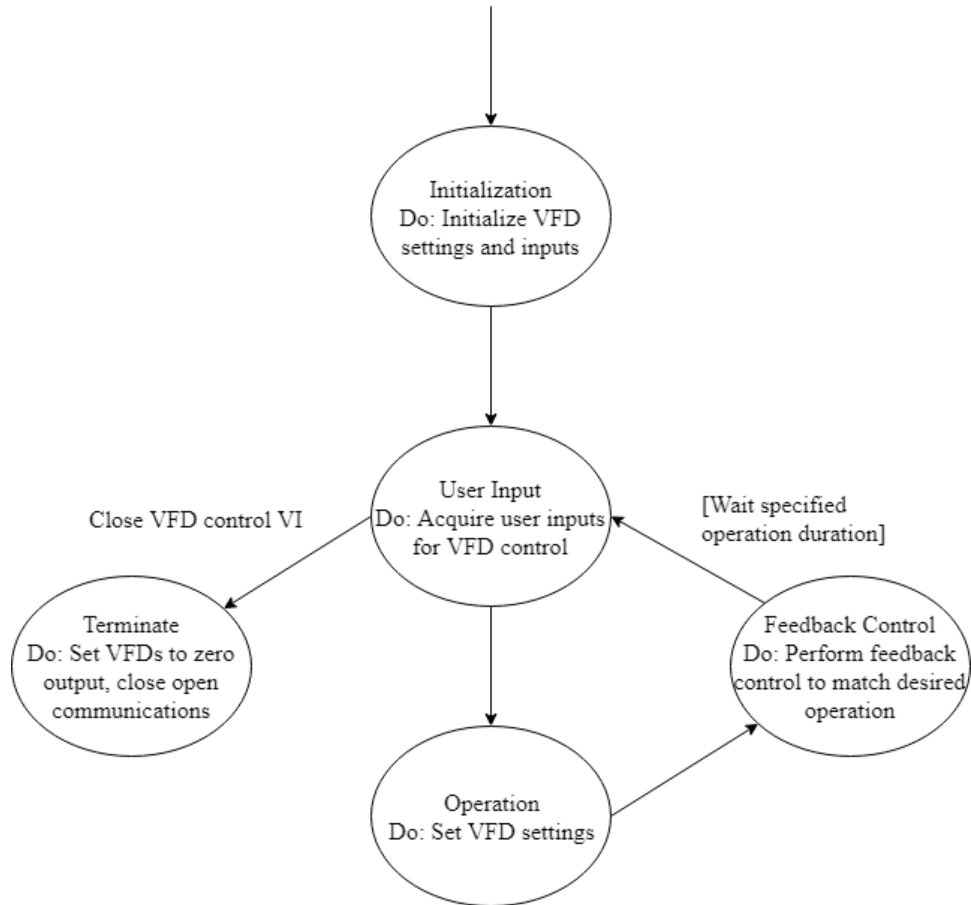

Figure 4.13. State transition diagram for rotating component control using VFDs (VFD.vi).

Here, as in the heater control module, after the module initializes all settings and variables, user inputs are determined. The VFDs are then set to specific operating conditions based on user inputs and system conditions, and subsequent system conditions are determined for the purpose of feedback control. This loop (user input, operation, feedback control) is repeated until the VFD control module is stopped, in which case the terminate state is activated.

Also similar to the heater control module, there are no safety functions included in this module. There are hard coded operating limits for each rotating component – the fan-cooled heat exchangers have maximum input frequencies limited to 60 Hz, which is the maximum power input frequency allowable in the VFDs, and the pump has its maximum frequency limited to a frequency that allows a maximum primary flow rate of 0.21 kg/s, which is essentially an upper limit in the CIET Facility due to air ingress at larger dynamic pressures. Although operators are trained and instructed in procedures to limit the primary flow rate to 0.18 kg/s, this hard-coded limit minimizes the consequence of mistakes and accidents during operation.

#### 4.2.3.2 Code Design

Similar again to the heater module, the code design of the rotating equipment VI, named VFD.vi, is very similar to the heater module code design. The primary difference between these control modules is that there are three VFDs under control thus requiring three times the structure as

compared to the heater control module. However, these repeated structures are essentially identical to each other making the programming burden only marginally greater. Further, because of this repetition, the design of the rotating component control module is highly modular, allowing for the addition or subtraction of rotating components to be done easily, assuming the use of identical VFDs. Figure 4.14 shows the initialization portion of this code that performs the initialization state.

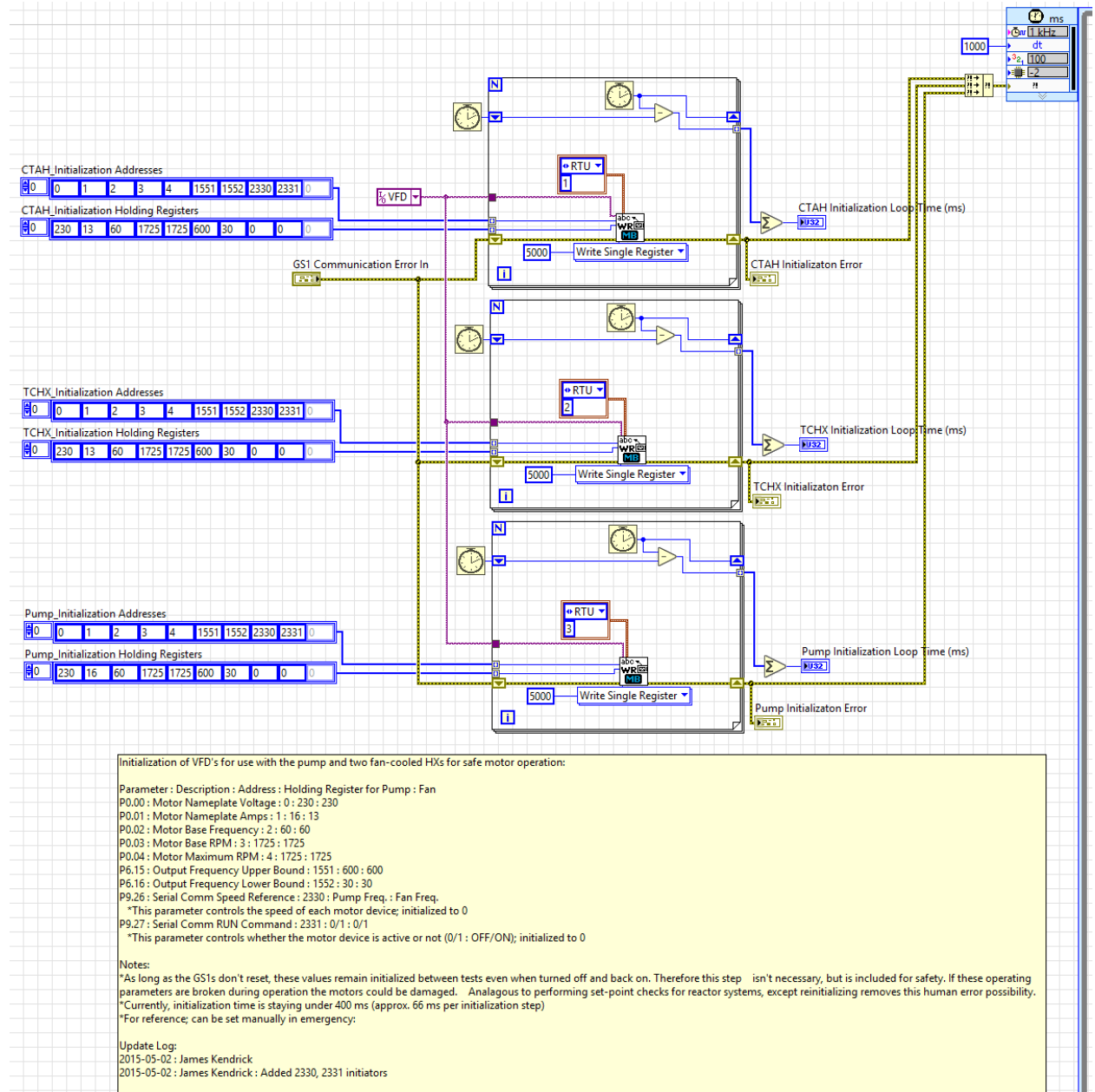

Figure 4.14. Initialization of the rotating equipment control module (VFD.vi).

All three VFDs for the rotating components (the CTAH, the TCHX, and the pump, in that order) have specific settings that must be set before they can operate their respective rotating component and be controlled by the control system. The settings for digital control by the control

system must be set manually before operating, but this is done only once during the life of the VFDs (barring any necessary factory resets) as these settings are saved in the VFDs. The other initialization settings are shown in Figure 4.14 and are set each time the VI runs to ensure correct and safe operation of the VFDs and rotating equipment. This control module includes notes on each initialization value and its purpose, collected in the large yellow note box at the bottom of Figure 4.14. The initialization values and corresponding addresses are sent to the VFDs using three for loops. Once initialization is complete, the rotating component control module moves into a single timed loop for the operation of each VFD, shown in Figure 4.15.

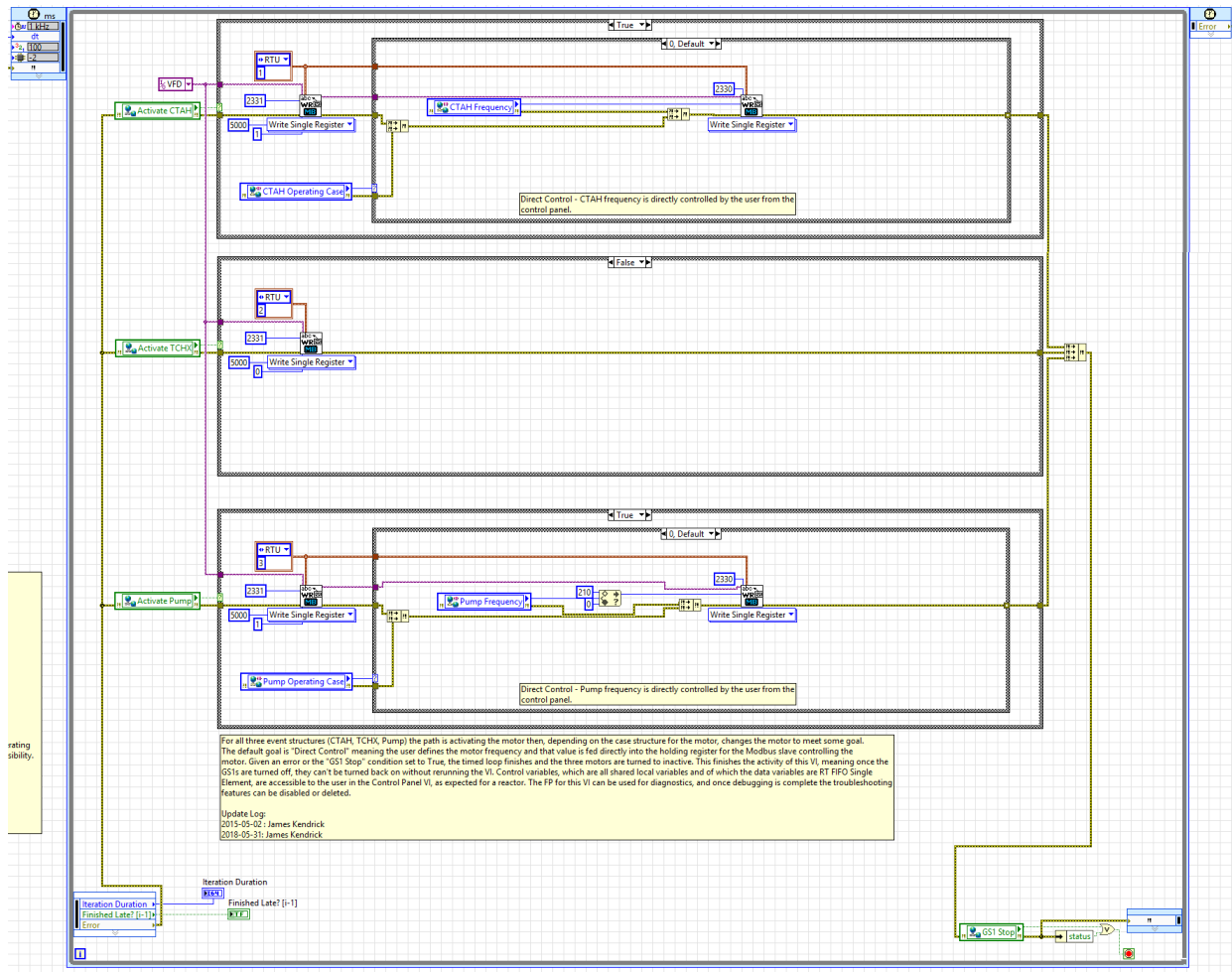

Figure 4.15. Control state of the rotating equipment control module (VFD.vi).

The operating state in the rotating equipment control module is essentially three case structures, one per VFD, within a timed loop. Each case structure allows for several control modes to be used independently for each rotating component. The first and third case structure in Figure 4.15 show manual control modes, the default control mode, for the CTAH and the pump, while the middle case structure shows an “off” state for the TCHX. This “off” state is not a termination state – rather, this allows the code to be as simple as possible, limiting computation resource use, while giving the operator the ability to turn on the TCHX if needed without having to re-execute any code. Using the case structures, the developer can include more advanced control algorithms or processes within this control module itself or use specific NPSVs to pass control signals from

advanced control modules or VIs that run external to this control module. This work anticipates significant growth and complexity in the way these components are controlled as they are controlled to more and more closely match the expected behavior in actual and theorized nuclear power plants. For this reason, this control module design allows for the most flexibility in how the rotating components are controlled for these purposes.

Once the operator is finished using the rotating equipment, the rotating equipment control module is closed using the termination code shown in Figure 4.16.

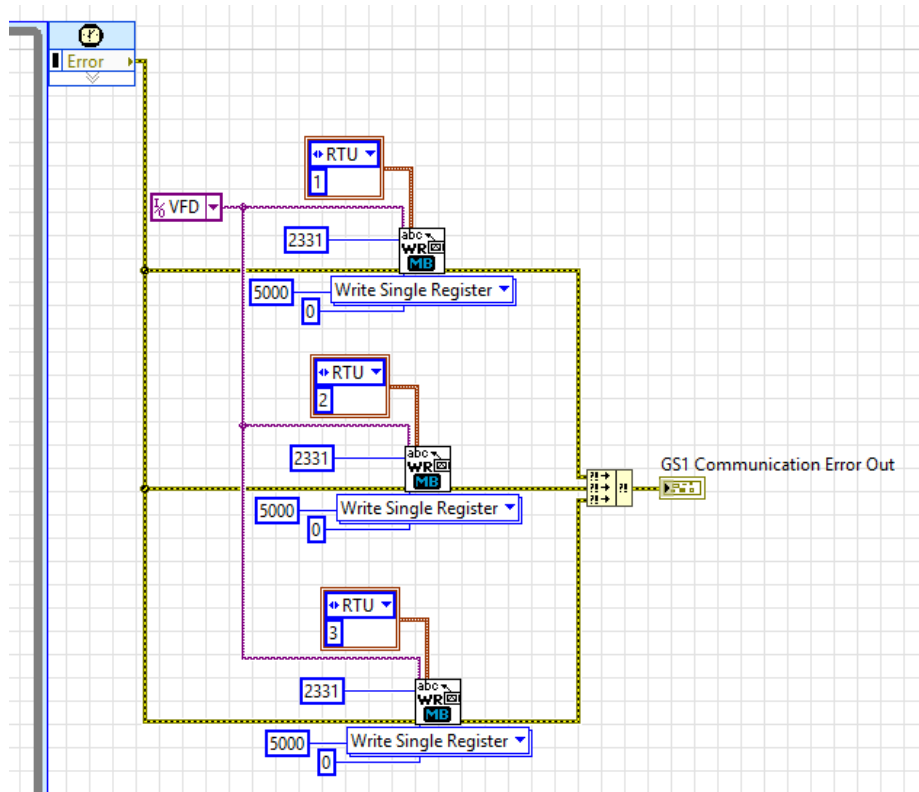

Figure 4.16. Termination state of the rotating equipment control module (VFD.vi).

Similar to the initialization code in Figure 4.14, the termination code here sends a final command to the VFDs that ceases their operation if needed. Any final error messages are then communicated to the operator.

Finally, Figure 4.17 shows the front panel for the rotating equipment control module.



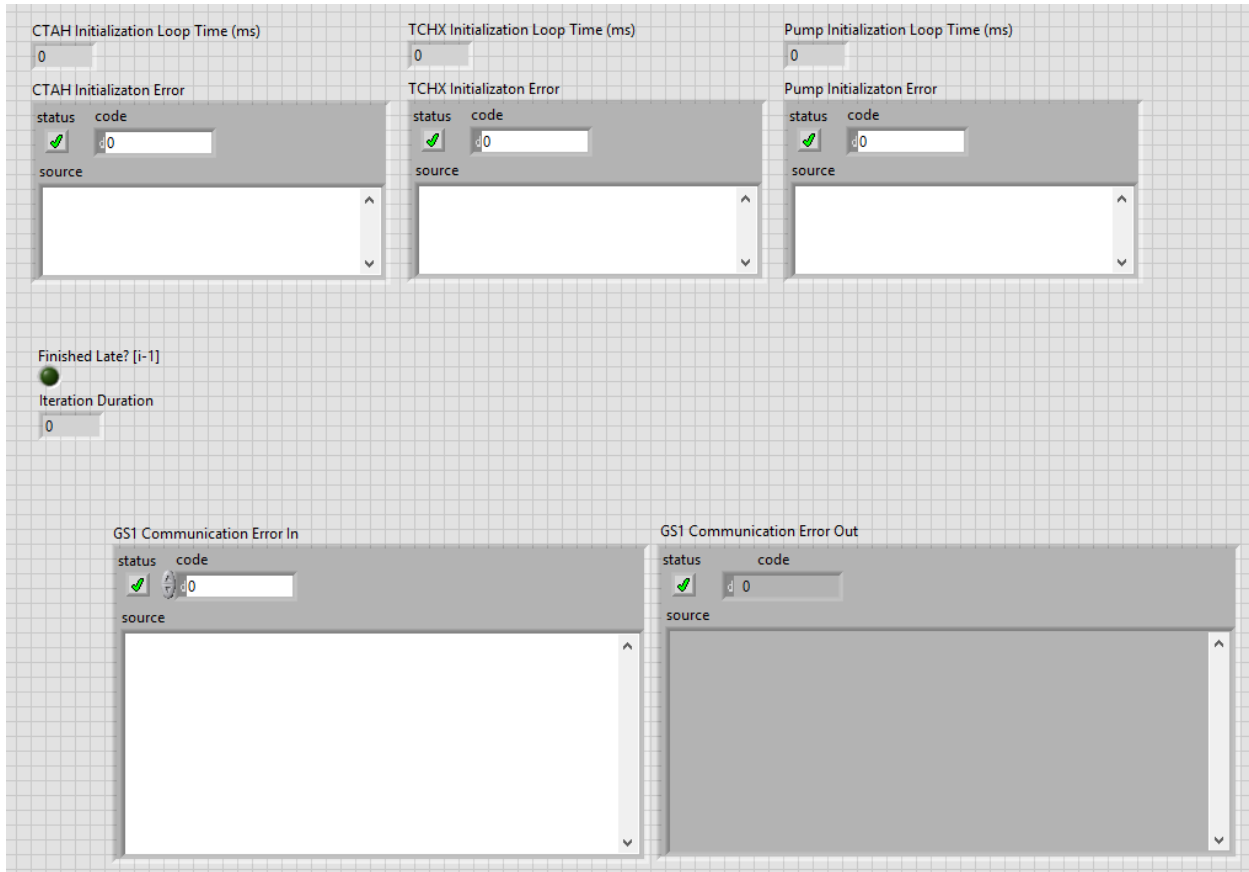

Figure 4.17. Front panel of the rotating equipment control module (VFD.vi).

Similar to the front panel for the data collection and communication control module, this front panel is used only for diagnostics. Provided here are the time it takes each rotating component to initialize based on the code in Figure 4.14 as well as any errors that occur during initialization. While the rotating equipment are operating, the front panel shows whether the timed loop finishes late relative to the desired loop duration (1 second) and it shows the actual duration of each loop iteration. Finally, the front panel shows any final error from the operation of this control module.

#### 4.2.4 User Interface

The essential function of the user interface portion of the CIET control system is to provide a user or multiple users acting as the system operator(s) the ability to see and interpret the operating conditions of the system and to change the system's settings to achieve desired operating conditions. Within the CIET Research Program, this may be as simple as controlling the CIET Facility to produce important thermal hydraulic conditions, such as steady-state natural circulation in both the primary and DRACS loops at a series of heater power inputs. However, as the research within the CIET Research Program has shifted to emphasize the control room and operator performance, how humans interact with the control system, and tools for supporting operator decision-making, the user interface has become increasingly more complex from the point of view of the control system design. This underscores the importance of modularity and encapsulation in the design of the control system, allowing the user interface to expand to several

operator interfaces and become increasingly more complex and nuanced in design and behavior while the rest of the control system design remains static.

The research focusing on the expanding the user interface, both its design and functionality, is primarily the responsibility of Christopher Poresky, who has designed and implemented the LabVIEW coding for this research and is discussed thoroughly in their dissertation [75]. As such, their work is not discussed here. Instead, this section focuses on the essential design of the user interface and the design and implementation of a simple, single-user interface in LabVIEW that was used earlier in the CIET Research Program. Some discussion is still included on the extensibility of this design for multiple user interfaces that has proven necessary for advanced user interface research.

#### 4.2.4.1 Functional Design

The functional design for the user interface is again in the form of a basic control module like those used for the heater and VFDs. Although no components are directly controlled using this control module, the “actuation” in this case is the sending and receiving of signals, specifically control and data signals, respectively. Instead of incorporating feedback control, this module includes a “Data Handling” state that is used to update the data server if used, display system data, and save data that was compiled from the PXIe in the data acquisition module. Figure 4.18 shows the state transition diagram for this control system module. This user interface design may be used as the only user interface to the system or as a primary user interface that also works alongside a number of secondary user interfaces.

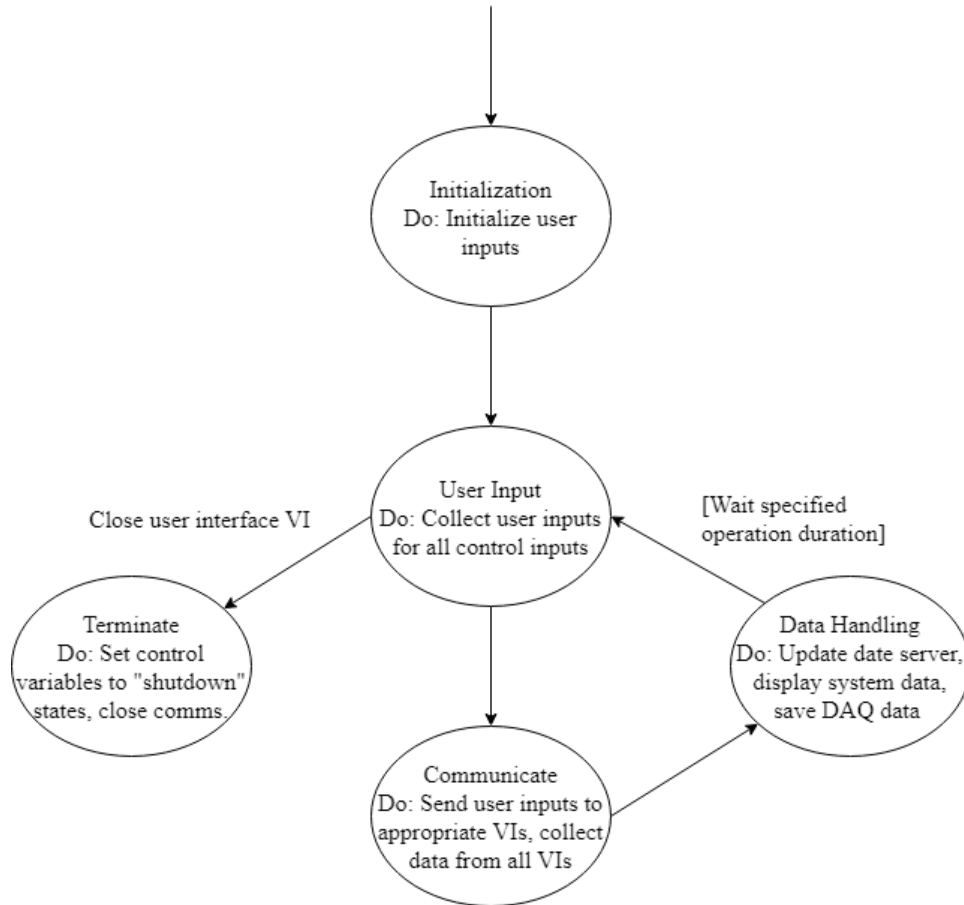

Figure 4.18. State transition diagram for primary user interface VI.

In general, this module is also responsible for starting and stopping the other control system modules (Data Acquisition, Heater, and Rotating Equipment modules); this is included in the Initialization and Terminate states, respectively. Although not necessary, the data server is a helpful tool if there is a large amount of data that is being handled throughout the control system and that needs to be accessed in many different places. This is especially important for providing data to and from secondary user interface modules that operate on separate computers or workstations. These secondary workstations may display the entire set of system performance data or a subset that is specific to its function, and the workstations may be delegated specific control responsibilities where control signals from these workstations are communicated back to the other control system modules responsible for system control. A good example of this distributed control is to have a workstation dedicated to the primary heat exchanger operation which is operated in a way that represents the behavior of a generic power conversion system, increasing and decreasing the load on the heat exchanger to simulate increasing and decreasing loads from a generic power plant. Figure 4.19 shows how a secondary user interface may function in this way.

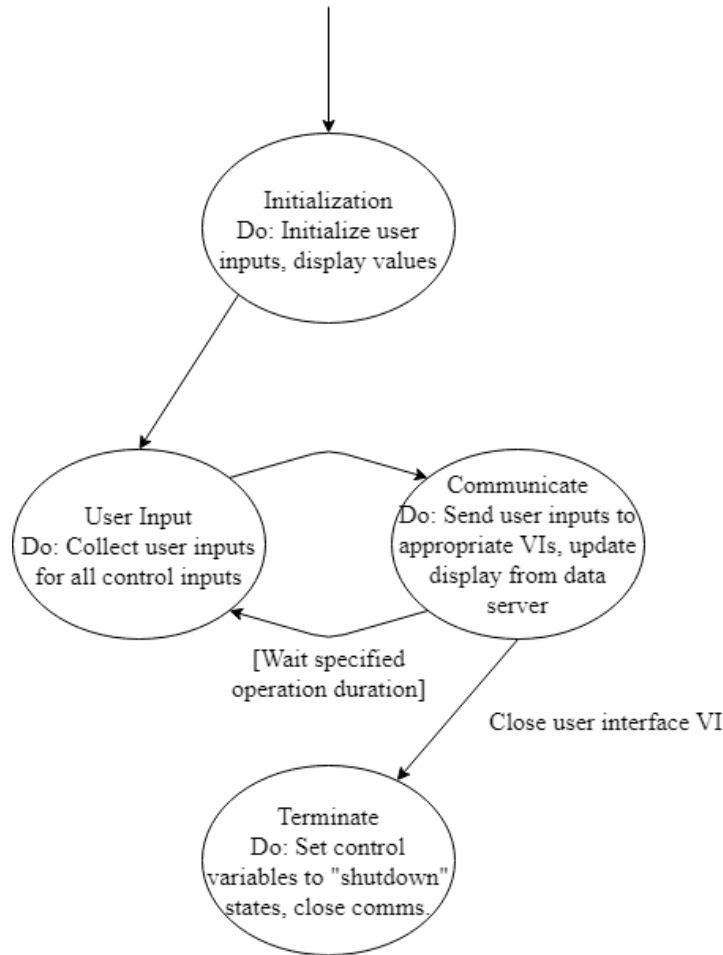

Figure 4.19. State transition diagram for secondary user interface VI(s).

The state transition diagram for a secondary user interface is identical in structure to the data acquisition module. The primary difference between the primary and secondary user interface modules is the Data Handling state. The only responsibilities of the secondary user interface module are to display data signals and send back control signals to the primary user interface module which are then passed on to the specific control module of relevance.

Protective functions that ensure safe operation are also included in this control module in the CIET control system. Because of its relatively small size and simplicity, it is easier to place this safety function here rather than in the individual control modules themselves, although this would be good practice in a larger and more complicated system. The protective function here has system data signals as input and outputs control signals that override user inputs to force the CIET Facility into a safe operational envelope. Safety is not guaranteed, but this protects the system from careless or inattentive operator actions and greatly increases overall safety in extreme operating conditions.

#### 4.2.4.2 Code Design

The design of the code for the primary user interface is similar in structure to the heater control module and rotating equipment control module, although in the simplest case, there is no embedded case structure to allow for multiple operating states. There may be one or several case structures within that allow for expanded functionality of user controls or data displays, such as advanced control algorithms or tools that complement default, direct control of components.

Figure 4.20 shows the initialization code for the user interface control module.

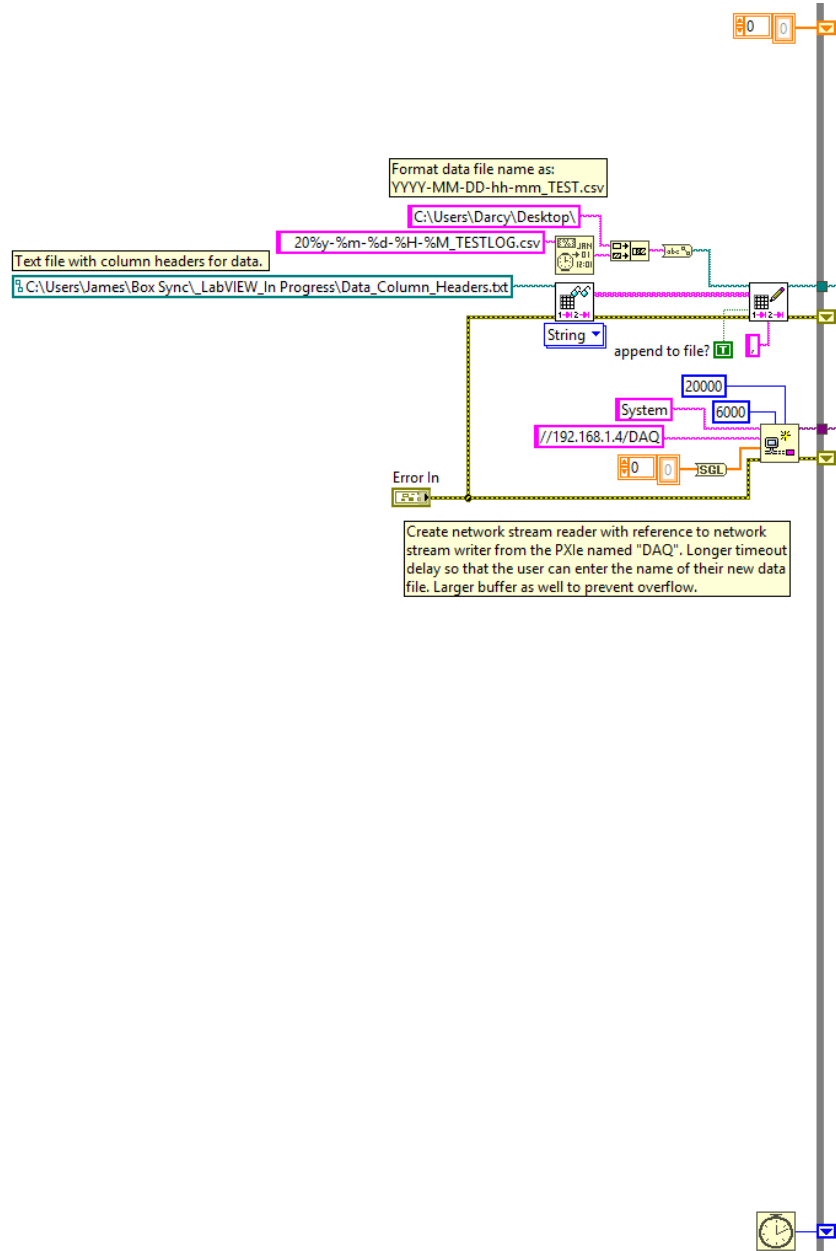

Figure 4.20. Initialization structure of the user interface control module (System\_Host.vi).

The initialization code here is similar to the code in the data acquisition control module as this is the endpoint of the data stream from that module. The code shown here initializes the connection to the data stream from the data acquisition control module and initializes a data file with data column headers. Figure 4.21 shows the code used to perform the operating state of the user interface control module.

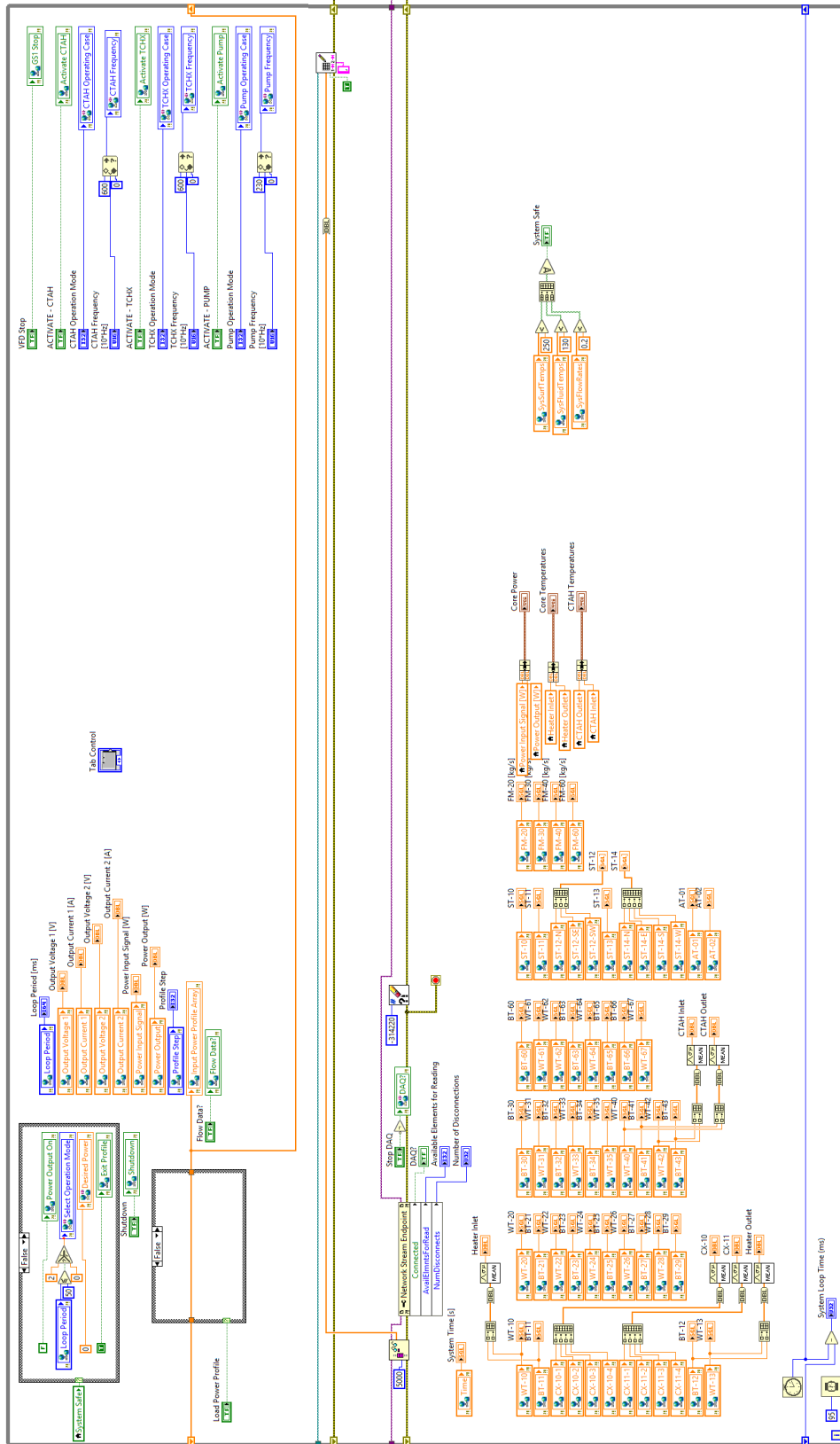

Figure 4.21. Code to display system data and communicate user inputs to other control modules within the user interface control module (System\_Host.vi).





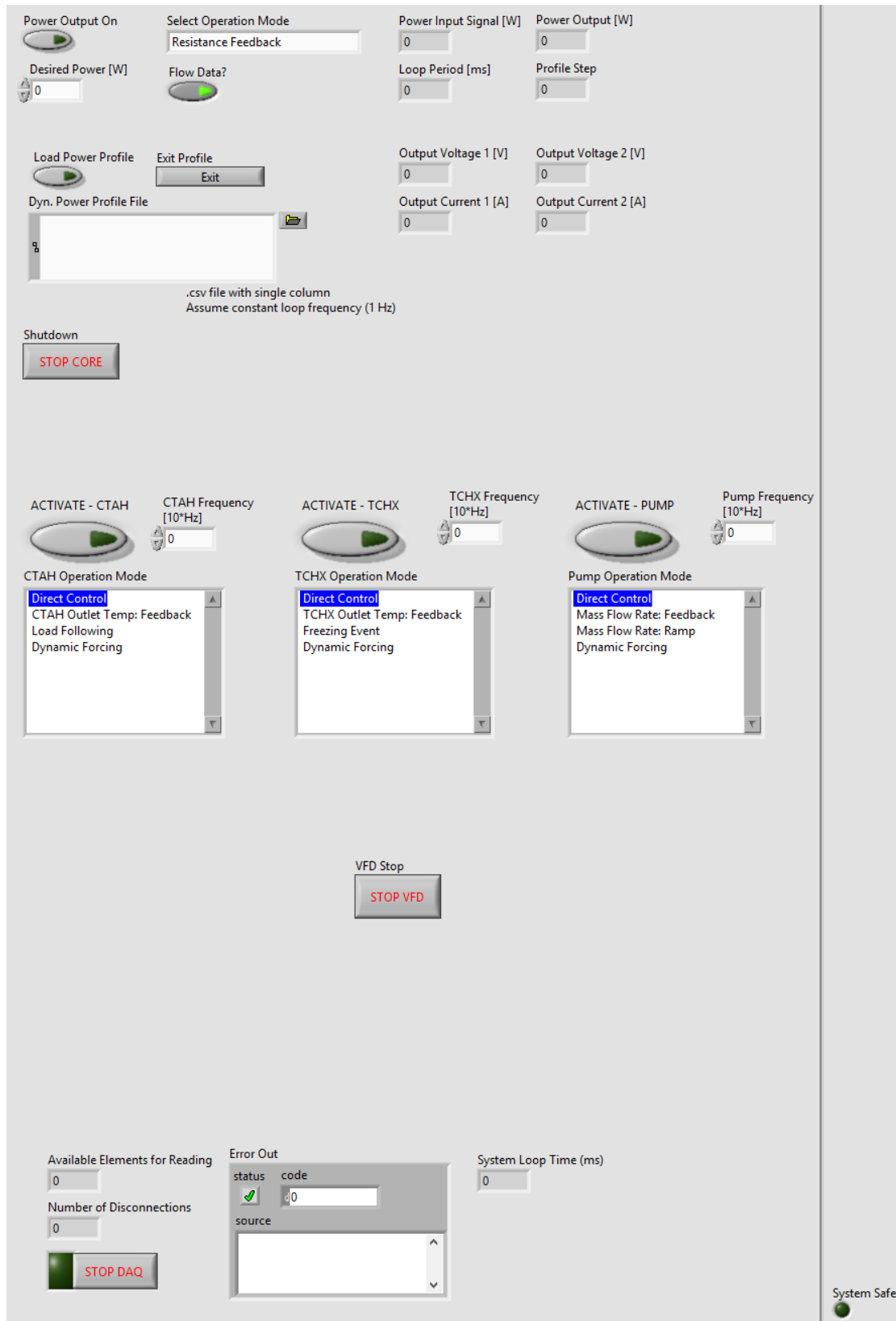

Figure 4.23. Front Panel of the user interface control module (System\_Host.vi) showing the user inputs available to the operator.

In this section of the front panel for the user interface control module, the user is given, from top to bottom of Figure 4.23, control inputs for the heater and rotating equipment as well as basic diagnostic information for the data acquisition system. In the top portion of this front panel that used to control the power supplies, the operator may turn the power supplies on and off, select their desired operation mode, input a static operating power, and load a dynamic power profile to be run at their command. For their reference, performance information from the heater control module that the operator sees includes the power output signal given to the heater control module, the power actually output by the power supplies to the heater, the heater control module loop duration, the current step within the dynamic power profile if it is running, and output voltages and currents from both power supplies. This information allows the operator to make informed decisions in their control of the power supplies and the system overall. Finally, the operator is able to close the heater control module using the shutdown button labeled “STOP CORE”.

In the middle portion of the left of the front panel, the operator is given control of the rotating equipment through control of the VFDs. All three VFDs are controlled in a similar manner, reflected in the user interface. The operator can activate and deactivate each VFD, select its operating mode from a given list, and set its operating frequency. The operator is also able to close the rotating equipment control module using the shutdown button labeled “STOP VFD”. There are no instrumentation signals or other signals displayed for the operator in this section as the VFDs do not provide feedback signals. Instead, the performance of the VFDs and thus rotational equipment is seen indirectly through system temperatures at the outlet of the two heat exchangers and through flow rates in the system – these signals are available in other parts of the user interface front panel.

In the bottom portion of the front panel, the operator is given diagnostic information for the data stream from the data acquisition module, the loop duration for the user interface control module, and the error signal produced when the user interface control module is closed, if one exists. These signals are helpful to monitor during an experiment to ensure all data sent from the data acquisition system through the network is being efficiently saved to the data file on the host computer and that a large buffer of data is not being accumulated. The operator can shut down the data acquisition control module using the “STOP DAQ” button in the bottom-left of the screen.

Last but certainly not least in Figure 4.23 is the “System Safe” indicator at the bottom-right of the figure. This indicator is normally lit green when the system is operating within a safe operation space, defined by the control system developer. The current safety limits include heater surface temperatures less than 250°C, system fluid temperatures less than 130°C, and system flow rates less than 0.2 kg/s. These safety limits are used to prevent damage to Teflon components that interface with the heater, potential fluid oxidation from elevated temperatures, and air bubble ingress that occurs at high flow rates. The design of these safety limits is largely based on engineering judgement and are easily modified in the future. Additional safety limits or boundaries are also readily integrated into this design. If the system is determined to not be operating in a safe state, the case structure at the top-left of Figure 4.21 (when viewed

horizontally) changes case and the heater output power is immediately decreased to 0 W until safe system conditions are reached.

Figure 4.24 shows the rest of the front panel for the user interface control module – the center and right portions of the front panel – that display system information for the operator.

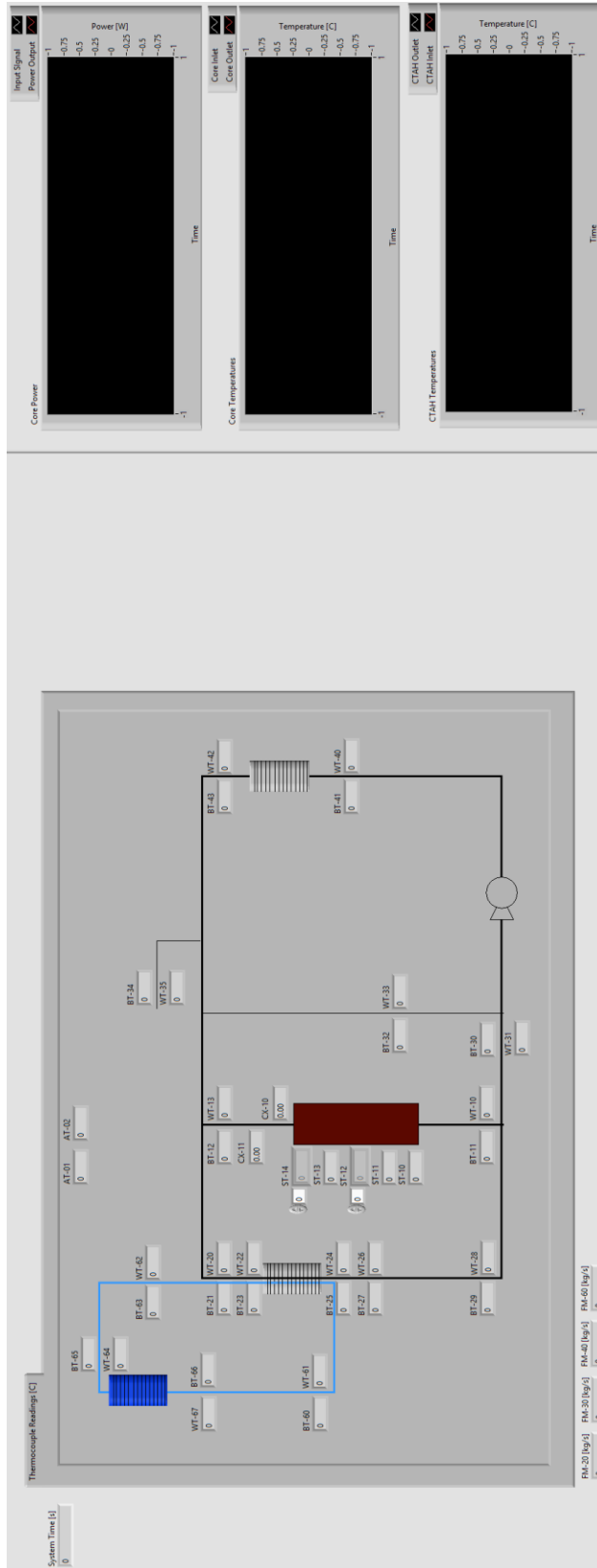

Figure 4.24. Front Panel of the user interface control module (System\_Host.vi) showing the system data displayed for the operator's reference.

The central panel of the front panel is a simplified diagram of the CIET Facility with temperatures displayed at their approximate positions in the facility. Mass flow rate data is displayed at the bottom-left of this system display. On the right panel of the front panel there are three major graphs that display, from top to bottom, both the desired and actual powers to the heater, the inlet and outlet temperatures of the heater, and the inlet and outlet temperatures of the CTAH. These are the most important signal trends for the operator to be aware of and provide the operator dynamic information on the system’s performance. There is a significant amount of empty space in the front panel as a whole. Much of this space could be better occupied by the existing controls and displays, but it could also be filled with additional functionality as desired. For a simple user interface for the operator where they are able to fully control the facility and see all instrumentation signals that are important for operation, this user interface is sufficient. To reiterate, the user interface module used here as an example is an outdated version that has been subsequently replaced with more advanced user interface modules for the purpose of research, primarily by Poresky [75]. The discussion here is, however, sufficient to define and describe the essential elements of a general user interface module, and the user interface used here as an example is fully capable of running experiments with the CIET Facility.

It is important to note that in the LabVIEW paradigm, all of the control modules described in this chapter live within a LabVIEW project, which is a collection of all of the needed elements of the full control system. Figure 4.25 shows the project items tree for the CIET control system.

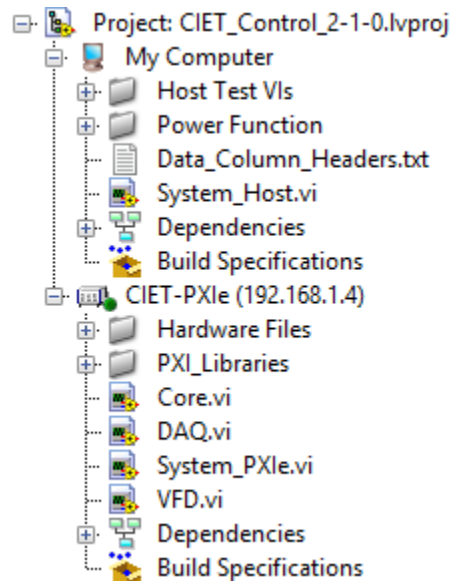

Figure 4.25. LabVIEW project item tree for the CIET control system.

In this project item tree, the primary two divisions are “My Computer” or the host computer which the code developer and system operator interface with and the “CIET-PXIe” which is the embedded system, often referred to here as the PXIe system, where much of the control system software runs. The primary item under the host computer is the user interface control module, “System\_Host.vi”. The rest of the control elements are found under the CIET-PXIe system. Other files stored in both places are sub-VIs that support the control modules, libraries of variables used in the control modules, ancillary files that interface with the control modules (e.g.

“Data\_Column\_Headers.txt” is a file used to include column headers in the file where all test data is recorded), and test VIs that are not in use.

To conclude discussion on the design and implementation of the control system for the CIET Facility, the next section discusses the unique aspects of LabVIEW as a software package and how it has been used here. This discussion is important for appreciating the work that has been done, for continued development and use of the control system, and for understanding the important inputs to quality assurance documentation discussed in the following chapter.

#### 4.2.5 Unique Aspects of LabVIEW

LabVIEW was the programming language or tool of choice at the beginning of this work primarily because it was already in use in combination with National Instruments hardware and because there was familiarity with it among graduate students working on CIET as well as professors on campus. The existing LabVIEW and National Instruments infrastructure within the TH Lab and at UC Berkeley, along with LabVIEW’s relatively quick learning curve before the program and language may be used in a basic way in experiments, made LabVIEW an easy choice, at least for the medium-term in the CIET Research Program. LabVIEW and the National Instruments ecosystem more broadly come with both supportive and challenging aspects as would any reasonable choice of instrumentation and control software or toolset. This section discusses these aspects for the purpose of informing future users of LabVIEW and National Instruments, both within the CIET Research Program and without.

As noted, LabVIEW is a graphical, general-purpose programming language (known as G) as contrasted with line-by-line or text-based programming languages such as C++, Java, or Python. LabVIEW code executes based on data flow rather than the procedural approach of following line after line of text [76]. Graphical programming is intuitive as a visual representation of the code’s performance, especially given its emphasis on data and the movement of data within the program. Although LabVIEW is not intrinsically object-oriented, it may be made so using an additional toolkit and intentional design [72]. However, beyond performing basic tasks, LabVIEW has a significant learning curve that may be challenging and is time intensive for new developers, especially those without access to expert help. LabVIEW includes a large library of functions as well as built-in tools within the development environment, plus additional modules and tools available from their website and third parties. Without expert guidance, developing internal expertise is very challenging. This points to an aspect of LabVIEW that is important to recognize and that is becoming more and more important in the university research environment – LabVIEW is a proprietary software tool and programming language as opposed to an open-source tool.

As products from a private company, LabVIEW, National Instruments hardware, and additional software toolkits and packages are well-developed and actively supported and improved by National Instruments. National Instruments’ software and hardware is very powerful in its ability to connect to instrumentation and control hardware. Further, it is convenient for all software and hardware to be integrated within one environment or ecosystem where the interface between different hardware components and software may be particularly challenging. National Instruments also has tools and additional control modules for additional uses of LabVIEW, such

as for FPGAs (field-programmable gate arrays) which are a promising technology for use in advanced digital control systems for power plants [77]. However, these tools and products come at a cost which is often challenging in a university research setting. Further, because these products are propriety, there is a niche user group and thus limited community support available online. Fortunately, LabVIEW software is provided at no cost to students at UC Berkeley and several professors are very experienced LabVIEW users. The work described in this chapter has been done with considerable guidance from resources on campus for both software development and hardware integration.

An original conclusion from the design and implementation of the original control system for the CIET Facility stated that [65]:

LabVIEW proved to be an effective and versatile platform in which to integrate hardware and develop and optimize control algorithms. The built-in front panels were also effective at allowing for intuitive user control of CIET.

This is still the case, although LabVIEW presents its own quirks and challenges of use. Overall, it is acceptable in the university laboratory setting given the integration into classes and the support from the university in the form of experienced lecturers, a campus-wide software license, and provided technical support from National Instruments. As these system and tools are further developed, industrial deployment will require the use of industrial hardware and software, although there is much future research and development to be performed before then.

### 4.3 Future Work

The work presented in this chapter has come to a finalized point, as has been shown. However, the CIET Research Program has continued to advance and the control system, particularly the user interface, has continued to have new and interesting demands placed upon it, necessitating future work for this project. Much of this research and future work is tangential to the discussion within this chapter thanks in large part to the flexible and extensible design used throughout, although there are potential improvements that have been found.

In the hardware space, adding a second analog signal input card (NI PXIe-4302) so that the PXIe system can collect both current and voltage input signals simultaneously would be ideal. This would allow the control system to move entirely to analog control of the power supplies while collecting data from the flow meters at the same time. Adding this second input card would allow the control system to be both simpler and more capable of complex operation in the future. Another significant hardware improvement to the facility, in instrumentation as opposed to control, would be to integrate level measurement methods into the control system to capture pressure differential signals from the manometer system in real time. Apart from weight signals that are collected during filling and draining operations, this would integrate all instrumentation signals into the PXIe system and ultimately the control system. This would be ideal for collecting and recording high quality test data that is maximally useful for future endeavors.

In the software space, after significant use during experiments and many minor revisions as problems were found and ironed out, the fundamental software design discussed throughout this

chapter has been found to be sound. The code presented in this chapter is a frozen version from June 2018, and has subsequently been modified, primarily to allow for a data server to be used with the more advanced user interface facility (the ARCO Facility). A near-term goal within the CIET Research Program is to finalize the control system for the CIET and ARCO Facilities and freeze them to represent a stable version of the software and hardware that is used for research. This stable version will be captured in design documents within the quality assurance program. This is the major future work that is foreseeable in regard to the CIET control system.

Given this future work, the CIET control system is well-designed for its purpose within the CIET Research Program. The next chapter discusses the integration of the control system's design, both the hardware and software components, with the quality assurance program. This is a critical integration within the CIET Research Program as all research is expected to satisfy important quality assurance requirements and the control system in particular is an integral component to all research performed with the CIET and ARCO Facilities. The discussion in the next chapter also hopes to show that the inclusion and integration of quality assurance requirements with design procedures is beneficial for the students within the CIET Research Program and the tools created for this purpose both guide the design process in a helpful way as well as produce clear quality assurance records that satisfy all requirements.



## 5 Quality Assurance Case Study

This chapter practically demonstrates the intersection of quality assurance and research through a case study using the CIET control system. These are the two primary areas of research that this dissertation has focused on and now this chapter examines their interaction, particularly in the context of research and development. Specific attention is given to the two procedures used to integrate the design of the control system into the quality assurance program, the Design Procedure and the Software Design Procedure. These procedures are the quality assurance tools used to shape the design process of the CIET control system in a way that ensures the control system adheres to the quality assurance requirements found in the ASME NQA-1 standard and in a way that supports reproducibility, includes best design practices, and instructs CIET personnel in quality assurance and good design practices.

Section 5.3 “Design Control” in the CIET Quality Assurance Plan contains the primary design commitments, including those for software design, that satisfy the primary design and software design requirements in the NQA-1 standard. These design and software design commitments in the CIET Quality Assurance Plan are satisfied using the Design Procedure and the Software Design Procedure through the detailed instructions they contain. In addition to instruction for the purpose of satisfying quality assurance commitments, these procedures are designed to contain instructions based on best practices developed within the CIET Research Program, the design and software design fields more generally, and instructions based on experience gained through their use. The goal of living documents such as these procedures and the other documents within the CIET quality assurance program is that not only do they comply with all requirements within the NQA-1 standard, they are the best possible tools for the research performed within the CIET Research Program. This development necessarily takes time and use, thus the efforts described in this chapter are only the foundation of these eventual documents.

To be clear, the control system was designed, developed, tested, and implemented before these procedures were developed. In fact, both procedures are still being developed using the experience from the control system design to inform their development. This is unfortunate as these procedures will be powerful tools to direct design activities and to train personnel to use good design practices and would have been very helpful for the design of the CIET control system. However, this is often the nature of research, that the “product” is developed while or even before the tools are developed.

Before viewing the CIET control system design through the quality-colored lens of the Design Procedure and Software Design Procedure, it is helpful to pause and consider the importance of control system design and quality assurance in software design outside of the CIET Research Program. Naturally reproducibility and scientific integrity in research are paramount in the CIET Research Program and quality assurance promises to be the right tool for the job there, but quality assurance does promise more. It is important to have a sense of “why” the CIET Research Program has gone to such effort to incorporate quality assurance into its research, and the following mini-case study on the Boeing 737 MAX is instructive for this.

## 5.1 Boeing 737 MAX Mini-Case Study

Boeing has experienced two fatal crashes with their most recent aircraft, the Boeing 737 MAX, which was introduced in 2011 and began flying in 2017. The first accident occurred on October 29, 2018, when Lion Air Flight 610, a Boeing 737 MAX 8, crashed into the Java Sea twelve minutes after takeoff, killing 189 passengers and crew. The second accident occurred on March 10, 2019, when Ethiopian Airlines Flight 302, a Boeing 737 MAX 8, crashed near the town of Bishoftu, Ethiopia, six minutes after takeoff, killing all 157 people aboard. Both crashes occurred during the first minutes of flight and have since been attributed to faulty stall prevention software, called the Maneuvering Characteristics Augmentation System (MCAS), designed specifically for the 737 MAX [78]. In both crashes, the plane's flight-control software pushed the nose of the plane down based on incorrect readings from a single sensor. Unfortunately, recent testing from government test pilots in a flight simulator found another flaw that could result in the same dangerous behavior. As corrective actions, Boeing is scaling back the power of the flight-control software and is linking the software's action to two sensors on each plane instead of relying on just one. Approval from the FAA (Federal Aviation Administration; the FAA is the regulator for civil aviation in the United States) of these corrective actions and ultimately the redeployment of the 737 MAX is still under investigation by the FAA making the redeployment date for the plane uncertain [79].

Software quality, especially for software essential for safety, is critical for the development of modern aircraft. It is impossible for this study to directly attribute these tragedies to deficiencies in or noncompliance to quality assurance requirements – that is not the goal of this mini-case study. The purpose of this discussion is to underscore the importance of software quality in safety-related applications, especially where human well-being is at risk. Quality assurance, although not a direct cause of failure due to poor software design, may still be a root cause of software failure where appropriate quality practices are not in place such as independent testing and review. There does seem to be a link, primarily related in news articles, between these crashes, the design and inspection of the aircraft, and poor quality assurance practices at Boeing enabled by poor regulatory oversight. This link shows that poor software quality is an important indication of the health of the design and implementation of the aircraft as well as the health of the organization as a whole and its relationship with its regulator.

In response to the Boeing 737 MAX crashes, there is an ongoing criminal investigation of the certification of the Boeing 737 MAX by the U.S. Department of Transportation's Inspector General with oversight by the U.S. Justice Department's criminal division. The FBI (Federal Bureau of Investigation) has also joined the investigation, bringing their significant resources to bear. There is also an audit of the FAA's certification process for the Boeing 737 MAX, requested by the Transportation Secretary Elaine Chao, which is an administrative action separate from the criminal investigation [80]. These investigations point to a suspect relationship between Boeing and the FAA which has been noted in the news in the past.

In 2000, an intensive FAA audit found "systemic" failures in Boeing's quality control process, "chiefly inadequate inspection and deviance from required manufacturing procedures," which after the audit altered the relationship between the FAA and Boeing leading the FAA to add hundreds of full-time quality inspectors at Boeing's plants [81]. However, concerns that the FAA

was not holding Boeing accountable to regulations began to mount again in 2012 with the reporting of cases of Boeing managers being slow to address safety issues and employees being afraid of retaliation for speaking up [82]. More recent FAA investigations that were settled by Boeing in 2015 revealed continued challenges with quality assurance practices, including a pattern of falsified paperwork and ignored procedures which created quality issues for Boeing and its suppliers. Boeing's quality errors included indicating work was complete when it was not, working without authorization, not taking corrective action in a timely manner, and a lack of documentation/records management. These problems indicate a severe culture problem, particularly around safety [81]. Amidst these concerns, however, Boeing has maintained a reputation of having a culture of safety and procedure compliance and the FAA is generally seen as doing their job in auditing Boeing and finding weaknesses to correct [81]. Delegation of oversight responsibility to Boeing from the FAA that has generated concern is in reality a common practice among aviation regulators and does not extend to companies policing themselves or self-certifying aircraft but consists of designated representatives who have been trained by the FAA and continue to receive its guidance. An audit of Boeing in the 1990s found that 95% of the Boeing 777 was inspected and certified by Boeing itself, which has an exceptional safety record and has not seen the criticism and catastrophe of the 737 MAX [82].

Given the evidence, it is hard to definitively say where blame belongs, but it is clear that quality assurance is always a key player in these discussions. When mistakes inevitably occur in complex systems and non-compliant parts or items leave a factory, quality assurance is meant to help trace and identify the problem, determine the root cause, and provide support for corrective action. Software quality assurance is particularly challenging given the ever-increasing complexity of software. Software is also unique compared to the traditional design and development of hardware because of the generally lower costs associated with software failure and the ability to modify software after deployment and often at-a-distance through updates and patches. Unfortunately, much of the effort given to software in business today is towards design and development over quality assurance. Bob Tapscott, chief designer and architect of the Jeppesen Aviation Database (JAD) that supplies flight direction to flight management system, identifies this fundamental problem in software development [83]:

It is far more interesting, and typically financially more rewarding to create software, be it for risk-management and financial derivatives products or for risk-mitigation and flight management systems, than it is to independently audit what others have created. As long as this remains the case, expect more problems. Even if the compensation issues are addressed, it takes a certain mindset to enjoy finding other people's mistakes, more than creating something new. So be it as a result of lack of funding or the right people, or cultural issues, much of these new 737 Max jets were 'self-certified' by Boeing. I am sure that is an issue that will be seriously re-thought.

In addition to the articles already cited, more in-depth discussion on the Boeing 737 MAX accidents and the importance of software quality in this context is found in an excellent article in IEEE's *Spectrum* magazine [84]. Software quality should have been more of a priority in the development of the Boeing 737 MAX MCAS and now Boeing must deal with these outcomes.

Again, this discussion is not meant as an indictment against Boeing, the FAA, or the commercial airline industry, but serves to emphasize the need for the use of appropriate quality assurance practices in high-risk industries. The work discussed in the rest of this chapter lives in this context and ultimately aspires to this purpose. Software quality assurance within the CIET Research Program is clearly far-removed from the level of risk in this mini-case study and in the commercial nuclear power industry, but as with all research, the research shown here is meant to influence and guide the practices in these commercial spaces as well as the people who do and will ultimately inhabit them.

## 5.2 Design Procedure for Instrumentation and Control Hardware

The physical design of the CIET control system includes the instrumentation in the CIET Facility, the National Instruments' hardware used to connect the personal computer to the hardware, and all cables and other accessories. The Design Procedure is used for this design because of its physical nature – the software and its design are captured through the Software Design Procedure. The Design Procedure includes instructions and supporting information to fully satisfy the quality assurance requirements committed to within the CIET Quality Assurance Plan. These instructions and supporting information are also specifically designed to support the design of items for the CIET Research Program and are meant to capture good scientific practices to support research. This completed procedure is then stored as a record within the CIET quality assurance program to provide a record of work performed for any future reference that may be helpful, such as instructing future CIET personnel or investigating the root cause of future issues resulting from current design decisions.

In general, the Design Procedure is meant to be used for all original designs related to the CIET Research Program. The instructions in the procedure are meant to be completed to a degree commensurate with the importance, complexity, or importance to safety of the item or product being designed. The extent of verification and the methods chosen when using the Design Procedure are also a function of the item's complexity, degree of standardization, importance to safety, and its similarity with previously proven items.

The relevant instructions from the Design Procedure are reproduced in this section using italics. Discussion for each step includes how and why each step is satisfied in the design of the CIET control system. The Design Procedure begins with instructions for the Designer, and when they have finished their sections, a Verifier reviews the information provided and performs specific verification checks. The two sections below reflect this separation of work. As the CIET control system was design, developed, tested, and implemented before these instructions were developed, the answers here are in retrospect and will be answered considering the work that has been done. This dissertation completes both the Designer and Verifier instructions and includes reflection on the use of these instructions.

### 5.2.1 Designer Instructions

*The item must be named and labeled. The item's name and an abbreviated name (if desired) must be specified and the item's label will be used throughout the CIET Information Repository.*

For the control system as a whole, the name and label are as follows:

Name: CIET Control System

Label: Control System

The name is intuitive, particularly given the extensive discussion up to this point. The label is short and to the point. Its purpose is to make the storage of related documents and records within the CIET information repository clear. For example, the completed Design Procedure for the CIET control system will be stored as: CIET-DES-PHY-001-00 Control System.pdf. In the future, if a new item to augment the control system is designed, this record will be revised and updated to reflect the as-built configuration.

For the individual components of the PXIe system, the names and labels are as follows:

Name: NI-PXIe-1082 Chassis

Label: NI PXIe-1082

Name: NI PXIe-8840 Quad-Core Controller

Label: NI PXIe-8840

Name: NI PXIe-4302 Analog Input Module

Label: NI PXIe-4302

Name: NI TB-4302 Analog Input Terminal Block

Label: NI TB-4302

Name: NI TB-4302C Current Input Terminal Block

Label: NI TB-4302C

Name: NI PXIe-4322 Analog Output Module

Label: NI PXIe-4322

Name: NI TB-4322 Analog Output Terminal Block

Label: NI TB-4322

Name: NI PXIe-4353 Temperature Input Module 1

Label: NI PXIe-4353-1

Name: NI TC-4353 Mini TC Connector Block 1

Label: NI TC-4353-1

Name: NI PXIe-4353 Temperature Input Module 2

Label: NI PXIe-4353-2

Name: NI TC-4353 Mini TC Connector Block 2

Label: NI TC-4353-2

Name: NI PXIe-4353 Temperature Input Module 3

Label: NI PXIe-4353-3

Name: NI TC-4353 Mini TC Connector Block 3

Label: NI TC-4353-3

Name: NI PXIe-8431/8 RS485 Serial Interface Module

Label: NI PXIe-8431/8

These names and labels are intuitive and correspond directly to the components sold by National Instruments which makes searching National Instruments' site for additional information, including manuals and supporting documentation, more straightforward.

A major goal in using the names and labels as described here is to make the use and reference of these items as straightforward and intuitive as possible for all CIET personnel. Transparency and usability are primary motivations here.

*Cite all supporting references and other applicable background data including the relevant information from the literature/background data. Include a summary of each reference and describe the relevance of the reference to the item (i.e. create an annotated bibliography).*

1. R. Upadhyaya and J. C. Kendrick, "Instrumentation and controls development for the compact integral effects test facility," UCBTH-15-006, Nuclear Engineering Thermal Hydraulics Laboratory, Berkeley, CA, Sept. 12, 2015.

This report provides significant detail for the original design and implementation of the control system used in the CIET Facility. The current control system designed here is a complete re-design from this original design, although much of the design and lessons

learned in the original design is kept intact in the new design. This re-design includes significant new control hardware although the instrumentation remains identical.

There are no other references used. Significant discussion with National Instruments took place to identify the best hardware to integrate with the current instrumentation in the CIET Facility and to provide the functionality desired for the CIET Research Program.

The lack of references here is not ideal – in the ideal case, significant research and investigation is completed before major design decisions are made and this section would adequately capture this process. However, given the CIET Research Program’s relationship with National Instruments, the existing hardware and software, and the campus resources available for National Instruments hardware and software, the decision to use National Instruments was relatively set before this design work began. The design of this control system hardware was then performed in collaboration with National Instruments’ technical support. This collaboration is a supplier-customer relationship rather than a design partnership; therefore, an External Organization Interface Procedure is not needed.

*Define the design inputs and their sources. Specify to the level of detail necessary to permit the design activities to be carried out in a correct manner and to provide a consistent basis for making design decisions, accomplishing design verification measures, and evaluating design changes.*

The design inputs were from two primary sources: (1) the need to integrate and use the existing instrumentation and hardware installed in the CIET Facility and (2) the need for better control of the heater, specifically faster control to allow dynamic inputs and transients to the CIET Facility. The design inputs from instrumentation and control hardware integration requirements include:

1. Three variable frequency drives (VFDs) that control the pump and both heat exchangers in the CIET Facility. The VFDs accept serial digital communication using the RS-485 standard.
2. The power supplies also use serial digital communication and use the RS-485 standard. There are two power supplies, although only one serial communication connection from the control system is needed with a simpler communication interface between the two power supplies.
3. Four Coriolis mass flow meters that output current signals between 4 and 20 mA
4. Fifty-two Type-T thermocouples that output low-voltage (in the low mV range) signals
5. Whatever control hardware is selected for the updated design, it must be able to interface with a personal computer used for experiments.

Design inputs from the need for better control of the heater, after much testing with the new hardware, proved to require analog control to achieve control signal frequencies greater than 1 Hz. The power supplies accept input voltage signals and provide output voltage signals between 0 and 10 V.

The description above adequately describes the design inputs for the CIET control system. Unfortunately, not all were known when this design began. The requirement for analog control of the power supplies came after significant testing and troubleshooting. Fortunately, the

National Instruments PXIe system that was purchased included hardware for analog input and output signals. The PXIe system is also flexible in that more control or instrumentation modules may be added or swapped out with the existing modules. This flexibility was specifically designed into the system to allow for unknown future requirements from ever evolving research needs, such as higher time-resolution control of the heater.

*List any appropriate design standards used for this item. ASME NQA-1 is implicitly included as this design is performed within the CIET Research Program.*

There were no additional design standards used except for ASME NQA-1, which as stated is implicitly invoked through the use of the Design Procedure under the CIET quality assurance program.

There often will be no standards that must be specified here and followed during the design. This instruction is more important for the design of prototypical components that will see commercial service, which is rare in the TH Laboratory.

*List the design methods, materials, parts, equipment, and processes essential to the function of the item.*

No specific design methods, materials, parts, or equipment were found to be essential to the function of the item. Specific materials, parts, and equipment were chosen as a function of the hardware available from National Instruments.

The processes that are essential for the function of the control system are the process of converting signals from instrumentation and control hardware into signals available to the control system operator through a user interface and converting control signals from the operator into control signals available to the control hardware in the CIET Facility. The ability to communicate these signals back and forth is the fundamental requirement of the control system and is the specialization of National Instruments in general.

The design of the control system was essentially the collection of the best equipment from National Instruments for use in the CIET Facility and its integration, similar to building a personal computer. As such, much of the true design work was completed by National Instruments and the purpose of this Design Procedure was then to select the best components and to confirm that they integrated correctly for use in the CIET Facility. This is a benefit of working with National Instruments and relying on their expertise in this area.

*List the assumptions needed for the design and identify the assumptions that must be verified during this design process.*

The major assumptions in this design are in the capability of National Instruments to choose and assemble the best hardware to meet the needs of the CIET Control System. The implicit assumptions here are:

1. All hardware components in the PXIe system will integrate correctly.

2. The PXIe system will integrate with the existing instrumentation and control hardware correctly.
3. The PXIe system will integrate with the personal computer that is used for developing the control system's software and all the tools needed for development and operation.
4. The performance from the PXIe system will satisfy the research needs of the CIET Research Program.

All of these assumptions were verified as the PXIe system was received and connected to the rest of the CIET Facility. Assumption 4 was tentatively verified before purchasing the PXIe system by reviewing the technical specifications of the final design from National Instruments.

*List the design objectives and the design analyses used to show that these objectives will be met.*

The design objectives overlap directly with the design inputs for the CIET control system in these instructions. This is most likely unique to the control system design.

*Identify all major computer calculation, including identification of the computer type, computer program name, program revision or version number, inputs, outputs, evidence of or reference to computer program verification, and the bases (or reference thereto) supporting application of the computer program to the specific physical problem. Only include computer calculations that merit this depth of detail provided. Common calculations using Excel, Mathematica, MATLAB, etc. should be included in the design but do not need all of the detail required here unless desired.*

No computer calculations were used for the design of the CIET control system.

*List the effects to overall facilities and/or organization operations that this new design has, including analysis as needed, for all facility and organization configurations including operation, maintenance, test, surveillance, and inspection activities.*

In the CIET Facility, the control system allows for the controlled operation, testing, and surveillance of the facility. The purpose of the control system is to provide the operator with adequate control of the facility and to collect and save important data from the facility. Maintenance, in general, will not involve the control system. A good example of this is the draining and filling of the facility. Inspection also will not necessarily require the use of the control system.

*Include the item label in the design. Where a physical label is not possible, record physical separation, procedural control, or other appropriate means of item identification.*

The label for the CIET control system ("Control System" along with the identifier for the Design Procedure, "CIET-DES-PHY-001-00") still needs to be written in permanent ink on the chassis of the PXIe system. The other components that comprise the control system, including the chassis, are appropriately labeled with identifying labels from National Instruments. These labels are recorded and thus traceable within the CIET Information Repository.



Because the control system is comprised of many smaller components, these components' product number, serial number, name, or other identifying information are included in design documents such as purchase orders and receipts. This allows labels already on these components to be used in place of unique identifiers that would have to be generated, recorded, and physically marked.

*If the item under design has a limited calendar or operating life or cycles, identify control to preclude the use of the item whose shelf or operating life has expired. Add the appropriate item disposition instructions to the CIET Calendar.*

The CIET control system does not have a specified limited operating life or operating cycle limit.

*When this Design Procedure includes one or more interfaces with another organization, use the External Organization Interface Procedure to establish and record assignment of responsibility and respective procedures for review, approval, release, distribution, and revision of documents involving design interfaces. Identify the status of the design information or document provided, and identify incomplete items that require further evaluation, review, and/or approval.*

Although this design is heavily influenced by National Instruments and relies in large part on their hardware, an External Organization Interface Procedure is not needed as the CIET Research Program is essentially their customer rather than their partner in the design of this control system. National Instruments is not responsible for the design of the control system; instead, they are responsible for providing a system that meets the requirements of the CIET control system. National Instruments have been helpful in suggesting hardware and confirming integration of the requested items, but they do not have the final design responsibility that the CIET Research Program maintains.

This is often the case for the CIET Research Program. It is rare that the CIET Research Program will collaborate on a design with an external organization. Therefore, this instruction and the use of the External Organization Interface Procedure are rarely used.

*If required, include specifications for handling, storage, cleaning, packaging, shipping, and preservation of items.*

No specifications are included here; handling, storage, packaging, and shipping are all responsibilities of National Instruments when they send the purchased system to the CIET Research Program. Once the system was in possession of the CIET Research Program, it was installed and integrated into the CIET Facility negating the need for storage requirements here. Cleaning and preservation fall under normal laboratory cleanliness and tidiness expectations.

Similar to the previous instruction for external organization interfaces, the description here is very common within the CIET Research Program and it is rare for additional steps to be taken.

*Specify, provide, and verify the existence of special equipment (such as containers, shock absorbers, and accelerometers) and special protective environments (such as inert gas atmosphere, specific moisture content levels, and temperature levels).*

Not applicable.

*Specify special handling tools and equipment to be utilized, controlled, inspected, and tested (prior to use). When special handling tools/equipment are used, provide that operators are trained appropriately.*

Not applicable.

*Include indications of handling, storage, and shipping requirements on item markings, particularly special protective environment or controls.*

Not applicable; this is the responsibility of National Instruments.

### 5.2.2 Verifier Instructions

The instructions for the Verifier were essentially performed naturally during the installation and operation of the control system hardware from National Instruments. Discussion for each instruction/question will effectively be reflections on work already performed. In the correct use of these instructions, the Verifier would more simply review the Designer's work in performing the instructions in the previous section.

*Review the Designer's work to this point, paying particular attention to design inputs; quality standards; design methods, parts, equipment, and processes; calculations (perform alternate calculations as needed); and evaluation of change effects on overall design in all configurations. The extent of the design verification is a function of the importance to safety, the complexity of the design, the degree of standardization, the state of the art, and the similarity with previously proved designs. Address the following requirements where applicable:*

*Were the design inputs correctly selected?*

Yes; the design inputs were comprehensive for the needs of the control system hardware.

*Are assumptions necessary to perform the design activity adequately described and reasonable? Where necessary, are the assumptions identified for subsequent reverifications when the detailed design activities are completed?*

Yes, assumptions were adequately described and reasonable given the experience with National Instruments within the CIET Research Program and others at UC Berkeley. No assumptions require reverification.

Assumption 2 ("The PXIe system will integrate with the existing instrumentation and control hardware correctly") was particularly problematic when installing the control system hardware. The control system is fully functional now and interfaces well with all peripheral components, but the VFDs and heater (digital communications) were challenging to implement. Significant additional research and troubleshooting was undertaken to understand all communication

requirements and their corresponding configurations in the VFDs and PXIe system, and to identify the correct hardware needed to connect the PXIe to the VFDs. Once analog communication with the power supplies was identified as a control priority, significant effort in understanding and implementing analog control was required as well. Two custom cables had to be created to connect the analog input and output cards in the PXIe system with the power supplies. Fortunately, there were excellent resources at UC Berkeley to help guide these efforts.

*Were appropriate design methods and computer programs used?*

Not applicable.

*Were the design inputs correctly incorporated into the design?*

Yes; the control system functions as desired.

*Is the design output reasonable compared to design inputs?*

Yes; the control system functions as desired.

*Are the necessary design inputs for interfacing organizations specified in the design documents or in supporting procedures or instructions?*

Not applicable.

*Have suitable materials, parts, processes, and inspection and testing criteria been specified?*

Not applicable.

### 5.3 Software Design Procedure for Control System

The software design of the CIET control system includes the software used to integrate and operate all control system hardware as well as the actual control programs designed using this software. The primary software used here is National Instruments' LabVIEW. The Software Design Procedure includes instructions and supporting information to fully satisfy the quality assurance requirements committed to within the CIET Quality Assurance Plan. These instructions and supporting information are also specifically designed to support the design of software items for the CIET Research Program and are meant to capture good scientific practices to support research. This completed procedure is then stored as a record within the CIET quality assurance program to provide a record of work performed for any future reference that may be helpful, such as instructing future CIET personnel or investigating the root cause of future issues resulting from current design decisions.

Similar to the Design Procedure, the Software Design Procedure is meant to be used for all original software designs related to the CIET Research Program. The steps in the procedure are meant to be completed to a degree commensurate with the importance, complexity, or importance to safety of the software item or product being designed. The extent of verification

and the methods chosen when using the Software Design Procedure are also a function of the software item's complexity, degree of standardization, importance to safety, and its similarity with previously proven items.

The major steps from the Software Design Procedure are reproduced in this section using italics. Discussion for each step includes how and why each step is satisfied using the design of the CIET control system. The Software Design Procedure begins with instructions for the Designer, and when they have finished their sections, a Verifier reviews the information provided and performs specific verification checks. The two sections below reflect this separation of work. As the CIET control system was designed, developed, tested, and implemented before these instructions were developed, the answers here are in retrospect and will be answered considering the work that has been done. This dissertation completes both the Designer and Verifier instructions and includes reflection on the use of these instructions.

### 5.3.1 Designer Instructions

*Cite all supporting references and other applicable background data including the relevant information from the literature/background data. Include a summary of each reference and describe the relevance of the reference to the item (i.e. create an annotated bibliography).*

1. D. M. Auslander, A.-C. Huang, and M. Lemkin, "A design and implementation methodology for real time control of mechanical systems," *Mechatronics*, vol. 5, no. 7, pp. 811-32, Oct. 1995.

Very helpful and thorough article on control system design for real time mechatronic systems. This article covers the differences between engineering design and computational technology when organizing the architecture of a control system and presents an effective task/state design methodology for the engineering design of a control system. Tasks and states as well as processes and threads are well-defined and -described. This article also introduces state transition logic for use in this context. This article addresses additional helpful areas such as multitasking performance and communication structures.

2. D. M. Auslander, J. R. Ridgely and J. D. Ringgenberg, *Control Software for Mechanical Systems: Object-Oriented Design in a Real-Time World*. 1<sup>st</sup> ed., Upper Saddle River, NJ: Prentice Hall, 2002.

Systematic treatment of the task/state design methodology of control systems for real time mechatronic systems. Includes many helpful examples as well as examples in code. Significant expansion on Reference 1.

3. R. Upadhy and J. C. Kendrick, "Instrumentation and controls development for the compact integral effects test facility," UCBTH-15-006, Nuclear Engineering Thermal Hydraulics Laboratory, Berkeley, CA, Sept. 12, 2015.

This report provides significant detail for the original design and implementation of the

control system used in the CIET Facility. The current control system designed here is a complete re-design from this original design, although much of the design theory and lessons learned in the original design is kept intact in the new design. This re-design includes significant new control hardware although the instrumentation remains identical which greatly affects the software design and overall control system architecture.

More generally, National Instruments has many resources on their website, such as a wealth of articles in their NI KnowledgeBase and in their user forums, that have proven invaluable in the development of the CIET control system. LabVIEW can be a challenging programming language without significant experience so leveraging these resources was very helpful.

Similar to the discussion of this instruction in the Design Procedure, the lack of references here is not ideal. In the ideal case, the annotated bibliography above would be greatly expanded as references are identified, recorded, and notes are taken during the initial research for the item and as the item's design and definitions are fleshed out in the following instructions.

*List any appropriate design standards used for this item. ASME NQA-1 is implicitly included as this design is performed within the CIET Research Program.*

No other standards were used in the design and implementation of the CIET control system.

*List and define all design requirements for this software, including but limited not to the operating system, the functions of the software, the interfaces of the software, performance requirements, installation considerations, design inputs, and design constraints.*

Operating System: The operating system must be able to run LabVIEW and all necessary modules (LabVIEW Real-Time Module and NI LabVIEW Model Interface Toolkit). The operating system on the personal computer and the operating system on the PXIe system should interface with each other seamlessly.

LabVIEW runs well on the Microsoft Windows operating system, which is the operating system of choice in the CIET Research Program (at least at the present time). The PXIe system also has an internal operating system, the LabVIEW Real-Time operating system, which runs LabVIEW and interfaces with the personal computer. Both operating systems should continue to allow additional LabVIEW modules and toolkits to be installed as well as other third-party software that is specifically designed for LabVIEW because the general expectation is that LabVIEW is running on a Microsoft operating system.

Software Functions: The control system software should integrate with all hardware associated with the CIET control system and allow the operator to use the control system and thus CIET Facility as desired. The software should be flexible enough to allow for a wide range of functionality including but not limited to a variety of feedback control methods and a variety of user interface designs, such as distributed control across multiple computers.

The CIET control system does allow for the software functions defined above. All hardware associated with the CIET Facility interfaces well with the control system thanks to the hardware

and software having a common developer in National Instruments. At this point, with a little effort, the control system has been able to perform all desired objectives within the CIET Research Program including feedback control for multiple components and distributed control across three user interface stations within the ARCO Facility.

Software Interfaces: LabVIEW is primarily a self-contained software tool, including a user interface. There is possibility for the need for software interface with MATLAB as it is a common engineering tool in the TH Laboratory.

This has been the experience of the CIET Research Program up to this point. An additional software interface that has been necessary is the ability to use OPC-UA communication methods between computers for which LabVIEW includes additional tools to make this possible.

Performance Requirements: The major performance requirement is that the operation of the control system be real-time which in the CIET Facility's case translates to the ability to send control signals and receive data and control signals at least every 0.1 seconds (10 Hz). The operation of the heater is also expected to need higher frequency control, most likely every 0.01 seconds (100 Hz). Higher frequency of the heater will allow the behavior of the heater in the system to more closely approximate the behavior of a nuclear reactor core, specifically the fuel elements within the core for which it is possible to experience extremely rapid temperature and power transients.

The CIET control system meets these timing requirements for the control of the data acquisition function (data is collected at 10 Hz) and the update of the user interface. The control of the VFDs and the power supplies are close to 2 Hz given the slow nature of digital communication using the MODBUS protocol. In general, this slower control is adequate in most experiments. However, better heater control is needed for frequency response testing which is a newer research method used in the CIET Facility. This newer demand spurred the investigation and implementation of analog control for the power supplies which does meet the requirement of 100 Hz control. Given the limitations of heat transfer mechanism kinetics, this frequency of operation should also allow the heater to closely approximate the range of transient behaviors of a nuclear reactor core.

Installation Considerations: Based on operating system compatibility and prior experience, the installation process for LabVIEW and its associated software is straightforward given enough time and patience. There is no further concern for this design requirement.

This has indeed been the continued experience in the CIET Research Program. There is some challenge in installing updates to the LabVIEW software, both on the personal computer and the PXIe system, but again, given sufficient time and patience there is no additional design requirement based on software installation. It is best practice to keep all software up to date using the latest versions from National Instruments when possible. Keeping software up to date is often tricky with LabVIEW because of the many, many software items that are installed and that have their own versions and updates. It is best practice to make a copy of the existing, functioning software before updating anything, allowing the user to revert back to this operational state if newer versions of software prove to be incompatible. If necessary, new

versions of software can be installed one by one to help identify incompatible software versions. Although this may sometimes be necessary and is often frustrating, it is still important to take advantage of the latest stable and compatible software provided by National Instruments to capitalize on their latest developments and to ensure the control system software in use is actively supported and not obsolete.

Design Inputs: Important inputs for the software are control and data signals from the interfacing hardware as well as control signals from the operator.

These are the design inputs for the CIET control system and they have remained stable. Other inputs include input signals from interfacing software such as MATLAB. Otherwise, LabVIEW is a very comprehensive and self-sufficient software that takes these inputs very well.

Design Constraints: Primary design constraints are inherent to the LabVIEW programming environment due to the unique language and the functions and tools available for the developer. The hardware components also present constraints to the developer in their maximum signal counts, maximal signal rates, and signal resolutions.

Although these are not clearly defined constraints, these are the primary design constraints. The control system has been developed to have all functionality desired within the constraints of the hardware and the software available. There are no constraints that would clearly be solved using an alternative development tool/language.

*List and define assumptions needed for design and whether these assumptions will need to be verified as part of the design process.*

There are no explicitly defined assumptions in the design of the software for the CIET control system, other than that it will work as desired (a bold assumption). This is based on the purpose, design, and experience of the National Instruments hardware and software. This assumption is verified as the software is designed and implemented. Where this assumption is broken, additional software and hardware will be identified and implemented. This assumption will naturally be verified as the design of the software proceeds.

*After this step, the Verifier is instructed to review all “pre-design” instructions so that the actual software design process may proceed as smoothly as possible. Once the Verifier finishes their review, the Designer continues with the following instructions.*

*List all design objectives and the associated analyses to show these objectives are met satisfactorily. Analysis should be written clearly and in such a way as to allow an outside person who has not been involved in the design, but is suitably educated, to read, understand, and confirm the suitability and accuracy of these analyses and their conclusions.*

These design objectives and the associated analyses, performed through testing, are discussed thoroughly in Section 4.2 in the previous chapter. This discussion should be included in the Software Design Procedure – ideally included and refined as the software is developed and tested, not afterward.

*List and define the necessary computational sequences to meet the software requirements and objectives defined above. As applicable, include numerical methods, mathematical models, physical models, control flow, control logic, data flow, process flow, data structures, process structures, and the applicable relationships between data structures and process structures. Identify computational sequences critical to the software's operation (e.g. control algorithms, filter algorithms, sensor linearization, etc.).*

The computational sequences necessary to meet the software requirements and objectives defined above are also discussed thoroughly in Section 4.2 in the previous chapter. This discussion should be included in the Software Design Procedure – ideally included and refined as the software is developed and tested, not afterward.

*Identify critical computer calculations from complex computational tools (e.g. MCNP, Serpent, SAM, RELAP5-3D, OpenFOAM, etc.; do not include Excel, Mathematica, MATLAB, etc.). As applicable, include identification of the computer type, computer program name and revision, inputs, outputs, evidence of or reference to computer program verification, and the bases (of reference thereto) supporting application of the computer program to the specific physical problem.*

There are no critical computer calculations from complex computational tools used in the development of this software.

### 5.3.2 Verifier Instructions

The instructions for the Verifier were essentially performed naturally during the design, testing, and operation of the control system software. Discussion for each instruction/question will effectively be reflections on work already performed. In the correct use of these instructions, the Verifier would more simply review the Designer's work in performing the instructions in the previous section.

*Were the design inputs correctly selected?*

Yes; important inputs for the software were control and data signals from the interfacing hardware as well as control signals from the operator.

*Are assumptions necessary to perform the design activity adequately described and reasonable? Where necessary, are the assumptions identified for subsequent reverifications when the detailed design activities are completed?*

No assumptions were taken other than the LabVIEW software in combination with the existing hardware, including the National Instruments hardware selected, will work as desired. This has indeed been the case so far, although this is true until it isn't – it is impossible to verify that this assumption is completely true until the lifetime and purpose of the CIET control system is complete. Although this is a large assumption that is hard to verify, it is appropriate given the



reputation of National Instruments and the extensive experience with their software and hardware both within the CIET Research Program and UC Berkeley.

*Were appropriate design methods and computer programs used?*

Yes; the design methods were selected specifically for this type of application and software, and the computer programs used, particularly LabVIEW, is specifically designed for this type of application and hardware.

*Were the design inputs correctly incorporated into the design?*

Yes; all design inputs were correctly incorporated into the design as all important inputs for the software, namely control and data signals from the interfacing hardware as well as control signals from the operator, were included.

*Is the design output reasonable compared to design inputs?*

Yes; the control system controls the CIET Facility as desired by the operator.

*Are the necessary design inputs for interfacing organization specified in the design documents or in supporting procedures or instructions?*

There were no interfacing organizations in the design of the software for the CIET control system.

*Have suitable materials, parts, processes, and inspection and testing criteria been specified?*

Unfortunately, no specific inspection and testing criteria were specified during the design and implementation of the control system software beyond testing the ability of the control system to meet operator instructions. This is a weakness in the software development experience in the TH Laboratory and which the Software Design Procedure aims to address.

#### 5.4 Application in Integral Effects Tests

The control system is a central component of the CIET Facility, if not the central component itself (after the physical facility, of course) – the control system connects the operator to the facility allowing them to perform actuations as they desire while collecting important data and feedback from the facility. No matter how the CIET Facility changes or how the ARCO Facility advances, the control system is the bridge between the two allowing research and development to be performed in a productive manner.

As the control system is refined and developed, especially as more functionality and control methods are added, the CIET Facility will be able to simulate the operations and performance of an FHR. The CIET Research Program expects its ability to control the CIET Facility to become more and more prototypical as research progresses. For example, as control of the heater is further developed, reactor feedback models using system temperatures as feedback inputs are

expected to be integrated into the control system. As these reactor feedback control methods mature, the behavior of the CIET Facility's heater will more and more simulate the behavior of a nuclear reactor core. Because the behavior of the "core" is entirely dictated by the control methods used, the behavior of the heater should be able to simulate a range of core designs for a range of nuclear reactors. The same control strategies are expected to be developed for the primary heat exchanger (i.e. the CTAH) as well, so that it operates in a manner that simulates the demands of the balance-of-plant in a nuclear power plant. Again, because this simulation is entirely dictated by the control methods (within the physics of the heat exchanger itself), a range of balance-of-plants should be able to be simulated in the CIET Facility. These additions to the control system should steadily transform the CIET Facility from a thermal hydraulics IET into an advanced reactor test bed which will be a powerful research tool. Further additions and modifications yet to be posited should only continue this trend, making facilities like the CIET Facility into invaluable research tools that, thanks to beneficial scaling relationships when using simulant fluids such as Dowtherm A, are accessible to university research programs in addition to national laboratories and industry. The heart of this advancement, the control system, because of its flexible, modular, and extensible design, can be applied to other integral effects tests (IETs) and similar facilities where there are purpose and function overlaps. This has been a primary goal of this research.

Quality assurance is an important tool in this research, as is shown in this chapter. CIET's quality assurance program provides a depth of provenance and an elevated level of commitment to scientific integrity to all research under its purview, including the control system design and implementation. Quality assurance methods help to provide reproducibility in design, ensuring that this system is flexible, modular, and extensible not only in its design but in practice, especially when applied to facilities beyond the CIET Facility. Through the quality assurance program, the control system research also is placed in the context of mature research and development efforts found in national laboratories and industry where quality assurance is not optional but embraced. The CIET Research Program understands that the development of the control system is one of progressive iteration with new work building on previous foundations. The work here is envisioned as a strong beginning for the eventual design and deployment of a mature nuclear power plant control system or component therein. With this development trajectory in mind, the use of a quality assurance program compliant to industry standards greatly increases the utility of this research and shows the CIET Research Program's commitment to contributing to these efforts.

This progress is not possible without the IET program as a development framework, effectively expanding the utility of IETs as a research and development tool. The use of simulant fluids and an emphasis on scaling relationships has lowered the costs of IETs while at the same time expanding their applications space. The control system research here, under the CIET quality assurance program, is a product of this advancement. It is exciting to imagine further outgrowths from IET research and development and how these may not only expand advanced nuclear power research and development but expand advanced nuclear power research and development within the university research domain effectively democratizing this research by lowering its risks and costs.

## 5.5 Future Work

The research described in this chapter, although a helpful case study in the application of the quality assurance program to the CIET control system, is still preliminary. Significant effort should be invested in the quality assurance tools used for software development as this research continues and matures.

Near-term future work includes finalizing the Design Procedure and Software Design Procedure and putting them to practice in the TH Laboratory to gain practical experience. This hands-on experience can then begin to be incorporated into the design and use of these procedures. Additionally, this work includes many documents and records not directly captured in the Design and Software Design Procedures that must be integrated into the quality assurance program correctly. How this will be done, in a way that is effective, transparent, and highly usable, needs considerable further thought. In general, as the control system and software development more broadly remain research priorities within the CIET Research Program, best practices from the control theory, mechatronics, and software development fields should be incorporated into this ongoing research as much as reasonable.

These have been exciting developments for the CIET Research Program and the TH Laboratory and much excellent future work is expected in this area.

## 6 Summary and Final Words

At the conclusion of this research, it is important to reflect upon the research accomplishments, the promising research only begun, and future research opportunities identified. This chapter summarizes the primary research efforts within this dissertation and describes future work that may be important to pursue.

Summaries in the sections of this chapter are meant to take the major conclusions and insights from this dissertation and present them concisely in order to reinforce them for the reader and to encourage continued research, study, and development of this research. These are fundamental ideas related to the quality of research and the experience of researchers, particularly students with long careers in front of them, and thus should be considered carefully. The work presented in this dissertation is the beginning of a longer conversation – a modest beginning at that – with rich and rewarding research and development yet to pursue.

This chapter concludes with a reflection on this research in the context of integral effects tests introduced in Chapter 1. Integral effects tests have been critical research and development tools in the nuclear engineering field and this research builds upon their legacy to continue integral effects test development and expand their use, both an expansion of the research questions they address and a broadening of the research settings where they may be appropriate tools.

### 6.1 Quality Assurance and Reproducibility in Research

Chapter 2 and Chapter 3 in this dissertation focus on quality assurance with an emphasis on its use in the university research setting and its impact on reproducibility in university research. Chapter 2 provides literature review on reproducibility in research, context for quality assurance through regulations, a description of the ASME NQA-1 quality assurance standard used in the nuclear industry in the U.S., how quality assurance has been used in research, and the observed and potential impacts of quality assurance through the concept of community. The goal of this chapter is to provide the motivation, context, and support to develop a quality assurance program useful for nuclear engineering research laboratories and programs, which Chapter 3 pursues. This section summarizes the important conclusions from Chapter 2 (and some of Chapter 3) while the following section does the same for Chapter 3.

Reproducibility is defined here as the ability to confirm that a single study's methodology and analyses are correctly performed which is a fundamental requirement for scientific study. Quality assurance practices seek to identify and provide sufficient detail of the minimum set of conditions necessary to provide confidence that a goal will be achieved, which is often the repetition of actions and thus reproducibility. It is important to note that high quality in research, provided by formal quality assurance processes, does not necessarily ensure reproducibility and vice versa.

From a review of the open literature on quality assurance programs and practices applied to research programs and laboratories, several common elements are identified and distilled and are summarized in Table 6.1.

Table 6.1. Essential elements and their descriptions for quality assurance programs designed for and implemented in research and development environments (reproduction of Table 2.2).

Element	Description
Personnel Commitment	Successful quality assurance programs depend on voluntary support and commitment from researchers that comes from understanding the need for and benefit from quality assurance practices in their research. All personnel within the research structure, including management, must have clear commitment to the quality assurance program – clear definitions of roles and responsibilities are necessary.
Modular Elements	A good quality assurance program should be flexible, modular, and non-redundant so that researchers choose and implement the parts that make sense and are beneficial. Document creation must directly involve relevant personnel, build upon good practices (and formalized instructions) that already exist, and should be careful not to unnecessarily expand the scope of the quality program.
Review	Review is a critical part of a quality assurance program, ensuring important planning is properly reviewed before being implemented. Further, structured review of results is critical as deviations and anomalies are expected in research and thorough review allows for discovery, corrective action as necessary, and progressive learning.
Knowledge Maintenance and Transfer	The quality program must include a permanent information/knowledge repository that is actively maintained and used in combination with a rigorous, quality-focused training program to continuously train new personnel, particularly students. This may be the most important element of the quality assurance program in a university research and development environment.
Communication	Consistent and clear communication is fundamental for collaboration within a research laboratory and for sharing knowledge with those outside of the laboratory. There must be clear structures within the research organization, both horizontal and vertical, to facilitate consistent communication including review of research (e.g. internal audits). There must also be clear means for sharing knowledge with the larger research community, which are generally carefully selected journal publications and conferences. Knowledge sharing should be in both directions, to and from the research laboratory.

In reviewing the essential elements from the nuclear power industry’s standard quality assurance requirements found in the ASME NQA-1 standard, there are several elements that are good practices in academic research particularly as they address challenges of reproducibility. All of the essential elements extracted from the NQA-1 standard are reflected in the best practices distilled from other disciplines, as shown in Table 6.2.

Table 6.2. Comparison of the essential quality assurance elements distilled from reviewing best practices in other research and development (R&D) environments and from the NQA-1 standard (reproduction of Table 3.1).

R&D Elements (Table 2.2)	NQA-1 Elements (Section 2.1.3)
Personnel Commitment	Clear responsibility of all personnel for quality-related activities
Modular Elements	Application of the graded approach
Review	Need for independent review and approvals; corrective action
Knowledge Maintenance and Transfer	Thorough and transparent documentation and record keeping; thorough understanding of the as-built configuration of the system, including on-going inspections to ensure continued performance
Communication	The need for independent review and approvals; thorough understanding of the as-built configuration of the system, including on-going inspections to ensure continued performance

The choice of the NQA-1 standard to use for the CIET Research Program is appropriate and advantageous compared to other standards because of the nature of research within the CIET Research Program and the desire for the standard used to fit the function of the organization and project. Even though the goals of the CIET Research Program are very different from those of a nuclear power plant, the essential elements of the quality assurance standard used in nuclear power plants aligns well with best practices from other research and development programs that have successfully implemented quality assurance programs. The NQA-1 standard applies to the CIET Research Program and supports its goals well including reproducibility of its research.

Chapter 2 also includes brief discussion on the social benefits from quality assurance practices integrated into research environments. Research organizations such as university research laboratories are fundamentally communities of people with similar interests and goals and quality assurance provides a helpful structure for strengthening and spreading this community. The social benefits that quality assurance practices bring, although intangible and difficult to quantify and attribute, can improve the quality of research substantially through improving reproducibility and instilling the pursuit of excellence in all community members. These benefits can also shift costs of reproducible research to the researchers themselves as they take on the organization and structure of a quality assurance program, thus answering a fundamental challenge identified by Freedman et al. [26].

## 6.2 The University Nuclear Quality Assurance Program

The purpose of the work described in Chapter 3 of this dissertation is to produce a Quality Assurance Plan and all necessary implementation documents, proven through consistent implementation, that satisfy the applicable requirements of Part I and Part II of ASME NQA-1-2008 with the NQA-1a-2009 Addenda in a graded approach tailored for research and development in the Thermal Hydraulics Laboratory at UCB. Further, a primary goal for this quality assurance program and implementation documentation is that it is applicable to a general set of university nuclear engineering laboratories. Applicability will ideally be captured in a template series for the Quality Assurance Plan and all necessary implementation documents. This template series will simply be called the University Nuclear Quality Assurance Program, or the UNQA Program. This work therefore has the potential to help extend good quality assurance practices to more fundamental and applied nuclear engineering research at university laboratories in the U.S. and aid in educating and training students that work in these laboratories. Quality assurance education and training will better prepare students to go on to work in the commercial nuclear power industry in the U.S. and elsewhere, potentially improving work there as well.

The primary document in the new quality assurance program is the Quality Assurance Plan. This document is the top-level document that describes the quality assurance policy, applicable quality assurance requirements, assigns major functional responsibilities for CIET Research Program work activities conducted by or for the CIET Research Program, and describes the application of the graded approach for quality assurance requirements and implementing procedures. Describing the application of the graded approach is an important function of the Quality Assurance Plan, and dedicated sections are included in each major piece of the plan, where relevant. The Quality Assurance Plan also includes the scope and applicability of the quality assurance program; the source requirements used for the Quality Assurance Plan, including regulatory documentation, consensus standards, and guides; and the quality program requirements satisfied by the quality assurance program. The Quality Assurance Plan most essentially defines the “what” of the quality assurance program while the implementation documents define the “who”, “how”, “when”, and “where”.

There are fourteen implementation documents in the new quality assurance program. There are two optional implementation documents that have been helpful in the initial design and implementation phase that will continue to be helpful through the lifetime of the program. All sixteen documents are listed below; all documents are described in more detail within the Quality Assurance Plan. Further, each document includes specific instructions within itself regarding when and how to use the document, and often includes information on why the document is designed and used.

1. Calendar Procedure (used to create the CIET Calendar)
2. Information Repository Procedure (used to create the CIET Information Repository)
3. External Organization Interface Procedure
4. Training Procedure
5. Design Procedure
6. Software Design Procedure
7. Purchased Items and Services Procedure
8. Special Process Control Procedure

9. Inspection Procedure
10. Test Procedure Template
11. Software Test Procedure Template
12. Measuring and Test Equipment Selection Procedure
13. Corrective Action Procedure (Corrective Action Log)
14. Audit Procedure
15. Requirements Mapping Table (Optional)
16. Quality Improvement Plan (Optional)

Currently, the quality assurance program for the CIET Research Program is still being drafted and finalized; the major elements are in place but there are several implementation documents that must be drafted, reviewed, approved, and implemented before all requirements in the ASME NQA-1-2008/1a-2009 standard are satisfied. Once the quality assurance program is complete and its design and implementation are formally audited, it will be ready to be transformed into a template series to create the UNQA Program. Additional documentation should also be created such as guidance on implementing the templates to create program-specific documents, best practices found from the CIET Research Program's use of its quality assurance program, and a formal structure for communication and collaboration for all research programs that choose to use the UNQA Program.

An important question asked in Chapter 2 was: is it possible to identify the minimum set of conditions necessary for reproducibility in nuclear engineering research? Although discussion in Chapter 2 and Chapter 3 did not clearly define an answer, in the context of the CIET Research Program, the answer lies in balancing the requirements of the NQA-1 standard with actual research needs through applying a graded approach. The NQA-1 standard's requirements cover the scope of the activities within the CIET Research Program and are rigorous through including all details needed for reproducibility in an industrial setting. In the nuclear energy field, given the reputation of the U.S. NRC, it can be assumed that reproducibility in industry should also be sufficient for reproducibility in research, at least considering the major elements included in the NQA-1 standard such as change management, procedure requirements, record keeping, etc. Given the scope and rigor of the NQA-1 standard, applying a graded approach should be able to confine the application of its requirements to the minimum set necessary for reproducibility. Applying a graded approach is imperfect because there is no well-defined method as no two organizations are the same. Instead, the graded approach used is defined by the research program invoking and implementing the requirements and thus requires honesty, transparency, and continuous review to strike the sufficient set of requirements needed for reproducibility. Therefore, this dissertation posits that there is no universal minimum set of conditions or requirements necessary for reproducibility, even restricted to the field of nuclear engineering research. Rather, this set of requirements is found through the judicious application of a graded approach to a quality assurance standard that is broad enough in scope and rigorous enough in its application to cover the minimal set of requirements for reproducibility in a wide range of quality assurance programs. In this case, the NQA-1 standard is the standard of choice for nuclear engineering research and the UNQA Program will tentatively be the best tool to use to jumpstart the graded approach needed to find the minimum set of requirements necessary for reproducibility within a university nuclear engineering research organization.



For broader adoption of the UNQA Program as well as consistent upkeep and long-term commitment, integrating the UNQA Program into the purview of the NQA-1 Standard Committee may be ideal, most likely in the form of including students as non-voting members and the creation of a Working Group focused on the UNQA Program. After a member of the CIET Research Program attended a committee meeting and talked with several members, it is clear that the NQA-1 Standard Committee sees the importance of quality assurance in universities. They certainly understand the importance of training students and young professionals in a way that clearly defines the importance of quality assurance in the nuclear industry, far better than the students of the CIET Research Program do. For quality assurance to be well-maintained and updated as a practice in industry, it is vital to train students and young professionals to use quality assurance as an important engineering tool that should be maintained and further developed to best serve the industry and its stakeholders. This requires consistent engagement and support over time, and there is no expectation to see the UNQA Program integrated into the NQA-1 standard in the near future, but it is nonetheless an important goal to strive for.

If this research is successful, sometime in the future, there may form a wider community of university nuclear engineering laboratories and research groups that have chosen to implement the UNQA Program and who are committed to quality assurance in their research. Creating a communitarian regulator, similar to INPO [56], could bring this community structure and direction; the function of identifying and codifying best practices as standards of excellence is especially compelling and would be a way to share and benefit from lessons learned within the community. Ideally this communitarian regulator would be integrated with the Working Group within the NQA-1 Standard Committee that officially oversees and maintains the UNQA Program. These two functions are mutually beneficial and there is no reason to separate these functions given limited resources.

In the near-term, there are changes that can be made to current practices within university research education that can support quality assurance acceptance, training, and integration in ways that meaningfully support reproducibility in science. Research institutions, particularly universities, are primary stakeholders in the research that they foster and must encourage and support best practices for reproducibility. University curricula for science and engineering disciplines for both undergraduate and graduate education should naturally include concepts that support reproducibility such as fundamentals of statistical analysis for data, fundamentals of experimental methodology, and fundamentals of technical communication and writing. In addition to including these concepts in lecture-based classes, laboratory or experimental classes should include these concepts as well to provide practical experience for students. Quality assurance practices, particularly in the laboratory setting, are a natural means of integrating these concepts into education, both theoretical and practical. Integrating quality assurance into education in these ways reflects modern industrial practice and connects university research to commercial use. This effectively emphasizes the importance of sound, reproducible science and research; prepares students for effective careers in industry or other research environments; and decreases the costs from irreproducible research, particularly for down-stream users of university research such as commercial companies and national research laboratories.

### 6.3 CIET Control System Development

The CIET control system is the operational foundation of the CIET Facility and allows operators to use the facility to perform a large variety of tests and to collect high-quality data. The CIET control system is comprised of many levels of abstraction that contain modular software that encapsulates the specific objects and functions within each level. The important variables, functions, and interfaces within each level are then shared with adjacent levels. The purpose of this architecture is to create a modular control system that is flexible for the end user, extensible for future development and expansion, and maintainable with the least effort (or cost) needed from students who are most likely not experts in the hardware and software used. This design also allows for these smaller modules of code to be developed, tested, and documented as part of the quality assurance program to ensure a high degree of quality throughout the control system. Figure 4.4 shows the high-level structure of the CIET control system, including levels of abstraction.

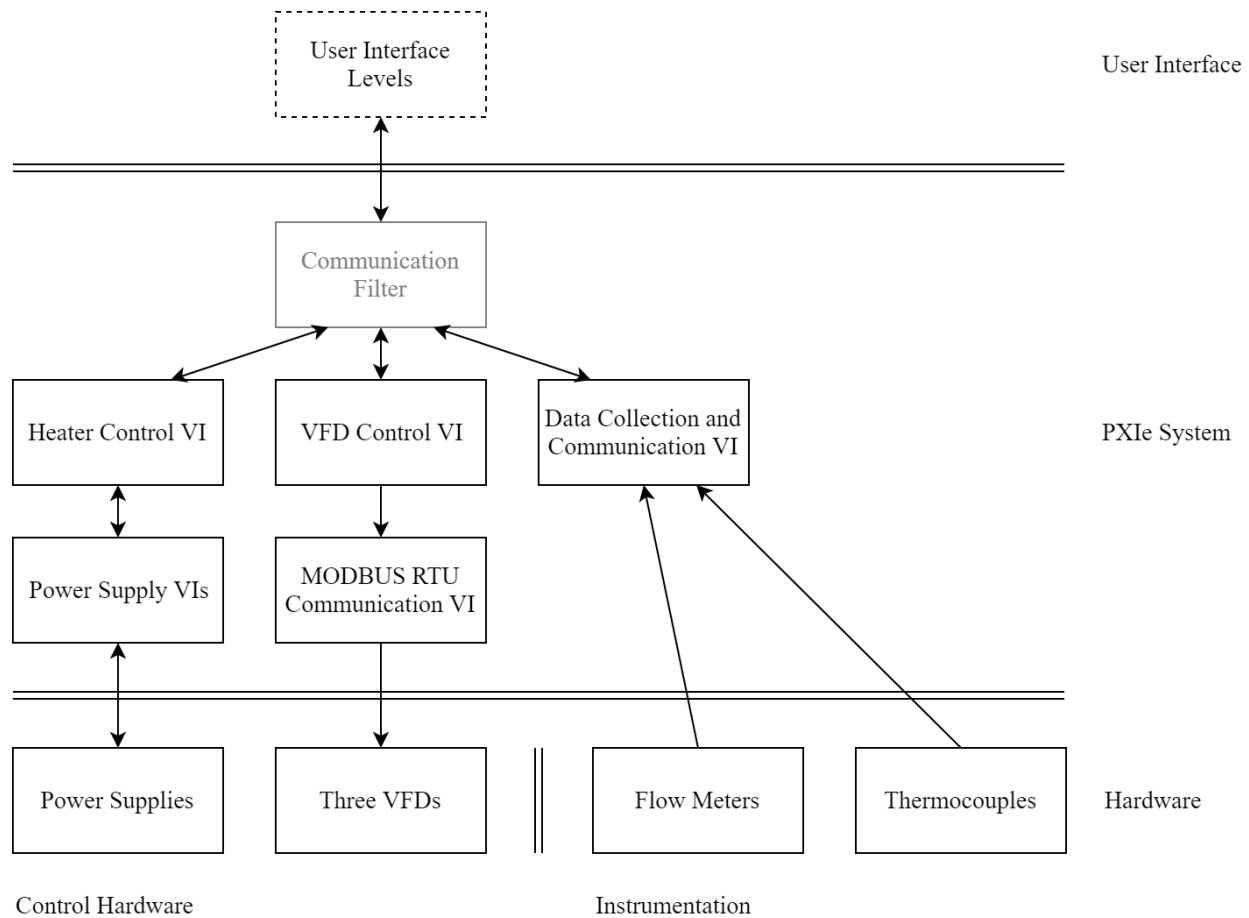

Figure 6.1. CIET control system high-level structure (reproduction of Figure 4.4).

Complementary to this structure, task and state organization, especially state transition diagrams, in combination with limited supporting documentation constitute complete engineering specification for the control of a system. Using task and state organization within the quality assurance program for the CIET Research Program ensures that good software design principles are used, thorough documentation is naturally generated, and all specifications needed for the

design and implementation of the control system are established. Further, state transition logic is itself not dependent on the specific software language or software tools being used. Therefore, the state transition logic and much of the system specifications may be applied to other similar systems with relative ease or the control system design may be re-written in a new software language or environment as the need arises (e.g. during significant hardware/software upgrades or if applied to industrial environments using industrial hardware and software).

In addition to organizing the CIET Facility's control system into tasks and states, the control system uses basic principles of object-oriented design. Object-oriented design is highly scalable and extensible, providing excellent maintainability of the software written using object-oriented programming. The attributes of encapsulation and abstraction are particularly important to create modular elements of the control system that are used in abstraction levels, allowing many developers to work together at once and to maintain and expand the portions of the system relevant to their work.

The major functions of the CIET control system are to collect and communicate data from instrumentation and system operation, control the heat input into the facility through the heater, control the fluid flow in the facility using the pump, control the heat extracted from the facility through two fan-cooled oil-to-air heat exchangers, and to allow an operator to control the facility in real time. These major functions are directly mapped to the major elements of the control system, referred to here as modules. Chapter 4 discusses in detail the functional design of each major control module and then shows and discusses how these designs are implemented in LabVIEW.

After significant use, the CIET control system has been found to be well-designed for its purpose within the CIET Research Program. As the control system is refined and developed, especially as more functionality and control methods are added, the CIET Facility will be able to simulate the operations and performance of an FHR. The CIET Research Program expects its ability to control the CIET Facility to become more and more prototypical as research progresses. For example, as control of the heater is further developed, reactor feedback models using system temperatures as feedback inputs are expected to be integrated into the control system. As these reactor feedback control methods mature, the behavior of the CIET Facility's heater will more and more simulate the behavior of a nuclear reactor core. Because the behavior of the "core" is dictated by the control methods used, the behavior of the heater should be able to simulate a range of core designs for a range of nuclear reactors. The same control strategies are expected to be developed for the primary heat exchanger (CTAH) as well, so that it operates in a manner that simulates the demands of the balance-of-plant in a nuclear power plant. Again, because this simulation is dictated by the control methods rather than the physics of the heat exchanger alone, a range of balance-of-plants should be able to be simulated in the CIET Facility. These additions to the control system should steadily transform the CIET Facility from a thermal hydraulics IET (integral effects test) into an advanced reactor test bed which will be a powerful research tool. Further additions and modifications yet to be posited should only continue this trend, making facilities like the CIET Facility into invaluable research tools that, thanks to beneficial scaling relationships using simulant fluids such as Dowtherm A, are accessible to university research programs in addition to national laboratories and industry. The heart of this advancement, the control system, because of its flexible, modular, and extensible design, can be applied to other

IETs and similar facilities where there are purpose and function overlaps. This has been a primary goal of this research.

Quality assurance is an important tool in this research. CIET's quality assurance program provides a depth of provenance and an elevated level of commitment to scientific integrity to all research under its purview, including the control system design and implementation. Quality assurance methods help to provide reproducibility in design, ensuring that this system is flexible, modular, and extensible not only in its design but in practice, especially when applied to facilities beyond the CIET Facility. Through the quality assurance program, the control system research also is placed in the context of mature research and development efforts found in national laboratories and industry where quality assurance is not optional but embraced. The CIET Research Program understands that the development of the control system is one of progressive iteration with new work building on previous foundations. The work here is envisioned as a strong beginning for the eventual design and deployment of a mature nuclear power plant control system or component therein. With this development trajectory in mind, the use of a quality assurance program compliant to industry standards greatly increases the utility of this research and shows the CIET Research Program's commitment to contributing to these efforts.

#### 6.4 Integral Effects Test Expansion

The research progress in this dissertation is built upon the important foundation of IETs in developing and understanding nuclear reactors, as described in Chapter 1. The use of simulant fluids and an emphasis on scaling relationships has lowered the costs and risks of IETs while at the same time expanding their application space. A primary conclusion from this research is that IETs have the potential to open myriad research avenues in universities and the present work only serves to open this discussion, beginning with control system architecture design as a case study. Furthermore, as regulations for advanced reactors take shape, this research may enable universities to have an important voice to address potential risks in the licensing process as well as to address the regulation of these risks. This is not unlike the improvements to computational power and capabilities that have brought resources and tools that were once only available to governments and large companies with significant resources to small research laboratories and university students [85]. Democratization of resources, tools, capabilities, and communication avenues have led to innovation and proliferation of technologies and ideas that have reshaped human life.

As this research expands to universities and as more and more private companies begin to focus on advanced nuclear reactor development and commercialization [86], an important question arises: what role do universities have in advanced nuclear reactor research and development? Traditionally, most nuclear reactor development has been performed by national research laboratories and large private or public companies with significant resources. Given the challenges faced by universities discussed in Chapter 3, university research programs operate under significantly constrained resources as compared to commercial entities, particularly constrained human resources due to the transient nature of students in universities. However, university research programs are typically not constrained in the research they choose to pursue and instead are encouraged to take on cutting edge research and to push forward the field's

understanding and capabilities. Given these unique constraints and liberties as well as the natural interest in progressing the state-of-the-art, university research may be best suited for concept development and testing, such as for novel computational methodologies, heat transfer mechanisms, and experimental techniques. NuScale Power is an example of a private company pursuing the development and commercialization of an advanced light-water reactor whose concept originated in university research [87]. As these roles and responsibilities take shape, an important unifying tool is quality assurance. If research from universities is to be used most effectively in commercial efforts, it must conform to commercial standards such as those for quality assurance. Quality assurance practices form a common expectation for research and development that will be particularly important as there are more and more entrants to the field, nuclear energy becomes more and more widespread, and more and more organizations of varied size and capability become involved.

It is exciting to imagine further outgrowths from IET research and development and how these may not only expand advanced nuclear power research and development but expand advanced nuclear power research and development within the university research domain, effectively democratizing this research by lowering its risks and costs.

## 7 References

- [1] C. W. Forsberg, P. F. Peterson and P. S. Pickard, "Molten-Salt-Cooled Advanced High-Temperature Reactor for Production of Hydrogen and Electricity," *Nuclear Technology*, vol. 144, (3), pp. 289-302, 2003. Available: <https://www.tandfonline.com/doi/abs/10.13182/NT03-1>.
- [2] G. Zheng *et al*, "Corrosion of 316 stainless steel in high temperature molten Li<sub>2</sub>BeF<sub>4</sub> (FLiBe) salt," *Journal of Nuclear Materials*, vol. 461, pp. 143-150, 2015. Available: <https://www.sciencedirect.com/science/article/pii/S0022311515001397>. DOI: 10.1016/j.jnucmat.2015.03.004.
- [3] C. W. Forsberg *et al*, "Tritium Control and Capture in Salt-Cooled Fission and Fusion Reactors: Status, Challenges, and Path Forward," *Nuclear Technology*, vol. 197, (2), pp. 119-139, 2017. Available: <http://www.tandfonline.com/doi/abs/10.13182/NT16-101>. DOI: 10.13182/NT16-101.
- [4] D. E. Shropshire and J. S. Herring, "Fuel-cycle and nuclear material disposition issues associated with high-temperature gas reactors," in *Americas Nuclear Energy Symposium 2004 Proceedings*, Miami Beach, FL, October 03-06, 2004. Available: <https://www.osti.gov/servlets/purl/839371>.
- [5] C. Forsberg *et al*, "Fluoride-salt-cooled high-temperature reactor (FHR) for power and process heat: Final project report," Department of Energy, Nuclear Energy University Programs, Washington, D.C., December 2014.
- [6] C. Forsberg *et al*, "Fluoride-salt-cooled high-temperature reactor (FHR) commercial basis and commercialization strategy," Massachusetts Institute of Technology, Cambridge, MA, December 2014.
- [7] C. Andreades *et al*, "Technical description of the "mark 1" pebble-bed fluoride-salt-cooled high-temperature reactor (PB-FHR) power plant," University of California, Berkeley, Berkeley, CA, September 30, 2014. Available: <https://fhr.nuc.berkeley.edu/references/>.
- [8] C. Forsberg *et al*, "Fluoride-salt-cooled high-temperature test reactor (FHTR): Goals, options, ownership, requirements, design, licensing, and support facilities," Massachusetts Institute of Technology, Cambridge, MA, December 2014.
- [9] FHR IRP, "Fluoride-salt-cooled, high-temperature reactor (FHR) subsystems definition, functional requirement definition, and licensing basis event (LBE) identification white paper," University of California, Berkeley, Berkeley, CA, August 2013. Available: <https://fhr.nuc.berkeley.edu/references/>.

- [10] FHR IRP, "Fluoride-salt-cooled, high-temperature reactor (FHR) methods and experiments program white paper," University of California, Berkeley, Berkeley, CA, May 2013. Available: <https://fhr.nuc.berkeley.edu/references/>.
- [11] FHR IRP, "Fluoride-salt-cooled high temperature reactor (FHR) materials, fuels and components white paper," University of California, Berkeley, Berkeley, CA, July 2013. Available: <https://fhr.nuc.berkeley.edu/references/>.
- [12] FHR IRP, "Fluoride-salt-cooled, high-temperature reactor (FHR) development roadmap and test reactor performance requirements white paper," University of California, Berkeley, Berkeley, CA, June 2013. Available: <https://fhr.nuc.berkeley.edu/references/>.
- [13] C. Forsberg *et al*, "Integrated FHR technology development: Tritium management, materials, salt chemistry control, thermal hydraulics and neutronics, associated benchmarking and commercial basis," Department of Energy, Nuclear Energy University Programs, Washington, D.C., September 30, 2018.
- [14] F. Rahnema, "Integrated approach to fluoride high temperature reactor technology and licensing challenges (FHR-IRP)," Department of Energy, Nuclear Energy University Programs, Washington, D.C., 2019.
- [15] N. Zweibaum *et al*, "Design of the Compact Integral Effects Test Facility and Validation of Best-Estimate Models for Fluoride Salt-Cooled High-Temperature Reactors," *Nuclear Technology*, vol. 196, (3), pp. 641-660, 2016. Available: <http://www.tandfonline.com/doi/abs/10.13182/NT16-15>. DOI: 10.13182/NT16-15.
- [16] U.S. Nuclear Regulatory Commission, "Regulatory guide 1.203: Transient and accident analysis methods," U.S. Nuclear Regulatory Commission, Washington, D.C., December 2005.
- [17] N. Zuber *et al*, "An integrated structure and scaling methodology for severe accident technical issue resolution: Development of methodology," *Nuclear Engineering and Design*, vol. 186, (1), pp. 1-21, 1998. Available: <https://www.sciencedirect.com/science/article/pii/S0029549398002155>. DOI: 10.1016/S0029-5493(98)00215-5.
- [18] B. Boyack *et al*, "Quantifying reactor safety margins: Application of code scaling, applicability, and uncertainty evaluation methodology to a large-break, loss-of-coolant accident," U.S. Nuclear Regulatory Commission, Washington, D.C., December 1989.
- [19] K. Umminger *et al*, "Integral Test Facility PKL: Experimental PWR Accident Investigation," *Science and Technology of Nuclear Installations*, vol. 2012, 2012. Available: <https://www.hindawi.com/journals/stni/2012/891056/cta/>.
- [20] G. G. Loomis, "Summary of the Semiscale program, 1965-1986," U.S. Nuclear Regulatory Commission, Washington, D.C., July 1, 1987.

- [21] K. B. Welter *et al*, "APEX-AP1000 confirmatory testing to support AP1000 design certification (non-proprietary)," U.S. Nuclear Regulatory Commission, Washington, D.C., August 2005.
- [22] S. M. Modro *et al*, "Multi-applications small light water reactor," Idaho National Laboratory, Idaho Falls, ID, December 1, 2003.
- [23] M. Baker, "1,500 scientists lift the lid on reproducibility," *Nature*, vol. 533, (7604), pp. 452-454, 2016. Available: <https://www.nature.com/news/1-500-scientists-lift-the-lid-on-reproducibility-1.19970>. DOI: 10.1038/533452a.
- [24] W. Thomas, *Report puts scientific replicability and reproducibility under the microscope*. The National Academies Press, Washington, D.C., May 23, 2019. Available: [https://www.aip.org/fyi/2019/report-puts-scientific-replicability-and-reproducibility-under-microscope?utm\\_medium=email&utm\\_source=FYI&dm\\_i=1ZJN,6AS02,E29EQR,OVB,FM,0](https://www.aip.org/fyi/2019/report-puts-scientific-replicability-and-reproducibility-under-microscope?utm_medium=email&utm_source=FYI&dm_i=1ZJN,6AS02,E29EQR,OVB,FM,0).
- [25] Open Science Collaboration, "Estimating the reproducibility of psychological science," *Science*, vol. 349, (6251), 2015. DOI: 10.1126/science.aac4716.
- [26] L. P. Freedman, I. M. Cockburn and T. S. Simcoe, "The economics of reproducibility in preclinical research," *PLOS Biology*, vol. 13, (6), 2015. Available: <https://doi.org/10.1371/journal.pbio.1002165>.
- [27] F. S. Collins and L. A. Tabak, "Policy: NIH plans to enhance reproducibility," *Nature*, vol. 505, (7485), pp. 612-613, 2014. Available: <https://www.nature.com/news/policy-nih-plans-to-enhance-reproducibility-1.14586>. DOI: 10.1038/505612a.
- [28] Global Biological Standards Institute, "The case for standards in life science research," Global Biological Standards Institute, Washington, D.C., December 2013.
- [29] J. Petit, "The quality approach and fundamental research: working towards a constructive alliance (part I)," *Accreditation and Quality Assurance*, vol. 4, (7), pp. 274-279, 1999. Available: <https://link.springer.com/article/10.1007/s007690050368>.
- [30] U.S. Nuclear Regulatory Commission, *About NRC*, U.S. NRC, Washington, D.C., July 16, 2019. Available: <https://www.nrc.gov/about-nrc.html>.
- [31] U.S. Department of Energy, *A brief history of the department of energy*, U.S. DOE, Washington, D.C., July 30, 2019. Available: <https://www.energy.gov/management/office-management/operational-management/history/brief-history-department-energy>.



- [32] U.S. Federal Government, "Code of Federal Regulations Title 10 Part 50 Appendix B: Quality Assurance Criteria for Nuclear Power Plants and Fuel Reprocessing Plants (10 CFR 50 Appendix B)," Washington, D.C., January 1, 2011.
- [33] U.S. Nuclear Regulatory Commission, "Quality assurance program criteria (design and construction)", RG 1.28, Rev. 5, U.S. NRC, Washington, D.C., October 2017.
- [34] W. Altman, T. Ankrum, and W. Brach, "Improving Quality and the Assurance of Quality in the Design and Construction of Nuclear Power Plants: A Report to Congress," NUREG-1055, U.S. NRC, Washington, D.C., May 1984.
- [35] U.S. Federal Government, "Code of Federal Regulations Title 10 Part 830 Subpart A: Quality Assurance Requirements (10 CFR 830 Subpart A)," Washington, D.C., January 1, 2011.
- [36] U.S. Department of Energy, "U.S. Department of Energy Order 414.1D: Quality Assurance", U.S. DOE, Washington, D.C., April 25, 2011.
- [37] U.S. Department of Energy, "Department of Energy Guide 414.1-2B: Quality Assurance Program Guide," U.S. DOE, Washington, D.C., August 16, 2011.
- [38] U.S. Department of Energy Office of Environment, Health, Safety, and Security, "Quality Assurance," U.S. DOE, Washington, D.C., July 30, 2019. Available: <https://www.energy.gov/ehss/services/nuclear-safety/quality-assurance>.
- [39] Nuclear Energy University Program, "NEUP QA Requirements Worksheet," U.S. DOE, Washington, D.C., July 31, 2019.
- [40] U.S. Department of Energy, "Financial Assistance Funding Opportunity Announcement: Fiscal Year 2019 Consolidated Innovative Nuclear Research," DE-FOA-0001913, U.S. DOE, Washington, D.C., September 10, 2018.
- [41] Nuclear Energy University Program, "Principal Investigators: Quality Assurance Requirements," U.S. DOE, Washington, D.C., July 31, 2019. Available: <https://neup.inl.gov/SitePages/Quality%20Assurance%20Requirements.aspx>.
- [42] J. Couzin-Frankel, "Journals under the microscope," *Science*, vol. 361, (6408), pp. 1180-1183, 2018. Available: <https://science.sciencemag.org/content/361/6408/1180>. DOI: 10.1126/science.361.6408.1180.
- [43] American Society of Mechanical Engineers, *Quality Assurance Requirements for Nuclear Facility Applications*. (2008/2009a ed.) New York, NY: The American Society of Mechanical Engineers, August 31, 2009.

- [44] American Society of Mechanical Engineers, *Quality Assurance Requirements for Nuclear Facility Applications*. (2015 ed.) New York, NY: The American Society of Mechanical Engineers, February 20, 2015.
- [45] Standards Committee on Nuclear Quality Assurance, "Standards Committee on Nuclear Quality Assurance: Charter," 2016. Available: <https://cstools.asme.org/csconnect/CommitteePages.cfm?Committee=O10500000>.
- [46] W. D. Travers, "Approaches for adopting more widely accepted international quality standards," SECY-03-0117, U.S. NRC, Washington, D.C., July 9, 2003.
- [47] J. P. Jackson, "Nuclear power plant quality assurance and quality control," in *The Sixth Pacific Basin Nuclear Conference*, 1987, pp. 647-649.
- [48] B. A. Nosek *et al*, "Promoting an open research culture," *Science*, vol. 348, (6242), pp. 1422, 2015. Available: <http://science.sciencemag.org/content/348/6242/1422.abstract>. DOI: 10.1126/science.aab2374.
- [49] M. Baker, "How quality control could save your science," *Nature*, vol. 529, (7587), pp. 456-4588, 2016. Available: <https://search.proquest.com/docview/1761243068>. DOI: 10.1038/529456a.
- [50] M. M. Robins, S. J. Scarll and P. E. Key, "Quality assurance in research laboratories," *Accred Qual Assur*, vol. 11, (5), pp. 214-223, 2006. DOI: 10.1007/s00769-006-0129-5.
- [51] H. Grochau *et al*, "Implementation of a quality management system in university test laboratories: a brief review and new proposals," *Accreditation and Quality Assurance*, vol. 15, pp. 681-689, October 23, 2010.
- [52] P. Vermaercke, F. Verrezen and S. Boden, "Implementing quality assurance in an R&D environment at the Belgian Nuclear Research Center - SCK-CEN," *Accreditation and Quality Assurance*, vol. 5, (1), pp. 21-27, 2000. Available: <https://link.springer.com/article/10.1007/s007690050004>.
- [53] M. Krapp, "Quality assurance in research and development: an insoluble dilemma?" *Fresenius' Journal of Analytical Chemistry*, vol. 371, (6), pp. 704-713, 2001. Available: <https://link.springer.com/article/10.1007/s002160100986>.
- [54] J. Petit, "The quality approach and fundamental research: working towards a constructive alliance (part II)," *Accreditation and Quality Assurance*, vol. 4, (11), pp. 458-462, 1999. Available: <https://link.springer.com/article/10.1007/s007690050412>.
- [55] P. Selznick, *The Moral Commonwealth: Social Theory and the Promise of Community*. Berkeley, California: University of California Press, 1992.

- [56] J. V. Rees, *Hostages of each Other: The Transformation of Nuclear Safety since Three Mile Island*. (1st ed.) Chicago, IL: University of Chicago Press, 1996.
- [57] V. Barq, "What Happens During a Refueling Outage?" NEI Nuclear Notes, May 8, 2012. Available: <http://neinuclearnotes.blogspot.com/2012/05/what-happens-during-refueling-outage.html>
- [58] Interaction Design Foundation, *Usability*, August 5, 2019. Available: <https://www.interaction-design.org/literature/topics/usability>.
- [59] S. Sinek, *Start with Why: How Great Leaders Inspire Everyone to Take Action*. (Paperback reprint ed.) New York, NY: Penguin Group, 2011.
- [60] Procedure Professionals Association, *Procedure Writer's Manual*. (2nd ed.) Procedure Professionals Association, 2016.
- [61] Procedure Professionals Association, *Procedure Process Description*. (2nd ed.) Procedure Professionals Association, 2016.
- [62] Nuclear Energy Institute, *Nuclear Generation Quality Assurance Program Description*. (Draft Revision 0 ed.) Nuclear Energy Institute, 2011.
- [63] C. G. Begley, A. M. Buchan and U. Dirnagl, "Robust research: institutions must do their part for reproducibility," *Nature*, vol. 525, (7567), pp. 25-27, 2015. Available: <https://www.nature.com/news/robust-research-institutions-must-do-their-part-for-reproducibility-1.18259>. DOI: 10.1038/525025a.
- [64] J. Petit and A. Muret, "A specific standard for quality in fundamental research," *Accreditation and Quality Assurance*, vol. 5, (1), pp. 28-34, 2000. Available: <https://link.springer.com/article/10.1007/s007690050005>.
- [65] R. Upadhyaya, J. Kendrick, "Instrumentation and Controls Development for the Compact Integral Effects Test Facility," UCBTH-15-006, University of California, Berkeley, Berkeley, CA, September 12, 2015. Available: <https://fhr.nuc.berkeley.edu/references/>.
- [66] J. Anderson, "Multimodal Controller Status," e-mail correspondence on: March 25, 2019.
- [67] World Nuclear Association, *Fukushima Daiichi Accident*, October 2018. Available: <https://www.world-nuclear.org/information-library/safety-and-security/safety-of-plants/fukushima-accident.aspx>.
- [68] C. Poresky *et al*, "Advanced reactor control and operations (ARCO): A university research facility for developing optimized digital control rooms," in *11th ANS NPIC&HMIT*, Orlando, FL, 2019.

- [69] D. M. Auslander, A. Huang and M. Lemkin, "A design and implementation methodology for real time control of mechanical systems," *Mechatronics*, vol. 5, (7), pp. 811-832, 1995.
- [70] D. M. Auslander, J. R. Ridgely and J. D. Ringgenberg, *Control Software for Mechanical Systems: Object-Oriented Design in a Real-Time World*. (1st ed.) Upper Saddle River, NJ: Prentice Hall, 2002.
- [71] Petkov, *How to explain object-oriented programming concepts to a 6-year-old*, June 27, 2018. Available: <https://www.freecodecamp.org/news/object-oriented-programming-concepts-21bb035f7260/>.
- [72] National Instruments, *LabVIEW Object-Oriented Programming: The Decisions Behind the Design*, November 20, 2018. Available: <http://www.ni.com/product-documentation/3574/en/>.
- [73] C. Poresky, "Frequency response in the CIET facility," UCBTH-17-002, University of California, Berkeley, Berkeley, CA, May 2017. Available: <https://fhr.nuc.berkeley.edu/references/>.
- [74] WS Hampshire Inc., *Typical Properties of PTFE/Teflon*, August 8, 2019. Available: [http://catalog.wshampshire.com/Asset/psg\\_teflon\\_ptfe.pdf](http://catalog.wshampshire.com/Asset/psg_teflon_ptfe.pdf).
- [75] C. Poresky, "Model Network Methodology for Experimental Development of Industrial Monitoring Systems." Ph.D. dissertation, Nucl. Eng. Dept., University of California, Berkeley, Berkeley, CA, 2019.
- [76] National Instruments, *Benefits of Programming Graphically in NI LabVIEW*, May 24, 2019. Available: <https://www.ni.com/en-us/innovations/white-papers/13/benefits-of-programming-graphically-in-ni-labview.html>.
- [77] International Atomic Energy Agency, "Application of field programmable gate arrays in instrumentation and control systems of nuclear power plants," IAEA Nuclear Energy Series No. NP-T-3.17, IAEA, Vienna, Austria, 2016. Available: [https://www-pub.iaea.org/MTCD/Publications/PDF/Pub1701\\_web.pdf](https://www-pub.iaea.org/MTCD/Publications/PDF/Pub1701_web.pdf).
- [78] Chicago Tribune Wire Reports, "Timeline: Boeing 737 Max jetliner crashes and aftermath," *Chicago Tribune*, 2019. Available: <https://www.chicagotribune.com/business/ct-biz-viz-boeing-737-max-crash-timeline-04022019-story.html>.
- [79] D. Koenig, "A new software glitch has been found in Boeing's troubled 737 Max jet," *Time Magazine*, June 27, 2019. Available: <https://time.com/5615292/boeing-737-max-software-problem/>.

- [80] S. Miletich, "FBI joining criminal investigation into certification of Boeing 737 MAX," *The Seattle Times*, 2019. Available: <https://www.seattletimes.com/business/boeing-aerospace/fbi-joining-criminal-investigation-into-certification-of-boeing-737-max/>.
- [81] D. Gates, "Falsified papers, sloppy work led FAA to fine Boeing," *Chicago Tribune*, 2017. Available: <https://www.chicagotribune.com/business/ct-boeing-fine-disclosure-20170213-story.html>.
- [82] P. Robison and M. Newkirk, "Relationship between Boeing, FAA safety regulators under scrutiny," *Insurance Journal*, March 25, 2019. Available: <https://www.insurancejournal.com/news/national/2019/03/25/521514.htm>.
- [83] L. Greiner, "Could software quality assurance processes have prevented the Boeing 737 MAX crash?" *IT World Canada*, May 6, 2019. Available: <https://www.itworldcanada.com/article/could-software-quality-assurance-processes-have-prevented-the-boeing-737-max-crash/417713>.
- [84] G. Travis, "How the Boeing 737 Max disaster looks to a software developer," *IEEE Spectrum*, April 18, 2019. Available: <https://spectrum.ieee.org/aerospace/aviation/how-the-boeing-737-max-disaster-looks-to-a-software-developer>.
- [85] E. v. Hippel, *Democratizing Innovation*. Cambridge, MA: The MIT Press, 2005. Available: <https://mitpress.mit.edu/books/democratizing-innovation>.
- [86] J. Milko, T. Allen, and R. Fitzpatrick, "Keeping Up with the Advanced Nuclear Industry," *Third Way*, August 22, 2019. Available: <https://www.thirdway.org/graphic/keeping-up-with-the-advanced-nuclear-industry>.
- [87] NuScale Power, "History of NuScale Power," NuScale Power, Portland, OR, August 22, 2019. Available: <https://www.nuscalepower.com/about-us/history>.

## 8 Appendices

Below are the appendices for this dissertation.

## 8.1 CIET Test Procedure Template

CIET-TST-PHY-PROC-XXX  
Revision 00

<b>TEST PROCEDURE</b>		
<b>Document Title:</b>	[Test Procedure Title]	
<b>Effective Date:</b>	[YYYY-MM-DD]	
<b>Approval</b>		
<b>Title</b>	<b>Name</b>	<b>Date</b>
<b>Preparer</b>		N/A
<b>Reviewer</b>		N/A
<b>Approver</b>		
<b>QA Criterion:</b>	11 – Test Control, 14 – Inspection, Test, and Operating Status	

University of California, Berkeley  
Department of Nuclear Engineering, Thermal Hydraulics Lab  
Compact Integral Effects Test (CIET) Research Program



	[Test Procedure Title]	CIET-TST-PHY-PROC-XXX
		Revision 00
		Page 2 of 20

**REVISION HISTORY**

Revision No.	Effective Date	Affected Section(s)	Description of Changes
00	[YYYY-MM-DD]	ALL	Initial Issue.



**TABLE OF CONTENTS**

1	Purpose .....	4
2	References .....	4
2.1	Test Configuration.....	4
2.2	Software and Programs .....	4
2.3	Tools and Equipment.....	4
2.4	Environment Conditions.....	5
3	Responsibilities .....	5
3.1	Experimenters .....	5
3.2	Observers.....	5
3.3	Stop Work Authority .....	6
4	Precautions and Limitations ( <i>Continuous use</i> ).....	6
4.1	Specific Precautions .....	6
4.2	Abnormal Event Occurrence.....	6
4.3	Limitations .....	7
5	Prerequisites ( <i>Continuous use</i> ).....	7
5.1	Specific Test Configuration.....	7
5.2	Specific Software and Programs and Tools and Equipment .....	7
5.3	Specific Environment Conditions .....	7
6	Instructions ( <i>Continuous use</i> ) .....	7
6.1	Phase 1: Preparing the Facility for Testing .....	7
6.2	Phase 2: [Name of Specific Test Instructions].....	11
6.3	Phase 3: Facility Shutdown and Cleanup.....	12
6.4	Phase 4: Records Storage.....	14
7	Acceptance criteria .....	14
7.1	Acceptance Criteria.....	14
7.2	Supporting References .....	15
7.3	Deviations and Additional Items of Note .....	15
8	Forms and Records.....	15
8.1	Forms .....	15
8.2	Records .....	15
9	Appendices.....	16
9.1	Valve Line-up Tables .....	16
9.2	Test Action Table ( <i>Continuous Use</i> ).....	20

	[Test Procedure Title]	CIET-TST-PHY-PROC-XXX
		Revision 00
		Page 4 of 20

## 1 PURPOSE

The purpose of this specific test is to [... This should be the high-level goal of the test and how it is important in the scope of the CIET Research Program at large. Use bullets if necessary.].

Specific objectives of this test are to [... These should be the specific goals or desired outcomes for which this test is being performed. Use bullets if necessary.].

Specific characteristics being tested in this test are [... These could be functional items, the performance of SSCs, operator actions, specific VI's, etc. Use bullets if necessary.].

See CIET-ORG-REF-001, "CIET Program Definitions" for additional definitions, specifically: Procedure, Test Procedure.

## 2 REFERENCES

### 2.1 Test Configuration

2.1.1 General piping and instrumentation diagram: CIET-CONFIG-VISIO-001-03 Two Loop P&I Diagram (included in Section 9.1.6)

2.1.2 [List of design documents that fully describe and characterize the as-built condition of the CIET and ARCO Facilities generally relevant to testing, including test configuration boundaries relevant to observers; delete items and complete section with "N/A" if not applicable.]

### 2.2 Software and Programs

2.2.1 National Instruments LabVIEW

2.2.2 MathWorks MATLAB and Simulink

2.2.3 [List of other standard software and programs necessary to perform the test; delete items and complete section with "N/A" if not applicable.]

### 2.3 Tools and Equipment

2.3.1 Coriolis flowmeters: calibrated at factory, no recalibration needed (see CIET-MES-TS-002\_SITRANS\_FC430\_Coriolis\_Flowmeters\_Technical\_Sheet)

2.3.2 Thermocouples: see CIET-MTE-CALIB-301\_Thermocouples\_Calibration\_Report, CIET-MTE-CALIB-302\_Thermocouples\_Calibration\_Report and CIET-MTE-CALIB-303\_Spare\_Thermocouples\_Calibration\_Report (NEED FOR RECALIBRATION)

2.3.3 Manometer lines: see CIET-MTE-CALIB-401\_Manometer\_Fluid\_Levels\_Calibration

2.3.4 CIET-MES-TS-002 SITRANS FC430 Coriolis Flowmeters Technical Sheet

2.3.5 [List of other tools and equipment that are generally available and necessary to perform the test, including measurement and testing equipment (i.e. instrumentation) and calibration requirements if necessary; delete items and complete section with "N/A" if not applicable.]

2.4 Environment Conditions

The CIET and ARCO Facilities are located in a controlled space, Room 1140, within Etcheverry Hall on the University of California, Berkeley's main campus. The environmental conditions in this room are controlled and sufficient for the successful performance of this test. Temperatures, humidity, air quality, lighting, and ambient noise are all standard for indoor, laboratory environments.

**3 RESPONSIBILITIES**

See CIET-ORG-REF-001 CIET Program Definitions for additional definitions, specifically: Approver, Preparer, Reviewer.

3.1 Experimenters

The Experimenters are responsible for reading, understanding, and following this procedure once it is approved by the Approver to satisfy all instructions herein. The Experimenters are also responsible for evaluating the performance of this procedure and the conformance of results to the Acceptance Criteria defined in Section 7.1. If the performance of this procedure does not meet the Acceptance Criteria for any reason, then the Experimenters are responsible for documenting all deviations and actions taken under Deviations and Additional Items of Note (Section 7.3).

At least two Experimenters shall be present to both perform the required actions in this procedure as well as to verify that this procedure is followed as written to the best of their abilities. The sections of this procedure that shall be followed as Continuous Use are Sections 4, 5, and 6; all other sections are Reference Use unless otherwise specified (See CIET-ORG-REF-001 CIET Program Definitions for Level of Use definitions, including Continuous Use and Reference Use).

[Additional sub-roles for Experimenters, such as Technician, Supervisor, Reactor Operator, etc.; use sub-sections or bullets as desired.]

3.1.1 List of Experimenter(s)

- Name, Role: \_\_\_\_\_
- Name, Role: \_\_\_\_\_
- Name, Role: \_\_\_\_\_
- Name, Role: \_\_\_\_\_

3.2 Observers

All observers present shall respect the boundaries and activities of this test and shall not interact with test activities unless explicitly asked to by the Experimenter(s).

### 3.3 Stop Work Authority

All personnel have the authority, and the responsibility, to stop work in progress which is not being done in accordance with approved procedures or where personnel safety or SSC integrity may be jeopardized.

## 4 PRECAUTIONS AND LIMITATIONS (*CONTINUOUS USE*)

Depending on the purpose and objectives of this test, there may be a range of hazards and corresponding requirements for the Experimenter(s). The general requirement to personnel is to match precautions with potential hazards. The basic safety requirements include closed-toed shoes and long pants.

[Add specific precautions or limitations below in Sections 4.1 and 4.2.]

**WARNING:** Failure to follow Sections 4.1 through 4.2 could result in bodily harm.

### 4.1 Specific Precautions

- 4.1.1 **IF** working within the bounds of the CIET Facility (i.e. in/under the scaffolding) **WEAR** lab coats and safety glasses
- 4.1.2 **IF** working with open Dowtherm A **WEAR** gloves to protect skin.
- 4.1.3 **IF** physically working directly with the heater when it is energized:
  - 4.1.3.1 **WEAR** face shields, thermally insulated aprons, and thermally insulated (and ideally electrically isolating) gloves.

**NOTE:** Examples of events requiring shutdown and/or evacuation and the use of Section 4.2 are: major leak, fire.

### 4.2 Abnormal Event Occurrence

**WARNING:** Failure to perform steps 4.2.1 through 4.2.4 with as little time in between as possible could result in bodily harm.

- 4.2.1 **STOP** the primary pump.
- 4.2.2 **DE-ENERGIZE** the power supplies to the heater.
- 4.2.3 **ISOLATE** the cause of the abnormal event.
- 4.2.4 **CLEAN** as necessary according to instructions in Section 6.3.7.

	[Test Procedure Title]	CIET-TST-PHY-PROC-XXX
		Revision 00
		Page 7 of 20

4.3 Limitations

4.3.1 Potential sources of uncertainty and error:

4.3.1.1 Presence of air bubbles in the flow paths.

**5 PREREQUISITES (CONTINUOUS USE)**

5.1 Specific Test Configuration

5.1.1 **CONFIRM** the following documents related to the unique Test Configuration necessary for this Test Procedure are correct:

5.1.1.1 [List of design documents that are unique to the as-built condition of the CIET and ARCO Facilities required for this specific test, including test-specific boundaries relevant to observers. N/A if none applicable.]

5.2 Specific Software and Programs and Tools and Equipment

5.2.1 **ENSURE** the following test-specific Software and Programs are available and ready to use:

5.2.1.1 [List of unique software and programs necessary to perform this specific test, including the LabVIEW Project for this test. N/A if none applicable.]

5.2.2 **ENSURE** the following test-specific Tools and Equipment are available and ready to use and **NOTE** calibration requirements where necessary:

5.2.2.1 [List of unique tools and equipment necessary to perform this specific test, including measurement and testing equipment (i.e. instrumentation) and calibration requirements if necessary. N/A if none applicable.]

5.3 Specific Environment Conditions

5.3.1 **CONFIRM** the unique Environment Conditions required for this specific test are correct and in place:

5.3.1.1 [List the unique Environment Conditions necessary for this specific test. N/A if none applicable.]

**6 INSTRUCTIONS (CONTINUOUS USE)**

6.1 Phase 1: Preparing the Facility for Testing

Steps 6.1.1 through 6.1.5 (Flowmeters through Cameras) may be performed in parallel to make efficient use of time while their sub-steps shall be performed sequentially. All other steps in this section shall be performed sequentially according to the conventions of Continuous Use procedures. The power supplies shall be prepared last (if used) to provide minimal exposure to high-power electricity during facility preparation.

6.1.1 Flowmeters:

6.1.1.1 **TURN ON** Coriolis mass flowmeters (Switch #1 in electrical panel on column West of CIET).

6.1.1.2 **IF** CIET has been operated recently **THEN CLOSE** Valves **V-11, V-22, V-32, V-42, V-43, V-60, and V-61** to isolate the Coriolis mass flowmeters.

6.1.1.3 **PERFORM** zero-point adjustment on all flowmeters (see CIET-MES-TS-002\_SITRANS\_FC430\_Coriolis\_Flowmeters\_Technical\_Sheet for details)

6.1.1.4 **RECORD** the zero-point adjustment standard deviation for each flowmeter (accessed through Setup > Zero Point Adjustment > Standard Deviation):

- **FM-20:** \_\_\_\_\_
- **FM-30:** \_\_\_\_\_
- **FM-40:** \_\_\_\_\_
- **FM-60:** \_\_\_\_\_

6.1.2 Computer and PXIe:

6.1.2.1 **TURN ON** the CIET computer **AND** the PXIe system, if not already on.

6.1.2.2 **OPEN** the test's LabVIEW Project on the CIET computer.

6.1.2.2.1 [Step sequence to open the LabVIEW Project for the control system. If able to perform in a single step, use Step 6.1.2.2 without sub-steps. Example given below.]

6.1.2.2.2 **NAVIGATE** to:

C > Transfer Between Accounts > Control System Versions > Active > CIET\_Control\_2-1-0

6.1.2.2.3 **OPEN** the LabVIEW Project for this test:

CIET\_Control\_2-1-2.lvproj

**RIGHT-CLICK** CIET-PXIe (192.168.1.4) and **SELECT** "Connect" from the menu (this may take a few moments; this connects the computer to the DAQ).

6.1.3 Variable Frequency Drives (VFDs):

6.1.3.1 **CONFIRM** white serial communication cables are not connected to the VFDs.

6.1.3.2 **TURN ON** VFDs (Switch #3 in electrical panel on column West of CIET).

6.1.3.3 **IF** any VFDs display the “cF2” error **THEN FOLLOW** the factory reset instructions below for each error-displaying VFD:

**NOTE:** The VFD that most commonly displays the “cF2” error is the VFD for the pump – there are portions of the “GS1\_Factory\_Reset.vi” that are hardcoded for the pump and must be changed if a different VI displays the “cF2” error.

- 6.1.3.3.1 **CONNECT** the VFD displaying the error to its respective white serial communication cable.
- 6.1.3.3.2 **OPEN** “GS1\_Factory\_Reset.vi” in the LabVIEW Project under: CIET-PXIe (192.168.1.4)\Hardware Files.
- 6.1.3.3.3 **ACTIVATE** the “Reset to Factory Default” button on the “Control Panel” tab **AND SELECT** the VISA resource name corresponding to the VFDs (“VFD”)
- 6.1.3.3.4 **RUN** “GS1\_Factory\_Reset.vi” **AND WAIT** for “Error Out” to display a Timeout Error (after approximately 5 seconds)
- 6.1.3.3.5 **PRESS** the “Stop Loop” button to stop “GS1\_Factory\_Reset.vi” **AND CLOSE** “GS1\_Factory\_Reset.vi”
- 6.1.3.3.6 **DISCONNECT** the white serial communication cable **AND TURN OFF** VFDs (Switch #3 in electrical panel on column West of CIET) **AND WAIT** for VFDs to power off (after approximately 8 seconds).
- 6.1.3.3.7 **TURN ON** VFDs (Switch #3 in electrical panel on column West of CIET).
- 6.1.3.3.8 **RESET** the settings on the VFD that was factory reset using the guide taped to the inside of the VFD enclosure.

6.1.3.4 **CONNECT** the three white serial communication cables to their respective VFDs.

6.1.4 Valve Line-up and Bubble Management

- 6.1.4.1 **PERFORM** valve line-up for “Test” in the Valve Line-up Table (Appendix 9.1).
- 6.1.4.2 **EXERCISE** (close and open) valves M-40, V-34, V-92, **AND V-91 SEVERAL TIMES** to vent potential bubbles.
- 6.1.4.3 **IF** bubbles are visible in the manometer lines **THEN VIBRATE** the lines to help bubbles move out of the system.

6.1.5 **IF** using Cameras and SmartShooter to collect manometer levels throughout the test:

- 6.1.5.1 **LAUNCH** SmartShooter software on CIET computer.
- 6.1.5.2 **REMOVE** covers from the camera lenses **AND TURN ON** the cameras.



6.1.5.3 **ADJUST** cameras' focal length to:

- Primary camera focal length: \_\_\_\_\_
- DRACS camera focal length: \_\_\_\_\_

6.1.5.4 **ENSURE** both cameras are detected in SmartShooter.

6.1.5.5 **ENABLE** live view on both cameras **AND** **AUTOFOCUS** both cameras.

6.1.6 **IF** using the Power Supplies:

6.1.6.1 **CONFIRM** all breakers are **OFF**:

- 6.1.6.1.1 **TWO BREAKERS** in the power center on the south wall (Breakers #9, #10)
- 6.1.6.1.2 **TWO BREAKERS** on the column East of CIET
- 6.1.6.1.3 **ONE POWER SWITCH** on the front consoles of **EACH** power supply (**TWO SWITCHES** in total)

6.1.6.2 **CONFIRM** that the electrodes are firmly connected to the top and bottom of the heater outer tube – **TIGHTEN IF NECESSARY**

**WARNING: DO NOT** turn on the power supplies if the heater outer tube is not electrically isolated from the rest of the loop, as this will energize the whole loop piping.

6.1.6.3 **CONFIRM** that the heater outer tube is electrically isolated by measuring the resistance between the upper and lower flanges and the rest of the loop using a multimeter found in the DAQ desk drawer (measured resistance overload or on order of M $\Omega$ )

6.1.6.4 **TURN ON** all breakers:

- 6.1.6.4.1 **TWO BREAKERS** in the power center on the south wall (Breakers #9, #10)

**WARNING:** The following step energizes the power supplies. **DO NOT** touch the back section of the power supplies, the cables that run from the breakers to the power supplies, the cables that run from the power supplies to the heater electrodes, or the electrodes themselves

6.1.6.4.2 **TWO BREAKERS** on the column East of CIET (**UNLOCK IF** necessary, using key in the DAQ desk drawer)

6.1.6.4.3 **ONE POWER SWITCH** on the front consoles of **EACH** power supply (**TWO SWITCHES** in total)

6.1.6.5 **IF** Dowtherm A temperatures will **EXCEED 80°C THEN USE** the cover gas system:



6.1.6.5.1 **OPEN** discharge valve on the gas cylinder **AND VERIFY** that the gage pressure is **AT LEAST 30 PSIG**

6.1.6.5.2 **SLOWLY OPEN** regulator **UNTIL** the regulatory pressure reads **10 PSIG**.

6.1.6.5.3 **OPEN V-102**.

6.1.6.5.4 **SLOWLY OPEN** the gas supply manifold rotameter's needle valve **UNTIL** minimal gas flow is seen and heard.

6.1.7 **VERIFY** that Phase 1 is complete:

Experimenter Initials and Time: \_\_\_\_\_/\_\_\_\_\_

6.2 Phase 2: [Name of Specific Test Instructions]

6.2.1 Phase 2.1: Preparatory Activities

6.2.1.1 **RUN** the Control System:

6.2.1.1.1 [Step sequence to start the control system VI(s). If able to perform in a single step, use Step 6.2.1.1 without sub-steps.]

6.2.1.2 **ACTIVATE** the Pump **AND** the CTAH.

6.2.1.3 **RUN** the Pump at **5 Hz** to **CONFIRM** there are no bubbles in the system **AND** that flow behavior is normal (no misaligned valves or other flow blockages).

6.2.1.4 **VARY** Pump frequency between 3 – 15 Hz to circulate and eliminate bubbles in the system.

6.2.1.5 **IF** there are no bubbles in the system **THEN SET** the Pump Frequency to 0 Hz **AND WAIT** at least one minute for the system to stabilize.

6.2.1.6 **VERIFY** that Phase 2.1 is complete:

Experimenter Initials and Time: \_\_\_\_\_/\_\_\_\_\_

6.2.2 Phase 2.2: Test Activities

6.2.2.1 **FOLLOW** the specific steps in the Test Action Table (Appendix 9.2)

6.2.2.2 **VERIFY** that Phase 2.2 is complete:

Experimenter Initials and Time: \_\_\_\_\_/\_\_\_\_\_

6.2.3 Phase 2.3: Concluding Activities

6.2.3.1 **IF** using the heater:

6.2.3.1.1 **SET** the heater power output to 0 W **AND WAIT** to reach 0 W output power.

6.2.3.1.2 **DEACTIVATE** the heater.

6.2.3.1.3 **SET** the CTAH to 60 Hz to initiate primary loop cool-down.

6.2.3.1.4 **WAIT** for system fluid temperatures to **DECREASE BELOW 40°C**.

6.2.3.2 **SET** the CTAH to 0 Hz **AND WAIT** to reach 0 Hz CTAH speed.

6.2.3.3 **DEACTIVATE** the CTAH.

6.2.3.4 **SET** the Pump to 0 Hz **AND WAIT** to reach 0 Hz Pump speed.

6.2.3.5 **DEACTIVATE** the Pump.

6.2.3.6 **STOP** the Control System:

6.2.3.6.1 [Step sequence to stop the control system VI(s). If able to perform in a single step, use Step 6.2.3.6 without sub-steps.]

6.2.3.7 **VERIFY** that Phase 2.3 is complete:

Experimenter Initials and Time: \_\_\_\_\_/\_\_\_\_\_

6.2.4 **VERIFY** that Phase 2 is complete:

Experimenter Initials and Time: \_\_\_\_\_/\_\_\_\_\_

### 6.3 Phase 3: Facility Shutdown and Cleanup

Steps 6.3.2 through 6.3.7 (Valve Line-up and Bubble Management through Dowtherm A clean-up) should be performed in parallel to make efficient use of time while their sub-steps shall be performed sequentially. All other steps in this section shall be performed sequentially according to the conventions of Continuous Use procedures. The power supplies shall be shutdown first (if using) to provide minimal exposure to high-power electricity during facility shutdown and cleanup.

6.3.1 **IF** using Power Supplies:

6.3.1.1 **TURN OFF** all breakers:

6.3.1.1.1 **ONE POWER SWITCH** on the front consoles of **EACH** power supply (**TWO SWITCHES** in total).

6.3.1.1.2 **TWO BREAKERS** on the column East of CIET **AND LOCK**.

6.3.1.1.3 **TWO BREAKERS** in the power center on the south wall (Breakers #9, #10).

6.3.1.2 **IF** using the cover gas system:

6.3.1.2.1 **CLOSE** discharge valve on the gas cylinder (V-100) **AND WAIT** for the regulator pressure to fall to **0 PSIG**.

6.3.1.2.2 **CLOSE** the regulator (V-101).

6.3.1.2.3 **CLOSE V-102**.

6.3.1.2.4 **CLOSE** the gas supply manifold rotameter's needle valve.

6.3.2 Valve Line-up and Bubble Management

6.3.2.1 **PERFORM** valve line-up for "Shutdown" in Valve Line-up Table (Appendix 9.1).

6.3.2.2 **EXERCISE** (close and open) valves **M-40, V-34, V-92, AND V-91 SEVERAL TIMES** to vent potential bubbles.

6.3.2.3 **IF** bubbles are visible in the manometer lines **THEN VIBRATE** the lines to help bubbles move out of the system.

6.3.3 **IF USING** Cameras and SmartShooter:

6.3.3.1 **TURN OFF** cameras **AND REPLACE** lens covers.

6.3.3.2 **CLOSE** SmartShooter.

6.3.4 Variable Frequency Drives (VFDs):

6.3.4.1 **DISCONNECT** the white serial communication cables.

6.3.4.2 **TURN OFF** VFDs (Switch #3 in electrical panel on column West of CIET).

6.3.5 Computer and PXIe:

6.3.5.1 **IF** no subsequent tests or activities are planned today **THEN:**

6.3.5.1.1 **TURN OFF** the Operator-Right computer **AND** Operator-Left computer.

6.3.5.1.2 **TURN OFF** the PXIe system.

6.3.6 Flowmeters:

6.3.6.1 **TURN OFF** Coriolis mass flowmeters (Switch #1 in electrical panel on column West of CIET).

6.3.7 **IF** Dowtherm A cleanup is required:

6.3.7.1 **SOAK UP** bulk liquid Dowtherm A using absorbent materials.

6.3.7.2 **CLEAN** Dowtherm A residue **USING** a mild detergent (e.g. 409 or *Simple Green*) and paper towels.

6.3.7.3 **DISPOSE** of Dowtherm A related trash as “Hazardous Waste” according to the UC Berkeley Hazardous Waste Program.

6.3.8 **VERIFY** that Phase 3 is complete:

Experimenter Initials and Time: \_\_\_\_\_/\_\_\_\_\_

#### 6.4 Phase 4: Records Storage

6.4.1 **SAVE** the following items in the CIET Information Repository under:

05 – TST – Test Control > 01 – PHY – Physical Test Control > Records > [Test Name] > [YYYY-MM-DD]

6.4.1.1 Data file from the Desktop as:

YYYY-MM-DD [Test Name] DATA.csv

6.4.1.2 [Include other files that need to be saved in the CIET Information Repository with the data and procedure from this test] as:

YYYY-MM-DD [Test Name] [INFORMATION TYPE (e.g. NOTES)].XXX

6.4.2 [Include any additional steps to save relevant test records (See Section 8.2) to the same location as above.]

6.4.3 **IF** no subsequent tests or activities are planned today **THEN TURN OFF** the Mission Control Computer.

6.4.4 **VERIFY** that Phase 4 is complete:

Experimenter Initials and Time: \_\_\_\_\_/\_\_\_\_\_

6.4.5 **SAVE** this completed procedure as:

YYYY-MM-DD [Test Name] PROCEDURE.pdf

In the CIET Information Repository under:

05 – TST – Test Control > 01 – PHY – Physical Test Control > Records > [Test Name] > [YYYY-MM-DD]

## 7 **ACCEPTANCE CRITERIA**

### 7.1 Acceptance Criteria

7.1.1 [List specific requirements for this test to perform/meet so that the purpose of the test is achieved. Acceptance Criteria should not include objectives that require post-test data analysis as that is outside the control of this test procedure.]

7.1.2 Data is successfully collected, including:

7.1.2.1 [List the data needed for post-test analysis.]

7.2 Supporting References

7.2.1 [List supporting references for the acceptance criteria, such as specified requirements contained in applicable design documents or other pertinent technical documents that provide approved requirements from CIET personnel with responsibility for design.]

7.3 Deviations and Additional Items of Note

List Deviations from this test procedure that affect the achievement of the acceptance criteria (Deviations that cause acceptance criteria not to be met or that must be included for acceptance criteria to be met). Also include Items of Note to ensure test reproducibility using this procedure in the future. Space is provided below to list Deviations and Items of Note, which shall be done during or shortly after the performance of Section 6.

7.3.1 DEVIATIONS:

7.3.2 ITEMS OF NOTE:

**8 FORMS AND RECORDS**

Forms are all completed forms as a result of performing this procedure whereas records are all new, revised, and cancelled procedures generated as a result of performing this procedure (i.e. point to the records generated by using this procedure).

8.1 Forms

8.1.1 [List of forms used; N/A if none applicable.]

8.2 Records

8.2.1 YYYY-MM-DD [Test Name] DATA.csv

8.2.2 YYYY-MM-DD [Test Name] PROCEDURE.pdf

8.2.3 [List of additional records created.]

**9 APPENDICES**

**9.1 Valve Line-up Tables**

[The valve line-up tables below are configured for forced circulation in the primary loop with the by-pass branch and DHX branch isolated. The DRACS loop is isolated, segmented and unused as well. The preparer shall adjust these tables to achieve the goals of the test. Delete this statement once the valve line-up tables are updated for this test.]

**9.1.1 Level 0 (Ground level)**

Valve Location	Valve Label	Test	√	Shutdown	√
<b>Flow Routing Valves</b>					
Bottom of heater	V-10	CLOSED		CLOSED	
Bottom of DHX	V-20	CLOSED		CLOSED	
Bottom of by-pass line	V-30	CLOSED		CLOSED	
Bottom of by-pass line	V-31	CLOSED		CLOSED	
Bottom of by-pass line	V-32	CLOSED		CLOSED	
CTAH line	V-40	5 OPEN		CLOSED	
Pump manifold area	V-41	CLOSED		CLOSED	
Pump manifold area	V-42	OPEN		CLOSED	
Pump manifold area	V-43	CLOSED		CLOSED	
Pump manifold area	V-44	OPEN		CLOSED	
Pump manifold area	V-45	CLOSED		CLOSED	
Bottom of DHX branch	V-80	CLOSED		CLOSED	
Bottom of DRACS	V-81	CLOSED		CLOSED	
Vent drum	V-90	OPEN		OPEN	
Fill/drain tank drain valve	V-93	CLOSED		CLOSED	
Fill/drain tank	V-94	CLOSED		CLOSED	
Fill/drain tank	V-95	CLOSED		CLOSED	
Fill/drain tank	V-96	CLOSED		CLOSED	
Fill/drain tank	V-97	CLOSED		CLOSED	
<b>Manometer Valves</b>					
Bottom of heater	M-10	OPEN		CLOSED	
Bottom of DHX	M-22	OPEN		CLOSED	
Pump manifold area	M-40	OPEN		CLOSED	
Pump manifold area	M-41	OPEN		CLOSED	
Pump manifold area	M-42	OPEN		CLOSED	
Pump manifold area	M-43	OPEN		CLOSED	

**9.1.2 Level 1**

Valve Location	Valve Label	Test	√	Shutdown	√
<b>Flow Routing Valves</b>					

Top of heater	V-11	5 OPEN		CLOSED	
Primary loop manifold	V-22	CLOSED		CLOSED	
Primary loop manifold	V-33	CLOSED		CLOSED	
Top of by-pass line	V-34	CLOSED		CLOSED	
<b>Manometer Valves</b>					
Top of heater	M-11	OPEN		CLOSED	
Top of heater	M-12	OPEN		CLOSED	
Top of DHX	M-20	OPEN		CLOSED	
Bottom of DHX	M-21	OPEN		CLOSED	
Bottom of DHX	M-60	CLOSED		CLOSED	
Top of DHX	M-61	CLOSED		CLOSED	

9.1.3 Level 2

Valve Location	Valve Label	Test	√	Shutdown	√
<b>Flow Routing Valves</b>					
Connection lines	V-50	CLOSED		CLOSED	
Connection lines	V-51	CLOSED		CLOSED	
Connection lines	V-52	CLOSED		CLOSED	
Connection lines	V-53	CLOSED		CLOSED	
DRACS loop	V-61	CLOSED		CLOSED	
Bottom of Tank 1	V-70	OPEN		CLOSED	
CTAH vent	V-92	OPEN		CLOSED	
<b>Manometer Valves</b>					
Bottom of CTAH	M-44	OPEN		CLOSED	
Top of CTAH	M-45	OPEN		CLOSED	

9.1.4 Level 3

Valve Location	Valve Label	Test	√	Shutdown	√
<b>Flow Routing Valves</b>					
TCHX line	V-60	CLOSED		CLOSED	
Bottom of Tank 2	V-71	CLOSED		CLOSED	
TCHX vent	V-91	CLOSED		CLOSED	
<b>Manometer Valves</b>					
Top of TCHX	M-62	CLOSED		CLOSED	
Bottom of TCHX	M-63	CLOSED		CLOSED	

9.1.5 Valve Turn Directions

Valve Type	CLOSED	OPEN
Ball Valve	Clockwise	Counter-clockwise
Needle Valve	Clockwise	Counter-clockwise

	[Test Procedure Title]	CIET-TST-PHY-PROC-XXX
		Revision 00
		Page 18 of 20

Manometer Valve	Perpendicular	Parallel
-----------------	---------------	----------

9.1.6 CIET P&I Diagram

Use the P&I Diagram to confirm correct flow routing for the experiment and its desired outcomes. [Resize as needed but keep legible].



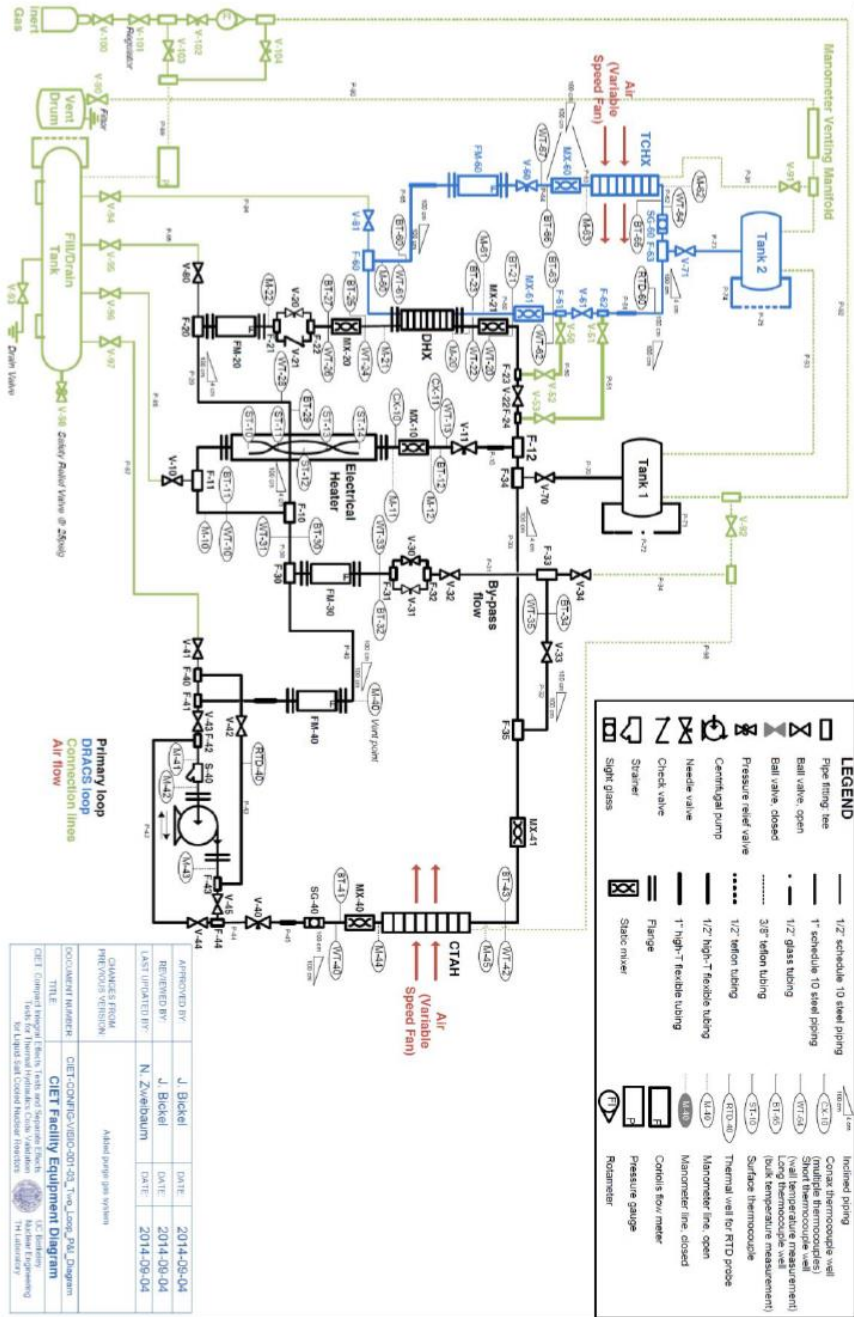

9.2 Test Action Table (Continuous Use)

Step	Description	System Time [s]	System Parameters			
			[Parameter 1]	[Parameter 2]	[Parameter ...]	[Parameter N]
1						
2						
...						
M						

Notes for Test: [Fill in any important notes for this action table or write "N/A".]

END OF DOCUMENT

## 8.2 PXIe System Control Hardware

Figure 8.1 is a snapshot of the National Instruments hardware that comprises the PXIe system.

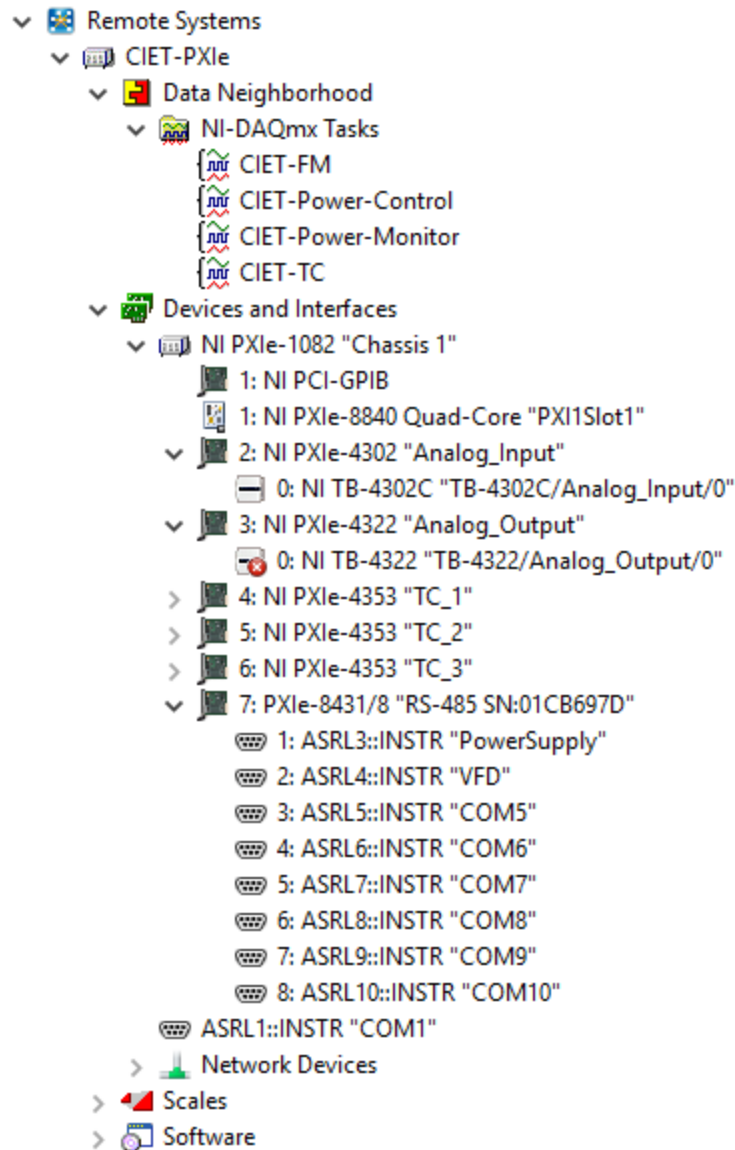

Figure 8.1. Copy of Figure 4.3; Control hardware included in the PXIe system for the CIET Facility; image captured in National Instruments Measurement and Automation Explorer (NI MAX).

In Figure 8.1, “Devices and Interfaces” include all of the hardware associated with the PXIe system, which are included under NI PXIe-1082 “Chassis 1” which is the model and name of the chassis of the PXIe system that houses all of the interfacing hardware. This hardware and a description of its function is included below, with the numbering corresponding the numbers underneath NI-PXIe-1082 “Chassis 1”:

1. “NI PCI-GPIB” is a communication port, specifically a GPIB (General Purpose Interface Bus defined by IEEE-488) port, that is on the outside of the PXIe controller. The CIET

control system does not take advantage of this port. NI PXIe-8840 Quad-Core “PXI1Slot1” is the first slot in the PXIe chassis, and this slot is occupied by the “controller” or brain of the PXIe system, which in this case is the NI PXIe-8840 Quad-Core controller.

2. NI PXIe-4302 “Analog Input” is, as the name suggests, the analog input card, which accepts voltage or current input signals depending on the terminal block that is connected to this card. Here, underneath NI PXIe-4302, NI TB-4302C “TB-4302C/Analog\_Input/0” is the terminal block shown to be connected, which is the terminal block necessary to accept the current signals output from the flow meters.
3. NI PXIe-4322 “Analog Output” is the analog output card which is connected to the NI TB-4322 “TB-4322/Analog\_Output/0” terminal block. This card and terminal block allow voltage signal outputs which are used to send control signals to the power supplies when operating in the analog control regime. The icon with the red “X” next to the terminal block indicates that no terminal block is currently connected to this card, which indicates that the power supplies should be controlled in the digital regime if the PXIe system is used in this configuration.
4. NI PXIe-4353 “TC\_1” is the first thermocouple input card connected to the CIET PXIe. As discussed above, this card interfaces with a terminal block that includes thirty-two miniature connector ports for thermocouples for ease of use.
5. NI PXIe-4353 “TC\_2” is the second thermocouple input card connected to the CIET PXIe. As discussed above, this card interfaces with a terminal block that includes thirty-two miniature connector ports for thermocouples for ease of use.
6. NI PXIe-4353 “TC\_3” is the third thermocouple input card connected to the CIET PXIe. As discussed above, this card interfaces with a terminal block that includes thirty-two miniature connector ports for thermocouples for ease of use. This card and terminal block are not currently used but are included in the configuration of the PXIe system to allow for expansion of temperature measurements.
7. PXIe-8431/8 “RS-485 SN:01CB697D” is a digital communication card that includes eight RS-485 communication ports. RS-485 is a common digital communication protocol that is used here to communicate with the power supplies (in the digital communication regime) and the VFDs, as indicated by the port listing below this card in Figure 4.3.
8. Although not numbered, the last hardware element listed underneath NI PXIe-1082 “Chassis 1” is a communication port labeled “ASRL1::INSTR “COM1””. Similar to the GPIB port, this is a communication port on the exterior of the PXIe controller that is unused by the CIET control system.