

UC Davis

Research Reports

Title

To Charge or Not to Charge: Enhancing Electric Vehicle Charging Management with LSTM-based Prediction of Non-Critical Charging Sessions and Renewable Energy Integration

Permalink

<https://escholarship.org/uc/item/77t9p8sf>

Authors

Tayarani, Hanif
Nitta, Christopher J.
Tal, Gil

Publication Date

2024-06-01

DOI

10.7922/G247486G

Data Availability

The data associated with this publication are available at:

<https://doi.org/10.5061/dryad.6wwpzgn60>

To Charge or Not to Charge: Enhancing Electric Vehicle Charging Management with LSTM-based Prediction of Non-Critical Charging Sessions and Renewable Energy Integration

June 2024

A Research Report from the National Center for Sustainable Transportation

Hanif Tayarani, University of California, Davis

Christopher J. Nitta, University of California, Davis

Gil Tal, University of California, Davis



TECHNICAL REPORT DOCUMENTATION PAGE

1. Report No. NCST-UCD-RR-24-10	2. Government Accession No. N/A	3. Recipient's Catalog No. N/A	
4. Title and Subtitle To Charge or Not to Charge: Enhancing Electric Vehicle Charging Management with LSTM-based Prediction of Non-Critical Charging Sessions and Renewable Energy Integration		5. Report Date June 2024	
		6. Performing Organization Code N/A	
7. Author(s) Hanif Tayarani, MS, https://orcid.org/0000-0002-2414-504X Christopher J. Nitta, PhD, https://orcid.org/0000-0003-1531-2771 Gil Tal, PhD, https://orcid.org/0000-0001-7843-3664		8. Performing Organization Report No. UCD-ITS-RR-24-09	
9. Performing Organization Name and Address University of California, Davis Institute of Transportation Studies 1605 Tilia Street, Suite 100 Davis, CA 95616		10. Work Unit No. N/A	
		11. Contract or Grant No. USDOT Grant 69A3551747114	
12. Sponsoring Agency Name and Address U.S. Department of Transportation Office of the Assistant Secretary for Research and Technology 1200 New Jersey Avenue, SE, Washington, DC 20590		13. Type of Report and Period Covered Final Research Report (October 2022 – December 2023)	
		14. Sponsoring Agency Code USDOT OST-R	
15. Supplementary Notes DOI: https://doi.org/10.7922/G247486G Dataset DOI: https://doi.org/10.5061/dryad.6wwpzgn60			
16. Abstract To maximize the greenhouse gas (GHG) emission reduction potential of Battery Electric Vehicles (BEVs), it is critical to develop EV dynamic charging management strategies. These strategies leverage the temporal variability in emissions associated with generated electricity to align EV charging with periods of low-carbon power generation. This study introduces a deep neural network tool to enable BEV drivers to make charging sessions align with the availability of cleaner energy resources. This study leverages a Long Short-Term Memory network to forecast individual BEV vehicle miles traveled (VMT) up to two days ahead, using a year-long dataset of driving and charging patterns from 66 California-based BEVs. Based on the predicted VMT, the model then estimates the vehicle's energy needs and the necessity of a charging session. This allows drivers to charge their vehicles strategically, prioritizing low-carbon electricity periods without risking incomplete journeys. This framework empowers drivers to actively contribute to cleaner electricity consumption with minimal disruption to their daily routines. The tool developed in this project outperforms benchmark models such as recurrent neural networks and autoregressive integrated moving averages, demonstrating its predictive capabilities. To enhance the reliability of predictions, confidence intervals are integrated into the model, ensuring that the model does not disrupt drivers' daily routine trips when skipping non-critical charging events. The potential benefits of the tool are demonstrated by applying it to real-world EV data, finding that if drivers follow the tool's predictive suggestion, they can reduce overall GHG emissions by 41% without changing their driving patterns. This study also found that even charging in regions with higher carbon-intensity electricity than California can achieve Californian emission levels for EV charging in the short term through strategic management of non-critical charging events. This finding reveals new possibilities for further emissions reduction from EV charging, even before the full transition to a carbon-neutral grid.			
17. Key Words Charging behavior, forecasting, machine learning		18. Distribution Statement No restrictions.	
19. Security Classif. (of this report) Unclassified	20. Security Classif. (of this page) Unclassified	21. No. of Pages 42	22. Price N/A

About the National Center for Sustainable Transportation

The National Center for Sustainable Transportation is a consortium of leading universities committed to advancing an environmentally sustainable transportation system through cutting-edge research, direct policy engagement, and education of our future leaders. Consortium members include: the University of California, Davis; California State University, Long Beach; Georgia Institute of Technology; Texas Southern University; the University of California, Riverside; the University of Southern California; and the University of Vermont. More information can be found at: ncst.ucdavis.edu.

Disclaimer

The contents of this report reflect the views of the authors, who are responsible for the facts and the accuracy of the information presented herein. This document is disseminated in the interest of information exchange. The report is funded, partially or entirely, by a grant from the U.S. Department of Transportation's University Transportation Centers Program. However, the U.S. Government assumes no liability for the contents or use thereof.

The U.S. Department of Transportation requires that all University Transportation Center reports be published publicly. To fulfill this requirement, the National Center for Sustainable Transportation publishes reports on the University of California open access publication repository, eScholarship. The authors may copyright any books, publications, or other copyrightable materials developed in the course of, or under, or as a result of the funding grant; however, the U.S. Department of Transportation reserves a royalty-free, nonexclusive and irrevocable license to reproduce, publish, or otherwise use and to authorize others to use the work for government purposes.

Acknowledgments

This study was funded, partially or entirely, by a grant from the National Center for Sustainable Transportation (NCST), supported by the U.S. Department of Transportation (USDOT) through the University Transportation Centers program. The authors would like to thank the NCST and the USDOT for their support of university-based research in transportation, and especially for the funding provided in support of this project.

To Charge or Not to Charge: Enhancing Electric Vehicle Charging Management with LSTM-based Prediction of Non-Critical Charging Sessions and Renewable Energy Integration

A National Center for Sustainable Transportation Research Report

June 2024

Hanif Tayarani, Institute of Transportation Studies, University of California, Davis

Christopher J. Nitta, Department of Computer Studies, University of California, Davis

Gil Tal, Institute of Transportation Studies, University of California, Davis

[page intentionally left blank]

TABLE OF CONTENTS

EXECUTIVE SUMMARY	i
Introduction	1
Background and Motivation	1
Related Work	2
Paper Contributions	9
Methods	10
Methodology.....	10
Data Description	12
Benchmarks.....	14
Evaluating Prediction Accuracy.....	14
Forecasting Results	15
Discussion.....	18
Beyond California Electricity Grid	22
Conclusions	23
References	25
Data Summary.....	33

List of Tables

Table 1. Charging management literature review..... 5

Table 2. Forecasting benchmark methods comparison..... 8

Table 3. Forecasting results. 16

List of Figures

- Figure 1. LSTM training framework. 11
- Figure 2. Non-critical charging detection framework..... 12
- Figure 3. CAISO, PJM, and ERCOT generation mix..... 13
- Figure 4. Electricity sector emissions..... 14
- Figure 5. Prediction reliability..... 17
- Figure 6. Number of charging days after skipping non-critical charging (CAISO)..... 19
- Figure 7. BEV charging emissions based on CAISO generation mix..... 20
- Figure 8. Annual hourly charging emission..... 21
- Figure 9. Charging days after skipping non-critical charging (PJM and ERCOT). 22
- Figure 10. BEV charging emissions based on PJM and ERCOT generation mix. 23

To Charge or Not to Charge: Enhancing Electric Vehicle Charging Management with LSTM-based Prediction of Non-Critical Charging Sessions and Renewable Energy Integration

EXECUTIVE SUMMARY

To maximize the greenhouse gas (GHG) emission reduction potential of Battery Electric Vehicles (BEVs), it is critical to develop EV dynamic charging management strategies. These strategies leverage the temporal variability in emissions associated with generated electricity to align EV charging with periods of low-carbon power generation.

This study introduces a deep neural network tool to enable BEV drivers to make charging sessions align with the availability of cleaner energy resources. This study leverages a Long Short-Term Memory (LSTM) network to forecast individual BEV vehicle miles traveled (VMT) up to two days ahead, using a year-long dataset of driving and charging patterns from 66 California-based BEVs. Based on the predicted VMT, the model then estimates the vehicle's energy needs and estimates the necessity of a charging session. This allows drivers to charge their vehicles strategically, prioritizing low-carbon electricity periods without risking incomplete journeys. This framework empowers drivers to actively contribute to cleaner electricity consumption with minimal disruption to their daily routines.

Our tool outperforms benchmark models such as recurrent neural networks and autoregressive integrated moving averages, demonstrating its predictive capabilities. To enhance the reliability of predictions, confidence intervals are integrated into the model, ensuring that the model does not disrupt drivers' daily routine trips when skipping non-critical charging events. We demonstrate the potential benefits of our tool by applying it to real-world EV data, finding that if drivers follow the tool's predictive suggestion, they can reduce overall GHG emissions by 41% without changing their driving patterns.

This study also found that even charging in regions with higher carbon-intensity electricity than California can achieve Californian emission levels for EV charging in the short term through strategic management of non-critical charging events. This finding reveals new possibilities for further emissions reduction from EV charging, even before the full transition to a carbon-neutral grid.

Introduction

Background and Motivation

The potential of electric vehicles (EV) to reduce emissions depends on the type of electricity generation mix used to charge these vehicles (1). Ambrose et al. (2) investigated the carbon emissions associated with EV charging across different countries. They found that the amount of fossil energy in the electricity mix is positively correlated with emissions from charging EVs. Another study found that charging EVs during the night (delayed charging) resulted in higher emissions in most US states due to the increase in coal generation during that time (3). Charging EVs with renewable energy sources such as solar, wind, hydro, or geothermal power can significantly improve EVs ability to reduce emissions. However, the uncertainty nature of most renewable energy resources, such as solar and wind power, currently limit their dispatchability (4). For instance, solar power, a major component of California's renewable energy mix, is only available during daylight hours and can be affected by factors such as clouds (5).

Developing strategies for managing EV charging is essential until the electric grid is fully decarbonized. These strategies should aim to maximize the use of renewable energy resources in EV charging so that the carbon reduction potential of EVs can also be maximized (6). Effective EV charging management can reduce carbon dioxide emissions by periodizing charging during less carbon-intensive hours. By strategically managing the times of EV charging, we can minimize carbon emissions and promote a more sustainable transportation system. In this study, we have developed a Deep Neural Network (DNN) tool that enables individual EV drivers to make environmentally charging decisions by estimating their daily energy requirements. We have used a Long Short-Term Memory (LSTM) network to forecast the vehicle miles traveled (VMT) for individual EVs two driving days in advance. Based on this information the tool estimates the amount of energy required to cover this VMT and suggests the necessity of a charging session. This suggestion can help drivers schedule charging sessions during low-carbon-intensity hours without significantly disrupting their travel routines. For some EVs, a particular charging session may be critical as the vehicle would have sufficient electric range to meet future driving needs. In contrast, for other EVs, a given charging session may be non-critical as the vehicle would have enough electric range to complete all driving until the next charging session.

This study defines non-critical charging sessions as those that can be safely skipped without affecting the EVs' ability to maintain a minimum of 20% state of charge (SOC) which correlates to between 46 and 67 miles of range, depending on the vehicle in our sample and is somewhat analogous to a low fuel state in a conventional vehicle. This buffer is chosen to prevent the risk of extreme discharge and preserve the battery's overall health (7).

This study developed a DNN tool that can provide suggestions to drivers, enabling them to potentially skip non-critical charging sessions and instead charge during off-peak hours, leading to a significant reduction in emissions. To demonstrate this, we used empirical driving data from 66 EVs driven in California over the course of a year. By shifting non-critical charging

sessions to low carbon intensity hours, we can measure the maximum emission reduction benefits achieved by shifting these non-critical charging sessions. We also studied how the charger power rating affects the emission reduction potential of shifting non-critical charging sessions.

To minimize the environmental impact of EV charging, we proposed to shift non-critical charging to lower carbon intensity hours. Therefore, we reduce the GHG per mile by managing non-critical charging sessions. This approach does not have a negative impact on charging costs since we are not shifting non-critical charging sessions to peak hours, which have higher charging costs compared to off-peak hours. Also, for those shifted non-critical charging sessions, we simulate the new charging events using a 6.6kW charger and a higher power (19kW), the maximum possible at Level 2 in the US. We aim to compare these charging rates and determine the most effective approach for managing charging sessions during low-carbon intensity periods. This comparative analysis demonstrates the potential benefits and feasibility of utilizing higher-power charging rate options to reduce carbon emissions associated with EV charging.

Related Work

Charging management uncertainty approach

Efficiently managing EV charging behavior is crucial for promoting sustainable energy usage and infrastructure growth. The existing literature in the field is extensive, and a wide breadth of diverse methods are attested. This section provides a comprehensive overview of these techniques, categorizing them based on their approach to handling uncertainty and their data sources.

The first section of the literature review focuses on using deterministic models in studying EV charging management. These models have been applied in various scenarios, such as commercial sectors and geographical regions. However, the limitations of these models have become more apparent as the complexities of EV charging behavior are revealed.

Several studies explored EV charging behavior using a deterministic approach. For instance in (8, 9), the authors analyzed charging station management using data obtained from the commercial sector of a city. However, they did not consider the uncertainty associated with EV behavior. Instead, they defined a predetermined behavior for drivers, which does not align with the uncertainty of drivers' behavior. Similarly, the authors in (10–14) also employed a deterministic approach and did not take into account the uncertainties linked to EVs while analyzing the charging behavior under various assumptions. In (10–14) authors collected data from individual buildings, cities, and entire countries at different scales, but they did not specify the particular load sector to which their dataset belongs. On the other hand, (15) utilized a similar research method, but they specifically examined the behavior of EV charging on a residential scale within a city. Notably, they analyzed real-world time-series data, which is more reliable than surveys, and generated data from limited datasets, as it provides an authentic

representation of actual phenomena and offers valuable insights into complex real-world behavior (16).

Due to the complex and diverse nature of EV charging behavior, deterministic approaches may not be suitable to manage this phenomenon effectively. To deal with the uncertainties that come with EV charging behavior, it is crucial to explore stochastic methods to manage them efficiently (16). Thus, the following sections will explore different techniques to analyze EV charging behavior uncertainties. These techniques fall under the category of stochastic approaches and can be classified into two types: those that use real data and those that use simulated data. Stochastic approaches include Markov chains, scenario-based modeling, Monte Carlo simulations, probability density functions, and machine learning-based models. These methods are powerful tools that can help us understand the intricate and uncertain landscape of EV charging behavior. By utilizing these methods, we can develop more precise and efficient charging management strategies by gaining a nuanced understanding of charging patterns.

Studies (17, 18) employ Markov chains and scenario-based methods to model load demand and electricity generation. These studies extend their scope to cities and countries and rely on a combination of timeseries and survey data. However, survey data due to its inherent limitations, may not offer the same level of precision as timeseries data. To address the shortcomings of Markov Chains, which are highly computational and time-consuming, several researchers have utilized Monte Carlo simulations to handle uncertainty in their study. Authors in (19) used Monte Carlo Simulation to model load demand uncertainty within a particular region, considering both commercial and residential sectors. However, they used a small sample to generate a large dataset to feed into their model. Similarly, authors in (20) apply probability density functions (PDF) to study the uncertainty in commercial sector load demand without specifying a geographical scope, with generated data. Although Monte Carlo and PDF have some advantages over the Markov chain, like being able to handle the continuous variable more accurately, their shortcoming in handling data with complex distribution, their dependency on random sampling, and their inability to learn the relevant features from data push researchers to use the new methods to solve the aforementioned problem.

In (21), authors employ linear regression modeling to analyze load demand within residential buildings, relying on generated data. The linear regression model is a solution to the time-consuming and computationally intensive problem of Monte Carlo simulation PDF and Markov Chain methods. However, due to the high complexity of the data and the nonlinearity of the driving and charging behavior of EVs, additional models are required to handle the nonlinearity of EV charging and driving data. The authors in (22–30) employ various machine learning-based models to investigate the uncertainty surrounding the charging behavior of EVs, with a focus on commercial buildings. Notably, studies (22–27) rely on real-world timeseries data collected from these commercial buildings to analyze EV charging behavior, providing valuable insights into practical scenarios. In contrast, studies (28–30) utilize simulated data generated from a limited dataset, which, while informative, may not fully capture the intricacies of real-world charging behavior.

Authors in (31–34) employed a range of techniques, including linear regression, Gaussian Mixture Models, Random Forest, and Statistical models, to model the uncertainties associated with EV charging behavior, with a specific focus on both commercial and residential sectors. In contrast, authors in (35–45) adopted a diverse array of stochastic methodologies, including agent-based modeling, deep learning, Monte Carlo simulations, and ARIMA, to explore the uncertainties surrounding EV charging behavior on a broader geographical scale, cities, regions, and entire countries. This set of studies lacks information on the energy sector to which their datasets belong. This detail is crucial to understanding and addressing EV charging dynamics across different sectors. Meanwhile, authors in (46) use ensemble learning to analyze load demand, particularly in residential buildings. Authors emphasized the importance of stochastic modeling supported by timeseries data. However, only residential EV loads were analyzed in this study, and most of the charging at work and public stations was neglected.

Authors in studies (47–50) employ travel behavior as a proxy for charging behavior, aiming to investigate uncertainties in charging behavior and estimate EV load demand based on trip behavior. However, their approach involves scenario-based modeling, including Monte Carlo simulations, to generate travel data for electric vehicles. In contrast, studies (51–53) comprehensively consider both travel and charging behavior concurrently, recognizing that the two are intricately linked, with charging behavior influenced by the travel behaviors of EV users, as indicated in (51). Incorporating travel behavior into charging management studies is crucial as it allows charging operators to consider all significant factors that may impact charging patterns.

On the other hand, authors in (52) employ trip chain simulations to model EV fleets within a city, while the study (53) adopts a deep learning LSTM model for real-time prediction of EV charging demand. The findings of the study suggest that machine learning models, particularly LSTM models, are well-suited for accurately predicting EV charging behavior, especially when handling time series data. Since we are predicting the charging and travel behavior of EVs using a timeseries dataset, we plan to use a deep LSTM network architecture to handle uncertainties and forecast behavior in order to effectively manage non-critical charging.

Table 1 provides a summary of EV charging management studies.

Table 1. Charging management literature review.

Category	References	EV Uncertainty			Uncertainty treatment technique	Parametric uncertainty sources	Geographical scope	Responsive load sector(s)	Data sources
		α^*	β^*	γ^*					
1	(8, 9)	X	X	X	NA	NA	City	Commercial	Not mentioned (8) Real Sample(9)
2	(10–14)	X	X	X	NA	NA	Building (10) City (11) Country (12) Not mentioned (13, 14)	Not mentioned	Real Sample (Survey) (10) Real Sample (11, 12, 14) Not mentioned (13)
3	(17, 18)	X	X	✓	Markov chain (17) Scenario Based (18)	Load Demand (17) Electricity Generation (18)	City (17) Country (18)	Not mentioned	Real Sample (17) Real Sample (Survey) (18)
4	(19)	X	X	✓	Monte Carlo	Load Demand	Region	Commercial & Residential	Generated
5	(20)	X	X	✓	Probability Density Function	Load Demand	Not mentioned	Commercial	Generated
6	(15)	X	X	X	NA	NA	City	Residential	Real Sample
7	(21)	X	X	✓	Linear Regression	Load Demand	Building	Residential	Generated
8	(22–30)	✓	X	✓	Deep learning (22, 24, 29) Auto Regression model (23) Ensemble learning (25) XGBoost (26) Statistical + random forest (27) Random Forest (28) Copula GAN (30)	Load Demand (22–24, 26–30) Charging Duration (25)	Building (22–25, 28–30) Region (26) Country (27)	Commercial	Real Sample (22–27) Generated (28–30)
9	(31–34)	✓	X	✓	Linear Regression (31) Gaussian Mixture Model (32) Random Forest (33) Min and Max interval (34)	Load Demand(31, 32, 34) Charging Duration (33)	Region (31, 32) Building (33) Not mentioned (34)	Commercial & Residential	Real Sample (34) Generated (34)

Category	References	EV Uncertainty			Uncertainty treatment technique	Parametric uncertainty sources	Geographical scope	Responsive load sector(s)	Data sources
		α^*	β^*	γ^*					
10	(35–45)	✓	✗	✓	Agent-based modeling (35) Decision tree-based model (36, 44) Deep learning (37, 38) Neural Network (39) Monte Carlo(40, 43) PDF (41, 42) ARIMA(45)	Load Demand	City (42) Region (43) Country(35–39, 41, 44) Not mentioned (40, 45)	Not mentioned Real Sample (36) Real Sample (Survey)(37–39) Generated (40–45)	
11	(46)	✗	✗	✓	Ensemble learning	Load Demand	Building	Residential Real Sample	
12	(47)	✗	✓	✓	Monte Carlo	Load Demand	Not mentioned	Commercial & Residential Generated	
13	(48, 49)	✗	✓	✓	Latin Hypercube Sampling (48) Monte Carlo (49)	Load Demand	Not mentioned	Not mentioned Generated	
14	(50)	✓	✓	✓	Monte Carlo	Load Demand	City	Residential Generated	
15	(51)	✓	✓	✓	Monte Carlo	Battery and SOC of vehicle	City	Not mentioned Generated	
16	(52, 53)	✓	✓	✓	Trip Chain simulation (52) Deep Learning (53)	Load Demand	City	Commercial & Residential Generated (52) Real Sample (53)	
	This Paper	✓	✓	✓	Deep Learning	Load Demand	Region	Commercial & Residential Real Sample	

α^* : Charging Behavior

β^* : Travel Behavior

γ^* : Electricity Demand

Method

In the context of addressing the challenges related to Battery Electric Vehicles (BEVs), timeseries forecasting plays a crucial role in predicting trip-related variables such as arrival time, destination, and charging behavior (54). Over the last decade, various statistical and Machine Learning (ML) methods have been proposed to predict charging behavior in BEVs, including simple linear regression, Autoregressive Integrated Moving Average (ARIMA), Support Vector Machines (SVM), and Artificial Neural Networks (ANN). Predicting charging behavior more precisely can optimize infrastructure use, relieve range anxiety, and improve battery health for BEVs (55, 56).

Statistical methods often have limitations due to their predefined structure, which can result in shortcomings in the model outcomes. For instance, ARIMA models capture patterns and dependencies in the data by combining autoregressive (AR), integrated (I), and moving average (MA) components. However, ARIMA struggles to capture sudden spikes or sharp fluctuations in the data accurately (57). Researchers explored combining statistical models with other methods, such as the transform function, can overcome this limitation (58). This function can decompose timeseries data into different frequency subseries and has been integrated with the ARIMA model for short-term forecasting. This hybrid approach has improved forecasting windspeed datasets characterized by high fluctuations (58).

Artificial intelligence-based approaches, including ML, which utilize data engineering because of their capability to handle complex nonlinear data, have become prevalent in various fields (59). Conventional neural networks, such as ANN, which have a small number of hidden layers, are widely employed in this field. To enhance their performance, Rafiei et al. introduced the Morlet wavelet function as the activation function for the hidden layers (60). SVMs are popular machine learning methods that are frequently used for short-term forecasting and utilize different kernel functions (e.g., linear, Gaussian) to transform data into a new space (61). However, these methods face limitations in effectively handling high-dimensional data, each with its own advantages and disadvantages.

Modern transportation systems often encounter challenges related to managing large volumes of data, and DNN approaches have emerged as the most effective solution (62). These approaches leverage multiple hidden layers of processing, enabling them to extract key data features (63). DNNs are a type of artificial neural network with multiple hidden layers that are trained rigorously. This key feature extraction capability makes DNNs popular in various research areas and has been successfully used in many forecasting studies, such as electricity price forecasting (64), load demand forecasting (65), wind speed forecasting (66), and other related areas.

The Long Short-Term Memory (LSTM) network is a type of Recurrent Neural Network (RNN). It is known for its ability to capture complex patterns and intricate temporal dependencies in time series data. LSTM has shown impressive performance in different forecasting domains, including energy demand, stock prices, and weather data. Several research studies have used

LSTM for short-term forecasting tasks such as load demand and air quality prediction, and deep LSTM models have demonstrated satisfactory results (67, 68).

Table 2 provides a comprehensive comparison of the advantages and disadvantages of forecasting benchmark methods.

Table 2. Forecasting benchmark methods comparison.

Methods	Pros	Cons
Statistical Methods (ARIMA)	Short processing time (65)	Low ability in sharp spikes prediction (57, 58)
	Good ability for short-term forecasting (57)	Low ability to analyze complex nonlinear patterns (69)
	Good performance in non-complex datasets (70)	Complex Model-identification (69)
	Training with the low number of samples (69)	Low ability in long-term prediction (71)
SVM	Without training difficulties like overfitting, and saturation (72)	Low ability in feature extraction for complex datasets (71)
	Well performance in classification tasks (73)	High computational time for large dimension data set (74)
	Suitable for short-term and long-term forecasting (61)	Lack of strong memory unit (69)
CNN	Good ability for handling simple non-linear problems (59)	Without memory unit (75)
	Having feature extraction ability for simple profiles (65)	Gradient vanishing problem (66)
	Implementing in classification task (76)	Overfitting problems during training (61, 69)
RNN	Using recurrent weights as memory (64)	Low feature extraction ability for large dimension datasets (75)
	Modeling temporal dependency's ability (64, 71)	Gradient vanishing problem (77)
	handling simple nonlinear problems (64)	Convergence and exploding gradients problems (67)
	Feature extraction ability (16)	
LSTM	High feature extraction ability (78)	Error accumulation problem (79, 80)
	Good ability in complex datasets (68)	Complex training procedure (81)
	Solving gradient vanishing problem (79)	

This study introduces a stochastic DL-based model to support BEV drivers in managing their charging events effectively. The main objective of the model is to identify non-critical charging events, allowing drivers to complete their daily routine trips without disruptions until the next critical charging event. Moreover, the model offers recommendations to skip these non-critical charging events and shift charging events to less carbon-intensive electricity hours, promoting sustainable transportation. By accurately predicting the VMT over two consecutive days, the model effectively determines non-critical charging and avoids overcharging, which can be

detrimental to battery health. Unlike deterministic approaches with consistent outcomes for specific inputs, the stochastic model considers the inherent uncertainty in the data.

By effectively managing non-critical charging events, drivers can potentially reduce emissions associated with driving by managing their charging to utilize more renewable energy resources. Implementing this model could significantly enhance the utilization of renewable energy for transportation, thus expediting the transition towards more sustainable transportation systems.

The model proposed in this study utilizes an LSTM network that has been trained using trips and charging data, including GPS routes, SOC, Day of the week, distance traveled since last charging, and time of day. By incorporating the LSTM model within the stochastic framework, the model can forecast the VMT for two consecutive driving days for individual BEV drivers based on their historical trip and charging data.

Paper Contributions

Many previous studies have relied on simulated vehicle data to study BEV charging behaviors due to a lack of real-world EV timeseries data. This research utilizes actual BEV trips and charging data to train an LSTM model to gain more accurate insights into individual charging patterns. By forecasting two consecutive days of VMT, our proposed methodology aims to improve BEV charging management by managing non-critical charging events compared to prior efforts. The proposed framework helps to bridge the gap between the electricity grid and the transportation sector, mitigating the carbon footprint of charging electric vehicles without disrupting drivers' routine behavior.

Furthermore, the stochastic nature of our model allows it to determine and adapt to changes in an EV driver's travel and charging routines over time. As new data becomes available, the model can identify changes in behavior and update its predictions accordingly. This dynamic learning process ensures the model stays accurate and provides the most precise forecasts as driving habits and charging behavior evolve. By consistently refining its training procedure based on the latest data. The results of this study can be used to create a model that provides drivers with timely and accurate forecasts regarding their charging requirements for their BEVs in order to advise the driver on skipping non-charging and reducing charging infrastructure usage, GHG per mile, and charging cost at the same time.

Methods

Methodology

This study aims to develop a predictive deep learning-based model that can determine non-critical charging events by accurately forecasting two consecutive driving days of VMT. This will enable drivers to decide whether they can skip their charging sessions based on their historical data. By predicting two consecutive driving days of VMT, drivers can manage non-critical charging events, which would help charging operators reduce the carbon footprint of EVs.

LSTM network

Figure 1 illustrates the architecture of LSTM networks utilized in this study. LSTMs are more robust than RNNs at handling the problem of vanishing gradients, which can happen when working with long sequences of data like EV trips and charging data (77). LSTMs have different gates that distinguish them from RNNs and make them a more powerful memory unit. There are three main gates in each LSTM network: the input gate, which controls how much of the new input is fed to the memory cell; the forget gate, which controls how much of the previous step is forgotten; and the output gate, which controls how much of the current state is sent to the next layer in the network (82). Thus, LSTMs are effective in processing timeseries data with complex nonlinear relationships and temporal dependencies, particularly second-by-second trip logs found in the BEV trip dataset (82). Additionally, LSTMs can extract critical features and be used for forecasting tasks, making them an ideal tool for EV charging behavior prediction. This study aims to develop a deep LSTM model that can predict two consecutive driving days of VMT. Unlike previous studies, this model will be configured using empirical data from 66 BEVs over the course of one year in the eVMT project dataset (83).

The proposed method utilizes DL techniques and consists of several stacked LSTM networks for the forecasting module. The input data for each network is taken from previous and current timesteps. The input gate stores information from the current and previous timesteps, while the forget gate discards unnecessary information from the memory cell, and the output gate retrieves useful information. Because of the stacked configuration, the features are propagated among the networks during the training process, allowing the deep LSTM networks to effectively learn complex and unpredictable phenomena.

Overall structure of the proposed framework

This study is divided into three stages, as shown in Figure 1. First, the model's training, validation, and testing datasets are generated using the eVMT project's dataset. In the second stage, the LSTM model is configured using the training and validation data from the previous stage. Finally, a series of experiments are conducted on the defined models using the testing dataset from stage one to evaluate the LSTM model.

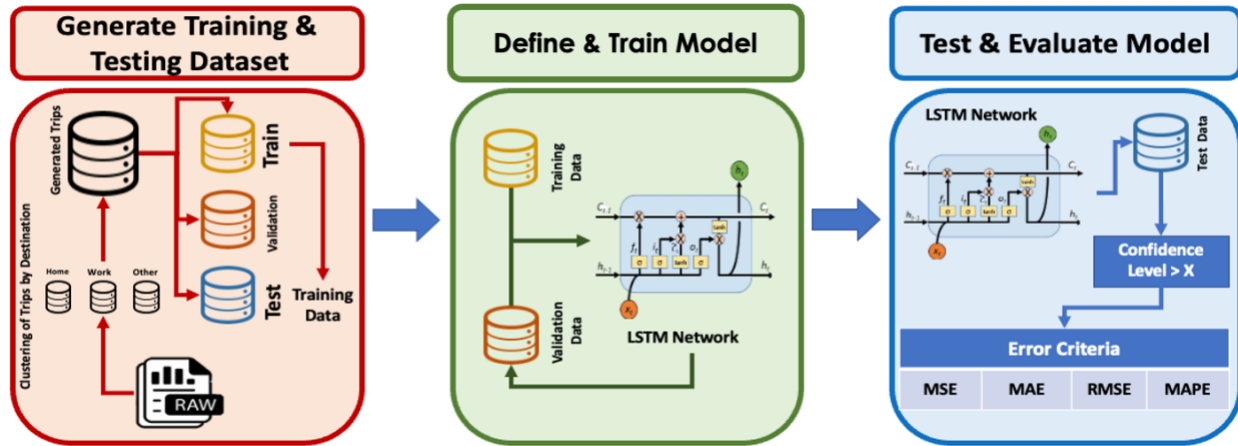

Figure 1. LSTM training framework.

The optimal model was trained on a daily basis, and the neural network weights were stored after each training session. This allowed us to capture and retain the driving behavior and features of the driver, enabling us to predict the VMT for the next two consecutive driving days. By utilizing the previous day's weights as the initial weights of our model, we were able to enhance the accuracy of our predictions and capture both the long-term and short-term dependencies in the data.

To ensure accurate predictions of consecutive driving days of VMT while minimizing disruptions to the driver's routine behavior, this study introduces the utilization of confidence intervals. To calculate these intervals, the Bootstrap method is employed (84), providing a robust approach applicable to various machine learning algorithms. By estimating confidence intervals, each prediction consists of a lower and upper bound, representing the range within which we can be 95% confident that the predicted value lies. To determine "Days with Reliable VMT prediction," we consider instances where the width of the confidence interval (upper bound - lower bound) is less than 10% of the car's range.

By incorporating confidence level estimations, we can discern which days have reliable predictions, enabling us to determine non-critical charging events and reschedule them for less carbon intensity hours. This is particularly applicable for overnight charging, as the base load during nighttime is primarily supplied from non-renewable power plants in California. However, the limited availability of chargers at workplaces necessitates careful consideration of the charging dilemma. To address this, we developed a model that predicts the VMT for the next two days. This ensures that if we choose to skip a non-critical charging session and are unable to charge during periods of low carbon intensity the following day, we will still have sufficient SOC until the end of the second day. We assumed they would have access to a charging station on the second day, and the model considered a buffer for them for the first day. For instance, if the model predicts that the driver will have at least a 20% SOC at the end of the following day, the model considers that current charging event as non-critical charging (Figure 2). This buffer is selected to avoid deep discharge of vehicles' batteries which could impact their battery health.

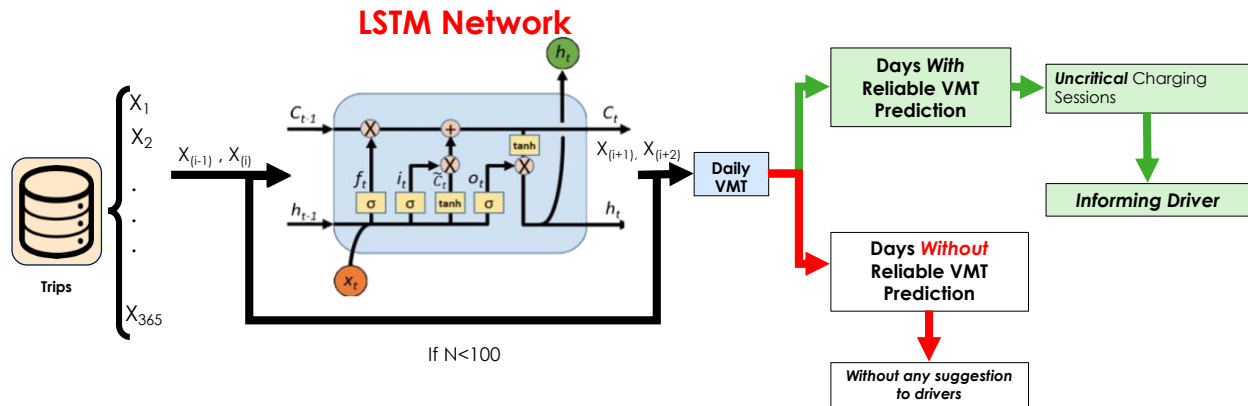

Figure 2. Non-critical charging detection framework.

Data Description

BEV dataset

The model used in this research was configured using a subset of the eVMT project's dataset, which is a California-wide study spanning five years (2015-2020). The eVMT project aimed to gain insight into the driving and charging behaviors of EVs (83). In this study, a subset of data from the 24 Chevrolet Bolts, and the 42 Tesla Model S vehicles was utilized for training and testing the LSTM model.

Electricity grid emission dataset

In order to improve accuracy and simulate real-world conditions, we collected the emissions associated with electricity generation and delivery in California throughout 2020 on an hourly basis (85). To show the capability of the developed model to manage the charging event of EVs and reduce the emissions associated with EV charging in different conditions, the model will be simulated on two other grids with different generation mixes rather than the California grid. Figure 3 shows the generation mix for these selected three different regional transmission operators (RTO). In contrast with CAISO, which has lots of solar power (Figure 3a), more than 60% of total generation in PJM and ERCOT is provided by Natural Gas and Coal power plants (Figure 3b, c).

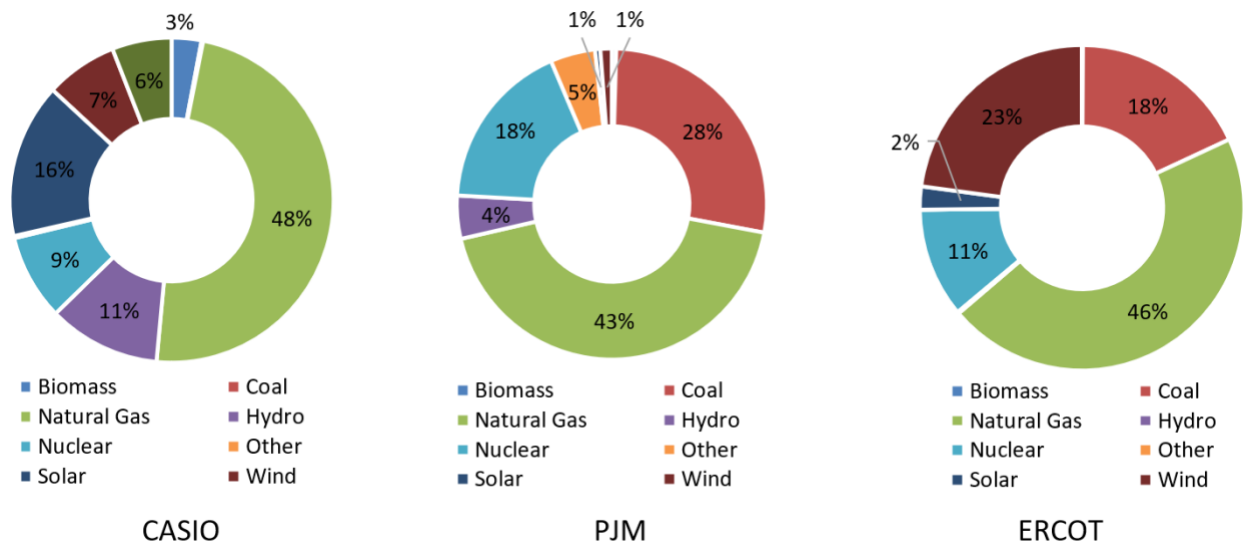

Figure 3. CAISO, PJM, and ERCOT generation mix.

Our model can intelligently reschedule non-critical charging events to times when the grid is running on cleaner energy. It's important to note that this doesn't always mean rescheduling to midday, as is often done in California. Instead, our model considers the unique energy mix of each Regional Transmission Organization (RTO) and adjusts accordingly.

As depicted in Figure 4a, the generation emission data reveals that due to the significant contribution of renewable sources, particularly solar power, the period from 8 AM to 5 PM exhibits less carbon intensity than other hours of the day in California. However, in PJM, the cleanest hours typically begin around 11 p.m., whereas in ERCOT, they begin around 10 p.m. (Figure 4). Our model is capable of taking into account the differences in energy generation and emissions across various regions.

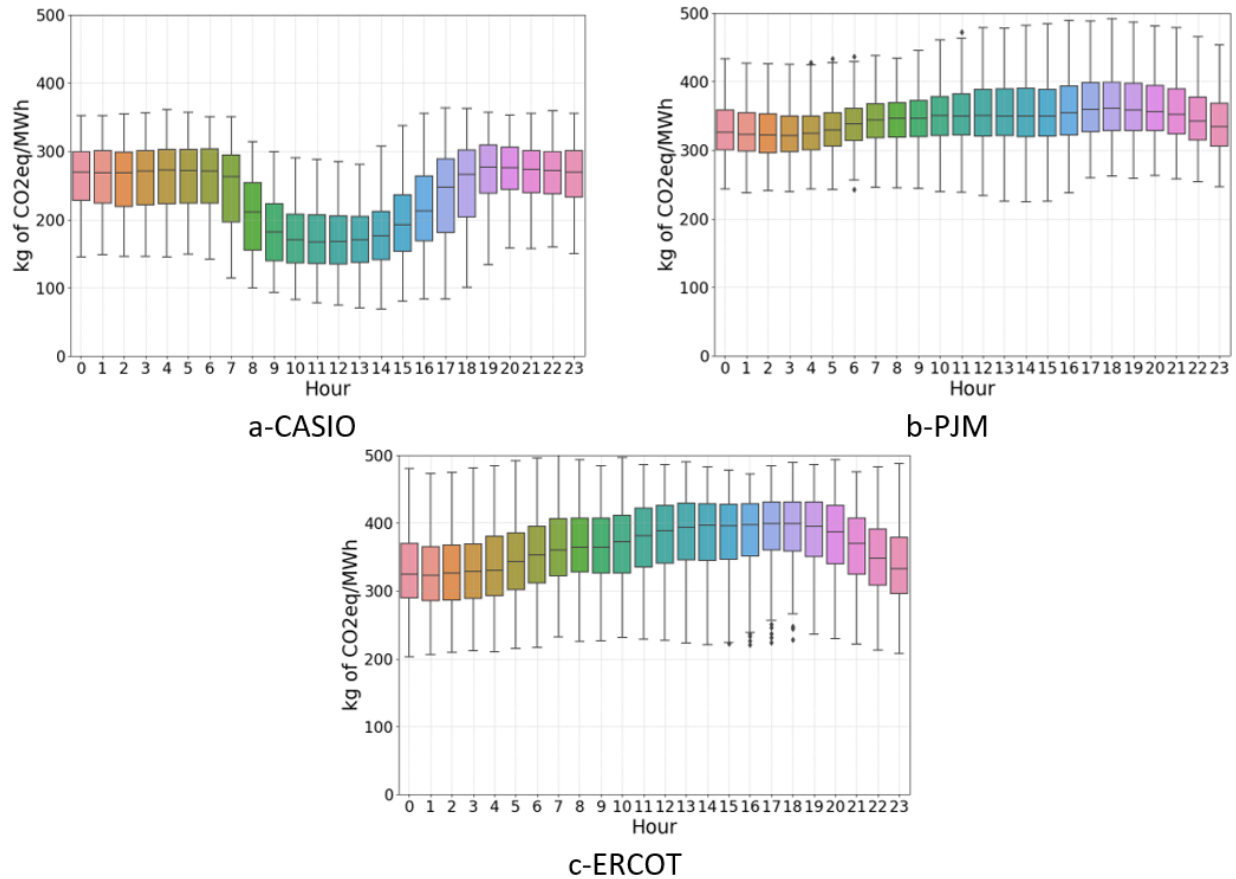

Figure 4. Electricity sector emissions.

Benchmarks

To conduct a comprehensive benchmark analysis and validate the effectiveness of our proposed method, we compare it with other techniques commonly used in short-term forecasting tasks. These include the ARIMA model, a well-established statistical method widely employed in time series forecasting. Additionally, we consider the RNN a popular benchmark method utilized in various short-term forecasting tasks. Furthermore, we examine the LSTM model, an upgraded version of the RNN designed to address the limitations of the traditional RNN. All the examined methods are trained using the Python 3.10.11 software and TensorFlow 2.10 (86, 87).

Evaluating Prediction Accuracy

This study employs four prominent error metrics, namely the mean absolute error (MAE), mean squared error (MSE), mean absolute percentage error (MAPE), and root mean square error (RMSE) (88), to assess the performance of the different methods. By utilizing these established metrics, we can effectively measure and analyze the performance of each method in this study.

$$MAE = \frac{1}{N} \sum_{i=1}^N (|\hat{Y}_i - Y_i|) \quad (1)$$

$$MSE = \frac{1}{N} \sum_{i=1}^N (|\hat{Y}_i - Y_i|)^2 \quad (2)$$

$$RMSE = \sqrt{\frac{1}{N} \sum_{i=1}^N (|\hat{Y}_i - Y_i|)^2} \quad (3)$$

$$MAPE = \frac{1}{N} \sum_{i=1}^N \left(\left| \frac{\hat{Y}_i - Y_i}{\hat{Y}_{i,mean}} \right| \times 100 \right) \quad (4)$$

Where N is the total number of charging observations, i is the index of output layer sample, \hat{Y}_i desired vector of sample i , Y_i output vector of sample i and $\hat{Y}_{i,mean}$ is Mean value of vector of observation i .

Forecasting Results

After conducting a grid search analysis, the LSTM networks are configured with 50 hidden units to avoid overfitting and improve accuracy. It is important to note that LSTM networks are more sensitive than RNN networks when it comes to learning rate values to prevent saturation during the training process. Consequently, an initial learning rate of 0.01 is set for the LSTM networks. To address the issue of overfitting and enhance the stability of the proposed model, an L2 regularization layer with a coefficient of 0.001 is used to minimize abrupt weight changes during the training process. Furthermore, to prevent overfitting, a dropout layer with a probability of 0.5 is incorporated into the model. Additionally, the mini-batch gradient descent method is utilized to reduce parameter updating variance and ensure smooth convergence during the training process. The training process is limited to a maximum of 50 iterations, with validation performed every 10 steps. After conducting a grid search analysis, we chose 50 epochs to optimize model accuracy and avoid overfitting. To evaluate the robustness of the proposed model, a comprehensive comparison is conducted, examining different methods for various vehicle models and drivers.

To train the model efficiently, a subset of 10 vehicles was selected from the total pool of 66 vehicles within the eVMT dataset. This subset comprises five Tesla vehicles and five Chevrolet Bolt vehicles. The initial training phase utilizing this subset will facilitate the development of the model. Subsequently, the model's performance will be evaluated by applying it to the remaining vehicles in the eVMT dataset, thereby assessing its capacity to generalize across a wider range of electric vehicles.

Table 3 demonstrates that the LSTM method outperforms both the RNN and ARIMA methods. The table presents the results of the four error criteria, indicating that the LSTM consistently exhibits superior performance across individual BEVs.

Table 3. Forecasting results.

Model		Chevy Bolt	Chevy Bolt	Chevy Bolt	Chevy Bolt	Chevy Bolt	Tesla Model S	Tesla Model S	Tesla Model S	Tesla Model S	Tesla Model S
Battery Capacity (kWh)		60	60	60	60	60	75	85	95	85	90
MAE(M)	LSTM	5.91	6.35	7.01	6.87	5.74	8.33	5.00	4.76	6.79	3.69
	RNN	13.63	13.41	13.77	12.43	14.31	12.40	35.10	11.63	18.41	5.00
	Arima	19.46	21.42	22.68	22.38	25.47	45.50	44.09	16.29	33.35	17.50
RMSE(m)	LSTM	9.72	9.84	10.51	9.82	9.41	11.86	7.97	8.40	10.22	6.59
	RNN	19.62	22.16	23.49	19.26	25.41	22.59	84.62	18.71	30.61	11.58
	Arima	27.43	31.32	33.95	30.56	39.86	67.65	100.46	25.84	45.88	31.22
MAPE(%)	LSTM	12.94	17.63	9.88	18.33	6.74	9.97	3.60	6.59	16.84	15.01
	RNN	26.32	28.77	18.26	29.75	17.48	14.93	25.64	14.12	36.56	18.35
	Arima	42.36	49.18	30.81	65.65	33.27	54.60	14.53	22.04	92.00	67.87
MSE(M ²)	LSTM	94.47	96.84	110.42	96.48	88.50	140.71	63.44	70.49	104.44	43.47
	RNN	384.90	490.87	551.88	370.86	645.79	510.43	7161.05	349.92	936.94	134.21
	Arima	752.61	981.12	1152.86	934.16	1589.17	4576.59	10093.07	667.57	2104.83	974.54

Based on the findings presented in Table 3, it is evident that the LSTM network demonstrates superior accuracy when it comes to short-term EV behavior forecasting. Given that the primary objective of this study is to minimize trip disruption while shifting non-critical charging to hours with low carbon intensity electricity hours, the LSTM model exhibits better performance when compared to the other benchmark methods.

To avoid disturbing the daily routines of drivers, it is crucial to have a reliable prediction of their driving and charging behavior. Our main goal is to shift non-critical charging events only when we have reliable predictions of EV behaviors on those days. Thus, when our predictive model's reliability is less certain criteria, we should refrain from suggesting any rescheduling to non-critical charging events. Figure 5 shows the reliability of our model in EV behavior prediction. This graph shows that for Tesla fleet, more than 75% of vehicles have reliable days prediction, more than 85% the entire studying period. For 25% of vehicles, 70% to 85% of days, we have reliable predictions. Likewise, for Chevrolet Bolts, the results show that for 75% of vehicles, we have a reliable prediction for more than 80% of the studying period. For 25% of our Chevrolet Bolts, we have a reliable prediction on 70% to 80% of days.

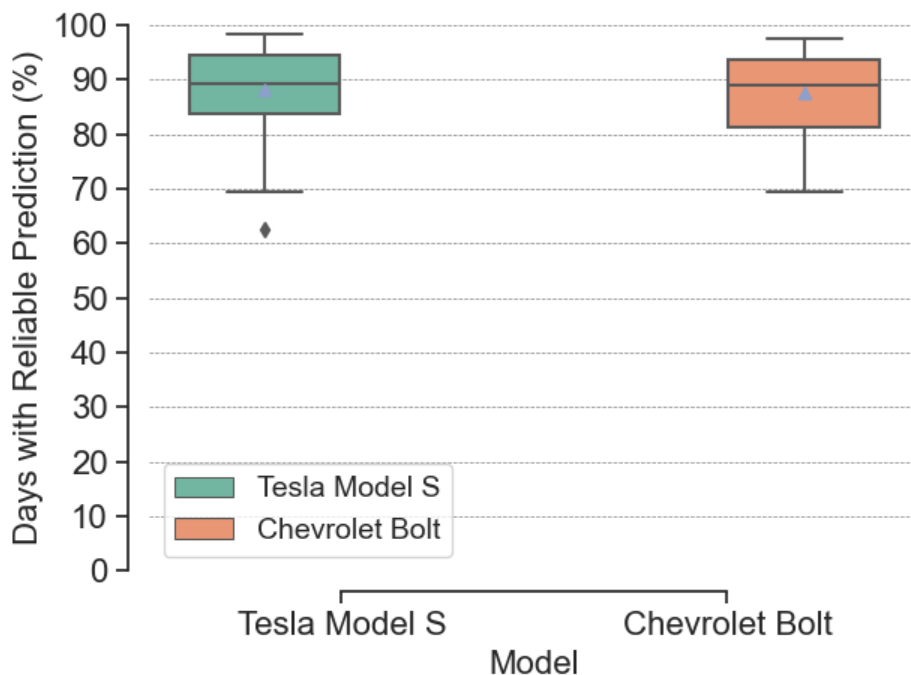

Figure 5. Prediction reliability.

Discussion

In this study, we introduced a DNN tool that determines non-critical charging sessions for individual EVs based on their predicted future travel behavior. The model utilized an LSTM network to predict the two-day ahead VMT of individual EVs; the energy required for the EVs to meet their predicted VMT determines which charging sessions are critical and which are not. Drivers can use this tool to shift non-critical charging sessions from high carbon intensity hours to low carbon intensity hours without significantly disrupting their travel routines, enabling the transportation sector to maximize the emission reduction potential of EVs and reach sustainability goals.

We empirically demonstrated the potential benefits of our tool by determining and shifting non-critical charging sessions recorded in a year-long travel dataset from 66 BEVs. As illustrated in Figure 6, we find that determining and omitting non-critical charging sessions reduced the total number of charging days i.e., the count of days with at least one charging session, for all EVs. We also explore the emission benefits of skipping, moving, or merging non-critical charging sessions, finding that there was up to 34% overall reduction in GHGs for all BEVs when non-critical sessions were moved to low carbon intensity hours. We find that this reduction did not drastically change when varying the charging rates of the sessions.

We conducted an analysis using two different charging rates to determine the most effective charging rate: a typical Level 2 charger with a power output of 6.6kW and a higher power output of 19kW. By employing these charging rates, we aimed to identify the most ideal charging rate that aligns with renewable energy availability and minimizes GHG emissions. We conducted an analysis to evaluate the potential benefits of our proposed DNN tool in achieving sustainable and environmentally friendly charging sessions for BEVs. Figure 6 demonstrates a comparison between two different charging rates (6kW and 19kW) and their impact on number of charging days for drivers. Although the 19kW Level 2 charger shows a slightly higher reduction in the number of charging days, further investigation is needed to determine its practical implications and cost-effectiveness since installing a 19kW charger is 5 times more expensive than a standard 6.6kW charger. This is mainly due to the requirement for utility grid updates, which may incur additional expenses. Therefore, it is crucial to carefully consider the feasibility and overall benefits of installing the Level 2 19kW charger.

By strategically shifting non-critical charging sessions to hours with high penetration of renewable resources, we observed a noteworthy decrease in the frequency of charging days, regardless of charging rates. After implementing our model and using 6.6kW and 19kW chargers, the number of charging days dropped by 34% and 40%, respectively. This outcome highlights the efficacy of our proposed DL approach in effectively managing charging sessions for BEVs and aligning them with the availability of renewable energy sources. (See Figure 6)

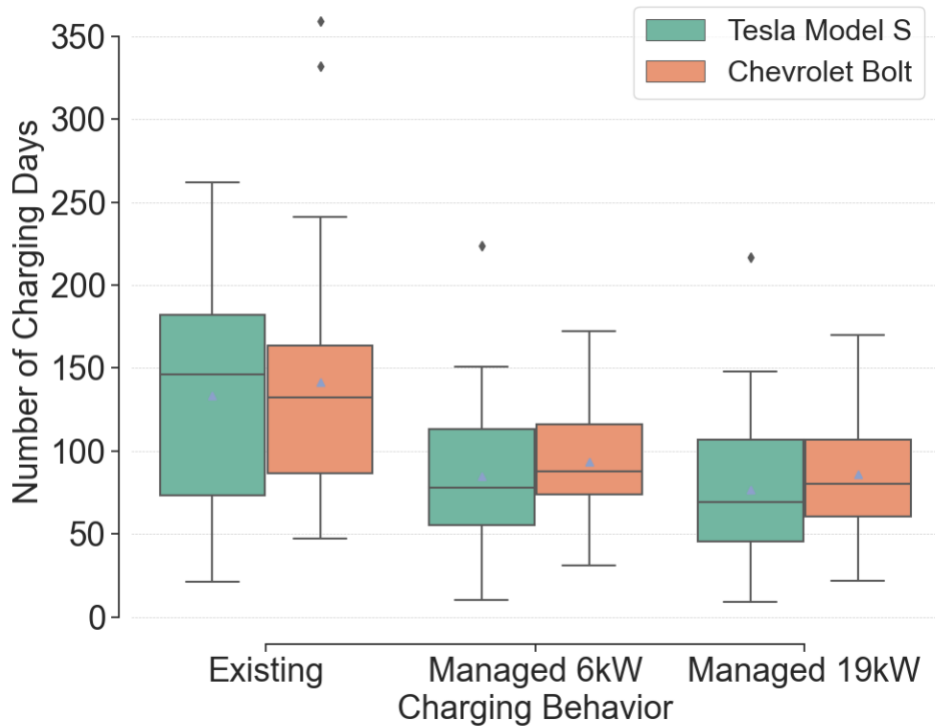

Figure 6. Number of charging days after skipping non-critical charging (CAISO).

By skipping non-critical charging events and charging during low carbon intensity hours, we can increase the reliance on renewable sources to power the EVs without disrupting drivers' routine trips. This aligns with the global efforts to transition to cleaner energy solutions and minimize environmental impact. In order to estimate the maximum emission benefits from our tool, we shifted determined non-critical charging sessions to low carbon intensity hours, which in California is typically between 8 AM and 5 PM. These hours also align with lower consumer electricity prices as peak hours are 5 PM to 9 PM (89), making this shift in charging realistically appealing to drivers. Thus, we have not considered electricity prices as a variable in our non-critical charging management problem. However, for the purpose of expanding and generalizing this study, we acknowledge the importance of incorporating electricity prices as a factor in future research, especially when considering alternative charging strategies beyond the 8 AM to 5 PM window.

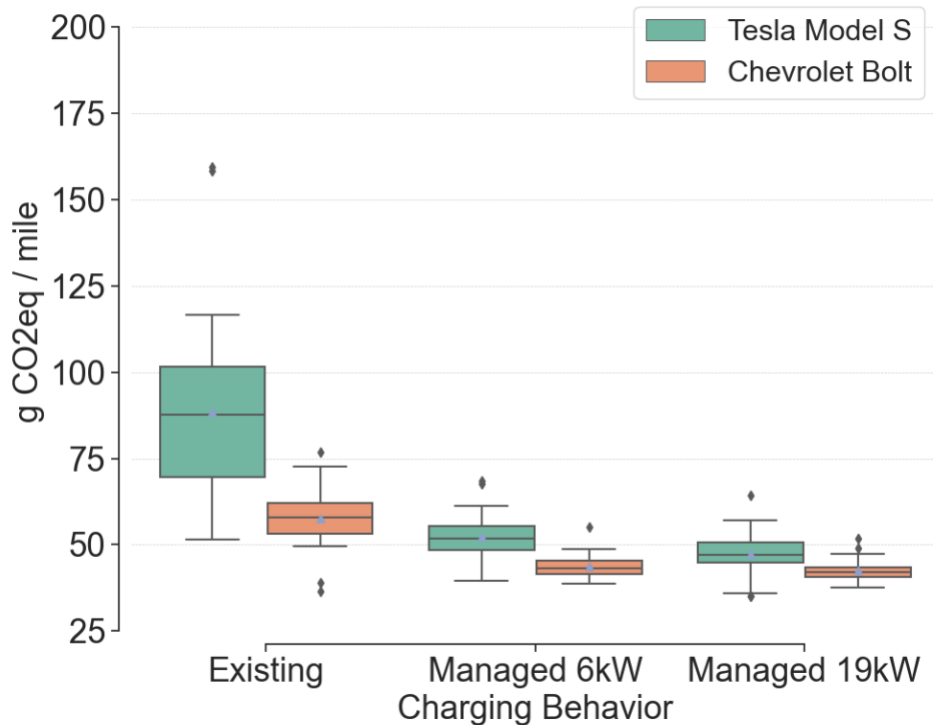
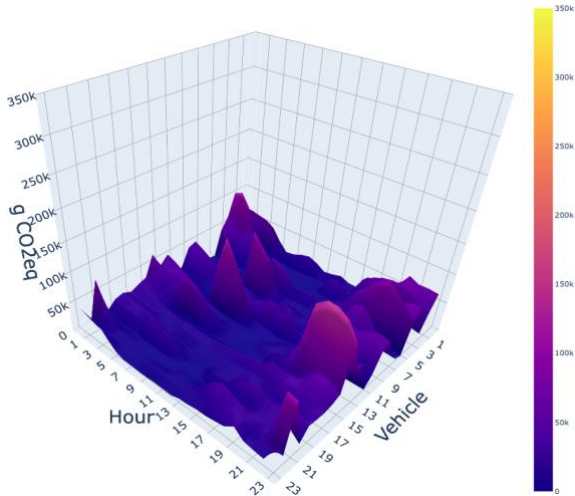

Figure 7. BEV charging emissions based on CAISO generation mix.

As illustrated in Figure 7, the results of our study reveal that employing a Level 2 charger with a 6kW capacity has the potential to reduce GHG emissions linked to BEV charging by approximately 36%. Notably, in our case study, an upgrade to a 19kW Level 2 charger could have even more substantial reductions, reaching 41%. However, this shift to non-peak less carbon intensity electricity hours can impose additional stress on the utility grid during those periods, potentially necessitating grid upgrades to accommodate this new demand.

Figure 8 provides a comprehensive overview of the total grams of CO_{2eq} emissions observed during the study period for each vehicle, drawing a comparison between the emissions generated by the actual charging events and those resulting from the utilization of our developed tool for managing the charging process. This figure illustrates the substantial potential for shifting a significant proportion of charging events to cleaner time slots, all while ensuring minimal disruption to the daily routines of drivers. This graph highlights occasional emission peaks (as depicted in Figure 8 b, c, e, f) in the managed charging events. However, the total emissions recorded in these instances remain significantly lower than those observed in the case of charging with non-managed behaviors, as evident from Figure 7.

Our goal is to shift non-critical charging sessions to less carbon intensity hours, which we define as between 8 a.m. and 5 p.m. However, Figure 8b and 8c show that charging sometimes extends beyond this window after 5pm to avoid disrupting drivers' routines behavior. This trend is especially noticeable in the first scenario, where a 6kW charger is used, which charges more slowly than a 19kW charger.



a - Existing Behavior (Chevrolet Bolt)

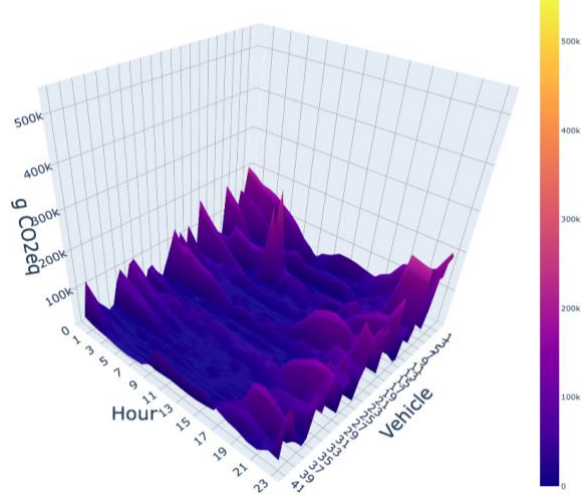

d - Existing Behavior (Tesla)

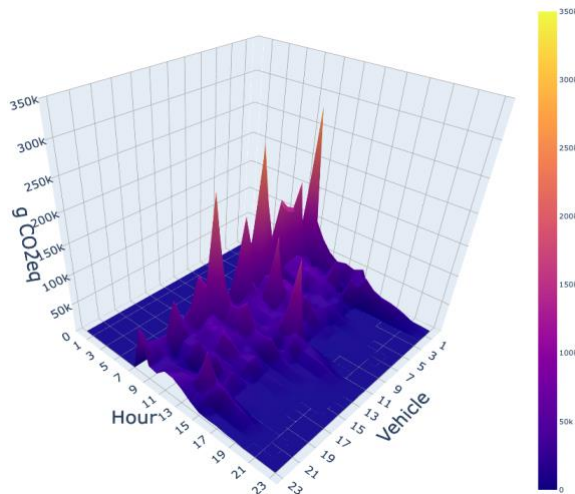

b - Managed 6kW (Chevrolet Bolt)

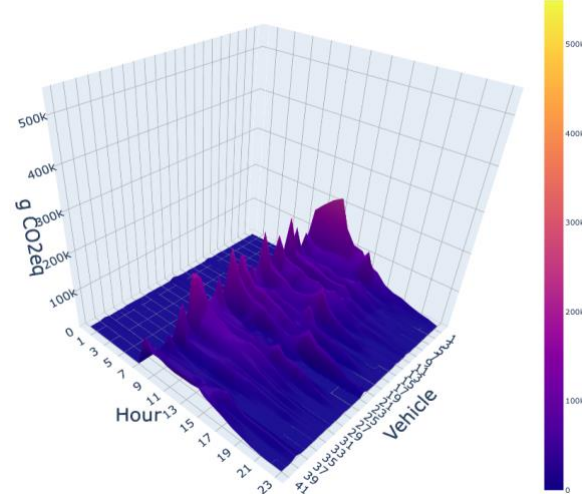

e - Managed 6kW (Tesla)

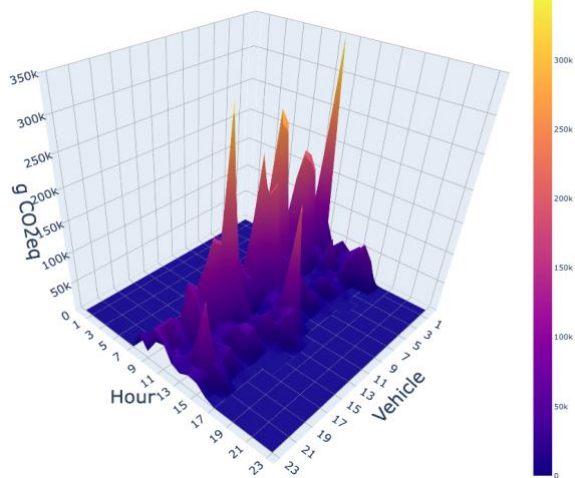

c - Managed 19kW (Chevrolet Bolt)

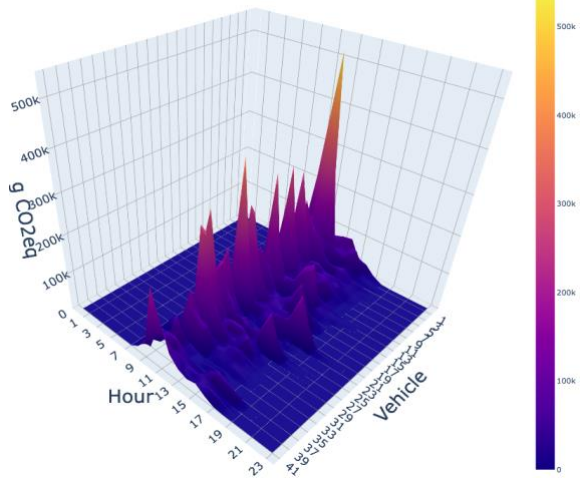

f - Managed 19kW (Tesla)

Figure 8. Annual hourly charging emission.

Despite the higher GHG emission reduction and decrease in the number of charging days associated with the 19kW Level 2 charger, it is important to consider the practical implications and cost-effectiveness of implementing such charging options. Installing 19kW chargers would require significant grid updates and infrastructure investments, which may not be feasible for all locations and could lead to higher costs. On the other hand, the 6.6kW Level 2 charger offers a more suitable and practical solution for many scenarios due to its existing infrastructure compatibility and lower installation costs (90). Thus, the 6.6kW Level 2 charger can still have considerable GHG emission reductions.

Beyond California Electricity Grid

The model we created can be used as a tool to optimize charging demand with minimal behavior change under different electricity generation conditions. To demonstrate the generalizability of our model, we estimate the maximum impact of managing BEV fleet charging in other RTOs. We wanted to see how much emissions we could save in regions with different generation mixes than California, which has a lot of solar energy. To answer this question, we selected two other RTOs in the US that have cleaner electricity at night than during the day. This allowed us to generalize our tool and see how practical it is in other regions. We chose PJM and ERCOT RTOs, which have cleaner electricity at night than in the morning. PJM is the RTO with the most installed generation capacity in the US, and ERCOT is the first RTO in North America.

Figure 9a and 9b show the number of charging days after implementing our tool and managing non-critical charging events, considering two scenarios: one with a 6.6kW charger and one with a high-power level-2 19kW charger. These figures show that even though the 19kW charger charges more than three times faster than the 6.6kW charger, the drop in the number of charging days for both fleets is approximately the same after managing non-critical charging events in both regions.

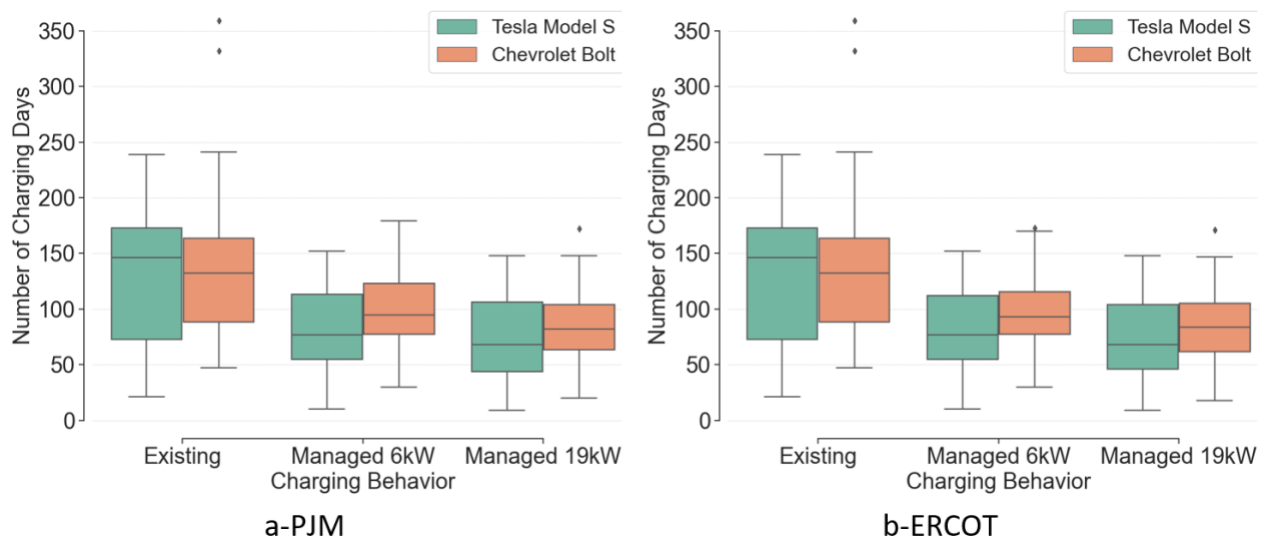

Figure 9. Charging days after skipping non-critical charging (PJM and ERCOT).

Figure 10a and 10-b show emissions from EV charging in our dataset for two regions with more fossil fuel generation and cleaner electricity at night. Even though these regions' grids are not as clean as California's grid, Figure 10a and 10b show that by managing non-critical charging events in these regions, we can reduce emissions to comparable levels to California when non-critical charging events are not managed. This means managing non-critical charging events may enable us to achieve CAISO's emission levels in the PJM and ERCOT regions in the short term before the generation mix cleans up.

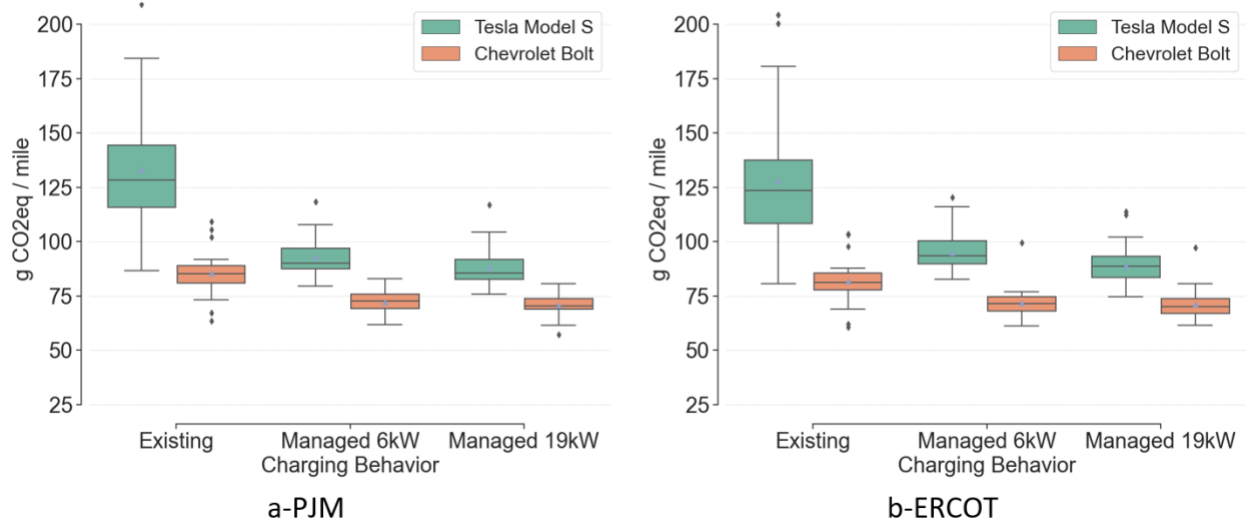

Figure 10. BEV charging emissions based on PJM and ERCOT generation mix.

Conclusions

In this study, we developed a tool using a deep LSTM network to identify non-critical charging sessions for individual electric vehicles based on their predicted future travel behavior. This tool can help individual EV drivers charge their vehicles with cleaner electricity and reduce the amount of GHG per mile. We achieved more accurate VMT predictions than benchmark models such as RNN and ARIMA. We successfully identified non-charging events that could be skipped to align future charging with renewable energy availability. Our findings demonstrate that the advanced dynamic deep LSTM model can effectively manage charging sessions, reduce dependence on non-renewable overnight charging in California, reduce the number of charging days, and thereby maximize the emission reduction potential of EVs. We simulated our tool to real-world EV data and found that if the driver follows the predicted suggestion, they can save up to 41% of the GHG emissions without changing their driving patterns.

Although our analysis showed that utilizing a Level 2 charger with 19kW demonstrated better results in terms of GHG emission reduction and charging days, it is essential to consider the associated installation cost. The higher power output of the 19kW charger would require grid updates and additional infrastructure investments, which can be economically challenging for some users. In contrast, the Level 2 charger with 6.6kW offers a more cost-effective solution, making it a suitable option for widespread adoption and implementation. Therefore, while both

charging rates offer environmental benefits, the 6.6kW charger presents a more practical and economically feasible choice for many users seeking to optimize their BEV charging sessions.

Our findings indicate that regions with less clean electricity than California can achieve similar emission levels for electric vehicle charging by managing non-critical charging events. This could serve as a temporary solution until the grid is fully cleaned and reaches its carbon neutrality target. While this study has contributed valuable insights, it is important to acknowledge the limitations of our research. Generalizing our findings to different geographical regions or charging infrastructures may require additional investigation. Factors such as charging station availability and the impact of charging demand on grid stability should be explored in future research to provide a more comprehensive understanding of sustainable charging events.

References

1. Alternative Fuels Data Center: Emissions from Electric Vehicles. https://afdc.energy.gov/vehicles/electric_emissions.html. Accessed Dec. 14, 2023.
2. Ambrose, H., A. Kendall, M. Lozano, S. Wachche, and L. Fulton. Trends in Life Cycle Greenhouse Gas Emissions of Future Light Duty Electric Vehicles. *Transportation Research Part D: Transport and Environment*, Vol. 81, 2020, p. 102287. <https://doi.org/10.1016/j.trd.2020.102287>.
3. Tamayao, M.-A. M., J. J. Michalek, C. Hendrickson, and I. M. L. Azevedo. Regional Variability and Uncertainty of Electric Vehicle Life Cycle CO₂ Emissions across the United States. *Environmental Science & Technology*, Vol. 49, No. 14, 2015, pp. 8844–8855. <https://doi.org/10.1021/acs.est.5b00815>.
4. Colmenar-Santos, A., A.-M. Muñoz-Gómez, E. Rosales-Asensio, and Á. López-Rey. Electric Vehicle Charging Strategy to Support Renewable Energy Sources in Europe 2050 Low-Carbon Scenario. *Energy*, Vol. 183, 2019, pp. 61–74. <https://doi.org/10.1016/j.energy.2019.06.118>.
5. California ISO. <https://www.caiso.com/Pages/default.aspx>. Accessed Jul. 27, 2023.
6. Hoehne, C. G., and M. V. Chester. Optimizing Plug-in Electric Vehicle and Vehicle-to-Grid Charge Scheduling to Minimize Carbon Emissions. *Energy*, Vol. 115, 2016, pp. 646–657. <https://doi.org/10.1016/j.energy.2016.09.057>.
7. Syed, M. A., and M. Khalid. Neural Network Predictive Control for Smoothing of Solar Power Fluctuations with Battery Energy Storage. *Journal of Energy Storage*, Vol. 42, 2021, p. 103014. <https://doi.org/10.1016/j.est.2021.103014>.
8. Afshar, S., Z. K. Pecenak, M. Barati, and V. Disfani. Mobile Charging Stations for EV Charging Management in Urban Areas: A Case Study in Chattanooga. *Applied Energy*, Vol. 325, 2022, p. 119901. <https://doi.org/10.1016/j.apenergy.2022.119901>.
9. Richard, R., H. Cao, and M. Wachowicz. EVStationSIM: An End-to-End Platform to Identify and Interpret Similar Clustering Patterns of EV Charging Stations across Multiple Time Slices. *Applied Energy*, Vol. 322, 2022, p. 119491. <https://doi.org/10.1016/j.apenergy.2022.119491>.
10. Guo, S., P. Li, K. Ma, B. Yang, and J. Yang. Robust Energy Management for Industrial Microgrid Considering Charging and Discharging Pressure of Electric Vehicles. *Applied Energy*, Vol. 325, 2022, p. 119846. <https://doi.org/10.1016/j.apenergy.2022.119846>.
11. Hipolito, F., C. A. Vandet, and J. Rich. Charging, Steady-State SoC and Energy Storage Distributions for EV Fleets. *Applied Energy*, Vol. 317, 2022, p. 119065. <https://doi.org/10.1016/j.apenergy.2022.119065>.
12. Mandev, A., P. Plötz, F. Sprei, and G. Tal. Empirical Charging Behavior of Plug-in Hybrid Electric Vehicles. *Applied Energy*, Vol. 321, 2022, p. 119293. <https://doi.org/10.1016/j.apenergy.2022.119293>.

13. Zhou, W., X. Cai, Y. Chen, J. Li, and X. Peng. Decoding the Optimal Charge Depletion Behavior in Energy Domain for Predictive Energy Management of Series Plug-in Hybrid Electric Vehicle. *Applied Energy*, Vol. 316, 2022, p. 119098. <https://doi.org/10.1016/j.apenergy.2022.119098>.
14. Rangaraju, S., L. De Vroey, M. Messagie, J. Mertens, and J. Van Mierlo. Impacts of Electricity Mix, Charging Profile, and Driving Behavior on the Emissions Performance of Battery Electric Vehicles: A Belgian Case Study. *Applied Energy*, Vol. 148, 2015, pp. 496–505. <https://doi.org/10.1016/j.apenergy.2015.01.121>.
15. Rao, R., X. Zhang, J. Xie, and L. Ju. Optimizing Electric Vehicle Users' Charging Behavior in Battery Swapping Mode. *Applied Energy*, Vol. 155, 2015, pp. 547–559. <https://doi.org/10.1016/j.apenergy.2015.05.125>.
16. Jahangir, H., H. Tayarani, A. Ahmadian, M. A. Golkar, J. Miret, M. Tayarani, and H. O. Gao. Charging Demand of Plug-in Electric Vehicles: Forecasting Travel Behavior Based on a Novel Rough Artificial Neural Network Approach. *Journal of Cleaner Production*, Vol. 229, 2019, pp. 1029–1044. <https://doi.org/10.1016/j.jclepro.2019.04.345>.
17. Arias, M. B., M. Kim, and S. Bae. Prediction of Electric Vehicle Charging-Power Demand in Realistic Urban Traffic Networks. *Applied Energy*, Vol. 195, 2017, pp. 738–753. <https://doi.org/10.1016/j.apenergy.2017.02.021>.
18. Zacharopoulos, L., N. Thonemann, M. Dumeier, and J. Geldermann. Environmental Optimization of the Charge of Battery Electric Vehicles. *Applied Energy*, Vol. 329, 2023, p. 120259. <https://doi.org/10.1016/j.apenergy.2022.120259>.
19. Mohseni, S., R. Khalid, and A. C. Brent. Stochastic, Resilience-Oriented Optimal Sizing of off-Grid Microgrids Considering EV-Charging Demand Response: An Efficiency Comparison of State-of-the-Art Metaheuristics. *Applied Energy*, Vol. 341, 2023, p. 121007. <https://doi.org/10.1016/j.apenergy.2023.121007>.
20. Cedillo, M. H., H. Sun, J. Jiang, and Y. Cao. Dynamic Pricing and Control for EV Charging Stations with Solar Generation. *Applied Energy*, Vol. 326, 2022, p. 119920. <https://doi.org/10.1016/j.apenergy.2022.119920>.
21. Sørensen, Å. L., B. Ludvigsen, and I. Andresen. Grid-Connected Cabin Preheating of Electric Vehicles in Cold Climates – A Non-Flexible Share of the EV Energy Use. *Applied Energy*, Vol. 341, 2023, p. 121054. <https://doi.org/10.1016/j.apenergy.2023.121054>.
22. Boulakhbar, M., M. Farag, K. Benabdelaziz, T. Kousksou, and M. Zazi. A Deep Learning Approach for Prediction of Electrical Vehicle Charging Stations Power Demand in Regulated Electricity Markets: The Case of Morocco. *Cleaner Energy Systems*, Vol. 3, 2022, p. 100039. <https://doi.org/10.1016/j.cles.2022.100039>.
23. Imara, M. N. F., and K. M. Liyanage. Electrical Vehicle Charging Demand Prediction Using Wavelet Based Analysis. Presented at the 2017 IEEE International Conference on Industrial and Information Systems (ICIIS), 2017.

24. Shanmuganathan, J., A. A. Victoire, G. Balraj, and A. Victoire. Deep Learning LSTM Recurrent Neural Network Model for Prediction of Electric Vehicle Charging Demand. *Sustainability*, Vol. 14, No. 16, 2022, p. 10207. <https://doi.org/10.3390/su141610207>.
25. Shahriar, S., A. R. Al-Ali, A. H. Osman, S. Dhou, and M. Nijim. Prediction of EV Charging Behavior Using Machine Learning. *IEEE Access*, Vol. 9, 2021, pp. 111576–111586. <https://doi.org/10.1109/ACCESS.2021.3103119>.
26. Almaghrebi, A., F. Aljuheshi, M. Rafeaie, K. James, and M. Alahmad. Data-Driven Charging Demand Prediction at Public Charging Stations Using Supervised Machine Learning Regression Methods. *Energies*, Vol. 13, No. 16, 2020, p. 4231. <https://doi.org/10.3390/en13164231>.
27. Jeon, Y.-E., S.-B. Kang, and J.-I. Seo. Hybrid Predictive Modeling for Charging Demand Prediction of Electric Vehicles. *Sustainability*, Vol. 14, No. 9, 2022, p. 5426. <https://doi.org/10.3390/su14095426>.
28. Park, M., Z. Wang, L. Li, and X. Wang. Multi-Objective Building Energy System Optimization Considering EV Infrastructure. *Applied Energy*, Vol. 332, 2023, p. 120504. <https://doi.org/10.1016/j.apenergy.2022.120504>.
29. Park, K., and I. Moon. Multi-Agent Deep Reinforcement Learning Approach for EV Charging Scheduling in a Smart Grid. *Applied Energy*, Vol. 328, 2022, p. 120111. <https://doi.org/10.1016/j.apenergy.2022.120111>.
30. Gharibi, M. A., H. Nafisi, H. Askarian-abyaneh, and A. Hajizadeh. Deep Learning Framework for Day-Ahead Optimal Charging Scheduling of Electric Vehicles in Parking Lot. *Applied Energy*, Vol. 349, 2023, p. 121614. <https://doi.org/10.1016/j.apenergy.2023.121614>.
31. Cui, D., Z. Wang, P. Liu, S. Wang, Y. Zhao, and W. Zhan. Stacking Regression Technology with Event Profile for Electric Vehicle Fast Charging Behavior Prediction. *Applied Energy*, Vol. 336, 2023, p. 120798. <https://doi.org/10.1016/j.apenergy.2023.120798>.
32. Powell, S., G. V. Cezar, and R. Rajagopal. Scalable Probabilistic Estimates of Electric Vehicle Charging given Observed Driver Behavior. *Applied Energy*, Vol. 309, 2022, p. 118382. <https://doi.org/10.1016/j.apenergy.2021.118382>.
33. Chung, Y.-W., B. Khaki, T. Li, C. Chu, and R. Gadh. Ensemble Machine Learning-Based Algorithm for Electric Vehicle User Behavior Prediction. *Applied Energy*, Vol. 254, 2019, p. 113732. <https://doi.org/10.1016/j.apenergy.2019.113732>.
34. Jin, Y., M. Amoasi Acquah, M. Seo, S. Ghorbanpour, S. Han, and T. Jyung. Optimal EV Scheduling and Voltage Security via an Online Bi-Layer Steady-State Assessment Method Considering Uncertainties. *Applied Energy*, Vol. 347, 2023, p. 121356. <https://doi.org/10.1016/j.apenergy.2023.121356>.
35. Chaudhari, K., N. K. Kandasamy, A. Krishnan, A. Ukil, and H. B. Gooi. Agent-Based Aggregated Behavior Modeling for Electric Vehicle Charging Load. *IEEE Transactions on Industrial Informatics*, Vol. 15, No. 2, 2019, pp. 856–868. <https://doi.org/10.1109/TII.2018.2823321>.

36. Zhao, Y., Z. Wang, Z.-J. M. Shen, and F. Sun. Data-Driven Framework for Large-Scale Prediction of Charging Energy in Electric Vehicles. *Applied Energy*, Vol. 282, 2021, p. 116175. <https://doi.org/10.1016/j.apenergy.2020.116175>.
37. Wang, K., H. Wang, Z. Yang, J. Feng, Y. Li, J. Yang, and Z. Chen. A Transfer Learning Method for Electric Vehicles Charging Strategy Based on Deep Reinforcement Learning. *Applied Energy*, Vol. 343, 2023, p. 121186. <https://doi.org/10.1016/j.apenergy.2023.121186>.
38. Sadeghi, S., H. Jahangir, B. Vatandoust, M. A. Golkar, A. Ahmadian, and A. Elkamel. Optimal Bidding Strategy of a Virtual Power Plant in Day-Ahead Energy and Frequency Regulation Markets: A Deep Learning-Based Approach. *International Journal of Electrical Power & Energy Systems*, Vol. 127, 2021, p. 106646. <https://doi.org/10.1016/j.ijepes.2020.106646>.
39. Gougheri, S. S., H. Jahangir, M. A. Golkar, A. Ahmadian, and M. Aliakbar Golkar. Optimal Participation of a Virtual Power Plant in Electricity Market Considering Renewable Energy: A Deep Learning-Based Approach. *Sustainable Energy, Grids and Networks*, Vol. 26, 2021, p. 100448. <https://doi.org/10.1016/j.segan.2021.100448>.
40. Schmidt, M., P. Staudt, and C. Weinhardt. Evaluating the Importance and Impact of User Behavior on Public Destination Charging of Electric Vehicles. *Applied Energy*, Vol. 258, 2020, p. 114061. <https://doi.org/10.1016/j.apenergy.2019.114061>.
41. Daneshzand, F., P. J. Coker, B. Potter, and S. T. Smith. EV Smart Charging: How Tariff Selection Influences Grid Stress and Carbon Reduction. *Applied Energy*, Vol. 348, 2023, p. 121482. <https://doi.org/10.1016/j.apenergy.2023.121482>.
42. Li, Z., and C. Ma. A Temporal–Spatial Charging Coordination Scheme Incorporating Probability of EV Charging Availability. *Applied Energy*, Vol. 325, 2022, p. 119838. <https://doi.org/10.1016/j.apenergy.2022.119838>.
43. Tian, J., Y. Lv, Q. Zhao, Y. Gong, C. Li, H. Ding, and Y. Yu. Electric Vehicle Charging Load Prediction Considering the Orderly Charging. *Energy Reports*, Vol. 8, 2022, pp. 124–134. <https://doi.org/10.1016/j.egyr.2022.10.068>.
44. Arias, M. B., and S. Bae. Electric Vehicle Charging Demand Forecasting Model Based on Big Data Technologies. *Applied Energy*, Vol. 183, 2016, pp. 327–339. <https://doi.org/10.1016/j.apenergy.2016.08.080>.
45. Amini, M. H., A. Kargarian, and O. Karabasoglu. ARIMA-Based Decoupled Time Series Forecasting of Electric Vehicle Charging Demand for Stochastic Power System Operation. *Electric Power Systems Research*, Vol. 140, 2016, pp. 378–390. <https://doi.org/10.1016/j.epsr.2016.06.003>.
46. Ai, S., A. Chakravorty, and C. Rong. Household EV Charging Demand Prediction Using Machine and Ensemble Learning. Presented at the 2018 IEEE International Conference on Energy Internet (ICEI), 2018.

47. Bai, X., Z. Wang, L. Zou, H. Liu, Q. Sun, and F. E. Alsaadi. Electric Vehicle Charging Station Planning with Dynamic Prediction of Elastic Charging Demand: A Hybrid Particle Swarm Optimization Algorithm. *Complex & Intelligent Systems*, Vol. 8, No. 2, 2022, pp. 1035–1046. <https://doi.org/10.1007/s40747-021-00575-8>.
48. Zhou, S., Y. Han, K. Mahmoud, M. M. F. Darwish, M. Lehtonen, P. Yang, and A. S. Zalhaf. A Novel Unified Planning Model for Distributed Generation and Electric Vehicle Charging Station Considering Multi-Uncertainties and Battery Degradation. *Applied Energy*, Vol. 348, 2023, p. 121566. <https://doi.org/10.1016/j.apenergy.2023.121566>.
49. Xing, Q., Z. Chen, Z. Zhang, X. Huang, Z. Leng, K. Sun, Y. Chen, and H. Wang. Charging Demand Forecasting Model for Electric Vehicles Based on Online Ride-Hailing Trip Data. *IEEE Access*, Vol. 7, 2019, pp. 137390–137409. <https://doi.org/10.1109/ACCESS.2019.2940597>.
50. Pagani, M., W. Korosec, N. Chokani, and R. S. Abhari. User Behaviour and Electric Vehicle Charging Infrastructure: An Agent-Based Model Assessment. *Applied Energy*, Vol. 254, 2019, p. 113680. <https://doi.org/10.1016/j.apenergy.2019.113680>.
51. Cui, L., Q. Wang, H. Qu, M. Wang, Y. Wu, and L. Ge. Dynamic Pricing for Fast Charging Stations with Deep Reinforcement Learning. *Applied Energy*, Vol. 346, 2023, p. 121334. <https://doi.org/10.1016/j.apenergy.2023.121334>.
52. Zhang, J., Z. Wang, E. J. Miller, D. Cui, P. Liu, and Z. Zhang. Charging Demand Prediction in Beijing Based on Real-World Electric Vehicle Data. *Journal of Energy Storage*, Vol. 57, 2023, p. 106294. <https://doi.org/10.1016/j.est.2022.106294>.
53. Wang, S., C. Zhuge, C. Shao, P. Wang, X. Yang, and S. Wang. Short-Term Electric Vehicle Charging Demand Prediction: A Deep Learning Approach. *Applied Energy*, Vol. 340, 2023, p. 121032. <https://doi.org/10.1016/j.apenergy.2023.121032>.
54. Majidpour, M. *Time Series Prediction for Electric Vehicle Charging Load and Solar Power Generation in the Context of Smart Grid*. UCLA, 2016.
55. Huber, J., D. Dann, and C. Weinhardt. Probabilistic Forecasts of Time and Energy Flexibility in Battery Electric Vehicle Charging. *Applied Energy*, Vol. 262, 2020, p. 114525. <https://doi.org/10.1016/j.apenergy.2020.114525>.
56. Tayarani, H., H. Jahangir, R. Nadafianshamabadi, M. Aliakbar Golkar, A. Ahmadian, and A. Elkamel. Optimal Charging of Plug-In Electric Vehicle: Considering Travel Behavior Uncertainties and Battery Degradation. *Applied Sciences*, Vol. 9, No. 16, 2019, p. 3420. <https://doi.org/10.3390/app9163420>.
57. Gilanifar, M., H. Wang, L. M. K. Sriram, E. E. Ozguven, and R. Arghandeh. Multitask Bayesian Spatiotemporal Gaussian Processes for Short-Term Load Forecasting. *IEEE Transactions on Industrial Electronics*, Vol. 67, No. 6, 2020, pp. 5132–5143. <https://doi.org/10.1109/TIE.2019.2928275>.

58. Aasim, S. N. Singh, and A. Mohapatra. Repeated Wavelet Transform Based ARIMA Model for Very Short-Term Wind Speed Forecasting. *Renewable Energy*, Vol. 136, 2019, pp. 758–768. <https://doi.org/10.1016/j.renene.2019.01.031>.
59. Palhares, R. M., Y. Yuan, and Q. Wang. Artificial Intelligence in Industrial Systems. *IEEE Transactions on Industrial Electronics*, Vol. 66, No. 12, 2019, pp. 9636–9640. <https://doi.org/10.1109/TIE.2019.2916709>.
60. Rafiei, M., T. Niknam, J. Aghaei, M. Shafie-Khah, and J. P. S. Catalão. Probabilistic Load Forecasting Using an Improved Wavelet Neural Network Trained by Generalized Extreme Learning Machine. *IEEE Transactions on Smart Grid*, Vol. 9, No. 6, 2018, pp. 6961–6971. <https://doi.org/10.1109/TSG.2018.2807845>.
61. Huang, C., L. Wang, and L. L. Lai. Data-Driven Short-Term Solar Irradiance Forecasting Based on Information of Neighboring Sites. *IEEE Transactions on Industrial Electronics*, Vol. 66, No. 12, 2019, pp. 9918–9927. <https://doi.org/10.1109/TIE.2018.2856199>.
62. Rusk, N. Deep Learning. *Nature Methods*, Vol. 13, No. 1, 2016, pp. 35–35. <https://doi.org/10.1038/nmeth.3707>.
63. LeCun, Y., Y. Bengio, and G. Hinton. Deep Learning. *Nature*, Vol. 521, No. 7553, 2015, pp. 436–444. <https://doi.org/10.1038/nature14539>.
64. Jahangir, H., H. Tayarani, S. Baghali, A. Ahmadian, A. Elkamel, M. A. Golkar, and M. Castilla. A Novel Electricity Price Forecasting Approach Based on Dimension Reduction Strategy and Rough Artificial Neural Networks. *IEEE Transactions on Industrial Informatics*, Vol. 16, No. 4, 2020, pp. 2369–2381. <https://doi.org/10.1109/TII.2019.2933009>.
65. Hoori, A. O., A. A. Kazzaz, R. Khimani, Y. Motai, and A. J. Aved. Electric Load Forecasting Model Using a Multicolumn Deep Neural Networks. *IEEE Transactions on Industrial Electronics*, Vol. 67, No. 8, 2020, pp. 6473–6482. <https://doi.org/10.1109/TIE.2019.2939988>.
66. Zou, W., C. Li, and P. Chen. An Inter Type-2 FCR Algorithm Based T–S Fuzzy Model for Short-Term Wind Power Interval Prediction. *IEEE Transactions on Industrial Informatics*, Vol. 15, No. 9, 2019, pp. 4934–4943. <https://doi.org/10.1109/TII.2019.2910606>.
67. Cui, M., M. Khodayar, C. Chen, X. Wang, Y. Zhang, and M. E. Khodayar. Deep Learning-Based Time-Varying Parameter Identification for System-Wide Load Modeling. *IEEE Transactions on Smart Grid*, Vol. 10, No. 6, 2019, pp. 6102–6114. <https://doi.org/10.1109/TSG.2019.2896493>.
68. Zhou, Y., F.-J. Chang, L.-C. Chang, I.-F. Kao, and Y.-S. Wang. Explore a Deep Learning Multi-Output Neural Network for Regional Multi-Step-Ahead Air Quality Forecasts. *Journal of Cleaner Production*, Vol. 209, 2019, pp. 134–145. <https://doi.org/10.1016/j.jclepro.2018.10.243>.
69. Deb, C., F. Zhang, J. Yang, S. E. Lee, and K. W. Shah. A Review on Time Series Forecasting Techniques for Building Energy Consumption. *Renewable and Sustainable Energy Reviews*, Vol. 74, 2017, pp. 902–924. <https://doi.org/10.1016/j.rser.2017.02.085>.

70. Rahimi, Z. H., and M. Khashei. A Least Squares-Based Parallel Hybridization of Statistical and Intelligent Models for Time Series Forecasting. *Computers & Industrial Engineering*, Vol. 118, 2018, pp. 44–53. <https://doi.org/10.1016/j.cie.2018.02.023>.
71. Jahangir, H., M. A. Golkar, F. Alhameli, A. Mazouz, A. Ahmadian, and A. Elkamel. Short-Term Wind Speed Forecasting Framework Based on Stacked Denoising Auto-Encoders with Rough ANN. *Sustainable Energy Technologies and Assessments*, Vol. 38, 2020, p. 100601. <https://doi.org/10.1016/j.seta.2019.100601>.
72. Jiang, H., Y. Zhang, E. Muljadi, J. J. Zhang, and D. W. Gao. A Short-Term and High-Resolution Distribution System Load Forecasting Approach Using Support Vector Regression With Hybrid Parameters Optimization. *IEEE Transactions on Smart Grid*, Vol. 9, No. 4, 2018, pp. 3341–3350. <https://doi.org/10.1109/TSG.2016.2628061>.
73. Ali, M. Z., M. N. S. K. Shabbir, X. Liang, Y. Zhang, and T. Hu. Machine Learning-Based Fault Diagnosis for Single- and Multi-Faults in Induction Motors Using Measured Stator Currents and Vibration Signals. *IEEE Transactions on Industry Applications*, Vol. 55, No. 3, 2019, pp. 2378–2391. <https://doi.org/10.1109/TIA.2019.2895797>.
74. Wen, L., K. Zhou, S. Yang, and X. Lu. Optimal Load Dispatch of Community Microgrid with Deep Learning Based Solar Power and Load Forecasting. *Energy*, Vol. 171, 2019, pp. 1053–1065. <https://doi.org/10.1016/j.energy.2019.01.075>.
75. Shrestha, A., and A. Mahmood. Review of Deep Learning Algorithms and Architectures. *IEEE Access*, Vol. 7, 2019, pp. 53040–53065. <https://doi.org/10.1109/ACCESS.2019.2912200>.
76. Liu, C.-L., W.-H. Hsaio, and Y.-C. Tu. Time Series Classification With Multivariate Convolutional Neural Network. *IEEE Transactions on Industrial Electronics*, Vol. 66, No. 6, 2019, pp. 4788–4797. <https://doi.org/10.1109/TIE.2018.2864702>.
77. Tan, Y., and G. Zhao. Transfer Learning With Long Short-Term Memory Network for State-of-Health Prediction of Lithium-Ion Batteries. *IEEE Transactions on Industrial Electronics*, Vol. 67, No. 10, 2020, pp. 8723–8731. <https://doi.org/10.1109/TIE.2019.2946551>.
78. Kong, W., Z. Y. Dong, Y. Jia, D. J. Hill, Y. Xu, and Y. Zhang. Short-Term Residential Load Forecasting Based on LSTM Recurrent Neural Network. *IEEE Transactions on Smart Grid*, Vol. 10, No. 1, 2019, pp. 841–851. <https://doi.org/10.1109/TSG.2017.2753802>.
79. Toubreau, J.-F., J. Bottieau, F. Vallée, and Z. De Grève. Deep Learning-Based Multivariate Probabilistic Forecasting for Short-Term Scheduling in Power Markets. *IEEE Transactions on Power Systems*, Vol. 34, No. 2, 2019, pp. 1203–1215. <https://doi.org/10.1109/TPWRS.2018.2870041>.
80. Tong, W., L. Li, X. Zhou, A. Hamilton, and K. Zhang. Deep Learning PM2.5 Concentrations with Bidirectional LSTM RNN. *Air Quality, Atmosphere & Health*, Vol. 12, No. 4, 2019, pp. 411–423. <https://doi.org/10.1007/s11869-018-0647-4>.

81. Ma, X., J. Zhang, B. Du, C. Ding, and L. Sun. Parallel Architecture of Convolutional Bi-Directional LSTM Neural Networks for Network-Wide Metro Ridership Prediction. *IEEE Transactions on Intelligent Transportation Systems*, Vol. 20, No. 6, 2019, pp. 2278–2288. <https://doi.org/10.1109/TITS.2018.2867042>.
82. Jahangir, H., H. Tayarani, S. S. Gougheri, M. A. Golkar, A. Ahmadian, and A. Elkamel. Deep Learning-Based Forecasting Approach in Smart Grids With Microclustering and Bidirectional LSTM Network. *IEEE Transactions on Industrial Electronics*, Vol. 68, No. 9, 2021, pp. 8298–8309. <https://doi.org/10.1109/TIE.2020.3009604>.
83. Tal, G., V. C. Karanam, M. P. Favetti, K. M. Sutton, J. M. Ogunmayin, S. S. Raghavan, C. Nitta, D. Chakraborty, A. Davis, and D. Garas. Emerging Technology Zero Emission Vehicle Household Travel and Refueling Behavior. 2021.
84. Brownlee, J. *Statistical Methods for Machine Learning: Discover How to Transform Data into Knowledge with Python*. Machine Learning Mastery, 2018.
85. Open Grid Emissions. *Singularity*. <https://singularity.energy/open-grid-emissions>. Accessed Jul. 18, 2023.
86. Welcome to Python.Org. *Python.org*. <https://www.python.org/>. Accessed Jul. 19, 2023.
87. TensorFlow. <https://www.tensorflow.org/>. Accessed Jul. 19, 2023.
88. Goodfellow, I., Y. Bengio, and A. Courville. *Deep Learning*. MIT Press, 2016.
89. PG&E, Pacific Gas and Electric - Gas and Power Company for California. <https://www.pge.com/>. Accessed Jul. 19, 2023.
90. Marika. EV Charging Stations — Level 2 Charging. *CleanTechnica*. <https://cleantechnica.com/2021/12/12/ev-charging-stations-level-2-charging/>. Accessed Jul. 24, 2023.

Data Summary

Products of Research

Additional data labels were created by performing calculations on data collected from eVMT project (CARB Contract 12- 319). As specified in the DMP, the additional data labels are not of use without the restricted eVMT data; however, they have been archived on the Dryad data repository and are available at <https://doi.org/10.5061/dryad.6wwpzgn60>. The complete labeled data will not be made publicly available as the original eVMT data is not publicly available. The eVMT data contains information that if made public could result in loss of confidentiality of participants. Christopher Nitta will be responsible for overseeing the management of this new data.

Data Format and Content

The complete data resides in a database and will be exported to CSV format for ease of backup/archiving and migration to another database.

Data Access and Sharing

The data has only been provided to team members who have completed IRB training. The collected raw data was used to generate labeled trip data. The additional labelling of the data did not create any new privacy issues, all potential confidential information already resided in the eVMT data that had been collected. The data that resides in the database was already de-identified to contain only IDs for vehicles. A separate data set is necessary to personally identify vehicle owner.

Reuse and Redistribution

The Institute of Transportation Studies of the University of California, Davis will continue to hold the IP rights to the raw eVMT data. The partial training data will not be transferred as the training data will only be useful when combined with the current eVMT data. The eVMT data contains information that if made public could result in loss of confidentiality of participants of CARB Contract 12-319. We plan to examine if the original training data (or significant portions of it) can be reconstructed from the trained models. Researchers have demonstrated that is it possible in some instances to reconstruct significant fractions of the training data from a trained neural network¹. If we can systematically demonstrate that there will not be a loss of confidentiality of the eVMT participants, then we will make the trained models publicly available.

¹ Haim, Niv, et al. "Reconstructing training data from trained neural networks." *Advances in Neural Information Processing Systems* 35, 2022.