

Lawrence Berkeley National Laboratory

Recent Work

Title

The LBL Advanced Light Source (ALS) Transverse Coupled-Bunch Feedback System - Recent Commissioning Results

Permalink

<https://escholarship.org/uc/item/7663d4vg>

Authors

Barry, W.

Byrd, J.

Corlett, J.

Publication Date

1994-10-01



Lawrence Berkeley Laboratory

UNIVERSITY OF CALIFORNIA

Accelerator & Fusion Research Division

Presented at the Beam Instrumentations Workshop,
Vancouver, Canada, October 2-6, 1994, and to be
published in the Proceedings

The LBL Advanced Light Source (ALS) Transverse Coupled-Bunch Feedback System— Recent Commissioning Results

W. Barry, J. Byrd, and J. Corlett

October 1994

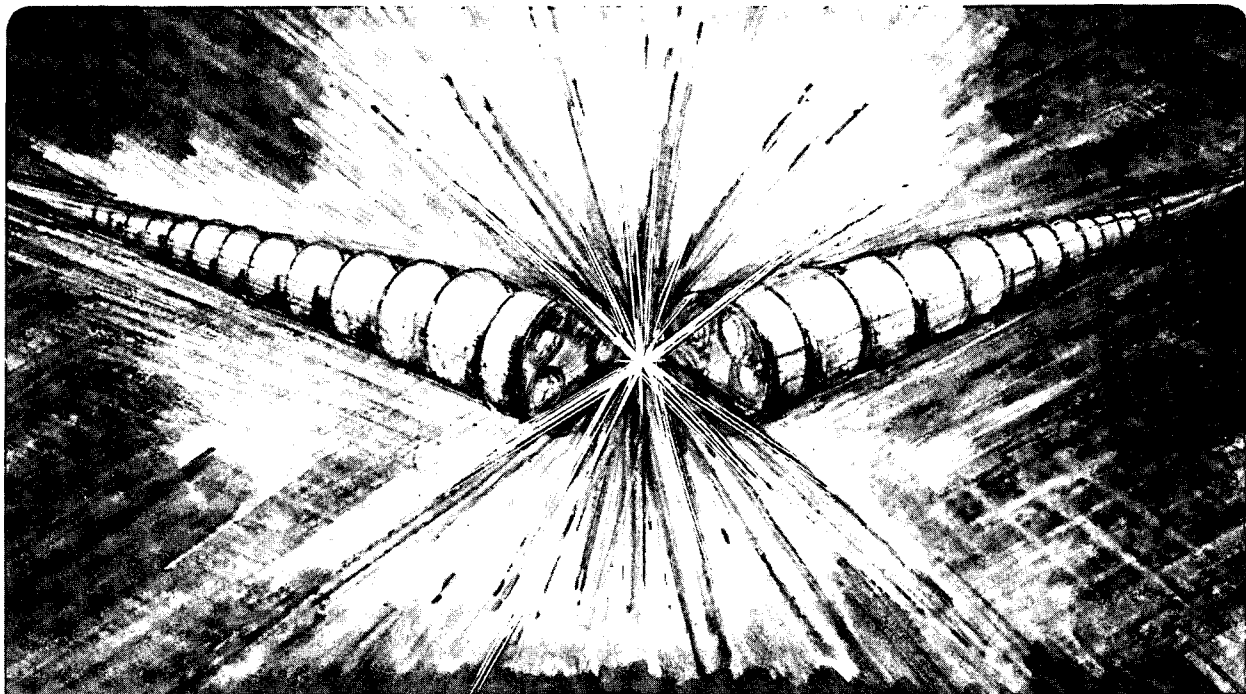

REFERENCE COPY
Does Not
Circulate
Bldg. 50 Library.
Copy 1
LBL-36279

DISCLAIMER

This document was prepared as an account of work sponsored by the United States Government. While this document is believed to contain correct information, neither the United States Government nor any agency thereof, nor the Regents of the University of California, nor any of their employees, makes any warranty, express or implied, or assumes any legal responsibility for the accuracy, completeness, or usefulness of any information, apparatus, product, or process disclosed, or represents that its use would not infringe privately owned rights. Reference herein to any specific commercial product, process, or service by its trade name, trademark, manufacturer, or otherwise, does not necessarily constitute or imply its endorsement, recommendation, or favoring by the United States Government or any agency thereof, or the Regents of the University of California. The views and opinions of authors expressed herein do not necessarily state or reflect those of the United States Government or any agency thereof or the Regents of the University of California.

**The LBL Advanced Light Source (ALS) Transverse Coupled-Bunch Feedback System —
Recent Commissioning Results***

W. Barry, J. Byrd and J. Corlett

Center for Beam Physics
Accelerator and Fusion Research Division
Lawrence Berkeley Laboratory
University of California
Berkeley, CA 94720

* This work was supported by the Director, Office of Energy Research, Office of Basic Energy Sciences, Materials Sciences Division, of the U.S. Department of Energy under Contract No. DE-AC03-76SF00098.

The LBL Advanced Light Source (ALS) Transverse Coupled-Bunch Feedback System - Recent Commissioning Results*

W. Barry, J. Byrd, J. Corlett
*Center for Beam Physics
Lawrence Berkeley Laboratory
Berkeley, California, 94720*

Abstract

The ALS transverse coupled-bunch feedback system is described along with some recent commissioning results. Results presented include transfer function measurements, demonstrations of multi-bunch damping, and demonstrations of simultaneous transverse and longitudinal systems operation.

INTRODUCTION

The LBL Advanced Light Source (ALS) is a third generation 1.5 GeV storage ring for producing synchrotron radiation in the .5 - 10000 eV range [1]. Because of the high average beam current (400 mA) and large number of bunches (328 in buckets separated by 2 nsec), a broad spectrum of transverse coupled-bunch modes can be excited by higher-order cavity resonances and the resistive wall impedance. In order to control growth of this coupled-bunch motion, a 250 MHz bandwidth bunch-by-bunch feedback system has been designed and partially commissioned at ALS.

The feedback system specifications and design are described in references [2] and [3]. In this paper, recent commissioning results are emphasized with only a brief overview of the system presented for orientation.

SYSTEM OVERVIEW

A block diagram of the ALS transverse feedback system is shown in Fig. 1. The system bandwidth is nominally 250 MHz which corresponds to half the maximum bunch rate of 500 MHz. In this case, horizontal and vertical beam moment signals (ΔX) are detected at the pickups on a bunch-by-bunch basis and used to correct the transverse beam motion. As shown, moment signals from two sets of pickups are summed in proper proportion to obtain a correction signal which is in quadrature with beam position at the kickers. This technique results in optimal damping and is adjustable to allow for arbitrary changes in tune.

The beam moment signals are detected as amplitude modulation of the $n=6$ (3 GHz) harmonic of the bunch rate in order to exploit the good sensitivity of the button pickups at this frequency. In contrast to the pickups, the stripline kickers operate at baseband (10 kHz - 250 MHz) where their efficiency is greatest. The moment signals are demodulated to baseband with microwave receivers which can be configured

*This work was supported by the Director, Office of Energy Research, Office of Basic Energy Sciences, Materials Sciences Division, of the U.S. Department of Energy under contract No. DE-AC03-76SF00098.

for either heterodyne or homodyne detection. The nominal detection mode is heterodyne. In this case, the moment signals are demodulated with a 3 GHz local oscillator signal which is phase-locked to the storage ring RF. At times, it may be desirable to operate the transverse feedback system in the presence of large synchrotron oscillations, i.e., in the absence of longitudinal damping. In this case, the oscillating arrival time of the bunches with respect to a fixed-phase local oscillator causes reduction and a possible sign change in the average feedback gain [4]. For this operating scenario, homodyne demodulation which employs a local oscillator signal derived from the sum of the four button signals is used.

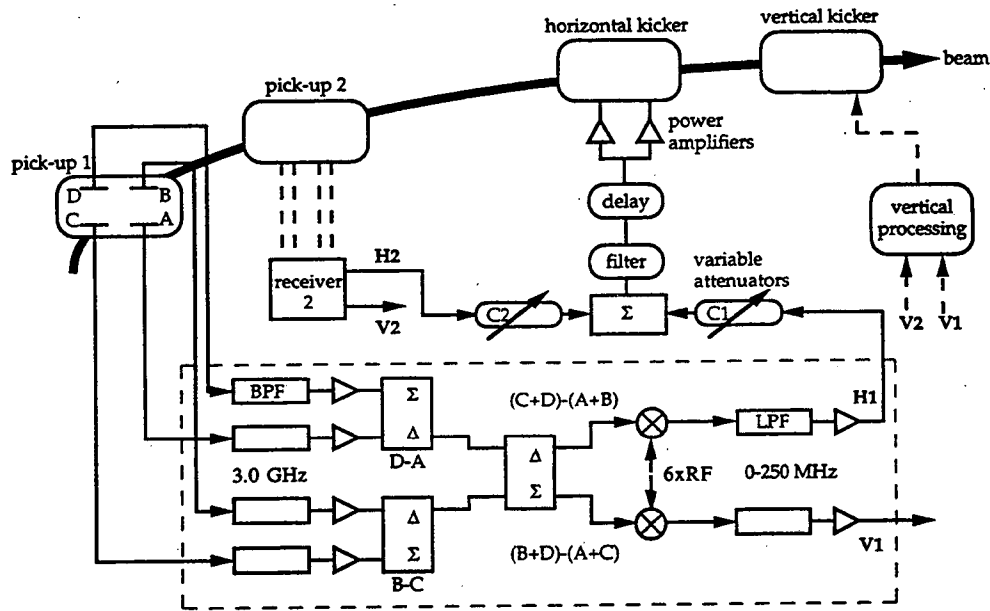

Figure 1. ALS transverse feedback system.

Baseband processing includes proportional mixing of the two pickup signals with attenuators, C1 and C2, and simple two-tap coaxial-cable notch filters for rejecting orbit harmonic signals. In addition, simple coaxial delays are used for timing the kick signals with respect to the bunch arrival times at the kickers. Four 150 W, 10 kHz - 220 MHz, class-A, commercial power amplifiers are used to drive each electrode of each kicker separately (300 W per kicker). The amplifier/kicker combination provides per-turn kicks ranging from 2.3 kV at 100 kHz to 1.6 kV at 220 MHz. At the nominal betatron tunes, these voltages and frequency range are sufficient to control any expected transverse coupled-bunch motion.

INITIAL COMMISSIONING RESULTS

At present, the pickups, kickers, receivers, one of two notch filters, and two of four power amps are installed and operating at ALS. The chassis for mixing the two pickup signals, the remaining notch filter, and the controls interface are under construction and nearing completion. The results reported here were obtained with a partial system consisting of a single pickup and receiver operating in the horizontal or vertical plane. In this case, a single electrode of the horizontal or vertical kicker was

driven as part of the feedback system. The other electrodes were used for driving the beam with the tracking generator of a spectrum analyzer to make transfer function measurements.

Setup and timing of the system is typically done in single-bunch mode. In addition, the first transfer function measurements were done with a single bunch in the ring. Figure 2a shows the beam transfer function amplitude for a single 2 mA bunch about a particular horizontal betatron line with and without the feedback system turned on. In this case, the receiver was configured in heterodyne mode. The open-loop gain of the feedback system, given approximately by the ratio of the feedback on/off responses, in this case, is about 20 dB. This is in fact a lower bound on the gain because the line widths are artificially broadened by the resolution bandwidth of the spectrum analyzer and tune jitter. The same measurement was performed with the receiver operating in homodyne mode at a lower gain as shown in Fig. 2b. Note that in both cases, the resonance is shifted upwards in frequency with the feedback on.

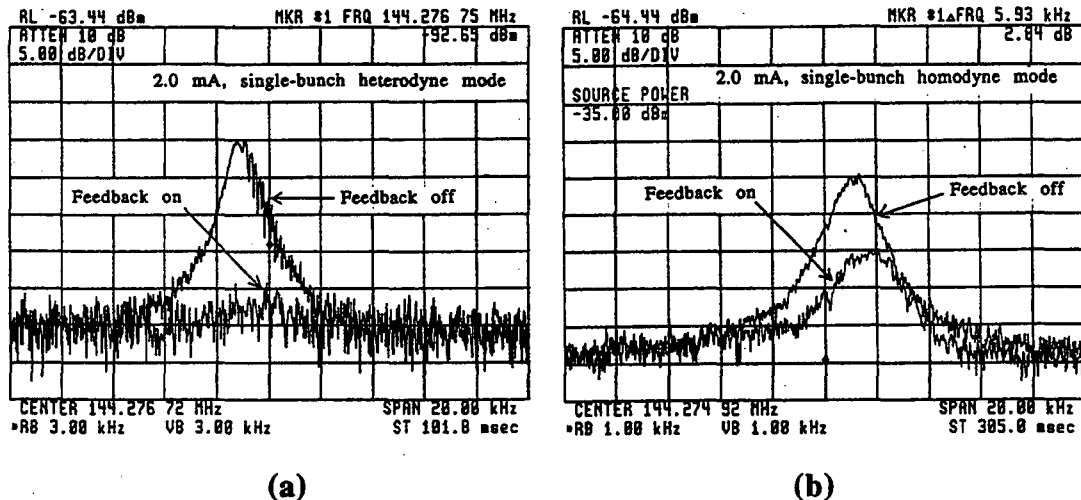

Figure 2. Single-bunch horizontal transfer functions.

This is because the single-pickup system can not meet the kick/position quadrature condition at the kicker. The result is a change in complex resonant frequency which manifests itself as a reduction in Q and a tune shift. The full two-pickup system can be adjusted to utilize the full gain to address only the damping component of the complex resonant frequency for any tune setting. A demonstration of gain control in single-bunch-heterodyne mode appears in Fig. 3a. Finally, a single-bunch demonstration of damping in the vertical plane is shown in Fig. 3b.

An example of multi-bunch damping is shown in Fig. 4. In this case, a 220 mA beam in 82 equally spaced (every fourth) buckets gives rise to significant spontaneous coupled-bunch motion as evidenced by the betatron sideband spectrum with the feedback turned off. With the feedback system on in homodyne mode, the motion is reduced to levels below the noise floor of the spectrum analyzer. The horizontal axes in Fig. 4 are in units of revolution frequency and have a range of 41 which covers one fourth of the 250 MHz baseband and all possible coupled-bunch modes for this fill pattern. Similar results under these conditions were obtained in heterodyne mode. In order to exercise the full bandwidth of the system, the

measurement of Fig. 4 was repeated with 320 bunches at 385 mA which is approximately the nominal ALS beam. The results, shown in Fig. 5, indicate complete damping of all but possibly one low-frequency mode. At present, investigations as to whether this line is actually a coupled-bunch mode or a spurious signal are ongoing.

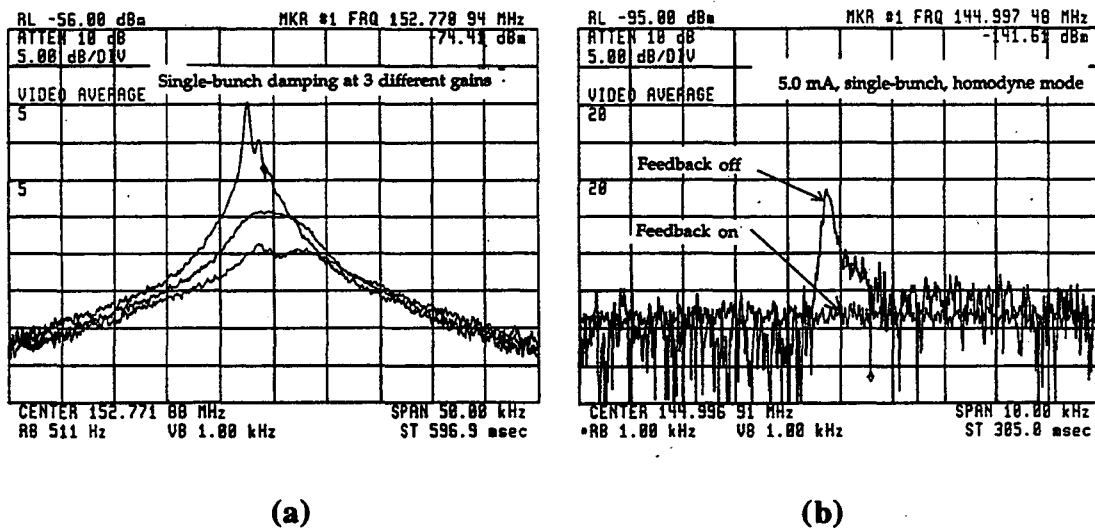

Figure 3. Gain control and vertical transfer function.

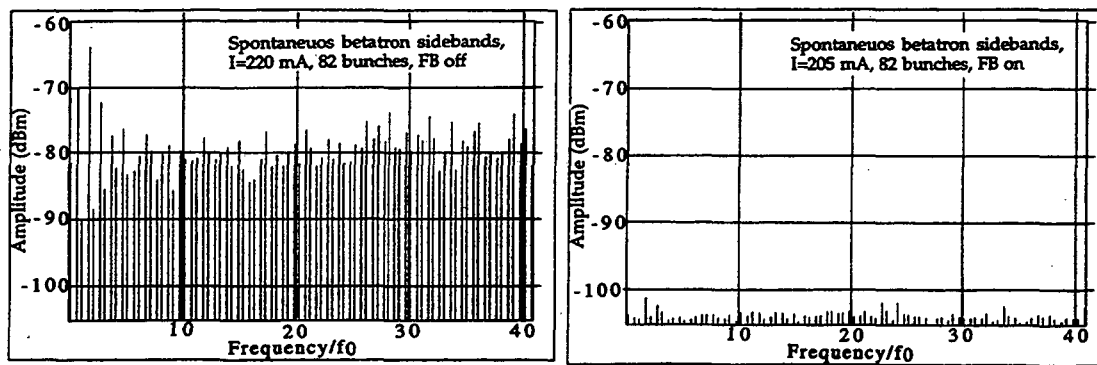

Figure 4. Horizontal multi-bunch damping, 82 bunches, 220 mA.

When transverse coupled-bunch modes are driven by oscillatory impedances such as higher-order modes in the RF cavities, large synchrotron oscillations can have a strong damping effect. Basically, this effect is the same as the gain dilution effect in the heterodyne demodulation technique. That is, the oscillating arrival time of a bunch at the impedance causes the phase of the excitation to be different on every turn resulting in a reduction in the average kick received by the bunch. In addition, with non-zero chromaticity, energy oscillations cause a bunch-by-bunch spread in tune which weakens bunch-to-bunch coupling in the transverse plane. If the synchrotron

oscillations are large enough, these effects can cause a significant decrease in the growth rates of transverse modes and possibly prevent growth of modes which would otherwise be unstable. These effects have been clearly seen at ALS during testing of

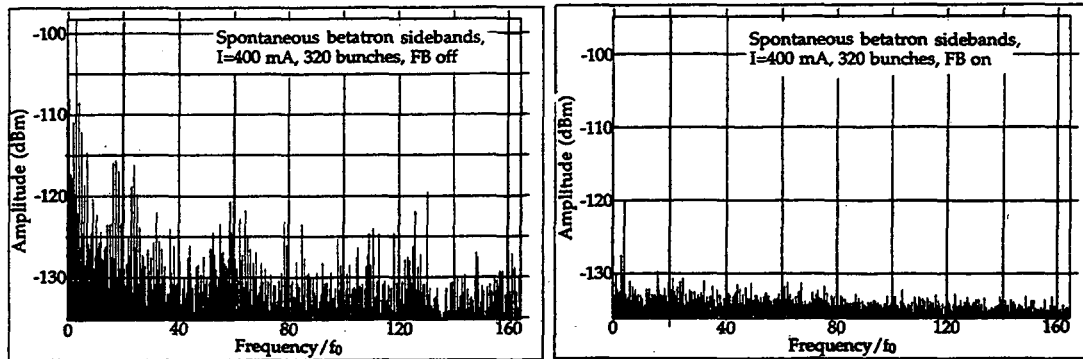

Figure 5. Horizontal multi-bunch damping, 320 bunches, 385 mA.

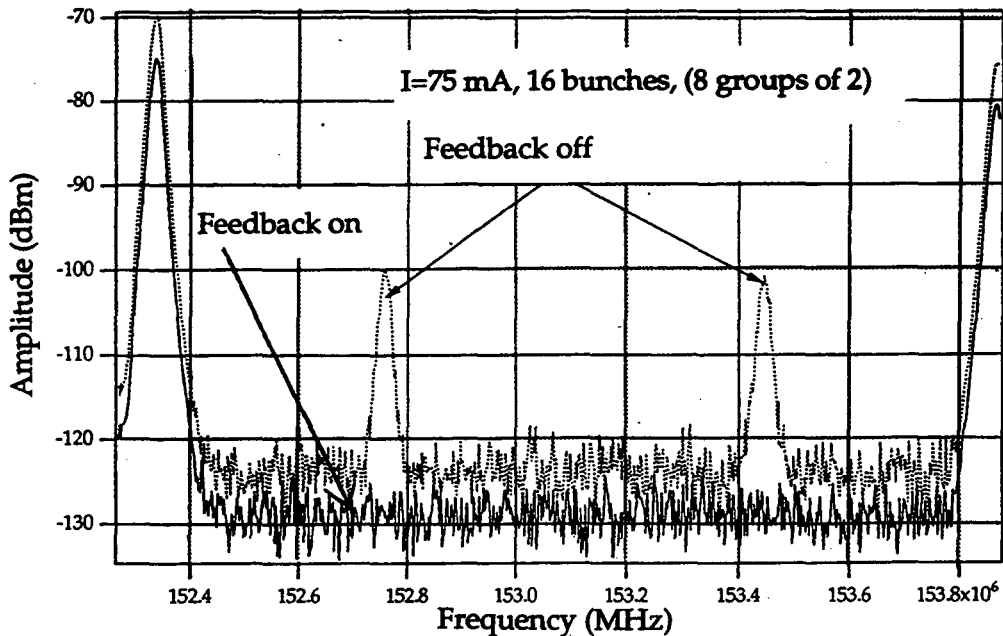

Figure 6. Transverse damping with longitudinal system operating.

the longitudinal feedback system [5]. At moderate currents (> 70 mA), strong betatron sidebands are present when the longitudinal system has damped the longitudinal coupled-bunch motion. In the absence of longitudinal damping, these lines are weak or not present at all. Therefore, an important aspect of the transverse system is its performance in conjunction with the longitudinal system. Presently, efforts are under way to characterize the simultaneous performance of the longitudinal and transverse systems with the first results shown in Fig. 6. Here, strong spontaneous betatron sidebands which appeared while operating the longitudinal system are completely damped by the transverse system. The fill pattern consisted of 16 bunches in 8 groups

of (2 separated by 4 nsec) spaced equally around the ring with an average current of 75 mA.

CONCLUSION

Significant progress in the commissioning of the ALS transverse feedback system has taken place. In particular, damping of transverse oscillations in both planes has been demonstrated with a single pickup system. In addition, testing of the system in conjunction with the longitudinal system has begun with very encouraging initial results. Present efforts are being directed towards the continued testing of the two systems simultaneously and the commissioning of the full two pickup transverse system.

ACKNOWLEDGMENTS

The authors wish to thank the many members of the LBL/SLAC - ALS/PEP-II feedback systems collaboration for many enlightening discussions and useful suggestions.

REFERENCES

1. "1 - 2 GeV Synchrotron Radiation Source", CDR, LBL Pub-5172 Rev., July, 1986.
2. W. Barry, J. Byrd, J. Corlett, G.R. Lambertson, and C.C. Lo, "Transverse Coupled-Bunch Feedback in The Advanced Light Source (ALS)", Proceedings of the 1994 European Particle Accelerator Conference, London, England, June 27 - July 1, 1994.
3. W. Barry, J. Byrd, J. Corlett, J. Hinkson, J. Johnson, and G. Lambertson, "Design of The ALS Transverse Coupled-Bunch Feedback System", Proceedings of the 1993 IEEE Particle Accelerator Conference, Washington, D.C., May 1993.
4. W. Barry, "Stability of a Heterodyne-Based Transverse Feedback System in the Presence of Synchrotron Oscillations", CBP Tech Note-58, LBL, July, 1994.
5. J. Fox, H. Hindi, I. Linscott, J. Olsen, G. Oxoby, L. Sapozhnikov, D. Teytelman, A. Drago, M. Serio, J. Byrd, and J. Corlett, "Operation and Performance of a Longitudinal Damping System Using Digital Signal Processing", Proceedings of the 1994 Beam Instrumentation Workshop, Vancouver, B.C., October 1994 (to be published).

LAWRENCE BERKELEY LABORATORY
UNIVERSITY OF CALIFORNIA
TECHNICAL INFORMATION DEPARTMENT
BERKELEY, CALIFORNIA 94720