

UCLA

UCLA Previously Published Works

Title

A Game Theory-Based Energy Management System Using Price Elasticity for Smart Grids

Permalink

<https://escholarship.org/uc/item/72z6z771>

Journal

IEEE Transactions on Industrial Informatics, 11(6)

ISSN

1551-3203

Authors

Wang, Kun
Ouyang, Zhiyou
Krishnan, Rahul
[et al.](#)

Publication Date

2015-12-01

DOI

10.1109/tii.2015.2426015

Peer reviewed

A Game Theory-Based Energy Management System Using Price Elasticity for Smart Grids

Kun Wang, *Member, IEEE*, Zhiyou Ouyang, Rahul Krishnan, Lei Shu, *Member, IEEE*,
and Lei He, *Senior Member, IEEE*

Abstract—Distributed devices in smart grid systems are decentralized and connected to the power grid through different types of equipment transmit, which will produce numerous energy losses when power flows from one bus to another. One of the most efficient approaches to reduce energy losses is to integrate distributed generations (DGs), mostly renewable energy sources. However, the uncertainty of DG may cause instability issues. Additionally, due to the similar consumption habits of customers, the peak load period of power consumption may cause congestion in the power grid and affect the energy delivery. Energy management with DG regulation is considered to be one of the most efficient solutions for solving these instability issues. In this paper, we consider a power system with both distributed generators and customers, and propose a distributed locational marginal pricing (DLMP)-based unified energy management system (uEMS) model, which, unlike previous works, considers both increasing profit benefits for DGs and increasing stability of the distributed power system (DPS). The model contains two parts: 1) a game theory-based loss reduction allocation (LRA); and 2) a load feedback control (LFC) with price elasticity. In the former component, we develop an iterative loss reduction method using DLMP to remunerate DGs for their participation in energy loss reduction. By using iterative LRA to calculate energy loss reduction, the model accurately rewards DG contribution and offers a fair competitive market. Furthermore, the overall profit of all DGs is maximized by utilizing game theory to calculate an optimal LRA scheme for calculating the distributed loss of every DG in each time slot. In the latter component of the model, we propose an LFC submodel with price elasticity, where a DLMP feedback signal is calculated by customer demand to regulate peak-load value. In uEMS, LFC first determines the DLMP signal of a customer bus by a time-shift load optimization (LO)

algorithm based on the changes of customer demand, which is fed back to the DLMP of the customer bus at the next slot-time, allowing for peak-load regulation via price elasticity. Results based on the IEEE 37-bus feeder system show that the proposed uEMS model can increase DG benefits and improve system stability.

Index Terms—Demand response, feedback control, game theory, loss reduction, optimization theory, price elasticity, smart grid.

NOMENCLATURE

DG	Distribution generation.
DPS	Distribution power system.
DLMP	Distribution locational marginal price.
DUC	Distribution utility company.
uEMS	Unified energy management system.
LMP	Locational marginal price.
PDR	Price demand response.
SE	Self-elasticity.
CE	Cross-elasticity.
ECS	Energy control system.
ECD	Energy consumption device.
LRA	Loss reduction allocation.
LFC	Load feedback control.
PDF	Probability density function.
LO	Load optimization.

I. INTRODUCTION

THE SMART grid is seen as the best approach in modernization of electric power systems [1], and the DPS is one of the most significant parts [2]. The decentralized devices in the DPS will produce high system loss, while power flow transmit from one bus to another through the branch or some power devices such as substation, and the similar power-consuming habit of customer, which is the main reason to cause peak-load period of power consumption, may aggravate the loss reduction problem. Thus, energy management system should be designed to dynamically adapt to DPS by controlling and regulating distributed devices to make power systems more effective and reliable. As for the application of energy management, using load forecasting to regulate energy distribution in microgrid is very hot in recent research. The authors in [3]–[5] presented an electric load forecast architectural model to integrate distributed renewable sources. This is to balance the power generation of companies and demand of customers.

Integration of DGs in DPS could greatly enhance the competitiveness power of distributed companies in a competitive environment and provide benefits for energy loss reduction and

Manuscript received August 22, 2014; revised December 22, 2014; accepted April 09, 2015. Date of publication April 23, 2015; date of current version December 02, 2015. This work was supported in part by the National Science Foundation of China under Grant 61100213, Grant 61170276, and Grant 61401107; in part by the Specialized Research Fund for the Doctoral Program of Higher Education (SFDPH) under Grant 20113223120007; in part by the National Science Foundation of Jiangsu Province under Grant BK20141427; in part by the Huawei Innovation Research Program under Grant YB2014010048; in part by the Nanjing University of Posts and Telecommunications (NUPT) under Grant NY214097 and Grant XJKY14011; in part by the 2013 Special Fund of Guangdong Higher School Talent Recruitment; and in part by the 2013 Top Level Talents Project in “Sailing Plan” of Guangdong Province. Paper no. TII-14-0888. (*Corresponding author: Lei Shu.*)

K. Wang and Z. Ouyang are with the Institute of Advanced Technology, Nanjing University of Posts and Telecommunications, Nanjing 210003, China (e-mail: kwang@njupt.edu.cn; ouyang@njupt.edu.cn).

R. Krishnan and L. He are with the Department of Electrical Engineering, University of California Los Angeles, Los Angeles, CA 90095 USA (e-mail: lhe@ee.ucla.edu).

L. Shu is with the Guangdong Provincial Key Laboratory of Petrochemical Equipment Fault Diagnosis, Guangdong University of Petrochemical Technology, Guangdong 525000, China (e-mail: lei.shu@ieee.org).

Color versions of one or more of the figures in this paper are available online at <http://ieeexplore.ieee.org>

Digital Object Identifier 10.1109/TII.2015.2426015

improve stability in the grid [6], [7]. The benefit of DGs in this paper is mainly considered as the net profit of DGs. Nodal pricing is one of the most effective mechanism in a DPS [8] to reduce losses and regulate DG generation, and the LMP is the most studied and developed method to detect nodal prices [9]–[12]. Generally, LMP is originally used in transmission systems. However, if this term is applied in the case of DPS, it is referred as DLMP. In this paper, we take the original node price calculated by the wholesale market price as LMP. Then, the node price calculated by uEMS after integrating LFC signal is seen as DLMP.

LMP in DPS consists of three parts: 1) cost related to providing energy (LMP energy); 2) cost of congestion (LMP congestion); and 3) cost burden to the system due to losses (LMP losses) [7], [9], [10], such as line losses and substation consumption. Moreover, congestion is generally not considered because of the radial topology of a DPS, which commonly feeds from one point [7]. Consequently, LMP in a DPS mainly includes energy price and distributed losses, and the energy price is commonly decided by the reference bus; hence, the key factor to provide fair competition environment is to fairly allocate the distributed losses among market participants.

LMP can provide an efficient economic signal for DG owners and investors to regulate their produced amount of energy with a pretty reasonable perspective [7]–[10]. The authors in [7] proposed that DLMP signal can be used to regulate DGs and used for LRA with game theory. In [13], DLMP signal was also used to control loads and energy storage devices. In addition, using demand response as a price signal to stabilize a DPS is well studied in several works [14]–[18]. In [14], demand response used to generate DLMP signal as feedback was discussed. Using demand response to reduce peak demand was studied in [15]. In [16], the management of energy system in smart grid was introduced to improve energy efficiency by demand response. The authors in [17] focused on smoothing energy consumption and reducing peak demand. Demand response in a real-time balancing market clearing with pay-as-bid pricing was studied in [18].

In the above-mentioned works, the common goals of energy management in DPS are to solve problems including loss reduction, benefit increasing, reduced losses allocation, feedback control, and system stability. The general user scenario for DPS with DGs and consumption devices connected can be summarized in Fig. 1.

In this paper, a DLMP-based uEMS is proposed, which optimizes both loss reduction for maximum DG benefit and load feedback for system stability. The features of uEMS are as follows:

- 1) using price signals as communication and control tools;
- 2) using DLMP with LRA to calculate and allocate system losses;
- 3) employing game theory to allocate DG in order to reduce system loss considering the DLMP and DG's cost function;
- 4) considering LFC with price elasticity to stabilize the system and reduce peak load and price.

To this end, the major contribution of our work is summarized that it is the first time to propose a uEMS considering both

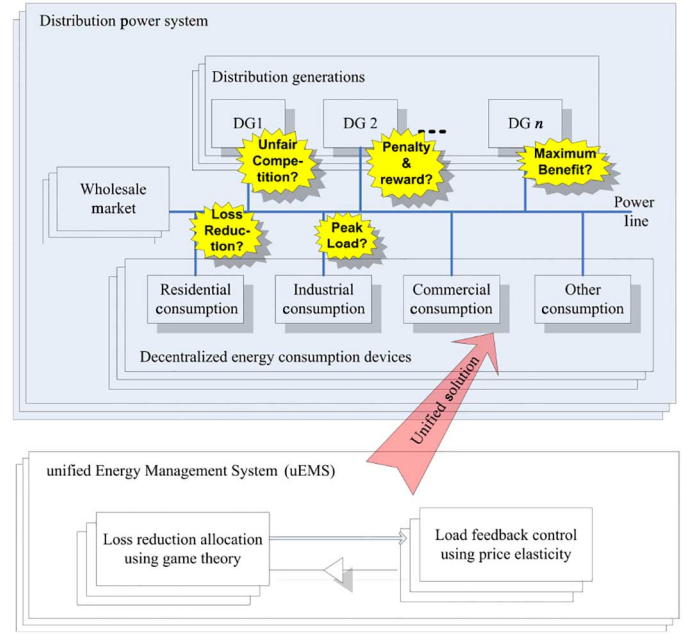

Fig. 1. User scenario in a DPS.

LRA and LFC. This paper uses DLMP as an economic signal to control and regulate DPSs.

This paper is organized as follows. In Section II, the theoretical approaches for uEMS are reviewed. In Section III, a system model is presented. In Sections IV and V, game theory-based LRA and DLMP feedback control using price elasticity are described in detail. In Section VI, the uncertainty in uEMS is investigated and results based on a modified IEEE 37-bus feeder system are provided. In Section VII, we conclude this paper.

II. REVIEW OF THEORETICAL APPROACHES

A. Existing LRA Method

In this section, the existing LRA method for DPS is briefly reviewed. In [7], a novel distributed class LMP method for LRA using game theory was proposed to increase the total DG benefit by clearly calculating energy loss reduction. In [8], a novel LRA method was proposed for a DPS connected with DGs, which shows that the contribution of a DG resource can significantly reduce energy losses. All these works are based on the distributed losses for each bus using LMP. The proposed nodal price for a DPS at time t can be described as follows:

$$d_t = u_t \left(1 + u_t \frac{\partial \text{Loss}_t}{\partial P_t} \right) \quad (1)$$

where u represents the price at reference bus and d is the price at nonreference buses. Loss denotes the energy loss and P represents the active power. Shapley, Aumann–Shapley, and nucleolus-based methods are the most common methods of game theory approaches in solving LRA in DPS. In this paper, Shapley value method has been chosen for solving LRA problem due to its good performance and simplicity of implementation [7]. According to [7], the Shapley value of a game v

is the average of the marginal vectors and can be represented as follows:

$$\varphi_i(v) = \sum_{i \in s} W(|s|) \times [v(s) - v(s - i)] \quad (2)$$

$$W(|s|) = \frac{(n - |s|)! \times (|s| - 1)!}{n!} \quad (3)$$

where i represents the DG player taking part in reduced amount of losses, $|s|$ is the number of members within each coalition, and n is the total number of players in the game. $v(s - i)$ is the reduced amount of losses related to coalition s when player i does not participate. $W(|s|)$ is the weighting factor of the Shapley value.

B. Existing Demand Response Method

It is challenging for a DPS to balance energy supply and load, because both may change rapidly and unexpectedly from different factors such as customer demand. The pricing signal is considered as one of the dominant approaches for energy flow control and energy management [14] that uses demand-side response to operate the system due to the price elasticity mechanism. In [19], the demand-side management to reduce peak-to-average ratio was introduced in smart grid. The elasticity of the load demand was discussed extensively in [20] and can be defined as follows in a DPS:

$$E = \left(\frac{\Delta L}{L_0} \right) \left(\frac{LMP_0}{\Delta LMP} \right) \quad (4)$$

where ΔL is the change of load while L_0 is the nominal operating level of load, LMP_0 is the nominal price of energy (cents/kWh), and ΔLMP is the change in LMP. Assuming that the change in LMP is small and the demand response is linear, then for a given E , the demand response model can generate a corresponding load response according to the change in LMP.

In terms of load response, two kinds of elasticity are considered: 1) SE; and 2) CE [14]. SE is the part of load response due to concurrent change in price, whereas CE denotes the load response due to preceding change in price. In a realistic scenario for a DPS, some price-incentive devices have the capability to detect nodal prices and schedule power consumption correspondingly, which could be considered as SE. On the other hand, customers may change the consumption behavior only after they receive the bill or are told about a different pricing scheme, where the load response (called CE) may arrive after the load changes. Therefore, the total demand response can be calculated as follows:

$$\Delta L_t = L_0 SE_t \frac{\Delta LMP_t}{LMP_t} + \sum_{i=1}^{i < t} L_t CE_{t,i} \frac{\Delta LMP_j}{LMP_j} \quad (5)$$

where ΔL_t and L_t are the change in load and nominal load at time-slot t , respectively. SE is the self-elasticity and CE is the cross-elasticity.

In [13], an energy management model using DLMP as a control signal in a DPS was proposed. The change in load is seen as a control signal that is fed back to the DLMP, allowing for

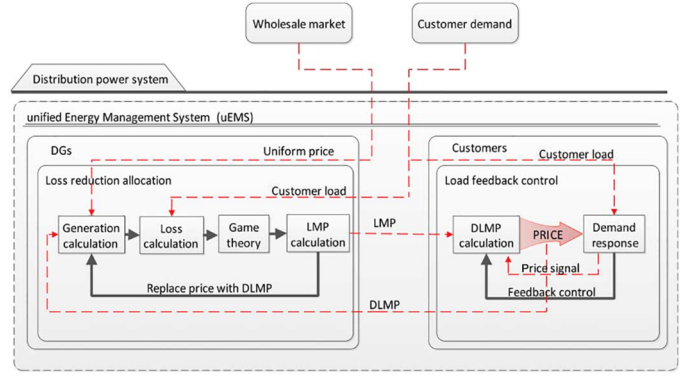

Fig. 2. uEMS model.

an updated DLMP to improve system stability. The closed-loop calculation of the DLMP can be defined as follows:

$$DLMP = LMP + s + B\Delta L \quad (6)$$

where s is a small perturbation signal in price (cents/kWh) and B is the gain of control system.

III. SYSTEM MODEL

We consider a DPS that consists of a set of customers U and DGs G , where customers and DGs are the representatives of energy consumer and provider. Other devices (e.g., capacitor bank unit) can be seen as customers that consume energy or DGs that mainly provide energy. Each customer $U_m \in U (0 < m \leq M)$ is equipped with an ECS and owns a number of ECDs, where M indicates the total number of customers. The ECS in each customer can communicate with the DPS as well as the ECDs within it. Through the ECS, each customer can control the consumption scheduling of each ECD. Each DG $G_k \in G (0 < k \leq K)$ consists of cooperative generators, and DUCs can control the DG P_k by demand, where K is the number of DG that is controlled. Here, only active power is considered to simplify the calculation procedure.

In this paper, we present a model named uEMS as shown in Fig. 2, which controls the DGs and customer consumption to improve the system stability and reduce system losses while maximizing DG benefits. Here, we consider 24-h sample period to study the model and the entire sample period interval (e.g., 1 day) is divided into T time-slots with equal duration, whose set is denoted by $t = 1, 2, \dots, T$ (e.g., 24 time-slots each of which has 1-h duration). We assume that the samples of energy consumption are determined at the beginning of the entire scheduling interval (e.g., 0:00 A.M.).

Fig. 2 shows the system model of uEMS for the DPS, where red lines represent data transfer links and black lines indicate algorithm processing steps. As shown in the figure, the wholesale market provides the DPS with stable energy power and dynamically changed uniform price. As for DGs, LRA is used with game theory to regulate DG according to its DLMP price and cost function, which guarantees that the total DG benefit is maximized due to game theory mechanism. As for customers, LFC is used to calculate a price signal to feedback to the

DLMP calculation according to the current trend of customer demand. Then, uEMS can regulate the DLMP price of each bus accordingly. As a result, customer demand is under control and system stability is improved. Sections IV and V will give the description of uEMS in detail.

IV. GAME THEORY-BASED LRA

This section introduces the game theory-based LRA, which determines the DLMP of each DG and customer in a DPS, and calculates the generation and involved distribution loss of each DG.

A. Loss Reduction Allocation

To achieve a fairly competitive electricity market environment, a game theory-based loss allocation is proposed to calculate system total losses and distributes them to each DG fairly. Although system losses are inevitable in a DPS, regulating DG can reduce the amount of system total losses. Specifically, the benefit from the reduced amount of system losses is allocated to each DG as a reward, which will encourage DGs to supply a more effective power system. This method is much better than allocating system losses directly to DG in proportion, because individual DGs can regulate their own generation by obtaining rewards or punishments in loss allocation.

A DPS without any connected DGs is defined as a base system, so that the reduced system losses can be calculated, as more DGs are connected to it. Equations (7) and (8) are defined by system loss $v(s)$

$$v(s) = \text{Loss}_{\text{base}} - \text{Loss}(s) \quad (7)$$

$$v(s - k) = \text{Loss}_{\text{base}} - \text{Loss}(s \setminus k) \quad (8)$$

where s is a set of different DGs, $v(s)$ is the loss reduction of s , and $s \setminus k$ is the set of s without G_k .

Since each DG may influence system total losses, optimal DG will minimize system total losses. In this model, each DG can be seen as a player in a cooperative game, where each player (generation is larger than zero) may influence system total losses, and the reduced amount of losses can be considered as the benefit of a game theory coalition and its allocation strategy. In this way, the LRA problem can be solved by the Shapley value method of game theory and LRA can be obtained by

$$\text{LRA}_k(v) = \sum_{k \in s} W(|s|) \times [v(s) - v(s - k)] \quad (9)$$

$$W(|s|) = \frac{(K - |s|) \times (|s| - 1)!}{K!} \quad (10)$$

Equation (9) is the utility function of game theory used to solve the loss reduction problem. LRA_k denotes the reduced loss belonging to G_k due to its participation, n is the number of DG, and $|s|$ is the number of DG in set s . Then, the DLMP deviation Δd of the k th DG to calculate its next iteration DLMP can be obtained by

$$(\Delta d)_{t,k}^i = \frac{\text{LRA}_{t,k}^i \times u_t}{P_{t,k}^i} \quad (11)$$

B. Iterative Method for LRA Calculation

In uEMS, the status of both the DG and customer is needed, including the generation, DLMP, loss, and benefit of DG, as well as consumption and DLMP of customer. However, because of the private agents in a DPS, the status information in each time-slot is unknown for DUCs. To this end, an iterative method is introduced to obtain status information of DG and customer in uEMS.

In this iterative method, we set an initial time-slot $t = 0$ and calculate status information of each time-slot by iteration. In LRA, the cost $C_{t,k}$ of each DG G_k in time-slot t can be obtained by

$$C_{t,k} = a_k P_{t,k}^2 + b_k P_{t,k} + c_k \quad (12)$$

where $P_{t,k}$ is the generation of G_k and a_k , b_k , and c_k are the coefficients of G_k . Initially, all DLMP $d_{t,k}$ of DG and customer equal to the uniform price u_0 of wholesale market, and the generation $P_{0,k}$ of each G_k is set to a fixed value that meets $C_{0,k} = u_0$ in (12). DG and DLMP of each bus at all time-slots can be calculated by

$$P_{t,k}^{i+1} = \frac{d_{t,k}^i - b_k}{2a_k} \quad (13)$$

$$d_{t,k}^{i+1} = u_t + (\Delta d)_{t,k}^i + B \times \text{feedback}_{t,k} \quad (14)$$

where i denotes the i th iteration, $d_{t,k}$ is the DLMP of k th DG in t time-slot, Δd is the deviation of DLMP in the i th iteration, B indicates the gain of load feedback DLMP signal [e.g., $B = 0.033$, which could be obtained by performance evolution as the similar process as in [14], where the optimal value of B is accessed by integral square error (ISE)], and d^{feedback} indicates the feedback of DLMP signal, which is calculated by LFC with price elasticity of uEMS.

Equations (12)–(14) can be used to calculate the optimal DG and DLMP. However, because of the interaction of DG, DLMP, and shared reduced loss, it is difficult to calculate the accurate value of each other by some equations directly. Hence, an iterative method for LRA calculation is proposed to deal with this challenge. The pseudocode of LRA is described in Algorithm 1. It should be mentioned that LRA will be run in each time-slot t of samples.

Algorithm 1. Implementation of LRA using game theory

Inputs: u_0 , $Load[]$ (energy consumption load of consumers)
Outputs: $LRA[]$, $d[]$, $P[]$

1. $LRA() \{$
2. $d[] = u_0$ // Initialize DLMP of each bus to wholesale market price u_0
3. $P[]$ // compute DG generation using equation (13)
4. $P^{\text{Previous}}[] = P[]$ // initialize previous generation to calculate deviation
5. $\Delta P[] = P[]$ // initialize generation deviation
6. **WHILE**(max $\Delta P[] < \varepsilon$) **DO** // terminal criterion
7. **FOR** $s \in S$ **DO** {
8. $Loss[]$ // calculate loss with DG coalition connected
9. **ENDFOR**

10. $LRA[]$ // calculate shapley value using $Loss[]$ by equation (9–10)
11. $\Delta LMP[]$ // calculate LMP deviation using $LRA[]$ by equation (11)
12. $d[] = d[] + \Delta LMP[]$
13. $\Delta d^{feedback}[]$ // run LFC with $d[], Load[]$
14. $d[] = d[] + \Delta d^{feedback}[]$
15. $P^{previous}[] = P[]$
16. $P[]$ // compute DG generation using equation (13)
17. $\Delta P[] = P[] - P^{previous}[]$
18. }ENDWHILE
19. }ENDLRA

Remark: The iterative method for LRA of uEMS can converge to a given terminate criterion ε that satisfies the following condition:

$$\max\{P_{DG,t,k}^{i+1} - P_{DG,t,k}^i\} \leq \varepsilon.$$

The iterative convergence is analyzed in Section VI-C.

LRA operates until the maximum of deviation of each DG is less than a given terminal criterion ε .

In each loop cycle, LRA first calculates the generation $P[]$ of each DG by each DG's DLMP $d[]$, then the optimal coalition s and the reduced loss of DG due to the coalition are detected. This reduced loss of each DG is considered as the benefit to remunerate DG and allocated to its nodal price, which is indicated by the deviation of LMP ($\Delta LMP[]$). Considering that DG is modeled as a constant power factor that is regulated by nodal price according to its cost function, the increment of nodal price for DG bus will affect its generation in return. Therefore, the new generation of each DG is calculated by $\Delta LMP[]$, and the maximum is used as a terminal criterion.

Meanwhile, the benefit of the DUC for a base system is represented as follows:

$$\text{benefit}_{t,\text{base}} = u_t \text{Demand}_t - d_t (\text{Demand}_t + \text{Loss}_{t,\text{total}}) \quad (15)$$

where Demand_t denotes the total demand of all customers in time-slot t and $\text{Loss}_{t,\text{total}}$ represents the total loss of all buses for DPS without any DG.

The benefit of DUC for a DPS with DLMP at DG-connected busses is shown in (16)

$$\text{benefit}_{t,\text{dps}} = u_t \text{Demand}_t - d_t (\text{Demand}_t + \text{Loss}'_{t,\text{total}}) - \sum_{k=1}^K P_{t,k} (d_{t,k} - u_t) \quad (16)$$

where $\text{Loss}'_{t,\text{total}}$ represents the total losses of all buses in DPS with DGs connected. The deviation of DUC's benefit can be calculated by subtracting (15) from (16)

$$\Delta \text{benefit}_t = d_t (\text{Loss}_{t,\text{total}} - \text{Loss}'_{t,\text{total}}) - \sum_{k=1}^K P_{t,k} (d_{t,k} - u_t) \quad (17)$$

where K is the number of DGs, and the term $\text{Loss}_{t,\text{total}} - \text{Loss}'_{t,\text{total}}$ is the reduced loss due to the contribution of connected DGs.

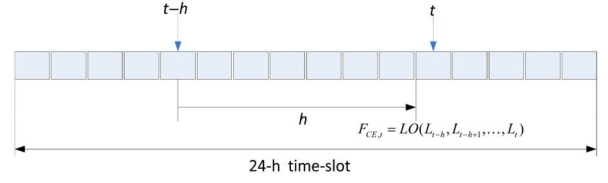

Fig. 3. Roles of time indexes t and h for CE.

V. LFC WITH PRICE ELASTICITY

By utilizing price elasticity, a load controller is designed to analyze the changes in the load, and a DLMP feedback price signal will be obtained. This feedback will influence the nodal price, which will have an impact on DG and customer consumption allowing for the system load to stabilize.

A. LO Algorithm

In actual demand response system, as the adjusting extent for customer demand varies widely for different DPSs and at different time-slots, CE factor needs to be determined up-to-date due to the trend of load changes and LMP changes. Thus, a mechanism called LO algorithm is employed in uEMS to calculate the real-time CE factor. It should be noted that for each time-slot t , the DLMP and load of the previous time-slot $t - 1$ are known, and the DLMP and load for future time slots are the variables to be determined. According to [21], $F_{CE,t}$ is used to illustrate the CE factor of demand response. $F_{CE,t}$ is only affected by a part of previous time-slots, i.e., the price change may delay a period of time to affect the load change. In this paper, we use parameter h to indicate this delay, and the CE mechanism can be described by a function with a variable between $t - h$ and t , as shown in Fig. 3.

Thus, CE factor vector $F_{CE,t}$ in time-slot t can be defined as follows:

$$F_{CE,t} = LO(L_{t-h}, L_{t-h+1}, \dots, L_t). \quad (18)$$

LO algorithm can calculate updated $F_{CE,t}$ according to real-time changes of price and load, and parameter h could dynamically change due to consumption behavior. To simplify LO algorithm calculation for illustration, however, a predicted array is used to calculate $F_{CE,t}$. Predicted array is a circular queue including 24 elements for each time-slot t , and elements from $t - h$ to t are used to calculate $F_{CE,t}$, as shown in Fig. 4.

This 24-element predicted array is used to calculate the CE factor vector using cross-product with load change vector, and then load feedback signal is calculated by this CE factor vector.

B. Price Elasticity Improvement Description

The block diagram of LFC for uEMS is shown in Fig. 5, in which linear control theory is used instead of nonlinear control theory because of the usage of small signal analysis.

In Fig. 5, the change in load demand is detected by price elasticity. The load elasticity signal E is generated by a LO algorithm and is used to feedback the DLMP signal. LFC

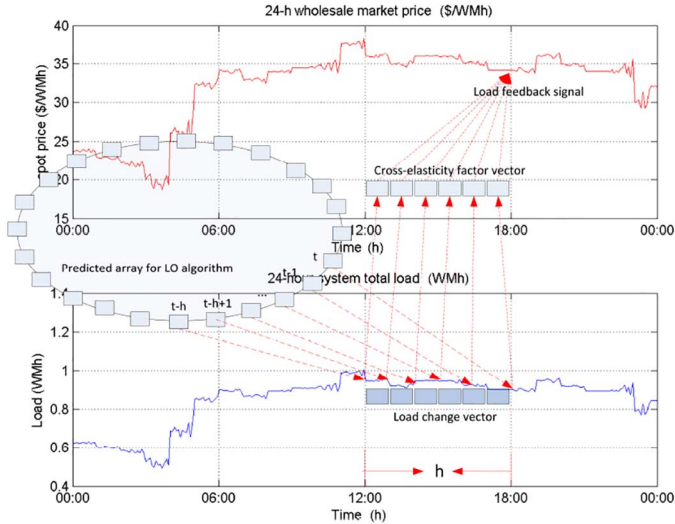

Fig. 4. Predicted array for CE factor calculation.

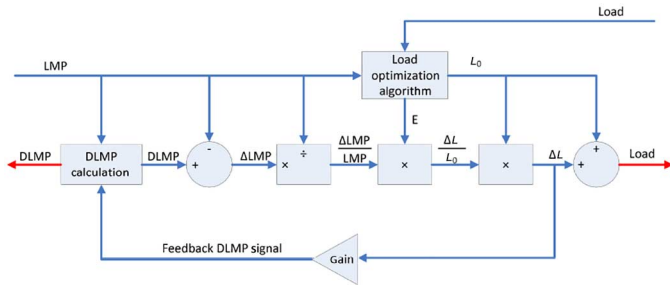

Fig. 5. LFC with price elasticity model diagram.

obtains the nodal price LMP of customers, while the system load is obtained via LRA. The LO algorithm acts as a policy that detects the load changes and generates related CE factors for demand response. The LFC then generates an updated DLMP signal, which is sent to LRA and is used to calculate a load value for the DPS. Furthermore, the DLMP signal is sent to the DG, so that the DG can regulate its generation.

In a DPS, load elasticity E can be defined in (4). Considering that the change of DLMP is small in a short-time period, we assume that the load response remains linear. For a given value of E , the model creates a load response to a change in the DLMP according to (4). In this paper, both the SE and the CE of load response are considered and the combination of them can be defined in (5). To simplify the study, we consider the SE and CE as constants, which are calculated by analyzing the 24-h historical data in an actual DPS.

As a result, the total load response can be defined as follows:

$$\Delta L_t = L_{t,0} F_{SE,t} \frac{\Delta LMP_t}{LMP_t} + \sum_{i=t-h}^{i<t} F_{CE,t} L_t \frac{\Delta LMP_i}{LMP_i}, \quad (0 \leq h \leq t) \quad (19)$$

where $F_{SE,t}$ and $F_{CE,t}$ indicate the SE factor and CE factor of time-slot t , respectively. Generally, $F_{SE,t}$ is the same value for all time-slot while $F_{CE,t}$ is the t th element calculated by LO algorithm as described in Section V-A.

Thus, (11), (14), and (19) show the new DLMP value at each bus of uEMS. The pseudocode of LFC is shown in Algorithm 2. It should be noted that LFC is called by LRA as a subfunction as shown in Fig. 2. LFC is designed to calculate a load feedback price signal with the input of LMP and load of each bus in (19). The SE factor F_{SE} and CE factor vector F_{CE} are calculated by previous load and newest LMP.

Algorithm 2. Implementation of LFC with price elasticity

Inputs: $Load[]$, $d[]$

Outputs: $\Delta d^{feedback}$

1. $LFC()\{$
2. $LMP[]$ // initialize with input LMP parameter
3. $L[]$ // initialize with input load parameter
4. F_{SE} // calculating self-elasticity factor using previous load and LMP
5. **FOR** $i = 0:1:h$ **DO**{
6. F_{SE} // calculate cross-elasticity vector using LO array and $L[]$
7. **ENDFOR**
8. ΔL // calculating load deviation using equation (19)
9. $\Delta d^{feedback} = B * \Delta L$
10. **return** $\Delta d^{feedback}$
11. **ENDLFC}**

$Load[]$ and $d[]$ are two input parameters that contain customer demand and LMP of each bus. A DLMP deviation is calculated and returned to the caller LRA function. In LFC function, LMP of each bus is initialized as an input parameter LMP array and the load of each bus is stored in $L[]$, which is used to calculate SE and CE factors. A predicted LO circular queue is used to calculate the CE factor vector as shown in Fig. 4.

VI. PERFORMANCE EVALUATION

A. Simulation Settings

In this section, the proposed uEMS model is simulated and analyzed in modified IEEE 37-bus feeder system with DGs connected to buses 6, 9, and 15, which are mostly the center of the test system, as shown in Fig. 6. The coefficients (a and b) of DG's cost function are shown in Table I from Proposition 1. It should be mentioned that coefficient c is related to fixed costs. Therefore, this parameter does not have influence on output.

Proposition 1: Coefficients of DG can be calculated by two given marginal price (d_1 , d_2) and marginal product ($P_{DG,1}$, $P_{DG,2}$) of DG by the following equations:

$$a = \frac{d_1 - d_2}{2(P_{DG,1} - P_{DG,2})} \quad (20)$$

$$b = d_1 - P_{DG,1} \frac{d_1 - d_2}{P_{DG,1} - P_{DG,2}}. \quad (21)$$

Proof: For a given DLMP d_t of DG at time-slot t , from (12) and (15), we have

$$\text{Benefit}(P_{DG,t}) = d_t \cdot P_{DG,t} - (aP_{DG,t}^2 + bP_{DG,t} + c). \quad (22)$$

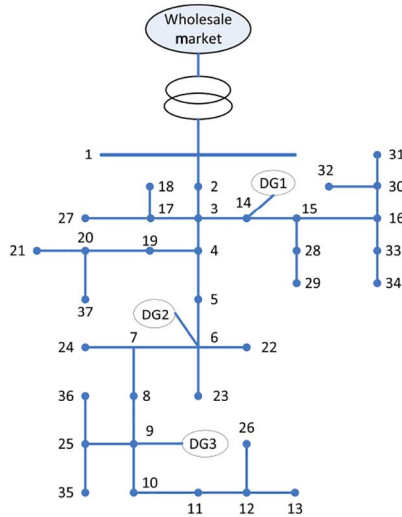

Fig. 6. Modified IEEE 37-bus feeder system.

TABLE I
COEFFICIENTS OF DG'S COST FUNCTION

DG	a (\$/MW ²)	b (\$/MW)	c (\$)	Maximum generation (MWh)
DG1	0.043	20	0	20
DG2	0.25	30	0	20
DG3	0.1	35	0	20

To maximize the DG's benefit, the above-mentioned equation can be solved as follows:

$$P_{DG,t} = \frac{d_t - b}{2a}. \quad (23)$$

Given two set of marginal price (d_1, d_2) and marginal product ($P_{DG,1}, P_{DG,2}$), we have

$$P_{DG,1} = \frac{d_1 - b}{2a} \quad (24)$$

$$P_{DG,2} = \frac{d_2 - b}{2a}. \quad (25)$$

Then, coefficients a and b can be obtained. ■

To analyze the performance of uEMS from the viewpoint of loss reduction, DG, DG benefit, and load stability for an actual DPS, the uncertainty in spot price, and demand scenarios must be modeled. Price and demand are defined by two different pdfs [22]. To describe their stochastic features, the processes of spot price and demand scenarios need to be statistically analyzed making the pdf of spot price and load approach real DPS. To this end, load and wholesale market price in ISO New England [23] are used to generate the wholesale market price and system total load in every 5 min for 24 h, with an active power demand peak of 124 WM.

B. Simulation Results Analysis

In this section, the uEMS performance is analyzed and compared to existing related algorithm. The simulation consists of two different parts: 1) LRA performance; and 2) LFC performance.

The performance of the game theory-based LRA algorithm in uEMS is analyzed and compared to the existing uniform price method (UNIF) and LMP method (LMP) in loss reduction, DG's benefit, and DG's DLMP price [7]. To find out how uEMS regulate DG and how DG combinations infect the DPS, three different DGs' combination scenarios are employed to analyze the uEMS model.

- 1) Base case (BASE) is an IEEE 37-bus feeder power system without any connected DGs.
- 2) Single DG case (SD) is the base case with a DG connected at bus 6, 9, or 15: SD#1 stands for DG#1 connected at bus 6, SD#2 stands for DG#2 connected at bus 9, and SD#3 stands for DG#3 connected at bus 15.
- 3) Multiple DG case (MD) is the base case with all three DGs connected to their respective buses, as shown in Fig. 6.

Fig. 7 shows the system losses for a 24-h time-slot of the SD and the MD scenarios. Fig. 7(a)–(c) compares system losses when UNIF, LMP, and uEMS are used in SD#1, SD#2, and SD#3, respectively. Fig. 7(d) compares system losses using UNIF, LMP, and uEMS for the MD case. It is obvious that uEMS significantly decreases system losses compared to UNIF and LMP. This improvement in system loss reduction is due to LRA, which regulates each DG to the optimal level. In uEMS, cooperation among DGs is considered. In the UNIF and LMP methods, a global optimal solution is hard to obtain, because of the complex coaction between DGs, which causes total system losses to increase. As shown in Fig. 7(d), the system losses of BASE are significantly larger than that of SD and MD, which illustrates that integrating DG in a DPS can effectively reduce system losses.

Fig. 8(a)–(c) shows the DG benefits for different methods (UNIF, LMP, and uEMS) of DG#1, DG#2, and DG#3 for SD#1, SD#2, and SD#3, respectively. From the figures, we can see that in SD#1 and SD#3, DG benefits are increasing but DG benefit in SD#2 is decreasing. This is because the employed game theory-based LRA regulates DGs to obtain maximum total benefit. Fig. 8(d) illustrates the MD case with three connected DGs and shows that although the benefit for a single DG may be decreased, the total benefit of all the three DGs with uEMS significantly increases the incremental benefit.

The customer LMP of uEMS with and without LFC is shown in Fig. 9. It can be seen that the fluctuation of customer LMP in uEMS with LFC is much smaller because the LFC can generate a feedback signal from the impact of price on load and regulate the nodal price of customer buses, which makes customer demand stable.

The energy consumption for customers with and without LFC is shown in Fig. 10. Clearly, uEMS with LFC can reduce the energy supply of wholesale market in peak load period. When customer load increases, a positive DLMP will be generated to increase the nodal price of customer buses, which stimulates DGs in the DPS to make generation.

C. Iterative Convergence Analysis

To fairly allocate distributed loss to each DG, an iterative method is used to calculate the deviation of distributed losses in

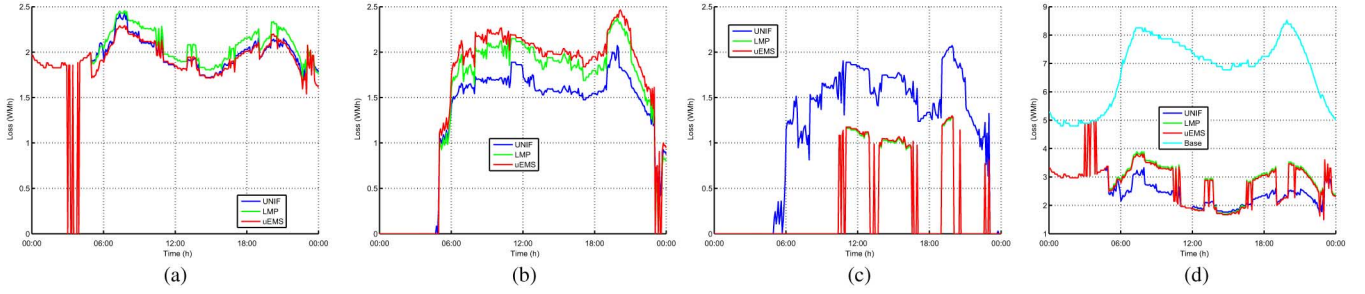

Fig. 7. System loss for uniform price, LMP, and uEMS. (a) System losses in SD 1 case. (b) System losses in SD 2 case. (c) System losses in SD 3 case. (d) System losses in MD case.

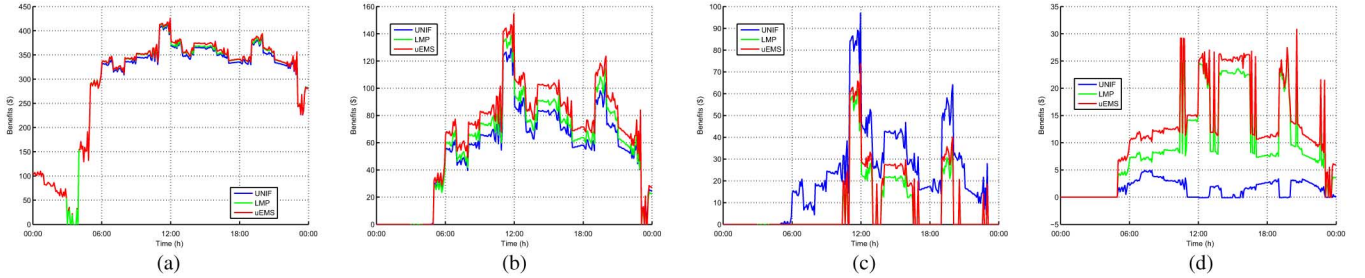

Fig. 8. DG benefit for uniform price, LMP, and uEMS. (a) DG benefits in SD 1 case. (b) DG benefits in SD 2 case. (c) DG benefits in SD 3 case. (d) DG benefits in MD case.

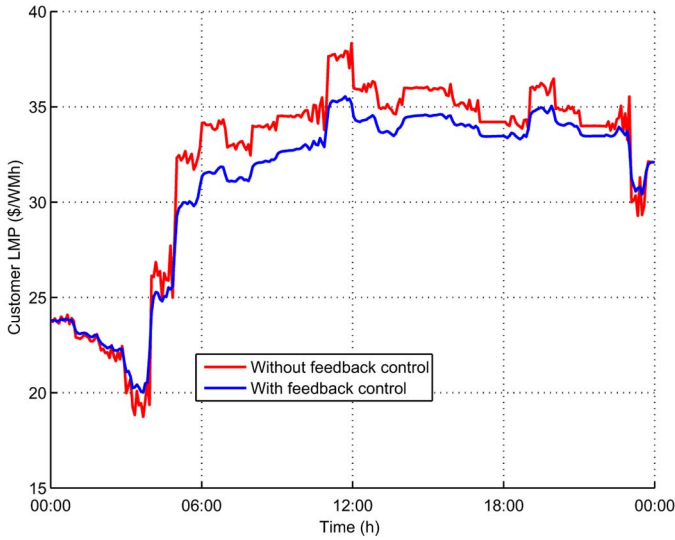

Fig. 9. Customer load for uEMS with and without LFC (price regulation for load shift: peak value of LMP reduces 5.6% and valley value of LMP increases about 15%).

uEMS. In this part, the convergence process of iterative LRA is analyzed. As shown in Fig. 11, three curves show different system losses with DG, each of which can be seen as a parabolic curve with only one minimum value $P_{DG,1}^{\text{optimal}}$, $P_{DG,2}^{\text{optimal}}$, and $P_{DG,3}^{\text{optimal}}$ for DG1, DG2, and DG3, respectively. It should be noted that the minimum value is the optimal status for loss reduction, where DG has optimal generation and system loss is minimum.

When the wholesale market price is 34.5 (\$/kWh) obtained in an iterative time-slot, the convergence process of LRA is shown in Fig. 11, where $P_{DG,k}^i$ indicates the system loss with generation for the k th DG in the i th iteration.

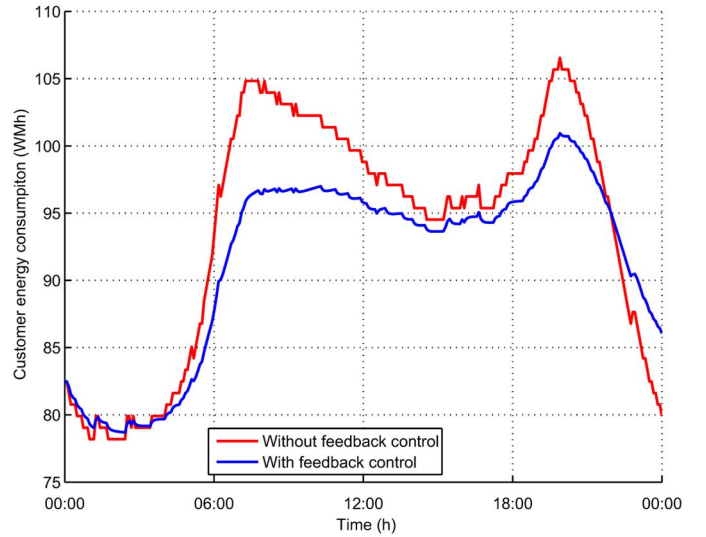

Fig. 10. Comparison of energy consumption for customers (energy regulation for load shift: peak value of energy consumption reduces 6% and valley value of energy consumption increases about 2%).

In this iterative method, each DG initially sets its DLMP to wholesale market price and its generation as $P_{DG,1}^1$, $P_{DG,2}^1$, and $P_{DG,3}^1$, respectively. The DG hence can be calculated according to (13) when the DG's marginal cost is set to equate its DLMP. Then, incremental DG (from zero to $P_{DG,1}^1$ as for DG1) may reduce the system loss and lead to an incremental of DLMP due to (11). Thus, DG may also change to a new value as $P_{DG,2}^2$ ($P_{DG,1}^2$ and $P_{DG,3}^2$ are not labeled because they are exactly the same as $P_{DG,1}^1$ and $P_{DG,3}^1$, respectively) because the DG intends to maximize its benefit. LRA iterative method thus loops around to calculate generation and reduces loss due to DG participant and DLMP until the

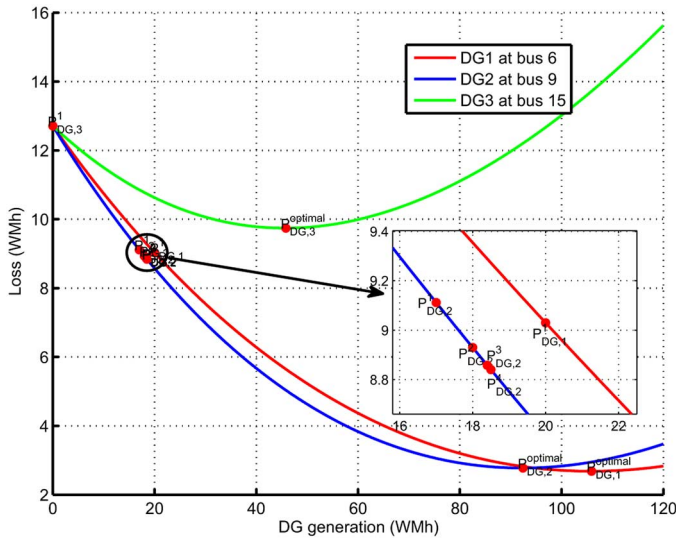

Fig. 11. System loss with DG generation (Here $\varepsilon = 0.05$, convergence outputs: $P_{DG,1}^i \equiv 20$, $P_{DG,1}^{i(1,2,3,4)} = \{16.9, 18, 18.2, 18.201\}$, $P_{DG,3}^i \equiv 0$).

terminal condition is satisfied by $\Delta P^i < \varepsilon$ as $P_{DG,2}^4$. As a result, LRA achieves maximum benefit of DG and reduces system loss.

Additionally, the speed of convergence for the proposed iterative method is also recorded within the per-5-min simulation of 24-h (total 288 times). 98.1% simulations converged after only one or two loops. Specifically, 87.4% of the simulations converged after one loop, 10.7% after two loops, and only 1.9% after more than two loops. It is shown that this iterative method in LRA has a high speed of convergence.

VII. CONCLUSION

In this paper, we proposed a unified energy management model called uEMS to realize loss reduction and maintain stability for a power system in a smart grid. The key feature in uEMS is using a price signal to regulate distributed devices throughout the whole DPS. Additionally, game theory is employed in a loss reduction algorithm to fairly allocate the losses reduced due to DG participation, and an iterative method is used to approximate the optimal generation scheme for DGs to obtain maximum benefits. Furthermore, a demand response mechanism is used to generate a DLMP signal as feedback to regulate the DLMP price for each bus. Both LRA and LFC are well integrated using a DLMP signal for the DPS. Simulation results based on a modified IEEE 37-bus system show that uEMS can lead to a more fairly competitive environment for DGs, where the model can increase DGs' benefits, reduce system losses, and improve stability. In the future, potential cooperative incentives [24] and communication requirements [25], [26] will be considered in this uEMS system.

APPENDIX GLOSSARY

See Table II.

TABLE II
LIST OF SYMBOLS IN THE PAPER

Symbols	Descriptions	Sections
d	price at non reference bus	II-A
u	price at reference bus	II-A
$Loss_t$	total losses of DPS at time t	II-A
t	time	II-A
k	bus	II-A
P	active power at bus or generation of DG	II-A
W	weight factor of the Shapley value	II-A
s	coalition of players for game theory	II-A
n	total number of players in game theory	II-A
$v(s)$	Reduced losses related to coalition s	II-A
E	elasticity of demand	II-B
δL	change of load	II-B
L_0	nominal load	II-B
LMP_0	change of LMP	II-B
ΔLMP	change of LMP	II-B
ΔL_t	change of load at time-slot t	II-B
L_t	total system load at time t	II-B
SE	self-elasticity	II-B
CE	cross-elasticity	II-B
B	gain of feedback control signal	II-B
U	set of customers	III
U_m	customer m	III
m	customer	III
M	total number of customers	III
G	set of DGs	III
G_k	DG k	III
k	DG	III
K	total number of DGs	III
LRA_k	reduced loss belong to DG_k	IV-A
$Loss_{base}$	loss of DPS without DG connected	IV-A
$Loss(s)$	loss of DPS with DG coalition s connected	IV-A
a_k	first coefficient of cost function for G_K	IV-A
b_k	second coefficient of cost function for G_K	IV-A
c_k	third coefficient of cost function for G_K	IV-A
$C_{t,k}$	cost for DG G_k in time-slot t	IV-B
$d^{feedback}$	Feedback of DLMP signal calculated by LFC	IV-B
$benefit_{t,base}$	total benefit of DUC for base system	IV-B
$benefit_{t,dps}$	total benefit of DUC for DPS	IV-B
$Loss'$	loss of DPS with DG connected	IV-B
$Demand_t$	total demand of all customers in time-slot t	IV-B
$F_{CE,t}$	cross-elasticity factor vector	V-A
h	delay of price elasticity	V-A
$F_{SE,t}$	self-elasticity factor vector	V-B

REFERENCES

- [1] A. I. Sabbah, A. El-Mougy, and M. Ibnkahla, "A survey of networking challenges and routing protocols in smart grids," *IEEE Trans. Ind. Informat.*, vol. 10, no. 1, pp. 210–221, Feb. 2014.

- [2] G. T. Heydt, "The next generation of power distribution systems," *IEEE Trans. Smart Grid*, vol. 1, no. 3, pp. 225–235, Dec. 2010.
- [3] L. Hernandez *et al.*, "Short-term load forecasting for microgrids based on artificial neural networks," *Energies*, vol. 6, no. 3, pp. 1385–1408, 2013.
- [4] L. Hernandez *et al.*, "Improved short-term load forecasting based on two-stage predictions with artificial neural networks in a microgrid environment," *Energies*, vol. 6, no. 9, pp. 4489–4507, 2013.
- [5] L. Hernandez *et al.*, "Artificial neural networks for short-term load forecasting in microgrids environment," *Energy*, vol. 75, no. 10, pp. 252–264, 2014.
- [6] S. J. Brown and I. H. Rowlands, "Nodal pricing in Ontario, Canada: Implications for solar PV electricity," *Renew. Energy*, vol. 34, no. 1, pp. 170–178, 2009.
- [7] K. Shaloudegi, N. Madinehi, and H. A. Abyaneh, "A novel policy for locational marginal price calculation in distribution systems based on loss reduction allocation using game theory," *IEEE Trans. Power Syst.*, vol. 27, no. 2, pp. 811–820, May 2012.
- [8] P. M. Sotkiewicz and J. M. Vignolo, "Nodal pricing for distribution networks: Efficient pricing for efficiency enhancing DG," *IEEE Trans. Power Syst.*, vol. 21, no. 2, pp. 1013–1014, May 2006.
- [9] J. C. Peng, H. Jiang, and C. Huang, "Independent marginal losses with application to locational marginal price calculation," *IET Gener. Transmiss. Distrib.*, vol. 3, no. 7, pp. 679–689, Jul. 2009.
- [10] J. B. Cardell, "Marginal loss pricing for hours with transmission congestion," *IEEE Trans. Power Syst.*, vol. 22, no. 4, pp. 1466–1474, Nov. 2007.
- [11] L. Fangxing and B. Rui, "Congestion and price prediction under load variation," *IEEE Trans. Power Syst.*, vol. 24, no. 2, pp. 911–922, May 2009.
- [12] H. Zechun, C. H. Zhong, and L. Furong, "An iterative LMP calculation method considering loss distributions," *IEEE Trans. Power Syst.*, vol. 25, no. 3, pp. 1469–1477, Aug. 2010.
- [13] B. R. Sathyanarayana and G. T. Heydt, "A roadmap for distribution energy management via multiobjective optimization," in *Proc. Power Energy Soc. Gen. Meeting*, 2010, pp. 1–8.
- [14] J. M. Boyd and G. T. Heydt, "Stability analysis of an energy managed smart distribution power system," in *Proc. IEEE Power Energy Soc. Gen. Meeting (PES)*, 2013, pp. 1–5.
- [15] K. Samarakoon, J. Ekanayake, and N. Jenkins, "Reporting available demand response," *IEEE Trans. Smart Grid*, vol. 4, no. 4, pp. 1842–1851, Dec. 2013.
- [16] P. Palensky and D. Dietrich, "Demand side management: Demand response, intelligent energy systems, and smart loads," *IEEE Trans. Ind. Informat.*, vol. 7, no. 3, pp. 381–388, Aug. 2011.
- [17] T. Shaojie, H. Qiuyuan, L. X. Yang, and W. Dapeng, "Smoothing the energy consumption: Peak demand reduction in smart grid," in *Proc. INFOCOM*, 2013, pp. 1133–1141.
- [18] A. G. Vlachos and P. N. Biskas, "Demand response in a real-time balancing market clearing with pay-as-bid pricing," *IEEE Trans. Smart Grid*, vol. 4, no. 4, pp. 1966–1975, Dec. 2013.
- [19] K. N. Hung, J. B. Song, and H. Zhu, "Demand side management to reduce peak-to-average ratio using game theory in smart grid," in *Proc. INFOCOM*, 2012, pp. 91–96.
- [20] D. S. Kirschen, J. B. Song, and H. Zhu, "Factoring the elasticity of demand in electricity prices," *IEEE Trans. Power Syst.*, vol. 15, no. 2, pp. 612–617, May 2000.
- [21] A. J. Conejo, J. M. Morales, and L. Baringo, "Real-time demand response model," *IEEE Trans. Smart Grid*, vol. 1, no. 3, pp. 236–242, Dec. 2010.
- [22] V. S. Pappala, I. Erlich, and K. Rohrig, "A stochastic model for the optimal operation of a wind-thermal power system," *IEEE Trans. Power Syst.*, vol. 24, no. 2, pp. 940–950, May 2009.
- [23] E. Litvinov, Z. Tongxin, G. Rosenwald, and P. Shamsollahi, "Marginal loss modeling in LMP calculation," *IEEE Trans. Power Syst.*, vol. 19, no. 2, pp. 880–888, May 2004.
- [24] K. Wang and M. Wu, "Nash equilibrium of node cooperation based on metamodel for MANETs," *J. Inf. Sci. Eng.*, vol. 28, no. 2, pp. 317–333, 2012.
- [25] K. Wang and M. Wu, "Cooperative communications based on trust model for mobile ad hoc networks," *IET Inf. Security*, vol. 4, no. 2, pp. 68–79, Jun. 2010.
- [26] V. C. Gungor *et al.*, "Smart grid technologies: Communication technologies and standards," *IEEE Trans. Ind. Informat.*, vol. 7, no. 4, pp. 529–539, Nov. 2011.
- [27] V. C. Gungor *et al.*, "A survey on smart grid potential applications and communication requirements," *IEEE Trans. Ind. Informat.*, vol. 9, no. 1, pp. 28–42, Feb. 2013.



Kun Wang (M'13) received the Ph.D. degree in information security from the School of Computer, Nanjing University of Posts and Telecommunications, Nanjing, China, in 2009.

He was a Postdoctoral Fellow with the Electrical Engineering Department, University of California Los Angeles, Los Angeles, CA, USA, from 2013 to 2014. He is an Associate Professor with the School of Internet of Things, Nanjing University of Posts and Telecommunications. He has authored over 50 papers in related international conferences and journals, including IEEE COMMUNICATIONS MAGAZINE, IEEE Globecom 2013, and the IEEE International Conference on Communications 2014. His research interests include wireless sensor networks, delay tolerant networks, stream computing, ubiquitous computing, mobile cloud computing, and information security technologies.

Dr. Wang is a member of the Association for Computing Machinery.



Zhiyou Ouyang received the M.S. degree in computer science from the School of Computer, Nanjing University of Posts and Telecommunications, Nanjing, China, in 2009.

His research interests include big data based forecasting, stream computing, cloud computing, information network, and smart grid.

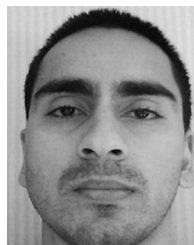

Rahul Krishnan received the M.S. degree in electrical engineering from the University of California Los Angeles, Los Angeles, CA, USA.

Currently, he works with Taiwan Semiconductor Manufacturing Company, Hsinchu, Taiwan. His research interests include statistical circuit modeling and machine learning.



Lei Shu (M'07) received the Ph.D. degree in computer science from the Digital Enterprise Research Institute, National University of Ireland, Galway, Ireland, in 2010.

Until March 2012, he was a Specially Assigned Researcher with the Department of Multimedia Engineering, Graduate School of Information Science and Technology, Osaka University, Osaka, Japan. Since October 2012, he has been with the Guangdong University of Petrochemical Technology, Guangdong, China, as a Full Professor. Since 2013, he has been working with the Dalian University of Technology, Dalian, China, as a Ph.D Supervisor. Meanwhile, he is also working as the Vice-Director with the Guangdong Provincial Key Laboratory of Petrochemical Equipment Fault Diagnosis, Guangdong. He is the Founder of the Industrial Security and Wireless Sensor Networks Laboratory, Maoming, China. His research interests include wireless sensor networks, multimedia communication, middleware, and security.

Dr. Shu was the recipient of the Globecom 2010 and International Conference on Communications 2013 Best Paper Award.

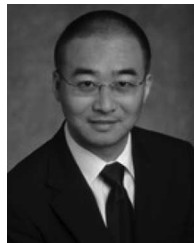

Lei He (M'99–SM'08) received the Ph.D. degree in computer science from the University of California Los Angeles (UCLA), Los Angeles, CA, USA, in 1999.

He is a Professor with the Electrical Engineering Department, UCLA, and was a Faculty Member with the University of Wisconsin, Madison, WI, USA, from 1999 to 2002. He has authored one book and over 200 technical papers. His research interests include modeling and simulation, very large scale integration circuits and systems, and cyber physical systems.

Dr. He was the recipient of 12 Best Paper Nominations, mainly from the Design Automation Conference and the International Conference on Computer-Aided Design, and five Best Paper or Best Contribution Awards, including the Association for Computing Machinery Transactions on Electronic System Design Automation 2010 Best Paper Award.