

# Lawrence Berkeley National Laboratory

## Lawrence Berkeley National Laboratory

### **Title**

Reaction of Hydrogen Sulfide with Oxygen in the Presence of Sulfite

### **Permalink**

<https://escholarship.org/uc/item/71j1g6p8>

### **Authors**

Weres, Oleh  
Tsao, Leon

### **Publication Date**

1983



# Lawrence Berkeley Laboratory

UNIVERSITY OF CALIFORNIA

## EARTH SCIENCES DIVISION

RECEIVED  
LAWRENCE  
BERKELEY LABORATORY

MAY 16 1983

REACTION OF HYDROGEN SULFIDE WITH OXYGEN  
IN THE PRESENCE OF SULFITE

LIBRARY AND  
DOCUMENTS SECTION

Oleh Weres and Leon Tsao

January 1983

### For Reference

Not to be taken from this room



Prepared for the U.S. Department of Energy under Contract DE-AC03-76SF00098

LBL-11377  
c.1

LBL-11377

REACTION OF HYDROGEN SULFIDE WITH OXYGEN  
IN THE PRESENCE OF SULFITE

Oleh Weres and Leon Tsao

Earth Sciences Division  
Lawrence Berkeley Laboratory  
1 Cyclotron Road  
Berkeley, CA 94720, USA

January 14, 1983

### ABSTRACT

Commonly, abatement of hydrogen sulfide emissions from a geothermal powerplant requires that hydrogen sulfide dissolved in the cooling water be eliminated by chemical reaction. Oxidation by atmospheric oxygen is the preferred reaction, but requires a suitable catalyst. Nickel is the most potent and thereby cheapest catalyst for this purpose. One mg/L nickel in the cooling water would allow 99% removal of hydrogen sulfide to be attained. A major drawback of catalytic air oxidation is that colloidal sulfur is a major reaction product; this causes rapid sludge accumulation and deposition of sulfur scale.

We studied the kinetics and product distribution of the reaction of hydrogen sulfide with oxygen, catalyzed by nickel. Adding sodium sulfite to the solution completely suppresses formation of colloidal sulfur by converting it to thiosulfate. The oxidation reaction is an autocatalytic, free radical chain reaction. A rate expression for this reaction and a detailed reaction mechanism were developed. Nickel catalyzes the chain initiation step, and polysulfidoradical ions propagate the chains.

Several complexes of iron and cobalt were also studied. Iron citrate and iron N-hydroxyEDTA are the most effective iron based catalysts. Uncomplexed cobalt is as effective as nickel, but forms a precipitate of cobalt oxysulfide and is too expensive for practical use.

## TABLE OF CONTENTS

Abstract	
Table of Contents	
List of Tables	
List of Figures	
<b>1. Introduction</b> .....	1
Acknowledgements .....	3
<b>2. A review of inorganic sulfur chemistry.</b> .....	4
2.1. Forward .....	4
2.2. Inorganic sulfur compounds .....	4
2.2.1. The polysulfides, sulfanes, and elemental sulfur .....	6
2.2.2. Thiosulfate .....	8
2.2.3. Thiophilic reactions .....	9
2.2.4. Polythionates .....	9
2.2.5. Sulfanemonosulfonates .....	11
2.2.6. Dithionate .....	11
2.2.7. Sulfate .....	12
2.3. Oxygen and hydrogen peroxide .....	12
2.4. The transition metals .....	15
2.5. Oxidation of hydrogen sulfide .....	17
2.5.1. Reaction of hydrogen sulfide with oxygen .....	17
2.5.2. Catalysis and inhibition .....	19
2.5.3. Reaction with oxygen over solid catalysts .....	21
2.5.4. Reaction with hydrogen peroxide .....	22
2.5.5. Summary .....	23
2.6. Oxidation of sulfite .....	24
2.6.1. Free radical chain reaction with oxygen .....	24
2.6.2. Proposed reaction mechanism .....	25
2.6.3. Other oxidation reactions .....	27
2.7. Oxidation of thiosulfate .....	28
<b>3. The reaction catalyzed by nickel</b> .....	30
3.1. Forward .....	30
3.2. Experimental methods .....	30
3.2.1. Synthetic cooling water with recharge .....	30
3.2.2. Work at lower pH .....	32
3.2.3. Determination of reactivity .....	32
3.2.4. Measurement of turbidity .....	33
3.2.5. Determination of reaction products .....	33
3.2.6. Safety considerations .....	34
3.3. Development of reactivity and turbidity .....	34
3.3.1. Reactivity and autocatalysis .....	35
3.3.2. The effect of sodium sulfite .....	37
3.3.3. The effect of thiosulfate .....	37
3.3.4. The effect of pH .....	37

3.4. Reaction kinetics .....	37
3.4.1. The rate expression .....	41
3.5. Distribution of reaction products .....	42
3.6. The reaction mechanism .....	45
3.7. Discussion .....	48
App. 3.1. Preparation and storage of solutions .....	49
App. 3.2. UV absorption spectra .....	51
App. 3.3. Computer code OXTAB .....	53
App. 3.4. Analysis of variance in rate data .....	53
<b>4. Catalysis by iron, cobalt, and other transition metals .....</b>	<b>57</b>
4.1. Forward .....	57
4.2. Experimental methods .....	57
4.2.1. Method for screening catalysts .....	57
4.2.2. Continuous flow kinetic system .....	57
4.3. Screening of potential catalysts .....	59
4.4. Wackenroder's reaction .....	60
4.5. Catalysis by iron compounds .....	61
4.6. Catalysis by cobalt .....	64
App. 4.1. Continuous flow kinetic system (cont.) .....	66
<b>5. Summary and discussion .....</b>	<b>69</b>
<b>References .....</b>	<b>71</b>

## LIST OF TABLES

1.1. Steam Composition: Geysers Unit 15 .....	1
2.1. Free energies of formation of sulfur compounds .....	5
2.2. Chemical species of sulfur .....	7
2.3. Free energies of the system $O_2 + 2 H_2$ .....	14
2.4. Mechanism of sulfite oxidation .....	26
3.1. Empirical rate law for $H_2S$ oxidation .....	41
3.2. Proposed reaction mechanism .....	46
3.3. Listing of computer code OXTAB .....	54
4.1. Screening of potential catalysts .....	59
4.2. Solutions used with flowing kinetic system .....	66

## LIST OF FIGURES

2.1. Electronic structure of $O_2$ .....	13
2.2. A typical reaction of singlet oxygen .....	13
2.3. Reduction potentials of the oxygen system at pH 7 .....	13
2.4. Cobalt(II) tetrasulfophthalocyanine .....	20
3.1. Effect of Wackenroder's Solution on reactivity .....	35
3.2. Turbidity and reactivity; sulfite:sulfide = 0.75 .....	35
3.3. Turbidity and reactivity at pH 7 .....	36
3.4. Reactivity vs. initial $H_2S$ .....	38
3.5. Reactivity vs. nickel concentration .....	38
3.6. Residual $H_2S$ vs. reaction time .....	39
3.7. Reactivity vs. temperature .....	39
3.8. Reactivity vs. pH .....	40
3.9. Reactivity vs. oxygen concentration .....	40
3.10. Reaction product distribution; no sulfite added .....	43
3.11. Reaction product distribution vs. pH .....	43
3.12. Reaction product distribution with $100\mu M Ni$ .....	44
3.13. Reaction products vs. sulfite:sulfide ratio .....	44
3.14. Reaction products vs. pH; no sulfite added .....	45
3.15. Reaction products vs. pH; $SO_3^{2-}/H_2S = 0.75$ .....	45
3.16. Apparatus for preparing anoxic solutions .....	50
3.17. UV absorption spectra of sulfur compounds .....	52
3.18. Absorption spectrum of SCW .....	52
4.1. Continuous flow kinetic system .....	58
4.2. Wackenroder's reaction .....	60
4.3. Catalysis by iron compounds .....	62
4.4. Effect of catalyst oxidation time .....	62
4.5. Comparison of FeHEDTA and FeCitrate .....	63
4.6. Reaction product distribution with FeCitrate .....	63
4.7. Reaction catalyzed by cobalt .....	64
4.8. Autocatalysis with CoCitrate .....	65
4.9. Reactivity vs. oxygen concentration .....	65
4.10. Mixing blocks .....	67
4.11. Electrode block .....	68

## CHAPTER 1 INTRODUCTION

At The Geysers Geothermal Power Plant of the Pacific Gas and Electric Company, surface condensers are used in combination with Stretford Units to reduce atmospheric emissions of hydrogen sulfide. Surface condensers reduce the fraction of  $H_2S$  originally in the steam that dissolves in the condensate. That fraction which does not dissolve in the condensate, but stays in the vapor phase and departs the condenser with the vent-gas is converted to elemental sulfur by the Stretford Unit. Even with surface condensers, a substantial fraction of the  $H_2S$  dissolves in the condensate (20-35%). The geothermal steam at The Geysers contains ammonia (Table 1.1), which increases the solubility of  $H_2S$  in the condensate by reacting with it as a base:

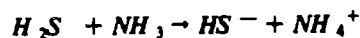

The  $CO_2$  in the steam has little effect on the solubility of  $H_2S$ , because the hydration of  $CO_2$  to carbonic acid is slow.

The  $H_2S$  in the condensate must be destroyed before it is emitted to the atmosphere. At present, this is done by adding hydrogen peroxide and a trace amount of iron hydroxyacetate to the condensate, to oxidize the  $H_2S$  to thiosulfate. This procedure is expensive.

Table 1.1

Steam Composition: Geysers Unit 15

Component	Concentration	
	(ppm)	(mmoles/kg $H_2O$ )
$H_2S$	135	4.0
$NH_3$	90	5.3
$CO_2$	1530	34.8
$B(OH)_3$	166	2.7
$H_2$	38	19.
$CH_4$	118	7.4
$N_2$	60	2.1

Sample collected by Henderson *et al.* (1980), on September 12, 1979. This is a representative analysis for The Geysers. Steam composition varies with time, and is different at each Unit.



Units 1 through 12 at The Geysers are equipped with contact condensers, and retrofitting them with surface condensers is not a practical proposition. In these Units 60-75% of the  $H_2S$  dissolves in the cooling water. Emission of  $H_2S$  from these Units can be abated only by oxidizing the  $H_2S$  in the cooling water. At present, oxidation is effected with hydrogen peroxide. Sodium hydroxide is used to help scrub  $H_2S$  from the condenser vent-gas into the cooling water.

Air would be the ideal oxidizing agent for such applications. The cooling water is saturated with atmospheric oxygen in the cooling tower; in principle, one need only add an appropriate catalyst to induce reaction between the dissolved oxygen and  $H_2S$ .

For a time, iron sulfate was added to the cooling water of Geysers Units 11 and 12 to catalyze the reaction (Allen *et al.*, 1975). A 30 ppm (mg/l) concentration of iron was maintained in the cooling water. The vent gas was discharged into the bottom of the cooling tower, enabling the  $H_2S$  in it to dissolve in the cooling water and be oxidized as well. Overall abatement efficiency better than 90% was achieved. However, the iron hydrolyzed to ferric hydroxide, and a large fraction of the  $H_2S$  was oxidized to colloidal sulfur. The iron hydroxide and colloidal sulfur combined to form a voluminous, hard to deal with sludge. This sludge was hard to dewater, and had to be handled and disposed of as toxic solid waste because of its arsenic and mercury content (from the geothermal steam). Also, the iron rich cooling water was highly corrosive. These problems caused the use of iron sulfate to be abandoned.

Nickel is the most potent catalyst for the reaction of  $H_2S$  with oxygen. Use of nickel sulfate was first considered by PG&E in 1973. In the first full scale field test (with Unit 2), nickel completely eliminated  $H_2S$  emissions from the cooling tower (Payette, *et al.*, 1974, pp. 53-55; Weres, *et al.*, 1977, p. XI-37; PG&E-DER, private communication). Unfortunately, the major reaction product was colloidal sulfur which accumulated in the water distribution trays of the cooling tower, and formed a solid, hard to remove scale. After this test, Unit 2 had to be removed from service for a month to undo the scaling damage. Consequently, work with nickel salts was abandoned.

Recently, catalysis by iron HEDTA was successfully demonstrated at The Geysers (Henderson and Dorighi, 1981; Yancey, 1981). With a concentration of iron in the cooling water between 5 to 20 ppm, 98% abatement was achieved without formation of iron hydroxide sludge. Adding sulfur dioxide to the cooling water of Unit 1 (obtained by burning the vent-gas) prevented the formation of sulfur sludge (Yancey, 1981). With Unit 9, addition of  $SO_2$  was not necessary (Henderson and Dorighi, 1981).

In 1978, the Department of Engineering Research of the Pacific Gas and Electric Company funded LBL to perform basic and applied research in support of PG&E's work on  $H_2S$  emission abatement at The Geysers. Beginning in 1979, the Division of Geothermal Energy of the U.S. Department of Energy provided additional support to LBL for this work. This report describes in detail the experimental work performed under these contracts.

Catalyst screening tests (described in Chapter 4) confirmed that nickel and cobalt are the most potent catalysts for air oxidation of  $H_2S$ . Because nickel is the less expensive of the two and does not form an oxysulfide precipitate as does cobalt, nickel alone was chosen for extensive further testing.

Chapter 2 reviews the literature on inorganic sulfur chemistry, with emphasis on aspects relevant to our work.

Chapter 3 describes our study of the kinetics and product stoichiometry of the nickel catalyzed reaction of hydrogen sulfide with oxygen in the presence of sulfite ion.

The kinetics and stoichiometry of reactions catalyzed by cobalt sulfate, cobalt citrate, iron citrate, iron EDTA, and iron HEDTA also were briefly studied. This work is described in Chapter 4, together with the preliminary screening of catalysts.

The practical implications of our results are summarized in Chapter 5.

---

\* HEDTA = N-hydroxyethylenediaminetriacetate. These tests took place after the work described herein had largely been completed.

The major results reported here are summarized in a journal paper (Weres and Tsao, 1983). Weres (1983, 1983a, 1983b) evaluated several condenser designs for geothermal power plants by computer modeling. These include novel, advanced design concepts. The computer code used in the modeling studies was documented by Weres (1983c). An overview of the environmental problems at The Geysers and other geothermal fields, and the technology available to deal with them was given in earlier reports (Weres *et al.*, 1977; Weres, 1980; Weres, 1983d).

#### **Acknowledgements**

We wish to thank S.G. Sharp of the Pacific Gas and Electric Company for providing us with chemical and test data from The Geysers Geothermal field. This report was critically reviewed by R.E. Russo of LBL.

This work was supported in part by the Assistant Secretary for Resource Applications, Office of Industrial and Utility Applications and Operations, Geothermal Energy Division of the U.S. Department of Energy under Contract No. DE-AC03-76SF00098. It was also supported by the Department of Engineering Research of the Pacific Gas and Electric Company under Contract No. 5-50-78.

## CHAPTER 2 A REVIEW OF INORGANIC SULFUR CHEMISTRY

### 2.1. Forward

In this chapter is summarized information from the chemical literature that was found useful in planning and interpreting the experimental work described in Chapters 3 and 4. This summary is not intended to be an exhaustive literature survey. It is intended to make the information we found in the literature conveniently accessible to a reader with interests similar to our own.

Sulfur compounds that may be produced by oxidation of hydrogen sulfide are reviewed in Section 2.2. Substantial literature exists on the oxidation of  $H_2S$ ,  $SO_2$ , and thiosulfate. The oxidation reactions of these compounds are reviewed separately in Sections 2.5, 2.6 and 2.7, respectively. The relevant chemical properties of oxygen and hydrogen peroxide are summarized in Section 2.3, and the transition metals are discussed in Section 2.4.

Several earlier reviews were useful in conducting our own. The book edited by Nickless (1968) gives an excellent overview of inorganic sulfur chemistry. The book edited by Karchmer (1970) and its sequel review the analytic chemistry of sulfur compounds in great detail; The chapter by Haff (1970) was particularly useful. The two volumes edited by Nriagu (1978) review the chemistry and transport of sulfur in the environment. In his own chapter, Nriagu (1978) reviewed the chemistry of sulfur in natural waters, and Urone and Schroeder (1978) reviewed the atmospheric chemistry of sulfur compounds. In 1972, the International Journal of Sulfur Chemistry published the proceedings of a symposium devoted to chemical aspects of sulfur dioxide emission abatement (see the reference to Schmidt, 1972). Benson (1978) reviewed the thermochemistry and chemical bond strengths of sulfur containing molecules and radicals. Sprung (1977) reviewed the atmospheric chemistry of  $H_2S$ . *Cmelins Handbuch der Anorganischen Chemie* contains voluminous information on inorganic sulfur chemistry.

The literature is full of speculative reaction mechanisms, intermediates, etc. Some of the chemical reactions proposed contain obvious errors or inconsistencies. In many cases, we corrected such reactions before quoting them. In other cases, the presentation of the reaction schemes was modified for the sake of brevity, clarity or nomenclatural consistency.

In many studies,  $H_2S$  and  $HS^-$  are not distinguished in the presentation or interpretation of the data. "Total sulfide" or " $H_2S$ " is used in the sense of " $H_2S + HS^- + S^{2-}$ " in many places in this review as well.

### 2.2. Inorganic sulfur compounds

The most stable and abundant forms of sulfur in nature are sulfate minerals, sulfide minerals, and "organic sulfur" in buried organic matter. Deposits of elemental sulfur also exist. Hydrogen sulfide and sulfate ion are the dominant forms of sulfur in natural fluids. They occur in reducing and oxidizing environments, respectively. Because most underground waters and gases are formed in reducing environments, they contain mostly hydrogen sulfide, in which the valence of sulfur is -2. When such fluids are brought to the surface and exposed to oxygen the  $H_2S$  ultimately is converted to sulfate ion in which the valence is +6. The oxidation reactions are very complex, and generally involve many intermediate oxidation states of sulfur. Many compounds and ions in which sulfur has an intermediate valence are known.

The free energy/sulfur atom decreases fairly regularly with increasing valence of sulfur (Table 2.1). However, thermodynamic stability correlates poorly with reactivity in the presence of oxygen. Species likely to be involved in the oxidation of  $H_2S$  are presented in Table 2.2 in the order of decreasing ease of oxidation. Polysulfides and the ions of  $H_2S$  and  $SO_2$  are readily oxidized; the other compounds oxidize so slowly that these reactions are difficult to study.

*Sulfur dioxide and the sulfites.* Disulfite (also called pyrosulfite) is formed by dimerization of bisulfite in concentrated solutions:

Table 2.1  
Free energy of formation and acidity of sulfur compounds  
Kcal/mole at 25°C

Species	$\Delta G_f^\circ$	$pK_a$	Source
$H_2S$ (g)	-8.02		1
$H_2S$ (aq)	-6.66	6.99	1
$H_2S_2$	-1.0	5.0	2
$H_2S_3$	1.6	4.2	2
$H_2S_4$	2.7	3.8	2
$H_2S_5$	3.1	3.5	2
$HS^-$	2.88	12.9*	1
$HS_2^-$	12.2	9.7	2
$HS_3^-$	11.9	7.5	2
$HS_4^-$	11.3	6.3	2
$HS_5^-$	10.9	5.7	2
$S^-$	20.5*		1
$S_2^-$	19.0		1
$S_3^-$	17.6		1
$S_4^-$	16.5		1
$S_5^-$	15.7		1
$SO_2$ (g)	-71.748		1
$SO_2$ (aq)	-71.871	1.77	1
$HSO_3^-$	-126.15	7.2	1
$SO_3^-$	-116.3		1
$S_2O_3^-$	-127.2		3

$S_2O_6^{2-}$	-248.*		4
$S_3O_6^{2-}$	-247.*		4
$S_4O_6^{2-}$	-240.*		4
$S_5O_6^{2-}$	-237.*		4
$HSO_4^-$	-180.69	1.99	1
$SO_4^{2-}$	-177.97		1
$H_2O$	-56.687	14.000	1

\* Not reliable

Sources of data:

- (1) Wagman *et al.* (1968), pp.43-48.
- (2) The  $pK_a$  values are from Schwarzenbach and Fischer (1960). The  $\Delta G_f^\circ$  values were calculated from the corresponding  $pK_a$  values, and the  $\Delta G_f^\circ$  values for polysulfide anions.
- (3) Rossini *et al.* (1952), p.38.
- (4) Latimer (1952), p.307.

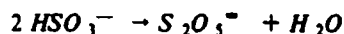

Despite their high valence, sulfite and disulfite are the species most easily oxidized. Both have an exposed, reactive, free electron pair, and readily undergo one electron oxidation to radical-ions. The radical-ions then rapidly react with oxygen. Bisulfite cannot easily be converted to a free radical in this way because a proton shields the otherwise reactive free electron pair. Sulfur dioxide is a Lewis acid, and therefore relatively unreactive. Consequently, lowering pH greatly increases the resistance of the sulfite system toward oxidation. The oxidation of sulfite is discussed further in Section 2.6.

*Hydrogen sulfide and bisulfide.* The bisulfide ion ( $HS^-$ ) can also be oxidized to a radical ion, but not as easily as sulfite; in bisulfide, there are no oxygen atoms to which the electron deficit can be spread. In practice, rapid oxidation of  $HS^-$  requires the presence of polysulfides to catalyze the reaction. Because hydrogen sulfide has no basic free electron pairs, is much less reactive. As with sulfites, lowering pH increases the resistance of the sulfide system to oxidation. The oxidation of  $H_2S$  is discussed further in Section 2.5.

### 2.2.1. The polysulfides, sulfanes, and elemental sulfur

The polysulfide ions are produced by partial oxidation of  $HS^-$ , or by reaction of sulfide salts with elemental sulfur. For example:

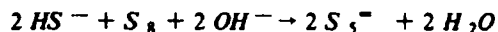

In solution, different polysulfides coexist in equilibrium, with tetra-, penta-, and hexasulfide usually dominant. A substantial concentration of polysulfides will be present if both  $HS^-$  and elemental sulfur are present, and  $pH > 8$ . Under these conditions, polysulfides may be the dominant form of sulfur in solution (Boulegue, 1976; Boulegue and Marchand, 1979).

Table 2.2

Sulfur species in order of decreasing ease of oxidation

Sulfites	$SO_3^-$ , $HSO_3^-$ , $S_2O_5^-$
Polysulfides	$S_n^-$
Eisulfide	$HS^-$
Hydrogen sulfide, sulfur dioxide	$H_2S$ , $SO_2$
Colloidal sulfur	$S^{(0)}$
Higher polythionates	$S_{n>4}O_6^-$
Tetrathionate	$S_4O_6^-$
Thiosulfate	$S_2O_3^-$
Trithionate	$S_3O_6^-$
Dithionate	$S_2O_6^-$
Sulfate	$SO_4^-$

The equilibrium relations between  $HS^-$ , elemental sulfur,  $OH^-$  and polysulfides have been studied by Teder (1971), Giggenbach (1972), and Boulegue (1976, 1978). Boulegue (1978) and Boulegue and Marchand (1979) have applied this information to interpreting the sulfur chemistry of natural waters. They also describe the electrochemical characteristics of the system  $HS^-$ -polysulfides, and describe how electrode potentials may be used to infer the presence of polysulfides and elemental sulfur.

Polysulfides are readily oxidized to elemental sulfur; the terminal atoms are prone to lose their negative charge and link up.

In acid solutions, polysulfides are protonated to sulfanes,  $H_2S_n$ . In aqueous solution sulfanes are unstable, and decompose to  $H_2S$  and elemental sulfur. This decomposition is catalyzed by base. A metastable "sulfane oil" can be obtained by slowly adding concentrated polysulfide solution to cold, concentrated acid with vigorous stirring. Individual sulfanes are obtained from this oil by fractional distillation (Burton and Machmer, 1968).

Schwarzenbach and Fischer (1960) determined the dissociation constants of di- through pentasulfane using a rapid flow method: rapidly flowing streams of acid and polysulfide solution were combined and the resulting pH measured before the sulfanes produced could decompose. The sulfanes are much stronger acids than is  $H_2S$  (Table 2.1), and their acidity increases with chain length. This increase is due to delocalization of the negative charge among the sulfur atoms of the polysulfide ion; the excess electrons are able to enter the empty, low-lying 3d-orbitals of the mid-chain sulfur atoms.

Delocalization of charge lowers the energy of the excited electronic states of the polysulfides, and greatly increases their absorption of light. Dilute polysulfide solutions have a strong yellow color, and are nearly opaque in the ultraviolet (Giggenbach, 1972; Appendix 3.2 in Chapter 3 of this

report). Likely, delocalization also favors the formation of polysulfido- radical-ions,  $^{-}S_n \cdot$ ; the electron "hole" is spread over the chain, and this lowers the free energy of the radical.

The most stable form of elemental sulfur is orthorhombic  $S_8$ ; metastable phases that contain  $S_6$  rings, other ring molecules or long, open chains of sulfur atoms also are known (Meyer, 1976). Reactions in aqueous solution that produce elemental sulfur produce colloidal sulfur; for example, the oxidation of  $H_2S$  and the acid decomposition of thiosulfate. Solid elemental sulfur is fairly unreactive; the reactivity of colloidal sulfur toward oxidizing agents and thiophilic agents (Section 2.2.3) is like that of the polythionates (Section 2.2.4).

### 2.2.2. Thiosulfate

Thiosulfate has free electron pairs on the peripheral sulfur atom, which back-bond into the empty 3d-orbitals of the central sulfur atom. Back-bonding greatly reduces the negative charge on the peripheral sulfur and thereby also its basicity and susceptibility to oxidation. The oxidation of thiosulfate is further discussed in Section 2.7.

At  $pH < 4$ , thiosulfate decomposes to colloidal sulfur and bisulfite or  $SO_2$ . There is an induction period that precedes the formation of colloidal sulfur (LaMer and Kenyon, 1947). The small amount of sulfur produced during the induction period remains in solution, and may be measured by spectrophotometry. During the induction period, the rate of formation of elemental sulfur is one-half order in hydrogen ion concentration, and three-halves order in thiosulfate concentration. The formation of colloidal sulfur is indicated by the sudden appearance of turbidity in the solution. In the turbid solution the rate of sulfur formation is first order in hydrogen ion concentration and second order in thiosulfate concentration, and the reaction is autocatalytic.

Davis (1958, 1964) demonstrated that the kinetic data are consistent with this mechanism:

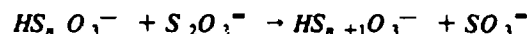
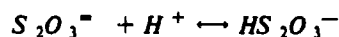

where  $3 < n < 8$ , followed by

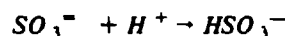
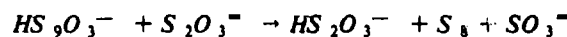

The postulated intermediates,  $HS_nO_3^{-}$ , called "sulfane monosulfonates", are discussed in Section 2.2.5. The limit of stability for thiosulfate is approximately pH 2. Near pH 4, the presence of  $HSO_3^{-}$  will prevent decomposition by favoring the back-reaction. The concentrates from which photographic fixers are prepared contain sodium or ammonium thiosulfate, with smaller amounts of sodium bisulfite, acetic acid, and other additives. The function of bisulfite is to prevent the acid decomposition of thiosulfate.

On heating, alkali thiosulfate salts in solution slowly decompose to  $HS^{-}$  and trithionate:



Trithionate will itself decompose on further heating; the ultimate products of decomposition of thiosulfate probably are  $H_2S$  and sulfate, with the net reaction:

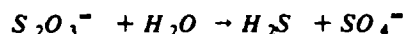

Although it is unstable in aqueous solution, pure thiosulfuric acid has been prepared by combining  $H_2S$  and  $SO_3$  in ether solution at low temperature (Schmidt, 1957).

### 2.2.3. Thiophilic reactions

Many reactions involving nucleophilic attack upon a sulfur atom are known. Often, the reaction center is a formally zero-charged sulfur atom, as in thiosulfate, polysulfides, or polythionates. Davis (1964, 1968) has systematically studied and described several such reactions. A useful concept is the "scale of S-nucleophilicity" or "thiophilicity":

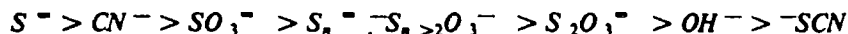

The position of an anion in this scale is a function of its basicity, and its potential for oxidative dimerization; thiophilicity increases with both, but oxidation potential is more important.

"Thiophilic" reactions which cause a stronger thiophile to be replaced by a weaker one are favored. Many reactions fall into this category; for example:

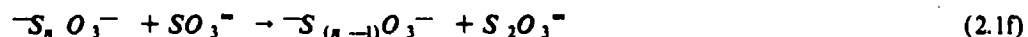
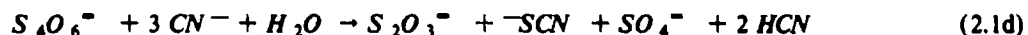

Reaction (2.1a), which is catalyzed by cupric ion, is used in the colorimetric determination of thiosulfate (Kelly *et al.*, 1969; Blasius, *et al.*, 1968). The thiocyanate produced in this way reacts with ferric iron, producing a brightly colored complex. Reactions (2.1b and c) are used in an analogous procedure for colloidal sulfur (Bartlett and Skoog, 1954). Reaction (2.1d) proceeds without a catalyst, and is used for the determination of tetrathionate in the presence of thiosulfate (Kelly *et al.*, 1969).

Most molecules that contain more than one nominally zero-valent sulfur atom will react with sulfite to produce thiosulfate. For example, reactions (2.1e and f) destroy colloidal sulfur and polysulfidomonosulfonates (Section 2.2.5). Reaction (2.1g) converts tetra- and higher polythionates to trithionate.

Reactions like (2.1h) are used in the commercial production of polysulfides.

The "thiophilic order" may be violated under some circumstances, as when a reaction product is removed by further reaction. The acid decomposition of thiosulfate is a case in point; the sulfite produced is immediately protonated to bisulfite.

### 2.2.4. Polythionates

Polythionates, also called "polysulfidodisulfonates", consist of a chain of sulfur atoms with a sulfonate group at either end; e.g. tetrathionate:



The corresponding "sulfanedisulfonic acids" may be prepared by reaction of sulfanes with sulfur trioxide in ether solution at low temperature (Schmidt, 1957b); e.g.,

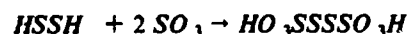



Polythionates are present in "Wackenroders's solution", prepared by mixing  $H_2S$  and  $SO_2$  in water. This solution contains substantial concentrations of tetra- and pentathionates, with smaller amounts of tri- and hexathionate also present (Janickis, 1969).

Polythionates also are formed when concentrated sodium thiosulfate solution is added to cold, concentrated, hydrochloric acid. From such solutions, pure salts of up to octathionate may be isolated (Lyons and Nickless, 1968; Yanitskii *et al.*, 1971).

The oxidation of polythionates probably begins with their decomposition to sulfate, colloidal sulfur, and either thiosulfate or sulfite. The stability of polythionates tends to decrease with increasing number of sulfur atoms. The qualitative chemistry of the polythionates and other sulfur oxoacids was reviewed by Haff (1970).

In alkaline solutions, penta- and higher thionates decompose rapidly with precipitation of colloidal sulfur. In acid solution they decompose more slowly.

Tetrathionate is produced by reaction of thiosulfate with mild oxidizing agents, e.g. iodine (*Ibid.*). Concentrated tetrathionic acid decomposes to sulfuric acid,  $SO_2$  and colloidal sulfur, but the dilute acid can survive boiling. Heating alkaline tetrathionate solutions will cause decomposition to trithionate and sulfur. In acid solution, tetrathionate is more stable than trithionate.

Trithionate is generally the most stable polythionate, and often is found among the products of oxidation of  $H_2S$  or thiosulfate. In acid media, trithionate slowly hydrolyzes to sulfuric acid, colloidal sulfur, and  $SO_2$ . In alkaline media it hydrolyzes to sulfate and thiosulfate.

Trithionate is produced by reaction of thiosulfate with oxygen, catalyzed by copper complexes (Section 2.7). Trithionate also is formed by reaction of thiosulfate with bisulfite at pH about 4:

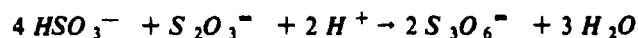

This reaction is followed by the slow hydrolysis of trithionate:



The net reaction is, then, the disproportionation of  $HSO_3^-$ , catalyzed by thiosulfate:

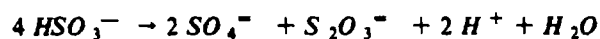

This slow disproportionation reaction proceeds in concentrates from which photographic fixers are prepared, and limits their storage life. When all the bisulfite initially present has been consumed, the thiosulfate rapidly decomposes, creating a precipitate of colloidal sulfur and spoiling the concentrate. The precipitation of colloidal sulfur happens suddenly, after an extended period in which the bisulfite decomposes, but the solution remains clear (Levenson, 1960; Levenson and Rumens, 1965).

The reaction of thiosulfate and bisulfite was studied by Battaglia and Miller (1968). During the initial part of the reaction, the rate of disappearance of bisulfite is first order in bisulfite, third order in thiosulfate, and third order in hydrogen ion. After about 10% reaction progress, the reaction becomes autocatalytic, and proceeds at a faster rate with a different rate law. A detailed mechanism, consistent with the initial period rate law, was proposed:

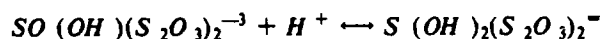
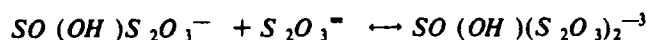
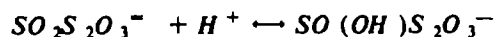
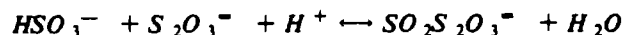

\* "J. Janickis" is the original, Lithuanian spelling of the name. It also appears in the form "I.V. Yanitskii", which results from the dual transliteration Lithuanian  $\rightarrow$  Russian  $\rightarrow$  English, or "J. Janitzki" in German transliteration.

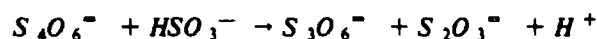
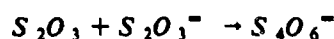

The fifth reaction is rate-determining during the initial period. After about 70% reaction progress, hydrolysis of trithionate to sulfate and thiosulfate becomes significant.

### 2.2.5. Sulfanemonosulfonates

The "sulfanemonosulfonates",  $HS_{n>2}O_3^-$ , and "polysulfidomonosulfonates",  $-S_{n>2}O_3^-$ , are very reactive, but probably are not particularly unstable in a thermodynamic sense. They are hard to isolate and characterize, but probably are intermediates in many reactions.

When a concentrated solution of a thiosulfate salt is added to cold, concentrated hydrochloric acid, sulfanemonosulfonates, polythionates,  $SO_2$ , and colloidal sulfur are formed. Yanitskii *et al.* (1971) isolated sulfanemonosulfonate salts containing 2 to 9 sulfur atoms from such mixtures. In each case, the cation was cobalt complexed by bulky organic ligands. Polysulfidomonosulfonates are intermediates in the reaction of sulfur with sulfite (2.1e and f).

The corresponding "sulfanemonosulfonic acids" may be prepared in a pure form by reaction of sulfanes with sulfur trioxide in ether solution at low temperature (Schmidt, 1957a); e.g.:

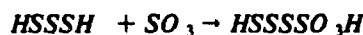

These acids may be kept for a short time at room temperature in concentrated HCl or glacial acetic acid. In less acidic media, they rapidly decompose to thiosulfate, colloidal sulfur, and  $SO_2$ . They are intermediates in the acid decomposition of thiosulfate. Chemically, the sulfanemonosulfonic acids behave like a combination of thiosulfuric acid and sulfane. For example, in concentrated HCl:

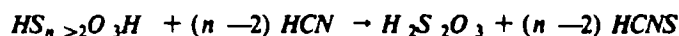

Weak oxidizing agents, like iodine in acid media, dimerize the sulfanemonosulfonic acids, as with thiosulfate:

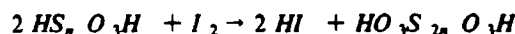

Schmidt (1957c) summarized the chemical relationship between the sulfanemonosulfonic acids, the polythionic acids, and thiosulfuric acid.

### 2.2.6. Dithionate

The chemical properties of dithionate are very different from those of the polythionates. The reaction of  $SO_2$  with certain mild oxidizing agents produces dithionate together with sulfate:



It is possible that dithionate also is formed by oxidation of disulfite (Schmidt, 1972); adding one oxygen atom to disulfite would convert it to dithionate. The mechanism of this reaction probably resembles that of sulfite oxidation.

Dithionate is relatively unreactive. However, in a boiling, concentrated solution, dithionic acid (which is fully dissociated) will decompose:

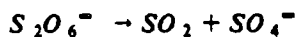

The oxidation of dithionate may begin with this reaction. In practice, very powerful oxidizing agents like dichromate in sulfuric acid are needed rapidly to oxidize dithionate.

Because dithionate is readily produced by partial oxidation of sulfites or  $SO_2$ , it probably is commonly associated with them. This association is not generally appreciated, because analytic procedures for dithionate are difficult and rarely effected. Traditional methods call for differential oxidation; for example, hydrogen peroxide in alkaline solution will convert all forms of inorganic sulfur except dithionate to sulfate, while dichromate will convert dithionate as well (Blasius *et al.*, 1969, p. 227). Gravimetric or titrimetric methods are used to determine the sulfate produced in either case, and the difference is taken as the concentration of dithionate. Direct gravimetric determination of dithionate is not possible because even the barium salt is soluble.

Raman spectrometry is by far the best method for determining dithionate and other oxo-anions of sulfur in mixtures (Meyer *et al.*, 1980). The detection limit for dithionate is claimed to be 1 mM. The method is least sensitive to  $SO_2$ , for which the detection limit is 30 mM.

### 2.2.7. Sulfate

If free oxygen is present, oxidation reactions will ultimately convert all the sulfur compounds discussed above to sulfate.

Many plants and microorganisms utilize sulfate as a source of sulfur for biosynthesis, and some microorganisms use it as an electron acceptor in their respiration, reducing it to elemental sulfur or  $H_2S$  (Postgate, 1968). These organisms "close the sulfur cycle" within the biosphere, by reducing sulfate produced by oxidation, both inorganic and organic.

Reduction of sulfate by inorganic reaction in aqueous solution has not been demonstrated in the laboratory or documented in nature. If inorganic reduction does occur, it probably is a very slow reaction, even under the conditions that exist in a geothermal reservoir.

### 2.3. Oxygen and hydrogen peroxide

The element oxygen exists in three allotropic forms. Ozone,  $O_3$ , is the least stable form. The most stable form is  $O_2$  in the electronic ground state  $^3\Sigma$ . Sometimes called *triplet oxygen*, this is the common form of the element oxygen in nature. In the  $^3\Sigma$  configuration, there are two electrons in  $2p\sigma$  bonding orbitals, four electrons in  $2p\pi$  bonding orbitals, and two electrons in  $2p\pi^*$  anti-bonding orbitals. The total bond order is two. In triplet oxygen, each  $2p\pi^*$  antibonding orbital contains one electron, and the spins of these two electrons are parallel. Thus, the oxygen molecule has two unpaired electrons, which impart the characteristics of a free radical; for example, oxygen is paramagnetic. A simplified representation of the  $^3\Sigma$  electronic structure is:

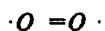

Triplet oxygen readily attaches itself to other radicals:

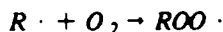

This type of reaction plays an important role in combustion processes.

In the presence of sensitizers (certain dyes), ultraviolet light excites triplet oxygen to "singlet oxygen",  $O_2(^1\Delta)$ . The energy of singlet oxygen is 23.4 kcal/mole above that of triplet oxygen (Valentine, 1973). In singlet oxygen, the two anti-bonding electrons are paired in one of the  $2p\pi^*$  anti-bonding orbital (Fig. 2.1). Thus, singlet oxygen is not a free radical. A simplified representation of its electronic structure is:

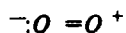

Singlet oxygen is a much stronger oxidizing agent than triplet oxygen. It is more energetic, and its dipolar electronic structure makes it able to react as both a nucleophile and an electrophile. A typical reaction of singlet oxygen is shown in Fig. 2.2.



*The reduction of oxygen.* Table 2.3 presents the free energies for several possible combinations of two oxygen atoms with four hydrogen atoms. Three points stand out:

- (1) Reduction of triplet oxygen by one electron to produce  $HOO \cdot$  (or its conjugate base  $O_2^{\cdot-}$ ) increases the free energy of the system. Therefore, one electron reduction is disfavored.
- (2) The free energy decrease associated with reduction of triplet oxygen by two electrons (to  $H_2O_2$ ) is relatively small.
- (3) The free energy decrease associated with reduction of either hydroxyl radical or hydrogen peroxide to water is large.

The reduction potentials of oxygen in aqueous solution at 25°C and pH 7 are summarized in Figure 2.3.

The potential for two electron reduction of triplet oxygen to  $H_2O_2$  is small, and the potential for one electron reduction to hydrogen superoxide ( $HOO \cdot$ ) is negative. Therefore,  $HOO \cdot$  is actually a reducing agent which may give up its odd electron and revert to triplet oxygen. In fact, oxidation of hydrogen superoxide to triplet oxygen is more likely than further reduction to hydrogen peroxide, despite the substantial potential favoring the latter reaction (Wilshire and Sawyer, 1979). Often, hydrogen superoxide will disproportionate to oxygen and hydrogen peroxide:



State	Free Energy (kcal/mole)	Formal Valence of oxygen
$2/3 O_3 + 2 H_2$	26.2	0
$O_2(^1\Delta) + 2 H_2$	23.4	0
$HOO \cdot + 3/2 H_2$	3.	-1/2
$O_2(^3\Sigma) + 2 H_2$	0.0	0
$2 HO \cdot + H_2$	-10.	-1
$H_2O_2(aq) + H_2$	-31.5	-1
$2 H_2O(liq)$	-113.4	-2

Energy of  $O_2(^1\Delta)$  is quoted from Valentine (1973). All other values in this Table and Fig. 2.3 quoted or calculated from tabulation by Latimer (1952), Appendix I.

The unfavorable energetics of reduction are compounded by kinetic factors. In particular, the complete absence of polar character in triplet oxygen precludes the electrophilic reactions favored by singlet oxygen and hydrogen peroxide. Therefore, low temperature reduction of triplet oxygen is impossible without suitable catalysts. Such catalysts may initiate free radical chain reactions, as in combustion, or they may simultaneously complex oxygen and the oxidation substrate, catalyzing their reaction (Section 2.4).

Ozone is readily reduced to water and either triplet or singlet oxygen. Singlet oxygen is reduced to hydrogen peroxide much more readily than is triplet oxygen, and even one-electron reduction of singlet oxygen has a positive potential.

Hydrogen peroxide, itself a powerful oxidizing agent, can oxidize inorganic substrates in at least four ways:

- (1) Many oxidation substrates are nucleophilic. With these, hydrogen peroxide can react as an electrophile. For example, in the reaction of  $H_2O_2$  with  $HS^-$ , Hoffman (1977) inferred the rate determining step to be:

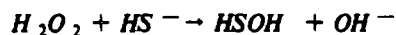

This step involves nucleophilic attack by  $HS^-$  upon one oxygen atom within the hydrogen peroxide molecule, resulting in the expulsion of  $OH^-$ . (See Section 2.5.3.)

- (2) The hydroperoxide ion  $HOO^-$  may displace an  $OH^-$  from the substrate. This substitution is followed by rearrangement to the ultimate oxidation product. The reaction of  $H_2O_2$  with  $HSO_3^-$  falls in this category (see Section 2.6.3).
- (3) A one electron reducing agent can convert  $H_2O_2$  to hydroxide and hydroxyl, as in Fenton's Reaction:

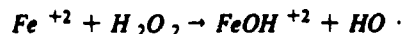

Hydroxyl radical, the most powerful oxidizing agent in the oxygen system, then reacts with other compounds. This reaction may be used to initiate free radical chain reactions; for example, between oxygen and  $H_2S$ .

- (4) Hydrogen peroxide may partake in free radical chains. For example, iron complexes are known to catalyze the reaction of  $H_2O_2$  with  $H_2S$ . This reaction has not been studied in detail, but may involve the chain propagation steps:

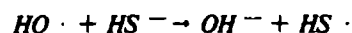
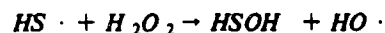

#### 2.4. The transition metals

Transition metal ions catalyze the oxidation of hydrogen sulfide and other sulfur compounds.

Some complexed transition metal ions possess two oxidation states of comparable stability. Reduction of such a complex by one electron often is possible, and will convert the oxidation substrate to a free radical. This reaction can initiate a chain reaction involving triplet oxygen. Complexes of iron, cobalt, and copper are believed to catalyze the oxidation of sulfur compounds in this way. Nickel has only one oxidation state of practical importance, and probably cannot catalyze reactions in this way.

The rate of a free radical chain reaction initiated by a catalyst commonly is proportional to the square root of catalyst concentration. However, the relationship between concentration and rate may be complicated by hydrolysis or precipitation of the catalyst. If the oxidation substrate is involved in the initiation step, its apparent kinetic order in the overall rate of oxidation may be one-half or three-halves.

To serve as a catalyst, a transition metal ion must usually be complexed by something other than water. In water, the more oxidized form commonly hydrolyzes, and may precipitate if not

otherwise complexed. This is particularly true of iron(III). Uncomplexed iron is an effective catalyst for  $H_2S$  oxidation, but its use results in the production of a noxious and corrosive ferric hydroxide sludge. Complexed with HEDTA or citrate, iron is a powerful catalyst for  $H_2S$  oxidation at low concentration and does not precipitate (Section 4.5).

Copper is a very potent catalyst for the oxidation of sulfite, but its effective concentration in solution is limited by the small solubility of cupric hydroxide at  $pH > 7$  (Section 2.6.1). Complexing agents may increase the catalytic potency of copper for this reaction, but this has not been tested. Complexation by ammonia is known to increase the catalytic potency of copper in the oxidation of thiosulfate (Section 2.7).

Complexation changes the half-cell potential between the two valence states. The higher oxidation state is stabilized by complexation more than the lower. Therefore, complexation makes it easier to oxidize the ion and harder to reduce it. Cobalt(III) presents the extreme example of this. The reduction potential of the hydrated ion is +1.842 volts, high enough to oxidize water. However, many complexes of cobalt(III) are stable, particularly the octahedral ammonia complex (reduction potential +0.1). The oxidation of iron(II) to iron(III) also requires complexation. For example, the reduction potential of hydrated iron(III) is +0.771, while that of hexacyanoiron(III) is only +0.36. Hydrolysis, which involves complexation by hydroxide, also favors oxidation. For example, iron(II) is oxidized by air only in neutral or basic media, where the iron (III) produced will precipitate as ferric hydroxide.

Uncomplexed copper(I) disproportionates to copper(II) and copper metal. Therefore, copper(I) is unstable unless stabilized by ligands. Also, copper can be displaced from solution by reaction with steel surfaces, if present. These are additional reasons for preferring suitably complexed copper as an oxidation catalyst.

Many sulfur compounds are good ligands; for example, sulfite,  $HS^-$ , and thiosulfate. Therefore, the reaction substrate or product may serve as the ligand needed for catalysis by a transition metal ion. Complexation of cobalt by sulfite must be postulated to explain the catalysis of sulfite oxidation by cobalt (Section 2.6.2).

Some complexing agents may inactivate a catalytic ion by sequestering it, thereby preventing the formation of catalytically active complexes. For example, EDTA blocks catalysis of  $H_2S$  oxidation by nickel (our own observation).

Many transition metal complexes involving oxygen as a ligand are known (Valentine, 1973; Martell, 1982). If an oxidation substrate is also present as a ligand, catalyzed transfer of electrons to the oxygen molecule may occur. This form of catalysis can initiate chain reactions, or directly induce oxidation. The metal ion expedites the reaction by 1) bringing the reactants together, 2) stabilizing the peroxide or superoxide radical that is produced, or 3) providing its low-lying empty 3d or 4s orbitals as conduits for electron transfer. In the second and third cases, the catalyst is directly involved in the oxidation of each molecule of the substrate.

Among the first series transition metals, cobalt complexes with oxygen particularly well (Martell, 1982). Most cobalt-oxygen complexes are binuclear. Their properties suggest that they contain a peroxide ion, which is complexed by cobalt(III) at either end. The formation of such a complex is believed to be the first step in the oxidation of complexes of cobalt(II) by oxygen (Cotton and Wilkinson, 1966, pp. 867-8). A few 1:1 cobalt-oxygen complexes also are known. In these, one end of the oxygen molecule is attached to the single cobalt ion; the electronic structure may be that of superoxide stabilized by complexing cobalt(III). The best known example is the oxygen complex of vitamin  $B_{12}$ . The iron complexes oxyhemoglobin and oxymyoglobin also belong to this category (Valentine, 1973). If an oxidation substrate is included in the coordination sphere, its one electron oxidation may be favored by stabilization of the superoxide ion produced. This may be the mechanism by which certain complexes initiate chain reactions.

In most 1:1 oxygen complexes, the two oxygen atoms are equidistant from the metal ion. Valentine cites many examples in which the metal ion is ruthenium, osmium, cobalt, rhodium, iridium, nickel, palladium or platinum. If a ligand capable of two electron oxidation also is present, these two electrons may be transferred to the oxygen molecule, converting it to a peroxide ion. In

fact, some of these complexes give off hydrogen peroxide when acidified. If two oxidizable ligands are present, each of them may lose a single electron to oxygen, producing two free radicals and a peroxide ion.

Some oxygen-containing complexes will react with an oxidation substrate by transferring oxygen atoms to it. Valentine cites examples in which an oxygen complex of platinum, palladium, iridium, rhenium, or ruthenium oxidizes  $SO_2$  in this way (Section 2.6.3).

In all well characterized transition metal complexes of oxygen, ligands other than oxygen also are present. The nature of these other ligands has a large effect on the stability of the complex and its reactivity.

## 2.5. Oxidation of hydrogen sulfide

Most literature references related to the oxidation of  $H_2S$  that we found are cited here. Patents were also found, but these are not cited or discussed. A mechanism for the reaction of  $H_2S$  with oxygen is presented in Section 3.6, in connection with our own experimental results.

### 2.5.1. Reaction of hydrogen sulfide with oxygen

The reaction between  $H_2S$  and oxygen is strongly promoted by catalysts that generate free radicals and initiate a chain reaction. Because radical chain reactions are typically of one-half kinetic order in the initiator, and nickel and cobalt are powerful catalysts at 1 ppm concentration, the presence of a few ppb of either would suffice to make the reaction proceed on a time scale of hours.

*The "uncatalyzed" reaction.* There have been numerous studies of the nominally uncatalyzed reaction between oxygen and  $H_2S$ . In fact, the reactions reported may have been catalyzed by traces of transition metal ions.

Avrahami and Golding (1968) studied the nominally uncatalyzed reaction of  $H_2S$  with dissolved oxygen in the pH range 11 to 14. Typically, the initial sulfide concentration was about  $100\mu M$ . Experiments were executed at various temperatures between 22 and  $55^\circ C$ . The reaction was followed by monitoring optical density 230 nm, where  $HS^-$  absorbs light most strongly (Ellis and Golding, 1959). At the beginning of an experiment, optical density would decrease with the concentration of  $HS^-$ . Later in the experiment, absorption at 230 nm was due mostly to thiosulfate, allowing the concentration of thiosulfate to be monitored.

Initially, both thiosulfate and sulfate were produced by the reaction. When  $HS^-$  no longer was present, the initially formed thiosulfate continued slowly to oxidize to sulfate. The oxidation of thiosulfate was about five-fold slower than the oxidation of  $HS^-$ . Sometimes opalescence, probably due to colloidal sulfur, was noticed.

Avrahami and Golding supposed the first step to be the formation of sulfite, which then reacted either with oxygen to form sulfate, or with oxygen and  $HS^-$  to form thiosulfate. Because sulfite was not observed, its reactions were presumed to be much faster than the others.

The concentration of  $HS^-$ , and later that of thiosulfate, decreased exponentially (i.e., first order kinetics). Tripling the concentration of oxygen doubled the rate of disappearance of  $HS^-$ . Increasing the pH by one unit doubled the reaction rate. The effect of temperature suggested an energy of activation = 8 kcal/mole. No induction period was observed (defined below).

Chen and Morris (1972) studied the nominally uncatalyzed reaction of  $H_2S$  and oxygen over the pH range 6 to 13. The initial sulfide concentration ranged from  $50\mu M$  to 20 mM. The reaction solutions were buffered. The concentrations of all sulfur species were determined by standard colorimetric methods. Usually, an induction period of up to one hour was observed at the start of the reaction; i.e., the concentration of sulfide would remain essentially constant for some time, and then begin to drop. Immediately after the induction period, the reaction rate was determined by calculating the slope of the curve of sulfide concentration vs. time. The apparent reaction orders in  $H_2S$  (including  $HS^-$ ) and oxygen were 1.34 and 0.56, respectively.



There were two maxima in the reaction rate as a function of pH, one in the range pH 6.7-8.0, depending on initial sulfide concentration, and the other at about pH 11. The reaction did not proceed below pH 6. The peak in reaction rate at about pH 7 was correlated with the formation of polysulfides as reaction intermediates. It was proposed that the reaction is catalyzed by polysulfides; i.e., it is autocatalytic. An induction period is characteristic of autocatalytic reactions; an autocatalytic reaction proceeds very slowly until a significant concentration of the autocatalyst has accumulated. A free radical chain mechanism was proposed, consistent with the apparent fractional kinetic orders of the reactants.

The presence of polysulfides is readily detected by measuring absorbance at 285 nm. Only polysulfides and other chain molecules absorb at this wavelength. Typically, the optical density at 285 nm would peak after about three hours, and would be greatest at pH 7.0. At pH < 6, polysulfides are protonated to sulfanes which decompose to colloidal sulfur and  $H_2S$ ; therefore, the autocatalytic reaction cannot proceed. At pH > 8.5, the reaction proceeds, but the major reaction product is thiosulfate. At high pH polysulfides are not produced, and the relatively rapid autocatalytic pathway is not available. The maximum, transient conversion of  $H_2S$  to polysulfides was estimated to be about 15%, which was attained with initial sulfide = 1 mM and pH near 7. At higher initial concentrations, formation of colloidal sulfur was favored, while lower concentrations favored the formation of thiosulfate and sulfite. Chen and Gupta (1973) confirmed and extended the results and conclusions of Chen and Morris (1972).

O'Brien and Birkner (1977) reported experiments similar to those of Chen and Morris. Initial sulfide concentrations from 10 to 80  $\mu M$  were employed, and experiments were performed at pH 4, 7.55, and 10. The solutions were buffered. Total sulfide, sulfite, and thiosulfate were measured by colorimetric methods. The reaction rate was low at pH 4, but increased with pH. Most data were taken at pH 7.55. At this pH, the apparent kinetic orders in  $H_2S$  and  $O_2$  were 1.0 and 0.8, respectively. Increasing ionic strength increased the reaction rate, suggesting reaction between like-charged ions. The formation of colloidal sulfur was not observed, and there was no induction period. The major reaction products were sulfite, thiosulfate, and sulfate. Sulfite was inferred slowly to oxidize to additional sulfate. An empirical rate law was derived, which describes the kinetics of formation of sulfite, thiosulfate and sulfate.

*Oxidation of  $H_2S$  in sea water.* No catalyst was intentionally added to the water in these studies, but the reaction probably was catalyzed by metal ions naturally present.

Östlund and Alexander (1963) used filtered, deoxygenated samples of water from a mangrove swamp in the Everglades. The oxygen concentration in the water was adjusted by bubbling a suitable gas mixture through it, and a known amount of  $Na_2S$  was added. The sulfide concentration was measured directly with an  $Ag_2S$  electrode; that is, the reaction was not quenched with sulfide antioxidant buffer before measuring sulfide concentration. The half-life of sulfide was about 20 minutes and the reaction was first order in sulfide concentration.

Cline and Richards (1969) used water from Lake Nitinat, an anoxic fjord on the coast of Vancouver Island. Typically, about 60  $\mu M$  sodium sulfide was added. Sulfide, sulfite, and thiosulfate were determined by colorimetric methods. No turbidity, which would have indicated production of colloidal sulfur, was observed. The results were consistent with a rate law that is first order in both sulfide and oxygen. The half-life of  $H_2S$  was about fifteen hours, and some experiments exhibited induction periods. The major oxidation products were sulfite, thiosulfate, and, presumably, sulfate, which was not actually measured. Usually, the product distribution was 30-35% thiosulfate, 10-15% sulfite, and the rest presumably sulfate. The concentration of sulfite tended to level off early, suggesting further reaction to sulfate was taking place. Adding 5  $\mu M$  iron(II) to the water accelerated the reaction somewhat, and increased the fraction of thiosulfate among the products to 82%.

Almgren and Hagström (1974) added 1 to 200  $\mu M$  of sulfide to sea water. The half-life of sulfide was about an hour, and the reaction was first order in sulfide. The rate increased with pH between 8.0 and 8.5. They also tabulated estimates of sulfide half-life in sea water published by other authors. These vary from 24 to 10,000 minutes, because of wide variations in trace catalysis and experimental technique.

### 2.5.2. Catalysis and inhibition

Chen and Morris (1972a) studied the effects of metals and organic compounds upon the oxidation of  $H_2S$ . They worked with initial  $H_2S$  concentrations of 10 to 100 mM, and pH 4.25 to 13. The disappearance of oxygen was monitored during the experiment. The terminal oxygen concentration indicated the ratio of  $O_2:H_2S$  consumed, and, presumably, the relative amounts of colloidal sulfur and thiosulfate produced. Nickel and cobalt were powerful catalysts down to  $10\mu M$ . Increasing nickel concentration increased the yield of colloidal sulfur. Manganese, copper, calcium, and magnesium had weak accelerating effects. Calcium and magnesium cannot directly catalyze redox reactions. These ions must exert their effect by complexing with the reactants, which suggests that reaction between anions is involved.

Chen and Morris found that many organic compounds accelerate the oxidation of  $H_2S$ . These compounds include hydroquinone (most effective), formaldehyde, phenol, pyrocatechol, and vanillin. These compounds all are easily oxidized through free radical chain reactions which induce the oxidation of  $H_2S$  as well. Formaldehyde greatly increased the yield of colloidal sulfur while pyrocatechol did not.

EDTA and several other chelating agents decreased the rate of oxidation. Likely, these compounds chelate and deactivate catalytic metal ions. Alcohols did not affect the rate of oxidation.

Snavely and Blount (1969) studied the removal of dissolved oxygen from water by reaction with  $H_2S$ ,  $SO_2$  or hydrazine. The initial  $H_2S$  concentration was 6 mM (200ppm). The range in pH was 2 to 10. Among the catalysts tested, the order of catalytic activity was:



With nickel and cobalt, the reaction rates were the same at pH 6 and 10. At pH 2 the rate of reaction was much smaller. The nominally uncatalyzed reaction proceeded at pH 10 only. An induction period frequently was observed. Its duration decreased with increasing catalyst concentration, often to zero with 5ppm of catalyst present. After the induction period, the rate of reaction was independent of  $O_2$  concentration. Increasing the concentration of nickel from 0.005 to 0.5 ppm increased the rate of reaction about ten-fold. When 50  $\mu n$  of  $Na_2SO_3$  was present with 200 ppm of  $H_2S$ , the rate of disappearance of  $O_2$  was less than with  $H_2S$  alone.

Cobalt proved the best catalyst for the reaction of oxygen with  $SO_2$ . Copper was the only metal tested that promoted the reaction of oxygen with hydrazine.

Snavely and Blount concluded that:

These results imply that the reaction of dissolved  $O_2$  with  $H_2S$  is autocatalytic and requires build-up of an intermediate species which is unstable at low pH ... perhaps a polysulfide.

Abel (1956) discussed "the autooxidation" of  $H_2S$  and proposed speculative reactions that yield colloidal sulfur, sulfite, or thiosulfate. The reaction scheme leading to thiosulfate was most plausible:

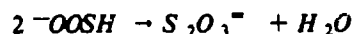
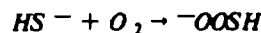

The intermediate compound  $^-OOSH$  is the conjugate base of "unsymmetrical sulfoxylic acid",  $HOOSH$ . There is no direct evidence for the existence of this acid or its anions, but they are sometimes inferred as intermediates in such reactions.

Hoffman and Lim (1979) studied the reaction between  $H_2S$  and  $O_2$  catalyzed by tetrasulphthalocyanine (TSP) complexes of divalent cobalt, nickel and copper over the pH range 5.5 to 12.1. These complexes resemble porphyrins (Figure 2.4). The decline of sulfide concentration was measured directly with an  $Ag_2S$  electrode. The dissolved oxygen concentration was measured with a dissolved oxygen probe.

The order of catalytic activity was:

COBALT 4,4',4'',4'''-TETRASULFOPHTHALOCYANINE

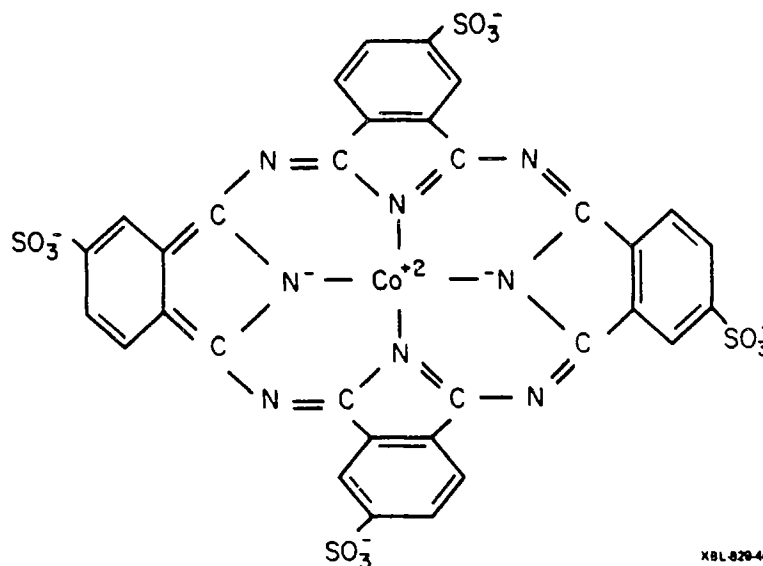
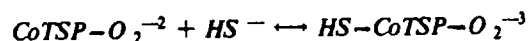
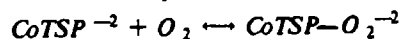

Fig. 2.4. Chemical structure of cobalt(II) tetrasulfophthalocyanine (drawn following Hoffmann and Lim, 1979).

Co TSP > Ni TSP > Cu TSP

At pH 8.3, Co TSP was catalytically active at 0.5 nanomolar concentration. In most experiments, the major reaction products were sulfate and thiosulfate, with a minor amount of sulfite also produced. With Co TSP above 100nM, colloidal sulfur and thiosulfate were the major reaction products.

The reaction catalyzed by Co TSP was studied in detail. The kinetic orders are one in both sulfide and CoTSP. The apparent kinetic order in  $O_2$  was determined as either zero or two-thirds, depending on the  $O_2/H_2S$  ratio. TSP complexes resemble certain enzymes and, in fact, the kinetics of this reaction may be fitted well using the bisubstrate Michealis-Menton Law used by biochemists. The initial steps of the reaction were inferred to be:



The first two reactions are reversible pre-equilibria, and the third is rate determining. Subsequent reactions which produce sulfate and thiosulfate are rapid and do not affect the overall rate. Increasing ionic strength increased the rate of reaction, consistent with a mechanism that involves a reaction between two anions. Between pH 5 and 8 the rate of reaction increased with increasing dissociation of  $H_2S$  to  $HS^-$ . Between pH 10 and 12 it increased again, apparently with increasing deprotonation of the catalyst. Deprotonation is believed to stabilize the more active, monomeric form of the catalyst.

Theodorus *et al.* (1976) reported that:

Attachment of cobalt-[tetraamino]phthalocyanine to cross-linked polyacrylamide produces a stable

oxidation catalyst with enhanced activity.

They hypothesized that attachment to a polymeric substrate enhanced activity by preventing pairing of the catalyst molecules (the bridge between them would be an  $O_2$  molecule coordinated by a cobalt ion at either end).

Cobalt tetrasulfo- or tetraaminophthalocyanine bound to polymeric or solid substrates is believed to be used in certain proprietary processes for  $H_2S$  removal from liquids and gases.

### 2.5.3. Reaction with oxygen over solid catalysts

Steijns *et al.* (1976) studied the reaction of  $H_2S$  with oxygen on solid catalysts at high temperature. The catalysts investigated included two kinds of activated carbon, a carbon molecular sieve, alumina, and a zeolite molecular sieve. All gave qualitatively similar results, and activated carbon was chosen for detailed study.

Below  $200^\circ C$ , 90% of the  $H_2S$  was converted to elemental sulfur, which remained in the pores of the catalyst. With increasing temperature, an increasing amount of  $SO_2$  was formed. Above  $300^\circ$ ,  $SO_2$  became the dominant product. The reaction was autocatalytic; a maximum reaction rate was observed when a certain amount of sulfur was present in the catalyst. Above that amount, catalytic activity decreased again, probably because the pores in the catalyst became completely filled.

At low  $O_2$  partial pressure, the empirical kinetic order in  $O_2$  was one, and decreased to zero with increasing partial pressure. At low  $H_2S$  partial pressure, the apparent kinetic order in  $H_2S$  was one-half, and decreased to zero with increasing  $H_2S$  pressure. From this, two reaction steps were inferred, one involving  $H_2S$ , the other  $O_2$ . At large partial pressure of  $H_2S$ , the catalyst was saturated with adsorbed  $H_2S$ , making  $O_2$  the rate controlling reactant. The inverse effect was observed at large partial pressures of  $O_2$ .

One-half kinetic order in  $H_2S$  suggests that reversible adsorption with dissociation precedes actual oxidation:

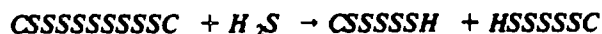

where  $C\text{SSSSSSSSC}$  represents a chain of sulfur atoms bonded onto the surface of the catalyst at either end. Energies of activation were determined for the reactions involving  $H_2S$  and  $O_2$ . With activated carbon, these were  $52 \pm 5$  kJ/mole and  $37 \pm 4$  kJ/mole, respectively. The yield of  $SO_2$  increased with increasing temperature because  $E_a$  for the oxidation of elemental sulfur is about 120 kJ/mole.

Steijns *et al.* (1976a) studied the oxidation of  $H_2S$  catalyzed by a zeolite molecular sieve using electron spin resonance spectroscopy, and constructed a reaction mechanism, based on these results. (Carbon could not be used, because its electrical conductivity is too high to allow ESR to be measured.)

The following sulfur-containing radicals were tentatively identified with distinct ESR signals:



These signals could be interconverted by exposing the catalyst to  $H_2S$ ,  $O_2$ , and  $SO_2$ :

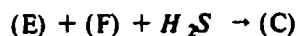
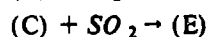
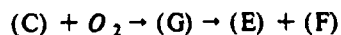

In the first reaction, addition of  $O_2$  to the system first replaced (C) with (G), and then (G) slowly declined as (E) and (F) increased. These observations suggest this reaction mechanism:

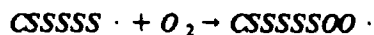
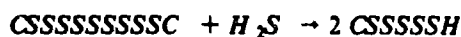

At high temperature, a side reaction produces  $SO_2$ :



#### 2.5.4. Reaction with hydrogen peroxide

Hoffmann (1977) studied the uncatalyzed reaction between  $H_2S$  and  $H_2O_2$ . Reaction with  $O_2$  was prevented by keeping  $O_2$  out of the system, and catalysis by transition metals was reduced by adding EDTA. However, there is no guarantee that catalysis did not occur, because some transition metal complexes are good catalysts. Sulfide concentration vs. time was measured directly with an  $Ag_2S$  electrode.

The rate data were consistent with this rate law:

$$-\frac{d[H_2S]}{dt} = k_1[H_2S][H_2O_2] + k_2[HS^-][H_2O_2]$$

which suggests two parallel mechanisms. The rate determining steps in the two mechanisms proposed are:

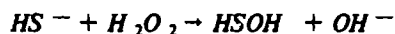
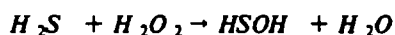

The second reaction is faster than the first and probably involves nucleophilic attack by  $HS^-$  upon  $H_2O_2$  with displacement of  $OH^-$ .

Below pH 6.7, the dominant reaction product was colloidal sulfur. Hoffman suggested that colloidal sulfur formed by a series of reactions like:

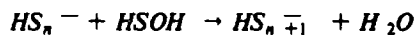
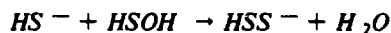

where n is between 2 and 8, followed by

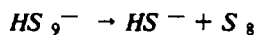

Each step involved thiophilic displacement, analogous to the acid decomposition of thiosulfate (Section 2.2.2). The colloidal sulfur produced was isolated and analyzed by X-ray diffraction, and proved to be microcrystalline, orthorhombic  $S_8$ . Presence of polysulfides was indicated by the transient appearance of a yellow color after the reagents were mixed.

About 20% sulfate also was produced at pH 6.7. The yield of sulfate increased with increasing pH, and it was the sole product at pH 8.5. Hoffman suggested the following reactions to account for sulfate formation:

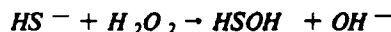

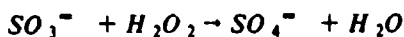
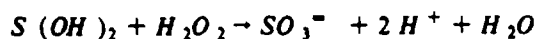

It is well known from industrial practice that the reaction of  $\text{H}_2\text{S}$  and  $\text{H}_2\text{O}_2$  is catalyzed by simple iron salts and various iron complexes. However, there is little on this subject in the scientific literature. Iron probably serves as a free radical chain initiator, because the reaction of  $\text{Fe}^{+2}$  with  $\text{H}_2\text{O}_2$  produces an abundance of hydroxyl radicals ( $\text{HO}\cdot$ ). Wassermann (1933) concluded that iron is a more potent catalyst for the reaction of  $\text{H}_2\text{S}$  with  $\text{H}_2\text{O}_2$  than for the decomposition of  $\text{H}_2\text{O}_2$ . If the opposite were true, iron would destroy the  $\text{H}_2\text{O}_2$  instead of catalyzing its reaction with  $\text{H}_2\text{S}$ . Wasserman noted that quinone, hydroquinone, and pyrogallol inhibit the reaction between  $\text{H}_2\text{S}$  and  $\text{H}_2\text{O}_2$ . They probably do so by scavenging free radicals and terminating the chains.

### 2.5.5. Summary

Hydrogen sulfide reacts with oxygen even when no catalyst has been added. Whether or not it can proceed in their absence, the reaction is affected by traces of catalytic metals present in the solutions. Stray catalysis limits the reproducibility and significance of the data obtained in many experiments, although valid qualitative observations have been made. When catalysts are added, stray catalysis becomes relatively unimportant, and does not limit the validity or utility of the data obtained.

There appear to be two different pathways for the reaction of  $\text{H}_2\text{S}$  with  $\text{O}_2$ . The first dominates in experiments with low initial sulfide concentration ( $<100\mu\text{M}$ ). This reaction produces thiosulfate, sulfate, and sulfite, and appears to be first order in both  $\text{H}_2\text{S}$  and  $\text{O}_2$ . The second pathway dominates in experiments with higher initial sulfide concentration ( $>100\mu\text{M}$ ). Colloidal sulfur is a major reaction product, and the reaction is autocatalytic: sulfur chain molecules are involved as catalysts or cocatalysts. Most authors refer to these unknown catalytic molecules as "polysulfides"; actually, they are more likely to be polysulfido- radical ions, similar to those inferred by Steijns *et al.* (1976a).

The autocatalytic reaction is catalyzed by transition metal ions, and may or may not occur in their absence. The dependence on nickel concentration reported by Snavely and Blount (1969) suggests one-half kinetic order in nickel, consistent with a free-radical chain reaction in which nickel participates in the chain initiation step. If so, the mechanism probably resembles that proposed by Steijns *et al.* (1976a), except that all species are in aqueous solution, and  $\text{H}_2\text{S}$  (or  $\text{HS}^-$ ) is directly involved. Catalysis by certain organic reducing agents which easily form free radicals is consistent with this interpretation (Chen and Morris, 1972a). Snavely and Blount established that the reaction is zero order in  $\text{O}_2$ , and that above pH 6 the rate is independent of pH.

The autocatalytic reaction produces sulfate and thiosulfate along with colloidal sulfur. Sulfite is not produced, because its presence is incompatible with that of colloidal sulfur. The yield of thiosulfate and sulfate increases with pH. Sulfate and thiosulfate may be produced by secondary oxidation of polysulfides or colloidal sulfur initially formed. The first, slower reaction pathway dominates only under conditions not conducive to the formation of sulfur chain molecules. Otherwise, the faster reaction catalyzed by sulfur chain molecules dominates.

In general, increasing the rate of reaction by adding a catalyst or increasing its concentration shifts the product distribution toward products of lower oxidation state:

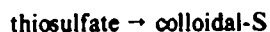
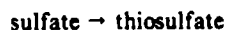

## 2.6. Oxidation of sulfite

This review will be limited to fundamental studies of the kinetics and mechanism of  $SO_2$  oxidation. Among others, Schmidt (1972) reviewed the chemical aspects of flue-gas scrubbing, and Pearce (1968) reviewed the chemistry of sulfuric acid manufacture.

### 2.6.1. Free radical chain reaction with oxygen

The reaction of sulfite with oxygen is catalyzed by light and certain transition metal ions. It is a fast reaction, with a time scale of seconds to minutes.

Early work on sulfite oxidation was reviewed by Bäckström (1934), who studied the reaction initiated by light from a mercury arc. By that time, it had been established that the reaction between oxygen and sulfite:

- (1) Can be initiated by ultraviolet light,
- (2) Is catalyzed by metal ions, particularly copper,
- (3) Is inhibited by certain reducing agents, including ethanol, glycerine, and cyanide, and
- (4) Is most rapid near pH 7 in the presence of reaction inhibitors. In the absence of inhibitors, the maximum rate may fall at higher pH.

Bäckström proposed a free radical chain mechanism. In the reaction catalyzed by copper, the initiation step is:

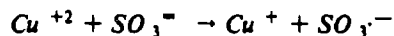

The chain propagation steps are:

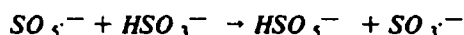
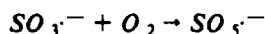

Sulfate is produced by the reaction:

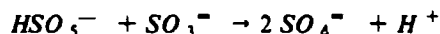

The rate of the photochemical reaction varies as the square root of light intensity in the presence of ethanol.

Fuller and Crist (1941) studied the oxidation of sulfite catalyzed by copper. Adding  $0.01\mu M$  copper sulfate greatly accelerated the reaction. Increasing the concentration of copper further, up to  $100\mu M$ , had no further effect on the rate. This was explained in terms of hydrolysis: the concentration of cupric ion is limited by the small solubility of cupric hydroxide. After saturation with cupric hydroxide has been reached, adding more copper does not increase the concentration of copper in solution.

Koganovskii and Taran (1955) confirmed that the rate maximum for sulfite oxidation falls near pH 7, and found that thiosulfate, phenol, and aniline inhibit the reaction.

Recent authors have used methods better suited to fast reactions. Barron and O'Hern (1966) studied the reaction catalyzed by copper. They reported three-halves kinetic order in total sulfite and zero kinetic order in oxygen. Adding cupric ion up to  $1\mu M$  increased the rate of reaction, but adding more, up to  $100\mu M$ , had no further effect. Cuprous ion had a slight inhibiting effect.

Mishra and Srivastava (1975) and Bengtsson and Bjerle (1975) studied the homogeneous reaction of sulfite and oxygen catalyzed by cobalt. Both studies reported the rate as zero order in oxygen, three-halves order in total sulfite, and one-half order in cobalt. The values of activation energy reported by the two studies were 21.5 and 13.6 kcal/mole, respectively. Bengtsson and Bjerle reported that the rate increased with increasing pH up to 8.5.

Bengtsson and Bjerle also studied the reaction under heterogeneous conditions; oxygen was absorbed from the gas phase while the reaction proceeded. The heterogeneous reaction rate,

calculated with proper correction for the finite rate of oxygen absorption, was about an order of magnitude lower than under homogeneous conditions. They attributed this difference to an "induction period", during which the concentration of free radicals increases. After oxygen is absorbed by a parcel of water, it takes a finite time for the reaction to "get going" in that parcel of water. The inferred reaction orders for cobalt and total sulfite were 0.5 and 1.5, as in the homogeneous case.

Hayon, Treinin, and Wilf (1972) studied the spectra and chemistry of the free radicals  $SO_2^{\cdot-}$ ,  $SO_3^{\cdot-}$ ,  $SO_4^{\cdot-}$ , and  $SO_5^{\cdot-}$ , which were produced by flash photolysis or pulse radiolysis of solutions containing  $SO_3^{2-}$ ,  $HSO_3^-$ ,  $S_2O_4^{2-}$ ,  $S_2O_6^{2-}$ , or  $S_2O_8^{2-}$ . They also studied the oxidation of sulfite, induced by flash photolysis of air-containing solutions of  $Na_2SO_3$ . The flash caused a strong, transient absorption typical of hydrated free electrons to appear. They suggested the following initiation step for the light induced reaction:

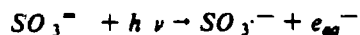

The radicals  $SO_3^{\cdot-}$  and  $SO_5^{\cdot-}$  were not efficiently removed from solution by alcohols, while  $SO_4^{\cdot-}$  was removed. They concluded that  $SO_4^{\cdot-}$  probably is involved in the oxidation of sulfite, as this reaction is inhibited by alcohols.

They proposed that in the reaction cycle that oxidizes sulfite,  $SO_4^{\cdot-}$  is produced by the reaction:

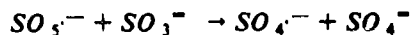

The  $SO_4^{\cdot-}$  can react with either  $SO_3^{2-}$  or  $HSO_3^-$ :

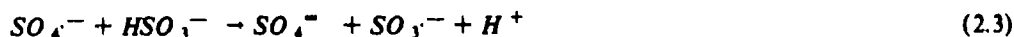

Reaction (2.3) is faster because the electrostatic repulsion between the reacting ions is smaller. Therefore, the rate of reaction decreases with increasing pH above 7, but it does not go to zero. At high pH, reaction (2.2) is replaced by the slower reaction (2.3). At pH 12,  $SO_4^{\cdot-}$  reacts with  $OH^-$ :



and  $O^{\cdot-}$  becomes a chain propagating radical. This radical and its conjugate acid  $HO^{\cdot}$  react with inhibitors (e.g. alcohols) much more rapidly than does  $SO_4^{\cdot-}$ , which accounts for the greater effect of inhibitors at high pH.

Formaldehyde protects bisulfite from oxidation by forming a stable, unreactive complex with it (Kurtenacker, 1924):



Formaldehyde is added to prevent interference by sulfite in the iodometric determination of thiosulfate.

### 2.6.2. Proposed reaction mechanism

To summarize the extensive work on sulfite oxidation catalyzed by light, cobalt, or copper, we propose the general mechanism in Table 2.4. It is an extension of the mechanism proposed by Hayon, Treinin, and Wilf.

In equations (1a and b)  $Co(II)X^{n-}$  and  $Co(III)X^{-(n-1)}$  represent unknown complexes of  $Co^{+2}$  and  $Co^{+3}$ .

Reaction (1a) is fast relative to (1b), and reaction (2) is fast relative to the other chain propagation reactions; otherwise, the concentration of  $O_2$  would affect the rate. We assume that:



Table 2.4

Proposed mechanism for the reaction of sulfite with oxygen

Initiation by cobalt:

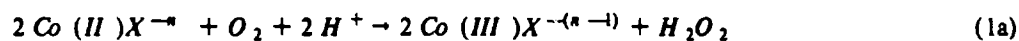

Initiation by copper:



Initiation by light:



Chain propagation at pH < 6:

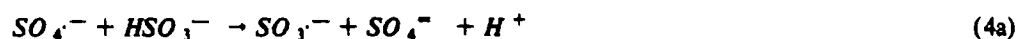
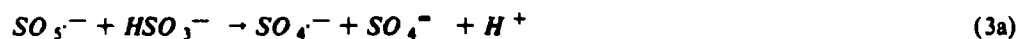

At  $8 < \text{pH} < 11$ , equations (3a) and (4a) are replaced by:



If pH > 11, reaction (4b) is replaced by:

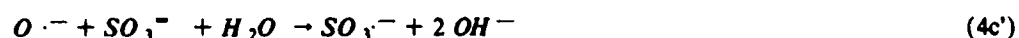

Chain termination:



where  $R_1^{\cdot}$  and  $R_2^{\cdot}$  are any two free radicals.

$$\frac{k_{3b}}{k_{3a}} = \frac{k_{4b}}{k_{4a}} = r$$

accelerated the reaction by several-fold at concentrations of 1 to 25 $\mu$ M. With each metal, a rate maximum was observed at a certain pH; pH 3.3 for Ti(IV), 1.7 for Zr(IV), and 3.0 for Nb(V).

Litvinenko (1969a) suggested that the reaction involves a complex of the catalytic ion with hydrogen peroxide, e.g.:

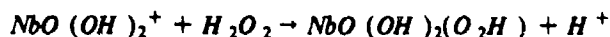

This explains the drop-off in reaction rate with decreasing pH. In the case of zirconium, increasing ionic strength decreases the rate of reaction. This may also contribute to the fall-off below pH 1.7 where the acid contributes a substantial fraction of the total ionic strength. The effect of ionic strength suggests that reaction between oppositely charged ions is involved.

Above the pH value that corresponds to the maximum reaction rate, the decrease in reaction rate with increasing pH may be due to increasing hydrolysis and polymerization of the catalytic ions. It is likely that the reaction of thiosulfate with  $H_2O_2$  produces trithionate and tetrathionate as well as sulfate. However, Litvinenko's experimental method allowed him to monitor the formation of sulfate only.

*Weak oxidizing agents*, like iodine or triiodide ion in acid media, oxidize thiosulfate to tetrathionate:

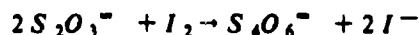

The classic "iodometric determination of thiosulfate" exploits this reaction. Awtrey and Connick (1951) studied the kinetics of this reaction at low pH, and proposed the following mechanism:

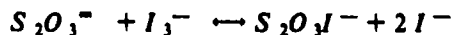

The first reaction is rapid, and its equilibrium lies far to the right. The second reaction is rate determining. When pH is low (3 or 4) and iodide ion is initially present, tetrathionate is the only product. At higher pH, or in the absence of iodide, some sulfate also forms.

Baldea and Niac (1970) studied the reaction of thiosulfate with chromate at low pH. The major reaction product was tetrathionate. They inferred the reaction mechanism:

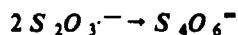
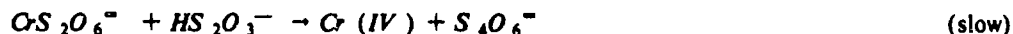
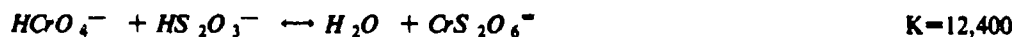

where Cr(III) and Cr(IV) represent unknown complex ions. The second reaction is rate determining.

## CHAPTER 3 THE REACTION CATALYZED BY NICKEL

### 3.1. Forward

Among the studies of air oxidation of hydrogen sulfide reviewed in Section 2.5.1, the results of Snavely and Blount (1969) were most detailed and informative. In particular, they noted that:

- (1) Nickel and cobalt are the most potent catalysts for oxidation of  $H_2S$ ,
- (2) The reaction is autocatalytic, and the cocatalyst produced by the reaction probably is a polysulfide,
- (3) The rate of reaction is independent of oxygen concentration,
- (4) Increasing the concentration of nickel hundred-fold increases the rate of reaction ten-fold, and
- (5) The reaction is inhibited by low pH, but the rate is independent of pH at intermediate values.

Other authors have noted the autocatalytic nature of the reaction, and that good "reactivity" can be correlated with a yellow color and strong UV absorption (Chen and Morris, 1972; Chen and Gupta, 1973). Their observations are reviewed in detail in Section 2.5.

A reaction product catalyzes the reaction, in this case as a cocatalyst acting together with nickel. This causes the chemical properties of the reaction medium to depend on its previous history. This introduces a large, additional variance into the kinetic data.

Initially we were told to assume that 15 seconds would be available for reaction, in transit from condensers to cooling tower. Accordingly, most kinetic data was gathered with 15 seconds reaction time. Much later, we learned that about 90 seconds would be available. Our rate data, mostly obtained with 15 seconds reaction time, can safely be extrapolated to 90 seconds, but the assumption of 15 seconds did affect our choice of experimental method.

In a contact condenser equipped geothermal Unit at The Geysers, the concentration of  $H_2S$  in the cooling water leaving the condenser typically is about  $150 \mu M$  (5ppm). In a surface condenser equipped Unit, this typically is about  $70 \mu M$ . For reasons of cost and safety, the concentration of nickel should be  $100 \mu M$  (6ppm) or less. Accordingly, most rate data were generated with 20 or  $100 \mu M$  nickel, and 70 to  $150 \mu M$  initial sulfide.

The combination of unstable reactants in low concentration, short reaction time, catalysis, and autocatalysis greatly increased experimental difficulties. In particular, autocatalysis made the use of a straightforward "once-through" kinetic apparatus (like that described in Chapter 4) inappropriate. Ultimately, we decided to use a simple experimental technique which would allow many data points to be generated, and allow experimental scatter to be overwhelmed by averaging. Each day a batch of "synthetic cooling water" (SCW) containing nickel was set up, and air and  $H_2S$  were added to it continuously. After some time (typically 1 or 2 hours) the SCW would reach chemical steady state. Then aliquots would be withdrawn from it and used for individual kinetic or other experiments.

Repeatability among experiments using different aliquots removed from the flask during a given run usually was good. Repeatability between different runs was poorer, especially in regard to reactivity. This placed obvious constraints on the experiments that could be performed. Reproducibility improved with experience.

### 3.2. Experimental methods

#### 3.2.1. Synthetic cooling water with recharge

Most experimental work on the  $Ni/SO_2$  system employed 1 liter of "synthetic cooling water" to which several reagent streams were continuously added, and from which aliquots were removed for analysis and other tests.

The SCW was formulated to resemble the cooling water of a typical Unit at The Geysers, when the Unit is operated with secondary abatement. However, in most experiments, sulfate only was included in the recipe instead of the mixture of thiosulfate, sulfate, and trithionate to be expected in the field. The SCW was prepared for each run by a twenty fold dilution of a concentrated stock solution which contained 0.004M  $(NH_4)_2CO_3$ , 0.073M  $(NH_4)_2SO_4$ , and 0.287M  $B(OH)_3$ . The resulting SCW contained 7.70mM  $NH_3$  plus  $NH_4^+$ , 0.40mM  $HCO_3^-$ , 14.36mM  $B(OH)_3$  plus  $H_2BO_3^-$ , and 3.65mM  $SO_4^{2-}$ . Essentially, it was a dilute solution of ammonium sulfate and boric acid. The pH was adjusted to that desired with 1.0M  $NaOH$ . Nickel sulfate stock solution was added to give the desired concentration of nickel, usually 20 or 100  $\mu M$ .

Most of the experiments were performed at pH 7.8. Because the SCW is naturally well buffered by  $NH_4^+$  and  $B(OH)_3$  above pH 7.5, additional buffering compounds usually were not needed. Experiments with SCW that contained ammonium chloride or boric acid only demonstrated that the only role of the major ions in the SCW was to buffer it; therefore, the particular recipe used had no effect on the results obtained.

The reaction vessel was a 1-liter Erlenmeyer flask. It was kept in a water bath thermostatted at 45°C, and was allowed to attain thermal equilibrium before the start of the experiment. To maintain a constant concentration of oxygen in the SCW, air from the house supply was bubbled through it at a rate of 0.25 l/minute using a porous diffuser stone. Occasional measurements indicated that the concentration of oxygen in the SCW was typically about 6 ppm. Because the oxidation rate proved to be independent of oxygen concentration (Fig. 3.9), it usually was not monitored. The SCW was stirred using an air driven, immersible magnetic stirring pad.

Three liquid reagent solutions were added to the SCW using a peristaltic pump (Manostat, with capacity for ten pump cassettes; used with 1/16" I.D. thin-walled Tygon tubing). Each solution was added at about 0.45 ml/min. One stream contained 0.0355 M sodium sulfide. The second contained about 0.022 M sulfuric acid, plus nickel sulfate at three times the concentration of nickel in the SCW. This amounted to adding  $H_2S$  at 16 $\mu M$ /min., while keeping the concentration of nickel in the SCW constant. Twenty minutes after the start of the reaction, a third reagent stream of sodium sulfite solution was added. The concentration of the  $Na_2SO_3$  was adjusted to give the sulfite:sulfide ratio desired in a given experiment.

The rate at which SCW was removed for analysis roughly equaled the influx of reagent solutions. Therefore, the volume of SCW remained roughly constant throughout, and so did the chemical feed rates per unit volume. The major ions in the SCW typically were diluted by about 30% over the course of the experiment, but this had no apparent effect. Whenever necessary, pH was manually adjusted with  $NaOH$  or  $H_2SO_4$ .

The output of the peristaltic pump cassettes varied from day to day, probably due to minute variations in the positions of the tubes in the cassettes. The cassettes were calibrated daily by running the output of each into a graduated cylinder for ten minutes. Using this calibration data, the pump speed and concentrations of the reagent solutions were adjusted to give the chemical feed rates desired.

It takes some time for the concentration of the cocatalyst (produced by the reaction) and the "reactivity" (defined in Section 3.2.3) to attain steady state values. Chemical steady state was reached after about two hours reaction time, and then the gathering of kinetic data could begin.

Sulfite ion can hinder the formation of the cocatalyst (Section 3.3.1). This is why the  $Na_2SO_3$  reagent feed was initiated twenty minutes after the start of the reaction. Otherwise, the initial presence of  $SO_3^{2-}$  would have prevented the formation of the cocatalyst and the development of reactivity. Once formed, the cocatalyst is not affected by the addition of sulfite in moderate amounts.

*Preparation of Wackenroder's solution.* Wackenroder's solution was prepared by mixing equimolar amounts of  $Na_2S$  and  $Na_2SO_3$  to give 0.2M total sulfur in the ultimate solution. The

\* Experience showed that a 1.0:1.6 ratio of added  $H_2SO_4$  to  $Na_2S$  suffices to neutralize the  $Na_2S$  and maintain a roughly constant pH. Some  $H_2SO_4$  is produced in solution by oxidation of  $H_2S$ , and this reduces the amount of  $H_2SO_4$  that needs to be added.

pH was lowered to 7.3 with sulfuric acid, and the solution made up to volume with deionized water. When first neutralized, this solution was opaque yellow, but became clear yellow after about 30 minutes.

### 3.2.2. Work at lower pH

Experiments below pH 7.8 required additional buffering compounds. A combination of 10mM each of phosphate and maleate was used. A concentrated buffer stock solution was prepared from maleic acid and monosodium orthophosphate, and its pH adjusted to that desired with *NaOH*. With this buffer added, the SCW was well buffered from pH 2 to 10.

This buffer (like others) slowed the development of reactivity if present from the start of the reaction. Therefore, the reaction was always initiated at about pH 7.8 without the buffer, and the buffer added at  $t = 60$  min. or later. The buffer was added as a concentrated solution, the pH of which had been adjusted to a value slightly lower than that desired in the resulting buffered SCW. Once established, reactivity is unaffected by the addition of the buffer (Section 3.3.4).

### 3.2.3. Determination of reactivity

"Reactivity" was used as an empirical measure of the solution's ability to destroy  $H_2S$ . To determine the reactivity, a 25 ml aliquot of SCW was removed from the flask and aerated by blowing air through it for a few seconds. This also reduced the amount of  $H_2S$  and sulfite in the SCW before measuring the reactivity. A magnetic stirring bar was added to the beaker containing the aliquot, and it was set upon a magnetic stirrer. Then a small amount of  $Na_2S$  solution was added to the beaker using an adjustable micropipette. (Gilson Pipetteman, Model P20 or P200, depending on volume.) Usually, enough  $Na_2S$  was added to introduce a total sulfide concentration of  $70 \mu M$ . Because the concentration of the sulfide stock solution was about 0.2 M, about  $9 \mu l$  would typically be added. After fifteen seconds, 25 ml of sulfide antioxidant buffer (SAOB) was added to the beaker with rapid stirring, and this quenched the reaction. Then electrodes were introduced to measure the residual sulfide concentration.

Immediately after the electrodes were put into the mixture of test aliquot and SAOB, the voltage reading dropped rapidly for several seconds, indicating increasing apparent sulfide concentration. After about 20 seconds the voltage reached a minimum and began to increase slowly. The minimum voltage observed was recorded and used to calculate the concentration of sulfide.

Finally, the measured sulfide concentration was divided by that initially introduced to give the fraction remaining after 15 seconds. The numerical value of this fraction is the quantitative expression of what we call "reactivity": if the fraction of  $H_2S$  remaining is small, reactivity is said to be good, and vice-versa.

The preparation and handling of the sulfide stock, SAOB, and other solutions is described in Appendix 3.1.

An Orion Model 701A potentiometer, Model 951 printer, and Model 605 electrode switch were used for all measurements of sulfide concentration and pH. The sulfide electrode used was the Orion Model 94-16, which is of the  $Ag_2S$  membrane type. The reference electrode used was the Orion Model 90-02, with Orion 900002 filling solution in the inner compartment and 10%  $KNO_3$  in the outer. Each day before use, the electrodes were standardized with freshly prepared standards in 50/50 SAOB/D.I. water, which corresponded to sample concentrations of 7 and  $70 \mu M$ . Typically, a sulfide electrode would last several months in daily service before failing by leakage through the  $Ag_2S$  membrane.

In their studies of  $H_2S$  oxidation, Östlund and Alexander (1963), Algren and Hagström (1974), Hoffmann (1977), and Hoffmann and Lim (1979) measured the concentration of  $HS^-$  directly with an  $Ag_2S$  electrode. In all cases, the time scale of the reaction was minutes to hours (Section 2.5). The response time of the  $Ag_2S$  electrode is about 10 seconds. In our work, an  $Ag_2S$  electrode could not be used to measure  $HS^-$  directly, because the time scale of the reaction was comparable to the electrode response time.

We also tried to measure the concentration of  $HS^-$  directly by UV absorption (Avrahami and Golding, 1968). This failed because "reactive" SCW is practically opaque to ultraviolet light. This work is summarized in Appendix 3.2.

There were several sources of random perturbation in the procedure used to determine reactivity. The temperature of the test aliquot probably varied. A small amount of sodium sulfide solution was transferred by micropipette. There was some error in measurement, and probably also some accidental oxidation during the transfer. Finally, the test aliquot probably lost some  $H_2S$  to the atmosphere during the 15 second reaction time. Degassing removes  $H_2S$  in competition with oxidation, and interferes most at low nickel concentrations, at which oxidation is slowest. In fact, the data collected with 20  $\mu M$  Ni show the most scatter; the 100  $\mu M$  Ni data were highly reproducible (Fig. 3.4). Nonetheless, most of the data were collected with 20  $\mu M$  Ni, because this is the concentration of greatest practical interest.

The effect of varying nickel concentration was studied by a dilution method: a batch of SCW was initially prepared with 100  $\mu M$  Ni. Test aliquots were removed and diluted with different amounts of preheated, nickel-free SCW to give the concentration of Ni desired in the actual test.

In a routine reactivity test, aeration of the test aliquot lowered its temperature from 45°C to about 35°C; therefore, most of the kinetic data actually were gathered at 35°C. In the experiments used to determine the effect of temperature, the temperature of the aerated test aliquot was adjusted with either an ice bath or a boiling water bath before the sodium sulfide was added.

Ordinarily, the reactivity test aliquot was aerated with air blown from the mouth. This typically resulted in an oxygen concentration of 3.5 to 4.0 ppm. To measure reactivity at other concentrations of oxygen, the aliquots were "aerated" with 100%  $N_2$ , air, 42/58  $O_2/N_2$ , or 100%  $O_2$ . The  $O_2$  concentration was then measured with a dissolved oxygen meter and probe before adding  $Na_2S$  (Yellow Springs Instruments Dissolved Oxygen Meter Model 54A and Model 5739 Probe).

In tests with varying pH, the pH of the aerated aliquot was adjusted by adding varying amounts of sulfuric acid or NaOH. The pH was then measured before adding the  $Na_2S$ .

#### 3.2.4. Measurement of turbidity

Turbidity was measured using an industrial process control turbidimeter (HF Industries, Model DRT 200). This instrument would be well suited for routine use at The Geysers.

Throughout, turbidity is reported in Nephelometric Turbidity Units (NTU). Turbidity is apparent to the naked eye at 20 NTU, and a colloidal sulfur sol of 150 NTU looks like diluted skimmed milk.

Initially, turbidity increases at about 30 NTU per ppm of elemental sulfur produced (compare Figures 3.1 and 3.10). Thus, less than 1 ppm of colloidal sulfur is apparent to the naked eye, and may be measured semiquantitatively with the turbidimeter.

#### 3.2.5. Determination of reaction products

The SCW used in experiments to study reaction product distribution differed from that described above in that acetate was used in the place of sulfate. Also, acetic acid was used to neutralize the  $Na_2S$ . This change allowed the amount of sulfate produced by the reaction to be determined. "Acetate based SCW" was not used in the other experiments because there was evidence that acetate decreased the rate of oxidation somewhat. In a few experiments "perchlorate based SCW" was used.

In the stoichiometric experiments aliquots were periodically withdrawn for the determination of colloidal sulfur, thiosulfate and trithionate. Sulfate was determined only at the end of the experiment. Colloidal sulfur was determined only if the solution was visibly turbid, and sulfite was determined rarely.

---

\*The acetate based SCW contained only half as much ammonium acetate as it should have; i.e., 3.65mM rather than 7.30mM. The same error was made in compounding the perchlorate based SCW. This probably had no effect on the results obtained.

**Colloidal sulfur.** The technique of Bartlett and Skoog (1954) was used in modified form. A 50 ml aliquot of SCW was filtered through a membrane filter under pressure with nitrogen (Millipore type VC, 0.1  $\mu$ m pore size, 47mm diameter). The filter was removed from the filter housing and dissolved in 10 ml of 95% acetone-water. This was mixed with 15 ml of the sodium cyanide reagent specified by Bartlett and Skoog. After a few minutes, a precipitate of filter material formed. The mixture was filtered through fine filter paper to remove this precipitate. The rest of the procedure proceeded as described by Bartlett and Skoog.

**Thiosulfate and trithionate.** The method of Kelly, *et al.* (1969) was used for the simultaneous determination of thiosulfate, trithionate, and tetrathionate. Tetrathionate was never detected in more than trace amounts, and these values are not reported here.

**Sulfate.** A variant of the standard gravimetric procedure was used. A 200 ml aliquot of SCW was membrane filtered to remove colloidal sulfur, if present. The pH of the aliquot was adjusted to about 2.5 with 0.1 N HCl. To remove thiosulfate, one percent tincture of iodine was slowly added with stirring until a persistent, faint yellow color formed. Twenty ml of 0.1 N  $BaCl_2$  was added, and the solution was covered and set aside at room temperature until the next day. Boiling was avoided to reduce interference by trithionate. Finally, the precipitate was filtered, ashed, and weighed the usual way.

**Sulfite.** The technique of West and Gaeke (1956) was used in modified form. The sodium tetrachloromercurate(II) reagent was eliminated from the procedure. Instead, a 10 ml aliquot of SCW was directly mixed with the p-rosaniline and formaldehyde reagents.

Dithionate is the only likely reaction product that these procedures would not have detected. Determination of dithionate is here, as in most contexts, an unsolved problem.

### 3.2.6. Safety considerations

Work with  $H_2S$ , solid sodium sulfide, and concentrated solutions of  $Na_2S$  can be hazardous. Most of the work of preparing  $Na_2S$  stock solutions was done under a fume hood, and these solutions were handled outside of the hood in small containers only. Spills of solid sodium sulfide and  $Na_2S$  stock were cleaned up promptly. Concentrated  $Na_2S$  solutions were never poured down the drain. They, along with waste solid sodium sulfide, were disposed of by reaction with an excess of ferric chloride solution. The resulting precipitate of iron oxysulfide was allowed to age, filtered out of solution, and then allowed to age again. Ultimately, it was disposed of as solid waste, and the residual ferric chloride solution was poured down the drain. The flask of SCW was set up and used in a water bath inside a fume hood. These precautions ensured safety, and largely eliminated complaints from others working in the same room.

### 3.3. Development of reactivity and turbidity

In these experiments the reaction was allowed to proceed while turbidity and reactivity were measured periodically. Usually the experiment was started with addition of  $Na_2S$ , acid, and air only, and the addition of  $Na_2SO_3$  commenced 20 minutes later.

Typical data are presented in Figures 3.1 and 3.2. Before the addition of sodium sulfite commenced at  $t = 20$  min. turbidity increased rapidly due to formation of colloidal sulfur.

#### 3.3.1. Reactivity and autocatalysis

In all cases, reactivity was poor at first (i.e., the residual fraction was large), but improved rapidly, reaching a steady state value about an hour after the start of the experiment. This is characteristic of an autocatalytic reaction.

Reactivity develops slowly or not at all if the addition of sodium sulfite is commenced at the very start of the reaction (not shown). This suggests that the unknown cocatalyst contains chains of zero valent sulfur atoms; sulfite destroys such molecules by converting the zero valent sulfur in them to thiosulfate. Most likely, "the cocatalyst" is a mixture of polysulfide ions ( $-S_n^-$ ), polysulfidomonosulfonate ions ( $-S_nSO_3^-$ ), and their corresponding radical ions. The yellow color of the SCW (when reactive but not turbid) suggests the presence of such molecules, and they are

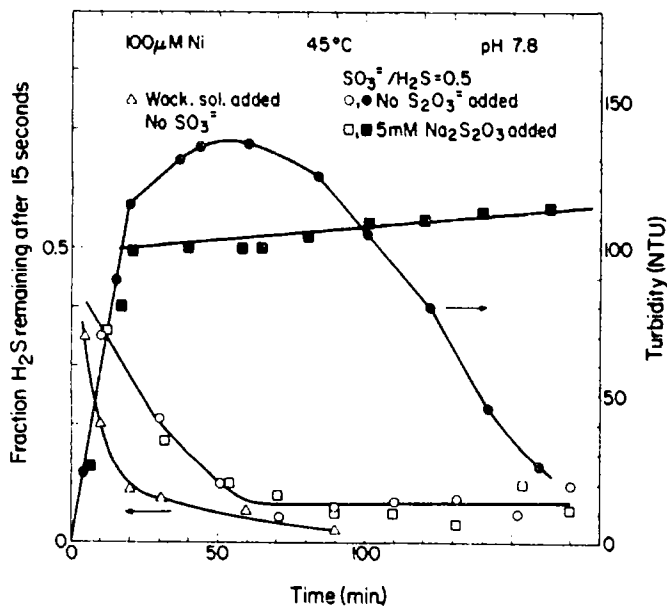

Fig. 3.1. Development of turbidity and reactivity. Sodium sulfite added from 20 minutes on; sulfite:sulfide = 0.50. Open triangles: Wackenroder's solution added at start, amounting to 400  $\mu$ M total sulfur; no sulfite added in this case. 70  $\mu$ M sulfide added in reactivity determinations. "Fraction  $\text{H}_2\text{S}$  remaining after 15s" is the fraction of that 70  $\mu$ M which remains after 15 seconds reaction time.

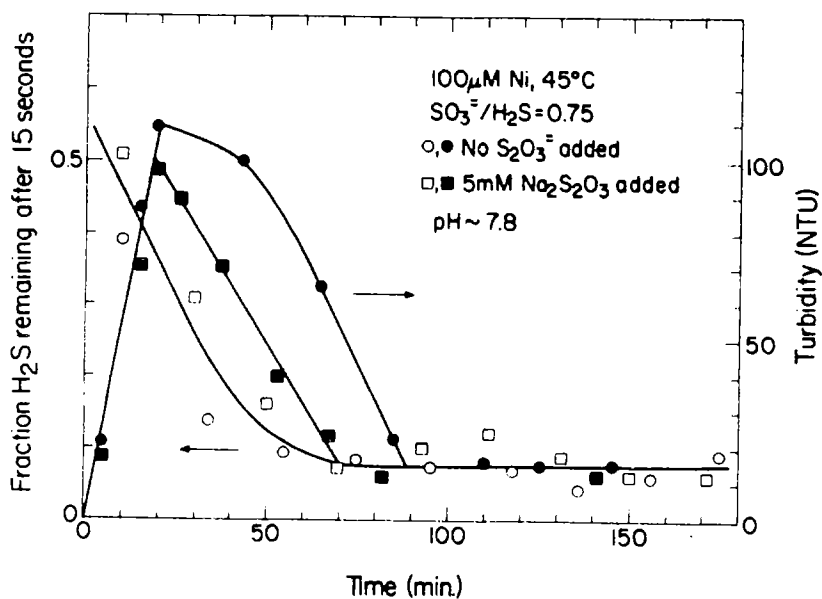

Fig. 3.2. Development of turbidity and reactivity; sulfite:sulfide = 0.75.



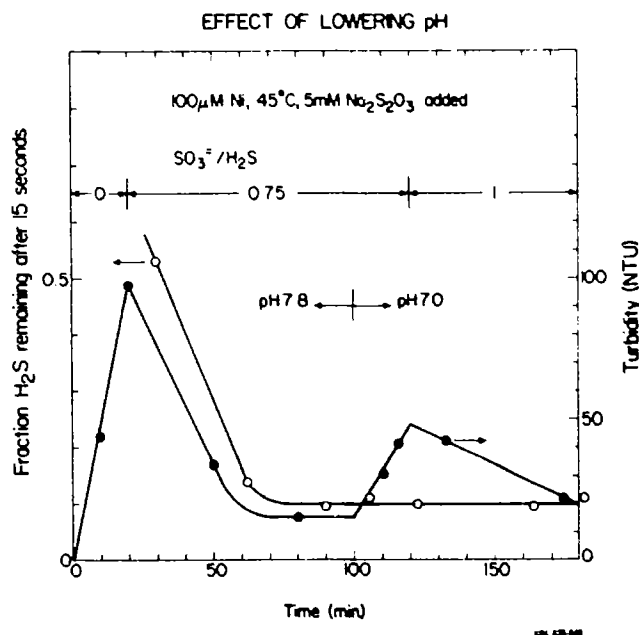

Fig. 3.3. Development of reactivity and turbidity; effect of lowering pH.

likely products of the partial oxidation of  $H_2S$ . Probably, polythionates ( $-O_2S_nO_3^-$ ) also are present, but are not catalytically active, being less prone to form radical ions.

However, reactivity would develop with sulfite added from the very start, if the sulfide and sulfite feeds were combined to form one reagent stream before being added to the SCW. Lowering the pH of this mixture by mixing it with the SCW essentially would produce Wackenroder's Solution, which contains polysulfides, polythionates, etc. In these experiments the SCW became yellow, but never turbid.

The effect of adding Wackenroder's solution as such to the SCW was tested. At the very start of the experiment, enough was added to introduce a total concentration of sulfur of  $400 \mu M$ . This accelerated the development of reactivity (Fig. 3.1).

Formally, the SCW was supersaturated with nickel sulfide by several orders of magnitude. Despite this, there was usually no sign of its precipitation. When there was, it was limited to the appearance of a bronze color in the otherwise blue and yellow SCW. This suggests that the nickel is complexed by polysulfides, and thereby kept from precipitating. The formation of this complex may be an aspect of autocatalysis.

Buffering compounds probably retard the development of reactivity (Section 3.2.2) by chelating nickel, and rendering it inactive. That buffers do not affect reactivity after it has been established suggests that the nickel is tightly chelated by polysulfides.

\*The colloidal sulfur in the SCW scatters blue light, producing a blue haze; the color of light transmitted by the SCW is yellow. Both colors are visible.

### 3.3.2. The effect of sodium sulfite

When the addition of sodium sulfite commences, the formation of colloidal sulfur is slowed. Under the proper conditions, the colloidal sulfur formed earlier is destroyed. The destruction of colloidal sulfur increases with increasing sulfite:sulfide ratio (compare Figs. 3.1 and 3.2).

This data suggests that at pH 7.8 a sulfite:sulfide mole ratio somewhere between 0.5 and 0.75 is needed to ensure good clarification. This is discussed further in Chapter 5.

### 3.3.3. The effect of thiosulfate

Five mM sodium thiosulfate was added at the beginning of some experiments. At sulfite:sulfide = 0.5, thiosulfate inhibited the "clarification reaction". This may be a case of inhibition by the reaction product. The parasitic reaction of sulfite with thiosulfate to give trithionate may also play a role:

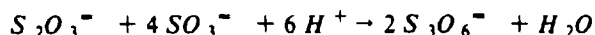

At sulfite:sulfide = 0.75 (Fig. 3.2), thiosulfate has the opposite effect: it enhances the clarification reaction. Perhaps, being a reducing agent in its own right, thiosulfate is able partially to protect sulfite from oxidation, thereby making more of it available for reaction with colloidal sulfur. In any case, there must be two opposing effects, either of which may predominate under different conditions.

The initial presence of thiosulfate and the sulfite:sulfide mole ratio have no effect upon the development of reactivity.

### 3.3.4. The effect of pH

The pH value 7.8 was originally chosen because it is approximately the "natural pH" of cooling water at The Geysers. It is also near the lowest pH at which the SCW has adequate buffering capacity. In the field, the cooling water pH would probably be maintained somewhere between 6.2 and 7.0 in order to reduce the amount of NaOH required. Therefore, some experiments were also made at pH values in this range. In these experiments, the SCW was buffered with phosphate and maleate (Section 3.2.2).

Fig. 3.3 depicts one such experiment. At the initial pH of 7.8, a mole ratio of 0.75 sufficed to prevent the formation of colloidal sulfur, but turbidity increased again after pH was lowered to 7.0. Increasing the sulfite:sulfide ratio to 1.0 caused turbidity to decrease again. This behavior probably is due to accelerated oxidation of sulfite at the lower pH (Section 3.6). Neither pH nor sulfite:sulfide ratio affects reactivity.

## 3.4. Reaction kinetics

Reactivity was determined under various conditions. These data are presented in Figures 3.4 to 3.9. The solid lines in Figures 3.4 to 9 were calculated using formula (3.1), with the parameters given in Table 3.1. The computer program used for this purpose is listed and documented in Appendix 3.3. The variance of the data is discussed in Appendix 3.4.

There was no correlation of reactivity with either pH or sulfite:sulfide ratio. Accordingly, data generated at various values of pH and sulfite:sulfide ratio were plotted and analyzed together in Fig. 3.4 and the following Figures.

The effect of temperature on residual  $H_2S$  suggests a small, positive energy of activation (Fig. 3.7). With 95% confidence (Student's t test), the energy of activation is between 0.9 and 2.9 kcal; 2.4 kcal is our best estimate.

There is no correlation between pH and reactivity between pH 5.5 and 8.5 (Fig. 3.8). With 95% confidence,  $-0.023 < \Delta(\text{Res.Frac.})/\Delta(\text{pH}) < 0.011$ . An apparent kinetic order in hydrogen ion as large as  $\pm 0.5$  is excluded with confidence  $> 99.9\%$ . Lowering pH to below 5 destroys the reactivity (not shown). Probably, at low pH the cocatalyst decomposes to colloidal sulfur as do thiosulfate and the polysulfides.

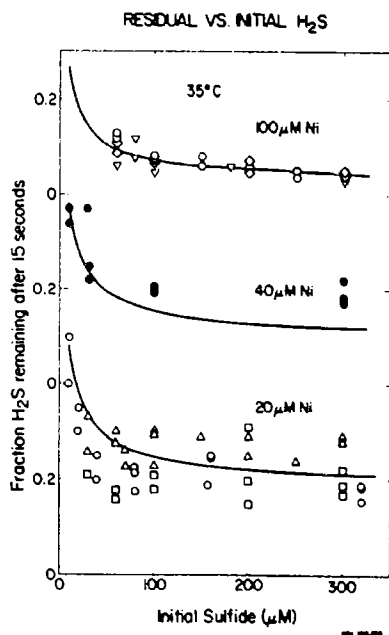
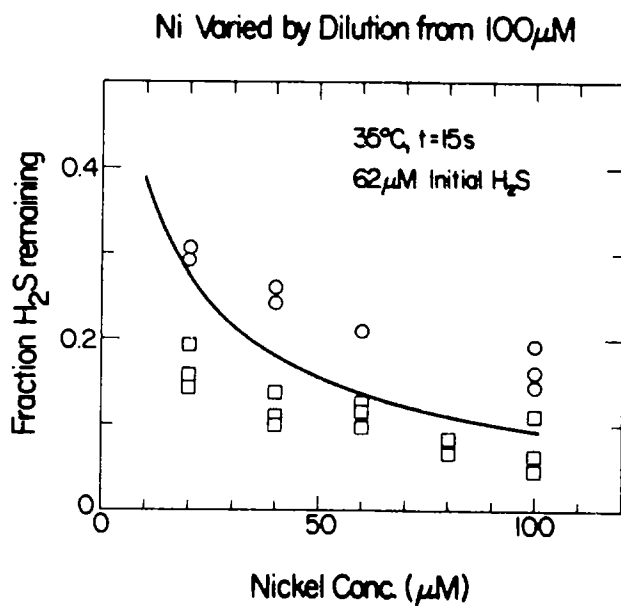

Fig. 3.4. Fraction sulfide remaining after 15 seconds; 35°C and various concentrations of nickel. Vertical scale displaced between curves. In Figures 3.4 to 3.9 different symbols represent data from different experiments. "Initial sulfide" is the amount added in reactivity determinations.



XBL 825-680

Fig. 3.5. Effect of varying nickel concentration. SCW containing 100 μM nickel diluted with varying amounts of nickel-free SCW.

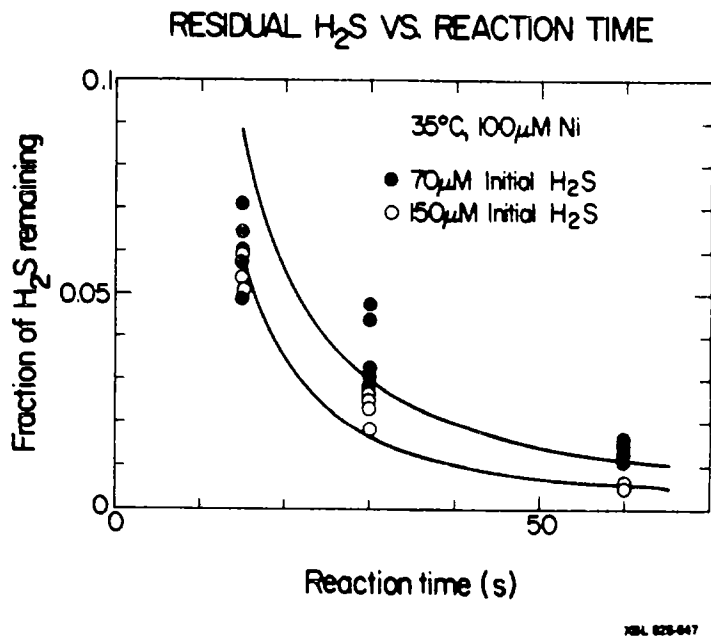

Fig. 3.6. Effect of varying reaction time on residual sulfide.

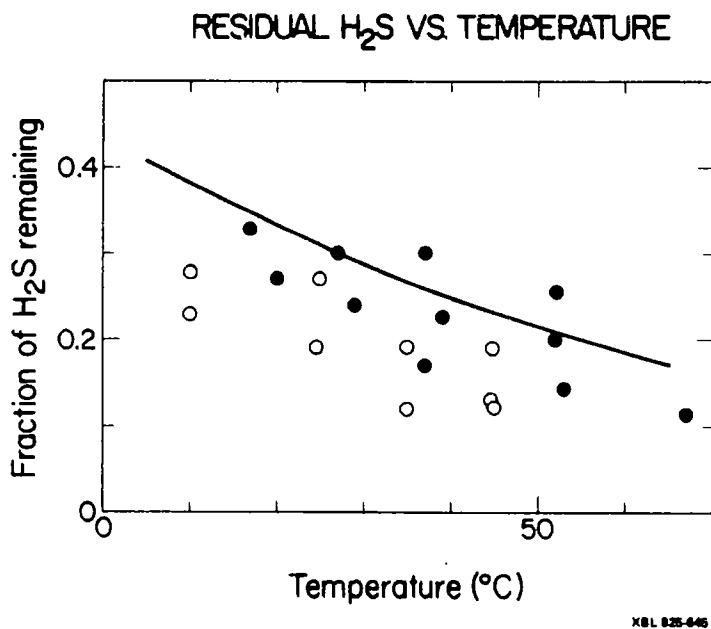

Fig. 3.7. Reactivity vs. temperature. Twenty μM nickel, pH 7.9, sulfite:sulfide = 0.75. 70 μM sulfide added in reactivity determinations.

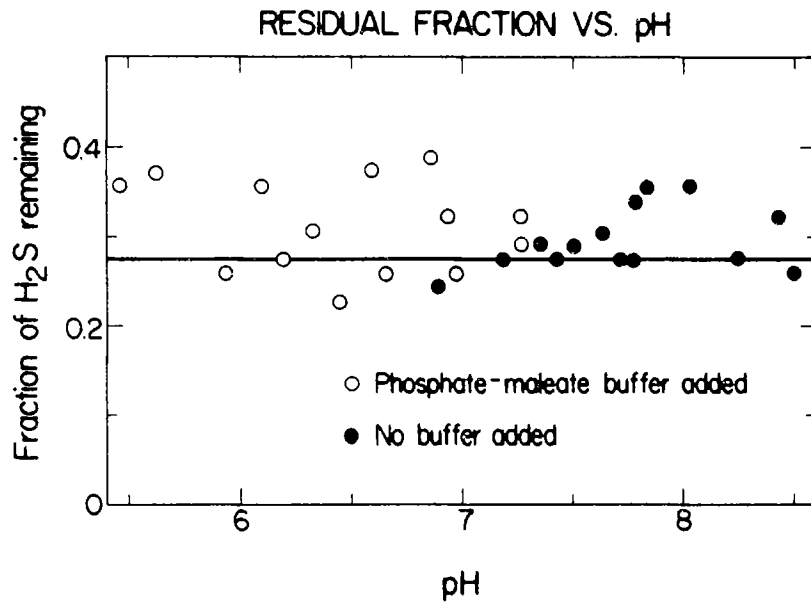

Fig. 3.8. Reactivity vs. pH. Twenty  $\mu\text{M}$  nickel,  $62\mu\text{M}$  sulfide added in reactivity determinations.

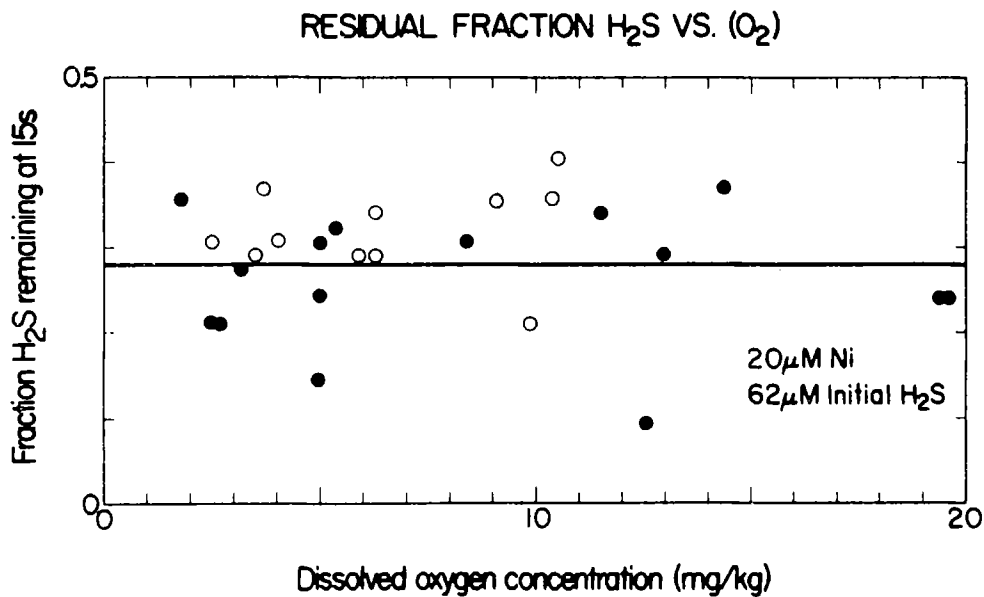

Fig. 3.9. Reactivity vs. oxygen concentration.

There is no correlation between reactivity and  $O_2$  concentration (Fig. 3.9). With 95% confidence,  $-0.005 < \Delta(\text{Res.Frac.})/\Delta(O_2) < 0.007$ . An apparent kinetic order in oxygen as large as 0.5 is excluded with confidence  $> 99.9\%$ . This indicates that monitoring and controlling oxygen concentration in the test aliquots used in reactivity determinations was not necessary.

Reaction with sulfite may have contributed to removal of  $H_2S$  from the SCW (Wackenroder's reaction; Section 4.4), but we doubt this was significant. First, there was no correlation between sulfite:sulfide ratio and reactivity. Second, the steady state concentration of sulfite in the SCW typically was only  $10 \mu\text{M}$ . Third, Wackenroder's reaction alone seems incapable of reducing the concentration of  $H_2S$  to below 5-12ppm (Payette, *et al.*, 1974, p. 43); typically, the concentration of sulfide added in the reactivity test was 2.2ppm.

### 3.4.1. The rate expression

The rate expression ultimately derived (3.1) is presented in Table 3.1. Here  $(H_2S)$  represents the total sulfide concentration as measured with an  $Ag_2S$  electrode, and  $(Ni)$  represents the total concentration of nickel in the solution, regardless of its form. That the concentrations of  $H_2S$  and  $HS^-$  do not appear separately is an expression of the observed independence of reactivity and pH.

The qualitative form of the data in Figures 3.4, 3.5, and 3.6 could best be fitted with these assumptions, which are embodied in (3.1):

- (1) The kinetic order in nickel is one-half.
- (2) The kinetic order in sulfide decreases from two to one with increasing sulfide concentration.

The only significantly different, but plausible alternative to (3.1) is:

Table 3.1

#### The Empirical Rate Expression

$$\frac{d(H_2S)}{dt} = \frac{k_2(H_2S)^2(Ni)^{0.5}}{1 + \frac{k_2}{k_1}(H_2S)} \quad (3.1)$$

where  $t$  is in seconds, and  $(H_2S)$ ,  $(Ni)$  are in moles per liter.

Rate is independent of  $(O_2)$  and pH.

At  $35^\circ\text{C} = 308 \text{ K}$ :

$$k_1 = 25 (\text{moles / l})^{-0.5} \text{ s}^{-1}$$

$$k_2 = 3 \times 10^6 (\text{moles / l})^{-1.5} \text{ s}^{-1}$$

The energy of activation is:

$$E_a = 2.4 \text{ kcal / mole}$$

$$\frac{d(H_2S)}{dt} = -k_1(H_2S)(Ni)^{0.5} \quad (3.2)$$

This expression was rejected, because it gave a visibly poorer fit. In particular, the fitted curves in Figure 3.4 were horizontal, straight lines, and the drop-off in the fitted curves in Figures 3.5 and 3.6 was much too rapid. Likewise, assuming that kinetic order in nickel = 1 is inconsistent with Figures 3.4 and 3.5: it causes the predicted residual fraction to drop off much too rapidly with increasing nickel concentration.

Minor variations from the form (3.1) are not excluded by the data; for example, the details of the change from second to first kinetic order may be different, or the kinetic order at low concentration might be three.

For purposes of fitting, expression (3.1) was converted to integral form. The values of  $k_1$  and  $k_2$  at 35°C were simultaneously estimated by a bivariate least-squares fitting procedure, using all data points in Figures 3.4, 3.5, and 3.6. The value of the activation energy  $E_a$  was estimated from the data in Fig. 3.7 only with the assumption that  $k_1/k_2$  does not change with temperature. The data in Figures 3.8 and 3.9 were not fitted at all.

The statistical uncertainty in the calculated value of  $k_1$  is about 10%; we accept this as the uncertainty of the reaction rate at 35°C, predicted using (3.1).

### 3.5. Distribution of reaction products

Normally, 75-90% of the sulfur put into the SCW was recovered. The sulfur recovery improved with increasing concentration of nickel, but deteriorated with decreasing pH. This suggests that the main source of the closure error was the loss of  $H_2S$  to the atmosphere. Incomplete recovery of sulfate and nondetermination of dithionate also may have contributed to it.

Fig. 3.10 illustrates the reaction product distribution with no sulfite added. The major reaction products are thiosulfate and colloidal sulfur, in that order, and there was a small amount of sulfate present at the end of the experiment. Only a trace of trithionate formed, if any. The curve of colloidal S vs. time is concave. The accumulation of colloidal S is limited by its further oxidation to thiosulfate and sulfate.

Fig. 3.11 illustrates reaction product distribution at sulfite:sulfide = 0.75 and two different values of pH. At pH 7.9 thiosulfate is the major product, and smaller amounts of sulfate and trithionate also are produced. No colloidal S is produced at this pH. At pH 6.5, thiosulfate is still the major reaction product, but more sulfate is produced than at pH 7.9. There is some colloidal S at pH 6.5, but little or no trithionate.

Figure 3.12 illustrates reaction product distribution with 100 μM Ni. Sulfur recovery is noticeably better than with 20 μM Ni, but the distribution of products is otherwise unchanged (compare to Figure 3.11).

Fig. 3.13 illustrates the effect of varying sulfite:sulfide ratio at constant pH. Thiosulfate is the major reaction product in all cases, but the yield of sulfate and trithionate increases rapidly with added sulfite. This suggests that sulfate and trithionate are produced mostly by reactions involving sulfite. Colloidal S is significant only when no sulfite is added.

Figures 3.14 and 3.15 illustrate the effect of varying pH at sulfite:sulfide = 0 and 0.75, respectively. In both cases, decreasing pH definitely favors the formation of sulfate at the expense of thiosulfate. With no added sulfite (Fig. 3.14), the amount of colloidal sulfur formed is not affected by pH. With sulfite added (Fig. 3.15), colloidal S is present only at the lowest pH.

### 3.6. The reaction mechanism

A proposed mechanism that is consistent with the data is presented in Table 3.2. The reactions are approximate and may be changed somewhat without materially affecting the conclusions. Which species are protonated is not known with certainty, and polysulfidomonosulfonates may take the place of polysulfides.

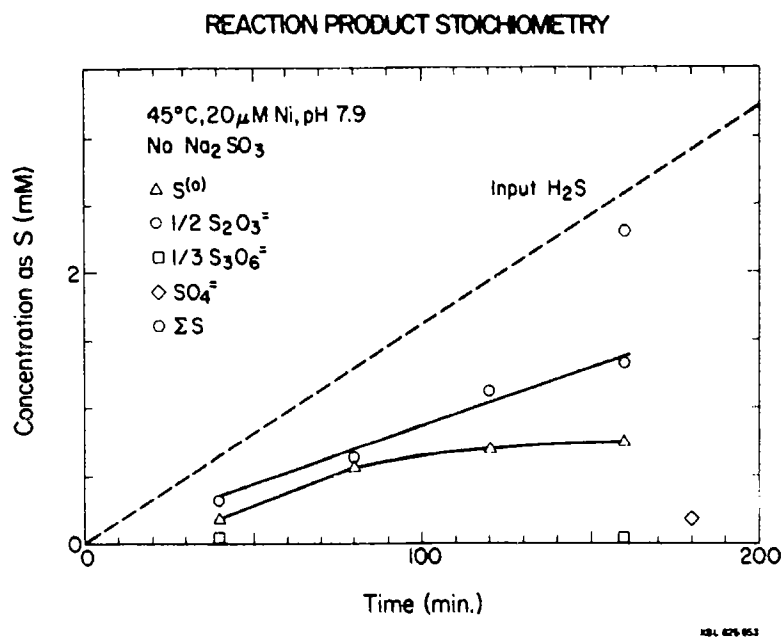

Fig. 3.10. Distribution of reaction products; 20  $\mu$ M nickel, no sulfite, pH = 7.9.

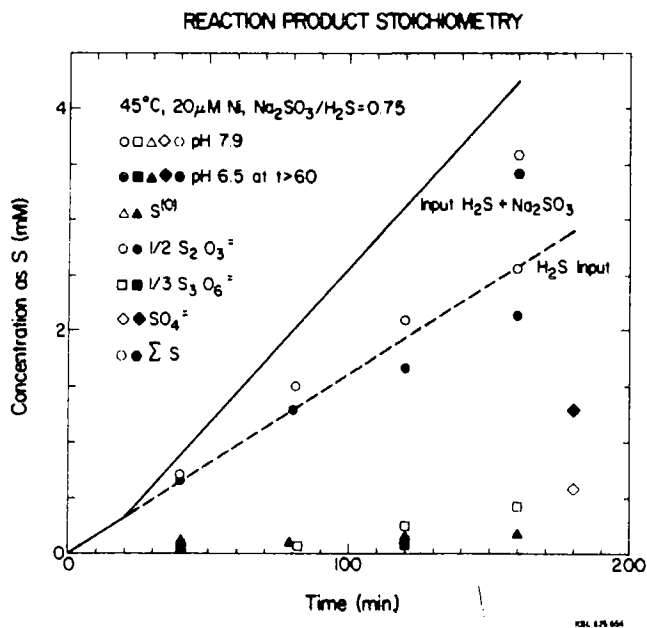

Fig. 3.11. Distribution of reaction products; 20  $\mu$ M nickel, sulfite:sulfide = 0.75. Open symbols: pH = 7.9. Solid symbols: pH = 6.5.



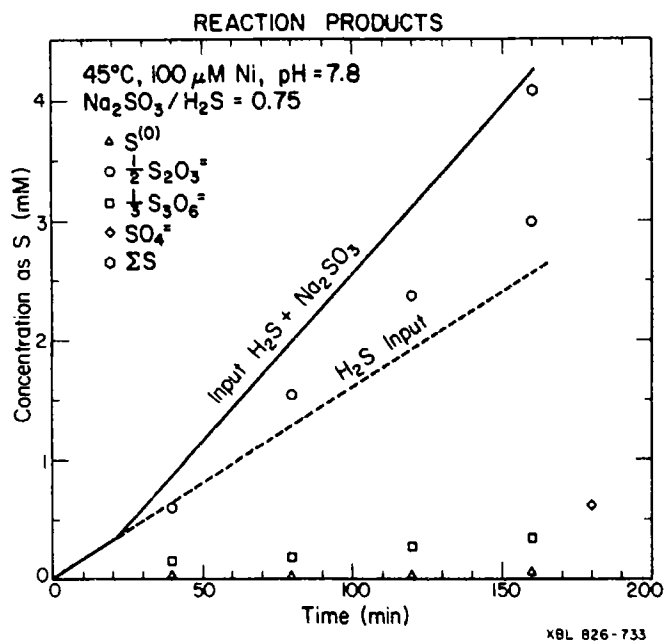

Fig. 3.12. Distribution of reaction products; 100 μM nickel, sulfite:sulfide = 0.75, pH = 7.8.

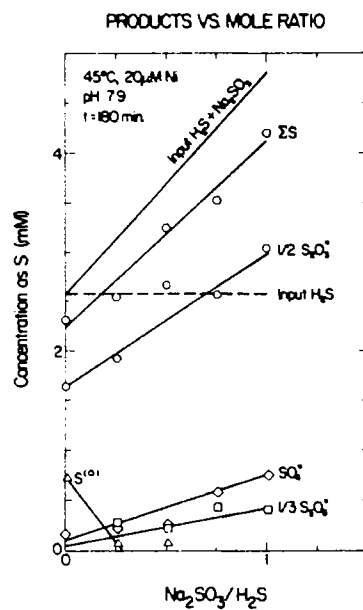

Fig. 3.13. Distribution of reaction products vs. sulfite:sulfide ratio; pH = 7.9, after 180 minutes reaction.

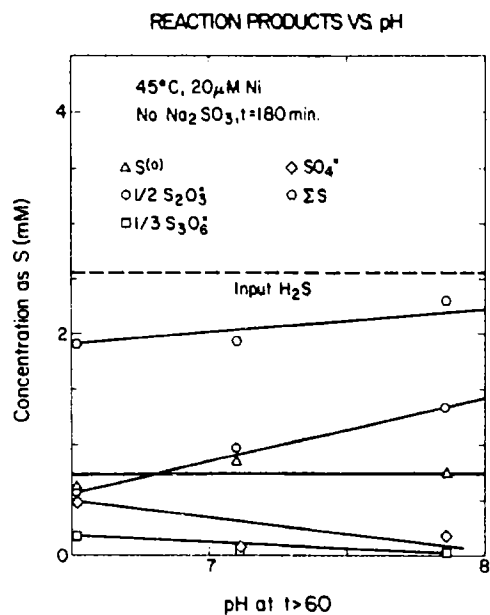

Fig. 3.14. Distribution of reaction products vs. pH; no sulfite added.

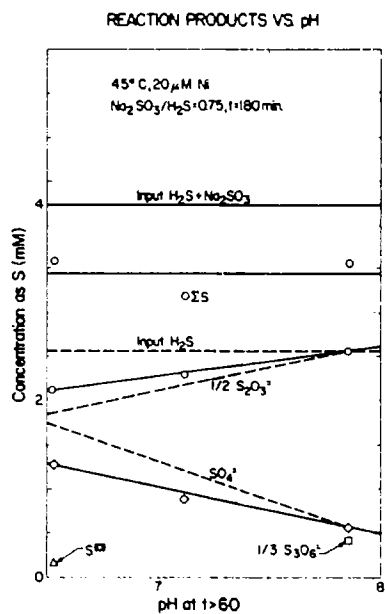
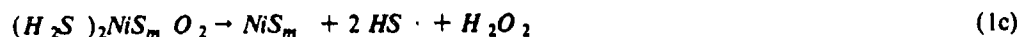

Fig. 3.15. Distribution of reaction products vs. pH; sulfite:sulfide = 0.75. Sloping dashed lines depict the yield of thiosulfate and sulfate at the given pH, corrected for the contribution of the first hour of reaction at pH 7.8.

Table 3.2  
Proposed reaction mechanism

Initiation:



Formation of  $S^{(0)}$ :



Termination:



where  $R_1 \cdot$  and  $R_2 \cdot$  are any two radicals or radical ions.

Multiplication of polysulfide chains:



Formation of thiosulfate:

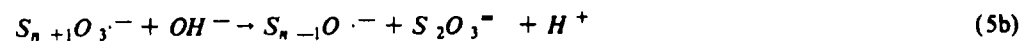

Also:



Formation of sulfate:

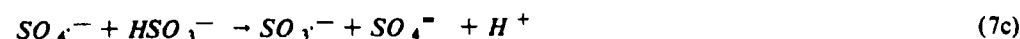
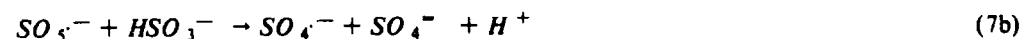

Formation of trithionate:

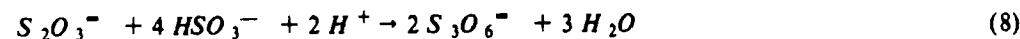

Formation of colloidal S:

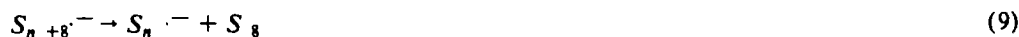

Reactions (1a to c) are a cycle that adds free radicals to the system. Reactions (1a) and (1c) are irreversible, and (1c) determines the overall rate of radical generation. Reaction (1b) is a rapid, reversible equilibrium with equilibrium constant  $K_{1b}$ . Reaction (1d) rapidly converts all  $HS^{\cdot}$  produced to relatively stable polysulfido-radicals, and does not affect the overall rate of reaction. With these assumptions, the rate of generation of free radicals is:

$$I = \frac{2k_{1c} K_{1b} (Ni)(H_2S)^2}{1 + K_{1b} (H_2S)^2} \quad (3.3)$$

All of the nickel is complexed which prevents the precipitation of nickel sulfide.

The total concentration of radicals varies slowly. The approximate balance between reactions (1) and (3) determines its steady state value:

$$(R)_{tot} = (I / 2k_3)^{0.5} \quad (3.4)$$

Reactions (2a, b, and c) are the chain propagation steps. Reactions (2b) and (2c) are rate determining. The corresponding rate law is:

$$\frac{d(H_2S)}{dt} = - \frac{2(R)_{tot} (H_2S)}{\frac{1}{k_{2b}} + \frac{1}{k_{2c}}} \quad (3.5)$$

Substituting (3.3) and (3.4) into (3.5) gives the explicit rate law.

When

$$1 \ll K_{1b} (H_2S)^2$$

this rate law becomes

$$\frac{d(H_2S)}{dt} = -k_1 (Ni)^{0.5} (H_2S) \quad (3.6a)$$

where

$$k_1 = \frac{2(k_{1c} / k_3)^{0.5}}{\frac{1}{k_{2b}} + \frac{1}{k_{2c}}} \quad (3.7a)$$

When

$$1 \gg K_{1b} (H_2S)^2$$

this rate law becomes

$$\frac{d(H_2S)}{dt} = -k_2 (Ni)^{0.5} (H_2S)^2 \quad (3.6b)$$

where

$$k_2 = k_1 (K_{1b})^{0.5} \quad (3.7b)$$

From the values of  $k_1$  and  $k_2$  given in Table 3.1, we estimate

$$K_{1b} = 1.44 \times 10^{10} M^{-2}$$

The limiting forms (3.6a and b) are also those of the empirical rate law (3.1). However, the rate law derived here is more complicated than (3.1). It can be integrated, but the integral form is clumsy and ill-suited for convenient analysis of kinetic data. This is why the similar but simpler form of (3.1) was used instead.

Neither (1a) nor (2a) is rate determining; therefore, the rate of reaction is independent of oxygen concentration.

This mechanism does not explain why the rate is independent of pH. Perhaps, reactions (2b and c) can utilize  $H_2S$  and  $HS^-$  at the same rate, or else changing pH has different effects that cancel out. No fully satisfactory explanation has been found.

Reactions (5a and b), which convert zero valent sulfur to thiosulfate, are side reactions which do not affect the rate of disappearance of  $H_2S$ .

A mechanism analogous to reactions (2a, b and c) and (5a) was postulated by Steijns, *et al.* (1976) to explain the oxidation of  $H_2S$  over solid catalysts at high temperature (Section 2.5.3).

The stoichiometric data suggest that the oxidation of sulfite is the major source of sulfate.

In particular:

- Very little sulfate is produced without addition of sulfite.
- The amount of sulfate produced increases with the amount of sulfite added.
- The amount of sulfate produced at pH 7.8 is less than at pH 6.5 or 7.0.

The oxidation of sulfite was reviewed in Section 2.6, and reactions (7a, b and c) are taken from Table 2.4.

The amount of trithionate formed also increases with the amount of sulfite added. This is consistent with reaction (8) which is discussed in Section 2.2.4.

### 3.7. Discussion

All earlier studies utilized a "one-shot" experimental design: a solution of known sulfide concentration, nickel concentration, etc., was prepared, and the decline of sulfide or oxygen concentration was monitored as a function of time. Experiments like this yield an empirical reaction rate that largely reflects the increasing concentration and effect of the cocatalyst. We used solutions which already had attained steady state cocatalyst concentration. Thus, the effect of varying cocatalyst concentration was eliminated.

Consequently, only qualitative comparison with the results of previous studies is possible. Overall, our conclusions agree with those of Snavely and Blount (1969) (Sections 3.1 and 2.5).

The exact nature of the cocatalyst has not been determined, but the molecule certainly contains a chain of zero-valent sulfur atoms. Most probably, "the cocatalyst" consists of a complex mixture of polysulfides, polysulfidomonosulfonates, and the corresponding radical ions, which interconvert and change chain length in the course of the reaction.

Contact condensers steam strip oxygen from the cooling water, rendering it anoxic between condenser and cooling tower. This is where the  $H_2S$  must be oxidized, if emission to the atmosphere is to be prevented. The oxidation reaction is able to proceed in the absence of oxygen, because the  $H_2S$  is removed by reaction with oxygen-containing polysulfido- molecules, rather than by reaction with oxygen itself (reactions 2b and 2c in Table 3.2).

The rate law presented in Table 3.1 fits the rate data to within the scatter of those data. Although it is incomplete in some respects, the reaction mechanism presented in Table 3.2

satisfactorily explains most of the data, both kinetic and stoichiometric. Why the rate of reaction is independent of pH over a fairly wide range (5.5 to 8.5) is the only major question that remains unanswered.

The mistaken decision to concentrate on 15 seconds reaction time seriously affected the choice of experimental technique, practically forcing us to use "aliquot tests", and quench the reaction with sulfide antioxidant buffer before measuring residual sulfide concentration. If we were now to repeat this work, we would use a different technique. "Synthetic cooling water" would be prepared as in this work, but kinetic measurements would be made using a "flowing" apparatus like that described in Section 4.2 and Appendix 4.1. A two channel, precision syringe sump would be used. One channel would pump sodium sulfide solution, and the other, properly "preaged" SCW. Reaction times of 30 to 150 seconds would be provided by varying pumping rate and/or the length of the delay coil, and the residual sulfide in the solution would be determined directly, by flowing it past an  $Ag_2S$  electrode. Reaction temperature would be controlled by immersing the delay coil and other tubing in a thermostatted water bath. Most work would be performed using nickel concentration no greater than  $20\mu M$ . Such is the wisdom of hindsight.

### Appendix 3.1. Preparation and storage of solutions

Sulfide antioxidant buffer (SAOB) and solutions of sodium sulfide and sodium sulfite are susceptible to oxidation by air, and means to control this were developed.

**Preparation of anoxic solutions.** A simple apparatus was developed for preparing and transferring anoxic solutions (Figure 3.16). A large graduated cylinder or a large flask was used as the deoxygenation vessel. This vessel was placed upon a magnetic stirrer. Frequently, a flexible plastic bag of the kind used to store intravenous pharmaceutical solutions was used to store anoxic solutions (see below).

A magnetic stir bar and the solution (or water) to be deoxygenated are put in the deoxygenation vessel and the stopper with tubes is put in place. The T-valves are initially set to allow gas flowing out of the deoxygenation vessel to go by way of the exhaust tube, and to leave the system by way of the gas exhaust line. The valve on the nitrogen cylinder is opened to allow moderate bubbling; no bubbles should reach the exhaust tube. The solution is stirred. After five minutes, the nitrogen flow is interrupted, the stopper removed, and chemicals are added (e.g., solid sodium sulfide). The stopper is replaced and nitrogen flow resumed briefly to purge any oxygen that may have been introduced.

At this time a clean IV bag is attached to the delivery tube, and the exhaust line is connected to the house vacuum. T-valve #1 is turned to evacuate the bag using house vacuum. (The vacuum flattens the bag.) Then this valve is turned to connect the bag to the deoxygenator and the nitrogen valve opened to fill the bag with nitrogen. The bag is again evacuated. This process is repeated once more to purge the bag of traces of oxygen. Finally, T-valve #2 is turned and the nitrogen valve opened again to drive the solution from the deoxygenator through the solution withdrawal tube into the collapsed bag. When no further solution can be driven out, the nitrogen is shut off, the bag removed from the tube, squeezed to eliminate the remaining nitrogen, and stoppered.

**Storage of anoxic solutions.** One liter IV bags proved ideal for the storage of anoxic solutions. Because they are collapsible, they allow small amounts of solution to be withdrawn without exposing the rest to air. The bags used were distributed by Travenol Laboratories, and their material of construction was stated to be "PL146 TM" plastic. They were obtained from a hospital and cold sterilized with 10% hydrogen peroxide before use. These bags proved very durable and showed no signs of deterioration after many cycles of filling and rinsing. Dilute  $Na_2S$  solutions ( $<0.04 M$ ) and solutions of ferrous salts were always stored in such bags.

Storage in an IV bag was frequently unnecessary. Because the diffusion of oxygen into an anoxic solution is very slow unless the solution is stirred or aerated, relatively concentrated solutions could be stored and used in open containers for up to several hours with little degradation. For example, the  $Na_2S$  stock solution used to determine reactivity was generally kept in an open bottle while work was in progress.

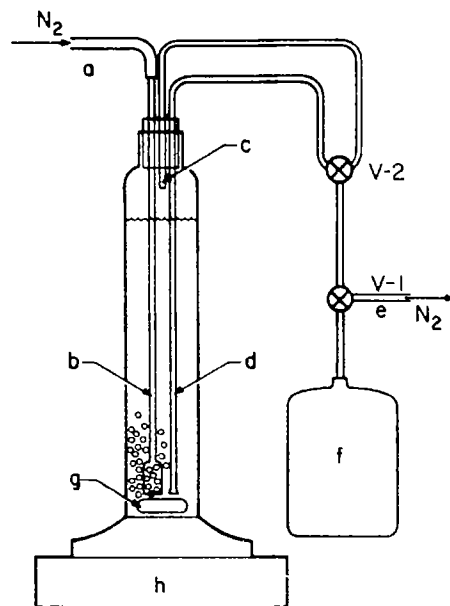

XBL 825-858

Fig. 3.16. Apparatus for preparing anoxic solutions. a. nitrogen from cylinder. b. nitrogen intake tube and diffuser. c. gas outlet tube. d. liquid outlet tube. e. line to house vacuum tap. f. intravenous solution bag. g. stirring pellet. h. magnetic stirrer.

**Preparation of sulfide antioxidant buffer (SAOB).** Sulfide antioxidant buffer is used to quench oxidation reactions and convert all sulfide species present to  $S^{2-}$ , which is what the sulfide electrode actually measures. To measure the concentration of sulfide in a solution, an aliquot of it is first mixed with an equal volume of SAOB. The SAOB recipe used by us was that given by Orion Research in their manual for the sulfide electrode, modified by replacing tetrasodium EDTA with acid EDTA and an equivalent amount of NaOH.

To prepare one liter of SAOB use:

95.94 g NaOH  
58.24 g EDTA  
35.00 g ascorbic acid

First dissolve the NaOH in about 0.25 l of deionized water. After cooling this solution, slowly add the EDTA to it while stirring, taking care that lumps do not form. After this has dissolved completely, add and dissolve the ascorbic acid, and add deionized water to give a final volume of 1 liter.

**Preparation of sodium sulfide stock solution.** BEFORE ATTEMPTING THE FOLLOWING PROCEDURE, REVIEW THE SAFETY PRECAUTIONS IN SECTION 3.2.6. The stock solution of  $Na_2S$  contained about 0.2 M sulfide. It was prepared from reagent grade  $Na_2S \cdot 9H_2O$  (Mallinckrodt). This material came out of the bottle in large lumps which were first broken with a hammer to pieces that would fit into a volumetric flask. These pieces were rinsed with deionized water to remove oxidation products and other superficial contaminants. (There was usually a white material on the surface of the lumps - probably elemental sulfur.)

A 2-liter volumetric flask was used as the deoxygenation vessel. Somewhat less than 2 l of deionized water was deoxygenated, about 100 grams of the washed lumps of  $Na_2S$  were added to

it, and the total volume was made up to 2 l with additional deionized water. Nitrogen flow was restarted to finish deoxygenating the solution, and continued with stirring until the crystals dissolved completely. Finally, the resulting solution was transferred by nitrogen pressure to prepared 62-ml polypropylene bottles with screw caps. The bottles were squeezed and carefully closed so that no air would remain in them. These bottles were rinsed of spilled sulfide solution, dried and the tops wrapped with Parafilm. Unopened bottles of  $Na_2S$  stock solutions could be stored indefinitely with no measurable decline in sulfide concentration.

Once or twice a week a fresh bottle of this stock solution was opened. The exact concentration of sulfide in the stock solution was determined by titration with lead nitrate, using a sulfide electrode to determine the end point. After the bottle had been unsealed, the screw cap only was used to reclose it, and the sulfide in it slowly oxidized to polysulfides. Spot checks indicated that the rate of decline in sulfide concentration after the bottle had been unsealed was about 1% per day.  $Na_2S$  solutions would be discarded when they turned yellow or after a week had elapsed since unsealing the bottle.

*Preparation and storage of sodium sulfite stock solutions.* Ordinarily, the sodium sulfite reagent solution of concentration equal to that of the  $Na_2S$  stock solution was prepared each day from a 1.0 M  $Na_2SO_3$  stock solution which was made up each Monday. In experiments that might have been sensitive to the exact concentration of sulfite, the sulfite solution was prepared each morning from crystalline reagent grade sodium sulfite. These solutions were prepared using water that had not been deoxygenated, and kept in an open container while in use. In retrospect, they probably should have been treated as were the sodium sulfide solutions. However, our data did not appear to have been affected by oxidation of the sodium sulfite solutions.

### Appendix 3.2. UV absorption spectra

Bisulfide ion has a pronounced absorption maximum at about 230nm in the near UV (Figure 3.17). Ellis and Golding (1959) measured the absorption of  $H_2S$  solutions at 230nm as a function of pH, and extracted values of the first acid dissociation constant from this data.

At 230nm, absorption by thiosulfate is severalfold weaker, while sulfate, sulfite and hydrogen peroxide hardly absorb at all. This suggests that UV absorption spectrophotometry may be an adequate analytic method when no other sulfur species are present. For example, this may be the case in the condensate line of a surface condenser-type Unit, before it joins the cooling water line.

When hydrogen peroxide is added to the condensate line for secondary abatement,  $H_2S$  abatement efficiency could be monitored by measuring the concentration of  $HS^-$  in the condensate just before it mixes with the cooling water. The emission rate determined this way would be somewhat high, because it would not allow for possible further oxidation in the cooling water line, etc. There would be some interference by thiosulfate. This could be corrected for by also measuring absorbance at 215nm where thiosulfate has maximum absorbance, and numerically correcting the measured concentration of  $HS^-$ .

The concentration of polysulfides, etc., in the condensate is unknown. If they are present, they may interfere strongly, making the technique impractical. This would have to be determined either experimentally or in the field.

Bisulfide probably could not be measured in the cooling water in this way, because there its concentration would be thirty-fold lower, and that of thiosulfate five-fold higher.

Once reactivity has been established, the SCW is practically opaque below 250nm (Fig. 3.18). This is why UV absorption spectrophotometry is practically useless for measurement of bisulfide when nickel is being used. The gradual increase of optical density with decreasing wavelength in the visible causes the SCW to appear yellow by transmitted light. The two peaks at about 340nm and 390nm are always present, but their intensity relative to each other and the background is highly variable. There appears to be some correlation between their size and the reactivity of the SCW; perhaps they are associated with the cocatalytic species.

The absorption spectrum of the SCW is associated with polysulfides and similar compounds. Polysulfides absorb strongly in the violet and ultraviolet (Giggenbach, 1972), and Wackenroder's



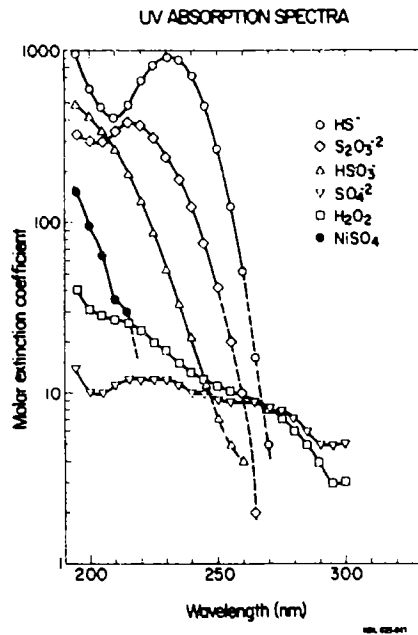

Fig. 3.17. UV absorption spectra of sulfur compounds.

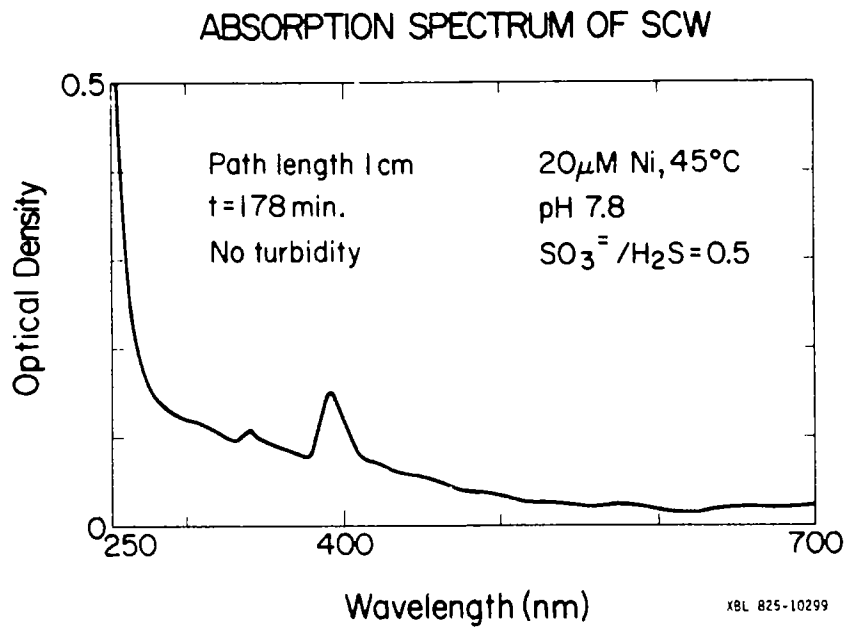

Fig. 3.18. Absorption spectrum of SCW.

solution is bright yellow. The yellow color and strong UV absorption have been correlated with the rate of  $H_2S$  oxidation by others (Chen and Morris, 1972; Chen and Gupta, 1973; Hoffman, 1977).

### Appendix 3.3. Computer code OXTAB

Computer code OXTAB calculates the rate and extent of  $H_2S$  oxidation, and outputs these results in tabular form. A listing of OXTAB and a sample input deck are presented in Table 3.3. It is written in CDC FORTRAN.

The subroutine KINOX performs the actual calculation, and may be used separately from the main program OXTAB. KINOX's input arguments TC, RT, CNI, and CSI are, respectively, the temperature in  $^{\circ}C$ , the reaction time, the total concentration of nickel in solution, and the total initial concentration of  $H_2S$ , including  $HS^-$ . Throughout, concentrations are molar, and time is in seconds. From these, KINOX calculates CSF, FRAC, RI, and RF. Respectively, these are: the sulfide concentration at time = RT, CSF/CSI,  $d(H_2S + HS^-)/dt$  at  $t = 0$ , and  $d(H_2S + HS^-)/dt$  at  $t = RT$ . Equation (3.1) and its integral form are used in these calculations.

OXTAB calls KINOX and generates tables of the input and output variables. Several tables may be generated per run. Within each table, one of the input variables TC, RT, CNI or CSI varies, while the other three are fixed.

The structure of OXTAB's input deck is:

Card 1:

NCARD (15)

Card 2:

VI(1 through 7) (7F10.2)

Card 1 specifies the number of tables to be generated during this job, and each subsequent card specifies a particular table. Card 2 is repeated NCARD times. The first four elements of VI contain the values of TC, RT, CNI, and CSI, respectively, to be used in generating the given table, except that one of these fields is left blank or contains a zero. The blank field or zero corresponds to the input variable which is to be varied in generating the table. The initial and maximum values of this input variable are specified in VI(5) and VI(6), respectively. The value by which it is to be incremented between lines of output is specified by VI(7).

The sample input deck at the end of Table 3.3 will specify one table, for  $35^{\circ}C$ ,  $100\mu M$  Ni, and  $70\mu M$  initial sulfide, with time varying from 10 to 60 seconds, in increments of 10 seconds.

If TC, RT, CNI and CSI are all specified, a single line of output calculated using these values will be generated. The remaining elements of VI need not be specified in this case. If several cards that specify single lines of output are grouped together, the resulting output will be combined in a single table. Mixing input cards that specify single lines with input cards that specify tables is not recommended.

The output from OXTAB is self explanatory.

### Appendix 3.4. Analysis of variance in rate data

The different symbols in each of Figures 3.4 to 9 represent data from different experiments. Most of the point scatter is associated with variation among experiments, rather than among points from any given experiment. This indicates that variations in development of reactivity are responsible for most of the point scatter, rather than variations in the actual reactivity measurements; autocatalysis seems responsible for most of the point scatter. Variation in electrode properties or experimental procedure from day-to-day would have affected the data similarly, but close examination of laboratory records lent no support to this hypothesis.

The scatter and deviation (from the fitted curves) of data from a given experiment increases with increasing complexity of that experiment. For example, each reactivity test in Figure 3.7 was preceded by adjusting and measuring the temperature of the test aliquot. Each reactivity test in

Table 3.3

Listing of Program OXTAB

```
PROGRAM OXTAB(INPUT,OUTPUT)
DIMENSION VI(8)
READ 1, NCARD
DO 2 N=1,NCARD
  READ 3, VI
  IV=0
  DO 4 KV=1,4
    IF(IV.GT.0.AND.VI(KV).LE.0) GO TO 2
    IF(VI(KV).LE.0.) IV=KV
  4 CONTINUE
  IF(N.EQ.1.OR.IV.GT.0) PRINT 5
  IF(N.NE.1.AND.IV.EQ.0) PRINT 6
  IF(IV.GT.0) GO TO 7
  CALL KINOX(VI(1),VI(2),VI(3),VI(4),VI(5),VI(6),VI(7),VI(8))
  PRINT 8, VI
  GO TO 2
  7 CONTINUE
  DEL=VI(7)
  PR=VI(5)-DEL
  PRF=VI(6)
  DO 9 K=1,60
    IF(PR.GT.PRF) GO TO 2
    PR=PR+DEL
    VI(IV)=PR
    CALL KINOX(VI(1),VI(2),VI(3),VI(4),VI(5),VI(6),VI(7),VI(8))
    PRINT 8, VI
  9 CONTINUE
  2 CONTINUE
  STOP
  1 FORMAT(16I5)
  3 FORMAT(8F10.2)
  5 FORMAT(1H1,10X,*TC*,7X,*RTIME*,9X,*CNI*,9X,*CSI*,9X,*CSF*,8X,
  1 *FRAC*,6X,*I RATE*,6X,*F RATE*/)
  6 FORMAT(1X/)
  8 FORMAT(1X,2F12.2,1P6E12.3)
END
SUBROUTINE KINOX(TC,RT,CNI,CSI,CSF,FRAC,RI,RF)
COMMON /KIN/ CK1,CK2,AK1,AK2
F(C)=1./(AK2*C)-ALOG(C)/AK1
DF(C)=-1./(AK2*C*C)-1./(AK1*C)
RATE(C)=-AK2*C*C/(1.+AK2/AK1*C)*SRNI
DATA R,CK1,CK2,H/1.98726,24.55,2.944E6,2436./
DATA CP,TCP,CNP,SRNI,DEL /1E-5,-300.,1E-4,1E-2,5E-4/
IF(CNI.NE.CNP) SRNI=SQRT(CNI)
```

```

CNP=CNI
IF(TC.EQ.TCP) GO TO 4
TCP=TC
TK=TC+273.15
TCF=-H/R*(1./TK-1./308.15)
TCF=EXP(TCF)
AK1=CK1*TCF
AK2=CK2*TCF
4 CONTINUE
RI=RATE(CSI)
IF(RT) 1,2,3
1 RETURN
2 CSF=CSI
RF=RI
FRAC=1.
RETURN
3 CONTINUE
CSF=CP
A=F(CSI)+SRNI*RT
DO 5 K=1,50
RAT=(F(CSF)-A)/DF(CSF)
CN=CSF-RAT
IF(CN.LE.0.) CN=0.5*CSF
CSF=CN
IF(ABS(RAT)/CSI.LT.DEL) GO TO 6
5 CONTINUE
6 CONTINUE
CP=CSF
FRAC=CSF/CSI
RF=RATE(CSF)
RETURN
END

```

Sample input deck:

```

1
35.  0.  0.0001  0.00007  10.  60.  10.

```

---

Figure 3.9 was preceded by changing the oxygen concentration in the test aliquot (by bubbling gas through it), and then measuring it. These drastic manipulations caused the point scatter in these Figures to be relatively large. Increasing nickel concentration greatly reduced point scatter (Figure 3.4) by making the competing effects of degassing and catalysis by stray impurities relatively less important.

To allow comparison of expressions (3.1) and (3.2), the data were reanalyzed by setting  $k_2/k_1 = 3 \times 10^6/25 = 1.2 \times 10^5$  in Eqn. (3.1), and calculating a new value of  $k_1$  for each data point. The average of these  $k_1$  values was 25.4, and the standard deviation 3.7 (STD/mean = 0.22).

Fitting the data using (3.2) gave an estimate of mean  $k_1 = 17.7$  and  $STD = 3.0$  (STD/mean = 0.28). Each data point yields an estimate of  $k_1$  in this case, and these are averaged. Thus, using (3.1) improves quality of the fit as measured by the value of STD/mean only slightly over that obtained with (3.2). The choice of (3.1) was ultimately adhered to because it gives a better fit in a qualitative sense (Section 3.4.1).

The 158 data points presented in Figures 3.4, 3.5 and 3.6 are an internally consistent subset of the 230 data points collected in the corresponding series of experiments. Data from four of the fifteen experiments in this series were grossly inconsistent with data from the other eleven, and among themselves. The apparently bad data from these four experiments was neither fitted nor included in the Figures. Fourteen of the data points from the "good" experiments were perturbed in an obvious way by spoilage (accidental oxidation) of the sodium sulfide solution used in reactivity measurements. These points also were deleted.

Values of mean  $k_1$  and STD were calculated for each of the fifteen data sets with  $k_2/k_1$  fixed as described above. Among the eleven data sets included in the final analysis, STD/mean ranged from 0.11 to 0.21. Among the four data sets dropped from the analysis, STD/mean ranged from 0.33 to 0.41. Three of the four mean  $k_1$  values calculated for these data sets deviate by a large amount from the other eleven. Also, when plotted, these four data sets looked "funny". All this confirmed the decision to drop these four data sets from the analysis of kinetic data.

## CHAPTER 4 CATALYSIS BY IRON, COBALT, AND OTHER TRANSITION METALS

### 4.1. Forward

Unchelated nickel was chosen as the most promising catalyst after various transition metal complexes had been screened. This screening work, described here, was completed before the intensive study of the nickel catalyzed reaction began (Chapter 3).

Because of autocatalysis, a "once through", flowing kinetic apparatus is unsuited for studying the nickel catalyzed reaction. Before the role of autocatalysis was appreciated, such an apparatus had been developed and applied to studying the oxidation reaction catalyzed by iron compounds. It is adequate for this purpose, because autocatalysis is much less pronounced with iron.

Cobalt also is a potent catalyst. Although cobalt is not a serious practical contender for geothermal applications because of cost, the kinetics of the cobalt catalyzed reaction were studied briefly, using the same methods as with nickel.

### 4.2. Experimental methods

In "continuous recharge experiments" reactivity, turbidity and reaction product distribution were determined as with nickel.

#### 4.2.1. Method for screening catalysts

The experimental method used in the early screening work was the precursor of the continuous recharge method described in Section 3.2.2.

Tenth-molar catalyst stock solutions were prepared. The sodium sulfide stock solution was about 0.2 M, and was always standardized before use. One-quarter liter of synthetic cooling water was prepared in an Erlenmeyer flask and preheated to 45°C in a thermostatted water bath. In this work, the SCW contained 1.70 mM  $NH_3$  plus  $NH_4^+$ , 0.786 mM  $HCO_3^-$ , 14.813 mM  $B(OH)_3$  plus  $H_2BO_3^-$ , 1.70 mM  $Cl^-$ , and 1.572 mM  $Na^+$ . Its pH was between 7.8 and 8.0.

At the beginning of the experiment there was no catalyst in the SCW. With stirring,  $Na_2S$  stock solution was added to the SCW to give 62 μM total sulfide (typically, about 80 μl of stock solution). A 25-ml aliquot of SCW was withdrawn by pipette and mixed with 25 ml of SAOB, and the concentration of sulfide was measured with a sulfide electrode. This procedure verified proper sulfide stock concentration and electrode calibration.

To the remaining 225-ml of SCW, catalyst stock solution was added to give the catalyst concentration desired, typically between 10 and 100 μM. The SCW was aerated for about 10 sec, and allowed to stand for about 3 min. With stirring, sulfide stock solution was again added to give 62 μM sulfide, allowing for the now smaller volume of SCW. A 25 ml aliquot was withdrawn by pipette. One minute after addition of sulfide, 25 ml of SAOB was added to this aliquot of SCW, and the sulfide content measured. The pH of the remaining SCW was measured. This cycle was repeated six times, with decreasing amounts of  $Na_2S$  stock solution to compensate for the decreasing volume of SCW.

In some experiments, aliquots of  $Na_2SO_3$  solution were added to the SCW in alternation with aliquots of  $Na_2S$ . These experiments demonstrated that a nickel bearing solution could be "clarified", and that good reactivity without accumulation of colloidal sulfur could be achieved only within a certain range of  $Na_2SO_3$  to  $Na_2S$  mole ratio. At that point, the method described in Section 3.2.2 for substituted for the one described here.

#### 4.2.2. Continuous flow kinetic system

This system is diagrammed in Figure 4.1. Solutions of  $Na_2S$  and ferrous compounds are prepared and kept anoxic. They are kept in intravenous solution bags which exclude oxygen and collapse without resistance as fluid is withdrawn. This keeps air from being drawn into them and

prevents significant changes in pump inlet pressure. The four reagent streams are driven by separate cassettes of a multi-channel peristaltic pump (Manostat). Their relative flow rates are determined by the diameters of the corresponding pump tubes. The relative flow rates of SCW:SAOB: $\text{Na}_2\text{S}$ :catalyst typically were about 1:1:0.08:0.025.

## CONTINUOUS FLOW KINETIC SYSTEM

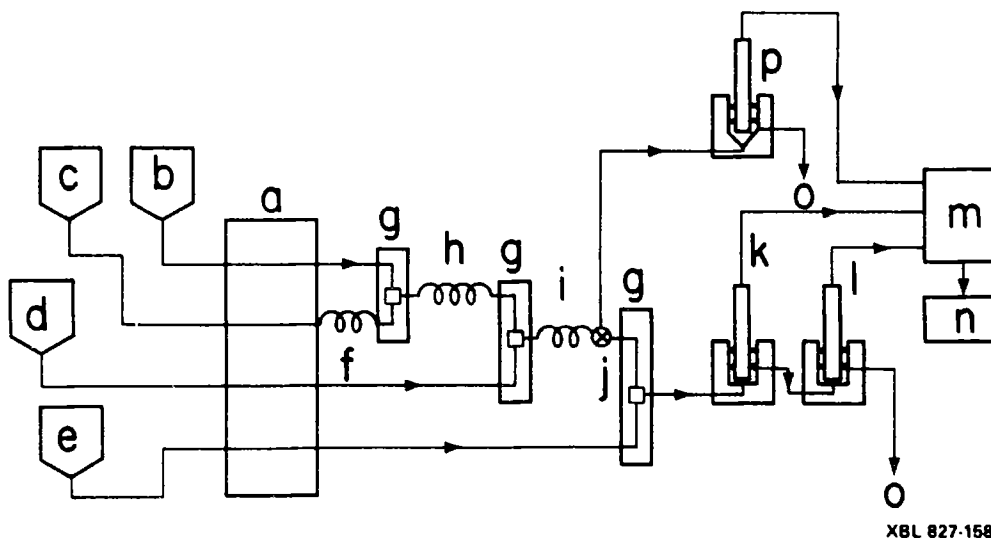

Fig. 4.1. Continuous flow kinetic system. a. peristaltic pump. b. stock solution of catalyst (anoxic). c. aerated "synthetic cooling water" without catalyst. d. stock solution of sodium sulfide. e. sulfide anti-oxidant buffer. f. preheating coil for SCW. g. "stirring blocks" (Fig. 4.10). h. delay coil for catalyst oxidation. i. delay coil for sulfide oxidation. j. three-way valve. k. reference electrode. l. silver sulfide electrode. m. potentiometer. n. printer. o. waste receptacle. p. pH electrode.

The flowing solutions are mixed in plastic "mixing blocks" (Figure 4.10). Each block contains a miniature magnetic stirring pellet, and rests upon a submersible, air driven magnetic stirring pad. (Unstirred "T-blocks" were found to give inadequate mixing due to laminar flow through them.) The SCW stream is preheated in a coil of thin-walled, 1mm I.D. Teflon tubing. All mixing blocks and coils are immersed in the water bath.

The catalyst solution is added to the aerated SCW in the first mixing block. The first delay coil (1mm I.D. Teflon) provides time for reaction of the catalyst with dissolved oxygen. With chelated iron(II), this allows the effect of "catalyst oxidation time" to be studied. It was found that changing this time interval had no effect, and that the initial oxidation state of complexed iron did not influence its catalytic potency. After this was realized, the catalyst was put into the SCW, and the first mixing block and delay coil were eliminated.

Sodium sulfide stock solution was added to the SCW in the second mixing block, typically introducing  $62\mu\text{M}$  sulfide. The length of the second delay coil determined the time available for the oxidation reaction. Either reaction time could be varied by substituting a delay coil of different length. The oxidation reaction was quenched in the third mixing block by adding an equal volume of SAOB to the SCW. Then the mixture flowed past the reference and  $\text{Ag}_2\text{S}$  electrodes, which were mounted in suitable "electrode blocks". The pH was measured by temporarily switching the flow of SCW to a pH electrode.

The peristaltic pump is the major source of trouble in this system. The tubes gradually distort or even collapse, causing the output of the pump channels to vary. This forced tedious daily calibration and frequent tube replacement. Numerous experimental runs were ruined by a sudden change in pumping rate in one or another channel. This problem could be eliminated by substituting a precision multichannel syringe pump for the peristaltic pump. Aside from this problem, the system is basically a good one. The intrinsic modularity of the various blocks and coils allows them easily to be rearranged to modify the experiment. The time resolution of the system could be increased by using miniature electrodes instead of standard sized (1-cm diameter).

Details of construction, solution formulation, and calibration are reviewed in Appendix 4.1.

#### 4.3. Screening of potential catalysts

Using the method described in Section 4.2.1, most of the first row transition metals were screened for catalytic activity. The results of these tests are summarized in Table 4.1. Catalytic

Table 4.1. Screening of potential catalysts.

$\mu\text{M}$ Catalyst	Calib. check	Residual $H_2S$ after given cycle ( $\mu\text{M}$ )						pH
		1st	2nd	3rd	4th	5th	6th	
50 $Ni^{+2}$	62	25	2	1	1	1	1	
20 $Ni^{+2}$	53	52	3	3	4			
10 $Ni^{+2}$	62	24	5	6	6	6	6	
20 $Co^{+2}$	68	65	24	16	20			7.93
124 Fe Cit.	50	16	36	34	35			7.81
100 $Cr^{+3}$	31	27	38	40	45			7.93
100 $Cu^{+2}$	64	2	19	40	49			7.93
10 Ni EDTA	51	47	48	66				7.90
100 $Mn^{+2}$	59	49	67	77				7.92
100 Cr Cit.	52	33	64	81				7.98
10 Ni Cit.	60	56	92	101				7.94
100 $VO_3^-$	55	52	84	106				
100 $MoO_4^-$	54	48	96	129				
100 $Zn^{+2}$	53	48	104	135				



activity is indicated if the residual sulfide concentration stabilizes after a few cycles. The lower this limiting concentration value, the stronger the catalyst. Lack of catalytic activity is indicated by a continuing increase in residual sulfide concentration, which indicates the accumulation of unreacted  $H_2S$  from cycle to cycle. Even in the worst case (zinc), the increase from cycle to cycle is much less than  $62\mu M$ , because  $H_2S$  is lost to the atmosphere. Precipitation of metal sulfides may also reduce the sulfide concentration.

The inferred order of catalytic activity is:



The other species tested are weakly catalytic or not at all. The nickel data clearly show autocatalysis, and autocatalysis is suggested with cobalt as well. In tests with nickel the SCW was yellow after the first cycle, and became turbid with further cycles.

Hydroquinone at a concentration of 2mM is also a potent catalyst, inducing an autocatalytic reaction (not shown). The solution turns very dark as reactivity develops. Hydroquinone is known readily to form relatively stable free radicals. Probably, these react with oxygen and  $H_2S$  as does the cocatalytic species inferred in the case of nickel, and polysulfido- chains grow out from them. As these radicals accumulate, they give the solution its dark color.

#### 4.4. Wackenroder's reaction

Hydrogen sulfide, in which sulfur has the valence -2, and sulfur dioxide, in which the valence is +4, react to produce a mixture of compounds of intermediate valence state. For example, if the ratio of  $SO_2$  to  $H_2S$  is 2, the main product will be thiosulfate, in which the formal valence of sulfur is +2. At lower ratios of  $SO_2$  to  $H_2S$ , there will also be formed polysulfides, colloidal sulfur, and higher polythionates (above tetra-), in all of which the average formal valence is  $< 2$ . This reaction is called Wackenroder's reaction, its product is called Wackenroder's solution, and it is used industrially in the Claus process.

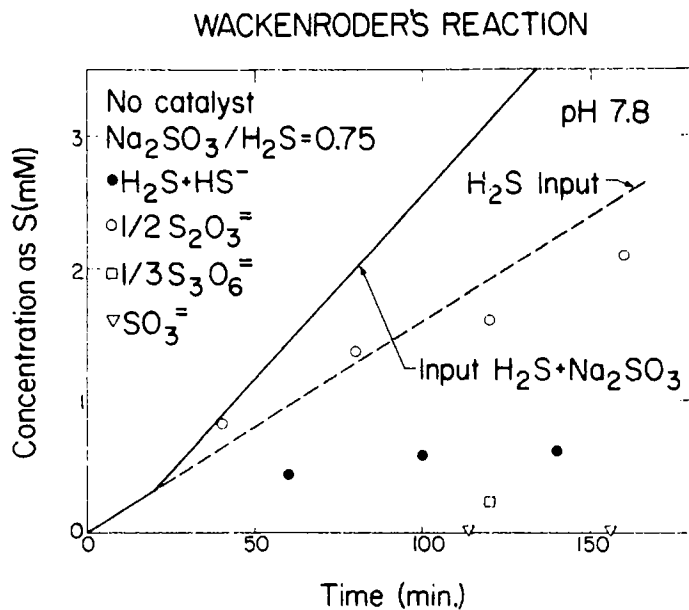

Fig. 4.2. Wackenroder's reaction; no catalyst added.

Wackenroder's reaction itself destroys  $H_2S$  in competition with oxidation. When working with weak catalysts (e.g. iron compounds), it is conceivable that Wackenroder's reaction will make a significant contribution to the overall rate of disappearance of  $H_2S$ , thereby confusing interpretation of the effect of the catalyst.

To test this hypothesis an experiment was run with no catalyst at all. The concentrations of reactants and products vs. time are presented in Figure 4.2. The solution was clear yellow, indicating the presence of polysulfides and/or polythionates, and the absence of colloidal sulfur. Under these conditions the extent of reaction is limited by the amount of sulfite introduced. Most of the sulfite is converted to thiosulfate by reaction with part of the  $H_2S$ , part of the unreacted  $H_2S$  accumulates in solution, while the rest is lost to the atmosphere. The trithionate probably was formed by reaction of sulfite with thiosulfate. Some sulfate probably was formed by oxidation of  $SO_3^{2-}$ , but it was not determined.

Clearly, this reaction's ability to destroy  $H_2S$  under these conditions ( $SO_2:H_2S < 1$ ) is too small to mimic rapid oxidation, and too small for it to serve as a means of  $H_2S$  emission abatement by itself.

#### 4.5. Catalysis by iron compounds

Several iron complexes were tested for catalytic activity using various experimental methods. The three most active complexes were found to be:



Uncomplexed iron(II), iron hydroxyacetate, iron oxalate, and iron DTPA<sup>\*</sup> showed weak catalytic activity. These four species were not studied further, because iron hydroxide precipitated from SCW that contained them. This may be why they were weaker catalysts than the other three; the better chelating agents keep the iron complexed and in solution.

Figure 4.3 compares the rates of reaction catalyzed by iron citrate and iron EDTA. Iron citrate is the stronger catalyst, and the initial oxidation state of iron makes no difference.

The catalytic action of iron complexes may include cycling between the two oxidation states; for example, oxygen reacts with iron(II) to give iron(III), and then iron(III) reacts with  $HS^-$  to give  $HS\cdot$  and iron(II). If so, the rate of the reaction of iron(II) with oxygen may affect the overall rate of  $H_2S$  oxidation. This was tested by varying the amount of time allowed for reaction of the catalyst, initially in the ferrous state, with oxygen before adding  $Na_2S$  (Figure 4.4). Varying the "catalyst oxidation time" has no effect, and this argues against such a cycle.

Precipitation of iron(III) hydroxide was more commonly observed with complexes of iron(II) than with iron(III). Consequently, work with iron(II) complexes was terminated once it was established that initial oxidation state makes no difference. Apparently, the iron (II) complexes are weak enough for part of the iron(II) to be unchelated. This unchelated iron(II) oxidizes to unchelated iron(III), which precipitates as iron(III) hydroxide before it can react with the free chelating agent. Apparently, iron(III) complexes are stable enough to prevent the precipitation of iron(III) hydroxide.

The data in Figure 4.5 were obtained using the methods described in Sections 3.2.1 and 3.2.3. There is little evidence for autocatalysis, and the catalytic activities of iron citrate and iron HEDTA appear equal. The reactivity data in Figure 4.5 is consistent with the citrate data in Figure 4.3. This supports the validity of the two experimental methods, and argues against a significant role for autocatalysis, since there is no opportunity for it to develop in the continuous flow experiments. The difference in turbidity may have been caused by the precipitation of iron hydroxide from the SCW containing Fe HEDTA.

\*HEDTA = N-hydroxyethylenediaminetriacetic acid, EDTA = ethylenediaminetetraacetic acid, DTPA = diethylenetriaminepentaacetic acid ("Siamese twins" of EDTA).

\*\*This was accidental. In this experiment, the catalyst recharge was in the sulfuric acid solution, as had been the practice with unchelated nickel. In the acid solution, the iron(III) was not chelated, and thus available for precipitation when it entered the SCW. In the experiment with citrate, the catalyst was added as a neutral solution of it alone, through a separate pump channel.

CATALYSIS BY IRON COMPLEXES

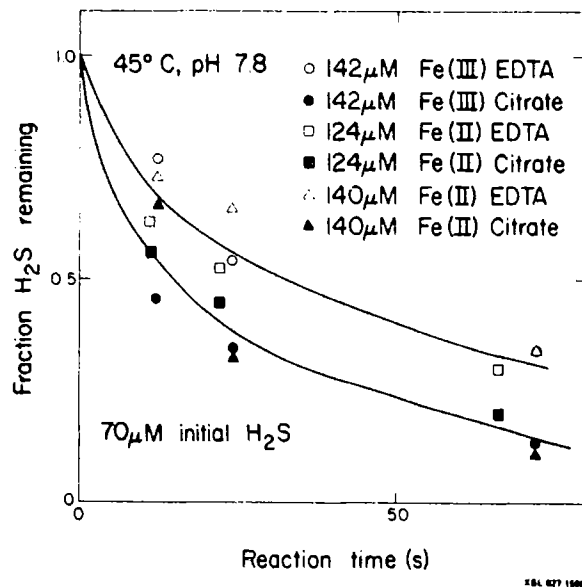

Fig. 4.3. Reaction catalyzed by iron complexes; comparison of catalysts, effect of catalyst's oxidation state. Data generated with continuous flow system.

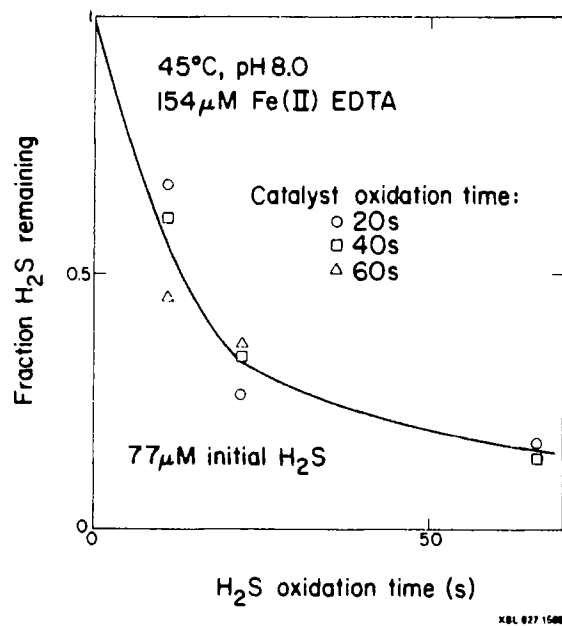

Fig. 4.4. Reaction catalyzed by iron complexes; effect of catalyst oxidation time.

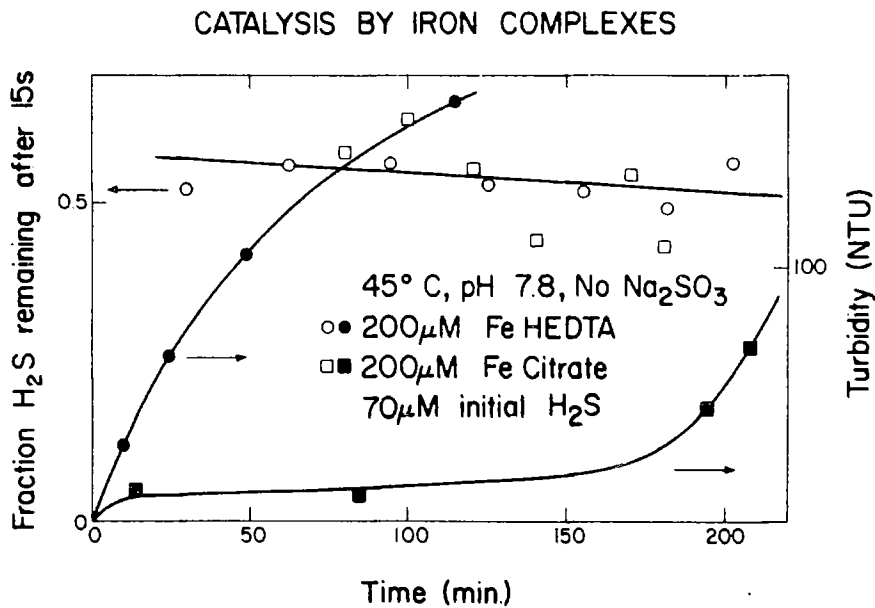

Fig. 4.5. Reaction catalyzed by iron complexes. Data generated by continuous recharge method, as with nickel. Difference is recorded turbidities may be not significant.

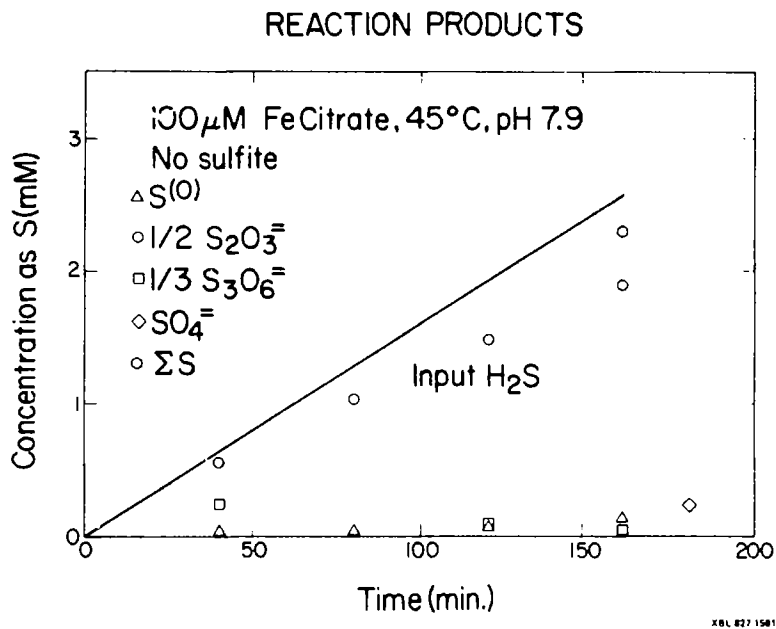

Fig. 4.6. Reaction product distribution; 100 μM iron(III) citrate, no sulfite, pH = 7.9.

In general, the repeatability of reactivity and turbidity data from experiments with iron complexes was less than with nickel. Probably, this was because the loss of  $H_2S$  to the atmosphere was relatively more significant with the more weakly catalytic iron complexes. Good kinetic data could be obtained with the continuous flow kinetic system, because it is closed and does not lose  $H_2S$  to the atmosphere, and because autocatalysis is not a significant factor with iron.

Figure 4.6 illustrates the distribution of reaction products with iron citrate and no sulfite added. Thiosulfate is the major reaction product, and little colloidal sulfur is produced (although the SCW is turbid).

These limited data do not allow a detailed reaction mechanism to be inferred.

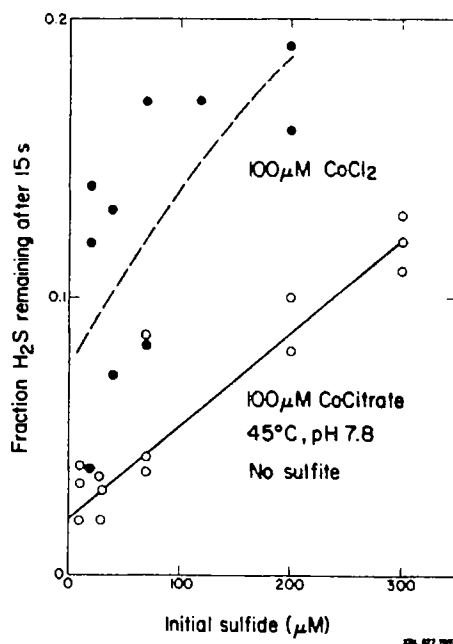

Fig. 4.7. Reaction catalyzed by cobalt. Solid symbols: 100  $\mu$ M cobalt chloride. Open symbols: 100  $\mu$ M cobalt citrate. 70  $\mu$ M sulfide added in reactivity determinations.

#### 4.6. Catalysis by cobalt

Uncomplexed cobalt is nearly as potent a catalyst for  $H_2S$  oxidation as uncomplexed nickel, while cobalt citrate is more potent still (Figure 4.7; compare with Figure 3.4). However, the variation of residual fraction with initial  $H_2S$  concentration is different. That the apparent kinetic order in  $H_2S$  is  $< 1$  suggests that the catalytic effect of cobalt can be saturated.

The reaction catalyzed by cobalt is very strongly autocatalytic (Figure 4.8), and the SCW has a very dark, reddish-black color. Because the SCW is nearly opaque, turbidity cannot meaningfully be measured, and the color of the SCW interferes with colorimetric determination of colloidal sulfur, thiosulfate, and trithionate. Thiosulfate is the main reaction product (not shown).

Adding a modest amount of magnesium chloride to the SCW causes a dark precipitate to form, leaving a clear yellow supernatant. This destroys the reactivity of the solution. Thus, both the color and reactivity of the SCW are associated with colloidal particles suspended in it. These probably consist of amorphous cobalt oxysulfide, and the oxidation reaction probably is catalyzed by their surface. This would explain catalyst saturation phenomena. The beneficial effect of citrate ion has not been explained.

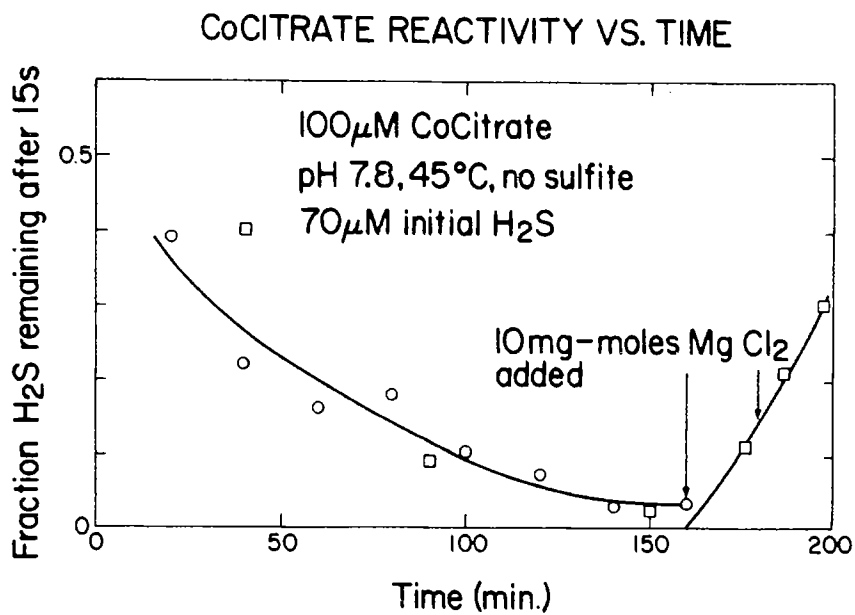

Fig. 4.8. Reaction catalyzed by cobalt citrate; 100  $\mu$ M cobalt citrate, no sulfite, pH 7.8. Squares: 10mM of magnesium chloride added at 160 minutes, and again at 180 minutes.

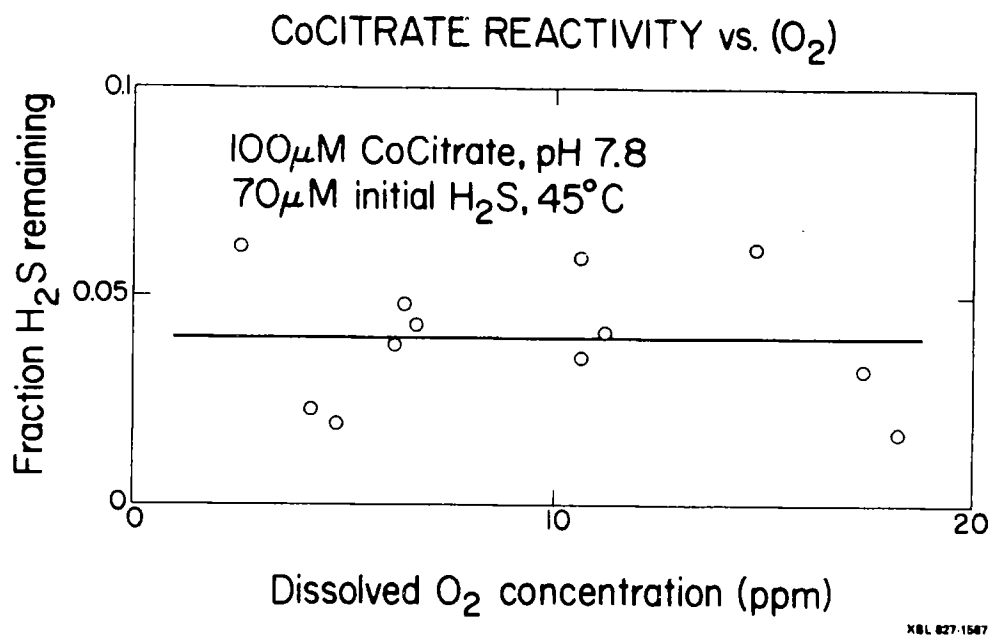

Fig. 4.9. Reaction catalyzed by cobalt; effect of oxygen concentration.

As with nickel, the concentration of dissolved oxygen does not affect reactivity (Figure 4.9), nor does the pH (not shown). Overall, this data suggests that with cobalt the radical initiation step takes place on the surface of colloidal particles, while the rest of the reaction mechanism is similar to that with nickel.

**Appendix 4.1. Continuous flow kinetic system (cont.)**

Typical solution compositions used with the flowing kinetic system are presented in Table 4.2.

Small changes in tube configuration in the cassette, combined with the gradual fatigue of the plastic caused the pump ratios to vary from day to day. Because of this, the system needed to be recalibrated daily. A solution of methyl orange with an optical density of 1.200 at 460 nm was fed successively into each pump channel, while the others pumped water. The actual pumping ratios were determined by measuring the optical densities of the resulting mixtures. To reduce pump tube deformation (flattening), the cassettes were unclamped at the end of each day and re-clamped the following morning.

The mixing and electrode blocks were machined from Lucite, and the machined surfaces polished to make them transparent. The inlet and outlet ports of the blocks were plastic screws fitted into threaded holes in the Lucite. The screws had holes drilled through them, into which thin-walled 1mm I.D. Teflon tubing fit snugly.

Figure 4.10 is a scale drawing of a mixing block. The magnetic stirring pellet was designed for use inside spectrophotometric cuvettes. It was a slotted, Teflon coated cylinder 9mm diameter x 6mm tall. The cavity in the mixing block was closed off above the pellet with a machined Teflon plug.

The electrode block used with the  $Ag_2S$  and reference electrodes is diagrammed in Figure 4.11. The pH electrode block was similar, except that its cavity had a conical bottom to provide room for the electrode's glass bulb (not shown). The annulus around the electrode barrel was tightly sealed with two O-rings. A similar but larger block was made for the dissolved oxygen probe (not shown).

Table 4.2. Solutions used with flowing kinetic system\*.

Stream	Frac.	$B(OH)_3$	$CO_2$	$NH_3$	$H_2S$	Catal.
SCW	.909	16.29	0.86	1.88		
Catal.	.0224					2.23
$Na_2S$	.0686				0.904	
Reaction	1.000	14.81	0.79	1.71	0.062	0.05

\* All concentrations in mM. Concentration given for  $CO_2$  includes  $HCO_3^-$  and  $CO_3^{2-}$ , and likewise for other acids and bases.

The electrodes were calibrated each day after the pumping ratios had been determined. A special solution of SAOB with a small, known concentration of  $Na_2S$  was prepared. Deaerated water was pumped through the other three channels. Knowing the pumping ratios, it was possible to relate the concentration of sulfide in the SAOB to a virtual concentration of sulfide in the reaction stream (i.e., SCW+catalyst+ $Na_2S$ ), which would give the same concentration in the electrode chamber and, thereby, the same electrode response. In practice, the amount of sulfide added was calculated so that the virtual sulfide concentration in the reaction stream would be  $10^{1/2} \times 62 \mu M$  or  $196 \mu M$ . A second calibration standard was prepared by diluting part of this solution ten-fold with additional SAOB. Flowing these two standards through the SAOB channel and recording the corresponding electrode responses allowed the electrode calibration equation to be determined.

Using the measured pumping ratios, the  $Na_2S$  and catalyst solutions were prepared to give the concentrations of sulfide and catalyst desired in the reaction stream.

Anoxic solutions of  $Na_2S$ , iron(II) compounds, and SAOB were prepared as described in Appendix 3.1. The oxygen content of solutions prepared in this way was sometimes measured using a dissolved oxygen probe fitted with a suitable, flow-through electrode block. Dissolved oxygen concentrations less than 0.2 ppm (the sensitivity of the probe) could routinely be achieved. Tests with deaerated water in all channels showed about 1ppm oxygen in the water leaving the system, probably due to diffusion of oxygen through the thin walls of the Teflon tubes that were used as connectors and delay coils.

Solutions of iron(II) complexes were prepared from Mohr's salt ( $(NH_4)_2SO_4 \cdot FeSO_4 \cdot 6H_2O$ ), which is a good source of iron(II), uncontaminated with iron(III). The other catalyst solutions did not require oxygen free preparation.

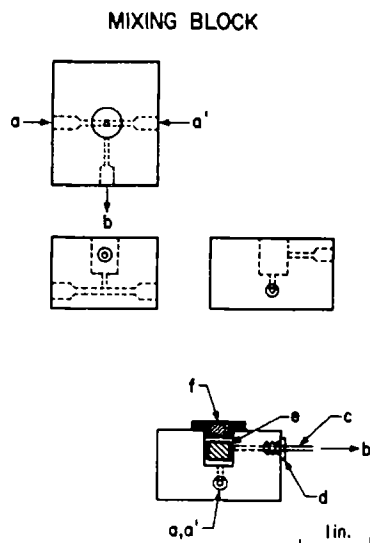

XBL 827-1884

Fig. 4.10. "Mixing block" in continuous flow system; machined from Lucite and polished. a, a', solutions to be mixed enter block. b. mixture exits block. c. solution tubes are 1mm I.D. thin-walled Teflon. d. drilled plastic screw. e. miniature Teflon-coated magnetic stirring pellet. f. plug machined from Teflon.



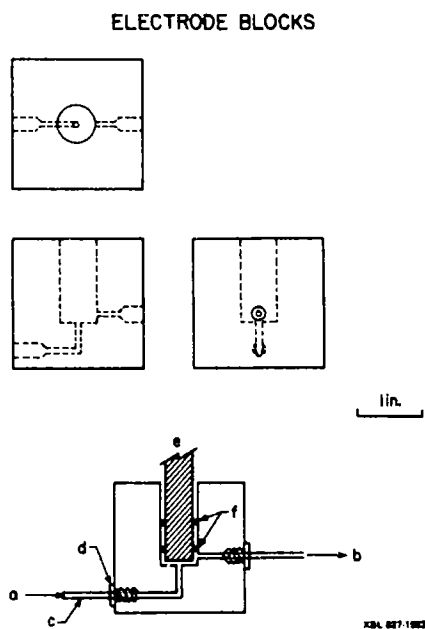

Fig. 4.11. "Electrode blocks" in continuous flow system; machined from Lucite and polished. a. mixed SCW and SAOB enter. b. solution exits block. c. 1mm I.D. thin-walled Teflon tube. d. drilled plastic screw. e. electrode. f. O-rings. Blocks for reference and silver sulfide electrodes are as shown. Cavity of pH electrode block has conical bottom to accommodate electrode bulb.

## CHAPTER 5 SUMMARY AND DISCUSSION

The rate of the nickel catalyzed reaction of  $H_2S$  with oxygen has been determined over a range of conditions, and an empirical rate expression that fits the data well has been derived. This rate expression allows meaningful extrapolation to other conditions, including those expected in the field. The reaction products also have been determined and explained well enough to allow estimates to be made for other conditions.

Because iron complexes are much weaker catalysts than nickel or cobalt, the iron catalyzed reaction could not properly be studied using our methods. However, we found little evidence that the iron catalyzed reaction is fundamentally different from that catalyzed by nickel. Aside from much lower catalytic activity, the major difference observed was that less colloidal sulfur formed with iron (compare Figures 4.5 and 6 to Figures 3.1 and 3.10). In the absence of sulfite, formation of thiosulfate and sulfate probably involves oxidation of colloidal sulfur initially formed. The accumulation of colloidal sulfur will be determined by the balance between the reactions that produce and remove it. Because the oxidation of  $H_2S$  (which produces colloidal sulfur) is much slower with iron than with nickel, less accumulation of colloidal sulfur is to be expected.

In the field, the oxidation reaction takes place in the anoxic part of the cooling water loop, and formation of colloidal sulfur probably is favored with iron, too. In fact, operation of Geysers Unit 11 with iron HEDTA but without  $SO_2$  caused extensive deposition of sulfur scale in the water distribution trays, as had happened with nickel in Unit 2 (PG&E-DER, private communication). Overall, we believe that there is little practical difference between iron HEDTA and nickel in this application, and that what is learned about one system can, in large measure, be applied to the other.

In contact condenser equipped Units at The Geysers, the  $H_2S$  in the condenser vent-gas will be converted to  $SO_2$  by a burner-scrubber or equivalent device, and this  $SO_2$  added to the cooling water. Enough caustic soda will be added to the cooling water to maintain pH at about 7.0. At this pH value, about half the  $H_2S$  will go with the vent-gas and be converted to  $SO_2$ , while the other half dissolves in the cooling water. This portion will need to be eliminated by catalyzed air oxidation in the cooling water.

Field conditions differ from our experiments in several respects:

- (1) Typically, about 90 seconds is available for reaction between condenser and cooling tower, not the 15 seconds used in our work.
- (2) The cooling water temperature between condenser and cooling tower typically is  $48^\circ C$ , rather than the  $35^\circ C$  used in our reactivity determinations.
- (3) With contact condensers, the cooling water is anoxic between condenser and cooling tower.

Using OXTAB, we estimate that in 90 seconds at  $48^\circ C$ ,  $10\mu M$  nickel in the cooling water (0.6 ppm) will eliminate 98% of the  $H_2S$  dissolved in it. This amounts to about 99% abatement overall. That the cooling water is anoxic between condenser and cooling tower should not affect this conclusion, as the rate of reaction is independent of oxygen concentration (Section 3.4).

That the cooling water is anoxic between condenser and cooling tower will affect the distribution of reaction products. Most of the sulfate produced in our experiments comes from oxidation of sulfite (Section 3.6). This parasitic oxidation reaction is favored, because the SCW is fully aerated at all times. By consuming sulfite, it increases the sulfite:sulfide ratio needed to prevent accumulation of colloidal sulfur. In the field, the  $SO_2$  probably will be added to the cooling water in the anoxic part of the system, where it is needed to prevent the formation of colloidal sulfur. There it will have the opportunity to react with the sulfur produced by oxidation of  $H_2S$  before being oxidized to sulfate itself.

The reaction products formed determine the amount of alkali that must be added (if any) to maintain an acceptable cooling water pH. The less sulfate produced, the less alkali needed. Reaction of bisulfite with thiosulfate to produce trithionate also will help decrease the production of

sulfate, and the need for alkali.

Test work at Geysers Unit 1, using iron HEDTA, has shown that acceptable cooling water pH can sometimes be maintained without addition of caustic soda (Yancey, 1981). This suggests that thiosulfate and trithionate are, in fact, the major reaction products, with little or no sulfate produced.

If 0.6 ppm Ni is indeed sufficient and little caustic soda need be added, the chemical cost of nickel/ $SO_2$  process will be negligible. That the process using iron HEDTA works very well suggests that the process utilizing nickel also will work, probably with much lower chemical costs.

As far as could be determined, there is no difference at all between iron HEDTA and iron citrate. Because iron citrate would be cheaper to use than iron HEDTA, iron citrate is to be preferred.

The reaction catalyzed by cobalt appears to involve reaction on the surface of colloidal particles, probably composed of cobalt oxysulfide. For this reason as well as cost, cobalt is unsuited for use in power plant cooling water. However, the catalytic particles are easily removed by flocculation, and this suggests use of cobalt in cases where the catalyst can and must be recovered from the treated water.

## REFERENCES

- Abel, E., 1956. Autooxidation in the sulfur group. *Monatsh. Chem.*, *87*:4, 498-502. (In German.)
- Allen, G.W., and Semprini, L., 1975. Measurement of hydrogen sulfide emissions abatement at Unit 11, The Geysers, using iron catalyst, December 3, 1975. Report 7485.29-75, Pacific Gas and Electric Co., Dept. of Engineering Research. San Ramon, CA, December 23, 1975.
- Almgren, T., and Hagström, I., 1974. The oxidation rate of sulphide in sea water. *Water Research*, *8*, 395-400.
- Avrahami, M., and Golding, R.M., 1968. The oxidation of the sulphide ion at very low concentrations in aqueous solution. *J. Chem. Soc. (A)*, 647-651.
- Awtrey, A.D., and Connick, R.E., 1951. The rate law and mechanism of the reaction of iodine with thiosulfate ion: the formation of the intermediate  $S_2O_3I^-$ . *J. Amer. Chem. Soc.*, *73*, 1341-1348.
- Bäckström, H.L.J., 1934. The chain mechanism of autooxydation of sodium sulfite solutions. *Z. Phys. Chem.*, *B25*:1, 122-138.
- Baldea, I., and Niac, G., 1970. The reaction between chromate and thiosulfate. II. The kinetics of tetrathionate formation. *Inorg. Chem.*, *9*:1, 110-114.
- Barron, C.H., and O'Hern, H.A., 1966. Reaction kinetics of sodium sulfite oxidation by the rapid-mixing method. *Chem. Engin. Sci.*, *21*, 397-404.
- Bartlett, J.K., and Skoog, D.A., 1954. Colorimetric determination of elemental sulfur in hydrocarbons. *Anal. Chem.*, *26*:6, 1008-1011.
- Battaglia, C.J., and Miller, W.J., 1968. The kinetics and mechanism of the reaction of thiosulfate with bisulfite in aqueous solution. *Phot. Sci. Eng.*, *12*:1, 46-52.
- Bengtsson, S., and Bjerle, I., 1975. Catalytic oxidation of sulphite in diluted aqueous solutions. *Chem. Engin. Sci.*, *30*, 1429-1435.
- Benson, S.W., 1978. Thermochemistry and kinetics of sulfur-containing molecules and radicals. *Chem. Rev.*, *78*:1, 23-35.
- Blasius, E., Horn, G., Knöchel, A., Münch, J., and Wagner, H., 1968. Analytical chemistry of sulphur compounds. Chapter 6 in Nickless (1968), pp. 199-240.
- Boulègue, J., 1976. Equilibria in the system  $H_2S$  - colloidal  $S_8$  -  $H_2O$ . *Comptes Rendus Acad. Sci. Paris (D)*, *283*, 591-594. (In French.)
- Boulègue, J., 1978. Electrochemistry of reduced sulfur species in natural waters - I. The  $H_2S$  -  $H_2O$  system. *Geochim. Cosmochim. Acta*, *42*, 1439-1445.
- Boulègue, J., and Michard, G., 1979. Sulfur speciation and redox processes in reducing environments. Pp. 25-50 in E.A. Jenne, Ed., *Chemical modeling in aqueous systems, speciation, sorption, solubility, and kinetics*. ACS Symposium Series 93. Amer. Chem. Soc.

\*PG&E reports are internal documents, generally not distributed outside the Company. They are cited here for the convenience of PG&E staff only.

(Washington, D.C.).

- Burton, K.W.C., and Machmer, P., 1968. Sulphanes. Chapter 10 in Nickless (1968), pp. 335-366.
- Byerley, J.J., Fouda, S.A., and Rempel, G.L., 1973. The oxidation of thiosulfate in aqueous ammonia by copper(II) oxygen complexes. *Inorg. Nucl. Chem. Lett.*, 9, 879-883.
- Byerley, J.J., Fouda, S.A., and Rempel, G.L., 1973a. Kinetics and mechanism of the oxidation of thiosulphate ions by copper(II) ions in aqueous ammonia solution. *J. Chem. Soc. Dalton*, 889-893.
- Byerley, J.J., Fouda, S.A., and Rempel, G.L., 1975. Activation of copper(II) ammine complexes by molecular oxygen for the oxidation of thiosulphate ions. *J. Chem. Soc. Dalton*, 1329-1338.
- Chanda, M., O'Driscoll, K.F., and Rempel, G.L., 1979. Polymer supported metal complexes as catalysts for oxidation of thiosalts by molecular oxygen II. Copper(II) complex of polystyrene-bound 2,2'-bipyridine. Preprint, *Can. Symp. Catal.*, 6, 44-51.
- Chen, K.Y., and Gupta, S.K., 1973. Formation of polysulfides in aqueous solution. *Envir. Lett.*, 4:3, 187-200.
- Chen, K.Y., and Morris, J.C., 1972. Kinetics of oxidation of aqueous sulfide by  $O_2$ . *Envir. Sci. Tech.*, 6:6, 529-537.
- Chen, K.Y., and Morris, J.C., 1972a. Oxidation of sulfide by  $O_2$ : catalysis and inhibition. *J. Sanit. Eng. Div., Proc. Am. Soc. Civil. Engin.*, pp. 215-227.
- Cline, J.D., and Richards, F.A., 1969. Oxygenation of hydrogen sulfide in seawater at constant salinity, temperature, and pH. *Envir. Sci. Tech.*, 3:9, 838-843.
- Cotton, F.A., and Wilkinson, G., 1966. *Advanced inorganic chemistry: a comprehensive text*. 2nd ed. Wiley-Interscience (New York).
- Davis, R.E., 1958. Displacement reactions at the sulfur atom. I. An interpretation of the decomposition of acidified thiosulfate. *J. Amer. Chem. Soc.*, 80, 3565-3569.
- Davis, R.E., 1964. Nucleophilic displacement reactions at the sulfur-sulfur bond. Survey of progress in chemistry, A.F. Scott, ed., Vol. 2, pp. 189-238. Academic Press (New York).
- Davis, R.E., 1968. Mechanisms of sulfur reactions. Chapter 4 in Nickless (1968), pp. 85-136.
- Ellis, A.J., and Golding, R.M., 1959. Spectrophotometric determination of the acid dissociation constants of hydrogen sulphide. *J. Chem. Soc.*, 25, 127-130.
- Fatora, D.A., 1976. Wash water recycling by catalytic oxidation of thiosulfates and sulfites. *J. Appl. Photogr. Engin.*, 2:4, 227-228.
- Freiberg, J., 1975. The mechanism of iron catalyzed oxidation of  $SO_2$  in oxygenated solutions. *Atmos. Envir.*, 9, 661-672.
- Fuller, E.C., and Crist, R.H., 1941. The rate of oxidation of sulfite ions by oxygen. *J. Amer. Chem. Soc.*, 63, 1644-1650.
- Giggenbach, W., 1972. Optical spectra and equilibrium distribution of polysulfide ions in aqueous

- solution at 20°C. *Inorg. Chem.*, *11:6*, 1201-1207.
- Haff, L.V., 1970. Oxygen-containing inorganic sulfur compounds. Chapter 4 in Karchmer (1970), pp. 183-199.
- Hayon, E., Treinin, A., and Wilf, J., 1972. Electronic spectra, photochemistry, and autooxidation mechanism in the sulfite-bisulfite-pyrosulfite systems. The  $SO_2^-$ ,  $SO_3^-$ ,  $SO_4^-$ , and  $SO_5^-$  radicals. *J. Amer. Chem. Soc.*, *94:1*, 47-57.
- Henderson, J.M., Ku, W.P.C., and Thoma, A.L., 1980. Material balance: Unit 15, The Geysers Power Plant. Report 411-80.12. Pacific Gas and Electric Company, Department of Engineering Research, San Ramon, CA. May 15, 1980.
- Henderson, J.M., and Dorigi, G.P., 1981. The low solids  $H_2S$  abatement technology Fe-HEDTA long-term test at The Geysers Power Plant Unit 9. Report 420-81.243. Pacific Gas and Electric Company, Department of Engineering Research, San Ramon, CA. October 1, 1981.
- Hoffmann, M.R., 1977. Kinetics and mechanism of oxidation of hydrogen sulfide by hydrogen peroxide in acidic solution. *Envir. Sci. Tech.*, *11:1*, 61-66.
- Hoffman, M.R., and Edwards, J.O., 1975. Kinetics of oxidation of sulfite by hydrogen peroxide in acidic solution. *J. Phys. Chem.*, *79:20*, 2096-2098.
- Hoffmann, M.R., and Lim, B.C., 1979. Kinetics and mechanism of oxidation of sulfide by oxygen: catalysis by homogeneous metal-phthalocyanine complexes. *Envir. Sci. Tech.*, *13:11*, 1406-1414.
- Janickis, J., 1969. Some aspects of the chemistry of polythionates and selenopolythionates. *Acc. Chem. Res.*, *2:10*, 316-320.
- Karchmer, J.H., (ed.), 1970. The analytical chemistry of sulfur and its compounds. Part I. Vol. 29 in *Chemical analysis: A series of monographs on analytical chemistry and its applications*. Wiley-Interscience (New York).
- Kelly, D.P., Chambers, L.A., and Trudinger, P.A., 1969. Cyanolysis and spectrophotometric estimation of trithionate in mixture with thiosulfate and tetrathionate. *Anal. Chem.*, *41:7*, 898-901.
- Koganovskii, A.M., and Taran, P.N., 1955. The oxidation of aqueous sulfite solutions by aeration. *Ukr. Khim. Zhur.*, *21:4*, 472-479. (In Russian.)
- Kurtenacker, A., 1924. Application of the aldehyde-bisulfite reaction in quantitative analysis. *Z. Anal. Chem.*, *64*, 56-61.
- LaMer, V.K., and Kenyon, A.S., 1947. Kinetics of the formation of monodispersed sulfur sols from thiosulfate and acid. *J. Colloid Sci.*, *2*, 257-264.
- Latimer, W.M., 1952. *The oxidation states of the elements and their potentials in aqueous solutions*. Prentice-Hall (New York).
- Levenson, G.I.P., 1960. The stability of concentrated ammonium thiosulfate solutions at high temperature. *Photog. Sci. Engin.*, *4:2*, 110-112.
- Levenson, G.I.P., and Rumens, M.G., 1965. The stability of concentrated thiosulphate solutions at

- high temperature. Part II. The loss of the sulphite. *J. Photog. Sci.*, *13*, 79-81.
- Litvinenko, V.A., 1966. Catalytic effect of titanium(IV) upon the oxidation of thiosulfate by hydrogen peroxide. *Ukr. Khim. Zhur.*, *32:12*, 1338-1342. (In Russian.)
- Litvinenko, V.A., 1969. Catalytic effect of zirconium(IV) upon the oxidation of thiosulfate by hydrogen peroxide. *Ukr. Khim. Zhur.*, *35:3*, 311-315. (In Russian.)
- Litvinenko, V.A., 1969a. Catalytic effect of niobium(V) upon the oxidation of thiosulfate by hydrogen peroxide. *Ukr. Khim. Zhur.*, *35:7*, 763-765. (In Russian.)
- Lyons, D., and Nickless, G., 1968. The lower oxy-acids of sulphur. Chapter 14 in Nickless (1968), pp. 509-534.
- Maas, T.A.M.M., Kuijer, M., and Zwart, J., 1976. Activation of cobalt-phthalocyanine catalyst by polymer attachment. *J.C.S. Chem. Comm.*, pp. 86-88.
- Mader, P.M., 1958. Kinetics of hydrogen peroxide - sulfite reaction in alkaline solution. *J. Amer. Chem. Soc.*, *80*, 2634-2639.
- Martell, A.E., 1982. Formation and stabilities of cobalt dioxygen complexes in aqueous solution. *Acc. Chem. Res.*, *15*, 155-162.
- Meyer, B., 1976. Elemental sulfur. *Chem. Reviews*, *76:3*, 367-388.
- Meyer, B., Ospina, M., and Peter, L.B., 1980. Raman spectrometric determination of oxysulfur anions in aqueous systems. *Anal. Chim. Acta*, *117*, 301-311.
- Mishra, G.C., and Srivastava, R.D., 1975. Kinetics of oxidation of ammonium sulfite by rapid-mixing method. *Chem. Engin. Sci.*, *30*, 1387-1390.
- Nickless, G. (ed.), 1968. *Inorganic sulphur chemistry*. Elsevier (Amsterdam).
- Nriagu, J.O., (ed.), 1978. *Sulfur in the environment (two volumes)*. Part I: The atmospheric cycle. Part II: Ecological impacts. John Wiley & Sons (New York).
- Nriagu, J.O., and Hem, J.D., 1978a. Chemistry of pollutant sulfur in natural waters. Chapter 6 in Part II of Nriagu (1978), pp. 211-270.
- O'Brien, D.J., and Birkner, F.B., 1977. Kinetics of oxygenation of reduced sulfur species in aqueous solution. *Envir. Sci. Tech.*, *11:12*, 1114-1120.
- Östlund, H.G., and Alexander, J., 1963. Oxidation rate of sulfide in sea water, a preliminary study. *J. Geophys. Res.*, *68:13*, 3995-3997.
- Payette, B., Long, M.E., and Payette, R., 1974. An engineering case study: hydrogen sulfide abatement at Pacific Gas and Electric's geothermal plant. College of Engineering, University of California, Berkeley. Written under the supervision of Prof. R.F. Steidel, Jr. No report number.
- Pearce, T.J.P., 1968. Sulphuric acid: physico-chemical aspects of manufacture. Chapter 15 in Nickless (1968), pp. 535-561.
- Postgate, J.R., 1968. The sulphur cycle. Chapter 8 in Nickless (1968), pp. 259-279.

- Rossini, F.D., Wagman, D.D., Evans, W.H., Levine, S., and Jaffe, I., 1952. Selected values of chemical thermodynamic properties: Circular of the National Bureau of Standards 500. U.S. Government Printing Office (Washington).
- Satterfield, C.N., Reid, R.C., and Briggs, D.R., 1954. Rate of oxidation of hydrogen sulfide by hydrogen peroxide. *J. Am. Chem. Soc.*, *76*, 3922-3.
- Sawicki, J.E., and Barron, C.H., 1973. On the kinetics of sulfite oxidation in heterogeneous systems. *Chem. Engin. J.*, *5*, 153-159.
- Schmidt, M., 1957. The acids of sulfur. I. Anhydrous thiosulfuric acid. *Z. anorg. u. allgem. Chem.*, *289*, 141-157. (In German.)
- Schmidt, M., 1957a. The acids of sulfur. II. A new class of sulfur acids. *Z. anorg. u. allgem. Chem.*, *289*, 158-174. (In German.)
- Schmidt, M., 1957b. The acids of sulfur. III. The anhydrous polythionic acids (sulfanedisulfonic acids)  $H_2S_3O_6$ ,  $H_2S_4O_6$ ,  $H_2S_5O_6$ ,  $H_2S_6O_6$ , and  $H_2S_7O_6$ ; preparation of solutions and salts of octathionic acid, decathionic acid, and dodecathionic acid. *Z. anorg. u. allgem. Chem.*, *289*, 175-192. (In German.)
- Schmidt, M., 1957c. The acids of sulfur. IV. The relationships between the chemical series  $H_2S_x$ ,  $H_2S_xO_3$ , and  $H_2S_xO_6$ . *Z. anorg. u. allgem. Chem.*, *289*, 193-202. (In German.)
- Schmidt, M., 1972. Fundamental chemistry of sulfur dioxide removal and subsequent recovery via aqueous scrubbing. *Int. J. Sulfur Chem. (B)*, *7:1*, 11-19.
- Schwarzenbach, G., and Fischer, A., 1960. The acidity of the sulfanes and the constitution of aqueous polysulfide solutions. *Helv. Chim. Acta*, *43:5*, 1365-1390. (In German.)
- Snavely, E.S., and Blount, F.E., 1969. Rates of reaction of dissolved oxygen with scavengers in sweet and sour brines. *Corrosion-N.A.C.E.*, *25:10*, 397-404.
- Sprung, J.L., 1977. Tropospheric oxidation of  $H_2S$ . *Adv. Envir. Sci. Tech.*, *7*, 263-278.
- Steijns, M., Derks, F., Verloop, A., and Mars, P., 1976. The mechanism of the catalytic oxidation of hydrogen sulfide: II. Kinetics and mechanism of hydrogen sulfide oxidation catalyzed by sulfur. *J. Catal.*, *42*, 87-95.
- Steijns, M., Koopman, P., Nieuwenhuijse, B., and Mars, P., 1976a. The mechanism of the catalytic oxidation of hydrogen sulfide: III. An electron spin resonance study of the sulfur catalyzed oxidation of hydrogen sulfide. *J. Catal.*, *42*, 96-106.
- Teder, A., 1971. The equilibrium between elementary sulfur and aqueous polysulfide solutions. *Acta Chem. Scand.*, *25*, 1722-1728.
- Valentine, J.S., 1973. The dioxygen ligand in mononuclear group VIII transition metal complexes. *Chem. Reviews*, *73:3*, 235-245.
- Urone, P., and Schroeder, W.H., 1978. Atmospheric chemistry of sulfur-containing pollutants. Chapter 8 in Nriagu (1978), Part I, pp. 297-324.
- Wagman, D.D., Evans, W.H., Parker, V.B., Halow, I., Bailey, S.M., and Schumm, R.H., 1968. NBS Technical Note 270-3: Selected values of chemical thermodynamic properties:



tables for the first thirty-four elements in the standard order of arrangement. U.S. Government Printing Office (Washington).

- Wassermann, A., 1933. Kinetics and inhibition of the iron-catalyzed hydrogen peroxide - hydrogen sulfide reaction. *Ann. Chem. Liebigs*, 503:2/3, 249-268. (In German.)
- Weres, O., 1980. An evaluation of the present and potential environmental impacts of the development of various types of geothermal resources. Pp. 73-94 in *Study of nuclear and alternative energy systems: Supporting paper 8: Energy and the fate of ecosystems*. National Academy Press, Washington, D.C.
- Weres, O., 1983. The partitioning of hydrogen sulfide in the condenser of Geysers Unit 15. *Geothermics* (in press).
- Weres, O., 1983a. Evaluation of surface condensers for geothermal powerplants by numerical modeling. (In preparation.)
- Weres, O., 1983b. Evaluation of contact and contact/surface hybrid condensers for geothermal powerplants. (In preparation.)
- Weres, O., 1983c. Documentation for program CNDSTR. Document LBID-622. Lawrence Berkeley Laboratory, Berkeley, CA. (In preparation.)
- Weres, O., 1983d. Environmental protection and the chemistry of geothermal fluids. A chapter in: *Geothermal energy technology*, J. Bresee and P.A. Witherspoon, eds. To be published by Marcel Dekker Inc., New York.
- Weres, O., Tsao, K., and Wood, B., 1977. Resource, technology and environment at The Geysers. Report LBL-5231. Lawrence Berkeley Laboratory, Berkeley, CA. About 350 pp. Available from the National Technical Information Service.
- Weres, O., and Tsao, L., 1983. Nickel catalyzed reaction of hydrogen sulfide with oxygen in the presence of sulfite. (In preparation.)
- West, P.W., and Gaeke, G.C., 1956. Fixation of sulfur dioxide as disulfidomercurate(II) and subsequent colorimetric estimation. *Anal. Chem.*, 28:12, 1816-1819.
- Wilshire, J., and Sawyer, D.T., 1979. Redox chemistry of dioxygen species. *Acc. Chem. Res.*, 12, 105-110.
- Yagi, S., and Inoue, H., 1962. The absorption of oxygen into sodium sulphite solution. *Chem. Engin. Sci.*, 17, 411-421.
- Yancey, M.A., 1981. Test of the Fe-HEDTA/vent gas incinerator  $H_2S$  abatement process: September 29, 1981 - October 5, 1981, Unit 1, The Geysers Power Plant. Report 420-81.293. Pacific Gas and Electric Company, Department of Engineering Research, San Ramon, CA. October 23, 1981.
- Yanitskii, I.V., and Valachunas, I.N., 1954. Studies of polythionic acids. IV. Sulfuration of hexathionic acid. *Zh. Obshch. Khim.*, 24, 790-795. (In Russian.)
- Yanitskii, I.V., Zelionkaite, V.I., and Yanitskis, V.I., 1971. Isolation of intermediate products of the acid decomposition of thiosulfate. *Zh. Neorg. Khim.*, 16:3, 617-621.