

# UC San Diego

## Postprints from ISIC

### Title

From Art to Science in Manufacturing: The Evolution of Technological Knowledge

### Permalink

<https://escholarship.org/uc/item/6z6703z5>

### Journal

Foundations and Trends in Technology, Information, and Operations Management, 1(2)

### ISSN

1571-9545

### Author

Bohn, Roger E.

### Publication Date

2005

### DOI

10.1561/02000000002

Peer reviewed

# From Art to Science in Manufacturing: The Evolution of Technological Knowledge

**Roger E. Bohn**

*University of California San Diego  
CA, USA*

*Rbohn@ucsd.edu*

## **Abstract**

Making goods evolved over several centuries from craft production to complex and highly automated manufacturing processes. A companion paper by R. Jaikumar documents the transformation of firearms manufacture through six distinct epochs, each accompanied by radical changes in the nature of work. These shifts were enabled by corresponding changes in technological knowledge. This paper models knowledge about manufacturing methods as a directed graph of cause-effect relationships. Increasing knowledge corresponds to more numerous variables (nodes) and relationships (arcs). The more dense the graph, the more variables can be monitored and controlled, with greater precision. This enables higher production speeds, tighter tolerances, and higher quality.

Changes in knowledge from epoch to epoch tend to follow consistent patterns. More is learned about key classes of phenomena, including measurement methods, feedback control methods, and disturbances. As knowledge increases, control becomes more formal, and operator discretion is reduced or shifted to other types of activity. Increasing knowledge and control are two dimensions of a shift from art towards science.

Evolution from art to science is not monotonic. The knowledge graphs of new processes are riddled with holes; dozens of new variables must be identified, understood, and controlled. Frederick Taylor

pioneered three key methods of developing causal knowledge in such situations: reductionism, using systems of quantitative equations to express knowledge, and learning by systematic experimentation.

Using causal networks to formally model knowledge appears to also fit other kinds of technology. But even as vital aspects of manufacturing verge on “full science,” other technological activities will remain nearer to art, as for them complete knowledge is unapproachable.

# 1

---

## Introduction

---

Since the first Industrial Revolution, technology has steadily transformed living standards and daily life. The aggregate effects of new technology – rising productivity and improving product performance – are visible effects of from new knowledge of “how to do things.” But what is the nature of this knowledge, and how does it evolve over time? This paper investigates long-term technological change and the evolution of enabling knowledge through the lens of a single industry over more than 200 years.

Changes in technological knowledge are usually observed indirectly, as changes in methods or performance. Performance that improves by more than can be explained by measured inputs is taken as evidence of changes in the stock of knowledge. Implicitly this assumes a causal chain approximately as follows: learning activities create new knowledge that allows the firm to implement superior designs and methods that improve local physical performance such as machine speed and material consumption, which ultimately causes better high level performance (Figure 1.1). But generally, the middle variables in this chain are not observed directly.

Our focus is on the intermediate steps of this chain – new knowledge, superior methods, and improved performance at workstations –

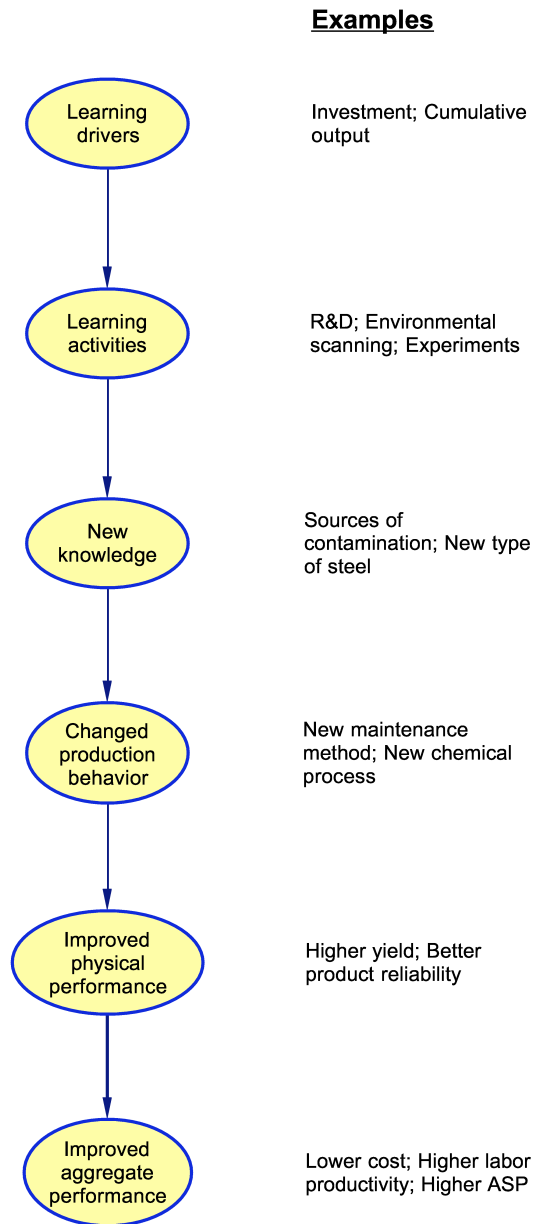

Fig. 1.1 Knowledge as an unobserved intermediate variable in technological change

that cause improved aggregate performance. Changes in production methods are explored in the companion paper, *From Filing and Fitting to Flexible Manufacturing: The Evolution of Process Control* by R. Jaikumar [15]. Here we explicitly examine the new knowledge that made possible these changes.

Our case study centers on the manufacturing methods of a single company over 500 years. The company, Beretta, has remained in family hands and has made firearms since its founding in 1492, when firearms were manufactured as a small-scale craft with only hand tools. Jaikumar identified six distinct epochs of manufacturing, characterized by different conceptions of work, different key problems, and different organizations (Table 1.1).

Each epoch constituted an intellectual watershed in how manufacturing and its key activities were viewed. Each required introducing a new system of manufacture. Machines, the nature of work, and factory organization all had to change in concert. Within Beretta, each of these epochal shifts took about ten years to assimilate.

A longitudinal study of a single industry is an excellent test-bed to examine technological change over a long period. In Jaikumar's study, the fundamental product concept changed little from the 16th to the late 20th century: a chemical explosion propels a small metal object through a hollow metal cylinder at high speed. With such product stability, changes in manufacturing stand out even more.

The central problem in manufacturing over the entire period was to increase process control, for once society moved beyond making unique items by hand predictability, consistency, and speed were achieved by progressively tightening control. Each new epoch revolved around solving a new process control challenge, generally reducing a novel class of variation. To accomplish this required major, often unexpected, shifts in many aspects of manufacturing (Table 1.2). The nature and organization of work changed, use and sophistication of machines increased, and, most important for our purposes, manufacturing control shifted, all requiring changes in knowledge.

We will describe shifts in technology using the metaphor of transformation *from art to science*. Jaikumar observed that "The holy grail of a manufacturing science begun in the early 1800s and carried

| Epoch  | Approx date |
|--|-------------|
| 0) The <b>Craft System</b> (circa 1500)  | 1500        |
| 1) The invention of machine tools and the <b>English System</b> of Manufacture                                     | 1800        |
| 2) Special purpose machine tools and interchangeability of components in the <b>American System</b> of Manufacture | 1830        |
| 3) Scientific Management and the engineering of work in the <b>Taylor System</b>                                   | 1900        |
| 4) <b>Statistical process control</b> (SPC) in an increasingly dynamic manufacturing environment                   | 1950        |
| 5) Information processing and the era of <b>Numerical Control</b> (NC)   | 1965        |
| 6) Flexible manufacturing and <b>Computer-Integrated Manufacturing</b> (CIM/FMS)                                   | 1985        |

Table 1.1 Manufacturing epochs [15]

on with religious fervor by Taylor in early 1900s is, with the dawning of the twenty-first century, finally within grasp.”<sup>1</sup> But precisely what does this mean? Is such evolution inevitable? Is it universal, or limited to manufacturing?

As late as the early 18th century, making firearms still relied entirely workers’ expertise. Documented or standardized methods were non-existent.

Production involved the master, the model, and a set of calipers. If there were drawings, they indicated only rough proportions and functions of components. Masters and millwrights, being keenly aware of the function of the product, oriented their work towards proper fit and intended functionality. Fit among components was important, and the master was the arbiter of fit. Apprentices learned from masters the craft of using tools. Control was a developed skill situated in the eyes and hands of the millwright.

Inasmuch as adaptive skills are really contingent responses to a wide variety of work conditions, procedures cannot readily

---

<sup>1</sup> Unattributed quotations are from [15].

|                               | English System                                   | American System                        | Taylor System                             | Statistical Process Control        | Numerical Control (NC)      | Computer Integrated Manufacturing |
|-------------------------------|--|--|---|------------------------------------|-----------------------------|-----------------------------------|
| Introduced at Beretta (world) | 1810 (1800)                                      | 1860 (1830)                            | 1928 (1900)                               | 1950 (1930)                        | 1976 (1960)                 | 1987                              |
| <b>Size Trends</b>            |  |  |   |                                    |                             |                                   |
| # of People (Min. Scale)      | 40   | 150                                    | 300                                       | 300                                | 100                         | 30                                |
| Number of Machines            | 3  | 50                                     | 150                                       | 150                                | 50                          | 30                                |
| Productivity Increase*        | 4:1  | 3:1                                    | 3:1                                       | 3:2                                | 3:1                         | 3:1                               |
| Number of Products            | Infinite   | 3                                      | 10  | 15                                 | 100                         | Infinite                          |
| Standards for Work            | Absolute product                                 | Relative product                       | Work standards                            | Process standards                  | Functional standards        | Technology standards              |
| Work Ethos                    | "Perfection"                                     | "Satisfice"                            | "Reproduce"                               | "Monitor"                          | "Control"                   | "Develop"                         |
| Worker Skills Required        | Mechanical craft                                 | Repetitive                             | Repetitive                                | Diagnostic                         | Experimental                | Learn/generalize/abstract         |
| Control of Work               | Inspection of work                               | Tight supervision of work              | Loose of work/tight of contingencies      | Loose supervision of contingencies | No supervision of work      | No supervision of work            |
| Organizational Change         | Break-up of guilds                               | Staff/line separation                  | Functional specialization                 | Problem-solving teams              | Cellular control            | Product/Process/Program           |
| Staff/Line Ratio              | 0:40   | 20:130                                 | 60:240                                    | 100:200                            | 50:50                       | 20:10                             |
| Line Workers per Machine      | 15   | 3                                      | 1.6                                       | 1.3                                | 1                           | 0.3                               |
| Process Focus                 | Accuracy   | Precision: Repeatability (of machines) | Precision: Reproducibility (of processes) | Precision: Stability (over time)   | Adaptability                | Versatility                       |
| Focus of Control              | Product functionality                            | Product conformance                    | Process conformance                       | Process capability                 | Product/process integration | Process intelligence              |
| Instrument of Control         | Micrometer                                       | Go/No-Go gauges                        | Stop watch                                | Control chart                      | Electronic gauges           | Professional workstations         |
| Rework**                      | .8   | .5                                     | .25                                       | .08                                | .02                         | .005                              |
|                               | *Over previous epoch **As fraction of total work |  |   |                                    |                             |                                   |

Table 1.2 Summary of epochal changes [15]



be transferred. Critical knowledge was mainly tacit, and a journeyman had to learn by observing the master's idiosyncratic behaviors. The master, who could solve the most difficult of problems, fashioned each product such that quality was inherent in its fit, finish, and functionality. [15, Section 2]

This description corresponds to technology as an art. Learning was by apprenticeship; quality was achieved by rework; progress occurred slowly by trial and error; techniques and knowledge were idiosyncratic.

In contrast, in the most advanced flexible manufacturing systems of the late 20th century people are normally absent from the production area, and machines execute complex contingent procedures under computer control. Operators manipulate symbols on workstations, and use scientific methods of observation, experimentation, and data analysis. Alternative production methods can be precisely described, tested, and embodied in software. Methods and general knowledge can be transferred to other locations, machines, and products with little effort and no face-to-face communication. This is manufacturing as a science. Manufacturing changed profoundly over the two century transition from art to science, with performance improvements on some dimensions of two orders of magnitude or more (Figure 1.2).

Transitions from art toward science can be seen in many technologies. Early aviation, literally a "seat of the pants" technology early in its development, today includes the Global Hawk aircraft, which can take off, cross the Pacific, and land without human intervention. In contrast, although product development technology has progressed tremendously, it still has remains in many ways more like art than a science.

Although we are concerned here with a relatively small industry that has not been leading edge since the mid-19th century, the evolution of knowledge and the transition from art to science are still critical in all high-tech industries, and influence many contemporary issues such as offshoring, automation, and outsourcing. These activities require transfers of knowledge and information across organizational and firm boundaries. We will see that the difficulty of such transfers depends on the detailed structure of knowledge. [18]

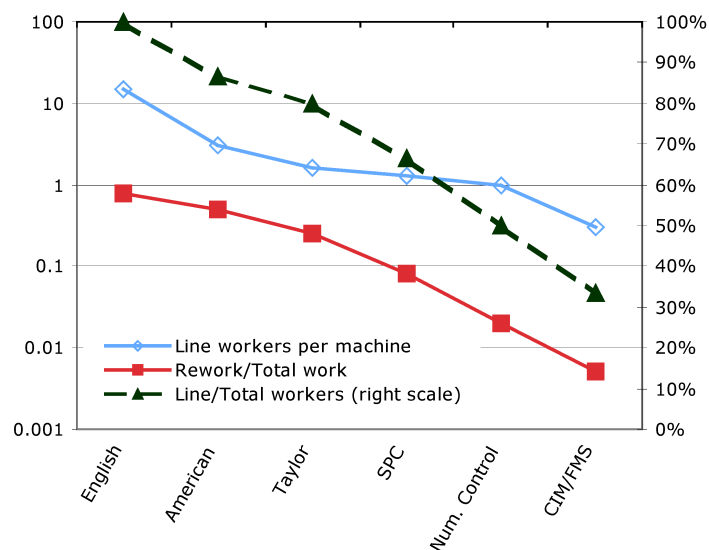

Fig. 1.2 Changing performance over six epochs [15]

In Section 1.1 we consider different ways of classifying technology along a spectrum from art to science. Section 1.2 presents a formal model of technological knowledge that supports precise descriptions of changes in knowledge when learning occurs. Prior research is presented in Section 1.3. The case study evidence is presented in Section 2 and Section 3.

In Section 2 we examine the first three epochs of manufacturing (approximately the 19th century), during which workers' discretion and insight were progressively reduced, culminating in Taylor's extreme division of labor and separation of intellectual work from line operations. We will see that the de-skilling of workers in the Taylor System rested on an unprecedented level of technological knowledge, developed by Taylor himself using several seminal concepts.

In Section 3 we examine the development of knowledge over the last three epochs, in which workers increasingly became problem solvers and knowledge creators, effectively reversing Taylor's de-skilling paradigm. We also examine the integration of formal science with practical engineering. Finally, we consider what happens when novel and immature physical processes are substituted for mature ones. Even

when the core physical process is entirely changed, considerable knowledge from old processes is still relevant.

In the concluding section we examine broad patterns of change in manufacturing over the centuries.

### 1.1. Art and Science in Technology

The metaphor of art and science in human endeavor is long established and widely used. Military treatises speak of the “art and science of war” as in a 1745 book that provides “a short introduction to the art of fortification, containing draughts and explanations of the principal works in military architecture, and the machines and utensils necessary either in attacks or defenses: also a military dictionary ... explaining all the technical terms in the science of war” [3]. Sometimes a clear distinction is made between “art” and “science,” as in the title of an American book on surveying circa 1802: *Art without science, or, The art of surveying: unshackled with the terms and science of mathematics, designed for farmers’ boys* [33]. The two are not as clearly differentiated in a 1671 title, *An introduction to the art of logick: composed for ... [those who do not speak Latin but] desire to be instructed in this liberal science* [28].

In modern usage art and science are generally viewed as the extremes of a spectrum. “Art” conveys the sense of a master craftsman using informal and tacit knowledge, “science” that of an engineer who uses mathematical equations to program computerized machines. Furthermore, the outcome from a craftsman is not as predictable or consistent as that from an engineer. The sense (whether legitimate or not) is that amateurs and low-volume production are at the artistic end, professionals and high-volume production at the scientific end (e.g., a home cook versus a packaged goods bakery). Most technical and managerial activities are perceived to require a mix, and progress in understanding a field to correspond to a gradual shift from “mostly art” to “mostly science.”

The range of methods in human endeavor can be examined along many dimensions. Particularly useful for characterizing technology are how work is done, quality of the results that are achieved, and how

well the technology is understood (Table 1.3). Any of these dimensions could be used to specify some measure of “art or science” and we might expect that all move toward “science” as a given technology advances.

The activity dimension describes how actions are carried out, whether according to rigid procedures or idiosyncratically. Procedure refers to specifying activities in advance and reducing them to complete and explicit rules that must be followed exactly. [16] We observe this in a lights-out factory, in which every intentional action results from explicitly stated computer instructions executed properly by microprocessors. Human discretion characterized the pre-manufacturing world of expert craftsmen who used rudimentary hand tools, informal judgment, and individualized methods without formal guidelines. But it is simplistic to equate degree of procedure with the extent of automation, which would imply that activities done by machines are fully rigid and those performed by people cannot be. Much of the emphasis during the Taylor epoch was on applying rigid procedure (“one best way”) to people, and in many factories today this continues to be the goal.

We can also characterize art-versus-science by the nature of the *knowledge* about a given technology. If nothing is known production is impossible; if everything is fully understood, we can call it completely science-based. We will analyze how knowledge moves from one extreme towards the other, through intermediate gradations. Among the criteria used to describe knowledge qualitatively the most common is probably the degree of explicitness – whether knowledge is tacit or codified. Polanyi pointed out that much knowledge cannot be written down, even when it is critically needed in order for a technological system to function properly.<sup>2</sup> [30]

Codified knowledge refers to knowledge that is transmittable in formal, symbolic language, whereas tacit knowledge is hard to articulate and is acquired through experience ... Tacit and codified knowledge exist along a spectrum, not as mutually exclusive categories ... For some knowledge, especially [sic] in medical practice,

---

<sup>2</sup> The literature on this topic is vast; Balconi’s analysis of tacit knowledge in modern manufacturing is similar in spirit to that in this paper [5].

|   | <b>Embryonic technology:<br/>“Art”</b>                          | <b>Ideal technology:<br/>“Science”</b> |
|---|---|--|
| <b>How <i>activities</i> are executed</b>   | Zero procedure; idiosyncratic                                   | Fully specified procedure              |
| <b>What <i>results</i> are achieved</b>     | Each one different, mostly poor                                 | Consistent and excellent               |
| <b>Characteristics of <i>knowledge</i>:</b> |   |  |
| <b>How knowledge specified</b>              | Tacit   | Codified                               |
| <b>What knowledge about</b>                 | Purely know-how   | Also know-why                          |
| <b>Extent of knowledge</b>                  | Minimal; can distinguish good from bad results, but little more | Complete                               |

Table 1.3 Dimensions of production technology on an art-science spectrum

the difference between tacit and codified is temporal: much codified knowledge in medicine today was tacit in the past. [14]

Knowledge that tells *what* to do but does not explain *why* things happen is also incomplete. For example, it is inadequate to debug problems.<sup>3</sup> Finally, we can examine the quality of the *results* achieved by a process. A perfect technology should always deliver perfect results, especially in conformance quality. At the other extreme, pure art would never produce the same thing twice, and much of what is produced is expected to be unusable.<sup>4</sup>

Movement along the dimensions of action, knowledge, and results (Table 1.3) tends to occur in concert, in part because the extent of available knowledge constrains procedures. For example, all desired actions to be performed by a numerically controlled (NC) machine tool must be specified in detail in computer programs, which are highly

<sup>3</sup> Know-how and know-why are often referred to as *procedural knowledge* and *causal knowledge*. See the discussion of [23] later. An additional category is *declarative knowledge*.

<sup>4</sup> Many other ways of classifying knowledge are used. For example, the distinction between collective and individual knowledge is important for designing knowledge management systems. [2]

formal procedures. Writing effective programs requires that knowledge be extensive and explicit. When these conditions are not met, procedures can still be specified but will not work well.

Each step of a process can be summarized by two measures, the amount known about it and the degree of procedure used to execute it (Figure 1.3). If these are consistent, points plotted on a graph will be near the diagonal, and over time a process step will normally move up and to the right. If knowledge is inadequate for the degree of procedure used, the plotted point will be above the diagonal and the step will not operate well. Conversely, if a process is below the diagonal, it could have been done in a more formal way, presumably reducing cost and improving consistency.

The increasingly formal execution of manufacturing from epoch to epoch is detailed in [15], corresponding to upward movement in Figure 1.3. Implicitly this requires greater knowledge. We address this next.

## 1.2. A Model of Technological Knowledge

New methods, if they are to be superior to their predecessors, must be based on new knowledge (Figure 1.1). To understand how technological knowledge changes and grows over time requires a disaggregated model, detailed enough to compare two knowledge states. Notwithstanding the substantial body of research on innovation and technology, specific knowledge is little analyzed in the technology management literature.

Recent studies of engineers, scientists and technicians have brought to light the social and political aspects of work ... [but] as a whole they overemphasize the importance of political actions and social networks and underestimate the importance of formal, often technical, knowledge in the carrying out of tasks. Formal knowledge looms in the background in nearly every study of technical workers. [4]

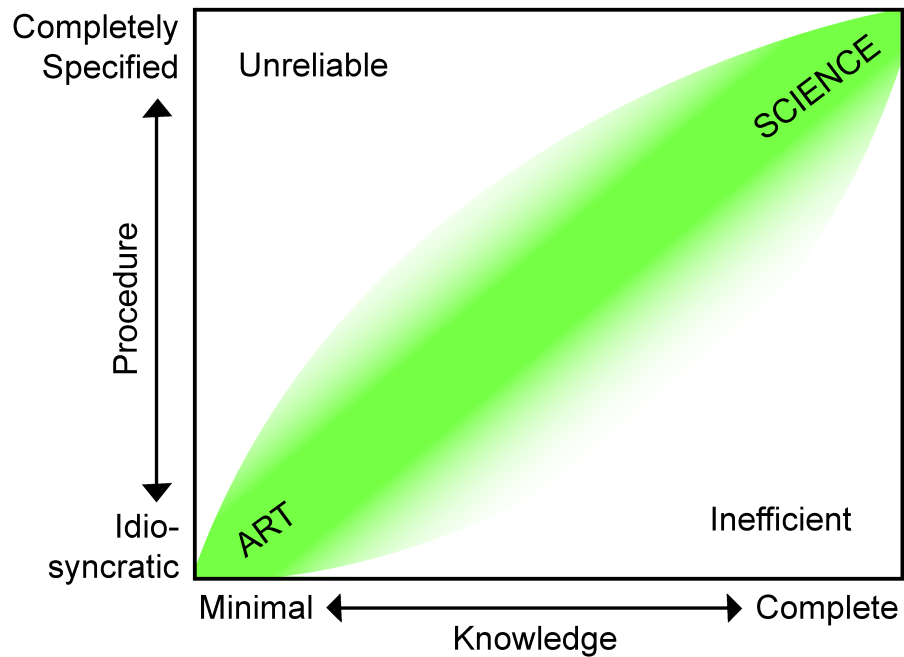

Fig. 1.3 Level of knowledge versus degree of procedure (adapted from [11])

To do our analysis we therefore develop and exploit a model of technological knowledge. It starts with the following observation:<sup>5</sup>

The core of technological knowledge is knowledge about causality in human-engineered systems.

Designing, building, or operating a technological system, whether a firearm or a factory, requires an understanding of the causal relationships among actions, events, and outcomes. Only with such knowledge can desired outcomes be achieved, and undesirable ones debugged.

Causality can be modeled formally using causal networks, directed graphs whose nodes are variables. Directed arcs between the nodes

<sup>5</sup> This theory of technological knowledge was developed jointly with R. Jaikumar. Previous work includes [9].

show causal relationships.<sup>6</sup> [29] Variables can be physical properties of an object, logical values, or information. Useful variables for a metal part, for example, might include its composition, shape, mass, hardness, and perhaps color. For a machine tool, they include control settings such as speed and feed, actual behavior such as cutting depth and vibration, and many elements of its design. These variables are linked in a dense network of causal relationships, and the state of knowledge at any moment can be summarized by depicting the causal network as it was understood (implicitly or explicitly) at that time. This known causal network expands as technological knowledge develops.

Relationships among variables can also be described by mathematical functions, in particular by systems of nonparametric simultaneous equations. Any such system can be summarized by a causal network. The simplest relationship is two variables A and B that cause a third variable C,  $C = f(A, B)$ . (Left side of Figure 1.4.) The properties and arguments of the function  $f$  are known only to a limited extent. Better knowledge about the technology corresponds to better understanding of the causal network's topology and of the specifics of the function  $f$ .

Genealogical terminology is used to express causal relationships. A *parent* causes a *child* if there is a direct link from parent to child. Parents often have many children, and children usually have many parents. *Descendants* are all nodes that can be reached by forward chaining from a variable and, equivalently, whose values may be affected by it. *Ancestors* include parents, grandparents, and so forth: any variable of which the child is a descendant. In Figure 1.4, E and F are both descendants of A, B, C, and D; E is a child only of D and F is a child of both B and D. Cycles are possible; one variable can be both ancestor and descendant of another. Such relationships create feedback, such as would occur if there were a directed link from E to A. A *causal path* from X to Y is a directional sequence of ancestors of Y, each variable having the previous one as its only parent in the chain.  $A \Rightarrow$

---

<sup>6</sup> Pearl's formal definition is "A causal structure of a set of variables  $V$  is a directed acyclic graph (DAG) in which each node corresponds to a distinct element of  $V$ , and each link represents direct functional relationship among the corresponding variables." (page 43) Note that this definition specifies *Acyclic* Graphs, which cannot have feedback. But feedback loops are central to process control and are central to any theory of modern technological knowledge. Therefore, we will allow cyclic graphs.



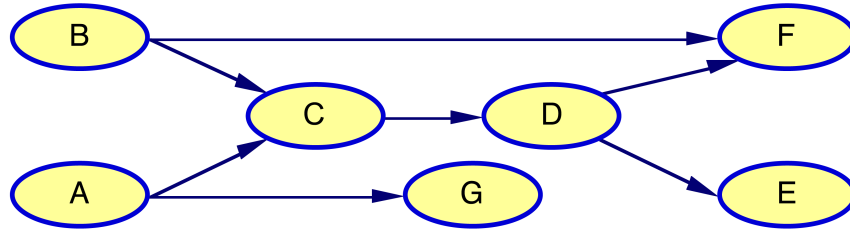

Fig. 1.4 Simple causal network

$C \Rightarrow D \Rightarrow F$  is a causal chain from A to F;  $B \Rightarrow F$  is also a chain. *Cousins* are variables with at least one common ancestor, but no causal path from one to another (such as D and G). Cousins are statistically correlated, but no causal relationship exists among them.

One value of causal networks is that they quickly identify how a variable can be altered; all and only its ancestors can affect it. Because of this property, any unexplained change in a variable reveals the existence of previously unknown parents. Causal networks also facilitate various kinds of counter-factual reasoning (difficult or impossible with standard statistical models), such as predicting how a system will behave under novel operating rules. [29] They thus not only represent knowledge abstractly, but also constitute useful knowledge in themselves.

It is often useful to select a small number of important variables that summarize the important results of a system. These are referred to as *outcome* variables for that system. In manufacturing, typical outcome variables are production rates, costs, and properties of the final product. These variables are chosen based on criteria from outside the system: *the ultimate goals of a causal system are selected exogenously*. Typical goals of a production system might include cost minimization, high conformance quality, and high output.

Causal networks reveal how the outcomes are determined by their ancestors. Each ancestor, in turn, has its own network of ancestors. The important input variables for one process include the outcome variables for upstream processes and suppliers, including the properties

of machines or materials passed from one to the other. In this way, causal paths can be traced back through industrial supply chains.

Causal networks for production processes are extremely complex, but not all variables are equally important. The status and behavior of a process or sub-process can generally be summarized by a few important intermediate variables. Good intermediate variables are often “choke points” in the causal network – many ancestral variables determine their levels, and they in turn exert multiple effects. They can include machine control settings, process behavior, and physical properties of products. Simply learning the identities of key variables is useful, and often requires considerable effort.

As Jaikumar showed, fabricating accurate parts by machining was a key activity throughout the history of firearms manufacture. Figure 1.5 shows a highly simplified causal network for machining. The most important variable, metal removal, is at the center. The shape and location of the metal removed from a workpiece are functions of the motion of the cutting tool relative to the workpiece surface, the cutting tool characteristics, and the composition and orientation of the workpiece before cutting begins. Behavior of the cutting tool is determined by the various processes that created or affect it, e.g. those related to the machine power train and to tool maintenance. A variety of machine adjustments enable workers to influence results, for example by changing the cutting depth. Almost without exception, adjustments are based on some form of feedback control. For example, in the pre-numerical control epochs an experienced machinist used sound, the shapes of chips from the workpiece, and other indicators to determine whether and how to adjust cutting. Higher order feedback loops (not shown in the figure) are used to diagnose systemic problems, and many small feedback loops embedded in subsystems’ control variables such as motor speed.

The causal network in Figure 1.5 emphasizes desired process variables and relationships. But what makes manufacturing especially challenging are undesired disturbances. An operator can set the *intended* behavior of a machine, but not the actual behavior. Disturbances arise both from outside the system, such as defective raw materials, and as side effects such as vibration and contamination. We will see that no

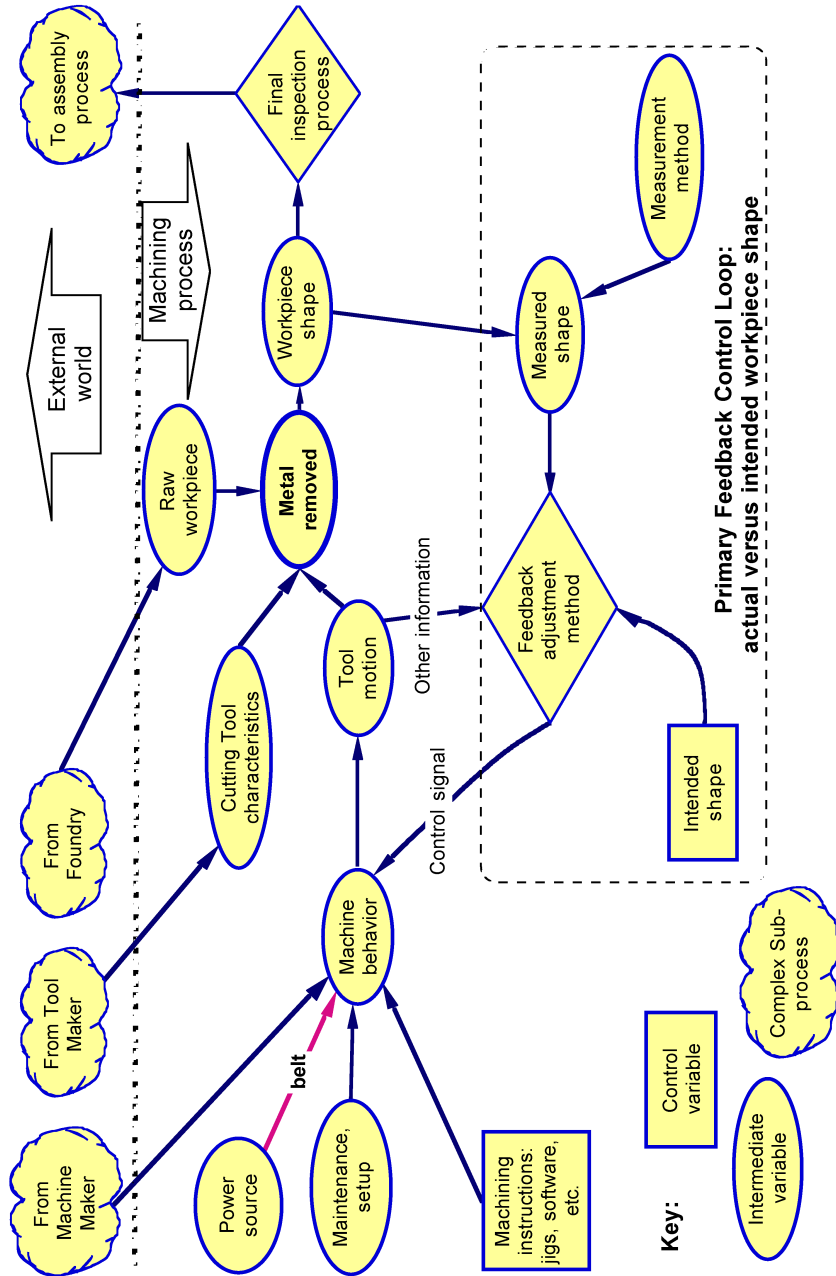

Fig. 1.5 Stylized causal knowledge graph for machining

complex process can be completely understood, much less measured in real time, so detecting disturbances, uncovering their sources, and devising counter-measures are never-ending stories. The causal knowledge graph includes whatever is known about disturbances and their effects.

This paper limits the domain of inquiry to “hard engineering.” We will analyze only knowledge about *human-designed systems intended to accomplish tangible physical tasks*. This excludes analysis of, among other things, worker motivation, strategic goal-setting, and political interactions among people and organizations. The virtue of limiting the domain so sharply is that objective truth exists, even if it can never be fully known.

*Axiom: The true causal network exists, is complete, and is deterministic.*

Pearl stated this as follows:

We view the task of causal modeling as an induction game that scientists play against Nature. Nature possesses stable causal mechanisms that, on a detailed level of description, are deterministic functional relationships between variables, some of which are unobservable. [29, p 43]

Applying this specifically to machining:

The following statement is the basis of the Deterministic Theory: “Automatic machine tools obey cause and effect relationships that are within our ability to understand and control and there is nothing random or probabilistic about their behavior” (Dr. John Loxham). Typically, the term random implies that the causes of the errors are not understood and cannot be eradicated ... The reality is that these errors are apparently nonrepeatable errors that the design engineers have decided to quantify statistically rather than completely understand. [20]

The evolution from art toward science occurs through identifying, in ever greater detail and breadth, “Nature’s stable causal mechanisms.”

In the following sections we analyze the knowledge about them that emerged in each epoch.

There is an important distinction between the *true causal network* and what is believed at a particular time in a specific organization. The true causal network exists and is deterministic, but it is never fully known. The belief network, in contrast, is never perfect or complete. For example, metal removal by a cutting tool can be described by a system of algebraic equations first crudely set down only circa 1900. Yet the relationships summarized by such equations were always active. For clarity, the known version of the true causal network will be referred to as the causal *knowledge graph*. This also sidesteps the problem that the organizational learning literature uses the term “knowledge network” to mean something entirely different.

### 1.2.1. Stages of Knowledge

The causal knowledge graph gives the overall structure of knowledge about a technology. The structure of the graph is only a partial description of what is known. The degree of knowledge about specific variables and relationships (nodes and arcs in the graph) shifts qualitatively as more is learned, passing through a series of stages. We use an extension of the framework from [16] and [9].

Knowledge about individual variables can be classified into six stages (Table 1.4). Initially, many of the variables in a process are not even recognized (Stage 0). Other variables in the same process might be almost completely understood and controlled. In between, knowledge about a variable has several possible degrees.

Similarly, two variables might be recognized as somehow related (for example they may be statistically correlated), but the nature of their relationship not known. With effort, more might become known about how one variable causes the other (Table 1.5).

Each node and each arc in a causal graph has its own stage of knowledge. Some combinations of stages, however, are impossible. For example, a variable cannot be adjustable unless at least one of its parents is adjustable and the magnitude of the relationship between them is known.

| Stage | Name                 | Description  | Comment   |
|-------|----------------------|--|---|
| 0     | Unknown              | Complete ignorance: the existence of X is not known  | Effects of X perceived as pure noise  |
| 1     | Recognized           | The existence of X is known, but magnitude is only known qualitatively. Even ordinal measure may not exist.  | X is an exogenous disturbance   |
| 2     | Measurable           | X can be measured on a cardinal scale, through a repeatable measurement process                              |   |
| 3     | Adjustable           | The mean level of X can be altered at will but the actual level has high variation                           | X is endogenous to the process  |
| 4     | Capable              | Control of the variance: Enough is known to reduce the variance of X to a fraction of its uncontrolled level | X can be used as a control or outcome variable for the process              |
| 5     | Perfectly Understood | Complete knowledge: X can be held at a target level under all conditions.                                    | Stage 5 knowledge is unreachable; it can only be approached asymptotically. |

Table 1.4 Stages of knowledge about control of an individual variable

### 1.3. Other views of technological knowledge

The most thorough analysis of specific technological knowledge is Vincenti's work on aeronautics. [41] *What Engineers Know and How They Know It* contains five detailed case studies of how specific aeronautical problems were solved, including the design of airfoils, design of propellers, and design and production of flush riveting. The cases cover the development of theoretical design tools, a series of empirical experiments to reveal the effects of design choices in the absence of adequate theory, and the case of riveting, in which dimensional tolerances and design of tools played key roles.

Vincenti classifies the knowledge developed by engineers in the case studies into six categories:

| Stage | Name             | Description  |
|-------|------------------|--|
| 0     | Ignorance        | No awareness that X and Y might be related. The true effects X on Y are perceived as a random disturbance                    |
| 1     | Correlation      | Aware X and Y are related but not nature of causality (ancestor, descendant, or cousin)                                      |
| 2     | Direction        | Direction of causality known (X a cause of Y, not a descendant or cousin)  |
| 3     | Magnitude        | Know the partial derivative of Y with respect to X (or shape of the partial function, for highly nonlinear relationships)    |
| 4     | Scientific model | Scientific model: Have a scientifically based theory giving functional form and coefficients of relationship between X and Y |
| 5     | Complete         | Complete knowledge. Stage 5 knowledge is unreachable; it can only be approached asymptotically                               |

Table 1.5 Stages of knowledge about the relationship between two variables (True relationship: X an ancestor of Y)

- **Fundamental design concepts:** The operational principles and normal configuration of working devices.
- **Criteria and specifications:** Specific criteria and quantitative targets for key intermediate variables. Examples include load per rivet, dimensional tolerances, and “stick force per g of gravity.”
- **Quantitative data:** Usually from experiments, and represented by tables or graphs.
- **Practical considerations:** Knowledge about issues that have little formal role, but nonetheless influence how something should be designed (e.g., the capabilities of specific machines).
- **Theoretical tools:** A broad category that includes intellectual concepts such as feedback, mathematical tools such as Fourier transforms, and theories based on scientific principles such as heat transfer.

- **Design instrumentalities:** Knowledge about how to design, such as structured design procedures, ways of thinking, and judgmental skills.<sup>7</sup>

Although he does not use the metaphor of art versus science, Vincenti is conscious of the progression of design knowledge and procedures from crude to exact, or as he puts it, from “infancy to maturity.” For example, he summarizes the development of airfoils as follows.

Finally we can observe – somewhat roughly – a progression of development in airfoil technology, which I take to comprise both explicit knowledge and methods for design. The first decades of the century saw the technology in what can be called its infancy. No realistically useful theory existed, and empirical knowledge was meager and uncodified. Design was almost exclusively by simple cut-and-try; that is, by sketching an airfoil and trying it out. No other way was possible. Today, airfoil technology has reached maturity. Using relatively complete (though not yet finished) theories, supported by sophisticated experimental techniques and accurate semitheoretical correlations of data, engineers design airfoils to specific requirements with a minimum of uncertainty. Little cut-and-try is needed by a skilled professional. Between the phases of infancy and maturity lay a half-century of growth. In this period theory provided qualitative guidance and increasing partial results, but wind-tunnel data were vital. Design was an uncertain and changing combination of theoretical thinking and calculation and cut-and-try empiricism ... Perhaps we could call this decade [of most rapid change, from late 1930s to early 1940s] the adolescence of airfoil technology, when rational behavior was on the increase but offbeat things could still occur. Whether or not we push the metaphor that far, we can at least see a progression of development through phases of infancy, growth, and

---

<sup>7</sup> This list has been extended by Bailey and Gainsburg’s study of building design, which added construction feasibility, organization of work, and engineering politics [4].



maturity, with a characteristic relationship of knowledge and design in each phase.<sup>8</sup> [41; p 50]

Vincenti is concerned with design, not manufacturing. Nonetheless, if we substitute “art” or “craft” for infancy, and “nearly perfect science” for maturity, his formulation of the transformation of technology from art to science is consistent with what we will describe for firearms manufacture. We will return to Vincenti’s classification of technological knowledge, which encompasses more issues but is less precise than the one used here, in the last section.

---

<sup>8</sup> Additional work on the evolution of knowledge using Vincenti’s framework includes [12] and [42].

## 2

---

### Evolution of Knowledge in a World of Increasing Mechanization

---

Machine tools, invented circa 1800, brought mechanical power and control to metal shaping. During the first three epochs of manufacturing, from 1800 to the early 20th century, the precision of these machines was progressively increased, mainly by mechanical means that constrained the behavior of machines and workers. The key developments of this period emphasized knowledge about different portions of the machining process (see Figure 1.5).

Little formal knowledge about any portion of the machining process existed prior to 1800. Quantitative measurement of parts not yet existing, the goal was to make each new firearm as similar as possible to the shop's working model. Even the conformance of finished parts to the model was judged idiosyncratically, by eye and caliper. Beyond this little can be said. Plates from Didier's *Encyclopedia* illustrate the range of hand tools available and undoubtedly there was qualitative knowledge (both verbal and tacit) about when and how to use them to achieve desired results.

## 2.1. English System

Different epochs emphasized the development of knowledge about different subsystems of processes. The state of technological knowledge in the English System is little documented, but we can infer general properties of the knowledge from what was achieved during that epoch. Technological breakthroughs revolved around three subsystems: the machine, specification of intended outcomes, and measurement of actual outcomes (Table 2.1).

Maudsley's achievement of highly accurate parts measurement using micrometers was accompanied by the invention of the engineering drawing. Accurate measurement and an absolute goal provided by the engineering drawing enabled a distinction between "better" and "worse" parts, which otherwise would have been judged merely "different" as in the Craft epoch. Taken together, the micrometer and the engineering drawing supported the creation of a basic feedback loop: keep removing material until a part is of the dimension specified in the drawings as measured by a micrometer. [15, Section 3]

Woodbury described Maudsley's other key contribution, the general purpose machine tool with highly precise lead screws for accurately cutting parts with a minimum of trial and error, in the four key elements: ample power and drive train sufficient to effect its delivery; adequate rigidity under the stress of cutting ferrous metal; precision in construction greater than the precision of the parts to be produced; and adjustability to accommodate flexibility in the parts. [44, pp 96–97] At a minimum, enough was thus known to design and build iron machines with these properties.

## 2.2. American System

The American System introduced new concepts of ideal outcomes based on tolerances and precision as well as accuracy. The corresponding new measurement method was the use of go/no-go gauges.

"Accuracy in this system, which might be as close as a thirty-second or sixty-fourth of an inch, was ensured by an elaborate system of patterns, guides, templates, gauges, and filing jigs." The use of these

| Key Invention                             | Portion of process (Figure 1.5) | Significance  |
|---|---------------------------------|---|
| Machine tool w. lead screw                | Machine                         | Accuracy in cutting   |
| Engineering drawing (projective geometry) | Specify target shape            | Ability to state desired goal and measure actual outcome enable feedback control for finer accuracy than can be delivered by the machine tool |
| Micrometer, standard plane                | Measurement method              |   |

Table 2.1 Key knowledge contributions of the English System

geometric devices to constrain the motion of cutting tools required the development of causal knowledge about linkages from jigs to final parts (Figure 2.1).

Colt and others developed, in parallel with knowledge about making firearms, the knowledge needed to design and build machine tools for specific purposes. Workers independent of those employed in the manufacture of firearms “built, maintained, set up, and improved machines.” Specialized machine tool companies emerged to sell these machines abroad to furnish entire firearms factories.

Implicit in the emergence of these companies is another fundamental innovation of this epoch: separation of organizational knowledge by causal module. A machine tool designer does not need to know what parts are to be fabricated, only how to construct a machine capable of cutting along precise trajectories. The parts maker need not understand the nuances of how the machine works, only a limited range of adjustment methods. Information is transmitted from one to the other through the jigs. This separation of toolmakers’ from tool users’ knowledge is vital to the success of capital equipment industries.

What conditions support this separation of users and suppliers? There are two key conditions, one physical, the other having to do with knowledge.

First, the technology itself must have a modular causal network, that is, the total causal network must be separable into two subnetworks with much denser connections within than between them. The comparatively few connections between the subnetworks must be almost

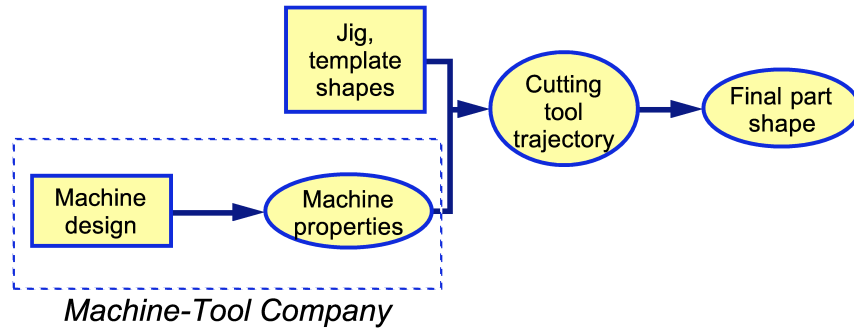

Fig. 2.1 Causal network from jigs to part shapes

entirely in a single direction. Such a network structure is observed, for example, with geographically separated suppliers and customers between which there is a one-way flow of intermediate product. Causal paths tying the firms together pass through these intermediate products.

Second, knowledge about the causal relationships that join the subnetworks must be sufficiently complete to enable the modularity to be exploited. The key relationships that link the subnetworks must be well understood and their variables be known and measurable.

If both conditions are met, each subnetwork can be controlled by its own organization (department or firm) and the two joined by an arms length relationship. In Figure 2.1, a cutting tool's trajectory is a function of only a limited number of machine tool properties. Knowledge about the causal linkages among these properties was sufficient in the American System to make separate machine tool companies feasible.

### 2.3. Taylor System

Their extensive research on the “hard” technology of machining would render the impact of Taylor and his team on the transition from art to science fundamental, even in the absence of their more well known work at the Watertown Arsenal on worker procedures and standardized methods for each job. Conducted in secret for more than 20 years, the research was finally presented, in 1906, to an overflow audience of 3,000 at a gathering of the American Society of Mechanical Engineers. [35]

| Key Invention                 | Portion of process (Figure 1.5) | Significance  |
|-------------------------------|---------------------------------|---|
| Elaborate jigs and fixtures   | Control method                  | Precision and flexibility possible  |
| Go/no-go gauges               | Measurement method              | Simple way to estimate precision  |
| General purpose machine tools | Machine                         | Separation of machine knowledge from product knowledge; organizational specialization |

**Table 2.2 Key knowledge contributions of the American System**

As in the other epochal shifts Taylor did not so much add to the established body of knowledge in its own terms, as shift the nature of the knowledge sought. His fundamental contributions to technological knowledge were several (see Table 2.3).

- Taylor’s reductionist approach to systems analysis divided parts production into linked subsystems, each carefully analyzed in isolation to arrive at a formally specified “best” process. He studied not only parts machining, but also indirect supporting activities.
- Taylor moved from qualitative and ordinal relationships among variables to systems of equations with numerical coefficients that could be solved quantitatively.
- Finally, he employed a much superior learning method, namely a large number of carefully controlled empirical experiments, to develop knowledge systematically.
- These three contributions enabled Taylor’s team to make specific discoveries about better manufacturing methods, perhaps most important their discovery of high-speed steel.

Each of Taylor’s contributions constitutes a move from art towards science. The scientific knowledge he developed was a prerequisite for the development of standardized work procedures – his “one best way” – for which he is more famous. In Taylor’s view, the best

| Key Invention   | Portion of process (Figure 1.5)    | Significance  |
|---|------------------------------------|---|
| Concepts of repeatable process, separable subsystem                   | Ancillary subsystems (e.g., power) | Allows separation and improvement of staff activities, reductionism in analysis   |
| Simultaneous equation models to describe complex causal relationships | Metal cutting                      | Represents knowledge in explicit and easily manipulated form                      |
| High speed (heat treated) steel; other specifics of cutting methods   | Cutting tool                       | Huge improvement in feasible cutting speeds, costs                                |
| Carefully controlled experiments; four-step learning process          | Learning method (not shown)        | Facilitates discovery of quantitative causal knowledge for any repeatable process |

Table 2.3 Key knowledge contributions of the Taylor System

way could be determined only after the behavior of each subsystem was understood and had been quantified. Thus, for each subsystem, he moved towards science along the knowledge axis in advance of corresponding movement along the procedural axis. We consider these advances in turn.

**2.3.1. Reductionist Approach to Manufacturing Systems**

Taylor’s insight was that production encompassed a host of distinct processes that could be analyzed and improved independently of the larger system they comprised. The sharpening of a tool, in his view, could be managed and optimized independently of the purpose for which the tool was to be used. As with the separation of capital equipment from firearms manufacture in the American System, this is feasible if and only if there is causal knowledge modularity. Taylor further realized that separation, analysis, and improvement could be applied to auxiliary processes such as accounting and maintenance as well as to materials processing.

Taylor applied this approach to all activities that had a significant effect on the overall rate of production, for example, the power transmission system (pink areas in Figure 1.5). The electrical motors of

Taylor's day were large and expensive, so a few central motors powered dozens of machine tools by means of a network of moving belts. [15, Figure 5.1]

Inasmuch as the speed of operators was largely determined by the speed of the machines as driven from a central location by belts, pulleys, and shafts, Taylor considered the standardization and control of these systems at their optimal level of efficiency essential. To this end he established the activities of belt maintenance and adjustment as a separate job and prescribed methods for scientifically determining correct belt tensions. [15, Section 5]

A great deal of the old belting was replaced with new and in some cases heavier belting. This made it possible to run machines at higher speeds and with greater power, so that full advantage could be taken of the cutting powers of high-speed steel, and also prepared the way for Barth's later standardization of cutting speeds and feeds. By the end of April 1910 the belt-maintenance system was in full operation and belt failures during working hours had been practically eliminated. [1]

Taylor studied and optimized the causal subnetwork that determined belt breakage and other belt-related influences on production rates (Figure 2.2). Belt failures had persisted despite limiting speeds. By standardizing and optimizing the belt maintenance system (B in Figure 2.2), the tradeoff between speed and belt reliability was substantially shifted outward, enabling faster speeds (A and D) while reducing the incidence of breaks (C). Since total production is the product of cutting rate and operating time, productivity improved substantially.

Taylor developed for the first time detailed knowledge and corresponding procedures for many other subsystems.

- Standardization of ancillary equipment (e.g., sockets, screws)
- Storeroom handling of in-process materials
- Tool maintenance (including tool room procedures and equipment)
- Cutting speeds (discussed below)



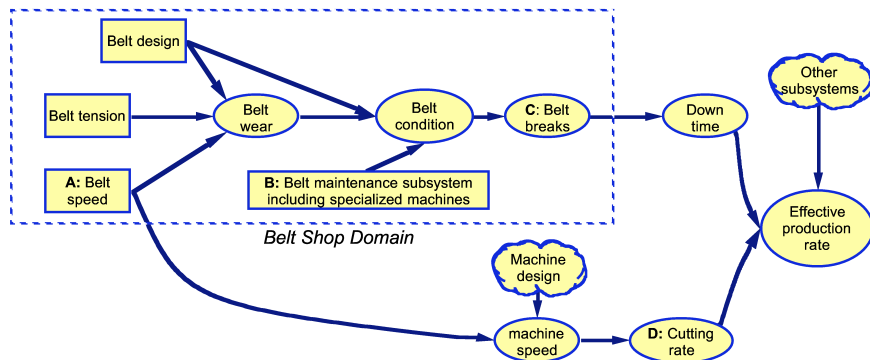

Fig. 2.2 Belt-related causal knowledge graph

- Tool design and fabrication, especially the metallurgy of new high-speed steels

For each subsystem, analyzing and prescribing behavior required the development of knowledge about at least three parts of its causal network.

- The *key outcome variables* that describe the results of the subprocess
- The *ancestral causal network* used to deduce what caused the outcomes including the identities of and relationships among *key intermediate variables*
- The *best levels* of key control variables not only for specific cases but also for ranges of operating requirements.

Just to establish which variables are important is no small task. In his 26-year investigation Taylor identified twelve groups of variables that affected optimal cutting speed (Table 2.4).<sup>1</sup>

In a seminal lecture and paper, Taylor presented these variables in terms of their effects on optimal cutting speed. The numbers in the

<sup>1</sup> This list is from [36], with modern terminology provided by [26]. Cutting speed is a key outcome variable because it directly drives output and total factor productivity.

| Variables that influence optimal cutting speed (from [35])                              | Magnitude of effect |
|---|---------------------|
| • Quality (e.g., hardness) of the metal to be cut                                       | 100                 |
| • Depth of cut  | 1.36                |
| • Work piece's feed per revolution  | 3.5                 |
| • Elasticity of the work or tool  | 1.15                |
| • Shape or contour as well as clearance and rake angles of the cutting edge of the tool | 6                   |
| • Tool material (e.g., chemical composition and heat treatment)                         | 7                   |
| • Use of a coolant such as water  | 1.4                 |
| • Tool life before regrinding   | 1.2                 |
| • Lip and clearance angles of the tool  | 1.023               |
| • Force exerted on the tool by the cut  | Not given           |
| • Diameter of the work piece  | Not given           |
| • Maximum power, torque, and tool feeding force available on the lathe                  | Not given           |

Table 2.4 Taylor's list of key variables related to cutting speed

last column are his estimates of the sensitivity of cutting speed to each variable. For example, the most potent decision variable is tool material, reflecting the importance of Taylor's discovery of high-speed steel and the way machining procedures had to change to take advantage of it. [15]

### 2.3.2. Expressing Causal Knowledge as Systems of Equations

Organizing variables as in Table 2.4 yields a simple causal structure in the manner of the shallow tree depicted in Figure 2.3. Taylor and his team recognized, however, that behavior was driven by systems of

nonlinear equations (although they did not use that terminology). They eventually expressed the relationships as equations such as:

$$V_{20} = \frac{\text{Constant} \left( 1 - \frac{8}{7(32r)^2} \right)}{\left\{ f \exp \left( \frac{2}{5} + \frac{2.12}{5+3r} \right) \right\} \left\{ \frac{48d}{32r} \exp \left( \frac{2}{5} + 0.06\sqrt{32r} + \frac{0.8(32r)}{6(32r) = 48d} \right) \right\}}$$

where  $V_{20}$  = cutting speed that leads to a 20 minute tool life, in feet per minute

$r$  = tool nose radius, in inches

$f$  = feed per revolution, in inches

$d$  = depth of cut, in inches [26].

These equations, derived empirically by fitting curves to experimental data, were too complex to solve, but the team was able to embody approximations of the most important into specialized slide rules (see Figure 2.4).<sup>2</sup> Each slide rule is an analog computer corresponding to a specific system of multivariate equations, and some were specific to a single machine. With them the values of the respective variables could be solved for, given values of enough of the other variables.<sup>3</sup>

Multiple slide rules with common variables were used to solve for multiple outcome variables. Cutting conditions, for example, were used by one slide rule to determine how much power the machine tool would require, by another to determine how much stress would be placed on the spur gears (Figure 2.5), and by a third to determine how long the cutting operation would take.

Some of Taylor's results are still used today. A summary relationship known as the Taylor equation, for example, is used to trade off cutting speed versus tool life, both of which have direct economic effects.

$$VT^n = C$$

<sup>2</sup> Taylor does not discuss how the curves were fit to data and he does not try to justify the functional forms he used. This was before the use of statistical analysis for experimental data and his data tables suggest heavy use of judgment. [35 exhibits]

<sup>3</sup> Solution methods are described in elaborate detail in [7].

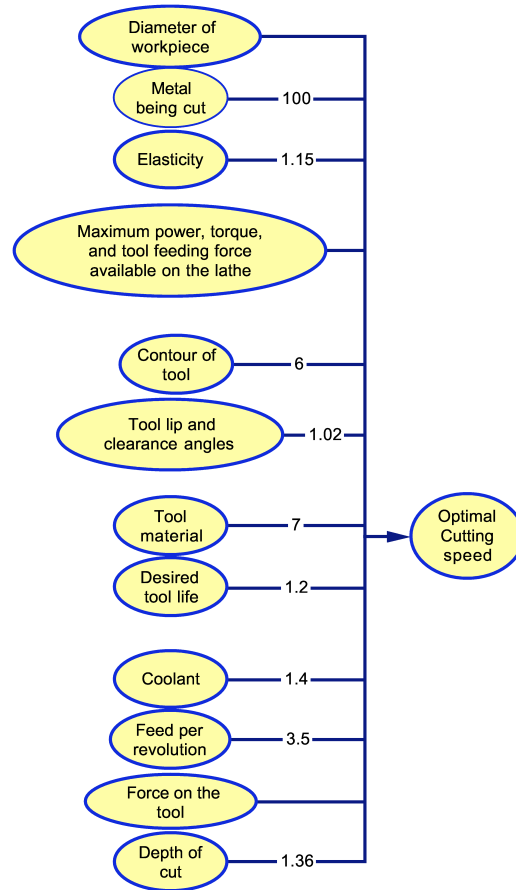

Fig. 2.3 Possible simplistic knowledge graph for cutting influences

where  $V$  = cutting speed in feet per minute,  
 $T$  = cutting time to produce a standard amount of tool wear,  
 $n$  is an empirical constant for the material being cut,  
and  $C$  an empirical constant for other cutting conditions such as tool design and material.

There are still no general predictive models for  $n$  or  $C$ , but engineering handbooks have tables of  $n$  for different metals and  $C$  can be estimated experimentally for a given situation. Figure 2.6 shows the corresponding causal knowledge graph.

CARL G. BARTIL.

TRANSACTIONS AMERICAN SOCIETY OF MECHANICAL ENGINEERS. VOL. XXV.

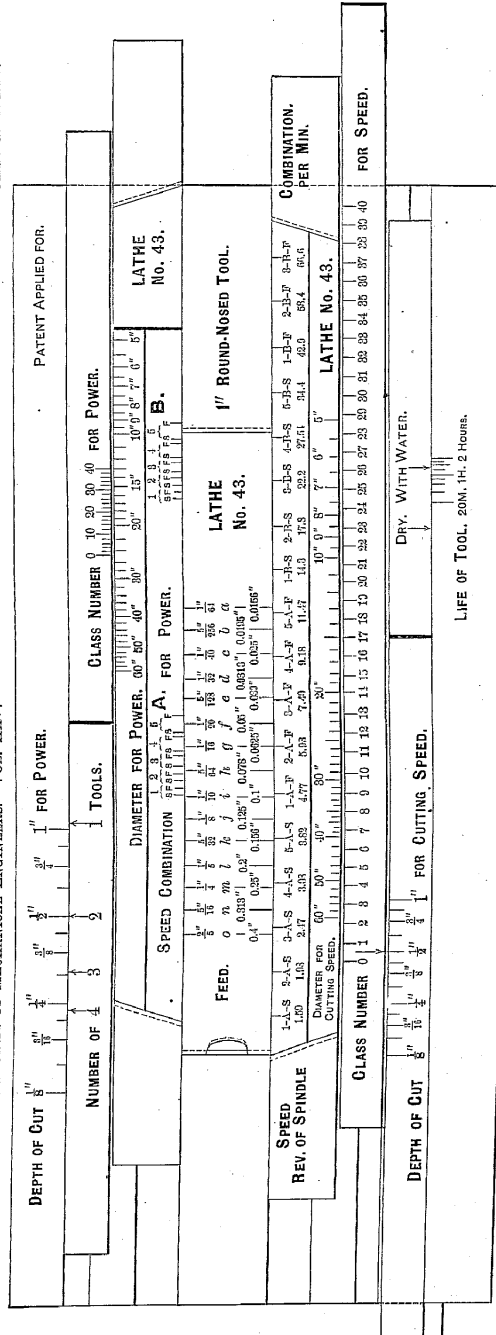

FIG. 5.

Fig. 2.4 Slide rule for key cutting variable relationships [7]

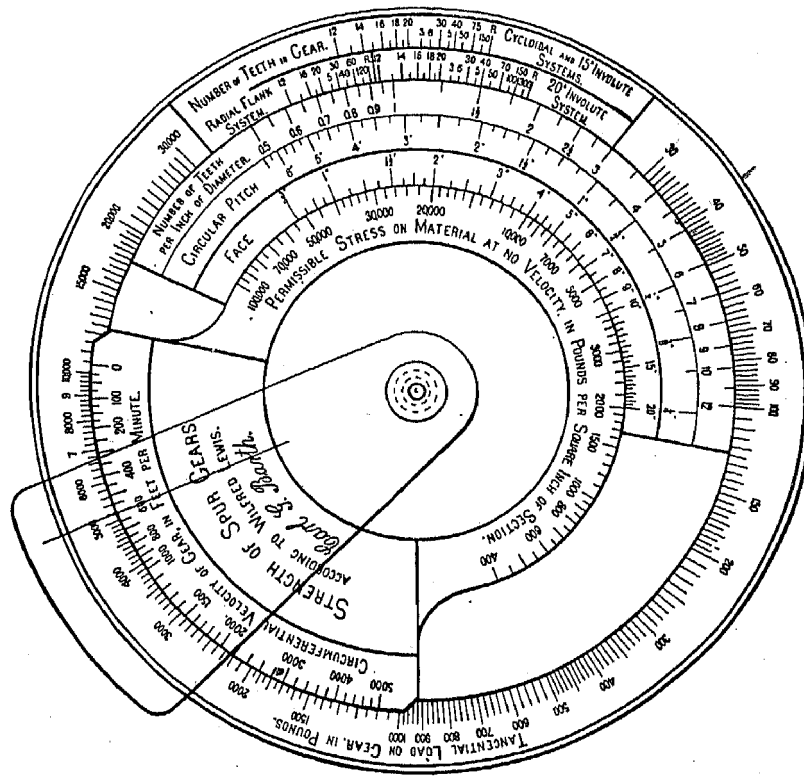

FIG. 8.

Fig. 2.5 Slide rule for side calculation [7]

The existence and use of these formulas, slide rules, and corresponding systems of equations show the extent of causal knowledge developed by Taylor. Not only did he identify the important *variables* that govern how machining should be done for high production rates, he also claimed that he understood the *relationships* among the variables well enough to derive *normative rules* for the best way to machine.

### 2.3.3. Systematic Learning by Experimentation

The third fundamental way in which Taylor and his team moved machining knowledge from art towards science was through a systematic learning methodology. This comprised two major innovations, (1) a

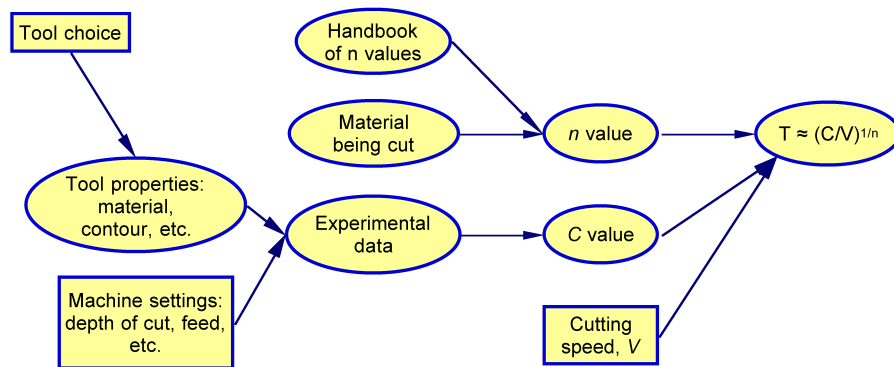

Fig. 2.6 Knowledge graph corresponding to Taylor equation  $VT^n = C$

procedure for learning about any subprocess, and (2) massive systematic experimentation to estimate the quantitative relationships in causal networks. Used with numerous subsystems, as for the infamous experiments on shoveling by “Schmidt,” the most elaborate applications of these methods were in the areas of metallurgy of cutting tools and formulating cutting equations.

With the benefit of a century of hindsight we can see that Taylor developed a more-or-less-repeatable procedure for learning about physical causality. He organized the analysis and prescription of behavior for each subsystem into four steps.

- (1) Identify the *key outcome variables* that describe the results of the subprocess. To make these variables operationally useful required establishing standard definitions and measurement methods. Taylor spent several years establishing the best way to measure tool wear, for example.
- (2) Determine the *ancestral causal graph* for these outcomes including the identities of, and to the extent possible, important relationships among, key intermediate variables.
- (3) Given this knowledge, determine the *best levels* of key control variables not just for specific cases but for ranges of operating requirements and conditions.

- (4) Establish *standard procedures* that make it easy for workers to use the best methods. This step essentially translated increased knowledge into formal procedures.

As important as his overall procedure was Taylor's use of massive numbers of controlled experiments. He identified key variables and relationships (steps 1 and 2) from experimental evidence. Taylor summarized his team's decades of experimentation on tooling and cutting speed as follows.

Experiments in this field were carried on, with occasional interruption, through a period of about 26 years, in the course of which ten different experimental machines were especially fitted up to do this work. Between 30,000 and 50,000 experiments were carefully recorded, and many other experiments were made, of which no record was kept. In studying these laws [sic] more than 800,000 pounds of steel and iron was cut up into chips with the experimental tools, and it is estimated that from \$150,000 to \$200,000 was spent in the investigation. [36]

Taylor devoted many pages of his exposition to experimental methodology, both successes and problems, as in the following passage.

[W]e had made one set of experiments after another as we successively found the errors due to our earlier standards, and realized and remedied the defects in our apparatus and methods; and we have now arrived at the interesting though rather humiliating conclusion that with our present knowledge of methods and apparatus, it would be entirely practicable to obtain through four or five years of experimenting all of the information which we have spent 26 years in getting. [35, p 42]

Taylor also acknowledges "failure on our part from various causes to hold all of the variables constant except the one which was being systematically changed."

But Taylor reserved his most devastating critiques for academics and other perceived experts. His criticisms of previous research included the following: [35, p 40ff]



- That researchers assumed they knew which variables were and were not important, and ran their experiments such that these assumptions were never tested;
- That researchers conducted detailed investigations of complex and difficult-to-measure variables of no actual importance, in particular obsessive investigation of the pressure exerted on the cutting tool, which “calls for elaborate and expensive apparatus and is almost barren of [effect]”;
- That researchers were also guilty of the converse; “several of those elements [variables] which are of the greatest importance have received no attention from experimenters” he complained, adding by way of example that “the effect of cooling the tool through pouring a heavy stream of water upon it, which results in a gain of 40 per cent in cutting speed, ... [has] been left entirely untouched by all experimenters”;
- That researchers used “wrong or inadequate standards for measuring” dependent variables;
- That researchers changed multiple variables at once and in *ad-hoc* fashion.

Taylor’s assessment of the best known previous research, conducted at the University of Illinois, is scathing. If his overflow audience hoped to be entertained as well as informed, they surely were not disappointed.

These experiments, from a scientific viewpoint, were so defective as to make it out of the question to deduce formulae, because no effort was made to keep the following variables uniform: (1) the shape of the ... tool varied from one experiment to another; (2) the quality of the tool steel varied; (3) the [heat] treatment of the tool varied; (4) the depth of the cut varied from that aimed at; (5) the cutting speed was not accurately determined at which each tool would do its maximum work throughout a given period of time; and (6) ... it does not appear that any careful tests were made to determine whether [the raw unfinished workpieces being cut were] sufficiently uniform throughout in quality ... The same criticism,

broadly speaking, applies to both the German and the University of Illinois experiments. [35, p 46]

Taylor's attention to detail (his biographers have commented on his obsessive personality) was vital to the success of his experiments and accounts for some of his major serendipitous discoveries. A modern description of Taylor's breakthrough development of high-speed steel portrays it as a premeditated and rational process, in marked contrast to Taylor's own account of his work.

Their investigation thus turned from the optimization of cutting conditions to the importance of heat treatment. Putting on one side conventional craft wisdom and the advice of academic metallurgy, Taylor and White conducted a series of tests in which tools were quenched from successively higher temperatures up to their melting points and then tempered over a range of temperatures. This work was made possible by use of the thermocouple which had not long been in use in industrial conditions. After each treatment, cutting tests were carried out on each tool steel ... Certain tungsten/chromium tool steels gave the best results ...

... The tools treated in this way were capable of machining steel at 30 [meters per minute] under Taylor's standard test conditions. This was nearly four times as fast as when using [the best previous] steels and six times the cutting speed for carbon steel tools. This was a remarkable breakthrough.

... High speed steels revolutionized metal cutting practice, vastly increasing the productivity of machine shops and requiring a complete revision of all aspects of machine tool construction. It was estimated that in the first few years, engineering production in the USA had been increased by \$8 billion through the use of \$20 million worth of high-speed steel. [40]

The tone of Taylor's description of this research is quite different. The breakthrough came when he attempted to demonstrate by running a trial in front of the foremen and superintendents of Bethlehem Steel his recent "discovery" that tools made from Midvale steel were the best. "In this test, however, the Midvale tools proved *worse* than those

of *any* other make ... This result was rather humiliating to us.” [35, p 51, emphasis added] Taylor's first reaction was to blame the workers who had made the sample tools, for heat treating them at too high a temperature. But this explanation was unproven and Taylor and his collaborator decided to characterize the exact effects of different temperatures. As expected, this revealed that tools were damaged by overheating to a temperature of around 1700 degrees F. But,

to our great surprise, tools heated up to or above the high of 1725 degrees F. proved better than any of those heated to the best previous temperature ...; and from 1725 F. up to the [melting point], the higher they were heated, the higher the cutting speeds at which they would run.

Thus, the discovery that phenomenal results could be obtained by heating tools close to the melting point, which was so completely revolutionary and directly the opposite of all previous heat treatment of tools, was the *indirect* result of an accurate scientific effort to investigate as to which brand of tool steel was [best]; *neither Mr. White nor the writer having the slightest idea that overheating would do anything except injure the tool more and more the higher it was heated.* [35 p 52, emphasis added]

Taylor's accounts of his research still elicit admiration. Although operating before the invention of statistical tools such as regression, design of experiments, and gradient search, Taylor clearly understood the importance of applying the scientific method. His sheer persistence and emphasis on careful empirical observation more than compensated for the inadequate statistical tools of his era.

#### 2.3.4. Taylor's Legacy

Taylor wrought fundamental changes in the nature of work and in the procedural dimension of the evolution of manufacturing from art to science, in much the same way as did the English and American Systems of manufacture. [15] But the impact of the Taylor System on how technological knowledge is developed, partitioned, and expressed was even more revolutionary and fundamental. The concepts of learning

through controlled experiments, of reductionism, and of expressing causal knowledge through systems of quantitative equations are still the bases of modern technology, and not just in manufacturing. Of course, Taylor's work was heavily influenced by its era; his methods had precedents in the natural sciences. But he harnessed their power and directed it at complex, real-world applications to manufacturing and process control.

Ironically, Taylor believed his innovations in factory management were more important than his work on machining and metallurgy. In his factories knowledge was not only developed independently for different activities, but was then used and maintained by staff specialists. In Taylor's shop, knowledge and execution were separated; workers were taught fixed methods for their jobs and only specialists were permitted to alter these procedures. But in the dynamic world the "one best way" changes frequently, and the necessary rates of problem solving and learning, which rely overwhelmingly on the intellectual abilities of workers, have increased dramatically. [17]

# 3

---

## Knowledge in a Dynamic World

---

The treatment of knowledge changed fundamentally in the dynamic world that followed WW II. Problem solving and learning, which entailed the development of new knowledge, had to become organic to the production process. Finding a single optimum production method was replaced by change as the central concern of manufacturing.

The first three epochs emphasized increasing mechanization in a world that was, at least ideally, static – doing the same tasks again and again, as efficiently as possible, at increasingly high volume. Discretion was progressively removed from workers, and knowledge about their tasks was subdivided and given to specialists, removing it from the shop floor ... In contrast, in the last three epochs, while the tools continued to become more mechanized, knowledge about the work was returned to workers and their discretion increased. The key goal shifted from efficiency at high volume to coping with a dynamic world of rapid changes such as high product variety and rapid product introduction. [15, Section 6]

But mechanization, in particular the development of increasingly autonomous machines, continued unabated. For a machine to operate autonomously a high level of knowledge is needed to guide responses

to or forestall disruptions. Taylor's contributions to knowledge management discussed in the previous section thus continued to be vital, even as his approach to shop floor management was being turned on its head.

The Statistical Process Control (SPC) epoch coincided with a flowering of academic research on the science of metal cutting. Taylor's attempt to determine empirical formulas for factors that affect the rate of machining was extended, with the goal of raising effective machine speeds and productivity through a deeper understanding of the underlying science. This research was not primarily concerned with the SPC agenda of controlling variation.

The organization of this Section is not strictly chronological. We first examine the knowledge effects of the SPC epoch and the coinciding academic development of the "engineering science of machining." We then explore how numerical control initially foundered for want of sufficient knowledge. Finally, we consider what happens with fundamentally different manufacturing processes.

### 3.1. Statistical Process Control Epoch

The SPC epoch arrived at Beretta in the 1950s with the contract to manufacture the Garand M1 rifle. [15, Section 6] SPC shifted concern from average performance to variations in performance. To understand causes of variation requires detailed knowledge about a process and its real-world operation. Beretta's newly formed quality control department "was responsible for quantitatively measuring the natural variability of every machine and the degree of fidelity of every tool, verifying tool conformity to design, and identifying possible causes of systematic error."

Because so many variables can disturb a process, the complexity of causal networks for variation is an order of magnitude higher than for ideal operation. SPC thus drove the development of much more detailed causal knowledge, with a strong emphasis on the actual behavior of processes and machines on the factory floor.

This reorientation was accompanied by a complementary shift from a static to a dynamic world view. Dynamic causal models, in

which sources and consequences of changes are explicitly monitored over time are vital to SPC. Each variable becomes a time series. Dynamic behavior such as the rate at which variables change had to go from being recognized to being measured (via control charts) to being adjustable. To eliminate adjustments between setups, for example, the rate of drift of key variables had to be constrained. But because dynamic behavior in this period was still not technically capable, processes escaped from control and interventions continued to be necessary.<sup>1</sup>

“Soft” innovations, such as control charts, were a hallmark of this period. The genius of the control chart is that it enabled operators, in a pre-computer era, to track dynamic variables and filter out real shifts from normal stochastic variation. Beretta’s quality control department employed a variety of even more sophisticated statistical techniques such as gauge R&R studies, which are still essential for physical measurement.<sup>2</sup>

These changes shifted the focus of manufacturing from *control* to *learning*. “The application of SPC provided one way by which errors could, over time, be observed, better understood, and eventually solved. Manufacturing’s evolution from an art to a science now included a systematic way of learning by doing.” They also directed attention away from the *product* to the *process*. SPC effectively democratized and replicated Taylor’s innovations in systematic learning about processes, even as his de-skilling of line workers was being reversed. Modern versions of SPC, such as Total Quality Management and Six Sigma, have institutionalized systematic learning, and moved it from the factory floor into general management.

---

<sup>1</sup> Tolerances were much tighter for the Garand rifle than previously (roughly .001 inches or 25 microns). Yet, rejects on Beretta’s frame line went down from 15% to 3%, and overall rework time went down from 25% to 8%. Thus process capability improved even though tolerances tightened, suggesting that effective process variability was reduced by two orders of magnitude (standard deviation by one order of magnitude).

<sup>2</sup> Gauge R&R studies deal with the problem that measurements are inherently imperfect, and variation in measurements can be confounded with variation in the processes being measured, leading to serious mistakes. Gauge R&R also quantifies measurement variance from different sources. Although it is actually a sophisticated ANOVA calculation, training material teaches it as a “cookbook” procedure, and it can be done with little statistical knowledge.

Beretta's introduction of synchronous lines both required and made easier an integrated view of production, involving analysis of *interactions* among variables in different parts of a process. The sequence of workstations that comprise a process could no longer be assumed to be independent. This necessitated a major shift in problem solving and learning from a focus on individual machine performance to a process orientation.<sup>3</sup> "Diagnosis and problem solving are now carried out by examining the workstation not in isolation, but as part of the entire system ... Synchronous lines forced an integrated view of the entire system of manufacture. Whereas the intellectual underpinnings of Taylorism were reductionism and specialization, that of SPC in a synchronous line was integration."

### 3.2. The Science of Cutting Metal

At roughly the same time that Beretta was introducing SPC, formal laboratory-based research into machining was being conducted by universities and company research labs. Much of this research emphasized machining-speed issues in the Taylorist tradition, over precision and quality which are central concerns of SPC. A distinguishing feature was the effort to develop models based on known scientific principles rather than just fit curves to empirical data.

The basic characteristic of science-based modeling of machining is that it draws on the established natural sciences, and particularly the science of physics, to establish reliable predictive models. These are models that can then be used to carry out reliable engineering calculations of the expected behavior or characteristics of a machining process, independent of empirical information.

Development of capability for science-based modeling of machining was quite dependent on the knowledge and understanding of machining developed by the [earlier] research on empirical modeling. A good example of such was the research done by the

---

<sup>3</sup> The impact of synchronous lines on knowledge modularity is a topic in itself. One factor is that with no inspection or delay between workstations, problems in a workstation propagate downstream without any chance to be removed. By the time a problem is finally observed at the end of the line, it could have originated anywhere upstream.



| Key Invention                    | Portion of Process (Figure 1.5)                                  | Significance   |
|----------------------------------|--|--|
| Control chart                    | Higher order feedback system for controlling process (not shown) | Attention focusing for problem solving and learning; leads to continuous improvement |
| Synchronous line                 | Multiple workstations  | Forces integrated perspective; interactions easier to study                          |
| Science-based models (see below) | Workpiece-tool interface   | Causal knowledge more general; integrate scientific knowledge from diverse sources   |

Table 3.1 Key knowledge contributions of the SPC epoch

Ernst–Merchant team ... in the period from 1936 to 1957, which culminated in the creation by Merchant of the basic science-based model of the machining process. [26]

Researchers found, for example, that the shear angle, the angle at which metal chips “peel away” from the face being machined, was key to predicting machining behavior. Shear angle being an important intermediate variable, it became a target for detailed causal modeling. “The ultimate goal of the above analysis leading to the shear angle relationships is to enable the estimation of all the relevant metal cutting quantities of interest, such as the forces, stresses, strains, strain rates, velocities, and energies *without actually measuring them*. For example ... knowing the shear stress of the metal and the cutting conditions, all of the above metal cutting quantities of interest can be calculated.” [19, p 86, emphasis added] We can thus say that for the first time the knowledge graph incorporated “first principle” scientific models.

Among its major accomplishments this research:<sup>4</sup>

- Extended Taylor’s empirical research to a range of additional operations (turning, milling, drilling) and issues (surface finish, costs, forces);

<sup>4</sup> Following is based primarily on [26].

- Established a qualitative understanding of what happens when a tool cuts. The research identified four basic processes: primary shear, secondary shear, fracture, and built-up edge formation. These correspond to four distinct causal models with only modest overlap; [26]
- Yielded further details of cutting tool design, including materials and geometries for different purposes;
- Originated theoretically based models of the forces at work in metal cutting (e.g., Figure 3.1);
- Contributed analytic models of heat and thermal effects in metal processing.

In addition to incorporating fundamental scientific models for the first time, this research was notable for its depth. More variables and more relationships were incorporated into knowledge graphs, reflecting the *fractal nature of causal knowledge*. The more closely a phenomenon is examined, the more complex it appears. The effects include:

- Individual variables are replaced by collections of more specific variables.
- When a variable is discovered to be important, its causes must be understood in turn.
- New relationships among variables are identified, so a causal knowledge subgraph that is initially tree-like becomes a more complex network.
- Engineered subsystems are created to control new key variables. These systems add complexity beyond that of the underlying physical process. Even a simple feedback loop requires its own new causal system with measurement methods, a calculation algorithm, and an adjustment method.

Cutting tool geometry provides an example of the intricacy of knowledge. The Taylor experiments discussed previously showed the importance of heat treatment, which we now know affects the grain structure of the tool. Elemental composition of the steel is also

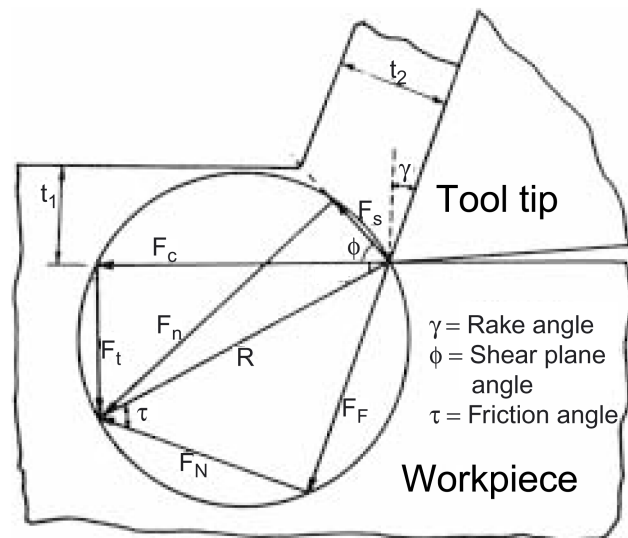

Fig. 3.1 Forces at work in chip cutting [25]

important. Tool geometry might seem more straightforward to describe, but six angles (and six corresponding dimensions) are required to begin to do so, and these six angles interact with more than 20 additional variables indicated by the underlined phrases.

*Single-Point Cutting Tool Geometry.* [A figure, not included here, shows] the location of [six] angles of interest on a single-point cutting tool. The most significant angle is the cutting-edge angle, which directly affects the shear angle in the chip formation process, and therefore greatly influences tool force, power requirements, and temperature of the tool/workpiece interface. The larger the positive value of the cutting-edge angle, the lower the force, but the greater the load on the cutting tool. For machining higher-strength materials, negative rake angles are used. *Back rake* usually controls the direction of chip flow and is of less importance than the side rake. Zero back rake makes the [chip] spiral more tightly, whereas a positive back rake stretches the spiral into a longer helix. *Side rake angle* controls the thickness of the tool behind the cutting edge. A thick tool associated with a small rake angle

provides maximum strength, but the small angle produces higher cutting forces than a larger angle; the large angle requires less motor horsepower.

The *end relief angle* provides clearance between the tool and the finished surface of the work. Wear reduces the angle. If the angle is too small, the tool rubs on the surface of the workpiece and mars the finish. If the angle is too large, the tool may dig into the workpiece and chatter, or show weakness and fail through chipping. The *side relief angle* provides clearance between the cut surface of the work and the flank of the tool. Tool wear reduces the effective portion of the angle closest to the workpiece. If this angle is too small, the cutter rubs and heats. If the angle is too large, the cutting edge is weak and the tool may dig into the workpiece. The *end cutting-edge angle* provides clearance between the cutter and the finished surface of the work. An angle too close to zero may cause chatter with heavy feeds, but for a smooth finish the angle on light finishing cuts should be small. [24, p 13–13]

Even six angles and six dimensions do not come close to fully describing an actual cutting tool's geometry. Moreover, how the tool is made can have a major effect on its performance.

The design of tools involves an immense variety of shapes and the full nomenclature and specifications are very complex ... The performance of cutting tools is very dependent on their precise shape. In most cases there are critical features or dimensions, *which must be accurately formed* for efficient cutting. These may be, for example, the clearance angles, the nose radius and its blending into the faces, or the sharpness of the cutting edge. The importance of precision in tool making, whether in the tool room of the user, or in the factory of the tool maker, cannot be over estimated. This is an area where *excellence in craftsmanship is still of great value*. [39, p 7, emphasis added]

In other words, even where the effects of *using* tool features can be predicted, the causal network for *making* good tools is not well under-

stood, and manufacturing them is closer to the art end of the spectrum even today.

The development of formal models of machining based on first principles generated considerable excitement, but appears to have had only limited impact on practice. One reason might be the tendency of academics to choose research issues based on the next logical intellectual problem rather than examine the most serious problems being encountered in the field. Jaikumar and Bohn [17] argue that in a dynamic world the critical problems tend to arise from poorly understood disturbances in real world manufacturing environments. Because not enough is known about them to simulate them in a laboratory, they must be studied on the factory floor, as Beretta did using SPC.

In some domains, moreover, theoretically grounded models did not agree well with experimental results.[19, p 86] One reason is that conditions (such as forces and temperatures) during metal cutting are much more extreme than those encountered during mechanical testing, where the relevant properties of materials are measured. Moreover, fundamental disagreements about correct ways to model particular phenomena persist. It is unclear, for example, whether the physics of metal cutting are sufficiently constrained to even have unique mathematical solutions.

Analysis of learning methods in another steel products industry, wire-making, illuminates the relationships among theoretical models, factory experimentation, and performance. [23 and articles cited therein] In one study, 62 process improvement projects were analyzed according to how extensively they developed theory-based causal knowledge (“conceptual learning”) and how extensively they tested proposed changes on the factory floor (“operational learning”). Surprisingly, neither approach was sufficient to improve performance. Only projects that were high on both scales led to actual improvements, and many projects had a negative effect on performance. These results suggest that scientific models of metal processing can be helpful, but by themselves do not provide sufficient knowledge of real-world causality.

### 3.3. NC and CIM/FMS Epochs

In order for a computer program to successfully control a cutting tool, sufficient knowledge is needed first to predict how a process will behave, second to write a recipe that will reliably achieve the required tolerances, and third to either avoid or respond to disruptions without manual intervention. As tolerances tightened and adaptability became important, more detailed knowledge of the causal network was needed. (Table 3.2) This knowledge was not available when NC tools were first built and used.<sup>5</sup>

The early problems of NC technology were partially due to limited formal knowledge of the machining process. A lot of the knowledge possessed by operators, such as when to make “on the fly” adjustments, was tacit or at least not accessible to programmers [and was therefore not incorporated into the NC programs]. This limited understanding of variations in machinability, tool wear, and part material properties, together with inadequate control strategies for coping with these shortcomings, significantly constrained early implementations of NC technology. But with effort, over time more of the tacit knowledge implicit in operator skills became precise, explicit knowledge that was used to develop procedures capable of dealing with a variety of contingencies. [15, Section 7]

Early implementations of numerical control were thus based on *less* knowledge than was accessible to conventional machinists, yet simultaneously employed a *higher* degree of procedure. The resulting attempt to operate above the diagonal region in Figure 1.3 resulted in frequent disruptions and poor outcomes.

In the SPC era and before, master mechanics working with general purpose machines usually accrued years of experience, during which they accumulated a wealth of idiosyncratic knowledge about how to perform in a wide variety of circumstances. They talked in terms

---

<sup>5</sup> The term NC here covers both Numerical Control and Computer Numerical Control.

| Key Invention  | Portion of Process (Figure 1.5) | Significance  |
|--|---------------------------------|---|
| Hardware and software for machine control                                    | Control system                  | Versatility   |
| Special purpose algorithms for signal processing, dynamic control, and other | Measurement; adjustment         | Sophisticated feedback and control despite noise        |
| Variety of hardware sensors  | Measurements                    | Monitoring or regulation of many variables in real time |

Table 3.2 Key knowledge in NC epoch

of a “feel” for the machine, the tools, and the parts they worked on. It was through this feel that they were capable of producing parts to exacting specifications. Watching them work, one had a sense that they recognized errors (e.g., vibration, chatter, structural deformation due to thermal forces) as they were happening and adapted their procedures to compensate for them. This, in engineering terminology, is an advanced form of adaptive control in an ambiguous environment. Such adaptive error recognition and compensation requires either ... the experiential and partly tacit knowledge of the skilled machinist, or alternately a high stage of formal knowledge approaching full scientific understanding of the machinery, sensor, and controller technology, as well as of the product, the process, and all their interactions. [15]

For example, a potential problem in most machining is “chatter,” a forced vibration of the tool against the workpiece that damages the surface as well as the tool. It is “easily detected by an operator because of the loud, high-pitched noise it produces and the distinctive ‘chatter marks’ it leaves on the workpiece surface.” [21] Once detected, an experienced operator can stop it and even rework the damaged surface on the fly. But for an NC machine tool to detect chatter requires electronically sensing and processing an appropriate signal, usually sound. Due to the background noise that accompanies machining, this represents a difficult signal-processing problem for computers, compared with

the excellent signal processing ability of the human nervous system. Having detected chatter, the NC machine must decide how to end it and, if possible, execute another pass to repair the surface finish. In other words, operators' knowledge about how to detect and deal with chatter must be replaced by adequate formal knowledge and complex signal processing. For many years, available formal knowledge was inadequate to solve this problem. Instead, NC programmers modified programs for particular parts to reduce cutting speeds. This avoided the domain in which chatter is likely to occur, at the cost of reduced productivity. Clearly, the more knowledge about when chatter will occur, the less safety margin is needed.<sup>6</sup>

To operate an untended FMS (Flexible Manufacturing System) requires even more knowledge than is needed to operate an equivalent set of NC tools. An FMS "lacks the stand-alone NC machine's almost constant attention from a machine operator, who can compensate for small machine and operational errors by realigning parts in a fixture, tweaking cutting tools, visually inspecting parts between workstations, and so forth." In the absence of this constant attention, small problems at one workstation can accumulate, and the number of possible contingencies that must either be prevented (which requires detailed understanding of their causes) or otherwise dealt with is much larger for FMS than for NC machines.

Consider the problem of tool breakage. A nearby operator can quickly detect a break, stop the machine, visually inspect the part for damage, instruct the machine to change tools, and take other corrective action. Although an operator can explain this sequence to an NC programmer, to equip a machine to detect a break is exceedingly complex. It took years for machine-tool makers to develop sufficient knowledge to add tool breakage and chatter detection to machine tools. Even when it detects a break, what response should the machine make? To diagnose the type of break and choose the best from among a set of possible responses requires considerable knowledge.

---

<sup>6</sup> A complementary approach developed later was to redesign machine tool structures to reduce the conditions under which chatter would occur. This required considerable research in applying mathematical theories of feedback and vibration. It is a superior solution in that it allows the tool to actually run faster without chatter. [26]



Jaikumar discusses the difficulties of problem solving in an FMS. The reason operators had to become knowledge workers, rather than vendors developing the necessary knowledge and selling their machines at a premium, is that much of the requisite learning and problem solving must be done at a local level. At the highest levels of speed and precision, individual machines exhibit idiosyncratic quirks that must be identified and compensated. Moreover, each plant, production line, and part number has specific characteristics and requirements. Owing to the interactions among all these variables, the preponderance of problems tend to be novel and local, although over time general knowledge can be built up and incorporated into machines and operating methods.

Research on process monitoring and response continues using a variety of advanced techniques. [21] A fundamental obstacle to process monitoring is that the working region of a machine tool is an extremely messy environment contaminated by coolant, chips, vibration, noise, dirt, and such. This exemplifies the problem of side effects. Energy applied in any form creates many children, of which only a few are desired. But all of the children propagate through the causal network, potentially causing disturbances at many points. Side effects are central to the nature of manufacturing and we return to them in the concluding Section.

The other development of the CIM/FMS epoch, computer integrated manufacturing (CIM), required additional knowledge about how to predict the behavior of part designs and manufacturing processes.

An engineer working with a number of different parts geometries could create and test [using simulation] different alternatives, settle on a tentative design, and then examine the manufacturing impacts of each part. A host of manufacturing related computer programs could then be used to create the NC programs needed to machine the components and even graphically display the tool path of a metal cutting program on the screen. When satisfied with the design, the engineer could transfer the program to a machining center and have the components fabricated automatically. [15, Section 8]

These simulations, and other capabilities embedded in CIM tools, rely on extremely high levels of knowledge about many phenomena. Complex systems of mathematical equations or equivalent algorithms are needed to model interactions among large numbers of variables and the knowledge generated must be “reduced to practice,” that is, embedded in the CIM system, by applying additional formal knowledge of yet another kind. CIM software is never perfect; gaps become apparent as new manufacturing methods, product designs, and materials are introduced. Considerable improvement also occurs over time in the number of phenomena that can be incorporated, accuracy of the models, and speed of computational algorithms.

### 3.4. New Physical Processes

Firearms manufacture at Beretta makes a particularly good longitudinal case study of manufacturing in part because the core technology – the dominant product design, material, and processing methods – changed surprisingly little over 200 years. Steel tools on powered machines progressively removed metal chips to make metal parts.

The latter part of the 20th century saw a variety of fundamentally different metal-working methods based on new physical principles. These were potentially available for making firearms. When a mature and well understood technology is replaced by a less understood newer technology, how does the causal knowledge graph change, and what are the consequences? Since new physical technologies are critically important to long-term progress in most industries, we discuss several examples in more detail than warranted by their current importance to firearms manufacture.

New methods of precision machining – among them, electrical discharge, electrical chemical, abrasive water jet, and ultrasonic machining – employ entirely different physical principles to remove metal from workpieces.<sup>7</sup> Electrical discharge machining (EDM), for example, removes material by means of thermal energy generated by a spark across a gap between the tool and workpiece. The spark produces an extremely high temperature (up to 10,000°C) plasma channel

---

<sup>7</sup> Technology descriptions are from [31].

that evaporates a small amount of material. As the tool and workpiece move according to a computer-controlled trajectory, the spark shifts and the workpiece is shaped.

Removing material by vaporizing it with a spark clearly involves different variables than cutting it with a metal tool. EDM process performance is unaffected by the *hardness*, *toughness*, and *strength* of the material, but is affected by *melting temperature*, *thermal conductivity*, and *electrical conductivity*, the converse of the variables that matter in conventional machining. Dimensional tolerances of three microns can be achieved. Increasing the peak current can increase the machining rate, but the surface finish becomes rougher. Maximum production rates are also limited because at too high a power, tool wear becomes excessive, machining becomes unstable, and thermal damage occurs.

In electrical chemical machining (ECM), used to make rifle barrels among other applications, an electrolytic fluid is pumped between the tool and workpiece and current is applied to the tool. A variety of electrolytes can be used. The workpiece surface material dissolves into metal ions that are carried away by the fluid. ECM performance, like the performance of EDM, is unaffected by the *strength* and *hardness* of either tool or workpiece and is affected by their *electrical parameters*, but unlike EDM, performance is unaffected by their *thermal* behavior.

Why use ECM instead of EDM when both processes can machine any electrically conductive material? ECM can fabricate parts with low rigidity such as those with thin walls. It is much faster and gives better surface finish, but has poor accuracy because the pattern of electrical current flow with a given tool is influenced by many factors and difficult to predict. Tool shape must thus be modified by trial and error before making actual workpieces. Even then accuracy is only 10 to 300 microns, which is greatly inferior to that achieved with EDM.

Abrasive water jet machining involves spraying water mixed with abrasive particles onto a workpiece. The particles remove material. Typically, the water pressure and velocity are extremely high, approximately one million pounds per square inch and supersonic, respectively, so safety and noise issues are important. Abrasive water

jet machining can shape ceramics and other nonconductive materials that ECM and EDM cannot, and which conventional machining has difficulty with. Not surprisingly, the characteristics, problems, and variables associated with abrasive water jet machining vary markedly from those encountered in ECM and EDM machining.

With such different variables and different physical principles, new processes start with less detailed causal knowledge graphs. Over time, new variables are identified as important, and new techniques developed to increase precision, speed, and other figures of merit. Table 3.3 shows some of the factors thought to influence ECM performance, very few of which are relevant to conventional machining. It is significant that trial and error are still required to choose the final ECM tool shape and, even then, the process is less accurate than other removal methods. This means that important portions of the causal network that determine final workpiece shape are not well understood. It was only recently, for example, that ECM accuracy was shown to improve with pulsed instead of continuous voltage. [31, p 13–32] Knowledge about ECM variables reported in Table 3.3 is at a much lower level than that about conventional machining, and overall the process remains much closer than conventional machining to art.

As always, knowledge develops by progressive exploration and refinement of the causal knowledge graph. Before a technology can be used, precision must be adequate and cost reasonable, at least for favorable applications. Once in use, a host of intermediate variables can be further improved as more is learned. For example, electrolysis is an undesirable side effect that corrodes the surface of parts in EDM (Figure 3.2).

Electrolysis, intrinsic to the early days of EDMing and continuing until the early 1990s, is caused by stray voltage from the cutting process interacting with contaminant in the dielectric fluid and attacking the workpiece. Electrolysis is particularly problematic when machining titanium, carbide, and stainless and mold steels, all of which suffer from poor surface integrity and shortened tool life due to the effects of electrolysis. They often require significant secondary machining operations and excessive polishing, which affect the overall accuracy of the machined part. Titanium turns

| Subsystem                            | Key Determinants of ECM Performance           |
|--------------------------------------|---|
| Electrical power system              | <b>Current</b>                                |
|                                      | <b>Current areal density</b>                  |
|                                      | <b>Voltage</b>                                |
|                                      | <b>Pulse shape</b> (on time, rise rate, etc.) |
| Electrolyte composition              | <b>Aqueous or nonaqueous</b>                  |
|                                      | <b>Organic/inorganic; specific molecules</b>  |
|                                      | <b>Alkalinity</b>                             |
|                                      | <b>Mixtures</b>                               |
|                                      | <b>Contamination</b>                          |
|                                      | <b>Passivating or nonpassivating</b>          |
| Electrolyte circulation system       | <b>Flow rate</b>                              |
|                                      | <b>Pressure</b>                               |
|                                      | <b>Temperature</b>                            |
|                                      | <b>Concentration</b>                          |
| Tool design; tool/workpiece geometry | Contour gradient                              |
|                                      | Radii   |
|                                      | <b>Flow path</b>                              |
|                                      | <b>Flow cross section</b>                     |
|                                      | Tool feed rate                                |

Table 3.3 Key variables affect electro-chemical machining; new variables in bold (based on [31])

“blue,” while stainless steel can be weakened by a thick recast layer; tool steels rust; and carbide suffers degradation, the result of cobalt binder depletion. [34]

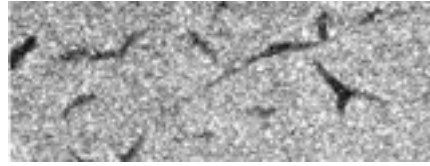

Fig. 3.2 Defects caused by electrolysis of carbide [34]

The leading vendors of EDM machines developed power supplies that reduced electrolysis without reducing cutting speed. Other improvements included better filtration of the electrolyte fluid and a variety of power-saving methods.

Whereas the new material removal processes are entirely different from conventional machining and require extensive new knowledge, some of the other causal knowledge subnetworks in Figure 1.5 change only modestly. For example, dimensional measurement methods for finished parts are similar no matter how a part is produced. An ECM machine is still numerically controlled, and knowledge about how to control movement during cutting requires only moderate additions. The mathematics of feedback control can be adapted for ECM rather than redeveloped from scratch. In most cases, taking full advantage of the different characteristics of the new process involves changes to the ancillary subsystems, but the causal knowledge graph requires only moderate additional *knowledge*, even if the optimal *method* turns out to be quite different.

Finally, progress from art to science for new processes being developed today is markedly faster than was the case for conventional machining. First, there is less to learn. Second, the fundamentals of art-to-science transition established by Taylor, namely reductionism, using systems of quantitative equations to express knowledge, and learning by controlled experiments, are well known and much more refined than when Taylor used them.<sup>8</sup> Third, the firearms industry, having lagged in the adoption of ECM and other new processes, can take advantage of knowledge developed elsewhere. Indeed, much of the

---

<sup>8</sup> And of course other learning tools are also available that were not available at comparable points in the development of conventional machining, such as sophisticated statistical methods, automated monitoring and data collection, and process simulation.

relevant knowledge need not even be thoroughly understood within the industry, as tools based on it can be purchased from suppliers, a consequence of the modularity property of knowledge graphs.

# 4

---

## From Art to Science

---

How should we characterize the evolution of manufacturing in the light of this examination of firearms over the course of two centuries? As Jaikumar showed, the central problem throughout the development of manufacturing has been achieving adequate process control. Once society moved beyond making unique items by hand, predictability, consistency, speed, and eventually versatility became key. All of these require control. Each successive epoch confronted problems whose solutions demanded new operating methods. Developing the solutions required deeper knowledge. The dual changes to procedures and their underlying knowledge constituted an evolution from art to science.

How procedures evolved is examined in Section 4.1. The regularity of changes in knowledge is considered in Section 4.2. The future of manufacturing is discussed in Section 4.3, as well as whether other activities of modern economies will reveal similar patterns.

### **4.1. Changes in Procedures**

Procedures specify what actions to take and how to perform them. The companion paper described how production evolved from completely idiosyncratic activities before 1800 to an all but unmanned manufactur-



ing plant in 1985 [15]. We can identify three major trends in procedures over these centuries: increasing specificity, increasing scope, and increasing depth in the causal network (Table 4.1).

To describe the first major trend in the evolution from art to science over the six epochs, how manufacturing activities have become more completely specified over time, we can construct a scale that measures the *formality* of procedures. At the extreme of zero procedure, no written or even mental plan of work exists; all actions are based on moment-by-moment decisions. At the opposite extreme of complete procedure, all activity is controlled by detailed written or programmed instructions. At intermediate points, high level instructions are specified, but details of implementation and responses to contingencies are left open. Over time, pictures became detailed written procedures. (Compare the sketches from the 18th century in Figure 2.3 of [15] with the 1950 operations sheet for the M1 rifle in Figure 6.3.) In parallel cams, jigs, and fixtures forced specified trajectories of machine motion – the principle of increasing mechanical constraint. The most formalized procedures can be realized in microprocessor-based systems, which require detailed instructions and allow for elaborate contingent behavior.

The second major trend was an ever expanding *scope* of activities governed by formal procedures. More machining subsystems (see Figure 1.5) were brought under explicit control. In the American System, for example, tools and methods were devised to control final inspection. In the Taylor epoch, proceduralization brought activities such as maintenance, tool making, and setup under formal control. With the debut of CIM and FMS, control of material flows, machine scheduling, and the translation of specifications from development into manufacturing were effected through computer programs. Untended operation of an FMS is possible today because virtually all normal activities including inspections, tool changes, and material movements are governed by programmed procedures.

The third trend we observe is increasing *depth* of control, measured by the number of generations controlled in the causal network. Consider an important intermediate variable such as cutting speed. Higher speed increases immediate output rates, but causes multiple problems. With greater knowledge, we can make a more sophisticated judgment of

| Nature of change        | Measure   |
|-------------------------|---|
| Formality of control    | Amount of detail used to specify procedures                                 |
| Scope/extent of control | Breadth of control, such as number of subsystems actively controlled        |
| Depth                   | Number of ancestral variables monitored or controlled for each key variable |

Table 4.1 Evolution of procedures from art to science

proper cutting speed, eventually reaching real-time decision-making. Although measuring more variables is costly and controlling them even more costly, depth of control tends to increase over time for reasons we discuss later.

Full proceduralization of all activities has never been achieved and in a dynamic world would be disastrous. Even in high volume repetitive manufacturing rare, diverse, or extreme circumstances will occur, and will not be well understood. To attempt to fully proceduralize them is counterproductive. For example, the response to emergencies should be “shut down the machine and signal for assistance.”

Moreover, the appropriate formality and scope of procedure fluctuates over time rather than increasing monotonically. When new processes or products are adopted, the initial level of knowledge is lower than before. Methods can be highly procedural and *bad* if knowledge is inadequate, as happened initially with NC machines. We now turn to the evolution of the underlying knowledge.

## 4.2. How Knowledge Evolved

Specific new knowledge was critical to each epoch, but changes in knowledge followed regular patterns from epoch to epoch. We can group the patterns, somewhat arbitrarily, into three categories. First, certain broad classes of problems recur, and make manufacturing inherently difficult. For example, more requirements are added over time. Second, there are classes of recurrent solutions, including the development of new mathematical methods for each epoch. Third,

causal knowledge graphs themselves have structure, and the structure evolves in specific ways. We address each in turn.

#### 4.2.1. **Why is Manufacturing Hard? Sources of Problems**

Presumably, every branch of human technology and endeavor has its own difficulties, but some are especially acute for manufacturing and came up in epoch after epoch.

**Growing list of requirements.** Additional outcome variables (system requirements) were added over time. Some were created by new product requirements propagating back through the causal network, such as the use of new raw materials.<sup>1</sup> In the modern era, emphasis increased on reducing side effects such as pollution, contamination, safety hazards, and noise.<sup>2</sup> Each new requirement forces rapid learning. Often, changes made to satisfy a new requirement interact with established portions of the process, leading to changes elsewhere.

**Both tolerances and operating speeds had to improve simultaneously.** Two fundamental manufacturing requirements are speed and precision/tolerance. At a given state of knowledge, operating speed can be traded off against conformance quality, including the tolerances achieved. A machine can be run slower to reduce its vibration; additional or more thorough inspection steps can be added to catch more problems; setups and calibrations can be done more often. Yet, both tighter tolerances and higher operating speeds were required in each epoch, for economic reasons. The only way to satisfy both was through better process control.

**Control of more and smaller disturbances.** Many important variables, such as the exact position of a tool relative to a cut surface, are influenced by dozens of ancestors. At a tolerance of 1/64th inch, many are too small to matter or even to detect, but at a few microns tolerance the number of relevant variables grows many-fold.

---

<sup>1</sup> Competitive dynamics drive many of these requirements; Beretta had to improve to keep up with other firms. This is the Red Queen paradox familiar to many industries – running faster and faster to stay in the same place.

<sup>2</sup> For example, in the 1980s Beretta engaged in a bitter fight to win a contract for a new US military sidearm. Winning required meeting a multitude of requirements, including local production.

**Control of side effects.** Wherever energy is applied in a process, it creates side effects such as heat, vibration, contamination, and electromagnetic interference that are transmitted through the local environment. Because of the sensitivity of high-precision operations, these can cause significant difficulties in disparate portions of the process. Control of heat during cutting, for example, is a side effect that has been a concern for more than a century, forcing more detailed understanding of its causes and effects (see [15], Figure 8.3). Taylor demonstrated the importance of coolant, but as tolerances tighten heat cannot be adequately removed from the cutting zone, so its effects must be compensated for. This requires much more knowledge than for cooling. And as operating speed increases, the magnitudes of side effects increase, even without considering tightening tolerances.

If we define side effects as “undesired descendants of a variable,” there are also many direct side effects of process and machine designs. For example, a tool can be strengthened by making it larger, but this changes its thermal properties and requires larger motors to move it.

**Solved problems may recur.** A solution that is adequate at one level of performance may be inadequate when requirements such as speed of production change, or when side effects from elsewhere increase. When this happened, old solutions were refined and new ones added.

#### 4.2.2. Measurement, Feedback, and Other Recurrent Solutions

Just as some problems are ubiquitous in manufacturing, some classes of solutions were vital to solving diverse problems across epochs.

**New Mathematical Methods.** New mathematical techniques supported the creation and articulation of knowledge in each epoch. Projective geometry ushered in the English System and simultaneous equations and custom slide rules were central to the calculations that were a hallmark of the Taylor system. Later epochs evolved on the back of statistical methods such as design of experiments in the SPC epoch, programming languages and Proportional-Integral-Derivative control in the NC epoch, and 3-D CAD and simulation techniques like FEM in the CIM epoch.

**Strategies for Controlling Variation.** Three generic strategies for controlling variation in a key variable are modifying the process to make it more robust, reducing variation in the most influential ancestors, and adding feedback control. An example is the problem of chatter discussed in Section 3, which can be solved by close operator monitoring of the machine, by reducing the speed of cutting, or by reinforcing the machine structure to reduce vibration.

**Feedback-based control.** Because causal knowledge graphs are never perfect renditions of the true causal network, all manufacturing depends on feedback, and increasing sophistication of feedback was a hallmark of evolution in procedures and knowledge. Consider an important intermediate variable  $W = f(\mathbf{X}, \mathbf{V})$  where  $\mathbf{X}$  and its effects on  $W$  are well understood but the constituents of  $\mathbf{V}$ , or the relationships  $\partial f/\partial \mathbf{V}$ , at low stages of knowledge. As  $\mathbf{V}$  varies according to its own causal network, it creates stochastic variation in  $W$  with no visible cause. One solution is to learn more about  $f$  and  $\mathbf{V}$ , and learn to control the most important elements of  $\mathbf{V}$ , but this is time-consuming and expensive. The genius of feedback is that  $W$  can be partially stabilized without understanding  $\mathbf{V}$ , by manipulating one or more elements of  $\mathbf{X}$  to compensate for measured changes in  $W$ . Feedback can also be used to reduce variation in  $W$  caused by parents in  $\mathbf{X}$  that are known but expensive to control. Learning enough about  $\mathbf{X}$  and  $\partial f/\partial \mathbf{X}$  to use feedback thus constitutes a critical step in learning to control  $W$ . It can change  $W$  from adjustable (stage 3 of knowledge) to capable (stage 4). As a result, *feedback is a general technique for interrupting the propagation of variation downstream through a causal network.*

**Improvements in measurement.** Feedback has serious limitations, one of which arises from the fact that  $W$  cannot be measured perfectly. Control of a variable by feedback is bounded by how well that variable is measured, and the evolution of measurement knowledge has played a key role in the evolution of manufacturing. Even where direct feedback is not used, accurate measurement is needed for calibration, adjustment, verification, and especially for learning.

Measurement techniques are production processes for information, with their own causal knowledge graphs, so knowledge about metrology evolved according to the patterns described here. Although measurement

technology often arrived from other industries, additional knowledge about how to use it effectively still had to be developed. For example, many measurement techniques are very sensitive to environmental disturbances, which are context dependent.

Accuracy, precision, repeatability, and related attributes are critical outcome variables for measurement processes. Less obvious is the importance of measurement *speed*. Because information turnaround time is a critical determinant of the effectiveness of feedback of all kinds, faster measurement enables better process control. If measurement takes several days, feedback cannot compensate for faster change such as diurnal or setup-caused. Faster measurement also increases the speed of subsequent learning [8, 38].

Measurement methods for a variable therefore tend to evolve through a sequence of techniques as metrology knowledge advances.<sup>3</sup>

- Measurement is generally first developed in a laboratory. To the extent that it is used in manufacturing, it is performed off-site using special equipment. This is acceptable because the variable is not measured routinely, but rather used in lab experiments.
- As metrology vendors develop special purpose tools embodying the new techniques, measurement is performed in specialized, on-site test labs. Although information turnaround can take days, such measurement can still be useful for field experiments, troubleshooting, checking incoming materials, and supporting various kinds of quality assurance, as well as calibrating production equipment and instruments.
- As technology progresses, measurement is performed on the factory floor in specific workstations. This was the norm for control charting and for measuring test pieces at the start of a batch.
- Measurement tools are built into machines, but the machine must be halted while a measurement is taken.

---

<sup>3</sup> Specifics of this sequence are based on unpublished notes on measurement in semiconductor and hard disk drive manufacturing.

- If a particular variable becomes important enough and is hard to control except by real-time feedback, measurement is ultimately performed while the machine is operating, with results available immediately.

Often, several different physical principles can be used to measure a variable. With different combinations of speed, precision, and cost, different methods are often employed concurrently at different locations. Economics plays a significant role in decisions about which variables to measure and how.

#### 4.2.3. Structure and Evolution of Knowledge Graphs

Causal networks for actual working systems such as factories reflect the specifics of the design, construction, and operation of that system. But they are determined by natural laws, operating at levels from the atomic and nanosecond (chemical reactions and semiconductor gates) to tens of meters and days (inventory flows in a bulk processing plant). Knowledge graphs, which approximate the underlying causal network, are further constrained by the way people and organizations learn. Based on the cases discussed here and in [15] we can describe these graphs and how they changed.

**Increasing local complexity.** Knowledge graphs for individual phenomena become more complex over time. Added complexity includes first the addition of previously unrecognized variables, second ever deeper graphs comprising more generations of ancestors, and third a growing number of links due to discovering additional relationships among variables.

**Rising stages of knowledge for variables and relationships.** Discovering *new* variables and causal relationships changes the structure of the knowledge graph. But learning can also improve knowledge about previously identified variables and causal relationships. This does not change the structure of the graph, but does change the stage of knowledge of individual elements. Many variables that are eventually tightly controlled (i.e., at stage 4) were at one time only recognized (i.e., at stage 1). For example, Taylor's serendipitous discovery that tool steel could be improved by (what we now call) heat treatment took

hardening from stage 0 (unknown) to stage 3 (adjustable). Decades of subsequent research led to a scientific model of the key relationships that brought knowledge to stage 4 (capable).

**Multiple solutions.** Because the causal networks that determine outcomes are complex, problems can usually be solved in multiple ways. For example, a causal path connecting a source of variation to a harmful effect can be interrupted at many links. Effectiveness, amount of new knowledge needed, and side effects vary for different solutions. New solutions are usually added, rather than replacing old ones.

**Backwards evolution of knowledge graphs.** Knowledge tends to evolve backwards. Deeper understanding of what causes a variable to vary hinges on a fuller understanding of parental relationships. Sometimes the parents can be partially controlled directly, but refining control of the parents requires understanding the grandparents, and so on.

**Punctuated gradualism.** Knowledge evolved by “punctuated gradualism,” meaning incremental learning interspersed with occasional technological discontinuities. Incremental learning takes the form of gradual accretion of knowledge about phenomena, and gradual adjustments of procedures and tools. Discontinuities occur when the introduction of a new technique or requirement forces rapid learning about a host of new phenomena, and re-visiting many old variables, such as occurred with electro-chemical machining.<sup>4</sup> Epochal shifts in manufacturing were marked by multiple discontinuities in parallel, but local discontinuities can occur at any time.

**Causal networks are not tree-structured.** It is convenient to model complex systems as hierarchical trees of systems and subsystems, and many authors including Vincenti have emphasized hierarchical decomposition of technological devices. However, causal networks are thickets and not trees.<sup>5</sup> That is, variables have multiple descendants and not just multiple parents. This makes them much more difficult to analyze and control. Changes to one variable, intended to produce a desired effect in a particular descendant, will also change many other

---

<sup>4</sup> This is a purely technological definition of disruptive change.

<sup>5</sup> Decompositions of systems into subsystems also differ from knowledge graphs in that links are not based on causal relationships.



descendants, often in undesirable ways. Environmental side effects are an example, but the phenomenon is much more general.

**Modularity.** As a partial substitute for tree-structure, manufacturing processes have some degree of modularity in their causal networks, and therefore in their knowledge graphs. This was demonstrated by Taylor's use of reductionism, which would not have worked without modularity (Section 2.3). In a near-modular network, although changing one variable will have many effects, most of the descendants are close to the original change. Closeness is measured by length of the causal path, but short paths usually correspond to physical closeness as well. In a modular process other subsystems can be ignored except for effects that propagate through the small number of relationships between modules.<sup>6</sup>

A very useful form of modularity is the sequential relationship among steps in a manufacturing process, such as raw material  $\rightarrow$  shaped part  $\rightarrow$  assembly  $\rightarrow$  tested product. Each step can be treated as a module, with many internal causal links and few external links. Furthermore, causal paths that link different steps/modules can only occur through one of three mechanisms: information flows, environmental side effects, and by far the most important, physical transfer of work in process (WIP). So, if something goes wrong with an upstream process it can be detected, at least in principle, by looking at the properties of the WIP. Clever rearrangement of WIP can quickly isolate a problem to a single step/module.

**Fractal nature of knowledge graphs.** The more closely a causal system is examined, the more detail it contains. To a plant manager, a phenomenon such as rework might be summarized by a single variable, whereas a process engineer will have complex and evolving knowledge of the same phenomenon. On a very different scale, a process engineer can alter a machine's behavior by setting a few parameters in a PID controller, but the activity set in motion by those parameters includes electrons flowing through millions of gates inside a microprocessor. As a result, the patterns discussed above, such as punctuated gradualism, occur on multiple scales. To the plant accountant, rework

---

<sup>6</sup> [32] has a detailed discussion of hierarchy versus modularity in metabolic networks.

evolves smoothly, while to the process engineer it is the result of multiple discrete changes, some of them radical.

### 4.3. The Quest for Perfect Science

We have seen that the progression of manufacturing from art towards science consisted of advances in knowledge and the methods that embody it. Each epoch brought major improvements; rework at Beretta declined from more than fifty percent to less than one percent of activity. Can we predict that at some point knowledge will be perfect? To what extent can we say that manufacturing approaches the “end of its history,” with complete understanding, absolute predictability, ideal performance, and nothing left to learn?

The answer is in two parts. Day-to-day production that exploits existing knowledge can approach this level. But dynamic tasks such as problem solving, design, and technology development, which extend knowledge, will always be a mixture of art and science.

For production in a static world, meaning a well-established process turning out a mature, thoroughly understood product for a known marketplace, it is feasible to bring processes to a level at which there is little left to learn and virtually all (normal) activity is highly procedural. The Taylor System was the apotheosis of this static view of manufacturing. Indeed, Taylor might be ecstatic about both how much is known by engineers today and how well procedures are executed by machines. Yet even when knowledge is virtually complete, some rare disruptions will necessitate human intervention.

But more fundamentally, the manufacturing world is not static. Competitive pressure, progress in upstream technologies such as materials science, and new features demanded by customers will inevitably drive the development of new products and new processes to produce them. Almost by definition, these products and processes will push the limits of what is known, and will therefore enter production only part way along the art-to-science spectrum.

Furthermore, the key tasks in a dynamic world are those of learning and problem solving, which are far from perfect science. Consider, for example, the problem of discovering and fixing a variety of

intermittent problems that are detected at the end of a long production process. Questions that must be approached more as craft than procedure include: Which problems do we work on first? Who should be assigned to a particular problem? How should overall problem-solving efforts be organized? Having diagnosed a problem, where in its causal network should we attempt to fix it? How do we know we have actually solved a problem? When should we drop a problem and move on to something else? Are several different problems manifestations of single underlying problem?

Such questions involve ambiguity and uncertainty, and answering them requires expertise. Learning and problem solving, because they will continue to require human judgment and intuition, will never reach full procedure or full knowledge. Balconi in a study of recent changes in European manufacturing industries reaches the same conclusion:

[T]raditional tacit skills of workers have become largely obsolete and modern operators on the shop floor are mainly process controllers and low-level problem solvers. Alongside this, the acceleration of innovation has made high-level problem solvers increasingly important. Tacit knowledge has thus remained crucial, but it has become complementary to a codified knowledge base and concerns problem solving heuristics, interpretation of data, etc ...

In fact the performance and survival of firms depends on the individuals' ability to solve problems, to control, to improve processes, to find new technical solutions and to design new products, to integrate various "bodies of understanding" and to build relations with clients and interpret market trends. In conclusion, whereas the product of searching activity in the technological field is codified knowledge (know-how and know-what), it is the process of searching itself and of creating new artifacts which is embodied in individuals (depending on acts of insight). [6]

Yet, although learning activities will never reach the level of static manufacturing tasks, there was considerable progress toward science from Taylor to the present. Table 4.2 summarizes some of the important developments, most of which are soft tools that assist experts.

Currently, the leading industry for innovation in learning methods and tools is probably semiconductors. There, the economic rewards for faster development and ramp-up are high, and the high noise levels and long time lags in semiconductor fabrication mandate use of more procedural learning methods.<sup>7</sup>

Finally, the engineering disciplines of control theory and artificial intelligence have made modest progress towards formal computerized learning in well-structured systems. Adaptive control methods can compensate for minor design errors and component failures. Some of the more ambitious systems gradually moving from academia into the semiconductor industry use explicit causal models of the system being controlled. Both theoretical models (stage 4 of causal knowledge) and empirical fitting to statistical data (stage 3) are employed. Such systems can monitor a sequence of steps in photolithography, continuously monitoring the process and detecting out-of-control equipment. Although we can expect continued incremental progress towards automatic systems for refining coefficients when the structure of the causal network is already known, unstructured learning has resisted automation and is likely to do so for the foreseeable future.

#### **4.3.1. Non-Manufacturing Applications**

We have examined the evolution of manufacturing and the structure of the knowledge that supports it; but the structure of knowledge for some other technologies is similar. Consider the analogy between manufacturing and air transportation systems. A factory is a complex system organized to transform raw materials into useful products, quickly and precisely. An airline is a complex system involving aircraft, maintenance, airports, and air traffic control organized to move individuals from one location to another, quickly, precisely, and reliably. Both factory and airline are designed and operated using technological knowledge, specifically physical cause and effect relationships that can be modeled as causal knowledge graphs. Among the many analogies, both are heavily concerned with maintaining control despite variation

---

<sup>7</sup> This is a vast topic. [13; 10; 43]

| Invention   | Epoch of first use | Area of improvement*                                       |
|---|--------------------|--|
| Controlled experiments  | Taylor             | Signal to Noise ratio (S/N)                                |
| Systems analysis using reductionism   | Taylor             | Information Turnaround Time (ITAT)                         |
| Mathematical modeling of phenomena  | Taylor             | Cost, ITAT, S/N, generalizability beyond conditions tested |
| Statistical concepts and techniques (e.g. control chart, regression, experimental design) | SPC                | S/N  |
| Using science-based explanations of phenomena   | SPC                | Generalizability; use of outside knowledge                 |
| Computer simulation of processes or products  | CIM/FMS            | Cost, ITAT, S/N  |
| Massive database of process variables (Factory Information System)                        | NC                 | Facilitates natural experiments e.g. data mining           |
| Interaction between academic research and field problems                                  | NC                 | Use of outside knowledge                                   |
| Faster, more precise measurement methods  | All                | ITAT, S/N  |
| * Principal impact of innovation on learning; terminology from [8]                        |                    |  |

Table 4.2 Selected innovations in methods of learning

in the environment: weather for aviation, conditions inside the plant for manufacturing.

Given these similarities, it is not surprising that we see analogous patterns in the evolution of procedures and knowledge in the two sectors. Methods of flying, guiding, and maintaining aircraft have become more scientific with increasing scope, increasing depth, and increasing formality, exemplified by the “automated cockpit” of contemporary commercial aircraft. As far as knowledge about aviation, there are analogs of most of the evolutionary patterns discussed in Section 4.2,

such as a growing list of requirements (passenger comfort; noise control at airports; anti-piracy), use of new mathematical methods (extensively discussed by Vincenti), feedback-based control, and improvements in measurement.

Vincenti has an excellent example of raising the knowledge stage of variables, specifically the struggle to identify variables that measure flying-qualities of different aircraft. This is defined as the ease and precision with which a pilot can control an aircraft. Initially, test pilots could express an opinion about an aircraft as “easy” or “hard” to control, but these subjective judgments were at stage 1 of knowledge. Decades of research were needed to fully define the key variables that should be used as formal specifications for designers. A report from 1937, for example, discusses how to measure 17 different variables during test flights of new aircraft. With hindsight, it is easy to overlook the initial confusion about the existence and definition of variables. Modern engineers routinely use a variable called “stick force per g” but “express amazement that any [other] maneuverability criterion ever existed and that it took [more than five years] to develop.” [41, p 96]

Similarities in the evolution of aviation and manufacturing are not too surprising given the extreme dependence of both on physical processes. For a less similar industry, we might look, for example, at the back rooms of banks and other information processing “factories.” Did such industries exhibit epochal shifts in the nature of work, from craft to functional specialization to statistical process control to, ultimately, process intelligence? Certainly we can point to many non-manufacturing industries in which managing intellectual assets is now critical, but historical research would be needed to investigate parallels with the intellectual shifts in firearms manufacture.

What about intellectual tasks such as design? The processes by which products are designed, the necessary supporting knowledge, and the tools employed by product designers all evidence evolution from art to science as we have defined it. As underlying knowledge about how products can be made to work becomes more elaborate, causal knowledge graphs grow. Design methods become more formal and procedural and portions of the design task more heavily automated. Draftsmen, for example, are no longer needed to translate design intent

into engineering drawings and design calculations that used to employ slide rules now employ digital simulation.

The types of knowledge identified in Vincenti's studies of aeronautical design, however, go beyond the knowledge of physical cause and effect that we have considered. His engineers made extensive use of meta-knowledge – knowledge about how to manipulate causal knowledge to arrive at new designs (not his terminology). One of Vincenti's knowledge categories is *design instrumentalities*, the understanding of how to carry out the activities of design. One type of design instrumentality is structured design procedures such as optimization, satisficing, and deciding how to divide a system into subsystems. Less tangible design instrumentalities include ways of thinking such as visual thinking and reasoning by analogy, and judgmental skills such as intuition and imagination. [41, p 219ff]

Vincenti points out an equally important class of meta-knowledge, namely the methods used to extend causal knowledge, which he classifies into invention, transfer of knowledge from science, theoretical engineering research, design practice, experimental engineering research, production, and direct trial. The methods Taylor used to develop manufacturing knowledge correspond roughly to the last three methods in Vincenti's list. The first three were also relevant in various epochs, such as theoretical engineering research on the forces and geometry of metal cutting in the 1950s.

Learning methods and design instrumentalities are meta-knowledge about how to create and then exploit causal knowledge about underlying physical systems. As with physical manufacturing, specific design and learning tasks that used to require experts can now be done by soft tools. Nevertheless, because they will always depend partly on creativity and human intuition, design and especially learning will never approach perfect science.<sup>8</sup>

---

<sup>8</sup> A number of engineers, managers, and academics contributed to this research. Most important was R. Jaikumar, who under better circumstances would have co-authored this paper. He was my collaborator on many of its ideas. Special thanks to Jai's former editor, John Simon, for his work on the manuscript. Paul Dambre of Bekaert, who uniquely combines mastery of both scientific theory and manufacturing practice in his industry, patiently shared his expertise and was always an eager sounding board and experimenter. None of them bears responsibility for errors and omissions. REB

## References

---

- [1] H. G. J. Aitken, *Taylorism at Watertown Arsenal; scientific management in action, 1908–1915*, Harvard University Press, Cambridge, Mass., 1960.
- [2] Maryam Alavi and Dorothy E. Leidner, “Review: Knowledge management and knowledge management systems: Conceptual foundations and research issues,” *MIS Quarterly*, vol. 25, no. 1, pp. 107–, 2001.
- [3] Anonymous, *The Theatre of the present war in the Netherlands and upon the Rhine: containing a description of all the divisions and subdivisions, rivers, fortified and other considerable towns, in the ten catholick provinces, the south-west part of Germany, the frontiers of France towards each, and all Lorraine, including the whole scene of military operations, that may be expected during the hostilities in those countries: with a general map, sixty eight plans of fortified places, and seventeen particular maps, upon a larger scale of the territories round most of the chief cities: also a short introduction to the art of fortification, containing draughts and explanations of the principal works in military architecture, and the machines and utensils necessary either in attacks or defences: also a military dictionary, more copious than has hitherto appear’d, explaining all the technical terms in the science of war*, J. Brindley, London, 1745.
- [4] Diane E. Bailey and Julie Gainsburg, *Studying Modern Work: A “Knowledge Profile” of a Technical Occupation*, May 17, 2004.
- [5] Margherita Balconi, *Codification of technological knowledge, firm boundaries, and “cognitive” barriers to entry*, DYNACOMP Working Paper, 2002.
- [6] Margherita Balconi, “Tacitness, codification of technological knowledge and the organisation of industry,” *Research Policy*, vol. 31, no. 3, pp. 357–379, 2002.
- [7] Carl G. Barth, “Slide rules for the machine shop as a part of the Taylor system of management,” *ASME*, vol. 25, pp. 49–62, 1904.



- [8] Roger E. Bohn, *Learning by Experimentation in Manufacturing*, Harvard Business School, working paper 88-001, June, 1987.
- [9] Roger E. Bohn, "Measuring and managing technological knowledge," *Sloan Management Review*, vol. 36, no. 1, pp. 61–73, 1994.
- [10] Roger E. Bohn, "Noise and learning in semiconductor manufacturing," *Management Science*, vol. 41, no. 1, pp. 31–42, 1995.
- [11] Roger E. Bohn and Ramchandran Jaikumar, "The development of intelligent systems for industrial use: An empirical investigation," In: *Research on Technological Innovation, Management and Policy*, Rosenbloom, Richard, JAI Press, Greenwich Connecticut, vol. 3, pp. 213–262, 1986.
- [12] Edward W. Constant, "Why evolution is a theory about stability: Constraint, causation, and ecology in technological change," *Research Policy*, vol. 31, pp. 1241–1256, 2002.
- [13] Daren Dance and Richard Jarvis, "Using yield models to accelerate learning curve progress," *IEEE Transactions on Semiconductor Manufacturing*, vol. 5, no. 1, pp. 41–46, 1992.
- [14] Amy C. Edmondson, Ann B. Winslow, Richard M.J. Bohmer, and Gary P. Pisano, "Learning how and learning what: Effects of tacit and codified knowledge on performance improvement following technology adoption," *Decision Sciences*, vol. 32, no. 2, 2003.
- [15] Ramchandran Jaikumar, "From filing and fitting to flexible manufacturing: A study in the evolution of process control," *Foundations and Trends® in Technology, Information and Operations Management*, vol. 1, no. 1, pp. 1–120, 2005.
- [16] Ramchandran Jaikumar and Roger E. Bohn, "The development of intelligent systems for industrial use: A conceptual framework," In: *Research on Technological Innovation, Management, and Policy*, Rosenbloom, Richard S., JAI Press, London and Greenwich, Connecticut, vol. 3, pp. 169–211, 1986.
- [17] Ramchandran Jaikumar and Roger E. Bohn, "A dynamic approach to operations management: An alternative to static optimization," *International Journal of Production Economics*, vol. 27, no. 3, pp. 265–282, 1992.
- [18] Bruce Kogut and Udo Zander, "Knowledge of the firm and the evolutionary theory of the multinational corporation," *Journal of International Business Studies*, vol. 24, pp. 625–645, 1993.
- [19] Ranga Komanduri, "Machining and grinding: A historical review of the classical papers," *Applied Mechanics Review*, vol. 46, no. 3, pp. 80–132, 1993.
- [20] Thomas R. Kurfess, "Precision manufacturing," In: *The Mechanical Systems Design Handbook*, CRC Press, 2002.
- [21] Robert G. Landers, A. Galip Ulsoy, and Richard J. Furness, "Process monitoring and control of machining operations," In: *The Mechanical Systems Design Handbook*, CRC Press, 2002.
- [22] M. A. Lapré, A. S. Mukherjee, and L. N. Van Wassenhove, "Behind the learning curve: Linking learning activities to waste reduction," *Management Science*, vol. 46, no. 5, pp. 597–611, 2000.
- [23] Michael A. Lapré and Luk N. Van Wassenhove, "Managing learning curves in factories by creating and transferring knowledge," *California Management Review*, vol. 46, no. 1, pp. 53–71, 2003.

- [24] Steven Y. Liang, "Traditional machining," In: *Mechanical Engineering Handbook*, CRC Press LLC, Boca Raton, pp. 13-9-13-24, 1999.
- [25] M. Eugene Merchant, "Mechanics of the metal cutting process I: Orthogonal cutting and the type 2 chip," *Journal of Applied Physics*, vol. 16, pp. 267-275, 1945.
- [26] M. Eugene Merchant, "An interpretive review of 20th century US machining and grinding research," *Sadhana*, vol. 28, no. 5, pp. 867-874, 2003.
- [27] Kazuhiro Mishina, "Learning by new experiences: Revisiting the flying fortress learning curve," In: *Learning by Doing in Markets, Firms, and Countries*, Lamoreaux, Naomi, Raff, Daniel, and Temin, Peter, University of Chicago Press, 1998.
- [28] John Newton, *An introduction to the art of logick: Composed for the use of English schools, and all such who having no opportunity of being instructed in the Latine tongue, do however desire to be instructed in this liberal science*, Printed by E.T. and R.H. for Thomas Passenger at the Three Bibles on London Bridge and Ben. Hurlock over against St. Magnus Church, London, 1671.
- [29] Judea Pearl, *Causality: Models, Reasoning, and Inference*, Cambridge University Press, Reprinted with corrections 2001, 2000.
- [30] Michael Polanyi, *The Tacit Dimension*, Doubleday, 1967.
- [31] K. P. Rajurkar and W. M. Wang, "Nontraditional machining," In: *Mechanical Engineering Handbook*, CRC Press LLC, Boca Raton, 1999.
- [32] E. Ravasz, A. L. Somera, D. A. Mongru, Z. N. Oltvai, and A.-L. Barabasi, "Hierarchical organization of modularity in metabolic networks," *Science*, vol. 297, pp. 1551-1555, 2002.
- [33] J. Sedger, *Art without Science, or, The Art of Surveying [Microform]: Unshackled with the Terms and Science of Mathematics, Designed for Farmers' boys*, Printed by Sampson, Chittenden & Crosswell, Hudson, N.Y., 1802.
- [34] Steve Szczesniak, "Anti-Electrolysis is pro EDM," *Modern Machine Shop*, 1998.
- [35] Frederick W. Taylor, "On the art of cutting metals," *Transactions of the ASME*, vol. 28, pp. 31-248, 1907.
- [36] Frederick W. Taylor, "The principles of scientific management," In: *Scientific Management (comprising Shop Management, The Principles of Scientific Management, and Testimony Before the Special House Committee)*, Harper & Brothers Publishers, New York, pp. xvi + 638, 1911.
- [37] Christian Terwiesch and Roger E. Bohn, "Learning and process improvement during production ramp-up," *International Journal of Production Economics*, vol. 70, no. 1, pp. 1-19, 2001.
- [38] Stefan H. Thomke, "Managing experimentation in the design of new products," *Management Science*, vol. 44, no. 6, pp. 743-762, 1998.
- [39] E. M. Trent, *Metal Cutting*, Butterworths, London, 2nd edition, 1984.
- [40] E. M. Trent and Paul Kenneth Wright, *Metal Cutting*, Butterworth-Heinemann, Boston, 4th edition, 2000.
- [41] Walter G. Vincenti, *What Engineers Know and How They Know It*, Johns Hopkins University Press, Baltimore, 1990.
- [42] Walter G. Vincenti, "Real-world variation-selection in the evolution of technological form: Historical examples," In: *Technological Innovation as an Evolu-*

- tionary Process*, Ziman, John, Cambridge University Press, Cambridge, pp. 174–189, 2000.
- [43] Charles Weber and Eric von Hippel, *Knowledge Transfer and the Limits to Profitability: An Empirical Study of Problem-Solving Practices in the Semiconductor Industry*, PICMET, Portland, 2001.
- [44] Robert S. Woodbury, *Studies in the History of Machine Tools*, MIT Press, 1972.