

Lawrence Berkeley National Laboratory

Lawrence Berkeley National Laboratory

Title

Lactonization and protonation of gluconic acid: a thermodynamic and kinetic study by potentiometry, nmr and esi-ms

Permalink

<https://escholarship.org/uc/item/6wr0j5k1>

Authors

Zhang, Z.
Gibson, P.
Clark, S.B.
[et al.](#)

Publication Date

2008-06-09

Lactonization and Protonation of Gluconic Acid: A Thermodynamic and Kinetic Study by Potentiometry, NMR and ESI-MS

Zhicheng Zhang,^{a, b} Paul Gibson,^a Sue B. Clark,^{a,*} Guoxin Tian,^b PierLuigi Zanonato,^{b,c} and Linfeng Rao^{b,*}

^aWashington State University, Pullman, WA 99164, U.S.A. E-mail: s_clark@wsu.edu

^bLawrence Berkeley National Laboratory, Berkeley, CA 94720, U.S.A. E-mail: LRao@lbl.gov

^cDipartimento di Scienze Chimiche, Università di Padova, via Marzolo 1, 35131, Padova, Italy

Abstract

In acidic aqueous solutions, gluconate protonation is coupled with lactonization of gluconic acid. With the decrease of pC_H , two lactones (δ/γ) are sequentially formed. The δ -lactone forms more readily than the γ -lactone. In 0.1 M gluconate solutions, if pC_H is above 2.5, only the δ -lactone is generated. When pC_H is decreased below 2.0, the formation of the γ -lactone is observable although the δ -lactone predominates. At $I = 0.1$ M $NaClO_4$ and room temperature, the deprotonation constant of the carboxylic group, using the NMR technique, was determined to be $\log K_a = 3.30 \pm 0.02$; the δ -lactonization constant, by the batch potentiometric titrations, was obtained to be $\log K_L = - (0.54 \pm 0.04)$. Using ESI-MS, the rate constants of the δ -lactonization and the hydrolysis at $pC_H \sim 5.0$ were estimated to be $k_1 = 3.2 \times 10^{-5} \text{ s}^{-1}$ and $k_{-1} = 1.1 \times 10^{-4} \text{ s}^{-1}$, respectively.

Key words: gluconic acid, protonation, lactonization, NMR, ESI-MS

1. Introduction

* Corresponding authors: s_clark@wsu.edu, LRao@lbl.gov

Gluconic acid, a polyhydroxyl carboxylic ligand, has been investigated for many years, mainly due to its importance in a variety of industrial, pharmaceutical and biological processes.^(1, 2) Many studies deal with solutions of high pH because gluconate forms strong complexes with metal cations in neutral to basic solutions.⁽³⁻⁷⁾ Fewer studies have been conducted in solutions of low pH, and thermodynamic data that describe solution behavior under acidic conditions are scarce and in disagreement. Two reasons likely contribute to this situation: 1) Under acidic conditions, the ability of gluconic acid to bind metal ions is weak or moderate,^(8, 9) making the studies less attractive for applications; 2) the studies at low pH are complicated by lactonization of gluconic acid,^(10, 11) a slow reaction that is coupled to fast chemical processes such as protonation/deprotonation and complexation. Though the formation of lactone is catalyzed by a hydrogen ion, lactonization as well as its reverse reaction (lactone hydrolysis) does not alter the acidity of solution. These complicating factors make direct determination of the protonation and complexation constants difficult by conventional techniques such as acid/base potentiometry under acidic conditions.

Recently, the complexation of gluconate with lanthanides and actinides has been a subject of study because gluconate is present in some high-level nuclear wastes and this presence affects the f-element speciation in the waste processing. The development of strategies for the treatment of those waste streams requires thermodynamic data concerning the f-element complexation under a wide range of proton concentrations (from acidic to basic). For this purpose, a description of protonation and lactonization of gluconic acid in acidic solutions is necessary.

Scheme I

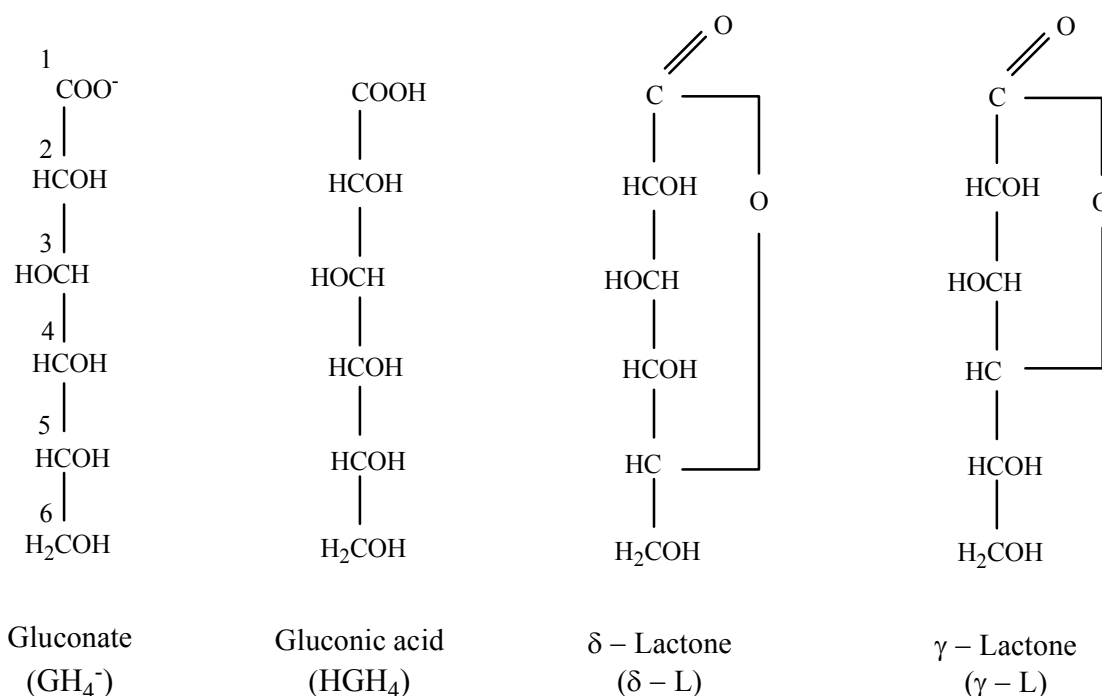

Gluconic acid refers to *D*-gluconic acid derived from natural *D*-glucose. To be consistent with the notations in the literature, gluconate, gluconic acid, and δ/γ-lactone, as shown in Scheme I, are denoted by GH₄⁻, HGH₄ and δ/γ-L, respectively, where the first H of HGH₄ refers to the proton on the carboxylate group and H₄ refers to four hydrogens on the secondary alcohols^(3, 12). The six carbon atoms are numbered from the top in order as C1 to C6.

In this paper, we report the thermodynamic and kinetic data on deprotonation and lactonization of gluconic acid. Our results were obtained by multiple techniques including ¹³C NMR spectroscopy, specially-designed potentiometric titrations, and electrospray ionization coupled with mass spectrometry (ESI-MS). This work aids in defining the conditions under which lactonization is important, the form of the lactones

that are produced, their rate of production, and the corrected protonation constant of the gluconate ligand under acidic conditions.

2. Experimental

Unless specifically described, all the experiments were conducted at $I = 0.1$ M NaClO₄ and room temperature. Deionized and boiled water was used in preparation of all solutions except those for the NMR experiments. All chemicals are reagent grade or higher. Sodium gluconate (Acros) was used as received without further purification.

All experiments except the NMR data collection were conducted under an inert atmosphere either by bubbling Argon through the solutions or by using a glove box filled with Argon.

2.1. NMR

NMR experiments were conducted to understand the deprotonation and lactonization of gluconic acid and further to determine the deprotonation constants. The stock solution of gluconate was prepared by dissolving sodium gluconate (NaGH₄) in 99.96% D₂O (Cambridge Isotope laboratories). Working solutions of gluconic acid were prepared by mixing appropriate amounts of the stock solution, DNO₃ (70% w/w in D₂O, Cambridge Isotope laboratories) or NaOD (40% w/w in D₂O, Cambridge Isotope laboratories), and D₂O. The final concentration of gluconate in the working solutions was 0.1 M and the acidity (pC_D or $-\log [D^+]$) ranged from 1.0 to 13.4. The prepared solutions were stored for three days before the ¹³C NMR spectra were recorded on a Varian 300 Spectrometer at the Center of NMR Spectroscopy in Washington State University. Separate

experiments had demonstrated that the time was sufficient for the lactonization to achieve equilibrium.

In the NMR measurements, the magnetic field was stabilized by locking to the D signal of the solvent. The sample temperatures were regulated to be 22.0 °C during all acquisitions. For individual samples, 5,000 to 10,000 scans were taken (with the proton decoupler turned on) and averaged to obtain the ^{13}C spectra. Sodium 2, 2 – Dimethyl – 2 – Silapentane – Sulfonate (DSS) was used to reference all ^{13}C NMR spectra, following the procedures reported elsewhere.^(13, 14) The pC_D of the solutions except the two “end” solutions was measured by a potentiometric procedure similar to that described in the next section. In this case, the electrode was calibrated by a standard acid/base titration in D_2O . The values of pC_D in D_2O were subsequently converted to pC_H in H_2O by the relationship: $\text{pC}_\text{D} = \text{pC}_\text{H} + 0.40$.⁽¹⁵⁾ The acidities of the two “end” solutions ($\text{pC}_\text{D} = 1.0$ and 13.4) were directly calculated from the quantities of D^+ and OD^- added in preparation of the working solutions because these values are beyond the working range of the pH electrode.

2.2. “Batch” potentiometric titration

Because gluconate protonation is coupled with the formation of lactone and the latter is a much slower reaction, a batch titration approach was designed to determine the lactonization constant, in conjunction with the protonation constant obtained from NMR experiments.

In a batch titration, a number of individual solutions containing the same quantity of gluconate were prepared. Different amounts of acid or base were added into each solution to simulate a titration, in which each solution represented a point in a typical titration.

After the solutions were stored for at least 3 days, the concentration of hydrogen ion in each solution were determined using a Metrohm pH meter (Model 713) equipped with a Ross combination pH electrode (Orion Model 8102). The electrode had been previously calibrated by a standard acid/base titration so that the *EMF* of the electrode could be converted to pC_H . A detailed description of the calibration of electrode is provided elsewhere.^(16, 17) Multiple batch titrations were conducted with solutions of different concentrations of gluconate. Given the protonation constants obtained from NMR, the constant of lactonization of gluconic acid was calculated with the program Hyperquad.⁽¹⁸⁾

2.3. ESI-MS

ESI-MS was explored to examine the formation of lactone and subsequently applied to estimate the rate constants of lactonization/hydrolysis. All ESI-MS measurements were performed on an Agilent 1100 series instrument – an electrospray ionization coupled with a quadrupole mass analyzer at Washington State University. A sample was injected into the electrospray by pressure infusion (50 mBar), and run with the following instrumental conditions: (1) 3500 V negative tip voltage, (2) 110 fragmentor factor, (3) 4.0 mL/minute flow rate of the sheath liquid, (4) 25 PSI spray gas, and (5) 150 °C drying gas. The mass spectrum of each run was averaged out from the recorded Total Ion Flow (TIF) data.

A gluconate stock solution was prepared by dissolving sodium gluconate into water. A sodium acetate solution, used as the sheath liquid for the electrospray, was prepared by dissolving an appropriate amount of sodium acetate (Aldrich) into water and then diluting with an equal volume of methanol (Aldrich). The final concentration of sodium acetate was controlled as 5 mM. This solution was degassed with an ultrasonic water bath (Branson) before being loaded into the instrument.

In the experiments, gluconic acid samples with varying pC_H were prepared by diluting the gluconate stock solution with water, and then acidifying it with perchloric acid. These samples, after being allowed to equilibrate for 3 days, were run under the instrumental conditions mentioned above to determine specific mass signals for the species present in the solutions.

For the kinetic experiments, a 50 mM NaGH₄ sample was prepared by diluting the gluconate stock solution with water, and then measured for a mass spectrum to define a starting point of the lactonization reaction. After this sample was acidified by 10%, a series of mass spectra were recorded as a function of time under the same instrumental conditions as described above.

In an estimation of the lactonization/hydrolysis rate constants, the data of mass spectra versus time were treated by the following procedures. We started by taking the intensities of two ion signals, where one is for indicating a gluconate anion (195m/z) and the other for indicating a lactone (337m/z), from the mass spectrum at time t . We assumed the intensities of those two signals (I_{195} and I_{373}) to be linearly correlated to $[GH_4^-]$ and $[L]$, respectively. With consideration of the limitations associated with the sample injection (pressure infusion) and the electrospray ionization for quantitative analysis,⁽¹⁹⁾ we made the following correction on the lactone signal. Because under our experimental conditions, a gluconate anion was present in large excess over gluconic acid or lactone, any change in $[GH_4^-]$ by lactonization was considered to be negligible throughout the kinetic course. As a result, an averaged intensity of the gluconate signal (I_{ave}) could be referred to as an expected value of the gluconate anion, and therefore, the intensity of the lactone signal at the time t was corrected as I_t by the following equation:

$$I_t = I_{373} (I_{195} / I_{ave}) \quad (1)$$

This corrected intensity (I_t) was used in the correlation with the lactone concentration.

3. Results and discussion

3.1. Assignment of ^{13}C NMR peaks

Within the pC_H range studied, we have observed six primary peaks for the six carbons of the gluconate molecule, and each of the six primary peaks sometimes had two smaller peaks associated with them, depending on chemical conditions. This is shown in Figure 1. Due to the rapid exchange of the proton ion in protonation, chemical shifts of individual carbons in the conjugate acid and base can not be separated.⁽²⁰⁾ As a result, one group with the six sharp intensive peaks, existing through the entire pC_H range and shifting with the pC_H , is attributed to the conjugate species (HG_H_4 and GH_4^-). These peaks are assigned to C1 (C=O), C2, C4, C5, C3 and C6 in order of increasing field (Figure 1) as previously published.⁽¹¹⁾

As pC_H approaches the acidic range, two additional groups appeared sequentially with slight intensities (Figure 1). The first group to appear represents the δ -lactone, and thus, the second is assigned to the γ -lactone. The intensities of lactone peaks increase with the decrease of the pC_H , but the chemical shifts of these peaks remain constant, implying that lactonization and hydrolysis have no effect on the NMR measurement for these two lactones. This observation is in agreement with earlier work by Sawyer et al.⁽¹⁰⁾ and Combes et al.⁽¹¹⁾, where they have confirmed the slow kinetics of lactonization/hydrolysis. For example, in the work by Combes et al., the rate constants of lactonization and hydrolysis were determined to be around 10^{-5} s^{-1} at pC_H 2.4.⁽¹¹⁾ Those

reaction rates are much below the ^{13}C NMR time scale. Therefore, the recording of ^{13}C NMR for the lactones, as indicated in Figure 1, is independent of those reactions.⁽²⁰⁾

The sequential appearance of the two groups of lactone peaks also suggests that formation of the two lactones occurs differently. The δ -lactone is formed more readily than the γ -lactone. As indicated from Figure 1a-b, if the pC_H is above 2.5, only the δ -lactone is formed. When pC_H is decreased below 2.0, the γ -lactone starts to form in measurable amounts (Figure 1c-d) although the δ -lactone predominates.

3.2. Protonation constants by NMR

In acidic aqueous solutions, gluconic acid (e.g., protonated gluconate) undergoes lactonization into δ - and γ -lactone, and the two lactones interconvert with each other, as shown in Scheme II.⁽¹⁰⁾

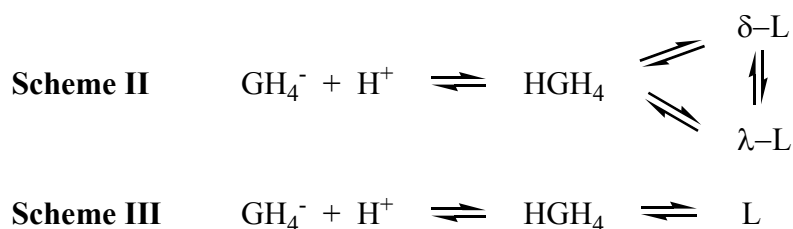

As discussed in the previous section, only the δ -lactone is formed at $\text{pC}_\text{H} > 2.5$. Furthermore, the pC_H is always above 2.5 under the experimental conditions of batch potentiometric titrations and ESI-MS, which were used to evaluate thermodynamic and kinetic properties of lactonization. We, therefore, made the following simplifications in this study, i. e., omitting the interconversion of the two lactones and considering only the δ -lactone (designated as L) formation (Scheme III). The equilibrium constants of protonation (K_a) and δ -lactonization (K_L) were defined as equations (2) and (3), respectively:

$$K_a = \frac{[\text{HGH}_4]}{[\text{GH}_4^-][\text{H}^+]} \quad (2)$$

$$K_L = \frac{[\text{L}]}{[\text{HGH}_4]} \quad (3)$$

where $[\text{HGH}_4]$, $[\text{GH}_4^-]$, $[\text{H}^+]$ and $[\text{L}]$ are denoted as the molar concentrations of HGH_4 , GH_4^- , H^+ and L , respectively.

Owing to the slow kinetics of lactonization/hydrolysis,^(10, 11) gluconate protonation can be monitored separately from lactonization/hydrolysis by NMR chemical shifts as a function of $\text{pC}_\text{H}^{(20)}$ so that a protonation constant can be independently determined. Taking a simple protonation system (equation (4)) as an example, we describe the principle behind this determination below. The protonation constant (K_H) is defined as equation (5).



$$K_\text{H} = \frac{[\text{HA}]}{[\text{A}][\text{H}]} \quad (5)$$

Where $[\text{A}]$, $[\text{HA}]$, and $[\text{H}]$ are the molar concentrations of A , HA , and H , respectively.

Since the two conjugate species (A and AH) undergo interconversion through the rapid exchange of a proton ion, an observed chemical shift (δ_obs) of each nucleus is a mole-fraction weighted average of the two resonances (δ_A and δ_HA), which is shown in equation (6):⁽²⁰⁾

$$\delta_\text{obs} = \frac{[\text{A}]\delta_\text{A} + [\text{HA}]\delta_\text{HA}}{[\text{A}] + [\text{HA}]} \quad (6)$$

Manipulation of equation (5) yields $[HA] = K_H [A] [H]$, and substitution into equation (6) gives the relationship between the observed chemical shift (δ_{obs}) and the proton ion concentration ($[H]$), expressed by equation (7):

$$\delta_{\text{obs}} = \frac{K_H [H] \delta_A + \delta_{HA}}{1 + K_H [H]} \quad (7)$$

where K_H , δ_A , and δ_{HA} are constant. The program HypNMR2000, having the approach described above, was used to fit the experimental data of δ_{obs} versus pC_H to obtain K_H .

The fitting result of gluconate chemical shifts versus pC_H by the program HypNMR2000⁽²¹⁾ is depicted in Figure 2, and the calculated protonation constants are summarized in Table II. As pC_H changes from 2.0 to 6.0, the largest displacement of chemical shift occurs to the C1 (C=O) atom (Figure 2), which suggests that the carboxylic group is deprotonated. The displacement magnitude (~ 3.0 ppm) and direction (e.g., towards higher frequency with increasing pC_H) are consistent with previous work,⁽²²⁾ confirming that the carboxylic group is the most acidic site for the HGH₄ molecule. Figure 2 also reveals that the C2 and C4 atoms exhibit the second largest displacements. In view of the pC_H range and the expected dissociation constants of aliphatic alcohols,⁽²⁵⁾ it is unlikely that these displacements are attributable to the deprotonation of a hydroxyl group of gluconate. A more plausible explanation is that the deprotonation of the carboxylic group initiates a modification in the conformation of the gluconate molecule, resulting in alterations in the hydrogen-bonding environment of the C2 and C4 hydroxyl groups, but not the C3, C5 and C6 groups. Similar behavior has been described by Cho et al. for isosaccharinic acid (ISA).⁽²³⁾

The calculated protonation constant of the carboxylic group is $\log K_a = 3.30 \pm 0.02$ (Table II). This value indicates that gluconic acid is a slightly stronger acid than simple monocarboxylic acids (e.g., $\log K_a \sim 4.6$ for acetic, butanoic and hexanoic acids⁽²⁴⁾), but similar to other α -hydroxycarboxylic acids (e.g., $\log K_a \sim 3.6$ for hydroxyacetic, 2-hydroxybutanoic and 2-hydroxyhexanoic acids⁽²⁴⁾) and isosaccharinic acid ($\log K_a \sim 3.2 - 3.3$ ⁽²³⁾). Such slightly stronger acidity might be attributed to the formation of hydrogen bonding between the carboxylate group and C2/C4 hydroxyl groups, which could stabilize the deprotonated form and result in a lower value for $\log K_a$.

In the near neutral to basic range of pC_H (6.0 to 13.0), it was observed that the chemical shifts simply inflect near the high pC_H edge. Due to the limited data, the exact reason for this inflection is hardly recognized and only some speculations are provided below. One is that deprotonation occurs to a hydroxyl group. While it is difficult to determine uniquely which group undergoes deprotonation, the C4 hydroxyl group appears to be a logical choice due to its largest shift displacement. The corresponding equilibrium and protonation constant ($K_{a'}$) are described as follows:

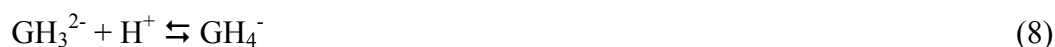

$$K_{a'} = \frac{[GH_4^-]}{[GH_3^{2-}][H^+]} \quad (9)$$

The HypNMR2000⁽²¹⁾ fitting yielded the constant, $\log K_{a'} = 12.9 \pm 0.6$. Taking into consideration of the high uncertainty introduced by limited data points available for the fitting at high pC_H , we elect to express this constant as $\log K_{a'} = 13 \pm 1$, which is close to the pK_a ($\log K_a$) range of the aliphatic alcohols (15-20).⁽²⁵⁾

Another possible reason for this inflection is the occurrence of sodium (Na^+) complexation with gluconate. Such a kind of complexation has been discussed in Cho et al.'s work⁽²³⁾ for ISA. The reaction between Na^+ and GH_4^- is expected to be weak, but the effect can be appreciable when the concentration of Na^+ is increased enough at high pC_H . This complexation may break the inner-molecular hydrogen bonding of gluconate, causing the conformation change and thereby producing the chemical shift displacement as we observed at pC_H near 13 in Figure 2.

3.3. Lactonization constant by potentiometry

The batch titrations in opposite directions are shown in Figure 3. The titration process was arranged as the base to acid direction first and then the acid to base direction. As discussed in the last section, only the carboxylic group deprotonates in this pC_H range (2.5 - 6.0). Given $\log K_\text{a} = 3.30$ obtained from the NMR study, the δ -lactonization constant was calculated to be $\log K_\text{L} = -(0.54 \pm 0.04)$ by fitting these titration data with the program Hyperquad.⁽¹⁸⁾

Sawyer et al. used the pH measurements and the optical rotation method to investigate the deprotonation and lactonization of gluconic acid within the pH range of 2.0-5.0, obtaining $\log K_\text{L} = -0.86$.⁽¹⁰⁾ Careful inspection of their work suggests the difference between their result and ours is caused by the different protonation constants they and we determined. Due to the limitations of the methods and techniques forty-five years ago, the protonation constant they determined likely has a large uncertainty. If their determined protonation constant ($\log K_\text{a} = 3.70$) is substituted by ours ($\log K_\text{a} = 3.30$), re-evaluation of the lactonization constant will yield $\log K_\text{L} = -0.51$, which is the same as ours considering our uncertainty. Also, Combes et al. employed an optical rotation

method, in combination with high performance liquid chromatography, to investigate the kinetics of the lactonization of gluconic acid and the hydrolysis of the δ -lactone at pC_H 2.4.⁽¹¹⁾ From their kinetic results, the stability constant of the lactonization was calculated to be $\log K_L = -0.65$, which is close to our value.

Assuming the hydroxyl group deprotonation at high pC_H and using our determined protonation and lactonization constants, the speciation of gluconic acid in the pH region from 2 to 14 was generated as shown in Figure 4. In the solutions of pC_H below 5, the two equilibria, protonation and lactonization, are coupled, and the ratio of the lactone and the acid remains constant as pC_H changes. At pC_H above 11.0, the hydroxyl group starts to deprotonate.

3.4. Rate constants of lactonization and hydrolysis

The rate constants of δ -lactonization and hydrolysis are defined as k_1 and k_{-1} , respectively (Scheme IV).



As an essential step for estimating these constants with ESI-MS, the mechanism of lactone ionization during the electrospray process has to be discussed first. Under a negative operation mode of ESI, a lactone could be accordingly ionized by two ways. One is deprotonation of a hydroxyl group of the lactone,⁽²⁶⁾ by which the lactone is directly ionized. The other is adduction of an anion to the lactone.⁽¹⁹⁾ The gluconate, a main anion in the sample, could be a good candidate for the adduct. The experimental results (Figure 5) verify both possibilities. Two types of lactone anions are formed and detected with ESI-MS: $m/z = 175$ (deprotonation of hydroxyl group) and $m/z = 373$

(lactone adducted by gluconate). Since the pC_H of the samples is located within the range of 3.0-6.5, the detected lactone is likely the δ -lactone. Figure 5 also indicates that without acidification, no lactone signals were observed (Figure 5a), but with the decrease of pC_H , lactone signals appear (Figure 5b-c). This observation is in agreement with our potentiometric results, i.e., an amount of the lactone is formed inversely to the pC_H of the gluconate solutions. It is therefore suggested that ESI-MS could be used to follow the formation of lactone. Between these two signals, 373m/z is more sensitive with the well-defined ionization mechanism, and hence chosen as an indicating signal for the lactone in the kinetics studies.

Using m/z of 373 as an indicator for the lactone, we employed ESI-MS to estimate the rate constants of lactonization and hydrolysis, taking advantage of the quick measurement compared to the slow kinetics of the lactonization/hydrolysis, and the capacity to identify the lactone. Assuming that δ -lactonization and hydrolysis follow pseudo-first-order reactions with respect to gluconic acid and the δ -lactone, respectively,^(10, 11) these two rate constants (k_1 and k_{-1}) are thus related to the equilibrium constant (K_L) by equation (10):

$$K_L = \frac{k_1}{k_{-1}} \quad (10)$$

And the corrected lactone signal (I_t) can be established as a function of time (t) by equation (11):

$$\text{Ln} \frac{I_e - I_t}{I_e - I_0} = (k_1 + \frac{K_L}{k_1}) t \quad (11)$$

where I_e and I_0 indicate the intensities of the lactone signal at equilibrium and initial points, respectively. The details for deriving equation (11) could be found elsewhere.⁽²⁷⁾

Table I lists the measured intensities of the gluconate signal ($m/z = 195$) and the lactone signal ($m/z = 373$) for the kinetic sample ($pC_H \sim 5.0$) as well as the related corrections mentioned in Section 2.3. Figure 6 shows the graph of $\ln(I_e - I_t)/(I_e - I_0)$ versus time t . The linear relationship confirms the assumption of pseudo-first-order reactions, and provides a rate constant of 0.523. Using this value, the δ -lactonization rate constant (k_1) is $3.2 \times 10^{-5} \text{ s}^{-1}$ according to equation (11), and consequently, the hydrolysis constant (k_{-1}) is calculated to be $1.1 \times 10^{-4} \text{ s}^{-1}$ from the value of $K_L = 0.29$, as described by equation (10). All obtained constants are summarized in Table II.

It is interesting that lactonization and hydrolysis follow first-order reactions with respect to the gluconic acid and the lactone, respectively, and the resulting rate constants are close to Combes et al.'s work ($k_1 = 3.807 \times 10^{-5} \text{ s}^{-1}$ and $k_{-1} = 1.730 \times 10^{-4} \text{ s}^{-1}$).⁽¹¹⁾

4. Conclusion

Gluconic acid undergoes two equilibria, carboxylate protonation and lactonization, in acidic media. The variation of lactonization with pC_H was investigated using ^{13}C NMR spectroscopy. With the decrease of pC_H , lactonization intensifies, but the formation of two lactones (δ - and γ -lactone) occurs differently. The δ -lactone is generated more readily than the γ -lactone. In 0.1 M gluconate solutions where the pC_H is above 2.5, only the δ -lactone is formed. When pC_H is less than 2.0, the formation of the γ -lactone is observable although the δ -lactone predominates.

The thermodynamic properties of these two equilibria were determined by NMR and batch potentiometric titrations. At $I = 0.1 \text{ M NaClO}_4$ and room temperature, the

carboxylate protonation and δ -lactonization constants were determined to be $\log K_a = 3.30 \pm 0.02$ and $\log K_L = - (0.54 \pm 0.04)$, respectively.

Negative-mode ESI-MS was applied to examine the formation of lactones within the pC_H range of 3.0-6.5. The δ -lactone is detected either as an alkoxide anion (deprotonation of hydroxyl group) or an adducted anion (adduction by gluconate). At $pC_H \sim 5.0$, ESI-MS was used to investigate the kinetic properties of lactonization and hydrolysis. The rate constants of the δ -lactonization (k_1) and the hydrolysis (k_{-1}) were estimated to be $3.2 \times 10^{-5} \text{ s}^{-1}$ and $1.1 \times 10^{-4} \text{ s}^{-1}$, respectively.

Acknowledgements

This work was supported by U.S. DOE's Environmental Management Science Program at Washington State University. The work performed at Lawrence Berkeley National Laboratory (LBNL) was supported by U.S. Department of Energy, Office of Science, Office of Basic Energy Sciences under Contract No. DE-AC02-05CH11231 at LBNL.

References

1. S. Yano, *Coord. Chem. Rev.* **92**, 113-156 (1988).
2. D. M. Whitfield, S. Stojkovky, and B. Sarka, *Coord. Chem. Rev.* **122**, 171-225 (1993).
3. D. T. Sawyer, *Chem. Rev.* **64**, 633 (1964).
4. W. R. Carper and D. B. Coffin, *Inorg. Chimica Acta* **167**, 261 (1990)
5. S. Goroux, P. Rubini, B. Henry, and S. Aury, *Polyhedron* **19**, 1567 (2000).
6. K. P. Zhernosekov, E. Mauerhofer, G. Getahun, P. Warwick, and F. Rosch, *Radiochim. Acta* **91**, 599 (2003).
7. P. Warwick, N. Evan, T. Hall, and S. Vines, *Radiochim. Acta* **92**, 897 (2004).
8. F. Coccioli and M. Vicedomini, *Inorg. Nucl. Chem.* **40**, 2103 (1978).

9. R. J. Motekaitis and A. E. Martell, *Inorg. Chem.* **23**, 18 (1984)
10. D. T. Sawyer and J. B. Bagger, *J. Amer. Chem. Soc.* **81**, 5302 (1959).
11. C. L. Combes and G. G. Birch, *Food Chemistry* **27**, 283 (1988).
12. R. L. Pecsok and J. Sandera, *J. Amer. Chem. Soc.* **77**, 1489 (1955).
13. D. S. Wishart, C. G. Bogam, J. Yao, F. Abildgard, H. J. Dyson, E. Oldfield, J. L. Markley, and B. D. Sykes, *J. Biomol. NMR* **6**, 135 (1995).
14. D. S. Wishart and A. M. Nip, *Biochem. Cell Bio.* **76**, 153 (1998).
15. R. G. Bates, determination of pH: *Theory and Practice* (Wiley, New York, 1964).
16. P. Zanonato, P. Di Bernardo, A. Bismondo, G. Liu, X. Chen, and L. Rao *J. Am. Chem. Soc.* **126**, 5515-5522 (2004)
17. L. Rao, T. G. Srinivasan, A. Yu. Garnov, P. Zanonato, P. Di Bernardo, and A. Bismondo, *Geochim. Cosmochim. Acta* **68**. 4821-4836 (2004).
18. P. Gans, A. Sabatini, and A. Vacca, *Talanta* **43**, 1739 (1996).
19. E. D. Hoffmann and V. Stroobant, *Mass Spectrometry, principles and applications*, 2nd edn. (Wiley, New York, 2002).
20. R. S. Drago, in *Physical Methods in Chemistry*, (Saunders, Philadelphia, 1977), pp. 252-253.
21. C. Frassinetti, S. Ghelli, P. Gans, A. Sabatini, M.S. Moruzzi, and A. Vacca, *Anal. Biochem.* **231**, 374-382 (1995).
22. D. E. Anderson, J. Lu, L. McIntosh, and F. W. Dahlquist, in *NMR of Proteins*, G. M. Clore and A. M. Gronenborr, eds. (CRC, Boca Raton, FL, 1993), pp. 258.
23. H. M. Cho, D. Rai, N. J. Hess, Y. Xia, and L. Rao, *J. Sol. Chem.* **32**, 691 (2003).
24. A. E. Martell and R. M. Smith, "NIST Critically Selected Stability constants of Metal Complexes," NIST Standard Reference Database 46 Version 6.0, developed by R. J. Motekaitis, distributed by NIST Standard Reference Data, 2001.
25. C. O. Silva, E. C. da Silva, and M. A. C. Nascimento, *J. Phys. Chem. A* **104**, 2402 (2000).
26. H. I. Kim, P. V. Johnson, L. W. Beegle, J. L. Beauchamp, and I. Kanik, *J. Phys. Chem. A* **109**, 7888 (2005).
27. J. H. Espenson, in *Chemical Kinetics and Reaction Mechanism* (2nd ed.), J. B. Speer and J. M. Morriss, eds. (McGraw-Hill, New York, 1995), pp. 46-48.

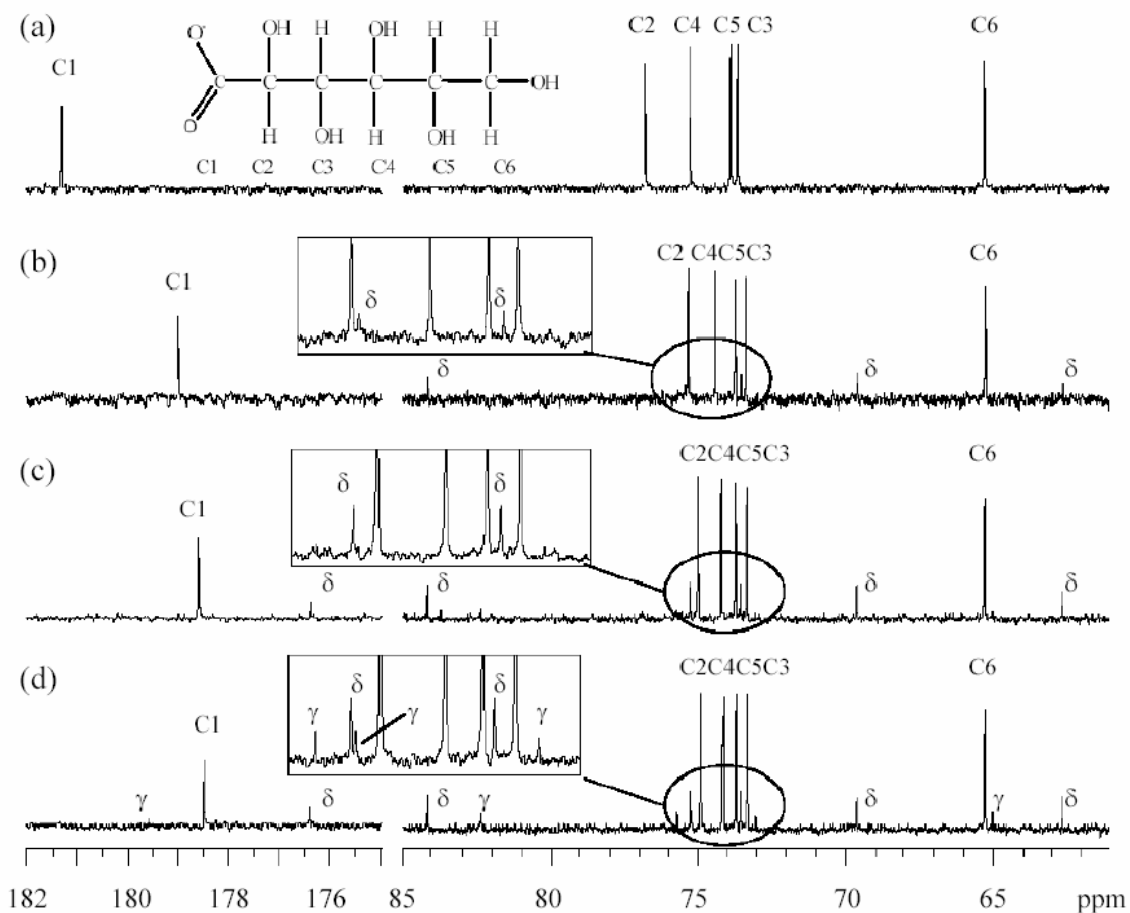

Figure 1. The ^{13}C NMR spectra of gluconic acid and related lactones. Varian 300 Spectrometer, 75.5 MHz for recording, 5000-10000 scans for individual spectra, 0.6 Hz line broadening. $C_{\text{NaGH}_4} = 0.1$ M in D_2O , $t = 22$ °C (room temperature). Acid/base for pC_H adjustment: $C_{\text{DNO}_3} = 70\%$ w/w in D_2O , $C_{\text{NaOD}} = 40\%$ w/w in D_2O . Peak identification is relative to standard ^{13}C NMR spectrum of gluconate [Aldrich 18,633-3] and δ -lactone [Aldrich G2000-1]. (a) $\text{pC}_\text{H} = 6.66$; (b) $\text{pC}_\text{H} = 2.54$; (c) $\text{pC}_\text{H} = 1.99$; (d) $\text{pC}_\text{H} = 1.42$.

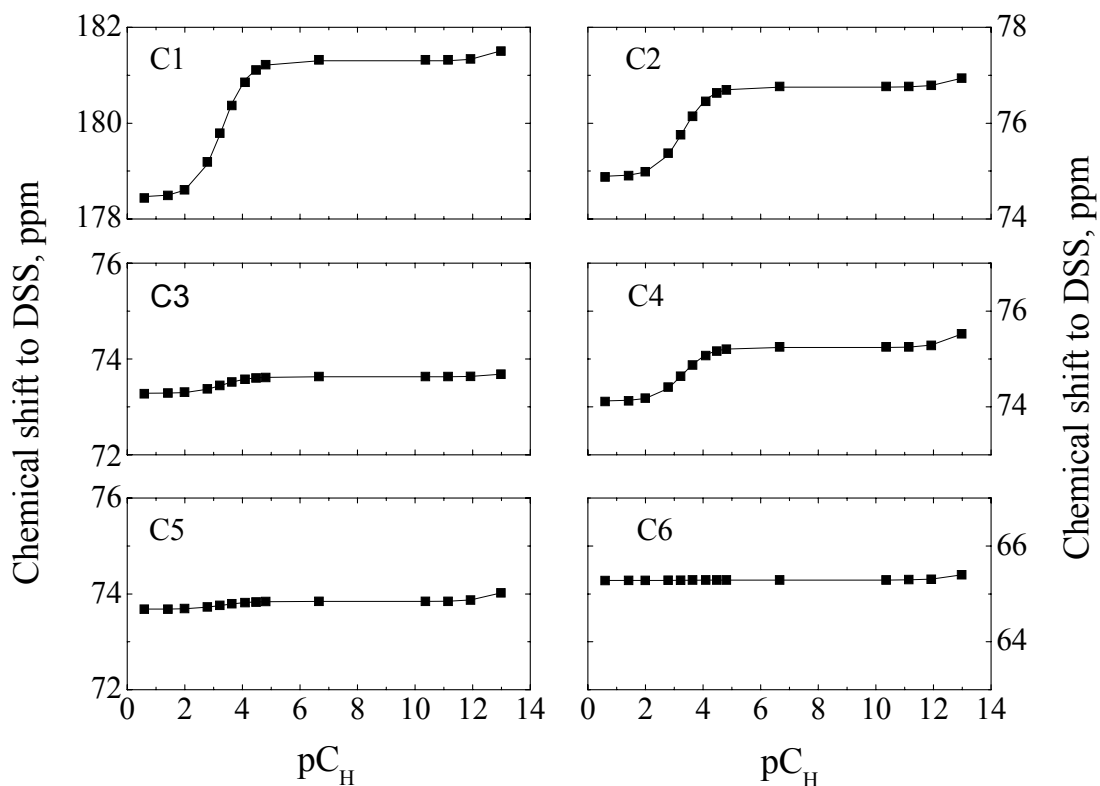

Figure 2. The HypNMR2000 fitting result for the chemical shifts of individual gluconate carbons as a function of pC_H . $C_{NaGH4}^0 = 0.1$ M, $t = 22$ °C (room temperature). Acid/base for pC_H adjustment: $C_{DNO3} = 70\%$ w/w in D_2O , $C_{NaOD} = 40\%$ w/w in D_2O . Symbol (■): experimental data; solid line: calculated values.

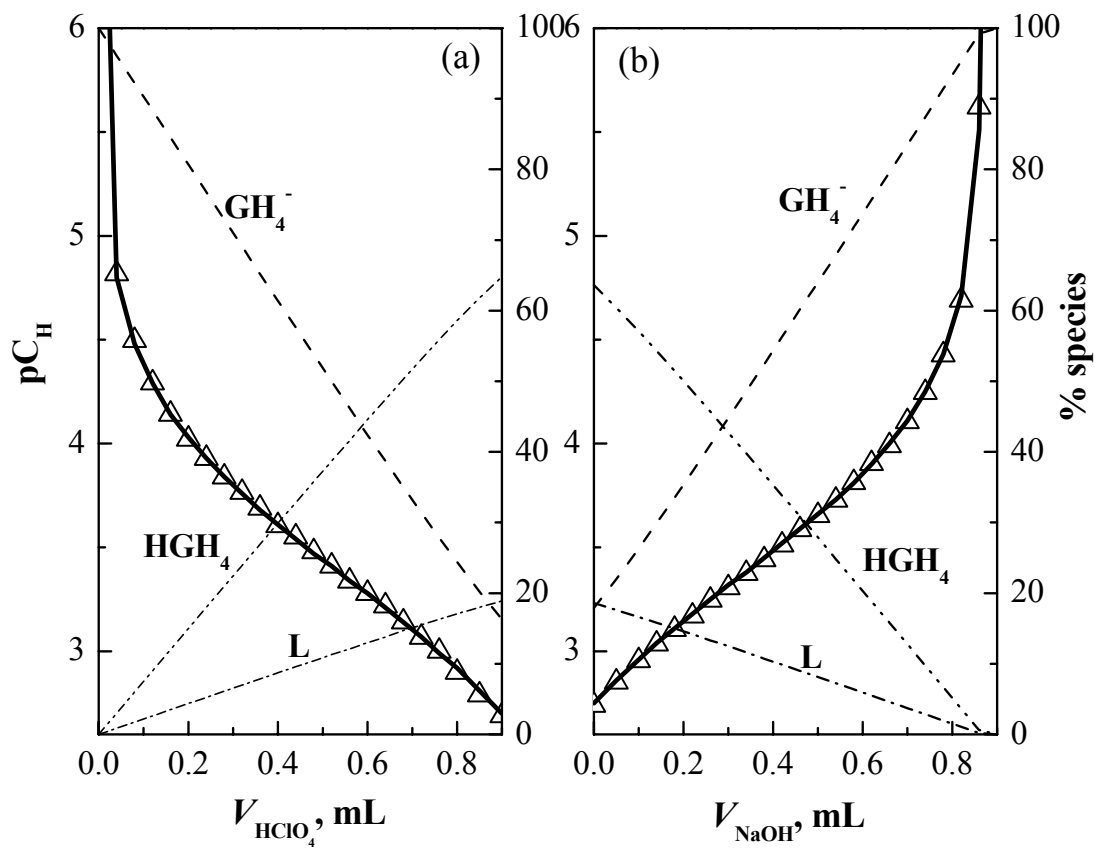

Figure 3. The batch titrations for lactonization of gluconic acid. $I = 0.1 \text{ M}$, room temperature. Cup solution: $V^0 = 20 \text{ mL}$, $C_{\text{NaGH}_4^0} = 50 \text{ mM}$. Titrant: $C_{\text{HClO}_4} = 0.9893 \text{ M}$ for the base to acid direction (a); $C_{\text{NaOH}} = 1.0015 \text{ M}$ for the acid to base direction (b). Symbol (Δ): experimental pC_{H} ; Solid line: fitted pC_{H} .

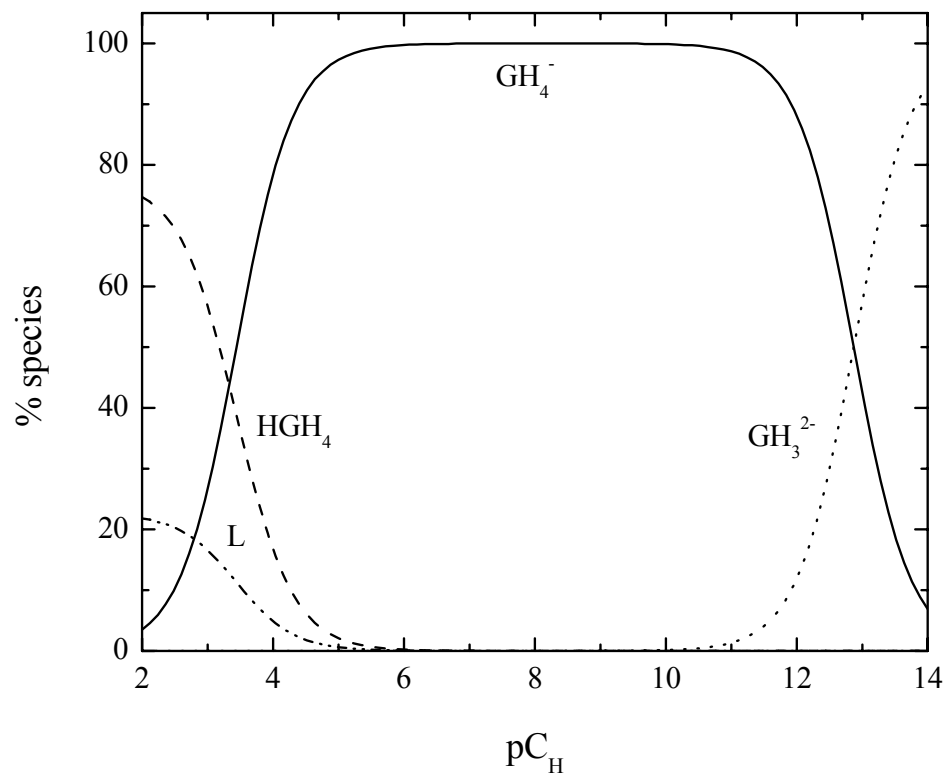

Figure 4. The speciation diagram of gluconic acid at the constant concentration of gluconate (0.1 M). Species fraction lines: solid – GH_4^- , dash – HGH_4 , dash dot dot – L, dot – GH_3^{2-} .

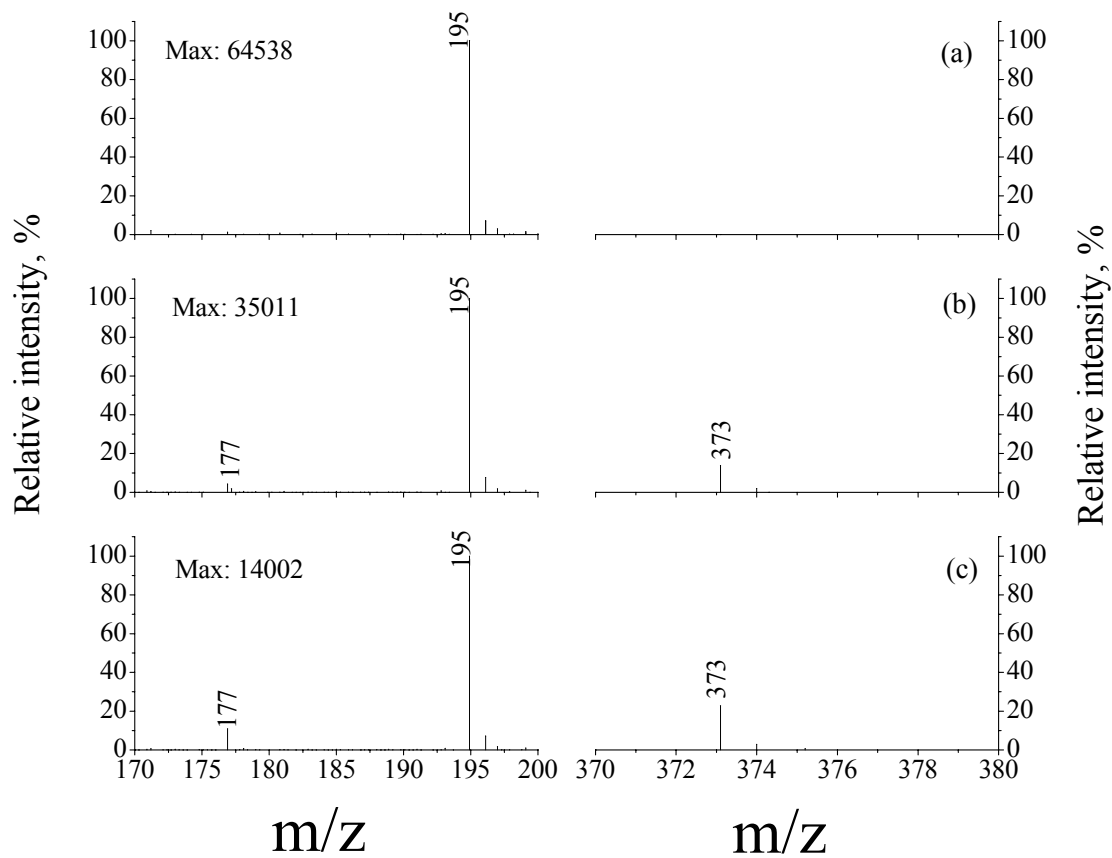

Figure 5. The mass spectra of the acidified gluconate sample. $C_{NaGH_4^0} = 50$ mM. (a) 0.0% acidification, $pC_H = 6.2$; (b) 50% acidification, $pC_H = 4.3$; (c) 100% acidification, $pC_H = 3.3$

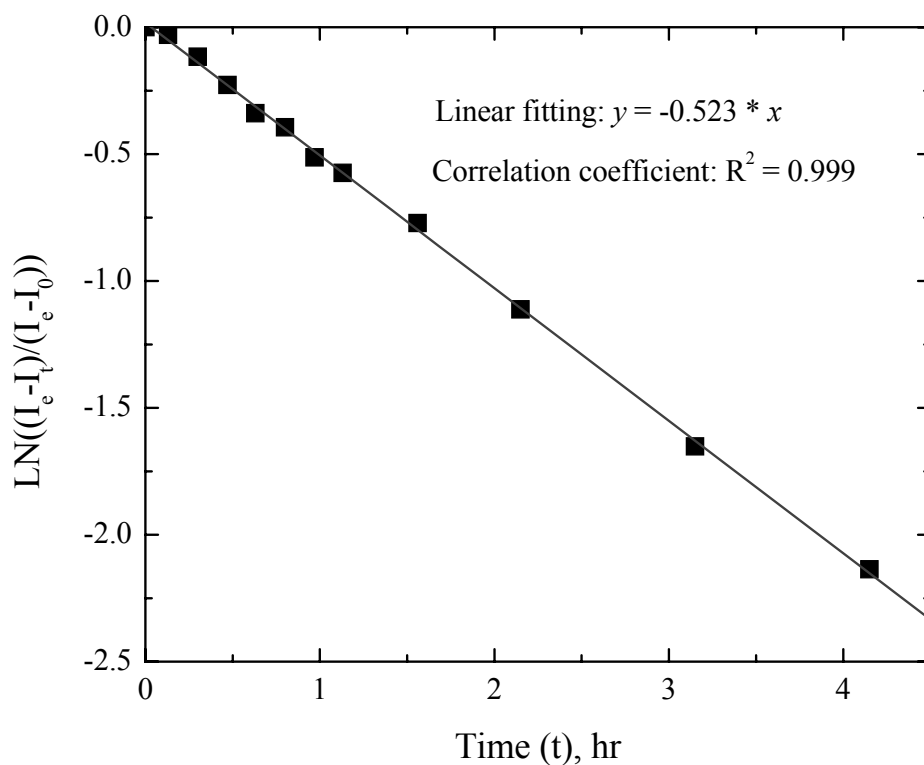

Figure 6. The results for kinetic study of lactonization of gluconic acid with ESI-MS. Starting solution: $C_{\text{NaGH}_4^0} = 50 \text{ mM}$, $V^0 = 10 \text{ mL}$, $pC_{\text{H}} \sim 6.2$; Added acid: $C_{\text{HClO}_4} = 0.99 \text{ M}$, $V_{\text{HClO}_4} = 0.05 \text{ mL}$, $pC_{\text{H}} \sim 5.0$. Symbol (■): experimental data; Solid line: fitted values.

Table I. The experimental data for kinetic study of lactonization of gluconic acid with ESI-MS. Starting solution: $C_{\text{NaGH}_4^0} = 50 \text{ mM}$, $V_0 = 10 \text{ mL}$, $\text{pC}_\text{H} \sim 6.2$; Added acid: $C_{\text{HClO}_4} = 0.99 \text{ M}$, $V_{\text{HClO}_4} = 0.05 \text{ mL}$; $\text{pC}_\text{H} \sim 5.0$

Time, t (hr)	Intensity ($I_{m/z}$)		Calibrated I_{373} (I_t)	Extent to equilibrium ($I_e - I_t / I_e - I_0$)%
	I_{195}	I_{373}		
0.00	65101	56	56	100.0
0.13	60110	318	315	97.0
0.30	62802	1090	1035	89.0
0.47	63010	1979	1873	79.6
0.63	63790	2805	2622	71.3
0.80	62900	3130	2967	67.4
0.97	56806	3470	3642	59.9
1.13	58910	3912	3960	56.3
1.56	58205	4750	4866	46.2
2.15	59606	6055	6057	32.9
3.15	57250	7001	7286	19.2
4.15	55500	7412	7945	11.8
36.00	55803	8395	8995	0.1
72.00	55010	8305	9002	0.0

Table II. Thermodynamic and kinetic properties of protonation and lactonization of gluconic acid.

Reaction	Stability/Kinetic Constants	Notice
Protonation: $H^+ + GH_3^{2-} = GH_4^-$ $H^+ + GH_4^- = HGH_4$	$\log K_a' = 13 \pm 1$ $\log K_a = 3.30 \pm 0.02$	NMR. $I = 0.1$ M, room temp. NMR. $I = 0.1$ M, room temp.
Lactonization: $HGH_4 = L + H_2O$ $HGH_4 \xrightleftharpoons[k_{-1}]{k_1} L$	$\log K_L = -(0.54 \pm 0.04)$ $k_1 = 3.2 \times 10^{-5} \text{ s}^{-1}$ $k_{-1} = 1.1 \times 10^{-4} \text{ s}^{-1}$	Batch titration. $I = 0.1$ M, room temp. ESI-MS. $pC_H \sim 5.0$, room temp.