

UC Berkeley

Room One Thousand

Title

Blacksmith Caravans on the Move

Permalink

<https://escholarship.org/uc/item/6k69x342>

Journal

Room One Thousand, 3(3)

ISSN

2328-4161

Authors

Bandukwala, Sachin
Smith, Melissa

Publication Date

2015

Copyright Information

Copyright 2015 by the author(s). All rights reserved unless otherwise indicated. Contact the author(s) for any necessary permissions. Learn more at <https://escholarship.org/terms>

Peer reviewed

Sachin Bandukwala and Melissa Smith

Blacksmith Caravans on the Move

[cart blacksmiths]

The *gaduliya lohar* are the traditional travelling blacksmiths of southeastern Rajasthan, who identify their ancestry as the weapon makers of the Rajput rulers of Mewad at Chittorgarh. When Mogul king Akbar invaded the fort, they escaped, and, ashamed at the failure of their weapons, vowed never to return to Chittorgarh until Mewad was restored. This identity has carried forward to the present, and still defines them as a community. Throughout their history, they have travelled from village to village, repairing and selling farm and household tools. As cities have expanded, and industrialized implements have taken the market, the competition has stiffened and work has dwindled. But the draw of the city remains, and many *lohar* have set up camp in the city for longer periods, and with fewer caravan accoutrements because ox carts are bulky and urban oxen are expensive to maintain. Still, the *gaduliya lohar* remain squatters, permanently camping and treated as outsiders wherever they are located.

balad gaadu (ox cart): the cart forms the base for the camp. Typically one couple per cart, and all associated children. Carts are simultaneously storage, shelter, bed structure, and transport.

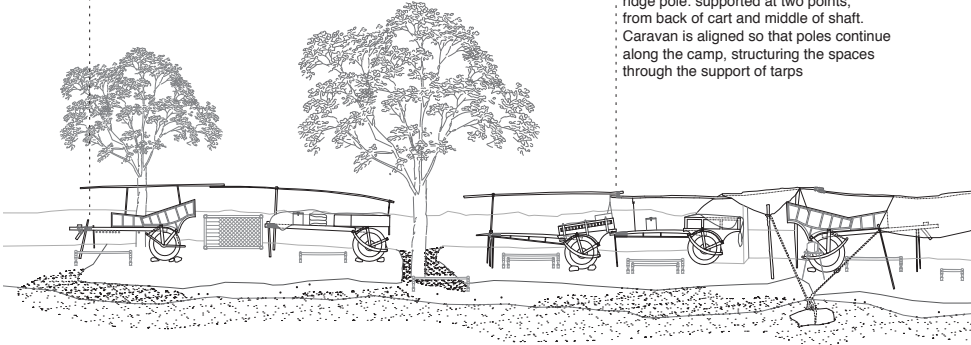

ridge pole: supported at two points, from back of cart and middle of shaft. Caravan is aligned so that poles continue along the camp, structuring the spaces through the support of tarps

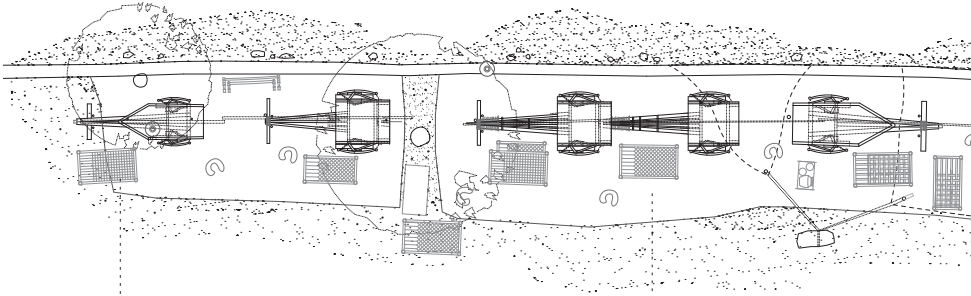

khaat (origin of 'cot'): lightweight wooden bedframe

otla (plinth): the caravan marks out its area between the road and boundary wall by creating a raised plinth of rammed earth and mud plaster, which is also used to finish the occupied section of the boundary wall. This defines 'ownership' and keeps water away.



field: They rely on open grazing land for fields, play, cattle grazing, and to relieve themselves.

tarp: plastic sheet replaces traditional grass thatch, because it is easier to assemble

vertical supports: stakes, ropes, columns and boulders. Lightweight, simply assembled columns tie the tarps to the plinth. Existing walls serve as base structure.

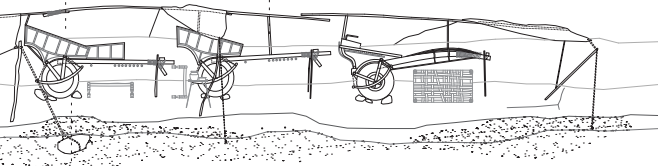

foundation: stones from the wall
brake wheels, anchor tarp ties

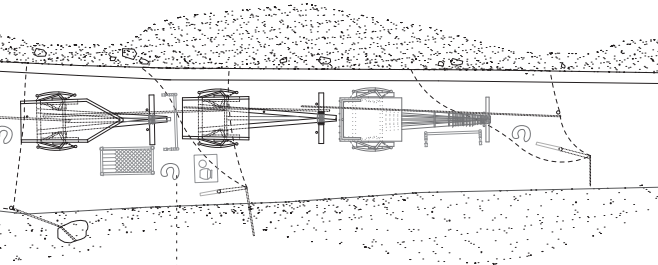

chula (stove, fire): mud plaster fire pit used for cooking

Figure 1: (drawing)
Illustration by
banduksmithstudio.

Figure 2: (below)



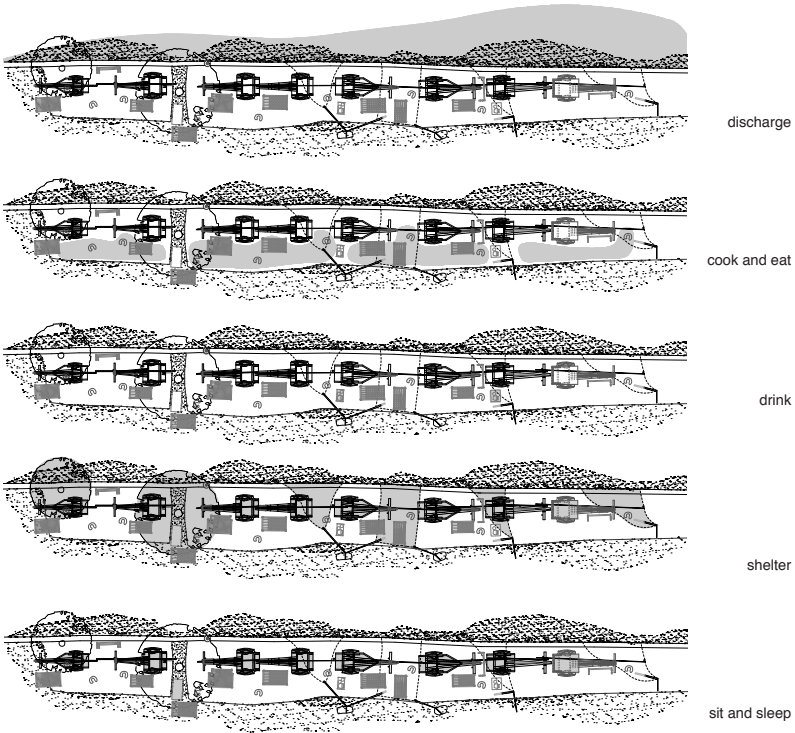

Figure 3: Illustration by banduksmithstudio.

[camp system]

Despite their continuing inability to fit into the recognized structures of the contemporary country, the simple system the travelling blacksmiths have evolved offers a potentially powerful model for the occupation of seasonal and cyclical spaces in dynamic, under-regulated, twenty-first century cities. The structure and organization of the *gaduliya lohar* camp is innovative in its ability to generate a complex social space on any site that fits the very basic parameters of a roadside with an adjacent wall, tree or fence. This capacity is built through the

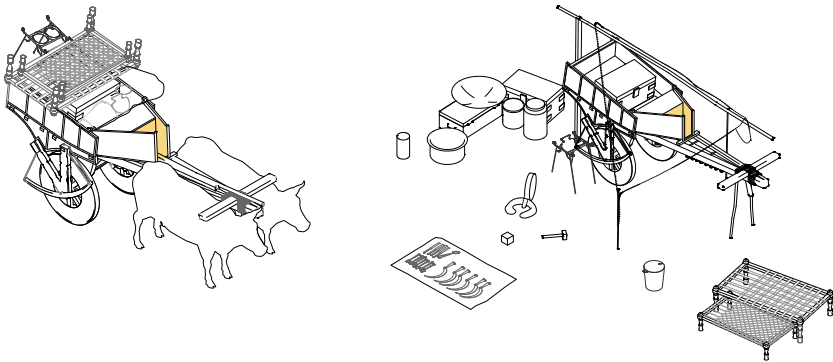

Figure 4: Packed and unpacked. Illustration by banduksmithstudio.

simple organizational structure—a string of carts lined up, one by one—with a strong base element—the cart—and a tied joint that connects elements in predefined relationships, carefully to certain elements, and loosely to others. The organization of horizontal planes, vertical columns, inclined columns, horizontal beams and heavy wheels on a hand-molded plinth, structures the ground temporarily, forms a space occupied by a group of families, and then disappears, leaving light traces behind. At once shelter, storage, sleep space and transport, the cart unfolds and refolds in a relaxed cycle, regenerating the social and physical organization of its space as it arrives in each new context.

The Cart and the Camp

[cart as vehicle, cart as camp]

Crafted carts carry the caravan, while the accessories around them showcase a similar spirit of lightness and mobility. Comfortably occupying the marginal spaces slated for future road expansion, a ubiquitous condition in India, the caravan remains ready to leave

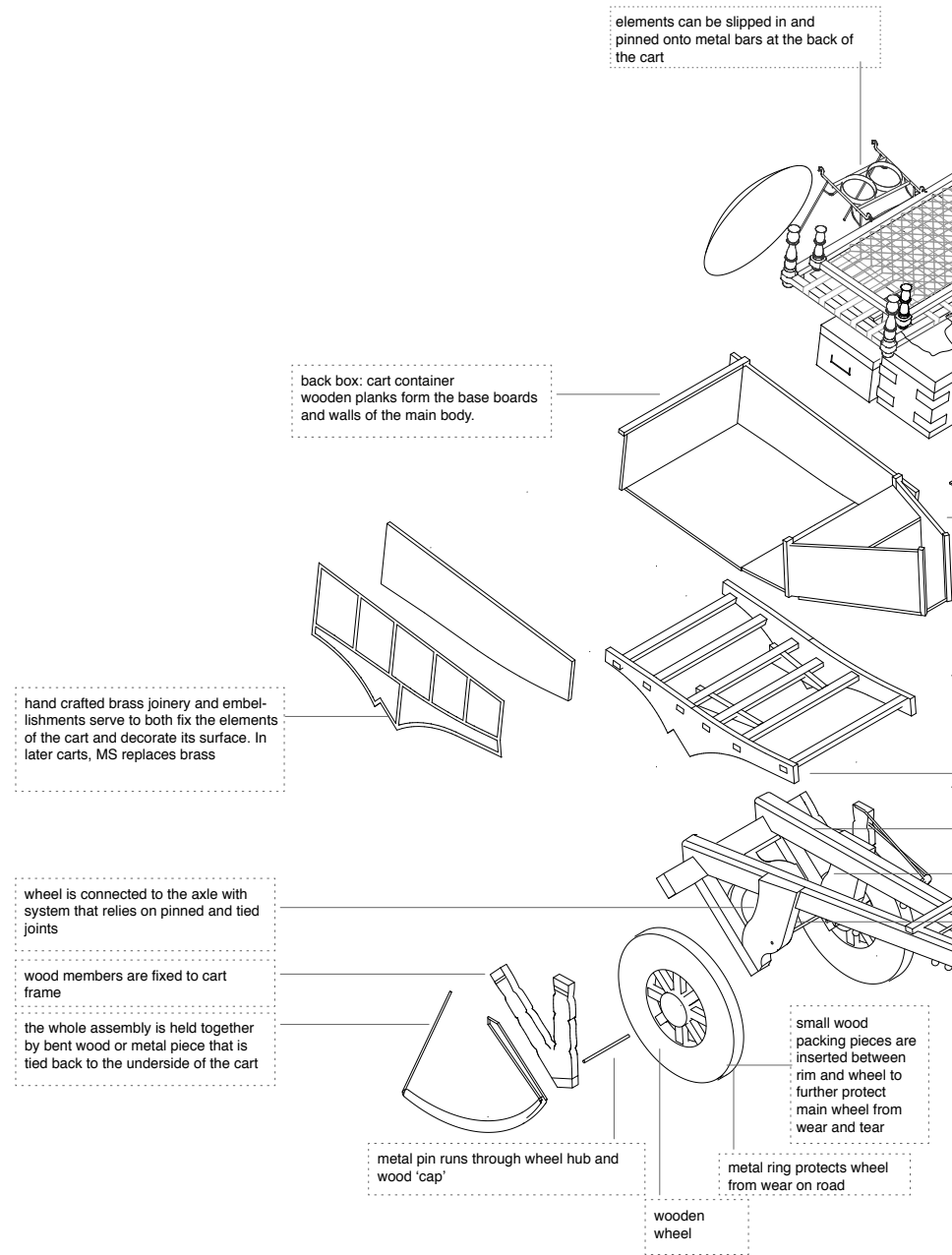

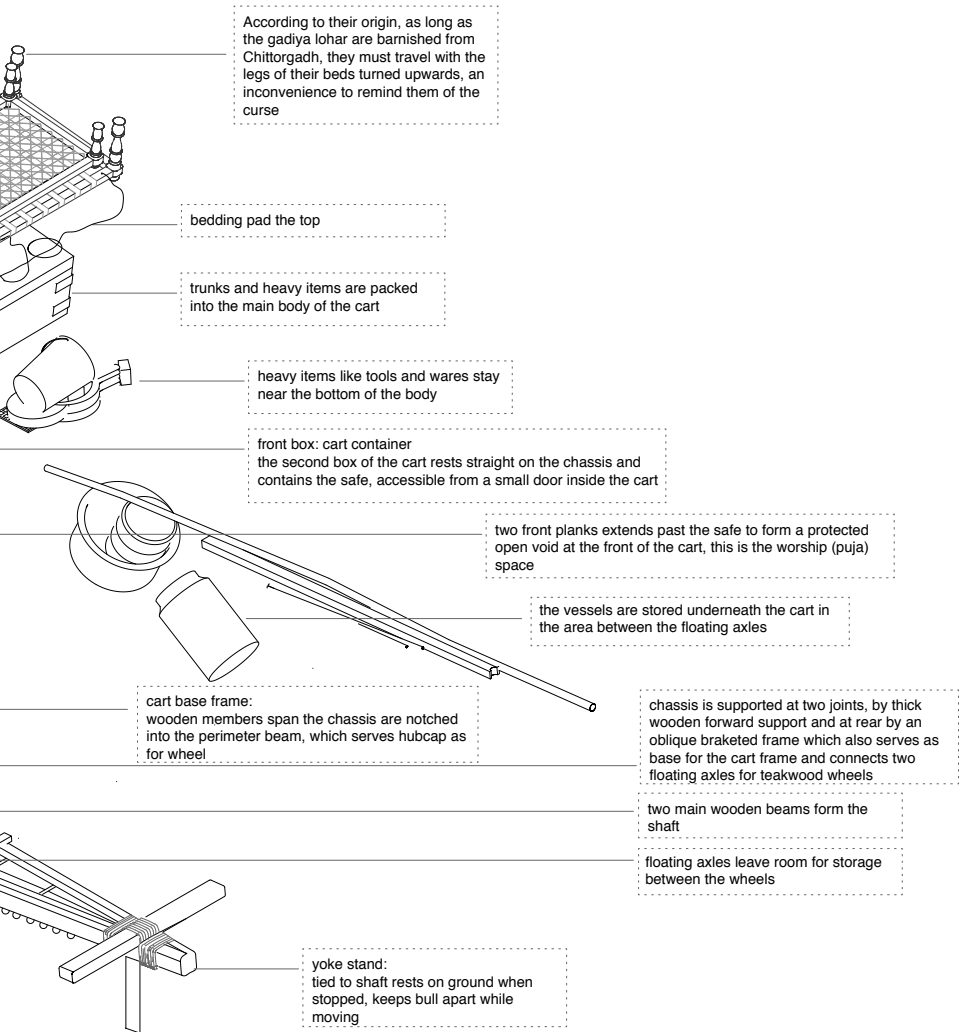
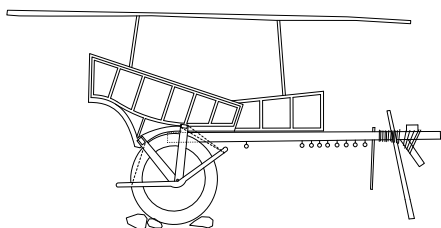
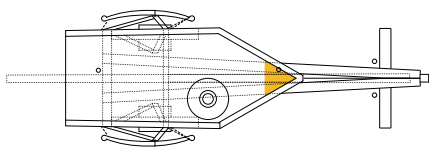

Figure 5: Illustration by banduksmithstudio.

variations on the shaft and yoke



type 1: Two straight wooden beams form the chassis support and are joined at the yoke with rope. a third wooden member runs down the center of the cart and protrudes from the yoke knot as a temporary stand



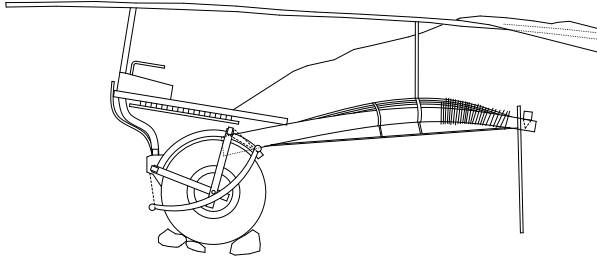

type 2: The two wooden beams are curved and joined with metal fabricated rods to create a bowed shaft which is tied back to the cart and yoke.

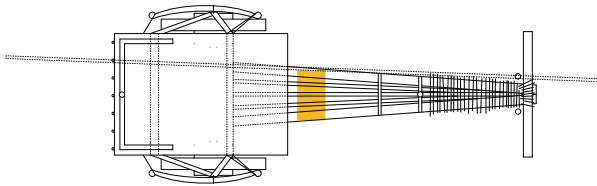
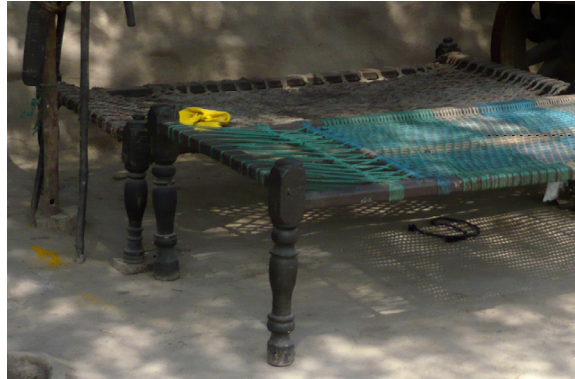
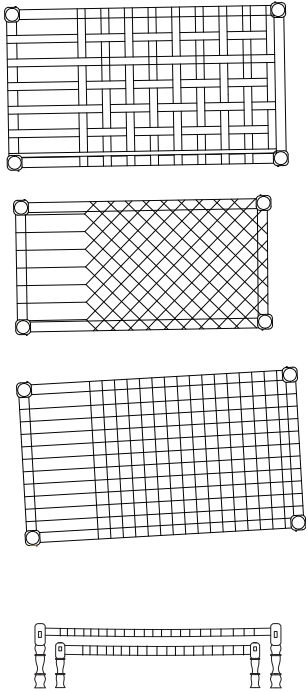

Figure 6: Illustration by banduksmithstudio.





khaat (origin of 'cot')

..... lightweight wooden bedframe in which ropes or strips are tied and woven to form the bed



..... Three sides are tightly woven while the fourth is left with a gap of a foot to facilitate tightening as the threads stretch over time. Cotton is preferred for its ventilating capabilities.

..... Plastic is also used because it is cheap and lasts longer.

..... *tel paani* (oil and water): the traditional process applied to create the finished protective surface of wood

Oil and water are applied in an alternating sequence, which pushes the oil into the veins of the wood, preserving it from moisture or insect damage. It is particularly effective in accommodating contraction and expansion due to the extremes of the desert-monsoon climate, because it does not seal the surface of the wood. Often used engine oil is used, because it is cheap and otherwise a waste product. This oil lends its black hue to the finished wood.

Figure 7: Illustration by banduksmithstudio.

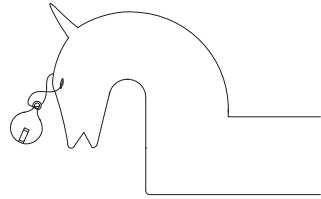
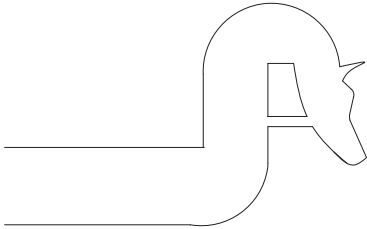
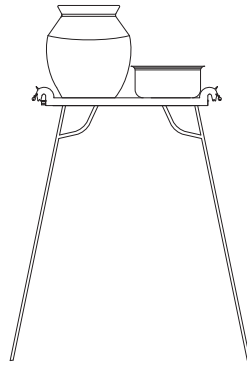
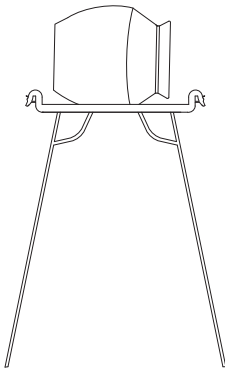

at a moment's notice. The cart stores goods, and tarps are stretched from wall to stake, while the lightweight beds and water jug stands, which casually define the area, can be scooped up and onto the cart, leaving nothing but mud plastered wall, plinth and fire pit behind.

[cart as object]

The cart itself is heavy, constructed from wood and bound by metal. At the site, even when space is occupied, it remains the source of storage. The cart is typically made for a new couple after they have completed one year together on the road, under the guidance of the



deg (water jug) stand

Crafted in iron, despite heavy material the lightweight character of the stand exhibits the deftness of the *lohar* craft.

1. Stand is slipped inside the pin joint of the wheel to hold its position next to the cart.
2. Water is kept elevated from the ground, to keep it clean and safe for drinking.
3. The camel and horse stands demonstrate different means of delicately bracing their light legs.

Figure 8: Illustration by banduksmithstudio.

man's parents. Once they have learned the ropes, they make their own. When camped, the load of the structure rests forward, on the wheels, propped up on stones or brick boulders. A simple stand supports the shaft, and two lightweight columns, positioned at the back of the cart and front of the shaft, carry the ridgepole for a tent. Dishes, wet or dry, hang in the space between floating axles, while trunks, objects and bedding are piled on top. Deep inside the cart is a safe whose door is accessible only from within the body of the cart. Ahead of the safe, perched on a protected platform, mid-shaft, is the *puja* (worship) space, where the family idol is kept.

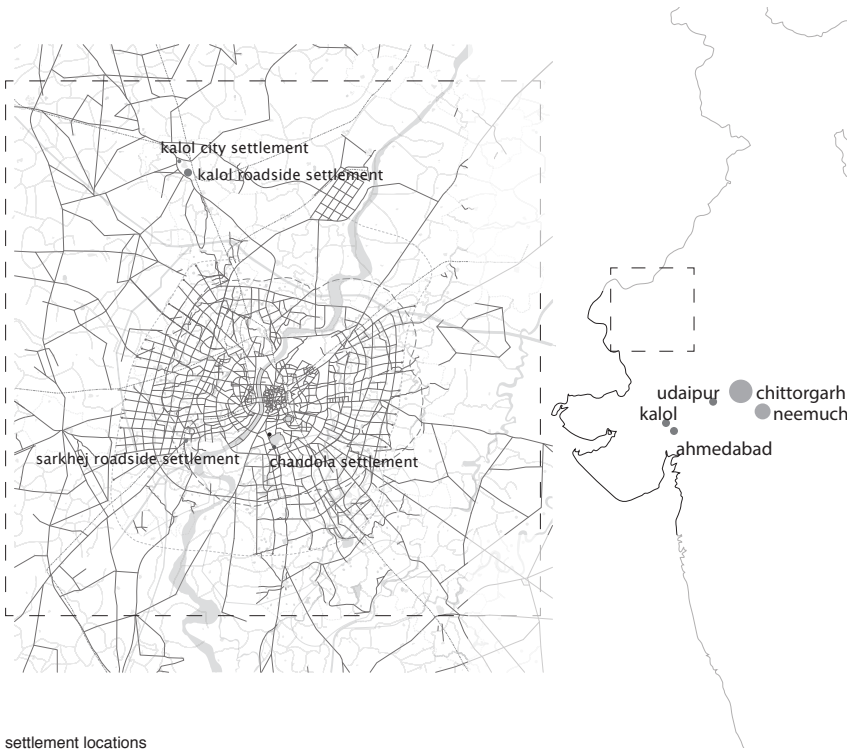

settlement locations

Figure 9: Illustration by banduksmithstudio.

[cart as life]

The cart anchors the arrangement, not only housing many functions and organizing the occupation, but also carrying the weight of identity and lineage. It also exemplifies the quality of the group's craft. The cart, home to their goods, crafts and family, is the most valuable and sacred element they own. Rather than pursue a deity or a place, the purpose of their life—and the source of their identity—is to pack, to walk, to arrive, rest, work, pack again and move.

The Draw of the City and the Evolution of Camp

[our pursuit]

We first ran into a community of eight on-the-move *gaduliya lohar* (travelling cart blacksmith) families in 2007, when they had paused for a few days in southern Rajasthan, on a regional two-lane highway between Udaipur and Kumbalgarh. Five years later, the act of finding out more about the people on the road took us on a journey of sideways conversations and lateral connections. How do you find people who don't live anywhere? We started by asking around, searching for the different types of nomadic communities in western India. We thought they might be *vanzara*, an itinerant community that moves up and down through forested areas. After hunting through books and journals with no success, we managed to find them through the advice of a friend from a small town in northern Gujarat. He noticed the ornate metalwork and suggested they might be *gaduliya lohar*, common in that region. From that point on, our pursuit consisted of asking likely suspects – fabricators, who work in the same field, and antique dealers, who look for the carts – chatting on the roadside, and following loose directions along the way to camps around the area. Eventually, we identified four groups and acquired directions to many more, uncovering the boundaries of the lifestyle of the caravan people as they approach the city.

[the limits of camp: cart as identity]

Of the four groups, two had carts and two did not. Two travelled, one rarely did, and one had permanently settled. Three groups lived in the open, along the road, one group lived in brick houses. Though they lived in widely different situations, from rural roadside to self-built city houses, they all identified as *gaduliya lohar*, originally from Chittorgarh, and still practiced the craft of

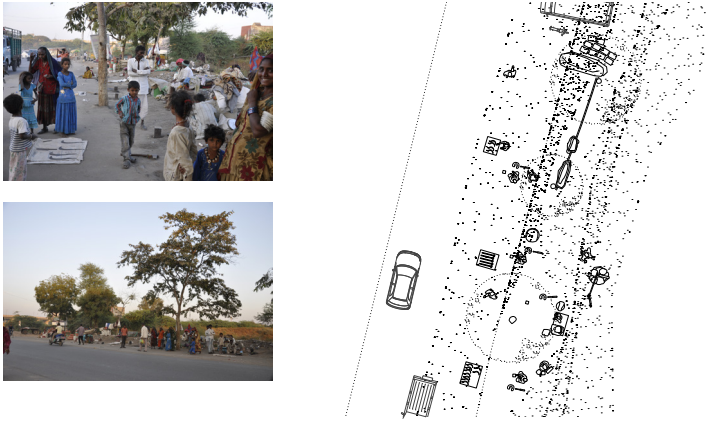

Figure 10: Illustration by banduksmithstudio.

blacksmithing, passed down through generations. Whether they had a cart or not, they associated themselves with the lifestyle. The cart holds such a strong presence in the lives and minds of the *gaduliya lohar*, whose own name is a sweet, intimate derivative of the word cart (*gaadu*), that even when the community has outgrown its function, the cart retained its place, becoming an object of worship. Even when they had to part with their cart, it would remain in their memory, intimately connected to their identity.

Roadside in Kalol, Gujarat

The smallest of the sites, this group lacks any form of transport. They move little, remaining at the small strip near the village pond, and use shared jeeps when they must. What remains are the tools and goods of their craft: anvils, hammers and blowers for fabricating wares, sold at the edge of the fledgling city. They retain the linear condition, spaced as couples along the edge of the road (Figure 10).

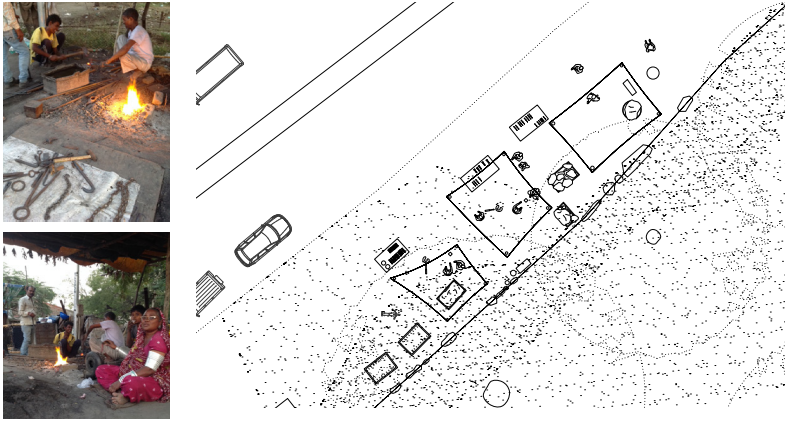

Figure 11: Illustration by banduksmithstudio.

Roadside in Sarkhej, Ahmedabad

This group is permanently settled, though temporary in appearance. They also have no carts and travel to their ancestral home, in Chittorgarh, about once every two years. They have trunks and tents, hammers and anvils, and sell their wares just in front of the workshop/home space, along the approach to a bridge at the edge of Ahmedabad, in the outskirts of the city but near a lot of construction related activity. They have evolved their repertoire to include some basic construction implements, such as hooks for bending rebar.

This group directed us to their relatives in Kalol, and also told us of their connection to Chittorgarh. They claimed that people who left were gone. Those who hadn't, could be found in the fort. Others are said to live in nearby Chittorgarh, in the villages surrounding the city of Neemuch. But it doesn't seem to matter very much to anyone. When the community does return, it is for a festival around Diwali, which is traditionally the time when the *gaduliya lohar* would set back out on the road after the monsoon has finished (Figure 11).

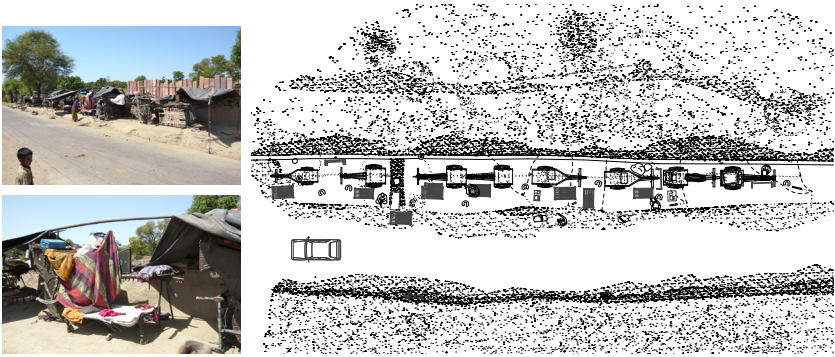

Figure 12: Illustration by banduksmithstudio.

Roadside Between Kumbhalgarh and Udaipur, Rajasthan

This was the first group we found and photographed. They had occupied the two-lane road between Kumbhalgarh and Udaipur, and yet appeared ready to leave at a moment's notice, though the abandoned cart at the front of the string hinted at the length of time they might have spent there. A common comment from the *gaduliya lohar* is that unlike the past, when they would spend ten to twelve days in a place and then move on, they now tend to settle for longer periods when they find acceptance in a community, because, with the growing emphasis on ownership, a declining need for their wares, and an increase in theft and robberies, finding a place on the road is becoming difficult (Figure 12).

[cart as home]

The space between the road and the plot line where the blacksmiths make their camp is a result of a policy of leaving room for future road expansion along the edge of almost every road in the towns or



Figure 13: Illustration by banduksmithstudio.

countryside of India. It has resulted in an extra ten feet on either side of the carriageway, which is often cared for neither by the city nor by the owner. This linear condition supports the inhabitation of many groups in the margin, ready to move out at a moment's notice, but settled while they are there. It is a permanently temporary condition, which impacts the architecture of their dwelling.

Settled in Kalol, Gujarat

[cart as relic]

The final group of *gaduliya lohar* we documented have settled at the edge of the city of Kalol where they acquired land to live on permanently. Of the fifty-plus people in the settlement, only one—the oldest—had actually lived on the road. Yet many of them retained the cart that their ancestors had used to travel. Now, immobile, the cart acts as storage and is placed inside the home, but its importance to the community's identity has not decreased.

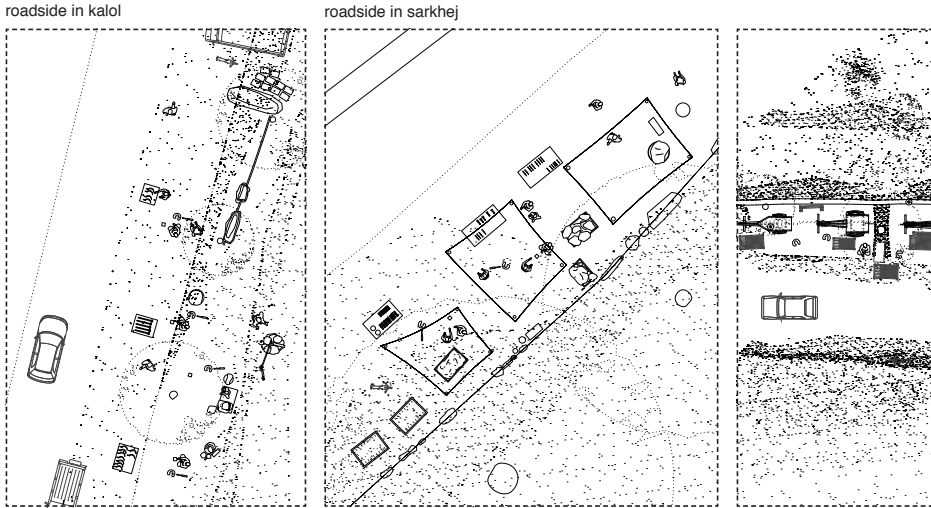

The worshiped element of the cart, the *puja* space, which links the people to their ancestors, has actually subsumed the cart itself, extending beyond its position at the head of the cart body into the entire cart and the room around. *Puja* was always located at the head of the cart, in the small space in front of the safe. Symbolically, this place for god would lead the community as they drifted from place to place. What once physically led them now connects them back to their history, through time and memory, to their ancestors and their identity as travelling blacksmiths (Figure 13).

[cart remains store, home]

The cart has become a relic, yet its presence defines the space as it did before; essentially, a pinned down version of the roadside settlements. Still occupying the in-between land, this time between buildings rather than road and boundary wall, carts

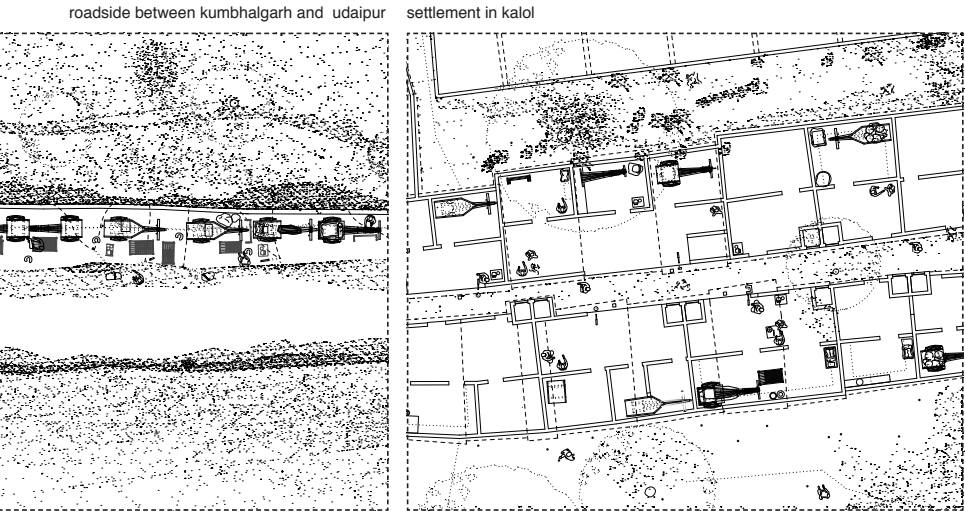

Figure 14: Cart as home. Illustration by banduksmithstudio.

stand at the back of sites, anchoring the storage, while wide verandas approach the path, and a *chula* (stove), is cemented into the finished floor. Walls and columns replace tent stakes and IPS (Indian Patent Stone, or poured cement floor) replaces packed earth plinths.

[cart as memory]

The story of the *gaduliya lohar* is a common, albeit extreme, tale of the inexorable pressures of modernization in India. Because they moved around, the *gaduliya lohar* have been pushed uncomfortably into India's contemporary systems of governance and ultimately, they are marginalized. Without a home, without land, and with a history of dependence on the goodwill of neighbors and of trade in kind, they are ill-equipped to function with the common denominator of money and ownership.



Figure 14: Photograph by authors.

Their problem is exacerbated as their craft is replaced. When their specific knowledge, acquired over centuries, is replicated overnight in factories, their value to society declines, and they are pushed further to the margins, where they begin to disappear. Fewer travel the roads, in fear of theft and attacks, and whether they move into built structures or not, they have begun to settle. Without a market for handcrafted metal inlay work and handmade agricultural tools, they halt their practice and, in a single generation, lose the skill.

[identity in cart]

The draw of the city and the push of the urban have slowly stripped away everything but the memory of the travelling blacksmiths—of who they are, where they are from, and what they once did. The response to this loss is manifested in the exaggerated position of *puja* on the cart. What once occupied a small, protected opening on the cart body, now extends onto the shaft, across the surface and even off the cart into whole room installations. As they move further from the continuous journey, and are drawn into the apparent permanence of urbanity, the symbolism of the element that once carried them grows stronger, a relic—*gaadu*—and a name—*gaduliya*—necessary to define their identity as they slip into the life of the city.