

Lawrence Berkeley National Laboratory

LBL Publications

Title

Tritium Calorimeter Setup and Operation

Permalink

<https://escholarship.org/uc/item/6hd3541n>

Author

Rodgers, David E

Publication Date

2002-12-01



ERNEST ORLANDO LAWRENCE BERKELEY NATIONAL LABORATORY

Tritium Calorimeter Setup and Operation

David E. Rodgers

Environment, Health & Safety Division

December 2002

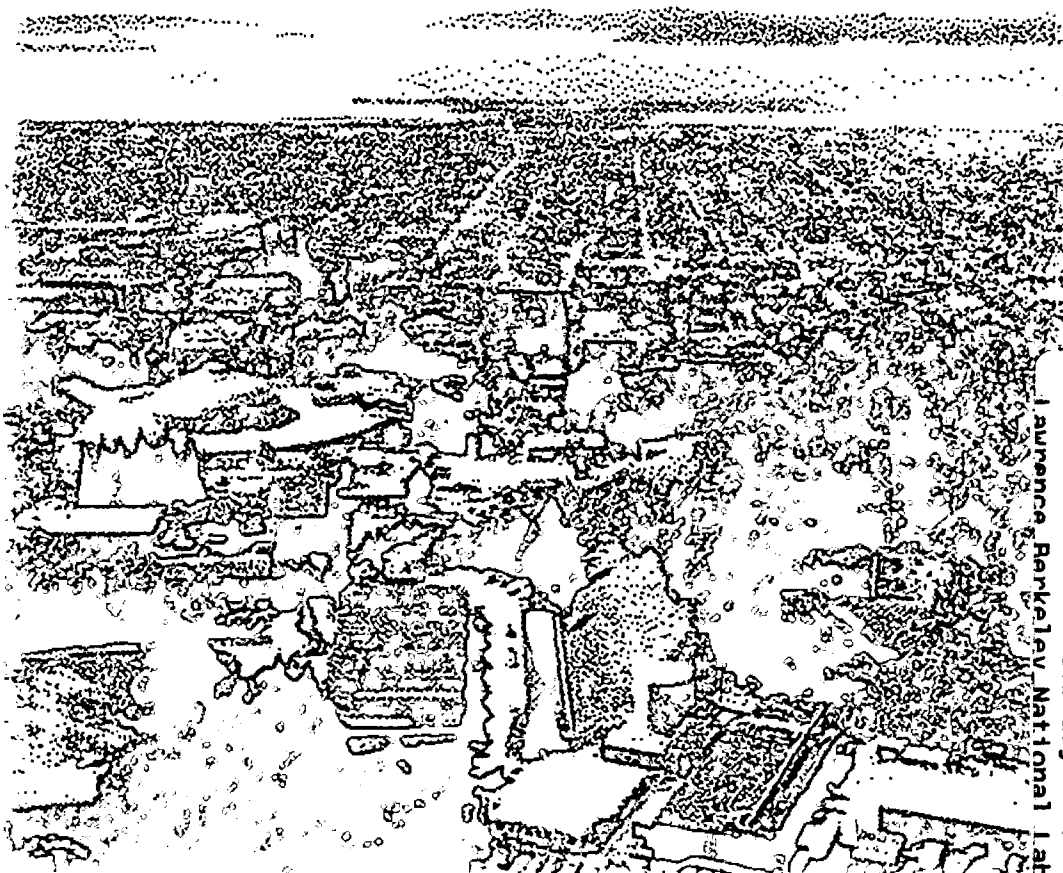

Lawrence Berkeley National Laboratory
Library Annex Reference
REFERENCE COPY
Does Not Circulate
COPY 1

DISCLAIMER

This document was prepared as an account of work sponsored by the United States Government. While this document is believed to contain correct information, neither the United States Government nor any agency thereof, nor the Regents of the University of California, nor any of their employees, makes any warranty, express or implied, or assumes any legal responsibility for the accuracy, completeness, or usefulness of any information, apparatus, product, or process disclosed, or represents that its use would not infringe privately owned rights. Reference herein to any specific commercial product, process, or service by its trade name, trademark, manufacturer, or otherwise, does not necessarily constitute or imply its endorsement, recommendation, or favoring by the United States Government or any agency thereof, or the Regents of the University of California. The views and opinions of authors expressed herein do not necessarily state or reflect those of the United States Government or any agency thereof or the Regents of the University of California.

**Lawrence Berkeley National Laboratory
Technical Services Group**

**Tritium Calorimeter
Setup and Operation**

December 17, 2002

This work was supported by the Director, Office of Science, U.S. Department of Energy
under Contract No. DE-AC03-76SF00098

TABLE OF CONTENTS

INTRODUCTION	5
THEORY	5
CONSTRUCTION DETAILS	5
INSTALLATION AND SET UP	6
SIGNAL CONNECTIONS	8
BATH TEMPERATURE PROBE	8
PROBE INSTALLATION	9
PROBE CALIBRATION	9
FINE TUNING THE PROBE CALIBRATION PARAMETERS.....	10
DATA ACQUISITION	10
ACQUISITION SOFTWARE	10
CONFIGURATION FILE.....	11
CHART DISPLAY	11
DATA STORAGE	11
DATA IMPORT INTO TELEMETRY DATABASE.....	12
MEASUREMENT CONTAINERS	12
SAMPLE CONTAINERS	12
BLANK CONTAINERS.....	12
PERFORMING MEASUREMENTS	13
DETERMINING BASELINE VALUES	14
CALIBRATION	15
CALIBRATION CAN	15
CALIBRATION MEASUREMENTS	15
CALIBRATION CALCULATIONS.....	15
OBSERVED PERFORMANCE	16
SENSITIVITY	16
SHORT TERM NOISE	17
LONG TERM NOISE	17
BASELINE STABILITY	17
BATH TEMPERATURE CONTROL	17
MAINTAINING WATER LEVEL.....	18
SOURCES OF NOISE	18
DATA REDUCTION	19
REVIEWING DATA.....	19
FINAL DATA CALCULATION	20
SUMMARY	20

ATTACHMENTS.....30

ATTACHMENT 1. EXAMPLE *CALORIMETER2.INI* FILE.....30

ATTACHMENT 2. EXAMPLE *STRIPCHARTBROWSER.INI* FILE.....33

ATTACHMENT 3. EXAMPLE CALCULATION SPREADSHEET.....34

ATTACHMENT 4. EXAMPLE CALIBRATION CALCULATION.....36

LIST OF FIGURES

FIGURE 1. EXAMPLE URANIUM BED.....21

FIGURE 2. CALORIMETER DETAIL WITH TOP INSULATION REMOVED.....22

FIGURE 3. EXTERNAL SET UP OF CALORIMETER.....22

FIGURE 4. MEASUREMENT CELL23

FIGURE 5. FUNCTIONAL SCHEMATIC OF THERMOELECTRIC HEAT SENSOR23

FIGURE 6. CALORIMETER SIGNAL CONNECTIONS.....24

FIGURE 7. 1-GALLON STEEL MEASUREMENT CAN (WITH LIFTER ATTACHED).....25

FIGURE 8. EXAMPLE OF SHORT TERM NOISE25

FIGURE 9. MEASUREMENT RESPONSE (1-MIN. AVERAGES) OF A SAMPLE WITH HIGH THERMAL
CONDUCTIVITY26

FIGURE 10. MEASUREMENT RESPONSE (2-HR RUNNING AVERAGES) OF A SAMPLE WITH LOW
THERMAL CONDUCTIVITY26

FIGURE 11. BASELINE DRIFT OVER TIME.....27

FIGURE 12. TYPICAL SHORT TERM SIGNAL AND BATH TEMPERATURE RESPONSE.....28

FIGURE 13. TYPICAL LONG TERM SIGNAL AND TEMPERATURE RESPONSE.....28

FIGURE 14. SIGNAL NOISE WITH AND WITHOUT HEATER OPERATING.....29

FIGURE 15. SIGNAL NOISE WITH NO HEATER, PUMPS OR CHILLER.....29

Introduction

LBNL developed tritium calorimetry capability to characterize the tritium inventory at the National Tritium Labeling Facility (NTLF). The NTLF has historically maintained 10,000 to 15,000 Ci of tritium, most in solid form as a tritide on uranium beds that are contained in small stainless steel cylinders (see figure 1). Prior to calorimetry, the tritium content was estimated from receipts and shipments and relied on process knowledge to track the tritium internally.

Theory

Tritium calorimetry is based on measuring the heat output of objects containing large amounts of tritium. The calorimeter is calibrated using a known amount of electric power, which can then be related to tritium activity by using the average energy released per tritium decay of 5.685 keV to derive a conversion factor in units of mW/Ci. Table 1 shows the derivation of this factor.

Table 1. Derivation of Tritium mW/Ci conversion factor

Item	Value	Units	Calculated as:
a	5.685	keV/d avg beta energy	constant
b	2.22E+12	d/min/Ci	constant
c	1.262E+13	keV/min/Ci	(a)(b)
d	1.262E+16	eV/min/Ci	(c)(1000)
e	1.6022E-19	J/eV	constant
f	2.0221E-03	J/min/Ci	(d)(e)
g	3.370E-05	J/s/Ci=watts/Ci	f / 60
	0.03370	mW/Ci	(g)(1000)

Calorimeter Construction

LBNL purchased the base calorimeter from International Thermal Instruments Company (ITI) in Del Mar, California. It is a dual-cell differential thermoelectric calorimeter with a temperature controlled water bath. The two measurement cells are identical and are suspended in the same

Tritium Calorimeter Set up and Operation

water bath. In operation, one cell is loaded with a matrix blank and the other with the sample to be measured. Using the difference in the signals from the two cells as the measurement signal minimizes the effects of temperature fluctuations in the bath.

The water bath is a double-walled 30-gal stainless steel tank with insulation filling the 2" gap between the walls. A stainless steel cover suspends the measurement cells in the bath. The water bath temperature controller (Julabo Model TD-BASIS) uses two pumps to circulate the bath water and controls the water temperature using heating elements. An external temperature-controlled water chiller provides a temperature bias against which the controller heater can regulate the bath temperature. The chiller circulates cooled water through ports in the temperature controller, which then directs the water through a heat exchanger immersed in the bath. The water circulation lines from the chiller to the controller are wrapped with ½-in. thick pipe insulation material. The cover is externally insulated with two 2-in thick sheets of Styrofoam which can be removed to provide access to the cell caps. Figures 2 and 3 show the basic construction details.

Figure 4 shows the construction details of the measurement cells. Each cell contains aluminum heat sinks which enclose thermoelectric elements embedded in a thermal insulating material. A thick nylon lid is used to access the cells. Figure 5 shows a generalized representation of how the thermoelectric elements operate. While the actual details of the thermoelectric elements are proprietary to the manufacturer, they essentially function as would a series of thermocouples, alternately positioned next to the inside and outside heat sinks. A temperature differential between the heat sinks produces a net voltage at the output terminals. The magnitude of the temperature difference is proportional to the total heat flow through the walls of the cell, which in turn is proportional to the rate of heat generation within the cell once thermal equilibrium is attained.

The output connector from each cell is routed to a signal box that provides an output for the signal from each cell and one for a signal representing the difference between the two. In normal operation, the difference signal output connector is connected to a digital voltmeter that is connected to a data acquisition computer through an IEEE-488 interface.

Installation and Set up

The unit was received from the manufacturer with neither the external chiller nor the water bath top insulation. Both were added when it became apparent the unit could not generate stable

Tritium Calorimeter Set up and Operation

readings without them. The unit was installed in a room where the temperature was controlled to $\pm 2^{\circ}\text{C}$.

The water bath was filled with de-ionized water to a level $1\frac{1}{4}$ -in below the top rim of the nylon insert in the fill hole in the tank cover, the maximum level allowed without water being forced over the rim by the action of the circulation pumps. Algacide was added to minimize algal buildup.

The chiller compensates for the heat generated by the mechanical action of the circulation pumps, which would otherwise raise the equilibrium bath temperature well above the ambient room temperature.

The chiller is set up for closed-loop circulation through the external water circulation ports of the bath temperature controller. All water connections to the bath are Tygon tubing and are clamped with stainless steel hose clamps. The chiller was filled with de-ionized water with algacide. A flow meter, Gilmont GF-1560 using a steel float, was installed in the loop. The chiller was set at 10-lbs water pressure with a flow rate of 2.66 lpm, which is 58 on the flowmeter scale.

The procedure for determining the optimum temperature set-points of the controller and the chiller is designed to minimize thermal fluctuations caused by cycling of the controller heater. The procedure is as follows:

1. Set the power level of the controller heater to its minimum level, 10%. This minimizes the rapid temperature changes when the controller cycles on.
2. Temporarily set the controller temperature to 2 or 3°C below the ambient air temperature and turn it on.
3. Set the temperature of the chiller to 1°C under ambient room temperature, turn it on and let the system reach thermal equilibrium. This may take six to eight hours or more, depending on the original temperature of the bath water. Equilibrium may be assumed when the temperature does not change for at least 60-min.
4. Observe the equilibrium temperature as indicated on the controller display. It should be approximately 1°C above the chiller temperature and very near ambient room temperature.
5. Add 0.08°C to the equilibrium temperature and round the result up to the nearest 0.1°C .

Tritium Calorimeter Set up and Operation

6. Re-set the controller temperature to the rounded value. This value is the nearest set-point temperature greater than 0.08°C above the equilibrium temperature. 0.08°C was selected as the minimum difference from observations of the system stability in this region.

For the initial calorimeter set-up, the chiller temperature was set to 19.5°C , the equilibrium temperature was 20.50°C and the controller set-point was 20.60°C .

Signal Connections

Figure 6 shows the schematic for signal connections. Each measurement cell has an external Lema connector on top for signal output. The signal cables are routed to the inside of the signal box through slots in the Styrofoam sheets. The front panel output of the signal box is the measurement cell signal minus the reference cell signal.

The signal box contains a power supply and voltage dividers to provide front panel outputs for system calibration voltages. The outputs are labeled at 1.21V, 3.20V, 6.24V and 9.55V, which are the no-load voltages. When connected to a 33-ohm calibration resistor, the supplied voltages are approximately 1.09V, 2.6V, 4.85V and 8.0V.

The difference output is connected to a Keithley 2182 NanoVoltmeter. The 2182 is set up for IEEE-488 output according to the manufacturer's instructions. The IEEE-488 address of the 2182 is expected to be 07 by the data acquisition software. During system calibration, the calibration voltage output to the resistor is split to a second 2182 to accurately determine the applied voltage. The calibration 2182 uses the same settings as the measurement 2182, but is not connected to the acquisition computer.

Bath Temperature Probe

As an aid in system diagnostics, a thermister temperature probe was added to monitor the water bath temperature independently of the temperature controller. The probe, a 33K ohm thermister on a 12-in stainless steel extension, is inserted through the cover of the water bath. The resistance is continually measured by a Keithley 2000 Multimeter. The probe was purchased from YSI Incorporated, Yellow Springs, Ohio, Part No. 032-46032-12-RP-72-ST.

Probe Installation

A Styrofoam plug was made to fit the bath fill-port in the top cover. A narrow hole was drilled through the center of the plug and the probe was inserted until ¼-in extended above the plug. The signal cable was routed through a slot in the bottom insulation sheet and connected to the 2-wire resistance input of the Keithley 2000. The multimeter was then connected to the acquisition computer using the IEEE-488 interface. The data acquisition program records the temperature and voltage readings of the calorimeter simultaneously.

Probe Calibration

The probe is primarily used to record relative changes in temperature and therefore its absolute calibration is not critical. A 2-point calibration was performed, assuming a linear response, using the calorimeter water bath and an ice water bath as the temperature references.

The probe was inserted into the calorimeter water bath at operational thermal equilibrium, 20.60°C, and the resistance reading stabilized at 36,047 ohms. The probe was then removed and inserted into a water ice bath and stabilized at 94,779 ohms.

The probe response was assumed to be of the form:

$$T = mR + c$$

where: T = temperature

m = the response factor of the probe in degrees/ohm

c = the temperature offset at 0 ohms.

The response factor, m , was calculated as:

$$m = (T_b - T_i) / (R_b - R_i)$$

where: T_b = bath temperature as indicated on the temperature controller panel (20.60°C)

T_i = Ice bath temperature (0°C)

R_b = indicated resistance in water bath, (36,047 ohms)

R_i = indicated resistance in ice bath (94,779 ohms)

The result was:

$$m = (20.60 - 0.00) / (36047 - 94779) = -0.0003507^\circ\text{C}/\text{ohm}$$

Tritium Calorimeter Set up and Operation

The temperature offset c was calculated as:

$$c = T_b - mR_b (= 20.60 - (-0.0003507)*36047) = 33.24 \text{ } ^\circ\text{C}$$

The acquisition program converts ohms to temperature using the equation:

$$T = R/Eff - bkg$$

where: Eff = the probe efficiency in units of ohms/degree

bkg = the temperature offset at 0°C

Therefore, Eff was calculated as $1/m = 1/(-0.0003507) = 2851.44$ ohms/degree, and bkg was set to c calculated above.

Fine tuning the probe calibration parameters

After initially performing and implementing the calibration as specified, the temperature measurements averaged 20.5963°C . The m and c values were then tweaked slightly to read exactly 20.6000°C . The resulting values were -0.00035078 degrees/ohm and 33.245°C , respectively.

Data Acquisition

A computer with a PCI IEEE-488 interface board, National Instruments PCI-GPIB with a Labview driver, is used for data acquisition. The 2182 NanoVoltmeter and the 2000 Multimeter are connected to the board with standard IEEE-488 cables.

Acquisition software

A Labview data acquisition program, Calorimeter2.vi, was developed to acquire, log and display the data. The program is a modification of the standard LBNL Telemetry data acquisition model.

The program accesses the IEEE-488 board to read the 2182 Nanovoltmeter voltage and 2000 Multimeter 2-wire resistance every five seconds. After twelve measurements, it computes a 1-min average of both readings and plots the averages on a chart. 2-hr running averages of both measurements are also computed and charted with every 1-min data point. The 1-min averages and 2-hr running averages are stored on a local log file. The data read interval, data average interval and running average interval can be configured to any value.

Configuration file

A configuration text file, Calorimeter2.ini, must be in the same directory as the program. An example configuration file is included as Attachment 1. The italicized notes explain the parameters and do not appear in the files used by the program. For a description of non-annotated entries in the configuration file, see MultiLoggerGlobals.vi in the Telemetry Labview development software.

The configuration file stores the temperature probe calibration parameters. Unlike the tritium measurement data, which is stored as raw mV and converted to Ci offline by the reporting spreadsheet, the temperature data is first converted from ohms to degrees and then stored. The temperature offset determined from the calibration is entered in the configuration file as the *Bkg* parameter in the section for the *degC* parameter, channel 01, and the *Eff* parameter, calculated as $1/m$, is entered as *Eff* in the same section.

Chart display

The chart will display either mV or Ci as selected by a front panel toggle. The mV reading is the net difference between the measurement and reference cells and is not corrected for a baseline value. The Ci value is calculated as the net mV minus a baseline mV value, times the calibration constant in Ci/mV. The baseline and calibration constant values can be manually entered in the display program's front panel. The default values are stored in the configuration file, as the *Eff* and *Bkg* parameters respectively, in the channel used for mV. Because only mV data is stored for temperature, the *Eff* and *Bkg* values are only used to provide an approximate Ci display when acquiring data.

Data storage

The required Directory structure on the data acquisition PC is as follows:

\Telemetry

\Telemetry \Applications (*for acquisition program and config file*)

\Telemetry \Data

\Telemetry \Data \Primary_Log (*for log files transferred to Telemetry database*)

\Telemetry \Data \Secondary_Log (*for local daily log files*)

Tritium Calorimeter Set up and Operation

The 1-min data points for mV, mV running average, temperature and temperature running average are stored in daily log files in the Secondary_Log directory. These files are named using the format *LogData_yyyymmdd.txt*.

Data Import into Telemetry Database

Data transfer to the LBNL telemetry database is not required, but is advised to maintain long-term storage. Typically, the Calorimeter pc is not set up for Telemetry database automatic data polling using FTP, but the data can be imported by copying the Secondary_Log daily data files to the Primary_Log directory of a configured Telemetry computer. All .txt files are automatically imported from these directories every 5-min from all configured telemetry computers.

Measurement containers

Sample containers

Items/materials to be measured are placed in one of two types of containers. A 1-gal steel can with rolled top-seals are used for most items. A cable tie attached to the top with an adhesive cable-tie anchor facilitates raising and lowering the can in the measurement cell (see figure 7).

Many uranium beds used for tritium containment are too long to fit inside the 1-gal steel cans. These beds are measured in a fabricated aluminum canister with an aluminum screw closure. Bolts are inserted into threaded holes in the top of the canister to facilitate tightening the screw closure and inserting and removing the canister from the cell.

Air space is minimized in each container by packing void space with crumpled aluminum foil. If bulk material is measured, it should fill the container as full as possible. Minimizing air space minimizes convection within the container which may cause uneven heat distribution. Uneven heat distribution may bias results because the tops of the cells do not contain thermoelectric sensing elements.

Blank containers

Blank containers are used as temperature references and to verify low level measurements. A blank container is prepared by filling a 1-gal steel can with crumpled aluminum foil and sealing the top. The heat-calibration can may be used as a blank reference can for convenience, to eliminate

Tritium Calorimeter Set up and Operation

the need for re-routing the calibration resistor leads through the nylon lids when switching between calibration and measurement. For other sample matrices, prepare blank containers from material approximating the sample matrix, since small differences in baseline offsets have been observed between differing matrices.

Performing measurements

All measurements, including baselines, samples and calibrations follow the same process.

1. Remove the deadweight and the top sheet of Styrofoam insulation.
2. Place the appropriate blank reference container in the reference cell. The reference cell is the one furthest away from the temperature controller.
3. Use the lifting attachment to place the container to be measured in the measurement cell. If the can does not drop to the bottom of its own weight, do not push it down. A snug container may result from the top seal being incompletely rolled and too large to fit. If this happens, re-seal the top or file down the outer edges until it is a sliding fit.
4. Replace the top sheet of Styrofoam, making sure all wires are properly seated in the appropriate slots.
5. Replace the deadweight on the Styrofoam to improve the seal between the top and bottom sheets.
6. Start the acquisition program if it is not running. The program normally runs continuously.
7. Observe the output as the system comes to thermal equilibrium. This may take 8 to 12 hrs for matrices with low thermal insulation, or as much as 4 to 7 days for thermally insulated matrices like molecular sieve. Short term fluctuations (on the order of minutes) range from 0.2 to 0.3 mV peak-to-peak (see figure 8).
8. The signal may start out very high or very negative if the initial temperature of the sample container is significantly higher or lower than the water bath temperature. Storing samples in the calorimeter room for a few days prior to measurement minimizes this effect.

9. It is common for a measurement to overshoot the final value and then settle back to it as equilibrium is reached.

Figure 9 shows an example of a tritium bed measurement reaching equilibrium in 10 hrs. These samples are of high thermal conductivity and reach equilibrium quickly. Figure 10 shows the measurement response of a sample consisting of very low thermal conductivity molecular sieve filling a 1-gallon can and containing approximately 100 Ci of tritium. The response initially starts very high, indicating that the sample was warmer than the bath temperature when placed in the cell, and does not achieve equilibrium during the five days of the measurement.

Equilibrium may be assumed when the 2-hr running average is constant, within the limits of the system noise, for 4-6 hours for low insulation matrices, or 1-2 days for high insulation matrices.

Determining baseline values

Even though a reference cell is used to cancel noise and offsets, the net output is usually not zero when no heat source is present in the measurement cell. A reading of 0.5 – 1.5 mV is typical, depending on the level of the bath water. This baseline offset must be determined and subtracted from all measurements. The baseline is determined by measuring a blank matrix of the sample type to be measured. Different matrices may exhibit different baseline values.

Baseline corrections are applied to every measurement. Experimental data shows that the baseline value increases as the water in the bath evaporates, at a rate of approximately 0.0067 mV/day, which is 0.9 Ci/day (see figure 11) When the bath water is replenished, the original baseline signal is restored (see the section on Maintaining Water Level). Baseline corrections are made by determining the baseline within 5 or 6 days of any sample measurement (to keep drift errors to 5 Ci or less) or by taking a single baseline measurement each time water is added to the bath, then using the measured mV/day drift value to correct this baseline value to the day of each sample measurement. The second method is more accurate, but requires two months or more of continuous baseline data to accurately confirm the drift correction value. Current calculation spreadsheets use this method.

Calibration

Calibration can

Calibration is performed by resistive heating of a calibrated 33 ohm resistor inside a measurement can. The calibration can was prepared by packing the resistor with crumpled aluminum foil in a 1-gal steel measurement can. The resistor was placed near the centerline in the bottom quarter of the can. The resistor leads were routed through a grommet in a small hole in the steel top, then the top was sealed to the can. These leads are routed through the center hole in the nylon cell lid and through the Styrofoam insulation. They are connected to the calibration voltage outputs of the signal box with a dual RCA-type plug connector.

The resistors are calibrated by measurement with high precision voltmeters, preferably by two measurements using independent meters.

Calibration Measurements

Calibrations are performed periodically, typically every six months, using the following procedure:

1. Place an appropriate reference container in the reference cell and the calibration can in the measurement cell. Route the resistor leads through the nylon cell lid.
2. Take a baseline measurement with no voltage applied to the resistor leads. The measurement time should be long enough to establish thermal equilibrium.
3. Insert the dual RCA connector from the calibration can into the lowest voltage output connector on the signal box.
4. Connect a piggyback connector from this same output connector to a Keithley 2182 Nano-voltmeter to record the applied voltage. The applied voltage will be lower than the listed voltage due to the load from the resistor. Record the start time and observed voltage in a lab book.
5. Record the observed voltage when the system reaches thermal equilibrium.
6. Repeat steps 3 – 4 for the remaining three calibration voltages.

Calibration Calculations

A spreadsheet is used to compute the calibration parameters as follows:

Tritium Calorimeter Set up and Operation

1. Save chart images of each equilibrium voltage and place them in the calibration calculation spreadsheet (see the section on data calculation).
2. Enter the observed applied voltage, the equilibrium mV reading and the baseline mV reading for each voltage used. Include the baseline reading as the first data point.
3. The spreadsheet performs the following:
 - a. Subtracts the baseline mV value from the measured equilibrium value for all voltages.
 - b. Calculates the heat dissipated in the resistor for each voltage using the equation $W = 1000 \cdot V^2 / R$, where V is the applied voltage and R is the calibrated value of the resistor.
 - c. Calculates the equivalent tritium content for each voltage using the conversion constant of 0.03370 mW/Ci. (see Table 1 for derivation).
 - d. Plots the Ci – vs. – net mV data, with the Ci values on the Y-axis.
 - e. Fits a linear regression line to the data, forcing the 0.0 value. The slope of this line is the calibration constant in Ci/mV.
 - f. Calculates the indicated tritium Ci value for each voltage by multiplying the Ci/mV calibration constant by the measured mV, then calculates the percent difference between this indicated Ci value and the theoretical Ci value computed from the resistor heat. The differences should be less than 2% and most are less than 1%. See Attachment 4 for an example calibration calculation spreadsheet.

Observed performance

Sensitivity

As of the writing of this document, the calibration constant is 129.4 Ci/mV and has been stable to within 0.1% of this value for 4 separate calibrations over a one year time frame. Table 2 shows the results of these calibrations.

Table 2

Date	Ci/mV	Comments
January 28, 2001	129.36	
March 1, 2001	129.53	
May 11, 2001	129.44	
November 7, 2001	129.44	3-point only (0, 1075, 6092 Ci)
Average \pm sdev	129.44 \pm 0.07	

Short term noise

The short term noise, meaning output fluctuations observable from minute to minute, varies from 0.2 mV peak to peak to 0.4 mV. The short term noise diminishes as the bath water level decreases due to evaporation, possibly reflecting a narrowing of the temperature operating range that requires less use of the heater (see figures 8 and 11).

The effects of short term noise are minimized by basing measurements on 2-hr running averages

Long term noise

The system under the current set-up shows drift in the 2-hr average over a range of about 0.04 mV, which represents about 5 Ci.

Baseline instability

Occasional baseline shifts up to 25 Ci have been observed at equilibrium, primarily after loading or unloading measurement cans. These instabilities have so far limited the assigned errors to a minimum of 25 Ci.

Bath temperature control

The thermister probe data shows that the water bath temperature is maintained within a range of about 0.001°C, even though the controller has only two significant digits in its set point display. See figure 12 for examples of short-term temperature readings, showing the 1-minute data readings and the superimposed 2-hr running averages. See Figure 13 for example long term readings,

showing only the 2-hr running averages. In figure 13 the high signal excursions represent new samples being placed in the cell. The fluctuation of the probe readings represent actual temperature variations in the bath as opposed to electrical noise. This was verified by observing that when the probe is placed in a Styrofoam insulator, the short term noise is observed to be a ripple of about 0.0001°C peak to peak on approximately a 10-min cycle.

Maintaining water level

Water loss from the bath due to evaporation is approximately 80 ml/day. Water must be added when the level drops to approximately $2\frac{1}{2}$ " from the top lip of the nylon annulus in the fill-hole. If the water level drops below this point, the thermal balance of the system is lost and the controller can no longer maintain a stable temperature. Refills are required approximately every 75 days.

Sources of noise

The three major sources of short term signal noise are:

1. Bath temperature fluctuations caused by cycling of the controller heater.
2. Bath temperature fluctuations caused by chiller temperature fluctuations
3. Noise from thermal sources other than the bath, such as the thermoelectric elements and the signal connectors.

To quantify the relative noise contributions from each of these sources, the signal was recorded under the following conditions with the results shown:

1. The temperature controller and chiller operating normally - 0.059 mV for 30-minute averages.
2. The heater in the controller turned off, but with the circulation pumps and chiller still operating - 0.047 mV for 30-minute averages.
3. The heater, pumps and chiller turned off - 0.022 mV for 60-minute averages.

Figure 14 shows the response before and after the heater was turned off at 14:00 hrs. The temperature starts dropping immediately after the heater is turned off, causing a sudden rise in signal which decays as the temperature approaches the new equilibrium state. Figure 15 shows the response after the heater, pumps and chiller are turned off. Under these conditions the temperature

drops steadily as the average bath temperature approaches room temperature, and the signal shows strong swings associated with the daily temperature cycles of the room.

The various noise components are summarized in table 3.

Table 3. Observed Calorimeter Noise Components

Noise source	mV	Ci
Short term	0.4	50
Long term	0.04	5
baseline shifts	0.2	25

Data Reduction

Reviewing Data

Charts of measurement data can be viewed separately from the acquisition program using the program StripChartBrowser.vi, which is a version of the acquisition program with the acquisition components removed. The program requires a configuration file similar to the acquisition program named StripChartBrowser.ini that must be in the same directory as StripChartBrowser.vi. An example configuration file is shown as Attachment 2. The meanings of the various parameters are the same as for the acquisition program configuration file.

The program is used by copying the daily log files from the \Secondary_Log directory of the data acquisition computer to a \Secondary_Log directory on the local computer on which the StripChartBrowser program resides. The path to the parent directory must be entered in the .ini file as the LogPath= entry in the *General* section. In the example shown, the files were copied to D:_My Documents\Calorimeter Daily Archives\Data\Secondary.

When the program starts, a prompt is given for the start date of the data to be reviewed and the number of days of data to review, in the format mm,dd,yyyy,n where n is the number of days. Up to 14 days of data may be loaded at a time.

The time-axis of the data chart can be changed by single clicking on the chart area and dragging it left or right. The Y-axis may be adjusted with the vertical control buttons. The bath temperature data is on the left axis and the mV measurement data is on the right axis. Each axis can be separately adjusted.

Final Data Calculations

Final data calculations are performed by a spreadsheet, Calorimeter_revN.xls, where N is the version number. Attachment 3 shows an example of a completed spreadsheet. Instructions for using this spreadsheet are as follows:

1. Capture images of the data acquisition chart or of the StripChart Browser chart showing the measurement process at equilibrium, both for the baseline measurement and for the sample measurement, with the chart set to show only the 2-hr average data, displaying at least 64-hours of data, and set to show mV, not Ci, on the right scale. Use a screen capture utility to capture the image and save it as a graphic file.
2. Insert the images into the appropriate sections of the Charts sheet of the spreadsheet.
3. Determine the best mV value for the baseline and the sample. Place arrows next to the charts to show the selected equilibrium mV values and label them with the selected value.
4. On the Data Sheet, enter the sample I.D. and description of the sample and/or matrix.
5. Enter the start time, stop time and equilibrium mV value of the baseline measurement.
6. Enter the Calibration date and Ci/mV value.
7. Enter the load time, end time and equilibrium mV value of the sample measurement.
8. The spreadsheet will then perform the following calculations:
 - a. The corrected baseline at the end time of the sample measurement is calculated using the indicated baseline drift factor in mV/day.
 - b. The corrected baseline is subtracted from the equilibrium sample mV, and multiplied by the Ci/mV calibration factor to yield the net Ci's of tritium.
 - c. The error is calculated as the root-mean-square of the following two error parameters:
 - i. 1% of the sample equilibrium value (to account for calibration errors)
 - ii. 25 Ci (to account for baseline instabilities.)

Summary

The LBNL tritium calorimeter is a stable instrument capable of measuring tritium with a sensitivity of 25 Ci. Measurement times range from 8-hr to 7-days depending on the thermal

Tritium Calorimeter Set up and Operation

conductivity and mass of the material being measured. The instrument allows accurate tritium measurements without requiring that the sample be opened and subsampled, thus reducing personnel exposure and radioactive waste generation.

The sensitivity limit is primarily due to response shifts caused by temperature fluctuation in the water bath. The fluctuations are most likely a combination of insufficient insulation from ambient air and precision limitations in the temperature controller. The sensitivity could probably be reduced to below 5 Ci if the following improvements were made:

1. Extend the external insulation to cover the entire bath and increase the top insulation.
2. Improve the seal between the air space above the bath and the outside air to reduce evaporation. This will limit the response drift as the water level drops.
3. Install an improved temperature controller, preferably with a built in chiller, capable of temperature control to $\pm 0.001^{\circ}\text{C}$.

Figure 1. Example Uranium Bed

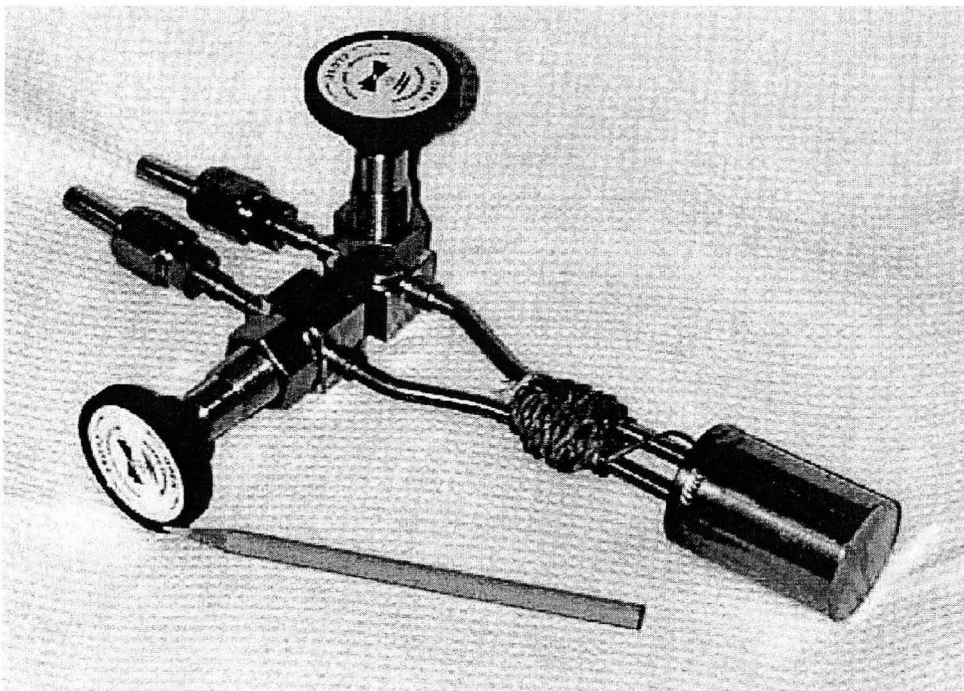

Tritium Calorimeter Set up and Operation

Figure 2. Calorimeter detail with top insulation removed

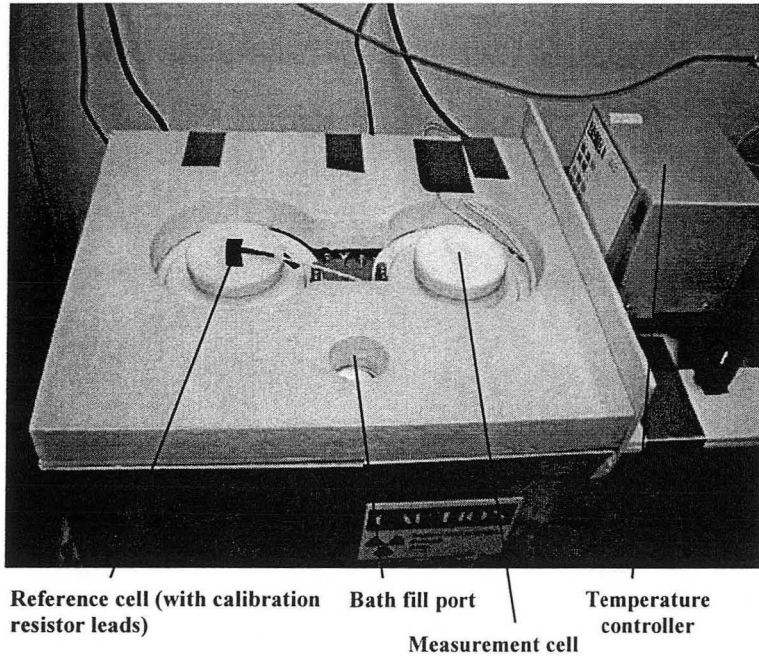
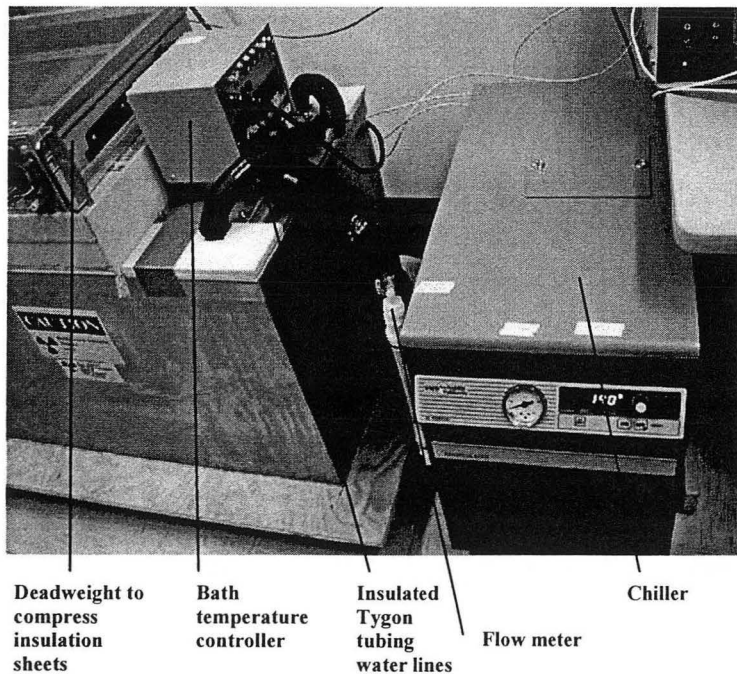

Figure 3. External Set up of Calorimeter



Tritium Calorimeter Set up and Operation

Figure 4. Measurement Cell

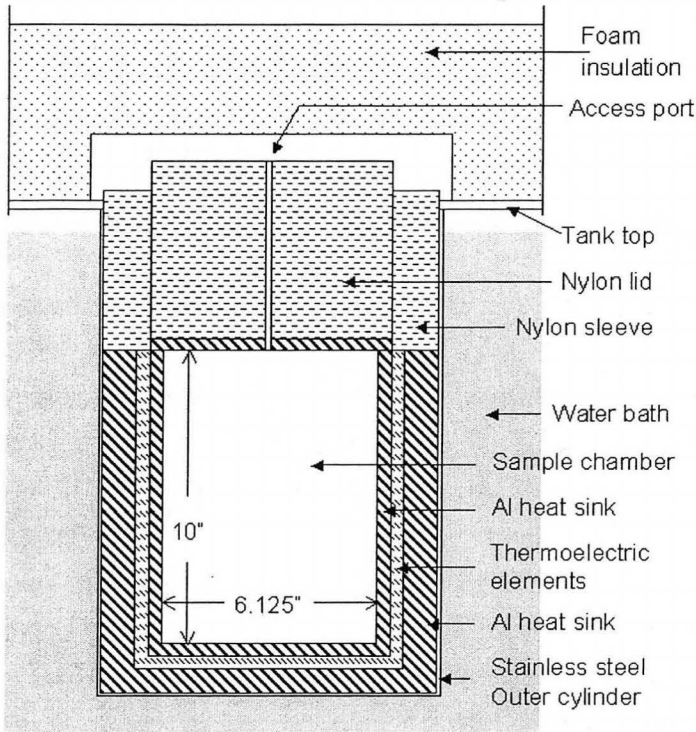
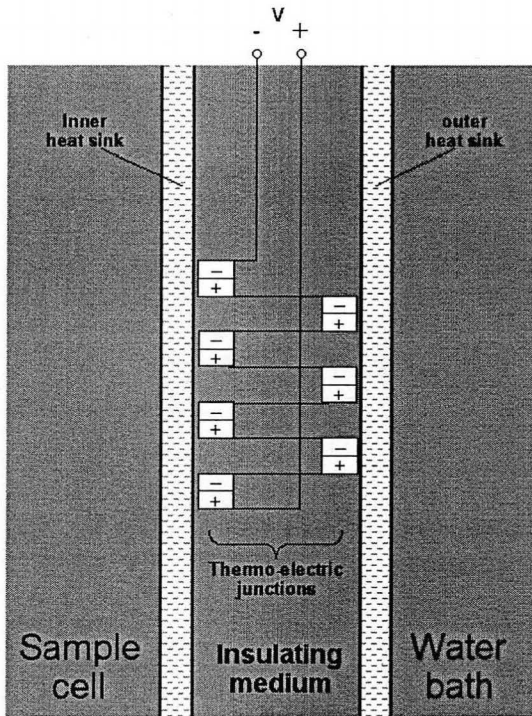

Figure 5. Functional Schematic of Thermoelectric Heat Sensor



Tritium Calorimeter Set up and Operation

Figure 6. Calorimeter Signal Connections

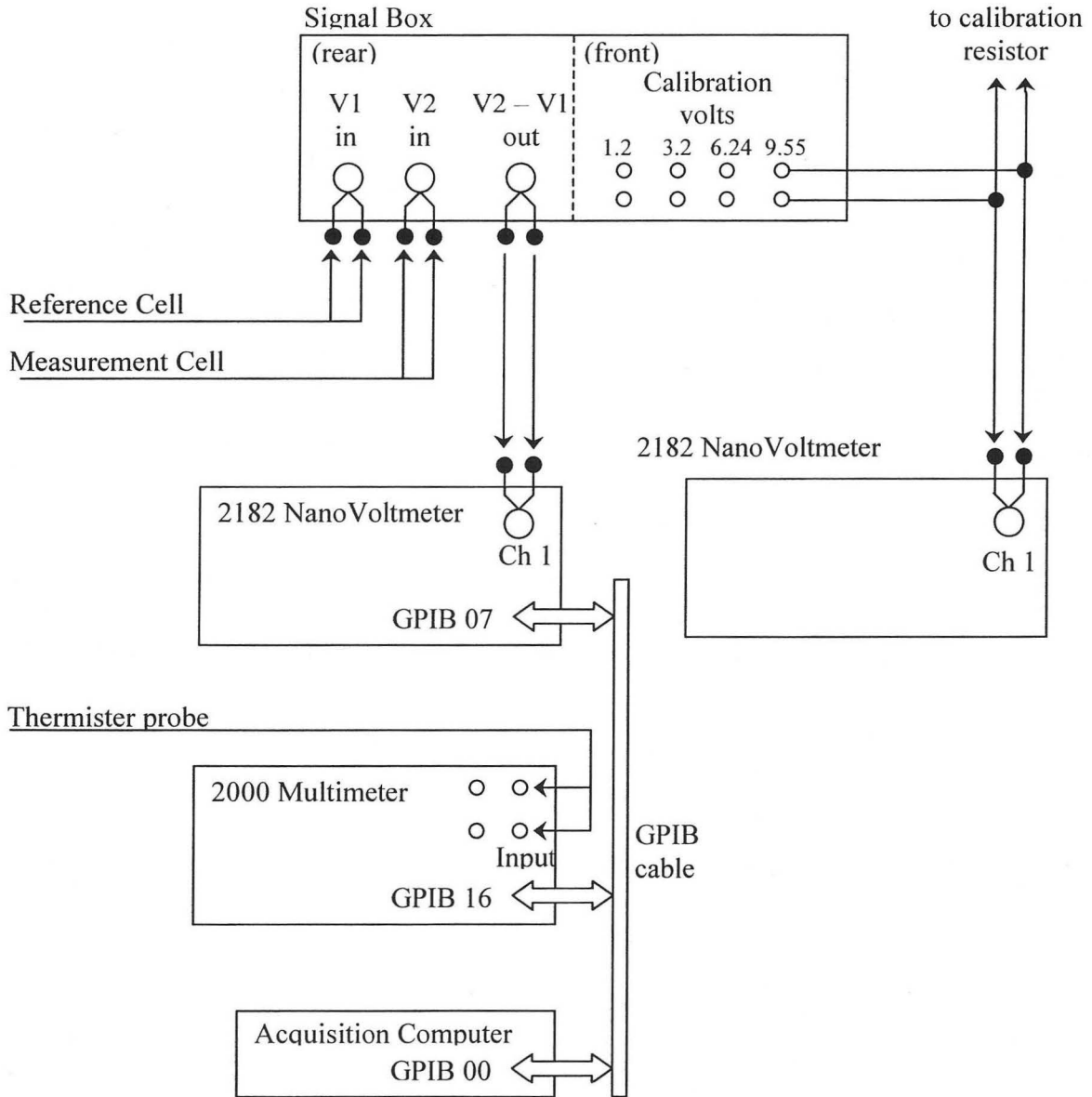

Figure 7. 1-Gallon Steel Measurement Can (with lifter attached)

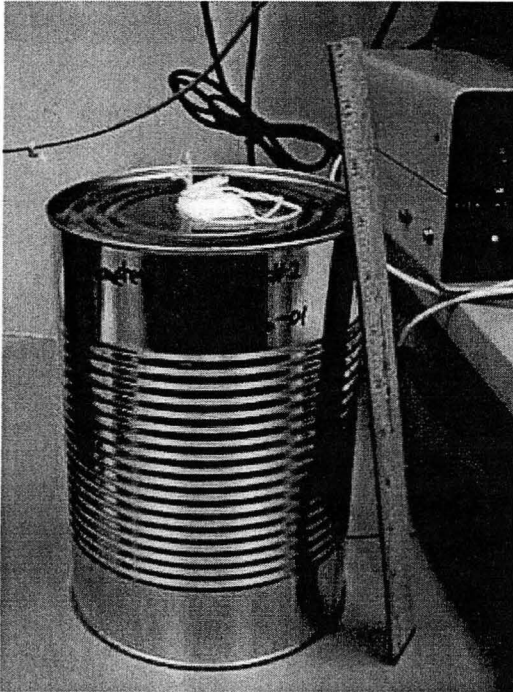
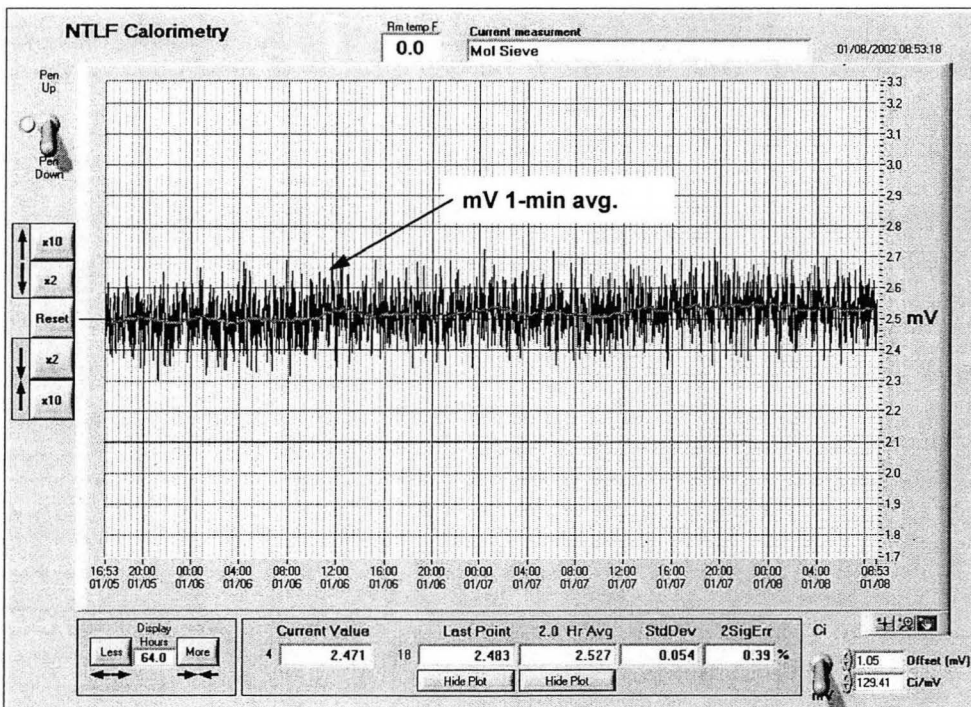

Figure 8. Example of Short Term Noise



Tritium Calorimeter Set up and Operation

Figure 9. Measurement Response (1-min. averages) of a Sample with High Thermal Conductivity

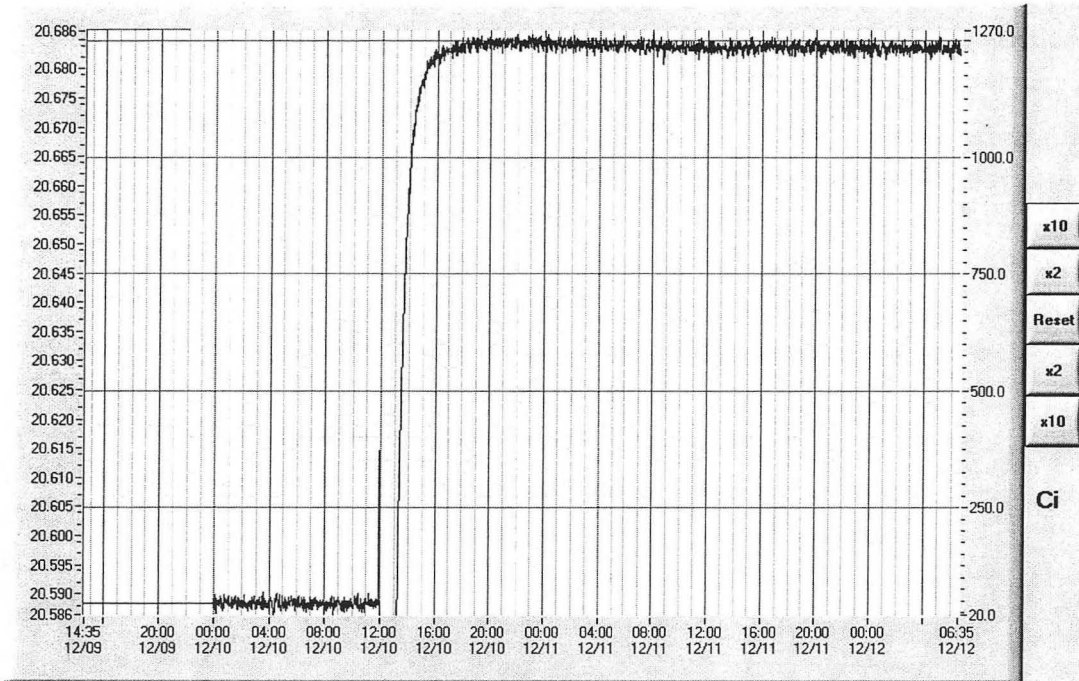
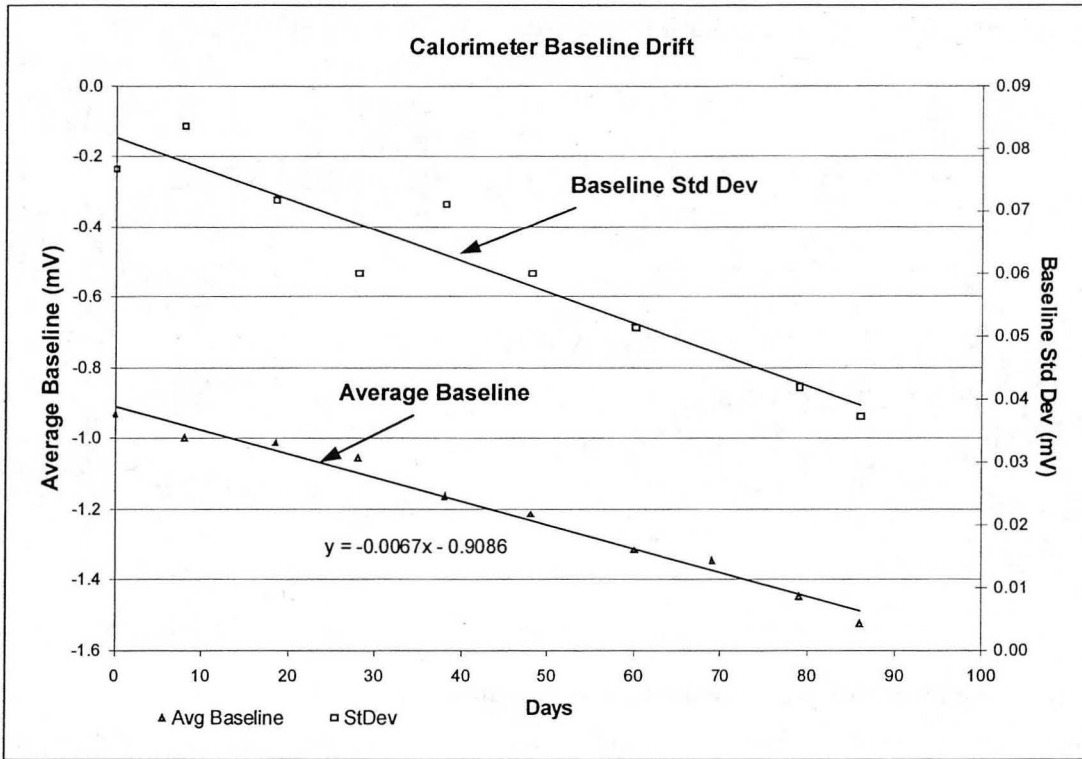

Figure 10. Measurement Response (2-hr running averages) of a Sample with Low Thermal Conductivity



Tritium Calorimeter Set up and Operation

Figure 11. Baseline Drift Over Time



Notes: Averages and standard deviations computed from 24-hour data sets of 1-minute values. Polarity set such that decreasing voltage is increasing temperature.

Tritium Calorimeter Set up and Operation

Figure 12. Typical short term signal and bath temperature response

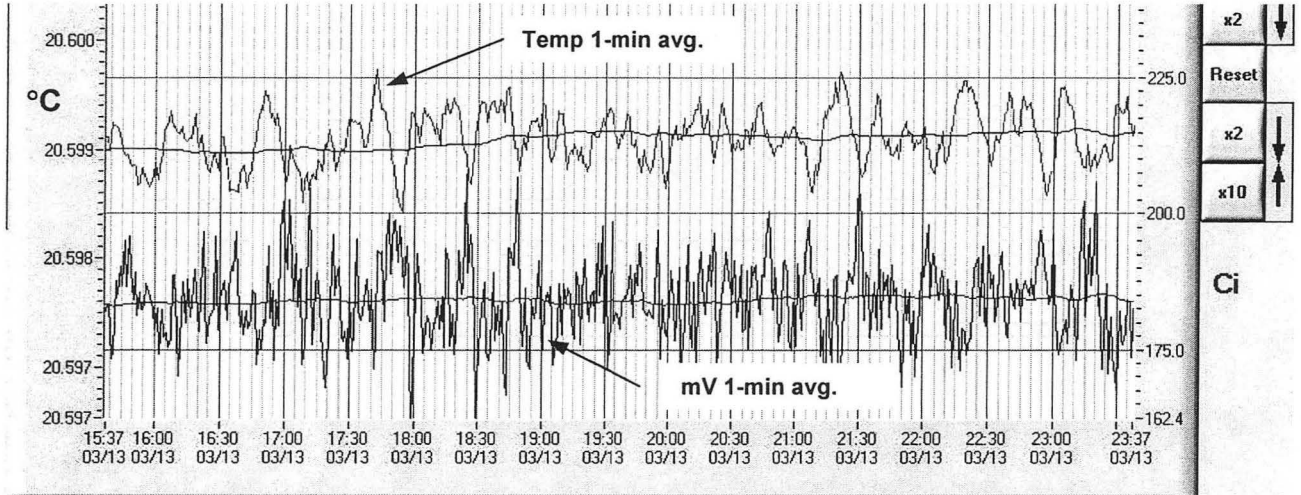
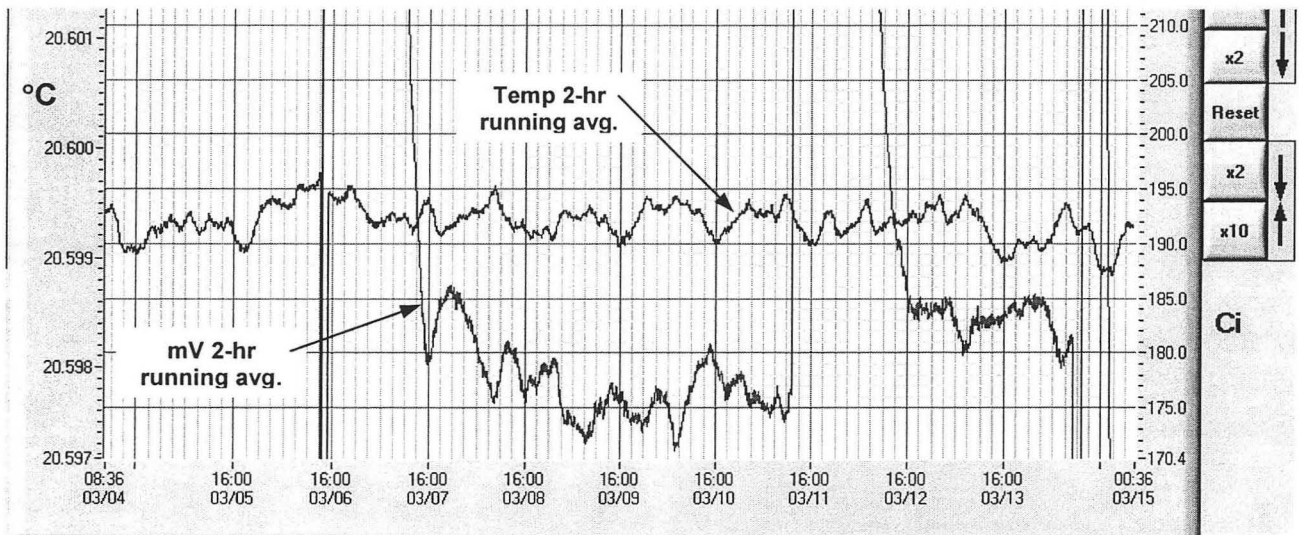

Figure 13. Typical long term signal and temperature response



Tritium Calorimeter Set up and Operation

Figure 14. Signal noise with and without heater operating

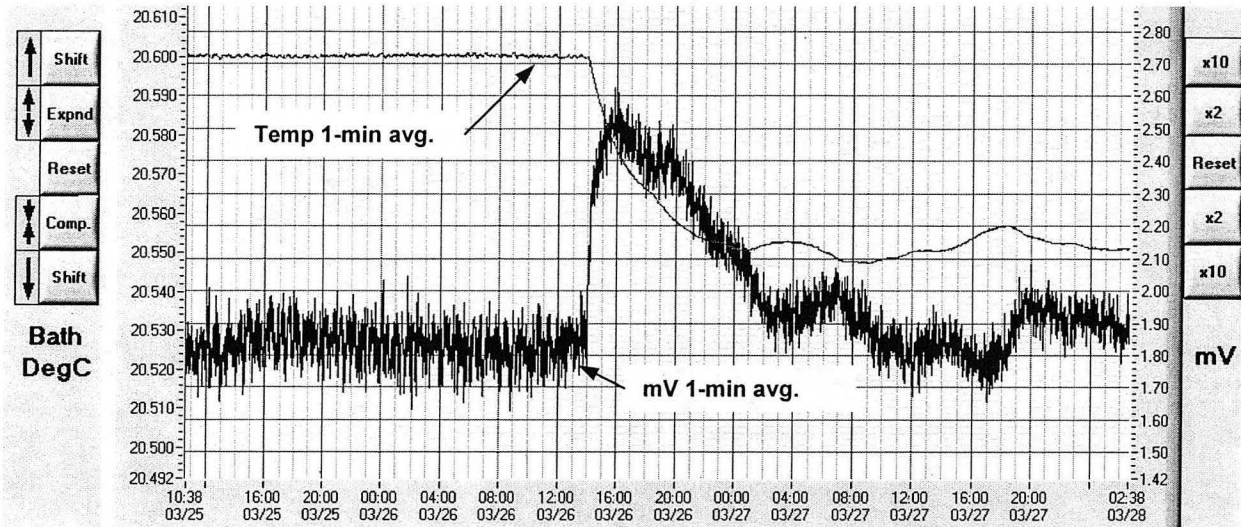
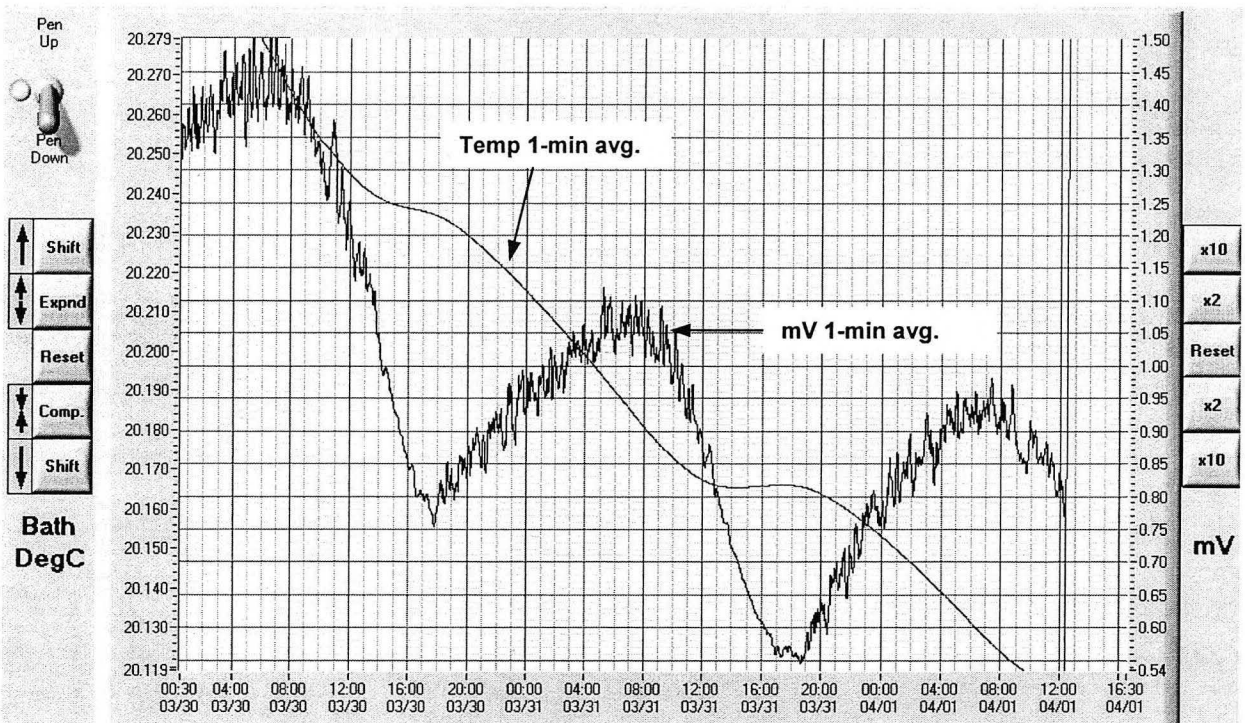

Figure 15. Signal noise with no heater, pumps or chiller



Tritium Calorimeter Set up and Operation

Attachment 1. Example Calorimeter2.ini file

This section only needed by Labview if Web server is to be enabled. The name in brackets must be the same as the application name.

[Calorimeter2]

WebServer.Enabled=True *Enable Web server to display front panel*
postScriptLevel2=False

Section for general config parameters

[General]

LogPath=C:\Telemetry\Data *Path of stored data files*
AltLog=FALSE
SerialOut=FALSE
SerialOutPort=0
RunAvgSec=7200 *length of running average (in seconds)*
RestartTag=FALSE *eliminates visible data breaks when re-starting program*
AutoFullScrn=FALSE
**Note - EnableOptions=TRUE causes the raw data to be logged to a debug text file
EnableOptions=FALSE *(see above)*
ReloadDays=3 *How many days of data to reload when re-starting*

Section for config parameters specific to the data graph

[Graph00]

Title=NTLF Calorimetry *Title to appear on the chart*
Subtitle=
GreenLine=0.0 *puts a dotted green line at the value specified*
ViewHrs=32 *default number of hours to display*
Precision=3 *Precision to show*
MaxY=22.0 *initial Y-scale maximum value (for Temp)*
MinY=18.0 *initial Y-scale minimum value (for Temp)*
RMaxY=5.0 *initial Y-scale maximum value (for Ci)*
RMinY=-5.0 *initial Y-scale minimum value (for Ci)*
ResDataPnts=10080 *number of 1-minute data points to retain in memory*

Section for config parameters specific to the chart for the optional FemtoTech H3 monitor data acquisition. Same as above.

[Graph01]

Title=Femtotech Tritium Monitor
Subtitle=Concentration
GreenLine=20
ViewHrs=24
MaxY=20
ResDataPnts=4400

[Ch00] *Parameters for mV acquisition*

Param=mVolts *parameter name (for compatibility with Telemetry database)*
Legend=Output *(NOT USED)*
InstrID=x *instrument ID*
Loc1=NTLFCalorim *acquisition location (for Telemetry database)*
Loc2=x *(NOT USED)*
IntSec=60 *# of seconds to integrate for each plotted data point*
LogSec=5 *# of seconds between data reads*
Eff=129.41 *default mV/Ci to use (may be changed on front panel)*
Bkg=0.87 *default baseline offset to use (may be changed on front panel)*
UnitRaw= *(NOT USED)*

Tritium Calorimeter Set up and Operation

Unit=mV *unit of result (for Telemetry database)*
UnitTotal= *(NOT USED)*
Graph=0 *Which chart to display the data on*
Plot=3 *Which plot to use on the chart*
File=TRUE *TRUE means to file the data. FALSE means to not file it.*

Config parameters for temperature monitor

[Ch01]
Param=DegC
Legend=Temp
InstrID=x
Loc1=NTLFCalorim
Loc2=x
IntSec=60
LogSec=5
Eff=-2850.79 *Probe efficiency in ohms/degreeC*
Bkg=33.245 *temperature offset at 0 ohms*
UnitRaw=Ohms
Unit=DegC
UnitTotal=
Graph=0
Plot=2
File=TRUE

Config for mV running average channel

[Ch02]
Param=mVoltsAvg
Legend=Running Avg
InstrID=x
Loc1=NTLFCalorim
Loc2=x
IntSec=300
LogSec=60
Eff=1.0
Bkg=0
UnitRaw=
Unit=mV
UnitTotal=
Graph=0
Plot=1
File=TRUE

Config for temperature running average channel

[Ch03]
Param=DegCAvg
Legend=Running Avg
InstrID=x
Loc1=NTLFCalorim
Loc2=x
IntSec=300
LogSec=60
Eff=1.0
Bkg=0
UnitRaw=Ohms
Unit=DegC
UnitTotal=

Tritium Calorimeter Set up and Operation

Graph=0
Plot=4
File=TRUE

Config for optional Femtototech tritium monitor
[Ch04]
Param=Tritium
Legend=Tritium conc.
InstrID=xx
Loc1=B75125
Loc2=xx
IntSec=60
LogSec=10
Eff=0.000001
Bkg=0
UnitRaw=Counts
Unit=uCi/m3
UnitTotal=
Graph=1
Plot=1
GraphOnOpen=TRUE
LowRnge=1
MedRnge=5
HiRnge=10

Attachment 2. Example StripChartBrowser.ini file

```
[StripChartBrowser]
WebServer.Enabled=false
```

```
[General]
LogPath=D:\_My Documents\Calorimeter Daily Archives path to sec. data files
AltLog=FALSE
SerialOut=FALSE
SerialOutPort=0
RunAvgSec=7200
```

```
[Graph00]
Title=Data Browser
Subtitle=
GreenLine=0.0
ViewHrs=32
```

```
[Ch00]
Param=mVolts
Legend=Output
InstrID=x
Loc1=NTLFCalorim
Loc2=x
IntSec=60
LogSec=5
Eff=1.0
Bkg=0
Alarm=0
UnitRaw=
Unit=mV
UnitTotal=
Graph=0
Plot=2
File=TRUE
HiRnge=10
```

```
[Ch01]
Param=mVoltsAvg
Legend=Running Avg
InstrID=x
Loc1=NTLFCalorim
Loc2=x
IntSec=300
LogSec=60
Eff=1.0
Bkg=0
Alarm=0
UnitRaw=
Unit=mV
UnitTotal=
Graph=0
Plot=1
File=TRUE
```

Attachment 3. Example Calculation spreadsheet (page 1 of 2)



Lawrence Berkeley National Laboratory

H3 Calorimetry Measurement

Calorimeter: LBL-1

U-Bed A
02/20/01

Sample I.D.: U-Bed A

Prepared by: _____
initials/date

Description: Empty bed

Reviewed by: _____
initials/date

Baseline Determination

Baseline start date/time: 2/24/01 10:40
Baseline stop date/time: 2/26/01 14:15
Baseline hours: 51.6
Baseline mV: -0.97

Error analysis

Minimum Precision (Ci): 25
% accuracy: 1

Calibration:

Reference: 3/1/01
Ci/mV: -129.53

Sample Measurement:

Load Date/time: 2/20/01 10:20
End date/time: 2/21/01 10:40
Measurement hours: 24.3
Equilibrium mV: -1.11

H3 Content (Ci):

18 ± 25

Attachment 3. Example Calculation spreadsheet (page 2 of 2)

U-Bed A
02/20/01

Baseline Chart

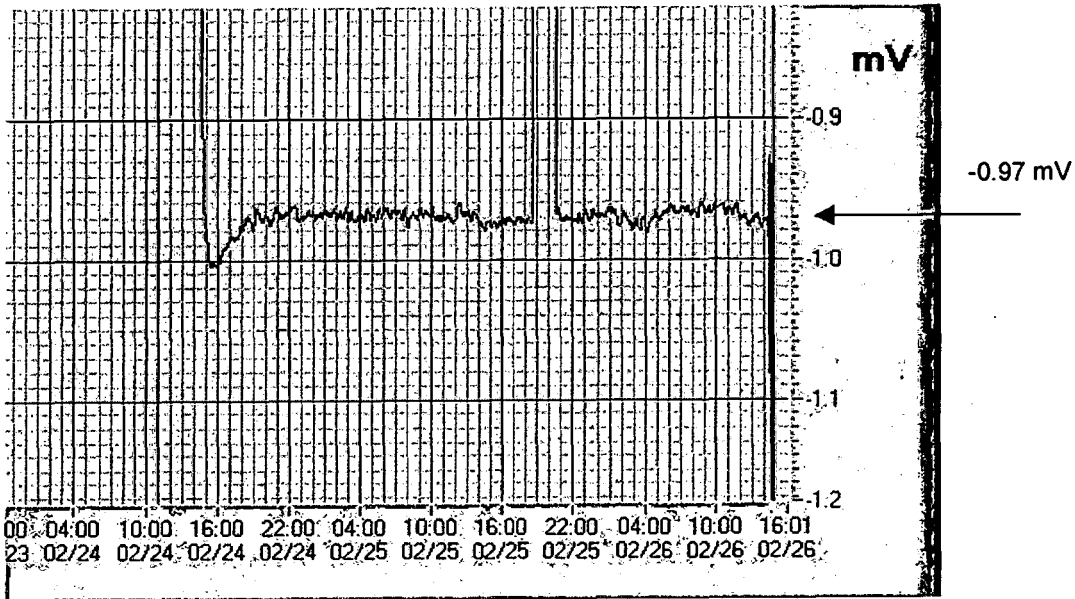

Measurement Chart

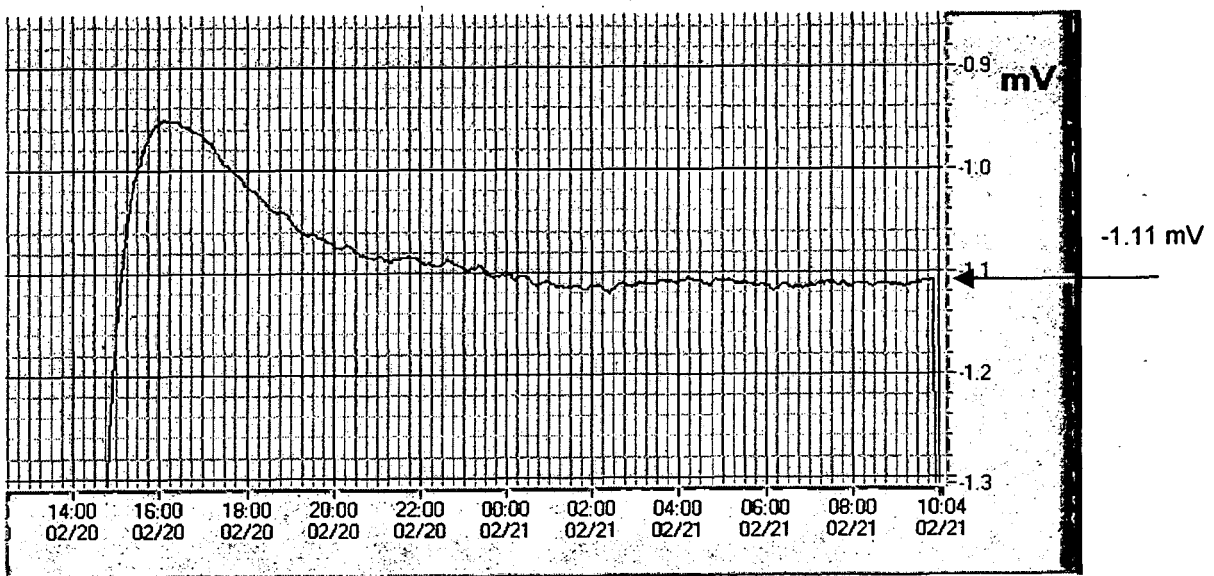

Tritium Calorimeter Set up and Operation

Attachment 4. Example Calibration Calculation

Calibration with new aluminum container
 Resistance Standard #1

** Ref cell = steel can blank **

May 11, 2001

32.8 ohm resistance

0.03370 mW/Ci

129.44 Ci/mV

Applied V	mW	Equiv. H3 Ci	Gross mV	Baseline mV	Net mV	Line Ci	Line dev (Ci)	Line dev (%)
0	0.0	0	0.78	0.780	0.00	0	0	
1.092	36.4	1079	9.25	0.780	8.47	1096	18	1.60
2.600	206.1	6116	48.15	0.780	47.37	6132	16	0.26
4.827	710.4	21079	163.70	0.780	162.92	21088	9	0.04
7.988	1945.4	57726	446.70	0.780	445.92	57720	-6	-0.01

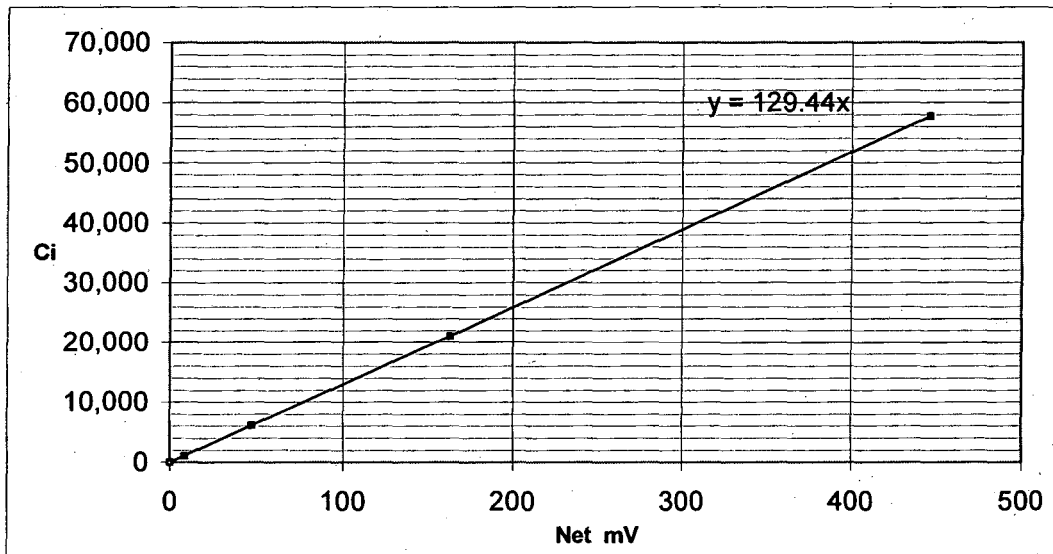

**ERNEST ORLANDO LAWRENCE BERKELEY NATIONAL LABORATORY
ONE CYCLOTRON ROAD | BERKELEY, CALIFORNIA 94720**