

# UC Irvine

## UC Irvine Previously Published Works

### Title

Gene mutations distinguishing gastric from colorectal and esophageal adenocarcinomas

### Permalink

<https://escholarship.org/uc/item/6ct7q5wh>

### Journal

Journal of Gastrointestinal Oncology, 11(1)

### ISSN

2078-6891

### Authors

Hoang, Tuyen  
Ganesan, Anand K  
Hiyama, Darryl  
[et al.](#)

### Publication Date

2020-02-01

### DOI

10.21037/jgo.2019.12.06

Peer reviewed



# Gene mutations distinguishing gastric from colorectal and esophageal adenocarcinomas

Tuyen Hoang<sup>1</sup>, Anand K. Ganesan<sup>2</sup>, Darryl Hiyama<sup>3</sup>, Farshid Dayyani<sup>4</sup>

<sup>1</sup>Institute for Clinical and Translational Research, <sup>2</sup>Department of Dermatology, University of California in Irvine, Irvine, CA, USA; <sup>3</sup>Department of General Surgery, University of California in Los Angeles, Los Angeles, CA, USA; <sup>4</sup>Department of Medicine, Division of Hematology and Oncology, University of California in Irvine, Irvine, CA, USA

**Contributions:** (I) Conception and design: All authors; (II) Administrative support: None; (III) Provision of study materials or patients: None; (IV) Collection and assembly of data: All authors; (V) Data analysis and interpretation: All authors; (VI) Manuscript writing: All authors; (VII) Final approval of manuscript: All authors.

**Correspondence to:** Tuyen Hoang, PhD. 834 Health Sciences Road, Irvine, CA 92697, USA. Email: tuyenh1@hs.uci.edu.

**Background:** Genetic analysis of gastrointestinal malignancies shows a great number of mutations. Most mutations found in gastric tumors are also found in colorectal and esophageal tumors. The challenge remains to identify mutations that distinguish gastric from colorectal and esophageal cancers. Using open-access cancer genomics data, we sought to identify mutations that accounted for the unique phenotypic features of gastric tumors.

**Methods:** Thirteen cancer genomics datasets with demographic, clinical, and genetic variables were analyzed. Pathologic stage and histology were compared between subjects with and without a specific mutated gene using two-sample t-tests, adjusted for multiple gene testing. Sequence convergence and functional impact of genetic mutations were analyzed using permutation test and PolyPhen-2 score.

**Results:** Analysis included 1,915 subjects with valid pathologic stage and histology. Mean age was 68 years (SD =10). About 54% were female. The most common race was Caucasian (37%) while minorities were rare with high rates of missing data (44%). Pathologic stage: 20% stage I, 35% stage II, 31% stage III, and 14% stage IV. Anatomical location: 30% gastric, 59% colorectal, and 11% esophageal. Histology of gastric cancer: 61% intestinal, 23% diffuse, 15% mixed, and 1% missing. Two mutated genes—*CDH1*, *RHOA*—distinguished gastric from colorectal and esophageal tumors. These mutations were highly specific to diffuse histology and advanced stages of gastric tumors and recurrent in transcribed regions known to impact protein functions.

**Conclusions:** *CDH1* and *RHOA* regulate cell-cell adhesion which is vital to cell growth and proliferation. Identification of these potential driver mutations is critical to better define therapeutic vulnerabilities for the rational design of gastric cancer therapies.

**Keywords:** Gene; gastric; colorectal; esophageal; adenocarcinoma

Submitted Sep 18, 2019. Accepted for publication Dec 06, 2019.

doi: 10.21037/jgo.2019.12.06

View this article at: <http://dx.doi.org/10.21037/jgo.2019.12.06>

## Introduction

Literature and our previous work indicated that tumor stage is the only significant predictor for survival of gastric cancer. Specifically, patients with tumors of localized stage have 70% probability of 5-year survival while patients with tumors of loco-regional stage have 30% probability of

5-year survival and those with metastasized cancer have 5% probability of 5-year survival (1,2).

There are three classification systems which classify gastric tumors into distinct subgroups beyond tumor stage. The Lauren histological classification groups gastric tumors into two main types of cell histology—intestinal and

diffuse (3). The WHO classification divides gastric tumors into papillary, tubular, mucinous, and poorly cohesive carcinomas (4). Recently, a genetic study published in the *Journal of Nature* introduces a new molecular classification of gastric tumors into four genetic subgroups: EBV-positive tumors, microsatellite unstable tumors, genomically stable tumors, and chromosomally unstable tumors (5). While numerous studies have linked diffuse histology and poorly differentiated tumors to poor prognosis, none of these classification systems explains the variability in patient survival better than tumor stage.

In our review of the literature, we found one genetic study that linked genetic mutations to patient survival. Performing genetic profiling of 521 gastric tumors of patients from 4 medical centers in different countries, it found a cluster of 171 genes associated with worse survival (6). Unfortunately, this finding has little clinical and translational utility because it is challenging to target hundreds of genes simultaneously via pharmacologic or genetic manipulation.

In search for genetic factors that could better explain survival beyond tumor stage, we focused on finding genes that are mutated in only gastric tumors, and once mutated, cause tumors to progress to advanced stages. However, we observed that most mutations found in gastric cancer are also found in colorectal and esophageal cancer. Therefore, the challenge remained to identify mutations that distinguish gastric from colorectal and esophageal cancers. We sought to identify mutations that accounted for the unique phenotypic features of gastric tumors using open-access cancer genomics data.

## Methods

Ethics approval for this study was exempted by the Institutional Review Board at the University of California in Irvine because this study is a non-human subject research, making use of public datasets with non-identifiable subjects (7).

### *Data collection*

We downloaded a total of 13 open-access cancer genomics datasets, including 7 gastric, 4 colorectal, and 2 esophageal adenocarcinoma datasets from cBioPortal website (8,9). These datasets were last accessed on May 8, 2019. Names of the studies, years from which these datasets were generated, and the numbers of subjects are listed in *Table S1*.

The datasets included demographic, clinical, and genetic variables of which descriptions can be found at the NCI Genomic Data Commons website (10). The following variables were selected for the analysis: age, gender, race, pathologic stage, histology, Hugo symbol, chromosome, start nucleotide position, end nucleotide position, mutation type, mutation classification, nucleotide change (HGVS<sub>c</sub>), and amino acid change (HGVS<sub>p</sub>).

Genetic variables were linked to demographic and clinical variables by subject identifier and tumor sample identifier. Since there was only one primary tumor sample per subject, the sample identifier was used interchangeably as the subject identifier. Each gene was identified by Hugo symbol which is human gene nomenclature while a specific mutation of a gene was defined by Hugo symbol, the affected chromosome, and the lowest numeric nucleotide position of the reported mutation on the genomic reference sequence. The final dataset used for analysis included three-nested levels of data: gene-specific mutations which were nested within genes, which in turn were nested within samples.

### *Statistical analyses*

To identify mutated genes discriminating diffuse histology from intestinal histology of gastric tumors, we compared the percentage of diffuse histology between subjects with and without a specific mutated gene using two-sample *t*-tests, adjusting for multiple gene testing. This analysis was applicable to only gastric cancer subjects with valid diffuse and intestinal histology.

To identify mutated genes distinguishing gastric from colorectal and esophageal tumors, we first quantified each subject's pathologic TNM stage into a continuous score from 1 to 8 as follows: IA=1, IB=2, IIA=3, IIB=4, IIIA=5, IIIB=6, IIIC=7, and IV=8. Then we compared the mean stage among four groups: non-carriers, gastric mutation carriers, colorectal mutation carriers, and esophageal mutation carriers. Mutated genes were considered as significant if the following criteria were met. Statistical significance: difference in the mean stage among the four comparison groups must be significant beyond random chance based on the overall F test and the post-hoc two-sample *t* tests with P value <0.05 after adjusted for multiple gene testing using Benjamini-Hochberg's false discovery rate (11). Equivalently, the unadjusted P values would be <10<sup>-6</sup>. Clinical significance: a mutated gene would be deemed as clinically significant if it discriminates the three tumor types into localized stages versus locoregional stages.

For the mutated genes that were found to be significantly associated with gastric histology and advanced tumor stages, we compared the genetic characteristics of these mutations against the background which included all genes in the datasets. Genetic characteristics included mutation type (i.e., single nucleotide polymorphism SNP, deletion DEL, insertion INS, etc.), mutation classification (i.e., missense, nonsense, frameshift, etc.), and single nucleotide substitution (i.e., A>C, A>G, A>T, etc.). To determine the impact of the genetic characteristics of the mutated genes upon protein functions, sequence convergence and functional impact were analyzed using permutation test and PolyPhen-2 score, respectively. PolyPhen-2 score is a probability value from 0 to 1, predicting the possible impact of amino acid substitutions on the stability and function of human proteins using structural and comparative evolutionary considerations (12).

## Results

### Demographic characteristics

After removing duplicated subjects across the datasets, we identified a total of 2,264 unique subjects. We excluded the subjects whose pathologic stages were missing, leaving a total of 1,915 subjects with valid pathologic stages, including 564 subjects with primary tumors of gastroesophageal adenocarcinoma, 1,140 subjects with primary tumors of colorectal adenocarcinoma, and 211 subjects with primary tumors of esophageal adenocarcinoma in the analysis. *Table 1* presents descriptive statistics of the demographic, clinical, and genetic variables of the study subjects. Majority of the subjects were between 40–80 years old (99%) while very few subjects were younger than 40 years (1%). Mean age was 68 years (SD=10). Fifty four percent were female and 46% were male. The most common ethnicity was Caucasian (37%) while minorities were rare with high rates of missing ethnicity data (44%).

### Clinical characteristics

Pathologic stages included 20% stage I, 35% stage II, 31% stage III, and 14% stage IV. By anatomical location, there were 30% gastric tumors, 59% colorectal tumors, and 11% esophageal tumors. The histology of the gastric tumors included 61% intestinal, 23% diffuse, 15% mixed, and 1% missing.

### Genetic characteristics

We excluded the genetic mutations that were non-exon and silent because of their presumably non-functional effects on proteins, leaving about 25,000 genes and 690,000 non-silent exon mutations in the genetic analysis. Mutation types were 86% SNP, 11% DEL, and 3% INS. Mutation classification included 80% missense, 12% frameshift, 5% nonsense, 2% splice, and 1% in-frame. Single variant substitutions included 56% G>A, 16% G>T, 14% A>G, 7% A>C, 4% A>T, and 3% G>C. Although we observed that G>A was the predominant signature, it is unclear how this signature is related to the cancer etiology.

Genetic mutations were heterogeneous across subjects, varying from 8 to 8,429 mutated genes per subject. No two subjects shared the same genetic mutation profile. *Figure 1* compares gene diversity among the three cancer types. Gastric and colorectal cancer subjects had the most diverse mutations with a maximum of 7,319 and 8,429 mutated genes per subject respectively while esophageal cancer subjects had significantly fewer mutated genes with a maximum of 3,459 (P=0.005).

The most common mutated genes include *TP53* (60%), *TTN* (54%), *APC* (45%), and *KRAS* (25%). Most mutated genes found in gastric tumors were also found in colorectal tumors. It was not the mutated gene itself but rather the frequency of a mutated gene that distinguished the two cancer types. For example, the mutated *APC* gene occurred in 10% of the gastric tumors as compared to 69% of the colorectal tumors; in contrast, the mutated *ARID1A* gene occurred in 26% of the gastric tumors as compared to 12% of the colorectal tumors. *Figure 2* lists the top five mutated genes with contrasting frequencies, including *ARID1A* and *PCDH1* which were more common in gastric tumors and *APC*, *BRAF*, *KRAS* which were more common in colorectal tumors.

### Mutated genes associated with diffuse-gastric histology

We found two mutated genes discriminating diffuse histology from intestinal histology of gastric tumors: the E-cadherin *CDH1* gene and the cell adhesion *RHOA* gene (*Table 2*). Subjects with these mutated genes were 5 to 6 times more likely to have diffuse histology than subjects without these mutated genes (odds ratios =5.7–6.6, P<10<sup>-6</sup>). Specifically, the percentage of diffuse histology was 64–70% among subjects with these mutated genes as compared to

**Table 1** Demographic, clinical, and genetic characteristics of the study subjects

Characteristics	Descriptive statistics (N=1,915 subjects)
Demographic characteristics	
Age (%)	
<40 years	1.2
40–60 years	21.1
61–70 years	29.6
71–80 years	33.6
81+ years	14.1
Missing	0.4
Gender (%)	
Female	54
Male	46
Race (%)	
Caucasian	37.2
Asian	5.4
African American	3.7
Hispanic	9.5
Missing	44.2
Tumor characteristics	
Pathologic stages (%)	
IA	16.2
IB	3.7
IIA	26.9
IIB	7.9
IIIA	17.9
IIIB	9
IIIC	4.5
IV	13.9
Anatomical location (%)	
Gastric	29.5
Colorectal	59.5
Esophageal	11

**Table 1** (continued)**Table 1** (continued)

Characteristics	Descriptive statistics (N=1,915 subjects)
Histology (gastric cancer only) (%) N=564 gastric cancer subjects	
Intestinal	61.4
Diffuse	23.2
Mixed	14.9
Missing	0.5
Genetic characteristics	
# mutated genes per subject	
Mean ± SD	393±731
Median	151
Range	8–8,429
Most common mutated genes (%)	
<i>TP53</i>	60.2
<i>TTN</i>	53.7
<i>APC</i>	44.7
<i>KRAS</i>	24.6
Mutation type (%) N=689,716 mutations	
SNP	86.4
DEL	10.7
INS	2.9
Mutation classification (%) N=689,716 mutations	
Missense	79.7
Frameshift	12.3
Nonsense	5.3
Splice	1.5
In-frame	1.2
Single variant substitution (%) N=596,491 mutations	
G>A	55.9
G>T	16.3
A>G	13.7
A>C	7.2
A>T	3.5
G>C	3.4

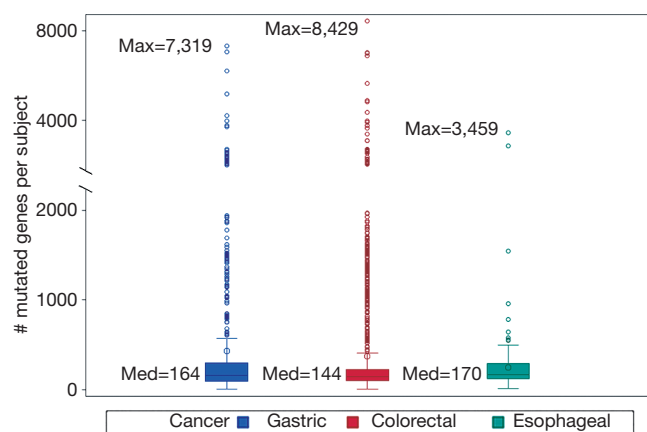

**Figure 1** Comparison of gene diversity among gastric, colorectal, and esophageal tumors.

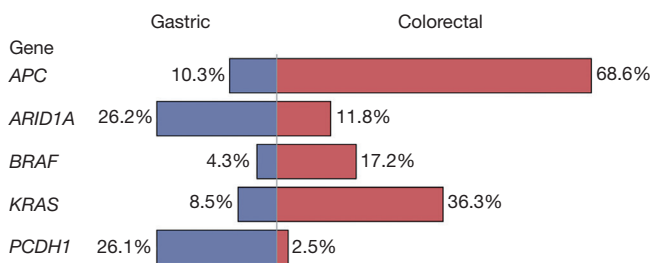

**Figure 2** Top five mutated genes with contrasting frequencies between gastric and colorectal tumors.

24–26% among subjects without these mutated genes. In contrast, the percentage of intestinal histology was 21–31% among subjects with these mutated genes as compared to 64–65% among subjects without these mutated genes (odds ratio =0.1–0.2,  $P < 10^{-6}$ ).

### *Mutated gene distinguishing gastric from colorectal and esophageal tumors*

We found *CDH1* to be the only mutated gene distinguishing gastric from colorectal and esophageal tumors: gastric cancer subjects who carried this mutated gene were more likely to have loco-regional tumors while colorectal and esophageal cancer subjects who carried this mutated gene were more likely to have localized tumors (Table 3). Specifically, the percentage of loco-regional stages was 66% among gastric mutation carriers as compared to 28% among colorectal mutation carriers and 0% among esophageal mutation carriers ( $P < 10^{-6}$ ).

### *CDH1 and RHOA recurrent hotspots and functional impacts*

We defined a recurrent hotspot as the mutation of a gene that occurred at the same nucleotide position in the gene sequence in three or more tumors. Figure 3 displays the nucleotide positions of *CDH1* recurrent hotspots in diffuse and intestinal tumors. In diffuse tumors, there was one recurrent hotspot involving G>T missense substitutions at nucleotide position 760 on exon number 6 in four tumors which resulted in protein change p.Asp254Tyr. This hotspot, affecting the calcium binding pocket connecting the extracellular cadherin domains EC1 and EC2, had the highest impact on protein function with PolyPhen-2 score of 1 (on a scale from 0 to 1). In intestinal tumors, there was one recurrent hotspot involving deletion mutations at nucleotide position 377 in three tumors. More importantly, 65% of *CDH1* mutations in diffuse tumors clustered in the sequence segment between nucleotide position 500 and 1,000 on exons 5 to 7, which affect the extracellular cadherin domains EC1 and EC2 and the calcium binding pocket connecting these two domains (Figure 4). In contrast, the majority of *CDH1* mutations in intestinal tumors were scattered in two opposite segments, before nucleotide position 500 and after nucleotide position 1,000. Permutation test indicated that the contrasting *CDH1* nucleotide positions between diffuse and intestinal tumors were statistically significant ( $P < 0.0001$ ).

We compared the nucleotide positions of *CDH1* mutations in gastric, colorectal, and esophageal tumors in the lollipop graph in Figure 5. There were two recurrent hotspots in gastric tumors (the same hotspots as mentioned in Figure 3) while there was no hotspot in colorectal and esophageal tumors. In addition, about 60% of *CDH1* mutations in gastric tumors clustered in the sequence segment between nucleotide position 500 and 1,000 while *CDH1* mutations in colorectal and esophageal tumors were scattered randomly. Permutation test indicated that the contrasting patterns of *CDH1* nucleotide positions between gastric and colorectal/esophageal tumors were statistically significant ( $P < 0.0001$ ).

In Figure 6, we compared *RHOA* recurrent hotspots in diffuse and intestinal tumors. In diffuse tumors, there were two recurrent hotspots involving A>G missense substitutions at nucleotide position 125 on exon number 2 resulting in protein change p.Tyr42Cys in seven tumors, and T>G missense substitutions at nucleotide position 169 on exon number 3 resulting in protein change p.Leu57Val in four tumors. The protein change p.Tyr42Cys is located in the effector binding domain while the protein change p.Leu57Val is located at the border of the GDP/GTP

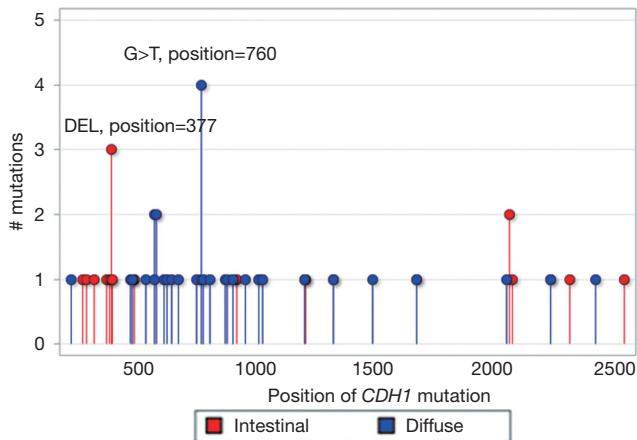

**Table 2** Mutated genes associated with diffuse-gastric histology

Genes	Subjects without mutations		Subjects with mutations		P value
	% diffuse (sample size)	% intestinal (sample size)	% diffuse (sample size)	% intestinal (sample size)	
<i>CDH1</i>	23.8 (n=500)	64.6 (n=500)	64.1 (n=64)	31.2 (n=64)	<10 <sup>-10</sup>
<i>RHOA</i>	25.8 (n=531)	63.8 (n=531)	69.7 (n=33)	21.2 (n=33)	<10 <sup>-10</sup>

**Table 3** Mutated gene distinguishing gastric from colorectal and esophageal tumors

<i>CDH1</i> gene	Non-carriers	Gastric mutation carriers	Colorectal mutation carriers	Esophageal mutation carriers	P value
Pathologic stage (mean ± SD)	4.4±2.2	5.4±2.1	3.2±2.1	2.7±1.5	<10 <sup>-6</sup>
Percentage of locoregional stages (%)	47.9	65.6	28.4	0.0	
Sample size (n)	1,661	64	186	4	

**Figure 3** Comparison of *CDH1* nucleotide positions in diffuse and intestinal gastric tumors.

binding domain (Figure 7). Both hotspots had high impact on protein function with PolyPhen-2 probability score of 0.718 and 0.999, respectively. There was no *RHOA* hotspot in intestinal tumors.

In Table S2, we listed detailed information of *CDH1* and *RHOA* mutations, including anatomical location, histology, nucleotide change (HGVS), amino acid change (HGVS), mutation type, and mutation classification.

#### *CDH1* and *RHOA* genetic landscapes against background

We compared the distribution of missense, nonsense, and

frameshift mutations of *CDH1* and *RHOA* between diffuse and intestinal gastric tumors, against the background which included mutations of all genes (Figure 8). The mutation types of the background were identical between diffuse and intestinal tumors with 78% missense, 18% frameshift, and 4% nonsense. In contrast to the background, the distribution of *CDH1* mutation types involved 97% missense mutations in diffuse tumors versus 70% missense mutations in intestinal tumors ( $P=0.0054$ ). Although different from the background, the distribution of *RHOA* mutation types was not statistically different between diffuse and intestinal tumors: 96% missense mutations in diffuse tumors versus 100% missense mutations in intestinal tumors ( $P=0.5830$ ).

In addition, we compared the distribution of single nucleotide substitutions of *CDH1* and *RHOA* missense mutations between diffuse and intestinal gastric tumors, against the background (Figure 9). Substitutions in the background were identical between diffuse and intestinal tumors with G>A as the most common missense substitution. In contrast to the background, G>A was significantly less common among *CDH1* mutations and *RHOA* mutations in diffuse tumors than intestinal tumors. Similarly, the single nucleotide substitutions of *CDH1* and *RHOA* missense mutations was different among gastric, colorectal, and esophageal tumors (data not shown). It is unclear how the dissimilarities in single nucleotide substitutions between histology types and cancer types are related to the cancer etiology.

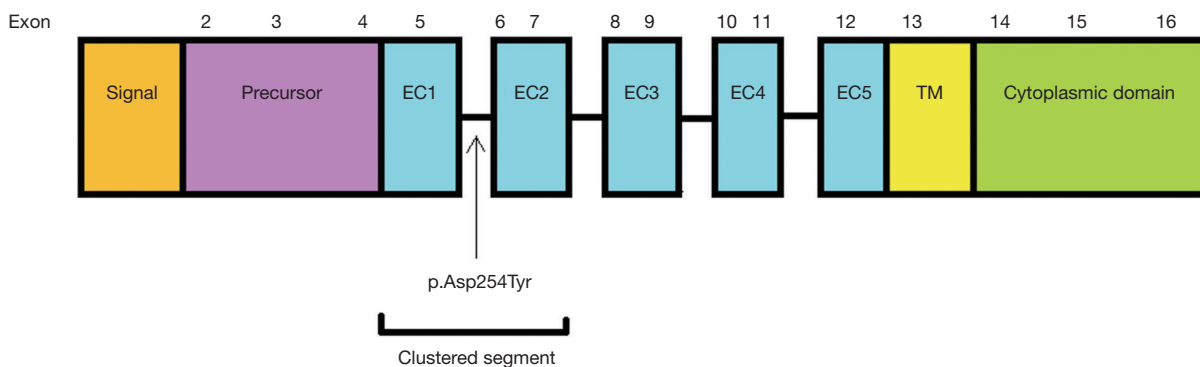

**Figure 4** Functional domains of CDH1 recurrent hotspot and clustered sequence segment in diffuse-gastric tumors.

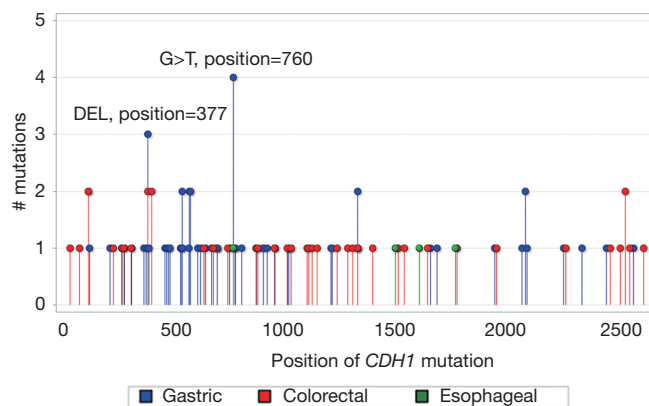

**Figure 5** Comparison of CDH1 nucleotide positions in gastric, colorectal, and esophageal tumors.

**Discussion**

Our genetic analysis of 1,915 subjects with gastrointestinal malignancies showed approximately 25,000 mutated genes in the tumors. At the subject level, the number of mutated genes varied from 10 to 8,000 per subject; no two subjects shared the same mutation profile. Of the three cancer types, gastric and colorectal tumors had the most gene diversity with the maximum number of mutated genes up to 7,000–8,000 per subject while esophageal tumors had only 3,500 per subject at the maximum. This finding was consistent with a global cancer study which found gastric and colorectal cancers with the largest gene diversity while esophageal cancer with moderate gene diversity (13). At the gene level, most mutations found in gastric tumors were also found in colorectal tumors. Therefore, it was not the mutated gene itself but rather the frequency of a mutated gene that distinguished the two cancer types. The top five

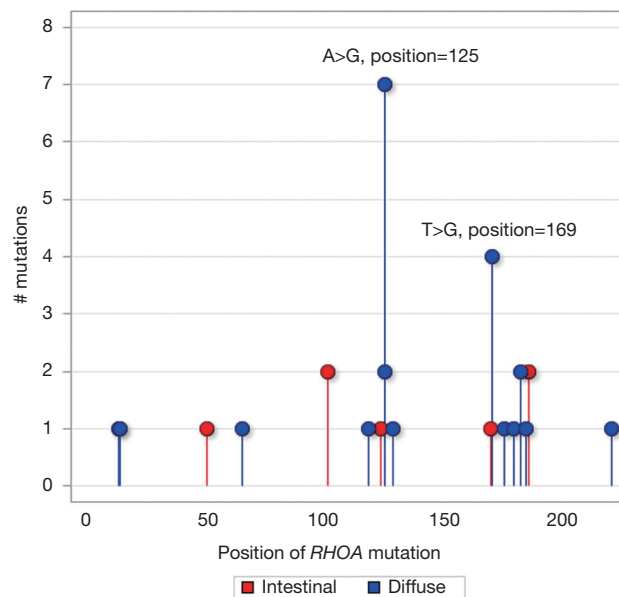
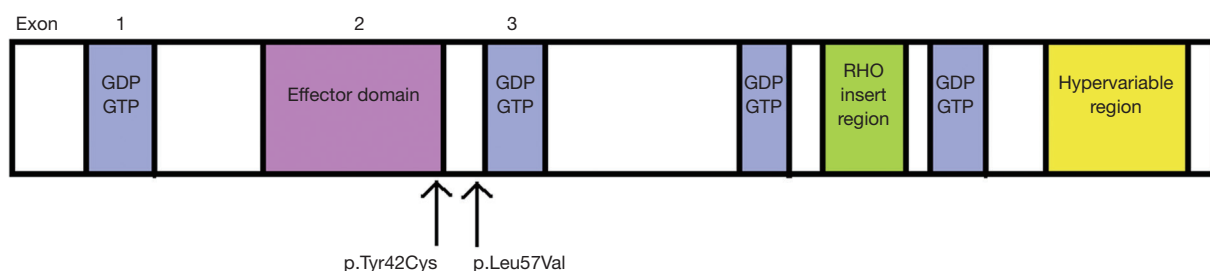

**Figure 6** Comparison of RHOA nucleotide positions in diffuse and intestinal gastric tumors.

genes with contrasting frequencies included ARID1A and PCDH1 which were more common in gastric tumors and APC, BRAF, KRAS which were more common in colorectal tumors. These genes were identified as driver genes in gastrointestinal and other cancers (14,15). In summary, genetic mutations of gastrointestinal malignancies were heterogeneous across tumors and anatomical locations.

We identified two mutated genes, the E-cadherin CDH1 and the cell adhesion RHOA, accounting for the unique phenotypic features of gastric tumors: these mutated genes were highly specific to diffuse histology and advanced stages of gastric tumors. More importantly, the underlying





**Figure 7** Functional domains of *RHOA* recurrent hotspots in diffuse-gastric tumors.

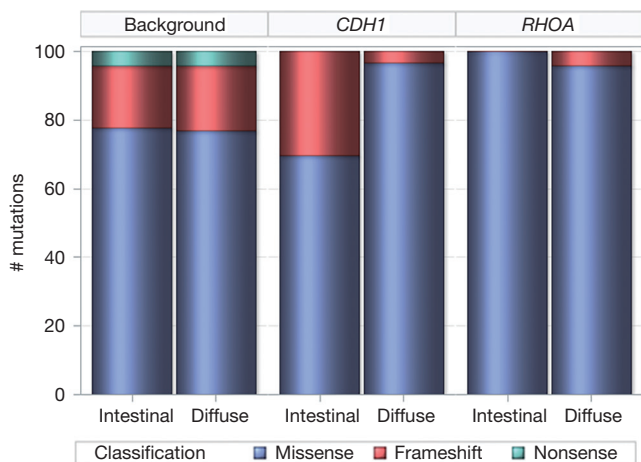

**Figure 8** Comparison of *CDH1* and *RHOA* mutation classifications between diffuse and intestinal gastric tumors, against background. Remark: background includes mutation classifications of all genes in gastric tumors.

genetic features of these mutations revealed that *CDH1* and *RHOA* manifested differently in diffuse tumors as compared to intestinal tumors, and differently in gastric tumors as compared to colorectal and esophageal tumors. In diffuse-gastric tumors, we found one *CDH1* recurrent hotspot involving G>T missense substitutions at nucleotide position 760 on exon number 6 which were known to impair the calcium binding pocket connecting the extracellular cadherin domains EC1 and EC2 leading to hereditary blepharochelodontic syndrome (16). In addition, a large number of *CDH1* mutations in diffuse-gastric tumors clustered in the sequence segment between nucleotide position 500 and 1,000 on exons 5, 6, and 7 which affect the extracellular cadherin domains EC1 and EC2 and the calcium binding pocket connecting these two domains. In contrast, there were no recurrent hotspots or clustered segments of *CDH1* mutations in colorectal or esophageal

tumors. The *CDH1* gene codes calcium-dependent cell adhesion proteins which are involved in mechanisms regulating cell-cell adhesions, mobility, and proliferation of epithelial cells and has a potent invasive suppressor role (17). While the germline *CDH1* has been known to account for hereditary diffuse-gastric cancer (18-20), this study shows that somatically mutated *CDH1* also defines diffuse-gastric cancer.

We found two *RHOA* recurrent hotspots involving A>G missense substitutions at nucleotide position 125 on exon number 2 and T>G missense substitutions at nucleotide position 169 on exon number 3 in diffuse-gastric tumors. These hotspots were known to impair effector binding and GDP/GTP binding (21-23). Diffuse morphological phenotype is characterized by early breaking off of signet ring cells through the basement membrane, which requires resistance to anoikis, followed by the acquisition of highly infiltrative behavior; literature indicates that the ability of *RHOA* hotspot mutants to promote anoikis evasion in the organoid culture system is consistent with the critical role of *RHOA* in this process (21,22). It has long been known that diffuse-gastric cancer is often associated with advanced tumor stages (2,24-26). If the role of *RHOA* in fostering tumor cell survival is further confirmed, targeting the *RHOA* pathway may become useful in the treatment of diffuse-gastric cancer.

This study, to our knowledge, is one of the largest genetic analyses of gastrointestinal malignancies, making use of thirteen open-access cancer genomics datasets including nearly 2,000 subjects. Altogether, the genetic landscapes of *CDH1* and *RHOA* mutations justified why the presence of these mutations placed diffuse-gastric cancer subjects at higher risk for advanced tumor spread than intestinal-gastric, colorectal, and esophageal cancer subjects. Our next step is to use this information to design therapeutic strategies to target *CDH1* and *RHOA* mutant gastric tumors.

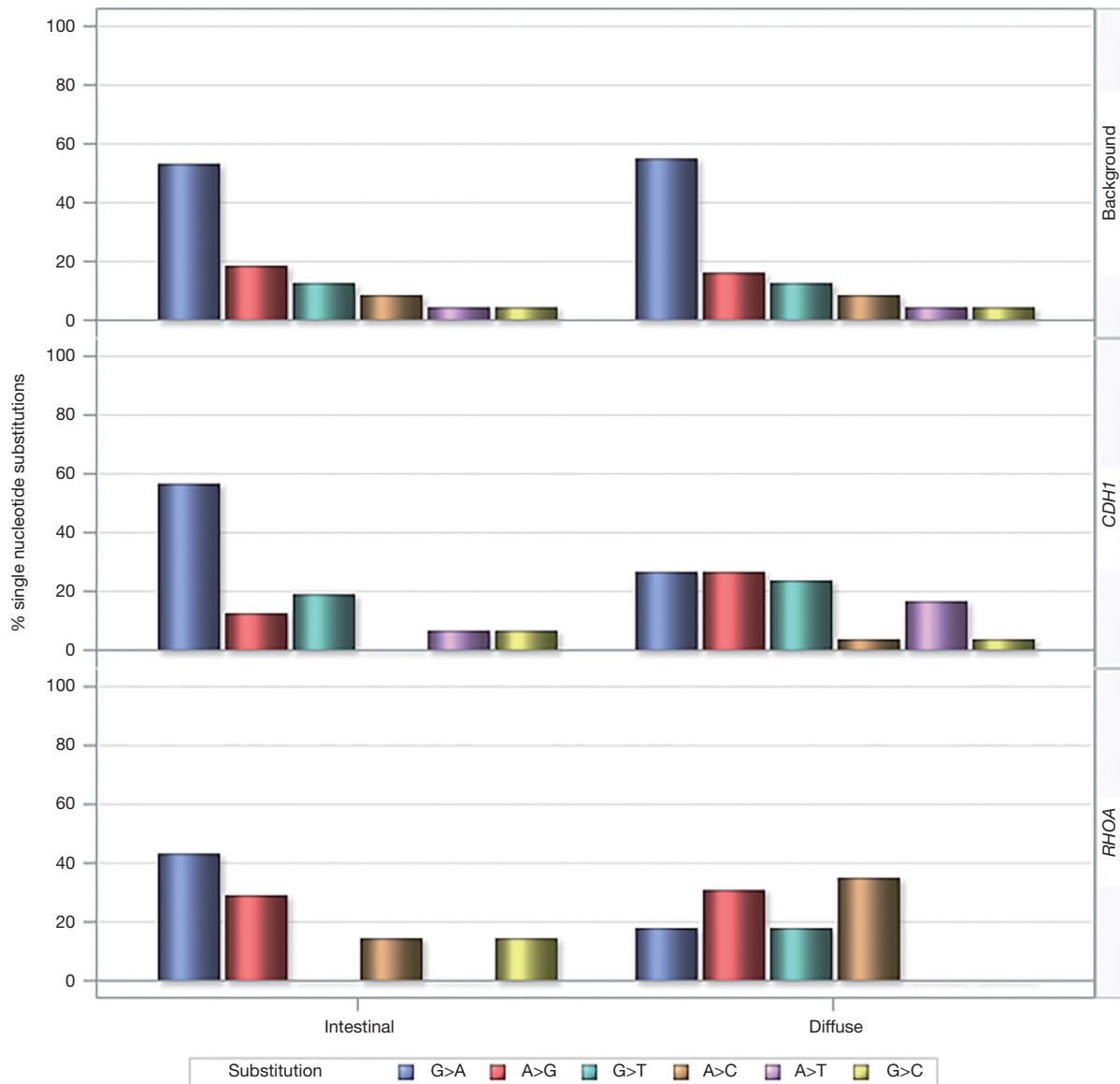

**Figure 9** Comparison of *CDH1* and *RHOA* single nucleotide substitutions between diffuse and intestinal gastric tumors, against background. Remark: background includes missense mutations of all genes in gastric tumors.

**Acknowledgments**

*Funding:* This work was partially supported by grant UL1 TR001414 from the National Center for Advancing Translational Sciences, National Institutes of Health (NIH), through the Biostatistics, Epidemiology and Research Design Unit. The content is solely the responsibility of the authors and does not necessarily represent the official views of the NIH.

**Footnote**

*Conflicts of Interest:* The authors have no conflicts of interest to declare.

*Ethical Statement:* The authors are accountable for all aspects of the work in ensuring that questions related to the accuracy or integrity of any part of the work are appropriately investigated and resolved. Ethics approval for

this study was exempted by the Institutional Review Board at the University of California in Irvine because this study is a non-human subject research, making use of public datasets with non-identifiable subjects.

## References

1. Surveillance, Epidemiology, and End Results (SEER) Program ([www.seer.cancer.gov](http://www.seer.cancer.gov)) SEER\*Stat Database: Cancer Stat Facts, Colorectal and Stomach Cancer, National Cancer Institute, DCCPS, Surveillance Research Program, released December 2018. Underlying mortality data provided by NCHS ([www.cdc.gov/nchs](http://www.cdc.gov/nchs)).
2. Hoang T, Park M, Hiyama D, et al. Predictors of outcomes in patients with gastric cancer treated with contemporary multimodality strategies—a single institution experience. *J Gastrointest Oncol* 2019. doi: 10.21037/jgo.2019.01.08.
3. Lauren P. The two histological main types of gastric carcinoma: diffuse and so-called intestinal-type carcinoma. an attempt at a histo-clinical classification. *Acta Pathol Microbiol Scand* 1965;64:31-49.
4. Hamilton SR, Aaltonen LA. editors. Tumours of the Digestive System. In: World Health Organization Classification of Tumours: Pathology and Genetics. Lyon, France: IARC Press, 2000.
5. Cancer Genome Atlas Research Network. Comprehensive molecular characterization of gastric adenocarcinoma. *Nature* 2014;513:202-9.
6. Tan IB, Ivanova T, Lim KH, et al. Intrinsic subtypes of gastric cancer, based on gene expression pattern, predict survival and respond differently to chemotherapy. *Gastroenterology* 2011;141:476-85, 485.e1-11.
7. Institutional Review Board at the University of California in Irvine. Available online: <https://www.research.uci.edu/compliance/human-research-protections/researchers/activities-irb-review.html>
8. Cerami E, Gao J, Dogrusoz U, et al. The cBio cancer genomics portal: an open platform for exploring multidimensional cancer genomics data. *Cancer Discov* 2012;2:401-4.
9. Gao J, Aksoy BA, Dogrusoz U, et al. Integrative analysis of complex cancer genomics and clinical profiles using the cBioPortal. *Sci Signal* 2013;6:pl1.
10. Grossman RL, Heath AP, Ferretti V, et al. Toward a shared vision for cancer genomic data. *N Engl J Med* 2016;375:1109-12.
11. Benjamini Y, Hochberg Y. Controlling the false discovery rate: a practical and powerful approach to multiple testing. *J R Statist Soc B* 1995;57:289-300.
12. Adzhubei IA, Schmidt S, Peshkin L, et al. A method and server for predicting damaging missense mutations. *Nat Methods* 2010;7:248-9.
13. Alexandrov LB, Nik-Zainal S, Wedge DC, et al. Signatures of mutational processes in human cancer. *Nature* 2013;500:415-21.
14. Bailey MH, Tokheim C, Porta-Pardo E, et al. Comprehensive Characterization of Cancer Driver Genes and Mutations. *Cell* 2018;174:1034-5.
15. Lawrence MS, Stojanov P, Mermel CH, et al. Discovery and saturation analysis of cancer genes across 21 tumour types. *Nature* 2014;505:495-501.
16. Ghoumid J, Stichelbout M, Jourdain AS, et al. Blepharocheilodontic syndrome is a CDH1 pathway-related disorder due to mutations in CDH1 and CTNND1. *Genet Med* 2017;19:1013-21.
17. UniProt Consortium. UniProt: a worldwide hub of protein knowledge. *Nucleic Acids Res* 2019;47:D506-15.
18. Guilford P, Hopkins J, Harraway J, et al. E-cadherin germline mutations in familial gastric cancer. *Nature* 1998;392:402-5.
19. Yoon KA, Ku JL, Yang HK, et al. Germline mutations of E-cadherin gene in Korean familial gastric cancer patients. *J Hum Genet* 1999;44:177-80.
20. Yabuta T, Shinmura K, Tani M, et al. E-cadherin gene variants in gastric cancer families whose probands are diagnosed with diffuse gastric cancer. *Int J Cancer* 2002;101:434-41.
21. Wang K, Yuen ST, Xu J, et al. Whole-genome sequencing and comprehensive molecular profiling identify new driver mutations in gastric cancer. *Nat Genet* 2014;46:573-82.
22. Kakiuchi M, Nishizawa T, Ueda H, et al. Recurrent gain-of-function mutations of RHOA in diffuse-type gastric carcinoma. *Nat Genet* 2014;46:583-7.
23. Atlas of Genetics and Cytogenetics in Oncology and Haematology. Available online: <http://AtlasGeneticsOncology.org>
24. Riquelme I, Saavedra K, Espinoza JA, et al. Molecular classification of gastric cancer: Towards a pathway-driven targeted therapy. *Oncotarget* 2015;6:24750-79.
25. Pernot S, Voron T, Perkins G, et al. Signet-ring cell carcinoma of the stomach: Impact on prognosis and specific therapeutic challenge. *World J Gastroenterol* 2015; 21:11428-38.
26. Kunz PL, Gubens M, Fisher GA, et al. Long-term survivors of gastric cancer: a California population-based study. *J Clin Oncol* 2012;30:3507-15.

**Cite this article as:** Hoang T, Ganesan AK, Hiyama D, Dayyani F. Gene mutations distinguishing gastric from colorectal and esophageal adenocarcinomas. *J Gastrointest Oncol* 2020;11(1):45-54. doi: 10.21037/jgo.2019.12.06

## Supplementary

**Table S1** Open-access cancer genomics datasets from cBioPortal

	Names of datasets	# subjects
1	Stomach Adenocarcinoma (Pfizer and UHK, Nat Genet 2014)	100
2	Stomach Adenocarcinoma (TCGA, Nature 2014)	295
3	Stomach Adenocarcinoma (TCGA, PanCancer Atlas)	440
4	Stomach Adenocarcinoma (TCGA, Provisional)	478
5	Stomach Adenocarcinoma (U Tokyo, Nat Genet 2014)	30
6	Stomach Adenocarcinoma (UHK, Nat Genet 2011)	22
7	TCGA data for Esophagus-Stomach Cancers (TCGA, Nature 2017)	559
8	Colorectal Adenocarcinoma (DFCI, Cell Reports 2016)	619
9	Colorectal Adenocarcinoma (TCGA, Nature 2012)	276
10	Colorectal Adenocarcinoma (TCGA, PanCancer Atlas)	594
11	Colorectal Adenocarcinoma (TCGA, Provisional)	640
12	Esophageal Adenocarcinoma (DFCI, Nat Genet 2013)	151
13	Esophageal Adenocarcinoma (TCGA, PanCancer Atlas)	182



**Table S2** Detailed information of *CDHI* and *RHOA* mutations

	Gene	Anatomical location	Histology	Nucleotide change (HGVS)	Amino acid change (HGVS)	Type	Classification
1	<i>CDHI</i>	GASTRIC	INTESTINAL	c.1006G>A	p.Glu336Lys	SNP	MISSENSE
2	<i>CDHI</i>	GASTRIC	INTESTINAL	c.1199A>T	p.Asp400Val	SNP	MISSENSE
3	<i>CDHI</i>	GASTRIC	INTESTINAL	c.1204G>C	p.Asp402His	SNP	MISSENSE
4	<i>CDHI</i>	GASTRIC	INTESTINAL	c.1320G>T	p.Lys440Asn	SNP	MISSENSE
5	<i>CDHI</i>	GASTRIC	INTESTINAL	c.1676G>A	p.Ser559Asn	SNP	MISSENSE
6	<i>CDHI</i>	GASTRIC	INTESTINAL	c.2071G>A	p.Ala691Thr	SNP	MISSENSE
7	<i>CDHI</i>	GASTRIC	INTESTINAL	c.2071G>A	p.Ala691Thr	SNP	MISSENSE
8	<i>CDHI</i>	GASTRIC	INTESTINAL	c.2080G>A	p.Val694Ile	SNP	MISSENSE
9	<i>CDHI</i>	GASTRIC	INTESTINAL	c.2245C>T	p.Arg749Trp	SNP	MISSENSE
10	<i>CDHI</i>	GASTRIC	INTESTINAL	c.2326C>A	p.Leu776Met	SNP	MISSENSE
11	<i>CDHI</i>	GASTRIC	INTESTINAL	c.2557T>C	p.Ser853Pro	SNP	MISSENSE
12	<i>CDHI</i>	GASTRIC	INTESTINAL	c.259A>G	p.Arg87Gly	SNP	MISSENSE
13	<i>CDHI</i>	GASTRIC	INTESTINAL	c.273del	p.His92IlefsT	DEL	FRAMESHIFT
14	<i>CDHI</i>	GASTRIC	INTESTINAL	c.304G>A	p.Ala102Thr	SNP	MISSENSE
15	<i>CDHI</i>	GASTRIC	INTESTINAL	c.360dup	p.His121Alafs	INS	FRAMESHIFT
16	<i>CDHI</i>	GASTRIC	INTESTINAL	c.370C>T	p.Arg124Cys	SNP	MISSENSE
17	<i>CDHI</i>	GASTRIC	INTESTINAL	c.377delC	p.Pro126Argfs	DEL	FRAMESHIFT
18	<i>CDHI</i>	GASTRIC	INTESTINAL	c.377delC	p.Pro126Argfs	DEL	FRAMESHIFT
19	<i>CDHI</i>	GASTRIC	INTESTINAL	c.377delC	p.Pro126Argfs	DEL	FRAMESHIFT
20	<i>CDHI</i>	GASTRIC	INTESTINAL	c.377dupC	p.Pro127AlafsTer41	INS	FRAMESHIFT
21	<i>CDHI</i>	GASTRIC	INTESTINAL	c.382del	p.His128Ilefs	DEL	FRAMESHIFT
22	<i>CDHI</i>	GASTRIC	INTESTINAL	c.476C>T	p.Pro159Leu	SNP	MISSENSE
23	<i>CDHI</i>	GASTRIC	INTESTINAL	c.913C>A	p.Leu305Ile	SNP	MISSENSE
24	<i>CDHI</i>	GASTRIC	DIFFUSE	c.1021T>G	p.Tyr341Asp	SNP	MISSENSE
25	<i>CDHI</i>	GASTRIC	DIFFUSE	c.1320G>T	p.Lys440Asn	SNP	MISSENSE
26	<i>CDHI</i>	GASTRIC	DIFFUSE	c.1489G>A	p.Glu497Lys	SNP	MISSENSE
27	<i>CDHI</i>	GASTRIC	DIFFUSE	c.2056T>C	p.Cys686Arg	SNP	MISSENSE
28	<i>CDHI</i>	GASTRIC	DIFFUSE	c.208del	p.Ser70Profs	DEL	FRAMESHIFT
29	<i>CDHI</i>	GASTRIC	DIFFUSE	c.2437_24		DEL	SPLICE
30	<i>CDHI</i>	GASTRIC	DIFFUSE	c.462_467d	p.Asp155_Trp1	DEL	INFRAME
31	<i>CDHI</i>	GASTRIC	DIFFUSE	c.468G>T	p.Trp156Cys	SNP	MISSENSE
32	<i>CDHI</i>	GASTRIC	DIFFUSE	c.469G>C	p.Val157Leu	SNP	MISSENSE
33	<i>CDHI</i>	GASTRIC	DIFFUSE	c.524T>C	p.Leu175Pro	SNP	MISSENSE
34	<i>CDHI</i>	GASTRIC	DIFFUSE	c.560_577d	p.Lys187_Ile1	DEL	INFRAME
35	<i>CDHI</i>	GASTRIC	DIFFUSE	c.563T>A	p.Val188Asp	SNP	MISSENSE
36	<i>CDHI</i>	GASTRIC	DIFFUSE	c.563T>A	p.Val188Asp	SNP	MISSENSE
37	<i>CDHI</i>	GASTRIC	DIFFUSE	c.569A>G	p.Tyr190Cys	SNP	MISSENSE
38	<i>CDHI</i>	GASTRIC	DIFFUSE	c.569A>G	p.Tyr190Cys	SNP	MISSENSE
39	<i>CDHI</i>	GASTRIC	DIFFUSE	c.602_628d	p.Pro201_Glu2	DEL	INFRAME
40	<i>CDHI</i>	GASTRIC	DIFFUSE	c.614T>C	p.Phe205Ser	SNP	MISSENSE
41	<i>CDHI</i>	GASTRIC	DIFFUSE	c.635G>A	p.Gly212Glu	SNP	MISSENSE
42	<i>CDHI</i>	GASTRIC	DIFFUSE	c.664A>G	p.Arg222Gly	SNP	MISSENSE
43	<i>CDHI</i>	GASTRIC	DIFFUSE	c.742A>T	p.Ile248Phe	SNP	MISSENSE
44	<i>CDHI</i>	GASTRIC	DIFFUSE	c.760G>A	p.Asp254Asn	SNP	MISSENSE
45	<i>CDHI</i>	GASTRIC	DIFFUSE	c.760G>T	p.Asp254Tyr	SNP	MISSENSE
46	<i>CDHI</i>	GASTRIC	DIFFUSE	c.760G>T	p.Asp254Tyr	SNP	MISSENSE
47	<i>CDHI</i>	GASTRIC	DIFFUSE	c.760G>T	p.Asp254Tyr	SNP	MISSENSE
48	<i>CDHI</i>	GASTRIC	DIFFUSE	c.760G>T	p.Asp254Tyr	SNP	MISSENSE
49	<i>CDHI</i>	GASTRIC	DIFFUSE	c.769G>A	p.Asp257Asn	SNP	MISSENSE
50	<i>CDHI</i>	GASTRIC	DIFFUSE	c.770A>G	p.Asp257Gly	SNP	MISSENSE
51	<i>CDHI</i>	GASTRIC	DIFFUSE	c.799_813d	p.Phe267_Val2	DEL	INFRAME
52	<i>CDHI</i>	GASTRIC	DIFFUSE	c.863A>T	p.Asp288Val	SNP	MISSENSE
53	<i>CDHI</i>	GASTRIC	DIFFUSE	c.869A>G	p.Asp290Gly	SNP	MISSENSE
54	<i>CDHI</i>	GASTRIC	DIFFUSE	c.895G>A	p.Ala299Thr	SNP	MISSENSE
55	<i>CDHI</i>	GASTRIC	DIFFUSE	c.895G>T	p.Ala299Ser	SNP	MISSENSE
56	<i>CDHI</i>	GASTRIC	MIXED	c.455A>G	p.Gln152Arg	SNP	MISSENSE
57	<i>CDHI</i>	GASTRIC	MIXED	c.948_950del	p.Met316_Phe317del	DEL	INFRAME
58	<i>CDHI</i>	GASTRIC	MIXED	c.1645G>T	p.Asp549Tyr	SNP	MISSENSE
59	<i>CDHI</i>	COLORECTAL	.	c.1003C>T	p.Arg335Ter	SNP	NONSENSE
60	<i>CDHI</i>	COLORECTAL	.	c.1019C>T	p.Thr340Met	SNP	MISSENSE
61	<i>CDHI</i>	COLORECTAL	.	c.1091_109	p.Thr364Serf	DEL	FRAMESHIFT
62	<i>CDHI</i>	COLORECTAL	.	c.1093G>A	p.Val365Ile	SNP	MISSENSE
63	<i>CDHI</i>	COLORECTAL	.	c.1099G>A	p.Asp367Asn	SNP	MISSENSE
64	<i>CDHI</i>	COLORECTAL	.	c.1115C>A	p.Pro372His	SNP	MISSENSE
65	<i>CDHI</i>	COLORECTAL	.	c.1137G>A	p.Thr379=	SNP	SPLICE
66	<i>CDHI</i>	COLORECTAL	.	c.1226G>A	p.Trp409Ter	SNP	NONSENSE
67	<i>CDHI</i>	COLORECTAL	.	c.1273G>A	p.Val425Ile	SNP	MISSENSE
68	<i>CDHI</i>	COLORECTAL	.	c.1297G>A	p.Asp433Asn	SNP	MISSENSE
69	<i>CDHI</i>	COLORECTAL	.	c.1320G>T	p.Lys440Asn	SNP	SPLICE
70	<i>CDHI</i>	COLORECTAL	.	c.1386del	p.Phe462Leuf	DEL	FRAMESHIFT
71	<i>CDHI</i>	COLORECTAL	.	c.1501G>A	p.Val501Met	SNP	MISSENSE
72	<i>CDHI</i>	COLORECTAL	.	c.1528G>A	p.Ala510Thr	SNP	MISSENSE
73	<i>CDHI</i>	COLORECTAL	.	c.1633C>T	p.Arg545Trp	SNP	MISSENSE
74	<i>CDHI</i>	COLORECTAL	.	c.1766A>C	p.Asn589Thr	SNP	MISSENSE
75	<i>CDHI</i>	COLORECTAL	.	c.1942G>T	p.Glu648Ter	SNP	NONSENSE
76	<i>CDHI</i>	COLORECTAL	.	c.221G>A	p.Arg74Gln	SNP	MISSENSE
77	<i>CDHI</i>	COLORECTAL	.	c.2254G>A	p.Val752Ile	SNP	MISSENSE
78	<i>CDHI</i>	COLORECTAL	.	c.2453C>T	p.Ala818Val	SNP	MISSENSE
79	<i>CDHI</i>	COLORECTAL	.	c.2498T>A	p.Phe833Tyr	SNP	MISSENSE
80	<i>CDHI</i>	COLORECTAL	.	c.2521G>A	p.Glu841Lys	SNP	MISSENSE
81	<i>CDHI</i>	COLORECTAL	.	c.2521G>A	p.Glu841Lys	SNP	MISSENSE
82	<i>CDHI</i>	COLORECTAL	.	c.2540C>T	p.Ser847Phe	SNP	MISSENSE
83	<i>CDHI</i>	COLORECTAL	.	c.2603G>A	p.Arg868His	SNP	MISSENSE
84	<i>CDHI</i>	COLORECTAL	.	c.263C>A	p.Pro88His	SNP	MISSENSE
85	<i>CDHI</i>	COLORECTAL	.	c.269G>A	p.Arg90Gln	SNP	MISSENSE
86	<i>CDHI</i>	COLORECTAL	.	c.302A>G	p.Tyr101Cys	SNP	MISSENSE
87	<i>CDHI</i>	COLORECTAL	.	c.377delC	p.Pro126Argf	DEL	FRAMESHIFT
88	<i>CDHI</i>	COLORECTAL	.	c.377delC	p.Pro126Argf	DEL	FRAMESHIFT
89	<i>CDHI</i>	COLORECTAL	.	c.394G>A	p.Val132Ile	SNP	MISSENSE
90	<i>CDHI</i>	COLORECTAL	.	c.394G>A	p.Val132Ile	SNP	MISSENSE
91	<i>CDHI</i>	COLORECTAL	.	c.628G>T	p.Glu210Ter	SNP	NONSENSE
92	<i>CDHI</i>	COLORECTAL	.	c.671G>A	p.Arg224His	SNP	MISSENSE
93	<i>CDHI</i>	COLORECTAL	.	c.736dupA	p.Met246AsnfsTer12	INS	FRAMESHIFT
94	<i>CDHI</i>	COLORECTAL	.	c.866C>T	p.Ala289Val	SNP	MISSENSE
95	<i>CDHI</i>	COLORECTAL	.	c.871G>A	p.Asp291Asn	SNP	MISSENSE
96	<i>CDHI</i>	COLORECTAL	.	c.944dup	p.Asn315Lysf	INS	FRAMESHIFT
97	<i>CDHI</i>	ESOPHAGEAL	.	c.1489G>A	p.Glu497Lys	SNP	MISSENSE
98	<i>CDHI</i>	ESOPHAGEAL	.	c.1596G>A	p.Trp532Ter	SNP	NONSENSE
99	<i>CDHI</i>	ESOPHAGEAL	.	c.1759G>T	p.Asp587Tyr	SNP	MISSENSE
100	<i>CDHI</i>	ESOPHAGEAL	.	c.760G>A	p.Asp254Asn	SNP	MISSENSE
101	<i>RHOA</i>	GASTRIC	INTESTINAL	c.101A>G	p.Tyr34Cys	SNP	MISSENSE
102	<i>RHOA</i>	GASTRIC	INTESTINAL	c.101A>G	p.Tyr34Cys	SNP	MISSENSE
103	<i>RHOA</i>	GASTRIC	INTESTINAL	c.123C>G	p.Asn41Lys	SNP	MISSENSE
104	<i>RHOA</i>	GASTRIC	INTESTINAL	c.169T>G	p.Leu57Val	SNP	MISSENSE
105	<i>RHOA</i>	GASTRIC	INTESTINAL	c.185G>A	p.Gly62Glu	SNP	MISSENSE
106	<i>RHOA</i>	GASTRIC	INTESTINAL	c.185G>A	p.Gly62Glu	SNP	MISSENSE
107	<i>RHOA</i>	GASTRIC	INTESTINAL	c.50G>A	p.Gly17Glu	SNP	MISSENSE
108	<i>RHOA</i>	GASTRIC	DIFFUSE	c.118G>A	p.Glu40Lys	SNP	MISSENSE
109	<i>RHOA</i>	GASTRIC	DIFFUSE	c.125A>C	p.Tyr42Ser	SNP	MISSENSE
110	<i>RHOA</i>	GASTRIC	DIFFUSE	c.125A>C	p.Tyr42Ser	SNP	MISSENSE
111	<i>RHOA</i>	GASTRIC	DIFFUSE	c.125A>G	p.Tyr42Cys	SNP	MISSENSE
112	<i>RHOA</i>	GASTRIC	DIFFUSE	c.125A>G	p.Tyr42Cys	SNP	MISSENSE
113	<i>RHOA</i>	GASTRIC	DIFFUSE	c.125A>G	p.Tyr42Cys	SNP	MISSENSE
114	<i>RHOA</i>	GASTRIC	DIFFUSE	c.125A>G	p.Tyr42Cys	SNP	MISSENSE
115	<i>RHOA</i>	GASTRIC	DIFFUSE	c.125A>G	p.Tyr42Cys	SNP	MISSENSE
116	<i>RHOA</i>	GASTRIC	DIFFUSE	c.125A>G	p.Tyr42Cys	SNP	MISSENSE
117	<i>RHOA</i>	GASTRIC	DIFFUSE	c.125A>G	p.Tyr42Cys	SNP	MISSENSE
118	<i>RHOA</i>	GASTRIC	DIFFUSE	c.128_129	p.Val43Glyfs	DEL	FRAMESHIFT
119	<i>RHOA</i>	GASTRIC	DIFFUSE	c.13C>T	p.Arg5Trp	SNP	MISSENSE
120	<i>RHOA</i>	GASTRIC	DIFFUSE	c.14G>A	p.Arg5Gln	SNP	MISSENSE
121	<i>RHOA</i>	GASTRIC	DIFFUSE	c.169T>G	p.Leu57Val	SNP	MISSENSE
122	<i>RHOA</i>	GASTRIC	DIFFUSE	c.169T>G	p.Leu57Val	SNP	MISSENSE
123	<i>RHOA</i>	GASTRIC	DIFFUSE	c.169T>G	p.Leu57Val	SNP	MISSENSE
124	<i>RHOA</i>	GASTRIC	DIFFUSE	c.169T>G	p.Leu57Val	SNP	MISSENSE
125	<i>RHOA</i>	GASTRIC	DIFFUSE	c.175G>T	p.Asp59Tyr	SNP	MISSENSE
126	<i>RHOA</i>	GASTRIC	DIFFUSE	c.179C>A	p.Thr60Lys	SNP	MISSENSE
127	<i>RHOA</i>	GASTRIC	DIFFUSE	c.182C>A	p.Ala61Asp	SNP	MISSENSE
128	<i>RHOA</i>	GASTRIC	DIFFUSE	c.182C>A	p.Ala61Asp	SNP	MISSENSE
129	<i>RHOA</i>	GASTRIC	DIFFUSE	c.184G>A	p.Gly62Arg	SNP	MISSENSE
130	<i>RHOA</i>	GASTRIC	DIFFUSE	c.220T>G	p.Tyr74Asp	SNP	MISSENSE
131	<i>RHOA</i>	GASTRIC	DIFFUSE	c.65T>G	p.Leu22Arg	SNP	MISSENSE
132	<i>RHOA</i>	GASTRIC	MIXED	c.116T>G	p.Phe39Cys	SNP	MISSENSE
133	<i>RHOA</i>	GASTRIC	MIXED	c.13C>T	p.Arg5Trp	SNP	MISSENSE
134	<i>RHOA</i>	GASTRIC	MIXED	c.205C>A	p.Leu69Met	SNP	MISSENSE
135	<i>RHOA</i>	GASTRIC	MIXED	c.77G>T	p.Ser26Ile	SNP	MISSENSE
136	<i>RHOA</i>	COLORECTAL	.	c.132C>T	p.Ala44=	SNP	MISSENSE
137	<i>RHOA</i>	COLORECTAL	.	c.14G>A	p.Arg5Gln	SNP	MISSENSE
138	<i>RHOA</i>	COLORECTAL	.	c.182C>T	p.Ala61Val	SNP	MISSENSE
139	<i>RHOA</i>	COLORECTAL	.	c.206T>C	p.Leu69Pro	SNP	MISSENSE
140	<i>RHOA</i>	COLORECTAL	.	c.206T>C	p.Leu69Pro	SNP	MISSENSE
141	<i>RHOA</i>	COLORECTAL	.	c.231C>T	p.Thr77=	SNP	MISSENSE
142	<i>RHOA</i>	COLORECTAL	.	c.253dupT	p.Ser85Phefs	INS	FRAMESHIFT
143	<i>RHOA</i>	COLORECTAL	.	c.275_276d	p.Leu92Ter	DEL	FRAMESHIFT
144	<i>RHOA</i>	COLORECTAL	.	c.364C>T	p.Arg122Trp	SNP	MISSENSE
145	<i>RHOA</i>	COLORECTAL	.	c.461T>G	p.Phe154Cys	SNP	MISSENSE
146	<i>RHOA</i>	COLORECTAL	.	c.46T>A	p.Cys16Ser	SNP	MISSENSE
147	<i>RHOA</i>	COLORECTAL	.	c.480A>G	p.Ser160=	SNP	MISSENSE
148	<i>RHOA</i>	ESOPHAGEAL	.	c.13C>T	p.Arg5Trp	SNP	MISSENSE
149	<i>RHOA</i>	ESOPHAGEAL	.	c.176A>G	p.Asp59Gly	SNP	MISSENSE
150	<i>RHOA</i>	ESOPHAGEAL	.	c.551G>A	p.Gly184Glu	SNP	MISSENSE