

UC Berkeley

UC Berkeley Electronic Theses and Dissertations

Title

Hybrid Aesthetics: Bridging Material Practices and Digital Fabrication through Computational Crafting Proxies

Permalink

<https://escholarship.org/uc/item/6384k94f>

Author

Torres, Cesar Armando

Publication Date

2019

Peer reviewed|Thesis/dissertation

Hybrid Aesthetics: Bridging Material Practices and Digital Fabrication through Computational
Crafting Proxies

by

Cesar Armando Torres

A dissertation submitted in partial satisfaction of the

requirements for the degree of

Doctor of Philosophy

in

Computer Science

and the Designated Emphasis

in

New Media

in the

Graduate Division

of the

University of California, Berkeley

Committee in charge:

Professor Eric Paulos, Chair

Professor Björn Hartmann

Professor Kimiko Ryokai

Summer 2019

Hybrid Aesthetics: Bridging Material Practices and Digital Fabrication through Computational
Crafting Proxies

Copyright 2019
by
Cesar Armando Torres

Abstract

Hybrid Aesthetics: Bridging Material Practices and Digital Fabrication through Computational
Crafting Proxies

by

Cesar Armando Torres

Doctor of Philosophy in Computer Science
and the Designated Emphasis in
New Media

University of California, Berkeley

Professor Eric Paulos, Chair

Creative technologies like digital fabrication led to the rise of the Maker movement, engendering grassroots innovation in education, manufacturing, and healthcare. Today, these creative technologies stand at a crossroads – despite a significant rise in participation, a deeper engagement with design and material is absent from traditional computer-aided design workflows. In this thesis, I will motivate the need for creative technologies to support the morphogenetic model of making, a thinking and working style characteristic of how practitioners work with physical materials but difficult to access in digital design tools.

To communicate my findings, I introduce the concept of a Crafting Proxy, an intermediary between a practitioner and a material that can be used to facilitate the interpretation, manipulation, and evaluation of a material as a part of a creative process. In these works, I employ a Research through Design (RtD) methodology to construct intermediate-level knowledge around the design, implementation, and evaluation of Crafting Proxies. I'll demonstrate how Crafting Proxies can be enacted within physical materials, physical tools, and physical practices to support morphogenetic workflows in domains such as light and heater design, and metalworking.

As a result, this work contributes a design method for creating crafting proxies and a set of design principles that inform how new materials and digital fabrication technologies can foreground the existing knowledge and practices of material practitioners and generate new forms and aesthetics that can alter the trajectory of the Maker movement towards a New Making Renaissance.

*This work is dedicated to Tim B. Campbell (1989-2015),
whose expressiveness knows no bounds.*

Contents

Contents	ii
List of Figures	v
List of Tables	xii
1 Introduction	1
1.1 Problem Definition	3
1.2 Significance and Broader Impacts	5
1.3 Contributions	7
1.4 Outline	7
1.5 Statement of Multiple Authorship and Prior Publication	10
2 A Profile of a Material Practice	12
2.1 Introduction	12
2.2 A Material Epistemology	15
2.3 Tensions of a Material Practice and Digital Fabrication	21
2.4 Definitions and Concepts	26
2.5 Summary	26
3 Related Work	28
3.1 Design Tools for Physical Making	28
3.2 Satisficing a Craft-based Practice	32
3.3 Analytical Frames for Understanding Materials	34
3.4 Summary	37
4 Crafting Proxies	38
4.1 What is a Proxy?	38
4.2 The Design Space of Crafting Proxies	39
4.3 Expanding the Proxy Design Space	40
4.4 Methodology	42
5 Wire Forming	44

5.1	Introduction	45
5.2	A Proxy-Mediated Practice	46
5.3	Related Work	48
5.4	Design Process	50
5.5	Wire-wrapping CAD Tool	51
5.6	Material Practice with Metal Wire	52
5.7	Shape Proxy Design	56
5.8	Scaffold Proxies	60
5.9	Workshop Evaluation	66
5.10	Results	68
5.11	Discussion	72
5.12	Summary	74
6	Light Forming	76
6.1	Introduction	77
6.2	Related Work	79
6.3	Conversational Profile	81
6.4	Composability: Deconstructing the LED	90
6.5	Luminaire CAD Tool	98
6.6	Design Artifacts	100
6.7	Workshop Evaluation	104
6.8	Results	104
6.9	Discussion	108
6.10	Summary	112
7	Heat Forming	113
7.1	Introduction	114
7.2	Related Work	115
7.3	Conversational Profile	116
7.4	Composability: Spatiotemporal Resistive Heaters	117
7.5	Resistive Heater CAD Tool	121
7.6	Electric Heat Perceivability	123
7.7	Design Artifacts	128
7.8	Workshop Evaluation	134
7.9	Qualitative Results	136
7.10	Discussion	141
7.11	Summary	144
8	Discussion	145
8.1	Crafting Proxy Design Method	145
8.2	Design Principles and Strategies for Crafting Proxies	148
8.3	Extensions of the Crafting Proxy Design Method	154

8.4	Summary	156
9	Computational Design Architecture	158
9.1	Architecture	158
9.2	SVG as a 2D Design Tool	160
9.3	SVG as a 2.5D Modeling Tool	162
9.4	SVG as an Interaction Design Tool	163
9.5	Discussion	164
9.6	Conclusion	165
10	Conclusion	166
10.1	Restatement of Contributions	166
10.2	Future Research Areas: The Case for a Hybrid Atelier	168
10.3	Summary	172
	Bibliography	174
A	Open-source Repositories	193
B	Wire Wrapping Workshop Study	194
B.1	Demographics Questionnaire	194
B.2	Warmup Tutorial Protocol	194
B.3	Think Aloud Brief	195
B.4	Post-Task Questionnaire	195
B.5	Post-study Protocol	196
C	Luminaire Study Questionnaires	197
C.1	Pre-study Interview Guide	197
C.2	Workshop	197
C.3	Followup Questionnaire	198
D	Resistive Heater Workshop Study	200
D.1	Tutorial Checklist	202
D.2	Post-study Questionnaire	203
E	Glossary	205

List of Figures

1.1	(left) <i>The Coiling Method</i> . A pottery technique developed across cultures and time periods that additively deposits material to build free-standing 3D forms. (right) <i>Fused Deposition Modeling</i> . A 3D-printing technique developed in 1989 that additively deposits material to build free-standing 3D forms ¹	2
1.2	Forming Wire: Crafting Proxies as an Armature	8
1.3	Forming Light: Crafting Proxies as an Immaterial Mediator	9
1.4	Forming Heat: Crafting Proxies as a Lens	9
1.5	An SVG-based Computational Design Architecture	10
2.1	(Left) A wall of a potter's studio holds tens of firing keys that each record the results of a firing of a unique clay body and glaze combination. The potter externalizes their mental model of the firing process onto her environment, grabbing a set of keys when deciding how to glaze her latest work and guiding her creative process. (Right) The keys each display a firing temperature and a patterned print used to mark and identify finished pieces ²	17
2.2	A Stained Glass Process. A glassworker cuts and grinds geometries from a pane of glass material which is often risky and error-prone. The glass geometries are lined with copper tape and soldered together. The skill of applying heat at the correct location, rate, and duration is tacit and developed experientially over time. The different resistances found in each material for forming processes introduced a value system. For glass, cutting textured glass results in more compositions that display a mastery of the medium than those with smooth glass ³	20
2.3	(top) Hylomorphic making in a stained glass practice – a cartoon is used to plan a composition, and glass it cut to match the design until the design matches the cartoon. (bottom) Hylomorphic making in Fused Deposition Modeling (FDM) 3D printing – an abstract form is imagined and specified as an STL model; the resulting form is imposed upon a host of different materials in a filament form factor; the form is considered complete when it matches the target model ⁴	22

2.4	The traditional CAD-CAM workflow. In the computer-aided design phase, a computational model is constructed using a modeling tool and typically exported as a watertight mesh (STL) or as curves (SVG). In the computer-aided manufacturing phase, the encoding is converted into a machine-interpretable geometry, a tool-path is then planned to satisfy that geometry, and the compiled set of instructions is then communicated to a computer numerical control tool. The CAM process is device-specific and needs to be run for each CNC tool.	23
2.5	(Left) A 3D print has experienced lift-off, a printing error that occurs when thermoplastic contracts and introduces internal stresses to the model. The common fix is to apply glue to the printing platform for stronger adhesion to overcome forces from contraction. (Right) A clay vase is wrapped in multiple different bags to control the drying rate of the clay. Drying too quickly can introduce internal stresses on the walls of the vase and cause fractures. The plastic bags are progressively removed, exposing thinner, faster-drying geometries first ⁵	25
3.1	Translators: (left to right) translating sculpting actions [176]; translating markers [169]; translating measurements [205].	29
3.2	Mediators: (left to right) mediating code [159], mediating signal [154], mediating air flow [199], compositing smart materials [99].	30
3.3	Monitors: (left) monitoring carving actions [225], (right) monitoring cutting actions [218].	30
3.4	Armatures: (left to right) supporting weaving [223], supporting painting [14], supporting wearable modeling [56].	31
3.5	(left) Lilypad Arduino [23]; (center) Chibitronics [156]; (right) E-textiles tester [153]	32
4.1	Immaterials are elements that are difficult to perceive or manipulate by the human body unaided.	41
4.2	Daniel Rozin. <i>Wooden Mirror</i> (1999). 830 square pieces of wood, 830 servo motors, control electronics, video camera, wood frame. Size - W 67" x H 80" x D 10" (170cm , 203cm, 25cm).	41
5.1	The CAD-CAM pipeline. Sketches or prototypes are converted into a computational representation using a modeling tool. The tool then encodes this representation in a form that is accepted by CNC machines. This representation is translated into machine-specific instructions and sent to a CNC machine for fabrication. Many machines produce artifacts that require some post-processing.	46
5.2	Proxy-Mediated Practice. 1) A wire-wrap jewelry design is converted into a computational representation, 2) this representation is translated into an armature, or tool, that helps with making the target design, 3) the armature allows for a material encounter to occur while still providing the benefits of digital fabrication.	47
5.3	Tools of the Trade. Pliers, jigs, mandrels, vises are commonly used in wire-wrapping and are often custom-made for specific jewelry designs. ⁶	48

5.4	Comparison against WrapIt [82]	50
5.5	ProxyPrint Computational Design Tool for Wire-Wrapping. ProxyPrint Computational Design Tool for Wire Wrapping. Users can drag common forms onto a canvas, manipulate paths, specify materials, and add ornamentation and connections. The tool produces a heightmap used to generate a 2.5D printable proxy.	51
5.6	Wire-shaping strategies. Opening and closing a jump ring using (top) axial bends and (bottom) lateral bends. Note the deformations that arise from lateral work-hardening.	55
5.7	How to Use a Shape Proxy	57
5.8	Routine for Shape Proxy Generation.	58
5.9	Deformations of a Heart Shape along the Axial Dimension	58
5.10	Hill Climbing Path	59
5.11	Proxy Shape Primitives	60
5.12	Three different proxies, or tools that aid users in the construction of an artifact, with different profiles of assistance. A schematic (left) provides fabrication feedback via an annotated construction proxy; a stencil (center) breaks down designs into elementary forms, c) a jig (right) provides a ritual high-fidelity fabrication process via a fabrication and construction proxy.	61
5.13	Proxy Scaffold - Jig	62
5.14	Proxy Scaffold - Stencil	63
5.15	Proxy Scaffold - Schematic	64
5.16	Study Setup	67
5.17	Questionnaire Results	69
5.18	Flow as a measurement of engagement. The boxplot depict the difference in perceived and actual completion time. Areas in the texture '+' field indicate the participant lost track of time.	70
5.19	Construction patterns were highly dependent on the first scaffold that was presented to participants. Schematic-first users moved with step-wise similarity, jig-first followed a linear progression, while stencil-first compartmentalized forms – an expert trait.	71
5.20	Wire-wrap Artifacts of Expert Participant 4	72
6.1	@ThePracticalDev Community - O'rly Book Cover Generator	77
6.2	Luminaire Design Tool, Simulation Interface, and Fabricated Luminaire	78
6.3	(left) Olafur Eliasson, <i>The Weather Project</i> (2003), (center) Daniel Rozin, <i>Wooden Mirror</i> (1999), (right) Printed Optics [210]	79
6.4	(left) Jim Campbell, <i>Exploded Views</i> (2011), (center) László Moholy-Nagy, <i>Light-Space Modulator</i> (1930), (right) Gjon Mili, <i>Picasso draws a centaur</i> (1949)	80
6.5	Adafruit LED Matrix (1613) ⁷	82
6.6	The Matrix Circuit Pattern. A circuit pattern for selectively controlling an LED.	83
6.7	Luminous LED Strip Light, a commodity smart LED strip ⁸ .	84

6.8	A lamp of the <i>Virgen de Guadalupe</i> cast in resin and inlaid with fiber optics. (center) A mechanical stepper motor rotates a stained glass disk above a lamp bulb; fiber optics capture the colored light acting as a sequencer. (right) A light sequencer program; the fiber optics bundle "reads" in light passed through a colored disk. Manufacturer unknown.	87
6.9	An LED was cast in acrylic resin (PMMA) using a packing plastic as a mold. As the resin cured, gases produced from the chemical reaction attempted to escape but were captured, forming bubbles. Light emitted from the LED interacts with these geometries, refracting and reflecting to form light gradients, shadows, and textures.	88
6.10	Luminaire Construction - Lamps are housed, powered, and controlled in the base level. Secondary optic elements in the <i>beam-shaping</i> layer shape light emitted from the lamps. The topmost <i>diffuser</i> controls the presentation of light using light-scattering surface properties ⁹	91
6.11	Trace assistance routine. a) user annotates SVG, b) positions are extracted and LED orientation is optimized, c) optimal path is extracted, d) design files produced for several processes, e) different substrates can be used to create rigid or flexible PCBs.	92
6.12	Parametric Models of Secondary Optic Systems. A scene is constructed with a light source (yellow), reflective materials (red), non-reflective materials (black), refractive material (light blue), and diffusive material (green).	93
6.13	Shape-Optimized Secondary Optic Element Pipeline	94
6.14	Simulated Annealing	95
6.15	Fabricated reflectors. A total internal reflection (TIR) reflector printing in clear resin (left). Light enters through an air cavity above the LED and is reflected internally, spreading light throughout the lens. A parabolic reflector printing in clear resin, with a coat of mirror spray and acrylic coating (right).	96
6.16	LED Diffuser	97
6.17	Polar Luminous Intensity Graph. The diagram indicates the distribution of the relative luminous intensity of the luminaire. Control systems are marked with dashed lines. Each reflector condition has a 40% glass by mass 3 mm diffuser.	98
6.18	Luminaire Creation Pipeline. a) Given an SVG graphic, our luminaire design tool aids users with laying out LEDs, visualizing light interactions, and specifying target areas to fill with light. In the callout, an LED is specified to fill a moon-shape. b) A computational design backend generates an optimal secondary optics system to achieve the desired design using ray tracing to guide a simulated annealing search. All files for 3D printing geometries and milling circuits are produced by the backend, c) an instruction set guides the user to assemble the luminaire.	99
6.19	Illumination views. Each view can be toggled by a user when composing their design to showcase different illumination concerns. Each light source interacts with neighboring geometries and shows light interactions such as mixture and shadow creation.	99
6.20	Illuminated Hair brooch (1 LED)	100
6.21	Sun Moon Lightwork (25 LEDs)	101
6.22	Tactile Cityscape (16 LEDs)	102

6.23	Haptic Button (1 Blue LED, 1 Green LED)	102
6.24	Luminaires fabricated from user designs: (top) simulated results from the luminaire design tool, (bottom) the final physical luminaire.	103
6.25	Participant 170 - Owl Luminaire	110
7.1	A Thermoreactive Composite. Thermochromic pigments are bound in gum arabic, giving it many of the same qualities as watercolor paints. A purple thermochromic glaze is applied to a chromostable watercolor composition depicting an apple. A silver ink resistive heater is coupled to the composition with Kapton tape; when triggered, it produces a dynamic ripening-apple illustration.	114
7.2	Parameters of a Thermoreactive Composite - The power supply and silver ink circuit are used to form a joule heater. This heater is inserted into the cuff of a sleeve with a screenprinted thermoreactive design made with liquid crystal paint.	118
7.3	Designing Heat Regions and Activation Times. A user draws an initial heat region (per the dimensions of the cuff design), subdivides the region into 5 using a widget, and specifies desired activation times. A computational model updates and computes the power specification.	119
7.4	Trace Design. Circuit design variables are queried from the circuit model for each heat region and a serpentine pattern is generated, specific to silver ink, to achieve the target resistance and power.	119
7.5	Characterization Routine.	120
7.6	Activation Energy of Various Thermoreactive Composites	121
7.7	Capturing Parameters of Thermoreactive Composites	122
7.8	Capturing a Thermoreactive Composition. An image is transferred through a network connected camera, processed through the web app, and transferred to form the backdrop of the design canvas.	123
7.9	Design Stage Concerns. Given a set of material parameters, the design stage allows a user to specify regions to heat and when to activate thermoreactive materials in those regions.	123
7.10	Resistive Heater Design Workflow. Four different views walkthrough the design stage interactions: a <i>thermal view</i> facilitates drawing heat regions and specifying heat region parameters, a <i>circuit view</i> aids with generating and adjusting serpentine patterns, a <i>temporal view</i> plays back a simulation of the heater design, and a <i>print view</i> presents the final circuit design; the design can then printed, adjusted in Illustrator, or incorporated into more complex circuits.	124
7.11	Fabrication Workflow. Heaters are fabricated and validated with a TLC sheet. The Phosphenes web app provides debugging assistance.	124
7.12	Digital Perceivability Mechanisms. The generated circuit and underlying circuit model are used to encode an interactive visual representation of circuit state, including power consumption, current distribution, and resistance. A digital stitching interaction requires physical effort to produce traces, while a splashing-rock modeling analogy conceptualizes electric heat.	126

7.13	Circuit Model and Thread Model Updates. The spool drains as more current is drawn to respective subheaters.	127
7.14	Physical Perceivability Mechanisms. (top) Liquid crystal sheets with the aid of a cold plate to reset activated materials serve as an iterative heat evaluation technique. (bottom) A TrC sleeve activates from left to right, serving as a wearable progress bar and dynamic texture.	128
7.15	Thermodynamic Painting Techniques	129
7.16	Thermodynamic Watercolor	129
7.17	The Buddha Mala	130
7.18	Liquid Crystal Collar and Cuff Wearable Display	131
7.19	Liquid Crystal Handbag with Underlying Copper Foil Heat Conductors	132
7.20	Thermochromic PLA Embossed Coaster	132
7.21	A Thermoreactive Print. (a) A silver ink resistive heater is placed inside a thermoreactive 3D print, (b) the thickness of the 3D-printed walls is used to modulate the mass in contact with the uniform heat source in the interior, (c) the thinner walls activate first, creating a windowing effect.	133
7.22	Workshop Heaters. Participants were tasked with creating a heater that would make 3 or more circles disappear from a thermochromic watercolor composition.	135
7.23	CSI Index Results	137
7.24	Haptic Retargeting. Glass-blowing practices use heat in ranges that far exceed current Thermoreactive Composites (TrCs). How might retargeting these haptic cues affect creative practices?	141
7.25	Copper Heat Smoothing. (left) A two-branch joule heater activates a TLC sheet; (right) a thin-sheet of copper is placed over the original heater, smoothing out the serpentine heat pattern.	142
7.26	Could shaping three-dimensional wire forms created three-dimension heat forms?	143
8.1	Crafting Proxy Design Method	145
8.2	A simple light simulation of LEDs in a California Bear reflector geometry. (left) A Cool Simulation - Low-definition media that engages the senses less completely; (right) A Hot Simulation - High-definition media.	149
8.3	Semiotics of Traditional Materials. (left) <i>Virg3n de Guadalupe</i> Fiber Optic Lamp, (center) Phosphenes <i>Buddha Mala</i> , (right) Illumination Aesthetics Illuminated Hairbrooch	151
8.4	Proxies for Biomaterials ¹⁰	155
8.5	Proxies for Electromagnetism ¹¹	155
9.1	Computational Design Architecture	158
9.2	2D Design Specification	160
9.3	SVG as Input Parameters	161
9.4	2.5D Model Generation - Mold Generation	162

9.5	SVG as Service Registry - The SVG encodes the IoT devices in a scene and exposes available services (e.g., sensing, actuation) that can be accessed by a web application.	164
10.1	Where can the interface exist in a material environment? ¹²	168
10.2	Settables: Shapeable viscoelastic materials that can be set into a final form. ¹³	169
10.3	Sites for Material Interfaces. (left) a deformable and haptic interface (piping bag) is used to deposit frosting onto the surface of a cake; (right) a surface with continuous interaction with the skin (foot pedal) is used to control a sewing machine. ¹⁴	170
10.4	Retargetting Data. (left) Movement of a soldering iron and interactions with a sponge are converted into sonic cues; (right) Data from an infrared camera is converted into a visual stimulus while thermoforming an acrylic bar.	171

List of Tables

2.1	Components of a Material's Conversational Profile	14
2.3	The Profile of a Material Epistemology	16
6.1	A Conversational Profile of Light	90
6.2	Qualitative Assessment Luminaire Design Tool and Fabricated Luminaire Objects . . .	103

Acknowledgments

I am incredibly fortunate to have had Eric Paulos as an advisor. He taught me to step out of the box, embraced my interdisciplinary quirks, and fostered such an open, inclusive, and creative environment at UC Berkeley.

I am incredibly indebted to my colleagues for their insight, knowledge, and expressiveness. Thank you Rundong Tian, Molly Nicholas, Christine Dierk, Sarah Sterman, Joanne Lo, James Pierce, Laura Devendorf, Vedant Seran, Katherine Wu, and especially Tim Campbell, my research *compadre*, who endured the early research years with me.

This work would not have been possible without the talented undergrads that have endured my mentorship. Thank you Jasper O’Leary, Jessica Chang, Advaita Patel, Emily Hill, Tina Taleb, Matthew Jörke, Sangyeon Lee, Tony Zhao, Neil Kumar, Connor Freeman, Alejandro Garcia Salas, Jaqueline Garcia, Niraj Rao, Ryan Kapur, Emily Chao, and Akhila Raju.

I am thankful for the support of my committee members: to Kimiko Ryokai, whose courses planted the initial seeds towards researching tangible computing, creativity, and learning; to Björn Hartmann whose inspirational work in design tool research motivated me to pursue this dissertation trajectory. A special thanks to Adobe Research for supporting my research, especially my mentors Wilmot Li and Mira Dontcheva.

The New Media program at Berkeley has been invaluable to who I am as an academic. I am grateful to have been part of the community and thank the people who made it what it is today, especially Gail de Kosnik, Greg Niemeyer, Ken Goldberg, Lara Wolfe, Nicholas de Monchaux, and Jill Miller.

To the BiDizens: Thank you for the incredible support network and valuable feedback. Thanks to Drew Sabelhaus, Elena Durán, Kristin Stephens-Martinez, Pablo Paredes, Valkyrie Savage, Andrew Head, Jeremy Warner, Eldon Schoop, Nate Weinman, Hezheng Yin, Deniz Dogruer, Julia Kramer, and Peggy Chi.

I am thankful to have received critical perspectives from the iSchool. Thanks to Noura Howell, Richmond Wong, Nick Merrill, and Marti Hearst.

Un mil gracias a mi familia, mi esposo José Buenrostro, mis papas César y Rosa, mis suegros Fran y Noemi, mi hermana la Dra. Brenda Torres, mis cuñados Estevan Mendoza y Donaldo Buenrostro, y mis amigos Katie Campbell, Laura Campbell, y Jim Campbell.

Lastly, to the inspiration behind it all – Frida Kahlo – whose artwork pushed the boundaries of accepted aesthetics and who embodied this philosophy in her life and being.

Chapter 1

Introduction

Someday artists will work with capacitors, resistors, and semiconductors as they work today with brushes, violins & junk.

Nam June Paik [141]

Creative technologies like digital fabrication¹ led to the rise of the Maker movement, engendering grassroots innovation in education, manufacturing, healthcare, and beyond [61, 130]. Today, these creative technologies stand at a crossroads – despite a rise in participation from lowering both technical and social barriers, there remains a gap between literacy, fluency, and competence [18]. Digital fabrication democratizes access to a variety of materials, processes, and techniques, but achieving fluency, or the “[intellectual] capabilities [to] empower people to manipulate the medium to their advantage and to handle unintended and unexpected problems when they arise” continues to be a pedagogical challenge [18]. In *The Art of the Maker* [41], Dormer describes this paradox of democratization – while skills are made available to a practitioner without needing to acquire them, it also confines a practitioner to other people’s way of thinking. For makerspaces oriented around Science, Technology, Engineering, and Math (STEM) fields, the proclivity of machines to remove the human hand from interactions with the physical material, eliminate the need for manual dexterity, and reduce the risk of human error is deeply rooted in manufacturing practices. This manufacturing legacy develops an epistemological monoculture that permeates through many makerspaces. This is not to make a blanket statement that no makerspace has achieved inclusivity or diversity of thought, but instead to point to intrinsic workflows that are deeply seated in mass-manufacturing values. In valuing “product” over “process,” knowledge remains blackboxed while replication and reproduction drive creative interactions, limiting the agency of the maker and the motivation for creative exploration [18].

¹ Definitions for terms, concepts, and abbreviations used throughout this dissertation have been made available in the Glossary (Appendix E).

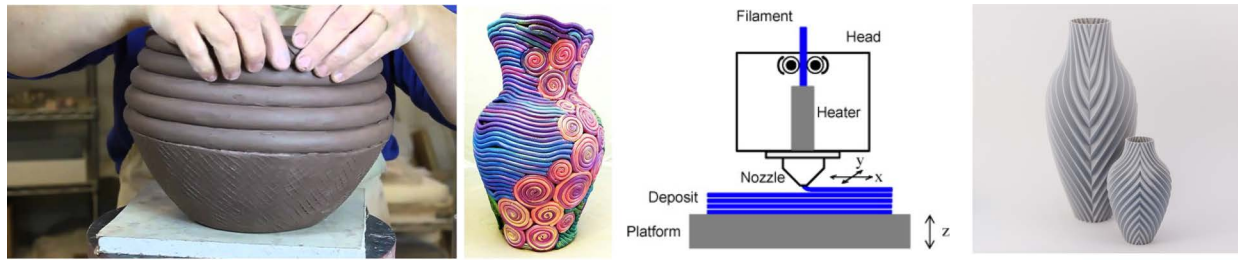

Figure 1.1: (left) *The Coiling Method*. A pottery technique developed across cultures and time periods that additively deposits material to build free-standing 3D forms. (right) *Fused Deposition Modeling*. A 3D-printing technique developed in 1989 that additively deposits material to build free-standing 3D forms².

As a motivating example (Figure 1.1), consider the core technology behind 3D Printing – Fused Deposition Modeling (FDM) [34]. Developed in 1989 by Statasys, Inc. the technique involves using a movable extruder to deposit material that self hardens over time, bonding from contact with previously extruded elements. Layer by layer, this coil of material accumulates to form a final 3D geometry. This technique bears a striking similarity to the Coiling Method, a ceramics technique that has developed across cultures dating back to at least 2500 BC. In the Coiling Method, a piece of clay is rolled into a tube, similar to the form one might encounter extruding from a 3D printer. A ceramicist then scores the tube (creating a rough texture) and applies a slip (a watered-down clay glue) on the contact points where the tube will “fuse” as it winds around proximal tubes.

Despite Fused Deposition Modeling (FDM) being portable to a variety of materials including clay [1], 3D printing workflows run counter to *sculptural thinking* (creating 3D forms) or even *clay thinking* (creating with clay), preventing digital fabrication practices access to the thousands of years knowledge embedded in these practices.

- *What might 3D printing have to gain from integrating the thousands of years of knowledge, tradition, and culture of clay-based “3D printing”?*
- *What might digital fabrication look like if ceramicist could also inform the design of these future technologies and spaces?*
- *How might ceramics as a discipline transform from a deeper engagement with computation, or digital fabrication from a deeper engagement with clay?*

Envisionment. While I pose these questions centered around clay, I envision a future where digital materials like neural networks, data, and signals sit alongside a host of physical materials.

² Image credits [left to right]: Bridges Pottery, from <https://youtu.be/2dsOf2uj3Zw>; Alene Sirott-Cope, from <https://www.pinterest.fr/pin/73253931415662977/>; Ahn et al. [4]; *Monochromatic Vase* by Devin Montes <https://www.devinmontes.com/>.

The aim is not to replicate our virtual way of making, but to discover how an embodied virtuality changes what we choose to make and who participates in making. I imagine these emerging practices developing hybrid aesthetics that operate outside of the prevailing traditions of digital or physical mediums but instead develop a new idea of what technology looks like. Much like we saw Eva Hesse [115] in the 1970s breaking the male-dominated sculptural practices of stone, metal, and wood, forming instead soft latex skins of “everyday materials” with cheesecloth and nets, or Turkle and Papert [196] breaking the notion of a singular way of thinking in computer science, I imagine digital fabrication taking on a new meaning where a makerspace is not a “collection of fabrication machines in a small workshop” [203], but a community of practitioners deeply engaged within a sociocultural practice. When designing digital fabrication technologies, like a 3D printer, the process it facilitates should not be abstracted and generalized to fit all, but instead be designed for reappropriation, allowing a community of practice to align digital fabrication with their value systems. I see the environments that support this new type of making relegating the screen to the background and instead engaging and enhancing the human body’s role in the creative process. Most importantly, I hope for creative technology to change its current dynamic of making novel and interesting objects, to instead prioritize cultivating agency, resiliency, and self-efficacy for past, current, and future practitioners to sustain a lifelong practice.

1.1 Problem Definition

For Human-Computer Interaction (HCI), it is not enough to simplify programs or develop streamlined software and hardware tools. For digital fabrication to reach the vision of personal fabrication, fabrication practices must support a more plural way of thinking [72]. I am specifically interested in supporting material crafting practices, henceforth referred to as material practices, that work with materials using a specific set of skills, methods of reflection, and the potential to achieve mastery [135]. I aim to develop a digital fabrication practice that is diametrically opposed to the goals of mass reproduction, building on historical antecedents to the Arts and Crafts movement (1880-1920) forming as a response to the impersonal and mechanized ideals of the Industrial Revolution (1760-1840) [211]. There are several contributing social, cultural, and technical factors that have influenced the limited intersection of digital fabrication with material practices, which I describe below. These tensions are discussed in detail in Chapter 2.

- **Aesthetic Pluralism.** Aesthetics refer to the philosophical analysis of the beliefs, concepts, and theories implicit in the creation, experience, interpretation, or critique of art (qtd. in [49]). Although a concept from art theory, aesthetics have widespread impact across disciplines. A minimalist aesthetic, for example, arose from a belief in clarity and intentionality and has influenced both art production, social forms, and interaction design towards removing artifacts or interactions that detract from a central message.

Material practitioners must negotiate whether they can maintain a craft identity when working with methods and aesthetics that “sit more comfortably with mass manufacturing than craft” [72].

- **Workflow Pluralism.** Digital fabrication practices arising from engineering differ from workflows in practices within art, anthropology, architecture, and archeology [85]. While some practices are goal-oriented, others are exploratory. Simple actions, like arriving at a makerspace without a preconceived idea or plan of action conflicts with the demand and limited resources makerspaces can provide.

The *de facto* fabrication workflow, the CAD-CAM pipeline, separates design and fabrication into two distinct steps: creating a computational representation of form, then converting this representation into machine instructions for fabrication. Current trends with multi-material 3D printing suggest an aim to remove interactions with materials altogether. However, material encounters, or the experiential creation of mental models from interactions with a material, are central to a material practice. The need for direct engagement with materials conflicts with the need to contain material processes in the CAD-CAM pipeline. Material practices are physically messy – a characteristic that conflicts with computers and electronics. Even abstracting the material and mediating the experience of interacting with a material has its limits, running into the classic dilemma of simulacra – the case in which the simulation will indubitably continue to neglect an important element of the real world [103].

- **Knowledge and Domain Transfer.** In order to work with a Computer Numerical Control (CNC) machine or a Computer-Aided Design (CAD) program, a material practitioner must learn an entirely new way of thinking (e.g., CAD thinking) which displaces the years of practice and skill they have developed. For instance, CAD programs oriented towards novices like TinkerCAD [8] use Constructive Solid Geometries (CSGs) to provide an elementary vocabulary of forms and operations (e.g., unite, subtract). This way of making 3D forms readily transfers to additive and subtractive sculpture practices, but does not support the wider repertoire of ceramics 3D forming techniques like coil, slab, or slip-casting methods. This tension from being unable to access the complete repertoire of skills echoes calls to support thick practice, allowing for the continuity of practice and supporting skills that have been acquired over time by using common physical interfaces as opposed to digitally mediating them [103]. Furthermore, an element of facilitating domain transfer involves finding instructional resources. When building on uneven skillsets, the ability for material practitioners to find an instructor or a peer to serve as one remains a challenge [184].
- **Maintenance** Many complex machines exist in material practices, and although they may break, longstanding practices have alternative methods (e.g., by hand) to achieve proximal results. Building trust in the continuous operation of ubiquitous computing devices is a central challenge in the home [44]. In digital fabrication spaces, a malfunctioning wireless router can quickly decommission the space; such brittleness in digital fabrication technologies limits the reliance and trust material practitioners place on these tools in their creative practice.
- **Inclusivity.** The maker identity has a deeper history with hacker culture and is associated with fields like engineering and computer science, largely composed of educated white men [105]. With the introduction of MAKE magazine and regional MakerFaires, the maker identity

has since developed to include children but remains predominantly male and middle class. In a content analysis of 10 years of magazine covers of MAKE magazine, Buechley [22] reported that only 14% featured women had been featured on the cover, with no representation of Black makers. This strong association of digital fabrication with the STEM fields and male-dominated practices influences the kinds of objects that produced, what is valued within the community, and their ways of making. As Rosner & Fox [163] describe, some communities have formed “alternative” makerspaces such as the women-organized hackerspace HackerMoms which incorporates craft processes like Failure Clubs that recognize and support the vulnerability of failure. These collectives also break traditional notions of hackerspaces, occurring in spaces that do not read as commercial fabrication workspaces, but instead as living rooms [163].

Thesis Tenets

To counteract these factors, I pose the following tenets for bridging material practices and digital fabrication and supporting material practitioners:

Tenet 1 Material practitioners should be able to access and incorporate the years of knowledge from their respective practices within digital fabrication workflows.

Tenet 2 Material practitioners should be able to use computation, electronics, and other emerging technologies like they would any other material. Such materials should be approachable and match their methods of producing, storing, applying, and transferring knowledge.

1.2 Significance and Broader Impacts

In digital fabrication, the 3D printer is just the first of many new practices where we see the computation inching closer to being a part of physical practices. Bridging material practice and digital fabrication has the potential to diversify how we encounter, experience, and interact with computation which I detail below.

Developing Communities of Practice (CoPs). In this work, I use the term creativity to refer to the social definition of creativity: “ideas and discoveries in everyday work practice that are novel with respect to an individual human mind or social community” (qtd. in [48]). Framing creativity as a social action is an important component of Communities of Practice (COPs) since material practitioners often organize into communities of people in a certain domain undertaking similar work. However, digital fabrication communities of practice are still nascent, but they are radically changing how creative work is being evaluated and appreciated. For instance, for novice digital fabrication users entering the community, computational design engines (e.g., support vector

graphics, parametric design, generative design) and repositories (e.g., online galleries, curated collections) lower the barrier to entry and minimize the risk of engaging with digital fabrication machines, but there are fewer mechanisms in place to sustain that practice. When a novice practitioner downloads and prints a 3D model from an online repository, the social evaluation and appreciation of such work within the CoP is devalued, whereas that same work to those outside the community is highly valued. Thus, for the novice practitioner, it is more rewarding to remain outside the CoP.

I argue that social appreciation by a community of practice is a central component to the motivations that drive aesthetics. In bridging these two communities of practice, I see emerging digital fabrication practices benefiting from mature mechanisms for supporting social creativity. For example, the painting art practice community has established a tradition of working with a medium (e.g., figure/ground), a value system on which to evaluate a painting (e.g., minimalism), and social and cultural mechanisms for developing expertise with the medium (e.g., critique, public exhibition, starving artist, lone creative genius). Supporting material practitioners like painters to enter the digital fabrication community can act as a way for new value systems to emerge that alter the motivations for what is valued and produced, leading to innovative design and ideas. Furthermore, many material practices readily integrate critique of society and culture and engagement with ethics within their value systems – elements which have growing relevance as technology interfaces with a larger breadth of human activity.

Technology Adoption and Participation. Aesthetics have a significant impact on technology adoption. Especially as we encounter interfaces in our surroundings, clothing, bodies, and cities, allowing material practitioners to inform how we perceive and interact with these technologies can democratize future trajectories beyond the reach of a single discipline. Material practices are also more approachable than engineering practices and carry more profound benefits of self-identity and self-efficacy formation that forms the tenet of their integration with Science, Technology, Engineering, Art, and Math (STEAM) pedagogy [120]. Moving past a superficial integration of Art and STEM, developing tools around material epistemologies aligns with initiatives in broadening participation in computer science and STEM fields.

Future Materials and Techniques. The landscape of materials, technologies, and fabrication techniques are quickly evolving. A user interface designer in the twenty-first century must not only be competent in working with computation and screen but be fluent in working with a wider repertoire of materials to be able to design for non-traditional sites of interaction (e.g., on skin, clothing, and surroundings). Material practices have a rich repertoire of techniques that are easily portable to new materials. Accessing and integrating techniques in established practices is one method of disseminating, advancing, and creating New Media practices.

1.3 Contributions

This dissertation contributes to a design method for bridging material practices and digital fabrication, composed of:

- **A Profile of a Material Practice** This work synthesizes theory around craft, aesthetics, and making with ethnographies of material practitioners. It compiles a profile that decomposes material epistemology into three components: *knowledge production*, *knowledge application*, *knowledge transfer*. This profile serves as an analytical tool to assess the capacity for tools to support a material epistemology.
- **The Concept of the Crafting Proxy** I introduce the concept of a Crafting Proxy – an intermediary between a practitioner and a material that can be used to facilitate interpretation, manipulation, and evaluation of a material as a part of a creative process. A Crafting Proxy is a type of creativity support tool that falls under a structuralist approach to creativity [180] – facilitating a method or process as a means of enhancing creativity. Crafting Proxies aim to support a material epistemology and are designed to facilitate material encounters, encourage wayfaring behaviors, and incorporate horizontal learning structures for more diverse and democratic forms of knowledge transfer. I synthesize intermediate-level knowledge gained from developing design tools that facilitate digital fabrication techniques with materials (wire) and immaterials (light and heat).
- **A Generalized Compositing Method.** This work generalizes the compositing design strategy employed for computational composites to inform how other emerging materials, besides computation, can be designed to be used by material practitioners. I describe analytical and ethnographic methods for extracting the conversational profile of a material, computational design algorithms for improving its composability or malleability, and the development of perceivability mechanisms used to reinforce material mental models. I synthesize workshop evaluations and artifacts build across three domains into design principles for navigating the Crafting Proxy design space.

As a result, the design method laid out by this work offers practical direction for composing new materials and technologies to foreground the existing knowledge and practices of material practitioners and generate new forms and aesthetics that can alter the trajectory of the Maker movement towards a New Making Renaissance.

1.4 Outline

This dissertation walks through important concepts around crafting theory, describes a series of projects that probe different areas of the Crafting Proxy design space, and culminates in a design method and a set of design principles. The document is organized as follows:

First, in Chapter 2, I argue for the need to better describe a material practitioner’s “way of knowing,” or epistemology. I present a profile of the material practitioner, synthesized from research

literature in anthropology and ethnography [172, 175, 85, 162, 194] and describe who material practitioners are, how they work and create, and the challenges they encounter when working within digital fabrication practices. This profile operates similar to a persona and is used to inform the design of tools created for forming wire (Chapters 5), light (Chapter 6), and heat (Chapter 7) and evaluate their capacity to support a material practice.

In Chapter 3, I motivate the novelty of Crafting Proxies and position their role in the broader research area of tangible computing, physical computing, and digital fabrication. I describe related work that aims to intersect craft with digital fabrication and the repertoire of tools that has emerged for physical-digital making. I also discuss how three different disciplines have approached understanding materiality and how I integrate these frames into our design method.

In Chapter 4, I describe the design space of Crafting Proxies and review the Research through Design (RtD) [222] methodology employed in this work used to construct intermediate-level knowledge around the design, implementation, and evaluation of Crafting Proxies.

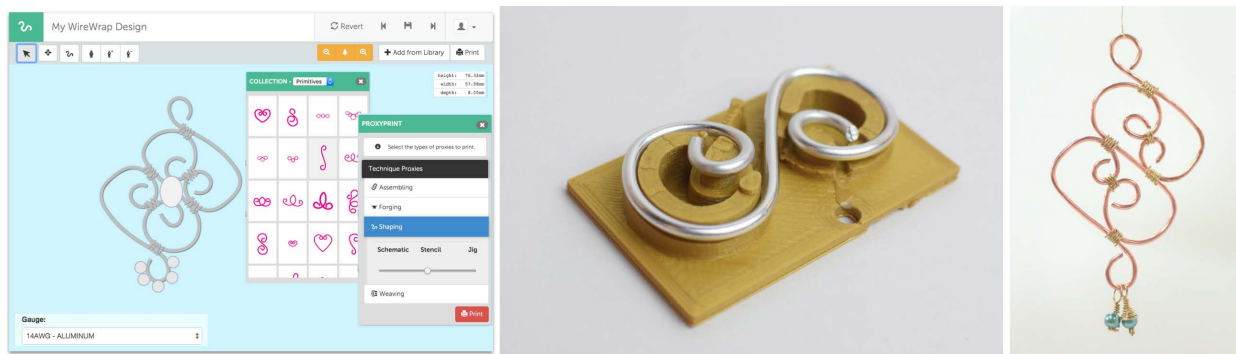

Figure 1.2: Forming Wire: Crafting Proxies as an Armature

In Chapter 5, I investigate the capacity of Crafting Proxies to act as physical armatures, or structural changes in the environment. This investigation is set in the domain of wire-wrapping, a popular form of metalworking for shaping metal wire into jewelry. I describe a digital design tool that operates similar to traditional CAD tools in digital fabrication workflows. However, I use this tool to communicate an alternative fabrication workflow that does not reduce interactions with the material like the traditional CAD-CAM workflow, but instead creates computationally-designed armatures that aid the practitioner to develop the final artifact and interact directly with a material.

In Chapter 6 and 7, I probe the capacity for *Crafting Proxies* to function as mediators, acting as an intermediary between an immaterial. Immaterials are element that are intangible and uncomposable, making them difficult for material practitioners to manipulate and perceive. Compositing is well-established strategy for exposing the forms, structures, and behaviors of one such immaterial – computation [201] – but has not been explored for other immaterials. These two chapters each explore a different immaterial, light and heat, and iterates on a generalized design method for compositing immaterials.

In Chapter 6, I explore how an intangible immaterial like electric light, can be used as a material and re-emerge as a first-class citizen in design. I first distill a conversational profile that describes

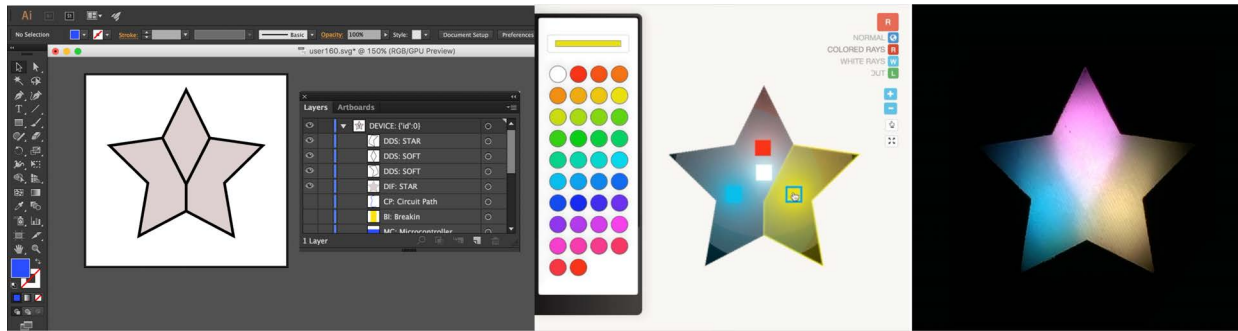

Figure 1.3: Forming Light: Crafting Proxies as an Immaterial Mediator

how light is used in both electronic practices and material practices. I then describe a *composeability design stage*, developing ways to expose additional creative inputs in what I term the material API that can be used to create forms that span the conversational profile. The result is luminaire design tool that decomposes the LED into computational design algorithms for creating Secondary Optic Elements (SOEs), including lenses, reflectors, and diffusers. I demonstrate how this material API can enable new *Illumination Aesthetics*, including light textures, sharp and soft light edges, and non-matrix light forms.

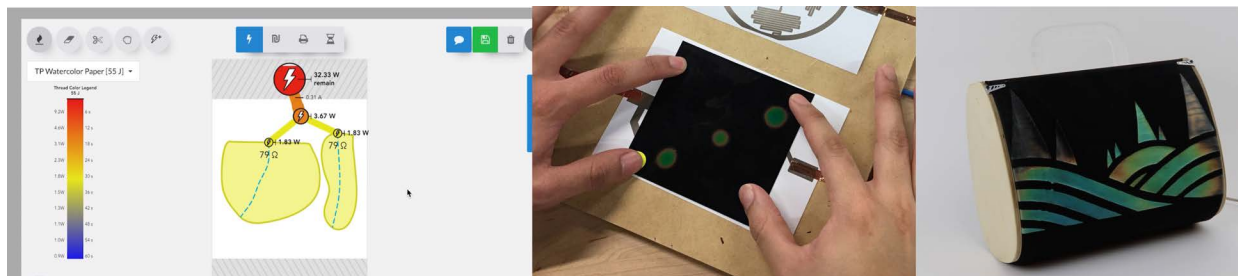

Figure 1.4: Forming Heat: Crafting Proxies as a Lens

In Chapter 7, I explore a second immaterial – electric heat. However, unlike light that is readily perceivable, heat poses additional challenges to becoming useful as a design material. Following a similar design method, I review how heat is used in thermoreactive composites – assemblages of heaters, substrates, and thermoreactive materials – within HCI practices and the ways that heat-centric workflows are complicated by heat’s immateriality. I then introduce a computational design algorithm that allows for the creation of inkjet-printed silver ink resistive heaters that extend heat’s material API as a spatiotemporal medium, allowing practitioners to specify what region to produce heat as well as when to activate a change in a thermoreactive material. To account for challenges to perception and cognition, I introduce a *perceivability design stage* that specifically explores ways of mapping the output of the physical stimuli (in this case heat) to the psychophysics of the human body, acting as a lens for the body to perceive heat interactions.

In Chapter 8, I summarize the intermediate-level knowledge generated from designing, implementing, and evaluating three Crafting Proxies as a generalized design method and offer a set of

design principles for navigating the Crafting Proxy design space.

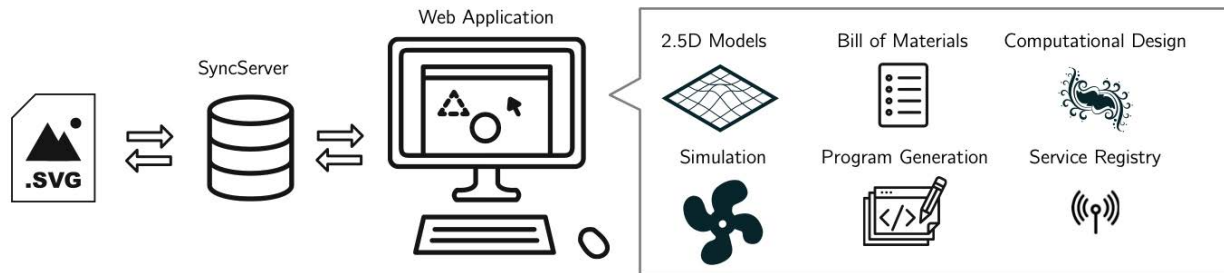

Figure 1.5: An SVG-based Computational Design Architecture

In Chapter 9, I review the current iteration of an evolving computational design architecture that serves as the engine for many of the interactions, tools, and techniques used in this dissertation to implement Crafting Proxies. The architecture uses a common Scalable Vector Graphic (SVG) format and binds it with the `paper.js` SVG manipulation library, allowing SVGs to act as a common interface to additive and subtractive fabrication techniques, computational design algorithms, and IoT interactions and programming.

I conclude in Chapter 10 with a reflection of how research areas might develop to further support material epistemologies and make a case for a *Hybrid Atelier*, a creative environment designed to support hybrid making. I describe the potential for accessing embodied material knowledge through *material parallels* and developing input and output devices that engage more of the body in creative sensemaking. I also contemplate how transferring material knowledge might move beyond the master-apprentice model and how lessons learned from our design investigations can inform a new generation of instructional resources that access and transfer tacit knowledge.

1.5 Statement of Multiple Authorship and Prior Publication

This dissertation reflects work that was previously published in ACM SIGCHI (Illumination Aesthetics [193]) and ACM DIS (ProxyPrint [191], Phosphenes [190]). Although I served as the first author and led the research and writing behind each work, the ideas, concepts, and artifacts were a product of a group effort and benefited greatly from the wide breadth of knowledge and expertise of the interdisciplinary Hybrid Ecologies Group including Joanne Lo, Rundong Tian, Christie Dierk, Molly Nicholas, Sarah Sterman, Chris Meyers, and Kuan-Ju Wu.

The core concept of proxies was developed as part of an internship with Dr. Wilmot Li at Adobe Systems Research. Expanding the role of creativity support tools towards developing material literacy was formed during a collaboration with Joanne Lo and Dr. Mira Dontcheva. For Illumination Aesthetics, the fabrication procedure and computational design algorithm were developed jointly with Niraj Rao, Ryan Kapur, and Jaqueline Garcia; the user study behind Illumination Aesthetics was developed and conducted with Molly Nicholas; central design artifacts were cocreated with Jasper O’Leary (Tactile Cityscape), Viraj Rao (Illuminated Hair Brooch). For Phosphenes, fundamental

resistive heater characterizations were conducted and studied by Jessica Chang; thermowatercolor experiments and artifacts were created by Advaita Patel (Phosphenes *Buddha Mala*); thermoreactive textiles were created with Kuan-Ju Wu (Phosphenes Handbag).

My advisor, Professor Eric Paulos, provided key insights, critique, directions, and advice on all projects detailed in this document.

In this document, I use the collective *we* when referring to the reader or describing technical content. I use the first person when presenting concepts, arguments, evaluations, and discussions.

Chapter 2

A Profile of a Material Practice

The role of this chapter is to argue for the need of a unified description of a material practitioner's "way of knowing," or epistemology. For design tools in digital fabrication, a large focus is on helping "novices" in accessing digital fabrication tools; however, casting this target user group under the dichotomy of expert and novice fails to recognize the deep knowledge that material practitioners could bring to digital fabrication practices.

The profile of a material practice I present here operates similar to a persona, a human-centered design method that constructs a fictitious description of a user group to help designers "understand, describe, focus and clarify user's goals and behavior patterns" [28]. The profile is presented using concepts from Human-Computer Interaction and derived from ethnographies of creative practitioners [172, 85, 175, 7], from a contextual inquiry of material practitioners conducted in previously published work [194], and from personal practice.

The profile breaks down a material epistemology into three areas: knowledge production, knowledge transfer, and knowledge application. I then describe opportunities for supporting material practitioners within current state-of-the-art digital fabrication practices. This profile is then used in subsequent chapters to both inform and assess the capacity of tools to support material practices.

2.1 Introduction

A material practice involves a practitioner working with materials, but this action is influenced by a variety of factors, from the practitioner's background and expertise, the availability of tools and materials (and knowledge of how to use them), to the types of materials and artifacts that are valued by a practitioner's professional community, by their viewers, or by their customers.

In this profile, I organize these influential qualities centered on the material (e.g., clay as forgiving ↔ economies of clay, availability of clay reclaimers, socially acceptability of error in a practice) as a way to distill a profile that can be used to contrast against non-traditional materials (e.g., hybrid materials, digital materials, smart materials, immaterials).

What is a Material?

Many definitions for what constitutes a material exist across a variety of disciplines. In HCI, the term material is complicated by the fact that many materials can be computationally mediated, or be represented virtually through techniques such as computer simulation or virtual reality, and mirror the ways one manipulates and interacts with physical materials in the real world. A growing trend in the field is the election of a definition that is not predicated on notions of physicality [69]. Instead, a material is understood to be the physical, virtual, or conceptual elements that can be formed to compose an artifact or experience. This definition allows for the term material to be contextual – a bell is composed of a *bronze material*, just as a bell tower is composed *bell materials*, just as the sound bells produce is composed of different *frequency materials*. This definition additionally allows virtual elements without physical qualities, such as computation, to be approached from a material perspective.

The Conversational Profile of Materials. In this work, I focus on the specific way in which materials are used, where materials are not simply ingredients in a design that can be arbitrarily changed but instead inform the design that is being created. Rosner [162] describes this influence as the ordering capacity of materials, where non-human actors enable, influence, constrain, or command action. This quality of materials having an active role in influencing the final artifact or experience during the creative process reflects the core tenants of craft. Materials used in this manner are referred to in this work as craft materials. Materials communicate in a variety of ways, proposing alternative courses of action or providing criteria for deciding which actions to take when engaged in a creative process. I assemble these communicative mechanisms into a conversational profile (Table 2.1): *sensorial feedback*, *affordances*, and *tradition*. This conversation profile is used to formally describe how materials operate in a creative practice and how to better facilitate a conversation with materials.

What is the Role of Tools?

Tools are central actors in creative processes but operate in the same capacity as craft materials. We might consider tools to be “tuned” or “well-designed” materials insofar as they communicate their conversational profiles well and more readily influence the creative process.

Tools influence actions. A well-designed tool, especially those that have undergone iteration, will expose available actions in its presentation. For example, in the case of a hammer, the affordance of its weight distribution through its fulcrum communicates proprioceptively its ability to exert a large force. The role of affordance in communicating action has been widely understood in cognitive science, where Maslow’s law of the instrument [122] formally captures the cognitive bias introduced from a familiar tool — a few moments with a hammer can quickly introduce a cognitive bias where many creative solutions are resolved by “treating everything as if it were a nail.”

Communicative Mechanisms of a Material's Conversational Profile
<p>Sensorial Feedback Materials relay information via a set of physical cues that provides rich feedback about a material's current state and potential future states. Materials highly suited for craft engage many of the body's senses, providing multimodal feedback through touch, taste, sight, sound, or smell. By engaging the full body in sensemaking, craft materials make use of a wider spectrum of cognition (e.g., embodied and spatial cognition).</p>
<p>Affordances Passive physical characteristics, or affordances, communicate available or potential actions. A filament form-factor, for instance, communicates the material as <i>extrudable</i>. A flexible filament communicates the material as <i>weavable</i>.</p>
<p>Tradition (or Cultural History) Materials can communicate the intrinsic value placed upon them by a culture, practice, or group of people. Using <i>barro negro</i>, a black clay body found in the manganese dioxide-rich soil of Oaxaca, has a different symbolic value in Oaxaca than elsewhere, just as how "preciousness" is ascribed to metals like gold or silver. Value may change over time as practices evolve, such as in the use of discontinued photochemicals used in increasingly rarer analog photographic practices [7]. Value can also transform from the mode of production. For instance, in response to mechanical reproduction, Benjamin [15] uses the term <i>aura</i> to describe the qualities of an object that cannot be communicated through mass reproduction, signifying its originality or authenticity. While two pieces of metal may be identical, the metal that is hand-crafted carries the mark of the hand and communicates its uniqueness unlike that of a pristine machine-formed metal.</p>

Table 2.1: Components of a Material's Conversational Profile

Tools access embodied knowledge. Tools, once learned, can elicit embodied cognition, or thinking through bodily activity. Sennett [175] describes the role of primary consciousness, or the ability to integrate observed events to create a sense of awareness, in the creative process. In the case of the hammer, the body acquires information in two ways: *peripherally*, through the haptic sensation of the hammer's handle impressing on the palm of the hand, and *focally*, through the visual percept of the hammer striking the nail. Although the haptic information is being perceived through the palm, the information is synthesized into the awareness that the head of the hammer has struck the nail. This selective coupling of sensory information can be used to explain the phenomena of a tool experienced as an "extension of the body" [126].

Tools support bricolage. An ecology of tools can aid with creativity. A bricolage practice describes an *in situ* "structuring of events through material assemblage and modification" restricted to the "treasury" of tools, materials, and skills that are available at hand [200]. Designing tools to

be plural, or reinterpretable past their designed function, can expand the repertoire available to the creative practitioner.

Who is a Material Practitioner?

Material practitioners are individuals that value, understand, acquire, and construct knowledge from their interactions crafting materials. Material practices include woodworking, metalworking, leather crafting, fiber arts, ceramics, painting, gardening, printmaking, drawing, cooking, and baking. A sugar worker, for example, must be highly conscious of changes in sensation, color, smell, texture, and reflectivity of sugar in the simple act of heating it. The logic of what to observe, how to asynchronously process multimodal stimuli, and how to make sense of how to manipulate sugar is developed over time.

Material practice can also include digital media practices, including digital painting, video editing, and certain types of programming. For instance, flow-based programming such as MAX/MSP or block-based programming such as Scratch provides a responsive and reactive environment for working with computation as a craft material. Other programming practices such as codebending treat existing open-source programs as malleable, shapeable materials by “hacking” subcomponents and modules and reappropriating them as elements of a larger composition to achieve new functionalities and forms [16].

2.2 A Material Epistemology

Ethnographies of material practitioners reveal essential distinctions in how knowledge is organized and constructed, how process and the environment play an important role in inspiring creative outcomes, and the different goals that motivate engaging in a material practice. To better understand the goals and behaviors of material practitioners, I synthesize these observations into three core elements a material epistemology: how knowledge is *produced*, stored and retrieved, how this knowledge is *applied* during a creative process, and ways in which knowledge is *transferred* and developed by novice learners. A summary of a material epistemology is provided in Table 2.3 and discussed below.

Knowledge Production

A metalworker develops an understanding of metal from working directly with the metal, i.e., through a material encounter. By observing how metal responds to bending, forging, heating, and quenching, a metalworker develops a material mental model, or an internal representation of a material’s properties and behaviors. The high dependence on observing a material’s physical feedback as it is manipulated forms an intimate relationship between a practitioner and material. Schön [173] describes this experiential way of knowing as thinking through doing, where knowledge is generated from external actions that test, move, and probe stimuli that offer feedback to mental models. These mental models guide the creative process and influence future behaviors and actions.

1. Knowledge Production	
Mental models are generated and reinforced through material encounters.	<ul style="list-style-type: none"> 1.1 Knowledge is generated from external actions that test, move, and probe stimuli, or thinking through doing, that offer feedback to mental models. 1.2 Engaging with materials over time develops an intuition of action, i.e. wayfaring. 1.3 Failures are framed as part of the creative process. 1.4 A collection of mental models of different materials form repertoires.
Tacit knowledge, versus explicit knowledge, is produced.	<ul style="list-style-type: none"> 1.4 Tacit knowledge is developed over time and internalized. 1.5 Knowledge is stored subconsciously, e.g., through muscle memory.
Tacit knowledge can be externalized and accessed through bricolage.	<ul style="list-style-type: none"> 1.4 Artifacts act as a documentation of process. 1.5 When made “available at hand,” artifacts support spatial cognition. 1.6 Tangible artifacts are shareable, supporting community reflection and critique.
2. Knowledge Transfer	
Knowledge is transferred via the master-apprentice model.	<ul style="list-style-type: none"> 2.1 Produces an uneven power structure. 2.2 Places burden of understanding on the learner. 2.3 Metaphors communicate tacit information.
Communities of Practice (COPs)s structure learning environments.	<ul style="list-style-type: none"> 2.1 Novices gain access through legitimate peripheral participation. 2.2 Vertical learning structures support creating zones of proximal development (ZPD). 2.3 The community defines the criteria for creativity from social evaluation.
3. Knowledge Application	
Knowledge is applied through the morpho-genetic (or form-generating) making.	<ul style="list-style-type: none"> 3.1 Form generating versus matter forming. 3.2 No correctness criteria; a form is evaluated as it emerges.
Practitioners engage in a conversation with materials.	<ul style="list-style-type: none"> 3.4 Materials have an influence on the forms that are generated. 3.5 Materials are recognized as dynamic (e.g., leather develop a patina).

Table 2.3: The Profile of a Material Epistemology

Notably, failures in material practices are readily accepted elements of material practices, acting as a way of refining a material mental model or providing provenance through “happy accidents” [194, 121]. Through practice, a collection of material mental models, techniques, and interactions are built over time to form a repertoire that is applied to make sense of new situations [172].

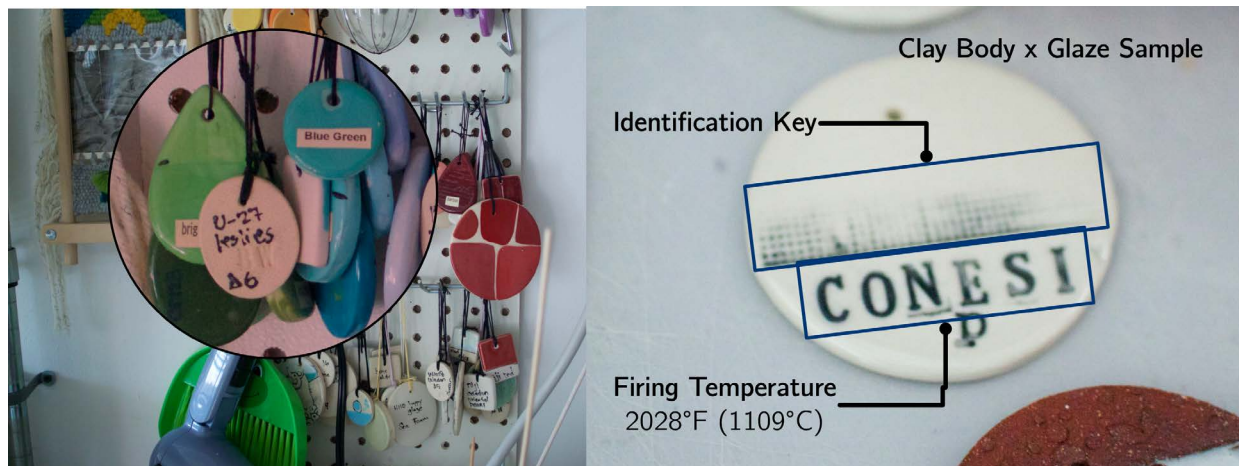

Figure 2.1: (Left) A wall of a potter’s studio holds tens of firing keys that each record the results of a firing of a unique clay body and glaze combination. The potter externalizes their mental model of the firing process onto her environment, grabbing a set of keys when deciding how to glaze her latest work and guiding her creative process. (Right) The keys each display a firing temperature and a patterned print used to mark and identify finished pieces¹.

In practice, some material practitioners adopt a bricolage practice whereby the creative process is informed by the host of materials, tools, and skills available at hand [109]. In the case of the potter’s studio (Figure 2.1), the potter externalizes her mental model of interactions between different clay bodies (e.g., porcelain, stoneware, earthenware) with different glaze compositions and colors onto *firing keys* — small samples that capture the results of the firing process. The keys serve both to guide her creative process and act as an artifact to communicate and transfer her firing experience to other guild members. These keys are available *at hand* which allows the potter to quickly compare and contrast different finishes, examine the texture and weight of different combinations, or conduct functional tests (e.g., evaluating the water tightness of the clay body).

Material practitioners do not exclusively construct knowledge from material encounters, but benefit as well from codified resources (e.g., books, videos, tutorials). However, the knowledge gained from material encounters produces tacit knowledge that often cannot be communicated through traditional learning resources. Tacit knowledge, in contrast to explicit knowledge, is difficult to communicate through language often existing in the subconscious [152]. In practices such as wood carving, tacit knowledge can include:

- The amount of pressure to exert on the wood-carving tool.

¹ From contextual inquiry with Potter (11/7/2017) [194].

- Processing the haptic feedback from the wood-tool interaction to determine if the blade is sharp or dull.
- The rhythm, motion, position, and cadence of the arm, wrist, and fingers.
- The viewing direction of the head and the areas to observe.
- How different woods interact with carving tools.
- The planning of carving paths.
- How to adapt or recover from mistakes.

While some of this knowledge can be codified through video or metaphor, most tacit knowledge is stored in the body as part of a repertoire and is maintained through practice. The portability of this knowledge to other domains is readily accessible — skills in wood carving, for example, readily transfer to chocolate carving.

Knowledge Transfer

In order to transfer tacit or embodied knowledge from one material practitioner to another, common techniques employ multimedia instructional resources like images and video to capture and convey this information [212] but often form an incomplete simulation of a making process. For instance, an instructional video lacks haptic or other sensory feedback mechanisms or the interactivity of an in-person training session. Metaphors prove especially useful in these contexts such as in conveying the amount of force to secure a nut (e.g., *Monkey-tight* versus *gorilla tight*) or how much sauce to add to a *poulet à la d'Albufera* (e.g., “Put on his jewels”) [175]; however, these metaphors only capture a small subset of the tacit information produced. Other strategies include introducing a talk out loud during a training session to unveil the cognitive process of the maker (i.e., where to look, how they interpret stimuli, how they decide actions) [20].

Pedagogical structures in material practices are instead firmly rooted in the master-apprentice model, a vertical social learning structure that scaffolds knowledge and instruction through interactions between a skilled and unskilled practitioner. The explicit levels of expertise more rigorously define zones of proximal development, referring to the difference between the task a learner can perform independently versus with guidance [202]. The zone refers to a sweet spot – if the task is too easy or too hard, it prevents learning from occurring. The master-apprentice has the benefits of behaviorist pedagogical strategies, introducing feedback mechanisms that ensure good habits develop, skill progresses, and practice endures.

However, the master-apprentice relationship is a highly uneven power dynamic, and for practices, such as STEM fields with social inequities [57], the hierarchical structure maintains power and control within expert practitioners. More horizontal structures have been proposed utilizing communities of practices [74] that distributes the learning resources a student has available. For example, the availability of more-skilled peers supports any member of the community to reach their zones of proximal development, while the increased visibility and status within the community act

as motivators and rewards to sustain practice, develop skills, or lend expertise, allowing a newcomer to enter through the periphery and move towards the center of community in a process known as legitimate peripheral participation [107, 48].

Despite these established learning structures, pedagogy still suffers from the expert blind spot, or the inability for the master to recall what it was like not to know [175]. For physical skills, the type of learning interaction in a master-apprentice model devolves to observing the “correct” way to manipulate a material. This places the burden of instruction on the student — the student must resolve how their actions do not match that of the more skilled practitioner. Design methods in HCI have explored ways of capturing tacit crafting information through ethnographic apprenticeship, placing an expert learner, i.e., a person with domain knowledge, to document their mental models throughout the learning session [214, 162]

Knowledge Application - Workflows

Over time, a material practitioner constructs an extensive repertoire of material mental models that aid in guiding actions and informing decisions during the creative process. Ingold distinguishes two models of making – hylomorphic (or matter-forming) making and morphogenetic (or form-generating) making – that allow us to more formally distinguish qualities of a material epistemology.

Commonly observed in engineering and scientific practices, hylomorphic making, from the Greek hyle, “matter”; morphe, “form,” describes a making process where design is largely a cerebral activity [85] (Figure 2.3). The process involves taking an imagined form and manifesting it as a sketch, schematic, or model. This form is then imposed on some matter until the final artifact resembles or behaves as imagined. An element of correctness and error follows this form of making, where success arises when the target design is achieved and failure when it does not. A hylomorphic workflow also encourages an object-bias, the quality in which materials are seen as uniform actors as opposed to dynamic forms (e.g., decomposing, oxidizing) [162].

Although the hylomorphic making is commonly observed in engineering and scientific practices, the pattern is also encountered in material practices. For example, in a stained glass practice (Figure 2.2), a *cartoon* represents a 1:1 scale depiction of glass forms and colors. The cartoon is used to form a pattern that acts as a guide to cut and grind glass to match the target geometries. The final pieces are assembled and soldered or caned together to form the final composition [63]. In this regard, the arrangement, geometries, and color composition were composed under a hylomorphic model of making. However, a different mode of making arises from elements not fully-specified in the cartoon. For instance, a glassworker still has the choice of which part of a pane of glass to cut from. A material encounter occurs in deciding how the unique imperfections, textures, or artifacts of each pane of glass will emerge in the composition and how the different patterns will interact with each other.

The physical act of cutting and soldering the glass introduces an element of risk and consequently, skill. In this act, a glassworker develops a familiarity with geometries that are difficult or impossible to cut (inner curves), glass that fragment in unexpected ways (textured glass versus smooth glass), or pattern combinations that form difficult to solder gaps (small geometries). Pye [155] describes this quality of an artifact in danger or uncertainty during the making process as the workmanship

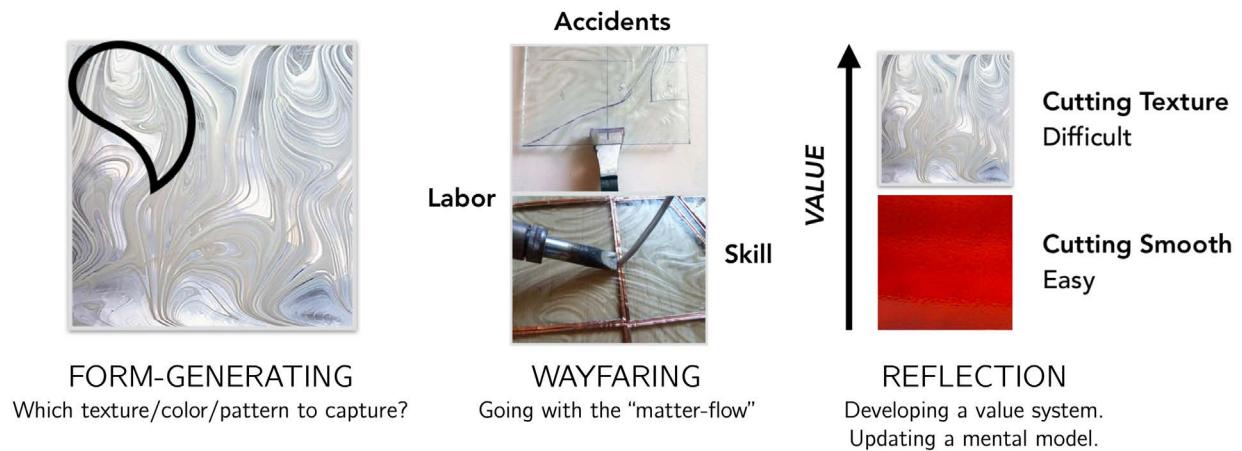

Figure 2.2: A Stained Glass Process. A glassworker cuts and grinds geometries from a pane of glass material which is often risky and error-prone. The glass geometries are lined with copper tape and soldered together. The skill of applying heat at the correct location, rate, and duration is tacit and developed experientially over time. The different resistances found in each material for forming processes introduced a value system. For glass, cutting textured glass results in more compositions that display a mastery of the medium than those with smooth glass².

of risk which forms an integral component of crafting in that it forces a reflective process — a practitioner must be mindful of the material, its properties and behaviors, and its conversational profile. The effort and difficulty of working with materials introduce a value system that informs the actions the practitioner will take.

Ingold describes this way of creating as following the morphogenetic model of making. Under this model, the design occurs during the act of making. Materials have a more active role, signaling to the maker potential deviations and alternatives. Ingold uses the term wayfaring to describe an “intuition of action,” where practitioners use past experiences (recover from errors, mistakes, and failures) to sense actions of resistance or opportunity and navigate the possible forms of a material [85]. Design is never a straight path from low fidelity to high-fidelity but involves explorations in different directions to gain an experiential understanding of material potentials. This skill, more importantly, develops resilience to adversity in the making process, integral to sustaining a practice, since it reframes errors and failures as important learning moments. This value system consequently introduces elements of craftsmanship, or the ability to develop skill in a practice, that in turn influence how designs are chosen and the evaluation criteria of a practice. To other glassworkers, a composition with rough-textured glass and small geometries with sharp inner curves demonstrates a mastery of the glass medium within a stained glass practice.

The morphogenetic model of making is a form of reflective practice, a process in which one

² Image credits [left to right]: Oceanside White on Clear Baroque Glass by Oceanside (BR/308-F) www.franklinartglass.com; 3D Benchy by CreateItReal from <https://www.createitreal.com/2017/01/16/highspeedbenchy/>, *How to: Stained Glass* by Sarah James from Instructables <https://www.instructables.com/id/How-To-Stained-Glass/>

reflects on actions, not dependent on established theory or technique, but constructs a new theory of the unique situation. These reflections include but are not limited to: what motivated or influenced the course of action, how the problem has been framed, and the role within a broader sociocultural or institutional context. Schon [173] relates a reflective conversation with materials as a “design situation where a practitioner constructs objects and relations using the active sensory feedback of materials” [173]. The incremental development and reflection cycle whereby materials “talk back” to the creative practitioner throughout a creative session direct the creative energies of the practitioner and shape how an artifact is formed.

2.3 Tensions of a Material Practice and Digital Fabrication

Both hylomorphic and morphogenetic ways of making are part of any creative practice and are not representative of an individual— an engineer may engage in a material practice and a metalworker in a scientific practice — but it represents two distinct ways of knowing and, by extension, making. In this section, I will argue that the morphogenetic qualities are less visible within digital fabrication practices and examine how other qualities of a material epistemology are difficult to realize within current digital fabrication practices.

Tensions in Knowledge Production

Complications of Immaterials. The ability to be formed is a distinguishing property of materialhood, but many materials in digital fabrication processes and spaces are challenging to see or manipulate during the making process.

Immaterials are a class of materials that cannot be *experientially* manipulated or converted into an artifact or experience. Electricity, for example, is a physical phenomenon; however, the presence of electricity in electronics is invisible. Without transducers to convert electricity into light, heat, or motion, electricity “as a material” cannot be realized. Lyotard [119] theorizes immaterials as being *imperceivable* with respect to the human perceptual system and *uncomposeable*, already forming the elementary parts of a system (e.g., atoms, ribosomes, electromagnetic waves).

Tensions of Digital, Physical, and Hybrid Materials. Other materials, such as hybrid materials, are formable through both digital and physical processes. For example, 3D printing allows a 3D print to have two materialities — a digital materiality gained from a digital mesh representation that encoded its form and a physical materiality from the artifacts of the 3D printing process. Smart materials refer to more active materials that respond to or can be significantly be controlled by external stimuli. Liquid crystal, a thermochromic material that changes color with changes in heat, can be formulated to respond to specific temperature ranges and is a common material for making passive thermostats. Several tensions arise around using digital and physical materials in a making process. Hybrid tools which facilitate this practice have gained traction in domains such as crafts by

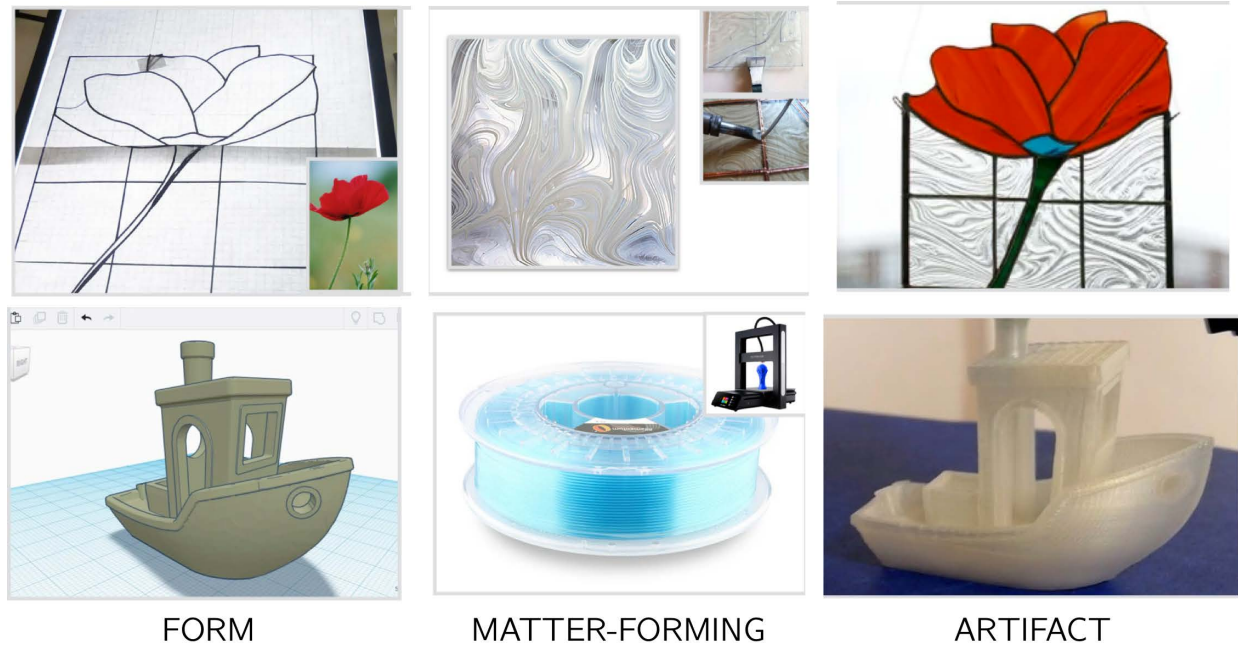

Figure 2.3: (top) Hylomorphic making in a stained glass practice – a cartoon is used to plan a composition, and glass is cut to match the design until the design matches the cartoon. (bottom) Hylomorphic making in Fused Deposition Modeling (FDM) 3D printing – an abstract form is imagined and specified as an STL model; the resulting form is imposed upon a host of different materials in a filament form factor; the form is considered complete when it matches the target model³.

outsourcing tedious labor to machines [29] or leveraging the machine as a collaborator, helper, or generative constraint [40]. However, tensions result from ambiguities between materials: physical processes are slow and near-at-hand; digital processes are inherently faster and are not limited by colocation [88, 137]. Other tensions between digital fabrication and handed fabrication arise from sociocultural practices such as:

- deskilling the artist by making the craft easier;
- masking the “hand of the artist,” or the distinction that an artifact is hand-made versus machine-fabricated,
- dishonoring the material, such as tacking on other media like electronics [137], and
- failing to listen to the material, such as when a wood knot is not “heard” by a CNC machine whereas a woodworker would detect it and alter the design [29].

Tensions in Knowledge Application

The *de facto* digital fabrication workflow for forming artifacts separates design and machining concerns, emulating product manufacturing relationships. As a commonly agreed-upon process workflow, it allows for a single common design file to be used by several different types of Computer Numerical Control (CNC) machines.

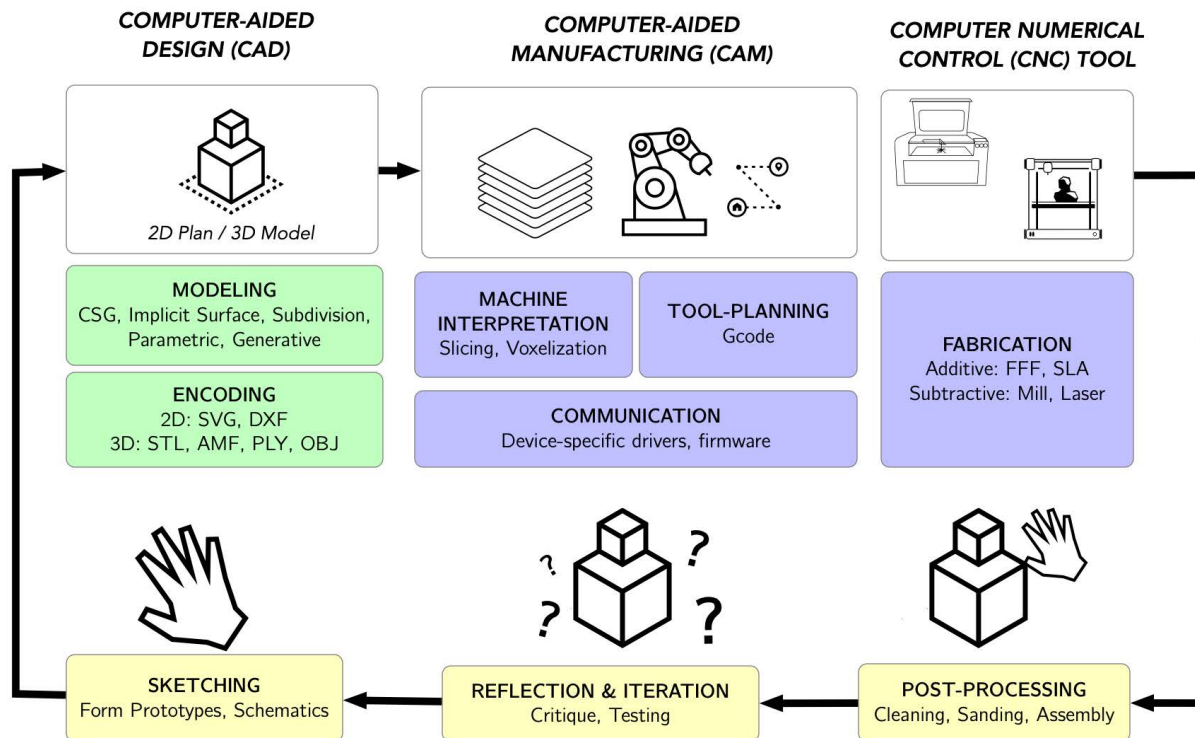

Figure 2.4: The traditional CAD-CAM workflow. In the computer-aided design phase, a computational model is constructed using a modeling tool and typically exported as a watertight mesh (STL) or as curves (SVG). In the computer-aided manufacturing phase, the encoding is converted into a machine-interpretable geometry, a tool-path is then planned to satisfy that geometry, and the compiled set of instructions is then communicated to a computer numerical control tool. The CAM process is device-specific and needs to be run for each CNC tool.

The Computer-Aided Design (CAD) phase involves using a modeling tool to create a digital representation of an object which is then typically exported as a watertight mesh (STL) or as a vector graphic (SVG). Because of the portability of the design file, i.e., accepted by many types of CNC machines, the form may be realized in any number of materials such as plastics, resins, clays, or metals. In addition, the time-consuming printing process often means that the print is left unobserved. The Computer-Aided Manufacturing (CAM) phase involves converting the digital

³ Image credits [left to right]: (top) *How to: Stained Glass* by Sarah James from Instructables <https://www.instructables.com/id/How-To-Stained-Glass/>; (bottom) Tugboat from <https://all3dp.com>; 3D Benchy by CreateItReal from <https://www.createitreal.com/2017/01/16/highspeedbenchy/>

CAD representation into machine-interpretable instructions. A tool path is generated that satisfies the target geometry based on the specific configuration of materials and machining tools, and the compiled set of instructions is then communicated to a CNC machine. The CAD-CAM workflow (Figure 5.1) compartmentalizes this synchronous interaction into a distinct design and fabrication step, with the human situated at either end of the pipeline.

The CAD-CAM pipeline is primarily influenced by the success of the computer graphics pipeline. Through an agreed-upon set of endpoints, a pipeline model allows research and industry to innovate components in isolation and swap-out components of the pipeline while still maintaining interoperability with a large number of processes and devices required to complete the pipeline. This aim for interoperability has led to a rich variety of modeling programs, a standardized file format (STL) and machine instruction language (g-code) that serve as common languages between the CAD-CAM-CNC steps, as well as a growing standardization of materials (e.g., in filament form or curable liquid form factors). Despite the advantages of the workflow, the CAD-CAM pipeline also removes the human from the loop. There are many distinct advantages to removing the human element, mainly contributing to a reduction in error and improvement in quality, but it also entails removing the potential for material encounters that form the basis of a material epistemology.

Material Agnoticism. In the landscape of digital fabrication, this has allowed a new material ecology to form driven by “maker-friendly” tools and machines that allow novice users to work in an abstracted computer-aided design (CAD) environment. The abstraction of materials in CAD and the standardization of materials as filaments or liquids in CAM has compartmentalized material knowledge.

From this lack of interaction with materials, knowledge of how to manipulate and form materials has become blackboxed, limiting a user’s ability to extend, deviate, recover, or reappropriate this knowledge without specialized training and study. For the creative practitioner who might have achieved mastery of a medium through years of practice, digital fabrication invalidates this knowledge in favor of the CAD-CAM digital fabrication workflow. The CAD-CAM pipeline follows a hylomorphic way of making (Figure 2.3). In the design stage, the maker is separated from interactions with the material, working instead with an abstract material that can take on the visual appearance of target materials. Working with an abstract material fundamentally changes the creative process — the material is unconstrained, exposing an infinite set of options for future states. In contrast, craft materials enact a distinct policy that places rewards and costs on different actions with and on materials.

Tensions in Knowledge Transfer

The CAD-CAM pipeline prevents practitioners from having a material encounter with the material during the forming process, which prevents the type of knowledge transfer central to their way of thinking. Consider the following scenarios (Figure 2.5):

Scenario A A makerspace student’s unattended 3D print has lifted off the printbed. A lab tech explains that this error typically happens when designs have large footprints



Figure 2.5: (Left) A 3D print has experienced lift-off, a printing error that occurs when thermoplastic contracts and introduces internal stresses to the model. The common fix is to apply glue to the printing platform for stronger adhesion to overcome forces from contraction. (Right) A clay vase is wrapped in multiple different bags to control the drying rate of the clay. Drying too quickly can introduce internal stresses on the walls of the vase and cause fractures. The plastic bags are progressively removed, exposing thinner, faster-drying geometries first⁴.

and instruct the student to thoroughly clean the printbed, apply an adhesive, and reprint.

Scenario B A ceramicist's vase has cracked. The ceramicist, having formed the clay with her hands, is acutely aware of how the material reacts to losing moisture. She observes that the crack occurs between the thicker body and the thinner lip of the vase. The clay in the lip had dried much more quickly than the clay in the body, contracting and fracturing at the boundary. A fellow ceramicist advises her peer to cover the lip in plastic so that it dries at a rate similar to the body.

Both scenarios feature similar problems with internal stresses caused by materials contracting during the fabrication process. However, the type of interaction and learning that occurs differs in significant ways:

1. The ceramicist has a more embodied understanding of what is happening with the clay, having felt the clay dry and contract in her hands while forming it; the student must rely on external resources to diagnose the issue (lift-off from internal stress caused by cooling plastic),
2. The fix is more causable, reinforced by what the ceramicist sees, feels, and smells; the student engages in a “hack” that circumvents the problem,

⁴ Image credits [left to right]: STAMPA 3D Store from <https://www.stampa3dstore.com/stampa-3d-com-e-evitare-le-deformazioni-degli-oggetti/>; Ultimaker 2 Manual from <https://ultimaker.com/>; Contextual inquiry with Potter (11/7/2017) [194].

3. If a problem surrounding internal stresses (cracks/warps) occur again in new contexts, the ceramicist has in their repertoire an understanding of how to diagnose unwanted material behavior and troubleshoot; for the student, the thermodynamics of plastic remain blackboxed.

Domain Transfer. Compared to the domain transfer that a woodcarver can benefit from in stone, chocolate, ice, soap, wax, or fruit carving, these skills do not transfer to CNC tools that also utilize subtractive methods. In order to work with a CNC machine or a CAD program, a material practitioner must learn an entirely new way of thinking (e.g., computational thinking) which displaces the years of practice and skill they have developed. For instance, CAD programs oriented towards novices like TinkerCAD [8] use Constructive Solid Geometries (CSGs) to provide an elementary vocabulary of forms and operations (e.g., unite, subtract). This way of making 3D forms readily transfers to additive and subtractive sculpture practices, but does not support the wider repertoire of ceramic 3D forming techniques like coil, slab, or slip-casting methods. This tension echoes calls to support thick practice, allowing for the continuity of practice and supporting skills that have been acquired over time by using common physical interfaces as opposed to digitally mediating them [103].

Furthermore, an element of facilitating domain transfer involves finding instructional resources. When building on uneven skillsets (i.e., across disciplines), the ability for material practitioners to find an instructor or a peer to serve as one remains a challenge [184].

2.4 Definitions and Concepts

For reference, the terms, concepts, and abbreviations used throughout the dissertation are available as a Glossary (Appendix E).

2.5 Summary

Material practitioners are individuals that value, understand, acquire, and construct knowledge from their interactions with materials, or material encounter. These interactions drive the development and refinement of material mental model that over time are collected into repertoires.

In a material practice, materials have an active role in the making process, influencing the type of design, artifact, or experience that is created. Materials communicate alternative courses of action, which I term its conversational profile (Table 2.1) from sensory feedback, affordances, or from how they are traditionally used or the value they are intrinsically given by a group of people.

Depicted in Figure 2.3, the profile of a material practice summarizes how practitioners produce knowledge through material encounters, engage in morphogenetic making, develop an intuition of action known as wayfaring, and transfer tacit knowledge under the master-apprentice model.

I describe opportunities to bridge digital fabrication and material practices, describing frictions between the two practices including: working with immaterials that do not offer sensorial feedback or affordances, workflows that prevent material encounters from occurring, a lack of potential

for domain transfer, and social and cultural barriers around access to training, supervision, and instruction.

In subsequent chapters, I use this profile to inform the design of Crafting Proxies and assess their capacity to support a material epistemology. I apply this profile to develop a way for material encounters to occur within a CAD-CAM pipeline and for mediating the conversational profile of immaterials to offer sensorial feedback to practitioners.

Chapter 3

Related Work

The first of many FabLabs was created in 2002 [203] despite the core technologies for the current workhorse of makerspaces – the 3D printer – being invented ten years prior [34]. These fabrication spaces served as small workshops with the goal of enabling everyone to make “almost anything.” This goal of democratizing digital fabrication and heralding in the next industrial revolution has been a major area of interest of the Human-Computer Interaction community. Research aims to enable practitioners to create novel and inspiring solutions as well as broaden participation and enable communities to participate in creating their own technology [127].

Our work builds on these initiatives, contributing to two core research areas centered around developing creativity in digital-physical, or hybrid, making. The first body of work is known as Creativity Support Tools (CSTs) and Design Tools research. I review work in this field that deals with hybrid making, or situations that contain both virtual sites (e.g., digital design tool, abstract materials) and physical sites (e.g., fabrication, physical materials) of making, in contrast to others types of tools in this area for supporting ideation, social creativity, or digital media.

The second body concerns different design strategies for negotiating hybridity, or design contexts that deal with digital and physical actors. I focus on work that specifically looks at negotiating craft and technology (e.g., in computation, in electronics, in digital fabrication).

Lastly, I discuss core analytical frames for understanding materials and creative practice used in this work.

3.1 Design Tools for Physical Making

Coined by Shneiderman in 1999 [178], the origins of creativity support tools have a dialectical relationship with *productivity support tools*, or tools aimed at improving efficiency and productivity, toward instead supporting discovery and innovation [180]. Nakakoji et al. [136] offer three metaphors to better describe the creative tasks that CSTs can support: enhancing performance (i.e., running shoes), developing skills (i.e., dumbbells), and enabling new experiences (i.e., skis). CSTs are closely related to design tools, with the distinction that design tools facilitate more than just the creative task but also the transcription of this task into a representation that is accessible by



Figure 3.1: Translators: (left to right) translating sculpting actions [176]; translating markers [169]; translating measurements [205].

computation or CNC tools. I draw upon CST and design tool research used in the context of physical making and organize this space using the frame of the proxy. A proxy, as described in Chapter 4, refers to a material, tool, or machine that acts as an intermediary between a practitioner and material. I describe work that has explored the different capacities a proxy can serve in facilitating creative work.

Translators

Most commonly seen in 3D sculpting, several tools aim to translate physical action to a digital representation and vice-versa. For virtual 3D sculpting, Sheng et al. [176] demonstrated how a physical prop could act as a proxy to a virtual model, serving as a reference to virtual geometries while translating physical clay-like sculpting actions into digital deformations. This strategy serves as a powerful tool to assist novices in interfacing with 3D CAD. In Makers' Mark [169], annotation stickers are placed on a physically sculpted form and when scanned are converted into mechanical and electronic components; this workflow allows practitioners to create interactive objects. Such translational strategies, especially in introducing slower physical interaction, have been shown to provide experts with a more reflective workflow [145]. Two-way translation has been explored in creating a bidirectional design and fabrication pipeline. The system ReForm [206] continually synchronizes a physical object and digital model, allowing practitioners to physically shape or digitally manipulate a form. This type of proxy is often constrained in its translational abilities, typically failing to capture an unknown quality important to the physical making process. A more usable configuration translates actions seamlessly between virtual and physical spaces, such as SPATA [205], an augmented caliper that transmits measurements in physical space or actuates to measurements in virtual space, or FormFab [132], a thermoforming interface that translates gestures into realtime plastic deformation, bridging the digital-physical gap through input-output coincidence. Matchsticks [188] demonstrated conceptual translation, matching high-level wooden joinery design intent to a repertoire of joinery cuts and fabrication workflows.

Mediators

While most translation proxies focus on an established physical-to-digital goal, i.e., clay to virtual clay, the inverse problem poses an additional challenge. Abstract or conceptual elements, such as

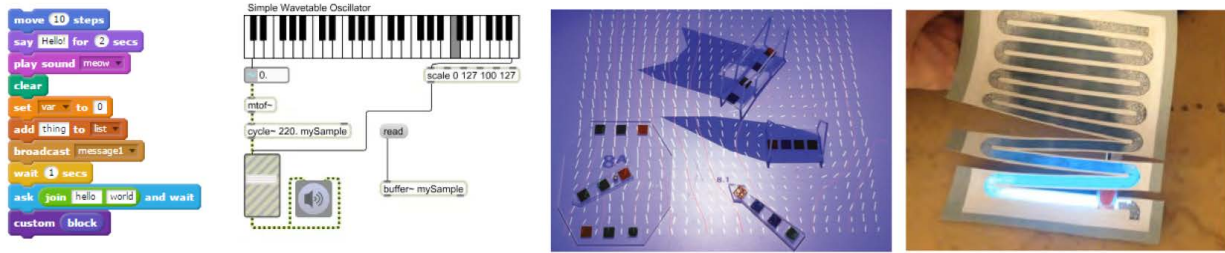

Figure 3.2: Mediators: (left to right) mediating code [159], mediating signal [154], mediating air flow [199], compositing smart materials [99].

computation, must be mediated, or designed to have a physical representation. Without a “ground truth,” the goals of this translation are defined intrinsically by the translator. The manner in which conceptual materials are mediated has a strong influence on how knowledge is produced, applied, and transferred. For a visual programming language like Scratch [159], programming mechanisms like control and iteration mechanisms are given a block-based form. The blocks enable direct manipulation gestures and are designed with uniquely shaped connective appendages acting as affordances, communicating the possible compositions of blocks into full-featured programs. Flow-based programs, such as MAXMSP [154], a flow-based programming language for multimedia artists, leverage input/output blocks that can be used to compartmentalize program functions into conceptual building blocks; this construction strategy manifests new programming practices like codebending [16].

In Section 3.3, I expand on the ways that different disciplines approach negotiating materiality.

Monitors



Figure 3.3: Monitors: (left) monitoring carving actions [225], (right) monitoring cutting actions [218].

The development of physical computing sensing and actuation technologies allow proxies to filter and monitor content in the creative environment. FreeD [225] is a digitally-guided milling tool informed by a predefined 3D model that slows down a spindle’s speed or retracts the shaft when a practitioner approaches making an error. In the inverse direction (informed by sensing the real world), Enchanted Scissors [218], a digitalized cutting device, prevents users from cutting unwanted

areas of a substrate by using a capacitive touch circuit to sense when the scissors are not in contact with a conductive trace; a servo motor then reposition a scissor’s arms to provide tangible feedback.

Lenses

Lenses refer to proxies that remap, retarget, and increase the saliency of stimuli to make the stimuli easier to perceive or present an alternative viewpoint. DemoCut demonstrated semi-automatic video tutorial editing filters that condensed and annotated videos to be perceptually and cognitively easier to digest and support learning [32]. In physical applications, Sculpt by Numbers used projected cues to provide visual feedback to users sculpting a 3D model [161]. In a mixed reality environment, Ludwig et al. demonstrated the use of projection mapping to produce *in situ* visual cues to facilitate the operation of a 3D printer, communicate the printer’s status, and recover from errors.

Armatures

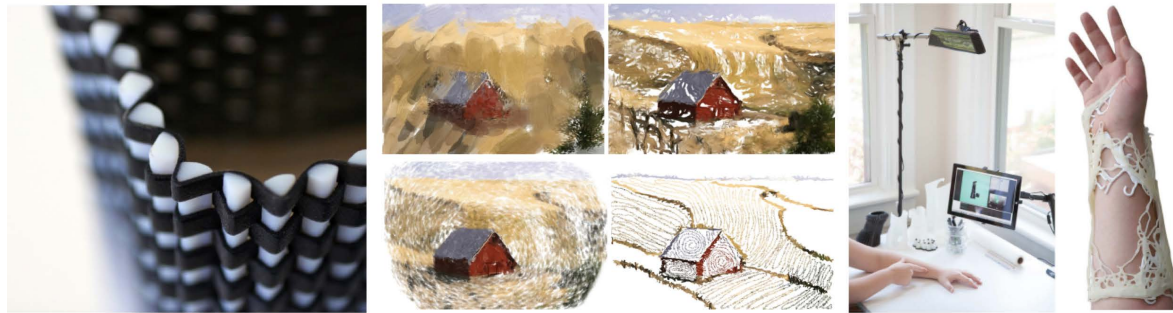

Figure 3.4: Armatures: (left to right) supporting weaving [223], supporting painting [14], supporting wearable modeling [56].

Armatures represent a type of proxy that alters the environment to support and passively influence certain types of physical actions and frame the type of forms that can be created. In sculpture, armatures are sacrificial support structure made of wire, newspaper wrapped in plastic wrap, or styrofoam. The shape of these armatures influences and supports the forms that are created (e.g., a face armature serving as the base structure for masks). In Hybrid Basketry [223], Zoran used 3D-printed structures to shape hand-woven patterns while maintaining engagement in a traditional craft practice. In faBrickation [131], Lego bricks were embedded into 3D prints, allowing parts to be easily connected, creatively recombined, and selectively iterated upon. In the digital painting system *Painting with Bob* [14], image-specific paintbrush textures supported novice painters in developing agency in digital art creation. These brushes provided a fail-safe in ensuring the creation of an intended form while maintaining freedom in how brushstrokes were applied. In Tactum [56], using the human skin as an armature influenced the creation of expressive, complex, and *wearable-oriented* 3D models.

3.2 Satisficing a Craft-based Practice

Integrating craft into technological workflows has been a common theme for tools for making. I first review these strategies and their respective limitations.

What is Craft?

While often conflated to mean a manipulation of the hand (i.e. hand-crafted), crafting more precisely refers to a specific material-forward method of making in which there is a direct encounter with the material, such that that the material has influence on the forms that are being generated during the act of making (i.e., craft-based practice) [138, 85]. In hybrid crafting, where computing and craft meet, Nitsche & Weisling [138] further distinguish that for crafting to occur, computation should refrain from mediating the materials or actions.

The different variants and orientations of craft-based inquiry that have emerged in HCI are defined by a careful integration of craft with digital and physical materials, the production of research products, and the creation of deep and embodied knowledge from ethnographic inquiry during the crafting practice [51]. I review some key approaches for integrating craft and technology below.

Intersecting Craft and Computation

Early work in hybrid making proposed an alternative epistemology of the computational crafter – although the crafter worked with computation, the act of integrating computation into craft materials would cause a re-examination of notions of computation (e.g., programming languages, computer architectures) [17], broadening what it means to engage in computational thinking. Golsteijn et al. [66] proposed that engaging in a crafting practice could function as a way to embed qualities of personal expression into digital media artifacts. Tsaknaki [195] further develops this notion through the concept of “making preciousness,” tying both cultural and material experiences through craft into interaction design.



Figure 3.5: (left) LilyPad Arduino [23]; (center) Chibitronics [156]; (right) E-textiles tester [153]

Intersecting Craft and Electronics

Perhaps the most successful of these endeavors is the Lilypad Arduino [23], an electronics construction kit that facilitated working with electronics and textiles. The kit defamiliarized the sites in which electronics are typically found, altered the artifacts that are researched and produced, and transformed the demographics of people who engage in electronics practices. The Lilypad demonstrated a strategy for broadening participation by *Building New Clubhouses*, or constructing and sparking new cultures versus trying to fit people into existing engineering cultures, evidenced by a female-dominated electrical engineering and computer science community continuing to emerge from the Lilypad [24]. Yet, despite this promising new subculture, e-textiles are a relatively nascent practice producing artifacts that fail to wed textile and electronics spheres of knowledge. For instance, leveraging traditional sewing and fiber art practices, e-textiles were used to explore ethnocomputing, or the study of interactions between culture and computing. E-textile workshops were used to diversify the contexts in which an American Indian indigenous communities explored computation, but in an open-ended design context, the integration of computation and indigenous knowledge were still viewed by students as two distinct bodies of knowledge [94].

Research is exploring how to more tightly integrate craft and electronics. A broader range of craft materials are being accessed through circuit stickers [157], through electronic components *made from* textiles [148], through tools that give circuit-creation access to the hand (e.g., silver ink pens, graphite pens, conductive thread), and through a more holistic integration with practices (e.g., via continuity-testing measuring tape, or electronic sewing pin probes [153]). This expanding repertoire and deeper practice has led to an expanding wearable computing prototyping platform but also indicates the potential for other material practices and computation to benefit from hybrid making.

Intersecting Craft and Digital Fabrication

Integrating craft and digital fabrication, the major research area of this dissertation, is an active area of exploration. The consensus is that the combination of craft and digital fabrication is “incompatible”[95], produces inherent tensions [88], and goes against the grain [29] of crafting and digital fabrication. To integrate the two, I describe some design approaches and their respective limitations.

One approach, most similar to our concept of proxies, theorizes a mediated middle ground that allowed a practitioner to fluidly move from physical to digital space. Kamath [95] found that a craft (sense-evaluate-shape) ran counter to the idealized digital-physical workflow afforded by digital fabrication. Kamath introduced a middle ground leveraging a digital scanner that allowed practitioners to evaluate and shape a digital form, allowing a reflective practice to emerge. However, computationally-mediating a material presents several tensions with craft practices, formed in part by some element of the real-world is neglected and the inability to access existing skills of a practice. Our approach positions this middle ground not in virtual space, but centered in the physical environment to allow practitioners to use leverage skill sets and communities of practice.

Alternatively, digital fabrication is situated as a collaborator or a facilitator of a crafting process. In the wild, Cheatle et al. [29] described how one wood-working studio practice had integrated digital fabrication into their workflows, remediating traditional relations of craft. While CNC tools and 3D scanning are used to outsource tedious labor and “grunt work,” they also enter into new material-flows, giving a new creative capacity to the practitioner. However, how these CNC tools are used go against the grain of the tool’s intention, a result of hacking and appropriation of the machine that relegates it to have the same relationship with the practitioner as that of a power tool like a chainsaw. While integrated with crafting workflows, the CNC tools are acknowledged as not capable of listening to the materiality of wood, only capable of making precise cuts and carves on some abstract surface. In the collaborative development of Arc, a CNC engraving tool for ceramics, within a clay studio, Rosner et al. [168] demonstrate four roles digital fabrication machines take in producing forms: *copying*, replicating movements of the hand, *translating*, mediating other inputs such as sound as form-giving elements, *connecting*, retaining evidence of new interactions with machines and acting as an index to the collaboration.

A third approach transcends the boundaries of craft-based practices through developing a fluency with digital materials or reifying the tradition-communicated elements of a digitally-fabricated artifact. In Hybrid Reassemblage, Zoran merges digital fabrication and traditional craft through the destruction and careful reassembly of a ceramic vase with 3D printed parts, embedding history and reclaiming the aura of a partially mechanically-reproduced object [224]. In Hybrid Basketry, Zoran [223] exposes a hybrid space in basket-weaving, created by leveraging 3D-printed wefts, arms, and lattices that allow for a basket-weaving practice to evolve. As a “physical manifestation of an intensifying desire to develop a new way of thinking,” Zoran demonstrates how attaining material literacy in both domains can engender new practices and aesthetics, however, bound by the need for others to join in hybrid making as a cultural practice. Supporting existing craft practices through digital fabrication continues to find friction between digital and physical workflows. Jacobs et al. [89] collaborated with the Namibian Ju/’hoansi people to explore how design and fabrication could be integrated with traditional materials and practices of hunter-gatherer craft. While digital design was found to find a role in this traditional crafting practice, digital abstractions conflicted with the concrete design practices of the Ju/’hoansi and the workflows conflicted with the social aspects of Ju/’hoansi making.

3.3 Analytical Frames for Understanding Materials

Different approaches have been examined for understanding materiality and its role in creative practice. In this section, I describe analytical methods for understanding materiality across Art, New Media, and HCI. The analytical methods are important for understanding how different disciplines have approached the problem of working with elements that do not have tangible qualities and the pitfalls of focusing too deeply on physicality.

Materiality in Art Practice

In art practice, theoretical discussions of materiality were popularized in the 1950s by art historian Clement Greenberg through the concept of material specificity [67]. The medium-specificity thesis states “each art form should pursue those effect that, in virtue of its medium it alone — i.e., of all the arts — can achieve.” which is often construed to mean “each art form should pursue ends that, in virtue of its medium, it achieves most effectively or best of all those effects at its disposal” [27]. More simply, medium specificity states that a painting does not reach its full potential when it borrows forms from other media (e.g., a sculptural brushstroke). The painting fails the medium in its hybridity. However, a large bias is introduced by the analyst in attempting to define what a medium’s properties are. Medium-specificity’s insular focus on maximizing the potential of a medium as opposed to situating the material (e.g., within a cultural moment) has since been rejected in modern art discourse. However, medium-specificity continues to permeate in how materials are interpreted by digitally-mediation tools [162] and how academic disciplines form [27]. In other instances, it is one of the strongest arguments for advocating for materiality as an emergent property or New Media [75].

Materiality in New Media

Within New Media, the material is strongly tied to a medium that, by its nature, has a powerful effect on how we interpret experience. The Medium is the Message [126] refers to the idea that the medium, or the channel in which a message is transmitted, significantly transform how a message is interpreted and in itself bear grounds for analysis. This was an analytical method developed by Marshal McLuhan in the 1960s during the times when the mediums of television, telephone, and print were under heavy public scrutiny. McLuhan ascribed that a medium is *an extension of the body* — each medium activates and attenuates unique sense ratios, or the different perceptual and information channels of the human body. For instance, cloth is considered an extension of the human skin. From this concept of sense ratios, he ontologically organized mediums based on the degree in which senses are engaged, relegating low-definition media as cool media (e.g., telephone) and high-definition media as hot media (e.g., photographs).

While a McLuhanistic view of the medium is mainly an analytical frame, he does provide some indication of how this affects the production of artifacts. Media props describes the unique ways in which a medium (when compared to other mediums) changes the signal (i.e., message) that is being conveyed. For example, a tune or melody in an NPR podcast between dialogues creates a feeling of place and narrative and is unique to the radio medium. Bodies on a stage acting out that same dialogue creates a feeling of presence, unique to theatre. However, both radio and theatre carry the media prop of liveness. In the *Ryerson Media Experiment* [126, pg.483] found that, despite conveying the same signal (a college lecture) across a variety of mediums (live, print, television, radio), the introduction of media props can transform the content and influence learning rates.

While similar to medium-specificity, media props advocate for an inspection of materials versus using it as criteria in which to evaluate the successfulness of a work.

Materiality in HCI

Within HCI, three views of materiality influence how digital materials are mediated in digital tools and materials [70]: 1) the *Tangible User Interface (TUI)*, 2) *Metaphysical Materiality*, and 3) *Craft*. In Tangible User Interfaces, the vision of *Tangible Bits* [87] and later *Radical Atoms* [86] extends the realm of mediation from a digital canvas to a physical and reactive context. By coupling bits (e.g., digital operations, structures, and forms) with atoms (e.g., physical, graspable and reactive objects), computational materials are made physical. This approach, however, is constrained by the ability to make transparent the mapping behaviors between computation and the physical object (e.g., a marble representing a voice recording) or developing a smart material. Under the metaphysical viewpoint, computational composites [201] take a conceptual material like computation and define its materiality through their interactions with other materials. These composites use a tightly-coupled physical proxy to remap behaviors, forms, and structures of computation as physical cues, acting as a *representation* of the conceptual material. Lastly, the crafting viewpoint describes a framing that leverages the communicative dimension of materials (e.g., the storytelling traditions of knitting augmented with data markers like GPS locations [165]).

Leveraging materiality in interaction design has become even more relevant with digital tools enacting influence on the physical environment. As new materials emerge within existing practices, Nitsche [137] observed the necessity of building on the material basis of the particular craft and rooting interaction in the complex interplay of materials. While often associated with designing experiential encounters within interaction design [62], more recently this *material turn* in HCI, i.e., the orientation for conducting interaction design research through a material lens [208], is being used to inform crafting (and material-driven design) practices with immaterials [9, 70]. The experience is characterized by materials having agency in the making process [187], taking on "a mind of their own," resisting or cooperating with the attempts of the practitioner to form them in a fashion is performative, resembling understanding, persuading, and responding to materials [53, 162, 99]. Giaccardi and Karana [62] introduced a framework for articulating how materials participate in the making process, identifying four experiential levels: *sensorial*, *interpretive*, *affective*, and *performative*. Schilling et al. [171] proposed discriminating the focus and attention of materials actors over time as a method of characterizing the "talk-back" that occurs during a creative session.

Digital materials complicate a conversation with materials, lacking a rich sensorial interaction that is central to a conversation with materials. Vallgård and Redström [201] advocated for the notion of computational elements as constituting many of the same characteristics as physical materials such as substance, structure, and surface. Extending the concept of a computational composite, Liu et al. [116] described smart materials having the ability to "[alter] a passive, static conversation into an active, sensorial interaction." In our work, I explore the generalizability of this compositing strategy to other immaterials, like computation, that share an intangible quality.

3.4 Summary

Unlike their digital counterparts, hybrid tools do not attempt to fully simulate physical material or the physical environment, allowing access to existing physical practices. Tools for hybrid making serve a variety of capacities, from translating and mediating content, structuring the creative environment, or providing guidance and feedback to the practitioner but often suffer from fidelity.

Integrating craft into technological workflows has been a common theme for design tool research, especially for situations that invite physical making. Allowing for these tools to support a craft-based practice with computation has many benefits, including diversifying who participates in making, the kinds of artifacts that are studied and produced, and defamiliarizing the sites in which we encounter computation. Although still disjoint, work in e-textiles and paper electronics indicate progress towards a deeper integration of craft-based practice within electronics.

For endeavors to achieve a craft-based digital fabrication practice, the space is complicated by the inherent differences between physical and digital materials. The ability to satisfy these differences is highly dependent on the practitioner's fluency with hybrid materials and their ability to hack and reappropriate CNC tools. For digital fabrication, the largest challenge remains in establishing a craft-based digital fabrication that is accessible to many, builds fluency, and accesses the social qualities of a craft practice.

The work I present in this dissertation builds on this goal and contributes to the *material turn* in HCI, i.e., the orientation for conducting interaction design research through a material lens [208]. Unlike prior work, I explore design tool research situated within a specific material practice. I'll demonstrate how crafting proxies can be enacted within physical materials, physical tools, and physical practices using computational design techniques to achieve a deeper integration with a material practice.

Chapter 4

Crafting Proxies

In this chapter, I introduce the concept of a Crafting Proxy as an intermediary between the practitioner and material. From the research literature, I construct a design space of proxies, delineate design concerns raised, and motivate the need to explore two key areas — *physical armatures* and *immaterial mediation*. I then describe the Research through Design (RtD) methodology used to build intermediate-level knowledge to expand our understanding of methods to support material practices.

4.1 What is a Proxy?

A **proxy** refers to an entity that acts as a substitute or representation for another. In its most traditional usage, a proxy is a person authorized to vote on behalf of another individual; in public health, infant mortality rates serve as a proxy to population health [158]; in computer science, a proxy server it is an intermediary between a user requesting a service from a third-party server. The proxy server offers important functions serving as an intermediary: providing security by monitoring and filtering content, serving as an authentication authority [104], translating, caching, and compressing information exchanges [102], and its most subversive role acting as a way to bypass internet censorship [134].

In creative practices, I leverage the concept of a proxy to describe the relationship between a practitioner and a material. A Crafting Proxy is a material, tool, or machine that is part of a larger network of a creative environment, which *mediates* interactions with a material facilitating interpretation, manipulation, and evaluation of emerging or potential forms as a part of a creative process. Framing this relationship as a proxy foremost allows us to leverage a connotation to the network and place creative action as a larger component of a sociotechnical system. It also acts as a way to situate creative activity outside a *digital* tool or *physical* tool dichotomy, colocating the virtual, physical, and even the biological on a common substrate. This colocation is similar to the effect of a proxy server transcending physical geographies (e.g., masking an IP address to appear one is in another country). A proxy framing also serves in establishing interactions as collaborations, reinforcing the “conversation with a material” basis of a material epistemology.

Lastly, a proxy allows us to acknowledge the intermediary role that materials, tools, and machine have in the creative process, implicitly influencing design ideation and evaluation criteria.

In contrast to inspirationalist and situationalist creativity support tools, *Crafting Proxies* are a type of structuralist creativity support tool, predicated on a specific method, process, or workflow driving creative thinking – in our case, supporting a material epistemology outlined in Chapter 2. Our intention is not to discount other orientations of creativity support tool, but to advocate for a creative process that has inspirationalist elements (e.g., bricolage) and situationalist elements (e.g., communities of practice) already integrated into time-tested practices (e.g., ceramics, needlecraft, metalworking).

4.2 The Design Space of Crafting Proxies

To develop the notion of *Crafting Proxies*, I first synthesize a design space from related work (Chapter 3), describe design considerations that have been identified, and then motivate two key areas of proxy design explored in this dissertation.

From the research literature in HCI in physical making referenced in Chapter 3, I identified proxies to have the following capacities:

- **Interpreters/Translators** - Proxies can serve as translators between two conceptual spaces. For example, translating between physical and digital forms or translating between physical actions and digital actions. This translation is often imperfect or incomplete, instead forming a simulacrum (e.g., 3D scanning unable to scan *every* quality of an object). In this sense, interpreters always act as mediators.
- **Mediators** - When conceptual materials do not have a physical form, a proxy can give form to these materials (e.g., visual blocks denote the Scratch programming language).
- **Monitors** - A proxy can act as a supervisor and provide feedback if unwanted actions are about to be performed (e.g., coaching, smart tools).
- **Lenses** - A proxy can filter content so as to present a different perspective of the form, reveal potential trajectories, or be used to make salient evaluation criteria (e.g., microscope, small multiples, guides).
- **Armatures** - A proxy can alter the environment to support and influence certain types of physical actions (e.g., digital palette).
- **Peers** - A proxy can provide access to a larger community of peers (e.g., forums, live streaming).

Design Concerns

Maker Bias. The ideal proxies are those that are designed by the practitioner and used by that practitioner, however, in many situations this is not always possible. Proxies made by other practitioners

and interaction designers will introduce bias into the creative process. Jennings and Giaccardi [91] advocated that navigating these biases should be guided by open-ended creative production and co-creation of tools with New Media practitioners within a “Research-in-Practice” approach. Open-ended, reconfigurable, and “hackable” tools have been shown to support reappropriation by creative communities, such as in the case of codebending [16].

Tool Influence. Proxies by definition influence creative process and “perform as materials,” resisting and accommodating to action [162]. As such, a proxy-mediated workflow should allow for multiple conversations to occur and not relegate a practitioner to a single design potential.

4.3 Expanding the Proxy Design Space

In this section, I motivate the relevance and extensibility of two proxy design areas investigated in this dissertation and describe our methodology for synthesizing intermediate-level knowledge.

Physical Armatures

A majority of creativity support tools have focused on digitally-mediating the creative process. In contrast to proxies that act as monitors such as “smart tools” or “coaches,” armatures have the distinct quality of being passive, introducing structural changes in the environment. The most simple example is the digital palette: a collection of swatches allows practitioners to leverage curated colors that align to aesthetics (e.g., Adobe Illustrator’s *metallic* color palette) or force practitioners to use a collection of colors because other actions are prohibitively expensive (e.g., Microsoft Paint swatches). Exposing additional control of color through hue-saturation-brightness (HSB) sliders integrates color theory into available actions, making it easier to specify tints and shades of a color. However, it is less understood how such armatures function in hybrid environments where creative sites are digitally-mediated (on a computer) or physically-mediated (in the real world).

Like color theory instantiated as HSB sliders, what does it mean to communicate material knowledge through a physical interface? How do different design decisions influence a practitioner’s actions? How might such armature proxies be incorporated into existing workflows that operate in hybrid environments? Understanding the design of physical armature proxies addresses Tenet 1:

Tenet 1 Material practitioners should be able to access and incorporate the years of knowledge from their respective practices within digital fabrication workflows.

In eliciting bodily action, physical armatures allow for physical interactions that leverage the repertoire of tacit knowledge that exists in material practices. I investigate physical armatures further in Chapter 5.

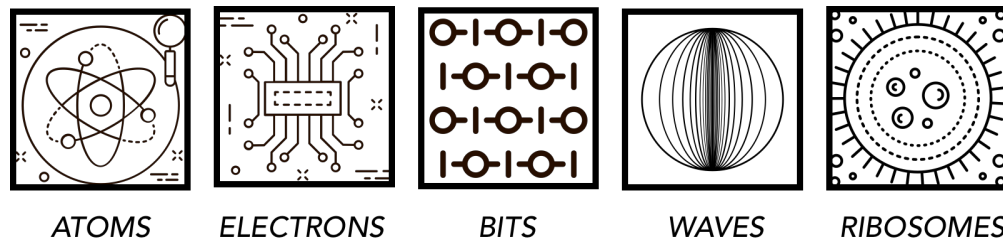

Figure 4.1: Immaterials are elements that are difficult to perceive or manipulate by the human body unaided.

Immaterial mediator

For abstract, intangible elements, or immaterials, such as computation, light, heat, electricity, or biology, the ability to form a material conversation is complicated. For the creative practitioner, it becomes trickier to work with such immaterial design elements as there are physical, chemical, and biological processes that govern the underlying potentials and interactions, and these form invisible and complex constraints that the designer needs to deal with. New media theory describes the limitations of immaterials as being (1) *inseparable*, containing content that cannot be disassociated from its structure (e.g., particles, waves, ribosomes), and (2) *imperceivable and intangible*, operating at a scale that is no longer human-operational (e.g., genetics, biochemistry) [119].

Several approaches aim to visualize immaterials (e.g., visual programming, data visualization, material simulation); however, the focus on *visual* explanation limits the ability of materials to be used in physical practices. Vallgård et al. argue that an immaterial like computation is a material, but in its raw form is difficult if not impossible to exploit [201]. Computational composites serve as one strategy for immaterials like computation to become useful in design. In a computational composite, computation is bound to a physical proxy that remaps behaviors, forms, and structures of computation as physical cues.

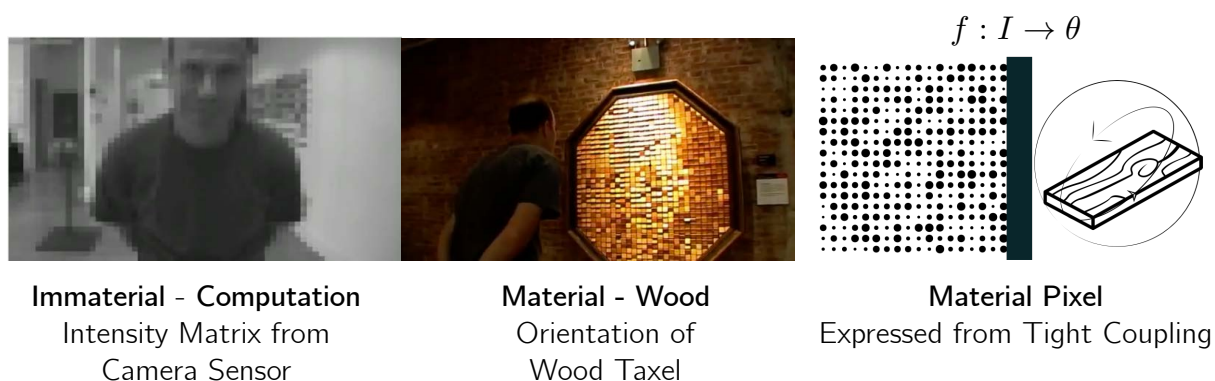

Figure 4.2: Daniel Rozin. *Wooden Mirror* (1999). 830 square pieces of wood, 830 servo motors, control electronics, video camera, wood frame. Size - W 67" x H 80" x D 10" (170cm , 203cm, 25cm).

For instance, Daniel Rozin's *Wooden Mirror* (1999) (Figure 4.2) is an art installation composed of taxels, or small wooden squares arranged in a dense grid, each able to be actuated by stepper

motors. When a bright light shines on the installation, each taxel reflects light or creates shadows based on its orientation. A small camera is mounted behind the grid of taxels, capturing the image of the viewer experiencing the artwork. Rozin takes the digital intensity matrix from the camera's CMOS sensor and uses it to control the orientation of each corresponded taxel in the wooden matrix, thereby creating a mirror of the viewer. *Wooden Mirror* is an example of a computational composite: an immaterial element, in this case, the digital intensity matrix from the camera sensor is mapped by some function to change the orientation of wooden taxels. Computation is tightly coupled to wood “to come to expression as a material” and allow us to experience the abstract concept of a pixel.

I see compositing as having the potential to address Tenet 2:

Tenet 2 Material practitioners should be able to use computation, electronics, and other emerging technologies like they would any other material. Such materials should be approachable and match their methods of producing, storing, applying, and transferring knowledge.

However, we understand less of the opportunities and challenges that arise when applying this compositing method to other immaterials. In our work, I explore the generalizability of computational composites by applying the method to two other immaterials – light and heat. Through its ubiquity through the LED, compositing electric light allowed us to examine immaterials that have a long history in material practices and are readily perceivable. Unlike computation, light, or electricity, working with heat allowed us to examine immaterials that operate at different temporal scale and are more difficult to perceive. Generalizing the compositing method has the potential to inform how other immaterials, such as biomaterials and electromagnetism, can be leveraged by material practitioners. I investigate immaterial mediators further Chapter 6 (light) and Chapter 7 (heat).

4.4 Methodology

This work employs a research methodology known as Research through Design where the act of designing artifacts or prototypes (whether it be an object, system, or tool) is used to reflect and engage with theories, technologies, and models from various disciplines and operationalize how they can be used in industry and by other practitioners. The act of designing produces new knowledge that sits between abstract theory and concrete real-world artifact known as intermediate-level knowledge (c.f. [181, (43.3.4.)], [222]). This type of knowledge provides information around:

1. How to operationalize theory, models, and systems from other fields. The act of concretizing an abstract concept or integrating a model in a real-world setting can elucidate gaps in theory or the conflicting frame of a model.

2. How to make the artifact and understand the missing knowledge domains needed for understanding the phenomenon under study.
3. Informing how future technologies should be made or the potential shift in experience and use without needing to fully flesh out a system.
4. Generalizing design principles for navigating complex design problems.

Being able to articulate intermediate-level knowledge has evolved to reflect a host of different design methods. These methods reflect a *process* for distilling theory, models, and knowledge from other domains, methods of *documenting and articulating* design decisions as manifested during the design process or enacted in the final artifact, and a means of *synthesizing* intermediate knowledge that is "contestable, defensible and substantive" [80]. Zimmerman et al. further describe evaluation criteria around invention, relevance, and extensibility [222].

I develop intermediate level knowledge around two underexplored areas of the Crafting Proxy design space — *physical armatures* and *immaterial mediators*. To describe process, I describe a design method (presented in Section 8.1), developed iteratively throughout this dissertation that provides an approach for satisfying components of a material epistemology and proxy design concerns. To document and articulate design decisions, I instantiate each core insight into a design artifact and annotate each work to form an annotated portfolio [58] (Section 5.8, 6.6, and 7.7). Lastly, to synthesize and substantiate proxy design principle, each design investigation is evaluated through a workshop study (Section 5.9, 7.8, and 7.8) inviting practitioners to create artifacts and reflect on the experience of a proxy-mediated practice.

The next three chapters document our exploration of the Crafting Proxy design space. The results of these design investigations are synthesized in Chapter 8.

Chapter 5

Wire Forming

One can say that computers of all things . . . are a means of making available effects of other people's skills to an individual without that individual having to acquire them. However, by acquiring no skills for oneself, then one is liable to be trapped by other people's thinking. The unskilled individual cannot override the principles of the machine.

Peter Dormer [41], *The Art of the Maker* (1994)

In this chapter, I explore the capacity for Crafting Proxies to act as armatures. Armatures have the distinct quality of being passive, introducing structural changes in the environment. These structural changes facilitate a material encounter by acting as a support structure to encourage creative engagement and exploration. While armatures readily facilitate digital interactions (e.g., choosing a color from a digital palette), how material knowledge can be communicated through physical armatures is less understood.

At the core of the argument I present in this chapter, I make the case that physical armatures can serve as a solution to the lack of material encounters within a CAD-CAM pipeline, and, in our proposed configuration, maintain the benefits of digital fabrication. I present an alternative workflow where instead of a digital fabrication process producing a final artifact, it generates a physical armature – a computationally designed tool that aids the practitioner in making the artifact

themselves¹.

To demonstrate our proxy-mediated workflow, we develop armatures for wire situated within wire-wrapping jewelry practice. As a case study, wire-wrapping exemplifies a material epistemology; at the same time, Computer Numerical Control (CNC) machines have been specially designed for working with wire [106]. This allows us to extend this pattern to other material practice – digital fabrication crossovers and generate intermediate-level knowledge towards the larger design of Crafting Proxies.

I first describe a conversational profile of wire, synthesizing the many ways wire communicates courses of action during a creative process. I then document a computational design algorithm for generating 2.5D models that function as wire-wrapping armatures and incorporate qualities of wire’s conversational profile as physical affordances. I present an evaluation of three variants of armatures that provide different levels of assistance and document how each armature can support different qualities of a material epistemology in physical-digital workflows.

5.1 Introduction

With the growth of digital fabrication practices, it has become possible to rapidly manufacture objects in a growing range of materials, including plastics, ceramics, and metal, from a single digital design representation. While the CAD-CAM pipeline lowers the barrier to entry and expands the range of materials that novice practitioners can work with, it also blackboxes the material knowledge away from the user preventing opportunities to reappropriate or deviate from the mode of production. Users are constrained to the available examples, templates, and methods of use prescribed by the authors of the blackboxed knowledge (e.g., laser cutters used as keychain factories [18]).

In this chapter, I describe a Armature Proxy that reframes the CAD-CAM pipeline to produce intermediate tools, or *proxies*, that can be used to assist practitioners in forming an artifact. In doing so, a proxy-mediated practice reintegrates the human in the loop while eliciting morphogenetic workflows. I operationalize the concept of a proxy-mediated workflow in the domain of wire wrapping, a popular metalworking medium that involves bending wire into aesthetic forms.

Why wire wrapping? Wire wrapping is a very popular form of metalworking and an ideal candidate for conversion into the CAD-CAM workflow. Metal wire already exists in a uniform ductile form-factor that many CNC machine design patterns afford and can be modeled as a less complex 1.5D material. Desktop CNC wire-benders are becoming widely available [146], however tooling limitations restrict the scale and resolution of manufacturable wire forms.

Wire wrapping as a practice exhibits many of the characteristics of DIY communities: namely, there exists burgeoning grassroots innovation in tools and techniques; there exists a culture of shared practice through tutorials, workshops, and magazines; it is an extremely popular practice for both

¹ Elements of this chapter were previously published in: Cesar Torres, Wilmot Li, and Eric Paulos. “ProxyPrint: Supporting Crafting Practice Through Physical Computational Proxies.” In: *Proceedings of the 2016 ACM Conference on Designing Interactive Systems*. DIS ’16. Brisbane, QLD, Australia: ACM, 2016, pp. 158–169. DOI : 10.1145/2901790.2901828.

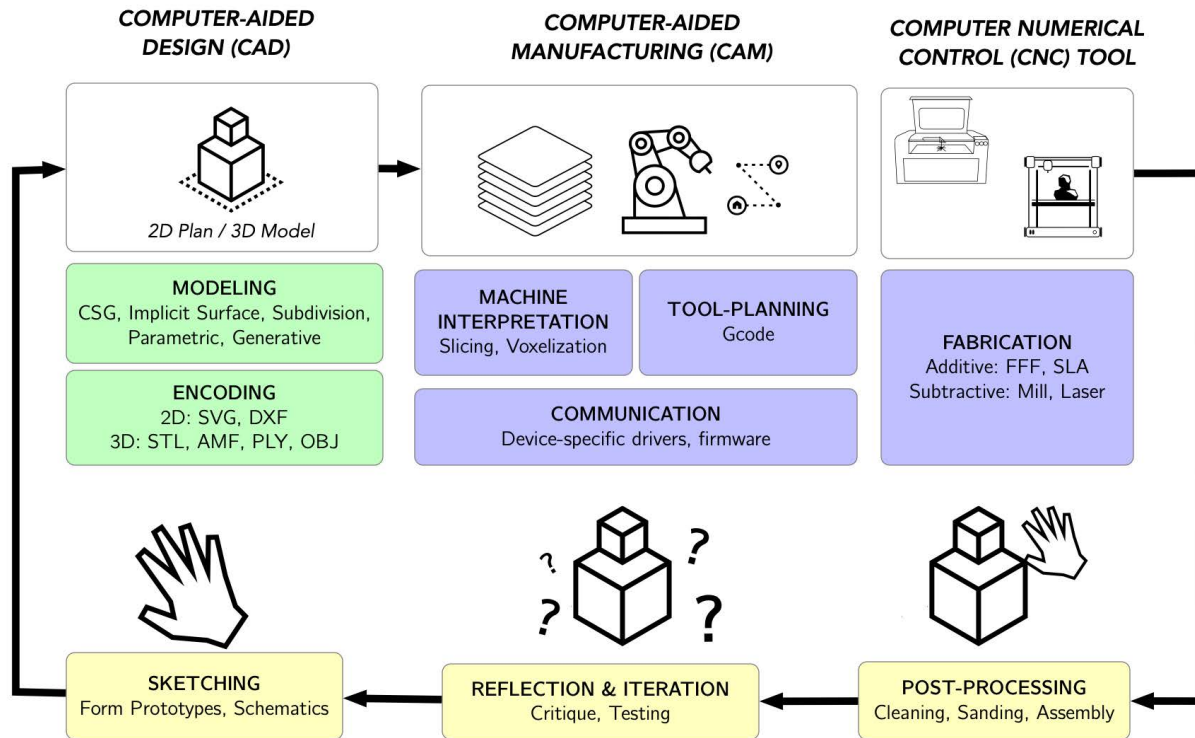

Figure 5.1: The CAD-CAM pipeline. Sketches or prototypes are converted into a computational representation using a modeling tool. The tool then encodes this representation in a form that is accepted by CNC machines. This representation is translated into machine-specific instructions and sent to a CNC machine for fabrication. Many machines produce artifacts that require some post-processing.

professionals and hobbyists (> 320K hits on Etsy). It also is deeply embedded in 1.5D material practices such as needlecrafts, basket weaving, acrylic bending, and knot tying and draws from a bank of metalworking techniques including patination, polishing, forging, welding, soldering, coiling, and work-hardening. These elements are lost within the CAD/CAM workflow.

Although this work is specifically oriented around jewelry making, the wire form is ubiquitous in digital fabrication practices. Wire forms can act as fastener, heating elements, conductive connectors, and are seen in emerging materials like shape memory alloys. Wire is also a close relative of thread form-factors. Thus, wire-wrapping represents an interesting and relevant context in which to investigate how proxies affect DF processes for both novices and experts.

5.2 A Proxy-Mediated Practice

A proxy-mediated practice is a version of a CAD-CAM workflow that reintroduces the human in the loop and reframes the goal of the workflow – instead of producing the final artifact as imagined in the CAD tool, it instead produces a custom tool, or *proxies*, to assist a practitioner in making the final artifact. This workflow allows for material encounters to re-emerge but provides the advantages

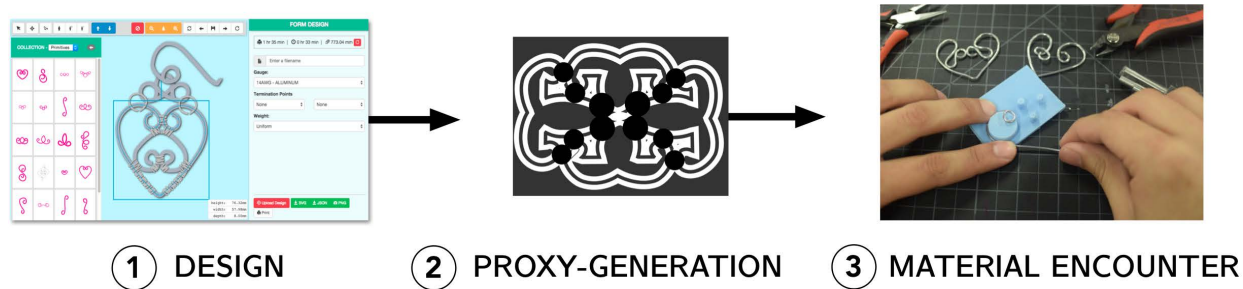

Figure 5.2: Proxy-Mediated Practice. 1) A wire-wrap jewelry design is converted into a computational representation, 2) this representation is translated into an armature, or tool, that helps with making the target design, 3) the armature allows for a material encounter to occur while still providing the benefits of digital fabrication.

of automation and abstraction inherent to a digital fabrication practice.

Armature proxies have the distinct quality of being passive, introducing structural changes in the environment. In traditional sculpture, armatures support, frame, and influence the manual creation process. By allowing users to work directly with a material, armatures facilitate a material encounter, allowing tacit material knowledge to be generated and refine a user’s mental model of a material’s properties and behaviors. This process is iterative, combining the affordances of a digital design file to refine designs and adhere to material constraints while also developing craftsmanship and physical dexterity.

One important consideration in supporting a material epistemology is allowing forms to deviate from the original intention, i.e. engaging in a morphogenetic workflow. This work explores how proxies might assist users with challenging aspects of the fabrication task by providing more customized design-specific scaffolding that complements and build on a user’s existing skill set but designed to encourage deviation and creativity.

In wire-wrap jewelry, a proxy-mediated practice is realized through a 3D-printed shaping proxy that provides custom bending geometries to assist with shaping wire into target forms. I explore three variants of a shaping proxy that offer different types of assistance to the practitioner — schematics, stencils, and jigs — and document how different design decisions can be implemented in proxies to encourage deviation, support morphogenetic workflows, and sustain practice.

² Image credits (left to right): Connie Fox at Jatayu from <http://www.jatayu.com/Education/StudioTour/ST-WrappingJigs.htm>; Barrel Nose Pliers from <https://www.amazon.com/Step-Barrel-Plier-Pack/dp/B005FMZ8VY>; Beadsmith Mandrel from <https://picclick.co.uk/>; Wire Wrapping Vise on Etsy from <https://www.etsy.com/uk/listing/242986933/wire-wrapping-jig-vise-fnt>; Beadalon Deluxe Thing-A-Ma-Jig from <https://www.dickblick.com/products/beadalon-deluxe-thing-a-ma-jig/>; Board for Wire Wrapped Jewelry by elgoem at Thingiverse from <https://www.thingiverse.com/thing:618600>

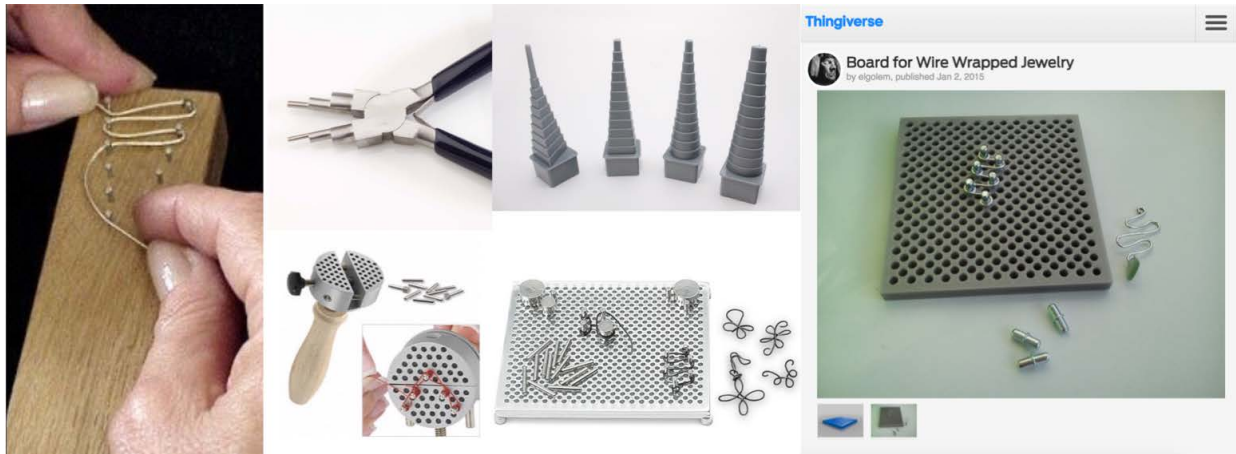

Figure 5.3: Tools of the Trade. Pliers, jigs, mandrels, vises are commonly used in wire-wrapping and are often custom-made for specific jewelry designs.²

5.3 Related Work

Creativity support tool research has explored methods of creating tools that enable more synergistic interactions between maker and materials. Below, I describe work around digital and physically augmented tools, instructional tools, and principles from traditional tools. Lastly, I describe work work around metal and wire bending.

Augmented tools

Digitally augmented tools or smart tools combine some digital or computational intelligence with manual usage, and primarily act in the service of providing higher accuracy or fidelity. FreeD, an augmented subtractive milling tool, provided feedback to users through autoshut off features. While FreeD provided support in adhering to a target 3D model design, it also provided a “human-override” mode that allowed users to deviate from the digital model. Enchanted scissors used conductive traces to detect and prevent incorrect cuts [218]. Peng et al. use common clay coiling techniques as a way to additively construct and digitally scan geometries at fabrication-time, allowing forms constructed during the making phase to be source material for a CAD design [145]. In Hybrid Basketry, Zoran explored how digital fabricated armatures can support and guide the basket-weaving process and influence the final artifact design [223]. Notably, the role of digital fabrication in Hybrid Basketry is not a driving or stopping force, but acts solely as a support structure. ProxyPrint builds on this idea of *passive* assistance and expands the set of computationally-generated support fixtures for the wire-wrap medium. I use these features to further explore how different types of assistance affect the making process and experience.

Augmented practice and materials

Abstracting materials into primitive additive and subtractive processes, such as fusing sand into glass, can omit much of the rich cultural history of people working with a material (e.g. glass-blowing). Several works investigate how the cultural experience of tools, mediums, and their practice can enhance the making experience. Jenkins et al. explored the religious experiences that are associated with crafting practices and created devotional gardening tools mediated with electronic and digital feedback [90]. Rosner et al. explored the combination of clay and digital fabrication, describing the tensions occurring from the displacement of the medium from the ceramist’s hand [164]. ProxyPrint complements this previous work; I similarly design the experience of handed practices into our armatures to allow for material encounters and opportunities for tacit knowledge transfer to re-emerge in the CAD-CAM pipeline.

Design-specific fabrication instructions

Some existing design tools focus on domains that require manual fabrication of the final artifact, such as plush toys [83], inflatable balloons [54], planar cardboard sculptures [78], and customized garments [198]. The output of these tools is typically a set of instructions for how to make the user-generated design. More implicit fine-grain instructions have been explored in systems like Sculpting by Numbers [161] which provides users with a “diff” between forms through a scanning and projection interface, non-intrusively aiding them in evaluating their progress.

Scaffolds on design

Several systems study the impact of levels-of-assistance on user experience and design outcome. Painting with Bob, a design tool for digital painting evaluates a simple toolset (e.g. an eraser that erases everything under the cursor) against a smart toolset (e.g. an eraser that erases similar color regions under the cursor) [14]. PortraitSketch provides a set of automatic assistance algorithms for adjusting user strokes while drawing to achieve a certain portrait aesthetic [216]. I similarly study the effects of level-of-assistance in the context of a physical material practice.

Wire design and fabrication

Some existing commercial products help users create wire-wrapped artifacts. Companies like WigJig and Beadsmith provide kits that allow users to create customized “jigs” by inserting different sized cylindrical pegs into a board (Figure 5.3). However, the discrete set of peg sizes and positions limits the designs that such kits can support. CNC wire benders such as DIWire have automated the wire bending process, with some tooling limitations. Such machines have been proposed as sites for interaction: Willis et. al. *Speaker* interactively “sculpts” wire based on sound wave forms [209]. Most relevant to the domain of our work is WrapIt [82], a computational design tool for converting line drawings into optimal wire wrap forms (“wire decompositions”) that can be fabricated with the help of a 3D-printed jig. I build on this work in several ways. First, while WrapIt focused

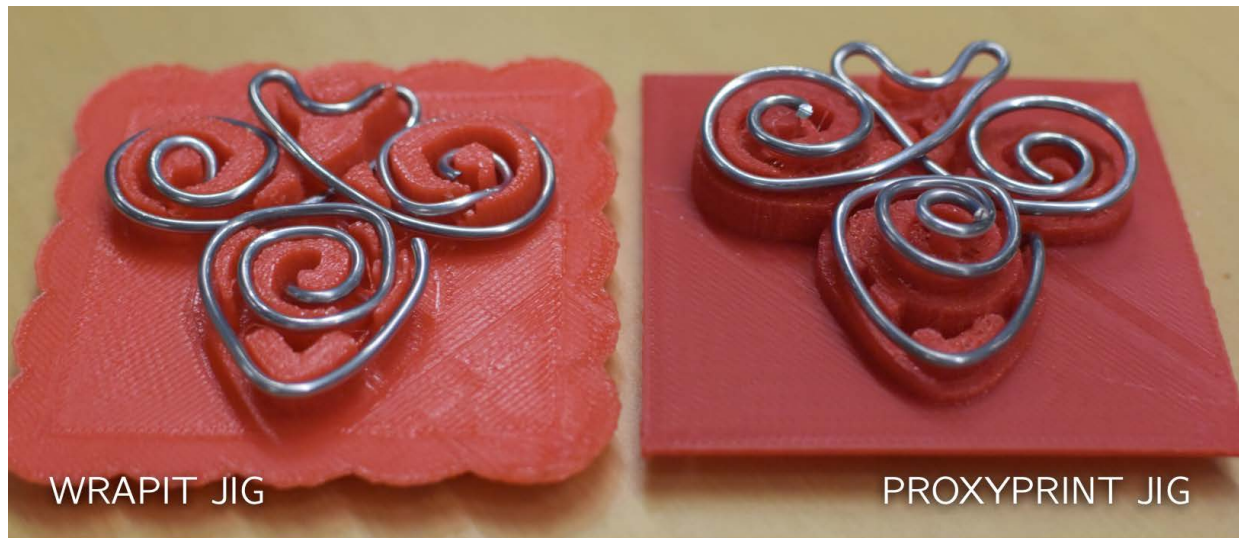

Figure 5.4: Comparison against WrapIt [82]

mainly on the design problem of converting line drawings into wire decompositions, I concentrate on the problem of fabricating a given design. Our wire shaping jig design offers some important improvements over the original WrapIt jig. I also investigate the question of level-of-assistance, which is critical for the design of physical tools that aid the creative process of manual fabrication.

5.4 Design Process

To explore the concept of a proxy-mediated practice, I first developed a computer-aided design tool that would support common actions and motifs of a wire-wrapping practice. The tool provided an annotated design file that could be sent to and interpreted by a CNC wire-bending tool.

Our design intervention explored how we might reappropriate the design files in this and other CAD-CAM based practices to transfer material knowledge and facilitate material encounters. To accomplish this, I first examined the wire-wrapping style. A style refers to the “constancy, or consistency, in the way an individual, or a group, treats the formal elements of art, or visual culture” [69]. I explored the wire medium not only by its physical affordances or properties, but also through the expert practice and tradition that have already produced conventional uses, meanings, and techniques with this material. By placing ourselves as the expert learner without previous wire wrapping experience, I distilled tacit knowledge from the material practice of working with metal wire.

I then developed a computational algorithm that integrates material knowledge of bending wire and planning bending action to generate a shaping proxy. This shaping proxy takes as input a target wire form from the wire-wrap CAD tool and generates a 3D model of a tool that assists with forming a wire. I leveraged this algorithm to explore how proxies can provide varying amounts of scaffolding for the user. To examine this aspect of the design space, I take the basic elements of our

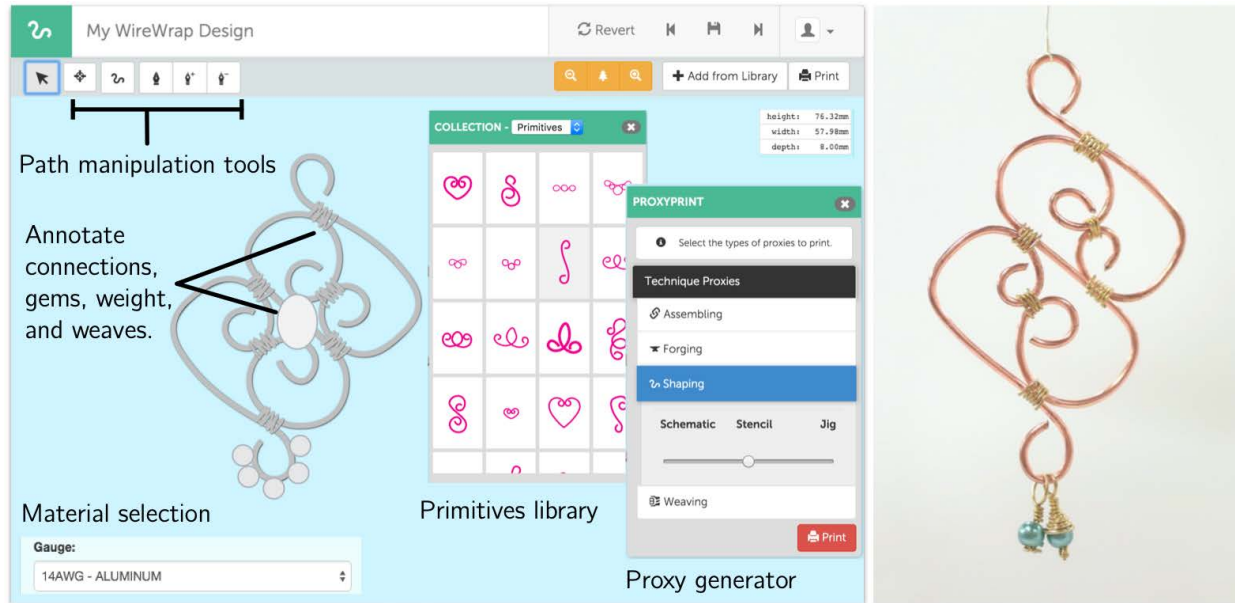

Figure 5.5: ProxyPrint Computational Design Tool for Wire-Wrapping. ProxyPrint Computational Design Tool for Wire Wrapping. Users can drag common forms onto a canvas, manipulate paths, specify materials, and add ornamentation and connections. The tool produces a heightmap used to generate a 2.5D printable proxy.

wire shaping proxy and consider design variations that offer different types of assistance. I refer to these variations as *scaffold proxies*. I use a workshop evaluation with 12 practitioners to evaluate and annotate these design artifacts and probe how different types of assistance can enhance and alter the creative process.

5.5 Wire-wrapping CAD Tool

I developed a wire-wrap computer-aided design tool to use as a design probe. The probe would mirror the traditional CAD-CAM pipeline, creating a digital design file that would then be transferred to a CNC tool for manufacturing. However, this pipeline would use the digital design file to embed material knowledge of the wire-wrapping practice into the design of the proxy tool. As opposed to a general-purpose 2D design tool, this tool incorporates the unique concerns of a practice, in this way advocating for specialized tools that better encode a practice. The wire-wrap CAD tool was thus designed to encode the necessary information needed to support this knowledge transfer and facilitate a material encounter with wire.

The tool was developed as a web application using the Computational Design Architecture described in Section 9. This web application syncs with a local SVG file to allow users to use existing SVG editors to create initial geometries for their design. The design is then converted into a 2.5D tactile model and 3D printed. Although the tool follows a direct manipulation interaction style

to simulate physical making, it is unavoidably not physical making. While wire-wrap practitioners might initially sketch designs on paper or inspired by an existing design, a material encounter requires active interaction with the physical material. I make progress in resolving this tension through digital design mechanisms, specifically:

- *A Library of Wire-Wrap Forms.* Sourced from artisan handbooks [19], wire-wrap design primitives were extracted and presented as importable forms on a digital canvas with actions to reflect, duplicate, and arrange elements to form symmetrical and rhythmic compositions. Binding these actions to hotkeys allowed for epistemic interactions, allowing users to reflect and think through different form interactions.
- *A Catalog of Gems, Beads, and Connectors.* A collection of gems and beads and a vocabulary of common connectors (e.g., coils, jump rings, ear wires) were converted into 2D SVG representations and collected into a wire wrap catalog. I manually captured the size and shape of each form; as an alternative, a 3D scanning process could more seamlessly allow practitioners to capture materials and incorporate elements of their surroundings and support a bricolage practice. The design tool exposed the catalog as a gallery of small multiples that could be drag-and-dropped onto the design canvas.
- *Decomposition of Forms.* A computational routine decomposed wire forms into hierarchical primitives. A heart shape, for example, was decomposed along its vertical symmetry. That half-form was then isolated as a curve and sharp bend. In the proxy-design phase, I describe how this hierarchical form tree was used to generate proxies that allowed for deviation from the initial design so as to not restrict and finalize the final form of the design in the computational design phase.
- *Material Specification and Visual Simulation* A database of common craft wire materials (e.g., aluminum wire, bronze wire) was created to encode both visual appearance (e.g., color and gauge) as well as physical properties (e.g., hardness). From the design tool interface, users could select SVG paths, assign a material, and impart these qualities onto the digital representation.

All of the wire wrap designs and primitives used in this work were sourced from artisan handbooks [19] and community forums³ and encoded as SVG drawings.

5.6 Material Practice with Metal Wire

While a finite element model (FEM) may be used to simulate the physics and interactions of wire, there is essential tacit knowledge that is not captured by scientific and engineering practices. In this section, I describe some tacit elements of the wire-wrapping practice encountered from personal practice in learning wire wrapping, similar to the role of an expert learner proposed by Wood et

³ www.pinterest.com

al [213], learning from wire-wrapping workshops, formal instruction, video tutorials, and instruction materials while documenting how a wire-wrapping mental model developed.

Wire-wrap Tradition

Formally, the wire-wrapping workflow is to first *shape* one or more wires into appropriate forms, then *forge* or *work-harden* wires so as to retain or enhance their form, and finally, connect separate elements to form a single coherent composition. These wire forms often serve a structural purpose, to secure beads and gems, or an aesthetic role, in constructing an experience. The workflow of a wire-wrap practitioner is highly reflective and follows a material epistemology described in Chapter 2. Metal wire resists or conforms to the actions of the wire wrapper; understanding how these behaviors change with each manipulation of the wire is an important yet tacit trait for mastering wire wrapping.

Choosing a Tool. Shaping a piece of wire into a desired form is the primary task in creating wire-wrapped artifacts. In general, it is difficult to bend wire to create smooth curves that match the proportions of a design. Wrappers employ hand tools and custom-built jigs for this purpose, but using such tools effectively is challenging. For example, different types of pliers heads are best suited for different types of bends: flat-nose for sharp angles, barrel- or taper-nose for curves and swirls, and chain-nose for general bending.

Producing Complex Forms. For complex geometries, wire wrappers leverage jigs, a custom armature that provides support for forming a specific design. These jigs range from more permanent solutions like nails screwed into a substrate of wood to more dynamic designs like pegboards. For designs with many identical components, wire wrappers employ a tool known as a *mandrel*, typically a cylindrical rod, that wire is wrapped around. A ring mandrel, for example, contains the geometries of different ring sizes stacked on top of each other. Using a technique like coiling, a wire is wrapped into a coil using a mandrel, removed from the mandrel, and then cut down the primary axis resulting in multiple copies of the wrapped form. This *coil-and-cut* technique is used for batch-producing circular connectors, or *jump rings*, a wire is wrapped around a cylindrical mandrel; the coil is cut and the resulting geometries forged against an anvil to work-harden the form.

Dealing with Work Hardening

A very practical material behavior is the *spring back* that occurs when a wire is bent. In a bending action, wire is compressed alongside the inside of a bend and strained on the outside bend introducing forces in compression and tension. Spring back is an artifact of *work hardening*, a plastic deformation caused by dislocation of a metal's crystal structure. Wire is softening by heating (and reforming) the crystal structure. Wire can be hardened through cold-forming techniques such as squeezing, bending, drawing, and shearing. The process of shaping the wire through bends or

hammering causes an increase of dislocations resulting in a work-hardened “rigid” wire. A wire wrapper develops a heightened awareness of a wire’s hard-soft state. It is the task of the wrapper to selectively harden wire in appropriate regions. This is desirable by metalworkers to a) increase the structural integrity of the form to prevent deformation (e.g., curves), b) combine softness and rigidity to create new material behaviors (e.g., ear wires), c) add aesthetic variety (e.g., texture), or d) connect or secure beads and gems.

Minimizing Interactions. Wire wrappers take care in limiting and reducing interactions with the wire. The more work that is done on the wire, the more areas that have been hardened; a slip of the hand may cause an unwanted bend which would be more difficult to remove within hardened areas of the design. Excessive work-hardening, such as that caused by bending a wire in the same spot multiple times, will cause the material to become brittle and prone to fracture. Experts plan the sequence of bends to minimize interference between the wire, pliers, and other tools as they manipulate the material.

Material Undo. In practice, traditional craft wire is usually annealed, a process that realigns the crystalline structure of the metal resulting in a more malleable “softened” wire and packaged in a spool in a softened state. Nylon pliers function to both compress and straighten the wire form, removing the imprint of the spool, and also harden the wire through friction so as to retain new bends more easily. The nylon wires also serve as a material “undo,” allowing accidental bends to be removed.

Marring and an Ornament Fail Safe. Materials softer than metal, in the form of fingers, nylon pliers, rubber hammers, and rubber anvils, prevent the marring, or scarring, of the surface of a metal. When using metal tools, wire wrappers pay special attention to the forces exerted on the wire or use sacrificial elements to hold and anchor a wire. When marring occurs accidentally, wire wrappers “cover-up” the mistake with a coil, bead, or weaving ornamentation. Additionally, forging the metal, i.e., deforming the metal with a metal hammer and anvil, is used to regain an unblemished wire.

Manipulating Wire

When forming wire into a shape, different geometries require the wire be held to anchor the part of the wire that is being manipulated. Some geometries require the practitioner to exert stronger forces making it more likely to accidentally deform unwanted areas of a wire. Wire-wrappers employ the following anchoring techniques.

Sacrificial Ends. Many wire wrap designs end in loops, curls, or spirals. Manipulating the end of a wire is particularly difficult, both with regards to exerting appropriate force and controlling the wire without distorting the design. Wire wrappers leverage excess material at each end to serve as manipulation handles. Once the form has been achieved, the residual material is clipped away.

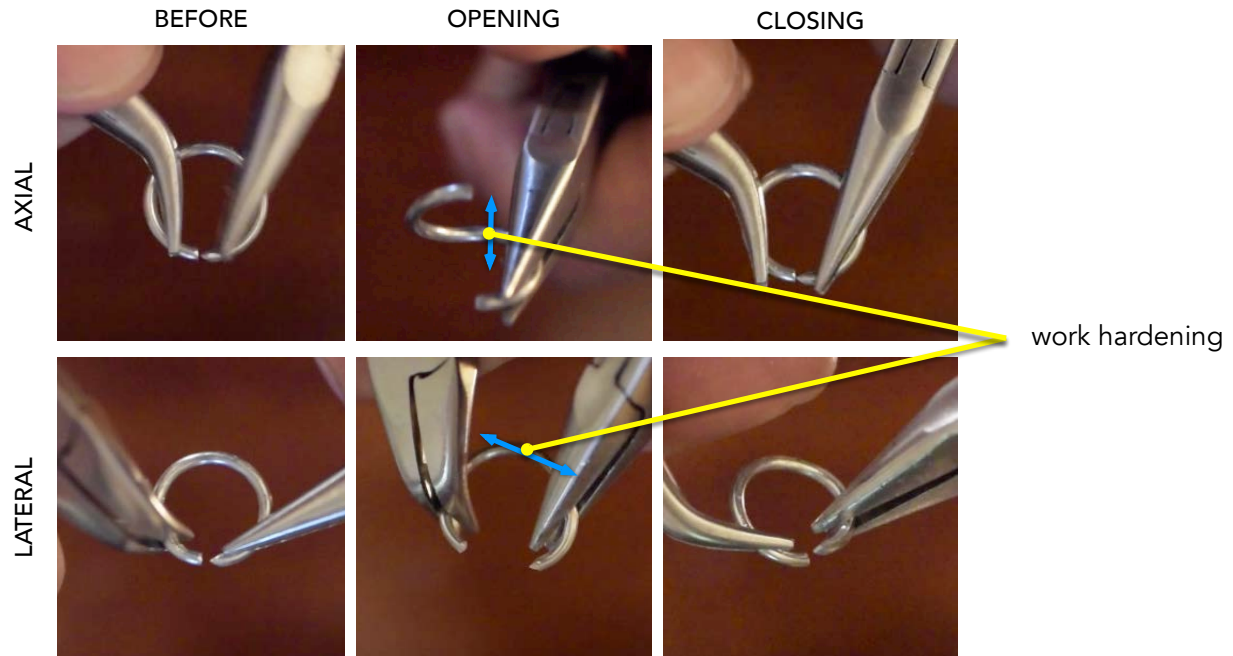

Figure 5.6: Wire-shaping strategies. Opening and closing a jump ring using (top) axial bends and (bottom) lateral bends. Note the deformations that arise from lateral work-hardening.

Axial Deformation. Wire wrappers recognize that the wire “has a mind of its own,” where spring back prevents the wire from sitting flat on a plane. Instead, practitioners often construct their designs in 3 dimensions by deforming the design on its axial dimension (in line with the direction of the wire).

For instance, a *jump ring* is a circular geometry typically used to connect elements together (Figure 5.6). Two strategies exist for opening and closing jump rings to add or remove elements.

- A *material naïve approach* manipulates wire as a 2D element. In deforming the ring along the planar dimension, this bending action work hardens a subarea of the ring. When the jump ring is closed, this work hardening deforms the jump ring.
- A *material-centric approach* manipulates the wire along its axial dimension, acknowledging the three-dimensionality in the wire’s resistance to laying flat. The jump ring is still work-hardened. However, it is work hardening along the dimension orthogonal to the wire form that prevents deformations to the ring while improving the ring’s resiliency to opening.

For more complex designs, axial deformations allow practitioners the ability to move finished elements of a design away from the active forming area and securely anchor their design.

Working with the WrapIt jig

The WrapIt jig [82] is a wire-wrapping jig is computationally generated from a target design (Figure 5.4)). Having a pre-defined form reduces the need to negotiate with the wire the potential forms it can take. Instead, custom physical “support walls” are placed around areas of high curvature to guide the shape of the wire and ensure that the resulting form matches that of the input design. While the jigs aid in accomplishing a wire-shaping task, some key frictions in using the jig reveal opportunities for embedded tacit material knowledge from the wire-wrapping practice.

Planar Assumption. The WrapIt jig followed the convention of making bending support geometries on a planar surface. However, since WrapIt jigs offered the ability to incorporate more complexity in the support geometry, it became more challenging for contact forces from friction and stress to maintain the wire on the jig. Additionally, for geometries with overlaps, the support walls were not tall enough to maintain the form in place.

Ordering Ambiguity. As design complexity rose, the ordering of the wraps becomes ambiguous. Finding the correct order of wraps to achieve all target geometries with one wire form was difficult to accomplish.

I leverage these insights and observations to inform the design of a shaping proxy that both increases the usability and effectiveness of shaping wire, but also communicate tacit knowledge from a material encounter with wire.

5.7 Shape Proxy Design

To shape wire, as described in the material practice section, a shaping proxy should:

- facilitate a material encounter with the wire
- assist with bending a wire smoothly into shapes
- clearly convey a bending sequence
- minimize physical obstructions that may interfere with bending interactions

Our shaping proxy design was inspired by the coiling technique for creating circular jump rings. The technique coils wire around a cylindrical mandrel, cutting laterally through the coil to create small open rings, and then flattening each ring to create a closed, circular shape. By coiling the wire along the mandrel, the user does not have to worry about interferences between subsequent rings. Our design operates similar to a computationally designed mandrel minimizing the physical obstructions to the user and supporting overlapping features in one continuous, uninterrupted wrap.

In the description of the computational design algorithm, I detail how each design decision leverages tacit knowledge gained from a wire-wrap material practice.

Computational Design Algorithm

Leveraging the SVG to 2.5D geometry creation process described in Chapter 9, the algorithm takes in a single SVG path and produces a heightmap which is then converted into a 2.5D model for fabrication. The resulting 3D-printed shaping proxy contains bending geometries that sit atop a rectangular base⁴.

The shaping proxy tool can then be used to shape wire as depicted in Figure 5.7:

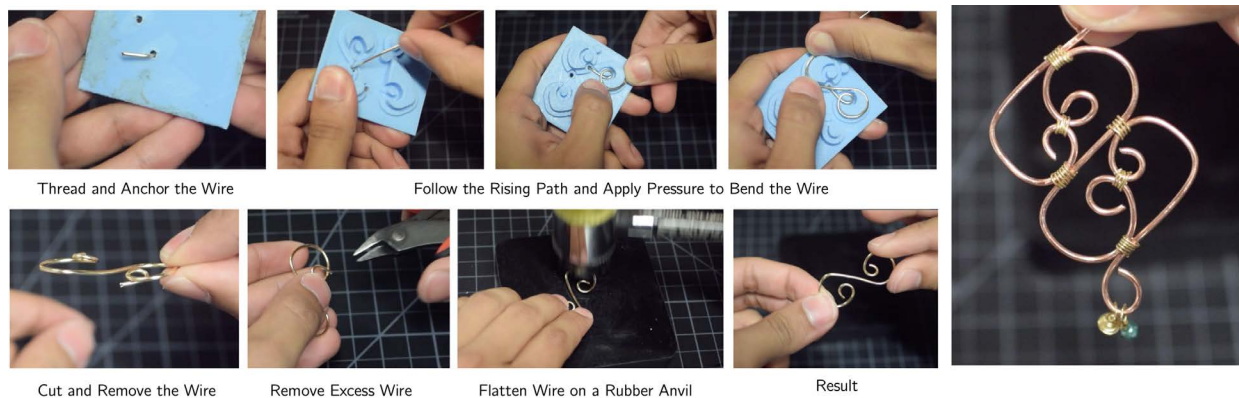

Figure 5.7: How to Use a Shape Proxy

1. A smooth work-hardened wire is threaded through a hole.
2. The wire is bent around geometries.
3. A cutting tool snips the anchored end of the wire and the resulting shaped wire is removed from the proxy.
4. A flattening phase compresses the design back down into plane (Figure 5.8). I used a rubber hammer and anvil to flatten large elements and nylon pliers for smaller ones⁵.

Process. An SVG editor is used to create path geometries that represent wire forms; this SVG is passed as input to a computational design routine that generates a shape proxy. The routine produces a set of polygon geometries placed on a 2D canvas and encoded with a height value. At the conclusion of the design routine, geometries are collected, and height values are normalized by remapping height values to grayscale values (between 0 and 255). Each geometry is then rendered with a fill or stroke color with the resulting grayscale value to form a 2.5D model heightmap.

⁴ Generated shape proxies were printed using Fused Filament Fabrication (FFF) at 0.1 mm layer height with PLA filament. At this resolution, proxies supported geometries small enough for shaping wire gauges from 16 AWG to 24 AWG while withstanding bending forces. All geometries were generated to support a wire geometry with a tolerance of 10%.

⁵ Using softer non-metal instruments prevents marring of the wire.



Figure 5.8: Routine for Shape Proxy Generation.

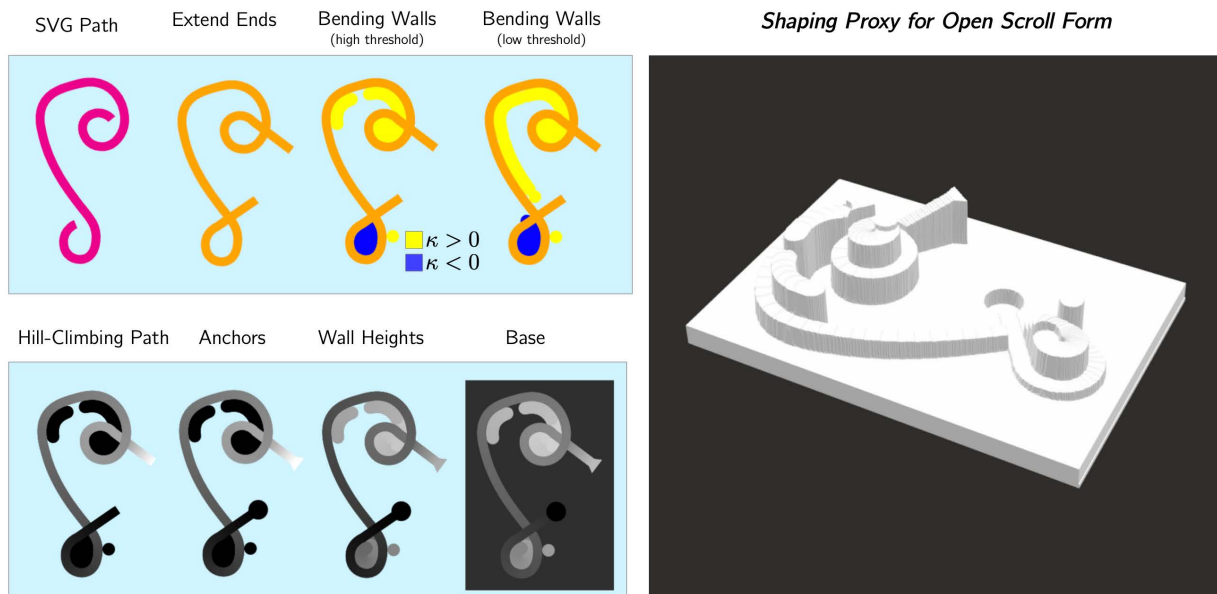

Figure 5.9: Deformations of a Heart Shape along the Axial Dimension

Routine. The routine for generating wrapping geometries is visually depicted in Figure 5.9 for an open scroll wire form.

- **Ends** Bending the ends of a wire is difficult to do without deforming the rest of the design. To prevent this, I extend SVG path ends by length 30 millimeters. For path ends that are part of a curve, maintain the same curvature so as to “complete the loop.” The extra length is easily snipped away using a flush cutter.
- **Anchor** To secure the wire to the proxy, a hole is placed at the start of the path equal to the wire diameter. These anchors are necessary to keep the wire in place and allow the user to put

longitudinal tension on the wire during wrapping.

- **Bending walls** Similar to the WrapIt jig, I generate physical “support walls” around areas of high curvature to guide the shaping of wire to a target form. A peg, or cylindrical geometry, is generated to provide a structure to bend the wire against; by walking the path geometry (at 0.3 mm steps) and computing the tangent, normal, and path curvature κ at each step. Curvature is calculated as:

$$\kappa = \left\| \frac{d\vec{T}}{ds} \right\| \quad (5.1)$$

where $d\vec{T}$ is the change in the tangent vectors between two points on a path and ds is the distance between the two points. At each step, a 6 mm diameter circle (peg) is placed normal to the path location if the curvature is positive or the negated normal if the curvature is negative. This operation results in many overlapping peg geometries which when rastered forms a wall on the interior curves, i.e., inside bends, of the path⁶. The algorithm exposes a curvature threshold as a hyperparameter that can be used to remove walls for geometries with less curvature, i.e., non-bending geometries.

- **Hill path** A significant insight from observing wire wrappers is that *the wrapping process does not need to occur on a single 2D plane*, even if the resulting piece is designed to be flat. Since wire is prone to not stay on a 2D plane, I generate a ‘hill-climbing’ geometry that maintains wire continually rising during the wrapping process. This winding path additionally provides an implicit cue for the ordering of wraps especially useful for when design complexity increases. However, even simple designs often contain forms with several overlaps, or self-intersections, which further complicates the ability for a wire during the making process to remain flat.

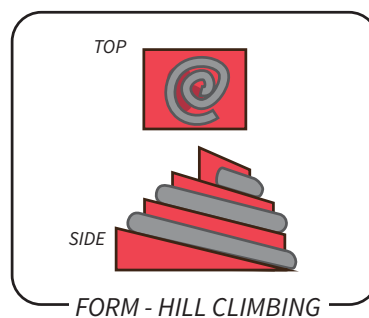

Figure 5.10: Hill Climbing Path

To create a rising geometry and ensure that a winding wire does not collide with itself, I computed the locations of self-intersections and divided the path on those markers. The

⁶ The peg-diameter should be adjusted based on the strength of the fabrication material and wire bending forces. Excessive force may cause proxy walls to break. Metal-based proxies, such as those from selective laser sintering (SLS), provide the most robust proxy.

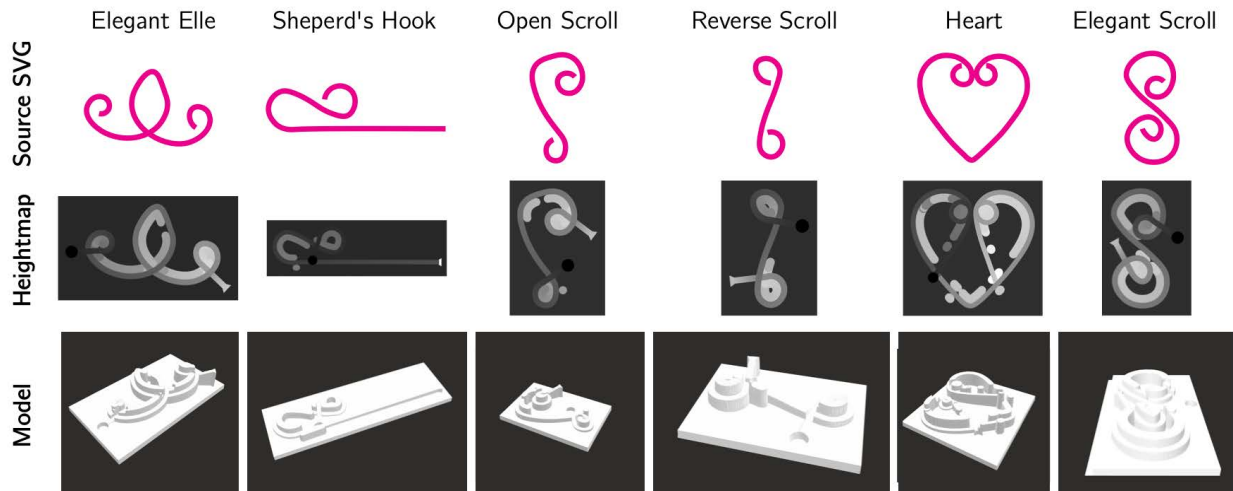

Figure 5.11: Proxy Shape Primitives

resulting paths were collected as an ordered set of levels, each subpath constituting the n th level of wrapping. Each n th level was then assigned a minimum height of nD and maximum height of $(n + 1)D$ where D is the diameter of the wire. A support cylinder (circular geometry) was placed at each point on the subpath and assigned a height value parametrized to its location on the level. This overlap gap ensures that previous portions of the path do not interfere with subsequent wrapping interactions. While the change in elevation may result in a small amount of distortion in the flattened geometry, I did not find this to be a problem in the artifacts that were created.

Due to the rising wire path, bending walls are assigned a height $1.5D$ taller than the nearest hill-climbing support cylinder.

- **Base** Lastly, a rectangular geometry is added that bounds all SVG elements with an additional padding of 5 millimeters. The height of this base geometry is specified as 2 millimeters.

The routine is able to handle small geometries (<2 mm spacing) with several overlapping segments (<6 overlaps) (Figure 5.11). The ability to wrap diminishes from areas with very high curvatures. Such geometries introduce strong forces on the bending geometries that overcome the strength of PLA-printed parts.

5.8 Scaffold Proxies

In this section, I describe the design of three distinct shaping proxies that provide different types of assistance to the user during the making process. These *scaffold proxies* all have the quality that they require a material encounter, i.e., interactions with wire that communicate a wire's work-hardening behaviors. Scaffold proxies each takes in a design created in the wire-wrap CAD tool and produces a design-specific tool to assist in shaping a wire. The three different scaffold designs are used to

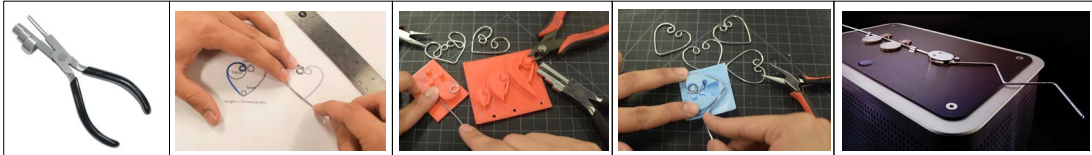

tool	armature	schematic	stencil	jig	CAD/CAM CNC
construction assistance	no	yes	some	yes	yes
fabrication assistance	yes	no	some	yes	yes

Figure 5.12: Three different proxies, or tools that aid users in the construction of an artifact, with different profiles of assistance. A schematic (left) provides fabrication feedback via an annotated construction proxy; a stencil (center) breaks down designs into elementary forms, c) a jig (right) provides a ritual high-fidelity fabrication process via a fabrication and construction proxy.

probe how a practitioner’s creative process, goals, and behaviors are affected by different properties of the three scaffolds.

For each scaffold, I describe the scaffold generation technique, connect the design decisions to making literature and material practices with wire, and describe the resulting interactions of twelve practitioners in a workshop study. The workshop study is described in Section 5.9, but, for convenience, the results are presented alongside the description of each scaffold.

In the study, each scaffold was generated for a heart design depicted in Figure 5.12. This design represents a common and recognizable form in the wire-wrap tradition that captures a gamut of wire-wrap geometries, including sharp bends, smooth curves, symmetry, and loop features. The heart geometries are referred to as the *endloops*, *heart-curves*, and *heart-bend*.

Jigs

Proxy Generation. Jigs are formed by creating shape proxies for all forms specified in the wire-wrap CAD tool.

Design Rationale. Jigs are a type of proxy that provides the highest level of physical and cognitive assistance in producing a target form and reducing error. The jig, however, is restricted in supporting only the form that it was designed to support. Jigs are commonly used in material practice serving as a means of refining the process for creating editions, i.e., batch-producing a design. Jigs are closer to a hylomorphic making style in so much as a single form is “baked in” to the tool. Opportunities for deviation arise from jigs in the act of composing symmetric forms (from flipping and attaching two copies together), forming a dielectric (e.g., a pair of earrings), or using the form as a base elementary material (e.g., linking forms to make chains and meshes). By indicating where to begin wrapping (the starting hole), how to proceed (continuously rising path), and where to end (terminating cliff), this proxy minimizes the cognitive effort of deciding how, where, and when to bend the wire. Moreover, the act of wrapping itself is constrained to pulling the wire tight against



Figure 5.13: Proxy Scaffold - Jig

the inner wall, which minimizes the physical skill and dexterity required to realize the design. In this respect, jigs encourage a fairly mechanical, repetitive interaction with the material.

Workshop Results. For many, the proxies provided to them offered a clear and singular route to achieve the design. I hypothesized that the jig would hinder creativity since it was so constrained to one design. However, I was surprised at how expert users viewed the guiding walls and other superfluous elements as interesting deviation points.

Risk and Guaranteed Success In the workshop, the jig represented a safety net with many participants vocalizing complete confidence in achieving the design task upon simply seeing the jig. This perception of guaranteed success elicited for some a desire to deviate from the form embedded in the jig. Despite the jig being designed for a single form, participants found ways of reappropriating creative agency from the jig. Several participants reappropriated the bending order of the jig, straying “off-the-path” and arriving at serendipitous designs. Others took advantage of non-design helper geometries of the jig, and a desire to incorporate these geometries to adhere to the aesthetics of the design:

Participant Expert #2: I dislike that I am only given one hole to anchor my design. I want holes everywhere — at the base of the [hillpath] and at the end. I want to start in a completely different place. I want these walls to end more symmetrically, and have gaps exactly the width of my wire so that I can use them in my design.

Ritual Participants that chose not to deviate from the design relished the ability not to have to actively plan wire bends and react to wire forms, succeeding agency to the jig.

Participant Novice # 1: The jig I could handle. I just had to follow the form. . . .I'm just going to go around and around the jig, letting it guide me to where I need to go.

This orientation created a very different relationship with the jig and other scaffolds. One participant likened this workflow to the rhythmic, mechanical, and repetitive movement of her hands when knitting garments.

Participant Expert # 4: I could just lose myself in the jig. I am totally absorbed in it. I don't have to think; I just do what it tells me to do. I surrender to it.

Stencils



Figure 5.14: Proxy Scaffold - Stencil

Proxy Generation. Stencils are formed by decomposing a form described in the wire-wrap CAD tool into subcomponents and introducing piecewise variations. At the highest granularity of the heart design, a stencil breaks down the heart along its axis of symmetry; this elementary form is then varied by scale or by altering end behaviors (loop, double-loop, straight) and printed as separate shaping proxies. At a lower granularity of the heart design, unique curvatures of the design are isolated and are varied in scale.

Design Rationale. Stencils represent a proxy that maintains some ambiguity in the forming process in contrast to producing only a single form. Stencils are more evocative of a morphogenetic making process since new forms are encouraged to emerge. Stencils also provide integration with the existing bricolage of tools and techniques. A wire-wrapper may choose to use hand tools to shape the larger gestalt of a form and then employ stencils for more intricate areas of their design.

or to introduce more complex geometries to their emerging form. Stencils introduce risk into the forming process - errors can occur from interference from the choice of bending steps.

Workshop Results.

Tool-switching as Morphogenetic Behavior Stencils elicited many behaviors described as morphogenetic making. Each stencil and general jewelry wrapping tool was laid out around the participant, many scanning through them as choices of where to take the design. Nearly all participants elected to deviate from the design, often employing a process of making a bend, reflecting on the form, and varying their working style based on the current or perceived future state of the wire. This working style was especially discernible in the amount of tool-switching that occurred during a creative session.

Schematics

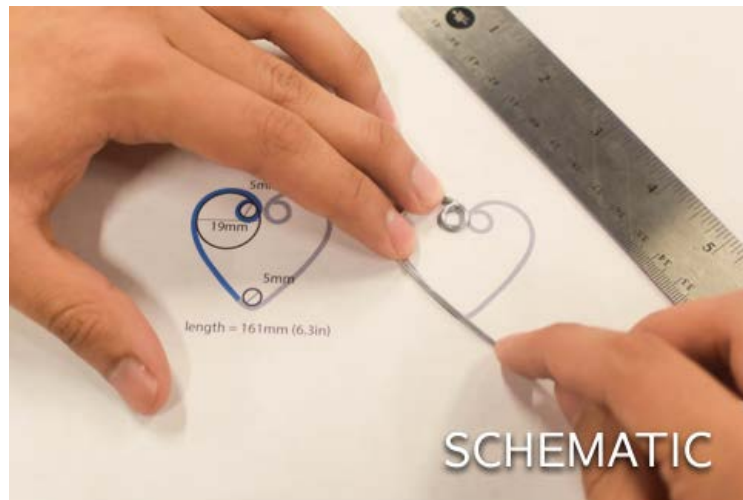

Figure 5.15: Proxy Scaffold - Schematic

Proxy Generation. The schematics generated from the wire-wrap CAD design were created as annotated drawings. The drawing was printed to scale and featured the following annotations: a) relevant measurements such as the length of the wire and the radii of curves, b) construction geometries such as the bounding circles of curves, and c) axes of symmetry.

Design Rationale. Schematics aims to make perceivable the construction and planning knowledge for forming material, similar to the type of information that is encoded when an abstract design file in the CAD process is converted into tool paths in the CAM phase. These instructions can be presented as a step-by-step instruction set or as annotations on a design file. While schematics are

not novel (they act as simple instructions for the maker), they provide a different type of assistance than the other scaffolding proxies.

During the making process, schematics provide a clear feedback mechanism for practitioners to evaluate the state and trajectory of a design. This feedback facilitates a reflective practice allowing practitioners to establish a clear evaluation metric to generate knowledge from “external actions that test, move, and probe stimuli that offer feedback to internal representations.” This evaluation metric evokes a hylomorphic way of making in promoting a singular form to emerge from the creative process.

Workshop Results.

Tacit Knowledge Gaps I observed significant variability in how participants planned, ordered, and executed their bends. Experts recognized that the loopends would require the most handling of the wire and elected to form these first. Novices chose first to begin shaping the larger heart-curves often not allocating sufficient material to create the loops at the end.

Sanity and Reflective Checks Since the schematic was printed to scale, many participants used it as a way to evaluate the correctness of their design. The wire was simply placed on the schematic and compared against the target form. This simple act took on two different forms: for novices, this comparison served as a *sanity check*, a verification that the participant was moving towards their target goal and not encountering errors. Sanity checks were used to match each bending step to visually approach the final design. If an element was accidentally misplaced, it would immediately be corrected. For experts, this action served as a *reflective check*, a reflection on how their bending actions affected the forms.

Risk and Deviation The schematic did not provide any physical assistance with manipulating the wire. Participants unanimously expressed a higher risk associated with schematics from needing to rely on the dexterity of their hands.

This perception affected the creative freedom associated with schematics. Deviating from the schematic design was viewed as too risky. Schematics elicited more proactive planning, or considering actions based on anticipated outcomes.

Participant Novice #1: I always worry about the symmetric part. That’s when I didn’t have control. I was particularly intimidated by [hand tools]. Hand tools are so free form . . . I didn’t know where to begin. I realized that I had to minimize the amount of contact I had with the wire.

The wire, initially work-hardened straightened with nylon pliers, would incur additional marks, mars, and imperfections from too much interaction with the hands. Participants likened this experience to the wire becoming “stale.” Novices used the sanity checks to develop confidence in their wire wrapping skills, but carefully and cautiously planned each step.

Evoking Craftsmanship Experts took the schematic as an opportunity to demonstrate their craftsmanship and mastery of the wire by attempting to replicate the intended form perfectly. Experts were more likely to use the schematic as a reflective check notably using the schematic less frequently while their wire forms took on intermediate forms. Experts were more prone to make movements meant for making shaping the wire easier:

Participant Expert #3: I'm not going to worry about that now. I know that I can make it look fine in the end; I need to focus instead on these [endloops] first.

5.9 Workshop Evaluation

The main goal of the workshop evaluation was to obtain qualitative feedback on how each scaffold proxies affects the making process. I anticipated that this experience would differ based on previous metalworking experience and structured our study design to elicit feedback from both novices and experts. The questionnaires, interview guides, and study protocols used in this study are available in Appendix B.

Participants. A total of 6 expert practitioners and 6 novices practitioners were recruited to participate in the workshop evaluation⁷. Participants were recruited from an internal mailing list at Adobe Systems and the surrounding community via Craigslist. The average age of the participants was 32 ± 8 (8 female, 4 male).

Procedure

The workshop exposed users to each of the three different scaffolds described in Section 5.8 with the same design prompt. The workshop lasted for one hour and consisted of a warm-up tutorial, shaping wire with each scaffold, and a post-study interview.

Setup. Participants were seated at a work table with the following tools: a ruler with mm/in, calipers, cutting mat, a rubber anvil and hammer, a permanent marker (Figure 5.16). Each participant was allowed to choose from three different-color spools of 16 gauge copper wire or 14 gauge aluminum. For each task, the following set of hand tools were made available: a flush cutter and [chain, barrel, taper, bent, nylon] – nose pliers.

Warm-up Task. To minimize newness effects, a small warm-up task introduced each tool and asked participants to make an “S” shape with no constraint on size; participants were required to cut, straighten, and bend the wire into shape using any of the tools. Lastly, I demonstrated how to use a shaping proxy for an unrelated design – specifically how to anchor a wire, follow the jig path, remove the wire, and flatten the final form with a rubber hammer.

⁷ Expertise was determined from self-reported 5-point Likert values on experience with crafting, metal, jewelry, and digital design tools. Participants reporting experience above neutral were labeled experts

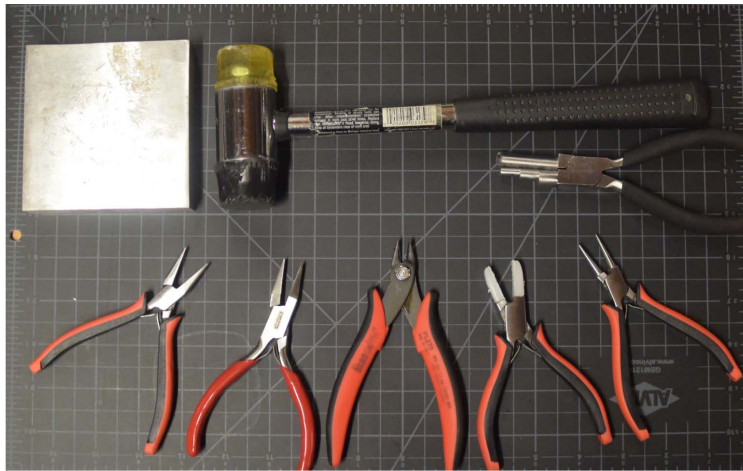

Figure 5.16: Study Setup

Scaffold Task. Each participant was tasked with shaping wire into a suggested heart form with each scaffold proxy. The task brief explicitly informed the participant that they could deviate from the specifics of the design, but that the final form should resemble a heart. The scaffolds were each presented in turn with the ordering block randomized. Between each task, participants filled out a questionnaire.

Participants were asked to think out-loud and relay their thoughts on the tools, their design process, and specifically their plans for construction. Participants were allowed as much time to complete each task to their satisfaction. All sessions comfortably fit into the allocated hour.

Metrics

Previous HCI research on creativity support has introduced several ways of characterizing how physical tools can support creative practices [124, 185, 226]. I derived metrics from this body of work to evaluate the experience of using scaffolding proxies. Participants rated their experience after using each scaffold using five-point semantically anchored Likert questions (1=Strongly Disagree, 5=Strongly Agree) :

- **Usability** – The *proxy* was usable.
- **Error** – I made many errors using this *proxy*.
- **Transparency** – I was unaware of the *proxy* when I was working with it. Transparency addresses the awareness of a tool during creative practice [124]. A highly transparent tool (e.g. keyboard) can act as a conduit; a less transparent tool (e.g. high-powered chainsaw) can add risk yet augment the workmanship potential of a craft.
- **Control** – I had control of the wire using the *proxy*.
- **Creativity** – I felt I had creative freedom with the *proxy*.

- **Quality** – I am happy with the final design.
- **Agency** – Given a *proxy*, I feel capable of making my own customized designs.

The questionnaire additionally asked participants to rank the three scaffolds in terms of speed and quality of design.

To describe the creative session, I took an informal measure of *flow*, or the absorption with the activity at hand. Flow is a common metric for measuring engagement [35] and while various methods exist for assessing flow, many techniques leverage Experience Sampling Method that has the potential to interrupt a creative workflow [36]. I focus on one measure of flow – temporary loss of time – which can be measured unobtrusively. I calculate **flow** as the difference between perceived and actual completion time such that if a participant completes a task in 11 minutes, but perceived it as taking 4 minutes, I denote a flow measure of -5 minutes.

Analysis

I used a within-subjects 2x3 factorial study design with two factors: **experience**, with two types - novice and experts; and **scaffold**, with three types - jigs, stencils, and schematics. Each participant completed the same design using each of the scaffold types. The order of the scaffolds was counterbalanced using a Latin square. Twelve participants completed 3 tasks each for a total of 36 tasks completed all together. Due to a small sample size and semantically anchored scale data, I look at descriptive statistics.

For qualitative analysis, I transcribed the think-aloud protocol of each session, the post-study interview, and reviewed study notes describing participant construction patterns for each scaffold. This data was axially-coded; I specifically annotated instances of planning and wayfaring. The resulting codes were refined and synthesized into themes presented alongside scaffold descriptions in Section 5.8.

5.10 Results

I first report quantitative results from the workshop session and the study questionnaire.

Session Results

Overall, each session statistic is described in Table 5.10 and reflects the unique and diverse creative sessions with each scaffold.

Completion Time (min)	Quality (Rank)	Speed (Rank)
Jig (6.2 ± 2.0)	(1.3 ± 0.8)	Jig (1.0 ± 0)
Schematic (7.8 ± 3.3)	(2.3 ± 0.5)	Stencil (2.3 ± 0.5)
Stencil (10.4 ± 3.1)	(2.4 ± 0.7)	Schematic (2.7 ± 0.5)

Sessions varied widely in completion times from either participants dealing with or recovering from error or engaged exploration. Stencils, which had the longest average duration time, was also the scaffold in which many participants chose to deviate from the original form. The more open-ended exploration of wire forms caused many participants to have trouble finding a place to stop. Participants agreed that jigs allowed them the quickest and most accurate wire forms; the result from the jig was used as a gold standard since the criteria for quality, as self-reported by participants, was symmetry, smoothness of curves, and low marring or blemish on the physical wire. Despite jigs consistently ranked above the other scaffolds, participants reported a different and valued experience with each scaffold. These qualities are described alongside scaffold descriptions in Section 5.8. The results are mirrored from Likert responses to usability and quality (Table 5.10, only total averages are reported due to similar responses between novices and experts).

Scaffold	Usability	Quality
Schematic	4.1 ± 0.7	3.1 ± 0.9
Stencil	4.0 ± 0.5	3.6 ± 0.9
Jig	4.5 ± 0.5	4.3 ± 0.7

Questionnaire Results

Summary statistics for responses for the questionnaire are reported in Figure 5.17. I then discuss interview responses in the context of specific observations and insights from the study.

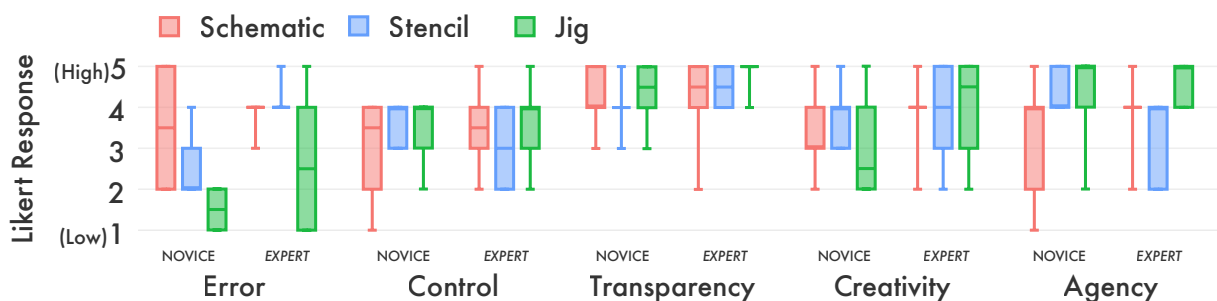

Figure 5.17: Questionnaire Results

Error. Compared to other scaffolds, wires shaped with the jig were subject to an additional level of scrutiny. Slight imperfections in symmetry were viewed as major flaws, whereas in the other two scaffolds such asymmetry was embraced as a “handcrafted” look. The amount of guidance the jig gave them changed the narrative of agency. When responding to error, users attributed the error to the jig; whereas, in the stencil and schematic condition, they blamed their own skill. One user vocalized that she did not view the jig as a tool, but as an extension of her hand:

Participant Novice #3: I relied on my hands mostly, not the hand tools. For me, the jig was the hand part.

Control. As anticipated, experts reported a greater experience of control than novices in the schematic condition, specifically when working with only hand tools. This difference in perceptions of control suggests that, as anticipated, there is a stage where a practitioner develops confidence when working with new materials. In providing fabrication assistance, jigs and stencils provided elements of this control.

Transparency. All three scaffold types were reported to blend into the making process, where participants placed much more focus on the wire. For experts, using the schematic to evaluate their design against reintroduced awareness in this scaffold.

Creativity. There was no notable difference in the creative freedom users associated with each scaffold. For each scaffold, participants found a way to reappropriate control of the wire form and deviate or otherwise find creative value from the design. Although novices reported less creative freedom with the prescribed form of the jig, they would, if successful, be elated at being able to make a professional-looking form. In particular, experts reported more creative freedom over novices for all scaffolds, suggesting that paths for deviation were more visible with background knowledge of wire wrapping.

Agency. In reflecting on their ability to make custom designs with each scaffold, participants felt more support and ability in using jigs. For novices, stencils provided both assistance but also invited enough creative curiosity to continue making forms. Experts showed more preference for the unrestricted fabrication that schematics offered.

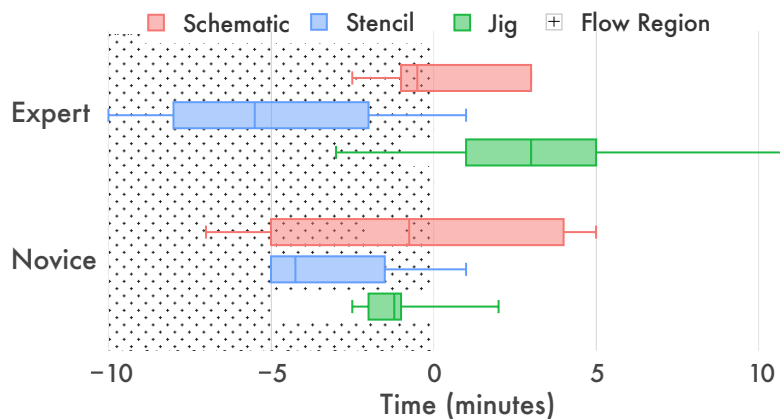

Figure 5.18: Flow as a measurement of engagement. The boxplot depicts the difference in perceived and actual completion time. Areas in the texture '+' field indicate the participant lost track of time.

Perceptions of Flow. Flow was calculated for each scaffold session and is depicted in Figure 5.18⁸. Sessions with negative flow indicate a larger effect on time perception and a stronger experience of “losing track of time” and engagement. While all scaffolds existed at some degree of flow, stencils had a noticeably larger effect with engagement for both experts and novices. For experts, jigs were found to be less engaging. For novices, schematics had a large variance in eliciting flow, especially since these sessions had mixed results with users being able to accomplish wire-bending goals.

Study Observations

Construction fixation. The within-subjects study design exposed all participants to each scaffold. While the scaffolds were presented were block randomized, I observed a relationship between the first scaffold presented to users in their workshop session and the way participant’s constructed their design using the **schematic**. Notably, the schematic did not enforce a specific construction strategy. I depict these construction patterns in Figure 5.19.

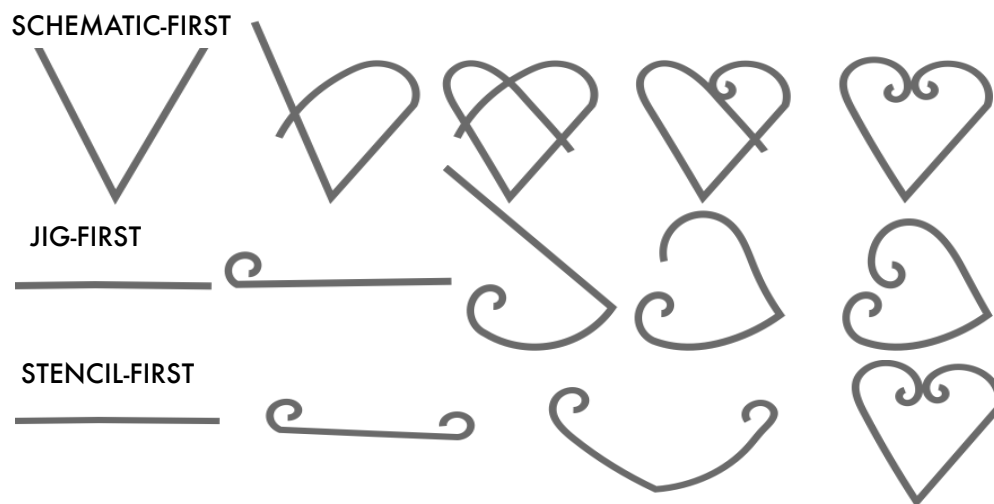

Figure 5.19: Construction patterns were highly dependent on the first scaffold that was presented to participants. Schematic-first users moved with step-wise similarity, jig-first followed a linear progression, while stencil-first compartmentalized forms – an expert trait.

- Schematic First - These participants moved closer to the final design with each step. However, if a step did not bring the design closer to the desired form, these participants would become more apprehensive and stop manipulating the wire as freely.
- Jig First - These participants followed a linear construction pattern, i.e., starting by forming one end of the wire and progressively shaping the rest of the wire, often being unable to

⁸ Time perception follows a *linear* Weber law with median $k = 0.77$ [5] which suggests that we would still see similar (albeit less profound) trends if we adjusted for perception error.

allocate enough material to achieve symmetry successfully. This construction pattern follows the construction strategy of the jig proxy, where a design is built up from end to end.

- Stencil First - These participants compartmentalized their construction into stages, isolating the more complex endloops, establishing symmetry with the heart curves, before finally introducing the heart bend. This strategy minimized the amount of interaction between different components of the design.

This priming effect suggests a construction fixation, or a cognitive bias that limits a person to construct a design in a prescribed way. This bias presents a unique opportunity for the design of making tools: *construction methodologies can be influenced by computational proxies to encourage expert best practices.*

5.11 Discussion



Figure 5.20: Wire-wrap Artifacts of Expert Participant 4

Facilitating a Morphogenetic Workflow

Despite some scaffolds encoded only a single form, the workshop revealed ways form-generating behaviors could emerge with physical proxies. The perception of the jig as a guaranteed success encouraged many participants to creatively reappropriate the mode of production offered by the jig. Participants deviated from the prescribed ordering of the jig or used helper geometries in their designs. Already commonly used in digital fabrication practices, templates offer a guaranteed success, however unlike the jig that introduces cognitive bias in “viewing everything as wrappable,” a template has a more limited influence on creative actions. The jig introduced a clear cognitive bias – *wrap-thinking* – that as an element of a larger environment could support a bricolage practice.

For experts, discerning wrap-thinking was easier as deviation points were easier to discern. The act of creating ambiguity in where to start, where to go, and where to end invited this type of

thinking. Future proxies could develop methods of facilitating wayfaring and indicate to the user the multiplicity of forms that can exist, such as with parametric vase, that can ‘ghost’ its design space and give physical cues to potential deviations. Stencils were similarly viewed as elements of a repertoire. Participants negotiated emerging forms and trajectories with the variety of tools and stencils laid out in front of them.

Maintaining a Material Practice

For many novice practitioners, the experience of working with a physical material introduced significant risk — the risk of not liking their design, risk of others judging their work and abilities, risk of unwisely investing time and resources. Thus, one of the most substantial challenges in sustaining practitioners in a practice is mitigating the risk involved with making. The three scaffolds demonstrated how the perceptions of risk would change the creative goals, process, and interpretations of the outcomes.

Ritual and Practice. With jigs that minimized the most risk, I encountered behaviors similar to needlecraft, where the muscle memory of physical action reduced the cognitive load on the maker. The “mindless” act of wrapping a wire around a form introduced an element of ritual practice, instilling pleasure in the act of making in being able to produce accurate, professional results. While such an interaction may seem somewhat limiting, existing theories of making raise the possibility that even repetitive or habitual creative actions can contribute to the joy of making [124] and that merely engaging in the process of creation has “intrinsic pleasures of creative action” [151] and matching the challenge and skill needed to execute a design becomes a source of personal enjoyment [182]; such self-expression has large socio-cultural benefits [10]. Foregrounding the spiritual and devotional qualities of a ritual practice, such as gardening, has been shown to be made possible through electronically augmented tools that make practitioners aware of their repetitive actions and movements[90]. For creative development, sustaining a practice is central to transitioning from everyday creativity (little-c) to professional creativity (pro-C) [100]. Incorporating ritual elements is a method to reduce risk, develop familiarity and comfort with a material, and behaviorally engage the body in sensemaking.

Who’s to Blame? Failures, or the subjective emotional experience caused by the interpretation of error as unrecoverable, can yield negative attitudes towards continuing or pursuing a practice [194]. In the workshop evaluation, participants had widely varying scrutiny of error and coincidentally failure associated with each scaffold. Designs made with jigs, which offered the most physical assistance, bore the highest level of scrutiny. However, with schematics and stencil, imperfections were associated with qualities and aesthetic of a handcrafted artifact. Notably, jigs were seen as an extension of the hand, yet were prescribed a level of scrutiny that would be associated with machine-made artifacts. This suggests that the agency given to a practitioner in the physical making process can be used to develop craftsmanship and resiliency towards interpreting errors as failures.

Proxy-Mediated Knowledge Transfer

The scaffolds allowed practitioners to choose their own level of fidelity and workmanship. Schematic provided evaluation criteria that participants used to sanity check their designs. Although this encouraged a modular construction process, the sanity check did not provide an opportunity for participants to reflect on the overall design process and anticipate errors. This lack of reflection suggests that the act of evaluating the validity of a design process must carry a cost or risk in order to elicit more reflective behaviors.

Extending to other Material Practices

I showed that through medium-aware design that takes into account the unique properties and cultural histories of materials, proxies can assist, enhance, and extend the wire-wrap medium. Other domains can benefit from such passive proxies; for instance, a ceramics proxy practice might involve stencils that form lathe bits for use with a pottery wheel. Because of the *passive* nature of proxies, participants found value in a proxy's non-intrusiveness and proposed a practice which follows: sketching an idea and "wrestling the material"; converting interesting forms into stencils; refining this into a final artifact. It is imprudent to disregard the new cultural histories that are arising from digital fabrication machines; works such as *Filament Sculptures* [110] that creates 3D forms from a 3D printer's characteristic extrusion demonstrate the gray area that exists between what is a tool and what is a material.

Limitations. Although the workshop captured a variety of different making styles and approaches, the evaluation is ultimately limited by the observations of a short creative wire-wrapping session. A longitudinal study could better capture the ability for different scaffolds to engage practitioners creatively. As noted in the results section, although the scaffolds were randomized in order presentation, I still observed some priming effects such as *construction fixation*. While this reaffirms a tool's influence in a bricolage practice, it also suggests that naturalistic study designs can better capture the environmental variables that are known to influence creative practice.

5.12 Summary

This chapter argued for an alternative digital fabrication workflow to the CAD-CAM pipeline that promotes a morphogenetic, or material-forward, way of making. I explored how such a workflow might operate in symbiosis with digital fabrication and a material practice known as wire-wrapping by developing a Crafting Proxies which function as an armature.

Our investigation revealed tacit knowledge that is inaccessible from sophisticated Computer-Aided Design (CAD) tools with abstracted representations of wire (e.g., Finite Element Model, bending simulations). In engaging with wire wrap practitioners, online resources, and personal practice, I discovered key techniques that professional wire wrappers employ to converse with wire including: dealing with work-hardening through *axial deformations*, a *coil-and-cutting* technique

for batch-producing similar wire forms, and a *material undo*, smoothing work-hardened bends with nylon pliers.

I developed a wire-wrapping CAD tool that incorporated and annotated a vocabulary of wire forms used in the wire-wrapping tradition and produced custom armatures, allowing practitioners direct contact with wire. The computational design for generating armatures built custom wrapping geometries around areas of high curvature; it also incorporated the *axial deformation* technique by creating a constantly rising geometry that would produce a non-planar wire shape that when pressed flat (via axial deformation) would form the target wire shape.

By changing design parameters in our algorithm, I created three variants of armatures that scaffold the type of assistance provided in shaping a wire, supporting zones of proximal development:

- Schematics - This armature presents information about a design to aid with planning actions and serving as evaluation criteria.
- Stencils - This armature modularizes components of a design and physically assists with creating variations of a design.
- Jigs - This armature assists with shaping wire with one, uninterrupted wrap, but is restricted to assisting with forming wire into a single target design.

In a workshop user study, I characterized these armatures between two populations – novice wire wrappers and expert wire wrappers – to understand how each armature affects the wire wrapping process and the design decisions that elicit a morphogenetic way of making.

The study reveals that tools that introduce a clear cognitive bias, such as in the case of stencils and jigs, are beneficial for encouraging deviation. Tools that encourage tool-switching provoked more morphogenetic actions, while encouraging ritual, or repetitive and mindful actions, were important for sustaining interaction with a material, instilling resiliency, and finding joy with the practice. I found this ritualistic quality of making to be best suited for developing wayfaring, developing a practice where the wire (and armature) more completely guide the course of action. Schematics, although the armature with the greatest potential for a material encounter, also introduced the largest potential for error. This workmanship of risk coupled with the clear evaluation metric the schematic provided served as an important motivator for eliciting craftsmanship.

From designing an armature to operate as part of a human-in-the-loop fabrication pipeline, I developed intermediate-level knowledge for how to incorporate the benefits of a digital medium (e.g., reprinting a variation, sharing a design) while facilitating a material encounter, embedding tacit knowledge as affordances, and structuring physical and cognitive assistance to create zones of proximal development. I take these design decisions forward to inform how Crafting Proxies can provide similar support but for immaterials that do not share the rich, responsive physical cues that materials like wire provides.

Chapter 6

Light Forming

In this chapter, I explore how a Crafting Proxy might be designed to act as a mediator between an immaterial and practitioner. Unlike materials like wire, immaterials lack tangibility or perceivability. I explore one kind of immaterial, light, which although perceivable is difficult to physically manipulate or compose into forms, especially in form factors such as the Light-Emitting Diode (LED). However, the LED is a staple of Maker culture and hobbyist electronics. Working with LEDs is relatively straightforward, involving a low-cost electronic component and a simple circuit to convert electrical energy into visible light. Light is a visually expressive, engaging, and captivating material, as is a testament in its ubiquity in electronics, festivals and carnivals, and urban spaces. However, the way light is used in practice with LEDs only thinly captures the full expressivity of light, but the immateriality limits how it can be used by material practitioners.

I apply a compositing strategy, previously demonstrated to be successful for immaterials like computation [201], and apply it to other immaterials in order to understand how compositing as a design strategy can be generalized. Compositing uses a physical material as a proxy, binding it to an immaterial in order to remap its behaviors, forms, and structures into physical cues. Using light as our immaterial of interest, I describe the design of a luminaire design tool that facilitates interactions with light as a craft material¹.

I first distill a conversational profile by surveying how different communities of practice have worked with light and through a formal analysis of light artifacts. Since light is a visual and reactive material, a host of physical materials can serve as proxies. In this design process, I introduce a *composability design stage*, developing computational design algorithms for configuring how light and reflective and refractive materials can be configured to orient, bend, shape, diffuse, and compose light (via Secondary Optic Elements (SOEs)). I describe how coupling these algorithms with an open-ended design tool can support knowledge production in a material epistemology.

¹ Elements of this chapter were previously published in: Cesar Torres, Jasper O’Leary, Molly Nicholas, and Eric Paulos. “Illumination Aesthetics: Light As a Creative Material Within Computational Design.” In: *Proceedings of the 2017 CHI Conference on Human Factors in Computing Systems*. CHI ’17. New York, NY, USA: ACM, 2017, pp. 6111–6122. DOI : 10.1145/3025453.3025466.

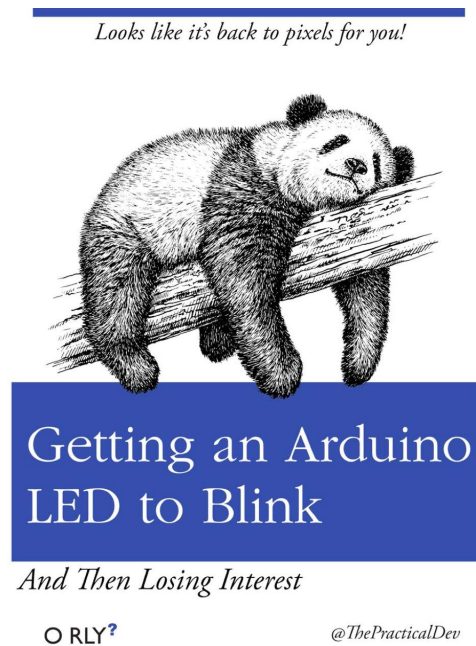

Figure 6.1: @ThePracticalDev Community - O’rly Book Cover Generator

6.1 Introduction

@ThePracticalDev community captures the sentiment of working with LEDs with their satirical technical book cover: *Getting an Arduino LED to Blink ... and Then Losing Interest* (Figure 6.1). As the “Hello World” of physical computing, controlling an LED is a rite of passage for many practitioners entering the practice, yet unlike programming’s “Hello World” that leads to a repertoire of richer programming concepts, the LED’s repertoire of available forms is limited to those included in the Arduino Example Library — blinking or fading.

One explanation for this lack of engagement with light is its lack of tangibility. Without this tangibility, central elements of a material practice are absent: material encounters (experiential information), wayfaring (form-generating behaviors), or material conversations (reflection-in-action). Despite several tangible elements being present *within* the LED, these elements are part of manufacturing blackbox where knowledge of internal workings (interactions between the semiconductor, phosphor, the lens, and the reflective cavity) are hidden to promote integration and ease of use. The blackbox prevents interactions with these form-giving elements relegating a user to a narrow material API, i.e., the available ways a material can be manipulated. For the LED, this API is limited to color and intensity.

However, deep practices exist that work around light’s intangibility, using its interactions with other materials to regain qualities of tangibility. For instance, one common practice is to bind an LED to an optic fiber, thereby allowing light to be bent, woven, transported, and shaped via interactions with the optic fiber. This strategy is very similar to how computation is bound to a physical proxy in computational composites [201], and provides us an important way to understand,

contrast, and extend a composite approach to other immaterials that are problematic to material practices.

Using this compositing design strategy, this work examines how we might impart material qualities to the LED to expand the available repertoire of light forms, understand how creative engagement can be elicited for light and other immaterials, and reflect on the limits of compositing as a material transformation technique.

Our design method first examines how different communities of practice use light as a material. Through a formal analysis, I examined both illuminated artifacts and workflows with LEDs to resolve how material and social factors influence how light forms emerge. I synthesize a conversational profile, acting like a persona, that informs how light can more readily communicate to a practitioner during the act of making and defines a target *light API*.

The second step of our process is improving the composability of light, i.e., the extent to which the light API can be accessed by the practitioner. Using best principles from optoelectronics literature, I created a digital fabrication pipeline for creating luminaires, a structure for powering, housing, and controlling one or more lamps, decomposed into three parts: the *control layer*, a *beam-shaping layer*, and a *diffuser layer*. Leveraging computational design techniques, I configured each of these layers to be able to capture a wider range of the light API.

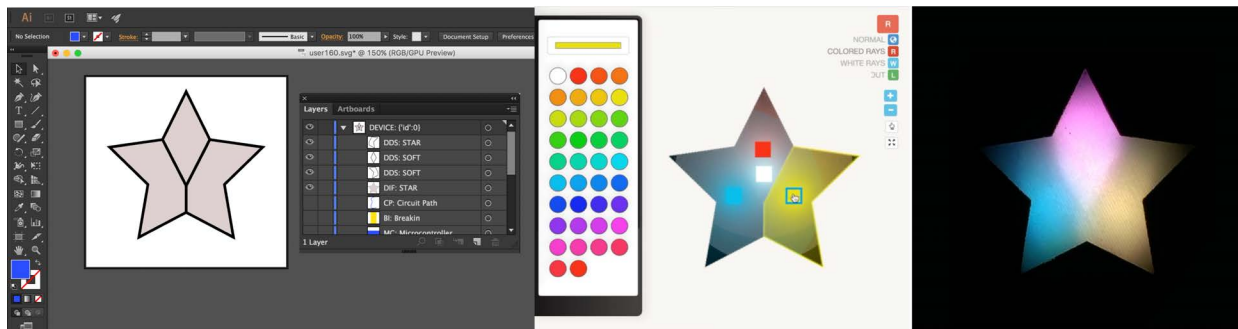

Figure 6.2: Luminaire Design Tool, Simulation Interface, and Fabricated Luminaire

The results are synthesized into a luminaire CAD tool that acts as a mediator, allowing light to be used as a craft material (Figure 6.2). Using ray tracing, I simulate light interactions with the LED and different materials to better relay the forms, behaviors, and structures of light. The fabrication then produces a set of 3D models, that when fabricated and assembled, produce a bespoke luminaire.

Using the tool, I create exemplar artifacts to annotate the range of *Illumination Aesthetics* enabled by access to an expanded light API. A workshop evaluation with 11 participants using our tool also indicates how a compositing approach communicated to participants an expanded repertoire of light forms, altered perceptions of light as a creative material, and elicited a deeper engagement with light as a medium. In summary, the contributions of this work include:

- a conversational profile of light that synthesizes the ways different communities of practice use light as a material

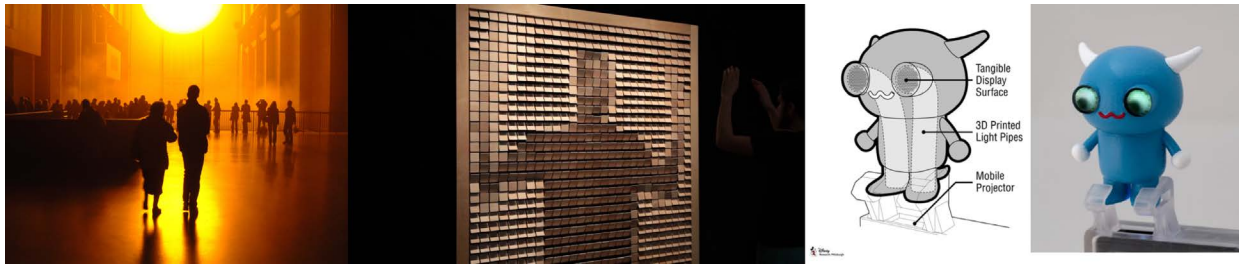

Figure 6.3: (left) Olafur Eliasson, *The Weather Project* (2003), (center) Daniel Rozin, *Wooden Mirror* (1999), (right) Printed Optics [210]

- a luminaire CAD tool that exposes a more expressive light API for manipulating and forming light and operationalizing the concept of an Immaterial Mediator
- exemplar artifacts that annotate novel light forms
- a thematic analysis of the creative process of 11 participants using our tool

The findings of this work are used to reflect on how configuring the LED as a composite adheres and challenges computational composites. This is used to inform design implications for a generalized compositing method that can be used for a range of different immaterials.

6.2 Related Work

A diverse community has explored methods of form-giving with light. We organize these related works based on how light is manipulated and then describe the experiential qualities of the resulting forms.

Refraction

Refraction refers to the bending of light caused by light waves traveling at different speeds between mediums of different densities. Refraction behaviors follow Snell's law where light is deflected at the interface of media A and media B, according to:

$$\frac{\sin \theta_A}{\sin \theta_B} = \frac{v_A}{v_B} = \frac{n_B}{n_A}$$

where θ_A is the angle of incidence, θ_B is the angle of refraction, v_X is the respective velocity and n_X is the respective index of refraction of waves in medium X.

As a form-giving element, practitioners make use of light's refractive qualities to blur and distort vision. In Eliasson's *The Weather Project*, a fine mist of water refracts light and is used to materialize moving indoor weather formations [45].

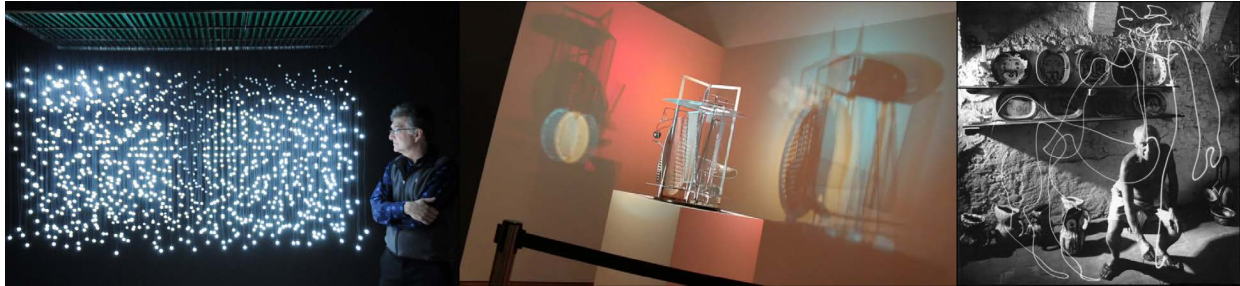

Figure 6.4: (left) Jim Campbell, *Exploded Views* (2011), (center) László Moholy-Nagy, *Light-Space Modulator* (1930), (right) Gjon Mili, *Picasso draws a centaur* (1949)

Light Tubes. By configuring a material with a lower refractive material, or *cladding*, around a material with a higher refractive index, or *core*, a phenomenon known as total internal reflection causes light to be confined within the core material. As the basis for fiber optics, total internal reflection is used to transport light (and respective images) across distances. Early work by Disney Researchers used fiber optics to transfer images from a projector into animated heads allowing dynamic images to register on diverse surfaces [113]. Willis et al. [210] further demonstrated the feasibility of 3D printing light pipes and lenses within geometries to channel light and create novel illumination and sensing capabilities. By bundling light pipes and routing them through a structure, this technique has been shown to create screens on both spherical geometries [21] and arbitrary geometries [147]. The resolution of this display technique is largely dependent on the density of light pipes. Ultimately, each individual light pipe terminates and forms a pixel. The dominant resulting form is a screen which inherits the experiential qualities of television and the motion picture.

Lenses. Lenses are comprised of a repertoire of specific geometries that leverage refraction to precisely focus, collimate, or redirect light rays. The range of possible beam forms is expanding with advances in optics, including double-cylindrical lenses to shape light into rectangular beams [30] or micro-array lenses to homogeneously diffuse light [174]. In a computational design process, Papas et al. fabricated lenses with refractive geometries to hide, reveal, and obfuscate images placed directly underneath [142]. This process utilized simulated annealing to optimize facet geometries to refract light in a pre-described manner. Readymade-lenses, embedded with magnets, were demonstrated to enable a wide range of tangible interactions with printed images [111].

Reflectors & Reflection

For reflective properties, Matusik et al. [123] demonstrated the feasibility of matching Bidirectional Reflectance Distribution Functions (BRDFs) with linear combinations of reflective inks. Utilizing the subtle reflective properties of wood, Daniel Rozin's *Wooden Mirror* actuated a grid of small wooden "pixels" to different orientations to create changes in value and form images [167].

Shadow-Creation

In *Exploded Views*, Jim Campbell creates three-dimensional animated shadows by controlling the intensity of several light sources suspended in a dense irregular grid [25] (Figure 6.4). Using a single light source and occluding resin geometries, Kumi Yamashita shapes light and shadow into complex forms [217].

Dynamic, Reactive, and Motive

Dynamic light has been explored in early work such as László Moholy-Nagy's *Light-Space Modulator* which spun reflective geometries to create visceral moving light installations [129]. Through long-exposure photography, the persistence of light was captured as a drawing and painting medium in influential works like Gjon Mili's *Picasso draws a centaur* [64].

As an interactive medium, the active, changing nature of light affords playful, information-rich interactions. Harrison et al. surveyed the design space of point lights in modern devices, notably linking common actuation behaviors ("On w/ Bright Flash") to functional evaluations ("Notification") [73]. Design work in this space has also explored light as an active patina, assigning visual light patterns to recorded user interaction history and activity with a tabletop surface [59]. Interactive objects have also been enabled by sensing changes in light through embedded optomechanics [21, 147, 210]. I see our technique working in tandem with optomechanical sensing, although I focus on expanding illumination aesthetics to enable even richer interactions.

Space-Filling

Notably, these works demonstrate a material and space-driven exploration of light. Utilizing projected light, James Turrell influences a viewer's depth perception by simulating 3D forms on 2D spaces (*Shallow Space Constructions*) [197].

Symbolic

Light has also been explored conceptually; most well known in this space, Dan Flavin created light objects that function as systems of investigation [50]. Pierce et al. further described other phenomenological dimensions of light in electronic objects as tied to the object, its material, and its source [150]. Our work particularly explores the design dimensions of illumination afforded through the optical manipulation of light. Light has been shown to afford emotional reactions and interpretations in objects such as luminaires [81].

6.3 Conversational Profile

To identify the conversational profile of light, I conducted a formal analysis [133, 11] to distill how form-giving elements are "arranged and function within a composition." I specifically delineate the different established traditions and practices across three light artifacts: the electronic light

(a simple LED, RGB LED), the computational light (a computationally-controllable LED), and material light (exemplar uses of LEDs as a craft material). Our analysis approaches these materials from a craft lens, focused on mapping the range of expressions encountered with that material with the underlying rationale for *why* such expressions are chosen.

Electronic Actors: The LED

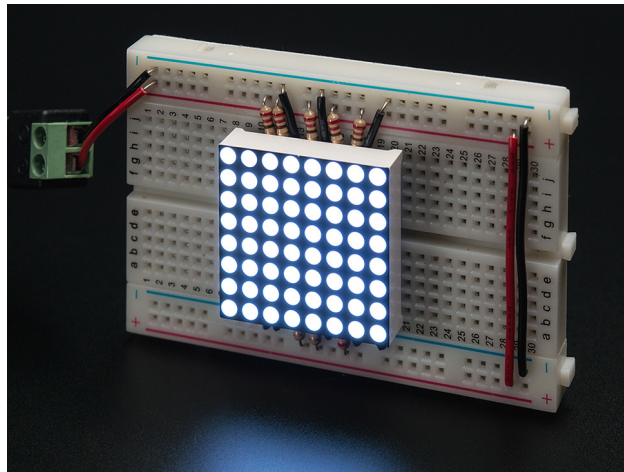

Figure 6.5: Adafruit LED Matrix (1613)²

The LED, or light-emitting diode, is a common electronic component found in hobbyist electronic toolkits is often found unlabeled or packaged in grab bags. Simple LEDs activate a semiconductor that emits photons with a specific emission spectrum, or color, when an electrical current is applied. By combining multiple semiconductors with different emission spectra (typically a red-, green-, and blue-dominant spectrum) within a single package, an RGB LED can be configured to emit a wider gamut of colors by controlling the intensity of each semiconductor component.

Integration. Introducing an LED into a circuit is relatively simple when electronic parameters are known; however, most packages do not encode this information. Common heuristics are used to acquire these parameters, limiting the current flow by introducing a $500\ \Omega$ resistor in series, applying a typical nominal voltage V_S like 5V, and measuring the forward voltage drop V_F [112]. Lastly, a resistor is integrated to act as a current limiter to the common operating current (10-30 mA) range as follows:

$$R_S = \frac{V_S - V_F}{I_F}$$

² <https://www.adafruit.com/product/1613>

Control. Introducing a variable resistor, such as a potentiometer, allows the current limiter to be dynamically controlled, achieving fading or color selection (i.e., knob for each RGB component) behaviors. More complex configurations use a pulse-width modulation (PWM) controller to send a square wave that powers the LED on and off; at specific frequencies, these on-off pulses are perceptually averaged, allowing the LED intensity to be controlled in a fashion similar to a potentiometer [42].

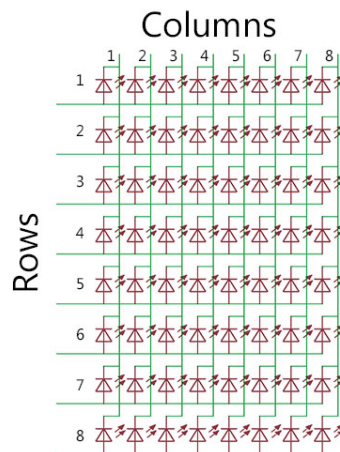

Figure 6.6: The Matrix Circuit Pattern. A circuit pattern for selectively controlling an LED.

Controlling more than one LED is expensive, requiring an individual control line for each LED. Alternatively, LEDs can be arranged in a matrix configuration allowing control to be specified with a common row and column input (Figure 6.6). This configuration reduces the number of input control pins to the number of columns and rows in a matrix. LED drivers and shift registers simplify the control logic for this configuration and are the basis for controlling screens, or high-density matrices of LEDs.

Expression. The LED thus offers the following parameters for controlling the expression of light.

- **Luminous Intensity** - The intensity of light produced by the LED is controlled by altering the current with a resistor or changing the duty cycle of a pulse-width modulated (PWM) signal to an LED.
- **Color** - The emission spectra is controlled by changing the intensity of three LEDs in a package (red, green, blue).
- **Viewing Angle** - Most LEDs contain lenses that shape and direct light across large distances (LEDs are typically manufactured for large screen applications); commonplace LEDs have viewing angles around 30° or 60° ; most LEDs have a non-uniform light distribution with most

of the energy produced directed in the $0 - 10^\circ$ range. The restricted viewing angle influences many designs to express the formal aesthetic of a point-light.

Forms. In interactive installations and e-textiles, light is often overwhelming – interactive lights are especially attention-grabbing, restricting the audience’s attention to these elements without reflecting on the other formal elements in the structure. When LEDs are integrated with passive mediums, they express a sensation of "being tacked on" not fully integrating into the passive material space. Through its fast, instantaneous changes, LED’s propensity to grab attention matches the high-energy social events like concerts and music performances and fails to communicate a "preciousness" that other materials like wood and leather share.

Dissemination. Photographing LEDs is notoriously difficult since taking a photograph head-on, in the direction of the viewing angle, causes most camera sensors to overexpose; even high-dynamic range photography cannot adequately capture the experience of light in a space. This limits the communicability of different light configurations.

The complexity of the matrix and LED driver circuit influenced the growth and use of readymade dot-matrix and 7-segment displays. Due to the complexity of circuit traces, dedicated circuit boards are needed and available from commodity electronics manufacturers, but the majority use a standard matrix layout.

Computational Actors: the Smart LED



Figure 6.7: Luminous LED Strip Light, a commodity smart LED strip³.

³ Image Credit: Luminous from <https://www.luminousindia.com/75w-led-strip-light-1222.html>

Configured with a microcontroller, LEDs can be controlled computationally powered, typically powered by a general purpose input-output (GPIO) pin configured to output a PWM signal, emulating the previous electronic configuration. Smart LEDs offset elements of this computational control directly onto the LED package.

Integration. The main restriction for using LEDs with a microcontroller is the need for 1:1 control lines; smart LEDs significantly reduce the number of control wires to one or two. By connecting LEDs to each other, LEDs form a communication strip that propagates information down the linked structure.

Control. Many smart LED control mechanisms employ a two-wire communication protocol (I²C or SPI) or single-wire communication to individually control many LEDs. This physical architecture aligns with the data structure used to program them (e.g., an array). While greatly simplifying physical setup, smart LEDs introduce an initial digital configuration step before anything is physically experienced, limiting its potential to support a material encounter.

Expression. With programmatic control, smart LEDs expose an light API that provides a streamlined control interface for controlling RGB components. This allows practitioners to control and intensity. Commodity LEDs provide 8-bit or 12-bit resolution of intensity values. However, these values are mapped to physical intensity, existing in the language of the hardware, as opposed to mapping to perceptual intensity.

Forms. When coupled with a microcontroller, the LED and computation form a computational composite. Specifically, the forms, structures, and behaviors of computation emerge as physical cues. For instance, a common interaction aesthetic is for LED signs or products to cycle between red, green, and blue colors. The computational forms are exposed when experiencing the LED sign – the deterministic cycling expose a computational loop; the alternations between red, green, and blue expose an array data structure ([R, G, B]). This lighting behavior represents one of the light form that requires the least amount of resistance from the computational material.

However, having colors represented in RGB space biases the colors that are used in light forms. For example, red, green, and blue are simply one channel at maximum output, but choosing a color like yellow (RGB = (255, 255, 0)) is more difficult to remember and implement. While a straightforward process (looking up the color on an RGB table), the additional effort in carrying out this action restricts the readily available behaviors, influencing many RGB designs to be biased towards red/green/blue behaviors.

A quality of the computational material is also exposed by the RGB cycles – digital atomicity. Atomicity refers to "an operation appears to occur at a single instant between its invocation and its response". This term is coincidentally used to refer to database transactions that "are guaranteed to either completely occur, or have no effects". In the RGB cycle, the fact that the previous red state does not interact or interfere with the oncoming green state is a byproduct of the atomicity of the data structure holding the different states and the update speed of the LED. Programming an LED to

have a "residue" (or hysteresis) from previous signals is a way of encoding richer expressions that do not have a digital aesthetic (i.e., atomicity), but require a level of computational craftsmanship that is not supported by LED practices.

Dissemination. Smart LEDs are having the highest success in emerging makerspaces. The available light API, via programmatic control, as well as successful hardware form factors such as the circular NeoPixel rings have altered the landscape of LED uses to include rotational elements. Programs are easily disseminated through online communities and the established 3D models in 3D printing repositories that directly house and integrate common configurations. Coupled with an infrared control module and an adhesive backstrip, LED light strips of arbitrary length have permeated the commercial market, allowing practitioners to integrate them as architectural elements and expose a finite light behavior library.

Over the past years, we have seen a significant shift from tradition *matrix* form factors towards *ring* form-factors popularized by Adafruit Industries and the Maker community. These forms leverage recent innovations in LED design that integrate inexpensive control modules in smart LEDs (DotStar/Neopixel), allowing hundreds to be controlled via one or two data wires. These data wires need only be connected from the output terminal of one LED to the input terminal of the other. This relaxed circuit constraint, alongside flexible PCB fabrication techniques, influenced the availability of LEDs in *strip* form factors that have been readily incorporated into architecture and a host of hobbyist projects.

Mechanical Actors: *The Virg n de Guadalupe* Fiber Optic Lamp

As a counterexample to computational and electronic light actors, I describe a mechanical light artifact found in a fiber optic lamp. Depicted in Figure 6.8, the *Virg n de Guadalupe* Lamp (depicted in 6.8) was encountered in Albany, CA at a local lighting shop. The lamp features a religious effigy, popular in Latin American households, surrounded by a glow surface halo⁴.

Integration. Light originates from a single, higher power lamp secured beneath a rotating plastic disk. Above the disk is a bundle of fiber optic cords that transports light from the bulb to the other edges of the halo. The fiber optic strands *texturize* the light, terminating at different lengths and created a clusters of small pixels at the edge of the effigy’s halo.

Control. Color is controlled by a rotating a tinted plastic disk that sits between the lamp and the fiber optic bundle. Light passes through the tinted disk, “becomes colored,” and then is transported by the optic fiber. The sequential motor rotates the disk at 5-6 RPM. The patterns on the disk are used to control the duration of a specific color, using the arc of a pie slice. Since the optic bundle

⁴ Light has often been connotated as a religious material; in primarily candle-lit medieval churches, gold leaf on paintings would create a glowing surface that contributed to an otherworldly quality of the subject; the flickering of the candlelight added to a vital quality [71].

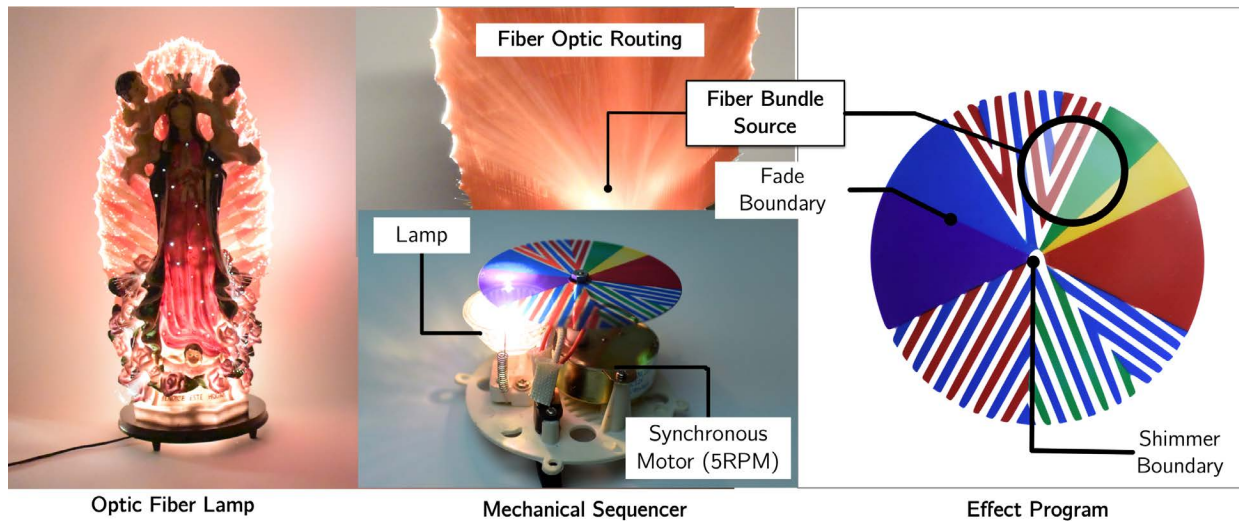

Figure 6.8: A lamp of the *Virgen de Guadalupe* cast in resin and inlaid with fiber optics. (center) A mechanical stepper motor rotates a stained glass disk above a lamp bulb; fiber optics capture the colored light acting as a sequencer. (right) A light sequencer program; the fiber optics bundle "reads" in light passed through a colored disk. Manufacturer unknown.

"reads" the light values as a circular input head, the transitions between two colors are faded (with only a few fibers picking up the color transition, followed over time by the rest of the fibers).

Here, I see several similarities to the computational LED — the rotating plastic disk acts as a *program*, encoding color instructions over time; the sequencer motor acts as a *control loop*, cycling through the instructions; the optic fiber acts as a hybrid *data structure* where each fiber is mapped to an area in physical space.

Expression. Despite having similar mechanisms as a computational program, a mechanical program allows behaviors to emerge that “go against the grain” of the computational program, similar to how placing coordinate systems from Cartesian to polar facilitates working with conic systems. A different class of expressions are available through the mechanical program: first, it operates at a different scale – individually programming the moment-by-moment behavior of each virtual strand LED would be a very tedious task; secondly, adding a fade in and out behavior would introduce significant bottlenecks on the computational processor – this computation is offloaded to a simple linear gradient on the tinted plastic disk program.

Forms. Because of fiber optic’s light transporting properties, light follows the patterns of the strands, materializing light in a wire form factor. These fibers are used to create streaks of light that terminate in bright points (from light escaping the fiber optic). Although a point light, similar to what we expect with the LED, these point lights are composed within a larger light composition, from the light forming a *glow surface* in the base cavity or from the refraction of light escaping the fiber optic strands. The configuration of a circular optical read head and pie-slice program

allows colors to transition gradually, unlike the sharp binary effect of digital atomicity found in computationally-controlled LEDs. Through pattern variations in the pie-slice program, different *light shimmer* behaviors express an ethereal quality to the overall lamp aesthetic.

Dissemination. Significant integration costs (proper configuration of the motor, optic bundle, lamp) restrict the use of light with mechanical actors, however the synchronous motor as sequencer is common pattern in optic fiber lamps.

Light as Craft Material

I analyzed artifacts that used LEDs with different material actors, each contributing to understanding the conversational profile of light and areas in which the expression of light is restricted. For the LED, the weight of digital actors (the microcontroller, programming) and electronic actors (the potentiometer, PWM generator, matrix configuration) outweigh the role of light as an actor. Restricted to light API of a hard-coded viewing angle, color, or intensity, light acts as a second-class design citizen in these configurations. This is further exemplified by the ubiquity of designs with point-light forms.



Figure 6.9: An LED was cast in acrylic resin (PMMA) using a packing plastic as a mold. As the resin cured, gases produced from the chemical reaction attempted to escape but were captured, forming bubbles. Light emitted from the LED interacts with these geometries, refracting and reflecting to form light gradients, shadows, and textures.

The fiber optic in the *Virg en de Guadalupe* Lamp serves as an exemplar of a deep practice with light; its more expressive qualities are mediated by its interactions with other materials including the fiber optic and the rotating program disk. In this way, the intangibility of light, which although a physical phenomenon, cannot be used as a material by itself. Through its interactions with other materials, light is made tangible. To communicate this insight, Figure 6.9 depicts an early experiment with casting an LED in an optically clear resin. The casting process used a discarded plastic tray as a mold. The process was imperfect with several bubbles forming during the resin curing process, however these trapped air bubbles created geometries that refracted light emanating from the LED. Furthermore, the opportunistic shape of the mold from the discarded tray yielded a geometry where some light rays surpassed the maximum angle of incidence, trapping the light and creating a *edge illumination*. Through its interactions with the refractive material its geometries, light was made tangible allowing new forms to emerge — creating shadows, filing space, and forming soft and hard edges.

From our formal analysis, I build and expand on four light behaviors lighting designer Brad Hindson [79] advocates are underutilized in design. I use the following **Conversational Profile of Light** displayed in Table 6.1 to guide the design of our Crafting Proxy.

Light is Refractive and Reflective	Light can be bent and redirected through both the intrinsic properties of a material and its underlying geometry. I see these properties manifest in reflectors for creating spotlights, in fiber optics to transport light, in lenses for collimating lenses to travel longer distances, or in the transparent faceted gems of a chandelier.
Light is Sharp and Soft	When light interacts with a surface, it can scatter create soft diffuse forms, or it can be focused to create sharp boundaries. Surface properties play an important role in defining this interaction, found in diffusers like lampshades or through the use of lens geometries.
Light is a Shadow Creator	Light is an interplay between illumination and shadow. Shadows are found on a gradient (e.g., the darker <i>umbra</i> , or inner cast shadow and the lighter <i>penumbra</i> , or outer cast shadow). The perception of brightness is mediated by the <i>simultaneous contrast effect</i> , or the perception of intensified difference when two contrasting stimuli are juxtaposed, and <i>brightness constancy</i> , or the effect of objects having the same level of brightness despite changes in global illumination [65].

Light is Space Filling	Light can fill a small cavity or an entire room. Light is an architectural form that can transform spaces. Descottes et al. [37] describe six principles that facilitate the dialogue between light and space – illuminance, luminance, color and temperature, height, density, and direction and distribution.
Light is Dynamic and Reactive	Light is reactive, responding to the most minute changes in its environment. We see elements of this reactivity captured in the <i>shimmer</i> mechanical light sequences of the optic fiber lamp. While the dynamicity of light is often relegated to an on/off switch or dimmer or Christmas light sequences, the potential of light as a dynamic material is engrained in its reactivity. Light’s reactivity contributes to its quality of being attention-grabbing.
Light is Symbolic	Light has been used as a material across history, carrying symbolic value from its use in representing the ethereal in gold leaf paintings of cathedral stained glass, to its representation of modern innovation (i.e., the light bulb) and enlightenment, to more modern representations of technology and the techno-aesthetic.

Table 6.1: A Conversational Profile of Light

6.4 Composability: Deconstructing the LED

In this section, I explore ways of improving the composability of light, or the extent to which the light API can be accessed by the practitioner and facilitate a wider gamut of the conversational profile with light (Table 6.1). Currently, the light API is limited to brightness, color, and viewing angle.

Our approach involved decomposing the LED into its separate components and building computational design routines that gave practitioners access to the light-forming elements. When composed together, these elements form a luminaire – a device that produces, controls, and distributes light. The Illuminating Engineering Society (IES) [84] defines luminaires as consisting of: one or more lamps or LEDs, optical devices designed to distribute light, sockets for supplying electric power, and the mechanical components required to support or attach the housing.

Our computational backend decomposes these elements into three layers:

- **Diffusion** (3-5 mm): consists of materials with light scattering properties that can diffuse or produce an even distribution of light.

⁵ Image credit [right]: Ashley Hunter at 1000 Bulbs from <https://blog.1000bulbs.com/home/how-led-light-s-work>

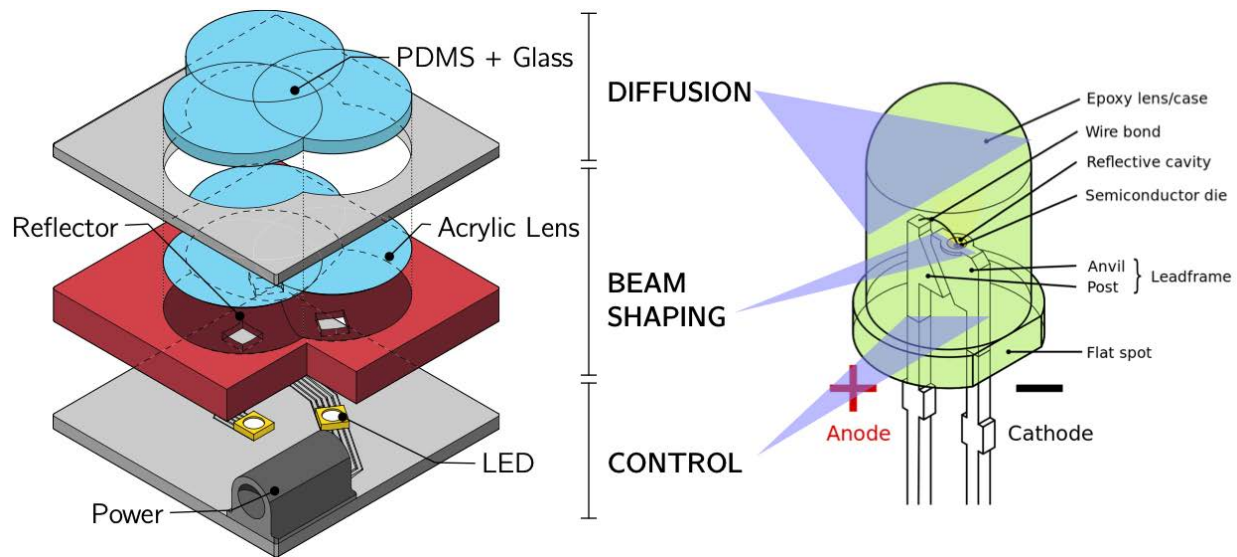

Figure 6.10: Luminaire Construction - Lamps are housed, powered, and controlled in the base level. Secondary optic elements in the *beam-shaping* layer shape light emitted from the lamps. The topmost *diffuser* controls the presentation of light using light-scattering surface properties⁵.

- **Beam Shaping** (10 mm): shapes light emitted from an LED using computationally-designed Secondary Optic Elements (SOEs) made with refractive or reflective materials. For instance, an SOE can be designed to redirect light rays to run parallel to each other maximizing the lumens over a given area (i.e., collimating lens). Appropriately configured, this lens is the driving technology that allows bike lights to be visible from a distance and evenly illuminate the path in front of them.
- **Control** (1.5 mm): composed of LEDs, a microcontroller, and a power connector on a printed circuit board (PCB).

I describe the features, computational design algorithms, and implementation details of each layer in the following sections. When then expose this expanded light API through a frontend luminaire CAD tool described in Section 6.5. This tool integrates these computationally designed components with fluid direct manipulation interactions to allow creative control of light forms.

Control Layer

PCB Layout. Inspired by the expanding control form factors of LED strips and NeoPixel rings, I created a computational layout algorithm that leverages the chaining circuit pattern to route power and control to any number of LEDs. This allows PCBs to express non-linear and non-matrix LED compositions. I expose the algorithm as a trace-assistance mechanism which produces appropriate configurable files for PCB milling, etching, or sketching, custom to a luminaire design. This mechanism automates the PCB design process, connecting LEDs using a strip-routing algorithm.

A strip represents the shortest route that connects the inlet of one LED to the outlet of another, passes once through each LED. The LED orientation is unconstrained, and, as additional tooling constraints, no path overlaps nor acute turns should exist.

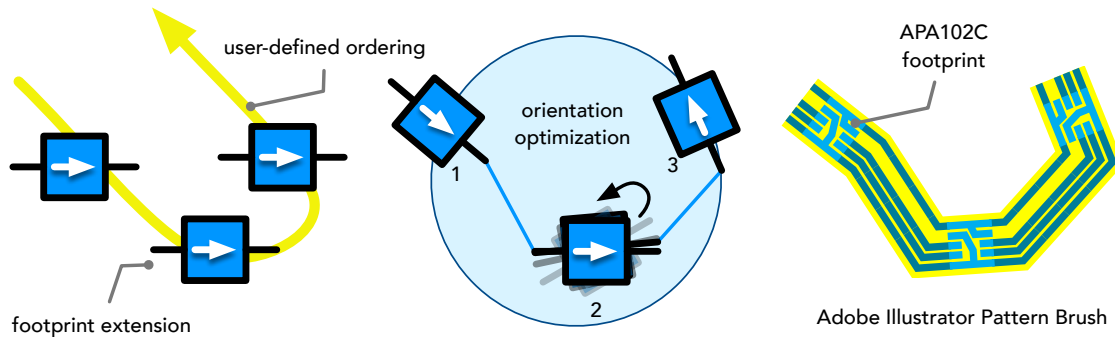

Figure 6.11: Trace assistance routine. a) user annotates SVG, b) positions are extracted and LED orientation is optimized, c) optimal path is extracted, d) design files produced for several processes, e) different substrates can be used to create rigid or flexible PCBs.

The algorithm first takes as parameters a target design (specified as an SVG) that encodes the position of a set of LEDs. Additionally, by projecting the LEDs onto a user-specified path p and sorting by path location, I obtain an ordering schema. When then carry out the following operations.

- Place the LED footprint at each LED position, extending the terminals of the footprint to prevent LEDs from resting on a curve or turn and improve solderability (Figure 6.11a).
- Generate a strip (a directed spatial graph) with 2-edge nodes at each LED terminal connected as specified by the ordering path p .
- To optimize LED orientation, I stochastically reorient each LED and reconstruct the strip. I utilize simulated annealing to guide the stochastic search, creating neighbor designs by changing the orientation of the nodes and using an acceptance probability function P conditioned on the length of the strip.

The final result is an SVG with the circuit footprints of the LEDs, an editable path that connects each LED from each respective input/output terminal to another. Using Adobe Illustrator's Pattern Brush, I then convert this trace into the circuit footprint required by the LED specification (Figure 6.11c). The *Pattern Brush* allows for the proper configuration of behaviors on circuit bends. I additionally resolve the footprints for the microcontroller and power supply connector components at the start of the strip to complete the circuit design. For logical control, I add a footprint for an 8-pin socket to hold an ATtiny85 microcontroller (DIP); for power, I affix a 3.1mm DC barrel jack footprint at the start of the strip.

The editable path allows users to add additional anchors and correct overlapping segments highlighted by our tool. Should an element of the algorithm cause a malformed PCB, the ability to export into a full-feature SVG editor allows users to recover from these errors. As advocated as a

design consideration for new media tools [91], should the algorithm not fully capture the design intent of the user, such as needing to integrate the LED circuit to part of a larger circuit, the SVG editor continues to allow open-ended activity.

The final PCB board can then be manufactured through acid etching or through PCB milling. I used the BantamTools Othermill to mill designs and then hand-solder LED components. A certain degree of expertise is needed to solder SMD LEDs; I found that once the technique is learned, one can comfortably solder 10 LEDs in 10-20 minutes. Solder paste techniques also exist which greatly speed up and simplify the process, although the actual paste is a more hazardous material.

Program Skeleton Generation. While powering and controlling one LED is a relatively trivial task, as the number of LEDs increases, so does the circuit complexity. Such designs do not scale well since each LED requires an individual control wire or a special LED driver chip that usually enforces a matrix layout. I leverage an advancement in LED technology — dotStar (APA102C) RGB LED — that allows both simplified routing, individual RGB control of each LED, and uses the 5050 SMD package which is still large enough for hand-soldering. With the right circuit footprint, routing devolves to connecting each LED as links on a single strip.

The hardware address of each LED is relative to the position from the microcontroller on the strip. I use this information to produce code for programming the LEDs to display user-defined colors and brightness. In particular, I translate spatial and hardware indexes, extract associated RGB values for each LED, convert the values into appropriate API command for the dotStar LED specification, and populate a code template that uses an ATTiny85 to send the appropriate signal.

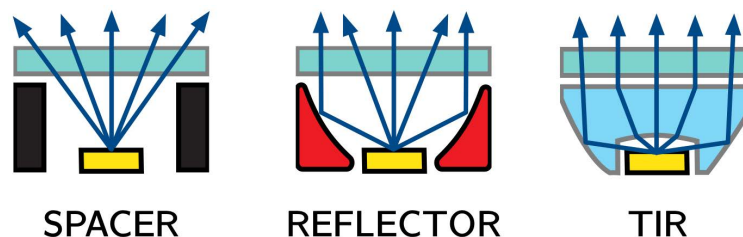

Figure 6.12: Parametric Models of Secondary Optic Systems. A scene is constructed with a light source (yellow), reflective materials (red), non-reflective materials (black), refractive material (light blue), and diffusive material (green).

Beam Shaping Layer

The shaping of light is facilitated through refractive and reflective materials. In secondary optic systems, the configuration of these different materials is used typically to collimate rays so as to transport light across a large distance. Common configurations of SOEs in industry are the spacer, reflector, and total internal reflection systems depicted in Figure 6.12 and described below:

- **Spacer.** Adding an air gap between the light source and diffuse material is the most basic geometry for achieving diffusion. It is highly subject to the light source beam angle: although

it works well for small diffusion targets, it requires a greater distance for large target diffusion areas limiting the range of possible applications.

- **Reflector.** Parabolic reflectors utilize reflective geometries to bounce light towards a specific direction. They are generally inefficient but are the most ubiquitous in lighting applications.
- **Total Internal Reflection (TIR).** If light traveling from a denser material (glass) escapes into a less dense material (air) and hits this interface at an angle greater than a critical angle, the light is reflected. This phenomenon, known as Total Internal Reflection (TIR), is commonly used to efficiently transfer light (e.g., fiber optics). Lenses which utilize this phenomenon typically have a cavity above the light source for rays of light to enter the lens medium at critical angles and achieve TIR (Figure 6.12c).

While secondary optic systems are readily available in consumer products, almost all manufactured SOEs shape light beams into circular areas. To better control the shape of the light beam, or the distribution of light emitting from one or more light sources, I computationally designed and fabricated shape-optimized SOEs (reflectors and lenses) that can be configured into systems with non-regular geometries.

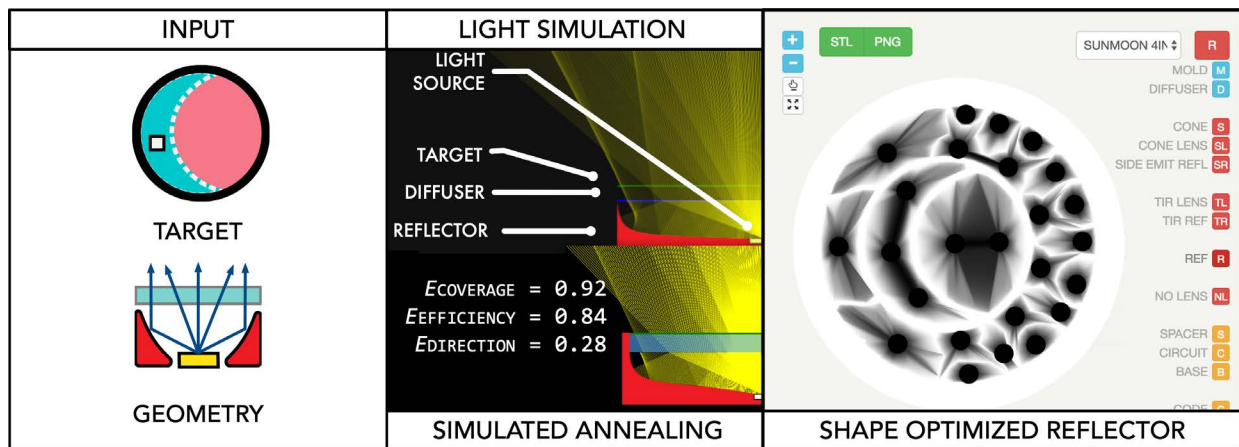

Figure 6.13: Shape-Optimized Secondary Optic Element Pipeline

Generating Shape-Optimized Secondary Optics. I decompose the procedure for generating shape-optimized SOEs into four stages:

1. **Input and Scene Construction** After a user finishes their luminaire design, the tool exports an annotated SVG file. It contains the LED position information and the user-specified shape to fill, henceforth referred to as the beam plane.

Given a specific parametric model, I then construct a scene depicting the configuration of the luminaire design. For instance, the moon shape depicted in 6.13 with a reflector geometry

is decomposed to a set of cross-sections. Each cross-section has a reflective material with a parabolic geometry, or reflector, and a refractive material, or diffuser, above the LED light source.

Each scene was specified as an SVG representation. I parametrized the bezier curves to stochastically generate different geometries (e.g, different parabolic forms for the reflector).

2. **Light Simulation** To assess the quality of each scene, I performed a ray tracing light simulation by casting rays from the LED out into the materials and geometries described by scene. Each ray is encoded with an intensity value that diminishes based on transmission rates of materials and adheres to light physics (Snell & Fresnel Laws). I computed a metric to describe the quality of the secondary optic system in shaping light to cover the beam plane: *coverage*, or the amount of area covered by the light; *directionality*, or the deviation of the light's exiting direction to the surface normal; and *efficiency*, or the ratio of exiting intensity versus the initial intensity of all the rays. These metrics are used to select optimal geometries in a stochastic search.

3. Simulated Annealing

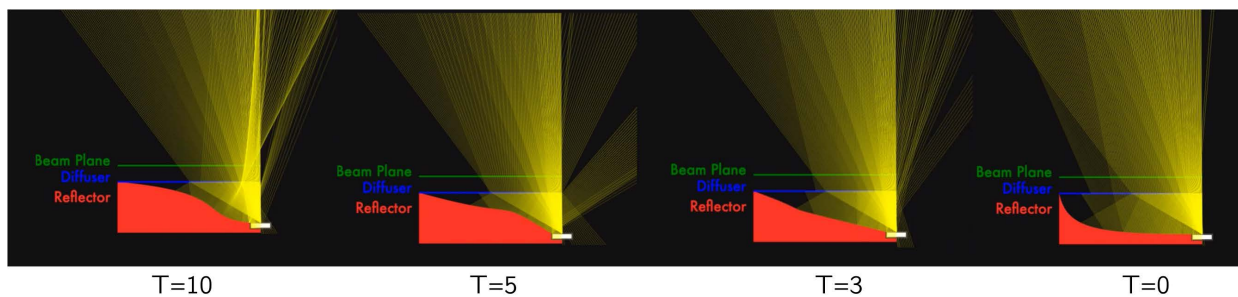

Figure 6.14: Simulated Annealing

Using simulated annealing, I find acceptable solutions in our non-linear search space as follows: I initially generate a random geometry that satisfies the secondary optic system construction pattern. Following the simulated annealing metaphor, I extract an annealing factor α representing the relative temperature of the system. A “neighbor” geometry is produced by computing a neighborhood of size α around each parameter in the model, and then choosing a random position within that neighborhood. An annealing factor of 1 would span the full parametric space, while an annealing factor approaching 0 would pick a nearby parameter configuration. During each time step, I compute the energy of the system from the ray tracer light metrics which determine whether a geometry is stored as an optimal solution.

4. **Geometry Construction** Unlike circular beam planes with a single profile curve, I require stitching together a hybrid geometry. I do this by treating each profile as an “elevation.” I then make a 2.5D geometry by creating level sets which act as a heightmap. This ensures that all geometries are moldable and produce the least amount of artifacts from the printing process.

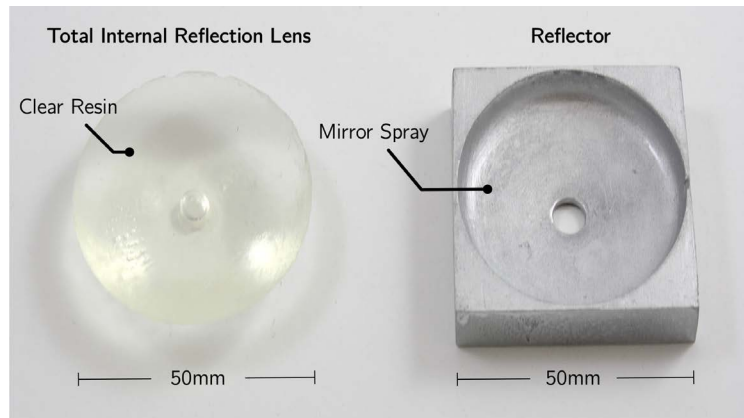

Figure 6.15: Fabricated reflectors. A total internal reflection (TIR) reflector printing in clear resin (left). Light enters through an air cavity above the LED and is reflected internally, spreading light throughout the lens. A parabolic reflector printing in clear resin, with a coat of mirror spray and acrylic coating (right).

Fabricating Secondary Optic Elements. Once the digital modeling files are produced, they are printed using various 3D printing techniques (Figure 6.15). In our case, a Type A FDM printer at 0.1mm resolution was used for most luminaires. When higher quality reflection or refraction was required, a Form 1+ SLA printer at 0.025mm resolution was used with clear resin. Resolution is an important factor since ridging artifacts from stereolithography can cause low-quality SOEs and uneven diffusion. Our pipeline alerts the user of luminaire quality issues when the LED density of the luminaire reaches a threshold above a reflector’s efficiency. Since 3D printing with reflective materials is currently not achievable with commercial digital fabrication tools, I created reflective geometries by spraying 3D prints with a coat of Mirror Spray (Rust-Oleum 267727). This provided a low-cost approach to achieving the desired reflectance.

Diffuser Layer

Diffusers control the final presentation of light, scattering light with the goal of uniformly illuminating a space or surface. For many applications, a host of materials can act as diffusers, from professionally-designed materials to ping pong balls and frosted acrylic. While a good diffuser is a key component to a successful luminaire, the effectiveness of a diffuser depends on the shape of the light beam itself. For this reason, diffusers such as frosted acrylic require a large distance between the diffuser and light source to illuminate larger areas (see Figure 6.12, Spacer). More advanced materials can diffuse light through refraction where light rays collide with material atoms and scatter.

Crafting Diffusers. I created a proxy-mediated fabrication technique (described in Chapter 5), or a human-in-the-loop pipeline that requires material engagement with the user. The role of computational design in this pipeline is to provide an armature for working with physical materials.

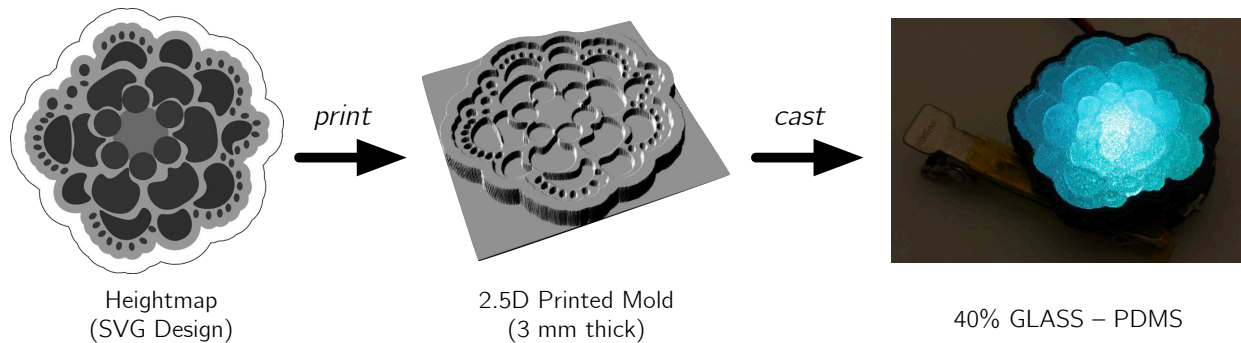

Figure 6.16: LED Diffuser

The diffuser fabrication technique leverages a maker-friendly PDMS silicone that can be used to encapsulate different refractive materials. Our technique uses highly refractive glass spheres (that are readily available in different sizes) commonly used to make reflective paint for roadways and signage; they can be mixed into the PDMS at different sizes, combinations of sizes, ratios of glass to PDMS. The mold can be designed to have different thickness, non-uniform thickness, or leverage the larger family of casting techniques (e.g., compression/press-molding).

The PDMS I used is TAP Platinum Silicone, a two-part 1:1 mixture which vulcanizes at room temperature. This silicone is especially forgiving for casting, readily removable from a cast for geometries with deep undercuts or fine details without the need for a mold release coating. PDMS also has good heat, chemical, and mechanical resistance properties and cures in 2 hours without the need to use a vacuum. While it is flexible, it also offers high dimensional stability.

The glass beads used were Cole Products glass beads with a refractive index greater than 1.5. These beads were used in a variety of sizes (from 0.1 mm to 3.0 mm); the different qualities of light interaction with bead size were explored in the example artifacts in the next section. Although I used glass beads, a host of different refractive materials could be encapsulated by silicone and provide different light interactions.

Characterizing Silicone-Glass Diffusers. To find the optimal mixture ratios, I doped disks (\varnothing 30mm x 3mm) with concentrations from 0% to 50% glass by mass mixtures in 5% increments⁶. Disks were also fabricated from Optigrafix Light Diffuser Film, 300 grit frosted acrylic. Diffuser disks were each placed above a 10 mm spacer beam-shaper above a 1W LED (120° viewing angle). Each disk was photographed (18 mm f/11 1/100 sec) and applied a Gaussian smoothing filter. Pixel values were mapped to luminosity using the camera's response curve. To extract the luminosity plot, the luminosity of each radius band was sampled and remapped to degrees from beam angle. To metrics were used to characterize the samples:

- Light transmission was calculated as the sum of luminosity values. The transmission rate was calculated as the transmission of a diffuser over the transmission of the uncovered LED.

⁶ Mixtures with glass concentrations above 50% by mass suffered from curing issues.

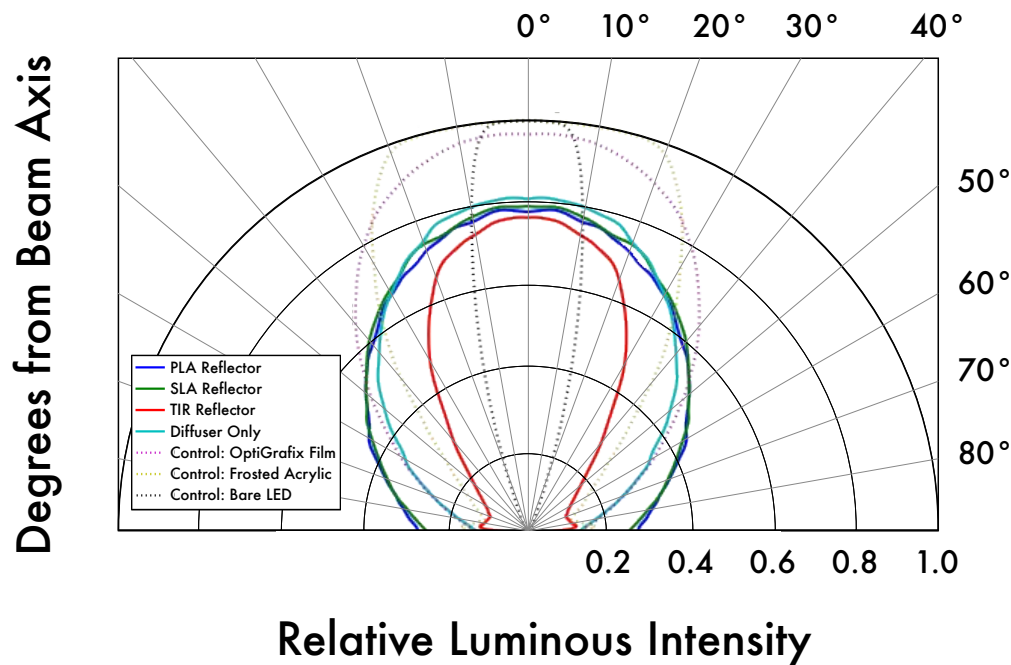

Figure 6.17: Polar Luminous Intensity Graph. The diagram indicates the distribution of the relative luminous intensity of the luminaire. Control systems are marked with dashed lines. Each reflector condition has a 40% glass by mass 3 mm diffuser.

- Light diffusion was calculated as the standard deviation of the relative luminous intensity across different viewing angles.

I found that 40% glass by mass-produced the highest diffusion and transmission rates.

The final polar luminosity curves for each system are displayed in Figure 6.17. The luminosity curves for secondary optic system elements notably show a more uniform distribution of light, redistribution the energy at the 0-10° range to the outermost viewing angles.

6.5 Luminaire CAD Tool

Our luminaire design tool was designed for users familiar with vector graphics and built as a web application (Figure 6.18). The web application incorporates the computational design backend for constructing secondary optic systems by allowing users to specify high-level luminaire design specifications such as LED placement, LED color, and target areas for the LED to fill. The tool uses the paper.js vector graphics scripting framework [108] which enables common vector editing operations and backwards compatibility with vector graphics applications.

Interactions. Users can then place, remove, and relocate LED elements anywhere in the scene. Geometries can then be created to interact with LED; users can specify whether paths block light

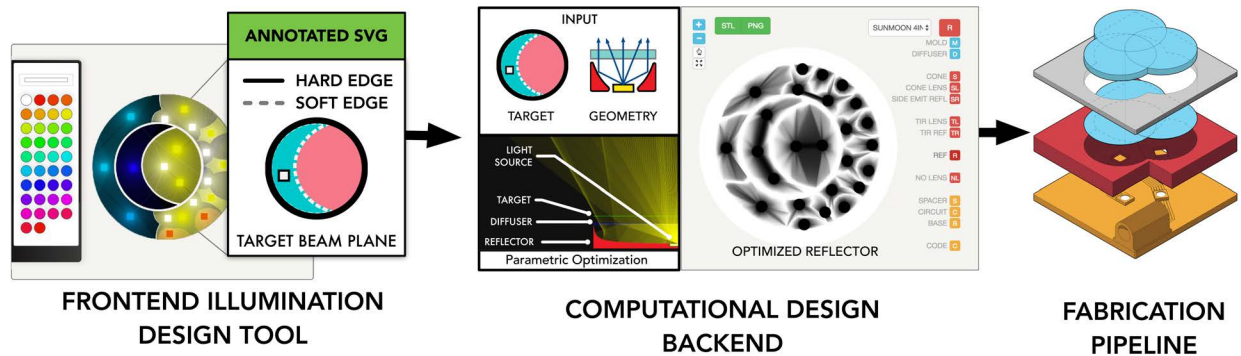

Figure 6.18: Luminaire Creation Pipeline. a) Given an SVG graphic, our luminaire design tool aids users with laying out LEDs, visualizing light interactions, and specifying target areas to fill with light. In the callout, an LED is specified to fill a moon-shape. b) A computational design backend generates an optimal secondary optics system to achieve the desired design using ray tracing to guide a simulated annealing search. All files for 3D printing geometries and milling circuits are produced by the backend, c) an instruction set guides the user to assemble the luminaire.

(hard edge) or allow light to pass through (soft edge). The user can also specify the color of the LED from a swatch panel. Otherwise, all interactions with the design take place in an external vector graphic editor (e.g., Adobe Illustrator) in order to leverage user’s knowledge of and expertise with existing graphic design tools. Depicted in Figure 6.19, I exposed different views to the user to prioritize different illumination aesthetic concerns.

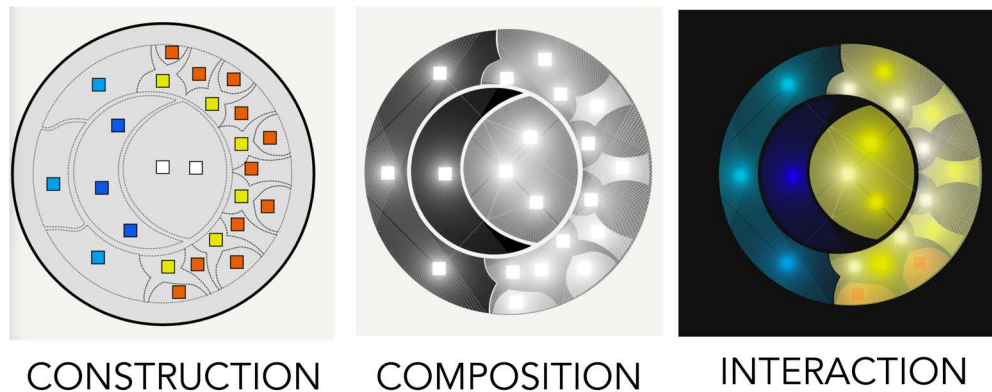

Figure 6.19: Illumination views. Each view can be toggled by a user when composing their design to showcase different illumination concerns. Each light source interacts with neighboring geometries and shows light interactions such as mixture and shadow creation.

Simulated Views

In a *construction view*, users are provided a clear view of housing elements (e.g., placement of nuts and bolts). This view allows a user to specify the shape to fill for each LED. In a *composition view*, white rays are radially emitted from each LED and interact with geometries, displaying the distribution of light in a scene as well as casting shadows when light blocking elements intersect with rays. An *interaction view* allows users to assign a unique color to track specific LED contributions in the overall illumination. Lastly, a “lights-out” toggle controls the background luminance to simulate a lit or unlit scene. In the composition and interaction views, the light simulation updates dynamically to the different geometries or specifications of the design. A user’s knowledge of light and its behavior is developed from direct manipulation of the LED – changing the quality of working with light to be more experiential.

Output. The design tools produces a set of 3D models for the enclosure, an SVG for PCB milling, a 3D model for casting a diffuser, and a 3D model for lenses (if specified). On fabricated, instructions are provided for soldering LED components, assembling the final luminaire, and programming the microcontroller.

6.6 Design Artifacts

Illuminated Hair Brooch

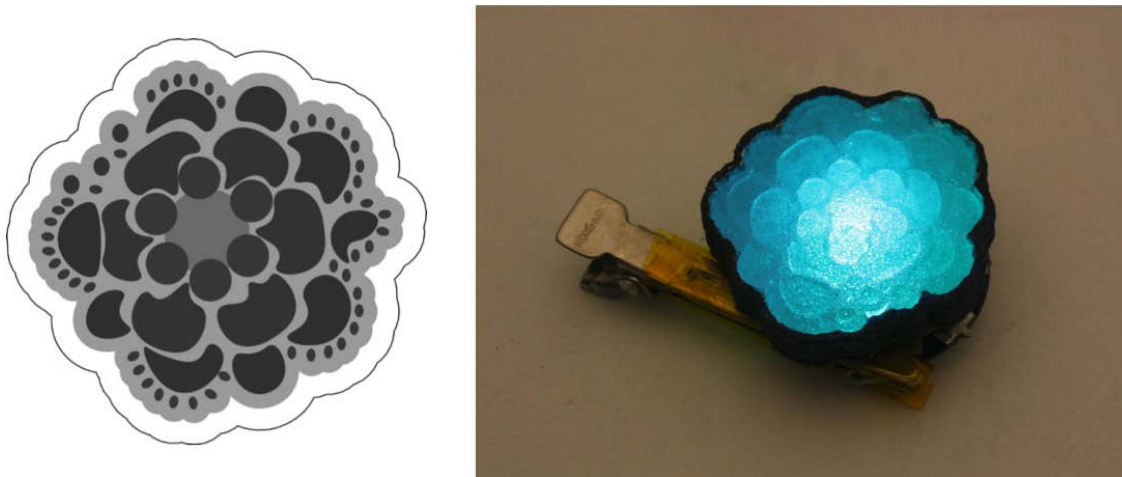

Figure 6.20: Illuminated Hair brooch (1 LED)

The sites in which we encounter LEDs are expanding; for sites like clothing and wearables, studies advocate a need for aesthetics that operate in the design space of ambiguity and slowness [38]. To probe wearable light aesthetics, we designed an illuminated hair brooch (Figure 6.20). Assembled on a hair brooch, a single LED control layer was configured with a computationally-designed 3

mm tall reflector holding a 2.5D crafted diffuser. The diffuser was cast at 40% glass-by-mass using 150-micron glass spheres; the floral pattern consists of 1 mm and 3 mm thick geometries held together by a common 1 mm thick PDMS substrate. Using relatively larger glass beads, the hair brooch diffuser created a more complex light texture. As an exemplar of *light as shadow creator*, the different thicknesses of the diffuser geometries altered transmission rates, creating gradations of intensity and casting shadows. These qualities match more of the complex texture of hair and clothing.

Sun Moon Glow Surface

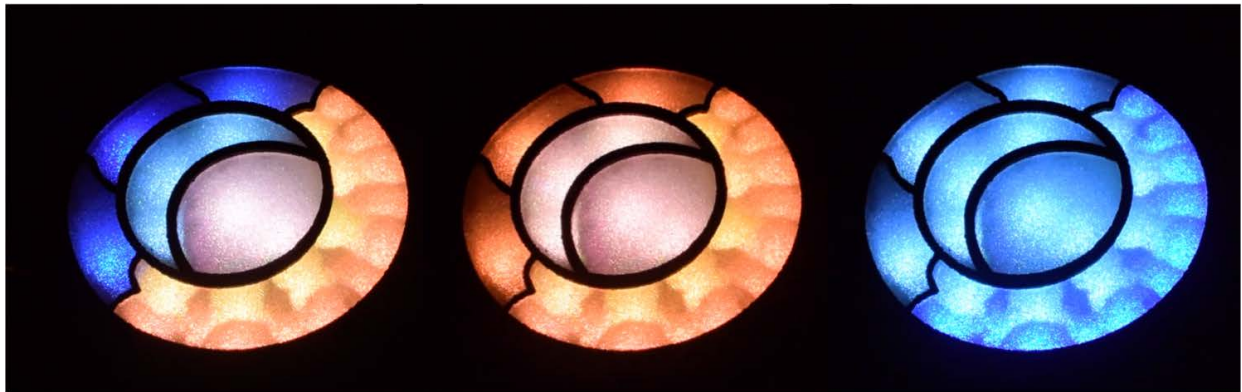

Figure 6.21: Sun Moon Lightwork (25 LEDs)

The sun-moon glow surface is an ornamental piece designed to probe compositions with many LEDs (Figure 6.21). Opposing the hard-edge matrix pattern, the sun-moon features a 32 LED non-matrix control layer, a 3 mm diffuser with 840-micron glass beads, and a computationally-designed reflector. As an exemplar of *light as sharp and soft*, the sunmoon reflector directs and shapes light beams from multiple LEDs to create soft edges (rays) and hard edges (moon segments). Although the component LEDs in the moon shape are more distinguishable, the smaller ray areas demonstrate the effectiveness of reflectors for blending lights in small areas. Rather than one LED controlling a single area, the sun-moon demonstrates how multiple LEDs can be used to compose a larger illumination composition.

Tactile Cityscape

The tactile cityscape investigates interactive light surfaces. The cityscape is composed of a 16 LED control layer with a reflector layer directing each LED to a building geometry. A diffuser is composed of a 2.5D cityscape, with building geometries ranging from 3 mm to 6 mm in thickness. These geometries are more pronounced versions of the light textures geometries. Instead, these geometries act as light-filling elements, giving a “body” to light. The 16 LEDs are programmed to change colors based on touch input, illuminating a path through the urban landscape. As an



Figure 6.22: Tactile Cityscape (16 LEDs)

exemplar of *light as space-filling*, the cityscape used large volumes of refractive material to capture and fill geometries with light.

Dynamic Haptic Button

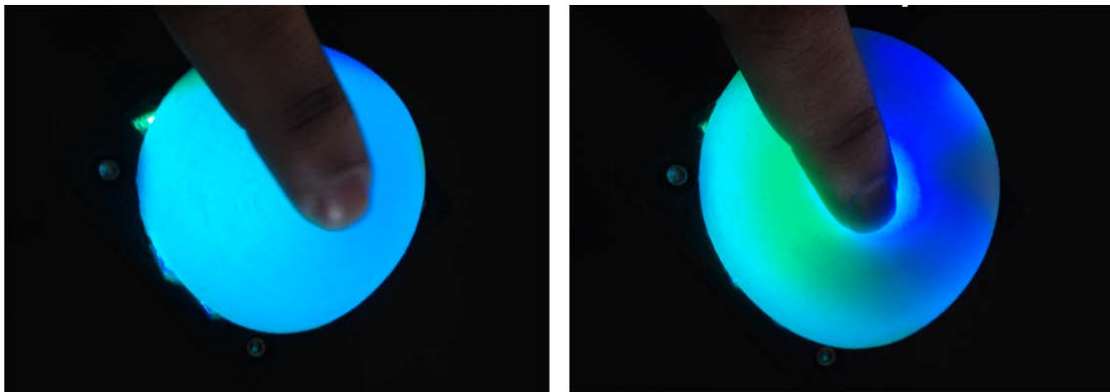

Figure 6.23: Haptic Button (1 Blue LED, 1 Green LED)

This haptic button probes reactive light surfaces. The diffuser is press-cast into a 5 mm dome geometry at 40% glass-by-mass (840-micron spheres) and positioned over a 1W LED. The dome, when deformed, produced dynamic diffuser geometries. The touch event is sensed with a capacitive touch sensor and programmed with different lighting behaviors. As an exemplar of *light as dynamic and reactive*, the haptic button creates a multitude of rich light expression by making use of the deformable diffuser actively reshaping and transforming the expression of the light beam.

User Artifacts

In a workshop study described in Section 6.7, 11 participants designed luminaires ranging from figurative to abstract (Figure 6.24). Several participants motivated their design decisions to elicit surprise, hiding elements in their design that would only be discoverable when power was supplied to



Figure 6.24: Luminaires fabricated from user designs: (top) simulated results from the luminaire design tool, (bottom) the final physical luminaire.

luminaire (**Participant #150, Participant #179, Participant #163, and Participant #199**). Others used the design task as a sandbox, for example, using a Venn diagram to explore color interactions (**Participant #134**). Overall participant’s assessment of their experience is summarized in Table 6.2. In particular, participants associated their perception of creative freedom with the tool (4.3) to their familiarity with design patterns developed through previous experience with Adobe Illustrator.

	Creative Freedom	Object Quality	Agency
Rating (out of 5)	4.3 ± 1.0	3.9 ± 1.2	4.3 ± 0.7

Table 6.2: Qualitative Assessment Luminaire Design Tool and Fabricated Luminaire Objects. Responses are semantically anchored on a 5-point Likert scale, positive responses = 5.

6.7 Workshop Evaluation

We invited 11 participants to take part in a workshop study designing their own luminaires. The main goal of this user study was to obtain qualitative feedback on how the design tool facilitated luminaire design. We were especially interested in understanding a user's mental model of light and how the Crafting Proxy would elicit material encounters. The questionnaires, interview guides, and study protocols used in this study are available in Appendix C.

Participants

A total of 11 participants were recruited from university mailing lists in Art, Architecture, and Design. The average age of participants was 22 ± 3 (7 female, 4 male). Participants were selected based on self-reported expertise with vector graphic design and SVG editors and previous exposure working with LEDs. A majority of users reported limited experience with 3D printing or digital fabrication tools.

Procedure

Each user participated in a 1-hour workshop and 30-minute follow-up interview and was compensated \$40. Each session resulted in a completed luminaire which was given to the user.

Workshop. Each workshop consisted of an electronics background questionnaire, a showcase of luminaires, a diffuser ranking task, a design tool tutorial, and a 40-minute design task. Each participant was tasked with creating a luminaire graphic with 5-7 LEDs not to exceed a 5" x 5" area. Participants were also asked to reflect aloud on the example luminaires, the design tool, and their design process. Due to fabrication time limitations, each luminaire was fabricated by the investigators after the workshop; some degree of experience is needed to solder surface mount components, although components are relatively large ($>5\text{mm}$) and with practice hand-solderable. Additional steps were taken to demystify the process during the follow-up.

Follow-up. After the luminaire was constructed, participants were invited back to reflect on the final design. To avoid black boxing the process, participants were given a tour of the fabrication machines and provided an explanation of the materials and techniques involved in producing their luminaire. We asked users a series of questions regarding their experiences with the design tool, as well as the final fabricated devices.

6.8 Results

All participants successfully completed their designs; some designs are represented in Figure 6.24. We first report survey responses, then present qualitative results from participant interactions with the luminaire design tool during the workshop, and finally discuss interview responses once

participants received their fabricated luminaires. We synthesize these findings into common themes and insights for designing Crafting Proxies.

Survey Results

In our survey, participants reported experience with through-hole component LEDs, while a few had interacted with addressable LED strips. The majority of users (8 of 11) had not worked with smart LEDs.

Barriers of Entry to LED Design

Prior to being introduced to our tool, users described their projects involving LEDs in simple, binary terms. Their LEDs were used for behaviors like flashing and fading. Even for more hardware and software-proficient users, the language used to talk about light was limited to the binary “on/off.” Other difficulties included hardware-to-design translation issues, especially in more complex designs like arranging LEDs in a circle:

Participant 170: I remember it being tricky to address the LEDs . . . we wanted the level of the circle to go up . . . there was endless debugging with the strips.

Users cited the cost of smart LEDs and the difficulty to program complex behaviors as the primary barriers to LED usage.

Perceptions of the LED Aesthetic

Functionally, participants reported that LEDs used in personal projects were mostly used to indicate status. Aesthetics was the principle reason limiting LEDs to this specific use case. A majority of our participants mentioned that the aesthetics of LEDs, even in strip form, were unpleasant, and physically painful: “they hurt your eyes if you look directly at [them].” Users universally criticized the “characteristic look” of LEDs and how their overpowering presence and salience in designs forced their user to focus on the mechanics of the light rather than the design or overall experience:

Participant 160: You look at them, and you think “those are LEDs.”.. I don’t like the characteristic look of LEDs. And I don’t want to look at something and go “there’s an LED inside that’s making that light up.”

Participants also described uncertainty relating to how their designs would appear in the final state, having difficulty prototyping and testing out various options:

Participant 169: Sometimes LEDs just don’t look that good. It’s hard to know what they’re going to look like to the user . . . I’d love to make something that just diffused all of the lights together so that I could make a really nice transition between colors.

One participant so disliked seeing the mechanics of the LEDs that she took the opportunity to design in physical barriers to her luminaire to obfuscate the light source (Figure 6.24 #134), opting for an edge/rim light that emphasized the silhouette, despite the fact that our luminaires have built-in diffusers:

Participant 134: [I don't want to] have that effect of seeing that bright LED directly. I feel like [seeing the LED underneath] reveals too much about how it functions.

Many participants never considered placing anything over the LEDs to affect the production of light. Some had attempted maneuvering around the bright lights by diffusing them with opaque or semi-transparent sheets, a plastic enclosure, or pre-fabricated lampshades. Despite strong negative experiences, users quickly warmed to the illumination aesthetic of the showcase luminaires:

Participant 179: It's very aesthetically pleasing. And I like ... the blend of colors that goes through it. It kind of reminds of seeing cities at night.

Workshop Results

Expanded Vocabulary Mirrors New Understanding

In our tool workflow, participants had to create and annotate their design geometries in an external vector graphics editor. Once a base design was created, our tool would load their graphics and apply treatments to more clearly indicate physical and conceptual geometries. Participants did have difficulty conceptualizing these distinctions in the abstract; however, direct manipulation of light sources grounded their mental model of how the design tool worked:

Participant 170: I'm thinking about the way the light is going to work. I wanted to define shapes, and I wanted to play with where the light was going to be placed.

One assumption we made was that participants would prioritize an arrangement of LEDs such as to produce a diffuse luminaire. However, for some, the light ray interactions became a formal element to consider. One participant investigated placing in an arrangement that would create new shapes and forms from shadow and color interaction.

Participant 179: There might be some leakage if the rays intersect [geometries] at an interesting angle.

This approach exposed the positive and negative spaces that arose from the shadows created from different geometries. As users gained familiarity with the new capabilities afforded by the tool, they frequently returned to edit their base vector file, further developing their understanding of what effects their choices would have, and beginning to conceptualize light as a craft material:

Participant 170: I'm noticing the other shape that you made, these sides were different, so I could direct it to this edge, or this edge only. Instead, I'm kind of diffusing it through the whole thing. I want to make one edge that encapsulates the shape but then also allows me to direct the light wherever I want.

For expert illustrators, the largest amount of design time was spent on examining light interactions with geometries. We saw different light aesthetic concerns arise from the different simulated views. The composition view influenced more thinking around light decay/falloff.

Participant 169: Also you can see a difference in the light intensity based on how concentrated the light beams are. I'm surprised that the light spreads so clearly in this [white ray view].

whereas the interaction (colored ray) view elicited more thinking about blending and LED color interactions:

Participant 170: A second ago, the light was down here, and it was covering more space, but it wasn't really blending. So it's helpful to see that there might be some blending up here if I put the light up here. . .

Participants verbalized a new consideration of the physical factors of the LED. A shift in vocabulary reflected this new understanding of the aesthetic potential of light. All participants conceded they had never really thought about light interactions before, and the tool represented a new engaging type of thinking that they were eager to pursue in future designs.

Followup Reactions

In the follow-up, participants shared a new awareness of LEDs in their daily life. Diffusion was a particularly salient trait that began to take form in new design projects.

Participant 134: I'm trying to make a tube of light . . . I was thinking about what kind of considerations I have to make to get the light to spread all around.

Even participants sensitive to the LED aesthetic were motivated by the diffusion of their luminaires:

Participant 134: I previously hadn't even thought about incorporating LEDs, but now I'm thinking about how we might incorporate LEDs to make things more user-friendly.

Expectations from the tool's simulated results and the final physical luminaire formed a hard contract with user's end perception of the tool. Notably, participants were satisfied with the fidelity of the tool to the fabricated design results of their design (3.9). Specifically, users responded positively to the texture and flexibility of the diffusers. Users were intrigued with the way the tool allowed emergent shapes to appear and expressed interest in the construction process. Some physical luminaires failed to meet expectations:

Participant 179: I can't really tell the different shapes that were initially in the design ... besides the hard, sharp boundaries. It is interesting [that] these cut off on each other a lot harder than I expected, like the yellow meeting the blue there's a sharp line of contrast – I thought there would be more of a mixing zone.

Despite this, participants reported feeling agency (4.3) to integrate their designs into more domain-specific projects upon understanding the limitations of the tool.

Renewal of Light as a Craft Material

Participants began to consider light as a material over which they could wield control. Users emphasized blending and mixing of colors to achieve novel effects and indicated a desire to “paint with light,” rather than simply add LEDs:

Participant 160: I've never even tried blending LED colors together, so this facilitates a little more advanced thinking: I don't want to just use LEDs separately; I want to blend them together to use color effects and make them brighter.

The tool allowed users to rapidly prototype their concepts, visualizing how the final piece would appear with the LEDs in place. Users readily incorporated soft and hard edges, mixing colors, and delineated conceptual boundaries in their designs; users expressed a desire to play around with the tool more and discover new light interactions.

Participant 169: I'd play around more with hard edges and soft edges, to see if I could get some nice mixing. I'd love to see how the color is actually changing and change it with more intention.

6.9 Discussion

Although this work discusses, explores, and expands the role of light in design, I see these insights and principles guiding the design of future materials and tools for hybrid making.

Light Composites

In this work, I explored how applying the compositing design pattern for an immaterial like computation might be applied to another immaterial like light. Compositing requires a tight coupling between a physical material that activates and makes visible changes to the immaterial. As referenced in Chapter 4, Daniel Rozin's Wooden Mirror couples the immaterial camera sensor matrix to wooden taxels, allowing the pixel to come into expression. From our synthesis of the conversational profile with light, I observed that ways material practitioners work with light is heavily influenced by its interactions with other refractive, reflective, and opaque materials. This reliance the secondary materials to shape and manipulate light echoes the role of the physical proxy in composites.

Expanding the Light Repertoire

The demand for an expanded LED aesthetic is present and growing. As flexible electronics develop, LEDs are being integrated into wearable applications, whether integrated onto tattoos [117], or embedded in clothing. In its most subversive role, low-cost LED “throwies” [166] have gained traction as urban graffiti. However, I saw a tension manifest in a common critique that LEDs (and electronics) in design are overpowering, distracting from any other elements. On the other hand, this saliency has been largely leveraged by interaction designers to engage and captivate audiences. Often, this “tacking on of media” [137] limits the exploration of the physical design space to instead focus on designing through digital manipulation. This line of thinking aligned with the mental model and LED interaction patterns of participants in our workshop.

Through light compositing, I saw how material-centric investigations could expand the electro-aesthetic and yield diverse light forms that capture a larger subset of the light’s material profile. I demonstrated how facilitating the interaction between the physical proxy and the immaterial can be a site for computational design. Leveraging established practices using secondary optic systems to manipulate and shape light; our computational design routines allowed for participants to explore a wider range of interactions. The conversational profile framed how each routine (the controller, beam-shaper, and diffuser) could be composed to support and expand light behaviors and form.

Through the use of reflectors, light was focused and redirected to have sharp and soft surface interaction (Figure 6.21). Tactile diffusers made from PDMS silicone and glass beads accessed the repertoire of 3D printing, casting, and mold making techniques. By changing the thickness of different areas of a diffuser, gradations of light and shadow were used to support *light as a shadow-creator* (Figure 6.20). In building large volumes of diffuser material, the workflow supported *light as form-filling* (Figure 6.22). Using a compression mold, a tactile dome diffuser allowed for the diffuser to change shape and leverage *light as a reactive material*. By changing the size of the refractive glass bead in the diffuser, these diffusers also formed a new illumination aesthetic — *light textures*.

Lastly, by introducing a trace assistance algorithm, I saw participants create luminaire designs that broke the traditional forms of the grid and strip (Figure 6.24) and decoupled the influence of electronic and computational actors on these light forms. In the workshop study, the shift in vocabulary towards thinking of light as a painterly material further indicates the effectiveness of casting light as a craft material.

Supporting a Material Epistemology

Blackboxing and Simulation. In many engineering practices, a common method of working with the complex interactions of various materials is via black boxing. Blackboxing compartmentalizes knowledge into systems made of components with inputs and outputs, removing the need to understand the inner workings and instead allowing more complex and sophisticated systems to develop. As a byproduct, many immaterials are found as readymade components, parts, and systems that abstract away the intricacies of working with the raw element and relaying physical cues

important for material workflows. The LED is an example of a manufacturing blackbox where the individual components shaping light are not part of the API that practitioners encounter.

While blackboxes lower the barrier to entry, there is little in building exploratory engagement with a material. I saw this behavior in how workshop participants their restricted view of the LED aesthetic and its role as a status indicator. This lack of exploration is a reoccurring theme in educational makerspaces and emerging digital fabrication practices, where laser cutters turn into keychain factories [18] or where only a small subset of the population contribute to new designs [139]. Our tool, while maintaining compartmentalization of computational design routines, leveraged the SVG as a method to specify more open-ended inputs. Like many CAD tools, the geometries were in conjunction with a simulation engine to provide the user with information about the behavior of the design. I showed how enabling real-time simulation of how light behaves with different geometries allows users to have a material encounter with light. The feedback from the simulation actively factored into how users explored different designs, but also in the ways they constructed knowledge of light and its behaviors. Furthermore, the different rendering styles, whether only viewing intensity or viewing color interaction, allowed users to focus on unique design concerns through an experiential encounter with light. While maintaining the benefits of the blackbox, material simulation was a powerful technique to also communicate internal workings and support a material epistemology.

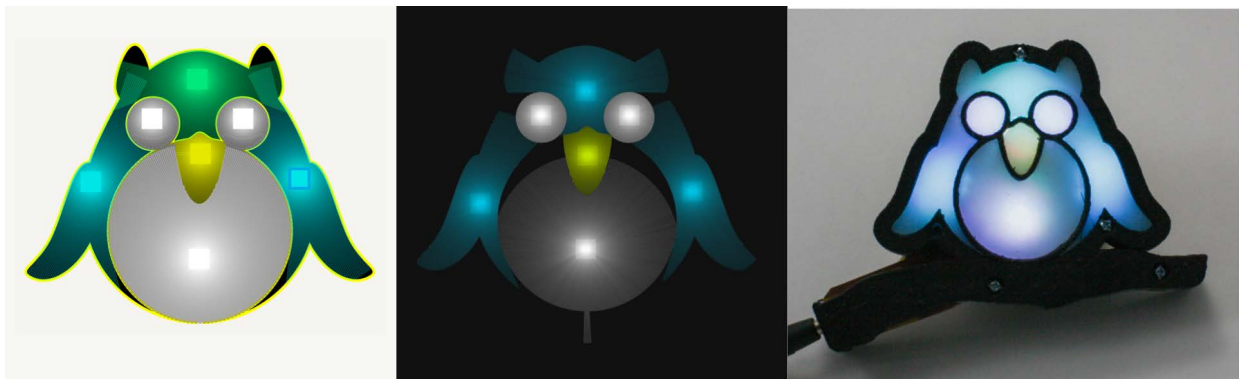

Figure 6.25: Participant 170 - Owl Luminaire

Integrated Workflows. One principle for creative thinking is to support open interexchange, or the ability for multiple tools to seamlessly interoperate [160]. As described in Chapter 9, I leveraged a Support Vector Graphics (SVG) synchronized between an SVG editor and a web application using the vector graphics library `paper.js`. I saw the benefits of this behavior in seasoned users of SVG editors like Adobe Illustrator (e.g., **Participant 170's** Owl Luminaire) that leveraged *vector graphic thinking*, a way of decomposing and building forms with boolean shape operations, with the feedback from the light ray simulation to iterate on complex geometries that used light as a graphic element. I see these details in how the participant chose to place the LED in the stomach region of the owl off-center. This allows a gradient to form that works similar to a highlight vector commonly

used in graphic design. While the synchronized SVG achieved interoperability, it also allowed for a different material epistemology to cognitively bias the creative direction of the luminaire.

Limitations

Our study demonstrated that in engaging with a material-centric workflow and expanded creative repertoires in the confines of a short hour-long workshop. Many users desired to continue iterating on their design, but many more aimed to start fresh, knowing the full capabilities of the tool and fabrication method.

In the design tool, participants engaged in the material manipulation of light through digital simulation (rendering and raytracing). However, due to fabrication time, users did not participate in the physical making of the displays and preventing exposure milling the circuit board, casting the diffuser, or applying reflective spraypaint to the 3D printed reflector geometry. I anticipate these material encounters would enhance participant's creative repertoire to, for example, deviate from the glass beads used as the refractive material in diffusers to experiment with doping different material in the PDMS silicone. The process walkthrough in itself clarified many participant's mental models of the LED that were readily being applied to active, creative projects.

Our fabrication technique, although bound by bed size, results in a final cost of 5" x 5" display component with 10 LEDs in the \$6-7 price range; as a standalone device, logical control and power bring the cost to \$12. I showed that I can generate geometries that more effectively diffuse a point light across a shape. Study participants all confirmed that design opportunities well deserved the cost; many cited access to fabrication facilities as the main issue to adoption.

In this work, I described an approach for designing light emitted from the more ubiquitous and low-cost LED. Our technique, however, needs at least (5 mm) above the light source to be effective. I envision our tool as supporting a wider ecology of materials, including electroluminescence (EL) wire and panels, and organic polymer LEDs [220], to foreground the physical design of light in interactive devices, wearables, and urban architecture. I see our technique used in conjunction with light pipe structures that can transport light more efficiently that could reduce the footprint currently required to illuminate luminaires with large surface areas and complex geometries (i.e., twists-and-turns). Current 3D printing resolution still introduces artifacts into fabricated lenses; an efficient transfer of light would be possible with smooth and optically-clear surfaces; however, I found aesthetically acceptable results using SLA printing techniques. As printing resolution improves, I foresee our tool as a preliminary step to designing custom non-imaging secondary optics for illumination design. While our current method requires assembly of different fabricated parts, our 2.5D approach is portable to multi-material stereolithographic printing, especially as optically clear and reflective materials become available for these processes.

Future Work

While this work explores light's properties of diffusion, several opportunities exist for expanding Illumination Aesthetics. For instance, more advanced optics geometries such as side-emission or

phase masks can be used to finely redirect light to specific locations and produce expressive interference patterns [221]; other techniques might incorporate motorized, high-powered, or architectural elements to create interactive urban lighting. I touch on this with our tactile illumination map in Figure 6.22, where an urban area is modeled using a 3D diffuser; buildings can be selectively illuminated to form an interactive map or become part of a physical data visualization showing city-specific data. While the work focuses on physical design, exploring the intersection of physical and digital control of light and other actuators, such as the sequential motor and light disk in the fiber optic lamp, could greatly expand electronic aesthetics.

6.10 Summary

In this chapter, I documented the design process for creating a Crafting Proxy that mediates a practitioner’s interaction with light by leveraging a compositing design strategy. I first synthesized a conversational profile, examining the ways that different communities have worked with light and through a formal analysis of three exemplar light artifacts. This profile revealed that through light regains elements of its tangibility through its interactions with refractive and reflective material.

To facilitate this interaction, I developed a computational design and fabrication pipeline for secondary optics systems that expand the light’s material API, or the available ways that light can be manipulated. Through a frontend design tool, this light API is exposed through a vector graphics tool and supported by a realtime light simulation. In our workshop study, 11 participants fabricated 11 custom luminaires and found that our tool altered existing perceptions of the role and function of the LED in interactive objects and displays. Through a set of exemplar artifacts, I demonstrated new *Illumination Aesthetics* that capture a wider gamut of the conversational profile of light, including *light textures*, soft and hard edges, reactive deformable diffusers, and non-matrix layouts.

This process revealed the effectiveness of material simulation in allowing for a material encounter to occur, the advantages of separating light concerns into different computationally designed subcomponents to expand the light repertoire, and the value of supporting existing skillsets for diversifying designs. Compositing served as a valuable design strategy for exposing creative trajectories for utilizing light as a creative material.

Chapter 7

Heat Forming

Unlike computation, light, or electricity, working with heat is more complicated since it reacts to or triggers reactions more slowly making it difficult to control (e.g., hysteresis, power) and perceive (e.g., thermoreceptor fatigue)¹. Controlling heat is much more nuanced, and when produced electrically, the high current needed can also quickly become a safety concern.

As an immaterial, heat is useful for understanding the boundaries of a compositing strategy. Our focus in this chapter is to design a Crafting Proxy that acts as a mediator and lens to heat, foregrounding the behaviors, forms, and structures of heat in material-driven practices and the ways that heat-centric workflows are complicated by heat's immateriality. I review how heat is used in practice and the variety of Thermoreactive Composites (TrCs) — assemblages of heaters, substrates, and thermoreactive materials — that exist across HCI including thermoreactive painting [143], thermoreactive sculpture [68], thermoreactive wearables [98], and thermoreactive clothing [38].

Heat is most limited by the means in which to control it, however, the ability to produce heat (via resistive heating) makes it an incredibly versatile material. Only requiring a conductive material and power supply, resistive heating can be used to produce heat in a variety of form factors including conductive thread, paint, ink, tape, and more. Through computational design techniques, I expand the available expressions of resistive heating to foreground heat as a spatiotemporal medium.

To account for challenges to perception and cognition, I introduce a *perceivability design stage* that specifically explores ways of mapping the output of the physical stimuli (in this case heat) to the psychophysics of the human body, acting as a lens for the body to perceive heat interactions and communicate the interconnectivity of electricity, heat, and thermoreactive materials.

¹ Elements of this chapter were previously published in: Cesar Torres, Jessica Chang, Advaita Patel, and Eric Paulos. "Phosphenes: Crafting Resistive Heaters Within Thermoreactive Composites." In: *Proceedings of the 2019 on Designing Interactive Systems Conference*. DIS '19. San Diego, CA, USA: ACM, 2019, pp. 907–919. DOI : 10.1145/3322276.3322375.

7.1 Introduction

Phosphenes is a Crafting Proxy that aids in the making of *Thermoreactive Composites* (TrC), a class of objects composed of a thermoreactive element and a heat-generating element (Figure 7.1). TrCs is a design pattern used to expose heat and its interactions with other materials as an experiential "conversation" that introduces, adjusts, and satisfies circuit requirements during the act of making.

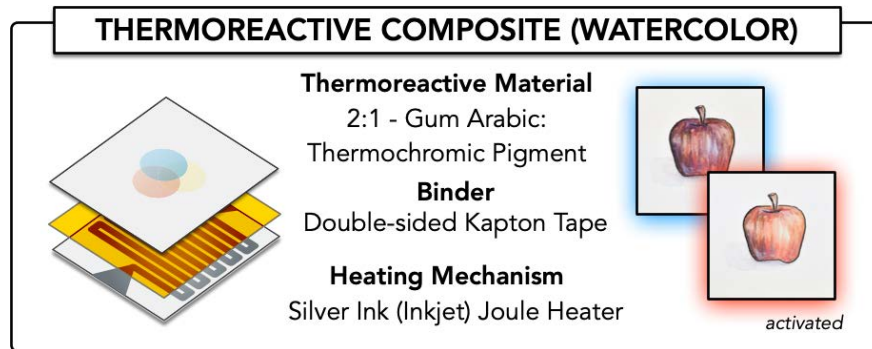

Figure 7.1: A Thermoreactive Composite. Thermochromic pigments are bound in gum arabic, giving it many of the same qualities as watercolor paints. A purple thermochromic glaze is applied to a chromostable watercolor composition depicting an apple. A silver ink resistive heater is coupled to the composition with Kapton tape; when triggered, it produces a dynamic ripening-apple illustration.

Crafting with resistive heaters, or supporting a material epistemology outlined in Chapter 2, is enabled in three ways:

1. Facilitating a material encounter through an iterative design practice through a maker-friendly fabrication pipeline that captures a composition, facilitates resistive heater design, and debugs and validates fabricated heaters.
2. Communicating the creative constraints between different conductor, power supply, and thermoreactive material combinations while maintaining electrically-valid and power-safe designs.
3. Expanding the malleability, expressivity, and composability of electrical heat through computational design algorithms that allow resistive heaters to activate specific areas of a thermoreactive composition at different times.
4. Exposing a live thermoelectric circuit model using responsive visual annotations, embodied design interactions, and responsive heat visualization (using commodity thermochromic liquid crystal [TLC] sheets).

7.2 Related Work

Emerging practices have used thermoelectric heating elements in a variety of form factors including Peltier elements [144] and resistive heaters from conductive thread [39, 98], silver ink [68, 219], and gold leaf [97]. Heating elements have been coupled with a variety of thermoreactive materials including gels [96, 128] and thermochromic pigments or liquid crystals [177] suspended in carriers that bind to paper, films, and threads.

In multimaterial-layer constructions, the thermal properties of materials have been used as actuation mechanisms [140, 47, 76, 204], as a 3D-forming technique [68, 6], as a sensing technology [2], or as a trigger for secondary effects (e.g. humidity [219]). Jonsson et al. [93] explored the somatic experience of heat and the different aesthetics that can be formed from leveraging the ambiguity of thermoception (e.g., subtleness; subjectivity) or the way heat interacts with materials (e.g., inertia, heat transfer). I add to these expanding practices and contribute a workflow that bolsters explorations with heat and thermoreactive materials through a faster, expressive, and more iterative practice enabled through silver inkjet-printed resistive heaters.

Resistive Heater Design and Fabrication

As a fabrication strategy, many resistive heating applications etch or mill copper plates or use copper wire coils. Resistive heaters have been embedded within existing material practices; Devendorf et al. [39] demonstrated that weaving conductive thread into knitting patterns can also be used to create different heat profiles. Recent advancements in silver ink printing allow for more user-friendly, fast, accurate, and effective prototyping techniques for resistive heaters [101]. Within silver ink circuit design, LightTrace [183] utilized the non-negligible resistance introduced by silver-ink traces to regulate current sent to LEDs and computationally adjusts the resistance by altering a trace's width or length. Phosphenes similarly incorporates circuit design patterns to control the power generation rates of resistive heaters but incorporates a *spatial dimension* to constrain heat distribution to user-specified areas and introduces a *temporal dimension* by assembling multiple heaters with different heat generation rates in parallel.

Circuit Design Tools

Circuit design tools have explored increasing the perceivability of electricity in circuits [13]. Toastboard, an instrumented breadboard, allowed users to verify electrical connections and prevent slips [43]. Bifröst [125] provides support for embedded system debugging; in a similar initiative both Bifröst and this work aim to increase the perceivability of electronic components; however, I take a material-centric approach in order to support users without electronics domain-expertise. Our prior work explored design tools that acknowledge the unique resistivity and construction challenges of working with conductive ink, thread, paint, and tape to explore and express LED circuit drawings [118]. Phosphenes similarly supports a variety of thermoreactive materials as well as circuit conductors.

7.3 Conversational Profile

Generating Heat

To generate heat, many applications use a technique known as joule or **resistive heating**, a process where electrical current I is converted into heat when electrons collide and transfer energy to conductor atoms [186]. Working with resistive heaters can be decomposed into two major components: (1) regulating an electric current that determines the heater's power, (2) controlling how heat moves through space via thermodynamics (diffusion, convection, radiation).

The heat generation rate, or *power*, is specified in watts is the product of current I and voltage V . These designs often employ space-filling curves, such as this serpentine pattern, to efficiently distribute heat.

Working with Resistive Heaters

In practice, connecting a resistive heater to a variable power supply and dialing in the input voltage is enough to configure a heater properly. Through trial and error, the heating rate can be adjusted to activate a thermoreactive material. Many commodity hobbyist heaters distribute heat over a small rectangular space; while a limited heat profile, many heaters can be composed side-by-side to heat larger and more varied spaces. This results in many thermoreactive composites having heat trigger a global binary on/off change (e.g., triggering a black thermochromic mask to disappear to reveal a hidden message) rather than leveraging more of heat's interactions with other materials and its respective behaviors and forms.

Constraining heat to a specific area requires custom resistive heaters or custom heat sinks, the latter of which would require expensive metalworking. Resistive heaters, on the other hand, can be made from conductive thread, copper wire, or silver ink and follow a similar construction pattern: in knowing the amount of power that needs to be generated ($P = IV$), the resistance of the heater can be determined ($R = V^2/P$). There exist a number of ways to cut thread, mill copper, or lay silver ink to satisfy the necessary resistance, but it will dramatically affect how heat is distributed. The most efficient heaters use wire forms in *serpentine lines*, also known as *meandering lines*, or other space-filling patterns to distribute heat evenly. For many wearable applications, the limits of the power supply (e.g., a lithium-ion battery) heavily constrains the power generation rates that are feasible. Controlling more than one heater at a time requires a microcontroller and special current control electrical components (e.g., h-bridge, BJT transistors) that adds significant complexity and a larger footprint (detrimental to many wearable applications).

In this process, the resistive heater, thermoreactive material, and power supply introduce several complex constraints that (1) limit the designs that can be made, (2) restrict the level of engagement with heat to a binary on/off, (3) are imperceivable when working experientially with these components.

7.4 Composability: Spatiotemporal Resistive Heaters

In this section, we describe a computational design algorithm for designing resistive heaters to activate Thermoreactive Composite.

For many application, joule heater design is based on two parameters. The conductive material properties and power supply. However, when configured in a Thermoreactive Composite, the heater must also be configured to the specific thermoreactive material properties and thermoreactive composition. For example, when powered by a 5V power supply, a $50\ \Omega$ heater generates about half a watt of power. When a cloth silkscreened with liquid crystal, a thermoreactive material that takes about 12 J to activate, is placed on top of this heater, we can expect to see a color transition in about 20 seconds (Figure 7.2).

Unlike common heater designs, our algorithm introduces a temporal component allowing users to selectively control which areas of a composition activate over time. The core insight is that each resistive heater is a collection of sub-heaters, connected in parallel to form a current divider circuit. Thus, the ability to control how much current is flowing over selective regions of a circuit allows us to control the activation times of thermoreactive materials. The TrC interactions described in this work are largely driven from the goal to activate a target area of the thermoreactive material within a certain period of time (rise time t) driven by a common power supply with nominal voltage V_S . In order to ensure safe operation, the power of the circuit is capped at the power rating of the conductive material and power supply.

Heating specific regions

Let a heater be modeled as a collection of n resistors R_i connected in parallel. Each resistor is designated a corresponding area A_i to heat up. In this configuration, each resistor i generates power P_i following Kirchhoff's Circuit Laws:

$$P_i = V_S^2 / R_i \quad (7.1)$$

When connected in parallel, resistors share a common input voltage source V_S and therefore do not introduce a voltage drop that affects other resistors. This allows each heater's power to be individually controlled by changing its resistance.

For silver ink (thickness d , and resistivity ρ), resistance can be controlled by either changing the trace length l or width w of silver ink heaters as follows:

$$R = \rho \frac{l}{dw} \quad (7.2)$$

To fill a specific area A_i with a serpentine pattern ($A = wl$)², the width of the trace can be computed as follows:

$$w = \sqrt{\frac{\rho A_i}{d R_i}} \quad (7.3)$$

² A conductive material with a small cross-section (i.e., wire) can be used to maximize current flow and localize heat over an area or volume; common patterns include serpentine (e.g., space heaters, radiators) and spiral patterns (e.g., stove heating elements).

Heating at specific times

Since a heater is composed of resistors connected in parallel, a current divider circuit is created (Figure 7.3) allowing us to specify the power generation rate of different areas by adjusting the resistance R_i . The power rate P_i to activate the thermoreactive material at time t is calculated as:

$$P_i = \frac{E_a}{t} \quad (7.4)$$

where E_a is the activation energy of the thermoreactive material (calculation: Figure 7.5, table: Figure 7.6).

Making a Heater

As an example, we describe the interactions for creating a Thermoreactive Composite "progress bar"(Figure 7.3). The composite is composed of a silver ink heater inserted into the cuff of a sleeve. The sleeve has a liquid crystal design screen printed onto the cuff. The heater is designed such that when current is supplied to the heater, it will activate the liquid crystal ($E_a = 12J$) pattern from left to right over the course of a minute.



Figure 7.2: Parameters of a Thermoreactive Composite - The power supply and silver ink circuit are used to form a joule heater. This heater is inserted into the cuff of a sleeve with a screenprinted thermoreactive design made with liquid crystal paint.

Given the above set of TRC parameters, a user draws a rectangular region (per the dimensions of the cuff design) on the digital canvas. Using a subdivision widget, the user splits this region into five subregions in order to assign each region a different rise time. A scale describes the relationships between rise time and power (Equation 7.4), assigning an identifying color to each combination. Colors are chosen on the thermographic scale - warm-colored regions (i.e., towards red) produce heat and faster rates than cool-colored regions (i.e., towards blue).

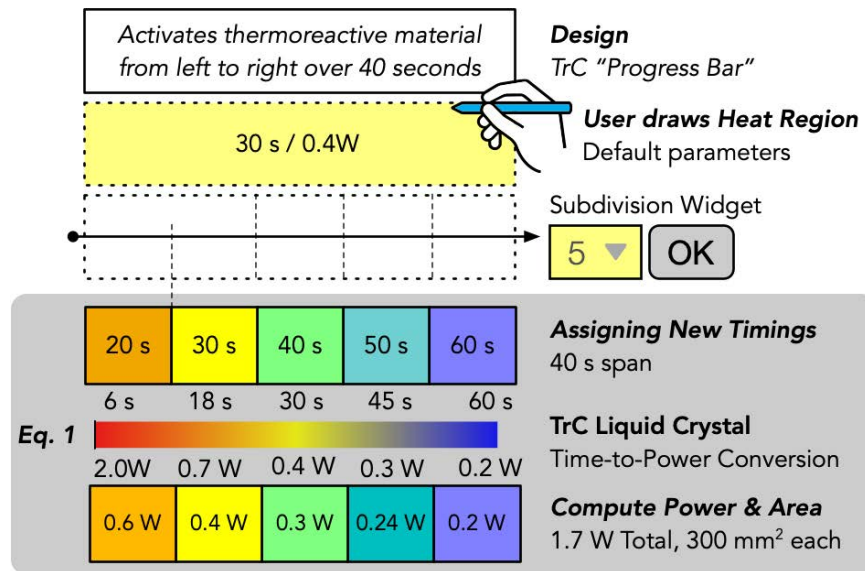

Figure 7.3: Designing Heat Regions and Activation Times. A user draws an initial heat region (per the dimensions of the cuff design), subdivides the region into 5 using a widget, and specifies desired activation times. A computational model updates and computes the power specification.

Notably, the time-power scale does not allow parameters that would allow unsafe heating rates (2.0 W max, 6 s quickest rise time). The user specifies a target rise time for each region of the progress bar; internally, a circuit model updates the target power, queries respective current draws for each sub-heater and calculates the trace width to generate a serpentine pattern with the ability to cover the target area.

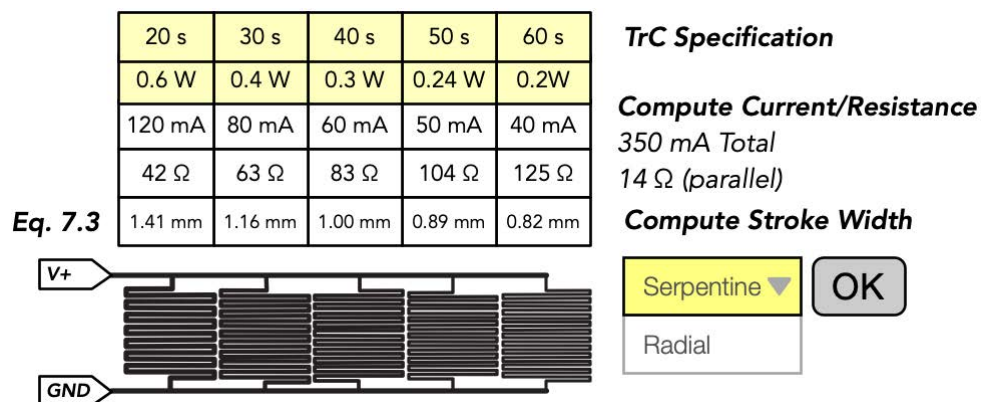

Figure 7.4: Trace Design. Circuit design variables are queried from the circuit model for each heat region and a serpentine pattern is generated, specific to silver ink, to achieve the target resistance and power.

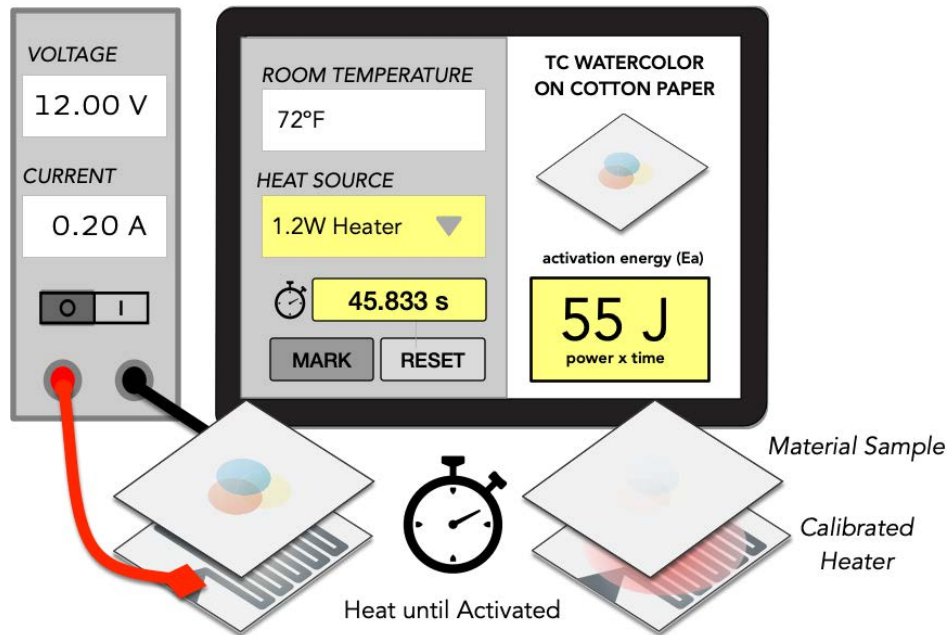

Figure 7.5: Characterization Routine.

Characterizing a New Material

Since the landscape of thermoreactive materials is rapidly evolving, we use the following characterization routine to determine the activation energy E_a of an unknown thermoreactive material, substrate, and joule heater configuration. For instance, while we know the activation material of thermochromic PLA with a 3 mm wall, this value would be more sensitive if compositions were made with thinner geometries.

To characterize a TrC combination, only a sample of a thermoreactive material on a target substrate, a heater with known power P , and a stopwatch are required. The routine follows:

1. If the power of the heater is unknown, then connect the heater to a power supply and apply a nominal voltage V_S . Measure the current draw I calculate power as ($P = VI$).
2. Attach the thermoreactive material and substrate (in the same way it will be used) to the heater, e.g., using double-sided tape or thermal epoxy.
3. Record a start time t_0 and power on the heater. Observe the thermoreactive material until a Just Noticeable Difference (JND) is detected and log the time t_f . For thermochromic materials, a JND refers to a color change. For thermo-programmable materials, a JND refers to a change in motion. Use the following formula to calculate the activation energy:

$$E_a = \frac{P}{t_f - t_i}$$

The activation energy captured by this routine represents a lower bound for activating the thermoreactive material, which only needs to be calculated once. The routine is limited by the assumption that the heater will be activated in the same environmental conditions (e.g., room temperature, starting from steady-state). It also considers a negligible convection factor (e.g., a breeze blowing on the composite). Our experiments with thermochromic materials yielded the following activation energies:



Figure 7.6: Activation Energy of Various Thermoreactive Composites

For thermochromic PLA filament, the routine was carried out for wall thicknesses from 2 millimeters to 10 millimeters. The resulting values were fit with an exponential model and yielded a regression coefficient of 0.9755, indicating a strong fit and predictive power. For materials that require an activation energy greater than 1kJ, we anticipate the exponential behavior is a result of the temperature differential between the environment and the thermoreactive material introducing a significant cooling term.

7.5 Resistive Heater CAD Tool

Phosphenes is a Crafting Proxy that aids a user in designing a resistive heater specific to a thermoreactive composition. The process uses silver-ink inkjet printing in order to create flexible resistive heaters on a PET substrate. To enable this workflow, I incorporate the composability mechanisms for composing heat described in Section 7.4 and perceivability mechanisms for exposing material cues in Section 7.6.

Creative Environment Configuration

The creative environment is composed of a tablet running design software and a network connected printer and camera. All components of the creative environment, unless otherwise noted, can communicate with each other via the WebSocket framework described in Chapter 9.

A resistive heater CAD tool was programmed as a paper.js web application that runs on a tablet configured on a gooseneck stand. This tablet can be moved and positioned hand-free throughout the creative environment.

An IPEVO document camera is configured to capture images of objects placed underneath and send these images to peripheral devices. The image data also contains the focal distance in order to configure accurate measurements with the image.

An Epson ET-2550 EcoTank printer is connected via Bluetooth to the tablet. The printer is configured with the AgIC silver ink system [3].

Workflow

The thermoreactive composite workflow consists of three stages:

Configuration Stage. In this stage, users specify the materials being used in the thermoreactive composite; a library of common conductors, power supplies, and thermoreactive materials allow for quick parameter selection; for parameters like the activation energy of a thermoreactive material E_a , I provide a walkthrough tutorial that describes the process of empirically deriving this value (Figure 7.5).

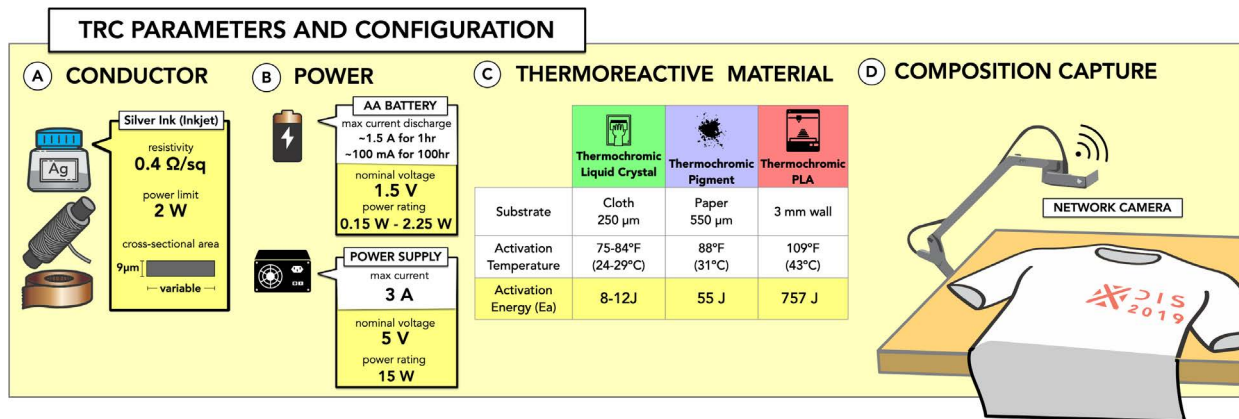

Figure 7.7: Capturing Parameters of Thermoreactive Composites

In the case of a thermoreactive shirt (Figure 7.7), the parameters are (a) a silver ink conductor [0.4 Ω/sq resistivity, 2W max], (b) 2 AA batteries [3V nominal voltage], and (c) thermochromic pigment on cloth [55J activation energy]. Using the tablet and camera, I record the dimensions of the shirt design and remotely take a picture that forms the backdrop of our digital canvas (Figure 7.8).

Design Stage. This stage uses a CAD tool to assist with generating traces with appropriate heat-generation properties for silver-ink inkjet-printed circuits (Figure 7.9). Heat can be applied to multiple regions of the design by drawing a polygon on the digital canvas (Figure 7.10). Through a UI widget, a user can control the heater pattern, orientation, and the rise time (time to activate thermoreactive material) of each region. Visual annotations on the canvas communicate to the user electrical and thermal properties of the composite and dynamically update as a user adds, adjusts, or removes a heat region or changes a TrC parameter.



Figure 7.8: Capturing a Thermoreactive Composition. An image is transferred through a network connected camera, processed through the web app, and transferred to form the backdrop of the design canvas.

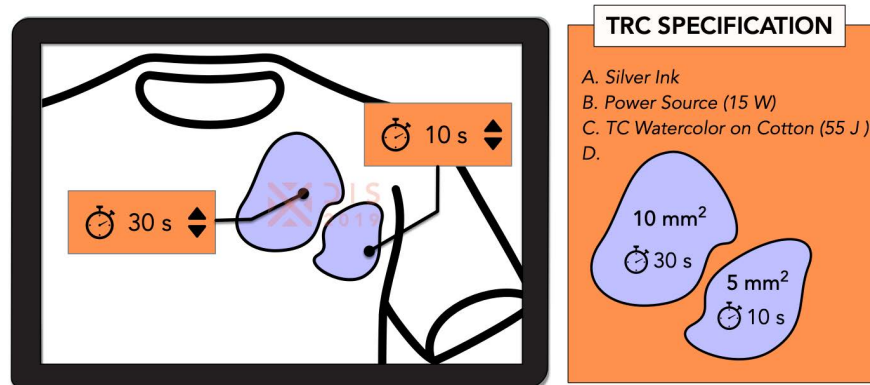

Figure 7.9: Design Stage Concerns. Given a set of material parameters, the design stage allows a user to specify regions to heat and when to activate thermoreactive materials in those regions.

Fabrication & Testing Stage. In this stage, circuits are printed and connected to a power supply using paper clips or copper tape (Figure 7.11). A liquid crystal sheet is used to visualize the circuits heating behavior; the digital design tool issues prompts to help collect feedback ("Region 1 heats up too quickly") into actionable recommendations that can be carried back to the design stage or debugged to resolve printing issues.

I found that a typical iteration for a custom resistive heater design takes less than 10 minutes and is portable to many different thermoreactive composite combinations.

7.6 Electric Heat Perceivability

Although circuit design is roughly similar to LEDs, heat is much more difficult to perceive than light is, which makes it challenging to work with experientially. While Phosphenes could automatically generate a circuit from user specifications, I instead consider introducing perceivability mechanisms

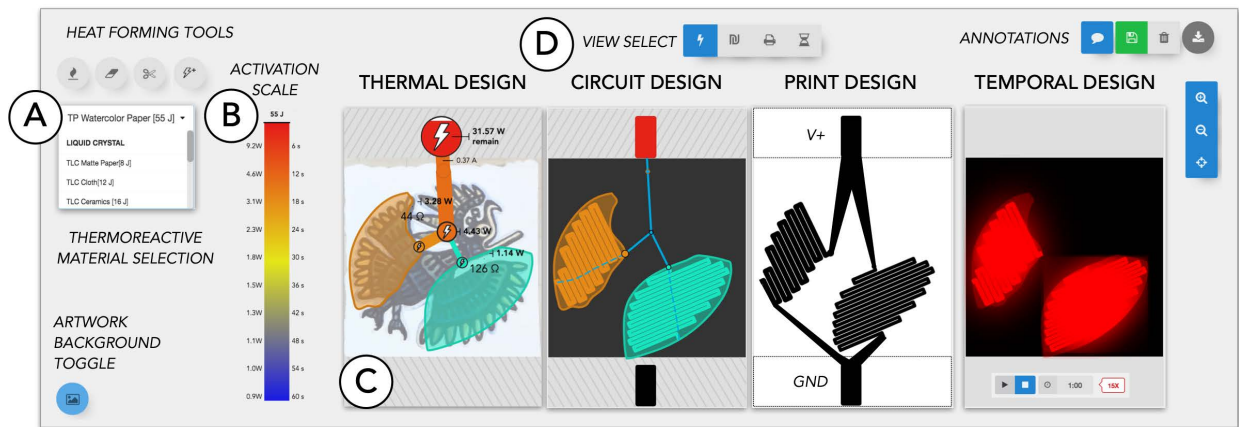

Figure 7.10: Resistive Heater Design Workflow. Four different views walkthrough the design stage interactions: a *thermal view* facilitates drawing heat regions and specifying heat region parameters, a *circuit view* aids with generating and adjusting serpentine patterns, a *temporal view* plays back a simulation of the heater design, and a *print view* presents the final circuit design; the design can then be printed, adjusted in Illustrator, or incorporated into more complex circuits.

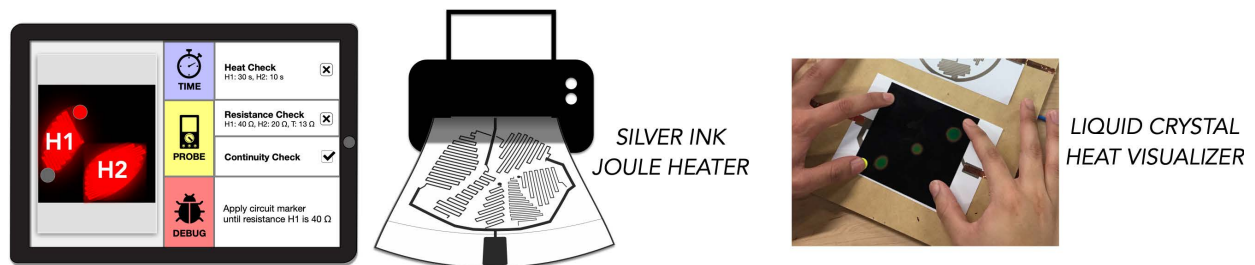

Figure 7.11: Fabrication Workflow. Heaters are fabricated and validated with a TLC sheet. The Phosphenes web app provides debugging assistance.

that can communicate the invisible constraints between different materials and design choices (Figure 7.12).

In our design process, I first consider the human perceptual limitations of perceiving heat and its interactions with other materials. I then explore strategies for developing mental models of thermodynamics and electricity from physics education literature. These principles are typically communicated through a modeling analogy, a core strategy from psychology and education, to communicate core theoretical concepts by mapping them to experiences that we are familiar with. The perceivability mechanisms I introduce are designed to provide additional physical cues and embodied interaction to aid with developing a unified model of electric heat.

Perception

Thermoreception. The body has two types of thermoreception sensors that detect temperatures above or below body temperature. Warm receptors are continuously active at constant temperatures above neutral skin temperature 34°C (93°F) [77]. Pain receptors activate at 45°C (113°F) [46], limiting heat judgment to above neutral skin temperature and below the pain threshold. However, thermoreceptors can become desensitized from prolonged exposure to a stimulus requiring a resting phase between temperature probing.

Visual short term memory (VSTM). While triggering a fast TrC interaction can be achieved within a second, the cooling rate is dependent on the difference between the activation temperature and the ambient temperature; for a typical interaction, this results in a 30 second rise and fall interaction. In the creative process, comparing and iterating on a TrC is a typical change-detection task. Due to the limited capacity of VSTM, successfully comparing differences between visual stimuli has been observed to become less effective within a few seconds [149], severely limiting the observability of electric heat interactions with thermoreactive materials.

Mental Models

Physics education commonly leverages the water-flow analogy [60], a system of relationships from hydraulics to electricity, in order to aid learners with constructing a mental model of how electrons behave. Alternative analogies include the moving-crowd model where current is represented by masses of objects (e.g., ant, people, cars), moving through passageways (e.g., tunnels, airports, highways). Such models have been shown to lead to better performance on parallel-resistor problems [60], and improve children's understanding of electrical concepts [13], yet carry the tradeoff of needing to be learned on top of the content that is being described [92]. From experience teaching and engaging with silver ink, the inverse relationship between resistance (heat generation rate), trace width, and trace length is a particularly cognitively demanding and confusing aspect of circuit design primarily due to circuit properties not being readily perceivable.

Perceivability Mechanisms - Thread Metaphor

To guide the thermal design process, we model the task of creating a heater analogous to tasks in the textile tradition. Our choice for this analogy coincides with the strong similarity of resistive heater design practice (laying out heaters using serpentine patterns) to working with thread in embroidery or cross-stitching practice. This analogy also holds the additional benefit of connoting a craft practice. Using the analogy of power as a thread, I convey the task of apportioning a finite amount of thread to cover regions of a design using patterns to maximize visual density (heat distribution design). When elements are altered on the canvas, our circuit model updates and relays thermal/circuit information using the thread metaphor, depicted in Figure 7.12, as follows:

- *Power Spool.* A power supply is represented as a spool of thread, conveying a finite resource (e.g., 5 W of thread). Power consumption is displayed through an animation of drawing thread and using up the power supply coupled with an annotation ("3.5 W remain") (Figure 7.13).

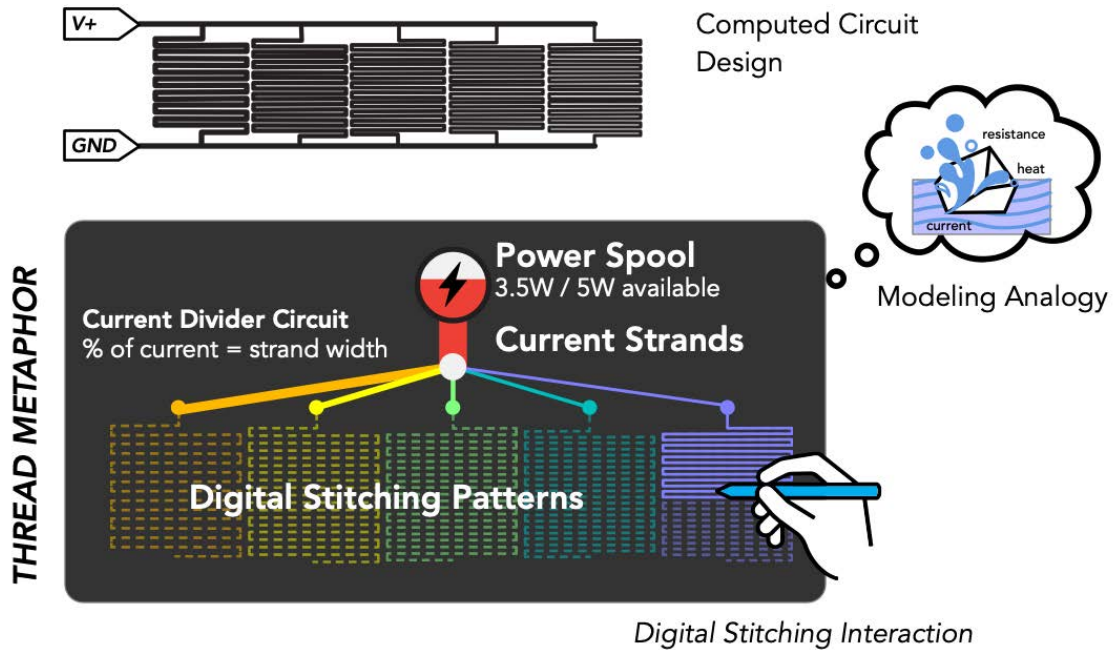

Figure 7.12: Digital Perceivability Mechanisms. The generated circuit and underlying circuit model are used to encode an interactive visual representation of circuit state, including power consumption, current distribution, and resistance. A digital stitching interaction requires physical effort to produce traces, while a splashing-rock modeling analogy conceptualizes electric heat.

- *Thermogram-colored thread.* In order to convey rise time and the power of the thread, each area is assigned an identifying color (similar to a cross-stitching legend) on the thermogram scale. Red threads heat quickly; blue threads heat slowly.
- *Current Multi-strand Thread* A thread is used to signify edges in a circuit graph where the thickness of the thread is mapped to the current flowing through it. To communicate the mechanics of the current divider pattern, a thread can be divided into thinner threads. In this manner, one thread can subdivide into 5 different threads such that the sum of widths of the child threads equals the width of the parent thread; this reflects Kirchhoff's Current Law, whereby currents entering a node and exiting a node must equal zero. The thread exiting the power node reflects the total current draw of the circuit.
- *Digital Stitching Interaction* (embodied resistance) To cause pause and encourage reflection, our tool does not automatically create the serpentine trace but instead requires users to engage in a physical stitching interaction, moving the hand back and forth over an outline of the trace; the effort from the interaction is proportional to the resistance required to generate the requisite amount of heat. For example, a 6W heater would require 3 passes with the finger, whereas a 0.5 W heater would require 30 passes. Each action pulls the trace along the specified pattern until the end terminal is reached, confirmed with a sound. Occasionally, the

trace generation algorithm produces unwanted results which users can correct by "restitching" the trace.

In the Phosphenes design tool, these values are updated dynamically as new heaters are added, modified, or removed.

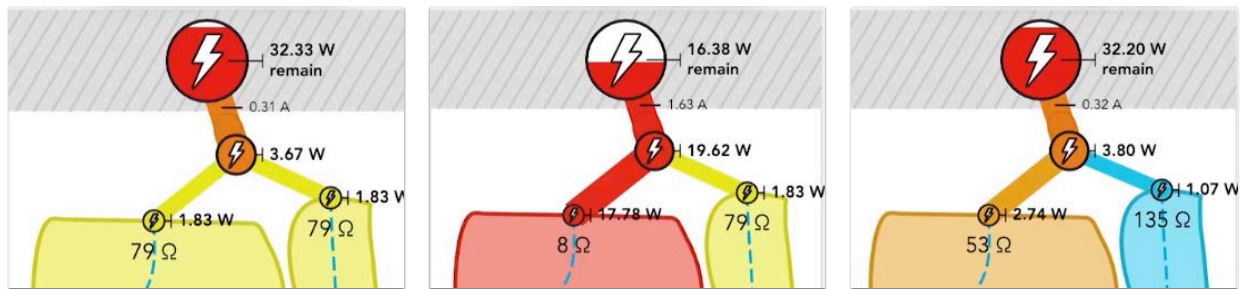

Figure 7.13: Circuit Model and Thread Model Updates. The spool drains as more current is drawn to respective subheaters.

Thermoelectric modeling analogy. Conduction and other thermodynamic principles are absent from common electrical modeling analogies. To better concretize thermoelectric concepts, I extended the water-flow analogy to convey resistive losses via heat or light: rocks in the electron river are used to represent resistance; water striking the rocks represents energy being released (Figure 7.12). Thermoreactive materials then function as nets that capture energy at different rates, e.g., a TLC sheet changes color when it has captured more than 50J of energy.

Electric heat visualization. Initially, I used an infrared camera to extract a meaningful heat visualization; however, such cameras were limited by resolution, frequent calibration, and a dependence on uniform infrared reflection. Large emissivity variations in materials produce inaccurate readings – this was the case with low emissivity silver ink. Instead, I used a passive visualization strategy with thermochromic liquid crystal (TLC) sheets with effective RGB color changes over $10^{\circ}F$ ($5^{\circ}C$). By placing the sheet over the heating element, a user can visualize heat distribution and heat flux (Figure 7.14). While a slight gap between the heater and the sheet can affect heat transfer, mechanical housing (e.g., picture frame) or a magnetic substrate can be used to apply uniform pressure and reduce convection. To aid with temporal perception and iteration, a cold plate was introduced to "reset" a TrC back to steady state. The cold plate is composed of a 92W Peltier element (TEC1-12706) bound with thermal paste to a steel bench block (hot side) and aluminum sheet (cold side). The cold plate achieved temperatures between $50\text{--}60^{\circ}F$ ($10\text{--}15^{\circ}C$), bringing fall times to 2 s.

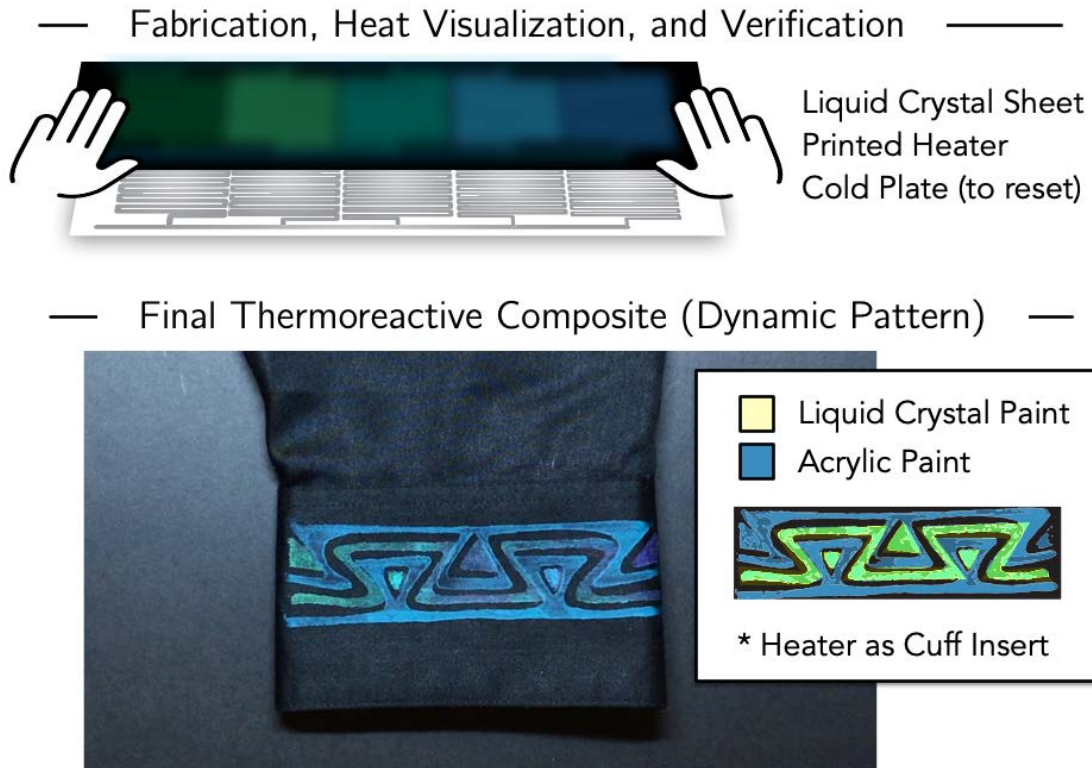

Figure 7.14: Physical Perceivability Mechanisms. (top) Liquid crystal sheets with the aid of a cold plate to reset activated materials serve as an iterative heat evaluation technique. (bottom) A TrC sleeve activates from left to right, serving as a wearable progress bar and dynamic texture.

7.7 Design Artifacts

The Phosphenes workflow was used to iteratively develop thermoreactive compositions with a variety of configurations.

Thermopainting

To create thermoreactive paintings, I created a thermochromic watercolor paint by mixing thermochromic pigment that activates at $91^{\circ}F$ ($32.7^{\circ}C$) with gum arabic in a 2:1 ratio. The resulting mixture was allowed to set in a watercolor palette. Unlike paints with acrylic binders that permanently dry, using gum arabic allows the paint to be re-wet and used like with any watercolor technique.

Painting Techniques. A set of painting techniques arose from mixing thermochromic compositions with chromostable compositions, as detailed below.

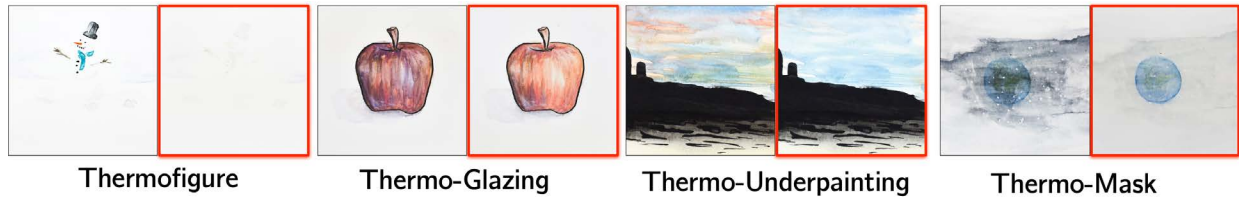

Figure 7.15: Thermodynamic Painting Techniques

- **Thermofigure** - A figure is rendered using only thermochromic pigment. When heated, the entire composition disappears. (Figure 7.15 - Snowman). This technique is useful for drawing attention to changes in state.
- **Thermo-Underpainting** - A chromostable wash is applied over a thermochromic underpainting (Figure 7.15 - Desert).
- **Thermo-Glazing** - A thermochromic wash is applied as a glaze over a chromostable underpainting (Figure 7.15 - Apple).
- **Thermomask** - A thermochromic mask is applied to occlude a thermostable underpainting (Figure 7.15 - World).

All thermopaintings created using these techniques were designed to complement the material profile of the joule heater.



Figure 7.16: Thermodynamic Watercolor

Thermodynamic Watercolor. This watercolor depicts a figure of a Mesoamerican bird motif. This aesthetic was chosen because of the occurrence of thick, outlined forms that segment regions of a composition. When working with heaters, the *halo effect* of the heater, or the soft distribution of heat around the boundaries of heat region, produced difficult to distinguish transitions and crept over to unwanted areas. An india ink outline was applied to the form into to mask the halo effect. This allowed the regions to take the aesthetic of pixels.

The work leveraged the *thermo-glazing* technique - a yellow chromostable was painted underneath, and a purple thermochromic wash was applied over the base composition. The colors were

chosen to represent the Mayan sun-moon duality. For a more rhythmic composition, the heater was designed to first activate the body, and then the wings.

This painting was assembled inside a glass frame. Power was rerouted using copper tape to a DC plug terminal drilled into the wooden frame.

In the act of wayfaring with this composition, I sought to understand how the halo effect might be leveraged to benefit a composition.

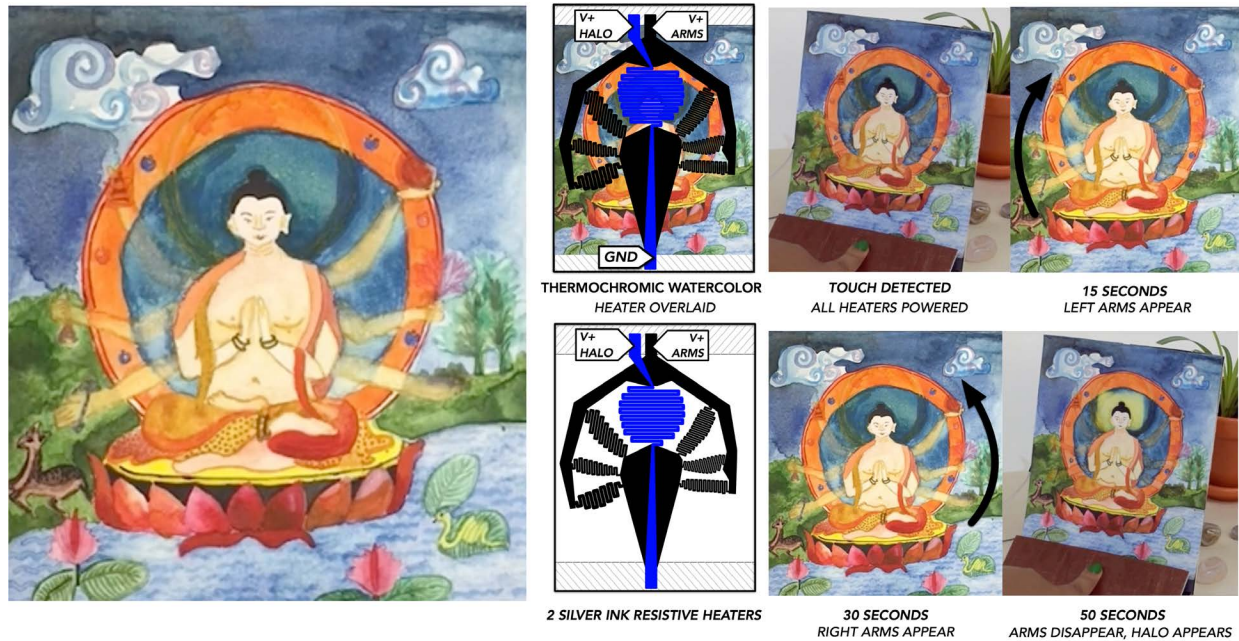

Figure 7.17: The Buddha Mala

Buddha Mala. The Buddha Mala is a devotional interface that operates similarly to Buddhist *malas*, or prayer beads, that are used to track the number of times a mantra is recited (Figure 7.17). The artifact is composed of a representation of Buddha as a watercolor thermopainting on a capacitive touch stand.

The arms and halo are rendered behind a blue *thermo-mask*. A printed joule heater was designed to activate and reveal each of the hand elements over the span of a minute culminated in the activation of the halo element. The halo element slowly fills and becomes more profound as more heat creeps to the boundaries of the element. The resulting interaction progressively reveals the Buddha figure, allowing a user to track their progress in a meditation session.

For all intents and purposes, the *Buddha Mala* is a non-emissive display and timer, but the experience would have been radically different experience if the interface was a stopwatch. The *Buddha Mala* serves as an example of how different an experience can be created when technology interfaces with a wider range of materials.

Textiles



Figure 7.18: Liquid Crystal Collar and Cuff Wearable Display

Liquid Crystal Sleeve Cuff. As an example of a wearable thermoreactive composite, a liquid crystal ink is suspended in screenprinting medium and screen-printed onto the cuff of a shirt. A Mesoamerican design motif was chosen for its easy to isolate areas to control the *halo effect*. This location was selected for the ability to easily insert and remove a PET-silver ink heater through the inseam of the cuff. Additionally, although flexible, the rigidity of the heater substrate complemented the desired state of the cuff.

Appearing on the wrist, the thermoreactive composite cuff affords many of the interactions of a smartwatch interface. Each element of the cuff can be addressed to activate for a specific action – a reminder, a notification, an alert, an update – or be used as part of a larger interaction widget such as the progress bar described in Figure 7.4.

The non-emissive nature of liquid crystal relays information unlike other mediums (e.g., vibrotactile, visual popups) allowing it to unobtrusively and continuously relay signal without becoming annoying or visually jarring. For example, the persistent feeling of heat on the skin can be used as a reminder, remaining warm until the task is accomplished.

Through its complex color transition profile, the material complements the aesthetics of fashion. It also retains elements of ambiguity - only the wearer knows the symbolic meaning of different elements being activated - a quality important to dynamic clothing [38]. Other sites for liquid crystal interfaces, such as the collar of a shirt, can mediate between sites of public and private display.

Handbag. A liquid crystal thermoreactive composite handbag was designed to explore how thermoreactive textiles might be incorporated into object form factors. The handbag design, featuring a vector graphic representation of a landscape, featured large regions of thermoreactive material. The heater was placed on a sheet of wood that was laser-cut with a living hinge pattern. The textile composition, silkscreened with liquid crystal, was wrapped around the wooden sheet and secured with doubled sided tape and sewn structural seams. The sheet was then placed around the profile of the handbag and secured with metal snaps.



Figure 7.19: Liquid Crystal Handbag with Underlying Copper Foil Heat Conductors

In the initial design of the handbag, I ran into limitations with the conductive material. To activate these large regions within 30 seconds, it required trace widths that created serpentine patterns with non-uniform heat distribution. The traces of the heater were easily visible in the thermoreactive material regions. To *smooth out* the heat artifacts, I cut thin sheets of copper in the shape of the heat region area. This allowed for the heat produced by the circuit to be conducted through copper material and create a more uniform heat distribution before reaching the composition.

The effect was a controlled, visually pleasing, and non-binary color transition that leverages heat's halo effect to achieve an analog aesthetic.

Thermal prints

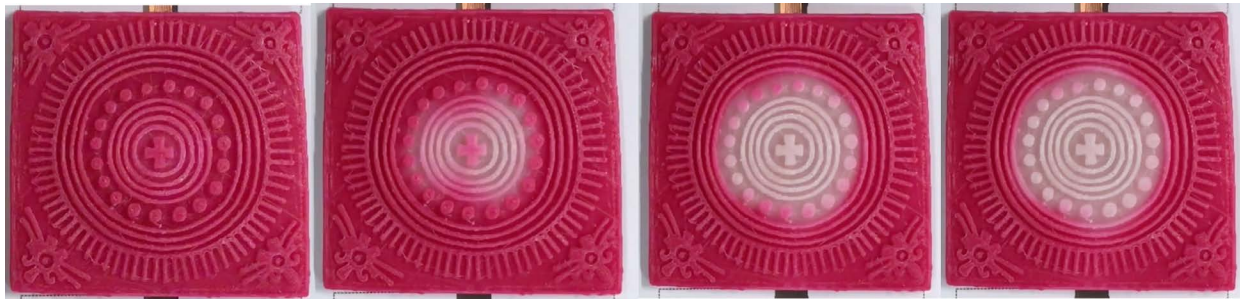

Figure 7.20: Thermochromic PLA Embossed Coaster

Coaster. The coaster represents an information display that can assume the shape and context of the task at hand while blending into the surrounding environment. In this example, a relief is 3D printed with thermochromic PLA. When placed on top of a joule heater, the relief becomes a heat sink. Designed to have elements with different exposed surface areas and different thicknesses, the relief draws and dissipates heat in different rates causing certain features to remain colored or uncolored longer periods of time. Unlike alerts that are useful for driving users towards an interaction, the TrC coaster acts as a recall mechanism, allowing users to gather information about state such as how long tea has been steeping.

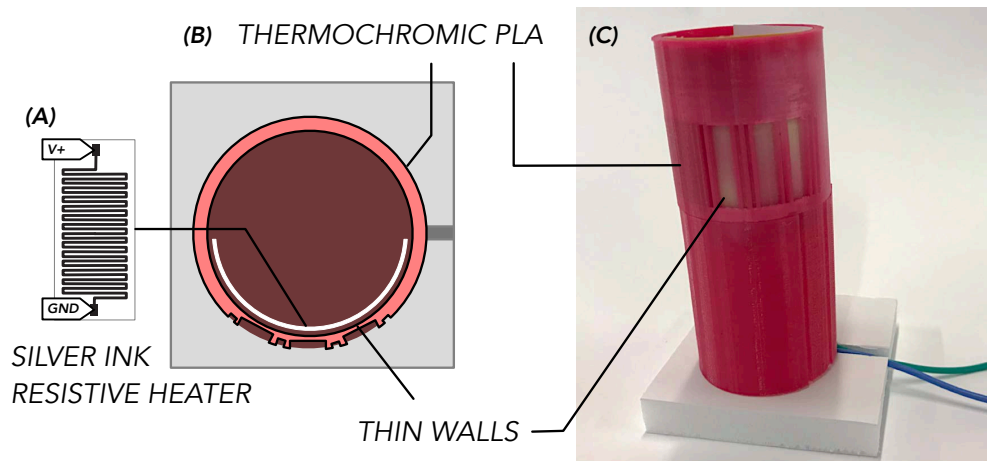

Figure 7.21: A Thermoreactive Print. (a) A silver ink resistive heater is placed inside a thermoreactive 3D print, (b) the thickness of the 3D-printed walls is used to modulate the mass in contact with the uniform heat source in the interior, (c) the thinner walls activate first, creating a windowing effect.

Window Tower. The window tower is another example of the PLA heatsink technique. A silver ink heater is attached to the inside diameter of a 3D printed cylinder. The cylinder has windows with different thickness of thermochromic PLA; when the heater is activated, these walls turn white. In order to achieve a *windowing effect*, whereby the halo effect does not interfere with other geometries, each area of interest is surrounded by thicker walls (acting similar to the outlines in the thermopainting compositions).

User Reactions

A total of 19 participants interacted with these artifacts as part of a workshop study for crafting resistive heaters described in Section 7.8. The reactions to the design artifacts are described below.

Many viewed the thermoreactive composites as fundamentally different from light-based or e-ink electronic displays. The interaction was characterized as more subtle, natural, and discrete; in particular, these interactions that could react to body temperature or produce energy similar to a body felt symbolically "more human".

The encoding of information as heat into everyday objects added a layer of complexity that many participants found could create and reinforce personal identity:

Participant M4: The [Buddha Mala] is an object that you might encounter in someone's home; their choice of having it tells you something more about that person and their aesthetic

The specificity of the display, in comparison to pixel-based devices, was found to add value both in reducing costs and in having a sustained function.

Participant M1: I'm much more likely to throw that in my bag and carry it with me than I would a display.

Interactions with the TrC were found to warrant longer attention than more familiar technological interactions; the hysteresis of the heat was viewed as part of the interaction.

Participant M5: Its a more complex representation. It fades in and fades out. You need to focus on it and its good for longer stretches of time.

The haptic characteristics of the heat generating elements, when embedded into clothing, were likewise viewed as fundamentally different from sound and vibration. TrCs were envisioned in medical applications like glucose monitoring that required constant feedback for users, for evaluating the thermodynamics of materials in techniques like injection molding or 3D printing.

Clothing as a site for display and feedback had mixed reactions. TrCs were envisioned as conveying biosignals, relationship statuses, or time-dependent nametags. Fashion potential caused a marked response from some participants, relishing the responsiveness of the material and the nuanced aesthetic. They were also seen as carrying social information from interactions with the general public e.g., familiar strangers, or used to enhance gameplay e.g., colored and heated marks during paintball.

7.8 Workshop Evaluation

To assess how Phosphenes supports crafting resistive heaters and working with heat, I invited participants from material practice and engineering backgrounds to attend a 1-hour workshop. This workshop was specifically designed to build familiarity with the unique challenges and opportunities of working with thermoreactive composites and to contrast the experiences of these different practitioners. In a pilot study, participants were asked to design a thermoreactive watercolor and resistive heater. A challenge of this setup was navigating the bias in familiarity: participants focused primarily on either their heater or their watercolor, restricting their exposure to unique TrC design challenges. I found that focusing the task on designing a heater to trigger a readymade composition allowed for many of the unique TrC concerns to surface, i.e., where to spatially generate heat and how to trigger a composition to have a meaningful composition. The questionnaires, interview guides, and study protocols used in this study are available in Appendix D.

Protocol. In our final workshop, I tasked participants with designing a heater that when triggered would cause 3 areas of a readymade thermoreactive watercolor (12 thermoreactive circles arranged in a 3x4 grid) to disappear (Figure 7.22). Participants were also interviewed beforehand on perceptions of electricity and heat as creative elements and engaged in a think-aloud protocol when viewing a range of thermoreactive materials, different thermoreactive composite combinations and exemplars, and in the heater design and fabrication task. Lastly, I conducted a post-study semi-structured interview probing on future creative trajectories, discoveries, and frictions.

DESIGN PROMPT
Make 3+ "circles" disappear.



Figure 7.22: Workshop Heaters. Participants were tasked with creating a heater that would make 3 or more circles disappear from a thermochromic watercolor composition.

Participants. Participants were recruited from departmental mailing lists in Design, Engineering, and New Media. A total of 19 participants (10 female, 9 male, avg. age 22 ± 4) took part in the study and were grouped based on survey responses querying familiarity with creative mediums, electronics tools, techniques, and theory as follows:

- **Engineering (E)** - 7 participants had extensive experience with circuit design, electrical concepts (e.g., Kirchhoffs' circuit laws), and heat transfer concepts.
- **Material (M)** - 7 participants were well-versed in material practices ranging from painting, quilting, and metalworking.
- **Hybrid (X)** - 5 participants possessed extensive experience in both engineering and material practices.

Measures

Creative Potential of TrCs. Unlike productivity support tools, creativity support tools are difficult to assess due to a large number of design variables and confounds without obvious measures to quantify (e.g., performance, time and error) [179]. For this reason, I administered the creativity support index [31], a psychometric survey grounded in creativity support tools literature which measures how well a tool "assists a user engaged in creative work". The index derives a possible 100 point score composed from assessments of 6 creative factors (Figure 7.23A). The score for each factor is determined in two parts: (1) a *factor count* independent of the task used to reflect a user group's preference for each creative factor (5 point max³, Figure 7.23B), (2) a *factor score*

³ Each creative factor is compared against the 5 other factors; a factor score represents the number of times a factor is valued over others; only 15 pts are distributed amongst the 6 factors representing the 15 possible combinations of factor pairs.

from two 10-point Likert scale questions (20 point max, Figure 7.23C). The factor count is used to weight the factor score; the resulting values are combined for a holistic CSI score. The index was used to evaluate the creative act of designing resistive heaters for use in thermoreactive composites; although the workshop task was scoped to thermoreactive watercolors, participants were asked to consider the tool's support for using the same workflow for other thermoreactive composite combinations.

Perceiveability of TrCs. Participants filled a post-study questionnaire with Likert scale questions querying the perceiveability and comfort of working with circuit concepts like resistance, current, power, and Kirchhoff's circuit laws as well as thermal concepts like conduction. In addition, I transcribed think-aloud audio, logged design tool interactions, and kept an inventory of heater prototypes.

7.9 Qualitative Results

All participants successfully designed a resistive heater with at least three resistors with different power requirements; all but one heater was functional; the defective heater was diagnosed during the study by the participant and researcher and resolved to be a printing error. Despite using the same thermoreactive composition, designs ranged from 3-6 resistors with motifs of form-giving heating elements (e.g., figurative rivers), symbolic relationships with the artwork (e.g., making cool-colored circles fade away), or pushing the limits of the fabrication and materials (e.g. maximum temporal difference; consuming all available power). I first report Likert ratings, CSI results, and then present themes that were observed from the think-aloud and semi-structured interviews.

Perceivability Ratings. On average, participants reported on a Likert scale from 0 to 10: comfort with the design and fabrication process (8.6 ± 1.1), comfort with working with joule heaters (8.4 ± 1.3), and an understanding of the electricity and thermal mechanics (9.0 ± 1.1). The process and electronics were viewed as approachable (9.1 ± 1.2).

CSI Results. Participant groups notably differed by the value placed on Exploration by hybrid practitioners (count 4.8X versus 3.9E and 3.7M) versus the value placed on Enjoyment by material practitioners (count 3.1M, versus 2.1E and 2.8X), and Results Worth Effort by engineering practitioners (count 3.7E versus 2.7M, 3.0X).

The CSI final adjusted score (Figure 7.23D) for each group breaks down as follows: engineering practitioners (65.5 ± 9.5), creative material practitioners (78.2 ± 7.4) and hybrid practitioners (84.3 ± 6.4). As a baseline, Cherry et al. reported Google Docs for a collaborative creative writing task with a CSI score of 87.73 (SD=11.30). These scores suggest a stronger affinity for the tool by hybrid and material practitioners and that an epistemological difference exists that can be supported by creativity support tools. Out of important factors, expressiveness was least supported for engineering practitioner (12.1/20.0), many citing a desire to have more control over parameters.

Creativity Support Dimensions	Independent Task Rating (distribution of 15 points)			Evaluation of the TrC Design Tool (20 points possible per dimension) average(factor count x factor score)					
	Avg. Factor Counts			Avg. Factor Score			Weighted Factor Score		
	E	M	X	E	M	X	E	M	X
Exploration	3.9 (1.3)	3.7 (1.1)	4.8 (0.4)	14.4 (1.8)	15.9 (2.7)	17.6 (1.5)	54.7 (17.7)	60.3 (24.9)	84.4 (10.2)
Enjoyment	2.1 (1.9)	3.1 (0.4)	2.8 (1.8)	13.7 (2.1)	16.4 (1.0)	17.0 (1.2)	27.9 (26)	51.9 (9.1)	47.6 (30.6)
Results Worth Effort	3.7 (1.3)	2.7 (2.0)	3.0 (0.7)	14.9 (2.0)	16.7 (2.5)	17.4 (2.1)	54.9 (19.5)	44.6 (34.8)	53 (16.9)
Expressivity	2.3 (1.7)	2.3 (1.3)	2.4 (1.1)	12.1 (3.3)	14.6 (2.4)	16.0 (3.1)	29 (22.2)	34.4 (23.3)	37.8 (16.4)
Immersion	1.9 (1.5)	2.0 (1.4)	1.6 (0.9)	11.6 (4.5)	13.9 (3.5)	13.6 (2.9)	26.7 (26)	28.4 (19.3)	23 (16.8)
Collaboration	1.1 (0.9)	1.1 (1.2)	0.4 (0.9)	6.3 (6.4)	14 (3.8)	13.8 (4.3)	4.1 (5.4)	14.3 (17.4)	7.2 (16.1)
				CSI Score (out of 100)			65.8 (9.1)	78.0 (7.5)	84.3 (6.4)

Figure 7.23: CSI Index Results

Familiarity of materials and process

The CSI factor score revealed the presence of an epistemological difference between engineering and material practices. Between the two practices, participants distinguished the focus on specification-based problem-solving in electronics as opposed to the open-ended nature of creative tasks. A common friction was adapting designs to fit the ecology of materials and components available and how widely they differ within their class (e.g., choosing motors, microcontrollers). Despite the tool automatically resolving current, voltage, and resistance values to fit a power specification, the tool did not provide an avenue for engaging with circuit equations, symbol manipulation or analysis. For engineering practitioners, the inability to engage with circuits in mismatched their creative process. This might additionally explain why engineering participants rated a lower expressiveness score since such familiar elements drive their workflows for circuit design. The parallel circuit construction strategy was viewed as a major comfort and simplification:

Participant X2: I feel so much more comfortable knowing [parallel construction] as a design parameter.

However, the design workflow removed the need to design for voltage drops introduced from series connections and changed the familiar element of symbol manipulation with voltage, current, and resistance characteristic of engineering practice.

Participant X5: I think with voltage and voltage drops. The interface changed this to thinking in terms of power rates and rise times.

In contrast, for material practitioners, the familiarity of material form factors such as paper and ink reinforced and matched their creative process. Electronics were viewed as being more brittle, susceptible to dysfunction, and lacking the kind of freedom of combination (or composability) as creative materials.

Participant X3: These are very familiar kind of tools: you use paints, things that look like pieces of paper, you use colors and those visual signals ... it's a lot more approachable than electronics in the other sense; those electronics are daunting, especially when you don't know anything about them.

Hybrid practitioners described their process as *sketching with hardware*, finding elements that spur their curiosity, then designing and engineering its function. Many relished the problem-solving component common in both practices, and described methods of probing and examining the invisible quality of electronics:

Participant X5: It's not easy to see what is happening. I work backward, first looking at readouts from pins. I connect wires to probe and see if I can get the value I expect and keep forming hypotheses until I'm sure I understand what is happening.

The familiarity of both practices by hybrid practitioners acted similar to a buffer solution, resisting and stabilizing adverse effects of defamiliarization, suggesting opportunities to develop curriculum that incorporates multiple disciplinary methods as a means of creating more resilient creative practices that can withstand exposure to unfamiliar elements.

Aesthetics of Electronics Design Tools

Aesthetics played a large role in perceptions of approachability, audience, and use. Participants found an affinity to the constructionist elements integrated into the tool: the familiarity of icons like the power symbol, animations like the draining power supply, the focus on color, the friendly rounded-edges of the serpentine patterns, and a nostalgic association and kinship with the Microsoft Paint program. Although all participants perceived a clear benefit over current circuit design tools, many strongly associated the interface as geared towards children. This suggests an opportunity exists to consolidate how constructionist elements are presented to reflect the aesthetics of professionalism (e.g., encoding variables as visual patterns versus color).

Contract of the Digital Hand

A common friction and surprise occurred when participants engaged in sketching interactions. One interaction, sketching a path to specify a heat region, caused pause, reflection, and unhappiness when the path retained its imperfect, hand-drawn look. In contrast, the digital stitching interaction rendered a smooth, regular, and even space-filling curve as the participant moved their finger back and forth. Participants expected that their hand-drawn strokes would be transformed into "perfect," aligned geometries. Such computer-mediated elements were seen to form a contract with the user, where both computer and user shared responsibility for the outcome:

Participant E1: If that were automated and [a badly drawn path] happened, it would be annoying. It would think the system should have known better. I would have blamed

it on the system, but having drawn it I feel like I take some responsibility in what actually happened.

This suggests that opportunities exist to design onboarding practices that scaffold and balance responsibility between human and machine to slowly instill reward and confidence.

Role of the Digital Stitching Interaction

In order to generate the serpentine pattern, users had to carry out a digital stitching action with a physical gesture; the serpentine path would only be generated once the amount of effort matched the resistance (and power rate) of the region in order to communicate how resistance reduced the heat generation rate of respective heaters. This stitching interaction was met with a bimodal response. Foreseeing the need to design a joule heater quickly, engineering and hybrid participants viewed the interaction as fun but frustrating and desired the ability to access this interaction as a configurable setting, scoring its value as a 2.9(1.9)[E] and 3.2(0.8)[X] on a 5-pt Likert. However, when the serpentine algorithm produced an undesirable result, participants viewed it as a troubleshooting technique that communicated the limitations and process of the serpentine algorithm.

Participant E4: It feels like a troubleshooting technique; doing that motion makes sure that [the circuit] is okay. For me, it's another level of check that makes you aware.

Material practitioners scored and perceived the digital stitching interaction *quite differently* 4.9(0.4)[M]. Initially viewing the act of making the serpentine pattern as complicated, they found the act of creating the serpentine pattern as engaging, joyful, and instilling agency:

Participant X5: It was fun and felt like you were making it; like you had a role in the work.

Participant X3: It made me feel like I was building the circuit myself; it gave me an understanding. I could have done it the other way [automatic generation], but creating the [traces] myself made me know what's going on inside.

Power as a creative material

Before being introduced to the tool, participants revealed different mental models of heat: one participant likened heat as a flow, taking time to move through materials; others described heat in terms of the everyday control mechanisms, e.g., controlling strength with a stove dial. As a creative material, many considered heat a byproduct: When I work with heat, it's about minimizing heat. Heat is not a desirable property (**Participant E4**). Electronics behind heat were perceived as complex; however, one participant, having previously deconstructed a hot glue gun, noted:

Participant X3: I thought [the glue gun] would be very complicated, or anything that works with heat. I took it apart and found that the only thing that was producing the

heat was these two metal plates ... It's actually just a resistor in there! It was rather surprising that it was so simple.

When participants were presented with the water-flow modeling analogy, reactions were mixed: some had never heard the water-flow analogy, yet were surprised at how easy it was to pick up or how much it aligned with their mental model. For engineering participants, the water analogy misaligned with their way of thinking, having already constructed a model based on formal definitions. The extension of the thermoelectric concepts, i.e., electron water colliding with resistive rocks caught by thermoreactive nets, was welcomed by all and viewed as a natural extension and "filling a gap."

The thread metaphor was viewed positively by all participants. Many described annotations of current and resistance in the cognitive background; their main focus was working with watts and distributing power to heat spaces. A major conceptual discovery that occurred with all participants was understanding power as a finite quantity.

Participant X4: I quickly realized from how the power source was draining that there are only so many watts available.

Compared to probing circuits with a multimeter, evaluating the heater with the liquid crystal sheet was preferred by all groups. As a visually engaging medium, the liquid crystal encouraged users to think about the mechanics of heat.

Participant E4: It is so cool to watch the liquid crystal change color. It makes me think about how the heat flows through the paper and heat transfer in general.

Participants noted a shift in how they conceptualized electricity and their relationship towards it.

Participant X4: It changes your relationship to electricity completely. I think it shows you a different aspect of electricity; where electricity doesn't just hurt you, shock you, is just used to power your electronic device, but can be used creatively... this process makes it more intimate.

The perceivability of electric heat and the material ecology around TrCs drove participant's perceptions about electricity:

Participant X5: The [TLC sheet] fixes electronics for me. It is a different, more fun, way of seeing electricity happen.

Participant M4: I feel electricity as more friendly, and I would enjoy doing this at home.

Participant X3: I thought that electronics were their own system. They are daunting since you don't know anything about them. They are closed-off. I can't go into that and touch things and find out how to work with them. Now, I can put [thermoreactive materials] on [heaters], and they will respond. I can do different tests with it. It feels a

lot more accessible on the hardware side. I don't need to go into the code, decompose the circuit, or connect new wires. It becomes a lot more visual and interactive, and in the process, I actually learn what is going on within the [resistors].

7.10 Discussion

In this work, the concept of computational composites was applied to electric heat in the form of Thermoreactive Composites; however, due to the complex and invisible constraints of the conductor, thermoreactive materials, and power supplies, these composites need to be carefully configured to allow heat to "be expressed as a material".



Figure 7.24: Haptic Retargeting. Glass-blowing practices use heat in ranges that far exceed current Thermoreactive Composites. How might retargeting these haptic cues affect creative practices?

Configuring Thermoreactive Composites

Phosphenes allows designers to develop resistive heaters specific to the thermoreactive materials and power supplies at hand. In the act of crafting the resistive heaters, the tool communicated creative constraints, updating visual cues that (1) communicate how different heaters change the power requirements of the circuit and whether the configured power supply and conductor will be able to safely satisfy them, and (2) building in a digital making interaction that requires physical effort from the user to complete the circuit design.

Unlike the responsiveness of computational composites, the relationship between heat and electricity was less visible in color-changing textiles, prints, or paintings. I leveraged a thermoelectric circuit model to represent this relationship and leverage simulation to render how heat would activate different materials for quicker iteration. Using the TLC sheets, heat was remapped from a haptic experience to a visual experience which reinforced many participant's mental model of electric heat but also altered their conceptions of heat as a creative material. I did not end up using the body's natural thermoception since many different Thermoreactive Composite combinations had a temperature differential that would be difficult to detect; I see opportunities to explore other

modalities like activating scent as a way to engage more of the body in sensemaking or develop a haptic device that senses these minute changes in temperature and renders them to match the psychophysics of the body.

Participants found that many of the tool's elements receded into the cognitive background as they actively engaged in wayfaring behaviors, corresponding with the morphogenetic (or form-generating) making [85]. Specifically, I observed designs evolve as participants interacted with the tool, especially influenced by the diminishing “power spool” that would respond to changes in the design or from the quality of heat distribution when using the TLC sheets.

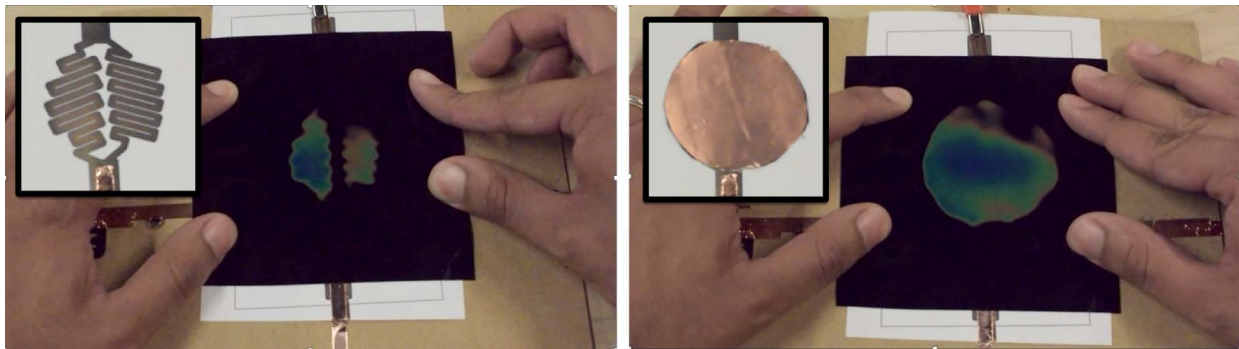

Figure 7.25: Copper Heat Smoothing. (left) A two-branch joule heater activates a TLC sheet; (right) a thin-sheet of copper is placed over the original heater, smoothing out the serpentine heat pattern.

Alternative Sites for Crafting Heat

Although the relationship with electric heat was conveyed and approachable, the creative potential for heat was only slightly breached. Phosphenes lowered the barrier and expense of visualizing heat interactions using TLC sheets and the design time for fabricating a custom heater. Figure 7.21 shows one Thermoreactive Composite (silver ink, thermochromic PLA) that reached the creative bounds of the resistive heaters. With a 2-3W power limit, silver ink could only trigger changes in particularly thin walls of thermochromic PLA in the < 1-minute range. However, changing the thickness of the walls was another way in which heat could be controlled and mediated since more mass requires more energy to activate. In this way, the thermoreactive material becomes the site in which heat is crafted. Mass is just one of many design variables that heat sink design is well suited to capture. While heat sinks are traditionally made from metal, it would be useful to also capture and incorporate these design practices into Thermoreactive Composites.

Extending Heat as a Material

Although systems with Peltier elements have introduced cooling elements [144], controlling how thermoreactives react when cooling remains an unexplored creative area. A wider range of thermal materials could enable new creative dimensions. Thermal insulators like silicone could be used to

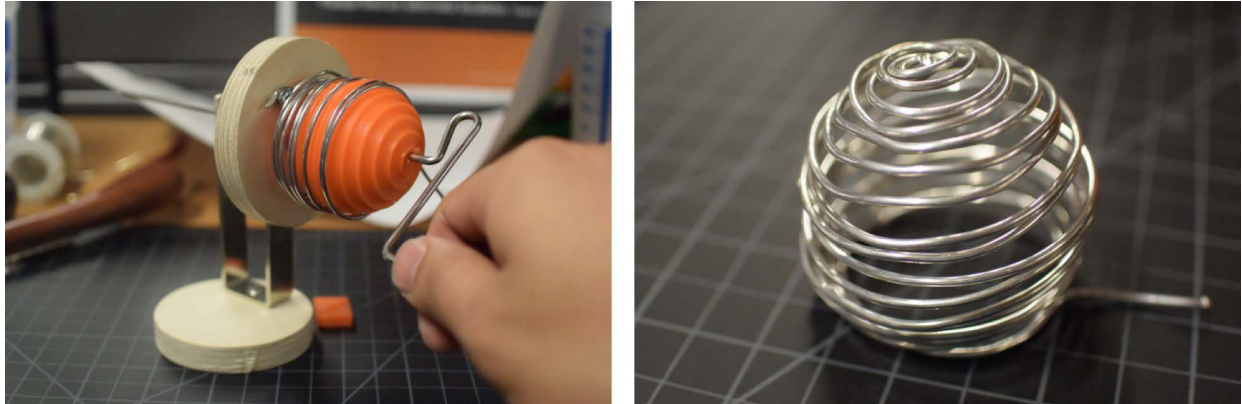

Figure 7.26: Could shaping three-dimensional wire forms created three-dimension heat forms?

edit, erase, and refine joule heater elements. Other conductive materials may include mechanically-attached heat sinks for selective heat transfer or the use of thermal compounds (pastes and adhesives) to smooth out heating artifacts. Cross-flow blowers could introduce a convection element and push cool or warm air through air-pipes in 3D objects([170]) to influence thermoreactive material activation. Silver ink is limited in both its power rating and archivability. While copper-plated PCBs serve as an alternative, other physical, creative practices like wire bending can be introduced to create stable three-dimensional heating elements and support broader working ranges. Our techniques worked well for material activations under the human thermal perception threshold, but working with hotter materials tangibly remains an open question that creative practices like glass blowing and welding may inform.

Immaterial Composites

With immaterial composites, I found that by coupling an immaterial with a physical proxy, behaviors, structures, and forms can become readily visible and manipulable. I demonstrated this technique for electric light (Chapter 6) and electric heat (Chapter 7).

Building on the concept of the computational composite, the binding of the immaterial to the physical proxy had much more nuance; if properly calibrated the two coupled materials could be in synergy – this is the site that I see computational design having a distinct advantage over analog methods.

The wide breadth of materials and their internal properties is something that could be captured by sensors. For example, for wood carving using a combination of infrared, light, a piezo electronics could characterize the softness of the wood and provide this type of feedback to the user. Heat, because of its slowness, also proved to showcase more of the nuances of properly calibrating the input and output thresholds of the composite.

7.11 Summary

I demonstrated a Crafting Proxy for designing resistive heaters within Thermoreactive Composites. Through the computational design of heater geometries and a thermoelectric model, our system exposed the ability to craft resistive heaters that distribute heat spatially and temporally as specified while accurately activating a range of thermoreactive materials. In a formal user study, I validated that our design and fabrication workflow facilitates an iterative design cycle that conveys both electrical design and thermal design concepts and renews the role of heat as a creative material. Through the Creativity Support Index, the study revealed a greater affinity for a material epistemology and the potential for *composability* and *perceivability* to act as driving design variables to support a broader range of users to participate in digital fabrication.

I found that, like in Chapter 6, computational design could similarly be used to interface heat and thermoreactive materials. However, because of the limited perceivability of heat, I needed to introduce a design step to remap physical stimuli to be perceivable and understandable and increase the information bandwidth of the physical stimuli.

In the next chapter, I discuss how the compositing design pattern can be extended to work with magnetism, UV and infrared light, biomaterials, and even new computational materials like neural networks. The next central challenge is understanding how more stimuli can be mapped to the human perceptual system in this way, engaging more of the body in the sensemaking process.

Chapter 8

Discussion

This work leveraged a Research through Design (RtD) methodology to build intermediate-level knowledge around the design, implementation, and evaluation of Crafting Proxies. The concept of a Crafting Proxy serves to formalize the different capacities that an intermediary between a material and a practitioner can serve within a material practice. I explored three different areas of the Crafting Proxy design space – armatures, mediators, and lenses – each situated in material practices with wire, light, and heat, respectively.

In this chapter, I reflect on how the compositing design strategy can be generalized and applied to new material and immaterial contexts, design principles to navigate the design space, and the extent to which material practices can be studied and supported using our proposed method.

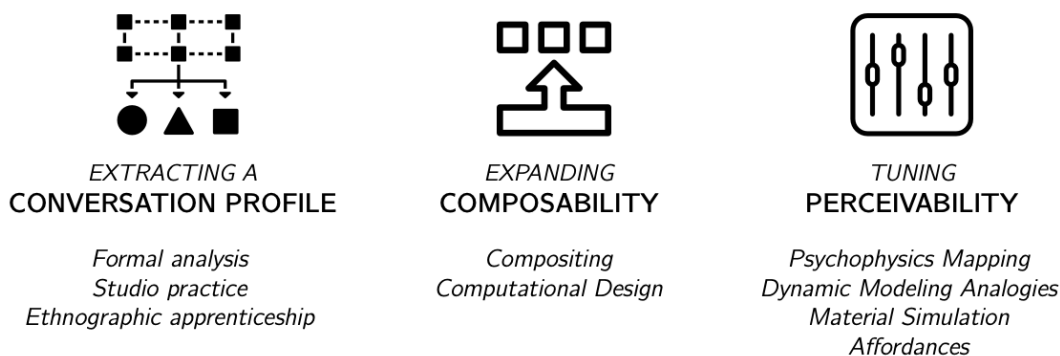

Figure 8.1: Crafting Proxy Design Method

8.1 Crafting Proxy Design Method

The Crafting Proxy Design Method is a material-centric approach aimed at designing a tool *for* a material situated within a practice. For instance, applying this method to a material like wood in a woodcarving practice aims to foreground the “talk-back” of wood to develop a deeper relationship

between the practitioner and material. This is in contrast to Computer-Aided Design (CAD) tools that work with an abstracted material (e.g., voxel or mesh) aimed at codifying existing woodworking techniques to be usable within a CAD-CAM pipeline.

The act of designing Crafting Proxies for both materials and immaterials allowed us to assess the boundaries of the Crafting Proxy design space and surface key considerations not addressed by the current compositing strategy, including:

- How do we interpret an immaterial’s “talk-back” within a creative practice?
- How does an immaterial’s “talk back” inform creative action and forms?
- How do we configure immaterials within a composite?
- How do we facilitate a material encounter?

I describe how our three-phase method addresses many of these challenges, motivate our design decisions, and address the limitations of our approach.

Extracting a Material’s Conversational Profile

The aim of extracting a conversational profile, much like a persona, is to inform the design process to be centered around a material, intended to satisfy and amplify the “talk-back” in a reflective practice. In Chapter 2, I formalized three components of a conversational profile (Table 2.1) to incorporate into Crafting Proxies: sensorial feedback, affordances, and tradition.

To understand a material’s sensorial feedback, I leveraged two analytical techniques. Using formal analysis [133, 11], I formulated a description of the arrangement and function of form-giving elements in a collection of artifacts. This technique aims to explain how the phenomena that we experience alters and informs our experience of a larger composition. While formal analysis is only intended to describe phenomena, it has the tradeoff of introducing a medium specificity bias - focusing on purely the physical properties of the materials versus identifying the sociomaterial qualities (e.g., the experience of a knitted blanket from loved one, versus a machine-made blanket).

To counteract this bias, our analysis leveraged Giaccardi & Karana’s material experience framework: For instance, in analyzing the *Virgen the Guadalupe* lamp, I explored how the performative elements (the object situated as a religious artifact), was supported by the affective elements (light as ethereal), defamiliarized at the interpretative level (optic fiber evoking a techno-aesthetic), and decomposed at the sensorial level (light fading, strobing, glimmering, reflecting, and refracting). These sensorial components were then clustered and synthesized into the conversational profile.

To understand affordances and tradition, I leveraged ethnographic apprenticeship techniques [215, 162]. For instance, in entering the practice of wire wrapping, I began as a novice and gained expertise, documenting important learning moments, experiencing error, and reflecting on the tacit knowledge developed in the act of engaging with wire. This allowed me to experience the affordances that guided my wire forming process. In situating myself in the larger community of practitioners, I positioned the wire forms in the tradition of wire wrapping practice as opposed to

engaging with forms enabled by new technology. This allowed me to develop a sensitivity for style, or the “constancy, or consistency, in the way an individual, or a group, treats the formal elements of art, or visual culture” [69]. However, as is common in ethnographic approaches, I introduce bias from my own predilections and the Western-oriented community of practice I became a part of. I see value in posing conversational profiles as a research area to develop across the variety of materials and practices that exist across cultures and disciplines.

As a reference, the profiles I synthesized are found in Sections 5.6, 6.3, and 7.3.

Expanding Composability

I used the resulting conversational profile to define a target material manipulation space. The goal of this design phase is to identify the current means of manipulating a material, i.e., its material API, and develop techniques for spanning a larger manipulation space to improve the composability, or malleability, of a material.

For light, the material manipulation space was bounded by the LED, limiting composability to light intensity and color. From optoelectronics literature, I identified methods of decomposing light into three components: a control module, beam-shaping module, and diffusing module. I then developed computational design algorithms that used an SVG as input to expand the repertoire of available forms, including hard-soft edge definition, textured diffusers, non-traditional control layouts, and passive haptic and deformable light interactions.

For heat, I explored a manufacturing technique for creating silver-ink inkjet-printed resistors. Used primarily as a binary heat-generating element, I developed computational design routines that expanded the expressivity of resistive heaters as a spatiotemporal medium. By modulating trace resistance by trace width and laying traces with space-filling curves, resistive heaters were designed to generate heat over target, non-rectilinear regions of interest. Through a circuit divider construction pattern, multiple heaters were arranged in parallel and configured with different heat generation rates, allowing resistive heaters to activate thermoreactive material over time.

Our composability strategies benefited from established engineering principles and advances in material fabrication techniques but shared a common computational design base. Computational design in these situations was used to surface material interactions (e.g., light and its interactions with refractive and reflective materials) and actively support creating and refining mental models (e.g., using dynamic modeling analogies). However, leveraging computational design is prone to introduce a maker-bias, where although a wider, more open-ended API is supported, it still reflects the design decisions and philosophies of the developer. I built our computational design engine on the SVG so as to incorporate the repertoire of 2D design skills that have developed across disciplines; as I discuss in this chapter, this allowed for unintended uses of the design tool which I see as a promising method to mitigate maker-bias.

Tuning Perceivability

Many immaterials have limited external states that are readily perceivable by the human perceptual system or understood by human cognitive processes. I incorporate a *perceivability step* focused on

configuring a composite to communicate its forms, structures, and behaviors of an immaterial. I approached this dimension from two approaches:

- From a *perceptual* approach, I examine how the physical stimuli produced by the physical proxy can be reconfigured to increase the information bandwidth to precognitive processes. For instance, the heat produced by the resistive heaters was remapped as a visual stimulus using thermoreactive materials. Using a formulation of liquid crystal that activates in the range of temperatures used in our target applications $91 - 101^{\circ}F$ ($32 - 37^{\circ}C$), heat stimuli was remapped to red, green, and blue color changes that allowed visibility of the temporal component of heat transfer.
- From a *cognitive approach*, I examined how heat and electric interactions are communicated in formal education. I developed a unified heat-electricity modeling analogy through a thread metaphor, which was then integrated into the design workflow as a dynamic modeling analogy. In the act of designing a heater, dynamically generated perceptual cues communicated electrical and heat behaviors. For instance, power as a finite material was communicated using a diminishing power spool that would lose “thread material” when heaters in the design drew more power.

This process made clear the bias towards visual, touch, and audio interfaces and the extent to which computational control can be enacted on physical stimuli. I discuss in future work trajectories for increasing the perceivability of immaterials and incorporating more of the human perceptual, cognitive, and motor abilities to engage in sensemaking.

8.2 Design Principles and Strategies for Crafting Proxies

In the following section, I describe design considerations, concerns, and strategies that arose from designing Crafting Proxies. These insights are synthesized across the proxies created, artifacts formed, and workshop evaluations in this dissertation.

Designing for Sensemaking

In this work, I explored two immaterials, light and heat, and formed composites with physical materials. These physical materials acted as mediators, remapping immaterial behaviors, forms, and structures to perceivable stimuli. From our design workshops, I observed the following principle:

Sensemaking Principle. Proxies that mediate the representation of a material (e.g., via simulation) benefit from cool, low-definition representations. These representations elicit active participation from the practitioner to make sense of what is occurring. Designing proxies to be open-ended, i.e., for unintended uses, can improve how proxies are reappropriated and controlled by the practitioner to make sense of their larger creative environment.

Hot and Cool Proxies. For light, I used a light simulation mediation strategy consisting of a ray tracer that would project rays from an SVG element annotated as an LED. These rays reacted to the geometries of other SVG elements annotated with refractive or reflective material properties. The simulation navigated the startup costs of housing, controlling, and programming LEDs, and allowed users to construct material knowledge through direct manipulation interactions. However, as intrinsic to all simulations, the simulacrum of real-world interaction was incomplete. To enable faster render times, a fixed number of rays were cast with a fixed number of bounces and rendered on a 2D-abstracted representation of the scene (Figure 8.2).

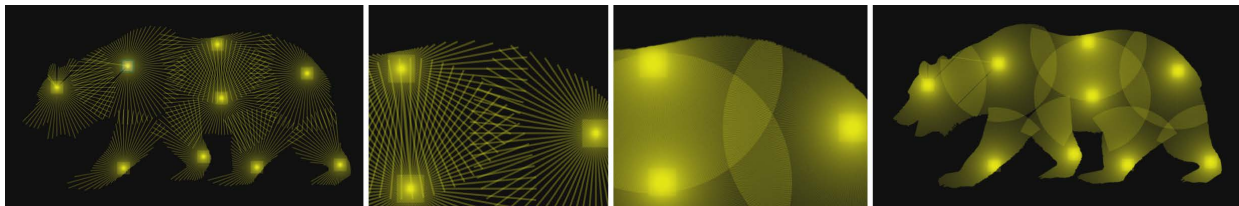

Figure 8.2: A simple light simulation of LEDs in a California Bear reflector geometry. (left) A Cool Simulation - Low-definition media that engages the senses less completely; (right) A Hot Simulation - High-definition media.

In the partial representation of the real-world, the light simulation forced users to “fill in the gap.” This is a quality of media that McLuhan [126] describes as cool – a low-definition media that engages senses less completely and requires greater amounts of interaction from the audience to construct a full representation (e.g., phone conversations, comic books). The low definition simulation allowed users to visually track individual rays and observe their individual behaviors while at the same time observing the gestalt of the simulation and the larger meta-behaviors of the LED (Figure 8.2). In a hot version of the simulation, this quality would be relegated to a purely visual processing task.

The simulation also introduced a maker-bias, similar to blackboxes, where the end-user practitioner does not have control over what was defined as the API. In our simulation, deciding to reduce the fidelity of the ray tracer had the tradeoff of reducing the saliency of shadows. Lacking a global illumination component, the material profile *light as shadow creator* was less supported in the luminaire design tool.

For heat, I used a passive mediation strategy leveraging Thermochromic Liquid Crystal (TLC) sheet to transform heat into a visual stimulus, remapping temperature ranges from 91 – 104°F

(32 – 40°C) to a red-green-blue spectrum. This rich visual feedback allowed practitioners in the workshop to experience electricity as “friendlier,” changing the affective qualities of electricity as a material. As a passive configuration, the liquid crystal sheet bypassed the maker-bias, readily integrating into material practice and facilitating experiments and explorations with materials not originally scoped for the proxy. As an example of a hot proxy, liquid crystal provided a high-fidelity representation, but in contrast to other hot media like photographs, the production and elicitation of this information are controlled by the practitioner. Because the thermoreactive materials used in Phosphenes all activated in the TLC activation range, the thermoreactive composites were easily configured with this passive material. However, material practices like glass blowing have a working temperature range of 1,090 – 1,320°C (2,000 – 2,400°F); this type of proxy would prove ineffective. In this situation, a digitally-mediated material that haptically retargets these stimuli dynamically would prove a more versatile proxy.

Developing the Aesthetics of Techno-Materials

In this work, I described three different ways that materials propose alternative courses of action during the creative process. While affordances are intrinsic material qualities, I demonstrated that proxies could be designed to mediate *sensorial feedback* via computational simulation (ray tracing for light) or through perceptual remapping (visualizing heat transfer through a thermoreactive liquid crystal).

However, focusing on these physical qualities reduces the sociomaterial dimension of artifacts to a perception task as opposed to a situated material engagement [162]. Capturing the tradition-communicating elements of materials are central to subverting the influence of sameness and mass-reproduction ideology of manufacturing practices. From design artifacts I created, I observed the following principle:

Aesthetic Development Principle. As new materials and fabrication techniques develop, Crafting Proxies benefit from tracing and connecting the semiotics of materials, or the longer history and origins that assign meaning to a material.

Part of my design process focused on analyzing and producing artifacts with religious motifs (Figure 8.3). Religious artifacts are unique in that their forms are heavily influenced by a material’s tradition-communicating elements, versus their sensorial feedback or affordances. These artifacts leverage a material’s intrinsic and symbolic worth to actively create a unique meaning or experience. For instance, the scarcity of a material like gold and its cultural value is used to communicate the authenticity and “oneness” of an artifact. Benjamin describes this quality of uniqueness as the aura of a work which is displaced when artifacts of mechanical reproduction are introduced [15].

In the *Virgen de Guadalupe* lamp, a religious artifact described in Section 6.3, I described how a mechanical light sequencer was able to create an experience that a programmatic light sequencer disallowed. The use of optic fiber to transport light and create light textures further moved away



Figure 8.3: Semiotics of Traditional Materials. (left) *Virg n de Guadalupe* Fiber Optic Lamp, (center) Phosphenes *Buddha Mala*, (right) Illumination Aesthetics Illuminated Hairbrooch

from the commonplace point-light aesthetic promoted by the ubiquity of the LED. In the *Buddha Mala*, I created a devotional interface for engaging in ritual action. The non-emissive nature of the display altered the experience of computer-mediated visuals, adding an element of personal identity and objecthood. The interface served as an example of a slow technology, evoking a longer, sustained, and ritual interaction. In anchoring materials with its symbolic and cultural signifiers, I see future potential for proxies to develop the aesthetics associated with techno-materials, or materials associated with technology. For example, the 8-bit audio [33] (e.g., chiptunes in video games) formed as a result of the limits of memory and expressivity of audio synthesizers in the 1980s. As techno-materials develop, how can these aesthetics be traced to a longer history of making that is not solely embedded within post-modern practices? For instance, with the illuminated hair brooch, although the glass-silicone diffuser achieved physically novel effects, the tradition of using glass and light together has a long, intricate history in the practice of stained glass, cathedrals, and religion. Within ethnocomputing, how might we foreground the tradition-communicating properties of materials used within indigenous and other underrepresented communities in emerging technologies like digital fabrication and e-textiles?

Sustaining Practice

A large focus of creativity support tools is on idea generation, but a clear differentiating quality of Crafting Proxies is the need to develop an intimate relationship with the material. In Chapter 5, I described how a mass-manufacturing aesthetic removes the human hand from fabrication, limiting the potential for material encounters to occur to at most a post-processing step. A central aim of the proxy is to re-introduce or augment material encounters; however, this is only effective if a practitioner sustains themselves in practice. From our workshop evaluations with practitioners of varying expertise, we observed:

Sustainability Principle. Agency and the risk are interconnected social motivators behind creative activity. Perceptions of agency can change the expected reward from engaging or completing a creative task, while risk can change the motivation for deviating and exploring novel forms. To achieve a deeper engagement with a material, different configurations of these two motivators are needed for practitioners to sustain interactions with a material and practice versus motivating a desire to build craftsmanship.

Risk-Prone Material Encounters. A central challenge of Crafting Proxies is achieving the delicate balance between risk and agency. Risk can emerge in a series of different contexts in creative practices, from the risk of damaging or wasting a scarce material or an unsuccessful artifact or experience (workmanship of risk), or the psychological risk from being perceived as less capable [194]. With the armatures developed in Chapter 5, I saw how the riskiest proxy, the schematic, forced workshop participants to carefully plan, sanity check, and form their wire to match the prescribed design. As might be expected, the perceived risk prevented novice and expert practitioners from deviating or innovating with their design. However, as a tradeoff, this risk also encouraged workmanship, especially by expert practitioners who demonstrated their ability to accurately replicate a prescribed form. For novices, this risk limited their ability to develop self-efficacy in the creative practice, but, because of the caution needed, caused a heightened awareness of the material and its interactions — in this sense yielding the strongest material encounter. To sustain practice, introducing risk is a later stage design dimension to activate, especially as a means of encouraging deviation and exploration. However, too little risk and a practitioner’s motivation to actively construct and refine material mental models is affected.

Ritual. In contrast, the jig proxies reduced the cognitive load and physical dexterity needed to accomplish the wire wrapping task, allowing users to engage in ritual action. While the awareness of the wire or agency to deviate was most restricted in this situation, it also was the practice that elicited the most enjoyment and potential to continue engaging in the practice. This material encounter is developed over time, but more importantly, sustains activity and builds familiarity with a material. For creativity support tools, this suggests that the repetitive, redundant, and tedious actions have an important role in sustaining practice and can be best utilized when they can be transformed as enjoyable and ritual.

Embodied Interactions. Embodied interaction, the enactment of knowledge and concepts through the activity of our bodies [114], is a distinguishing quality of a material epistemology. Through physical interaction with a material and the creative environment, the body of the material practitioner is actively involved in sensemaking. While the Crafting Proxies developed each allowed for a material encounter, interactions with tablets, computers, mice, and pens limited the extent to the bodily actions that could be included with computational technology. In Phosphenes, I introduced an embodied stitching interaction that required users to carry out several physical swiping motions to lay out a serpentine trace. This interaction, while intended to convey the relationship between heat

and resistance, had the effect of causing participants to feel agency in their actions (X5: “. . . felt like you were making it; like you had a role in the work”) and reflection (X3: “It made me feel like I was building the circuit myself . . . creating the [traces] myself made me know what’s going on inside.”). This stitching interaction did not introduce any additional risk — serpentine patterns were already precomputed, and the users stitching actions were not linked to its design. For material practitioners, the serpentine pattern was perceived as intimidating, but the stitching interaction allowed them to develop familiarity with the serpentine pattern and reassess their relationship with electricity (M4: “I feel electricity as more friendly, and I would enjoy doing this at home.”). While risk was much less pronounced than its counterparts, the Phosphenes CAD tool mitigated the aesthetic of CAD tools instantly producing results, and instead invited the practitioner to actively participate in sensemaking.

Supporting Idea Generation through Bricolage

In the series of three workshop studies described in this work, I reflect on when designs created by participants led to creative insights and innovations outside of what was “designed into” the tools, leading to the following observation:

Cognitive Bias Principle. Crafting Proxies benefit from introducing an acute cognitive bias as a creative constraint, framing the practitioner’s actions towards a particular way of thinking. Such proxies need to support tool-switching, not constraining the practitioner to only thinking in a single style. When a part of a larger environment of tools and materials, such proxies can support a bricolage practice.

In Illumination Aesthetics, I saw a participant with a deep practice using Adobe Illustrator in a graphic design practice able to fluidly transform her design intention into a series of boolean shape operations. When coupled with the ray-tracing light simulation, this participant developed a dialectical relationship between geometry and light that went beyond light “filling up a shape” like that of a pixel. Instead, the light forms she created cast light as a gradient-maker. In this regard, the success of this interaction was enabled by the ease of mapping this unknown (electric light) to a known material in the practitioner’s repertoire (linear and radial gradients). These light gradients were then appropriated to create subforms of shadow and highlight common in graphic design practices. In this process, I saw the strength of cognitive bias arising from a deep practice with the tool (within a graphic design practice) in being able to reappropriate this unknown material. The resulting forms were significantly different from other participants’, who although had previous experience with vector editors had not used the tool within a graphic design practice.

In ProxyPrint, I saw another instance in which an expert wire wrapper used support geometries never intended for the final design as additional sites to wrap a wire. For her, this proxy jig transformed everything into a wrappable site, much like the canonical example of cognitive bias with the hammer making everything look like a nail. The interaction with this jig had a wider effect, casting other objects in the space as sites for wire-wrapping.

I see this quality of tool's cognitive bias as central to crafting aligning with the bricolage view that the creative process is influenced by the available materials, tools, and skills in the environment. In this regard, increasing the potential for creative insight and innovation can be as simple as introducing tools that elicit and cognitively bias practitioners towards a different way of thinking, or that defamiliarize the situation at hand. Such tools share the properties of being modular and disjoint but facilitate *tool-switching*, or readily accepting and adapting to the "inputs" of forms generated during a creative exploration.

8.3 Extensions of the Crafting Proxy Design Method

A core contribution of this work investigated and operationalized compositing as a design method that could extend beyond computational composites. Compositing allowed for a Crafting Proxy to act as mediator and lens, directly grafted onto immaterials and configured to increase the information bandwidth between physical stimuli and the human perceptual system. I explored this technique on two immaterials, light and heat, and found that each immaterial presented unique challenges.

Our process introduced a composability phase where the material API, or the available inputs and expressivity of inputs, is used to create more malleable materials. For light, the use of secondary optic elements allowed for LED to be decomposed, with each component accessible and configurable through computational design. For heat, the use of a parallel resistive heater construction allowed for heat to be accessed as a spatiotemporal medium.

Our investigations revealed that heat, at the temperature ranges we were dealing with, was difficult to perceive. In contrast, heat used in glass blowing practices causes both visual changes in the glass, changes in glass plasticity, and transfers heat to the environment that is sensed by the full body. I further developed the compositing method to include a perceivability phase that introduced considerations for mapping the proxy's physical stimuli to human psychophysics. In our workshop study, these perceivability mechanisms were shown to make heat and electronics more approachable and support a material epistemology.

Moving forward, I see this compositing method as serviceable to current and emerging immaterials, including biomaterials, electromagnetism, neural networks, chance, and beyond. Below, I describe how compositing can be approached for a subset of these immaterials.

Biomaterials: *Vibrio harveyi*. *Vibrio harveyi* is a bioluminescent marine bacterium. Found in tropical waters, this microorganism has been associated with the milky seas effect, a phenomenon where ocean waters produce blue light. Future environments might leverage such an organism as a sustainable alternative to silicon-based light, such as to provide alternative sources of lighting in the urban environment. Advances in genetic engineering and the isolation of the bioluminescence gene indicate a potential development of other bioluminescent organisms, including fungi and flora.

¹ Image credits (left to right): priyanka from The Noun Project <https://thenounproject.com/term/cell/1764085>; Puneet Varma at Alchetron from <https://alchetron.com/Vibrio-harveyi>; UniDx from <https://unidx.org/>; Jim Deacon from <http://archive.bio.ed.ac.uk/jdeacon/microbes/shape.htm>

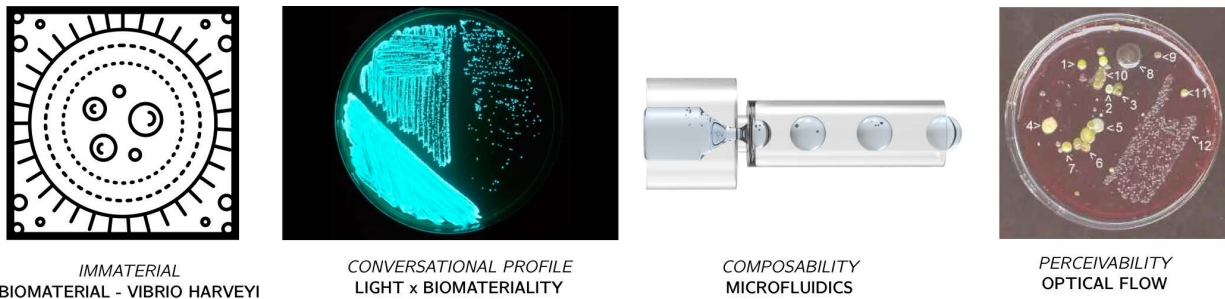

Figure 8.4: Proxies for Biomaterials¹

As a microorganism, the ability to manipulate or view the organism requires building a mental model that is difficult to acquire experientially. To understand and expose bioluminescence as a design material, we can adopt the conversational profile of light as a base. The conversational profile can be further developed from incorporating the biomateriality introduced by *Vibrio harveyi*. As originating from a living organism, bioluminescence was the ephemeral and environmentally dependent behaviors of reproduction, mortality, and lifespan. As free-moving organisms, biomateriality also includes complex motile relationships like clustering.

For composability, liquid control techniques, such as microfluidics, can be used to increase the malleability of this marine bacterium. For perceivability, working with biomaterials operates over long temporal scales. In this regard, insights learned from working with heat could be used to inform methods for increasing temporal perceivability or likewise from material practices like gardening. Furthermore, sensing routines, such as optical flow analysis of video microscopy, could be used to track bacteria colonies and support an experiential encounter with bacteria.

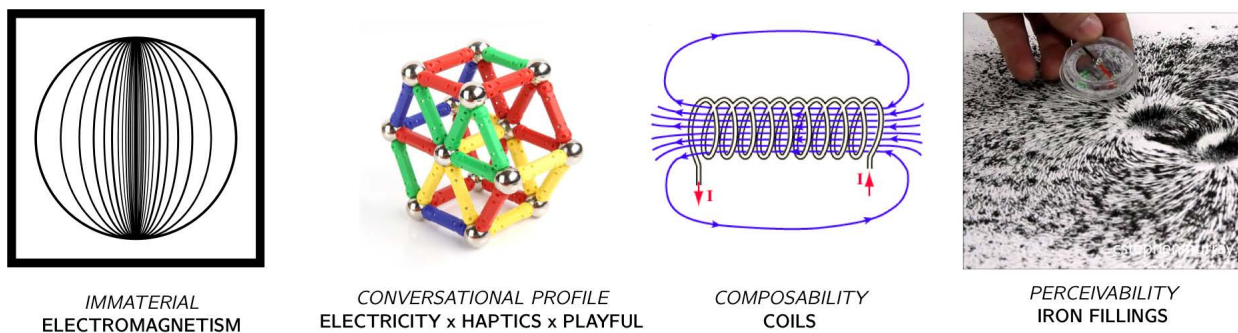

Figure 8.5: Proxies for Electromagnetism²

Electromagnetism. Electronic components like electromagnets are commonly used to generate a current along a coiling conductor and produces an electric force. This phenomenon is very similar

² Image credits (left to right): emilegraphics from The Noun Project <https://thenounproject.com/term/electromagnetic-fields/437916>; ToySharing Magnetic Building Set from <https://www.amazon.in/s?k=ToySharing>; Gambini et al. [55]; cstephenmurray from <https://youtu.be/snNG481SYJw>.

to our explorations of electric heat and electric light, but to a larger degree produces a result that is difficult (if not impossible) to perceive unaided by the human body.

For electromagnetism's conversational profile, rare earth magnets are readily integrated into a variety of mechanisms in material practices, creating a vocabulary of attraction, repulsion, release, and alignment. The electric materiality (via the analog control mechanisms) are closely tied to computational materiality (via the digital signal used to control the components).

Electromagnetism has a well-defined composability; as its base unit, coils are an elementary building block to weave forces. The coil presents a site for computational design to expand the composability of magnetic fields. Much like I resolved electrical and thermal interactions with a thread-based modeling analogy, a Crafting Proxy for electromagnetism could leverage a similar analogy to communicate the relationship between the thickness of the coiling wire and the number of winds and support its manual creation through armature proxies.

Magnetism is difficult to perceive; however, through the ubiquity of rare earth magnets, the mental model for magnetic interactions is well established. Communicating magnetic fields is easily achieved through simulation [12] and could employ similar feedback mechanisms like the ray tracer used in *Illumination Aesthetics*. However, more tangible variants (such as iron filings), could be used to provide physical cues that reinforce mental models. As a programmable material, electromagnets can be controlled to produce magnetic fields in static locations but at different strengths and polarities; these properties are not readily perceivable. Coating coils in a thermoreactive material like liquid crystal can leverage the heat byproduct as an indirect indicator of strength. An environment with a grid of magnetometers could also be used to communicate how magnetic fields are being generated; as a largely haptic conversational profile, such environments could help expand the haptic vocabulary of electromagnetic interactions.

Developing proxies to express electromagnetism as a material has much larger implications for the host of materials that fall under the electromagnetic spectrum, including UV and infrared light.

8.4 Summary

Designing Crafting Proxies revealed several nuances for supporting a material epistemology. I synthesized these insights into a three-part design method: resolving the conversational profile of the material, expanding its expressivity, composability, and malleability, and tuning physical cues produced from interactions with the material to match human psychophysics.

To support creativity, I identified the need to create cool feedback mechanism, or mechanisms that relay an incomplete picture to actively engage the practitioner in sensemaking. I discussed the need to anchor materials in their cultural, social, and symbolic values to regain the aura of an artifact and connect aesthetics to established practices. Lastly, I relayed how tools that introduce a clear cognitive bias support a bricolage practice, and when part of a larger ecology of tools and materials can support idea generation. To sustain practice, I discussed the role risk has in developing craftsmanship, ritual action in building familiarity with a material, and embodied interactions in altering perceptions of agency.

Lastly, I described and reasoned how our proposed method could be applied to other immaterials including biomaterials, like bioluminescent microorganisms, or immaterials like electromagnetism to come into expression as a craft material. I claim that many of the conversational profiles are portable to other materials which suggest a potential to construct a material ontology that can help identify how two similar materials can benefit from the set of ways that diverse practices have developed for interpreting or composing them.

In the next chapter, I describe a vision of how material practices and digital fabrication might develop and describe areas of future work for supporting creative thinking, foregrounding existing material knowledge, and engaging a more comprehensive range of motor, perceptual, and cognitive abilities in augmented creative environments.

Chapter 9

Computational Design Architecture

Every proxy design implemented in this dissertation leveraged a common computational design engine that has evolved throughout this research. In this chapter, I describe the architecture that was purposefully designed at its onset to relegate 3D design to a 2.5D space in order to leverage existing skills and mental models familiar to material practitioners. This prototyping technique allowed us to leverage the repertoire of SVG manipulation techniques offered by a dedicated SVG editor without needing to recreate common design tool features (selection, manipulation, style selection, annotation) while reducing the marginal cost (in terms of effort, time, and monetary cost) for users to integrate this computational design tool in their workflow. This configuration also made interfacing with CNC tools more approachable since many users had previously built rapport with SVG editors.

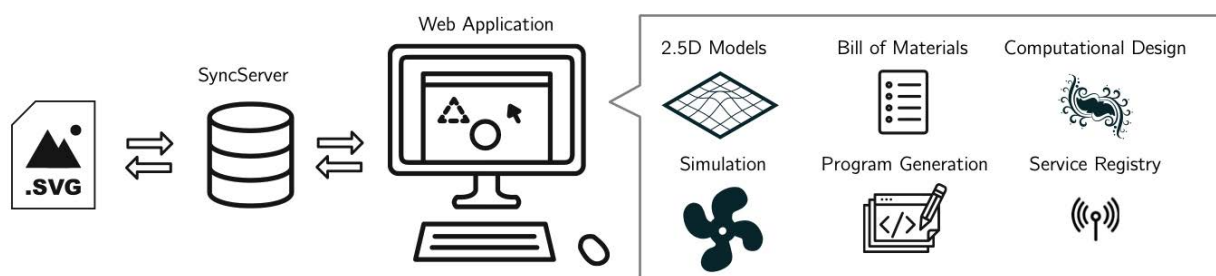

Figure 9.1: Computational Design Architecture

9.1 Architecture

The computational design architecture consists of four elements:

- **SVG** A Scalable Vector Graphic serves as a common substrate between a full-feature SVG editor and a web application.
- **Editor** A full-feature SVG editor like Adobe Illustrator or GIMP.

- **Web App** A web application uses `paper.js`¹, a javascript library that provides an API for creating, manipulating, and editing Scalable Vector Graphic (SVG) elements through web-based interactions. The computational design capabilities of `paper.js` allowed us to expand the expressivity of the SVG, using it as an input to computational design algorithms, to generate 2.5D models, and to relay feedback from computer simulation.
- **Server** A WebSocket server facilitates communication between the SVG editor and the `paper.js` web application. Communication between the web application and WebSocket server allows for communication to other devices in the environment.

Technical Implementation Details

Synchronizing Across Editor and Web Application. To streamline interactions between the editor and web application, we use the `watch` system command to monitor changes to the SVG file. When a change is detected, the server triggers the web application to update its current representation. When a user saves their file in the web application, the server bypasses the need to download the SVG. Instead, SVG data is transmitted over the dedicated WebSocket and saved to the file system. Saving over the original file refreshes the content in the SVG editor.

Information Transfer Between Web App and SVG Editor. To capture state information from the web application to the editor, we export the session information as a JSON string attached to the `data` attribute of the corresponding SVG element. For example, selecting a path in the web application and designating it as representing copper tape will bind material metadata to the SVG path.

Conversely, a user can communicate information from the editor to the app by using the SVG name attribute accessible in Adobe Illustrator through the *Layers Panel*. We use a vocabulary of symbols as prefixes (e.g., “M” for Materials) to designate SVG paths as representing different materials (e.g. “M: Conductive Thread”). In the app, we match against a database of materials and update the representation of the path (Figure 9.2).

Communicating to Hardware. To enable communication with other hardware interfaces, we open connections via UART serial or UART Bluetooth interfaces connected to the computer hosting the computational design engine. We then route commands originating from the web application to connected devices. Conversely, messages originating from the hardware devices are routed through the WebSocket attached to the web application. For Arduino microcontrollers, we facilitate this streaming architecture by developing the Probe Arduino library (Appendix A) that minimally modifies existing Arduino sketches to enable communication and handling of messages sent through this streaming architecture.

The streaming architecture processes information round-robin and routes commands (e.g. `L, 0, 255,255,255`) to registered pointers to function declarations (e.g., `L -> change_led_color`). These

¹ <http://www.paperjs.org>

functions consume necessary parameters from the serial stream. Specially formatting Serial.print messages are used to send information to the web application. The streaming architecture is easily disabled by sending a command through the *Arduino Serial Monitor*.

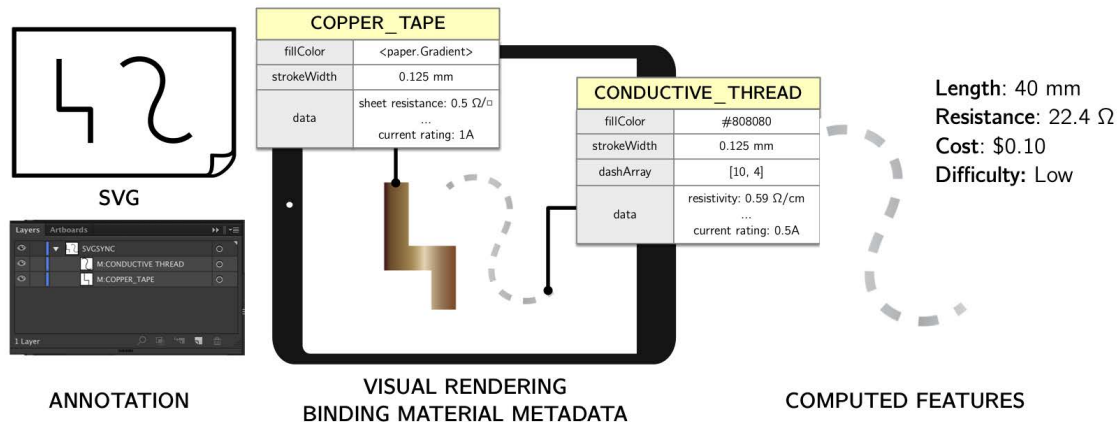

Figure 9.2: 2D Design Specification

9.2 SVG as a 2D Design Tool

The capacity of the computational design architecture to mark and encode geometries with metadata can be used to create rich annotated drawings. These annotations can then serve to create novel interactions that facilitate creative activity.

Annotations for Material Specification

Annotations can serve to designate the different materials and their properties. For example, when a path is labeled with a material `M:COPPER_TAPE` or `M:SILVER_INK`, this is matched against a database of materials; this database holds information about the material's formal characteristics (color, shape, width), its behavioral properties (thermal, optic, electrical), and well as its economic properties (unit cost, supply).

Using this information, the web application can:

- **Adjust Appearance.** The SVG representation is updated based on information in the material database to achieve a more faithful representation of the physical materials that the SVG elements denote.
- **Compute Features.** The geometries of the different SVG elements can be used against physics models to derive special properties. For heat forming (Chapter 7), conductive materials were assigned to path elements, and the length, width, and thickness of the material were used to compute information about its resistance. For physical armatures (Chapter 5), we

computed the curvature of different SVG elements to determine where to include structural geometries for bending wire.

Annotations for Spatial and Relational Specification

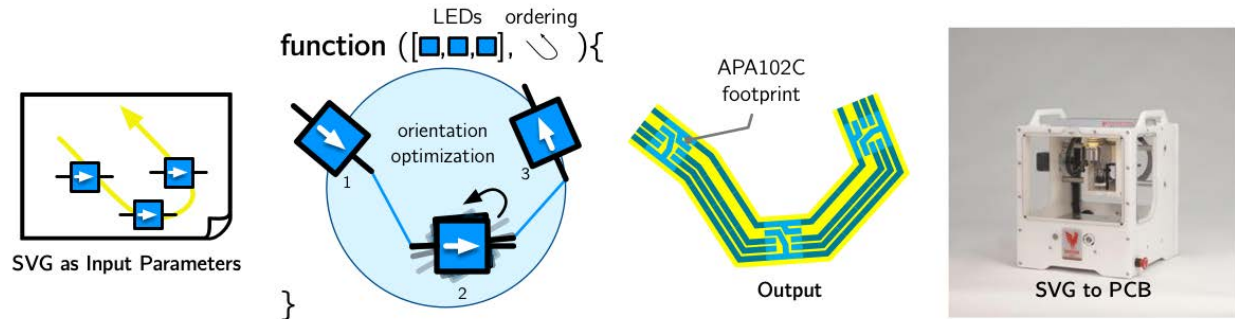

Figure 9.3: SVG as Input Parameters

Furthermore, an annotated SVG can also encode ontological or spatial relationships, allowing the computational design architecture to serve as:

- **Computational Model Frontend.** Computational models, such as a circuit model, can be bound to SVG elements. Based on some target properties, the model can update SVG elements to satisfy these requirements. In heat forming (Chapter 7), we programmed a lumped circuit model to use as input an SVG path encoded as a power supply and SVG path representing circuit traces connected in parallel. This was used to update geometries of respective traces to reach target power generation rates.
- **Simulation Interface.** Conversely, user interactions with the SVG elements can reconfigure the model and provide the user with additional information about interactions with SVG elements. The same circuit model mentioned above was used to give visual feedback to the user, communicating which trace was drawing the most current. For light forming (Chapter 7), materials on the canvas were denoted with reflective, refractive, and light generation properties. A ray tracing algorithm was then used to cast light rays in the scene which would simulate light physics interactions.
- **Computational Design Algorithms.** The SVG also provides rich information about different spatial relationships that can be fed as inputs to a computational design algorithm. For example, consider an SVG file intended to be laser cut. As input, a bin-packing algorithm could take the set of cut paths and the geometry of the stock material being cut and rearrange these cut geometries to minimize material usage. Such routines can also include procedural information such as including post-processing cuts to "clean up" the stock material for reuse.

In Ellustrate [118], we used this information to create template matching instructions for fabricating soft circuits; both the graph and node properties were used to dynamically generate custom design-specific instructions.

- **Bill of Materials / Skeleton Code Generation.** Information from the scene graph can be used to populate a bill of materials. When these materials are electronic components, these components can be resolved into libraries and setup protocols and synthesized into a code skeleton that reduces the startup costs of configuring a new or evolving hardware configuration. For light forming (Chapter 6), we used the web application to generate an Arduino sketch which specified the color of over 25 different LEDs and generated the instruction set for configuring the I²C Dotstar LEDs to replicate the design.

Design Output

The SVG produced by our computational design architecture serves as a common interface to 2D CNC machines - the SVGs developed were used to prepare the files for laser cutting computationally-generated geometries [26], for making PCB boards with the Bantam Tools Othermill [192, 193], for inkjet printing silver ink circuits [190], and for CNC vinyl cutting masks for screenprinting [190].

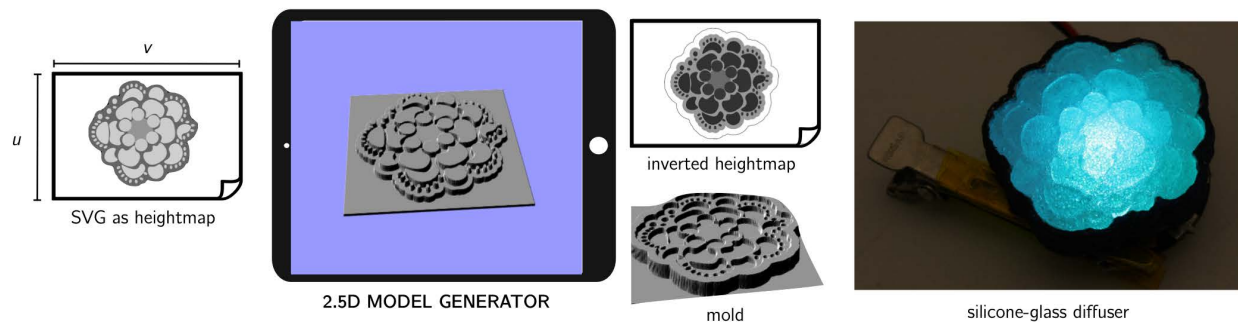

Figure 9.4: 2.5D Model Generation - Mold Generation

9.3 SVG as a 2.5D Modeling Tool

To also leverage additive manufacturing techniques, we integrated a 2.5D model generator into the Computational Design Engine pipeline. First, we generated a heightmap H by rendering the SVG canvas as a PNG. This image was then mapped by uv coordinates to the vertices on the top face of a high-resolution planar mesh P . Vertices were then transformed normal to the plane by a scalar magnitude μ based on the pixel value of the corresponding uv coordinate on the heightmap:

$$P(u, v) = P(u, v) + c\vec{n}H(u, v)$$

where $H(u, v)$ is a pixel value between 0 and 1 at location (u, v) on the heightmap. White areas in the heightmap were thus c tall, whereas black areas are holes.

Expressivity of Heightmaps

Since these geometries were generated using an SVG, it allows geometries like ramps to be generated from linear gradients, or spheres and cones to be generated from radial gradients with a corresponding cubic or linear profile. As an additional benefit, heightmaps allowed for a complete intermediary representation of a 3D model but at the low computational expense of a PNG image. STL models were generated opportunistically from a web server hosting the computational design engine.

Expressivity of 2.5 Geometries

The ability to form 2.5D geometries from an SVG representation had immediate benefits of using less memory and bandwidth than full 3D modeling tools. Additionally, these 2.5D models facilitating techniques for generating:

- **Molds.** By inverting the heightmap, the model generator facilitated the creation of molds. In being restricted to 2.5D geometries, this reduced any molding errors during the demolding process. This technique was used to generate 2.5D molds for casting silicone-glass mixture to create custom diffusers (Figure 9.4).
- **Tactile Surfaces.** As a texture mapping technique, the model generator readily assisted with adding texture to 3D prints. This was used in HapticPrint to create computationally generated textures that matched target feel aesthetics [189].
- **Enclosures.** By separating enclosure geometries into two components, a case and lid, computational design routines can also add a hole and countersink geometries for fasteners, as seen in the luminaire enclosures (Chapter 6).
- **Structural Armatures.** In Chapter 5, we showed how structural armatures can be generated custom to a design that assists with forming and joining wires. This technique can be extended to creating jigs for a variety of materials.
- **Behavior-driven Geometries.** By taking into consideration material properties, we showed how the 2.5D model generator can generate computationally-designed lense geometries (Chapter 6 and heat sinks (Chapter 7)).

Design Output

The STLs produced by our design tool are readily supported by FDM and SLA printing techniques.

9.4 SVG as an Interaction Design Tool

The ability to have a computational representation of a scene can act as a bill of materials. When these materials can communicate with each other, the SVG can function similar to a service registry

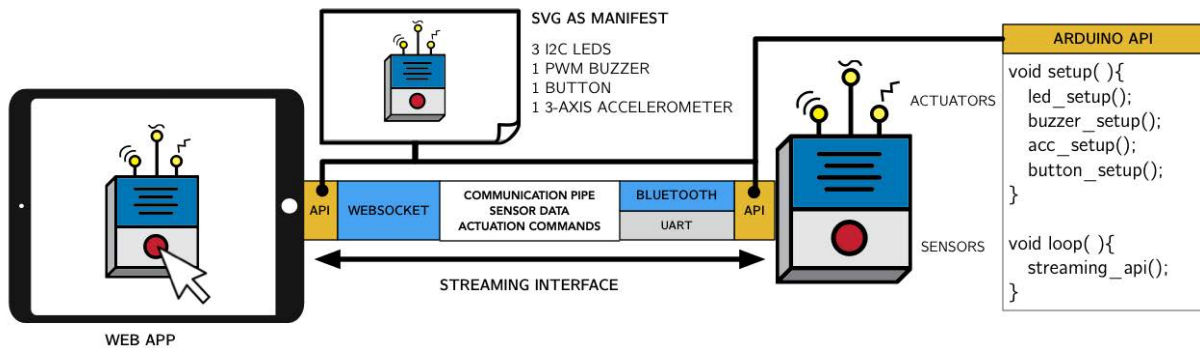

Figure 9.5: SVG as Service Registry - The SVG encodes the IoT devices in a scene and exposes available services (e.g., sensing, actuation) that can be accessed by a web application.

(Figure 9.5). Leveraging the WebSocket server, the web application can use these registered services to facilitate:

- **Signal Processing.** Sensor information originating on a hardware device can be streamed to the web application and processed into higher order events (e.g., capacitive load signal to a touch or release event).
- **Sending Commands.** Web interactions can be translated into commands that are sent and interpreted by hardware (e.g., changing the color of the SVG led sends a command for the corresponding realworld LED to also change color).
- **Interaction Mapping.** Since we use a streaming architecture, commands can be sent and received without needing to upload and compile code. This allows the web application to be used to specify an interaction logic, controlling the behavior of connected devices to user-defined actions.

In *A Conversation with Actuators* [192], I used the service registry capacity of SVGs to act as an interaction design tool – I created an interface for forming digital waveforms which were then sent to IoT devices specified in the SVG. Additionally, using the SVG as a central registry along with spatial encoding properties allows designs to leverage relational and spatial information. For instance, a signal can be sent to IoT devices in an environment based on their distance from a user (specified as an SVG element).

9.5 Discussion

The SVG provided a 2D design interface to a variety of Computer Numerical Control (CNC) machines; the computational design architecture expanded the expressivity of what could be created from an SVG. Although the SVG allowed some material practitioners to access their vector design skillset, not all practitioners have prior experience working with SVGs. I see the next step as

converting scene information from pen and pencil sketches into SVG graphics to provide and access paper sketching as an interface to digital fabrication tools.

The computational architecture is restricted to 2.5D geometries which limits some functionality; however, 2.5D constraints benefit the user in mitigating tooling constraints of mass-manufacturing fabrication techniques (e.g., vacuum-forming is 2.5D restricted) as well as adding a creative constraint that introduces a cognitive bias.

Our architecture allowed for 2D design, 2.5D model generation, and interaction design; one unexplored area is to leverage sensors from the environment to automatically update the SVG and have a closed loop between digital manipulation and physical manipulation.

9.6 Conclusion

The computational design architecture presented provides a critical alternative to 3D CAD tools; by prioritizing 2.5D design, it allows 2D design tools like SVG editors that have a deeper practice in graphic design disciplines to diversify both the types of forms that can be created and the people using them. This architecture was developed and iterated upon in several different works, drawing out the versatility of the architecture to achieve many computational design, simulation, and control techniques. The current version of the architecture has been made available publicly. For convenience, the repository links are relayed here and in the Appendix A.

- **SVGSync** An SVG-based computational design engine.
<https://github.com/Hybrid-Ecologies/svg-sync>
- **Illumination Aesthetics** A luminaire CAD tool.
<https://github.com/Hybrid-Ecologies/illumination-aesthetics>
- **Phosphenes** A resistive heater CAD tool.
<https://github.com/Hybrid-Ecologies/phosphenes>
- **ProxyPrint** A wire-wrapping CAD tool and armature proxy generator.
<https://github.com/Hybrid-Ecologies/proxyprint>
- **Bag o' Jigs** A collection of wire-wrapping shaping proxies.
<https://www.thingiverse.com/thing:3691845>
- **Arduino Probe** A streaming API for Arduino devices.
<https://github.com/Hybrid-Ecologies/arduino-probe>

Chapter 10

Conclusion

This final chapter reviews the contributions of this work, describes limitations and their effects on the generalizability of our findings, and concludes with the vision of the *Hybrid Atelier* — an enactment of digital fabrication embedded within a material practice. In this vision, I describe areas of future work for supporting creative thinking, foregrounding existing material knowledge, and engaging a more comprehensive range of motor, perceptual, and cognitive abilities in creative activity.

10.1 Restatement of Contributions

In this dissertation, I motivated a need to bridge digital fabrication and material practices. I argued that design tools needed to support a more plural way of thinking and developed a profile of the material practitioner that identified knowledge production, application, and transfer as three core design considerations (Chapter 2). This profile serves as a resource for both the research and design community to inform the design and evaluation of tools for supporting a material epistemology.

To guide system and tool design, I proposed the strong concept of a Crafting Proxy, an intermediary between a practitioner and a material, that allowed us to more rigorously define and develop the different capacities that tools can serve in a creative practice (Chapter 4). From the profile, I identified two underexplored areas in the proxy design space: communicating material knowledge through a physical interface, and the design complications introduced from immaterials.

Through the design, implementation, and evaluation of Crafting Proxies for wire, light, and heat, I assessed the boundaries of the Crafting Proxy design space and surfaced key considerations not addressed by current design strategies (Chapter 5 - 7). I synthesized a design method that can be applied onto new material contexts, grounded in design theory and defined by two criteria for systems design: maximizing *composability* and *perceivability* (Chapter 8).

As a technical contribution, this work provides a computational design architecture for facilitating interactions between digital and physical design environments (Chapter 9). I demonstrated the benefits of integrating this architecture around existing vector graphic practices, allowing material practitioners to access an existing skillset. I showed how this architecture met and expanded the

expressivity of 3D CAD tools, supporting: annotation, feature computation, simulation, modeling, computational design algorithms, mold, armature, PCB design, and enclosure design. This architecture also facilitated communication to IoT devices and acted as a registry for creating bills of material or for generating code skeletons.

Lastly, I presented design principles for guiding the design of Crafting Proxies synthesized from workshops evaluations with material practitioners and from artifacts created during the design process 8. I summarize these principles, organized within the three core design considerations of a material epistemology:

- Knowledge Production
 - Allow and support material encounters by amplifying the sensorial feedback and affordances of the material.
 - Anchor materials in symbolic and cultural values to regain the aura of artifacts.
 - For immaterials, bind a physical material and map the output stimuli to human psychophysics.
 - Create *cool* feedback mechanisms that provide incomplete information to engage the practitioner in active sensemaking.
- Knowledge Application
 - Support morphogenetic workflows by designing ritual interactions and encouraging tool-switching.
 - Leverage embodied interactions to alter perceptions of agency.
 - Support idea generation by designing tools with a single, clear cognitive bias.
 - Expand the expressions and forms capable in a material API.
- Knowledge Transfer
 - Design access to an established material repertoire.
 - Provide cues that foreground interactions and relationships between materials.
 - Gradually introduce risk to build craftsmanship, and sustain practice through ritual interactions.

Limitations

A major limitation of this work was the focus on individual creativity. In material practices, communities of practitioners form into ateliers, studios, kitchens, guilds, workshops, and makerspaces that readily share skills, serve as social support structures, create spaces for critique and reflection of work, and collectively define the aesthetics of their practice. I see the work defined here as addressing a structural deficiency in how creative technologies are being developed; by aligning

these technologies to material epistemologies, I demonstrated that new and emerging material could be developed to be more approachable and easier to reappropriate from existing domain knowledge. I anticipate that changing the nature of digital fabrication workflows is a step towards better leveraging social creativity, but in the following section, address additional opportunities for leveraging communities of practice.

10.2 Future Research Areas: The Case for a Hybrid Atelier



Figure 10.1: Where can the interface exist in a material environment?¹

This dissertation initiated a discussion about the design and development of tools for physical making and the unintended impact of digital fabrication workflows within a manufacturing tradition. In this section, I reflect on how research efforts can further support material epistemologies and diversify how computation is used in a creative environment in the vision of a *Hybrid Atelier* (Figure 10.1).

¹ Image Credit (left to right, top to bottom); all altered: Sands Films Costume Workshop by Simon Fernandez from <https://www.simonfernandezphotography-archive.com/Music-Photogra/Sands-Films-Costume-Workshop/i-FxtzfRn>; UNT Printmaking Studio from <http://untprintmakingblog.blogspot.com/2010/12/>; Gardunos Ristorante by Mark Garduno from <https://www.gardunosristorante.com/pages/love-to-cook>; Seraphim Studios Glass Studio by Stedman House from https://stedmanhouse.com/292951_glass_studio/292975_glass_studio_2019/

One increasingly relevant design consideration was acknowledging the role of the body in sensemaking. In engaging with different creative practitioners, I found that restricting cognition to a 19" screen limited the ability for material practitioners to access a larger material repertoire and benefit from a community of practice. Their creative environments allowed them to leverage wider range of motor, perceptual, and cognitive abilities – I see opportunities for research initiatives that further increase the domain transfer potential between material practitioners and current digital fabrication practices, engage more of the human body in sensemaking, and advance tacit-transfer techniques beyond the master-apprentice model.

Accessing Material Knowledge

The computational design architecture used in this work allowed for existing SVG editors like Adobe Illustrator to be an interface to additive manufacturing CNC processes. The tool introduced two cognitive biases: a *vector-thinking* (the use of boolean operations to construct geometries), and *heightmap-thinking* (constraining geometries to satisfy 2.5D). Although many 3D CAD applications accept SVG path annotations, our architecture used the final rastered image supporting geometries like domes (radial gradient, arc profile), spikes (radial gradient, linear profile), and ramps (linear gradient). In constraining designs to 2.5D geometries, the architecture readily allowed for the creation of molds for creating casts. This allowed us to access a repertoire of 3D forming and replication techniques from sculptural practices, including slip casting and compression molding. This most directly achieves the aims of this work in increasing the potential of domain transfer between material practices and digital fabrication.



Figure 10.2: Settables: Shapeable viscoelastic materials that can be set into a final form.²

Mapping Material Ontologies. Where else might we encounter material parallels, or behaviors, skills, and techniques that can be applied from one material to another? For instance, *settables* might refer to materials that have the unique property of existing in a shapeable viscoelastic state that can be set into some final form like silicone, clay in slip-cast form, chocolate, frosting, and

² Image Credits: (left to right) From contextual inquiry with Potter (11/7/2017) [194]; Polytek Development Corp. from <https://www.polytek.com/tutorial/two-piece-silicone-mold-small-bust>; Cadence Chocolates from <http://www.cadencechocolates.com/blog/2016/9/5/how-cadence-chocolates-bonbons-a-re-made>; The Candle Place from <https://thecandleplace.mx/categoria-producto/relleno-de-envases/>; Cassie Johnston at Wholefully from <https://wholefully.com/goodnight-gelatin-cherry/>

thermoplastics (Figure 10.2). How might we capitalize on material knowledge across domains such as molding and casting for working with settables?



Figure 10.3: Sites for Material Interfaces. (left) a deformable and haptic interface (piping bag) is used to deposit frosting onto the surface of a cake; (right) a surface with continuous interaction with the skin (foot pedal) is used to control a sewing machine.³

Embodied Information Retrieval. In HCI, we have seen human dexterity develop around the keyboard, pen, and mouse, but the hand and body have much more richness and nuance than what is being captured. One opportunity lies in accessing the dexterity of the hand and body in input and output interfaces. 3D printing pens, such as the 3Doodler⁴, allow users to manipulate a handheld extruder in a pen form factor but relegates the act of extruding material to a single extruder button. In contrast, a piping bag, a nozzled plastic bag filled typically with frosting, is used in cake-decorating practices to precisely transfer, deposit, and shape extrusions of frosting through rich haptic interactions from applying pressure to a bag (Figure 10.3).

Despite the similarity in interaction, the challenges of integrating rigid and non-rigid components along with sensing and actuation implements in a handheld or body-operated form factor limit the interaction space to finger-based interactions. These challenges mirror many design concerns of wearable technologies. As a research area, there are opportunities in developing ethnographic description of the nuanced control of different types of materials as well as integration of sensing, actuation, and deformable interfaces to incorporate new form factors like brushes, pipettes, pipe bags, carving tools, or foot pedals into the lexicon of the hybrid creative environment.

Transferring Material Knowledge

Beyond the Master-Apprentice. The method in which knowledge is stored and transferred in a material epistemology has several tradeoffs. Foremost, as largely tacit in nature, this type of

³ Image Credits (left to right): Joshua Russell at Craftsby from https://youtu.be/q2_y5_7K390; Shannon Casper at all the sprinkles from <http://allthesprinkles.com/blog-montauk/2015/8/7/65100-pedal-pusher>

⁴ <https://the3doodler.com/>

information resists traditional forms of codification. The act of codifying tacit process allows for knowledge to be transferred through traditional information channels (i.e., books and tutorials). However, widespread adoption and dissemination can lead to a single process becoming a standard, creating an epistemological monoculture that privileges those that align with the way of thinking it supports. Although an expert might be able to vocalize how they know what they know, it often represents how they were taught to accomplish a goal rather than what they actually do [175]. Consider, for example, the act of debugging a computer program. One common codified technique is to use print statements to verify the expected logic and operation of a program; however the information of what to write in the print statements, when to use them, where to place them, when to enable, disable, or remove them, or how they might affect other processes is part of a deeper tacit debugging practice.

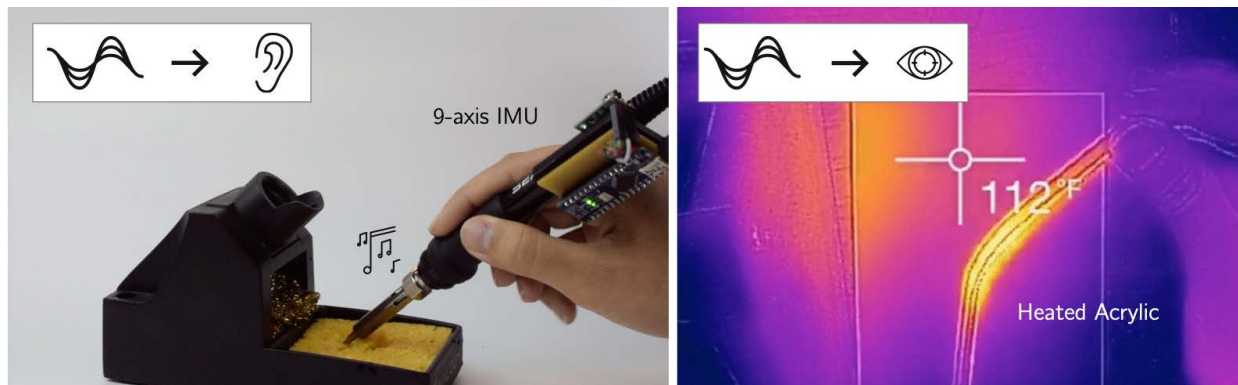

Figure 10.4: Retargetting Data. (left) Movement of a soldering iron and interactions with a sponge are converted into sonic cues; (right) Data from an infrared camera is converted into a visual stimulus while thermoforming an acrylic bar.

Perceptual Retargeting and Data Visceralization. Time-tested strategies for transferring tacit knowledge rely heavily on one-on-one instruction. While this type of instruction provides immediate feedback, it introduces an uneven power structure and barriers to entry. As a future research area, one might consider how the transfer of tacit skills be scaled and be made more accessible? This work identified the important role cognitive and physical cues have in experientially building and refining mental models of material interactions, or material encounters. Every creative practice, both digital and physical, leverage subtle cues that aid practitioners in navigating state and intention which take years of practice to observe. For ceramicists, the haptic response of the clay communicates the clay’s workability. For programmers, develop an intuition code smells, or surface-level characteristics of a program that are indicative of a deeper underlying problem that, if left unaddressed, could lead to more troublesome problems. This intuition shapes how programs are composed and tested. How might we similarly leverage the non-attentive cognitive processing systems to enhance and deepen the role of the body in creative practices?

In Chapter 7, I used a dynamic modeling analogy to reinforce the relationships between electricity and heat, leveraging a thread metaphor to communicate the power as a finite material, current

divider circuit mechanics, and resistance. These interactions were largely displayed visually and point to an opportunity to develop multimodal interfaces that redundantly communicate behaviors across multiple information processing channels. For instance, I used a swiping finger moving back-and-forth map physical effort to the resistance of the trace that was being created. How might alternative modalities, such as the affordances of a deformable interface, be used to more directly communicate resistance via stretching, pulling, shearing, and twisting? How can difficult to observe motion be relegated to an aural signal that maps motion to pitch and tone? A tighter integration of human psychophysics and feedback mechanisms could serve as a basis for introducing perceivability mechanisms that heighten our abilities to perceive interactions across a variety of immaterial contexts: between acids and metals, microbes and agar, or threads and the GPU.

I foresee the future generation of instructional resources that enhance tutorial material to encode tacit information, adapt content to fit individual learners in physical and digital environments, and allow the larger community of creative practitioners to share tacit skill.

10.3 Summary

In this dissertation, I set out to fulfill two tenets:

Tenet 1 Material practitioners should be able to access and incorporate the years of knowledge from their respective practices within digital fabrication workflows.

Through the design of Crafting Proxies, or intermediaries between the practitioner and tool, I introduced a new type of digital fabrication workflow – a proxy-mediated practice. I showed how this workflow could still fit into the existing CAD-CAM pipeline, but also allow practitioners to have a material encounter by printing an armature to assist them in making the final artifact. Through variants of this proxy, I defined the armature design space that exposed risk, ritual, and cognitive bias as central design concerns for facilitating morphogenetic workflows.

Tenet 2 Material practitioners should be able to use computation, electronics, and other emerging technologies like they would any other material. Such materials should be approachable and match their methods of producing, storing, applying, and transferring knowledge.

I explored the generalizability of the compositing design method to apply to more than just computation. Using computational simulation and modeling, I showed how computational design could function as an intermediary to configure, expose, and augment physical cues that describe the form, structure, and behaviors of immaterials. Our design method increased the composability and perceivability of these materials, and through workshop evaluations I demonstrated how these Crafting Proxies could allow material practitioners access to immaterials.

As a result, this laid out a design method for composing new materials and technologies to foreground the existing knowledge and practices of material practitioners and generate new forms and aesthetics that can alter the trajectory of the Maker movement towards a New Making Renaissance and the genesis of Hybrid Aesthetics.

Bibliography

- [1] *3D Potter*. en-US. 2017. URL: <https://3dpotter.com>.
- [2] Yomna Abdelrahman, Alireza Sahami Shirazi, Niels Henze, and Albrecht Schmidt. “Investigation of Material Properties for Thermal Imaging-Based Interaction”. In: *Proceedings of the 33rd Annual ACM Conference on Human Factors in Computing Systems*. CHI ’15. New York, NY, USA: ACM, 2015, pp. 15–18. ISBN: 978-1-4503-3145-6. DOI: 10.1145/2702123.2702290.
- [3] *AgIC*. 2015. URL: www.littleblackcarrot.com/shop/agic-circuit-en/agic-circuit-print/agic-ink-prototype-kit/.
- [4] Daekeon Ahn, Jin-Hwe Kweon, Soonman Kwon, Jungil Song, and Seokhee Lee. “Representation of surface roughness in fused deposition modeling”. In: *Journal of Materials Processing Technology* 209.15-16 (2009), pp. 5593–5600.
- [5] Lorraine G Allan. “The perception of time”. In: *Perception & Psychophysics* 26.5 (1979), pp. 340–354.
- [6] Byoungkwon An, Ye Tao, Jianzhe Gu, Tingyu Cheng, Xiang ’Anthony’ Chen, Xiaoxiao Zhang, Wei Zhao, Youngwook Do, Shigeo Takahashi, Hsiang-Yun Wu, Teng Zhang, and Lining Yao. “Thermorph: Democratizing 4D Printing of Self-Folding Materials and Interfaces”. In: *Proceedings of the 2018 CHI Conference on Human Factors in Computing Systems*. CHI ’18. Montreal QC, Canada: ACM, 2018, 260:1–260:12. ISBN: 978-1-4503-5620-6. DOI: 10.1145/3173574.3173834.
- [7] Art21. *Sacred Grounds*. Oct. 2017. URL: <https://art21.org/playlist/sacred-grounds/>.
- [8] *Autodesk TinkerCAD*. en-US. 2010. URL: <https://www.tinkercad.com>.
- [9] Bahareh Barati, Elisa Giaccardi, and Elvin Karana. “The Making of Performativity in Designing [with] Smart Material Composites”. In: *Proceedings of the 2018 CHI Conference on Human Factors in Computing Systems*. CHI ’18. New York, NY, USA: ACM, 2018, 5:1–5:11. ISBN: 978-1-4503-5620-6. DOI: 10.1145/3173574.3173579.
- [10] Shaowen Bardzell, Daniela K. Rosner, and Jeffrey Bardzell. “Crafting quality in design: integrity, creativity, and public sensibility”. In: *Proceedings of the Designing Interactive Systems Conference*. ACM, 2012, pp. 11–20. URL: <http://dl.acm.org/citation.cfm?id=2317959>.

- [11] Sylvan Barnet. *A short guide to writing about art*. Pearson/Prentice Hall, 2011.
- [12] João Pedro A Bastos and Nelson Sadowski. *Electromagnetic modeling by finite element methods*. CRC press, 2003.
- [13] Elham Beheshti, David Kim, Gabrielle Ecanow, and Michael S. Horn. “Looking Inside the Wires: Understanding Museum Visitor Learning with an Augmented Circuit Exhibit”. In: *Proceedings of the 2017 CHI Conference on Human Factors in Computing Systems*. CHI ’17. Denver, Colorado, USA: ACM, 2017, pp. 1583–1594. ISBN: 978-1-4503-4655-9. DOI: 10.1145/3025453.3025479.
- [14] Luca Benedetti, Holger Winnemöller, Massimiliano Corsini, and Roberto Scopigno. “Painting with Bob: Assisted Creativity for Novices”. In: *Proceedings of the 27th Annual ACM Symposium on User Interface Software and Technology*. UIST ’14. New York, NY, USA: ACM, 2014, pp. 419–428. ISBN: 978-1-4503-3069-5. DOI: 10.1145/2642918.2647415.
- [15] Walter Benjamin. “The Work of Art in the Age of Mechanical Reproduction”. In: *Visual Culture: The Reader* (1936).
- [16] Ilias Bergstrom and R. Beau Lotto. “Code Bending: A New Creative Coding Practice”. In: *Leonardo* 48.1 (2015), pp. 25–31. DOI: 10.1162/LEON_a_00934.
- [17] Glenn Blauvelt, Tom Wrensch, and Michael Eisenberg. “Integrating Craft Materials and Computation”. In: *Proceedings of the 3rd Conference on Creativity & Cognition*. C&C ’99. New York, NY, USA: ACM, 1999, pp. 50–56. ISBN: 978-1-58113-078-2. DOI: 10.1145/317561.317572.
- [18] Paulo Blikstein. “Digital fabrication and ’making’ in education: The democratization of invention”. In: *FabLabs: Of machines, makers and inventors* (2013), pp. 1–21.
- [19] Jodi Bombardier. *Artisan filigree: wire-wrapping jewelry techniques and projects*. Fort Collins, CO: Interweave, 2013.
- [20] Jane Bozarth. *Show your work*. John Wiley & Sons, 2014.
- [21] Eric Brockmeyer, Ivan Poupyrev, and Scott Hudson. “PAPILLON: Designing Curved Display Surfaces with Printed Optics”. In: *Proceedings of ACM Symposium on User Interface Software and Technology*. UIST ’13. New York, NY, USA: ACM, 2013, pp. 457–462. ISBN: 978-1-4503-2268-3. DOI: 10.1145/2501988.2502027.
- [22] Leah Buechley. *Culture, STEM Education, & Making*. Keynote. Stanford University, 2013. URL: <https://digitalcommons.montclair.edu/cgi/viewcontent.cgi?article=1084&context=eldc>.
- [23] Leah Buechley, Mike Eisenberg, Jaime Catchen, and Ali Crockett. “The LilyPad Arduino: using computational textiles to investigate engagement, aesthetics, and diversity in computer science education”. In: *Proceedings of the SIGCHI conference on Human factors in computing systems*. ACM. 2008, pp. 423–432.

- [24] Leah Buechley and Benjamin Mako Hill. “LilyPad in the wild: how hardware’s long tail is supporting new engineering and design communities”. In: *Proceedings of the 8th ACM conference on designing interactive systems*. ACM. 2010, pp. 199–207.
- [25] Jim Campbell. *Exploded Views*. 2011.
- [26] Tim Campbell, Cesar Torres, and Eric Paulos. “Fl.UIs: Liquid-Mediated Vision Based Touch Surfaces”. In: *Proceedings of the Ninth International Conference on Tangible, Embedded, and Embodied Interaction*. TEI ’15. New York, NY, USA: ACM, 2015, pp. 85–88. ISBN: 978-1-4503-3305-4. DOI: 10.1145/2677199.2680604.
- [27] Noël Carroll. “The Specificity of Media in the Arts”. In: *Journal of Aesthetic Education* 19.4 (1985), pp. 5–20. DOI: 10.2307/3332295.
- [28] Yen-ning Chang, Youn-kyung Lim, and Erik Stolterman. “Personas: from theory to practices”. In: *Proceedings of the 5th Nordic conference on Human-computer interaction: building bridges*. ACM. 2008, pp. 439–442.
- [29] Amy Cheatle and Steven J. Jackson. “Digital Entanglements: Craft, Computation and Collaboration in Fine Art Furniture Production”. In: *Proceedings of the 18th ACM Conference on Computer Supported Cooperative Work & Social Computing*. CSCW ’15. New York, NY, USA: ACM, 2015, pp. 958–968. ISBN: 978-1-4503-2922-4. DOI: 10.1145/2675133.2675291.
- [30] Hsi-Chao Chen, Jun-Yu Lin, and Hsuan-Yi Chiu. “Rectangular illumination using a secondary optics with cylindrical lens for LED street light”. en. In: *Optics Express* 21.3 (Feb. 2013), p. 3201. DOI: 10.1364/OE.21.003201.
- [31] Erin Cherry and Celine Latulipe. “Quantifying the Creativity Support of Digital Tools through the Creativity Support Index”. en. In: *ACM Transactions on Computer-Human Interaction* 21.4 (June 2014), pp. 1–25. DOI: 10.1145/2617588.
- [32] Pei-Yu Chi, Joyce Liu, Jason Linder, Mira Dontcheva, Wilmot Li, and Bjoern Hartmann. “Democut: generating concise instructional videos for physical demonstrations”. In: *Proceedings of the 26th annual ACM symposium on User interface software and technology*. ACM. 2013, pp. 141–150.
- [33] Karen Collins. “In the Loop: Creativity and Constraint in 8-bit Video Game Audio”. en. In: *twentieth-century music* 4.02 (Sept. 2007). DOI: 10.1017/S1478572208000510.
- [34] S Scott Crump. *Apparatus and method for creating three-dimensional objects*. US Patent 5,121,329. June 1992.
- [35] Mihaly Csikszentmihalyi. *Flow: The psychology of optimal experience*. New York: Harper & Row, 1990.
- [36] Mihaly Csikszentmihalyi and Reed Larson. “Validity and reliability of the Experience-Sampling Method.” In: *The Journal of nervous and mental disease* 175.9 (1987), pp. 526–536.

- [37] Hervé Descottes and Cecilia E Ramos. *Architectural lighting: designing with light and space*. Princeton Architectural Press, 2013.
- [38] Laura Devendorf, Joanne Lo, Noura Howell, Jung Lin Lee, Nan-Wei Gong, M. Emre Karagozler, Shiho Fukuhara, Ivan Poupyrev, Eric Paulos, and Kimiko Ryokai. “I Don’t Want to Wear a Screen”: Probing Perceptions of and Possibilities for Dynamic Displays on Clothing”. In: *Proceedings of ACM SIGCHI Human Factors in Computing Systems*. CHI ’16. Santa Clara, California, USA: ACM, 2016, pp. 6028–6039. ISBN: 978-1-4503-3362-7. DOI: 10.1145/2858036.2858192.
- [39] Laura Devendorf, Joanne Lo, Noura Howell, Jung Lin Lee, Nan-Wei Gong, M. Emre Karagozler, Shiho Fukuhara, Ivan Poupyrev, Eric Paulos, and Kimiko Ryokai. “I Don’t Want to Wear a Screen”: Probing Perceptions of and Possibilities for Dynamic Displays on Clothing”. In: *Proceedings of the 2016 CHI Conference on Human Factors in Computing Systems*. CHI ’16. New York, NY, USA: ACM, 2016, pp. 6028–6039. ISBN: 978-1-4503-3362-7. DOI: 10.1145/2858036.2858192.
- [40] Laura Devendorf and Kimiko Ryokai. “Being the Machine: Reconfiguring Agency and Control in Hybrid Fabrication”. In: *Proceedings of the 33rd Annual ACM Conference on Human Factors in Computing Systems*. CHI ’15. New York, NY, USA: ACM, 2015, pp. 2477–2486. ISBN: 978-1-4503-3145-6. DOI: 10.1145/2702123.2702547.
- [41] Peter Dormer. *The art of the maker*. Thames and Hudson London, 1994.
- [42] Nick Dossis. *Brilliant LED Projects: 20 Electronic Designs for Artists, Hobbyists, and Experimenters*. McGraw-Hill Publishing, 2012.
- [43] Daniel Drew, Julie L. Newcomb, William McGrath, Filip Maksimovic, David Mellis, and Björn Hartmann. “The Toastboard: Ubiquitous Instrumentation and Automated Checking of Breadboarded Circuits”. In: *Proceedings of the 29th Annual Symposium on User Interface Software and Technology*. UIST ’16. Tokyo, Japan: ACM, 2016, pp. 677–686. ISBN: 978-1-4503-4189-9. DOI: 10.1145/2984511.2984566.
- [44] W Keith Edwards and Rebecca E Grinter. “At home with ubiquitous computing: Seven challenges”. In: *International conference on ubiquitous computing*. Springer, 2001, pp. 256–272.
- [45] Olafur Eliasson. *Olafur Eliasson the Weather Project*. 2003. URL: <http://www.tate.org.uk/whats-on/exhibition/unilever-series-olafur-eliasson-weather-project/olafur-eliasson-weather-project>.
- [46] Eli Eliav and Richard H Gracely. “Chapter 3 - Measuring and assessing pain”. In: *Orofacial Pain and Headache*. Ed. by Yair Sharav and Rafael Benoliel. Edinburgh: Mosby, 2008, pp. 45–56. ISBN: 978-0-7234-3412-2. DOI: <https://doi.org/10.1016/B978-0-7234-3412-2.10003-3>.
- [47] Samuel M. Felton, Michael T. Tolley, Cagdas D. Onal, Daniela Rus, and Robert J. Wood. “Robot self-assembly by folding: A printed inchworm robot”. In: *Robotics and Automation (ICRA), 2013 IEEE International Conference on*. IEEE, 2013, pp. 277–282.

- [48] Gerhard Fischer, Elisa Giaccardi, Hal Eden, Masanori Sugimoto, and Yunwen Ye. “Beyond binary choices: Integrating individual and social creativity”. In: *International Journal of Human-Computer Studies* 63.4-5 (2005), pp. 482–512.
- [49] Paul A Fishwick. *Aesthetic computing*. Mit Press, 2008.
- [50] Dan Flavin. *Diagonal of May 25, 1963*. 1963. URL: <http://www.themodern.org/collection/Diagonal-of-May-25-1963/1126>.
- [51] Raune Frankjær and Peter Dalsgaard. “Understanding Craft-Based Inquiry in HCI”. In: *Proceedings of the 2018 Designing Interactive Systems Conference*. ACM. 2018, pp. 473–484.
- [52] Jonas Frich, Lindsay MacDonald Vermeulen, Christian Remy, Michael Mose Biskjaer, and Peter Dalsgaard. “Mapping the landscape of creativity support tools in HCI”. In: *Proceedings of the 2019 CHI Conference on Human Factors in Computing Systems*. ACM. 2019, p. 389.
- [53] Verena Fuchsberger, Martin Murer, and Manfred Tscheligi. “Materials, Materiality, and Media”. In: *Proceedings of the SIGCHI Conference on Human Factors in Computing Systems*. CHI ’13. New York, NY, USA: ACM, 2013, pp. 2853–2862. ISBN: 978-1-4503-1899-0. DOI: 10.1145/2470654.2481395.
- [54] Yohsuke Furuta, Nobuyuki Umetani, Jun Mitani, Takeo Igarashi, and Yukio Fukui. “A film balloon design system integrated with shell element simulation”. In: *Proc. of Eurographics* (2010). URL: <http://www.jst.go.jp/erato/igarashi/projects/balloon/balloon.pdf>.
- [55] Laura Gambini. “Expansion of the Magnetic Flux Density Field in Toroidal Harmonics”. In: (2017).
- [56] Madeline Gannon, Tovi Grossman, and George Fitzmaurice. “Tactum: A Skin-Centric Approach to Digital Design and Fabrication”. en. In: ACM Press, 2015, pp. 1779–1788. ISBN: 978-1-4503-3145-6. DOI: 10.1145/2702123.2702581.
- [57] Josephine A Gasiewski, M Kevin Eagan, Gina A Garcia, Sylvia Hurtado, and Mitchell J Chang. “From gatekeeping to engagement: A multicontextual, mixed method study of student academic engagement in introductory STEM courses”. In: *Research in higher education* 53.2 (2012), pp. 229–261.
- [58] Bill Gaver and John Bowers. “Annotated portfolios.” In: *interactions* 19.4 (2012), pp. 40–49.
- [59] William Gaver, John Bowers, Andy Boucher, Andy Law, Sarah Pennington, and Nicholas Villar. “The History Tablecloth: Illuminating Domestic Activity”. In: *In: DIS*. 2006.
- [60] Dedre Gentner and Donald R. Gentner. *Flowing Waters or Teeming Crowds: Mental Models of Electricity*. Tech. rep. DTIC Document, 1982. URL: <http://oai.dtic.mil/oai/oai?verb=getRecord%5C&metadataPrefix=html%5C&identifier=ADA115300>.
- [61] Nathan Gershenfeld. *Fab: the coming revolution on your desktop—from personal computers to personal fabrication*. Basic Books, 2007.

- [62] Elisa Giaccardi and Elvin Karana. “Foundations of Materials Experience: An Approach for HCI”. en. In: ACM Press, 2015, pp. 2447–2456. ISBN: 978-1-4503-3145-6. DOI: 10.1145/2702123.2702337.
- [63] James Gick. *Creating with Stained Glass*. Future Crafts Today, 1976.
- [64] Gjon Mili. *Picasso draws a centaur*. 1949.
- [65] E Bruce Goldstein. *Sensation and perception*. Cengage Learning, 2009.
- [66] Connie Golsteijn, Elise Hoven, David Frohlich, and Abigail Sellen. “Hybrid Crafting: Towards an Integrated Practice of Crafting with Physical and Digital Components”. In: *Personal Ubiquitous Comput.* 18.3 (Mar. 2014), pp. 593–611. DOI: 10.1007/s00779-013-0684-9.
- [67] Clement Greenberg. “The Crisis of the Easel Picture”. In: *Partisan Review* 15 (1948), pp. 481–484.
- [68] Daniel Groeger, Elena Chong Loo, and Jürgen Steimle. “HotFlex: Post-print Customization of 3D Prints Using Embedded State Change”. In: *Proceedings of the 2016 CHI Conference on Human Factors in Computing Systems*. CHI ’16. New York, NY, USA: ACM, 2016, pp. 420–432. ISBN: 978-1-4503-3362-7. DOI: 10.1145/2858036.2858191.
- [69] Shad Gross, Jeffrey Bardzell, and Shaowen Bardzell. “Structures, Forms, and Stuff: The Materiality and Medium of Interaction”. In: *Personal Ubiquitous Comput.* 18.3 (Mar. 2014), pp. 637–649. DOI: 10.1007/s00779-013-0689-4.
- [70] Shad Gross, Jeffrey Bardzell, and Shaowen Bardzell. “Structures, Forms, and Stuff: The Materiality and Medium of Interaction”. In: *Personal Ubiquitous Comput.* 18.3 (Mar. 2014), pp. 637–649. DOI: 10.1007/s00779-013-0689-4.
- [71] Beth Harris and Steven Zucker. *Tempera Paint*. en. 2011. URL: <https://www.khanacademy.org/humanities/special-topics-art-history/creating-conserving/painting-materials-techniques/v/tempera-paint>.
- [72] Jane Harris. “Digital practice in material hands: How craft and computing practices are advancing digital aesthetic and conceptual methods”. In: *Craft Research* 3.1 (2012), pp. 91–112.
- [73] Chris Harrison, John Horstman, Gary Hsieh, and Scott Hudson. “Unlocking the expressivity of point lights”. In: *Proceedings of the 2012 ACM annual conference on Human Factors in Computing Systems*. 2012, pp. 1683–1692. URL: <http://dl.acm.org/citation.cfm?id=2208296>.
- [74] Scott Harrison and Catherine Grant. “Exploring of new models of research pedagogy: time to let go of master-apprentice style supervision?” In: *Teaching in Higher Education* 20.5 (2015), pp. 556–566. DOI: 10.1080/13562517.2015.1036732.
- [75] N. Katherine Hayles. “Print Is Flat, Code Is Deep: The Importance of Media-Specific Analysis”. en. In: *Poetics Today* 25.1 (Mar. 2004), pp. 67–90. DOI: 10.1215/03335372-25-1-67.

- [76] Felix Heibeck, Basheer Tome, Clark Della Silva, and Hiroshi Ishii. “uniMorph: Fabricating Thin Film Composites for Shape-Changing Interfaces”. In: *Proceedings of the 28th Annual ACM Symposium on User Interface Software & Technology*. UIST ’15. New York, NY, USA: ACM, 2015, pp. 233–242. ISBN: 978-1-4503-3779-3. DOI: 10.1145/2807442.2807472.
- [77] Herbert Hensel. “Cutaneous Thermoreceptors”. In: *Somatosensory System*. Ed. by Ainsley Iggo. Berlin, Heidelberg: Springer Berlin Heidelberg, 1973, pp. 79–110. ISBN: 978-3-642-65438-1. DOI: 10.1007/978-3-642-65438-1_4.
- [78] Kristian Hildebrand, Bernd Bickel, and Marc Alexa. “crdbrd: Shape Fabrication by Sliding Planar Slices”. In: *Proc. of Eurographics*. 2012.
- [79] Brad Hindson. *Light as Material – Rethinking How We Use Light*. 2013.
- [80] Kristina Höök and Jonas Löwgren. “Strong concepts: Intermediate-level knowledge in interaction design research”. In: *ACM Transactions on Computer-Human Interaction (TOCHI)* 19.3 (2012), p. 23.
- [81] Jettie Hoonhout, Lillian Jumpertz, Jon Mason, and Tom Bergman. “Exploration into Lighting Dynamics for the Design of More Pleasurable Luminaires”. In: *Proceedings of Designing Pleasurable Products and Interfaces*. DPPI ’13. New York, NY, USA: ACM, 2013, pp. 185–192. ISBN: 978-1-4503-2192-1. DOI: 10.1145/2513506.2513526.
- [82] Emmanuel Iarussi and Wilmot Li. “WrapIt: Computational Jigs for Wire Wrapping”. In: *Proc. of SIGGRAPH Asia*. 2015.
- [83] Yuki Igarashi and Takeo Igarashi. “Designing Plush Toys with a Computer”. In: *Commun. ACM* 52.12 (Dec. 2009), pp. 81–88. DOI: 10.1145/1610252.1610275.
- [84] Illuminating Engineering Society. *Discover Lighting: An Introduction to Lighting Basics*. 2011. URL: <http://www.ies.org/lighting/sources/luminaires.cfm>.
- [85] Tim Ingold. *Making: Anthropology, archaeology, art and architecture*. Routledge, 2013.
- [86] Hiroshi Ishii, Dávid Lakatos, Leonardo Bonanni, and Jean-Baptiste Labrune. “Radical atoms: beyond tangible bits, toward transformable materials”. In: *interactions* 19.1 (2012), pp. 38–51.
- [87] Hiroshi Ishii and Brygg Ullmer. “Tangible bits: towards seamless interfaces between people, bits and atoms”. In: *Proceedings of the ACM SIGCHI Conference on Human factors in computing systems*. ACM, 1997, pp. 234–241. URL: <http://dl.acm.org/citation.cfm?id=258715>.
- [88] Jennifer Jacobs and Leah Buechley. “Codeable objects: computational design and digital fabrication for novice programmers”. In: *Proceedings of the 2013 ACM annual conference on Human factors in computing systems*. 2013, pp. 1589–1598. URL: <http://dl.acm.org/citation.cfm?id=2466211>.
- [89] Jennifer Jacobs and Amit Zoran. “Hybrid Practice in the Kalahari: Design Collaboration Through Digital Tools and Hunter Gatherer Craft”. en. In: *Proc. CHI ’15*. ACM Press, 2015.

- [90] Tom Jenkins. “Devotional Gardening Tools”. In: *CHI '13 Extended Abstracts on Human Factors in Computing Systems*. CHI EA '13. New York, NY, USA: ACM, 2013, pp. 2219–2226. ISBN: 978-1-4503-1952-2. DOI: 10.1145/2468356.2468743.
- [91] Pamela Jennings and Elisa Giaccardi. “Creativity support tools for and by the new media arts community”. In: *NSF Workshop Report on Creativity Support Tools*. Citeseer, 2005, pp. 12–14. URL: <http://citeseerx.ist.psu.edu/viewdoc/download?doi=10.1.1.357.4914%5C&rep=rep1%5C&type=pdf>.
- [92] Samuel Johsua and Jean-Jacques Dupin. “Using “Modelling Analogies” to Teach Basic Electricity: A Critical Analysis”. In: *Learning Electricity and Electronics with Advanced Educational Technology*. Ed. by Michel Caillot. Berlin, Heidelberg: Springer Berlin Heidelberg, 1993, pp. 39–55. ISBN: 978-3-662-02878-0.
- [93] Martin Jonsson, Anna Ståhl, Johanna Mercurio, Anna Karlsson, Naveen Ramani, and Kristina Höök. “The aesthetics of heat: guiding awareness with thermal stimuli”. In: *Proceedings of the TEI'16: Tenth International Conference on Tangible, Embedded, and Embodied Interaction*. ACM. 2016, pp. 109–117.
- [94] Yasmin Kafai, Kristin Searle, Cristobal Martinez, and Bryan Brayboy. “Ethnocomputing with electronic textiles: culturally responsive open design to broaden participation in computing in American indian youth and communities”. In: *Proceedings of the 45th ACM technical symposium on Computer science education*. ACM. 2014, pp. 241–246.
- [95] Ayodh Vasant Kamath. “Integrating digital design and fabrication and craft production”. PhD thesis. Massachusetts Institute of Technology, 2009.
- [96] Hsin-Liu (Cindy) Kao, Miren Bamforth, David Kim, and Chris Schmandt. “Skinmorph: Texture-tunable On-skin Interface Through Thin, Programmable Gel”. In: *Proceedings of the 2018 ACM International Symposium on Wearable Computers*. ISWC '18. Singapore, Singapore: ACM, 2018, pp. 196–203. ISBN: 978-1-4503-5967-2. DOI: 10.1145/3267242.3267262.
- [97] Hsin-Liu (Cindy) Kao, Christian Holz, Asta Roseway, Andres Calvo, and Chris Schmandt. “DuoSkin: Rapidly Prototyping On-skin User Interfaces Using Skin-friendly Materials”. In: *Proceedings of the 2016 ACM International Symposium on Wearable Computers*. ISWC '16. Heidelberg, Germany: ACM, 2016, pp. 16–23. ISBN: 978-1-4503-4460-9. DOI: 10.1145/2971763.2971777.
- [98] Hsin-Liu (Cindy) Kao, Manisha Mohan, Chris Schmandt, Joseph A. Paradiso, and Katia Vega. “ChromoSkin: Towards Interactive Cosmetics Using Thermochromic Pigments”. In: *Proceedings of the 2016 CHI Conference Extended Abstracts on Human Factors in Computing Systems*. CHI EA '16. New York, NY, USA: ACM, 2016, pp. 3703–3706. ISBN: 978-1-4503-4082-3. DOI: 10.1145/2851581.2890270.

- [99] Elvin Karana, Elisa Giaccardi, Niels Stamhuis, and Jasper Goossensen. “The Tuning of Materials: A Designer’s Journey”. In: *Proceedings of the 2016 ACM Conference on Designing Interactive Systems*. DIS ’16. New York, NY, USA: ACM, 2016, pp. 619–631. ISBN: 978-1-4503-4031-1. DOI: 10.1145/2901790.2901909.
- [100] James C Kaufman and Ronald A Beghetto. “Beyond big and little: The four c model of creativity”. In: *Review of general psychology* 13.1 (2009), pp. 1–12.
- [101] Yoshihiro Kawahara, Steve Hodges, Benjamin S. Cook, Cheng Zhang, and Gregory D. Abowd. “Instant Inkjet Circuits: Lab-based Inkjet Printing to Support Rapid Prototyping of UbiComp Devices”. In: *Proceedings of the 2013 ACM International Joint Conference on Pervasive and Ubiquitous Computing*. UbiComp ’13. Zurich, Switzerland: ACM, 2013, pp. 363–372. ISBN: 978-1-4503-1770-2. DOI: 10.1145/2493432.2493486.
- [102] Dan Kikinis. “System in which a Proxy-Server translates information received from the Internet into a form/format readily usable by low power portable computers”. US5727159A. Mar. 1998. URL: <https://patents.google.com/patent/US5727159A/en>.
- [103] Scott R. Klemmer, Björn Hartmann, and Leila Takayama. “How bodies matter: five themes for interaction design”. In: *Proceedings of the 6th conference on Designing Interactive systems*. 2006, pp. 140–149. URL: <http://dl.acm.org/citation.cfm?id=1142429>.
- [104] Hiroshi Kobata and Robert Gagne. “Securing computer network communication using a proxy server”. US20060005237A1. Jan. 2006. URL: <https://patents.google.com/patent/US20060005237A1/en>.
- [105] Jessica Carew Kraft. “Who Is A Maker?” en. In: *BRIGHT* (June 2019). URL: <https://brightthemag.com/who-is-a-maker-603aca72118f>.
- [106] Pensa Labs. *DIWire*. en-US. 2013. URL: <https://www.pensalabs.com>.
- [107] Jean Lave and Etienne Wenger. “Legitimate peripheral participation in communities of practice”. In: *Supporting lifelong learning*. Routledge, 2001, pp. 121–136.
- [108] Juerg Lehni and Jonathan Puckey. *Paper.js*. 2011.
- [109] Claude Lèvi-Strauss. *The savage mind*. University of Chicago Press, 1966.
- [110] LIA. “Filament Sculptures”. In: 2014. URL: <http://www.liaworks.com/theprojects/filament-sculptures/>.
- [111] Rong-Hao Liang, Chao Shen, Yu-Chien Chan, Guan-Ting Chou, Liwei Chan, De-Nian Yang, Mike Y. Chen, and Bing-Yu Chen. “WonderLens: Optical Lenses and Mirrors for Tangible Interactions on Printed Paper”. In: *Proceedings of ACM SIGCHI Human Factors in Computing Systems*. CHI ’15. New York, NY, USA: ACM, 2015, pp. 1281–1284. ISBN: 978-1-4503-3145-6. DOI: 10.1145/2702123.2702434.
- [112] *Light Emitting Diode or the LED Tutorial*. en. Aug. 2013. URL: https://www.electronicstutorials.ws/diode/diode_8.html.

- [113] Gordon E. Liljegren and Eugene L. Foster. “Figure with back projected image using fiber optics”. US4978216 A. U.S. Classification 353/28, 353/74; International Classification G09F19/00, G09F19/18, G09F19/08, A63H33/22, G03B21/00, A63H3/36, G09F19/02, G03B21/62; Cooperative Classification G09F19/02, G09F19/18, G09F19/08, G09F2019/086, G09F19/00, G09F2019/088; European Classification G09F19/18, G09F19/08. Dec. 1990. URL: <http://www.google.com/patents/US4978216>.
- [114] Robb Lindgren and Mina Johnson-Glenberg. “Emboldened by Embodiment: Six Precepts for Research on Embodied Learning and Mixed Reality”. In: *Educational Researcher* 42.8 (2013), pp. 445–452. DOI: 10.3102/0013189X13511661.
- [115] Lucy R Lippard. *Eva Hesse*. New York University Press New York, 1976.
- [116] Szu-Yu Liu, Tung-Jen E. Tsai, and Daniel Alenquer. “Exploring Computational Composite: An Approach To Sensorial Interaction”. en. In: ACM Press, 2016, pp. 337–340. ISBN: 978-1-4503-3950-6. DOI: 10.1145/2818052.2869083.
- [117] Joanne Lo, Doris Jung Lin Lee, Nathan Wong, David Bui, and Eric Paulos. “Skintillates: Designing and Creating Epidermal Interactions”. In: *Proceedings of Designing Interactive Systems*. DIS ’16. Brisbane, QLD, Australia: ACM, 2016, pp. 853–864. ISBN: 978-1-4503-4031-1. DOI: 10.1145/2901790.2901885.
- [118] Joanne Lo, Cesar Torres, Isabel Yang, Jasper O’Leary, Danny Kaufman, Wilmot Li, Mira Dontcheva, and Eric Paulos. “Aesthetic Electronics: Designing, Sketching, and Fabricating Circuits Through Digital Exploration”. In: *Proceedings of the 29th Annual Symposium on User Interface Software and Technology*. UIST ’16. New York, NY, USA: ACM, 2016, pp. 665–676. ISBN: 978-1-4503-4189-9. DOI: 10.1145/2984511.2984579.
- [119] Jean-François Lyotard. *Les immatériaux*. Centre Georges Pompidou, 1985.
- [120] Margaret E Madden, Marsha Baxter, Heather Beauchamp, Kimberley Bouchard, Derek Habermas, Mark Huff, Brian Ladd, Jill Pearon, and Gordon Plague. “Rethinking STEM education: An interdisciplinary STEAM curriculum”. In: *Procedia Computer Science* 20 (2013), pp. 541–546.
- [121] Leah Maestri and Ron Wakkary. “Understanding repair as a creative process of everyday design”. In: *Proceedings of the 8th ACM conference on Creativity and cognition*. ACM. 2011, pp. 81–90.
- [122] Abraham H. Maslow. *The Psychology of Science*. New York: Harper & Row, 1966.
- [123] Wojciech Matusik, Boris Ajdin, Jinwei Gu, Jason Lawrence, Hendrik P. A. Lensch, Fabio Pellacini, and Szymon Rusinkiewicz. “Printing Spatially-varying Reflectance”. In: *ACM SIGGRAPH Asia 2009 Papers*. SIGGRAPH Asia ’09. New York, NY, USA: ACM, 2009, 128:1–128:9. ISBN: 978-1-60558-858-2. DOI: 10.1145/1661412.1618474.
- [124] Malcolm McCullough. *Abstracting Craft : The Practice Digital Hand*. The MIT Press, July 1998.

- [125] Will McGrath, Daniel Drew, Jeremy Warner, Majeed Kazemitabaar, Mitchell Karchemsky, David Mellis, and Björn Hartmann. “Bifröst: Visualizing and Checking Behavior of Embedded Systems Across Hardware and Software”. In: *Proceedings of the 30th Annual ACM Symposium on User Interface Software and Technology*. UIST ’17. Quebec City, QC, Canada: ACM, 2017, pp. 299–310. ISBN: 978-1-4503-4981-9. DOI: 10.1145/3126594.3126658.
- [126] Marshall McLuhan. “Understanding media”. In: *The Extensions of Man*. New York (1964).
- [127] Bakhtiar Mikhak, Christopher Lyon, Tim Gorton, Neil Gershenfeld, Caroline McEnnis, and Jason Taylor. “Fab Lab: an alternate model of ICT for development”. In: *2nd international conference on open collaborative design for sustainable innovation*. 2002, pp. 1–7.
- [128] Viktor Miruchna, Robert Walter, David Lindlbauer, Maren Lehmann, Regine von Klitzing, and Jörg Müller. “GelTouch: Localized Tactile Feedback Through Thin, Programmable Gel”. In: *Proceedings of the 28th Annual ACM Symposium on User Interface Software & Technology*. UIST ’15. Charlotte, NC, USA: ACM, 2015, pp. 3–10. ISBN: 978-1-4503-3779-3. DOI: 10.1145/2807442.2807487.
- [129] László Moholy-Nagy. *Moholy-Nagy, László: Light-Space-Modulator*. en. text. Sept. 2016. URL: <http://www.medienkunstnetz.de/works/licht-raum-modulator/>.
- [130] Catarina Mota. “The rise of personal fabrication”. In: *Proc. C&C*. ACM, 2011, pp. 279–288. URL: <http://dl.acm.org/citation.cfm?id=2069665>.
- [131] Stefanie Mueller, Tobias Mohr, Kerstin Guenther, Johannes Frohnhofen, and Patrick Baudisch. “faBrickation: fast 3D printing of functional objects by integrating construction kit building blocks”. In: *Proceedings of the SIGCHI Conference on Human Factors in Computing Systems*. ACM. 2014, pp. 3827–3834.
- [132] Stefanie Mueller, Anna Seufert, Huaishu Peng, Robert Kovacs, Kevin Reuss, François Guimbretière, and Patrick Baudisch. “FormFab: Continuous Interactive Fabrication”. In: *Proceedings of the Thirteenth International Conference on Tangible, Embedded, and Embodied Interaction*. ACM. 2019, pp. 315–323.
- [133] Marjorie Munsterberg. *Writing about art*. CreateSpace Independent Publishing Platform, 2009. URL: <http://writingaboutart.org/pages/formalanalysis.html>.
- [134] Steven J Murdoch and Ross Anderson. “Tools and technology of Internet filtering”. In: *Access denied: The practice and policy of global internet filtering* 1.1 (2008), p. 58.
- [135] Martin Murer, Anna Vallgarda, Mattias Jacobsson, and Manfred Tscheligi. “Un-Crafting: Exploring Tangible Practices for Deconstruction in Interactive System Design”. In: *Proceedings of the Ninth International Conference on Tangible, Embedded, and Embodied Interaction*. TEI ’15. New York, NY, USA: ACM, 2015, pp. 469–472. ISBN: 978-1-4503-3305-4. DOI: 10.1145/2677199.2683582.
- [136] Kumiyo Nakakoji. “Meanings of tools, support, and uses for creative design processes”. In: *International design research symposium*. Vol. 6. 2006, pp. 156–165. URL: <http://www.kidresearch.jp/publications/IDRS-nakakoji-rev-wt-header.pdf>.

- [137] Michael Nitsche, Andrew Quitmeyer, Kate Farina, Samuel Zwaan, and Hye Yeon Nam. “Teaching Digital Craft”. In: *CHI '14 Extended Abstracts on Human Factors in Computing Systems*. CHI EA '14. New York, NY, USA: ACM, 2014, pp. 719–730. ISBN: 978-1-4503-2474-8. DOI: 10.1145/2559206.2578872.
- [138] Michael Nitsche and Anna Weisling. “When is It Not Craft?: Materiality and Mediation when Craft and Computing Meet”. In: *Proceedings of the Thirteenth International Conference on Tangible, Embedded, and Embodied Interaction*. TEI '19. Tempe, Arizona, USA: ACM, 2019, pp. 683–689. ISBN: 978-1-4503-6196-5. DOI: 10.1145/3294109.3295651.
- [139] Lora Oehlberg, Wesley Willett, and Wendy E. Mackay. “Patterns of Physical Design Remixing in Online Maker Communities”. en. In: ACM Press, 2015, pp. 639–648. ISBN: 978-1-4503-3145-6. DOI: 10.1145/2702123.2702175.
- [140] Simon Olberding, Sergio Soto Ortega, Klaus Hildebrandt, and Jürgen Steimle. “Foldio: Digital Fabrication of Interactive and Shape-Changing Objects With Foldable Printed Electronics”. In: *Proceedings of the 28th Annual ACM Symposium on User Interface Software & Technology*. UIST '15. Charlotte, NC, USA: ACM, 2015, pp. 223–232. ISBN: 978-1-4503-3779-3. DOI: 10.1145/2807442.2807494.
- [141] Nam June Paik and John Cage. *Nam June Paik: Electronic Art*. 16. Galeria Bonino, 1965.
- [142] Marios Papas, Thomas Houit, Derek Nowrouzezahrai, Markus Gross, and Wojciech Jarosz. “The Magic Lens: Refractive Steganography”. In: *ACM Trans. Graph.* 31.6 (Nov. 2012), 186:1–186:10. DOI: 10.1145/2366145.2366205.
- [143] Roshan Lalintha Peiris and Suranga Nanayakkara. “PaperPixels: A Toolkit to Create Paper-based Displays”. In: *Proceedings of the 26th Australian Computer-Human Interaction Conference on Designing Futures: The Future of Design*. OzCHI '14. New York, NY, USA: ACM, 2014, pp. 498–504. ISBN: 978-1-4503-0653-9. DOI: 10.1145/2686612.2686691.
- [144] Roshan Lalintha Peiris and Suranga Nanayakkara. “PaperPixels: A Toolkit to Create Paper-based Displays”. In: *Proceedings of the 26th Australian Computer-Human Interaction Conference on Designing Futures: The Future of Design*. OzCHI '14. New York, NY, USA: ACM, 2014, pp. 498–504. ISBN: 978-1-4503-0653-9. DOI: 10.1145/2686612.2686691.
- [145] Huaishu Peng, Amit Zoran, and François Guimbretière. “D-Coil: A Hands-on Approach to Digital 3D Models Design”. In: *CHI*. 2015.
- [146] Pensalabs. *D.I. Wire*. 2015. URL: <https://www.pensalabs.com/diwire-pro/>.
- [147] Thiago Pereira, Szymon Rusinkiewicz, and Wojciech Matusik. “Computational Light Routing: 3D Printed Optical Fibers for Sensing and Display”. In: *ACM Trans. Graph.* 33.3 (June 2014), 24:1–24:13. DOI: 10.1145/2602140.
- [148] Hannah Perner-Wilson, Leah Buechley, and Mika Satomi. “Handcrafting textile interfaces from a kit-of-no-parts”. In: *Proceedings of the fifth international conference on Tangible, embedded, and embodied interaction*. ACM. 2011, pp. 61–68.

- [149] W. A. Phillips. “On the distinction between sensory storage and short-term visual memory”. In: *Perception & Psychophysics* 16.2 (Mar. 1974), pp. 283–290. DOI: 10.3758/BF03203943.
- [150] James Pierce and Eric Paulos. “Electric Materialities and Interactive Technology”. In: *Proceedings of the SIGCHI Conference on Human Factors in Computing Systems*. CHI ’13. New York, NY, USA: ACM, 2013, pp. 119–128. ISBN: 978-1-4503-1899-0. DOI: 10.1145/2470654.2470672.
- [151] Andrew Polaine. “The Flow Principle in Interactivity”. In: *Proc. of Interactive Entertainment’05*. IE ’05. Creativity & Cognition Studios Press, 2005, pp. 151–158. ISBN: 0-9751533-2-3. URL: <http://dl.acm.org/citation.cfm?id=1109180.1109204>.
- [152] Michael Polanyi. *The tacit dimension*. University of Chicago press, 2009.
- [153] Irene Posch and Geraldine Fitzpatrick. “Integrating Textile Materials with Electronic Making: Creating New Tools and Practices”. en. In: ACM Press, 2018, pp. 158–165. ISBN: 978-1-4503-5568-1. DOI: 10.1145/3173225.3173255.
- [154] M Puckette and D Zicarelli. *Max MSP software*. 1990.
- [155] David Pye. *The nature and art of workmanship*. Cambridge UP, 1968.
- [156] Jie Qi and Leah Buechley. “Sketching in Circuits: Designing and Building Electronics on Paper”. In: *Proceedings of the SIGCHI Conference on Human Factors in Computing Systems*. CHI ’14. New York, NY, USA: ACM, 2014, pp. 1713–1722. ISBN: 978-1-4503-2473-1. DOI: 10.1145/2556288.2557391.
- [157] Jie Qi, Andrew "bunnie" Huang, and Joseph Paradiso. “Crafting Technology with Circuit Stickers”. In: *Proceedings of the 14th International Conference on Interaction Design and Children*. IDC ’15. New York, NY, USA: ACM, 2015, pp. 438–441. ISBN: 978-1-4503-3590-4. DOI: 10.1145/2771839.2771873.
- [158] D D Reidpath and P Allotey. “Infant mortality rate as an indicator of population health”. In: *Journal of Epidemiology & Community Health* 57.5 (2003), pp. 344–346. DOI: 10.1136/jech.57.5.344.
- [159] Mitchel Resnick, John Maloney, Andrés Monroy-Hernández, Natalie Rusk, Evelyn Eastmond, Karen Brennan, Amon Millner, Eric Rosenbaum, Jay S Silver, Brian Silverman, et al. “Scratch: Programming for all.” In: *Commun. Acm* 52.11 (2009), pp. 60–67.
- [160] Mitchel Resnick, Brad Myers, Kumiyo Nakakoji, Ben Shneiderman, Randy Pausch, Ted Selker, and Mike Eisenberg. “Design principles for tools to support creative thinking”. In: (2005).
- [161] Alec Rivers, Andrew Adams, and Frédo Durand. “Sculpting by Numbers”. In: *ACM Trans. Graph.* 31.6 (Nov. 2012), 157:1–157:7. DOI: 10.1145/2366145.2366176.

- [162] Daniela K. Rosner. “The Material Practices of Collaboration”. In: *Proceedings of the ACM 2012 Conference on Computer Supported Cooperative Work*. CSCW ’12. New York, NY, USA: ACM, 2012, pp. 1155–1164. ISBN: 978-1-4503-1086-4. DOI: 10.1145/2145204.2145375.
- [163] Daniela K. Rosner and Sarah E. Fox. “Legacies of craft and the centrality of failure in a mother-operated hackerspace”. In: *new media & society* (2016), p. 1461444816629468. URL: <http://nms.sagepub.com/content/early/2016/02/23/1461444816629468.abstract>.
- [164] Daniela K. Rosner, Miwa Ikemiya, and Tim Regan. “Resisting Alignment: Code and Clay”. In: *Proceedings of the Ninth International Conference on Tangible, Embedded, and Embodied Interaction*. TEI ’15. New York, NY, USA: ACM, 2015, pp. 181–188. ISBN: 978-1-4503-3305-4. DOI: 10.1145/2677199.2680587.
- [165] Daniela K Rosner and Kimiko Ryokai. “Spyn: augmenting knitting to support storytelling and reflection”. In: *Proceedings of the 10th international conference on Ubiquitous computing*. ACM. 2008, pp. 340–349.
- [166] Evan Roth and James Powderly. *LED Throwies*. 2006.
- [167] Daniel Rozin. *Wooden Mirror*. 1999.
- [168] Hidekazu Saegusa, Thomas Tran, and Daniela K. Rosner. “Mimetic Machines: Collaborative Interventions in Digital Fabrication with Arc”. In: *Proceedings of the 2016 CHI Conference on Human Factors in Computing Systems*. CHI ’16. New York, NY, USA: ACM, 2016, pp. 6008–6013. ISBN: 978-1-4503-3362-7. DOI: 10.1145/2858036.2858475.
- [169] Valkyrie Savage, Sean Follmer, Jingyi Li, and Björn Hartmann. “Makers’ Marks: Physical markup for designing and fabricating functional objects”. In: *Proceedings of the 28th Annual ACM Symposium on User Interface Software & Technology*. ACM. 2015, pp. 103–108.
- [170] Valkyrie Savage, Ryan Schmidt, Tovi Grossman, George Fitzmaurice, and Björn Hartmann. “A Series of Tubes: Adding Interactivity to 3D Prints Using Internal Pipes”. In: *Proceedings of the 27th Annual ACM Symposium on User Interface Software and Technology*. UIST ’14. Honolulu, Hawaii, USA: ACM, 2014, pp. 3–12. ISBN: 978-1-4503-3069-5. DOI: 10.1145/2642918.2647374.
- [171] Markus Lorenz Schilling, Ron Wakkary, and William Odom. “Focus Framework: Tracking Prototypes’ Back-Talk”. In: *Proceedings of the Twelfth International Conference on Tangible, Embedded, and Embodied Interaction*. TEI ’18. New York, NY, USA: ACM, 2018, pp. 684–693. ISBN: 978-1-4503-5568-1. DOI: 10.1145/3173225.3173259.
- [172] Donald Schon. *The reflective practitioner*. 1983.
- [173] Donald A. Schon. “Designing as reflective conversation with the materials of a design situation”. In: *Research in Engineering Design* 3.3 (Sept. 1992), pp. 131–147. DOI: 10.1007/BF01580516.

- [174] Peter Schreiber, Serge Kudaev, Peter Dannberg, and Uwe D. Zeitner. “Homogeneous LED-illumination using microlens arrays”. In: vol. 5942. 2005, 59420K–59420K–9. DOI: 10.1117/12.618747.
- [175] Richard Sennett. *The craftsman*. Yale University Press, 2008.
- [176] Jia Sheng, Ravin Balakrishnan, and Karan Singh. “An interface for virtual 3D sculpting via physical proxy.” In: *GRAPHITE*. Vol. 6. 2006, pp. 213–220.
- [177] Midori Shibutani and Akira Wakita. “Fabcell: Fabric Element”. In: *ACM SIGGRAPH 2006 Sketches*. SIGGRAPH ’06. New York, NY, USA: ACM, 2006. ISBN: 978-1-59593-364-5. DOI: 10.1145/1179849.1179990.
- [178] Ben Shneiderman. “User interfaces for creativity support tools”. In: *Proceedings of the 3rd conference on Creativity & cognition*. ACM. 1999, pp. 15–22.
- [179] Ben Shneiderman. “Creativity Support Tools: Accelerating Discovery and Innovation”. In: *Commun. ACM* 50.12 (Dec. 2007), pp. 20–32. DOI: 10.1145/1323688.1323689.
- [180] Ben Shneiderman. “Creativity support tools: accelerating discovery and innovation”. In: *Commun. ACM* 50.12 (Dec. 2007), pp. 20–32. DOI: 10.1145/1323688.1323689.
- [181] Pieter Stappers and Elisa Giaccardi. *Research through Design*. en. 2017, pp. 1–94. URL: <https://www.interaction-design.org/literature/book/the-encyclopedia-of-human-computer-interaction-2nd-ed/research-through-design>.
- [182] Erik Stolterman. “The nature of design practice and implications for interaction design research”. In: *International Journal of Design* 2.1 (2008), pp. 55–65.
- [183] Tung D. Ta, Fuminori Okuya, and Yoshihiro Kawahara. “LightTrace: Auto-router for Designing LED Based Applications with Conductive Inkjet Printing”. In: *Proceedings of the 1st Annual ACM Symposium on Computational Fabrication*. SCF ’17. Cambridge, Massachusetts: ACM, 2017, 3:1–3:10. ISBN: 978-1-4503-4999-4. DOI: 10.1145/3083157.3083160.
- [184] Jane Taylor and Katherine Townsend. “Reprogramming the hand: Bridging the craft skills gap in 3D/digital fashion knitwear design”. In: *Craft Research* 5.2 (2014), pp. 155–174.
- [185] Michael Terry and Elizabeth D. Mynatt. “Recognizing Creative Needs in User Interface Design”. In: *Proceedings of the 4th Conference on Creativity & Cognition*. C&C ’02. New York, NY, USA: ACM, 2002, pp. 38–44. ISBN: 1-58113-465-7. DOI: 10.1145/581710.581718.
- [186] *The Joule Heating Effect*. 2018. URL: <https://www.comsol.com/multiphysics/the-joule-heating-effect>.
- [187] Jakob Tholander, Maria Normark, and Chiara Rossitto. “Understanding Agency in Interaction Design Materials”. In: *Proceedings of the SIGCHI Conference on Human Factors in Computing Systems*. CHI ’12. New York, NY, USA: ACM, 2012, pp. 2499–2508. ISBN: 978-1-4503-1015-4. DOI: 10.1145/2207676.2208417.

- [188] Rundong Tian, Sarah Serman, Ethan Chiou, Jeremy Warner, and Eric Paulos. “MatchSticks: Woodworking Through Improvisational Digital Fabrication”. In: *Proceedings of the 2018 CHI Conference on Human Factors in Computing Systems*. CHI ’18. Montreal QC, Canada: ACM, 2018, 149:1–149:12. ISBN: 978-1-4503-5620-6. DOI: 10.1145/3173574.3173723.
- [189] Cesar Torres, Tim Campbell, Neil Kumar, and Eric Paulos. “HapticPrint: Designing Feel Aesthetics for Digital Fabrication”. In: *Proceedings of the 28th Annual ACM Symposium on User Interface Software & Technology*. UIST ’15. New York, NY, USA: ACM, 2015, pp. 583–591. ISBN: 978-1-4503-3779-3.
- [190] Cesar Torres, Jessica Chang, Advaita Patel, and Eric Paulos. “Phosphenes: Crafting Resistive Heaters Within Thermoreactive Composites”. In: *Proceedings of the 2019 on Designing Interactive Systems Conference*. DIS ’19. San Diego, CA, USA: ACM, 2019, pp. 907–919. ISBN: 978-1-4503-5850-7. DOI: 10.1145/3322276.3322375.
- [191] Cesar Torres, Wilmot Li, and Eric Paulos. “ProxyPrint: Supporting Crafting Practice Through Physical Computational Proxies”. In: *Proceedings of the 2016 ACM Conference on Designing Interactive Systems*. DIS ’16. Brisbane, QLD, Australia: ACM, 2016, pp. 158–169. ISBN: 978-1-4503-4031-1. DOI: 10.1145/2901790.2901828.
- [192] Cesar Torres, Molly Jane Nicholas, Sangyeon Lee, and Eric Paulos. “A Conversation with Actuators: An Exploratory Design Environment for Hybrid Materials”. In: *Proceedings of the Thirteenth International Conference on Tangible, Embedded, and Embodied Interaction*. TEI ’19. Tempe, Arizona, USA: ACM, 2019, pp. 657–667. ISBN: 978-1-4503-6196-5. DOI: 10.1145/3294109.3295643.
- [193] Cesar Torres, Jasper O’Leary, Molly Nicholas, and Eric Paulos. “Illumination Aesthetics: Light As a Creative Material Within Computational Design”. In: *Proceedings of the 2017 CHI Conference on Human Factors in Computing Systems*. CHI ’17. New York, NY, USA: ACM, 2017, pp. 6111–6122. ISBN: 978-1-4503-4655-9. DOI: 10.1145/3025453.3025466.
- [194] Cesar Torres, Sarah Serman, Molly Nicholas, Richard Lin, Eric Pai, and Eric Paulos. “Guardians of Practice: A Contextual Inquiry of Failure-Mitigation Strategies in Creative Practices”. In: ACM Press, 2018.
- [195] Vasiliki Tsaknaki. “Making Preciousness: Interaction Design through Studio Crafts”. PhD thesis. KTH Royal Institute of Technology, 2017.
- [196] Sherry Turkle and Seymour Papert. “Epistemological pluralism: Styles and voices within the computer culture”. In: *Signs: Journal of women in culture and society* 16.1 (1990), pp. 128–157.
- [197] James Turrell. *Shallow Space Constructions*. 1968.
- [198] Nobuyuki Umetani, Danny M. Kaufman, Takeo Igarashi, and Eitan Grinspun. “Sensitive Couture for Interactive Garment Modeling and Editing”. In: *ACM SIGGRAPH 2011 Papers*. SIGGRAPH ’11. New York, NY, USA: ACM, 2011, 90:1–90:12. ISBN: 978-1-4503-0943-1. DOI: 10.1145/1964921.1964985.

- [199] John Underkoffler and Hiroshi Ishii. “Urp: a luminous-tangible workbench for urban planning and design”. In: *Proceedings of the SIGCHI conference on Human Factors in Computing Systems*. ACM. 1999, pp. 386–393.
- [200] Anna Vallgård and Ylva Fernaeus. “Interaction Design As a Bricolage Practice”. In: *Proceedings of the Ninth International Conference on Tangible, Embedded, and Embodied Interaction*. TEI ’15. New York, NY, USA: ACM, 2015, pp. 173–180. ISBN: 978-1-4503-3305-4. DOI: 10.1145/2677199.2680594.
- [201] Anna Vallgård and Johan Redström. “Computational Composites”. In: *Proceedings of the SIGCHI Conference on Human Factors in Computing Systems*. CHI ’07. New York, NY, USA: ACM, 2007, pp. 513–522. ISBN: 978-1-59593-593-9. DOI: 10.1145/1240624.1240706.
- [202] Lev Semenovich Vygotsky. *Mind in society: The development of higher psychological processes*. Harvard university press, 1980.
- [203] Julia Walter-Herrmann and Corinne Büching. *FabLab: Of machines, makers and inventors*. transcript Verlag, 2014.
- [204] Guanyun Wang, Youngwook Do, Tingyu Cheng, Humphrey Yang, Ye Tao, Jianzhe Gu, Byoungkwon An, and Lining Yao. “Demonstrating Printed Paper Actuator: A Low-cost Reversible Actuation and Sensing Method for Shape Changing Interfaces”. In: *Extended Abstracts of the 2018 CHI Conference on Human Factors in Computing Systems*. CHI EA ’18. Montreal QC, Canada: ACM, 2018, D105:1–D105:4. ISBN: 978-1-4503-5621-3. DOI: 10.1145/3170427.3186531.
- [205] Christian Weichel, Jason Alexander, Abhijit Karnik, and Hans Gellersen. “SPATA: Spatio-tangible tools for fabrication-aware design”. In: *Proceedings of the Ninth International Conference on Tangible, Embedded, and Embodied Interaction*. ACM. 2015, pp. 189–196.
- [206] Christian Weichel, John Hardy, Jason Alexander, and Hans Gellersen. “ReForm: integrating physical and digital design through bidirectional fabrication”. In: *Proceedings of the 28th Annual ACM Symposium on User Interface Software & Technology*. ACM. 2015, pp. 93–102.
- [207] Mark Weiser. “The Computer for the 21 st Century”. In: *Scientific american* 265.3 (1991), pp. 94–105.
- [208] Mikael Wiberg. “Methodology for Materiality: Interaction Design Research Through a Material Lens”. In: *Personal Ubiquitous Comput.* 18.3 (Mar. 2014), pp. 625–636. DOI: 10.1007/s00779-013-0686-7.
- [209] Karl D.D. Willis, Cheng Xu, Kuan-Ju Wu, Golan Levin, and Mark D. Gross. “Interactive Fabrication: New Interfaces for Digital Fabrication”. In: *Proc. of TEI*. TEI ’11. ACM, 2011, pp. 69–72. ISBN: 978-1-4503-0478-8. DOI: 10.1145/1935701.1935716.

- [210] Karl Willis, Eric Brockmeyer, Scott Hudson, and Ivan Poupyrev. “Printed Optics: 3D Printing of Embedded Optical Elements for Interactive Devices”. In: *Proceedings of the 25th Annual ACM Symposium on User Interface Software and Technology*. UIST ’12. New York, NY, USA: ACM, 2012, pp. 589–598. ISBN: 978-1-4503-1580-7.
- [211] Robert W Winter. “The arts and crafts as a social movement”. In: *Record of the Art Museum, Princeton University* 34.2 (1975), pp. 36–40.
- [212] Nicola Wood. “Designing for Tacit Learning: an investigation of design strategies for multi-media supported learning in the crafts”. en. In: *European Academy of Design Conference* (2003), p. 17.
- [213] Nicola Wood. “Unknown knowns; uncovering tacit knowledge for the design of interactive media”. In: *CUMULUS Conference: Pride and Pre-design: the Cultural Heritage and the Science of Design* (2005). URL: <http://shura.shu.ac.uk/963/1/fulltext.pdf>.
- [214] Nicola Wood. “Transmitting craft knowledge : designing interactive media to support tacit skills learning”. PhD thesis. Sheffield Hallam University, 2006. URL: <http://shura.shu.ac.uk/3202/2/10701209.pdf>.
- [215] Nicola Wood, Chris Rust, and Grace Horne. “A Tacit Understanding: The Designer’s Role in Capturing and Passing on the Skilled Knowledge of Master Craftsmen”. en. In: (2009), p. 14.
- [216] Jun Xie, Aaron Hertzmann, Wilmot Li, and Holger Winnemöller. “PortraitSketch: Face Sketching Assistance for Novices”. In: *Proceedings of the 27th Annual ACM Symposium on User Interface Software and Technology*. UIST ’14. New York, NY, USA: ACM, 2014, pp. 407–417. ISBN: 978-1-4503-3069-5. DOI: 10.1145/2642918.2647399.
- [217] Kumi Yamashita. *Fragments*. en-US. 2009. URL: <http://kumi Yamashita.com/light-shadow>.
- [218] Mayu M. Yamashita, Junichi Yamaoka, and Yasuaki Kakehi. “Enchanted Scissors: A Scissor Interface for Support in Cutting and Interactive Fabrication”. In: *ACM SIGGRAPH 2013 Posters*. SIGGRAPH ’13. New York, NY, USA: ACM, 2013, 33:1–33:1. ISBN: 978-1-4503-2342-0. DOI: 10.1145/2503385.2503422.
- [219] Lining Yao, Jifei Ou, Chin-Yi Cheng, Helene Steiner, Wen Wang, Guanyun Wang, and Hiroshi Ishii. “bioLogic: Natto Cells As Nanoactuators for Shape Changing Interfaces”. In: *Proceedings of the 33rd Annual ACM Conference on Human Factors in Computing Systems*. CHI ’15. New York, NY, USA: ACM, 2015, pp. 1–10. ISBN: 978-1-4503-3145-6. DOI: 10.1145/2702123.2702611.
- [220] Tomoyuki Yokota, Peter Zalar, Martin Kaltenbrunner, Hiroaki Jinno, Naoji Matsuhisa, Hiroki Kitanosako, Yutaro Tachibana, Wakako Yukita, Mari Koizumi, and Takao Someya. “Ultraflexible organic photonic skin”. In: *Science Advances* 2.4 (2016). DOI: 10.1126/sciadv.1501856.

- [221] Qiang Zhou, Wenzheng Yang, Fengtao He, Razvan Stoian, Rongqing Hui, and Guanghua Cheng. “Femtosecond multi-beam interference lithography based on dynamic wavefront engineering”. en. In: *Optics Express* 21.8 (Apr. 2013), p. 9851. DOI: 10.1364/OE.21.009851.
- [222] John Zimmerman, Jodi Forlizzi, and Shelley Evenson. “Research through design as a method for interaction design research in HCI”. In: *Proceedings of the SIGCHI conference on Human factors in computing systems*. ACM, 2007, pp. 493–502. URL: <http://dl.acm.org/citation.cfm?id=1240704>.
- [223] Amit Zoran and Leah Buechley. “Hybrid Reassemblage: An Exploration of Craft, Digital Fabrication and Artifact Uniqueness”. In: *Leonardo* 46.1 (Feb. 2013), pp. 4–10. DOI: 10.1162/LEON_a_00477.
- [224] Amit Zoran and Leah Buechley. “Hybrid Reassemblage: An Exploration of Craft, Digital Fabrication and Artifact Uniqueness”. In: *Leonardo* 46.1 (Feb. 2013), pp. 4–10. DOI: 10.1162/LEON_a_00477.
- [225] Amit Zoran and Joseph Paradiso. “The freed: a handheld digital milling device for craft and fabrication”. In: *Adjunct proceedings of the 25th annual ACM symposium on User interface software and technology*. ACM, 2012, pp. 3–4. URL: <http://dl.acm.org/citation.cfm?id=2380299>.
- [226] Amit Zoran, Roy Shilkrot, Suranga Nanyakkara, and Joseph Paradiso. “The Hybrid Artisans: A Case Study in Smart Tools”. In: *ACM Trans. Comput.-Hum. Interact.* 21.3 (June 2014), 15:1–15:29. DOI: 10.1145/2617570.

Appendix A

Open-source Repositories

The computational design architecture employed in this work and referenced in Chapter 9 has been made publicly available on GitHub. Links to respective repositories are listed below:

- **SVGSync** An SVG-based computational design engine.
<https://github.com/Hybrid-Ecologies/svg-sync>
- **Illumination Aesthetics** A luminaire CAD tool.
<https://github.com/Hybrid-Ecologies/illumination-aesthetics>
- **Phosphenes** A resistive heater CAD tool.
<https://github.com/Hybrid-Ecologies/phosphenes>
- **ProxyPrint** A wire-wrapping CAD tool and armature proxy generator.
<https://github.com/Hybrid-Ecologies/proxyprint>
- **Bag o' Jigs** A collection of wire-wrapping shaping proxies.
<https://www.thingiverse.com/thing:3691845>
- **Arduino Probe** A streaming API for Arduino devices.
<https://github.com/Hybrid-Ecologies/arduino-probe>

Appendix B

Wire Wrapping Workshop Study

The following appendix contains the questionnaires, tutorial checklist, and interview guides used in the wire-wrapping workshop study presented in Chapter 5.

B.1 Demographics Questionnaire

- Age
- Gender

These questions were placed on a 10 pt. scale, semantically anchored with "No experience" (0), "Expert" (10). Rate your experience with:

- Physical art and/or crafts (e.g., painting, knitting, glass-blowing, pottery)
- Metalworking (e.g., wire wrapping, welding)
- Digital design tools

B.2 Warmup Tutorial Protocol

The tutorial was slotted for as a 5-minute introduction to materials and warm-up task. The following standard tools were presented: flat nose plier, nylon plier, flush cutter, barrel-nose plier. The following techniques were then demonstrated to participants, making the following points:

- **Cutting wire** Cut with the flush cutter to have a flush end. This prevents sharp points.
- **Straightening wire** Straightening wire is good for hardening the wire to keep its form. Operation: Cut a piece of wire from the spool. Hold in dominant hand with flat-nose pliers; run nylon pliers across the length on both dimensions. Compare the feeling of non-work hardened to the hardened wire.

- **Bending** Hold wire close to the portion that is being bent. This technique provides more control.
- **Gauge selection** Gauges run inversely. Gauges appropriate for forms (14-20 AWG). Gauges good for connections and weaving (22-28 AWG).

B.3 Think Aloud Brief

The following brief is used to introduce participants to the think-aloud protocol.

In this study, we are interested in what you say to yourself as you perform some tasks that we give you. In order to do this, we will ask you to think aloud as you work on the tasks. What I mean by think aloud is that I want you to say out loud everything that you say to yourself silently. Just act as if you are alone in the room speaking to yourself. If you are silent for any length of time, I will remind you to keep thinking aloud. Do you understand what I want you to do?

We used the following criteria to define critical events to log:

- Accidents, mistakes, and slips
- Deviations in design intention
- Learning moments

B.4 Post-Task Questionnaire

After each task, the following questionnaire was administered. Questions were anchored with semantic labels: Strongly Disagree (1), Disagree(2), Neutral(3), Agree (4), and Strongly Agree (5).

- The *PROXY* was usable.
- I made many errors using this *PROXY*.
- I was aware of the *PROXY* when I was working with it.
- I had control of the wire using the *PROXY*.
- I felt I had creative freedom with the *PROXY*.
- I am happy with the final design.
- Given *PROXY*, I feel capable of making my own customized designs.

B.5 Post-study Protocol

At the conclusion of the study, the following questionnaire was administered, followed by a short interview with participants.

Post-Study Questionnaire

- Rank the designs based on your perceived best (Schematic, Jig, Stencil).
- Rank the designs based on speed (Schematic, Jig, Stencil).

Interview Guide

The following questions were used to guide a short interview with participants.

- When might you use one jig over another? Can you think of situations? What types of designs?
- How would you modify the jigs that you used today?
- I'd like you to think about your experience working with the wire. Did you learn anything about working with wire? What advice might you give to a person learning to work with wire?
- Did you feel like you contributed to the design? What might you have done differently design-wise? Given your knowledge of working with wire, what might you have done differently in creating the digital design?
- Did you want to do something different that the tools did not allow you to do? Was there a part of the process that was natural? Unnatural? Surprising? Could you describe that process?
- Did you feel you had control of the material? Did you feel you had creative freedom?
- What did you have trouble with? What was the most enjoyable?
- Which task did you feel you had the least control? Most control? Least vulnerable to error? Most vulnerable to error?

Appendix C

Luminaire Study Questionnaires

The following appendix contains the questionnaires and interview guides used in the luminaire design workshop study presented in Chapter 6.

C.1 Pre-study Interview Guide

Experience with LEDs in the Wild

Share any experiences you have with LEDs in commercial products. Where and how do you typically see LEDs used? Describe a time you saw an LED in the workplace or at home.

LED usage in projects

Tells us about a project where you used LEDs. Where were the LEDs located, how did they behave. Did they make it to the final prototype of a project? Did you manipulate them digitally or in an analog fashion? What do you wish you could have done w/ LEDs. How did you decide which LEDs to use? If you did your project again, what would you change?

LED treatments

Describe any special treatments you have added to LEDs. Special treatments refer to adding any diffusers or anything that would alter the light emitted by the LED. For instance: a cut ping-pong ball, a 3d-printed case, fiber-optics, etc.

C.2 Workshop

The following brief is used to introduce participants to the think-aloud protocol.

In this study, we are interested in what you say to yourself as you perform some tasks that we give you. In order to do this, we will ask you to think aloud as you work on the

tasks. What I mean by think aloud is that I want you to say out loud everything that you say to yourself silently. Just act as if you are alone in the room speaking to yourself. If you are silent for any length of time, I will remind you to keep thinking aloud. Do you understand what I want you to do?

We used the following criteria to define critical events to log:

- Accidents, mistakes, and slips
- Deviations in design intention
- Learning moments

The following questions were used to probe the creative process.

- Could you describe your design?
- Why did you choose that design element?
- Could you walk me through your process?
- Was this your original idea?
- Do you think the tool influenced your design? How? Which part?
- If you had unlimited time what else would you have done?
- Did the design tool/workflow work for you?
- Do you see this fitting into your design practice?

C.3 Followup Questionnaire

Likert Scale Questions

Questions were anchored with semantic labels: Strongly Disagree (1), Disagree(2), Neutral(3), Agree (4), and Strongly Agree (5).

- The web application "design tool" was usable.
- The design tool was confusing.
- The design tool was surprising.
- I felt intrigued by what was possible when using the design tool.
- I felt I had creative freedom while using the design tool.

- I am happy with the way the design tool helped me to design.
- I'm happy with how my final design came out.
- I would be more likely to use LEDs in my projects using this design tool.
- I don't see much of a difference in the way the LEDs look.

Appendix D

Resistive Heater Workshop Study

The following appendix contains the questionnaires, tutorial checklist, and interview guides used in the resistive heater workshop study presented in Chapter 7.

Demographics Questionnaire

Please answer the following questions:

- Age
- Gender
- Profession
- Educational Background

Material Practice Questionnaire

The following questions are formatted as 5-pt Likert scale questions anchored with semantic labels: N/A (0), Novice (1), Intermediate(3), and Expert (5).

Rate your expertise with the following practices (shuffled):

- Graphite (Drawing)
- Oil Paints
- Acrylic Paints
- Watercolors
- Printmaking
- Metalworking

- Glassworking
- Woodworking
- Clay and Ceramics
- Fabrics
- Needlework
- Photography
- Digital Electronics (X)
- Analog Electronics (X)
- Programming (X)

The following questions are formatted as 5-pt Likert scale questions anchored with semantic labels: Strongly Disagree (1), Disagree(2), Neutral(3), Agree (4), and Strongly Agree (5).

I feel comfortable with the following concepts (shuffled):

- Kirchoff's Current Law (KCL)
- Kirchoff's Voltage Law (KVL)
- Resistors in series
- Resistors in parallel
- Voltage drops
- Current dividers
- Voltage dividers
- Resistive heaters
- Resistivity of different materials

I feel capable of carrying out (shuffled):

- Circuit design of resistors
- Circuit analysis of resistors
- Physical debugging of resistor circuits

I feel comfortable using the following tools (shuffled):

- Voltmeter (Voltage)
- Anemometer (Current)
- Ohmmeter (Resistance)
- Continuity Checker
- Power supplies
- Breadboards
- Wire
- Oscilloscope

I feel comfortable with the following concepts (shuffled):

- Conduction
- Convection
- Radiation
- Conservation of Energy

D.1 Tutorial Checklist

The following concepts were reviewed before working with the design tool.

- Conductive material
- Power supply – could be battery
- Running "current" is connecting voltage to ground. Measured in amps (I) and I is used to represent it.
- "Resistance" - Water crashing against rocks – converted to heat. Measured in Ω .
- Amount of heat generated will be based on the rate of water crashing against the rocks. The power equation is $I^2 * R$.
- A power supply can supply a finite amount of power (36 watts).

A walkthrough of the design tool consisted of the following elements:

- The tool allows us to design heaters which are printed using a conventional inkjet printer.

- Mental model – a range with different burners at different heat settings.
- The tool will allow you to specify these heat regions and guide you through how to connect a power source.
- Heat regions need to be connected to a power source.
- Every material has a different amount of resistance (length and width). The tool has done the calculations, but needs you to specify the target rise time and orientation of the serpentine pattern.
- Four Modes – Power (for drawing regions and setting parameters), Circuit (for making traces), Simulation (for visualizing how the heater will behave), and Print (for seeing the final output of the tool).

D.2 Post-study Questionnaire

The following questionnaire was administered at the conclusion of the design task. These questions were anchored with semantic labels: Strongly Disagree (1), Disagree(2), Neutral(3), Agree (4), and Strongly Agree (5).

- I feel comfortable working with joule heaters.
- The process of creating joule heaters was intuitive.
- I have an understanding of how thermo-materials and heat interact with each other.
- I have an understanding of how joule heaters work.
- The electronics were approachable.

The following questions had an N/A option if the participant did not interact with the resource or interaction **X** was an important resource or interaction:

- Cold Plate
- Network camera
- The circuit view within the design tool.
- The simulation view within the design tool.
- The print view within the design tool.
- Automatic generation of the heaters
- The brushing interaction in the circuit view.

- Liquid crystal paper for testing the heater.
- Multimeter

Appendix E

Glossary

Jump to:

A | B | C | D | E | F | G | H | I | J | L | M | N | O | P | R | S | T | U | W | Z

A

aesthetics The philosophical analysis of the beliefs, concepts, and theories implicit in the creation, experience, interpretation, or critique of art (qtd. in [49]). A minimalist aesthetic, for example, arose from a belief in clarity and intentionality, influencing both art production and social forms towards removing artifacts or interactions that detract from a central message. 3, 6

affordance Qualities of an object that communicate possible ways it can be used. For example, a pen form-factor communicates the available action of a pen (e.g. holdability, writability, pointability). 14, 30, 45, 150

agency The capacity to coordinate learning skills, motivation, and emotions to reach a goal. 3, 152

armature Armatures are a type of proxy that have the distinct quality of being passive, introducing structural changes in the environment. These changes in the environment facilitate a material encounter by acting as a support structure to encourage creative engagement and exploration. 8, 39, 44, 45, 49, 74, 75, 145, 152

Arts and Crafts movement An anti-industrial economic and social reform aimed at recapturing hand-crafted practices. 3

aura The quality of originality or authenticity of an object that has not been reproduced. 14, 34, 150, 156, 167

B

bricolage A type of forming that relies on the availability of craft materials in the environment, typically characterized by improvisation. An *in situ* “structuring of events through material

assemblage and modification” restricted to the “treasury” of tools, materials, and skills that are available at hand [200] . 14, 16, 17, 153, 154, 156

C

CAD-CAM pipeline A process that for forming an artifact that separates design and machining concerns and emulates product manufacturing relationships. As a commonly agreed upon process workflow, it allows users the ability for a common design file to be used by several different types of machines. vi, 4, 24, 27, 44, 46, 74, 146, 172

CNC machine A machine that can be controlled computationally. 4, 23, 45, 164, 208

code smell Surface-level characteristics of a program that are indicative of a deeper underlying problem that, if left unaddressed, could lead to more troublesome problems. For example, while hard coding variables gives immediate functionality, this action can lead to extra work in the future to refactor code or unexpected programming bugs. 171

codebending A programming practice that involves modifying existing programs and re-adapting their function as a standalone applications to components of a larger system [16]. 15, 30, 40

Coiling Method A clay-forming technique that builds a 3D form by coiling a tube of clay around itself. Different layers are scored and applied a slip, or watered-down clay, acting as a glue and binding together the separate coils. 2

Community of Practice Communities formed by people who engage in a process of collective learning in a shared domain; communities develop a shared repertoire of resources, form social support structures, and define the criteria for advancing the practice. 3, 5, 6, 16, 18

compositing A design strategy that “binds” two or more materials together to form a metamaterial that exhibits behaviors or properties of its components as well as behaviors and properties unique to the composite. . 7, 8, 76, 112, 113, 144, 145, 146, 148, 154, 209

computational thinking A set of problem-solving skills for “thinking like a computer,” restructuring solutions into forms that could be interpreted by a computer (e.g., as inputs and output, as an API, as a neural network formulation). 26, 32, 208

computational composite A concept used to articulate how a computer or computation can act as a material in design. A composite is formed when a physical material is bound to computation; the physical material acts as a proxy, conveying the behaviors of computation. 7, 36, 41, 42, 141, 143, 154, 209

Computer-Aided Manufacturing A fabrication stage where digital representation from the design phase is converted into a machine-interpretable geometry. A tool path is generated that satisfies the target geometry based on the specific configuration of materials and machining tools, and the compiled set of instructions is then communicated to a computer numerical control tool.

- Computer-Aided Design** A design phase where a digital representation of an object is created using a modeling tool, typically exported as a watertight mesh (STL) or as vector graphics (SVG). 4, 23, 74, 75, 146
- Constructive Solid Geometry** A solid modeling technique that allows a modeler to create complex object using boolean operations (unite, subtract, intersect) to combine simpler objects. 4, 26
- conversation with materials** (also *reflective conversation with materials*) A design situation where a practitioner constructs objects and relations using the active sensory feedback of materials [173]. See also morphogenetic (or form-generating) making . 13, 16, 38, 74, 146, 211
- conversational profile** (also *conversational profile of a material*) acting like a persona, that informs how light can more readily communicate to a practitioner during the act of making and defines a target *material API*. 7, 13, 26, 27, 45, 76, 78, 112, 146, 156
- cool medium** A cool medium refers to low-definition media that engages the senses less completely and requires more participation and interaction from the audience. Examples include the phone and comic books. See also hot media. x, 35, 149, 156, 209
- craft** A method of making in which there is a direct encounter with the material, such that that the material has influence on the forms that are being generated during the act of making (i.e. craft-based practice) . 13
- craft material** A material that has an active role in influencing the final artifact or experience during the act of making. 13, 157
- Crafting Proxy** A material, tool, or machine that is part of a larger network of a creative environment, which mediates interactions with a material facilitating interpretation, manipulation, and evaluation of emerging or potential forms as a part of a creative process. 1, 7, 8, 9, 10, 27, 38, 43, 44, 45, 74, 75, 76, 112, 113, 114, 121, 144, 145, 146, 148, 150, 151, 152, 153, 154, 156, 166, 167, 172
- craftsmanship** The desire to do a job well for its own sake [175]. 20, 75, 152
- creativity** (also *social creativity*) “ideas and discoveries in everyday work practice that are novel with respect to an individual human mind or social community” (qtd. in [48]). 5, 16
- Creativity Support Tools (CSTs)** A tool that runs on one or more digital system, encompasses one or more creativity-focused features, and is employed to positively influence users of varying expertise in one or more distinct phases of creativity [52] . 28, 39
- CSI** Creativity Support Index. 144

D

design tool Tools that are used to influence the production, expression, and perception of design ideas. 28

digital atomicity The quality of a digital material where an operation appears to occur at a single instant between its invocation and its response. This term is coincidentally used to refer to database transactions that "are guaranteed to either completely occur, or have no effects". . 85

digital material A material that has a virtual representation and is manipulated through digital processes. Examples include the array, matrix, data, or digital signal. 12

digital fabrication A practice that engages with Computer Numerical Control (CNC) machines with workflows that follow a Computer-Aided Design (CAD) preceded by a Computer-Aided Manufacturing (CAM) process. 1

E

embodied interaction The enactment of knowledge and concepts through the activity of our bodies [114]. 152

embodied virtuality A vision of an environment where technology is embedded into everyday objects, spaces, and the human body, yet recedes into the background, seamlessly interconnected and gracefully integrated with humans and human activity [207] . 3

epistemology The way an individual values, understands, acquires, and constructs knowledge; a way of thinking and knowing. Examples include computational thinking, design thinking, or thinking through doing. 7, 12

ethnocomputing The study of interactions between computing and culture. 33, 151

F

Fused Deposition Modeling (FDM) (also *Fused Filament Fabrication (FFF)*)An additive fabrication technique that involves using a movable extruder to deposit material that self hardens over time, fusing from contact with previously extruded elements. Layer by layer, this buildup of material accumulates to form a 3D geometry. v, 2, 22

G

g-code The *de facto* machine language commonly used to control CNC machines. 24

GIMP GNU Image Manipulation Program. 158

H

HCI Human-Computer Interaction. 3, 9, 28, 34, 36, 39, 113

hot media A hot medium refers to high-definition media that engages one or more senses completely, requiring little interaction from the audience. Examples include radio (complete audio), film (complete audio/visual), and virtual reality. See also cool media. x, 35, 149, 150, 207

hybrid material A material that can be formed through digital and physical processes. 12, 21

hybrid making A material that is formed through occurs in physical sites (e.g., machining, hand production) and digital sites (e.g., CAD, physical computing) of making. 10, 28

hybrid aesthetics The beliefs, concepts, and theories implicit in the creation, experience, interpretation, or critique of artifacts that are made from digital or physical materials or via physical or digital processes. 3, 173

hylomorphic making (from the Greek hyle, “matter”; morphe, “form”) A type of making where a practitioner creates a form (a mental image, a schematic, a sketch) and shapes a material until that material matches the form. Hylomorphic comes from the greek for matter-forming. 19, 24

hysteresis A physical phenomenon where a physical property lags behind changes in the effect; for instance, turning off a heater will not “turn off” the effect of the heater; heat will dissipate slowly and affect future outputs of the heater.. 86, 113, 134

I

I²C Inter-integrated Circuit Protocol. 85, 162

immaterial Physical, virtual, or conceptual elements that during the creative process cannot be formed. Immaterials have properties of lacking tangibility as well as decomposability. As an example, although electricity is a physical phenomenon, the presence of electricity in electronics is invisible without transducers that convert this energy into light, heat, or motion. vi, 7, 8, 12, 21, 26, 41, 42, 75, 76, 113, 145, 148, 157, 166, 172

immaterial composite A variant of a computational composite, the applies the compositing design strategy to allow immaterials to be both perceivable and tangible. 143

Industrial Revolution A transition from hand production methods towards the development of machine tools and the rise of the mechanized factory system. 3

inspirationalist creativity A view of creativity where breaking away from familiar structures elicits creative solutions. Examples include taking nature walks, interpreting inkblots, viewing random photos, or defamiliarizing objects. 39

intermediate-level knowledge A type of knowledge that sits between abstract theory and a concrete real-world artifact. Examples include guidelines, annotated portfolios, patterns, and heuristics. 7, 9, 38, 40, 42, 45, 75, 145

J

JSON JavaScript Object Notation. 159

L

law of the instrument A cognitive bias introduced by a familiar tool like a hammer; wielding a hammer, many creative solutions are resolved by “treating everything as if it were a nail” [122]. 13

LED Light-Emitting Diode. 76, 149

legitimate peripheral participation A type of apprenticeship model in which newcomers enter the community from the periphery and move toward the center as they become more knowledgeable [107, 48]. 16, 19

lens A lens is a type of proxy that remaps or presents stimuli in ways that are more perceivable and salient. Examples include microscopy or x-ray imaging. 9, 113, 145, 154

luminaire Luminaires are devices that produce, control, and distribute light. The Illuminating Engineering Society (IES) [84] defines luminaires as consisting of: one or more lamps or LEDs, optical devices designed to distribute light, sockets for supplying electric power, and the mechanical components required to support or attach the housing. 9, 76, 78

M

maker-bias Bias introduced into a tool, especially a computational tool, that forces a practitioner into the way of thinking of the maker. Examples include digital camera interfaces promoting a certain type of picture taking. 147, 149, 150

Maker movement (2005-?) A social movement aimed at democratizing access to STEM fields that emphasizes learning through doing in a social environment. 1, 7, 173

makerspace A colocated community of practice where practitioners gather to make, typically with digital fabrication tools, while sharing ideas, equipment, and knowledge. 1

master-apprentice model A type of training where an apprentice is placed under the watch of an experienced practitioner. In this model, a master demonstrates the skill, the apprentice attempts to imitate the actions, and the master corrects any mistakes. 10, 16, 18, 26, 211

material The physical, virtual, or conceptual elements that can be formed to make up an artifact or experience. This definition of material is referential— a bell may be recognized as composed of a bronze metal material, just as a bell tower may be recognized as composed of bell materials, just as the sound bells produce may be recognized as composed of different frequency materials. 13, 26

- material parallel** Behaviors, skills, and techniques that can be applied from one material to another. 169
- material epistemology** A way of thinking characteristic of material practitioners that involve materials having an active influence on the creative process. Knowledge is produced from material encounters, is applied through morphogenetic workflows, and is transferred through the master-apprentice model. See Table 2.3. 21, 27, 43, 45, 76, 144, 154, 156, 166, 167
- material API** The material application programming interface. The API is a material's set of allowable inputs (e.g., paper can be cut, folded, and scored) and the corresponding material manipulation space (e.g., the forms of origami). 9, 77, 112, 147, 154, 167
- material practitioner** Individuals that value, understand, acquire, and construct knowledge from their interactions with materials. 5, 15
- material practice** Refers to engaging in the act of working with materials using a specific set of skills, methods of reflection, and the potential to achieve mastery. 3, 145
- material encounter** The experiential creation or refinement of mental models from interactions with a material. vi, 4, 7, 15, 16, 17, 26, 27, 44, 46, 47, 75, 110, 112, 151, 152, 167, 171, 211
- media props** The unique characteristics of a particular medium used to influence and shape a message (e.g., a tune or melody in an NPR podcast between dialogues creates a feeling of place and narrative; bodies on a stage acting out that same dialogue creates a feeling of presence and liveness.). 35
- mediator** The act of transforming one representation into another where the translation rules are defined by the maker of the mediator. 8, 76, 78, 112, 113, 145, 148, 154
- medium specificity** The medium-specificity thesis states “each art form should pursue those effect that, in virtue of its medium it alone — i.e., of all the arts — can achieve.” which is often construed to mean “each art form should pursue ends that, in virtue of its medium, it achieves most effectively or best of all those effects at its disposal” [27]. 146
- mental model** An internal representation of a concept or real-world artifact that guides a person's thought process which influences behaviors and actions. As an example, the mental model of an orange, of its shape, composition, and juicing process, can be extended to lemons or other similar objects. 4, 15, 26
- modeling analogy** A method of representing the phenomena of one world, the target system, through another analagous, more understandable system. 148
- morphogenetic making** A type of making where a practitioner engages in wayfaring, where encounters with materials influence decisions and actions of where to take the design, evolving the form over time. Morphogenetic refers to form-generating. See also: conversation with materials . 16, 19, 20, 26, 74, 75, 142, 207, 211

N

New Media New Media refers to media that complicates traditional notions of a medium (e.g., Who is the composer of a piece of electronic music? [119]). 6, 34, 35, 40

O

object-bias The bias of viewing materials as static object as opposed to dynamic (e.g., leather gaining a patina from use). 19

ordering capacity the quality of a material, tool, or environment to influence creative action. 13

P

PCB Printed Circuit Board. viii, 86, 91, 92, 93, 100, 143, 162, 167

persona A human-centered design method that constructs a fictitious description of a user group to help designers “understand, describe, focus and clarify user’s goals and behavior patterns” [28]. 8, 12

personal fabrication A vision of digital fabrication scaling to hundreds of million of users, democratizing the creation of artifacts to a range of diverse disciplines. 3

PLA Polylactic Acid Filament. 142

R

reflective practice A process in which one reflects on actions, not dependent on established theory or technique, but constructs a new theory of the unique situation. Reflections include what motivated or influenced the course of action, how the problem has been framed, and the role within a larger sociocultural or institutional context. 20

repertoire A collection of examples, images, understandings, or actions built over time by a practitioner and applied to make sense of new situations [172]. 6, 16, 17, 18, 26, 112

Research through Design (RtD) A research methodology where the act of designing artifacts or prototypes (whether it be an object, system, or tool) is used to reflect and engage with theories, technologies, and models from various disciplines and operationalize how they can be used in industry and design practitioners [222]. 8, 38, 42, 145

resiliency the capacity to recover from difficulties. 3

ritual A repetitive yet mindful action that does not introduce a large cognitive load or require acute attention. 75, 152, 156, 167

S

- self-efficacy** A person's sense of being able to deal effectively with a particular task. 3
- sense ratios** A characterization of mediums based on the different combinations and proportions of human perception each medium elicits. 35
- simulacrum** An unsatisfactory imitation or substitution. It can also refer to an intentional distortion which bears no relation to reality. 4, 39, 149
- situationalist creativity** A view of creativity that acknowledges social motivators such as rewards, competition, recognition, rejection, and ridicule that drive and hinder creative work. 39
- smart material** A material that is intelligent or responsive and can be significantly controlled by external stimuli. 12, 21, 36
- SOE** Secondary Optic Element. 9, 76
- spatiotemporal medium** A medium that has duration and location as a dimension that unfolds to the viewer over time and across space. 9, 113, 147, 154
- SPI** Serial Peripheral Interface. 85
- STEAM** Science, Technology, Engineering, Art, and Math. 6
- STEM** Science, Technology, Engineering, and Math. 1, 5, 210
- STL** Stereolithography. 23, 24
- strong concept** Strong concepts are design elements abstracted beyond particular instances which have the potential to be appropriated by designers and researchers to extend their repertoires and enable new particular instantiations [80]. . 166
- structuralist creativity** A view of creativity where creativity is part of an orderly method. Examples include combinatorial generation, structured brainstorming, or design thinking. 7, 39
- SVG** Scalable Vector Graphic. v, 10, 23, 149, 158, 159, 164
- T**
- tacit knowledge** A type of knowledge that is difficult to convey through words. It is a relationship between the *proximal*, referring to sensations and perceptions of the human body, in response to the *distal*, or the object in focus [152]. 16, 17, 74
- The Medium is the Message** A concept that the medium has a strong influence on how content is interpreted. 35

Thermoreactive Composite A class of objects consisting of an assemblage of heaters, substrates, and thermoreactive materials. The thermoreactive material acts as a proxy, exposing the structures, forms, and behaviors to practitioners. x, 113, 117, 141, 142, 144

thick practice Allowing for the continuity of practice and supporting skills that have been acquired over time by using common physical interfaces as opposed to digitally mediating them [103]. 4, 26

thinking through doing An epistemological style, also known as *reflection-in-action*, where knowledge is generated from external actions that test, move, and probe stimuli that offer feedback to internal mental models. 15, 16, 208

TLC Thermochromic Liquid Crystal. ix, x, 124, 142, 149, 150

TUI Tangible User Interface. 36

U

UART Universal Asynchronous Receiver/Transmitter. 159

W

wayfaring A type of forming that readily evolves the target design based off of interactions with materials. Ingold [85] describes this process as an "intuition of action". 7, 16, 20, 26, 75, 142

WebSocket A two-way communications protocol that operates over a single TCP connection and allows for event-driven communication between devices. 121, 159, 164

work-hardening The strengthening of metal as a result of dislocation movements and dislocation generation within the crystal structure of the material. 74

workmanship of risk The quality of an artifact in danger or uncertainty during the making process [155]. 19, 75, 152, 156

Z

zones of proximal development The difference between what a learner can do without help and what they can achieve with guidance from an instructor or peers [202]. 16, 18, 75