

# Lawrence Berkeley National Laboratory

## Recent Work

### Title

PROCEEDINGS OF THE LIGHTING-ELECTROMAGNETIC COMPATIBILITY CONFERENCE

### Permalink

<https://escholarship.org/uc/item/6355093t>

### Authors

Verderber, R.R.  
Berman, S.M.

### Publication Date

1982-09-01



# Lawrence Berkeley Laboratory

UNIVERSITY OF CALIFORNIA

RECEIVED  
LAWRENCE  
BERKELEY LABORATORY

## ENERGY & ENVIRONMENT DIVISION

FEB 9 1983

LIBRARY AND  
DOCUMENTS SECTION

Conference held at the Lawrence Berkeley Laboratory,  
Berkeley, CA, March 18-19, 1982

PROCEEDINGS OF THE LIGHTING-ELECTROMAGNETIC  
COMPATIBILITY CONFERENCE

September 1982

### TWO-WEEK LOAN COPY

*This is a Library Circulating Copy  
which may be borrowed for two weeks.  
For a personal retention copy, call  
Tech. Info. Division, Ext. 6782.*

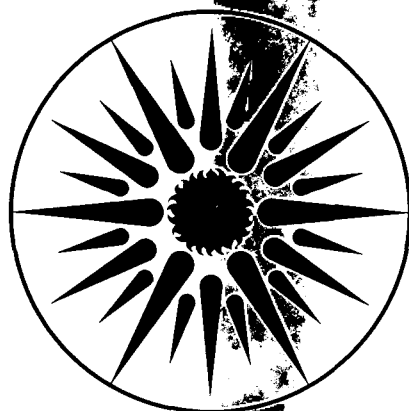

ENERGY  
AND ENVIRONMENT  
DIVISION

LBL-15199  
e2

## **DISCLAIMER**

This document was prepared as an account of work sponsored by the United States Government. While this document is believed to contain correct information, neither the United States Government nor any agency thereof, nor the Regents of the University of California, nor any of their employees, makes any warranty, express or implied, or assumes any legal responsibility for the accuracy, completeness, or usefulness of any information, apparatus, product, or process disclosed, or represents that its use would not infringe privately owned rights. Reference herein to any specific commercial product, process, or service by its trade name, trademark, manufacturer, or otherwise, does not necessarily constitute or imply its endorsement, recommendation, or favoring by the United States Government or any agency thereof, or the Regents of the University of California. The views and opinions of authors expressed herein do not necessarily state or reflect those of the United States Government or any agency thereof or the Regents of the University of California.

LBL-15199  
EEB-L 82-09  
L-68

A Lighting-Electromagnetic Compatibility Conference was held at Lawrence Berkeley Laboratory, Berkeley CA, on March 18 and 19, 1982. This is a partial record of that conference.

PROCEEDINGS OF THE  
LIGHTING-ELECTROMAGNETIC COMPATIBILITY CONFERENCE

Editors: Rudolph R. Verderber  
and  
Samuel M. Berman

Lighting Systems Research  
Lawrence Berkeley Laboratory  
University of California  
Berkeley CA 94720

September 1982

This work was supported by the Assistant Secretary for Conservation and Renewable Energy, Office of Building Energy Research and Development, Building Equipment Division of the U.S. Department of Energy under Contract No. DE-AC03-76SF000098.

## Preface

On March 18 and 19, 1982, a conference was held at Lawrence Berkeley Laboratory to discuss and identify any existing or potential problems of electromagnetic disturbances caused by light sources and lighting systems. Concern over possible problems has arisen as new lighting systems are developed to operate at high frequencies. These systems include solid-state ballasts, powerline communication, electrodeless fluorescent lamps, and phase-control systems.

The conference drew more than eighty participants. It consisted of one day of invited presentations and one day of "breakout" sessions, which met informally to discuss and share information about selected topics. The results of each group discussion were presented to the entire conference by the session chairmen.

This proceedings reviews the activities of the Lighting-Electromagnetic Compatibility Conference. It includes several of the papers that were presented, a summary of each breakout session in the format chosen by the various chairmen, a summary of the conclusions, and an outline of the future effort the lighting community must make in this area.

## Acknowledgements

Principal support for the conference came from the U.S. Department of Energy, Office of Building Energy Research and Development, through its Buildings Equipment Division, John Ryan, Director and Robert Boettner, Program Manager. Additional support was provided by:

Institute of Electrical and Electronic Engineers  
The Industry Application Society  
Production and Application of Light Committee  
K.T. Risberg, Chairman

National Electronic Manufacturers Association  
Lamp Section  
Thomas J. Ryan, Section Staff Executive

Subcommittee of Electromagnetic Interference  
General Engineering Committee  
NEMA Lamp Section  
Edward Yandek, Chairman

David W. Taylor Naval Ship Research and Development Center  
Annapolis Laboratory Electrical Systems Division, T.J. Doyle

## TABLE OF CONTENTS

Conference Program .....	1
Conference Prologue .....	7
Samuel M. Berman	
Biological Effects of Radio-Frequency Radiation .....	9
Asher R. Sheppard	
Reduction of AM Radio Interference through Control of Radiated Electric Field .....	24
Victor D. Roberts	
Electrical System Waveform Distortion .....	35
James P. Goodman	
Conducted and Radiated Signatures of Fluorescent Lamp Systems in C&I Environments .....	53
Sina Javidi	
EMI Measurements of Lighting Systems .....	74
A. Authur, L. Leung, and R. Verderber	
Summaries of Breakout Sessions .....	97
Biological Effects	99
Commercial/Industrial Impacts	101
Residential Impacts	103
EM Measurements	105
EM Lighting Data Base	108
Regulations	109
EM Attenuation Techniques	110
Conference Conclusions .....	111
List of Participants .....	112

# **THE LIGHTING-ELECTROMAGNETIC COMPATIBILITY CONFERENCE**

**Lawrence Berkeley Laboratory  
Building 50 Auditorium  
Berkeley, California**

***March 18 and 19, 1982***

***Sponsors:***

**U.S. Department of Energy  
Lawrence Berkeley Laboratory  
Institute of Electrical and Electronics Engineers  
National Electrical Manufacturers Association  
David W. Taylor Naval Ship R&D Center**

# HOST:

## LAWRENCE BERKELEY LABORATORY

Lighting Systems Research

Samuel M. Berman, *Principal Investigator*

### *Lighting-Electromagnetic Compatibility Committee*

Robert Boettner (DOE)

Gilbert Reiling (NEMA)

Ken Risberg (IEEE)

Victor Roberts (GE)

Joseph Sherman (Navy R&D)

Rudolph Verderber (LBL), *Chairman*

### *LBL Staff and Associates*

Al Arthur

Pam Balch

Terry Benzschawel

(UC School of Optometry)

Sam Berman

Bob Clear

Jean Ferrari

Martin Greenberg

(UC School of Medicine)

Daniel Greenhouse

(UC School of Optometry)

Don Jewett, MD

(UC School of Medicine)

Leon Leung

Oliver Morse

Francis Rubinstein

Rai-ko Sun

Rudy Verderber

Ruth Williams

### *Hosts of Coffee Breaks*

Duro-Test Corporation

General Electric Company

GTE Sylvania

North American Philips Lighting Company, Inc.

Westinghouse Corporation



## INTRODUCTORY REMARKS

For the past several years the lighting industry has been responding to the national energy crisis by introducing lower-power and more energy-efficient lighting components and systems. Many of the more efficient lighting systems being developed and introduced will be improved by operating at high frequencies. These new systems will provide additional sources of conducted and radiated electromagnetic energy. Manufacturers, federal agencies, and end users are concerned that these new energy-efficient lighting systems be made compatible with both the safety of personnel and existing electronic systems. This concern has contributed to the delay in introducing these systems into the marketplace.

Lawrence Berkeley Laboratory's Lighting Systems Research group and industrial research laboratories active in this area wish to help resolve this uncertainty by convening a conference, attended primarily by members of the lighting community, to discuss and present the salient aspects of electromagnetic interference as it affects the compatibility of these high-frequency lighting systems. We hope that this gathering will provide guidance to catalyze an effective course of action that will help alleviate the industry's concern.

An ad hoc Lighting-Electromagnetic Compatibility committee has been assembled which is representative of the lighting community through the organizations sponsoring this conference. In order to encourage the exchange of ideas, the committee has formulated the format and topics for papers and "breakout" sessions for this two-day conference. The committee appreciates the interest you are showing through your participation and wishes to thank the invited speakers and session chairmen for their efforts to make this conference a success.

# PROGRAM

## INVITED PRESENTATIONS

Thursday, March 18, 1982

*(morning session)*

Chairman: Mr. George Clark, GTE Sylvania

- 9:00 *Welcome to the Conference*  
Dr. Samuel M. Berman, Principal Investigator, Lighting Systems Research  
Lawrence Berkeley Laboratory
- 9:15 *Electromagnetic Measurements – Radiated and Conducted*  
Mr. Chris Kendall, Principal Consultant  
Chris Kendall Consultants
- 9:45 *The FCC's Concern about RF Lighting Sources*  
Mr. L. Art Wall, Chief of RF Devices Branch  
Federal Communications Commission
- 10:15 *Coffee Break*
- 10:30 *Electrical System Wave Form Distortion*  
Mr. James Goodman, electrical engineer  
David W. Taylor Naval Ship R&D Center
- 11:00 *Energy Conservation in Navy Shipboard Lighting Systems*  
Mr. Steve McPherson, project engineer, Energy R&D Office  
Mr. Joseph Sherman, project engineer, Energy R&D Office  
David W. Taylor Naval Ship R&D Center
- 11:30 *Conducted and Radiated Signature of Fluorescent Lamp Systems*  
Mr. Sina Javidi, fluorescent design engineer  
Dr. Edward M. Yandek, Manager, Fluorescent Electronic Product Engineering  
Dr. Gilbert H. Reiling, Manager, Lamp Technology Program Development  
General Electric Company
- 12:00 *Lunch – LBL cafeteria*

*(afternoon session)*

Chairman: Dr. Gilbert H. Reiling, General Electric Company

- 1:30 *Biological Interactions with RF Electromagnetic Wave*  
Dr. Asher Sheppard, research physicist  
J. L. Pettis Veterans Administration Hospital
- 2:00 *EM Data Base of High-Frequency Lighting Systems*  
Mr. Allan A. Arthur, staff scientist  
Mr. Leon P. Leung, engineer  
Dr. Rudolph R. Verderber, staff scientist  
Lawrence Berkeley Laboratory
- 2:30 *Reduction of AM Radio Interference through Control of Radiated Electric Fields*  
Dr. Victor D. Roberts, Manager of Lighting Systems Program  
General Electric Company
- 3:00 *Coffee Break*
- 3:15 *EMI Reduction Techniques in Lighting Systems*  
Dr. Edward H. Stupp, Technical Program Leader  
Philips Laboratories (North American Philips Co., Inc.)
- 3:45 *EMC Requirements in the Consumer World*  
Mr. Harold A. Gauper, Jr., EMC engineer  
General Electric Company

Friday, March 19, 1982

Chairman: Mr. Edward W. Morton, Westinghouse Electric Corporation

*(morning session)*

9:00 *Meet at Building 50 Auditorium to form breakout sessions*

9:15 *Meet for assigned sessions at Building 50 Auditorium or at Building 50, Room 4205*

*EM Measurements*

Chairman: Mr. Joel Shurgan  
Duro-Test Company

*Commercial and Industrial Impacts*

Chairman: Mr. Bill Alling  
Luminoptics Corporation

*Regulations*

Chairman: Mr. L. Art Wall  
Federal Communications Commission

*Residential Impacts*

Chairman: Dr. Edward M. Yandek  
General Electric Company

*EM Lighting Data Base*

Chairman: Mr. Allan A. Arthur  
Lawrence Berkeley Laboratory

*EM Attenuation Techniques*

Chairman: Dr. Edward H. Stupp  
Philips Laboratories

*Biological Effects of EM Radiation*

Chairman: Dr. Samuel M. Berman  
Lawrence Berkeley Laboratory

10:00 *Coffee Break*

10:15 *Return to breakout sessions to prepare recommendations*

11:15 *Presentation of group reports by chairmen. (All participants convene in Building 50 Auditorium.)*

11:15 *EM Measurements*

11:30 *Regulations*

11:45 *Data Base*

12:00 *Lunch – LBL cafeteria*

*(afternoon session)*

1:15 *Commercial and Industrial Impacts*

1:30 *Residential Impacts*

1:45 *EM Attenuation Techniques*

2:00 *Biological Effects of EM Radiation*

2:15 *Open Discussion*

Correspondence: Bldg. 90, Room 3111

Telephone: (415) 486-5605

Lawrence Berkeley Laboratory, University of California, Berkeley, CA 94720

## CONFERENCE PROLOGUE

Samuel M. Berman  
Principal Investigator, Lighting Systems Research  
Lawrence Berkeley Laboratory  
University of California  
Berkeley, California

When energy operating costs are compared with the costs of lamps, fixtures, controls, and wiring, lighting expenditures are completely dominated by energy expenses, which are 80% of the total.

The dominant energy-using component for lighting -- the lamp -- has a much shorter lifespan than other lighting component or the building in which it is installed, increasing the opportunities to replace the less efficient with the more efficient.

With electrical energy prices rising rapidly, accelerated entry of energy-efficient lighting into the consumer market allows users and utilities more cost-effective options and assures the government that energy resources are being used in the most societally responsible manner.

In the 1980s electronics will become a much bigger part of the lighting package because control systems will provide the necessary flexibility to produce significant energy savings. Solid-state devices and switching systems utilizing components operating at high frequencies will become more commonplace.

This conference is an example of the lighting industry's concern and responsibility in assuring users that as new technologies are brought to market, due consideration will be given to their impacts on man, machinery, and the environment.

LBL, working under the auspices of the Department of Energy, will encourage the flow of information among members of the whole lighting community, thereby assuring a more rapid penetration of acceptable energy-efficient lighting technologies.

This community, working together with due concern for all the attributes of quality lighting, will enable the industry to provide the consumer with the technically best, most cost-effective, and most desirable lighting systems, thereby maintaining our international success and prominence.

## BIOLOGICAL EFFECTS OF RADIO-FREQUENCY RADIATION

Asher R. Sheppard, Ph. D. (Veterans Administration Medical Center,  
Loma Linda CA)  
Neurobiology Laboratory, Research Service - 151, J.L.  
Pettis V.A. Hospital, Loma Linda, CA 92357, and Assistant  
Research Professor, Department of Physiology and Pharmacology,  
Loma Linda University School of Medicine, Loma Linda, CA  
92354.

**ABSTRACT.** The electromagnetic radiation from proposed new lighting systems falls into a portion of the spectrum of non-ionizing radiations (NIRs) that has been little explored. NIR bioeffects research has moved from an initial interest only in the heating effects to a consideration of non-thermal interactions, particularly those related to modulated or pulsed RF waves. Worldwide standards for NIR in the range 10 MHz to 300 GHz are reviewed along with the underlying biophysical principles. Philosophies of standards-setting are discussed. The bioeffects literature is briefly reviewed in order to indicate some current research trends. It is suggested that the weak fields associated with EMI from lighting sources would be a biological concern only if non-thermal interactions at very low levels prove important.

### 1.0 INTRODUCTION

For consideration of biological effects, the electromagnetic spectrum is segregated into the realms of "ionizing radiation," such as X-rays and nuclear decay products, and "non-ionizing radiation" (NIR) which extends from high frequency microwaves to the extremely low frequencies at which power is transmitted commercially.

This distinction follows from the recognition that energies sufficient to ionize matter may cause significant structural changes at the chemical and tissue levels, while non-ionizing electromagnetic fields (EMFs) cannot generally produce profound changes in chemical structure. It was initially felt that any bio-effects of NIR were due to heat deposition in biological tissues, and initial standards for

microwave EMFs were determined by consideration of the heating effects of the field in comparison with normal metabolic heat which the body can adequately dissipate to maintain normal body temperature. In the U.S.A. the occupational RF exposure standard has been set at  $10 \text{ mW/cm}^2$  (continuously) incident power density over a wide frequency range (10 MHz-100 GHz CW).

The assumption of an electromagnetic field safety standard based upon accommodation to the NIR-imposed heat load presumes that there are no biomolecules, tissues or organs specialized to transduce NIR and no structures affected by "microthermal" changes. For many years these assumptions have been under challenge by the evidence from various studies for bio-effects of weak NIR, sometimes only at specific modulation frequencies.

At present, the existing NIR standards in the U.S.A. are undergoing review or revision over much of the spectrum. Several agencies are involved: American National Standards Institute (ANSI), Committee C95.1; Environmental Protection Agency; Bureau of Radiological Health and Electromagnetic Radiation Management Advisory Council; National Institute for Occupational Safety and Health; Occupational Safety and Health Administration; and various state or local agencies in Massachusetts, New York and Oregon. The ANSI Committee revisions have been based upon a need to reduce the allowable exposures at frequencies in the range of 30-100 MHz to take into account resonance of the adult human body at those frequencies. Resonance increases the internal fields which also produces greater heating. There is increasing wariness among the public (9) which has led to proposal of more stringent NIR standards. In view of the essentially non-thermal nature of fields below  $1 \text{ mW/cm}^2$ , it may be tacitly assumed that these proposals are based upon the possibility of transduction of the NIR as a biological signal.

## 2.0 BIOPHYSICAL CONSIDERATIONS

The penetration depth of EMF varies inversely with the square root of the frequency so that while the depth in muscle is 7 cm at 100 MHz, it increases to 22 cm at 10 MHz and 70 cm at 1 MHz. (Tissues of lower water content have still larger penetration depths, e.g., 60 cm at 100 MHz, for fat.) Below frequencies of about 100 MHz there is essentially complete penetration of the body by the incident electric field. However, at very much lower frequencies, approxi-

mately in the range of several kilohertz, the conductive properties of the tissue become dominant over the dielectric properties and the body behaves more and more like a perfect conductor inside of which the electric field would be zero. For example, at 60 Hz the incident field is attenuated by a factor of  $10^6$  within the body.

Resonance between the body or a part of the body and the incident EMF occurs at frequencies dependent upon the body shape and orientation as well as its dielectric properties and relation to the ground plane. For plane wave irradiation away from ground with the electric field vector oriented vertically along the axis of the body, the adult human body absorbs RF energy resonantly at about 70 MHz (13, 15, 17) and a child is resonant at 200 MHz, a rat at 900 MHz and a mouse at 2000 MHz.

In the case of exposures at the much lower frequencies of about 100 kHz or 10 MHz proposed for various new lighting technologies, all persons and portions of the body would be well below resonance and in the near field zone. Calculations for absorption in the near field zone are imprecise due to the complex nature of relation between the electric and magnetic fields. For this same reason exposure standards in the near field should be expressed in terms of the separate electric and magnetic field strengths, rather than the power density which is defined only for a plane electromagnetic wave.

In general, the absorbed power varies with frequency in the following manner (14):

1. Far below resonance (wavelength exceeds 5 times body length, or approximately below 30 MHz for adults):

$$P_{\text{abs}} \propto f^2$$

2. Near resonance (wavelength between 3 and 5 times height, or 30-50 MHz for adults):

$$P_{\text{abs}} \propto f^{-2.5} \text{ to } f^3$$

3. Above resonance (wavelength from 2.5 times to 0.3 height, or from resonance to about 500 MHz for adults):

$$P_{\text{abs}} \propto 1/f$$

4. Well above resonance power absorbed asymptotically approaches one-half the incident power over the body cross section.

The specific absorption rate (SAR) is a useful measure of the energy absorbed by an object under far-field conditions. Assuming a plane wave, the SAR is given by,

$$\text{SAR} = (1/2\rho)\omega\epsilon_0\epsilon''E_{jn}^2$$

where  $\rho$  is the mass density [kg/m<sup>3</sup>],  $\epsilon''$  is the imaginary part of the relative permittivity,  $\epsilon_0$  is the permittivity of free space, and  $E_{jn}$  is the electric field in the tissue.

It is apparent that the SAR is useful to quantify the absorbed energy under far field conditions for which the internal fields are known. In the case of the frequencies below resonance, where knowledge of the individual electric and magnetic components is necessary, the SAR is not an accurate concept by which to measure energy deposition, since even the incident power density cannot be well-defined. Nonetheless the SAR has been calculated for the region below resonance as an indication of the trends in power absorption below resonance.

Figure 1 shows the relation between absorbed power and frequency for a human phantom over the frequency range from well below to well above resonance. Note that both scales are logarithmic and the "bump" in absorption at resonance represents an increase of about one order of magnitude.

### 3.0 RF STANDARDS

Various philosophic principles have been employed in the difficult process of setting health and safety standards. There is a perceived difference between the attitudes brought to bear in standards setting in the U.S.A. and other Western Bloc countries as contrasted with the approach in the U.S.S.R. and Eastern Bloc nations. The Eastern Bloc approach emphasizes the view that any physiologic alteration signals a stress upon the adaptive systems of the body and is to be avoided. Thus, experimental evidence of physiological effects at a given exposure level becomes evidence for limitation of exposure at that level.



In the Western countries there is a strong attempt made to distinguish physiological effects from harmful effects. The technical approach to standard setting employs the concept of a "risk" that is defined for a particular "dose" following experimental derivation of a "dose-response curve." The final social judgment is supposed to take into account a balance between the quality and magnitude of the risk as compared to the benefits of the agent to which the population is exposed. In practice, there is rarely sufficient data to carry out all steps of the risk assessment process, and similarly there is rarely adequate definition of the minimum level for a physiological effect of presumed adaptive significance.

Much notice has been taken of the 1000 fold difference between the U.S.A and U.S.S.R. RF standards of  $10 \text{ mW/cm}^2$  and  $10 \text{ uW/cm}^2$  for occupational exposure, although when expressed in terms of the corresponding electric and magnetic field strengths the ratio is 31 times at frequencies above 300 MHz, and 10 times at frequencies from 10-30 MHz. From the point of view that emphasizes the transduction by a molecular structure a comparison of field strengths is more appropriate, whereas from the thermal point of view a comparison of energy fluxes is more appropriate. In practice the standards-setting procedure in both cases proceeds under the influence of a pragmatic need to avoid demonstrable harm and yet allow technological progress without undue regulation. These pragmatic needs are of greatest need for military radar applications and both nations make special considerations for exposures encountered in the military.

Table 1 lists some current standards for RF exposure.

#### 4.0 BRIEF SURVEY OF BIOLOGICAL EFFECTS

##### 4.1 Influence of Modulation

The existing and proposed U.S.A. standards are not concerned with the possibility of increased biological influence due to modulation of the carrier wave at extremely low frequencies. Such modulation may be incidental to rotating beams or poor filtering of 60/120 Hz in the power supply to the RF generator. A number of studies with amplitude modu-

lated signals indicate a highly frequency-dependent effect on calcium exchange for whole brain in vivo (1) and in vitro (6, 7, 8), as well as for membrane fragments (24, 41). The results of some of these indicate that the effect on measured calcium efflux is highly dependent on the modulation frequency with maximum effects occurring at 16 Hz, a frequency that is within the spectrum of signals produced by brain electrical activity. There is equally surprising evidence that effects are measurable only within a narrow band of electric field strength (43, 7). Other reports with low frequency modulated signals indicate effects on cytotoxicity of human lymphocytes with a peak effectiveness at 60 Hz (27).

Biophysical principles and explicit measurements indicate that at the frequencies used in the above studies, there will be only a very small transmembrane potential (of the order of microvolts) due to demodulation of the radiofrequency field at the cell membrane (37, 38, 42).

There are studies from the U.S.S.R. that also support the concept of a modulation-dependent effect of RF electromagnetic fields. For example, Shandala (42) reports on research with a 40 MHz EMF modulated at 50 Hz which, after a 2 hour exposure "disturbs the mechanism for assessing situational and trigger stimuli" in rats examined on a behavioral test. Similarly, Shandala reports on a disruption of maze performance among rats exposed to modulated RF, but not to rats exposed to the unmodulated EMF.

#### 4.2 Effects with CW EMFs

Johnson et al. (21) found behavioral, but no physiological effects among adult rats exposed in utero at 5 mW/cm<sup>2</sup> (CW, @ 918 MHz). Lovely et al. (25) found effects on rat behavior and blood biochemistry following exposures to 0.5 mW/cm<sup>2</sup> EMFs at 2.45 GHz.

Other important controversies concern the extent of "non-thermal" effects on the nervous system for which there has been favorable evidence in studies by Wachtel et al. (50), Kamenskii (23) and refutation by Chou and Guy (10).

Finally, there has been considerable controversy generated by data that suggest a change in the blood-brain barrier induced by CW microwave EMFs at 5-10 mW/cm<sup>2</sup> (12, 2, 34), although Merritt et al. (29) could not replicate the effect.

Faced with the confused state of the literature throughout the RF range, in consideration of the safety of RF heaters, the Canadian Department of National Health (48) found that, "There are no reliable data available on biological effects of RF radiation on human beings."

There has also been considerable interest at the extreme low range of the frequency spectrum where the major issue concerns 60 Hz electric power transmission. At 60 Hz, unlike frequencies in the megahertz range, the coupling to the body is so very poor that typically internal electric fields are only one-millionth the strength of the incident electric field (45). Thus, internal fields of  $10^{-4}$  V/cm are typical for humans exposed to an incident 60 Hz electric field of  $10^4$  V/m.

Studies of calcium efflux from whole chick brain exposed directly to weak electric fields ( $<100$  V/m in air) oscillating at extremely low frequency also found effects on calcium exchange from whole brain (6, 8) with similar indications of windowing of response according to both the frequency and field strength. In vivo studies performed on rabbits exposed to a 14.5 kV/m 50 Hz electric field at a power substation disclosed substantial effects on growth and development and provided cytological evidence for substantial alterations in cytoskeletal components. In particular, an aberrant lamellar form of endoplasmic reticulum and alterations of microtubule structure were observed throughout portions of the brain (18, 19). In vivo studies of miniature swine exposed to 30 kV/m electric fields at 60 Hz disclosed a pattern of reproductive abnormalities that requires further investigation (35).

In contrast, there are numerous studies at many RF frequencies and at 50/60 Hz, that demonstrate the complete absence of physiological, behavioral, and reproductive alterations in test animals during acute and chronic exposures (e.g., @ 50/60 Hz (36), and for review (45); @ RF frequencies for review see (16, 30, 39)). The controversy generated by this situation, in which effects are observed only in certain tests, has not been resolved and may indicate that the more "subtle" effects of weak NIR fields have a selective action that is unlike the broadly toxic effects of large doses of ionizing radiation, large thermal loads, or large doses of toxic chemicals. The absence of gross pathophysiologic findings in many studies would ordinarily suggest that the "subtle" effects are of little practical interest with respect to human health. However, because an effect on the information processing function of cells and tissues is implied by certain data, a more cautious approach has been

followed by many persons who have reviewed the literature (22, 28, 30, 26, 11).

Although the literature is rich with contradictory reports at particular frequencies (especially 2.45 GHz, 918 MHz, 450 MHz), there has been relatively little research at frequencies below 30 MHz, the range in which new lighting sources will operate. There are some data from experience with short-wave diathermy which operates at 13.56 or 27.12 MHz, frequencies in the same band as some proposed lighting devices. The aforementioned Canadian study (48) disclosed few reports of adverse effects from diathermy exposures which involve very large exposures. These few reports suggest that apart from accidental burns, dizziness and nausea were reported in a very few cases.

No mutagenic effects were observed with various RF fields (10 V/m @ 29-146 MHz) in a set of studies by Mittler (32), yet earlier research by Heller and Texeira-Pinto (20) and Mickey (31) did observe chromosomal aberrations at 27 MHz at unspecified field strengths.

Research at frequencies of 20 and 100 kHz, of particular interest for other proposed lighting sources, is especially rare.

## 5.0 BIO-EFFECTS of LIGHTING-PRODUCED EMFS

There is not sufficient evidence to make a well-founded judgment of the biological effects on persons exposed chronically to RF fields at frequencies of about 20 kHz, 100 kHz or 10 MHz, at levels well below 1 V/m and magnetic field strengths well below 1 A/m. Such weak fields are not a hazard due to any thermal mechanism but have not been examined for possible direct influences on the body interior. There is no apparent reason to believe that such influences would be significant, except that low-frequency modulated signals should be carefully considered, especially since the penetration depth is great in this frequency range. At the lower frequencies, the magnetic field may be of greater concern than the electric and further evaluation is required. At higher frequencies of about 10 MHz existing standards suggest a wide margin of safety for proposed systems which would not achieve field strengths near the levels at which even the most stringent present electric field standards pertain (4 V/m in the USSR, see Table 1).

Table 1. Selected RF Exposure Standards.

Identity	Frequency	Exposure	Notes
ANSI(1977) U. S. A.	10 MHz- 100 GHz	10 mW/cm <sup>2</sup> any waveform, indefinite duration	Under revision (see below) Occupational
ANSI(1981) * U. S. A.	0.3-3.0 MHz 3-30 MHz 30-300 MHz 300-300 MHz 1.5-3.0 GHz	100 mW/cm <sup>2</sup> 900/f(MHz) <sup>2</sup> mW/cm <sup>2</sup> 1 mW/cm <sup>2</sup> f(MHz)/300 mW/cm <sup>2</sup> 5 mW/cm <sup>2</sup>	Public & Occ.; any waveform; indefinite duration.
Canada *	10 MHz-1 GHz 1 -300 GHz 1 -300 GHz	1 mW/cm <sup>2</sup> , indefinite 5 mW/cm <sup>2</sup> , indefinite 1 mW/cm <sup>2</sup> , indefinite	Occupational Public
Poland *	.3 -300 GHz .3 -300 GHz	0.2 mW/cm <sup>2</sup> , 10 h 1 mW/cm <sup>2</sup> , 8 h	Occupational Public
U. S. S. R. (1977)	10-30 MHz 30 -50 MHz 50 -300 MHz .3 -300 GHz .3 -300 GHz	20 V/m, workshift 10 V/m, 0.3 A/m workshift 5 V/m, workshift 0.01 mW/cm <sup>2</sup> , workshift 0.01 mW/cm <sup>2</sup> , workshift	Occupational
U. S. S. R.	30-300 kHz 0.3-3.0 MHz 3-30 MHz 30-300 MHz .3 -300 GHz	20 V/m 10 V/m 4 V/m 2 V/ .01 mW/cm <sup>2</sup>	Residential

Sources: Stuchly (46); Shandala (42).

\* indicates a proposed standard

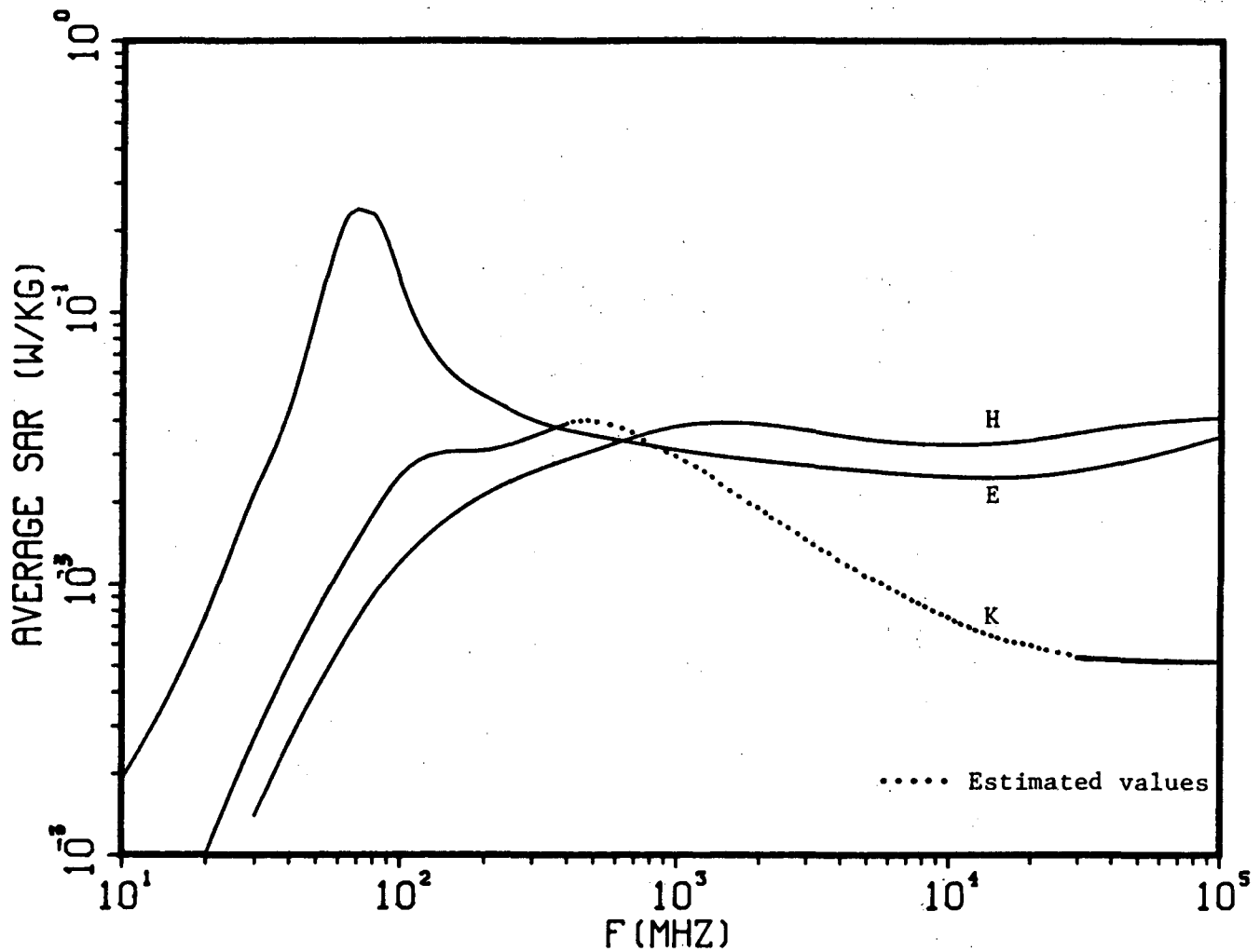

FIGURE 1. Whole Body Averaged Specific Absorption Rates for Homogenous Models of the Human Body. Incident power is  $1 \text{ mW/cm}^2$ . E, H, and K indicate polarizations of the electric, magnetic and propagation vectors parallel to the long axis of a prolate spheroid. (14)

## 6.0 REFERENCES

1. Adey, W.R., Bawin, S.M. and Lawrence, A.F., 1982. Effects of weak amplitude-modulated microwave fields on calcium efflux from awake cat cerebral cortex. Bioelectromagnetics, in press.
2. Albert, E. and J.M. Kerns, 1981. Reversible microwave effects on the blood-brain barrier, Brain Res., 230: 153-164.
3. American National Standards Institute, 1974. Safety levels of electromagnetic radiation with respect to personnel. Report ANSI-C95.1.
4. Bawin, S.M. and W.R. Adey, 1976. Sensitivity of calcium binding in cerebral tissue to weak environmental electric fields oscillating at low frequency. Proc. Nat. Acad. Sci. USA 73: 1999-2003.
5. Bawin, S.M., W.R. Adey and I.M. Sabbot, 1978. Ionic factors in release of  $^{45}\text{Ca}^{2+}$  from chicken cerebral tissue by electromagnetic fields. Proc. Nat. Acad. Sci. USA 75(12): 6314-6318.
6. Bawin, S.M., L.K. Kaczmarek and W.R. Adey, 1975. Effects of modulated VHF fields on the central nervous system. Ann. New York Acad. Sci. 247: 74-80.
7. Blackman, C.F., J.A. Elder, C.M. Weil, S.G. Benane, D.C. Eichinger, and D.E. House, 1979. Induction of calcium-ion efflux from brain tissue by radio-frequency radiation: effects of modulation frequency and field strength. Radio Science 14: 93-98.
8. Blackman, C.F., Benane, S.G. and Kinney, L.S. 1981. Effects of ELF radiation on calcium ion efflux from brain tissue in vitro. Bioelectromagnetics Soc. 3rd Annual Meeting, Washington, D.C. Proceedings, p. 47 (abstract).
9. Brodeur, P., 1977. The zapping of america. W.W. Norton, New York.
10. Chou, C.-K. and A.W. Guy, 1977. Quantitation of microwave biological effects. In: Biological Effects and Measurements of Radio Frequency Microwaves, D.G. Hazzard, ed. HEW publication 77-8026. Bureau of Radiological Health, Rockville, MD, pp 81-103.

11. Cleary, S.F., 1977. Biological effects of microwave and radiofrequency radiations. CRC Crit. Rev. Environ. Contr. 7: 121-166.
12. Frey, A.H., S.R. Feld and B. Frey, 1975. Neural function and behavior: Defining the relationship. In: Biologic Effects of Non-Ionizing Radiation, P.E. Tyler, ed. Ann. NY Acad. of Sci., 247: 433-439.
13. Gandhi, O.P., K. Sedigh, G.S. Beck and E.L. Hunt, 1976. Distribution of electromagnetic energy deposition in models of man with frequencies near resonance. In: Biological Effects of Electromagnetic Waves, C.C. Johnson and M.L. Shore, eds, HEW Publ. 77-8010, Bureau of Radiological Health, Rockville, MD, pp. 44-67.
14. Gandhi, O.P. 1975. Strong dependence of whole animal absorption on polarization and frequency of radiofrequency energy. Ann NY Acad Sci, 247: 532-538.
15. Gandhi, O.P., 1980. State of knowledge for electromagnetic absorbed dose in man and animals. Proc. IEEE, 68: 24-32.
16. Glaser, Z.R. and C.H. Dodge, 1976. Biomedical aspects of radio-frequency and microwave radiation: a review of selected soviet, east european, and western references. In: Biological Effects of Electromagnetic Waves, C.C. Johnson and M.L. Shore, eds, HEW Publ. 77-8010, Bureau of Radiological Health, Rockville, MD, pp. 2-35.
17. M.J. Hagmann and O.P. Gandhi, 1979. Numerical calculation of electromagnetic energy deposition for a realistic model of man. IEEE Trans. Micr. Th. and Tech., MTT 27: 804-809.
18. Hansson, H-A., 1981. Lamellar bodies in Purkinje nerve cells experimentally induced by electric field. Brain Research 216: 187-191.
19. Hansson, H.A. (1981b). Purkinje nerve cell changes caused by electric fields: Ultrastructural studies on long-term effects on rabbits. Medical Biologu, 59: 103-110.
20. Heller, J.H. and A.A. Teixeira-Pinto, 1959. A new physical method of creating chromosomal aberrations. Nature, 183: 905-906.
21. Johnson, R.B., S. Mizumori, D.E. Meyers, A.W. Guy,



- and R.H. Lovely, 1977. Effects of pre- and post-natal exposures to 918 MHz microwave radiation on development and behavior in rats. (Abstract) URSI Symposium on Biological Effects of Electromagnetic Waves, Airlie, VA. Oct-Nov., 1977.
22. Justesen, D.R., 1980. Microwave irradiation and the blood-brain barrier. Proceedings of the IEEE, 68: 60-67.
  23. Kamenskii, Y. I., 1964. The effect of microwaves on the functional state of the nerve. (In Russian.) Biophysics USSR, 9: 758-764.
  24. Lin-Liu, S. and W.R. Adey. 1982. Low frequency amplitude modulated microwave fields changed calcium rates from synaptosomes. Bioelectromagnetics, in press.
  25. Lovely, R.H., A.W. Guy, R.B. Johnson and M. Mathews, 1978. Alteration of behavioral and biochemical parameters during and consequent to 500  $\mu\text{W}/\text{cm}^2$  chronic 2450 MHz microwave exposure. In: Proceedings IMPI/U.S. URSI Symposium on Electromagnetic Fields in Biological Systems, Ottawa, p. 34.
  26. Lu, S-T, W.G. Lotz and S.M. Michaelson, 1980. Advances in microwave-induced neuroendocrine effects: the concept of stress. Proceedings of the IEEE, 68: 73-84.
  27. Lyle, D.B., Schechter, P., Adey, W.R. and Lundak, R.L., 1982. Suppression of T-lymphocyte cytotoxicity following exposure to sinusoidally amplitude modulated HF fields. Bioelectromagnetics, in press.
  28. McCree, D. I., 1980. Soviet and eastern european research on biological effects of microwave radiation. Proceedings of the IEEE, 68: 84-91.
  29. Merritt, J.H., A.F. Chamness and S.J. Allen, 1978. Studies on blood-brain barrier permeability after microwave irradiation. Radiat. and Envir. Biophys., 15: 367-377.
  30. Michaelson, S.M., 1980. Microwave biological effects: an overview. Proceedings of the IEEE, 68: 40-48.
  31. Mickey, G.H., 1963. Electromagnetism and its effect on the organism. NY St. J. of Medicine, 63: 1935-1942.

32. Mittler, S., 1977. Failure of chronic exposure to nonthermal fm radio waves to mutate Drosophila melanogaster. J. of Heridity, 68: 257-258.
33. Oscar, K. J. and T. D. Hawkins, 1979. Microwave alteration of the blood brain barrier system of rats. Brain Res. 126: 281-293.
34. Phillips, R. D., E. L. Hunt, R. D. Castro and N. W. King, 1975. Thermoregulatory, metabolic, and cardiovascular response of rats to microwaves. J. of Appl. Physiology, 38: 630-635.
35. Phillips, R. D., 1981. Biological effects of electric fields on large animals. ACBEEF/Contractor Workshop, Electric Power Research Institute, New Orleans, LA, April 14-15.
36. Phillips, R. D., L. E. Anderson and W. T. Kaune, 1981. Biological effects of high-strength electric fields on small laboratory animals. Interim Report, October 1, 1979-March 31, 1981. DOE/RL/O1830-T7 (DE82002426). Available from NTIS, Springfield, VA 22161.
37. Pickard, W. F. and F. J. Rosenbaum. 1978. Biological effects of microwaves at the membrane level: Two possible athermal electrophysiological mechanisms and a proposed experimental test. Math. Biosci. 39 235-253.
38. Pickard, W. F. and Y. H. Barsoum. 1981. Radio-frequency bioeffects at the membrane level: separation of thermal and athermal contributions in the characae. Department of Electrical Engineering, Washington U., St. Louis, MO 63130.
39. Proceedings of an international symposium, 1974. Biological effects and health hazards of microwave radiation. P. Czerski et al., eds. Warsaw, October, 1973. Polish Medical Publishers, Warsaw.
40. Proceedings of the IEEE, 68: 60-67, 1980.
41. Ross, D. H. and H. L. Cardenas, 1981. Effects of RFR exposure on calcium binding to rat-brain membranes. In: USAF radiofrequency radiation bioeffects research program -- a review, J. C. Mitchell, ed. Aeromedical Rev. 4-81, USAF School of Aerospace Medicine, Brooks AFB, TX 78235, pp. 285-295.
42. Shandala, M. G., M. I. Rudnev, V. V. Varetsky, G. I.

Lysina and N.N. Vasilevsky, 1982. US-USSR Cooperation on the problem: "Environmental health study". Task III. Study of the biological effects of physical environmental factors. Topic 3.1 Study of the biological effects of non-ionizing microwave radiation. National literature survey on the effects of electromagnetic fields (0-300 Hertz) and of noise on the nervous system. Kiev, USSR, p. 19. (Available from NIEHS, Research Triangle Park, NC).

43. Sheppard, A.R., S.M. Bawin, and W.R. Adey, 1979. Models of long-range order in cerebral macromolecules: effect of sub-ELF and of modulated VHF and UHF fields. Radio Science 14: 141-145.
44. Sheppard, A.R., S.M. Bawin and W.R. Adey, 1981. Possible cell demodulation of the elf component of an elf-modulated 450 MHz field. (Abstract) 3d Annual Meeting of the Bioelectromagnetics Society, Washington, D.C. August.
45. Sheppard, 1977. A.R. and M. Eisenbud, Biologic Effects of Electric and Magnetic Fields of Extremely Low Frequency. New York: New York University Press. pp. 421-423.
46. Stuchly, M. A., 1977. Health Aspects of radiofrequency and microwave radiation exposure. Part 1. Environmental Health Directorate, Department of National Health and Welfare, Ottawa K1A 0K9, Canada. Document 77-EHD-13.
47. Stuchly, M. A., 1978. Health Aspects of radiofrequency and microwave radiation exposure. Part 2. Environmental Health Directorate, Department of National Health and Welfare, Ottawa K1A 0K9, Canada. Document 78-EHD-22.
48. Stuchly, M.A. and M.H. Repacholi, 1980. Dielectric (rf) heaters guidelines for limiting radio-frequency exposure. Publ. 80-EHD-58. Environmental Health Directorate, Department of National Health and Welfare, Ottawa, K1A 0K9, Canada.
49. Tell, R.A. and F. Harlen, 1979. A review of selected biological effects and dosimetric data useful for development of radiofrequency safety standards for human exposure. J. Microwave Power, 14: 405-424.
50. Wachtel, H., R. Seaman, W.T. Joines, 1975. Effects of low-intensity microwaves on isolated neurons. Annals New York Academy of Sciences, 247: 46-62.

REDUCTION OF AM RADIO INTERFERENCE  
THROUGH CONTROL OF  
RADIATED ELECTRIC FIELD

Victor D. Roberts  
Lighting Systems Programs  
Electrical Systems and Technology Laboratory  
Corporate Research and Development Center  
General Electric Company  
Schenectady, New York 12301

The control of electromagnetic interference is becoming an increasingly important aspect of electronic product design. For residential applications, interference with AM radios is of particular concern. Interference control activities in the AM band have traditionally centered on magnetic (H) field radiation since the FCC does not limit E field radiation below 18 MHz, and it has been assumed that AM radios using ferrite rod antennas are H field receivers. During this study, it was determined that the E field sensitivity of some AM radios is approximately equal to their H field sensitivity. It was also determined that one particular electronically ballasted lamp design could be made interference free by controlling both E and H field radiation. An effective E field shield is described which does not require connection to the power supply ground.

#### INTRODUCTION

One of the issues that must be considered during the design of electronically ballasted lamps is electromagnetic compatibility (EMC) with other electronic equipment. For residential applications, possible interference with AM radio receivers is an important consideration for lamps whose primary operating frequency is below 1600 kHz. I wish to describe an interesting EMC problem we discovered during the design phase of an electronically ballasted lamp.

#### GENERAL DISCUSSION

The conclusions of this study are applicable for any lamp or other electronic product designed for the residential market. However, the actual lamp used for this investigation is known as a Solenoidal Electric Field (SEF) lamp. The SEF lamp, shown in Figure #1, is an electrodeless fluorescent lamp. The discharge is driven as a single turn secondary on a ferrite toroid. The primary winding on the toroid is driven by a 100 kHz power oscillator located in the base of the lamp. By eliminating the electrodes, we can obtain high efficiency in a lamp with a short, fat, discharge path.

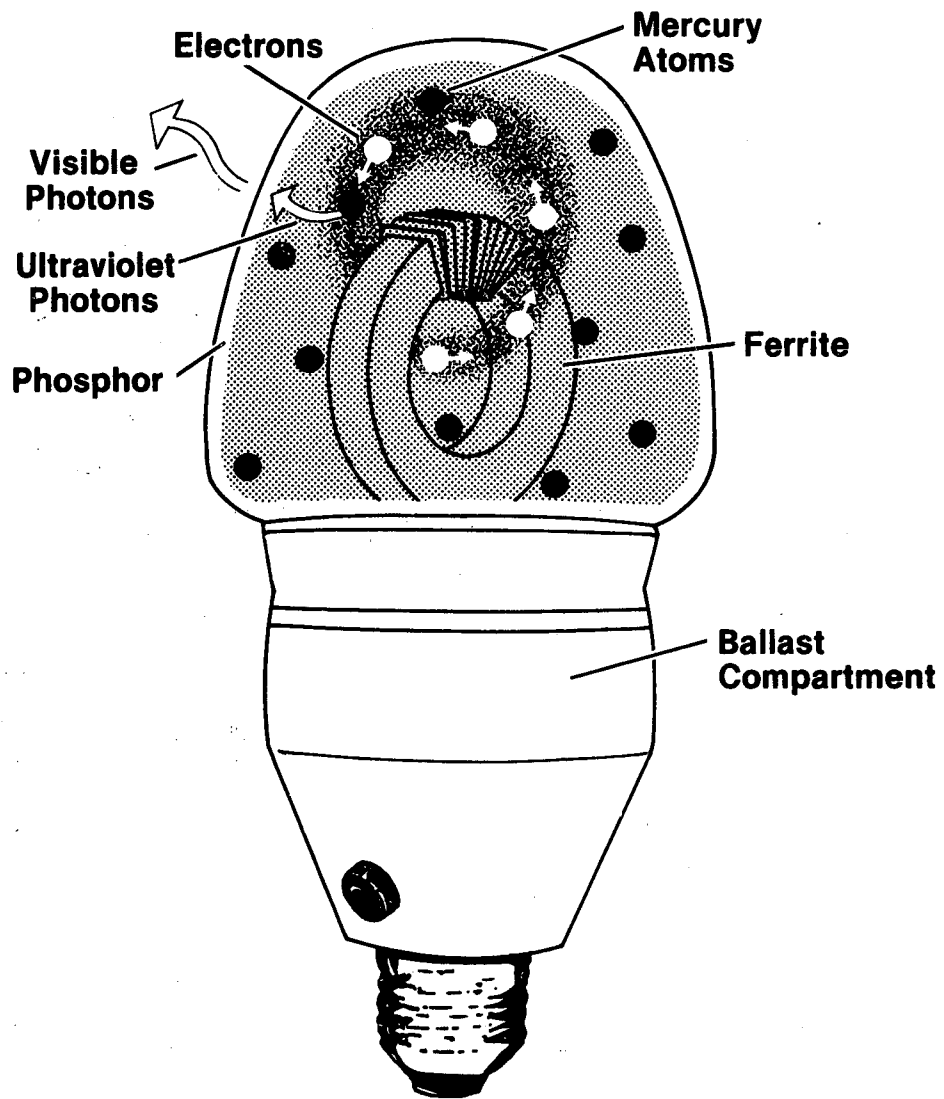

Figure #1. Solenoidal Electric Field lamp with integral 100 kHz ballast.

Since the lamp is driven by a 100 kHz non-sinusoidal signal, we anticipated that harmonics of the driving frequency might produce AM radio interference if the system was not properly designed. We expected that our major problem would be magnetic field radiation (H field) since we believed that residential AM radios were designed to be H field receivers. They use ferrite rod antennas which are supposed to be sensitive to the magnetic field component of the incident traveling wave, and we therefore expected that these radios would be substantially less sensitive to E field than to H field. This assumption was reinforced by FCC Rules and Regulations Part 18, Section 18.143(a) which state "An approved type of field strength meter using loop pickup shall be used for measurements on frequencies below and including 18 MHz..." Since loop antennas are sensitive only to H field, the FCC places a limit of the radiated H field, but does not specify any limitation on the E field.

To prevent AM radio interference, we established a design goal for H field radiation which we felt would provide interference free reception. To our surprise, lamps which met this specification still produced considerable interference. Figure #2 shows the H field radiation from a typical SEF lamp. The strong signal at 100 kHz is the fundamental. As expected from a square wave source, the second harmonic at 200 kHz is very small while the odd harmonics at approximately 300 and 500 kHz are rather strong. As is customary practice, the H field data is presented in equivalent E field units for far field radiation. That is, the actual H field, measured in amperes per meter is multiplied by 377 ohms and presented in units of volts per meter. Our self imposed design limit of 58 db above 1  $\mu$ V/M at 2 feet is also shown. It can be seen that, except for the low end of the AM band, the lamp met our goal, yet strong interference could be detected even near 1400 to 1600 kHz. This implied that either our H field specification was incorrect, or, that something other than H field was causing the problem.

The E field radiation from this same lamp is shown in Figure #3. It is considerably stronger than the H field radiation from the same lamp system which was shown in Figure #2. For the reason stated above, however, the E field was assumed to be not important.

The significant difference between the E and H field spectrums brings up the question of coupling between these two fields. We often assume that E and H are coupled simply by the free space wave impedance of 377 ohms. However, this convenient relationship only holds in the far field, while the near field situation is considerably more complex. Equations 1-3 give the three field components generated by a short electric dipole of length  $d$  carrying a current  $I_0$ .  $Z_0$  is the impedance of free space,  $\beta$  is the wave number and  $r$  is the distance between dipole and observer.

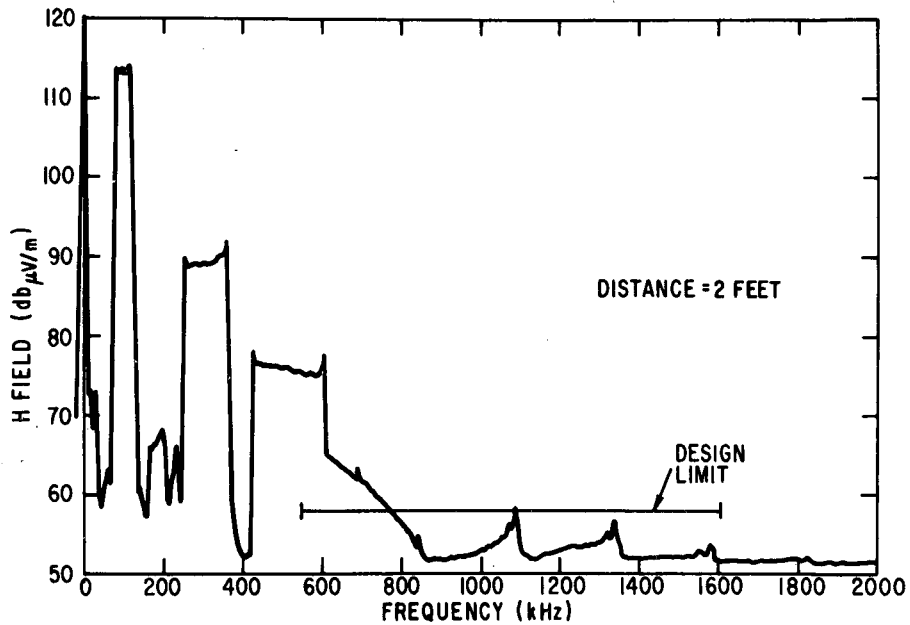

Figure #2 Radiated magnetic field intensity from typical Soleniodal Electric Field lamp (H field shown in equivalent E field units for far field radiation).

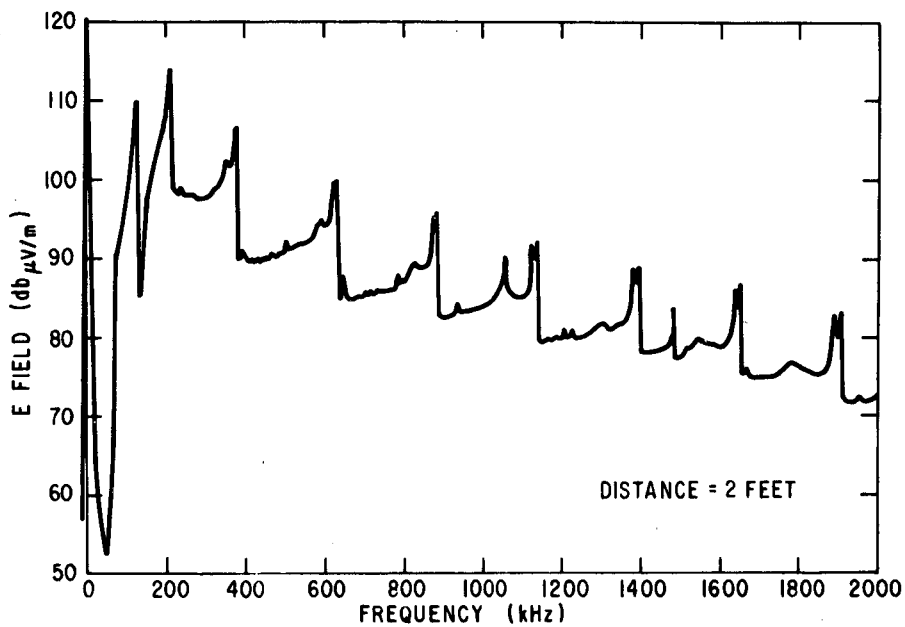

Figure #3 Radiated electric field intensity from typical unmodified Soleniodal Electric Field lamp.

$$H_{\phi} = \frac{I_0 d}{4\pi} (\sin \theta) e^{j(\omega t - \beta r)} \left[ j \frac{\beta}{r} + \frac{1}{r^2} \right] \quad \{1\}$$

$$E_r = Z_0 \frac{I_0 d}{4\pi} (\cos \theta) e^{j(\omega t - \beta r)} \left[ \frac{1}{r^2} - j \frac{1}{\beta r^3} \right] \quad \{2\}$$

$$E_{\theta} = Z_0 \frac{I_0 d}{4\pi} (\sin \theta) e^{j(\omega t - \beta r)} \left[ j \frac{\beta}{r} + \frac{1}{r^2} - j \frac{1}{\beta r^3} \right] \quad \{3\}$$

$$Z_0 = \sqrt{\mu_0 / \epsilon_0} \quad \beta = 2\pi / \lambda \quad \{4\}, \{5\}$$

In the far field,  $r$  is much greater than  $\beta$  and Equations 1-3 reduce to simpler form where the following two relationships hold:

$$\frac{E_{\theta}}{H_{\phi}} = Z_0 \quad \{6\}$$

$$E_r \rightarrow 0 \quad \{7\}$$

In the near field,  $r$  is much less than  $\beta$  and Equations 1-3 reduce to the following more complex relationship between the field components:

$$\frac{E_{\theta}}{H_{\phi}} = \frac{Z_0}{\beta r} \quad \{8\}$$

$$\frac{E_r}{H_{\phi}} = (\text{ATN } \theta) \frac{Z_0}{\beta r} \quad \{9\}$$

The transition from near to far field takes place where:

$$\beta r = \frac{2\pi}{\lambda} r = 1 \quad \{10\}$$

For the AM band this transition point ranges from 30 meters at 1605 kHz to 90 meters at 535 kHz. Thus it is obvious that in our case, when we measure the lamp radiation at 2 feet, we are definitely in the near field region.

The previous equations were developed for a small electric dipole. If we had, instead, assumed a small magnetic dipole, the far field relationship between  $E$  and  $H$  would have remained unchanged, but a different near field relationship would have been developed.

The lamp can actually act as a combination of sources, electric and magnetic, and may also be more complex than simple dipoles. The near field relationship between  $E$  and  $H$  is therefore not known a priori. However, in the far field, the relationship

$$\frac{E_{\theta}}{H_{\phi}} = Z_0 \quad \{6\}$$



continues to hold. For this reason, E and H must be separately determined in the near field, while in the far field it is possible to measure one and calculate the other.

Faced with our interference problem and our belief that we had established a reasonable H field level, we developed the hypothesis that the cause of our problem was E field. We immediately tested this theory by placing a grounded conducting shield over the lamp. The result - our AM interference was eliminated.

Once E field had been identified as the cause of our interference, we were faced with designing a shield which would work without a connection to building ground. A greatly simplified picture of an electronic lamp ballast is shown in Figure #4. The ballast consists of a line operated power supply operating a high frequency oscillator. The oscillator is capacitively coupled to the (conducting) ballast case through power transistor heat sinks and similar paths. The ballast case is then coupled to the outside world through stray capacitance. External electric fields are generated by the potential of the ballast case (or power transistors for designs using a non-conducting ballast case) relative to earth ground.

The traditional solution to this problem is to enclose the E field source in a shielded box which is then connected to the power line ground. This "shorts" the potential to ground and eliminates the external E field. In residential applications, however, the building ground is usually not available, especially for portable lamps.

We found that an equally effective solution could be obtained by enclosing the ballast in a conductive shield which is then connected to the internal power supply common. This option, shown in Figure #5, eliminates the external E field by returning the capacitively coupled currents to the power supply without allowing them to pass through the outside world. Since this places 60Hz line voltage on the ballast shield, the system must be designed so that the user does not come in contact with the shield. One simple way to do this is to construct a plastic ballast shell with a conductive liner, connected to circuit common, which acts as the E field shield. Figure #2, presented earlier in this report, showed the radiated E field from an unmodified lamp. Figure #6 shows the E field after the metal ballast case had been connected to circuit common. There is a substantial reduction of E field, especially at the higher frequencies. Figure #7 shows the radiated E field after the lamp had also been covered with a shield which was similarly connected to circuit common. The E field is now extremely low, and the interference is essentially eliminated.

One of our original assumptions had been that AM radios were significantly less sensitive to E field than they were to H

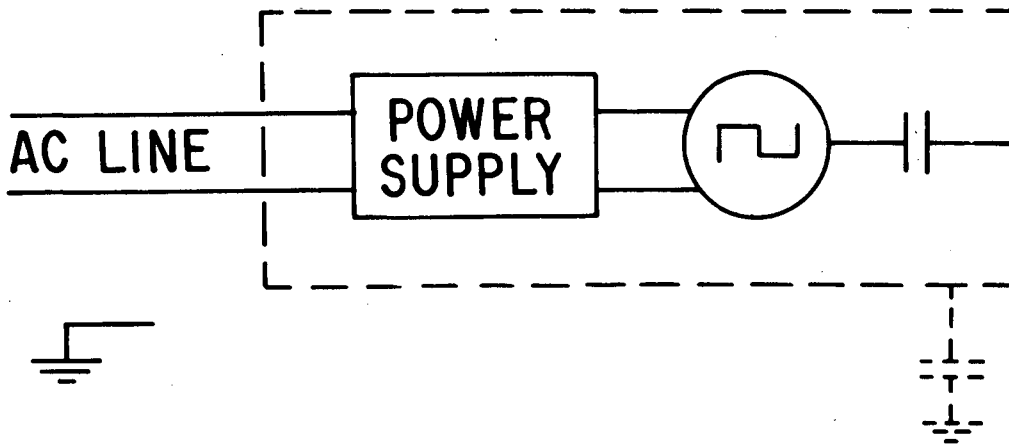

Figure #4 Greatly simplified picture of electronic lamp ballast in conducting, non-grounded case.

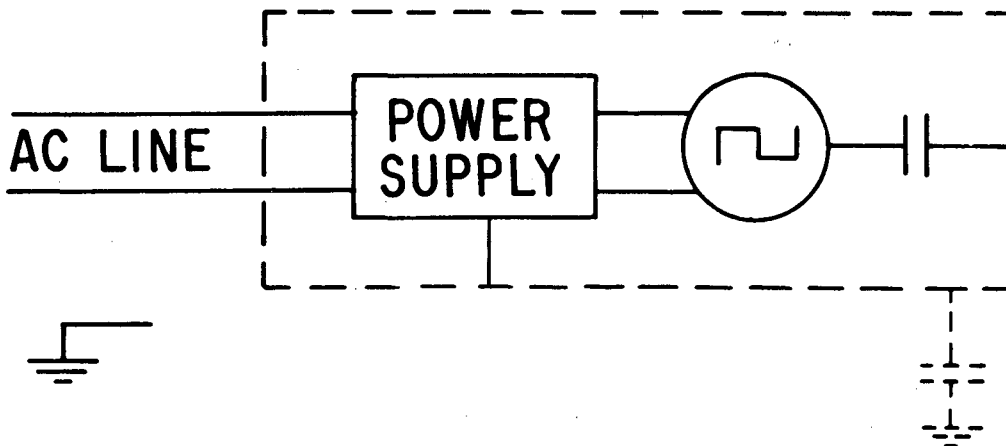

Figure #5 Electronic lamp ballast with shield connected to "floating" circuit common to eliminate electric field interference.

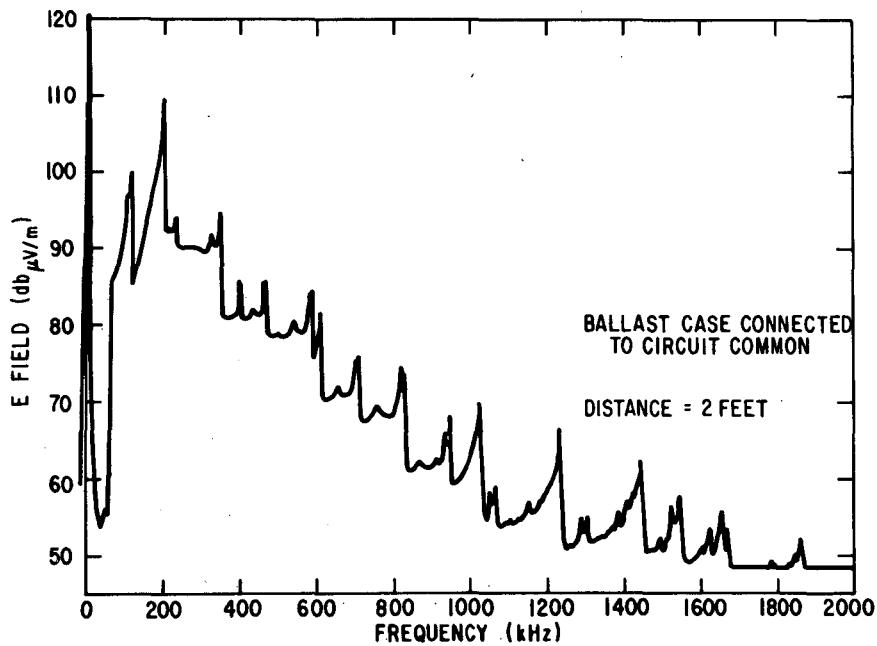

Figure #6 Radiated electric field from Solenoidal Electric Field lamp with ballast case connected to circuit common.

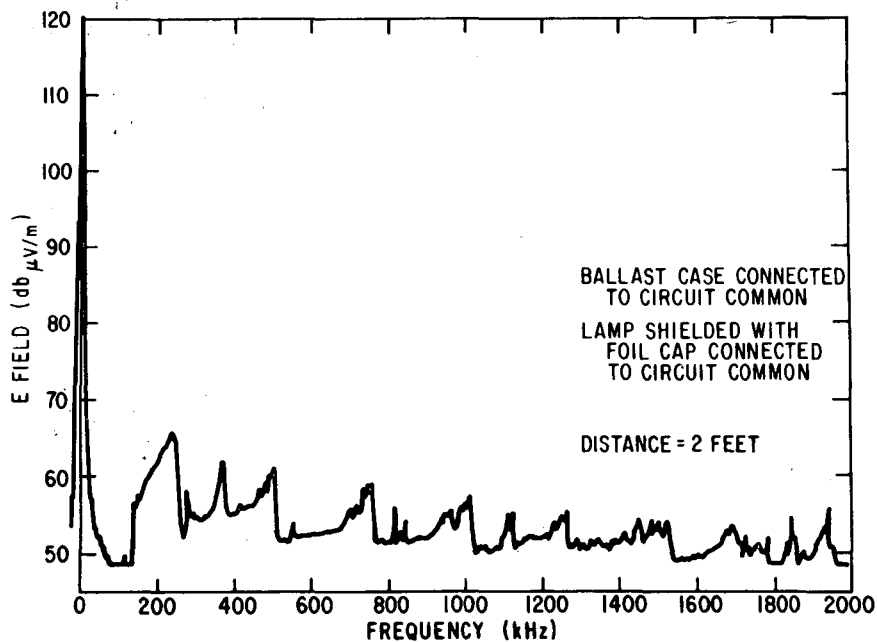

Figure #7 Radiated electric field from Solenoidal Electric Field lamp with ballast case and foil lamp shield connected to circuit common.

field, i.e. they were H field receivers. Since we had shown that the lamp would generate interference unless the E field was reduced to approximately the level we had established for our H field specification, it seemed that our assumption regarding the relative E and H field sensitivities of AM radios was incorrect. We therefore set up a small experiment to measure relative E and H field sensitivities of some typical radios.

The equipment shown in Figure #8 was set up to measure H field sensitivity. The radio under test was placed on the axis of a 76 cm, 11 turn shielded loop driven by an oscillator. The radio was aligned so that the axis of its internal ferrite rod antenna was parallel with the axis of the loop. The H field source was calibrated with the aid of a 5 inch loop receiving antenna which had been previously calibrated. To measure the E field sensitivity, we used a parallel plane line as shown in Figure #9. The line was excited by an oscillator and the E field was simply calculated from the measured voltage across the line and the 45 cm separation of the two plates. The radio was supported on non-conducting blocks and data was taken in all three orientations of the radio relative to the direction of the E field.

Two different tests were run. For the first, we measured the signal strength required to produce one volt output at the ear phone jack. The drive signal was AM modulated at 1 kHz to a depth of 30%. For the second test, we used a CW signal and measured the signal strength required to produce 20 db of quieting at the ear phone jack. We ran the tests at both RF and IF frequencies and used two different General Electric portable radios. RF data was taken at three dial settings: 600 kHz, 1 MHz, and 1.5 MHz. The results of the tests are shown in Table #1.

TABLE #1  
RESULTS OF AM RADIO SENSITIVITY TESTS

RADIO "A"

1 Volt Output	E Field	46 to 50 db <sub>μV/M</sub>
	H Field	52 to 58 db <sub>μV/M</sub>
	E Field (IF)	96 db <sub>μV/M</sub>
Quieting Test	E Field	80 to 89 db <sub>μV/M</sub>
	H Field	89 to 91 db <sub>μV/M</sub>

RADIO "B"

Quieting Test	E Field	86 to 95 db <sub>μV/M</sub>
	H Field	79 to 80 db <sub>μV/M</sub>

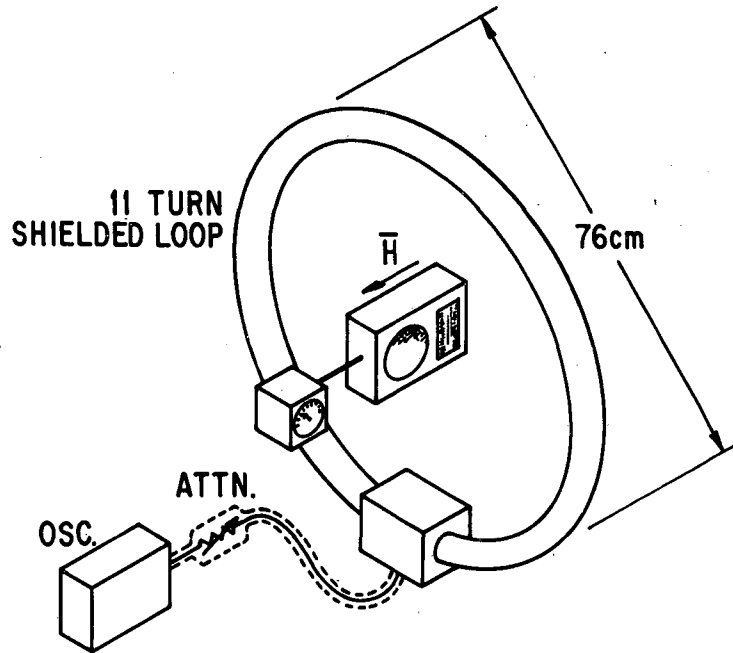

Figure #8 Equipment used to measure magnetic field sensitivity of AM radio.

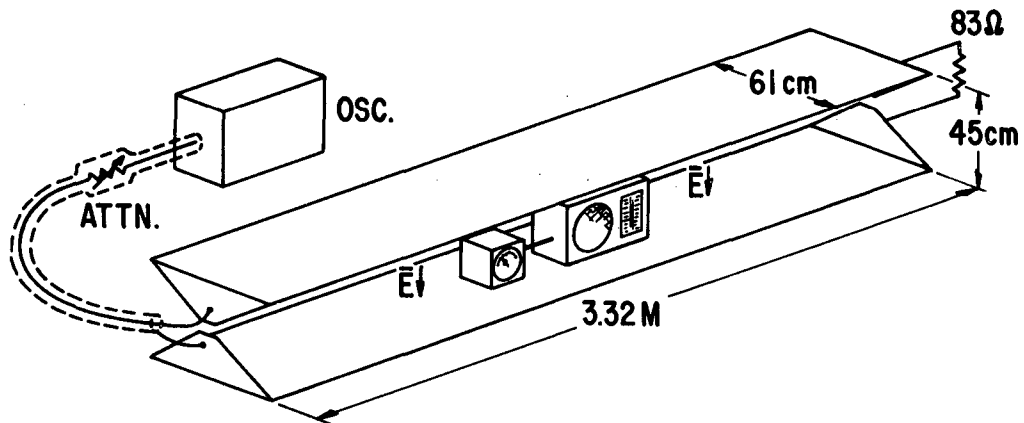

Figure #9 Equipment used to measure electric field sensitivity of AM radio.

The data indicates that, for each radio tested, the E field sensitivity is generally within 10 db of the H field sensitivity for that same radio. Radio "A" is slightly more sensitive to E field than to H field, while for radio "B", the reverse is true. The data also shows that, while the sensitivity for 20 db quieting was substantially different than the 1 volt output sensitivity, the E to H field ratios remain about the same. Finally, the data proves that the E field pickup is an RF stage problem and not an IF problem, since the measured E field sensitivity at the IF frequency is at least 40 db lower than at the RF frequencies.

AM radios do indeed use ferrite rod antennas, and these are sensitive to H field. If so, why the high E field sensitivity? The most probable reason is that modern radios use high impedance FET transistors in the front end and they are often constructed in plastic cases without any sort of conductive shields. We can probably expect that the more expensive radios will have less problem with E field pickup, since many of them incorporate shields around the RF stage.

This investigation was conducted with only two radios from only a single manufacturer. A much more comprehensive investigation is required to establish an E field level which will provide protection for the majority of residential applications.

#### CONCLUSIONS

We can draw three conclusions from this study:

- 1) AM radio E field sensitivity is approximately equal to H field sensitivity - at least for the radios tested.
- 2) FCC Rules and Regulations do not protect AM radios from E field interference.
- 3) Simple shielding methods can be effective even in the absence of a "ground wire".

# ELECTRICAL SYSTEM WAVEFORM DISTORTION

J. P. Goodman  
Electrical Systems Division  
David Taylor Naval Ship R&D Center  
Annapolis, MD  
March 1982

## Table of Contents

### Subject

Abstract.....	.....
Table of Contents.....	.....
Introduction.....	.....
Review of Terms and Concepts.....	.....
Shipboard Alternating Current Electric Power Quality Requirements.....	.....
Source Impedance of Rotating Machines.....	.....
Relationship Between Generator Harmonic Voltages and Nonlinear Load Harmonic Currents.....	.....
Rectifier Loading Effects.....	.....
Static (Non-Rotating) Power Sources.....	.....
Reduction of Nonlinear Load Effects by Active or Passive Filters.....	.....
Summary.....	.....

### ABSTRACT

Interaction phenomena between electric power sources and system loads can result in poor power quality for sensitive electronic equipment. The paper discusses load linearity, power system source impedance, typical problem loads and approaches to restoring electric power quality. Although the discussion is primarily on naval shipboard power systems the theory also is applicable to commercial power systems and equipment.

## INTRODUCTION

An important consideration in modern naval shipboard electric power systems is maintaining compatibility between electric power sources and system load equipment. Some equipments are very sensitive to the normal power system fluctuations and are often given their own "dedicated" power source. Other electrical loads generate a great deal of interference and have to be removed from the central ship service power systems and given their own dedicated power sources. This long-adhered-to policy of removing both the very sensitive loads and the high-interference loads from the central power systems has resulted in a great number of dedicated power sources.

The electric power quality degradation is usually in the form of, transient voltage sags or surges, harmonic distortion, and/or amplitude modulation of the system voltage. The nonlinear loads cause the system voltage waveforms to be non-sinusoidal or contain harmonic distortion; the high-power pulsing loads cause amplitude modulation of the system voltage. Abrupt load energization or de-energization often results in voltage sags, surges, and transients. This paper briefly discusses mainly the nonlinear load/voltage waveform distortion problem and some approaches to dealing with it.

## REVIEW OF TERMS AND CONCEPTS

This paper is intended as a brief discussion of electrical system source/load interactions. The short review of some electrical terms and concepts given below may be helpful in understanding the presentation:

### A. Harmonic Distortion of periodic waveforms

Figure 1 shows two familiar signals, the square wave and the perfect sine wave, represented both as signal amplitude vs. time and as signal amplitude vs. frequency. The signal vs. frequency display shows the frequency "components" of a periodic waveform. These can be mathematically determined by a process known as Fourier Analysis. A waveform analyzer is the physical embodiment of this method and can resolve signals into their various frequency components in a single display, such as items (b) and (d) of Figure 1. The signal amplitude vs. time displays, such as in items (a) and (c) of Figure 1 maybe obtained using an oscilloscope. The frequency domain display, item (d), of the perfect 400-Hz sine wave in item (c) shows that this signal contains mainly one component at the fundamental frequency. Figure 2, item (a) shows the a.c. line current to a three-phase, full-wave bridge rectifier power supply with resistive load (circuit in item (b)). This signal contains 25 to 30% total harmonic distortion, with the odd, non-triplen harmonic magnitudes approximately  $1/n$  th of the fundamental, where  $n$  is the harmonic number. This rectifier circuit is discussed later in more detail as many of the present shipboard electronic equipments have this type of power supply. Item (c) is a computer simulation of the actual circuit (item (a)). Generally, when any periodic waveform becomes non-sinusoidal, its frequency representation starts to show component signals at integer multiples of the fundamental, in addition to the fundamental.

### B. Amplitude modulation of a sinusoidal signal



Equivalent Signals in Time and Frequency Domains

Item (a)  
Square Wave in Time Domain  
X = 0.5 msec/div  
Y = 0.5 volt/div

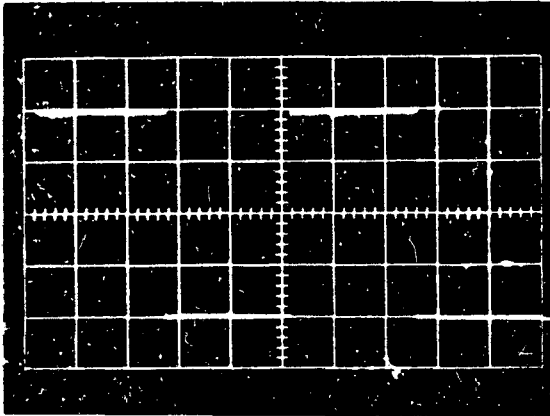

Item (b)  
Equivalent Square Wave  
in Frequency Domain, 0-20kHz  
Y = 10 dB/div

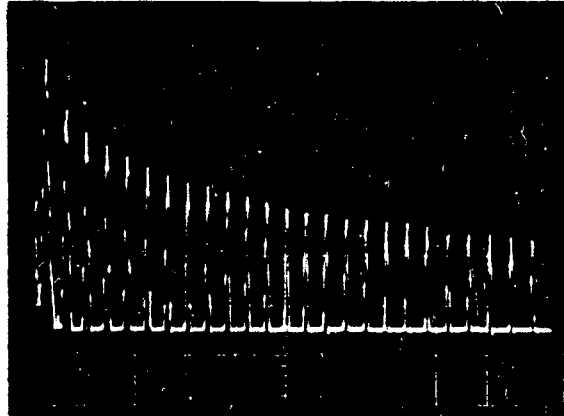

Item (c)  
Near Perfect 400-Hz Wave  
in Time Domain  
X = 0.5 msec/div  
Y = 0.5 volt/div

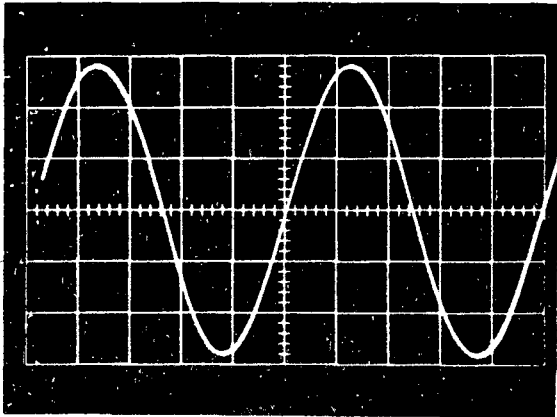

Item (d)  
Corresponding 400-Hz Wave  
in Frequency Domain,  
0-10 kHz  
Y = 10 dB/div

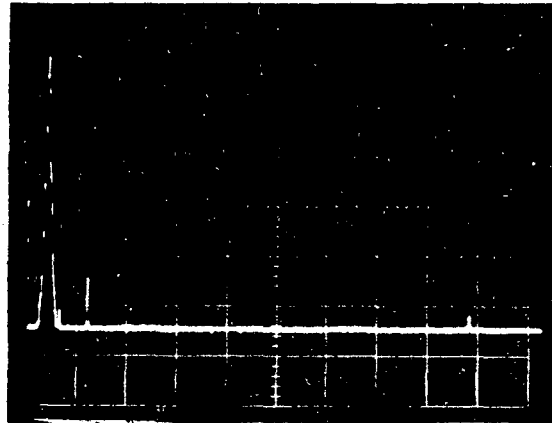

Comparison of Sine and Square Wave Time and  
Frequency Domain Representation

Figure 1

Item (a) - A-C Waveform  
 Y = 20 amp/div  
 X = 0.5 msec/div  
 A 400-Hz 60 kW M-G Set  
 With Full-Wave Bridge Load  
 (22 Amperes)

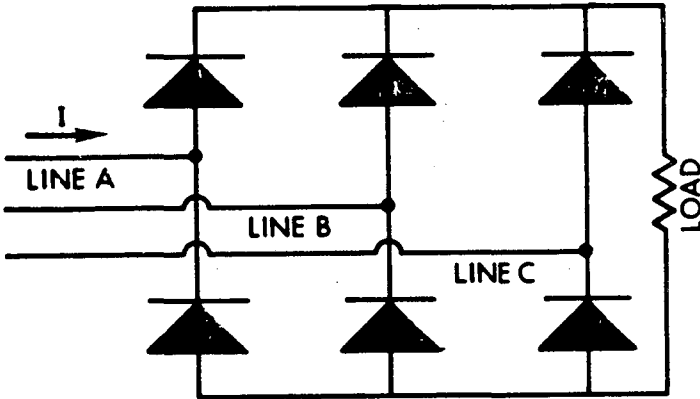
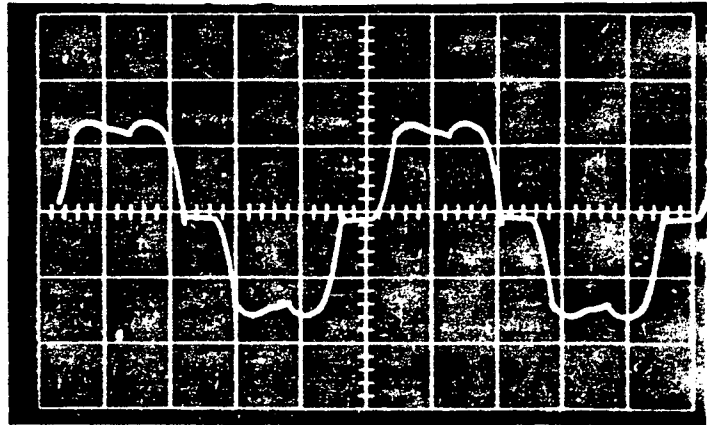

Item (b) - Three-Phase Full-Wave Bridge

Item (c) - Computer Simulated Three-Phase Full-Wave Bridge Current Input

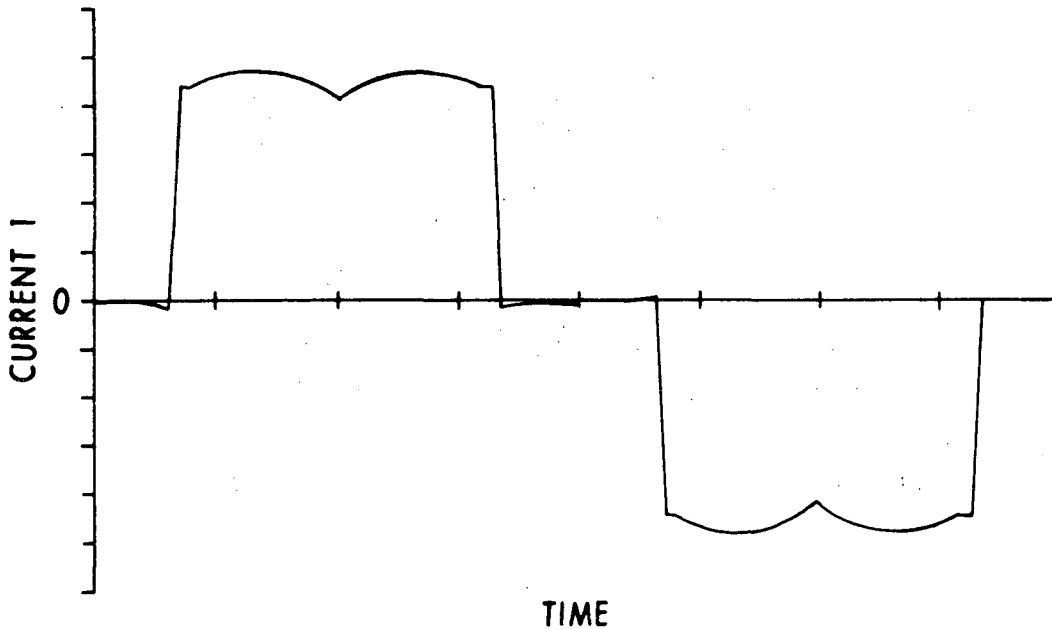

Comparison of "Real Life" and Computer Model  
 Three-Phase Full-Wave Rectifier Bridge Input Line Current  
 Figure 2

Another way that a signal can contain frequency components other than the fundamental is by amplitude modulation of the signal. Items (a) and (b) of Figure 3 show a complex amplitude modulation of the 400-Hz fundamental current into a radar set, which is mainly at a frequency of 16 Hz. Since the amplitude modulation is non-sinusoidal, the frequency breakdown of the signal shows, in addition to the principal modulation sidebands, modulation sidebands on each side of the fundamental at integer multiples of the amplitude modulation frequency. Item (c) is a time photo of the current in items (a) and (b). Item (d) is the system voltage modulation resulting from the modulating current. Item (e) shows individual cycles of the item (c) current and item (d) voltage. If the Figure 3 modulation had been a sinusoidal 16 Hz modulation then only the 416 Hz and 384 Hz side bands would have been present and equal in magnitude in the item (a) current.

#### C. Linear Loads

Linear electric loads draw current in proportion to the applied voltage. If a pure sine wave voltage is supplied to a linear load the resulting current will also be a pure sine wave. The linear loads include resistors, inductors, and capacitors and any conceivable combination of these three elements.

#### D. Nonlinear Loads

Simply stated, a nonlinear electric load is one to which a pure undistorted sine wave of voltage can be applied and the resulting current is not a pure undistorted sine wave. The nonlinear load current can contain a considerable amount of harmonic distortion at multiples of the fundamental frequency. Examples of nonlinear loads in wide use in shipboard electrical equipment include 3-phase full-wave bridge rectifier AC to DC power supplies, saturable reactors, magnetic amplifiers, and variable-voltage-type motor speed controllers, to name a few. The nonlinear circuit elements are actually undergoing significant impedance changes on a subcycle basis.

E. The pulsating nonlinear load is a combination of the nonlinear load and the amplitude modulating load. The interesting phenomenon that usually accompanies this combination is that amplitude modulation sidebands appear on the harmonic distortion components as well as on the fundamental. Several of the navy shipboard high-power pulsing missile guidance and search radars fall into this category.

### SHIPBOARD ALTERNATING CURRENT ELECTRIC POWER QUALITY REQUIREMENTS

The interface standard for Navy shipboard a.c. electric power systems is DOD-STD-1399, Section 300 (formerly MIL-STD-761 and MIL-STD-1399, Section 103.) This standard establishes characteristics and utilization of shipboard a.c. electric power. It establishes limits on the degradation of electric power quality both at the outputs of system power sources and at the input terminals of electric power users.

The intent of this standard is to ensure that equipment designers are aware of the quality of electric power that electrical loads will actually receive so that multiple electric loads operating from the same power source

Item (a)  
Line C Current, 0-500 Hz  
Y = 10 dB/div

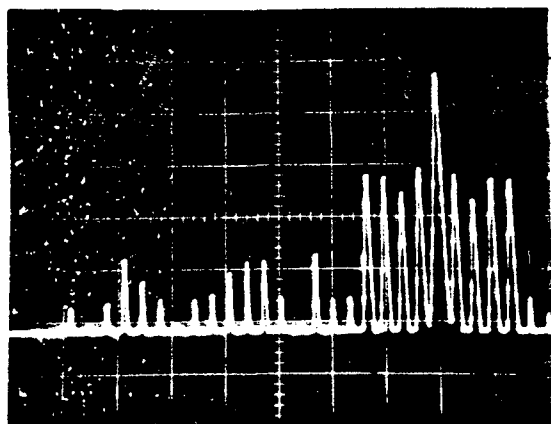

Item (b)  
Line C Current, 0-2 kHz  
Y = 10 dB/div

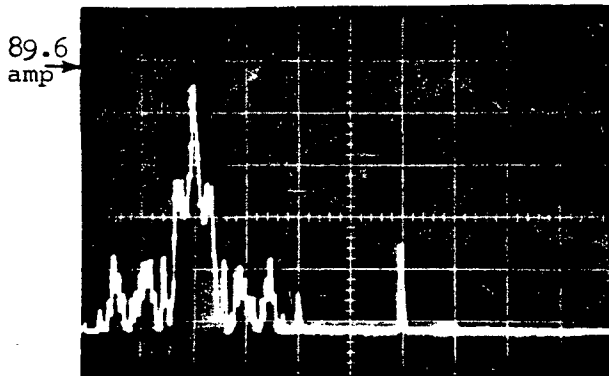

Item (c)  
Line C Current Modulation  
Y = 40 amp/div  
X = 20 msec/div

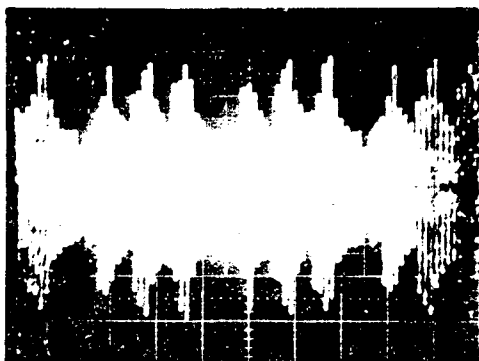

Item (d)  
ØCA Voltage Modulation (1.41% Peak)  
Y = 5.12 volts/div  
X = 20 msec/div

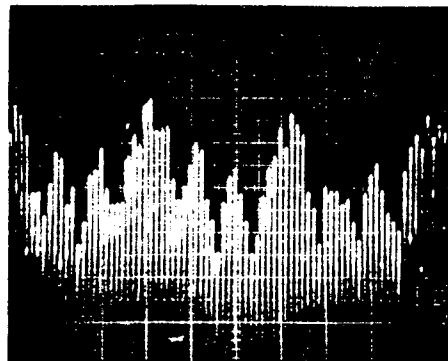

Item (e)  
ØCA Voltage (Large Trace)  
Y = 204.8 volts/div  
Line C Current (Small Trace)  
Y = 40 amp/div  
X = 0.5 msec/div

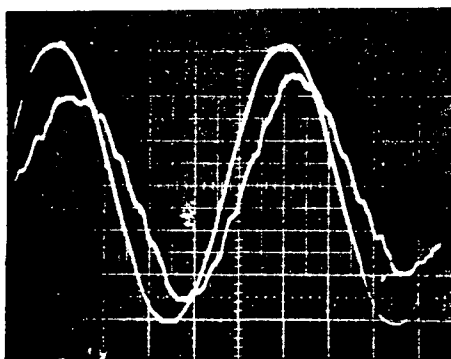

INPUT VOLTAGE AND CURRENT PHOTOGRAPHS OF A  
SHIPBOARD SEARCH RADAR SUPPLIED BY A  
200 KW, 450 VOLT 400 HZ GENERATOR

Figure 3

can operate without interfering with each other. The standard also places restrictions on electronic load equipment to prevent excessive degradation of the system voltage. Figure 4 lists several of the important electric power quality parameters from this standard.

#### SOURCE IMPEDANCE OF ROTATING MACHINES

Figure 5 describes a method of determining the approximate harmonic impedance of a rotating machine while it is de-energized. Figure 6 shows impedance vs. signal frequency plots for several 400-Hz generators using this method. Sixty hertz machines have source inductance at harmonic frequencies which are 6.67 times (400 : 60) higher than those of the 400-Hz machines. However, since the corresponding harmonic frequencies of the 60 Hz machines are 6.67 times lower numerically, than those of the 400-Hz machines, the higher inductance is exactly compensated for by the lower frequency, with the end result that the impedances of both 60 and 400 Hz machines are numerically equal for the same number harmonic i.e., the 2000 Hz (5th harmonic) impedance, in ohms, of a 400 Hz, 100 kW machine is approximately the same as the 300 Hz (5th harmonic) impedance of a 60-Hz 100 kW machine.

Another method of empirically determining the approximate harmonic impedance of a machine would be to operate a relatively high power nonlinear load on the machine. By dividing the generator's line to neutral equivalent harmonic voltage (this is the line-to-line harmonic voltage divided by  $\sqrt{3}$ ) by the corresponding load harmonic current, a harmonic source impedance can be established at each harmonic frequency. This method requires that the output voltage of the machine have relatively low harmonic distortion before the large nonlinear load is applied, i.e. minor interference from static exciter and field regulation circuits. Figure 7 shows this method of determining the total source impedance of a 400-Hz power source containing a generator, transformer, and a line voltage regulator (LVR). For this system the slope of the impedance versus frequency line is 55 microhenries, the line to neutral source impedance.

A quick "ball-park" rule for figuring the relationship between nonlinear load harmonic currents and the harmonic voltage they create on the generator is as follows: when the 5th harmonic current drawn (or more correctly generated) by the nonlinear load equipment is two-to the three percent of the full-load 0.8 power factor current rating of the generator, the 5th harmonic voltage developed on the generator terminals will be approximately 2% of the fundamental. However, since the harmonic impedance of the generator is mostly inductive it takes only 1% 11th harmonic current to generate 2% 11th harmonic voltage; similarly only 0.5% 23rd harmonic current will generate 2% 23rd harmonic voltage, and so on. However, since higher frequency components of most nonlinear loads decrease in magnitude at a higher rate (> 6 db/octave) than the generator harmonic impedance is increasing (6 db/octave) the higher frequency components are not usually a problem to the power system.

#### RELATIONSHIP BETWEEN GENERATOR HARMONIC VOLTAGES AND NONLINEAR LOAD HARMONIC CURRENTS

The design of nearly all generators is such that when linear loads are applied the voltage distortion is usually within the type III power limits of DOD-STD-1399 Section 300. The contribution of machine winding imperfections,

Figure 4

ELECTRIC POWER, ALTERNATING CURRENT

INTERFACE STANDARDS FOR SHIPBOARD SYSTEMS

MIL-STD 1399, SECTION 300 - GENERALIZED REQUIREMENTS

ELECTRICAL POWER CHARACTERISTICS (PARTIAL LIST)

PARAMETER	TYPE I	TYPE II	TYPE III
VOLTAGE (RMS)	440 OR 115	440 OR 115	440 OR 115
FREQUENCY (HZ)	60	400	400
STEADY STATE TOLERANCES			
VOLTAGE	± 5%	± 5%	± 1/2%
VOLTAGE MODULATION	2%	2%	1%
TOTAL HARMONIC DISTORTION	5%	5%	3%
MAXIMUM SINGLE HARMONIC	3%	3%	2%
FREQUENCY	3%	5%	1/2%
SPIKE VOLTAGE (VOLTS)	2500	2500	2500

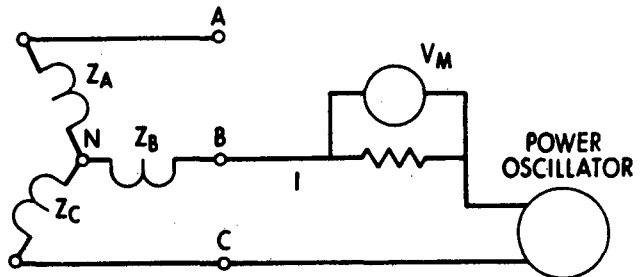
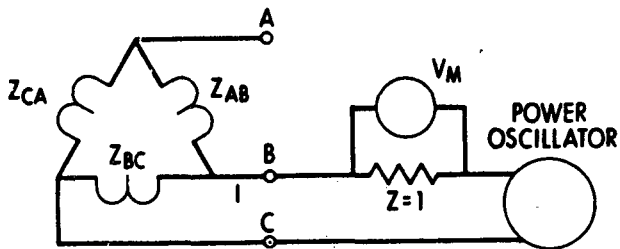

DELTA

$$z_{\phi} = z_{BC}(z_{AB} + z_{CA}) / (z_{AB} + z_{BC} + z_{CA})$$

$$z_{BC} = z_{AB} = z_{CA}$$

$$z_{\phi} = z_{BC}(2z_{BC}) / (3z_{BC}) = 2z_{BC}/3 = v_{BC}/I$$

Where:

$$I = v_M/z \text{ (By definition (from Wye equivalent circuit))}$$

$$z_{L-N} = v_{BC}/zI.$$

$$\therefore z_{L-N} = z_{\phi}/2 = z_{BC}/3$$

$z_{\phi}$  = Impedance per phase

$z_{L-N}$  = Equivalent line-to-neutral impedance

$z_{L-L}$  = Line-to-line impedance

I = Input current (injected by oscillator)

$v_{BC}$  = Voltage per phase

$v_M$  = Voltage proportional to current flow (I) through Z

WYE

$$z_{L-N} = z_A = z_B = z_C$$

$$z_{\phi_{B-C}} = z_B + z_C$$

$$z_{L-L} = 2z_B = 2z_{L-N} = v_{B-C}/I$$

Where:

$$I = v_M/z$$

$$\therefore z_{L-N} = v_{B-C}/2I = z_B$$

Determination of 3-Phase Rotating Power Source Harmonic Impedance by Stationary Signal Injection Technique

Figure 5

Figure 6

SOURCE IMPEDANCE VS FREQUENCY  
FOR SEVERAL 400-HZ, 450-VOLT GENERATORS

OBSERVATION: A QUICK "BALL-PARK" RULE FOR ESTIMATING THE RELATIONSHIP BETWEEN HARMONIC LOAD CURRENTS AND THE CORRESPONDING VOLTAGES THEY CREATE ON THE GENERATOR OUTPUT TERMINALS IS: WHEN THE 5TH HARMONIC CURRENT GENERATED BY THE NONLINEAR LOAD IS 2-3% OF THE FULL-LOAD, 0.8 PF CURRENT RATING OF THE GENERATOR, THE 5TH HARMONIC VOLTAGE DEVELOPED ON THE GENERATOR TERMINALS WILL BE APPROXIMATELY 2% OF THE FUNDAMENTAL.

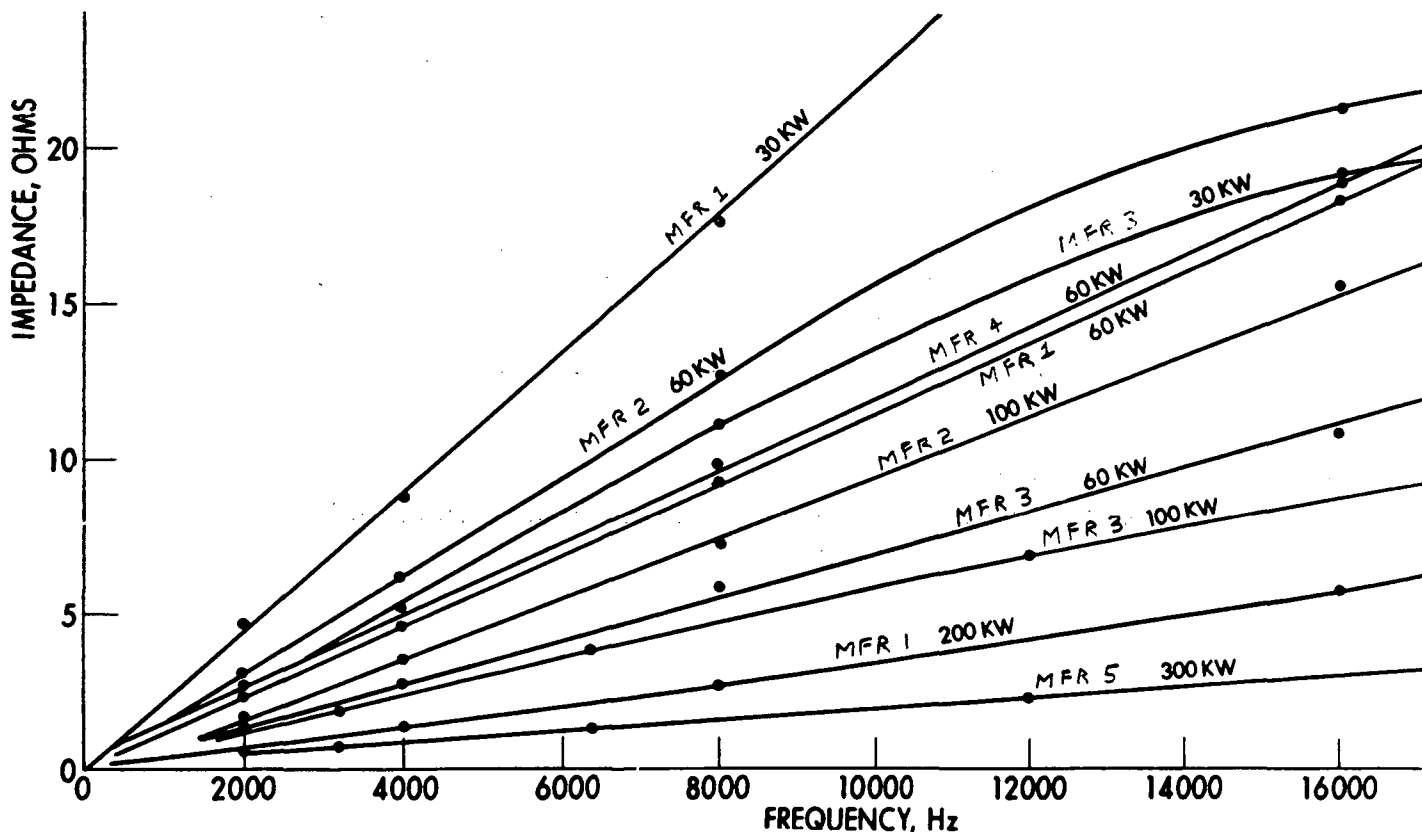



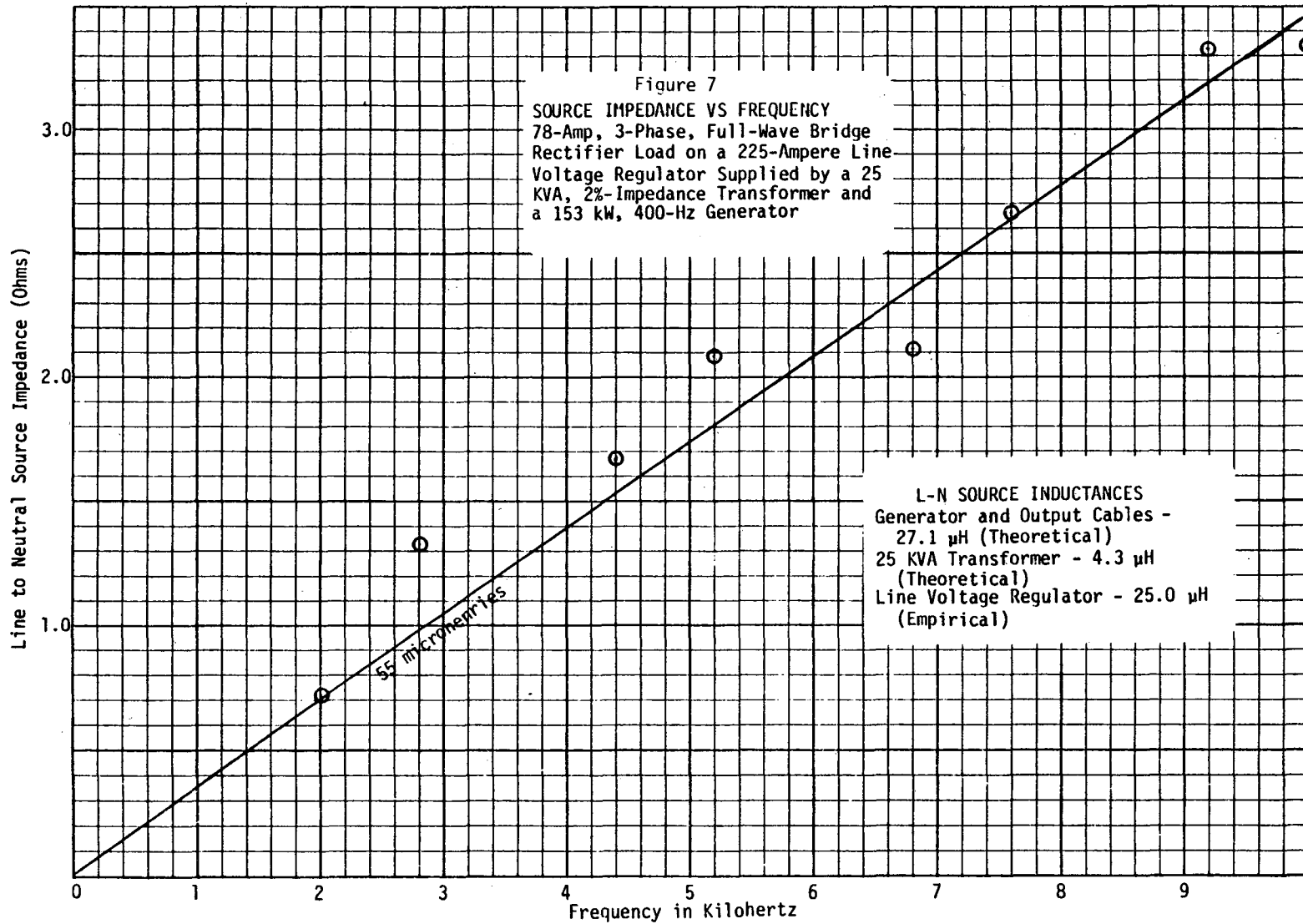

slot phenomena, etc. are rarely ever the cause for more than 0.5 to 1.5% harmonic distortion. To supply field current, most generators have nonlinear static exciters fed from the output voltage, and on the smaller kW size machines, are a significant contributor to output voltage harmonics. The field requirements for rotating machines vary from less than 1% of the generator's full-load rating, for large machines, to as much as 10% for small machines. Because of this the static exciter and voltage regulator contribution to output voltage harmonics can be significant on the smaller machines.

When a nonlinear load is applied to a generator, the generator is forced to circulate the harmonic currents demanded by the load. The generator does not generate the harmonic current in the same manner that a voltage pushes a current through an impedance. With a nonlinear load, the harmonic currents are generated by the changing impedance characteristics of the nonlinear load itself. The generator simply looks like an inductor to harmonic currents flowing from nonlinear loads. The generator's impedance to the flow of these currents is measurable and fairly predictable. Thus, degradation of the source voltage waveform is a natural consequence of nonlinear loads operating on the system. Figure 8 depicts this same situation in a familiar home situation using commercial electric power.

#### RECTIFIER LOADING EFFECTS

The three-phase, full-wave, bridge-rectifier a.c. to d.c. power supply is widely used in most shipboard electronic equipment. This type of nonlinear load generates odd, non-triplen harmonic currents on the a.c. input line at approximately  $1/n$  ratio, where  $n$  is the harmonic number; i.e., the 5th harmonic current is approximately  $1/5$  or 20% of the fundamental, the 7th is  $1/7$  or 14% of the fundamental, and so on. In actual practice this type of power supply is usually accompanied by a transformer and output d.c. filtering with the overall result that the higher number harmonic currents on the a.c. input line are considerably less than the  $1/n$  rule values. From the above relationships between harmonic currents and voltages on rotating machine terminals it would appear that when three-phase full wave bridge rectifier loads are used on rotating generators, on the order of 2% 5th harmonic voltage will be developed on the generator terminals when the machine is loaded to only 10 to 15% of its actual rating. Also since the machine impedance to harmonics is basically an inductance, the higher odd non-triplen harmonic voltage usually contribute significantly to the total voltage harmonic distortion. Referring back to Figure 2, the actual current measured on the input of a three-phase full wave bridge rectifier and associated transformer and also the theoretical line current harmonics for a three phase full wave bridge rectifier circuit without a transformer supply are shown for comparison.

#### STATIC (NON-ROTATING) POWER SOURCES

In the past few years solid state frequency changers which convert 60 Hz power into 400-Hz power have replaced rotating motor generator sets in some shipboard applications. In general they have less harmonic distortion than equivalent size MG sets when supplying the same nonlinear load. The reason for this is usually that the solid state units often have large passive output

# INTERFERENCE BETWEEN ELECTRICAL LOADS

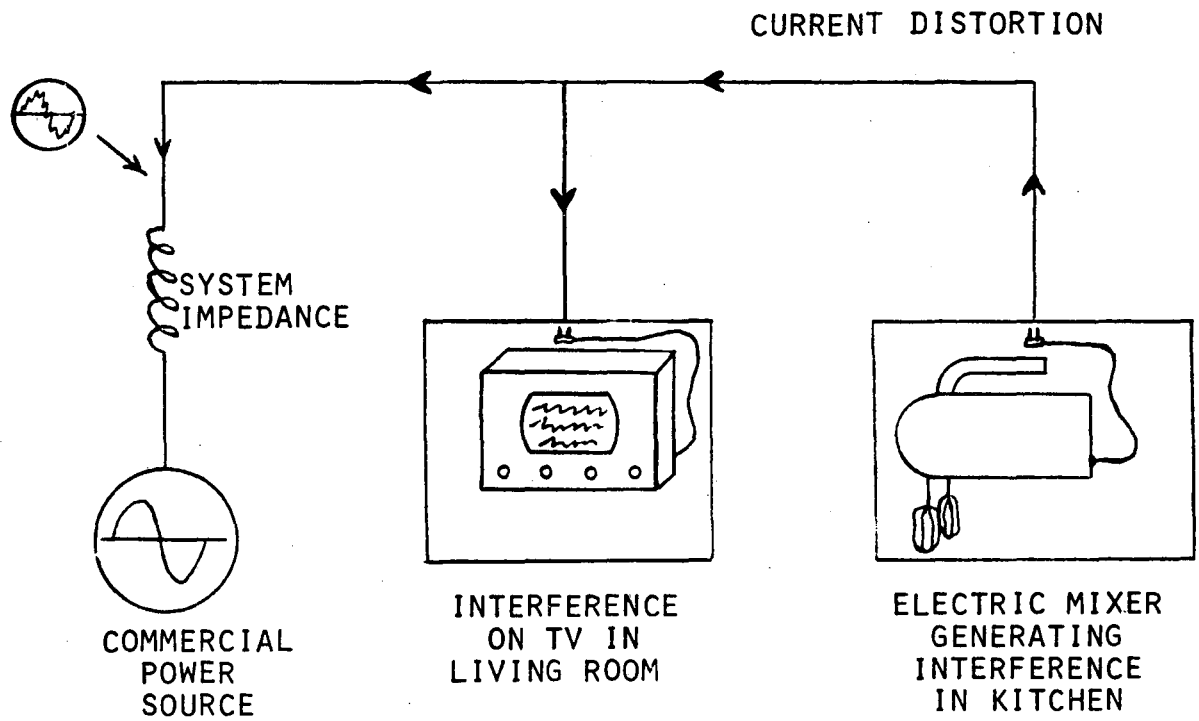

Figure 8

filters which serve a dual purpose. The filters remove distortion from the internally generated voltage which is usually a piece-meal generated non-sinusoidal wave. The same output filter also aids in circulating harmonic currents from nonlinear loads so that these currents are not reflected as voltage harmonics by the frequency changer output impedance.

#### REDUCTION OF NONLINEAR LOAD EFFECTS BY ACTIVE OR PASSIVE FILTERING

The generation of interference between electrical system equipments and possible approaches to correction is shown diagrammatically in Figure 8. In situations where nonlinear load harmonic distortion is excessive there are several alternatives. These include (1) lowering the source impedance by larger capacity generators, (2) redesigning the load so that it is more linear, (3) isolation of high-interference loads and highly sensitive loads by dedicated power sources, or (4) installation of interface hardware (active or passive filters) so that neither the load equipment nor the power sources have to be changed.

Changing the generator to a higher capacity unit and isolating the high-interference and highly sensitive loads by dedicated systems are usually expensive approaches. In a number of cases redesigning the a.c. to d.c. power supplies of nonlinear loads from the three-phase full wave rectifier type to the multiphase rectifier type has been successful in establishing load/source compatibility. The active or passive filter approach has the advantage of not having to make changes to either the power source or the existing nonlinear loads. With this approach there is no need to prevent harmonic currents from flowing out of the nonlinear loads into the power system. Rather, the flow of load harmonic currents are diverted into the interface device, or filter, and circulated between the nonlinear load and the filter. Such a filter could be thought of as a garbage disposal path. The proportionality constant between the harmonic currents and system harmonic voltages is the total system impedance. This includes mainly all the linear loads on the system of which the generator itself is by far the lowest in impedance. The effect, therefore, of a shunt-type interface filtering device is to divert the distortion components away from the generator and linear system loads into the filter. It will also reduce source-generated distortion by a voltage divider action between the source impedance and the shunt filter elements. Several approaches to accomplishing this are shown in figures 9 thru 11.

#### SUMMARY

The problem of degraded electric power quality and improper operation of sensitive loads on the system is not likely to be cost-effectively resolved without communication between power system designers and the system load equipment designers. The power system designers could insist that the loads become more linear, less pulsing, and have gentle energization characteristics so that the power system is not perturbed by the loads. Meanwhile the load equipment designers may insist that their equipment is not working as intended and blame it on "bad power", hoping that the power system designers will increase their cable sizes, transformers, generators, etc. and provide lower source impedance, so that the loads can remain nonlinear but the conversion of load harmonic currents into source harmonic voltages will be reduced. Both the load and the source designers may welcome the interface active or passive

device which usually requires little or no changing of the source or the loads. Whichever method or combination of methods is decided upon communication is necessary between the various efforts for cost effective solutions.

## SHUNT FILTERING OF UNWANTED DISTORTION

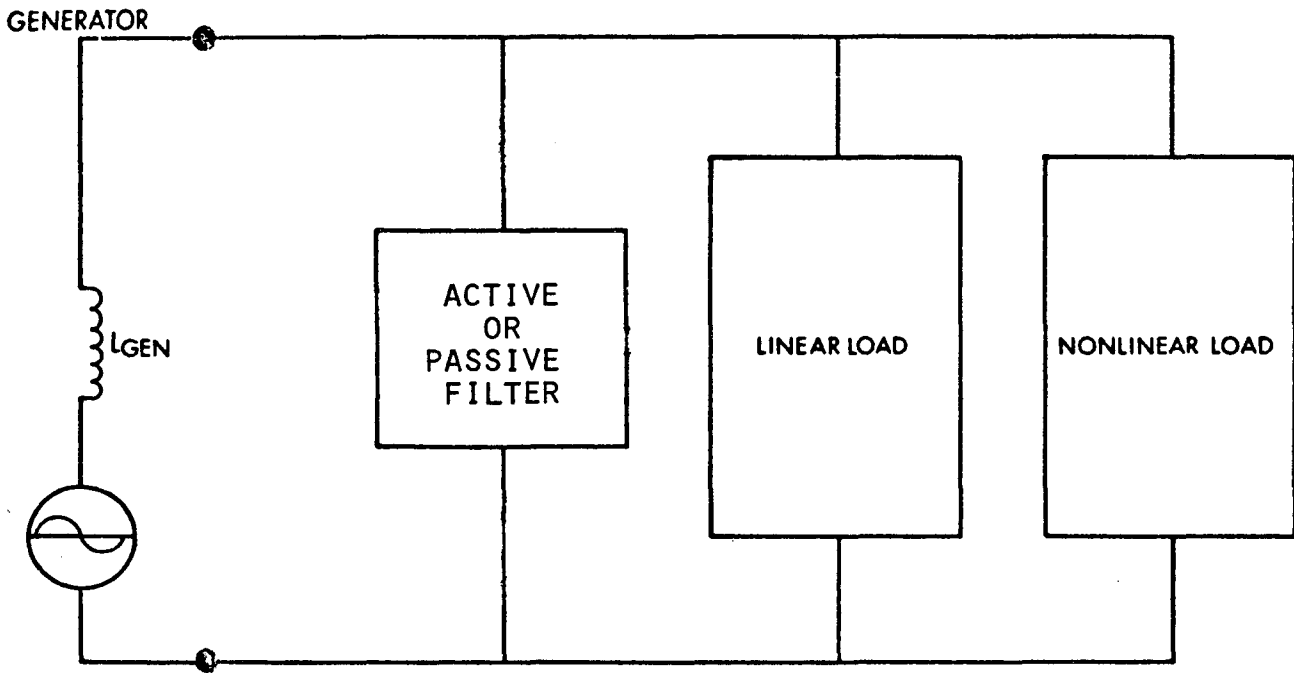

### DESIRABLE FILTER CHARACTERISTICS

- A. HIGH IMPEDANCE TO FUNDAMENTAL
- B. LOW IMPEDANCE TO UNWANTED DISTORTION
- C. NO SERIES LINE ELEMENTS
  - 1. RATED FOR FULL GENERATOR LINE CURRENT
  - 2. REDUCES SYSTEM RELIABILITY

Figure 9

## A DISCRETE - FREQUENCY APPROACH TO SHUNT FILTERING OF UNWANTED DISTORTION

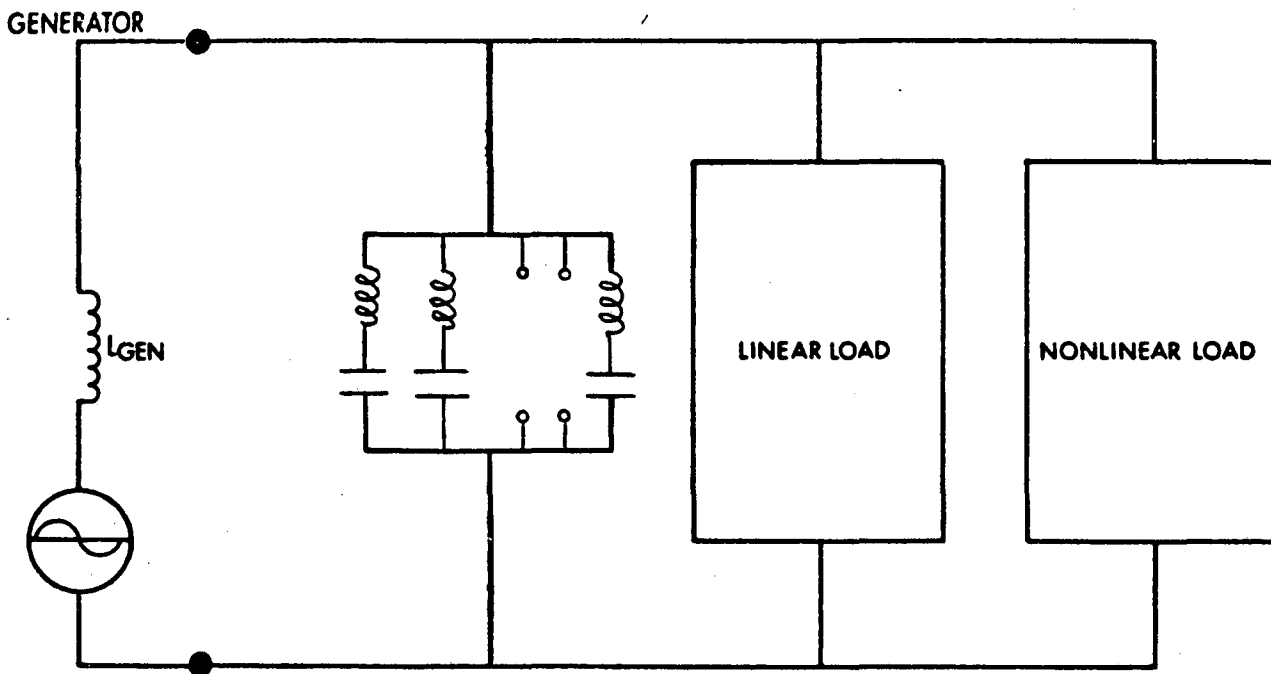

Figure 10

### FILTER CHARACTERISTICS

- A. ONE L-C PAIR FOR EACH UNWANTED FREQUENCY
- B. LOW IMPEDANCE TO UNWANTED DISTORTION
- C. NO SERIES LINE ELEMENTS
- D. RELATIVELY LOW CAPACITIVE IMPEDANCE TO FUNDAMENTAL
- E. NEEDS GAIN CONTROL AT FREQUENCY WHERE FILTER CAPACITANCE IS PARALLEL RESONANCE WITH GENERATOR INDUCTANCE

## A BROADBAND APPROACH TO SHUNT FILTERING OF UNWANTED DISTORTION

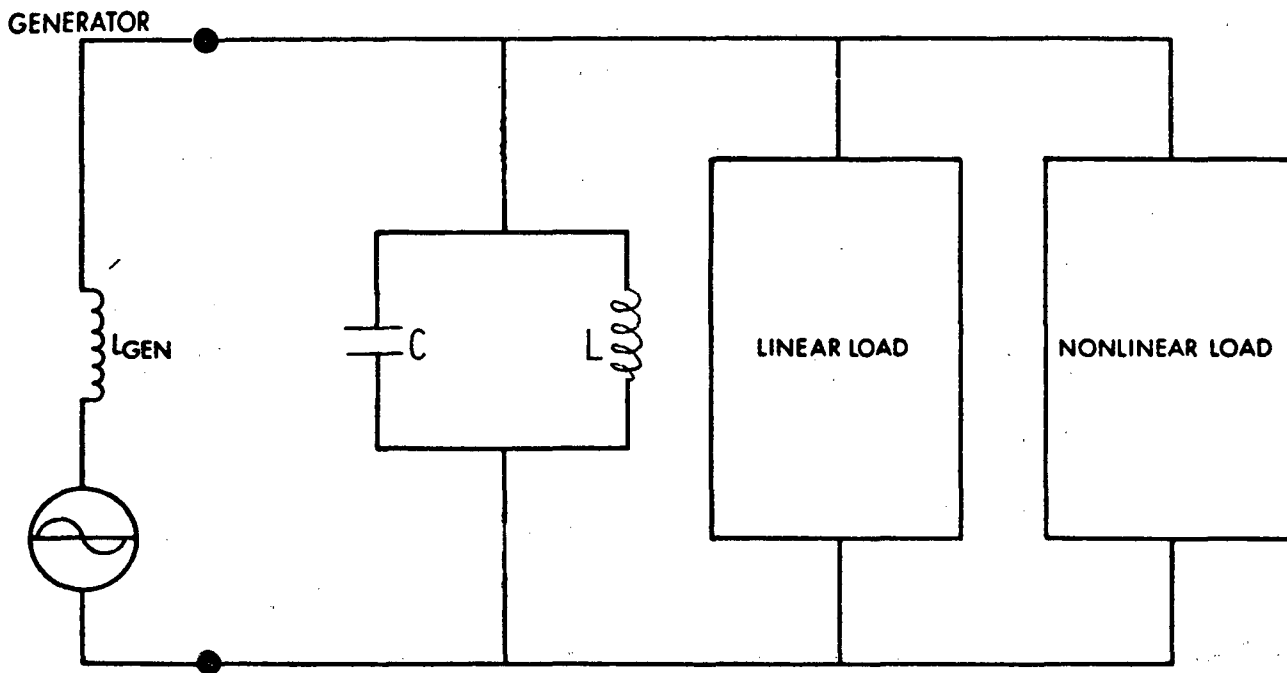

Figure 11

### FILTER CHARACTERISTICS

- A. HIGH IMPEDANCE TO FUNDAMENTAL
  - B. LOW IMPEDANCE TO UNWANTED DISTORTION
  - C. NO SERIES LINE ELEMENTS
  - D. NEEDS GAIN CONTROL AT FREQUENCY TO FUNDAMENTAL
- CAPACITANCE IS IN PARALLEL RESONANCE WITH  
GENERATOR INDUCTANCE



CONDUCTED AND RADIATED SIGNATURES OF FLUORESCENT LAMP SYSTEMS  
IN C&I ENVIRONMENTS

SINA JAVIDI  
GENERAL ELECTRIC COMPANY  
FLUORESCENT SYSTEMS DEPARTMENT  
NOBLE ROAD, NELA PARK  
EAST CLEVELAND, OHIO 44112

ABSTRACT

The power-line conducted EMI and radiated EMI generated by four samples of electronic fluorescent ballasts, and four samples of electromagnetic ballasts are presented. Conducted and radiated test protocols are given for these experiments. Proposed FCC limits under Part 18 of Rules and Regulations are compared to the EMI levels of the test samples.

## 1 WHY THE TREND TO ELECTRONIC LIGHTING SYSTEMS?

Due to the rising cost of energy and the need for energy conservation, increased attention is being focused on design and development of electronically ballasted lighting systems for home environment use as well as in commercial/industrial applications. The initial cost of these systems are justified via energy savings. The energy cost savings are the result of higher power conversion efficiency inherent to electronic lighting systems and the ability to manage the energy required through the use of controls.

## 2 THE IMPACT OF THE FCC REGULATIONS

The FCC has jurisdiction over electronic lighting systems operating at or above 10 KHz, under Part 18 of the current Rules and Regulations. The proposed Rules under Part 18 are designed to limit conducted EMI emanations for the frequency band of 10 KHz. Radiated EMI specifications will limit the out-of-band emissions for the frequency interval of 10 KHz to 18 GHz. Any ISM equipment operating at a frequency not designated as an ISM frequency will have to comply with the proposed limits, if the limits are adopted.

Most electronic ballasts designed for the C&I market would probably utilize metal enclosures, therefore the radiated interference will be greatly attenuated. In this case the FCC proposed limits of out-of-band emissions will not impose an unreasonable problem, except for very low frequencies such as the band below 500 KHz.

In the case of conducted emanations a similar situation exists. Above the frequency of 500 KHz, filter components of reasonable cost and size can be implemented to reduce the conducted EMI. However, in order to filter out the harmonics within the LF and MF bands (e.g., 10 KHz), larger components must be used, and the cost of such components may be prohibitive.

## 3 TEST SAMPLES

Four samples of electronic fluorescent ballasts and four samples of electromagnetic fluorescent ballasts were acquired. The experimentation purpose was to determine EMI levels generated by the electronic and electromagnetic ballasts currently available in the market.

#### 4 TEST EQUIPMENT

For power line conducted and radiated EMI measurements the following test equipment were employed:

- HP Spectrum Analyzer  
141T Display Section  
8443A Tracking Generator  
8353B RF Section  
8552B IF Section
- HP 7004B X-Y Recorder  
1717A Preramps for X, and Y channels  
17175A Response Filter for Y channel
- HP 8447A Preamplifier
- Quasi-Peak Detector (Built to the FCC specs)
- Solar 7334-1 Loop Antenna
- Singer 95010-1 Rod Antenna
- Solar 7333-57-PJ-50-N LISN's

Tektronix 7603 Mainframe Oscilloscope, and 7L5 Spectrum Analyzer (with L3 module). This unit was used for peak detection.

#### 5 GENERAL MEASUREMENT CONSIDERATIONS

- Reception Band-Width of 10 KHz was set for all measurements.
- One hour warm-up period was allotted for EMI test equipment.
- Five minute warm-up period was allotted for devices under test in all experiments.
- All measurements were performed in a shielded room. For the case of radiated field measurements the results are not perfectly accurate due to the field reflections in the shielded room. However, since an open-field measurement site was not readily available, field measurements were performed in a shielded room, and the assumption was that field reflections by all test samples will produce the same effects in the field measurement experiments. Therefore, although each field signature may not be perfectly accurate by itself, it will be very accurate relative to other signatures.

## 6 CONDUCTED EMI MEASUREMENTS

Figure 1 displays the test set up for conducted EMI measurements. Both HP and Tektronix spectrum analyzers were used. The Quasi-Peak detector was used in conjunction with the HP spectrum analyzer to yield Q-P signatures. The Tektronix spectrum analyzer was used to yield the peak signatures.

## 7 RADIATED EMI MEASUREMENTS

Figure 2 displays the test set-up for radiated magnetic and electric fields (H-field and E-field respectively). The loop antenna and the pre-amplifier were employed for H-field measurements. The rod antenna was used for E-field measurements. Both Q-P and peak signatures were obtained. The antenna was placed 10 inches away from the ballast. Within a 10 inch radius, the location of maximum field pick-up was determined and then the experiment began. Radiated measurements were also performed at one meter distance.

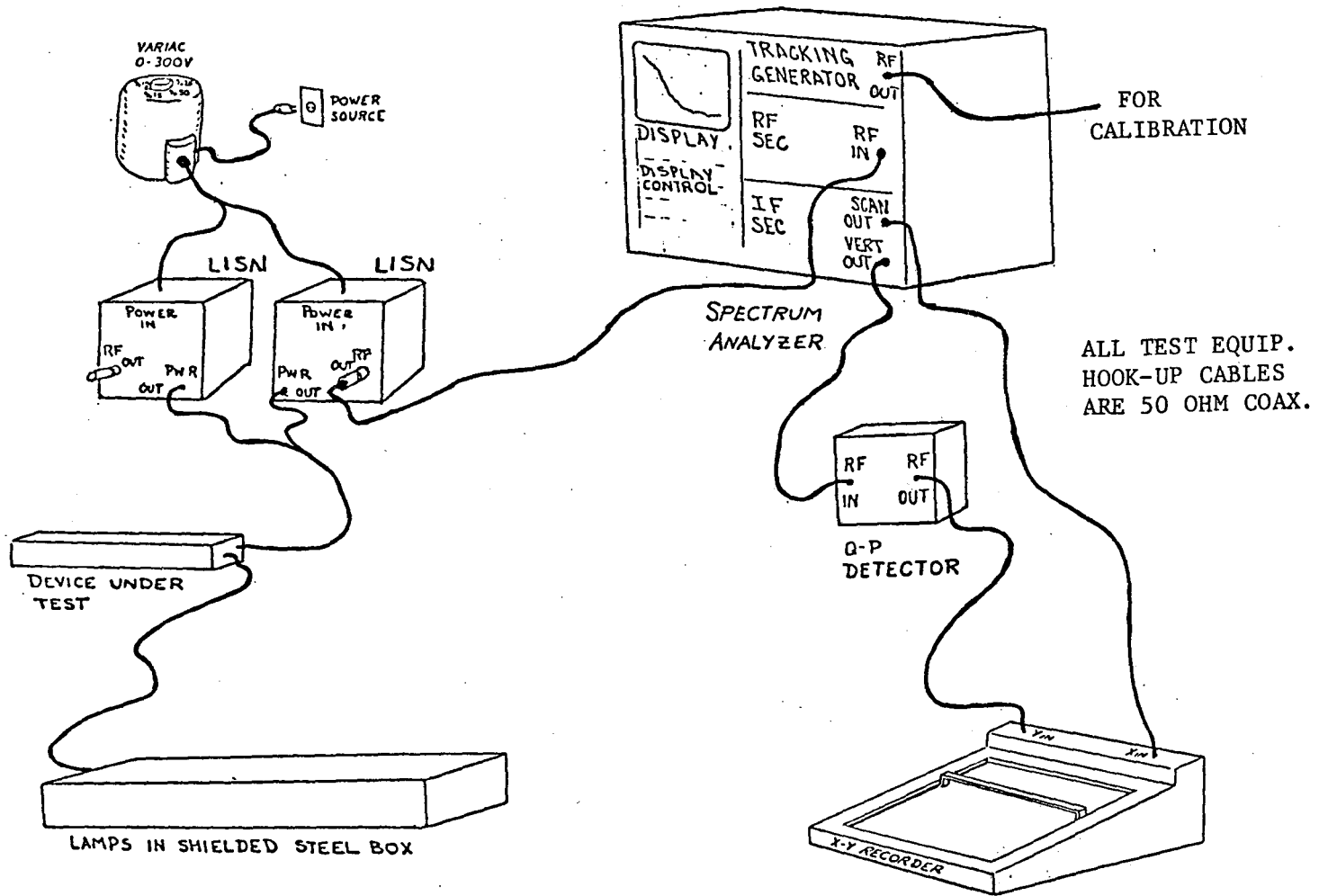

CONDUCTED EMI TEST PROTOCOL  
FIG.1.

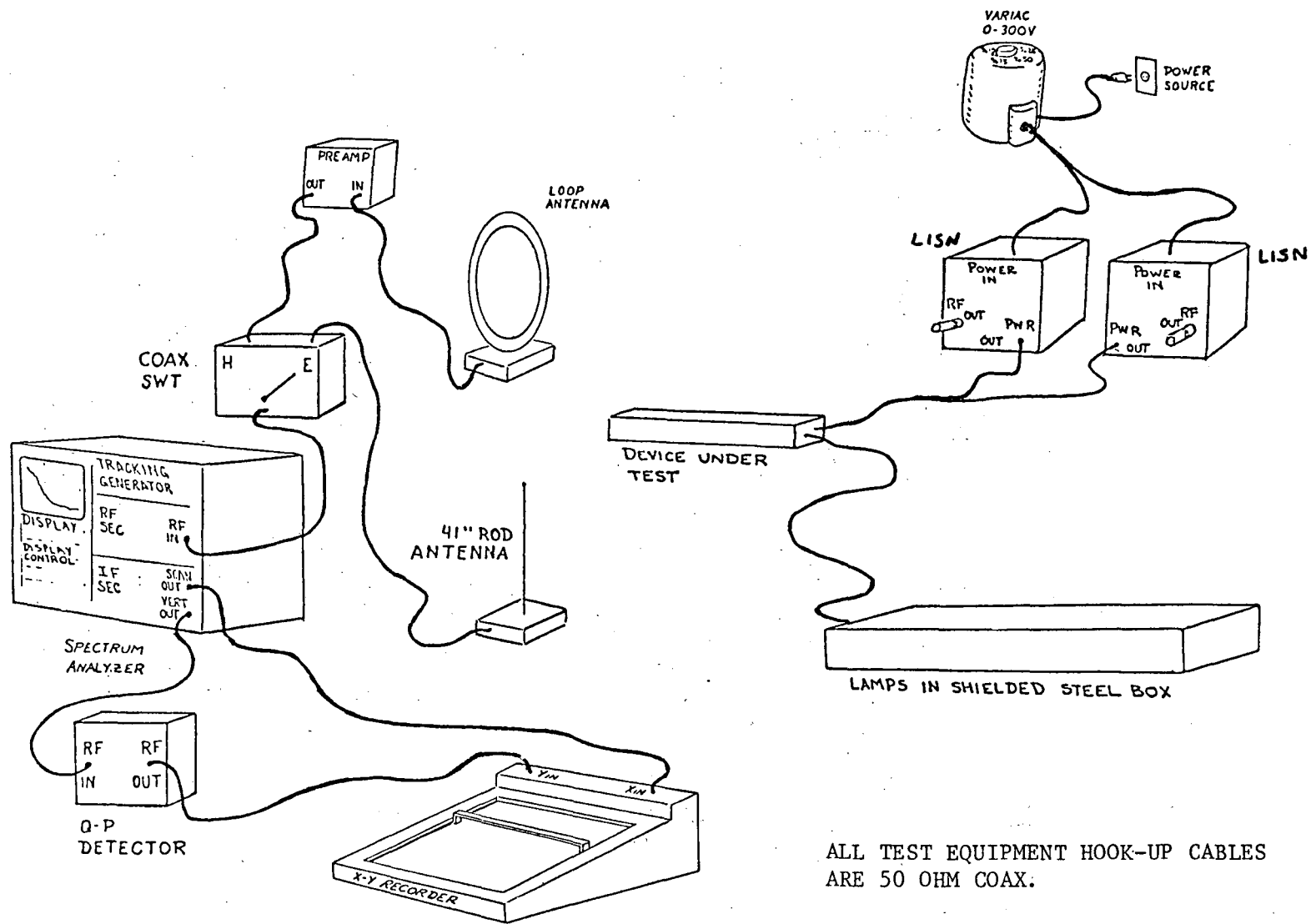

RADIATED EMI TEST PROTOCOL.  
FIG. 2

ALL TEST EQUIPMENT HOOK-UP CABLES  
ARE 50 OHM COAX.

## 8 TEST RESULTS

Attached graphs display the conducted and radiated EMI signatures generated by all eight samples tested. On every sheet the Quasi-Peak signatures for the frequency interval of 0 to 5 MHz (labeled A), and 0 to 50 MHz (labeled B) are displayed. In addition to the Q-P signatures, the Peak signatures are superimposed on each graph. The classification of attached graphs is as follows:

- 1a thru 4a: Conducted EMI, Electronic Fluorescent Ballasts.
- 5a thru 8a: Conducted EMI, Electro-Magnetic Fluorescent Ballasts.
- 1b thru 4b: Radiated H-Field, Electronic Fluorescent Ballasts, 10" dist.
- 5b thru 8b: Radiated H-Field, EM Ballasts, 10" dist.
- 1c thru 4c: Radiated E-Field, Electronic Fluorescent Ballasts, 10" dist.
- 5c thru 8c: Radiated E-Field, EM Ballasts, 10" dist.
- xb: Radiated H-Field, Electronic Fluorescent Ballast, 1 m distance.
- xc: Radiated E-Field, Electronic Fluorescent Ballast, 1 m distance.
- yb: Radiated H-Field, EM Ballast, 1 m distance.
- yc: Radiated E-Field, EM Ballast, 1 m distance.
- For all graphs the following apply:

Label (A): 0-5 MHz, Quasi-Peak, HP Equipment.

Label (B): 0-50 MHz, Quasi-Peak, HP Equipment

Superimposed Picture: 0-5 MHz, Peak, Tektronix Equipment.

Solid Lines: Proposed FCC Limits of Part 18 For Commercial ISM Equipment. These lines correspond to 0-5 MHz scale (i.e., scale A)

## 9 FCC PROPOSED LIMITS OF P18, ISM EQUIPMENT

### 9.1 Radiated Fields Limits

#### OUT OF BAND EMISSION LIMITS

#### SECTION 18.108

<u>Frequency (MHz)</u>	<u>Field Strength (uv/m)</u>	<u>Distance (meters)</u>	<u>Band No.</u>
0.01 to 0.85	200	30	1
0.285 to 0.440	900	30	2
0.490 to 1.605	200	30	3
1.605 to 3.950	900	30	4
3.950 to 30.0	200	30	5
30 to 108	30	30	6

TABLE 1

Assuming that fields will be attenuated as inverse of distance, we will find the following relation:

$$H_1/H_2 = d_2/d_1; \text{ assuming } 1/d \text{ field attenuation,}$$

where:

H<sub>1</sub> = Fields at the distance d<sub>1</sub>

H<sub>2</sub> = Fields at the distance d<sub>2</sub>

In general if it is assumed that fields will be attenuated as the n-th power of inverted distance then the general formula becomes as follows:

$$H_1/H_2 = (d_2/d_1)^n; \text{ assuming } (1/d)^n \text{ field attenuation,}$$

Since open field site was not readily available all the radiated field measurements were performed in a shielded room, and the distance from the antenna to the device under test was 10 inches, and 1 meter.



The following table displays the interpolation results from 30 meters to 10 inches, for n=1,2, and 3.

Sec. 18.108 of FCC P18  
Interpolated to 10 inches \*  
(1/r)<sup>n</sup> Assumption

Frequency MHz	FIELD STRENGTH							Band No.
	n=1		n=2		n=3		Distance inches	
	v/m	dBuv/m	v/m	dBuv/m	v/m	dBuv/m		
0.01 to 0.285	0.024	87.45	2.78	128.88	327.77	170.31	10	1
0.285 to 0.49	0.11	100.52	12.51	141.95	1,474.97	183.38	10	2
0.49 to 1.605	0.024	87.45	2.78	128.88	327.77	170.31	10	3
1.605 to 3.95	0.11	100.52	12.51	141.95	1,474.97	183.38	10	4
3.95 to 30	0.024	87.45	2.78	128.88	327.77	170.31	10	5
30 to 108	3.54E-3	70.97	0.42	112.40	49.17	153.83	10	6

TABLE 2

\* The formula for interpolation employed here is as follows:

$$\text{Field Strength} = (\text{F.S. at 30 meters}) \left( \frac{30\text{m}}{10 \text{ in}} \right) \left( \frac{39.37\text{in}}{\text{m}} \right)^n$$

at 10 inches

$$\text{F.S. in dBuv} = 20 \log \text{F.S./lv}$$

Table 3 displays the interpolation results from 30 meters to 1 meter, for n=1,2, and 3.

$$F.S. \text{ at } 1m = (F.S. \text{ at } 30m)(30m/1m)^n$$

Frequency	FIELD STRENGTH						BAND No.
	n=1		n=2		n=3		
MHz	V/m	dBuv	V/m	dBuv	V/m	dBuv	
0.01 to 0.285	0.01	75.56	0.18	105.11	5.40	136.65	1
0.285 to 0.49	0.03	88.63	0.81	118.17	24.30	147.71	2
0.49 to 1.605	0.01	75.56	0.18	105.11	5.40	136.65	3
1.605 to 3.95	0.03	88.63	0.81	118.17	24.30	147.71	4
3.95 to 30	0.01	75.56	0.18	105.11	5.40	136.65	5
30 to 108	0.90E-3	59.08	0.03	88.63	0.81	118.17	6

TABLE 3; DISTANCE = 1m

### 9.2 Conducted EMI Limits

The power line conducted EMI limits, under the FCC proposed limits of Part 18, Nonconsumer ISM Equipment are displayed in Table 4.

FCC PROPOSED LIMITS P18, NON-CONSUMER ISM EQUIPMENT  
(AVERAGE VALUE)  
CONDUCTED EMI

Frequency KHz	Non-Consumer ISM Equipment	
	mv	dBuv
10 to 100	10.0	80
100 to 150	10.0	80
150 to 200	3.0	69.54
200 to 500	2.0	66.02
500 to 30,000	1.0	60

TABLE 4

## 10 SUMMARY OF RESULTS

Graphs #9 thru 14 display the EMI profiles obtained from all eight samples in a compact form. Samples generating the highest degree of EMI, and lowest degree of EMI have been displayed in a piecewise - linear format. The FCC proposed limits are superimposed on these graphs. The scale selected on these six graphs is the scale A, or 0-5MHz scale, because in most cases the noise levels above 5 MHz were way below the proposed limits.

The results have been categorized into two groups, namely electronic ballasts EMI profiles group, and electromagnetic ballasts EMI profiles group. Each group has been subcategorized into three subgroups, namely conducted EMI, radiated H-field, and radiated E-field subgroups. Therefore, there are six, (2\*3), graphs.

## 11 ANALYSIS OF THE RESULTS & COMMENTS

A careful study of the EMI signatures generated by eight samples under test reveals the following facts about these samples:

- Radiated EMI generation by both electronic and electromagnetic is reasonably "low", when compared to the proposed limits under the FCC P18 of Rules and Regulations. The only problem area is the EMI levels below 500 KHz. At such low frequencies the task of reducing noise levels will be costly and difficult.

### Pertinent Assumptions:

- a - Limit interpolation results are accurate at 10" distance;
- b - Radiated EMI measurements are reasonably accurate in a shielded room.
- The conducted EMI levels are reasonably "low" for both electronic and electromagnetic ballast at and above the AM broadcast band. However, below 500 KHz the noise levels are above the proposed limits of P18, in both electronic and electromagnetic ballasts. Significantly higher levels of interference have been detected in the case of electronic ballasts than electromagnetic ballasts for lower than 500 KHz frequencies.

As mentioned before, filter components required for reducing conducted EMI at low frequencies (i.e., less than 500 KHz) are both costly and physically large. These two factors, (i.e., cost and size) make the task of reducing EMI at lower frequencies very difficult. The implementation of filter components in the manufacturing phase of the product will - in most cases - be unacceptable because of cost. Whereas, in the design phase, circuit boards can be reconfigured, the physical location of circuit components can be altered, and problems such as electric and magnetic field coupling, and common mode coupling can be remedied more economically.

- Generally speaking, electronic ballasts generate higher levels of EMI than electromagnetic ballasts. Whether or not the EMI generation by electronic ballasts causes objectionable interference within the AM broadcast band or other frequency bands in a commercial/industrial environment has not been determined yet, and requires indepth research.
- The FCC proposed limits under Part 18 of Rules and Regulations are probably more stringent than need be for frequencies below the AM broadcast band. This subject needs to be re-evaluated by the FCC with the joint participation of the lighting industry.

#### ACKNOWLEDGEMENTS

I would like to thank Mr. Bob Wein for his assistance in performing the experiments and acquiring test samples employed for the experimentation. Thanks to Mr. Ed Yandek and Mr. John Giorgis for their constructive comments regarding the technical aspects of this report.

The art work by Mr. Bill Kuret is greatly appreciated. And last but not least thanks to Rose Intihar and Reggie Sodo for preparation of this manuscript.

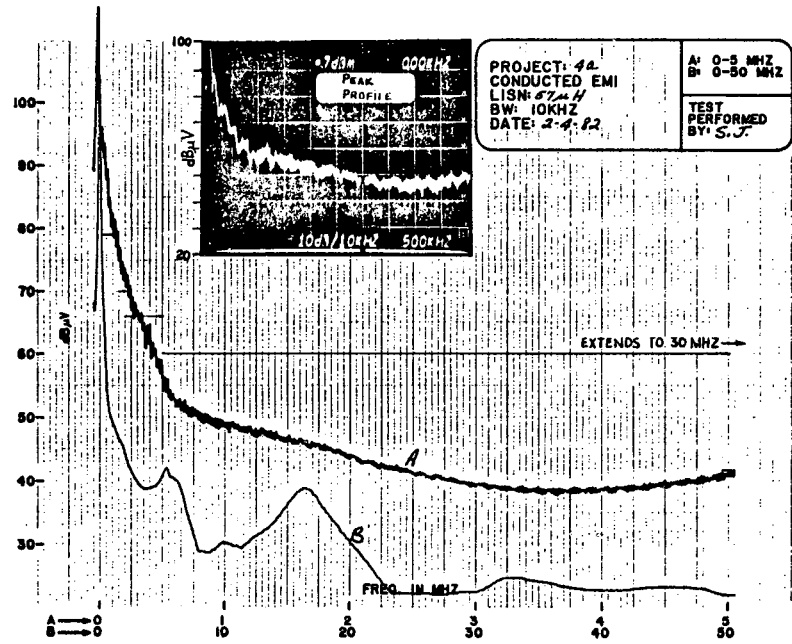
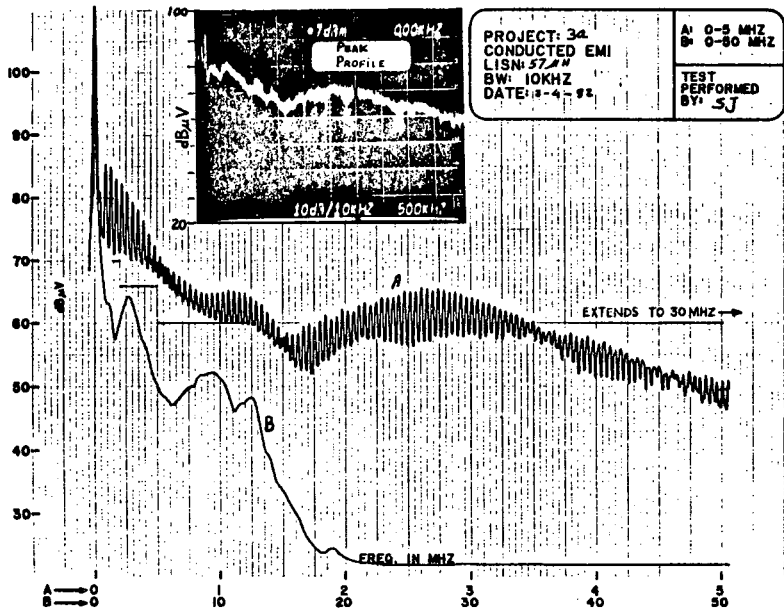
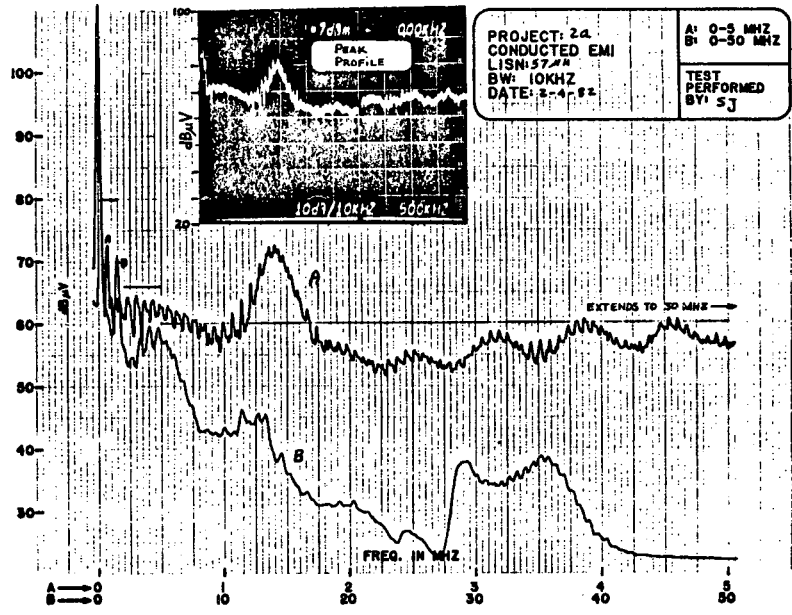
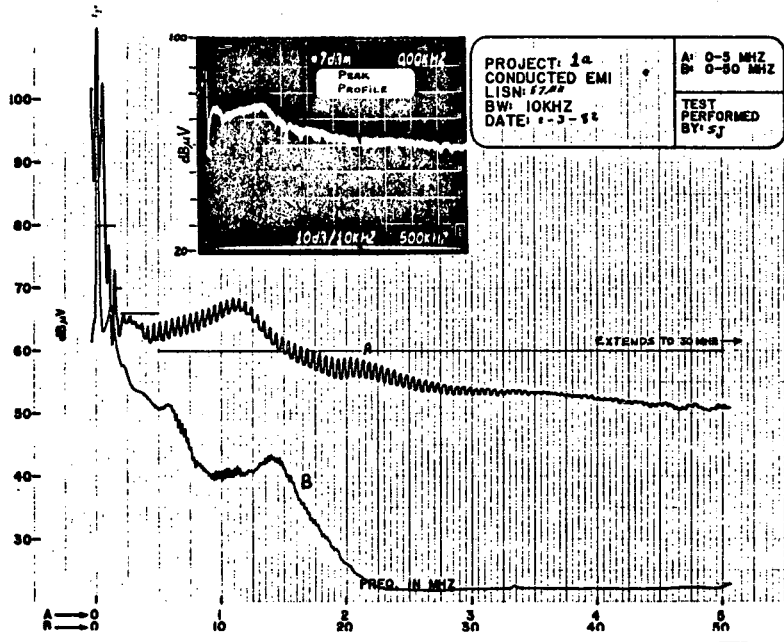

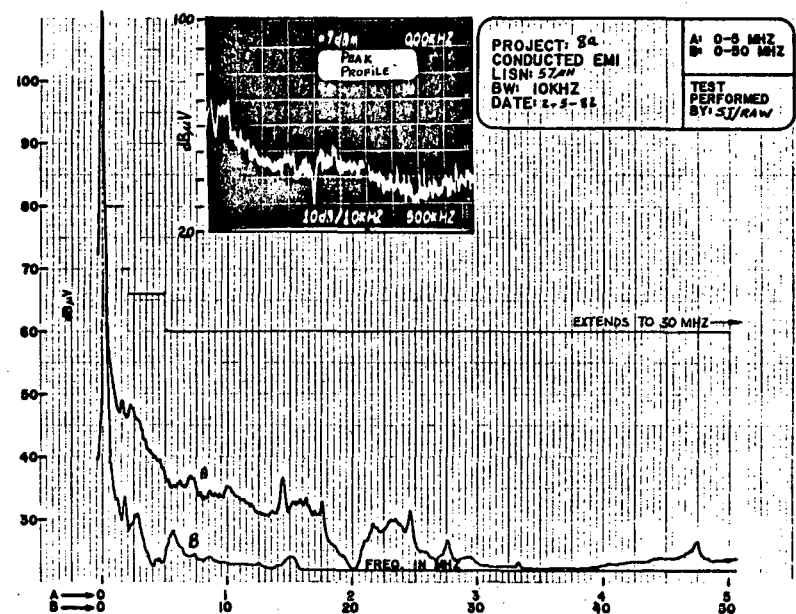
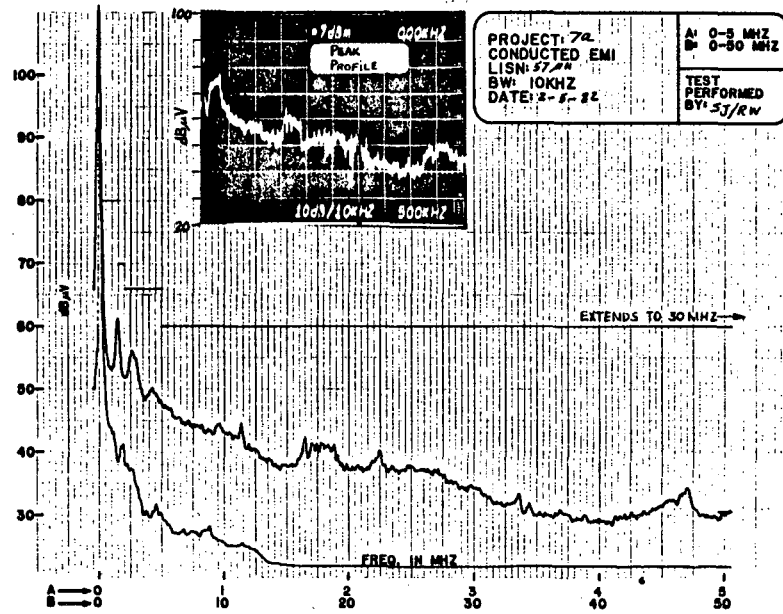
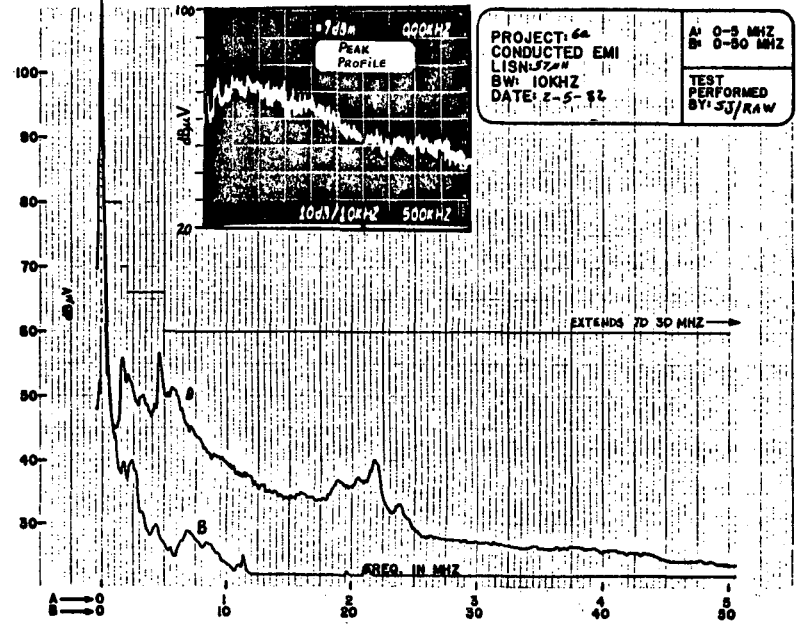
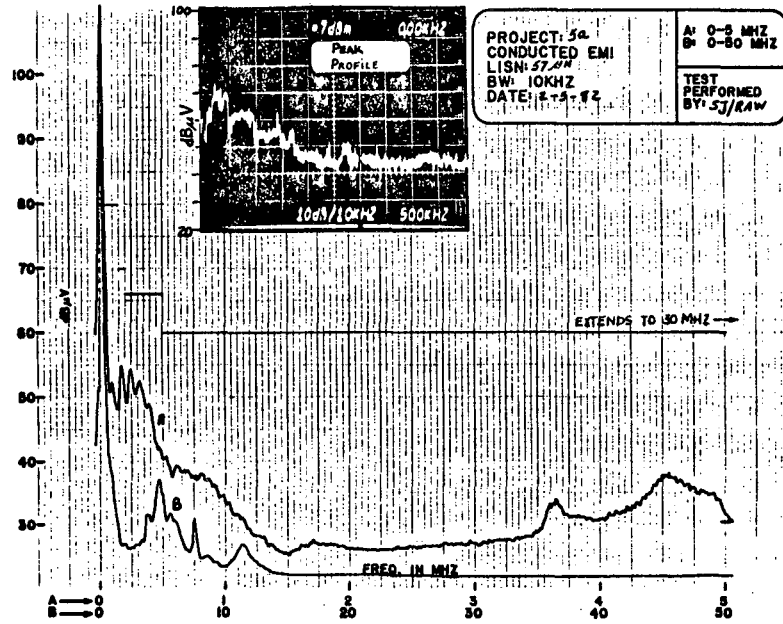

PROJECT: 1b  
 RADIATED H-FIELD  
 ANT. TYPE: LOOP  
 BW: 10KHZ  
 DATE: 2-9-52

A: 0-5 MHZ  
 B: 0-50 MHZ

TEST PERFORMED BY: SJ/RAW

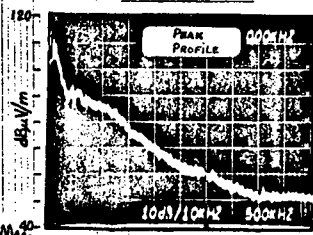
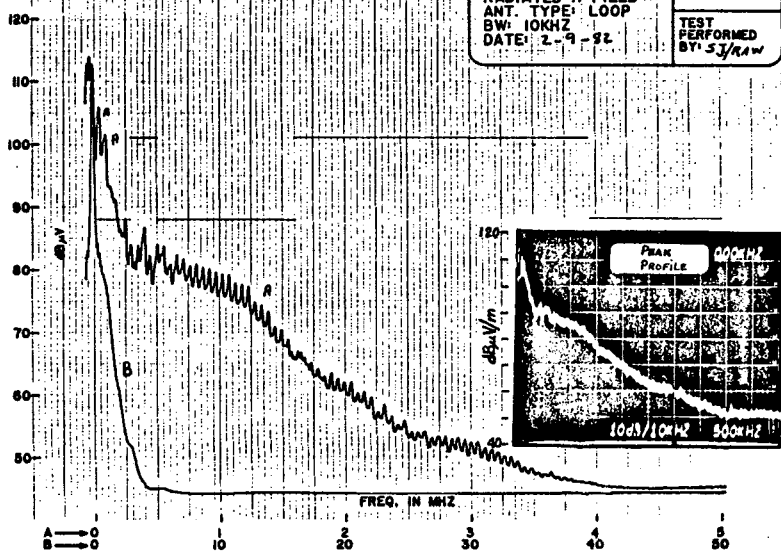

PROJECT: 2b  
 RADIATED H-FIELD  
 ANT. TYPE: LOOP  
 BW: 10KHZ  
 DATE: 2-9-52

A: 0-5 MHZ  
 B: 0-50 MHZ

TEST PERFORMED BY: RAW

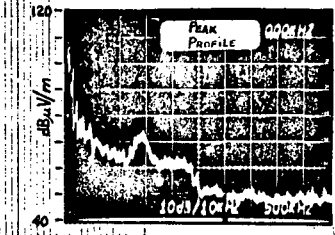
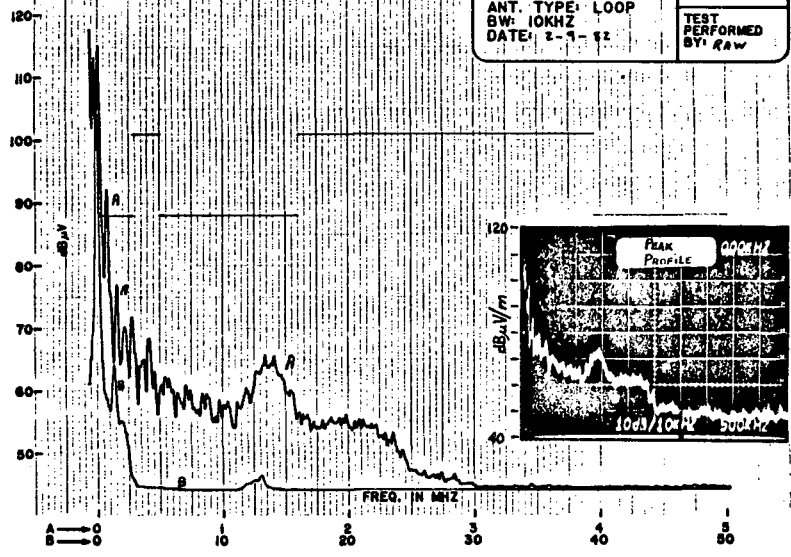

PROJECT: 3b  
 RADIATED H-FIELD  
 ANT. TYPE: LOOP  
 BW: 10KHZ  
 DATE: 2-9-52

A: 0-5 MHZ  
 B: 0-50 MHZ

TEST PERFORMED BY: SJ/RAW

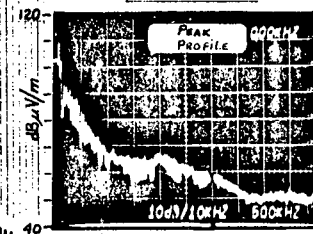
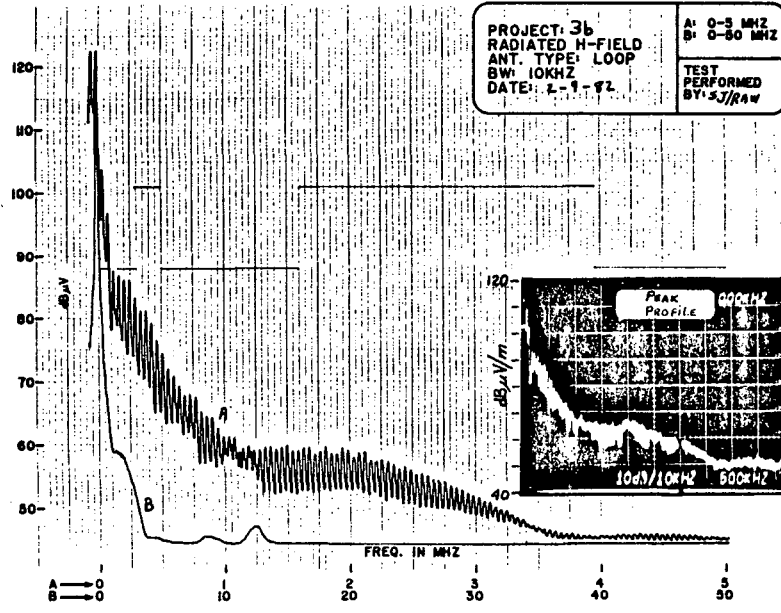

PROJECT: 4b  
 RADIATED H-FIELD  
 ANT. TYPE: LOOP  
 BW: 10KHZ  
 DATE: 2-9-52

A: 0-5 MHZ  
 B: 0-50 MHZ

TEST PERFORMED BY: SJ/RAW

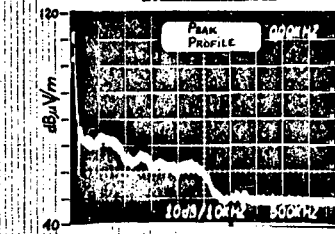
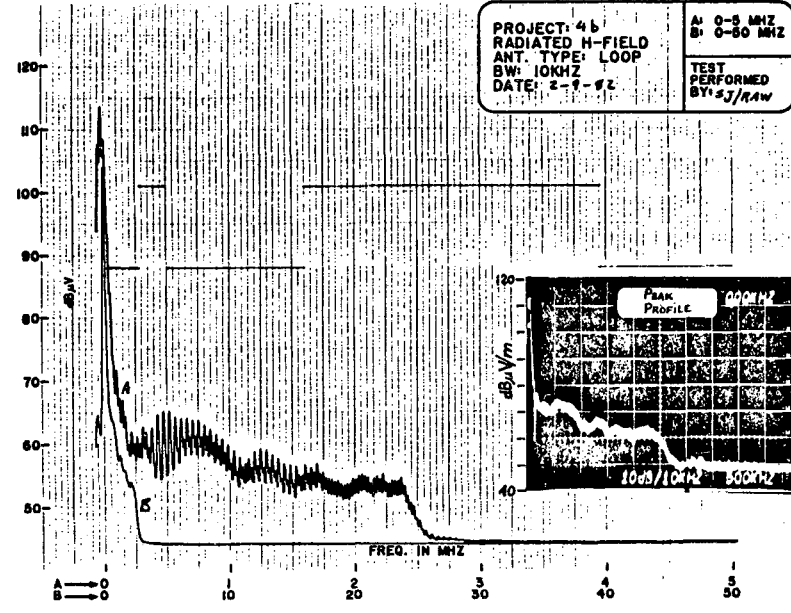

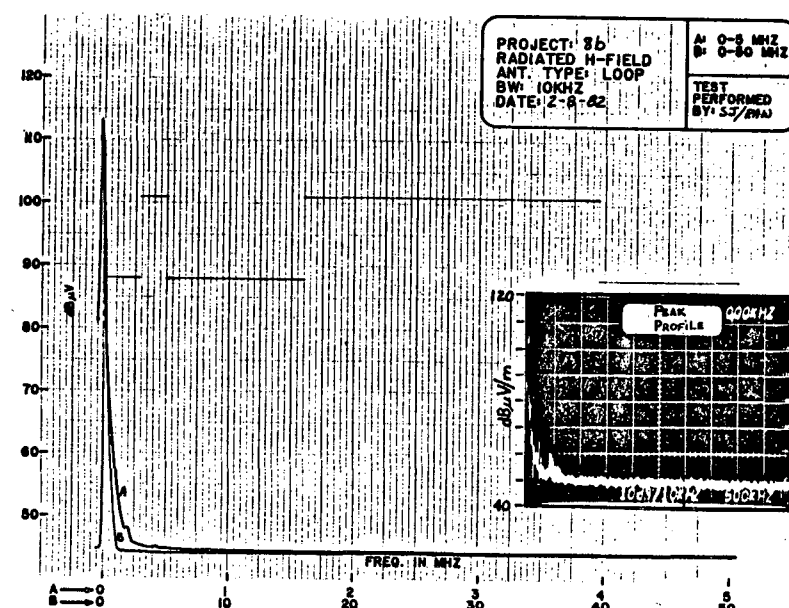
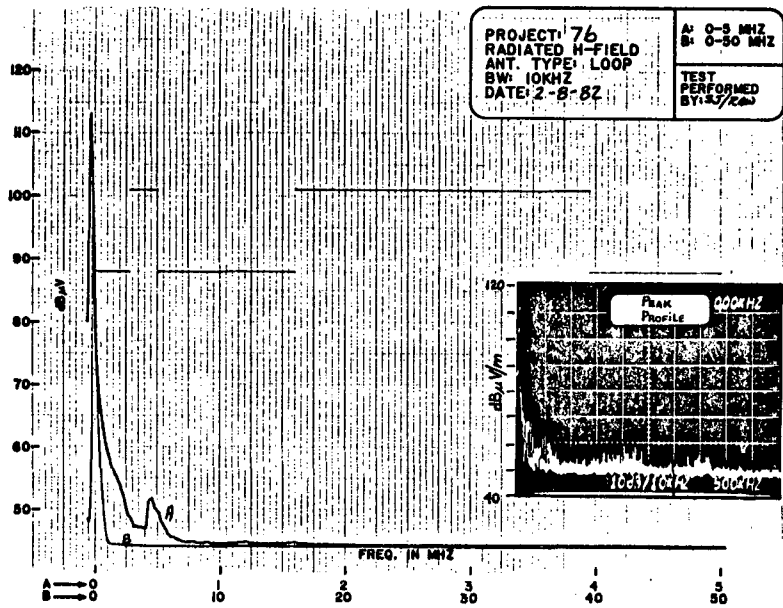
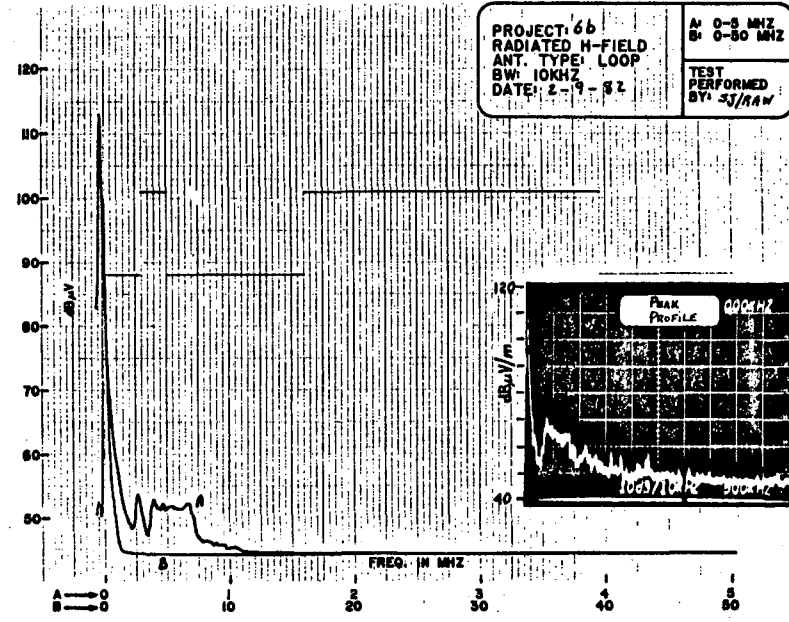
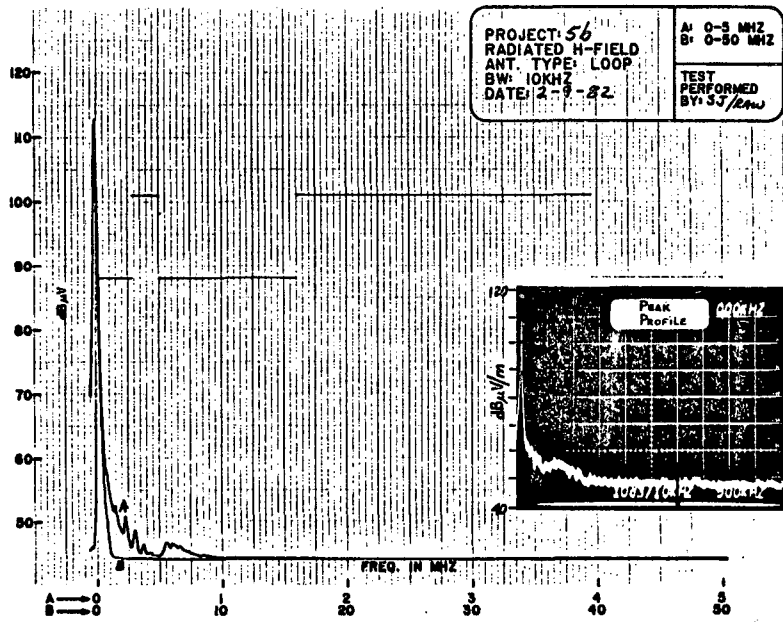



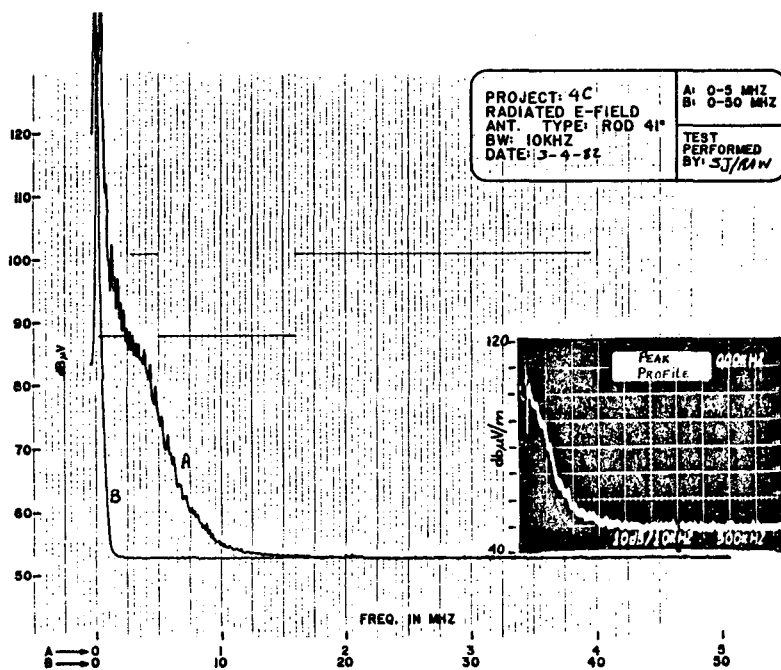
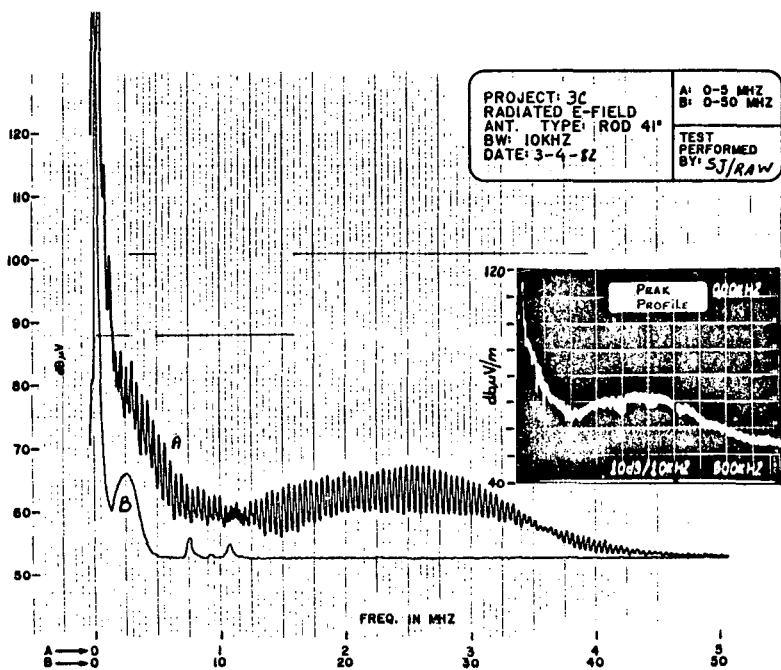
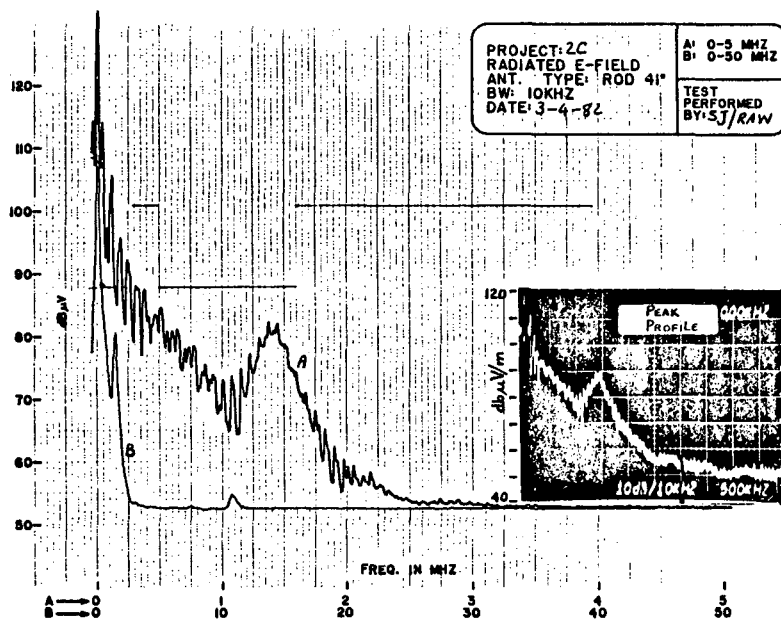
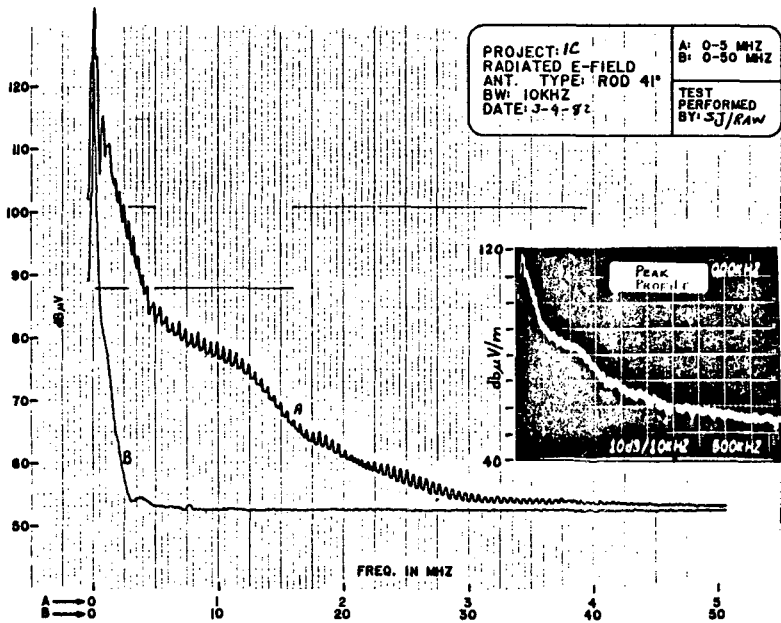

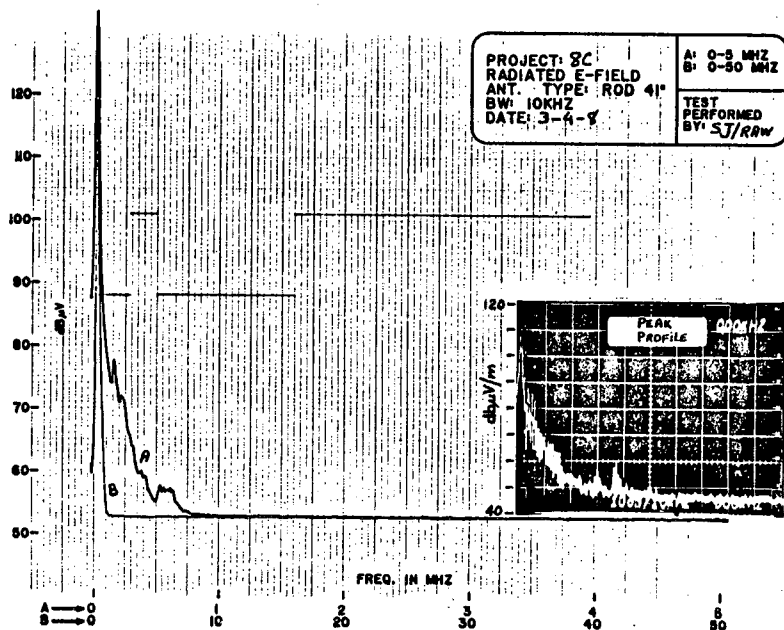
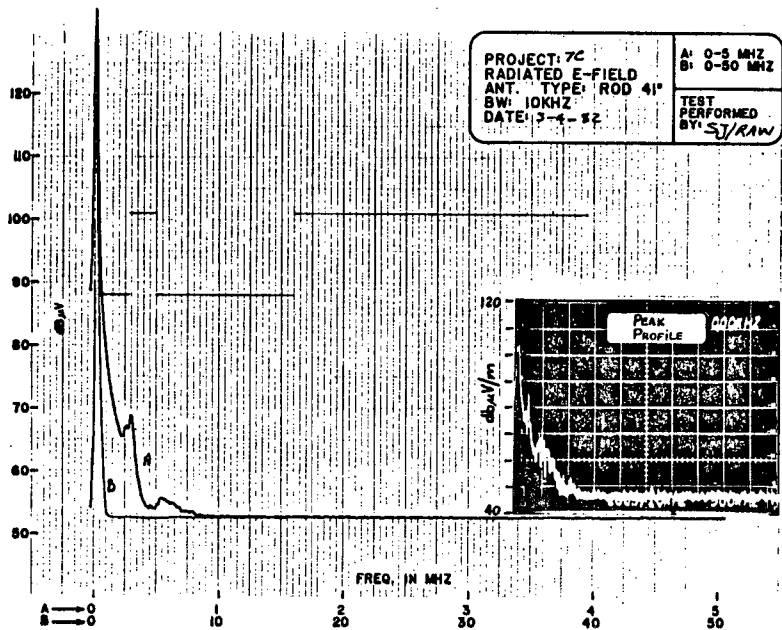
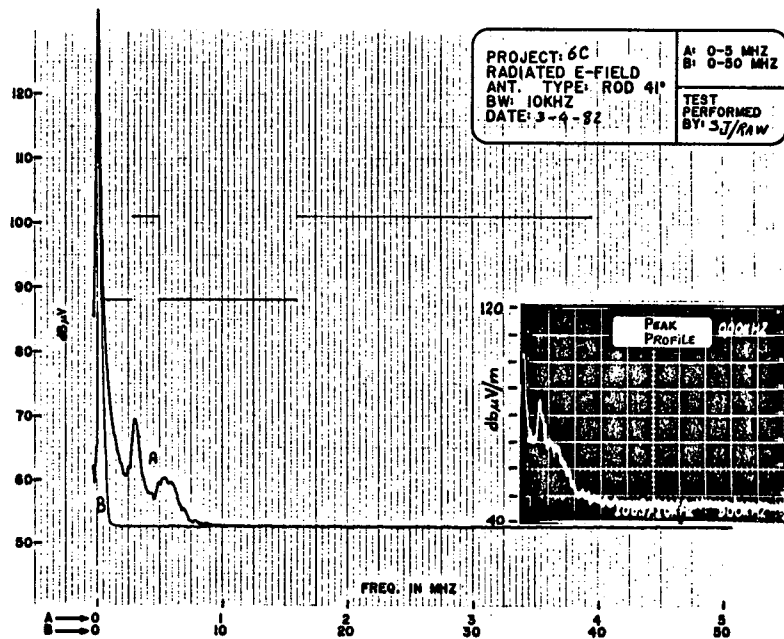
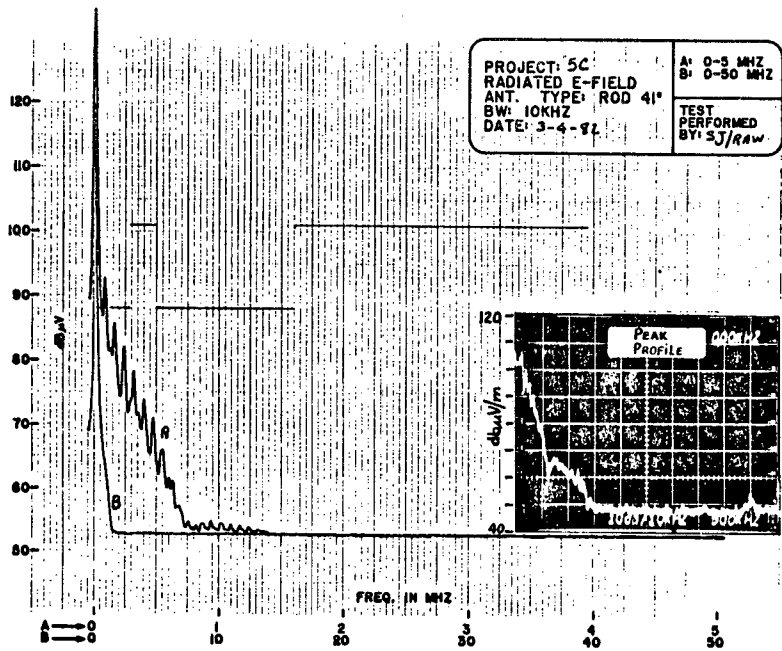



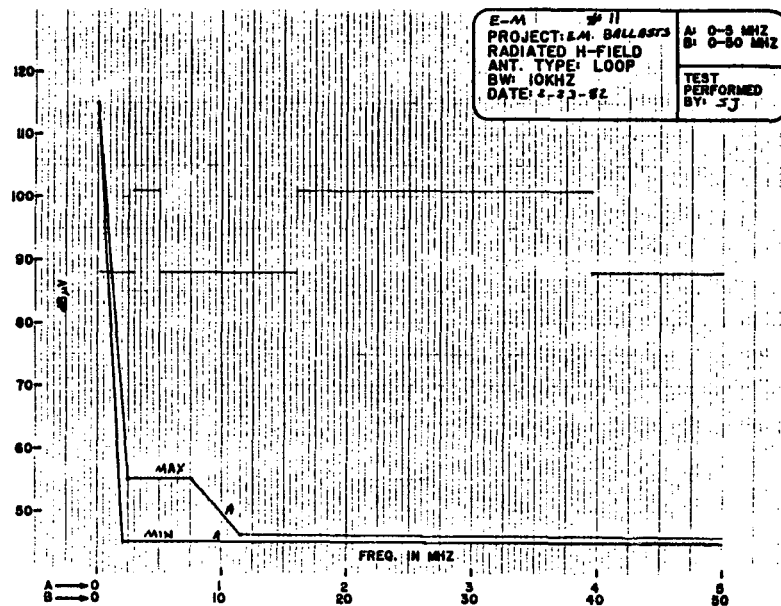
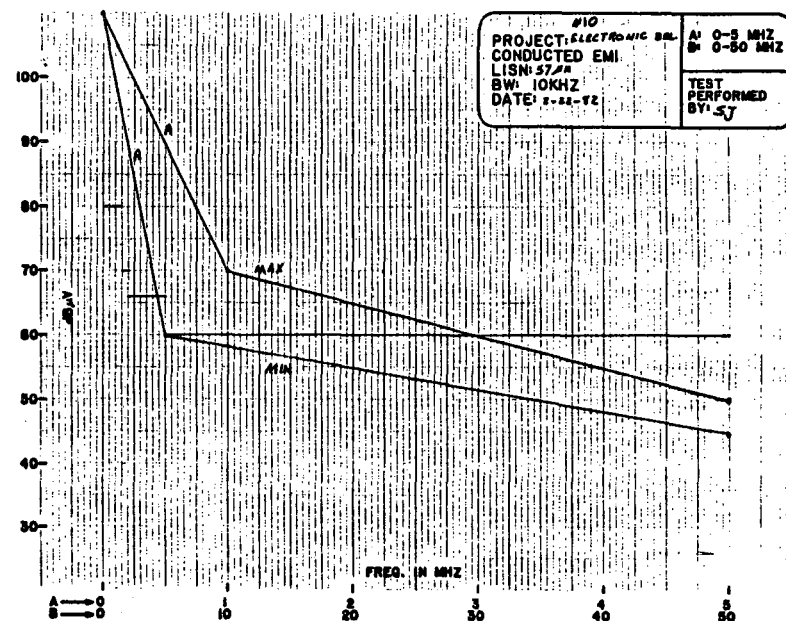
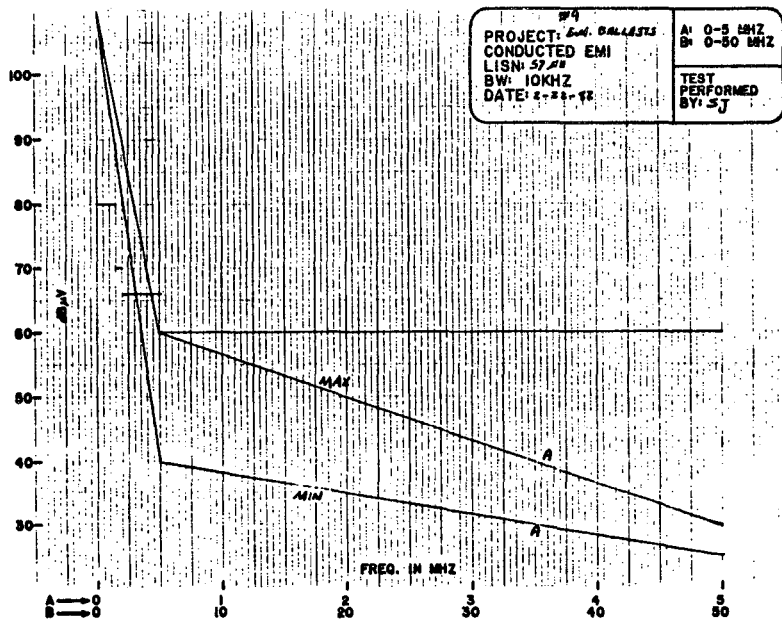

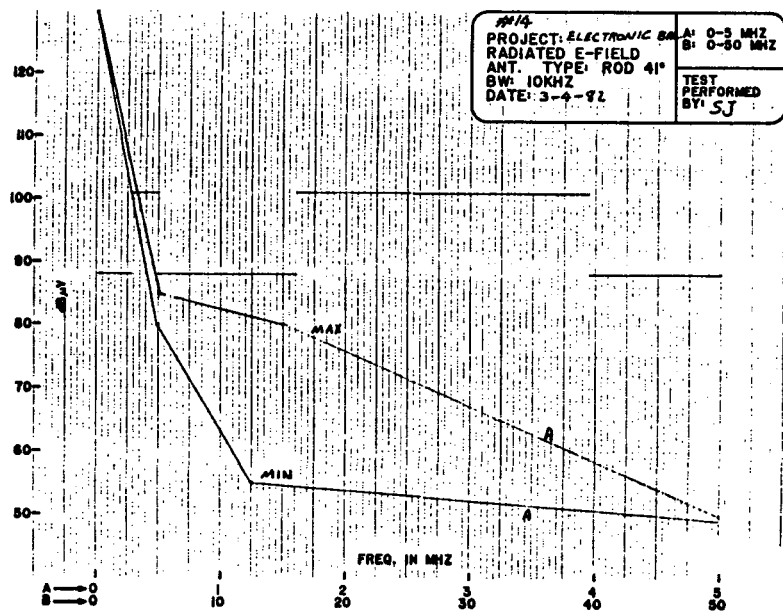
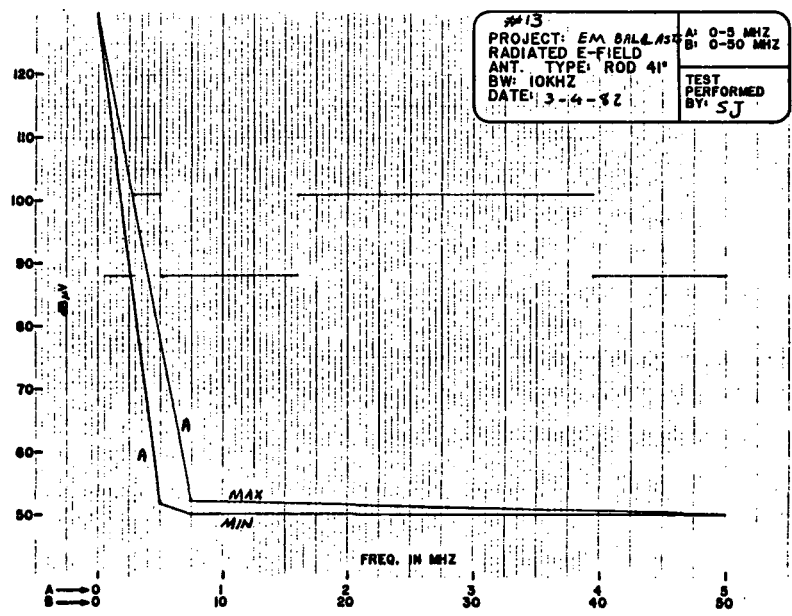
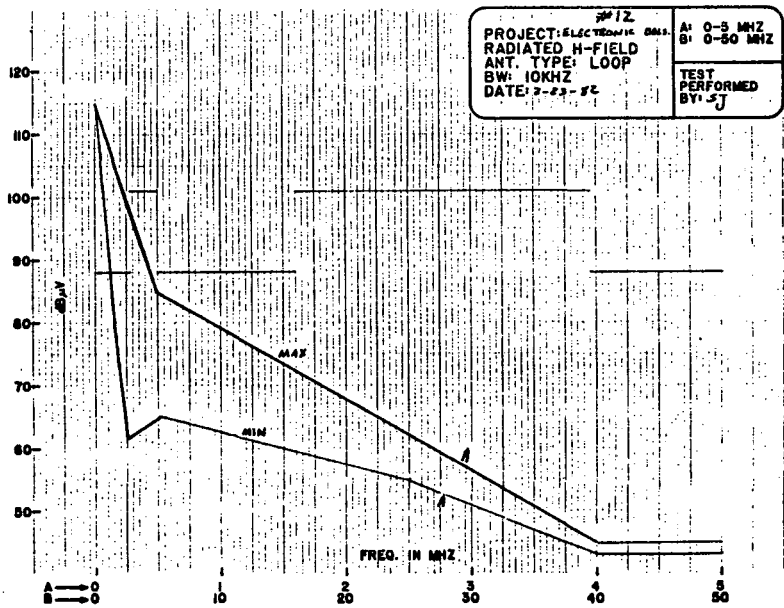

## EMI MEASUREMENTS OF LIGHTING SYSTEMS

Allan Arthur, Leon Leung, and Rudolph Verderber

Lighting Systems Research  
Lawrence Berkeley Laboratory  
University of California  
Berkeley, CA 94720

### ABSTRACT

Electromagnetic interference (EMI) measurements were made on several types of gas-discharge lamps operated at 60 Hz and at high frequency. Electric and magnetic field data were collected to determine the near-field impedance (1 to 4 kHz). The radiated E field at one meter from the lamps was 1 to 10 volts per meter. H fields were measured at 1 milliamperes per meter.

On-site EMI measurements from an installation of 140 solid-state ballasts operating lamps at high frequency show radiated and conducted levels that are about the same magnitude as those produced by a single solid-state ballasted system.

### 1.0 INTRODUCTION

Many new energy-efficient lighting systems that are being developed and introduced into the marketplace employ the gas-discharge lamp as a light source. To further increase their efficacy, these light sources are being operated at higher frequencies -- in the 20 to 40 kHz region and the 100 kHz to 13 MHz regions. Existing gas-discharge lamps that are operated at 60 Hz radiate electromagnetic energy in the AM broadcast band but at levels that have been found to be tolerable in nearly all applications. Yet the increased use of discharge lamps, as well as their operation at high frequencies, could impact the performance of existing electronic systems.

This report, which presents the measured electromagnetic interference (EMI) levels from gas-discharge lamps operated at normal (60 Hz) and at high frequency, is one step in assessing potential impacts. The test procedure used to measure the lighting systems is described. The data are presented for the commonly employed two-lamp, 40-watt, T-12, rapid-start fluorescent lamps operated with a standard core-coil ballast and twelve differently designed solid-state ballasts. Additional results are

provided for new types of efficient lamps, designated as circline and compact fluorescent lamps, which are designed to be installed in Edison-type sockets (as replacements for the incandescent lamp). Finally, the EMI data obtained from a demonstration at the Veterans Administration Medical Center in Long Beach, California, are used to compare the EMI levels from a large-scale installation of high-frequency lighting systems with EMI from a single fixture.

## 2.0 TEST SETUP

The EMI measurements were made in a small building in which the lighting system could be turned off and no other electrical equipment was in use. The existing ambient levels were suitably low to detect the EMI levels from our test systems. Measurements were considered valid when they were 10 dB above the ambient, which yields an experimental error of 5%. The device for measuring EM intensity was a Hewlett-Packard HP 3585A spectrum analyzer. The E field was measured with a one-meter rod antenna having an integral amplifier connected by coaxial cable to the spectrum analyzer. The spectrum analyzer was placed about 20 feet from the radiation source because it was the source of a 24-kHz signal. By placing the meter at a distance and enclosing it in a copper mesh screen, the signal suitably attenuated.

The rod antenna was positioned one meter from the center of the lighting fixture. The radiated E field was not significantly polarized. A six-inch loop antenna was used to measure the H field. The loop antenna was also positioned one meter from the center of the fixture. The H field was directional, and the antenna was oriented to sense the maximum field. The conducted EMI was measured using a wide-band clamp-on current probe affixed to one of the 60-Hz sides of the line. A 10  $\mu$ F capacitor was used to provide a low impedance for the EMI current and to standardize the line impedance. The input power, voltage, and current to each system were measured with high-frequency meters.

In order to compare the effects of the various ballasts, all ballasts operated the same two F40 lamps. The lamps were new and were burned in for more than 100 hours before any EMI measurements were made. All of the data presented are corrected for the antenna calibration.

### 3.0 RESULTS

#### 3.1 Frequency Analyzer Tracings

Figures 1 through 5 show the raw data obtained from the spectrum analyzer for the two-lamp, 40-watt, T-12, rapid-start system operated at high frequency with a solid-state ballast.

Figure 1 shows the radiated E field from a typical high-frequency ballasted, two-lamp, 40-watt, T-12 fixture for lamps on and lamps off. The fundamental excitation to the lamp is at about 24 kHz; the harmonics of that excitation drop off at about 40 dB per decade. Both the fundamental excitation frequency presented here and the harmonics are well above the background. Figure 2 shows the same E-field EMI data in the range of 0 to 5 MHz. At 5 MHz most of the EMI from the lamp has faded into the background noise. Evident in both pictures are the spectrum lines of the local Bay Area AM radio stations. It is interesting to note that even at one meter from the lamp, the radio stations are considerably above the EMI from the lamp operated at high frequency.

Figure 3 shows the spectrum analyzer photograph of the H-field data for the lamps operated with a high-frequency ballast. The band pass for the H-field pickup was good to only 30 kHz. Only that band is shown in the spectrum analyzer photographs, limiting the data to the fundamental excitation to the lamp. The spectral spike just to the right of the fundamental, at 24 kHz, is part of the background and therefore should be disregarded.

An H-field intensity of 1 mA per meter was obtained for the fundamental excitation to the lamp. Combining this measurement with the E-field measurement yields a field impedance of 1 K  $\Omega$  to 4 K  $\Omega$  at one meter from the fixture ( $E/H \cong$  impedance).

Figure 4 shows the levels of conducted EMI being reflected back to the 60-Hz line in the 0 to 200 kHz range. The lamps-on picture shows that the background is a broadband noise underlying the fundamental and the harmonic peaks.



In Figure 5 the conducted EMI is photographed in the range of 0 to 600 Hz. The highest peak on the left of the picture is the fundamental (60 Hz); the photograph shows the higher harmonics up through the ninth harmonic. These harmonics are reflected back to the line due to the nonlinear nature of the ballast as a load. The clamp-on current probe has a rising frequency response in this range, and the peaks are the uncorrected amplitudes of the harmonics in this range. Corrected harmonic data will be shown later.

### 3.2. Nature of Near Fields

The expected impacts of the EM fields from the lighting systems will be in the near field. Theory states that in the near field the decrease in intensity is inversely proportional to the distance cubed. The far field begins at a distance of  $\lambda/2\pi$ , where  $\lambda$  is the wavelength of the radiation. For a 30-kHz wave, the far-field  $\lambda/2\pi$  is approximately one mile; thus at one meter we are measuring the near field. Figure 6 plots data taken from a two-lamp, F40 system operated at high frequency at source antenna distances of one, two, three, and four meters. The field intensities of the fundamental (24 kHz) and its harmonics are plotted; they show a dependence inversely proportional to the cube of the distance. This verifies that these measurements, at 1 meter, are in the near field. We can extrapolate these near-field measurements to the far field for a higher frequency (for example a 100-kHz fundamental), where  $\lambda/2\pi \cong 477$  meters. For the E and H levels measured from these lamps, there should be little EMI to interfere with communications because the EM field in the far field would be reduced by a factor of  $10^9$ .

Figure 7 shows the range of values of the radiated E field at one meter for two F40 fluorescent lamps operated at high frequency with 12 different solid-state ballasts and at 60 Hz with a standard core-coil ballast. The measurements were made over a range of frequencies for 20 kHz to 5 MHz. The cross-hatched area contains all of the high-frequency data points. The fundamental operating frequencies from the ballasts ranged from 20 to 40 kHz. The peak value of the fundamental E field is 1 to 10 volts per meter. The E-field

values toward the background level of EMI. A calculation of the E field for the two-lamp fixture (lamp voltage 100 V; positive column about 37 inches,  $E_0 \sim 10$  V/m) at one meter should be slightly less than 10 volts per meter at the fundamental lamp frequency. Similarly, the peak value of the E field of the lamps operated at 60 Hz will also be about 10 volts per meter at 60 Hz. Thus values less than 10 volts per meter are in error for the fundamental frequencies of some of the high-frequency ballasted lamps. Such errors could be due to the fundamental drive frequency being frequency-modulated--the spectrum analyzer cannot be synchronized to measure its magnitude. Further work is required to substantiate this explanation. However, the two-lamp F40 systems operated with all of the solid-state ballasts tested have a greater radiated E field over the measured frequency range than do the same lamps operated at 60 Hz with a standard core-coil ballast.

The decrease in E field for the higher harmonics is plotted in Figure 8 for the two F40 lamps operated by two different solid-state ballast designs. Each system shows a distinctly different rate of decrease of the harmonics. If the lamp voltage supplied by the ballasts were exactly sinusoidal, there would be no higher harmonics. Thus the fall-off of the harmonics will be steeper for the lamp voltage shapes closer to sinusoidal. These types of plots are a measure of the lamp voltage waveshapes and are evidence of the importance of the lamp waveshapes in reducing unwanted interference.

Figure 9 is a plot of the conducted EMI data from the different solid-state and core-coil ballasted two-lamp F40 systems. The large spread of EMI levels is due to different ballast circuit designs. Some ballasts include filtering circuits in the front end which attenuate the high frequencies that are reflected from the lamps. Similar to the radiated EMI from 20 kHz to 4 MHz, the conducted EMI measurements for all of the high-frequency systems are greater than for the 60-Hz system. These conducted levels can be as great as hundreds of milliamps.

Figure 10 shows the harmonic content of the input power from 60 to 600 Hz. The value of the harmonic content is given as a percentage of the fundamental.

The thin solid lines represent the harmonics from a core-coil ballast. The thick solid lines show the range of values measured for the various solid-state ballasts. These results show that solid-state ballast systems can be designed to have a lower harmonic content than the standard 60-Hz core-coil ballast. However, some solid-state ballasts display more than four times the harmonic content of core-coil ballasts. There are two reasons to attenuate higher harmonics reflected back to the line from the ballast: 1) Europe has stringent restrictions on the production of higher harmonics from power systems; exporters of these products must consider these requirements. 2) The third and ninth harmonics cause currents to flow in the neutral of a wye-connected three-phase system; thus the ballast with high harmonic content will draw excess current in the neutral lines in wye-connected three-phase systems, presenting a possible fire hazard.

### 3.4 On-Site EMI Data

The above measurements of EMI were made on single fixtures under laboratory conditions. It is important to relate these measurements to field measurements taken where many of these systems are installed. LBL staff compiled field data for two solid-state ballast demonstrations, one conducted in the Pacific Gas & Electric (PG&E) Building in San Francisco, California,<sup>1</sup> and the other in the Veterans Administration (VA) Medical Center in Long Beach, California.<sup>2</sup>

Figures 11 and 12 show data collected approximately two years ago at the VA Medical Center in Long Beach. In this demonstration, 140 energy-efficient solid-state ballasts were installed in the floor space where the data were measured. The data shown in Figure 11 are EMI data from an area full of solid-state ballasted fixtures. Data were collected one meter below a given fixture, the same distance at which the laboratory measurements were made. The figures

also show the voluntary FDA guidelines for emission and susceptibility for medical devices. The E fields are about the same as for single two-lamp F40 fixtures (see Figure 7) that were measured in the same manner (source-antenna distance of one meter). This similarity occurs because in the near field the intensity drops as the cube of the distance: since the other fixtures were farther from the antenna, their contribution to the EMI was negligible compared to that of the test fixture. Also, the oscillators of the various solid-state ballasts are incoherent; therefore the energy would add in quadrature.

Figure 12 shows the conducted EMI levels from the 140 solid-state ballasts at the VA demonstration. The measured conducted EMI magnitude for the 140 two-lamp F40 high-frequency systems is no greater than the magnitude measured for the single two-lamp F40 system (see Figure 9).

### 3.5 Energy-Efficient Incandescent Replacements

Industry is introducing circline and compact fluorescent lamps that can be used in place of incandescent lamps (ie., they can be placed in Edison sockets). Figure 13 plots the radiated E field for several types of core-coil systems and solid-state ballasted lamps operated at high frequency. The results are similar to the results for the two-lamp, F40, fluorescent systems.

Figure 14 shows the conducted data for the solid-state ballasted compact and circline lamps. The EMI levels of the fundamental frequency, 60 to 80 dB, are less than those for the F40 lamps (70 to 120 dB). This indicates that these solid-state ballasts can be designed to attenuate the high-frequency components at various levels.

## 4.0 SUMMARY

Conducted and radiated electromagnetic radiation were measured for gas-discharge lamps operated at 60 Hz and at high frequency. The intensity of the field decreases as the reciprocal of the distance cubed, and

represents near-field data. The radiated E fields measured one meter from two F40 lamps at the fundamental frequency are slightly less than 10 volts per meter. The decrease of the harmonic peaks depends upon the shape of the lamp voltage. The conducted EMI from the high-frequency systems depends upon ballast design, which can be made to significantly attenuate the levels.

The 60-Hz harmonic content of the input power also depends upon ballast design.

The magnitude of the EMI (conducted and radiated) of a large group of fixtures installed in an office space is about the same as that of a single fixture.

#### ACKNOWLEDGEMENT

This work was supported by the Assistant Secretary for Conservation and Renewable Energy, Office of Building Energy Research and Development, Building Equipment Division of the U.S. Department of Energy under Contract No. DE-AC03-76SF00098.

#### REFERENCES

1. J. Jewell, S. Selkowitz, and R. R. Verderber, Solid-State Ballasts Prove to be Energy Savers, LD&A, Jan. 1980, pp. 36-42.
2. R.R. Verderber, A. Arthur, O. Morse, and F. Rubinstein, Energy-Efficient Management of Lighting in a VA Medical Center, LBL Report 12659, Lawrence Berkeley Laboratory, May 1981.

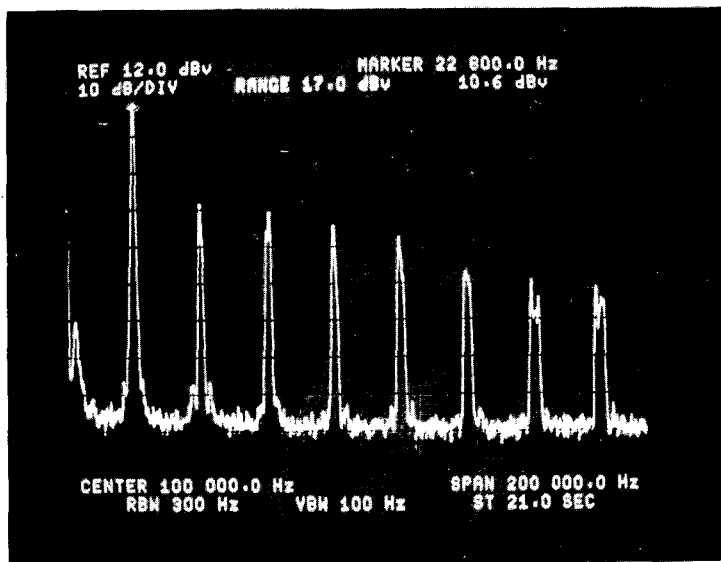

XBB 824-4074

LAMPS ON

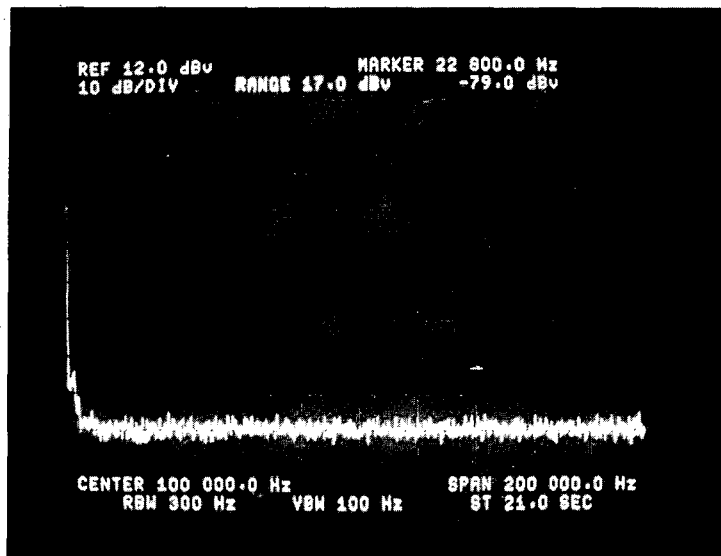

XBB 824-4076

LAMPS OFF

Figure 1. Spectrum analyzer photograph of radiated E field for two F40 lamps operated with solid-state ballast; frequency range 0 to 200 kHz.

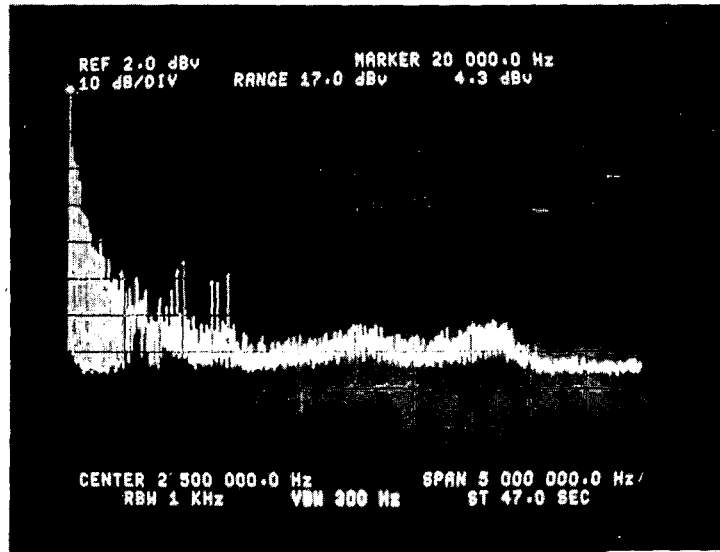

XBB 824-4075

LAMPS ON

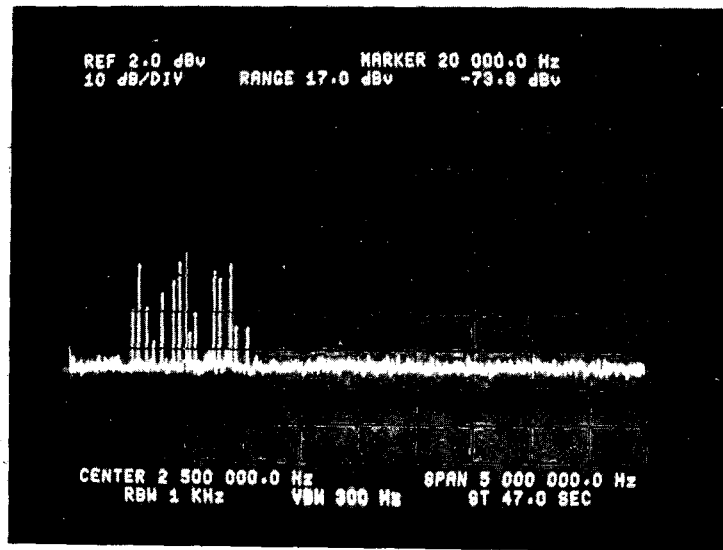

XBB 824-4078

LAMPS OFF

Figure 2. Spectrum analyzer photograph of radiated E field for two F40 lamps operated with solid-state ballasts; frequency range 0 to 5 MHz.

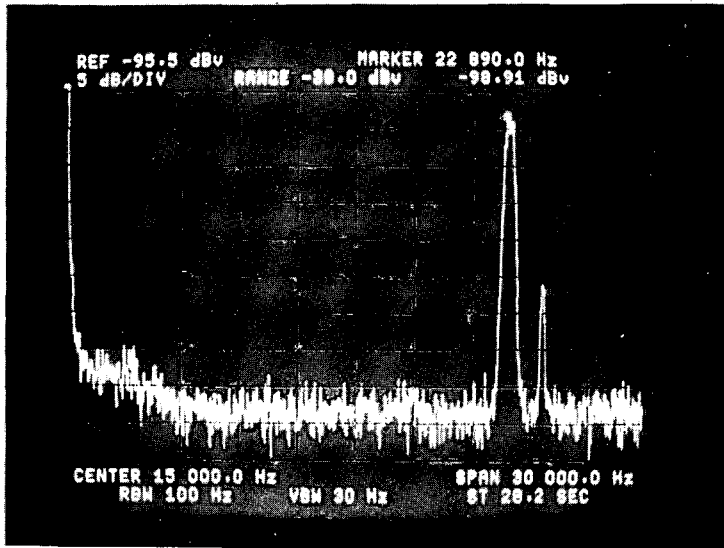

XBB 824-4077

LAMPS ON

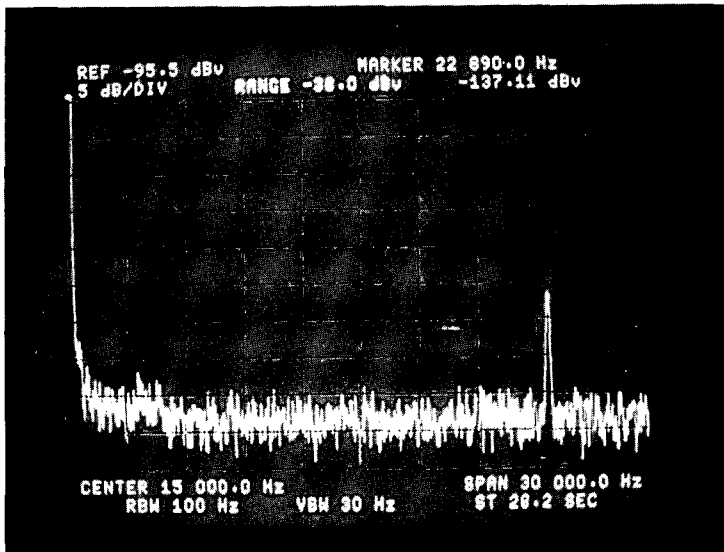

XBB 824-4081

LAMPS OFF

Figure 3. Spectrum analyzer photograph of radiated H field for two F40 lamps operated with solid-state ballasts; frequency range 0 to 30 kHz.



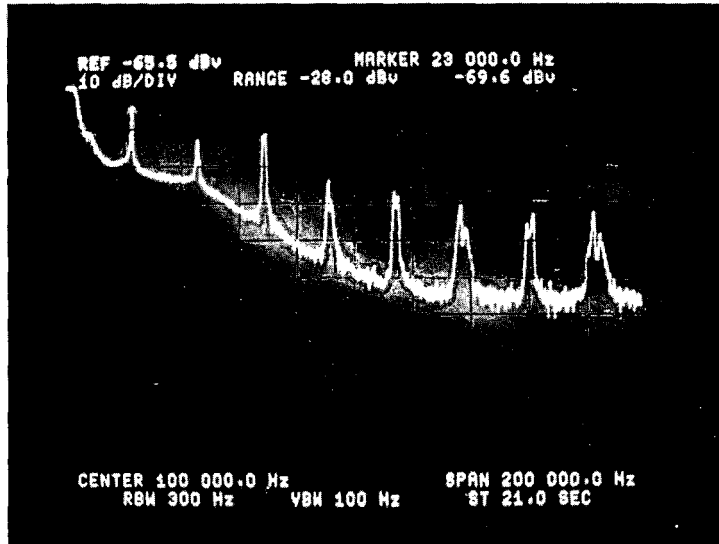

XBB 824-4083

LAMPS ON

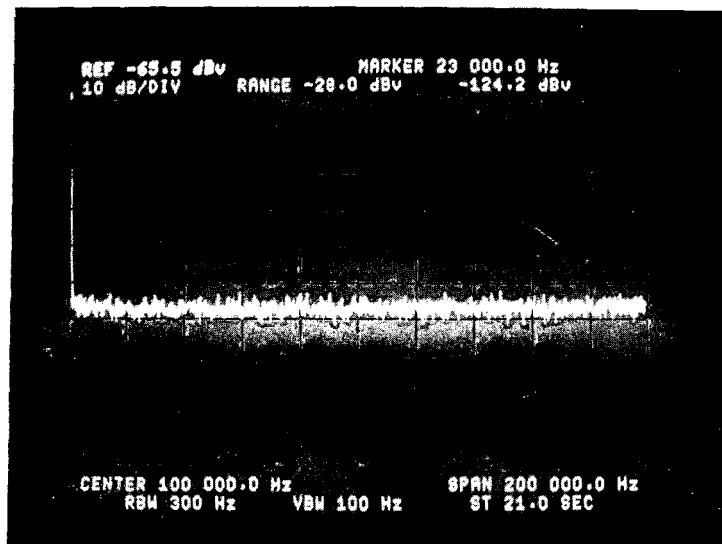

XBB 824-4082

LAMPS OFF

Figure 4. Spectrum analyzer photograph of conducted EMI reflected back to the line for two F40 lamps operated with solid-state ballasts; frequency range 0 to 200 kHz.

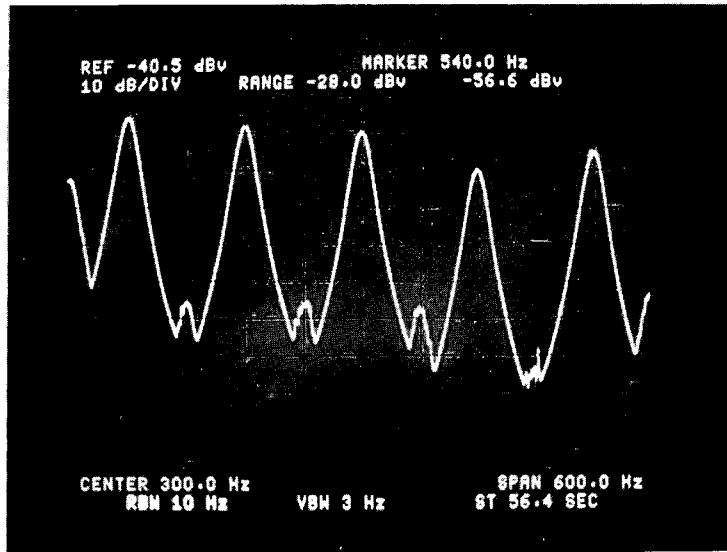

XBB 824-4080

LAMPS ON

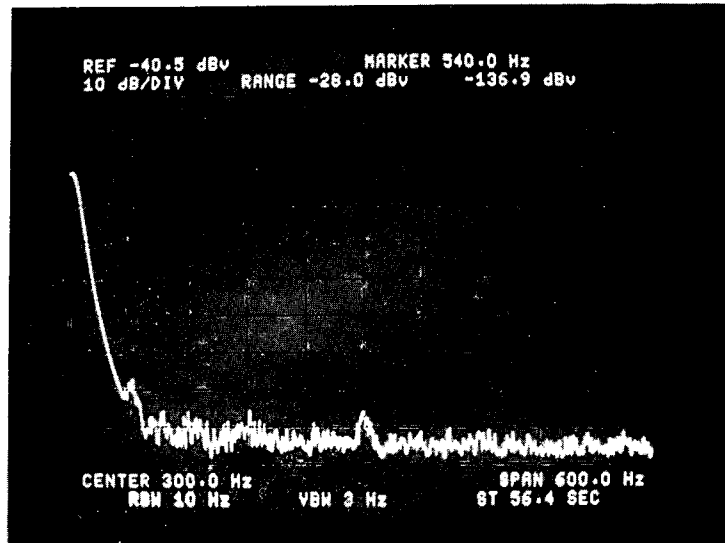

XBB 824-4079

LAMPS OFF

Figure 5. Spectrum analyzer photograph of conducted EMI on the line for two F40 lamps operated with solid-state ballasts; frequency range 0 to 600 Hz.

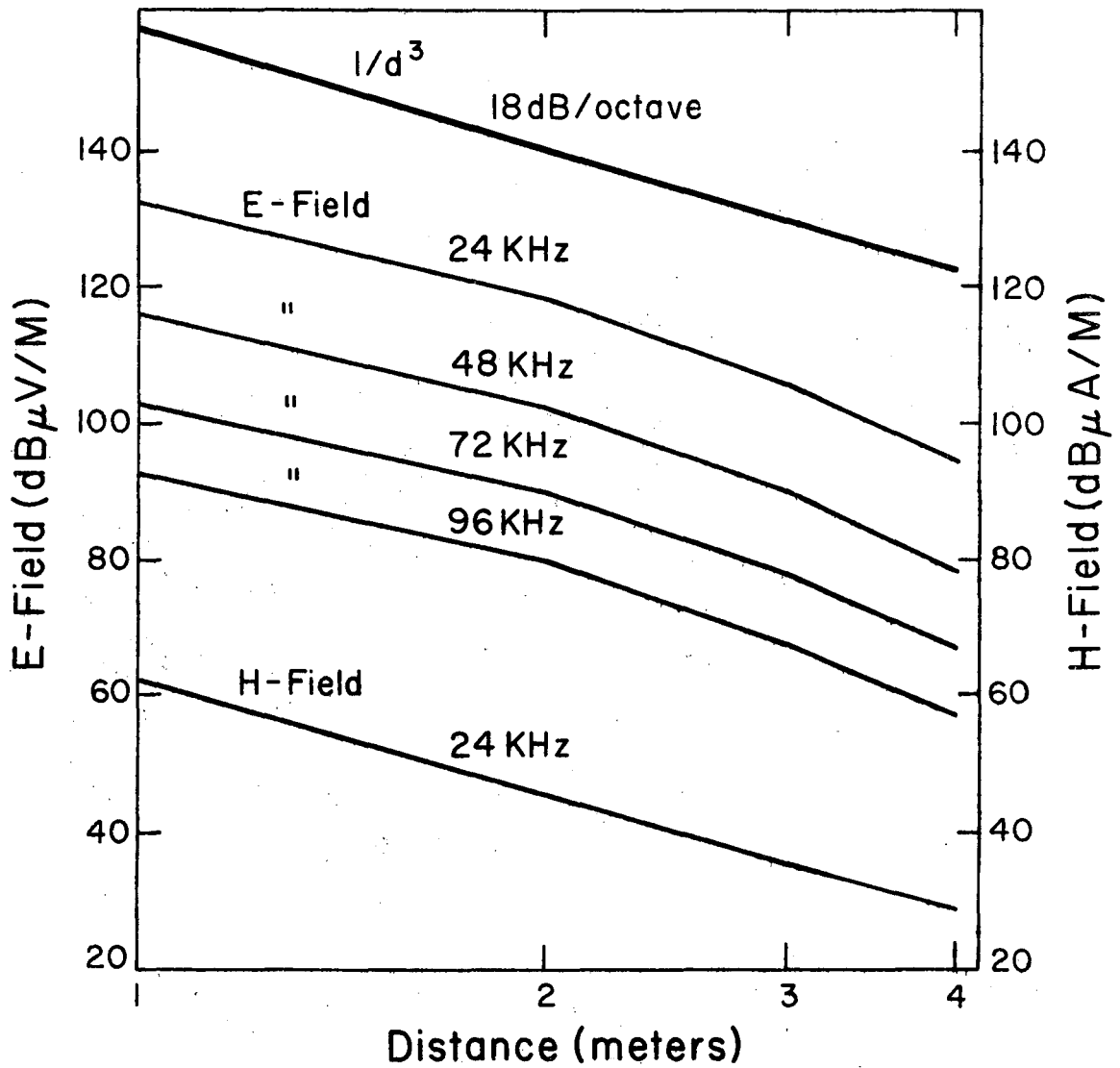

XBL 825-610

Figure 6. Measured E and H fields from a two-lamp F40 lamp system operated at various distances. Field intensities are plotted for the fundamental and its harmonics.

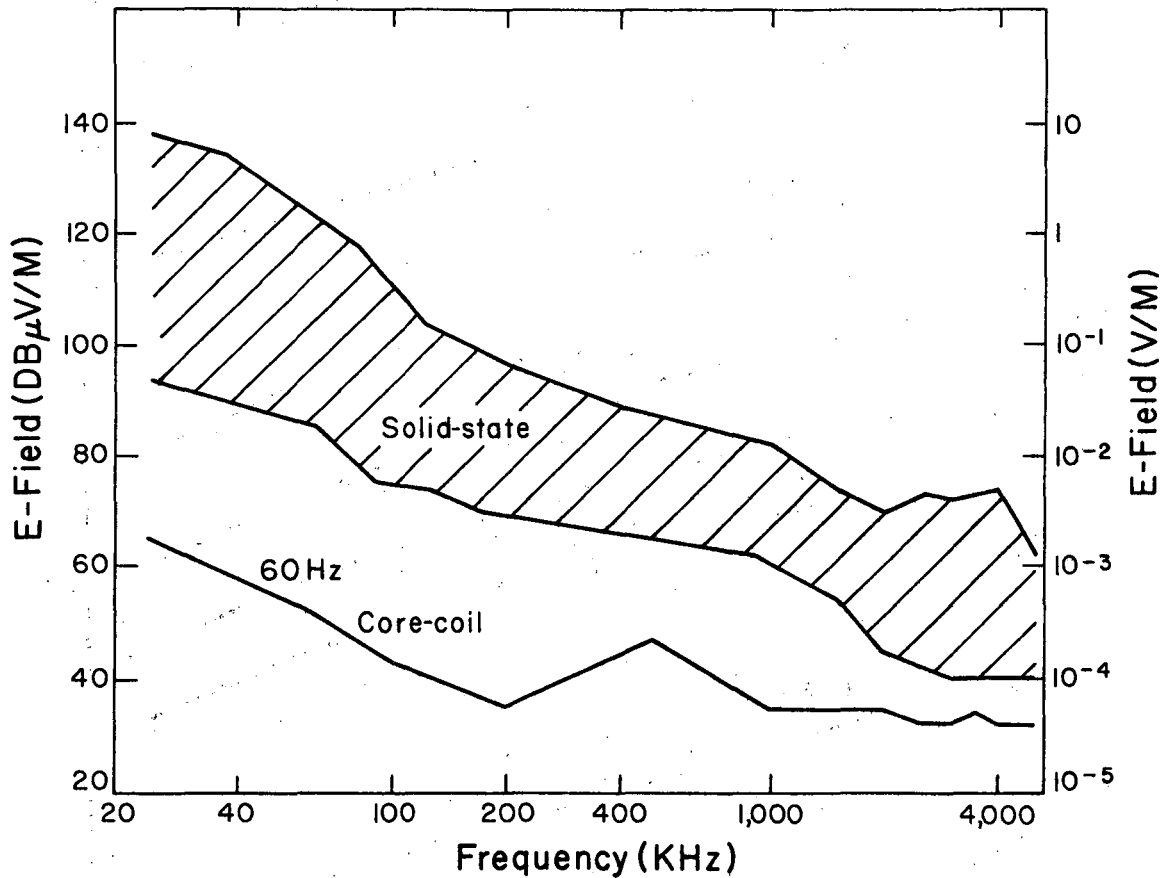

XBL 825-612

Figure 7. Radiated E field for fluorescent lamps operated with 12 different types of solid-state ballasts (crosshatched area) and with a core-coil ballast.

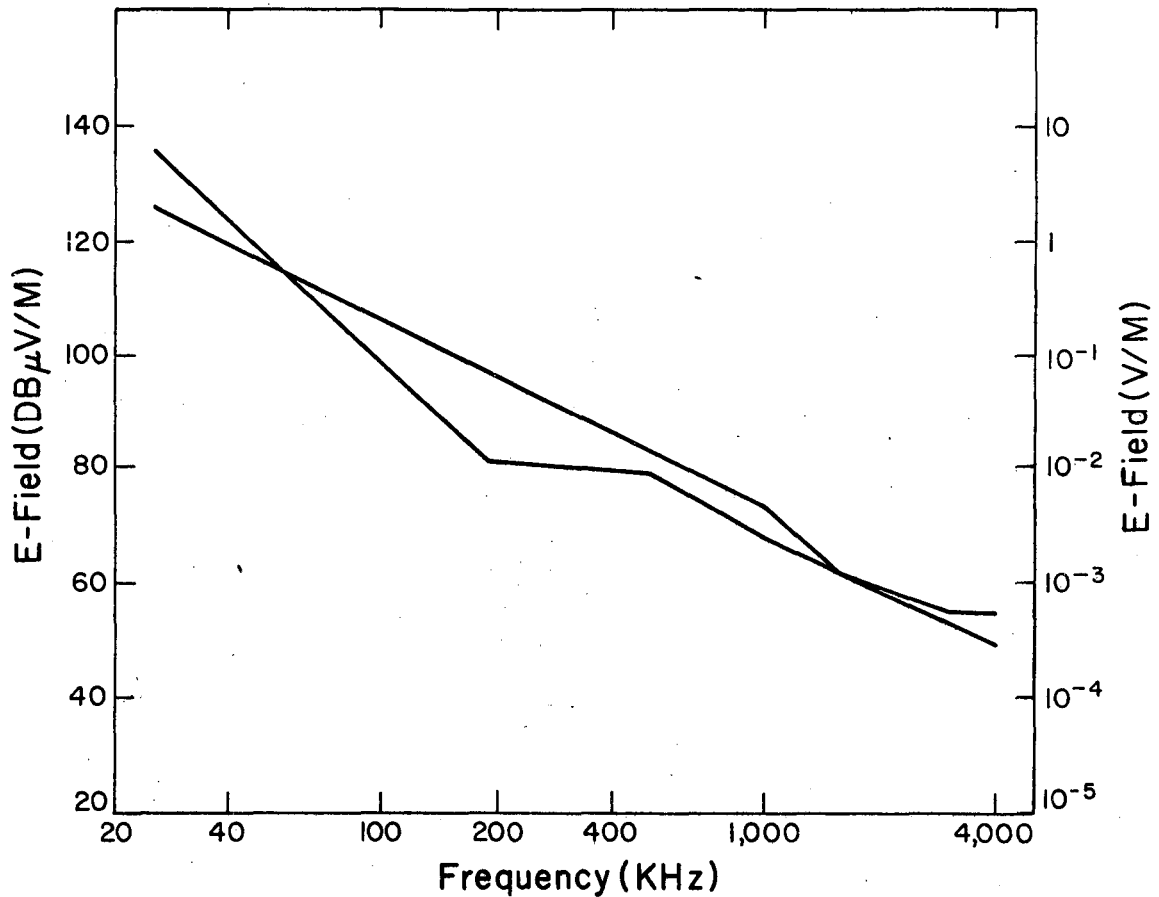

XBL 825-611

Figure 8. Rate of decrease for harmonic content for a lamp driven with different sinusoidal shapes. The curve that drops off more steeply is closer to a sinusoidal shape.

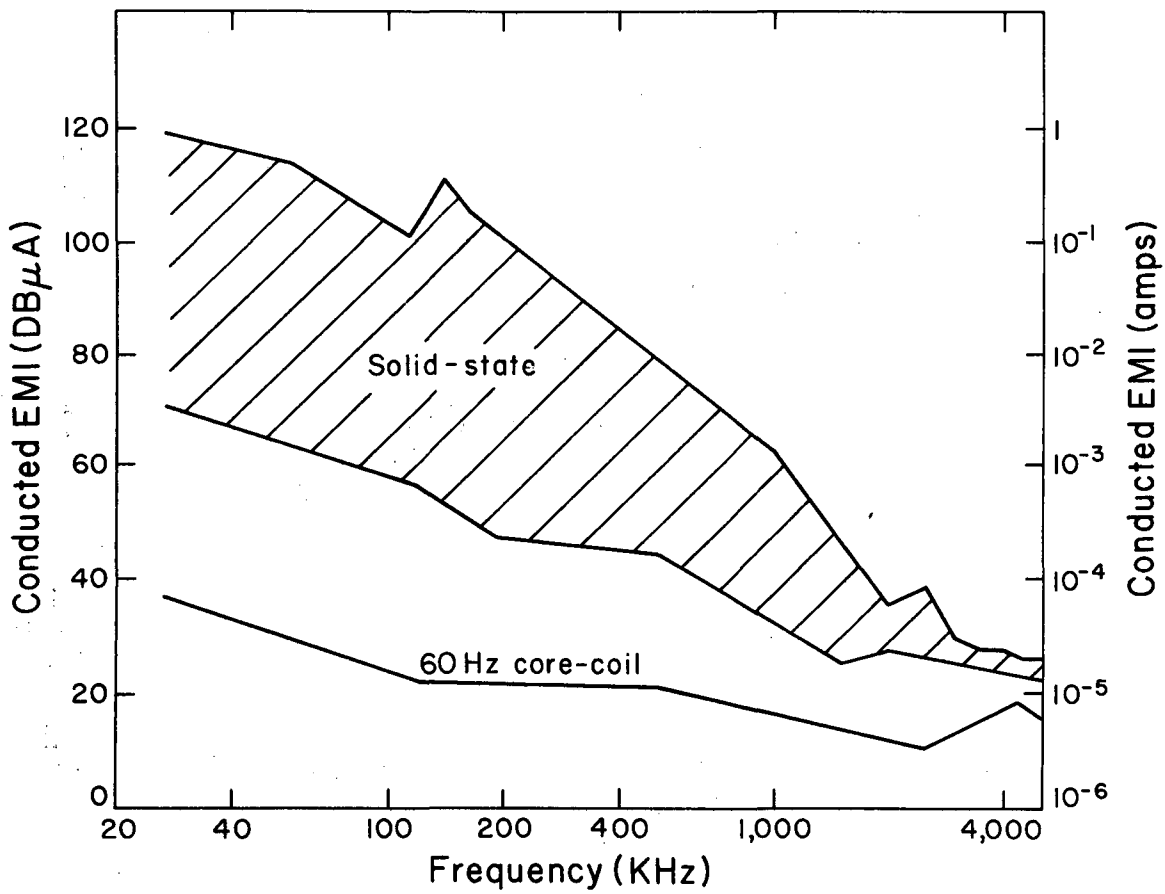

XBL 825-616

Figure 9. Conducted EMI to the line for fluorescent lamps operated with 12 different solid-state ballasts (crosshatched area) and with a core-coil ballast.

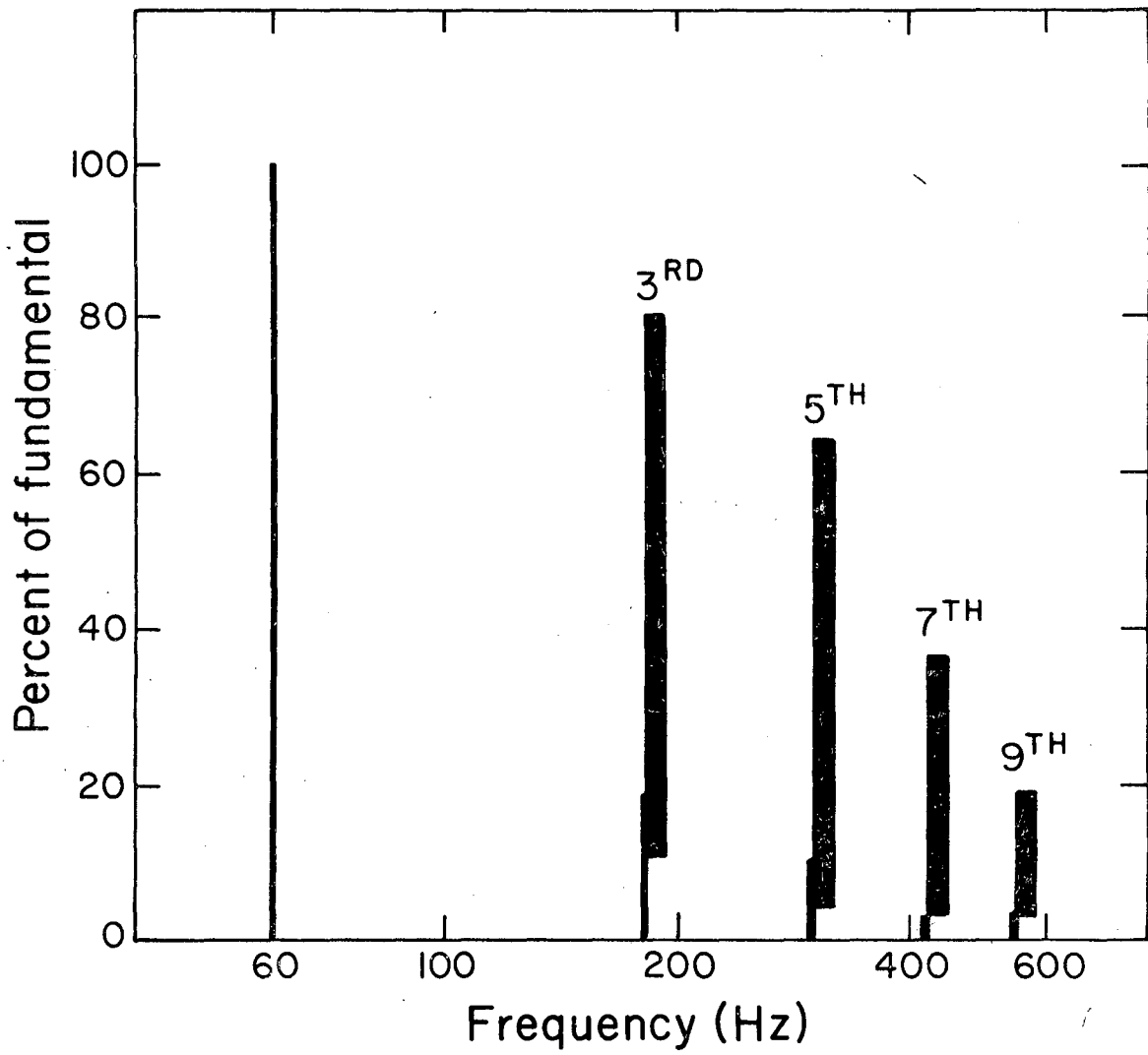

XBL 825-615

Figure 10. Ranges of harmonic content measured for fluorescent lamps operated with various solid-state ballasts.

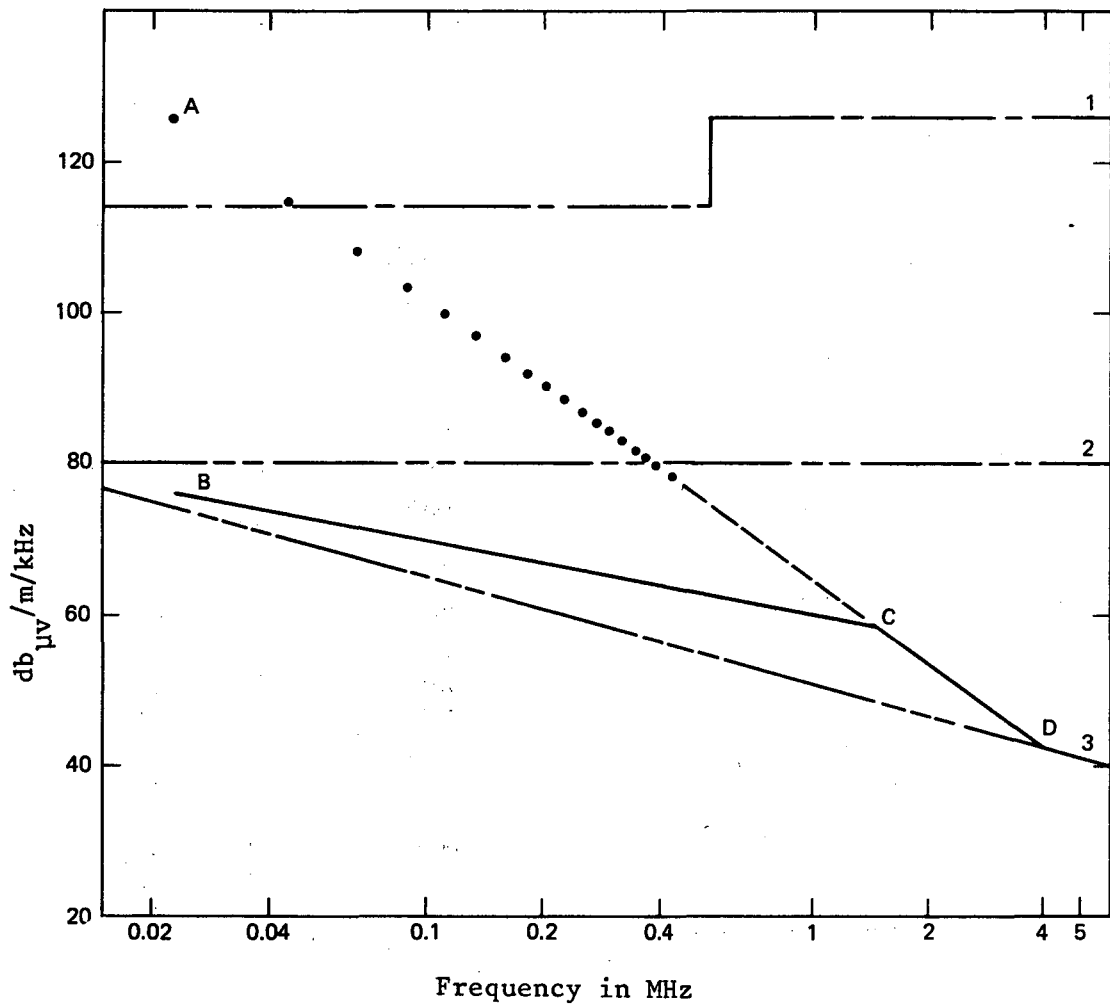

XBL 813-414

Figure 11. Typical electric-field radiated EMI for a two-lamp solid-state ballasted fixture:  
 (AC) narrowband peaks of 23 kHz and harmonics;  
 (BCD) broadband background noise.  
 (1) FDA susceptibility limit;  
 (2) FDA narrowband limit;  
 (3) FDA broadband limit.



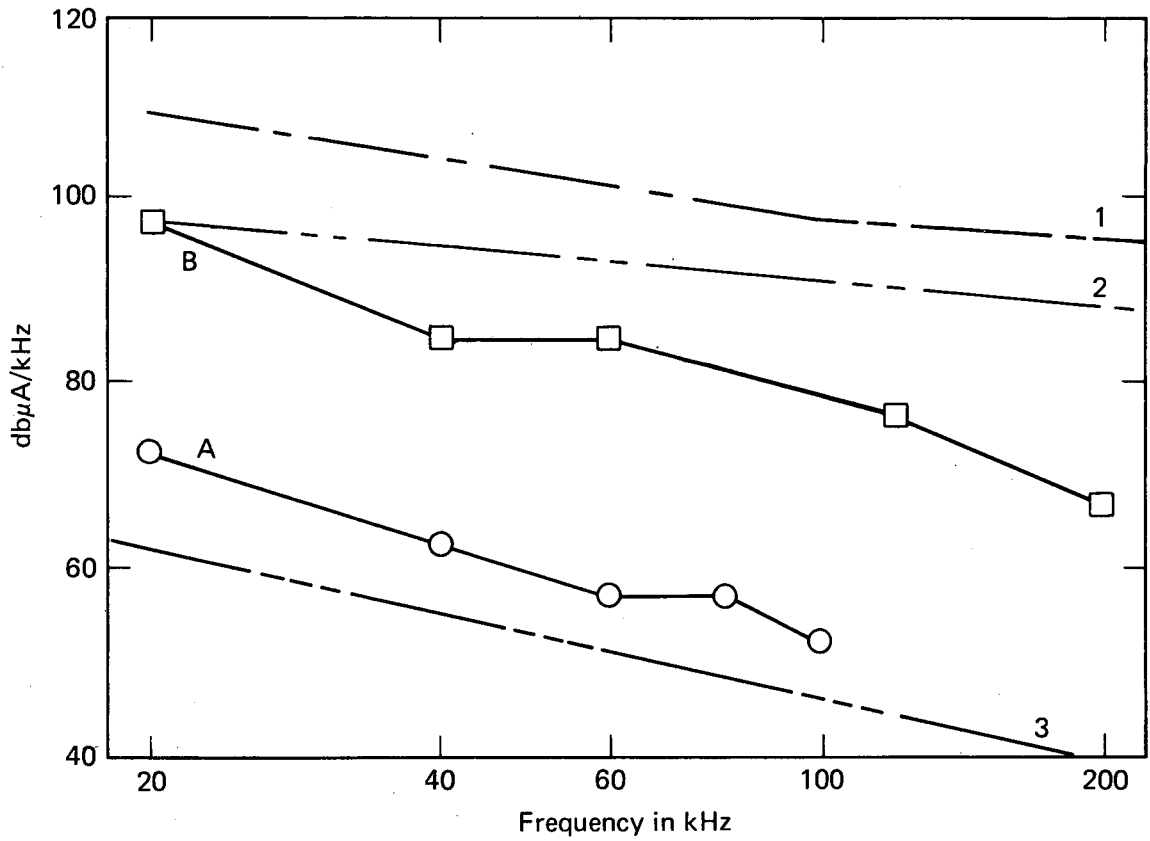

XBL 813-412

Figure 12. Conducted EMI measured in space with 140 two-lamp fluorescent fixtures:  
 (A) conventional ballast;  
 (B) solid-state ballast.  
 (1) FDA medical devices susceptibility limit;  
 (2) FDA narrowband emission limit;  
 (3) FDA broadband limit.

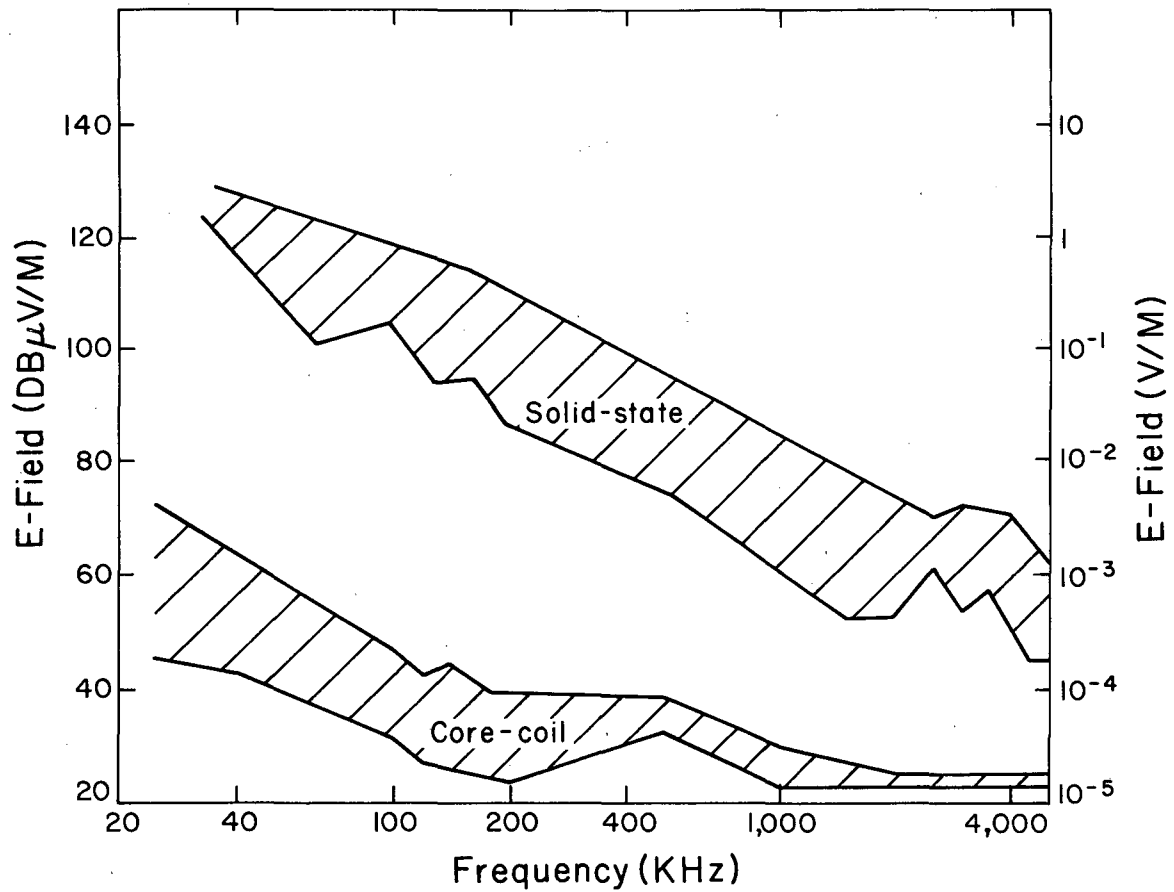

XBL 825-614

Figure 13. Radiated E field from several types of discharge lamps designed to replace the incandescent lamp.

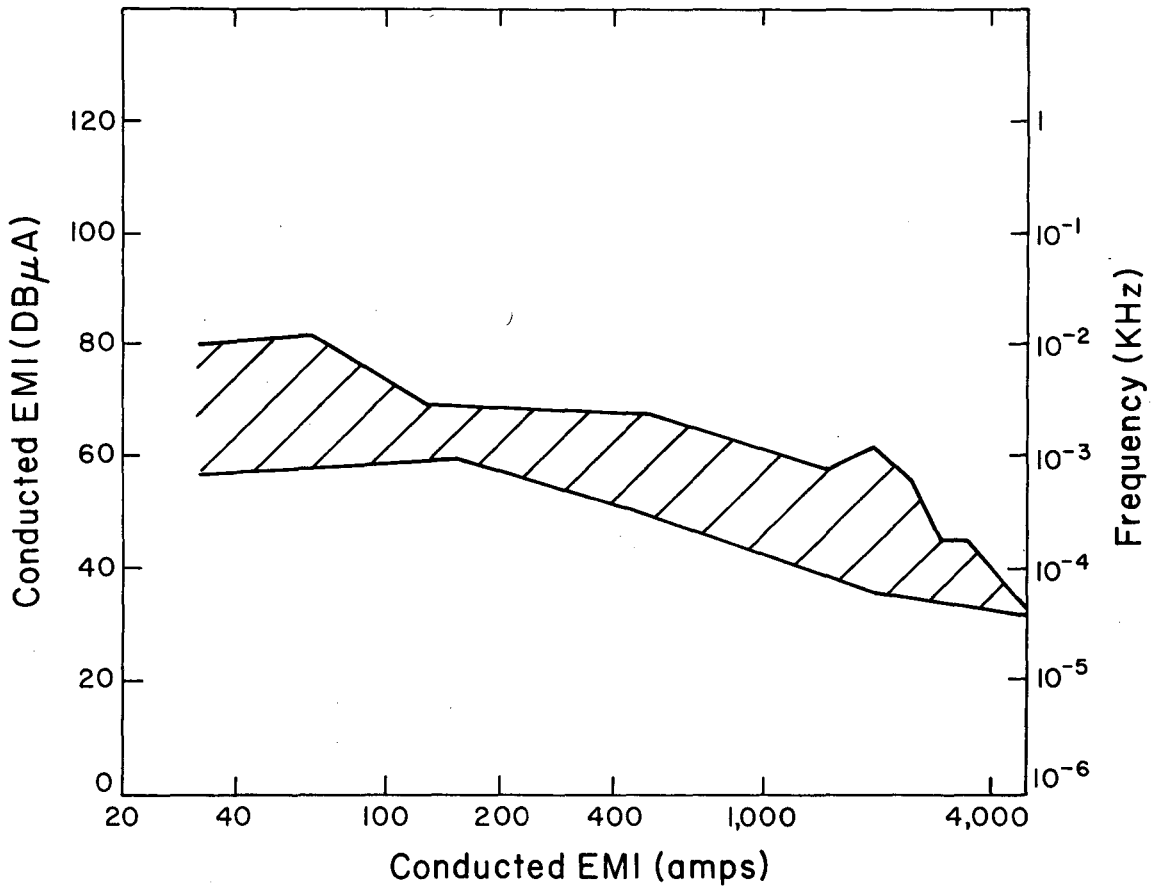

XBL 825-613

Figure 14. Conducted EMI from several types of solid-state ballasted compact and circline fluorescent lamps.

SUMMARIES OF  
BREAKOUT SESSIONS

## BIOLOGICAL EFFECTS OF EM RADIATION

Chairman: Sam Berman (LBL)

Members:

Alan Budner (BPA)	Joseph Petrisch (GSA)
John Clegg (Brigham Young Univ.)	Gil Reiling (GE)
Martin Greenberg (UC Med.)	Francis Rubinstein (LBL)
Donald Jewett (UC Med.)	Asher Sheppard (VA)
Charles Miller (NBS)	Bill Worthing (NEMA)

Two excellent compendia of information on the biological effects of EM radiation are noted: (1) the January 1980 issue of the Proceedings of the IEEE and (2) the Report of the U.S. House of Representatives Committee on Science and Technology, "Research on Health Effects of Nonionizing Radiation," July 1979. Additionally, the text by Sheppard and Eisenbud, "Biological Effects of Electric and Magnetic Fields of Extremely Low Frequency" 1977 has at the end of Chapter I an excellent annotated bibliography for references before 1977. Finally, Portland State University, through its science librarian R.W. Lockerby, has compiled an extensive bibliography on the subject of this session (Public Administration Series Bibliography No. P-649).

### Nature of the Problem

Lighting systems are expected to employ an ever increasing amount of high-frequency components in the form of ballasts, switching and control systems, and gaseous-discharge lamps pulsed at high frequencies.

An order of magnitude of the field strengths that might be involved in the form of radiated electromagnetic energy is provided by the LBL measurements. A single fluorescent lamp was driven by an assortment of ballasts with different electronics all operating in the 30 kHz range. Figures 1 and 2 from the presentation by Arthur, Leung, and Verderber at this conference give the electric and magnetic field strengths one meter from the lamp/ballast system as a function of frequency. These experiments also show that the dominant field strengths fall with a power law given by the cube of the inverse distance. Thus, it is expected that in a building only the nearby systems will be relevant for determining the field strength with a factor of 2 or 3 above the values shown in Figures 1 and 2. This provides an order of magnitude of the field strengths that are of interest for possible lighting health impacts.

## Session Recommendations

Using this order of magnitude as a guideline, the session members unani-  
mously agreed that present data, experience, and anecdotal medical report-  
ing indicate from the point of view of human health that there is no immed-  
iate need for requesting regulations or codes specifying limitations on  
levels of field strengths, power, or specific frequency band widths when  
dealing with the expected electromagnetic radiation emanating from the  
range of presently conceived lighting technologies.

However, since the magnitude of the fields expected from these lighting  
technologies is at or higher than the limits of exposure to naturally  
occurring environmental conditions, there is a number of categories where  
more information is needed before many possible human impacts could be  
fully assessed. In particular, benchmarks are needed for exposure dura-  
tion and dose response covering a wide range of frequencies, but especially  
in the ranges just below the AM broadcast band where the emissions are ex-  
pected to have their largest magnitudes. In this case, investigations  
should be carried out in environments where humans have already been ex-  
posed to fairly intense levels of EM radiation. Such environments as weld-  
ing and induction heating work areas as well as LORAN-C operators' areas  
could serve as an important starting point, since they have all been in  
operation for some time. Furthermore, in these cases due caution should  
be given to the nature of the dose response information that is gathered  
because of biases that influence just what should be recorded as a response.  
In addition, attention should be given to the spectrum of responses under  
consideration as well as the measuring devices for both physical and phy-  
siological parameters.

Even for those devices which operate at frequencies far beyond the radio  
broadcast band, it is expected that carrier frequencies of much lower fre-  
quency will be radiated, and these could very well be in the range below  
500 kHz.

## Unresolved Session Concerns

Opinion in the session was quite divided on the question of whether there  
is an immediate concern because some devices proposed will have emitted  
field strengths greater than what exists in the natural environment where  
humans have spent most of their existence.

Some felt that, since the lighting industry is just about to embark on  
the production of a host of new lighting systems using high-frequency com-  
ponents, more information provided as soon as possible would be helpful  
in preventing any potential harmful products from reaching the market  
with their associated expenses of plant investment and possible liability.

Others felt that, since there is at present no expected negative health  
impact, the industry should proceed as rapidly as possible to respond to  
the user's concern to slow down rising electricity costs by providing  
more energy-efficient lighting.

## COMMERCIAL AND INDUSTRIAL IMPACTS

Chairman: Bill Alling (Luminoptics)

Members:

Bill Braun (Honeywell)	Wing K. Luk (ANSI)
Harry Clayton (IOTA Eng.)	Steve McPherson (Naval Ship R&D)
Sam DePasquale (Jefferson Electric)	Charles Miller (NBS)
Gerald Felper (Datapower)	Kim Newman (Jefferson Electric)
Calvin Grubbs (Thomas Ind.)	Bill Pierpont (Naval Civil Eng. Lab)
Billy Helton (Lithonia)	Tom Reed (Quietlite Int'l.)
Sina Javidi (GE Co.)	Thomas J. Russo (Electrides Corp.)
Al Kurtzan (ALKO Mfg. Co.)	

The Commercial/Industrial breakout committee met to develop recommendations for the conference proceedings. After considerable discussion the group felt that there were five primary areas of concern as follows:

1] That there is a need to define and characterize the commercial/industrial environment with regard to both conducted and radiated emissions. Susceptibility standards could then be developed similar to FDA Standards for a hospital environment. The Task Group felt that this was important to bring order to the commercial/industrial environment and to set specific minimum standards which future designers of electronic equipment could utilize.

2] That an industry task group be formed with the view of allocating frequency bands within the low and very low frequency bands. As it now stands, there are no rules or guidelines for the designer of electronic equipment in the very low frequency spectrum and it is thought that unless some order is established at an early time the problem of EMI will increase in the future. By allocating bands within the spectrum to broad categories of devices, i.e. solid state ballasts, carrier communications, etc., it may be possible to limit EMI in the future or at very least identify the character of the problem when coherent effects are encountered.

3] The Task Group felt that the current LISN Impedance matching devices (LISN's) should be reviewed by an industry group to determine their applicability to measurements in the Commercial/Industrial sector. By inference it was also thought that should the industry feel that the current methods were inadequate that this same group would develop new standards.

4] In general, the Task Group thought that separate standards for EMI should be developed for the commercial and industrial sector apart from any others. Looking toward the future the group saw more and more sources for EMI being placed with the C&I environment and felt that this environment was unique enough to warrant the effort.

5] That an industry group be formed to explore the desirability of defining the interrelationships and effects of power factor and third harmonic distortion on the C&I sector. This group should include representatives from the major utility companies. If necessary a USA standard would be developed.



## RESIDENTIAL IMPACTS

Chairman: Ed Yandek (GE & NEMA)

Members:

Bob Boettner (DOE)	Jim McCarthy (ALKO Mfg.)
Bob Clear (LBL)	Vic Roberts (GE)
Frank Latassa (N.A. Philips)	Dave Stiles (Robertson Transformer)
Susan Lepman (L&S Lighting)	Rudy Verderber (LBL)

### 'PROTECTION' IN THE HOME ENVIRONMENT

In general, radiated emissions will fall off very quickly with distance. There will probably not be a problem beyond a few feet, and certainly not beyond a single dwelling household. Within a common dwelling, such as an apartment or condominium, it is possible to interfere with a 'near neighbor' in a one or two foot distance situation (i.e., opposite sides of a common wall).

### RESIDENTIAL ENVIRONMENT KNOWLEDGE NEEDS

More needs to be known regarding the expectations and tolerance of residential consumers. 'Harmful interference' is subjective and must be better defined and characterized. Expectations must be expressed in terms of a protection distance for various types of receivers and services.

Existing information regarding AM/FM/TV signal levels needs to be collected, analyzed, and examined with respect to residential RF lighting EMC impact. Items such as signal quality, home construction techniques, and cable TV will influence the determination of service protection levels and limits.

Much more needs to be known with respect to susceptors encountered in the residential environment. This is true both for existing devices and for future devices.

### CONDUCTED IMPLICATIONS

The home environment represents some unique challenges with respect to conducted emanations. Power lines are configured in a variety of ways, each having different EMC properties: Knob and tube, 'Romex' jacketed, and metallic sheathed (conduit, flexible armored). Relevant LISN characteristics need to be specified.

Utility implications also need to be addressed, particularly line harmonic distortion and power factor.

### A ' PROBLEM' ?

There is probably the 'potential' for a problem if the above areas are ignored. The magnitude of the problem is probably not serious presently since the numbers of products serving this market are small. Initially, 'problems' are probably more evident from a marketing rather than an FCC perspective.

### CALL TO ACTION

The following groups and agencies should undertake to apply their expertise and leadership in solving the above types of problems.

- LBL - continue to catalyze efforts aimed at filling in the "knowledge gaps" discussed.
- NBS - develop improved/more relevant measurement techniques for lighting sources and suitable application distances.
- FCC - continue to protect authorized broadcast services - encourage the development of more relevant LISN's and near field E-field limits.
- NEMA- take an industry leadership role to coordinate manufacturer's recommendations for an RF lighting specification and in developing a proposal for RF lighting.
- EPRI - coordinate utility concern regarding line distortion and power factor.
- ANSI - aid in the generation and dissemination of lighting/EMC standards.

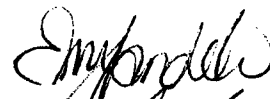

E. M. Yandek  
Chairman, Residential Impacts

## EM MEASUREMENTS

Chairman: Joel Shurgan (Duro-Test)

Members:

Bob Clark (Robertson Transformer)	Ed Morten (Westinghouse)
Hal Gauper (GE Co.)	A. R. Naysmith (ETL)
Leon Leung (LBL)	Gil Reiling (GE)
James Lester (GTE)	J. Wagget (EE Tech)
E. Marrie (Universal)	Richard Woodbury (Brigham Young Univ.)

### Summary

The session started with the reference of Hal Gauper to ANSI publications C63.2, C63.3, and C63.4. C63.2 covers the meter used in the measurement of radio noise in the .015 to 25 megahertz range, C63.3 and C63.4 cover the measurement techniques in the 20 mhz to 1 ghz range and the .015 to 25 mhz ranges respectively. Also available are many commercially produced devices such as spectrum analyzers made by Hewlett Packard. Application notes are available from Hewlett Packard for methods in accordance with C63.2 and C63.3. These devices are easily saturated; this can be checked by using various settings of the input attenuator to check for obvious deviations from linearity.

Other devices are made by Tecronics, Seimans Rhode and Schwartz and others.

The U.S. is moving towards CISPR Standards, but at this time there is less than full agreement.

Dr. Miller, of NBS has kindly offered the services of his group in developing apparatus in measurements in this area.

Mr. Lester brought out the point that in some instances, the detection antenna may be as large as the generating device; this may be a problem, especially in near-field work at lower frequencies. Mr. Gauper suggested that a monopole be used below 30 mhz, impedance matching may be a problem. A one meter rod seems to be an industry compromise at present. In any case, measurements should be made in an area free of standing waves and electrically quiet.

Both E field and H field strengths should be determined, near the noise source they may not be simply related by Maxwell's equations.

Mr. Woodbury stated that in low frequency measurements, above 450 khz, LISN devices would probably be best, below 450 khz transformers may be more applicable.

Ed Morton discussed the problems with AM receivers picking up radiated noise, especially in the near field.

There was a general discussion of the radio receiver problem, apparently less expensive receivers pick up both E field and H field and are not likely to be re-designed to reduce noise. Another question discussed was the levels of precision and accuracy available. Mr. Gauper stated that plus or minus 3 dB for E field measurements is about as precise as is possible at present, accuracy is not much better, perhaps plus or minus 2 dB. Several methods of measurement are used including the "Quazi Peak" method and much depends on the band width.

Mr. Woodbury pointed out that above 450 khz, in measuring noise spectra, the harmonics of a low frequency source tend to fuse.

Mr. Gauper pointed out also that when ever possible, the measuring instruments should be those used in common in other industries, and possibly developed for them. This would reduce equipment costs and make it possible for small organizations to afford the needed instrumentation.

Computer analysis of the noise spectra was also discussed; it was agreed that it would be desireable at some stage not far away, but little is available now. Digitizing transient data would be of great help, especially in lamp starting where repetitive measurements are impossible. It would also be of value to be able to store data in analogue or digital form, especially for rapidly changing data and for monitoring by unattended equipment.

Mr. Lester also pointed out that it may be possible to use a sphere technique if the lamp or ballast were treated as a point source. A cell somewhat like the device described the previous day by Mr. Miller of NBS might be very useful.

Also discussed was the need for measurements of Heterodyne effects between many small sources all differing slightly from a mean value and spread out in a limited space.

In summary, the following remarks were made:

H. Gauper: Uniform methods should be devised, tailored to specific needs of the problem.

Ed Morton: We should specify measurements methods for both short term and continuous noise generation.

Mr. Clark: Standards should not favor larger organizations by requiring inordinately expensive equipment.

Dr. Reiling: Standards methods are needed.

Mr. Woodbury: Laboratory standards should be generated in a central facility such as the FCC or NBS.

Mr. Lester: Agreed with Mr. Woodbury.

I may not have used proper titles for the various participants. Please correct this when possible.

Thank you,

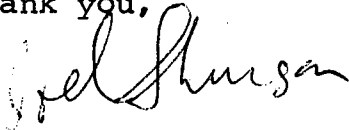

Joel Shurgan

## EM LIGHTING DATA BASE

Chairman: Al Arthur (LBL)

Members: Barrie Luttge (EXO Corp.)  
J. Thompson (House Electric)  
Dick Troth (VA Office of Construction)

### Summary

- 1) A committee composed of OEM's and lighting system manufacturers and large consumer groups could be formed and would establish relevant parameters to characterise the lighting systems and their components. The parameters may well go beyond the scope of EMI and include energy saving parameters such as efficacy, power factor, cost, reliability and safety.
- 2) A committee could then be convened (possibly the same committee) to establish standard methods and instruments to measure each of the chosen parameters. Two levels of EMI instrumentation would be considered: one that would provide consistent accurate data under carefully controlled laboratory conditions, and a second that would provide a simple inexpensive means to obtain approximate results under field conditions.
- 3) Finally, one or more independent testing laboratories could be certified by the committee to perform the tests. Those manufacturers of lighting systems and components who were interested in providing information to the database could then submit equipment for evaluation to the testing laboratory.

## REGULATIONS

Chairman: Art Wall (FCC)

Members:

Robert Burke (Triad-Utrad)	Arnold Mercer (Universal)
George Clark (GTE)	Dave Mullen (GTE)
Jerry Coddington (Energy Saver)	Richard Ravas (Westinghouse)
D. Liametz (Designetics)	Joe Sherman (Naval Ship R&D)
Murlin Marks (U/L, Inc.)	

### Summary

1. Separate standards will be required for each operating environment (commercial, industrial, residential, and outdoor).
2. It is possible to permit frequency allocations in the lower frequency bands (20 kHz to 200 kHz).
3. It may be necessary to develop susceptibility standards for all equipment operating in each environment.
4. There is a need to review the applicability of present impedance matching techniques and circuits when measuring EMI. Do present LISN fairly characterize C&I environments?
5. A task group should be formed to study the technical relationships of the technologies which go into new systems (controls, ballasts, EDP, and communications).

## EM ATTENUATION TECHNIQUES

Chairman: Ed Stupp (Philips Labs)

Members:

Bob Carlson (Luminoptics)	Oliver Morse (LBL)
Bill Elliot (Quietlite Int'l.)	Joe Nuckolls (GE Co.)
Dale Fiene (Robertson Transformer)	Fred Parker (JEELA, Inc.)
E. Freegard (Advance Transformer)	Lloyd Perper (IOTA Eng.)
Jim Goodman (Naval Ship R & D)	Tom Rutner (Triad-Utrad)
Bob Munson (DayBrite)	Jerry Zonis (ETI & Alpha)

### Summary

1. If an EMI problem exists, the manufacturer of the component generating the electromagnetic energy should be responsible. The solid-state ballast manufacturer, for example, must address this problem. The manufacturer should of course work with the lamp and fixture groups to minimize effects.
2. The preferred manner is to minimize the EM generation through circuit design. LC filters are most important in reducing conducted EMI.

Minimizing the conducted EMI is important because its transmission over power lines will result in its efficient radiation into space. There will always be radiated EM energy from lamps -- for example, four-foot lamps operate at 100 volts; thus, the field is about 100 V/m.

There are many useful techniques for modifying circuit components; beads are useful for reducing switching transients, and wire-wrapped resistors are useful for attenuating high frequency.

3. Conductive coatings on lenses and lamps represent a possible solution. However, these can cause potential safety problems at high frequency.

Future designs could include an embedded grid in the plastic lenses to attenuate radiated EMI.

Conductive (metal) grids on fixtures without plastic lenses could serve to control the light flux and attenuate radiated EMI.



## CONFERENCE CONCLUSIONS

The lighting community is concerned with the resolution and identification of the potential effects of the increased generation of electromagnetic energy from new efficient lighting systems. The lack of information on the effects of this energy on man, machinery, and the environment could inhibit the development and introduction of these systems, which could provide the means to greatly reduce energy use for lighting while supplying high quality illumination.

It is necessary to know the limits of EMI levels that would be satisfactory for general use in commercial, industrial, outdoor, and residential applications.

There is a need for a standard method to measure the EMI levels generated by lighting systems. In particular, near fields are important for lighting applications. A low-cost field instrument for on-site measurement of lighting systems would be helpful.

The few large-scale installations of solid-state ballasts have observed no adverse effects. A more extensive data base is required.

Research should be initiated to determine the EMI impacts of these lighting systems before they have penetrated more than 50% of the market.

Electromagnetic waves at very high and low frequencies and high power are known to affect humans. Neither the frequency ranges used by lighting systems, 60 Hz to 10 MHz, nor the power levels are expected to be dangerous. However, competent scientific endeavors in this area are limited and should be pursued.

Professional organizations and the independent national laboratories concerned with present and future use of energy-efficient lighting systems must initiate programs in the above areas. The Federal Communications Commission should play an active role in helping the community develop and use lighting systems that will not interfere with existing operations.

Satisfactory resolution of the issues discussed at this conference could help expedite the acceptability of new energy-efficient lighting systems, thereby assuring a cost benefit to consumers and a more efficient use of our energy resources.

LIGHTING-EMI  
LIST OF PARTICIPANTS

Bill Alling	UMC-Luminoptics, San Ramon CA
Al Arthur	LBL
C. Douglas Auburg	BPA, Portland OR
Sam Berman	LBL
Bob Boettner	DOE, Washington, D.C.
Wm. F. Braun	Honeywell, Ontario, Canada
Alan Budner	BPA, Portland OR
Robert V. Burke	Triad-Utrad, Huntington IN
Robert Carlson	Luminoptics, San Ramon CA
George Clark	GTE Product Corp., Danvers MA
Robert Clark	Robertson Transformer, Blue Island IL
Harry Clayton	IOTA Eng., Tucson AZ
Robert Clear	LBL
John C. Clegg	Brigham Young Univ., Provo UT
Jerry Coddington	Energy Saver Assoc., Tempe AZ
Theodore Cohn	U.C. School of Optometry, Berkeley CA
Sam DePasquale	Jefferson Electric, Bellwood IL
Bill Elliott	Quietlite Int'l., Reno NV
Gerald Felper	Datapower, Inc., Santa Ana CA
Dale Fiene	Robertson Transformer, Blue Island IL
Ernest M. Freegard	Advance Transformer Co., Chicago IL
Harold Gauper, Jr.	GE Co., Schenectady NY
Jim Goodman	Naval Ship R&D Center, Annapolis MD
Martin Greenberg	U.C. Medical School, San Francisco CA
Dan Greenhouse	U.C. School of Optometry, Berkeley CA
Calvin Grubbs	Thomas Industries, Garland TX
Mike Harms	LBL
Billy G. Helton	Lithonia, Conyers GA
Sina Javidi	GE Co., Cleveland OH
R. E. Jennings	Public Works, Canada
James Jewell	IES, PG&E, San Francisco CA
Donald Jewett	U.C. Medical School, San Francisco CA

Joseph Klems	LBL
Al Kurtzan	ALKCO Mfg. Co., Sunnyvale CA
John La Giudace	Citibank, New York NY
Frank Latassa	N.A. Philips Lighting Co., Lynn MA
Susan Lepman	L&S Lighting, Berkeley CA
James Lester	GTE Sylvania, Danvers MA
Leon Leung	LBL
D. Liametz	Designetics Assoc., Secaucus, NJ
Wing K. Luk	ANSI, New York NY
Barrie Luttgé	EXO Energy Engineering Corp., Mountain View CA
Murlin Marks	Underwriters Lab., Inc., Santa Clara CA
Edward K. Marrie	Universal, Patterson CA
Steve McPherson	Naval Ship R&D Center, Annapolis MD
James McCarthy	ALKCO Mfg. Co., Sunnyvale CA
Arnold Mercer	Universal, Patterson CA
Charles Miller	National Bureau of Standards, Boulder CO
Oliver Morse	LBL
Edward Morton	Westinghouse, Bloomfield NJ
David Mullen	GTE Products Corp., Danvers MA
Bob Munson	DayBrite, Tupelo MO
A. R. Naysmith	ETL, Cortland NY
Eliyahu Ne'eman	LBL
Kim Newman	Jefferson Electric, Los Angeles CA
Joe Nuckolls	GE Co., Hendersonville NC
Fred Parker	JEELA, Inc.
Lloyd Perper	IOTA Eng., Tucson AZ
Ronald Peterson	Northwest Industrial Lamp, OR
Joseph Petritsch	Government Services Administration, San Francisco CA
Bill Pierpoint	Naval Civil Engineering Lab, Port Hueme CA
Richard J. Ravas	Westinghouse R&D, Pittsburg PA
Tom Reed	Quietlite Int'l., Reno NV
Gil Reiling	GE, Cleveland OH
Victor Roberts	GE, Schenectady NY
Francis Rubinstein	LBL

Thomas Russo	Electrides Corp., Staten Island NY
Tom Rutner	Triad-Utrad, Huntington IN
Jim Schellenberg	UMC-Luminoptics, San Ramon CA
Stephen Selkowitz	LBL
Asher Sheppard	Veterans Administration, Loma Linda CA
Joe Sherman	Naval Ship R&D Center, Annapolis MD
Joel Shurgan	Duro-Test Corp., North Bergen NJ
Edward H. Stupp	Philips Labs, Briarcliff Manor NY
David Stiles	Robertson Transformer, Blue Island IL
Juris Sules	GE, Cleveland OH
Rai-Ko Sun	LBL
Dick Troth	Veterans Administration, Office of Construction, Washington, D.C.
Rudy Verderber	LBL
J. Wagget	EE Tech, El Segundo CA
Art Wall	FCC, Washington, D.C.
Richard C. Woodbury	Brigham Young Univ., Provo UT
R. W. Worthing	NEMA, CA
Ed Yandek	GE & NEMA, Cleveland OH
Jerry Zonis	ETI & Alpha Energy

This report was done with support from the Department of Energy. Any conclusions or opinions expressed in this report represent solely those of the author(s) and not necessarily those of The Regents of the University of California, the Lawrence Berkeley Laboratory or the Department of Energy.

Reference to a company or product name does not imply approval or recommendation of the product by the University of California or the U.S. Department of Energy to the exclusion of others that may be suitable.

TECHNICAL INFORMATION DEPARTMENT  
LAWRENCE BERKELEY LABORATORY  
UNIVERSITY OF CALIFORNIA  
BERKELEY, CALIFORNIA 94720