

# Lawrence Berkeley National Laboratory

## Lawrence Berkeley National Laboratory

### **Title**

Test Results on D-12A-2

### **Permalink**

<https://escholarship.org/uc/item/6185p1kb>

### **Author**

Hassenzahl, W.

### **Publication Date**

1984-08-08

TEST RESULTS ON D-12A-2\*

W. Hassenzahl

The purpose of this report is to describe the recent tests of D-12A-2. The tests of D-12A-2 began on April 30 and ended on May 8. The unusually long test period was a result of an extensive series of magnetic field measurements in which we attempted to determine the shielding affects of a sextupole compensating coil and the decay of the currents induced in this coil.

This report is short, but much of the data from the tests are included or summarized. We begin with a description of the coil and conductor, continue with the training history, the results of magnetic measurements, including the use of a sextupole compensating coil and then describe the results of heater induced quenches including estimates of axial and transverse quench propagation velocities.

D-12A-2 Magnet Description

The D-12 Magnet is a 1-m long, two layer SSC model wound with two conductors that are similar but do not have the final superconductor pro-

---

\* This work was supported by the Director, Office of Energy Research, Office of High Energy and Nuclear Physics, High Energy Physics Division, U.S. Dept. of Energy, under Contract No. DE-AC03-76SF00098.

posed for the SSC. The major coil parameters are given in Table I and the conductor is described in Table II. The coil cross section is shown in Fig. 1. Several voltage taps were included during construction and these are shown on the wiring diagram, Fig. 2. The load line for the coil and the short sample characteristics of the two conductors are given in Fig. 3.

Table I

PARAMETERS OF THE D-12A-2 1 METER LONG SSC MODEL DIPOLE

	<u>layer 1</u>	<u>layer 2</u>
Inside Diameter (mm)	39.88	59.44
Outside Diameter (mm)	58.93	76.61
Pole Angle (°)	73.96	40.86
End Outside Diameter (mm)	76.61	76.61
Number of Wedges	10	6
Wedge Angle (°)	7.531	6.888
Precompression (psi)	12,000	20,000
Midplane Shim (mm)	0.75	0.80
Coil Length (m)	0.9954	0.6926
Conductor Length (half layer)(m)	17.5	10.9

---

Inductance (mH)	~.8
Maximum Current (A)	6430
Iron Outside Diameter (mm)	219.1
Iron Inside Diameter (mm)	86.1
Bore Diameter (mm)	
Maximum Field (T)	6.5

Table II

## CONDUCTOR FOR D 12 A2 MODEL COIL

<u>Conductor Type</u>	<u>Cable</u>	<u>Cable</u>
Superconductor	NbTi	NbTi
Cable Twist Pitch (mm) <sup>-1</sup>	12	16
Conductor Length (m)	17.5	10.9
Number of Strands	23	27
Cable Dimension Insulated (mm <sup>2</sup> )	1.52x9.42	1.28x8.64
Compaction (percent)	89.5	88.7
Insulation Thickness (mm)	2x0.025	2x0.025
Strand Diameter (mm)	0.807	0.635
Copper to Superconductor Ratio	1.03	1.33
Number of Filaments	665	504
Filament Diameter (μm)	22.0	18.5
Strand Twist Pitch (mm) <sup>-1</sup>	0.16	0.24

The voltage taps installed in the coils and shown in Fig. 2 were connected to isolation amplifiers to give the channels listed in Table III. This is the maximum possible number of channels and for some runs only a few of the channels were used. Four heaters were also built into the magnet. They were mounted in grooves in the islands and were in thermal contact with the first turn of each half layer.

#### Training and Precompression

The D-12A-2 exhibited some training before reaching 6400 A, which appears to be short sample, on the 14th quench. The training sequence is shown in Fig. 4 and Table IV. The low quench currents for quenches 21 to 25 were during the fast ramp tests. In fact there is negligible reduction in

$I_{\max}$  for  $\dot{B}$  up to 0.3T/s. This magnet was not tested in He II so there is no cyclic loss data.

During assembly the coil was compressed to 12,000 psi in layer 1 and 20,000 psi in layer 2 by the iron rings. The compression remaining at 4 K before the coil was energized was less than 2,000 psi on each layer.

Table III

CHANNELS IN DATA FILES FOR THE EARLY QUENCHES ON D-12A-2

<u>Channel No.</u>	<u>Signal</u>
1	Whole Magnet
2	Top Half
3	Bottom Half
4	Layer 2, Top
5	Layer 2, Top
6	Layer 2, Bottom
7	Layer 1, Bottom
8	Most of 1, Top
9	Dead, See 31
10	Most of 2, Bottom
11	Most of 1, Bottom
12	Top 1, 4 to 2
13	Top 1, 2 to 1
14	Top 1, lead end
15	Top 1, side
16	Top 1, far end
17	Top 1, side to sp
18	Top 2, turn 1
19	Top 2, 1 to 3
20	Bottom 2, 3 to 1
21	Bottom 2, 1 to spl
22	Bottom 1, sp to sid
23	Bottom 1, far end
24	Bottom 1, side
25	Bottom 1, lead end
26	Bottom 1, 1 to 2
27	Bottom 1, 2 to 4
28	Current
29	Balance, filtered
30	Balance, raw
31	Most of Top 2

Table IV  
 QUENCH HISTORY FOR D-12A-2

<u>Quench Number</u>	<u>Current</u>	<u>Section</u>	<u>Ramp rate</u>
1	4500	Layer 2, Top	$2 \times 10^{-3}$ Hz
2	4870	Layer 2, Top	$2 \times 10^{-3}$ Hz
3	5065	Layer 2, Top	$2 \times 10^{-3}$ Hz
4	5534	Layer 2, Bottom	$2 \times 10^{-3}$ Hz
5	5734	Layer 2, Bottom	$2 \times 10^{-3}$ Hz
6	5680	Layer 2, Top	$2 \times 10^{-3}$ Hz
7	5924	Layer 2, Top	$2 \times 10^{-3}$ Hz
8	5963	Layer 2, Top	$2 \times 10^{-3}$ Hz
9	6022	Layer 2, Top	$2 \times 10^{-3}$ Hz
10	6139	Layer 2, Top	$2 \times 10^{-3}$ Hz
11	6197	Layer 2, Top	$2 \times 10^{-3}$ Hz
12	6315	Layer 2, Top	$2 \times 10^{-3}$ Hz
13	6383	Layer 2, Top	$2 \times 10^{-3}$ Hz
14	6412.	Layer 2, Top	$2 \times 10^{-3}$ Hz
15	6334	Layer 2, Top	$2 \times 10^{-3}$ Hz
16	6295	Layer 2, Top	$2 \times 10^{-3}$ Hz
17	6344	Layer 2, Top	$2 \times 10^{-3}$ Hz
18	6383	Layer 2, Top	$2 \times 10^{-3}$ Hz
19	6422	Layer 2, Bottom	$5 \times 10^{-3}$ Hz
20	6324	Layer 2, Bottom	$1 \times 10^{-2}$ Hz
21	5631	Layer 1, Top	$2 \times 10^{-2}$ Hz
22	5973	Layer 1, Top	$5 \times 10^{-2}$ Hz
23	5953	Layer 1, Bottom	$2 \times 10^{-2}$ Hz
24	5856	Layer 1, Top	$5 \times 10^{-2}$ Hz
25	5309	Layer 1, Bottom	$7.5 \times 10^{-2}$ Hz

This level of compression is not sufficient to restrict motion when the coil is energized so some training was expected. The loss of compression when cold is due to the large thermal contraction of the aluminium islands and the coils relative to the iron rings.

### Heater Tests

Four heaters were installed in the D-12A-2, one on each pole island. The effect of these heaters on the coil are shown in Figs. 5, 6, and 7. In Fig. 5 we see the power in milliwatts required for a heater in the layer 1 island to quench the coil at different current levels. The two sets of data shown, which correspond to constant heater power and constant coil current, are in good agreement.

Figure 6 shows the heater energy required to quench the coil for a pulse duration of 25 ms. These two figures thus define the stable regime for energy and power inputs for a 10 cm length of conductor in the high field region.

Figure 7 shows the transition from a pulsed (energy) input to a continuous (power) input. This occurs at a period of 0.5 to 1.0 seconds. Shorter times have been observed in the past, for other magnets. The long response time is attributed to the poor thermal contact between the heater element and the conductor.

### Magnetic Measurements

The field quality of D-12A-2 was measured for a variety of conditions: warm and cold, with and without a compensating coil, at many currents, and during different current cycles. The harmonic content of the coil at room temperature is given in Table V for the central and integral fields at a reference radius of 1 cm.

Table V

HARMONIC CONTENT OF D-12A-2 AT ROOM TEMPERATURE,  
2.0 A, at a REFERENCE RADIUS OF 1 CM, % OF DIPOLE.

<u>Harmonic Number</u>	<u>Field</u>	
	Central	Integral
2	0.042	0.090
3	0.045	0.593
4	0.020	0.018
5	0.030	0.012
6	0.013	0.001
7	0.006	0.004
8	0.004	0.001
9	0.004	0.003

The sextupole field in the central region is quite reasonable, 0.04 percent, but when the ends are included the field quality degrades considerably. These ends, which were not designed to have a low sextupole component, are too poor at present to be acceptable, even in a 16 m long coil where their effect would be diluted.

The magnetic field in the coil in the superconducting state was measured with the sextupole compensating coil in and out of the persistent mode. The sextupole in the magnet at 3 T, without correction, was 180 G. This value was reduced to 20 G when the compensating coil was in persistent mode from zero current. The affects of the compensating coil are seen in Figs. 8 and 9. The lower curve in Fig. 8 shows the characteristics of the magnet itself. Hysteresis in the superconductor (residual currents in the filaments) has a major effect at low fields. In the intermediate field region, the 0.6 percent sextupole is roughly constant and at high fields the iron begins to saturate and introduce a larger component. The upper curve



in Fig. 8 shows the sextupole component with the compensating coil in the persistent mode. In Fig. 9 we see the sextupole field for these two cases on an absolute scale of Gauss. The correction is quite good, the residual field is only a few Gauss at low excitation.

#### Quench Propagation Velocities

During some of the quenches the development of the resistive voltage across various segments of the coil was observed in adequate detail to determine quench propagation velocities. This data, which is summarized in Table VI, was on the runs when quenches were produced by the heaters so a priori, one might expect them to be slightly high, but they are in reasonable agreement with the data from previous magnet tests.

Table VI

#### QUENCH PROPOGATION VELOCITY RANGES FOR WATER INDUCED QUENCHES

<u>Current (A)</u>	<u>Velocity (m/s)</u>
3000	3-6
4000	8-25
5000	18-25
6000	40-60

Fig. 1

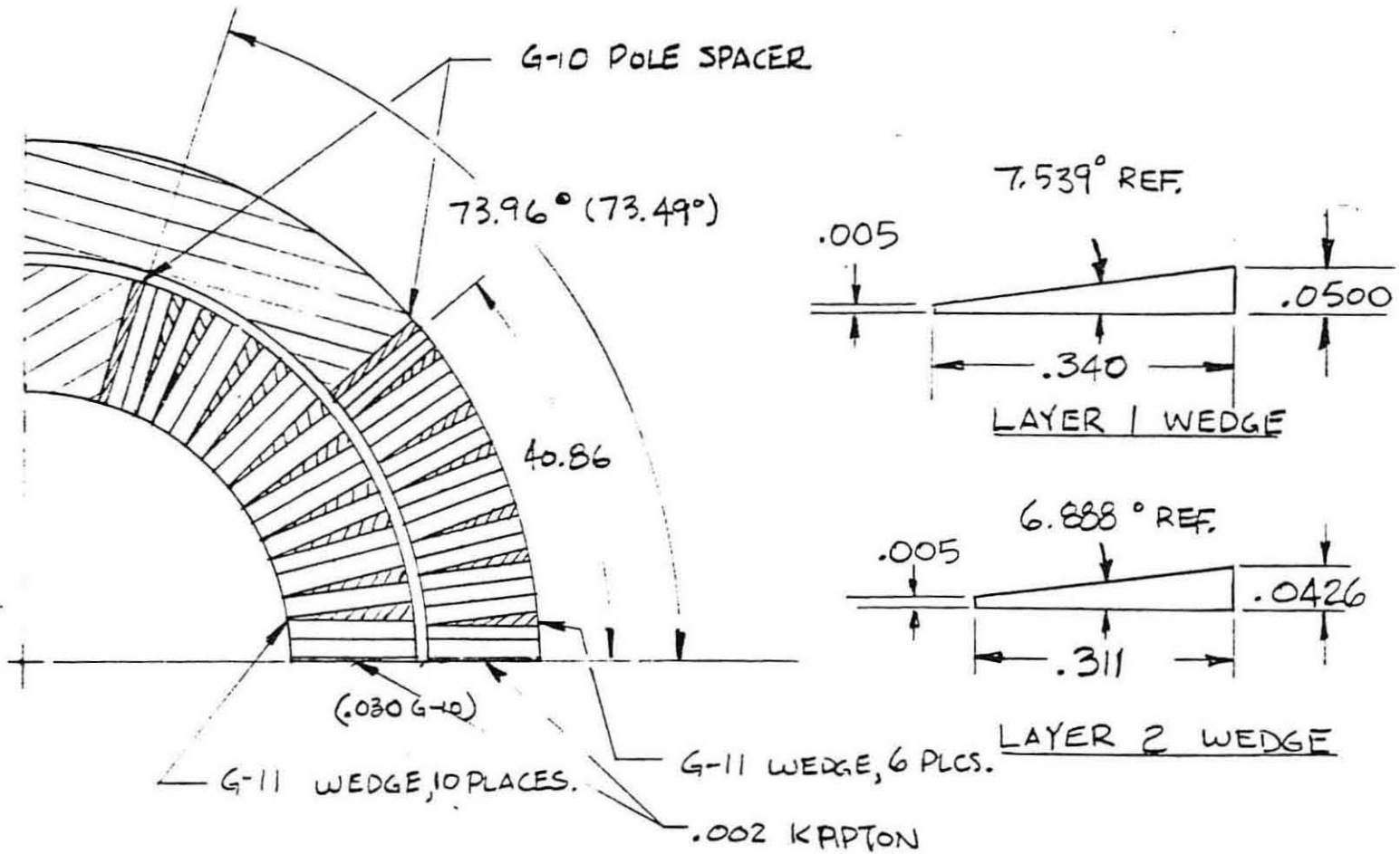
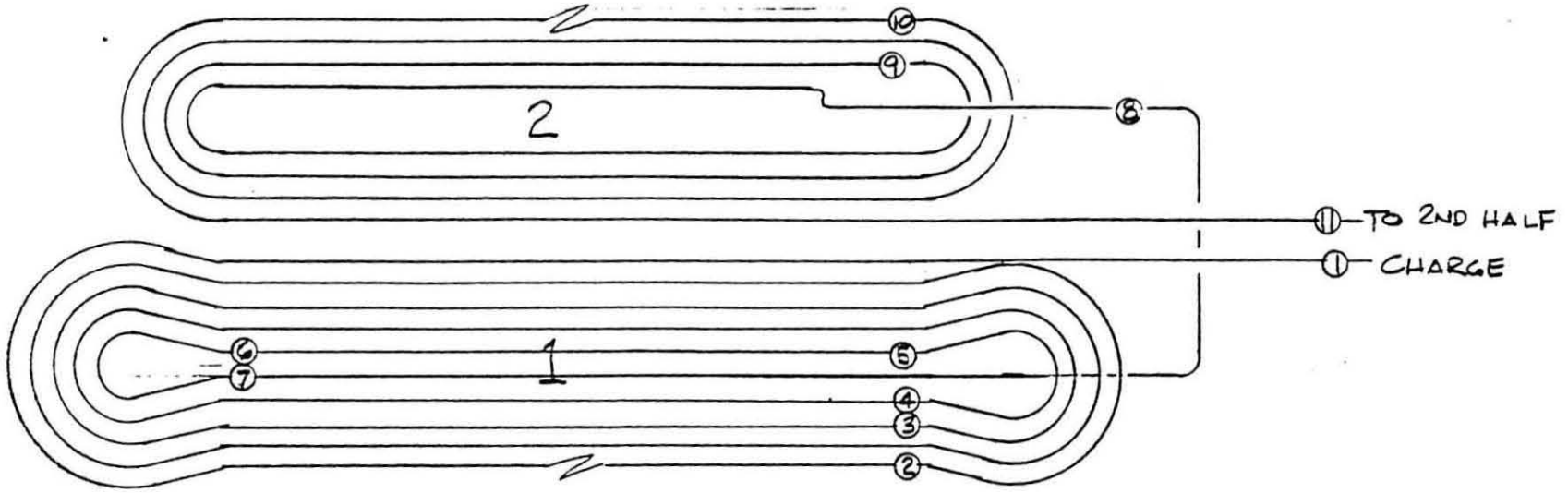

Fig. 2



D-12A-2 Load Line and Short Sample Curves

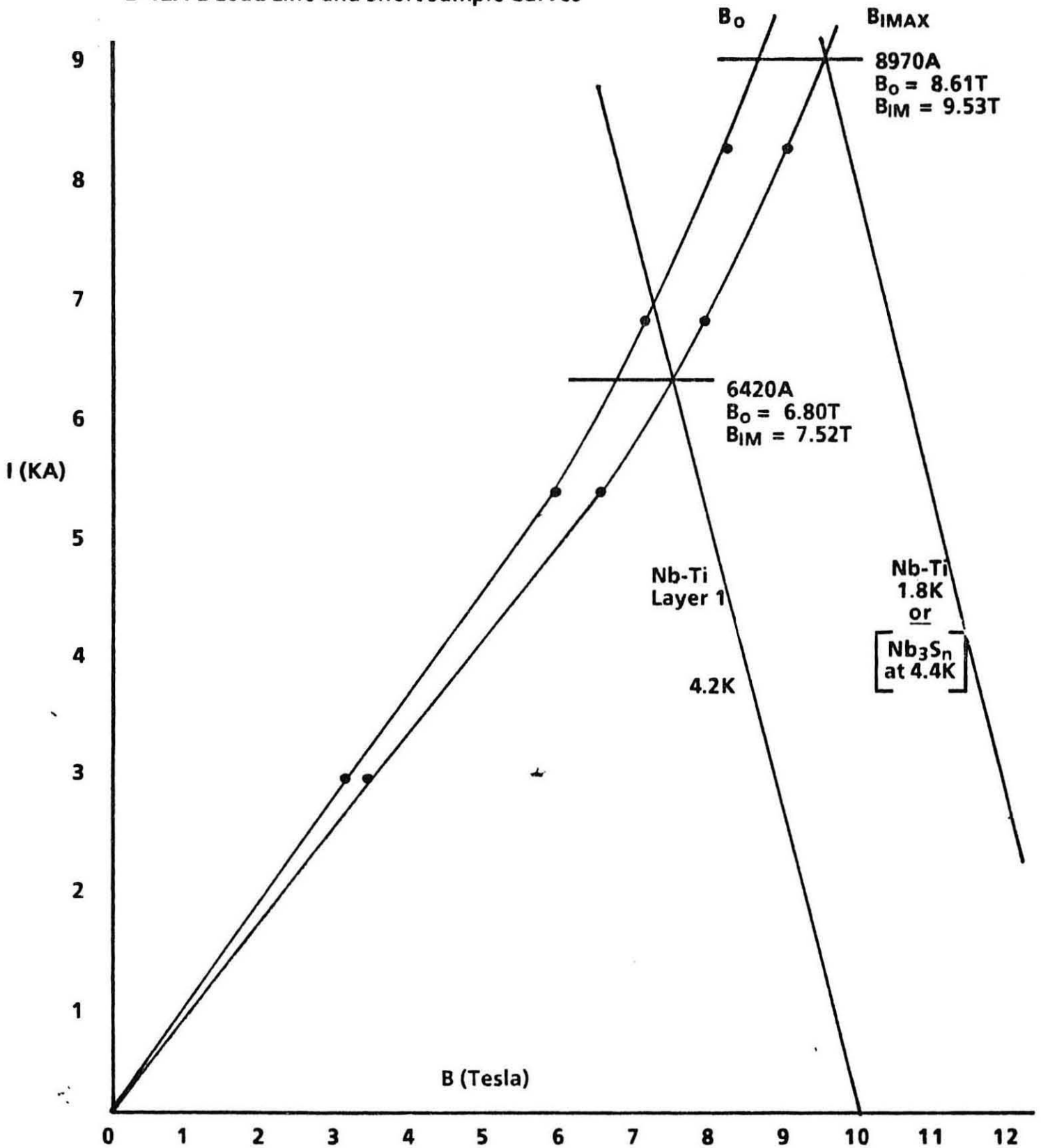

Fig. 3

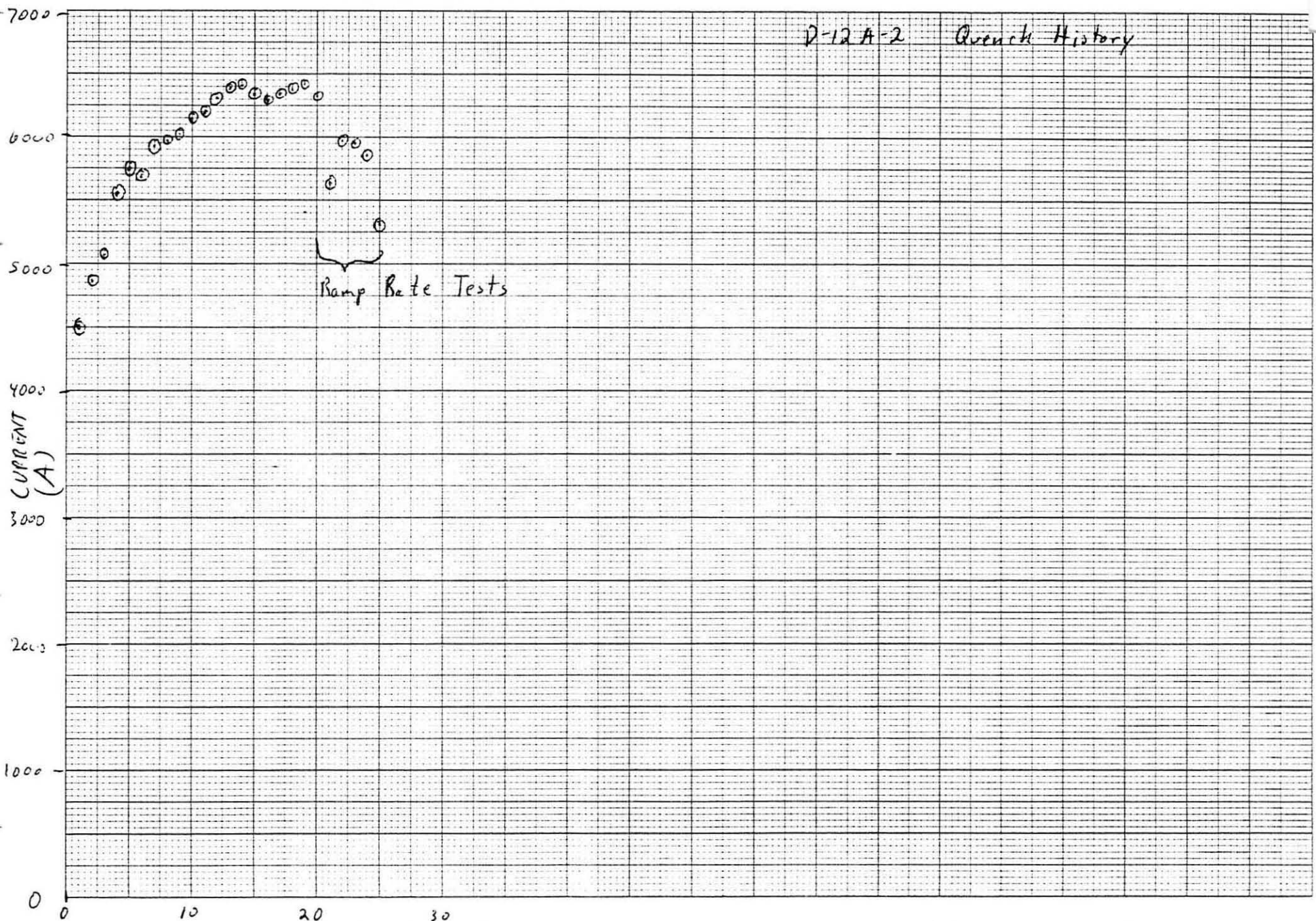
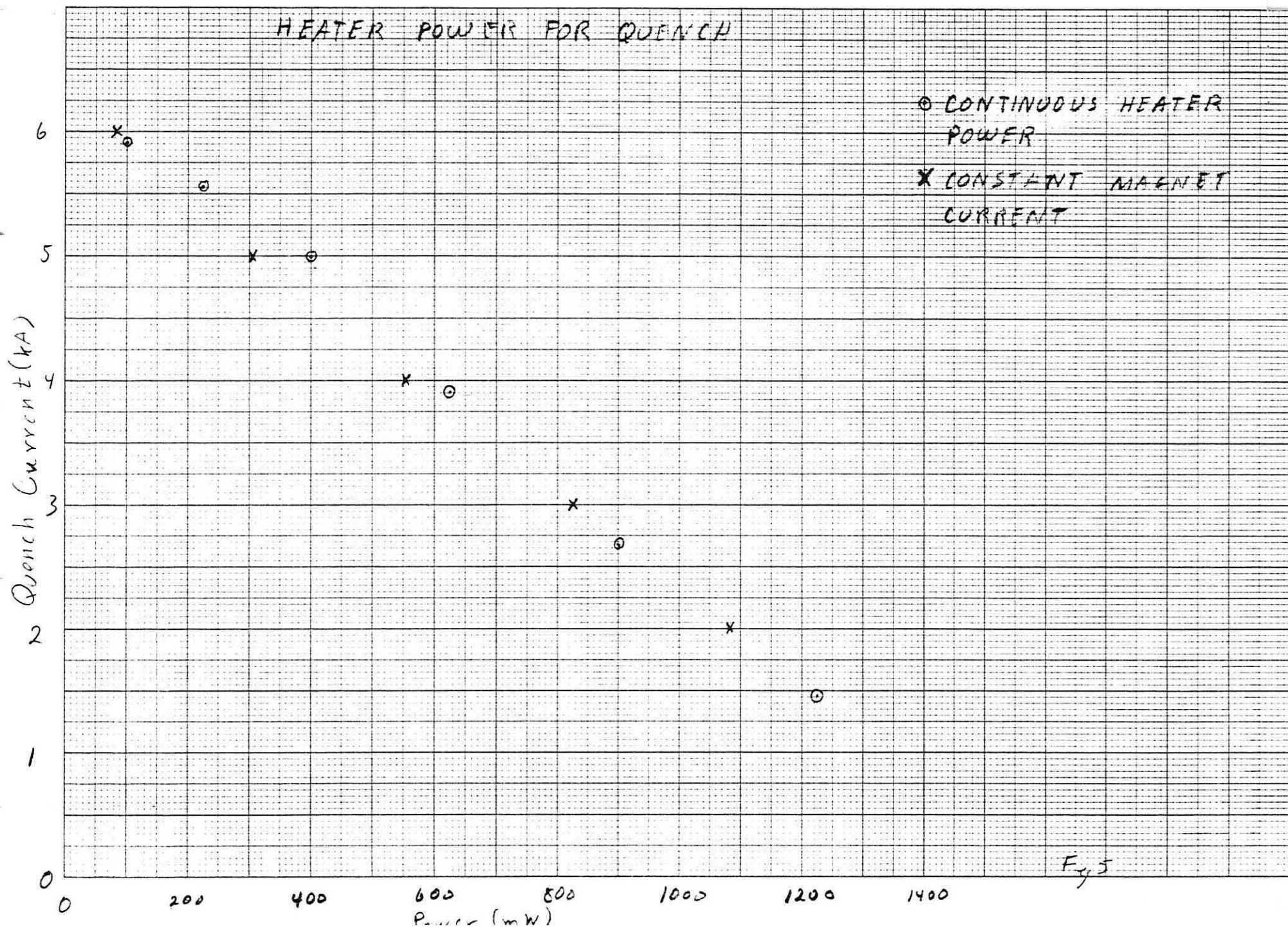

Fig 4

## HEATER POWER FOR QUENCH



5/7/84

### QUENCH ENERGY at 25ms PULSE

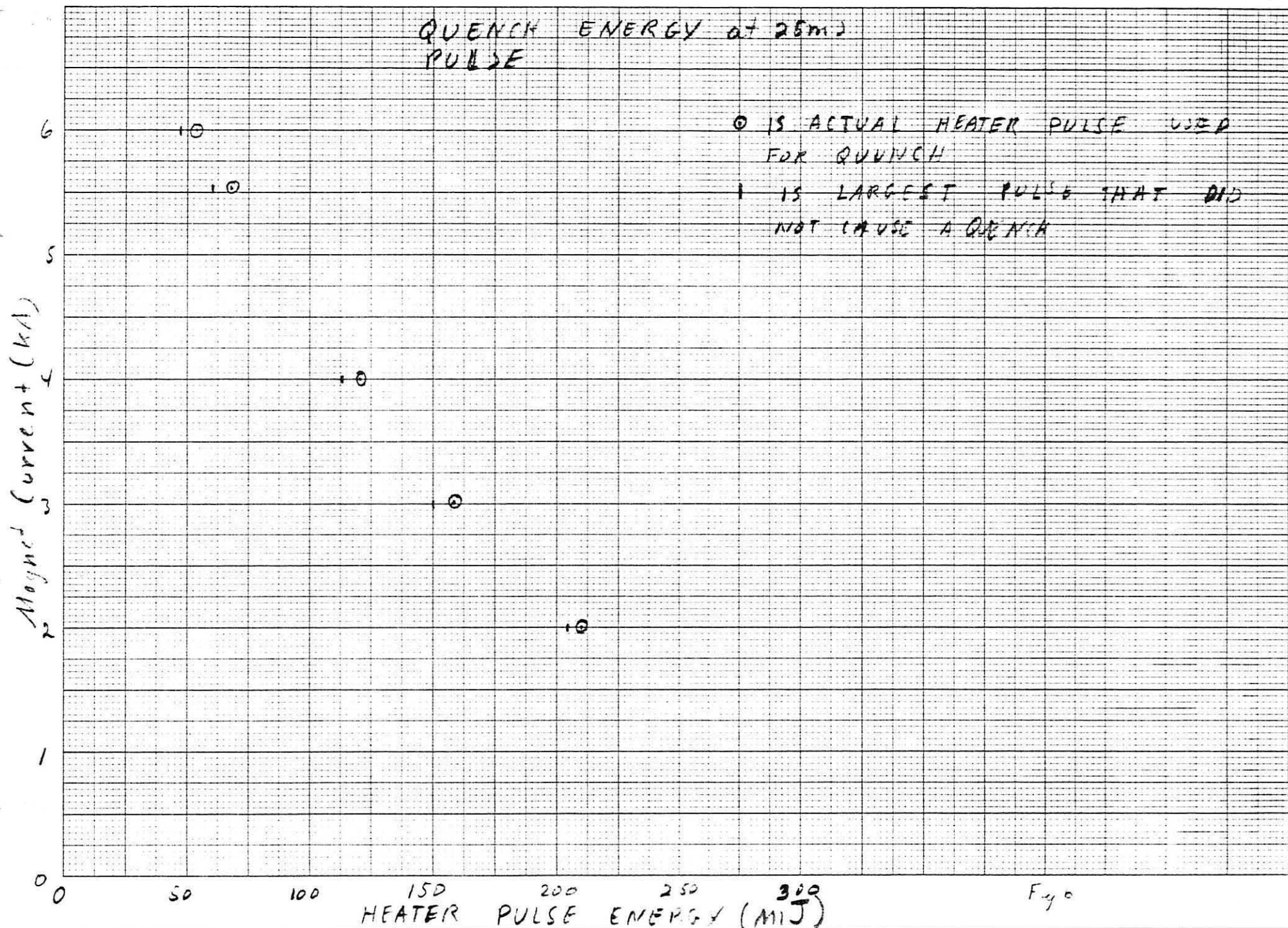

WH  
5/7/84

# PULSE ENERGY FOR A QUENCH AT 5000 A

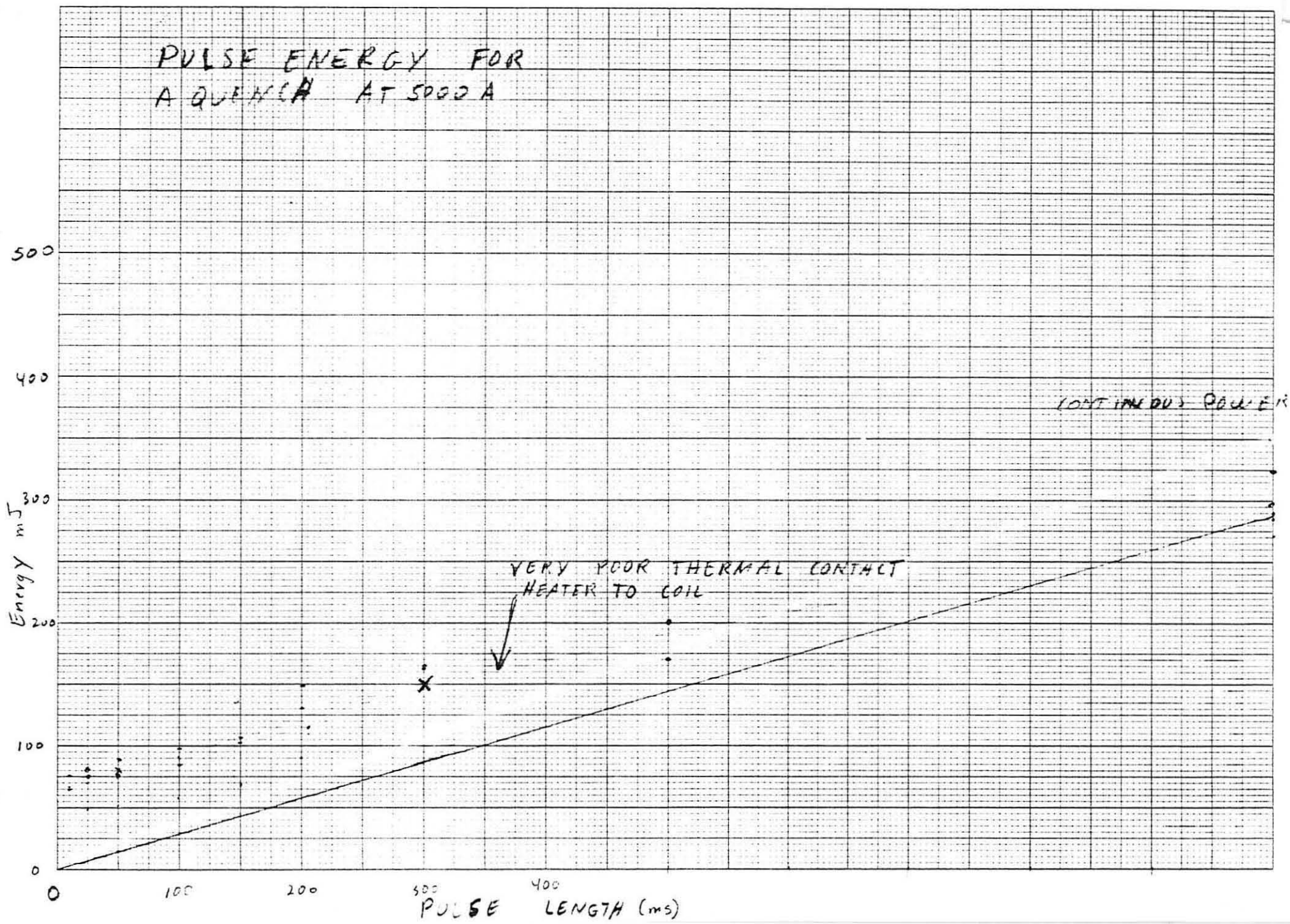



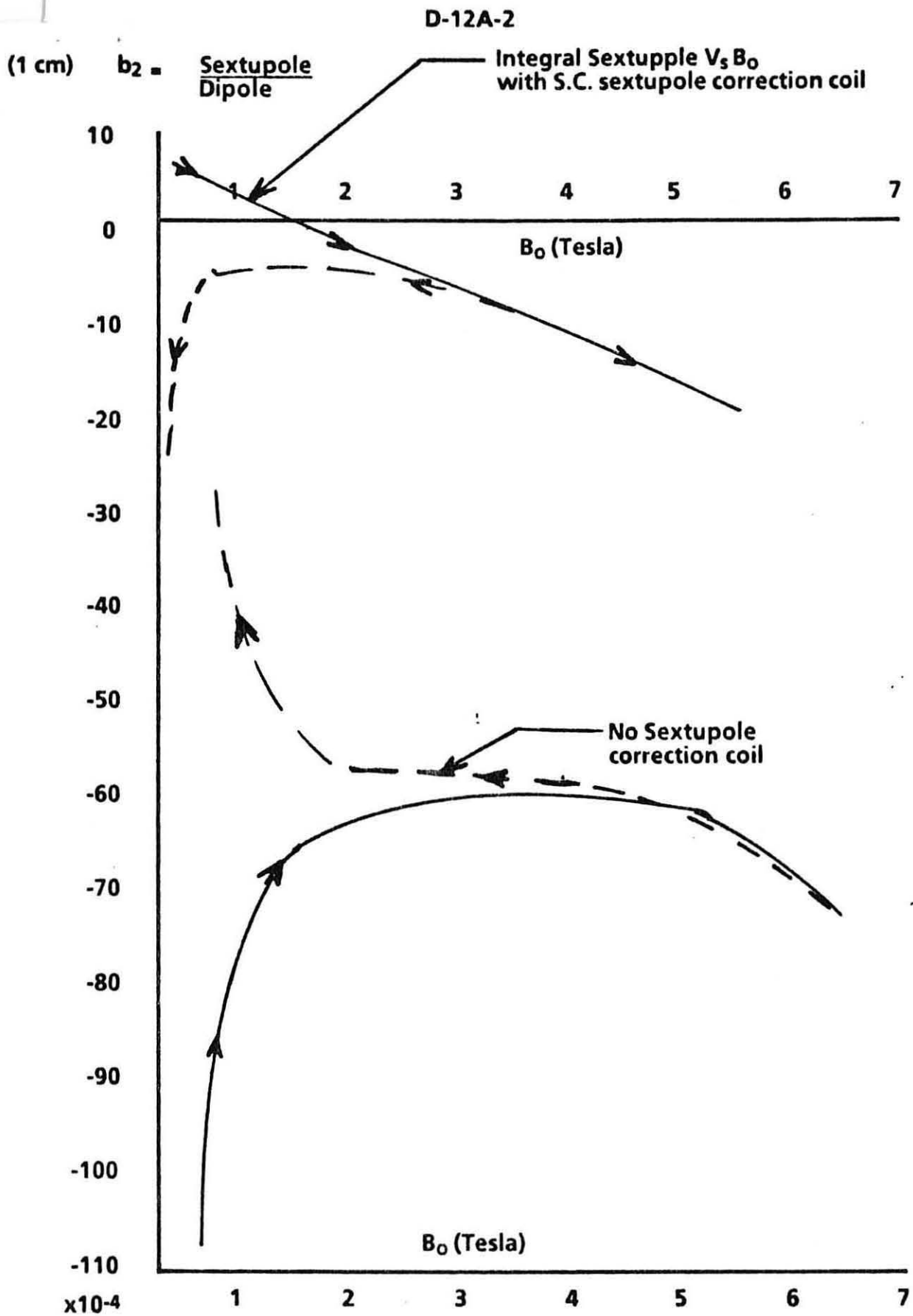

Fig 8

SSC Model Magnet - LBL #D-12A-2  
Integral Sextupole Field  $V_s$  Central Field

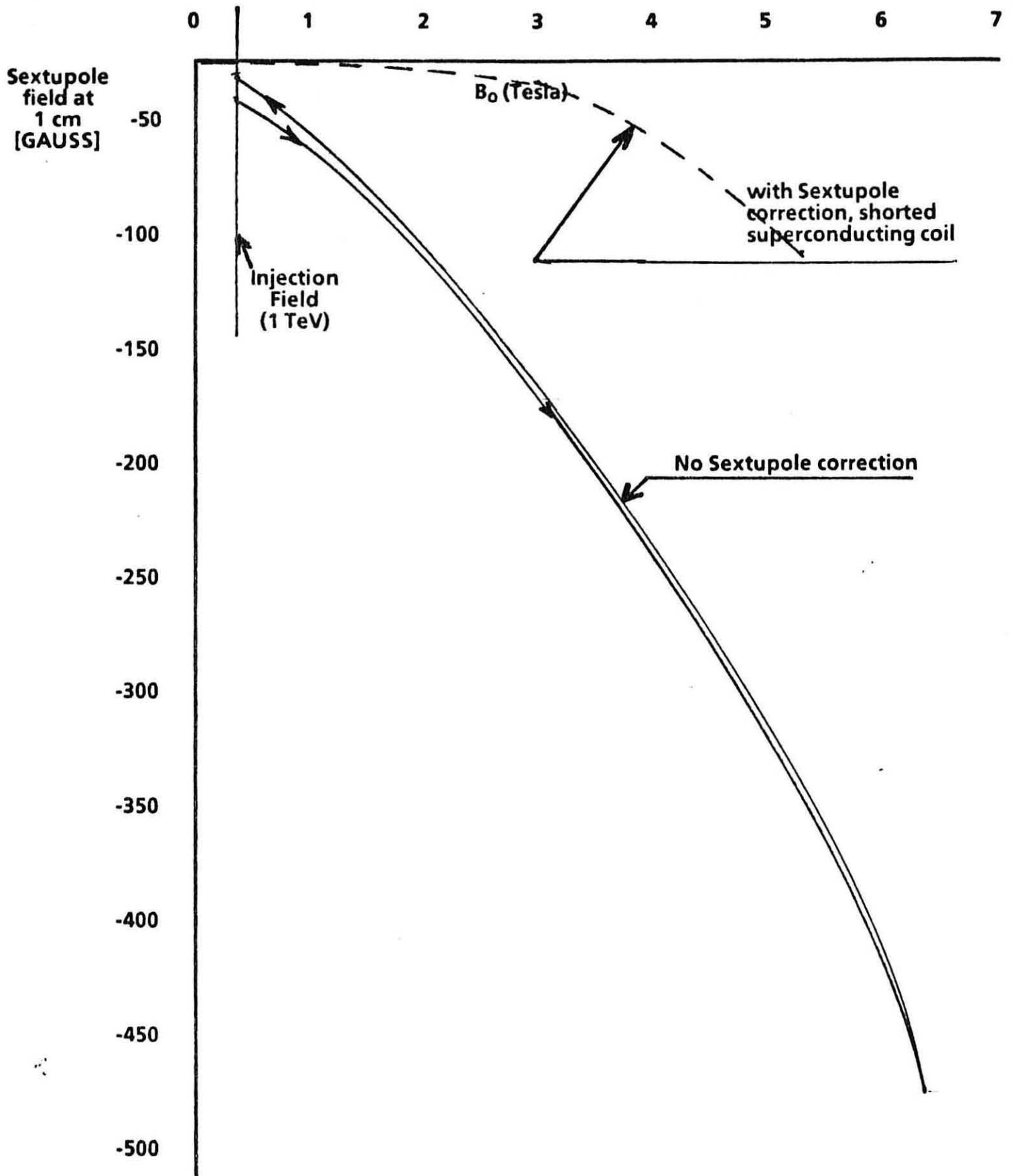

Fig 9