

Lawrence Berkeley National Laboratory

Recent Work

Title

Testing of a High Current DC ESQ Accelerator

Permalink

<https://escholarship.org/uc/item/5xc9j1j6>

Authors

Kwan, J.W.

Ackerman, G.D.

Anderson, O.A.

et al.

Publication Date

1991-05-01



Lawrence Berkeley Laboratory

UNIVERSITY OF CALIFORNIA

Accelerator & Fusion Research Division

Presented at the IEEE Particle Accelerator Conference,
San Francisco, CA, May 6-9, 1991, and to
be published in the Proceedings

Testing of a High Current DC ESQ Accelerator

J.W. Kwan, D.G. Ackerman, O.A. Ackerman, C.F. Chan,
W.S. Cooper, G.J. deVries, W.B. Kunkel, L. Soroka,
W.F. Steele, and R.P. Wells

May 1991

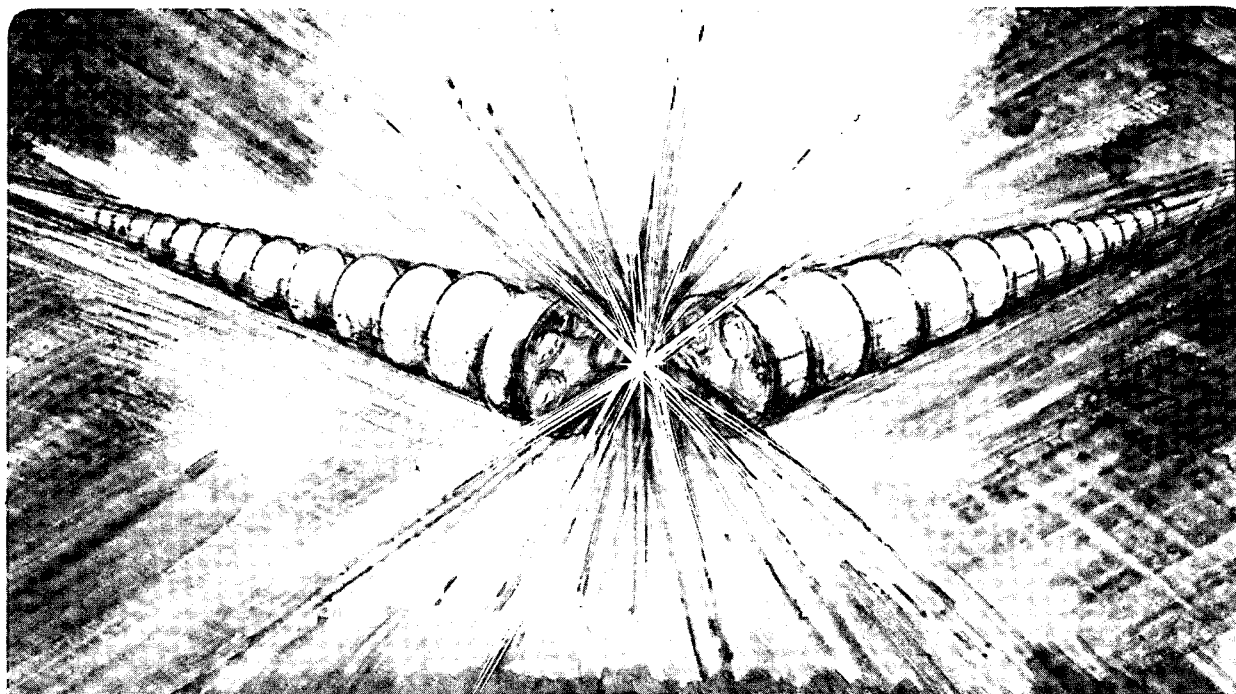

1 LOAN COPY 1
1 Circulates 1
1 for 4 weeks 1 Bldg. 50 Library.
Copy 2

LBL-29974

DISCLAIMER

This document was prepared as an account of work sponsored by the United States Government. While this document is believed to contain correct information, neither the United States Government nor any agency thereof, nor the Regents of the University of California, nor any of their employees, makes any warranty, express or implied, or assumes any legal responsibility for the accuracy, completeness, or usefulness of any information, apparatus, product, or process disclosed, or represents that its use would not infringe privately owned rights. Reference herein to any specific commercial product, process, or service by its trade name, trademark, manufacturer, or otherwise, does not necessarily constitute or imply its endorsement, recommendation, or favoring by the United States Government or any agency thereof, or the Regents of the University of California. The views and opinions of authors expressed herein do not necessarily state or reflect those of the United States Government or any agency thereof or the Regents of the University of California.

Testing of a High Current DC ESQ Accelerator

J. W. Kwan, G. D. Ackerman, O. A. Ackerman, C. F. Chan, W. S. Cooper,
G. J. deVries, W. B. Kunkel, L. Soroka, W. F. Steele, and R. P. Wells

Lawrence Berkeley Laboratory
University of California
Berkeley, CA 94720

Presented at the
IEEE Particle Accelerator Conference
San Francisco, CA
May 6-9, 1991

This work is supported by the Director, Office of Energy Research, Office of Fusion Energy, Development and Technology Division, of the U.S. Department of Energy under Contract No. DE-AC03-76SF00098.

Testing of a High Current DC ESQ Accelerator

J. W. Kwan, G. D. Ackerman, O.A. Anderson, C.F. Chan, W.S. Cooper,
G. J. deVries, W. B. Kunkel, L. Soroka, W. F. Steele, R. P. Wells

Lawrence Berkeley Laboratory, University of California,
Berkeley, CA 94720

A high current dc electrostatic quadrupole (ESQ) accelerator is being developed for negative-ion-based neutral beam heating and current drive on the next generation tokamak. Beam energy and current will eventually be in the MeV and multi-ampere range. This CCVV (constant-current variable-voltage) accelerator uses a series of identical ESQ modules. We have successfully tested a prototype CCVV accelerator up to 200 keV with a 100 mA He⁺ beam (with space charge equivalence of 140 mA of D⁻) for a pulse length of 1 s. Testing was also done with a 42 mA H⁻ beam (H⁻ beam current was limited by source performance). There was almost no beam loss in the ESQ accelerator. No emittance growth was found if the beam injected from the preaccelerator into the ESQ accelerator had low aberration. We are presently designing a proof-of-principle one-channel CCVV accelerator that would accelerate 1.0 A of D⁻ to 1.3 MeV energy.

I. INTRODUCTION

Next generation tokamak fusion reactors, e.g. the International Thermonuclear Experimental Reactor (ITER), require D⁻ neutral beams with energy as high as 1.3 MeV and with pulse lengths as long as two weeks. To meet these requirements, we are developing CCVV accelerators that can carry high current in a single channel. The ESQ sections provide strong focusing and quickly remove secondary electrons before they gain significant energy. Concept and design details of the CCVV accelerator and the neutral beam line were reported earlier by Anderson *et al.*^{1,2}

One important characteristic of this design is that the accelerator is modular. A prototype, which has a matching/pumping module plus one 100-keV acceleration module, was built for testing. It is capable of accelerating 0.14 A of D⁻ beam up to 200 keV. This beam has the same equivalent current (i.e. the same space charge) as 0.20 A of H⁻ ions or 0.10 A of He⁺ ions. Earlier we tested the prototype with 42 mA of H⁻ beam. At present we lack an ion source that can produce 0.2 A of H⁻ ions (or 0.14 A of D⁻) in a single channel operating with long pulses. In this paper, we report the result of testing the prototype with 0.10 A of He⁺ beams.

In testing the CCVV accelerator prototype, we measured the beam current and the beam emittance before and after the ESQ modules to determine the amount of beam loss, aberration and emittance growth. Measured envelope parameters were compared with calculated envelope parameters to evaluate the usefulness of the envelope code.

Supported by U.S. DOE Contract No. DE-AC03-76SF00098

II. APPARATUS

A schematic diagram of the CCVV prototype is shown in Fig. 1. There are two ESQ modules; the first has three quadrupole units and the second has two. The quadrupole electrodes are round rods, supported at one end by flat plates. Beam acceleration occurs at the free rod ends and in the gaps between plates. The prototype is designed to transport the beam at 100 keV through the first ESQ module and then accelerate the beam to 200 keV energy in the second ESQ module.

Between the ion source and the ESQ modules is a Pierce type preaccelerator designed to inject 0.14 A of D⁻ at 100 keV energy into the first ESQ module. Permanent magnets are

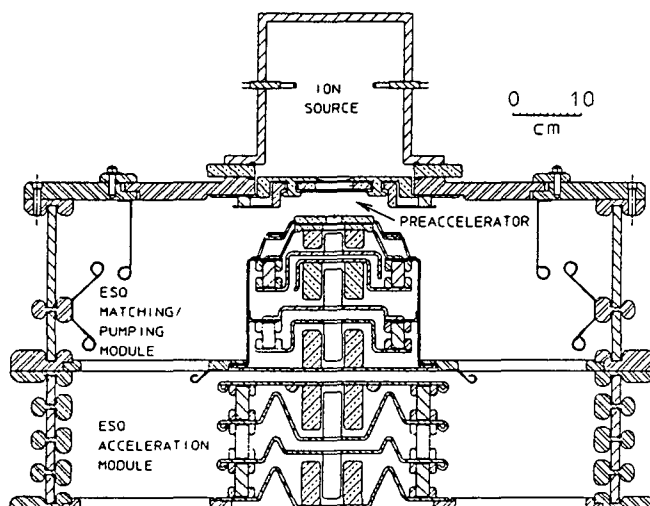

Fig. 1. Schematic Diagram of the prototype ESQ Accelerator

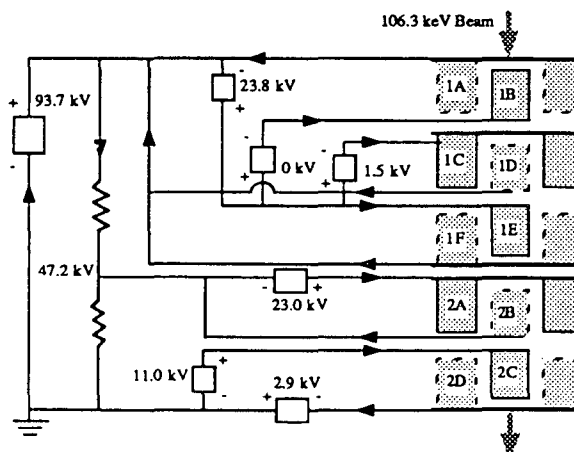

Fig. 2. Circuit diagram of the ESQ accelerator.

embedded inside the second electrode of the preaccelerator to trap electrons only when the apparatus is used to produce negative ion beams. These permanent magnets are removed for positive ion beams.

Stripping of negative ions produces electrons which in turn produce X-rays. In order to minimize the stripping loss, thus optimize the power efficiency of the acceleration system, the apparatus is designed for high conductance pumping to quickly remove the gas from the beam axis.

The ion source is a 20-cm-diam, 23-cm-deep multicusp dc source developed for volume-production of H^- (or D^-) ions.³ The same ion source, operating without the "filter rods", can be used to produce He^+ ions. With a 3-cm-diam aperture, the ion source can produce up to 100 mA of H^- beam in 10 ms pulses. Nevertheless, a 2-cm-diam aperture was used when we tested the ESQ with a 42 mA H^- beam because the smaller aperture produced a H^- beam with less aberration and lower effective beam temperature. In the case of testing the ESQ with a He^+ beam, a 2.6-cm-diam aperture was used to produce more than 100 mA of steady He^+ beam current.

A combination of voltage divider and floating power supplies is used to provide voltages on the ESQ modules. A schematic circuit diagram is shown in Fig. 2. The floating power supplies allow maximum flexibility in tuning the ESQ during the test phase. Generally, the power supplies are held to within 1 % tolerance of the specified voltages. The voltages indicated in the diagram are the actual values used to obtain the emittance diagram shown in Fig. 4.

III. EXPERIMENTAL RESULTS

We have successfully accelerated a 105 mA He^+ beam to 202 keV with the prototype CCVV accelerator. The pulse length was not limited by breakdowns; we have demonstrated pulses longer than 1 s. Typical potential difference across a quadrupole is about 25 keV. The drain current for the ESQ electrodes in the first and the second modules are typically in the order of 20 mA and 10 mA respectively. Only $\approx 3\%$ of the He^+ beam was lost in the ESQ; the uncertainty of the calorimetric measurements can be as high as 2-3%.

Figure 3 shows the projectional emittance diagram of a 100 mA He^+ beam leaving the preaccelerator at 101 keV energy (the ESQ was removed from the beam line in order to make

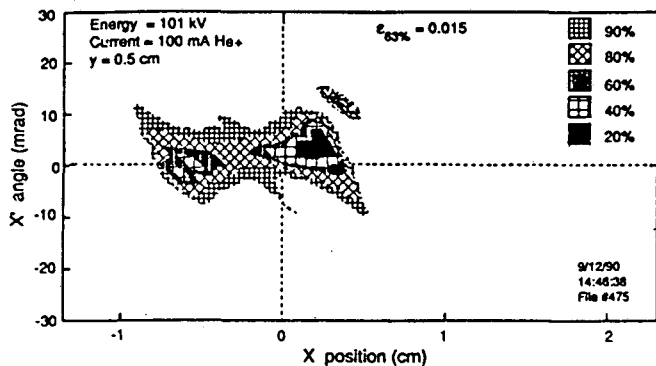

Fig. 3. Emittance Diagram of a 100 mA He^+ beam leaving the preaccelerator at 101 keV energy.

this measurement). The 63% intensity contour on the diagram gives a normalized emittance of 0.015π -cm-mrad. With a 2.6-cm-diam beam-forming aperture, this emittance value corresponds to that of a 0.5 eV Gaussian beam. Aberrations in the beam optics are preserved as the beam propagates through the ESQ modules. Figure 4 shows the emittance diagram as the beam emerges from the ESQ at 200 keV energy (the emittance diagram on the other transverse axis has a much wider beam envelope thus confirming an elliptical beam spot). In propagating through the two ESQ modules, the projectional emittance increases by 13% from 0.015 to 0.017π -cm-mrad $\pm 5\%$ of experimental errors.

When the beam current was reduced to 84 mA, the aberrations introduced in the preaccelerator disappeared and we found no emittance growth in the ESQ. Figures 5a and 5b are the $x-x'$ and $y-y'$ emittance diagrams of a 84 mA He^+ beam leaving the ESQ at 200 keV.

Figure 6 shows the result from the envelope code¹ using input data from the actual potentials applied to the ESQ electrodes and from the measured beam parameters leaving the preaccelerator (in absence of the ESQ modules). Comparing Fig. 5a and 5b with Fig. 6, we found a small discrepancy between the measured and the calculated beam envelopes at the ESQ exit which is corrected by assuming that the addition of the ESQ module at the end of the preaccelerator increases the divergence of the beam entering the ESQ by 20 mrad. We shall check this assumption in future experiments. Nevertheless, the envelope code was proven to be the most valuable tool in assisting tuning of the ESQ accelerator. We are improving the code to account for the gap focusing between units of quadrupole electrodes.

Similar results were obtained when we operated the ESQ accelerator with H^- beams. Using the ESQ accelerator, we have accelerated 42 mA of H^- to 200 keV. The beam loss within the ESQ modules was estimated to be 9%, presumably due to stripping of the H^- ions by the H_2 gas. We measured no emittance growth within the 5% experimental uncertainty. Most of the current drain from the quadrupole electrodes in the matching/pumping ESQ module (i.e. the first module) were related to the electrons from beam stripping and their secondary electrons. The electrical power consumed by the ESQ module was less than 2% of the beam power.

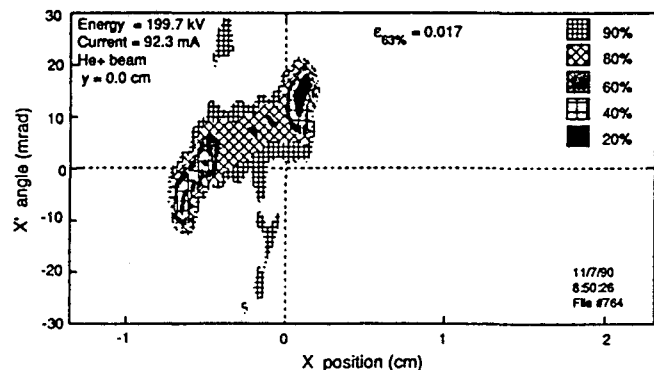

Fig. 4. Emittance Diagram of a 92.3 mA He^+ beam leaving the ESQ accelerator at 200 keV energy.

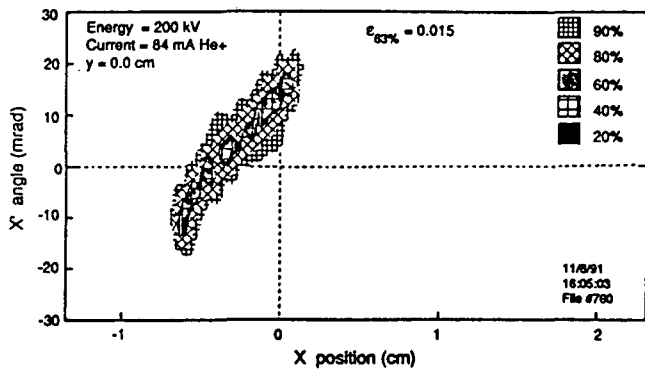

Fig. 5a. Emittance ($x-x'$) of a 84 mA, 200 keV He⁺ beam.

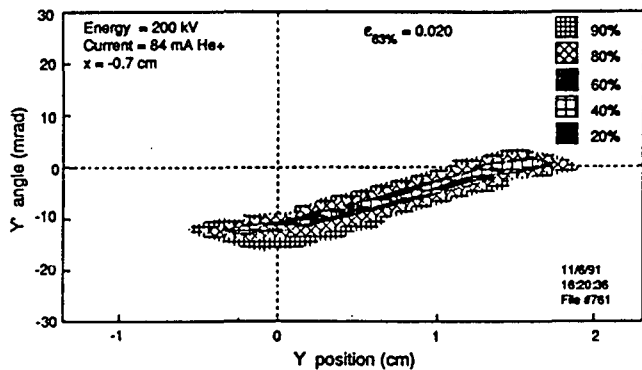

Fig. 5b. Emittance ($y-y'$) of a 84 mA, 200 keV He⁺ beam.

IV. DISCUSSION

In summary, we have successfully accelerated 0.10 A of He⁺ beam (equivalent to 0.14 A of D⁻) to 200 keV using the prototype CCVV accelerator. Beam loss and emittance growth are both small; the latter can be improved by providing beams with better optics at the preaccelerator. Tuning the accelerator can be done with the assistance of the envelope code. Eventually, when the performance of the CCVV accelerator is well characterized, frequent tuning would not be necessary and the floating power supplies can be replaced by voltage dividers.

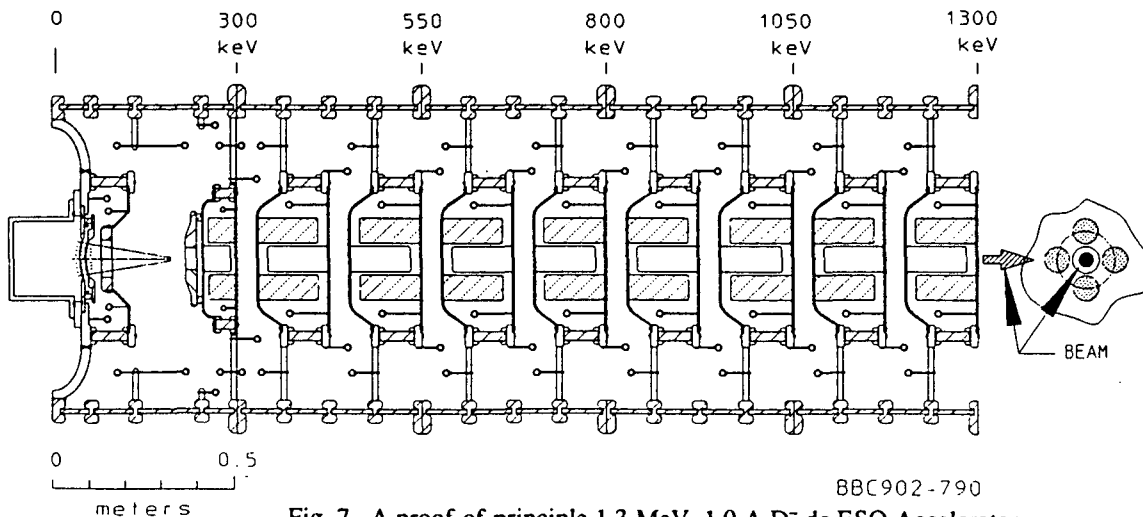

Fig. 7. A proof-of-principle 1.3 MeV, 1.0 A D⁻ dc ESQ Accelerator.

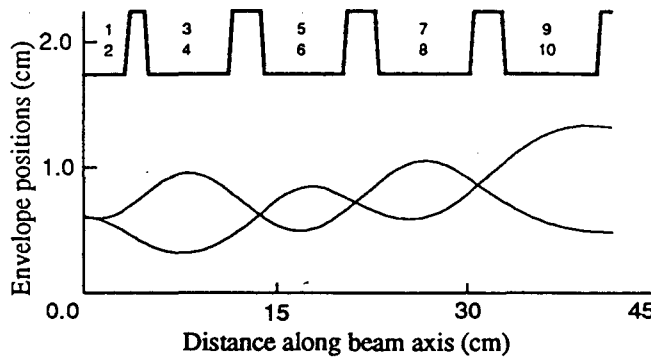

Fig. 6. Beam envelopes of a 84 mA He⁺ beam in the ESQ.

We are proposing to build a proof-of-principle 1.3 MeV, 1.0 A (D⁻) CCVV accelerator (Fig. 7)⁴. This new accelerator will have quadrupole units approximately 2.5 times larger in length and in diameter than the present prototype. By keeping the same electric field strength, the new ESQ accelerator will accelerate ion beams at 250 keV per module; thus only 4 ESQ modules are required to reach the 1.3 MeV final beam energy (here the preacceleration is 300 keV). The accelerator will also produce beams of half or three-quarter energy with no change in current.

V. REFERENCES

- [1] O.A. Anderson, L. Soroka, C.H. Kim, R.P. Wells, C.A. Matuk, P. Purgalis, W.S. Cooper, and W.B. Kunkel, Proc. 1988 European Particle Accelerator Conf., Rome, Italy; S. Tazzari, Ed.; World Sci. Pub. Co, Singapore, p.470 (1989).
- [2] O.A. Anderson, L. Soroka, C.H. Kim, R.P. Wells, C.A. Matuk, P. Purgalis, J.W. Kwan, M.C. Vella, W.S. Cooper, and W.B. Kunkel, Nucl. Instrum. and Meth. B40/41, 877 (1989).
- [3] J.W. Kwan, G.D. Ackerman, O.A. Anderson, C.F. Chan, W.S. Cooper, G.J. deVries, K.N. Leung, A.F. Lietzke, and W.F. Steele, Rev. Sci. Instrum. 61, 369 (1990).
- [4] O.A. Anderson, et al., IAEA Thirteenth International Conference on Plasma Physics and Controlled Nuclear Fusion Research, Washington, DC, 1990 (to be published).

LAWRENCE BERKELEY LABORATORY
UNIVERSITY OF CALIFORNIA
INFORMATION RESOURCES DEPARTMENT
BERKELEY, CALIFORNIA 94720