

Lawrence Berkeley National Laboratory

LBL Publications

Title

Sensor-based demand controlled ventilation

Permalink

<https://escholarship.org/uc/item/5s93p1hm>

Author

De Almeida, Anibal T.

Publication Date

1997-07-21

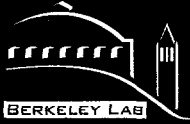

ERNEST ORLANDO LAWRENCE BERKELEY NATIONAL LABORATORY

Sensor-Based Demand Controlled Ventilation

Anibal T. De Almeida and William J. Fisk
Environmental Energy
Technologies Division

July 1997

RECEIVED
OCT 08 1997
OSTI

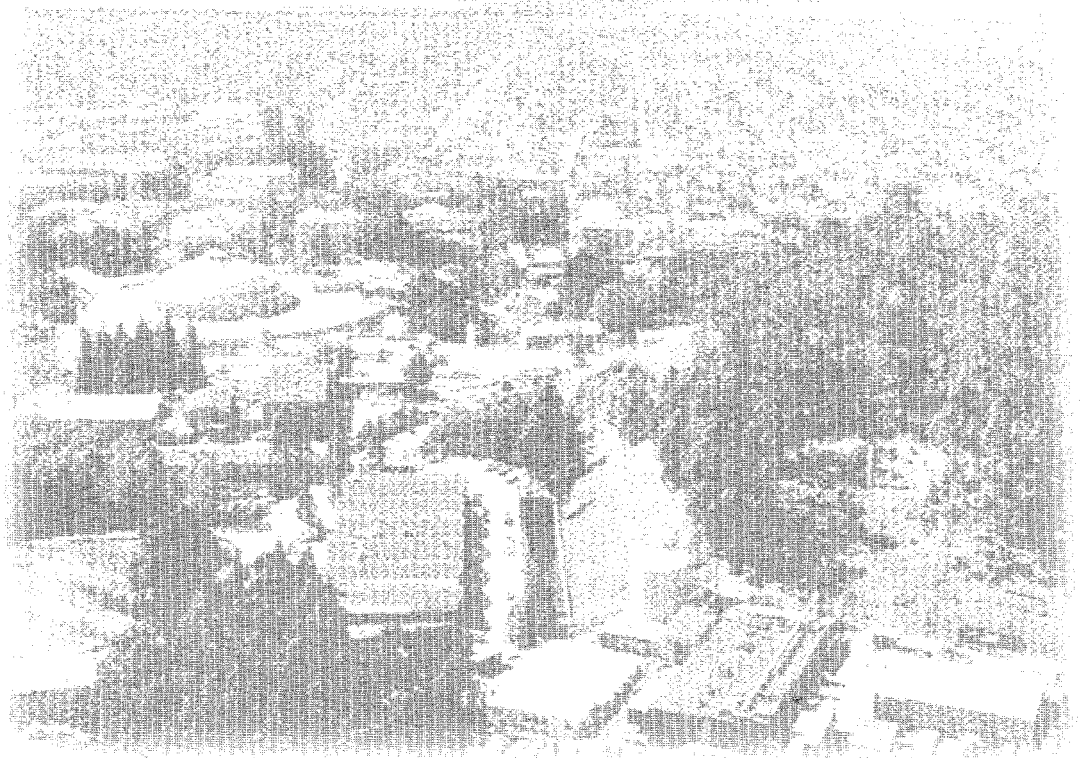

DISTRIBUTION OF THIS DOCUMENT IS UNLIMITED

h **MASTER**

DISCLAIMER

This document was prepared as an account of work sponsored by the United States Government. While this document is believed to contain correct information, neither the United States Government nor any agency thereof, nor The Regents of the University of California, nor any of their employees, makes any warranty, express or implied, or assumes any legal responsibility for the accuracy, completeness, or usefulness of any information, apparatus, product, or process disclosed, or represents that its use would not infringe privately owned rights. Reference herein to any specific commercial product, process, or service by its trade name, trademark, manufacturer, or otherwise, does not necessarily constitute or imply its endorsement, recommendation, or favoring by the United States Government or any agency thereof, or The Regents of the University of California. The views and opinions of authors expressed herein do not necessarily state or reflect those of the United States Government or any agency thereof, or The Regents of the University of California.

This report has been reproduced directly from the best available copy.

Available to DOE and DOE Contractors
from the Office of Scientific and Technical Information
P.O. Box 62, Oak Ridge, TN 37831
Prices available from (615) 576-8401

Available to the public from the
National Technical Information Service
U.S. Department of Commerce
5285 Port Royal Road, Springfield, VA 22161

Ernest Orlando Lawrence Berkeley National Laboratory
is an equal opportunity employer.

LBL-40599
UC-1600

SENSOR-BASED DEMAND CONTROLLED VENTILATION

Anibal T. De Almeida
Dep. Eng. Electrotecnica
Universidade de Coimbra
Polo II
3000 Coimbra, Portugal

and

William J. Fisk
Staff Scientist, Indoor Environment Program
Environmental Energy Technologies Division
Lawrence Berkeley National Laboratory
Berkeley, CA USA

July 1997

This work was supported by the Assistant Secretary of Energy Efficiency and Renewable Energy, Office of Building Technology, State, and Community Programs, Office of Building Systems of the U.S. Department of Energy (DOE) under contract No. DE-AC03-76SF00098 and by the NATO Scientific Affairs Division.

DISCLAIMER

**Portions of this document may be illegible
in electronic image products. Images are
produced from the best available original
document.**

SENSOR BASED DEMAND CONTROLLED VENTILATION

Anibal T. De Almeida
Dep. Eng. Electrotecnica
Universidade de Coimbra
Polo II
3000 Coimbra, Portugal
Tel: 351-39-700-6218
Fax: 351-39-35672
Email: adealmeida@isr.uc.pt

William J. Fisk
Staff Scientist, Indoor Environment Program
Environmental Energy Technologies Division
Lawrence Berkeley National Laboratory
Berkeley, CA USA
Tel: (510) 486-5910
Fax: (510) 486-6658
Email: WJFisk@lbl.gov

July 21, 1997

ABSTRACT

In most buildings, occupancy and indoor pollutant emission rates vary with time. With sensor-based demand-controlled ventilation (SBDCV), the rate of ventilation (i.e., rate of outside air supply) also varies with time to compensate for the changes in pollutant generation. In other words, SBDCV involves the application of sensing, feedback and control to modulate ventilation. Compared to ventilation without feedback, SBDCV offers two potential advantages: (1) better control of indoor pollutant concentrations; and (2) lower energy use and peak energy demand. SBDCV has the potential to improve indoor air quality by increasing the rate of ventilation when indoor pollutant generation rates are high and occupants are present. SBDCV can also save energy by decreasing the rate of ventilation when indoor pollutant generation rates are low or occupants are absent.

After providing background information on indoor air quality and ventilation, this report provides a relatively comprehensive discussion of SBDCV. Topics covered in the report include basic principles of SBDCV, sensor technologies, technologies for controlling air flow rates, case studies of SBDCV, application of SBDCV to laboratory buildings, and research needs.

SBDCV appears to be an increasingly attractive technology option. Based on the review of literature and theoretical considerations, the application of SBDCV has the potential to be cost-effective in applications with the following characteristics: (a) a single or small number of dominant pollutants, so that ventilation sufficient to control the concentration of the dominant pollutants provides effective control of all other pollutants; (b) large buildings or rooms with unpredictable temporally variable occupancy or pollutant emission; and (c) climates with high heating or cooling loads or locations with expensive energy.

At present, most SBDCV systems are based on monitoring and control of carbon dioxide (CO₂) concentrations. CO₂ sensors provide a simple and relatively inexpensive way to indirectly monitor the indoor air quality component related to human bioeffluents. There is a limited number of well-documented case studies that quantify the energy savings and the cost-effectiveness of SBDCV. The case studies reviewed suggest that in appropriate applications, SBDCV produces significant savings with a payback period typically of a few years.

At present, the lack of low-cost, sensitive, and reliable IAQ sensors is a key constraint to improving the cost-effectiveness of many possible applications of SBDCV. However, rapid advances in sensor technologies are expected. If the price of sensors drops sharply and the quality improves, the potential cost-effective applications of SBDCV will be extended significantly.

1. INTRODUCTION

1.1 Background

There is a growing concern about the environmental and health impacts of pollutants. Although most people are aware of the global, regional and local problems associated with outdoor air pollutants such as carbon dioxide (CO₂), chlorofluorocarbons (CFCs), nitrogen oxides (NO_x), ozone (O₃), sulfur dioxide (SO₂), as well as with the problems from water contaminants and solid waste, there is more limited perception of the health risks associated with pollutants in the indoor environment. However, there is evidence of strong links between the indoor environment, where we spend 90% of our lives, and health and productivity. Some of the most relevant connections between IAQ and health and productivity are the following (Fisk and Rosenfeld 1996):

- Infectious disease transmission (e.g. airborne transmission of viral respiratory disease and tuberculosis) may be significantly influenced by characteristics of buildings and building ventilation.
- Symptoms of allergies and asthma may be stimulated by indoor exposures to dust mites, fungi, volatile organic compounds, and pollens from outside air.
- Sick-building syndrome symptoms, such as irritation of the eyes, nose, and skin, headache and fatigue, are experienced frequently by a substantial fraction of the occupants of office buildings.
- The mental and physical performance of workers may be influenced by indoor thermal conditions and by lighting.
- The lifetime of some types of electronic equipment is reduced by indoor particles and chemical pollutants. Poor humidity control can further aggravate the reduction in lifetime due to indoor pollutants.

The quality of the indoor environment is dependent upon a number of factors which include temperature, air velocity, humidity, lighting level, lighting quality, noise, and the concentrations of a variety of gaseous and particulate pollutants. After providing a general introduction to indoor air quality, this report focuses on a ventilation control technology for maintaining indoor

air pollution within acceptable limits in an energy-efficient way. SBDCV is a relatively new technology that has been applied in a small number of buildings. This report summarizes currently available information on applications for SBDCV, on integration of SBDCV with energy management and control systems, and on the energy performance and economics of SBDCV. Additionally, available sensors and means of controlling ventilation rates are described.

1.2 Pollutants in the Indoor Environment

The pollutants in the indoor environment may come into the building with outside air or may be generated internally. For indoor-generated pollutants, indoor concentrations often substantially exceed the background outdoor concentrations.

For non-industrial occupations in indoor air settings, e.g., office workers, or for schools, the American Society of Heating, Refrigerating, Air-conditioning Engineers (ASHRAE) lists various standards or guidelines applicable in the U.S. for common indoor air pollutants (ASHRAE 1989). These are provided as guidance, rather than enforceable standards, and are based on federal (e.g., HUD, EPA, CPSC) and state guidelines. Ambient (outdoor) air pollutant standards are also provided by ASHRAE (1989) as additional guidance and are summarized in Table 1.1. Health and Welfare Canada (1987) has provided guidelines for indoor air concentrations of aldehydes, carbon dioxide, carbon monoxide, nitrogen dioxide, ozone, particulate matter, sulfur dioxide and water vapor for non-carcinogenic health effects; and also for formaldehyde. The World Health Organization (1987) has also developed some guidelines for indoor air quality in non-industrial settings. Several of the important indoor pollutants are described in the following paragraphs.

Table 1.1 National ambient air quality primary standards (adapted from summary in ASHRAE 1989)

Contaminant	Long Term			Short Term		
	Concentration		Averaging Time	Concentration		Averaging Time
	$\mu\text{g m}^{-3}$	ppm		$\mu\text{g m}^{-3}$	ppm	
Sulfur dioxide	80	0.03	1 year	365	0.14	24 hours
Particles (PM ₁₀)	75 ^a	----	1 year	260	----	24 hours
Carbon monoxide	----	----	----	40,000	35	1 hour
Carbon monoxide	----	----	----	10,000	9	8 hours
Ozone	----	----	----	235 ^b	0.12 ^b	1 hour
Nitrogen dioxide	100	0.053	1 year	----	----	----
Lead	1.5	----	3 months ^c	----	----	----
a annual geometric mean						
b standard is attained when expected number of days per calendar year with maximum hourly average concentration above 0.12 ppm is equal to or less than 1						
c three month period is calendar quarter						

Carbon dioxide (CO₂) is a metabolic product and is also produced during combustion. Human occupancy is normally the main source of carbon dioxide in the indoor environment, which leads to an increase of indoor concentrations in relation to the outdoor levels. The outdoor CO₂ concentration is approximately 350 ppm, whereas indoor concentrations are usually in the range of 500-2000 ppm. At these concentrations, CO₂ is not thought to be a direct cause of adverse health effects; however, CO₂ is a surrogate for other occupant-generated pollutants, such as body odors. The indoor CO₂ concentration is often used as an indicator of the rate of outside air supply per occupant, although it is clearly an imperfect indicator as discussed by Persily and Dols (1990). The 8-hour workplace threshold limit value for CO₂ is 5,000 ppm (ACGIH 1994). The minimum ventilation rates in the current version of ASHRAE Standard 62 "Ventilation for Acceptable Indoor Air Quality" are selected, in part, to maintain indoor CO₂ concentrations below 1000 ppm (ASHRAE 1989).

Carbon monoxide (CO) is present in outdoor air. Indoor concentrations may be higher than outdoor concentrations due to smoking and unvented combustion (e.g., use of unvented space heaters) or to failures in the combustion exhaust vent systems of vented appliances. Short-term exposures to highly elevated concentrations of carbon monoxide can cause brain damage or death. Lower concentrations can cause other health effects, for example chest pain among people with atherosclerosis (heart disease).

Nitrogen oxides (NO_x) are also present in outdoor air. Like CO and CO₂, NO_x is a combustion product, thus, indoor concentrations may be higher than outdoor concentrations if combustion products are generated indoors or leak to indoors because of failures in vent systems of vented appliances. NO₂ is usually considered to be the most important of the indoor nitrogen oxides. Exposures to high concentrations of NO₂ (e.g., 0.5 ppm in individuals with respiratory ailments) can cause respiratory distress. Epidemiological studies suggest that long term exposure to much lower concentrations of NO₂ may be associated with increased respiratory illness among children.

Moisture is generated indoors due to human metabolism and human activities, namely cooking and washing, as well as due to unvented combustion activities. The acceptable relative humidity for human thermal comfort is approximately in the range 25-60% (ASHRAE 1993). The implications of high humidity for human health are complex and still a subject of debate (Baughman and Arens 1996, Arens and Baughman 1996). In some situations, high relative humidities may contribute to growth of micro-organisms that may adversely affect health. Condensation of water on cool indoor surfaces (e.g., windows) may damage materials and promote the growth of microorganisms.

Volatile organic compounds (VOCs): The indoor air typically contains dozens of VOCs at concentrations that are measurable. VOCs are emitted indoors by building materials (paints, particle boards, adhesives, etc.), furniture, equipment (photocopying machines, printers, etc.), cleaning products, and combustion activities (cooking, space heating, smoking, indoor vehicle use). Additionally, human metabolism is also responsible for the release of VOCs. The outdoor

air also contains VOCs that enter buildings. Some VOCs are suspected or known carcinogens or causes of adverse reproductive effects. Some VOCs also have unpleasant odors or are irritants. VOCs are thought to be a cause of sick building symptoms.

The total volatile organic compound (TVOC) concentration, which is often used as a simple, integrated measure of the VOCs, is operationally defined as the total mass of measured VOCs per unit volume of air, exclusive of very volatile (e.g., formaldehyde) organic compounds. Laboratory studies in which humans have been exposed to mixtures of VOCs under controlled conditions (Molhave et al. 1986 and 1993) have documented increased health symptoms at TVOC concentrations of the order of milligrams per cubic meter of air. As an indicator of health effects, the TVOC concentration is inherently flawed because the potency of individual VOCs to elicit irritancy symptoms varies by orders of magnitude (Tenbrinke 1995). The potency for other potential health effects such as cancer or reproductive effects is also highly variable among compounds. Despite these limitations, unusually high TVOC concentrations, above one or two mg m^{-3} , may provide an indication that adverse health effects from TVOCs are likely.

Particles are present in outdoor air and are also generated indoors from a large number of sources including tobacco smoking and other combustion processes. Some particles and fibers may be generated by indoor equipment (e.g. copy machines and printers). Mechanical abrasion and air motion may cause particle release from indoor materials. Particles are also produced by people, e.g., skin flakes are shed and droplet nuclei are generated from sneezing and coughing. Particles may contain toxic chemicals. Some particles, biologic in origin, may cause allergic reactions or be a source of infectious disease. The size of particles in suspension in the air is mostly in the range 100 micrometer and smaller, with the large majority of indoor particles smaller than one micrometer. Of particular concern are the particles smaller than approximately 2.5 microns, which are more likely to deposit deep inside the lungs.

Radon is a radioactive gas. The primary source of radon in most buildings is the surrounding soil and rock. Radon enters buildings from soil as soil gas is drawn into buildings and also enters by diffusion through the portions of buildings that contact soil. Earth-based building materials and water from wells can also be a source of radon. Radon exposure increases the risk of lung cancer. The U.S. EPA guideline for indoor radon is a 4 pCi/L maximum annual average concentration.

1.3 Indoor Air Pollution Mitigation Techniques

Indoor air pollutants can be mitigated using the general approaches described in the following paragraphs (Fisk and Grimsrud 1993, EPRI 1993).

Source removal/substitution/modification. Pollutant source removal or substitution of a potential source with a lower-emitting product prevents pollutants from entering the indoor environment and is generally the most effective and energy-efficient mitigation strategy. To obtain good indoor air quality, it is necessary to adopt a combination of source-control measures which may include proper selection of building materials, furniture and equipment, avoiding the infiltration of some pollutants (e.g. radon from soil and combustion products from parking

garages) and restricting or isolating tobacco smoking. Additionally, the rate of pollutant emission from some sources can be reduced, for example by application of coatings and by allowing materials to age (VOC emissions from building materials often decline over time).

Air cleaning. The removal of some pollutants from indoor air and from incoming outdoor air can be achieved with air cleaning equipment such as the air filters commonly used to remove particles from air. The types of air filters used most often in building HVAC systems have a low efficiency for particles with a size smaller than approximately $2\ \mu\text{m}$ -- the particles most important for health; however, more efficient filters are readily available. In applications such as cleanrooms requiring very low particle concentrations, high-efficiency particle air (HEPA) filters are used. These filters have a removal efficiency in excess of 99.97% for $0.3\ \mu\text{m}$ particles. To extend the life of HEPA filters, pre-filters are often used.

Other pollutants such as VOCs and ozone can also be removed from indoor air with air cleaners, for example, with granular sorbents. The sorbent can be activated carbon, but more recently chemically activated carbon or chemically treated activated alumina are increasingly being used. This trend is due to the irreversible chemical reaction of contaminants with the chemical reagent, thus maintaining a high concentration gradient that produces a high removal efficiency, even at low contaminant levels in the air (Kelly 1993). The performance, lifetime, and operating cost of sorbents, when used in actual field settings where the air contains multiple pollutants with temporally variable concentrations, has been inadequately studied.

Local (or spot) ventilation Air can be exhausted (or both supplied and exhausted) near concentrated pollutant sources such as restrooms, kitchen stoves, blueprint rooms, etc. This type of ventilation is used to minimize the transport of pollutants from these sources to surrounding indoor areas. If the pollutant generation process is episodic, the local ventilation may be applied only during periods of pollutant emission.

General Ventilation. General ventilation, i.e., ventilation that occurs throughout the building or zone, improves the indoor environment by diluting and removing the indoor-generated pollutants with outside air. For most indoor-generated pollutants, general ventilation is the dominant process of indoor pollutant removal; however, pollutant source control and local ventilation are usually more energy efficient and effective options for controlling indoor air quality and should be used to reduce the required quantity of general ventilation. General ventilation (hereinafter called ventilation) is still required in virtually all buildings because buildings contain some spatially-distributed indoor pollutant sources that cannot be eliminated (e.g., people and building materials).

2. INFLUENCE OF VENTILATION RATE ON IAQ

2.1 Background

To understand the potential of sensor-based demand-controlled ventilation, it is necessary to have a general understanding of equilibrium relationships between ventilation rate and indoor air

pollutant concentrations and also an understanding of the nature of the temporal response of indoor pollutant concentration to a change in ventilation rate. At equilibrium, indoor pollutant concentrations depend on the outdoor concentration, on indoor pollutant source strengths and on the total rate of pollutant removal. The pollutant source term can include both pollutant emission from the primary (i.e., original) source and desorption of pollutant from other indoor materials on which the pollutant previously adsorbed. In addition to pollutant removal by ventilation and air cleaning, some pollutants are removed from indoor air by deposition on surfaces, sorption on surfaces, chemical reactions, or radioactive decay. Mass-balance models of varying complexity are used to relate indoor pollutant concentrations to ventilation rates and the other factors.

2.2 Mass Balance Models

To relate ventilation rates and indoor pollutant concentrations, we start with a transient model for a pollutant in a building or zone with thoroughly mixed indoor air, a stable indoor pollutant emission rate that is independent of the indoor pollutant concentration, and a constant rate of ventilation. Many previous papers have presented such models (e.g., Nazaroff et al. 1993, Persily and Dols 1990, Fisk et al. 1987). The rate of pollutant removal by radioactive decay or chemical reaction within the indoor air is assumed to be negligible. The assumption of a emission rate that is independent of the indoor concentration means that we are neglecting pollutant desorption from indoor surfaces. The mass balance equation is

$$\frac{dC}{dt} = \frac{G}{V} + \lambda_v C_{out} - \lambda_v C - v_d \frac{S}{V} C - \frac{Q_{ac}}{V} C \epsilon_{ac} \quad (1)$$

where C is the indoor concentration, t is the time variable, G is the indoor pollutant generation rate, V is the indoor air volume, λ_v is the air exchange rate (outside air flow divided by indoor air volume), C_{out} is the outdoor concentration, v_d is the deposition velocity for the pollutant, S is the area of surfaces on which indoor pollutants are removed by deposition, Q_{ac} is the rate of air flow through an air cleaner, and ϵ_{ac} is the efficiency of the air cleaner. For simplicity, we have used a form of the equation that is appropriate for situations when only recirculated indoor air (not a mixture of outside and recirculated air) passes through the air cleaner.

2.3 Pollutant Removal by Ventilation Only

To illustrate equilibrium relationships between ventilation rate and indoor pollutant concentration, a steady state version of the equation is employed ($dC/dt = 0$). If there is no air cleaner ($\epsilon_{ac} = 0$), and the deposition velocity is negligible, the solution to the steady state equation is

$$C = C_{out} + \frac{G/V}{\lambda_v} \quad (2)$$

If the ventilation rate is expressed as a flow rate per person (Q_{person}), rather than a flow per unit volume and the pollutant emission rate is a per person value (G_{person}), the analogous equation is

$$C = C_{out} + \frac{G_{person}}{Q_{person}} \quad (3)$$

Equation 2 or 3 can be used to derive equilibrium relationships between ventilation rates and indoor concentrations of non-reactive gaseous pollutants such as carbon dioxide and carbon monoxide and low molecular weight organic compounds that do not adsorb significantly on surfaces. Based on equation 2, the predicted steady state concentrations of a hypothetical indoor pollutant are presented in Figure 2.1 for the case of no pollutant in the outdoor air (curve 1) and for the case with a significant pollutant concentration in outdoor air (curve 2). For both curves, we have used the same indoor pollution generation rate, selected arbitrarily to obtain a concentration of 1 (arbitrary units) on curve 1 when λ_v is 1 h^{-1} .

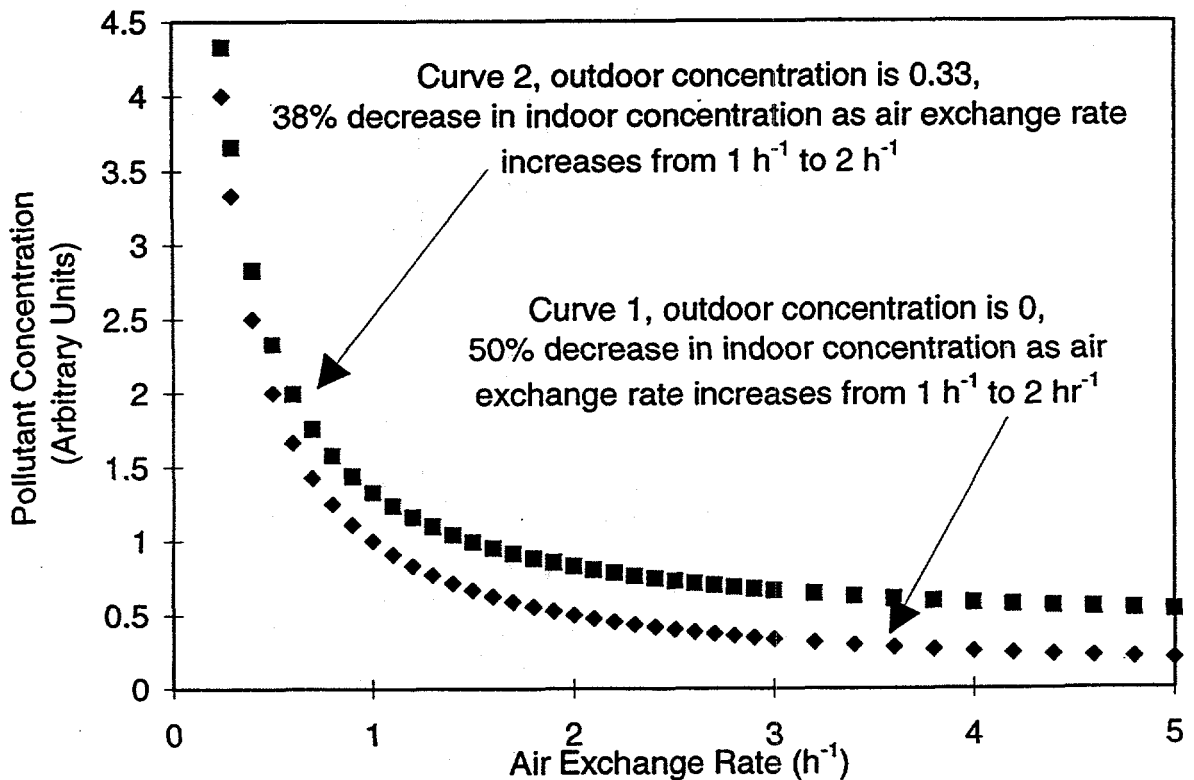

Figure 2.1 Equilibrium relationship between indoor pollutant concentrations and ventilation rates based on equation 2 which assumes negligible air cleaning and pollutant deposition and a pollutant source strength independent of the indoor concentration.

Figure 2.1 illustrates that benefits of increasing ventilation rates are greatest when the initial ventilation rate is low. A comparison of these two curves illustrates that ventilation is much more effective in controlling indoor air quality when the outdoor pollutant concentration is

negligible. For example, an increase in the air exchange rate from 1 h^{-1} to 2 h^{-1} is associated with a 50% reduction in pollutant concentration on curve 1 (negligible outdoor concentrations) and with a 38% reduction on curve 2 (significant outdoor pollutant concentration). Curve 1 represents the situation when changes in ventilation rate have the largest possible impact on the indoor pollutant concentration. Changes in ventilation will have a smaller impact on the indoor pollutant concentration when there is a significant outdoor concentration of the pollutant, or additional pollutant removal by deposition or air cleaning, or a pollutant emission rate that increases as the indoor concentration decreases.

Figure 2.2 presents an example of the application of equation 3 for predicting equilibrium indoor carbon dioxide concentrations in an office setting. The assumptions used to generate this curve were an outdoor concentration of 350 ppm and a carbon dioxide generation rate per person (ASHRAE 1989) of 0.30 L min^{-1} (0.011 cfm). Figure 2.2 must be used with caution because carbon dioxide concentrations often do not reach equilibrium in office buildings (Persily and Dols 1990).

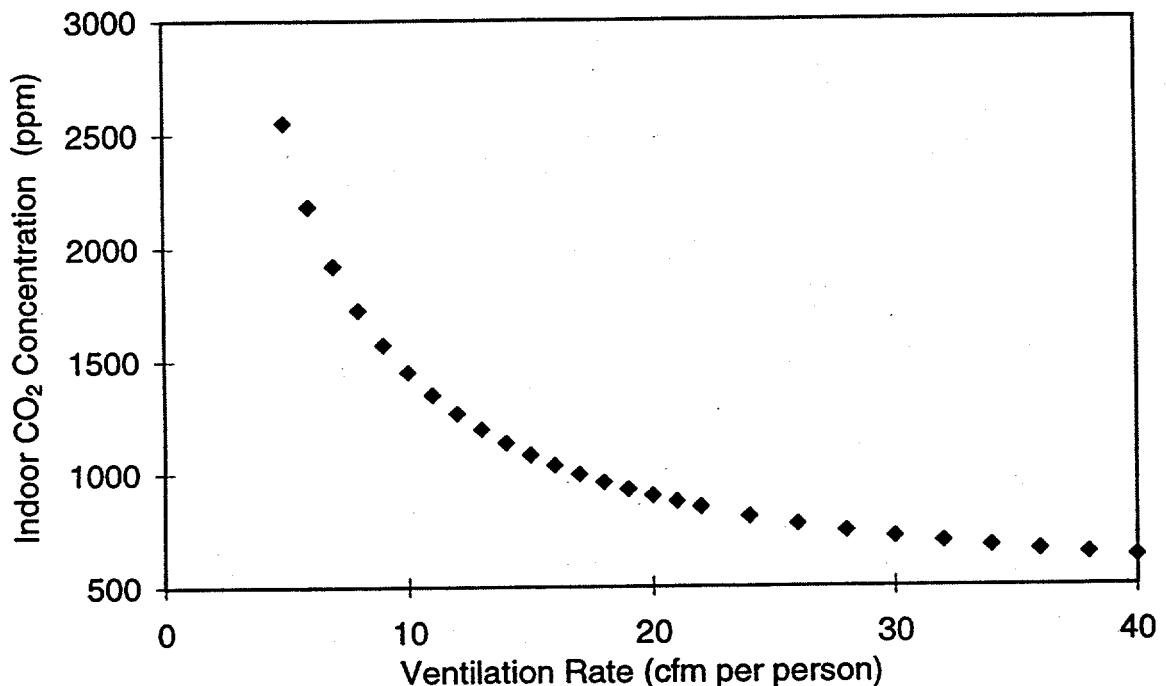

Figure 2.2 Equilibrium relationship between indoor carbon dioxide concentration and ventilation rate based on equation 3. A carbon dioxide generation rate of 0.011 cfm per person and an outdoor concentration of 350 ppm were assumed.

Figure 2.3 is an example of a measured time history of carbon dioxide concentration in an office building. Through inspection of the figure, it is evident that CO_2 concentrations in this building never stabilized at an equilibrium value. Thus, the measured peak CO_2 concentration can not be easily used to determine the rate of outside air supply per occupant.

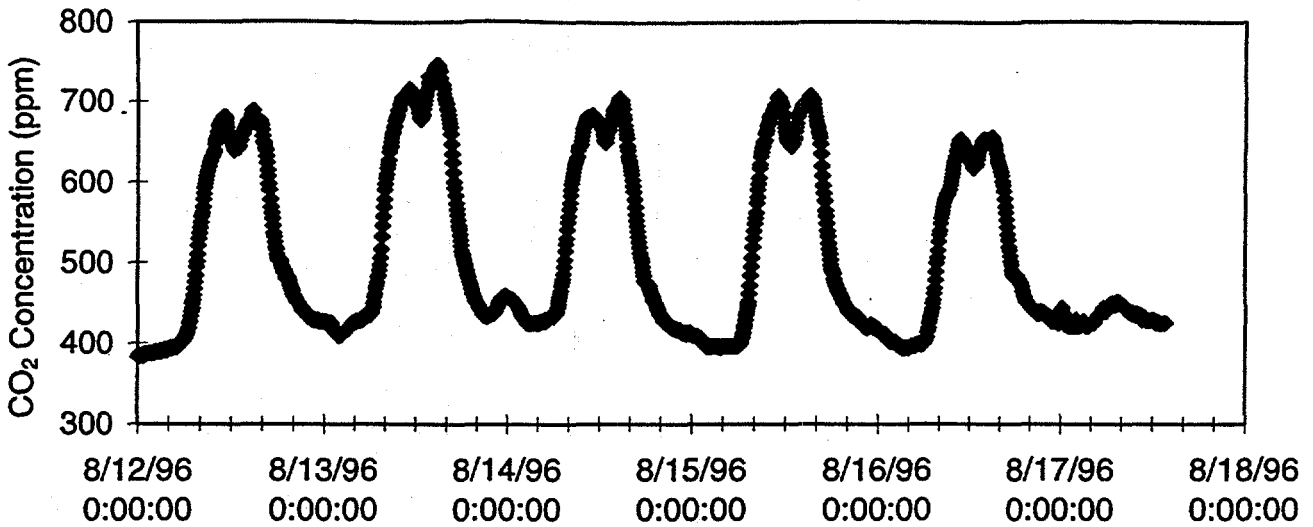

Figure 2.3 Example time history of carbon dioxide concentration inside an office building

2.4 Pollutant Removal by Ventilation and Deposition or Air Cleaning

When a pollutant is removed from indoor air by deposition on surfaces (e.g., particles or ozone) or by air cleaning, changes in ventilation have a smaller impact on the equilibrium indoor concentration. The solution to equation 1 at equilibrium ($dC/dt = 0$) with the pollutant deposition and air cleaning terms included is

$$C = \frac{G/V + \lambda_v C_{out}}{\lambda_v + v_d \frac{S}{V} + \frac{Q_{ac} \epsilon_{ac}}{V}} \quad (4)$$

The additional pollutant removal terms in the denominator of Equation 4 (compared to Equation 3), reduces the magnitude of changes in indoor pollutant concentrations when the ventilation rate is increased or decreased. Therefore, SBDCV, which depends on changes in ventilation rate to maintain acceptable IAQ, will be more effective when the rates of pollutant deposition and air cleaning are small.

2.5 Pollutant Removal When Source Strength is a Function of Indoor Concentration

When the indoor pollutant emission rate is a function of the indoor pollutant concentration, more complex models must be employed. For example, formaldehyde emissions from building materials such as particle board often increase as the indoor concentration decreases.

(Formaldehyde emission rates also increase with temperature and humidity and decrease as the formaldehyde source ages.) The required models are complex and will not be presented in this

report. However, we note that it can be difficult to obtain large reductions in formaldehyde concentrations by increasing the ventilation rate when the formaldehyde source is a pressed wood product (Matthews et al. 1986, Fisk and Grimsrud 1993).

2.6 Rate of Response to an Introduction of Pollutant Source or a Step Change in Ventilation Rate

SBDCV systems must respond to changes in indoor pollutant generation through appropriate adjustment of ventilation rates. When a pollutant source strength changes or ventilation rates are increased or decreased, the indoor pollutant concentrations will decrease or increase over time until a new equilibrium concentration is attained. The nature of the response can be derived from the transient version of the mass-balance equation. For simplicity, we will consider only situations with no pollutant deposition or air cleaning and with perfect mixing of the indoor air. The transient mass balance equation becomes

$$\frac{dC}{dt} = \frac{G}{V} + \lambda_v (C_{out} - C) \quad (5)$$

with an initial condition $C(0)$ and an equilibrium concentration

$$C_{equil} = C_{out} + \frac{G/V}{\lambda_v} \quad (6)$$

The solution to Equation 5 is

$$C = C_{equil} + (C(0) - C_{equil})e^{-\lambda_v t} \quad (7)$$

If

$$C' = C - C_{out} \quad (8)$$

equation 7 becomes

$$C' = C'_{equil} + (C'(0) - C'_{equil})e^{-\lambda_v t} \quad (9)$$

If at time equals 0, the indoor and outdoor concentration are identical ($C'(0) = 0$) and a pollutant source is introduced in the building

$$\frac{C'}{C'_{equil}} = 1 - e^{-\lambda_v t} \quad (10)$$

Equation 10 indicates that the time to attain an equilibrium concentration after the introduction of (or step change in) a pollutant source (e.g., people) in a building depends on the air exchange rate of the building. The reciprocal of the air exchange rate is called the nominal time constant. If the air change rate is 1 h^{-1} , a typical minimum value for an office building, the nominal time constant for the ventilation process equals one hour. During one nominal time constant after the introduction of a pollutant source inside the building, the pollutant concentration difference (indoor concentration minus outdoor concentration) will increase to 63% of the equilibrium pollutant concentration difference. After two and three time constants, the indoor pollutant concentration difference will increase to 86% and 95%, respectively, of the equilibrium value.

The response of indoor pollutant concentration to a step change in air exchange rate, with a constant indoor pollutant source is indicated by equation 9. In figure 2.4, the predicted concentration time history is illustrated for air exchange rates of 2 h^{-1} and 3 h^{-1} , assuming the outdoor pollutant concentration is negligible, the initial ventilation rate is 1 h^{-1} , G/V equals unity, and the initial concentration before the step change is at the equilibrium value for the ventilation rate of 1 h^{-1} .

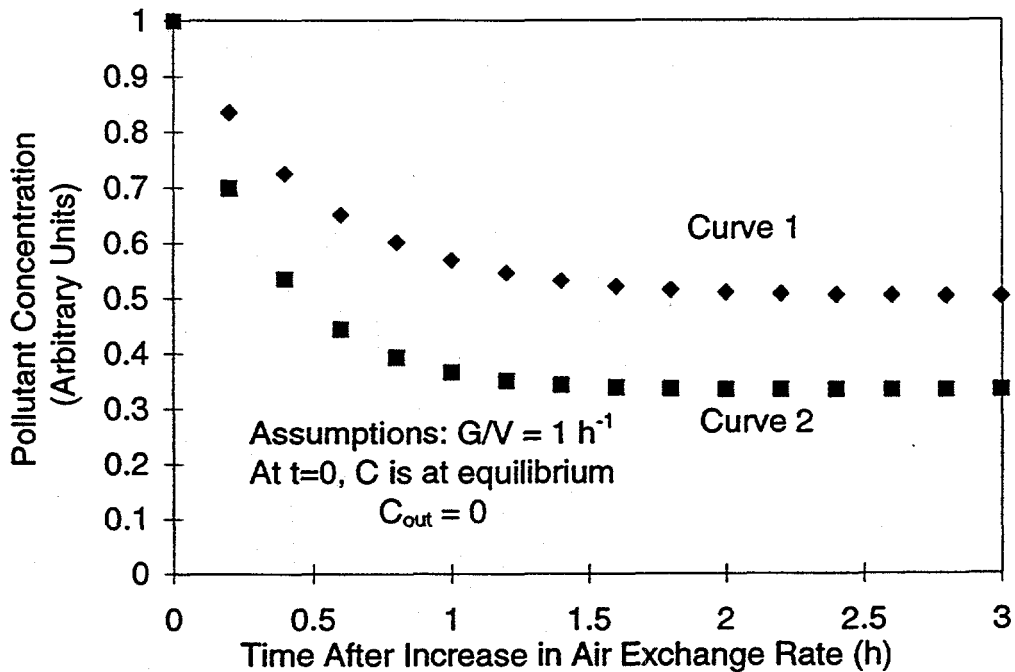

Figure 2.4 Predicted time history of pollutant concentration, based on equation 10, after ventilation rate is increased from 1 h^{-1} to 2 h^{-1} (Curve 1) or 3 h^{-1} (Curve 2)

3. DEMAND-CONTROLLED VENTILATION

3.1 Basics of Demand Controlled Ventilation

In most buildings, occupancy and indoor pollutant emission rates vary with time. With demand-controlled ventilation (DCV), the rate of ventilation (i.e., rate of outside air supply) also varies with time to compensate for the changes in pollutant generation. In other words, DCV involves the application of sensing, feedback and control to modulate ventilation. Compared to ventilation without feedback, DCV offers two potential advantages: (1) better control of indoor pollutant concentrations; and (2) lower energy use. DCV has the potential to improve indoor air quality by increasing the rate of ventilation when indoor pollutant generation rates are high and occupants are present. DCV can also save energy by decreasing the rate of ventilation when indoor pollutant generation rates are low or occupants are absent.

The type of control system used in DCV can vary in complexity and cost. Manual control of ventilation by the building occupants is one option. Examples range from the simple opening and closing of windows by occupants of a residence to task ventilation in offices, in which each occupant can adjust a local air supply located near their workstation. Programmed time clocks are another control option if the schedule of occupancy or pollutant emissions are known in advance. Time clock control is common in office buildings that are occupied only during the daytime periods of weekdays. The third option, and major focus of this document, is SBDCV.

SBDCV is the process of automatically controlling the rate of outside air supply to a building through the use of pollutant sensors (or possibly occupancy sensors) to determine the need for outside air. The measured pollutant concentrations are inputs to a system that controls the rate of outside air supply.

SBDCV is only applicable when certain conditions apply. There must be a basis for selecting a maximum acceptable pollutant concentration. A suitable pollutant sensor with a real time (or near real-time) output signal is required. A means of automatically adjusting the outside air supply is required. Mechanical ventilation systems with automatic controls usually fulfill this requirement. DCV is likely to be much more practical or cost effective when the following additional conditions apply:

- (a) the building has one or a few dominant pollutants;
- (b) the indoor pollutant emission rate of the dominant pollutant varies considerably over time;
- (c) the indoor pollutant generation rate is somewhat unpredictable, otherwise ventilation rates could simply be programmed to vary over time; and
- (d) energy costs are high due to severe climates, high energy prices, or large flow rates of outside air.

Recently with the development of less expensive and higher performance gas pollutant sensors, SBDCV is becoming increasingly attractive. The investment required to install SBDCV depends on the existing ventilation type. In buildings (offices or other types of commercial buildings) that

already have variable air volume ventilation with digital controls, CO₂-based ventilation control requires little additional investment (typically a few \$1000) per zone controlled. If, however, extensive installation of flow-control hardware and control equipment is required to implement SBDCV, the required investment will be much larger.

3.2 Use of CO₂ Sensors for Demand Controlled Ventilation

At present, most SBDCV systems are based on monitoring and control of CO₂ concentrations. Although CO₂ is not dangerous to human health at the concentrations normally encountered in buildings, there is a strong correlation between the indoor emission rate (and indoor concentration) of CO₂ and the emission rate of other occupant-generated bioeffluents (e.g., body odors). Thus, CO₂ sensors provide a simple and relatively inexpensive way to indirectly monitor the indoor air quality component related to bioeffluents. The emission rates of some other indoor pollutants may also be correlated roughly with CO₂ emission rates. For example, VOC and particle emissions from office equipment (used by occupants) may vary approximately with occupancy. On the other hand, the rate of VOC emissions from building materials and furnishings is likely to correlate poorly with occupancy.

Current standards and codes for minimum ventilation rates in large buildings, such as ASHRAE Standard 62-1989 "Ventilation for Acceptable IAQ" (ASHRAE 1989), list minimum rates of outside air supply per occupant. The presumption within these standards is that the specified minimum rate of ventilation per occupant is adequate for the control of both occupant-generated pollutants and other indoor-generated pollutants. Because pollutant emission rates, from sources other than occupants, vary greatly among buildings, this presumption can lead to IAQ problems. The proposed revision to ASHRAE Standard 62 (ASHRAE 1996) specifies minimum ventilation rates that are the sum of minimum ventilation rates per occupant and minimum ventilation rates per unit floor area.

In buildings with a high occupant density, it is more likely that the prescribed minimum rates of outside air supply per occupant also result in acceptable concentrations of pollutants not generated by occupants. For this reason, the use of CO₂ sensors to control outside air is particularly attractive in buildings or rooms with a high occupant density, e.g., auditoriums, meeting rooms.

As illustrated in Figure 2.2, there is a direct relation between ventilation rates per person and steady-state indoor CO₂ concentrations. The minimum rate of outside air supply in ASHRAE Standard 62-1989 (15 cfm/occupant) corresponds to a steady state indoor CO₂ indoor concentration of 1000 ppm, assuming an outdoor concentration of 300 ppm and the CO₂ generation rate typical of office workers. Based on the relationship illustrated in Figure 2.2, a control system that provides just enough outside air to maintain CO₂ concentrations below 1000 ppm or 800 ppm may be considered¹. Such a control scheme is likely to be too simple for many buildings. For example, in an office building with a low occupant density and occupancy only

¹ . The SBDCV system will typically regulate the minimum outside air supply. Economizer controls may increase outside air quantities during periods of mild weather.

during the daytime, many hours could elapse after the start of occupancy before indoor CO₂ concentrations reach 1000 ppm. If no outside air ventilation was provided during this period, the indoor concentrations of pollutants that are not generated by occupants could be excessive, leading to occupant complaints and health risks. To devise a control scheme for SBDCV based on indoor CO₂ sensors, the dynamic nature of the relationship between occupancy, outside air supply, and CO₂ concentrations must be considered. Also, a judgment is required regarding the adequacy of the ventilation control scheme for indoor pollutants generated from sources other than occupants. Additional types of pollutant sensors may be necessary to assure adequate IAQ.

There are a number of potential control strategies for using CO₂ sensors in the control of outside air and a variety of possible locations for sensing the CO₂ concentration. The approach described above, a simple maximum CO₂ setpoint, with the CO₂ sensor responding to the return-air concentration, has received the most attention. In some office buildings, this approach is combined with an early-morning purge of the building, using a temporary high ventilation rate to dilute pollutants that accumulated during the night. One control strategy that has been recently proposed (Federspiel 1996, Ke and Mumma, 1997) is to modulate the rate of outside air supply so that it is proportional to the indoor rate of CO₂ generation, determined from measurements and mass balance calculations. The indoor CO₂ generation rate is a much better surrogate for occupancy than the indoor CO₂ concentration. Modeling and field trials are needed to identify the preferred control options and sensor locations.

Although a SBDCV system, with only CO₂ sensors, is clearly imperfect because it does not react to pollutants other than CO₂, most existing ventilation systems have no system for measuring or automatically controlling the minimum outside air supply. An imperfect SBDCV system based solely on CO₂ sensors may still be superior to the current practice which can lead to both excessive and inadequate rates of minimum outside air supply.

3.3 Use of VOC and CO₂ Sensors

CO₂ sensors provide a signal which is correlated with occupancy and the associated pollutant emissions; however, the pollutant load due to the building materials and furnishings and to other sources is not sensed. Thus, in buildings where the human pollutant load is not dominant, CO₂-based SBDCV could lead to insufficient ventilation.

Recently there is a trend to also use other gas pollutant sensors, primarily sensors for volatile organic compounds (VOCs) in SBDCV systems (see Sections 6), often in conjunction with CO₂ sensors. The cost of VOC sensors is decreasing and the performance, e.g., sensitivity and stability, is improving (Spence 1995). Although this is an attractive option, existing VOC sensors may still have an inadequate sensitivity and stability. Additionally, the appropriate use of VOC sensors is complicated because there is a high variability in the potency of different VOCs to cause irritation (Ten Brinke 1995) or chronic health effects (e.g., cancer) and because maximum acceptable VOC concentrations, for mixtures of multiple VOCs, have not been established.

There is considerable evidence to suggest that total volatile organic compound (TVOC) concentrations exceeding a few milligrams per cubic meter are likely to lead to health symptoms (Molhave 1986 and 1993, Ten Brinke 1995); however, lower concentrations are not necessarily acceptable. One of the initial opportunities for use of VOC sensors in SBDCV is to ensure that VOC concentrations do not exceed some relatively high level. This type of control system could reduce complaints during periods of temporary high indoor VOC emission rates, such as the high emission rates associated with painting or installation of new carpeting.

At the present time, there is very limited literature on the simultaneous use of CO₂ and VOC sensors in SBDCV systems, although a growing number of installations is planned (Flood 1994).

3.4 Use of Other Types of Sensors for SBDCV

In residential buildings relative humidity sensors have also been used for ventilation control, but they are only effective for moisture control. Other residential pollutants are not well correlated with relative humidity.

In buildings with variable occupancy schedule, but in which the number of occupants during the period of occupancy is relatively stable (e.g. a classroom in a junior school), occupancy sensors may provide the most cost-effective solution for SBDCV. The occupancy sensor would increase ventilation from a low value to a fixed higher value during periods of occupancy.

Particle sensors might be used to control ventilation rates in buildings or rooms (e.g., smoking lounges) with high particle generation rates. Unfortunately, most high quality real-time particle sensors cost several thousand dollars. A Japanese manufacturer, (Figaro), markets a solid state sensor that responds to gaseous components of cigarette smoke and the manufacturer provides some information on the response of the detector in environments with smoking. Faulkner et al. (1996) used a low cost (\$2500) optical particle counter in a system that automatically modulated air recirculation rates (thus air filtration rates) in a clean room, but this instrument is too expensive for use in most normal indoor environments. The cost of instruments that use light scattering to measure particle concentrations in real time is decreasing, thus, cost-effective particle sensors may be available in the future.

3.5 Technologies for Varying Air Flow Rates

To control the ventilation rate, several technologies are available including the following:

1. *Cycling the fans on-off.* This method is not suitable for large fans and increases the wear on the motor, starting gear and transmission.
2. *Changing the opening of the fan dampers or fan inlet vanes.* Both dampers and the inlet vanes are flow restriction devices that can be used to modulate air flow rate; however, this flow-control method is not energy efficient.

3. *Changing the speed of the fan motor.* Electronic variable speed drives (VFDs) used to control the speed of the fans are the most energy efficient way to control the ventilation rate. VFDs can change the motor speed in a continuous way in order to meet load requirements.

Figure 3.1 shows the relative energy performance of several technologies to control the ventilation rate. This figure shows that variable speed drives are significantly more efficient than dampers and inlet vanes. Variable speed drives are expensive for small motors (the relative price decreases as the size of the motor increases) but their use is generally cost-effective in applications where there are variable flow requirements and there are a large number of operating hours per year. Table 3.1 provides typical prices for electronic variable speed drives.

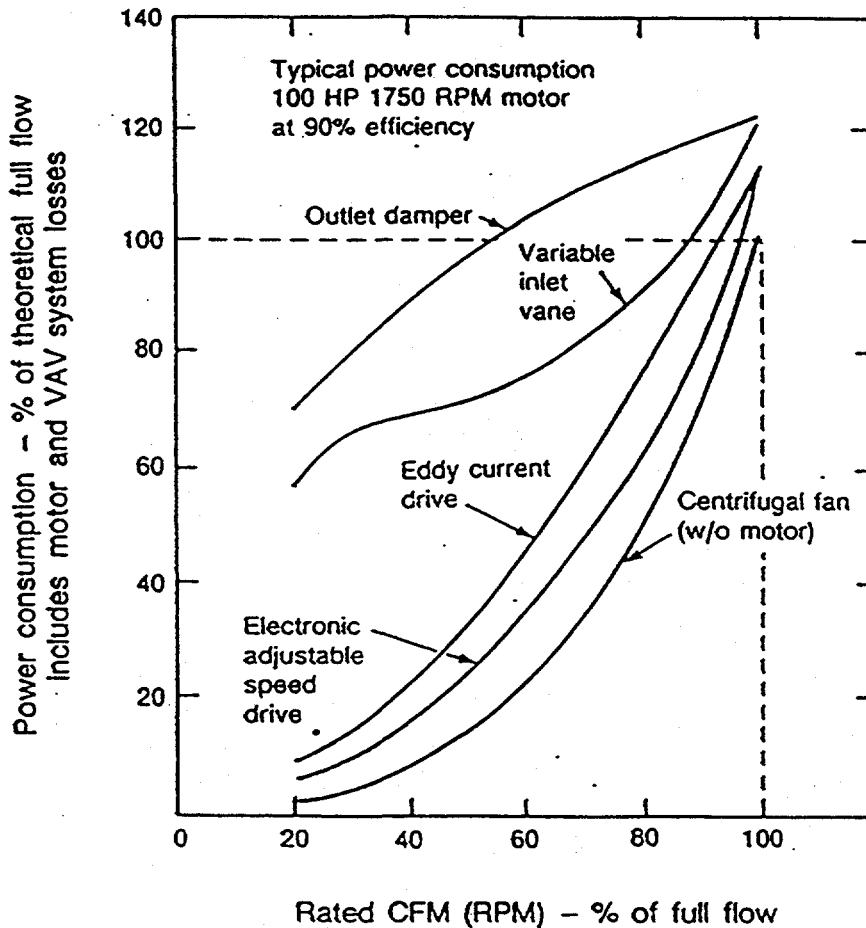

Figure 3.1 Performance of several technologies to control the air flow rate (Greenberg et al. 1988)

Table 3.1 - Approximate cost of variable speed drives (US dollars)

Horsepower (hp)	1	5	7.5	20
Cost (\$)	600	1500	1900	3200

In mass-produced home appliances such as variable speed heat pumps and heat exchangers, the cost can be substantially less than indicated in table 3.1, e.g., as low as U.S. \$25/hp.

4.0 POTENTIAL INFLUENCE OF SBDCV ON ENERGY USE

This section provides a general discussion of the potential energy savings associated with SBDCV. Examples of the energy savings reported in case-studies are described in section 7.

One of the major driving forces for SBDCV is the fact that higher outside-air ventilation rates can increase building energy use, the required HVAC equipment capacities, and the associated energy and equipment costs. Several studies have used computer models to examine the relationships between outside air ventilation rates and energy use (Eto and Meyer 1988; Eto 1990; Steele and Brown 1990; Ventresca 1991, Mudarri and Hall 1993, 1996) The findings vary considerably with the type of building, type of HVAC system, occupant density, and climate. For example, if minimum ventilation rates are reduced from 20 cfm/occupant to 10 cfm/occupant, the estimated savings in HVAC energy (i.e., fan, heating and cooling energy) vary from negligible to approximately 50%. In office buildings with HVAC systems that have an economizer, increasing or decreasing the average minimum ventilation rates from approximately 20 cfm/occupant to 5 cfm/occupant is likely to change total HVAC energy use by only a few percent to 10% (Eto and Meyer 1988; Eto 1990, Mudarri and Hall 1993, 1996). The larger energy savings are expected in buildings with a high and variable occupant density (e.g., sports arenas, auditoriums, courtrooms, theaters etc.) located in a severe climate.

The potential energy savings cited above are model predictions for large buildings that supply a mixture of outside and recirculated air. In buildings that supply 100% outside air to the conditioned space, larger savings would be expected. In these buildings, fan energy savings will be especially significant because fan power increases with the cube of the flow. Thus a modest decrease of 20% in the air flow translates into 50% fan energy savings. However, in buildings that supply a mixture of outside and recirculated air, SBDCV will have only a small influence of total air flow rates and fan energy.

Presently, the rates of outside air supply to most large buildings is rarely measured and poorly controlled. The limited available data suggests that a very significant fraction of office buildings in the U.S. have minimum ventilation rates substantially above or below the rates specified in ventilation codes (e.g., Fisk et al. 1991, Persily and Grot 1985, Turk et al. 1987, Grot and Lagus 1995). The practice of setting minimum rates at a level necessary for the highest anticipated (worst-case) occupancy, will often lead to ventilation rates above the levels specified in codes. SBDCV offers the potential to save energy in over-ventilated buildings and to improve IAQ (with some increase in energy use) in under-ventilated buildings.

5. USE OF ENERGY MANAGEMENT SYSTEMS FOR DEMAND CONTROLLED VENTILATION

5.1 Energy and demand control functions

Energy management systems (EMS) are increasingly being used in medium and large commercial buildings to provide energy cost savings without impairing normal building

functions (EPRI 1986). A network of sensors distributed in the building gathers in real time the most relevant variables which characterize the building operating condition. Those variables may include temperature, humidity, air flow rate, pressure, light levels, occupancy of rooms, on/off status of loads, etc. Pollutant sensors (such as sensors for carbon dioxide) are readily added to EMS.

With the information acquired by the sensors the controller optimizes the operation of the building by controlling the actuators and ventilation components which influence the different building variables. The actuator components typically include pumps, fans, compressors, lights, valves, and dampers.

In a typical EMS, field panels provide an interface between the controller and the distributed clusters of sensors and actuators distributed in the building. Communication links, typically implemented with MODEMs, allow bi-directional transfer of information between the controller and the field panels

Advanced EMS with environmental control capabilities can perform the following functions:

Start/stop control: Equipment may be turned off when the building is unoccupied according to a set schedule. This may or may not include equipment for supply of outside-air ventilation. At a minimum, the ventilation rate may be able to be reduced during the hours of non-occupancy.

Optimal start/stop: The EMS system may restart equipment at the latest possible time before reoccupancy. This can also be applied to the ventilation system, based on the building time constant for the removal of air pollutants. The restarting of the ventilation system should precede occupancy sufficiently to reduce the indoor concentrations of pollutants that accumulated indoors when the ventilation system was not operating.

Temperature and ventilation set point modification: Temperature set points and ventilation rate may be modified when building is unoccupied.

Economizer control: Economizer operation normally implies the admission of outside air well in excess of minimum ventilation requirements when the outside air temperature (or enthalpy) is suitable for cooling (or for cooling and dehumidification) of the building interior. With the exception of the few situations where the outside air is more polluted than the inside air, economizer operation is not affected by environmental controls. However if the outside air has to be cleaned, the associated costs and the temperature difference will determine the optimal amount of outside air ventilated into the building. For example, Shah (1995) has explored the use of a control system that reduces outside air supply to telephone switching offices when outside particle concentrations are high. This procedure is under investigation, because particles contribute to the failures of the circuit boards used in telephone switching offices.

Peak Electrical Demand control: EMS can limit the peak electrical demand by automatically switching off selected equipment, on a priority basis, during short periods of time. EMS can also control the operation of thermal storage equipment. In theory, it should be possible to reduce the

admission of outside air for short periods of time during periods of peak loads without significantly affecting IAQ. Providing a high rate of outside air supply prior to the period of peak demand, may permit larger decreases in outside air supply during peak load periods.

Duty cycling: EMS is frequently employed to periodically switch off equipment for a certain period of time. This feature is can typically be found in the control of air handling equipment, where, for example, the fans are stopped 15 minutes every hour. However the frequent starting of motors decreases their lifetime and may also increase maintenance requirements in the belt transmissions. Temperature and pollutant sensors might be used to optimize the periods when the air handling equipment is switched off.

Monitoring/Alarm: EMS can be used to acquire information on the building operating conditions and detection abnormal situations. Equipment malfunctions can also be detected. Pollutant sensors can detect excessive concentration of pollutants both in the indoor and in the outside air, as well as to provide the corresponding alarms. The performance of filters can also be monitored and the need for their replacement optimally determined.

5.2 Real-time Control of Electricity Demand Combined with SBDCV

Some large consumers, who have special electricity rates, are connected with the utility through a phone line, in order to receive requests for reducing the peak electricity load, as well as to communicate present and forecasted demand. The operator traditionally closes the link, instructing the EMS to respond to the utility signals. Current manual load shedding/shifting response to utility prices is too labor intensive and operationally inefficient for large-scale implementation of real-time price controls.

Energy management systems (EMS), which can control loads in a automatic manner in response to real-time prices, have been developed in a project involving the Electric Power Research Institute, Con Edison, New York State Energy Research and Development Authority (NYSERDA), Pacific Gas and Electric, and Honeywell (Flood 1994). Real-time prices are sent to the customer whose EMS can modulate some of the loads (e.g. air conditioning, ventilation, non-essential lighting), in order to reduce peak demand, maintaining at the same time all the services required.

The application of demand controlled ventilation coupled with real-time price control can be used to modulate the ventilation load by controlling the temperature, VOCs, and carbon dioxide levels within a window of acceptance, whose limits may be adjusted as a function of the real-time prices. In theory, this strategy can not only deliver energy savings but also substantial peak power savings. Large commercial buildings with long thermal time constants, low pollutant emission from the building materials, building furnishings and consumer products, as well as having a large volume of air per occupant, are the most attractive buildings for this type of ventilation control.

A first experiment carried out in a large hotel in New York (Flood 1994) with only basic on-off load control capabilities, showed impressive savings, 1.2 MW reduction in the peak demand and

an energy reduction of 186,000 kWh. It is estimated that automatic real-time price control can typically reduce the electricity costs by 10-15%, compared with manual load shedding.

The next natural step was the implementation of pilot projects with continuous load control, to respond to real-time price signals. One of the prime targets for continuous load control are the ventilation loads. NYSERDA has a contract with Spence Associates to develop a combined sensor CO₂ /VOCs which is going to be used for real-time control of ventilation. The first system has been installed in a large office building and the second will be implemented in the same hotel where RTP on-off controls have already been successfully applied.

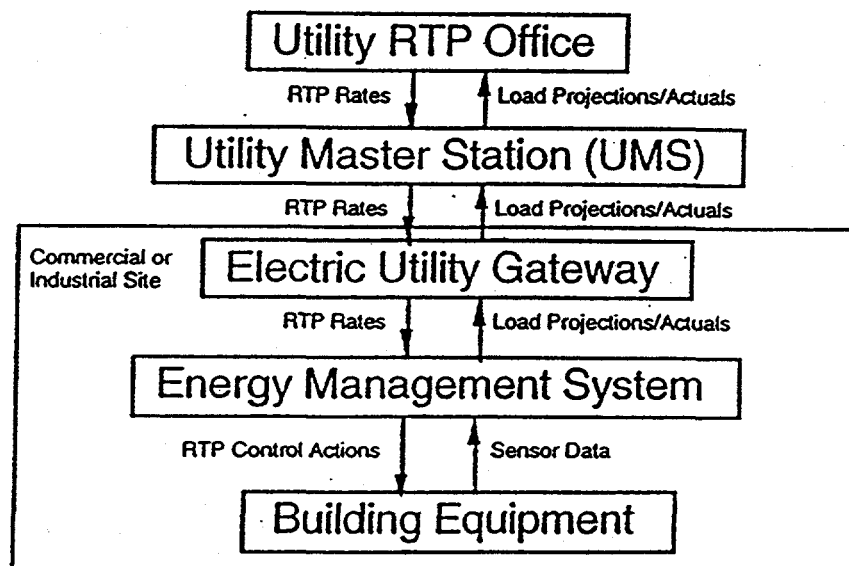

Figure 5.1 Diagram of a real-time price control link connected to an Energy Management system (Flood 1994, reproduced with permission)

These pilot projects can provide important information to help to advance the state-of-the-art of SBDCV. Information is needed on the performance (e.g., stability) of the CO₂ and VOC sensors, the best locations for sensors, the impact on energy and peak savings of different control-system set points; and correlations of the response of the pollutant sensors with occupant responses to the environments.

6. SENSORS FOR SBDCV

6.1 Background and Suggested Sensor Performance Criteria

The need to control and automate industrial processes has led to the appearance in the market of a wide array of sensors. These sensors allow the monitoring and control of a large number of parameters, at a generally modest price. Although some types of sensors developed for industrial applications can also be used for the non-industrial indoor environment (e.g. temperature, pressure, flow sensors), the sensor technologies for indoor air pollutants at present lag in terms of performance-to-price ratio relative to industrial sensors. This lag may be due to the lack of a strong market pull for the development of mass-produced low-cost indoor air quality sensors. Additionally, environmental sensors for industrial applications are normally designed to deal with higher, easier to measure, pollutant concentrations than those present in non-industrial buildings.

The sensors already readily available in the market include humidity, carbon dioxide, carbon monoxide, mixed pollutant sensors, particle counters and occupancy sensors.

Suggested characteristics of pollutant sensors used for SBDCV in non-industrial buildings are described in Table 6.1. To construct this table, we assumed that the sensors' minimum detection limits should approximately correspond to the lower limit of pollutant concentrations inside buildings and that the sensor resolution and maximum drift between calibrations should be less than approximately 10% of a typical indoor pollutant concentration. For all sensors, we have assumed that measurements should be available at least every 30 minutes which is on the order of a typical ventilation time constant. For particle sensors used in smoking rooms, in which the indoor particle source strength may change instantaneously, a faster sensor response is suggested. The suggested criteria in Table 6.1 are based substantially on professional judgments and are intended only as approximate criteria.

Suggested criteria for particle sensors are expressed in terms of particle mass per unit volume of air, consistent with the health based standards for particles. When particle sensors measure particle number concentration, a conversion to mass concentration is necessary using a typical particle density. Different performance criteria are suggested for control of ventilation in general indoor spaces, where particle concentrations are usually much less than $100 \mu\text{g m}^{-3}$ and for control of ventilation in smoking rooms which are likely to have higher concentrations. For spaces with minimal smoking, we assumed that the goal would be to generally maintain particle concentrations well below the concentration specified in the national ambient air quality standard of $75 \mu\text{g m}^{-3}$ for particles with a diameter less than $10 \mu\text{m}$. For smoking rooms, and other spaces such as bars with high levels of smoking, the control system would likely be designed to maintain particle concentrations below a higher setpoint, roughly comparable to the value in the national ambient air quality standard of $75 \mu\text{g m}^{-3}$.

For TVOC sensors, we also provide criteria for two applications. The first application is the use of TVOC sensors only to prevent unusually high TVOC concentrations from occurring indoors (e.g. $> 1 \text{ mg m}^{-3}$) during periods of unusually high indoor VOC emission rate. Although the relationship between TVOC concentration and health effects are poorly understood, these unusually high TVOC concentrations are more likely to be a cause of adverse health effects. The second application is the use of TVOC sensors, possibly in combination with CO_2 sensors, for routine control of ventilation rates. In this application, the sensor must be suitable for the lower TVOC concentrations that typically occur indoors. Because the potential of different VOCs to cause irritation varies widely, the TVOC concentration, a simple measure of total mass concentration, may be a poor parameter for routine control of ventilation rate.

Table 6.1 suggests a maximum value of sensor drift between calibrations. The frequency at which building operators would be willing to calibrate sensors is unknown; however, we doubt that sensors would be calibrated more than once or twice a year in most buildings.

Table 6.1. Suggested characteristics for pollutant sensors used for SBDCV.

Pollutant	Typical Range Indoors	Sensor Minimum Detection Limit	Sensor Resolution	Sensor Max. Drift Between Calibrations	Sensor Required Specificity	Maximum Period Between Measurements
Carbon dioxide	350 - 2000 ppm (often < 1000 ppm maximum)	350 ppm	≤ 50 ppm	50 ppm	insensitive to temp., RH, other gases	30 min
Humidity	10% - 80% RH 0.002 - 0.015 absolute humidity	10% RH	≤ 5% RH	5% RH	insensitive to temp., other gases	30 min
Particles in indoor spaces with minimal smoking	10 - 100 $\mu\text{g m}^{-3}$ (minimal smoking)	10 $\mu\text{g m}^{-3}$	≤ 0.05 $\mu\text{g m}^{-3}$	0.05 $\mu\text{g m}^{-3}$	insensitive to temp., gases	30 min
Particles in smoking rooms	unknown	50 $\mu\text{g m}^{-3}$	≤ 10 $\mu\text{g m}^{-3}$	10 $\mu\text{g m}^{-3}$	insensitive to temp., gases	10 min
TVOC high limit control only	0.1 - 5 mg m^{-3}	1 mg m^{-3}	≤ 0.2 mg m^{-3}	0.2 mg m^{-3}	responds ~ to total carbon for VOCs with 50 °C - 250 °C boiling point	30 min
TVOC routine control	0.1 - 5 mg m^{-3} , usually < 1 mg m^{-3}	0.04 mg m^{-3}	0.04 mg m^{-3}	0.04 mg m^{-3}	responds ~ to total carbon for VOCs with 50 °C - 250 °C boiling point	30 min

6.2 Humidity Sensors

Many types of humidity sensors are available commercially. The following types of humidity sensors are most likely to be used in SBDCV systems:

Capacitive sensors: These sensors use a foil sensitive to humidity placed between two electrodes. The variation of the relative humidity causes the material to adsorb a variable amount of water, which causes the dielectric constant of the foil to change, thus changing the capacitance of the sensor. An electric circuit coupled to the sensor performs sensor output linearization and temperature compensation. The cost of these sensors is modest and they have a very low hysteresis, but they are sensitive to contamination by dust and organic compounds.

Resistive sensors: These sensors feature a plastic substrate covered with a hygroscopic film (e.g., lithium chloride). Due to the absorption of the humidity, the resistance of the sensor drops exponentially with the decrease in the relative humidity. These sensors have good precision, low hysteresis, short response time and do not require frequent recalibration. They are however sensitive to chemical vapors, free water and very high humidities.

Dew point sensors: A mirror is chilled (e.g. with a thermoelectric Peltier module) until condensation starts to occur. The onset of condensation is detected by a photodiode, through attenuation of the reflection of a light beam produced by a light emitting diode. When condensation starts to occur, the temperature of the mirror is measured with a temperature sensor, giving the dew and thus allowing the accurate determination of the absolute humidity. The cost of these sensors usually exceeds the cost of capacitive and resistive humidity sensors and some chilled-mirror sensors require frequent maintenance.

Many commercially available humidity sensors should have a performance consistent with the criteria in Table 6.1 and a reasonable cost, e.g., US \$100. However, the applications for SBDCV based on measured humidity appear to be limited.

6.3 CO₂ Sensors

In building environments where there is no combustion, the difference between indoor and outdoor concentrations of CO₂ at steady state is directly related with the building occupancy. Carbon dioxide sensors can be therefore used, sometimes inappropriately, to control the minimum rate of outside air supply per occupant.

The sensors for detection and monitoring the carbon dioxide use the infrared absorption principle. These sensors have a relatively low cross-sensitivity to other gases, fairly good accuracy (typically around 30-100 ppm). Some sensors need frequent recalibration. There are two main CO₂ sensor types available:

Photo-acoustic infrared CO₂ sensors: The components of this sensor type are a light source, an infrared filter, a cell chamber and a microphone. The filter is placed in front of the light source

to ensure that only the wavelengths which are absorbed by the carbon dioxide can pass into the cell chamber. In the cell chamber filled with the air from the room, the molecules of CO₂ absorb the infrared light as a function of its concentration. The energy absorbed increases the vibrating energy of the molecules, leading to an increase of the temperature. If the cell chamber is closed the temperature variations produce pressure fluctuations. If the infrared beam is modulated, the pressure fluctuations will also be modulated, the amplitude of the modulation being dependent on the CO₂ concentration. The acoustic effect of the pressure fluctuation is measured by a microphone, thus giving a measure of the CO₂ concentration. The main disadvantage of this method is its discontinuous nature, as the sampling chamber has to be closed between samples.

Photometric CO₂ sensors: In these sensors the infrared light is emitted by a light source and is reflected by mirrors in order to create a long path in the sampling chamber. After reflection the light strikes an infrared sensor. The transmission of several wavelengths is strongly affected by the CO₂ concentration and thus the received signal in the infrared sensor changes accordingly. The air entering the measuring cell is filtered to prevent particles from entering the cell.

Carbon dioxide sensors with performance meeting the criteria in Table 6.1 are presently available, although some products may not have the resolution or stability suggested in this table. The current price range for CO₂ sensors is approximately US \$350-\$3000. Because of the large increase in the sales of these sensors, the manufacturers predict that the price will drop by 50% in a few years. Manufacturer's product literature indicated that both types of CO₂ sensors need recalibration approximately every 6 months, although our experience suggests that more frequent calibrations are necessary.

6.3 Mixed Pollutant Sensors

Two main types of sensors are used to monitor the concentration of mixed pollutants in indoor environments:

Sensors based on homogeneous metal oxide semiconductor : These sensors are based on semiconductor metal oxide compounds (type n: tin, zinc and iron oxides; type p: copper, nickel, cobalt) in which the conductivity changes due to reaction of the gases with oxygen on the oxide surface (see Figure 6.1). The type n sensors react to combustible gases such as CO₂, H_mC_n and alcohols. The majority of the odors generated by the human body belong to this group and are detectable. To increase the sensor sensitivity, the sensors are heated in range 100-500 °C.

The structure of the semiconductor layers can be of three types: polycrystalline, single crystal and thin layer. Polycrystalline semiconductors are based in tin oxide, being easy to manufacture and having a wide range of application. However their response time is slow and they are sensitive to humidity. Thin layer sensors are highly sensitive to simple gases such as H₂S, CO, NO₂ and C₂H₅OH. However their sensitivity can change with humidity and temperature, they have slow response time, poor long term stability and poor reproducibility. Monocrystalline sensors are also being investigated, presenting generally good reproducibility. However they are expensive to manufacture.

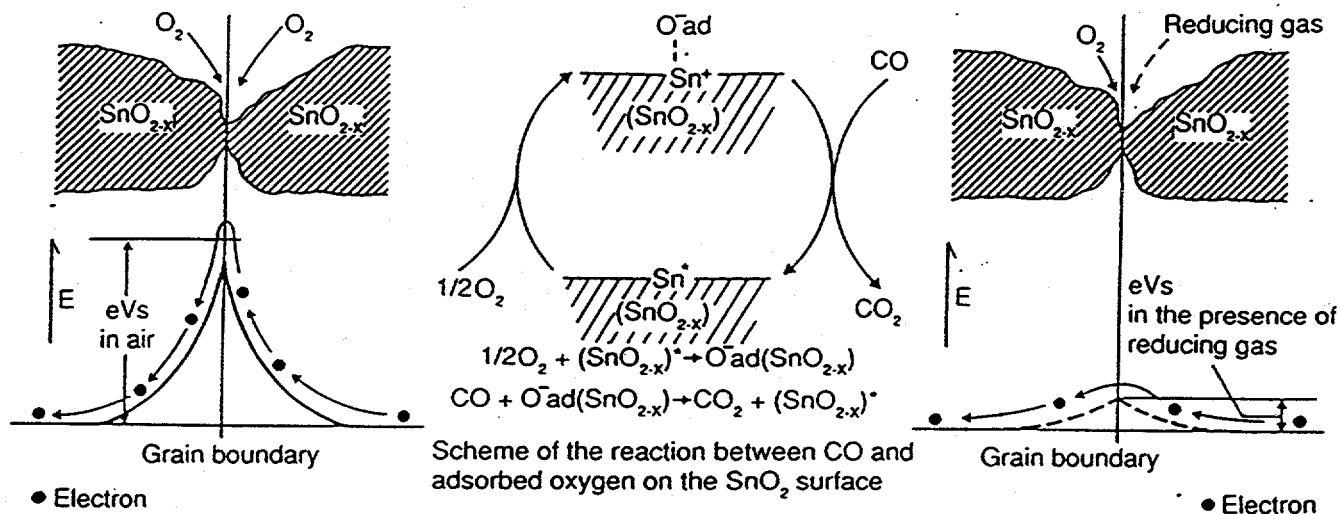

Figure 6.1 Structure of the semiconductor tin oxide gas sensors (Figaro 1994, reproduced with permission)

Catalytic gas sensors: These sensors are based in the determination of the amount of heat released by an exothermal reaction of a non-oxidized gas with a metallic catalytic surface. Typically these sensors have a heated platinum wire buried in a probe covered with a thin catalytic layer. The sensor is heated to 550 °C. The reaction with the gas produces an increase of the temperature and thus an increase of the resistance of the heated wire (about 0.4% / °C). The resistance of the wire is measured giving a signal dependent upon the gas concentration.

Mixed gas sensor elements are inexpensive, typically in the range \$10-30. However, complete sensors including temperature and humidity compensation, linearization and adjustment of baseline cost in the range \$100-500. Mixed gas sensors can provide a qualitative assessment of indoor air quality and can be used to sense for example bioeffluents and the VOCs generated by the building fabric. Some sensors are provided with a selective filter, which makes them more sensitive to a particular gas (e.g. carbon monoxide).

Mixed gas sensors have two main functional disadvantages. First, their response is not specific to a particular gas or to the total mass of carbon in VOCs, but to a combination of oxidizing gases. This makes it difficult to calibrate and interpret the output of these sensors. Second, their baseline output is subject to drift, therefore, these sensors have been restricted to measuring large short term variations of IAQ (e.g. smoking in a room). The resetting of the zero normally requires that the sensor is flushed with outside air. Research is being carried out on methods to stabilize baseline signals (Spence 1995). The presently-available mixed gas sensors would not meet the suggested performance criteria in Table 6.1 for TVOC sensors.

6.4 Particle Counters

Particle counters are used to count the number of particles above a certain threshold size, per unit of volume. Most of the counters are based on the scattering of a laser beam by the particles and detecting and counting the scattered light with photosensors. These instruments usually provide the number concentration of particles in various particle size bins. Subsequent calculations are necessary if an estimate of particle mass concentration is desired. Particle counters for particles above 0.3 microns in diameter are usually based on laser diodes and have moderate cost, about \$3,000 upwards. To count particles down to 0.1 microns in size, more powerful lasers are used which increase the cost to approximately \$10,000 and higher. For even smaller particles, condensation nucleus counters must be used, which increases the cost even further.

The performance of presently available particle counters meets the criteria suggested in Table 6.1, except possibly the criteria for sensor stability. Also, frequent cleaning of the optical system may be necessary, especially when the sensor is used in an environment with a high particle concentration. Unfortunately, the cost of currently-available particle sensors is too high for many potential applications.

6.5 Occupancy Sensors

Occupancy sensors are able to detect the presence of people by detecting, with a passive infrared sensor, the infrared radiation emitted by people. Other occupancy sensors emit a beam of ultrasound waves and detect people or any other moving object by the changes operated in the reflected beam when it bounces on a moving target. Some occupancy sensors use a combination of infrared and ultrasound sensors to achieve a more reliable operation. Occupancy sensors costs are typically in the range \$50-200. The existing occupancy sensors appear to be generally suitable for use in SBDCV systems.

6.6 New Sensor Developments

This section describes emerging sensor technologies for pollutants. Further research is necessary to determine if these emerging technologies will yield sensors that can practically be used in SBDCV systems.

Sensor arrays for subjective human responses: Research is being carried out in the development of sensor arrays which can measure the indoor air quality and mimic the subjective human response with respect to the acceptability of air (Wenger 1994). One of the most recent developments uses a large number (46) of gas sensors of different types to generate detailed information on the contaminants. Several pattern recognition techniques have been used to adapt sensor response to the judgments of a panel. Artificial neural networks produced the best matching results with a high correlation coefficient to the human response.

There is large potential for sensor performance improvement in terms of cost, sensitivity to the significant pollutants, stability and speed of response. To monitor and control the indoor air quality it would be desirable to have a low cost integrated sensor which could track

simultaneously the concentration, even at low levels, of the different pollutants. An inexpensive "electronic nose" with a high discrimination capability may be a possibility by combining microelectronics, microsensor and selective layer technologies. A few of the promising technologies are described below.

Gas-sensitive materials for use in sensors: The most critical components in advanced environmental gas sensors are the gas sensitive materials. Calixarenes, a caged structure material, may be used to selectively trap molecules of organic compounds (Gopel 1993). Recent work is targeted at improving the selectivities and sensitivities of ordered supramolecular cages. In a similar way the structures of oligomers, polymers or biomolecular function units can also be fine tuned for selective gas sensing.

Those gas sensitive organic materials can be used as selective coatings for several types of transducers. The amount of the gas trapped by the coating can modify a range of properties including capacitance, reflectivity, refractive index, mass, thermal capacity, or temperature. (Temperature increases result from the heat released when the gas absorbs on the selective coating.)

Silicon-based transducers provide an economically attractive substrate for the implantation of the selective layer because of the potential for implementing the sensor excitation and the signal processing in a silicon chip. One key area of sensor development is the provision of a stable interface between the selective coating and the silicon, in order to ensure a long sensor lifetime.

Another key area of sensor development is the stability of the response of the selective layer. After exposure to gas pollutants for long periods of time, the selective layer may lose its initial sensitivity due to the impregnation of the gas molecules. In order to purge and recover the sensitivity of the sensor, a common technique consists of applying heat to the element to thermally desorb the gas (Brysek 1991). This requires that the gas sensor is made on a thermally isolated structure. Polysilicon heating resistors have successfully been applied with thermally isolated structures to produce a fast (less than 2 msec) heating of the gas sensing layer.

Emerging sensor technologies: Several emerging technologies may lead to the appearance in the market of highly sensitive and selective gas sensors suitable for SBDCV. Two promising ways of implementing selective gas sensors are the flexural plate wave (FPW) and the surface acoustic wave (SAW) devices (Grate et al. 1991 and 1992). Figure 6.2 shows the structure of a FPW device. The key feature of the device is a membrane whose thickness is only a few percent of the elastic wave which is going to cross it. Interdigital transducers are used to excite the membrane at around 5MHz. The membrane is made of silicon nitride covered with a chemically selective sorbent layer, which can trap the gas to be measured. Sorption of the gas under isothermal conditions yields a shift in the frequency due to the added mass.

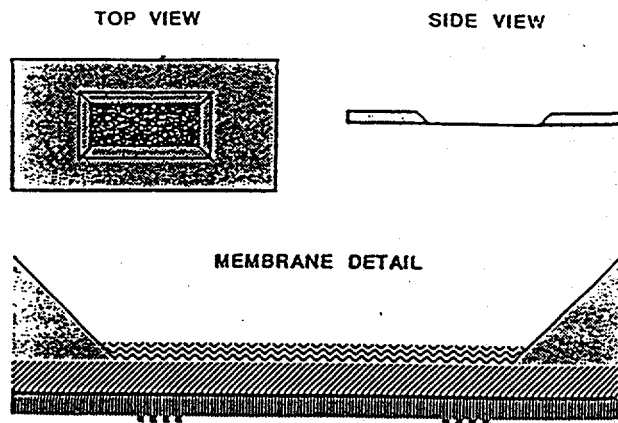

Schematic diagrams of a flexural plate wave device. In the top view, the membrane is shown in black at the bottom of the etch pit. The interdigital transducers are on the opposite side of the membrane, and thus are not shown in this view. The side view and membrane detail show cross sections through the center. The structures in the membrane detail (shown with exaggerated vertical scale) are, from top to bottom, the supporting silicon substrate on the sides, the polymer overlayer, the silicon nitride layer, the aluminum ground plane, the piezoelectric zinc oxide layer, and the aluminum interdigital transducers.

Figure 6.2 Flexural plate wave (FPW) sensor (Grate et al. 1992, reproduced with permission)

Figure 6.3 shows the principle a SAW device. In this device, interdigital transducers are used to launch surface Rayleigh waves on a thick piezoelectric plate (typically quartz or lithium niobate). In the SAW device the plate thickness is much larger than the acoustic wavelength. High mass sensitivity is achieved by using high frequencies (around 150 MHz). The way the gas vapor influences the sensor is similar to that in FPW devices.

Schematic diagrams of a surface acoustic wave delay line device. The aluminum interdigital transducers are shown in black on the gray quartz substrate. The devices at 158 MHz used in this study also have a thin silicon dioxide protective layer (not shown) covering the transducers.

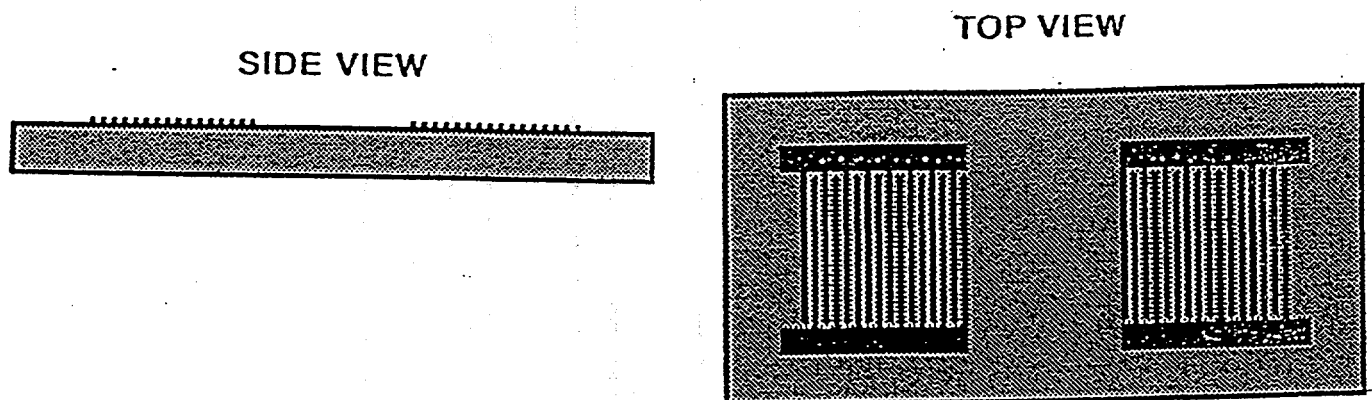

Figure 6.3 Surface acoustic wave (SAW) sensor (Grate et al. 1991, reproduced with permission)

Optical Interferometers have the potential to be able to measure concentrations as low as parts per billion (Shandle 1993), thus being potentially suitable for indoor environmental monitoring. Figure 6.4 (Shandle 1993) shows an integrated-optic interferometer. A glass substrate of approximately 6 cm² surface, coated with a thin film which has a slightly higher index of refraction than glass. The thin film is made with a material that reacts in a detectable and reversible way with the gas whose concentration needs to be measured. The developed sensor is based on the variation of the film's index of refraction, which varies proportionately to the amount of contaminant it absorbs. The light emitted by the laser diode is split into two beams. One beam travels through the glass substrate, acting as a reference. The other propagates through both the substrate and the thin film. If the thin film changes the index of refection there will be a phase shift, varying directly with the gas concentration. In tests this low cost device was able to detect gas concentrations down to 100 parts per billion. A single sensor can be used to detect more than one gas by applying several types of films to the glass substrate as shown in Figure 6.4.

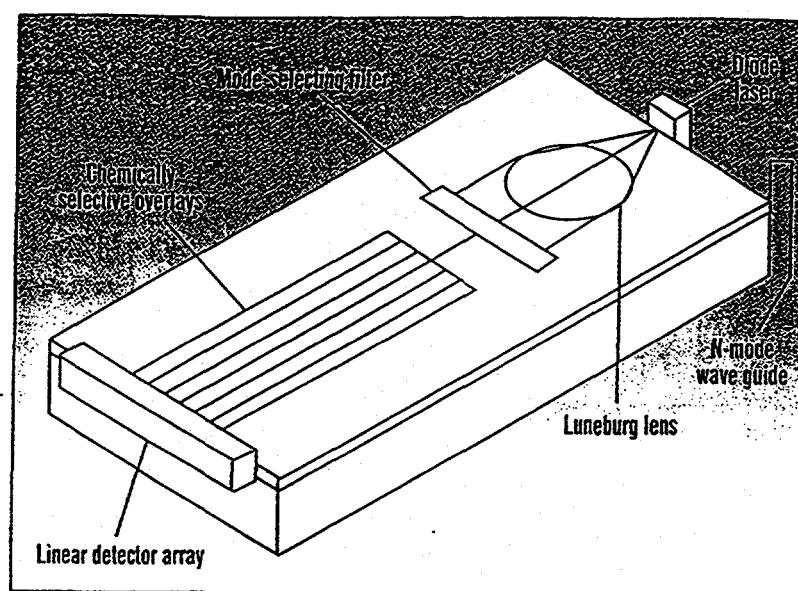

Figure 6.4 Integrated optic interferometer (Shandle 1993, reproduced with permission)

The IBM Research Division's laboratories (Maliniak 1994) developed an extremely sensitive micromechanical structure which can be used to detect very small concentrations of a particular gas. Silicon cantilever beams, about 400 microns long and 1.5 microns thick, are coated with aluminum (Figure 6.5). When a silicon cantilever is heated it bends due to the difference in the thermal expansion coefficients. A laser beam can measure the amount of bending, down to 1/100th of the diameter of an atom. The cantilever can be sensitized to detect a specific gas by application of a coating. The chemical reaction of the gas with the coating material releases heat

which bends the lever. Because the calorimeter is so sensitive, the chemical reaction of a few gas molecules is enough to produce a detectable response. Due to its small dimensions, arrays of hundreds of levers can be integrated in a single integrated circuit. Thus a single sensor can be made to respond a large spectrum of gas pollutants, an objective of the highest relevance for optimal monitoring and control of indoor air quality.

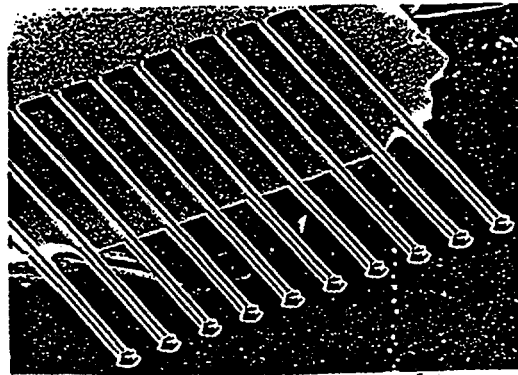

Figure 6.5 Silicon microstructure used for microcalorimetric sensing of very small gas concentrations (Source Malinik 1994, reproduced with permission)

7. CASE STUDIES OF SENSOR BASED DEMAND CONTROLLED VENTILATION IN RESIDENTIAL AND COMMERCIAL BUILDINGS

7.1 Limitations of Existing Literature

There is a lack of well documented case studies describing in detail the IAQ performance, the energy savings (fan energy, heating energy and cooling energy), and the cost-effectiveness of SBDCV. Most of the literature reviewed provides incomplete information on savings and cost effectiveness and is based on short-term studies. The literature involves case studies of a few days to a couple of years. No really long-term case studies (e.g., 10 years) are reported. Only a few studies included assessments of occupants' ratings.

Most of the case studies used CO₂ or humidity sensors to control the ventilation rate, thus, the literature provides very limited information on the use of other sensors. The case studies with CO₂ - based SBDCV, generally did not include measurements of a broad range of pollutants, thus, there are insufficient data to determine if CO₂ controls cause problems with other pollutants. (In a couple of case studies it was concluded that CO₂ control is not adequate when there is tobacco smoking.)

Developing general conclusions about the magnitude of energy savings from SBDCV is difficult because the energy savings can vary greatly depending on the climate, type of ventilation system, occupancy pattern, use of heat recovery, pollutant setpoint, and on the reference case used as the baseline for estimates of savings. Despite these limitations, the literature provides an indication

of the likely range of energy savings, and associated payback periods, for certain types of buildings.

7.2 Literature Reviewed

The sources of literature reviewed are the following:

A state-of-the-art review of demand controlled ventilation carried out by the International Energy Agency (IEA 1990) reviewed 31 papers published in the period 1979-1989. Only twelve papers contained quantitative information on the energy savings achieved or pay back time achieved. The case studies involved the following types of buildings: dwellings (3 studies), school (1 study), assembly rooms such as auditorium or lecture hall (5 studies), university library (1 study), bank (1 study), and office (2 studies).

A report from the International Energy Agency (IEA 1993) contained 13 papers on case studies of demand controlled ventilation implemented in different IEA Countries (7 related to dwellings, 1 related to schools, 2 related to auditoriums, 3 related to conference or board rooms in office buildings). Again energy savings and cost-effectiveness are not always described in detail.

Nine additional recent papers were reviewed. These papers describe case studies in 3 auditoriums (Fehlmann et al. 1993, Svennberg 1993 and Zamboni et al. 1992), 2 offices (Meckler 1994 and Haghight 1993), 1 university restaurant (Meier 1993), 1 indoor sports arena (Smith 1993), 1 dwelling (Kesselring et al. 1993) and 1 industrial research facility (Reed 1994). Two of the papers related to auditoriums describe case studies already partially described in the IEA (1993) reference. Three papers (Carpenter 1996, Federspiel 1996, Ke and Mumma 1997) that describe computer modeling to evaluate CO₂ - based demand controlled ventilation were also reviewed.

7.3 Findings from Case Studies of SBDCV

Assembly rooms: The case studies related to assembly rooms (e.g. auditoriums, lecture halls, concert halls, social clubs, cinemas and theaters, indoor sports arenas) reported substantial HVAC energy savings in a range of 11% (cinema) to over 50% (auditoriums). Payback times are in the range 1-3 years, with the exception of the cinema case study which reported a 4.8 year payback period.

The cost-effectiveness of SBDCV in this type of building is associated with the highly variable and unpredictable occupancy pattern. Human occupancy is also the main source of pollutants in these building types because of the high occupant density. For example the indoor sports arena can have an occupancy ranging from a few hundred to 18,000 (Smith 1993). One added bonus of SBDCV, noted in the sports arena case study, is lower maintenance costs due to longer filter life. This type of benefit should also be realized in other types of buildings with SBDCV.

CO₂ sensors were used to control the ventilation rate in 7 of the investigations. Two case studies used an IAQ mixed gas sensor. The performance of the sensors was generally described as

satisfactory. In a few studies, CO₂ sensors were used for control of ventilation and mixed gas (VOCs) sensors were simultaneously used to collect data on VOC concentrations (IEA 1990).

Figure 7.1 shows an example of computer predictions of energy savings from CO₂-based SBDCV in an auditorium (IEA 1992b) located in a cold climate (Norway). The reference case for the energy savings calculations was continuous ventilation at a rate sufficient to maintain CO₂ below a set point with full occupancy of the auditorium. As expected, the predicted energy savings increase as the occupancy decreases below full occupancy. As maximum allowable concentration of CO₂ increases, energy savings decrease.

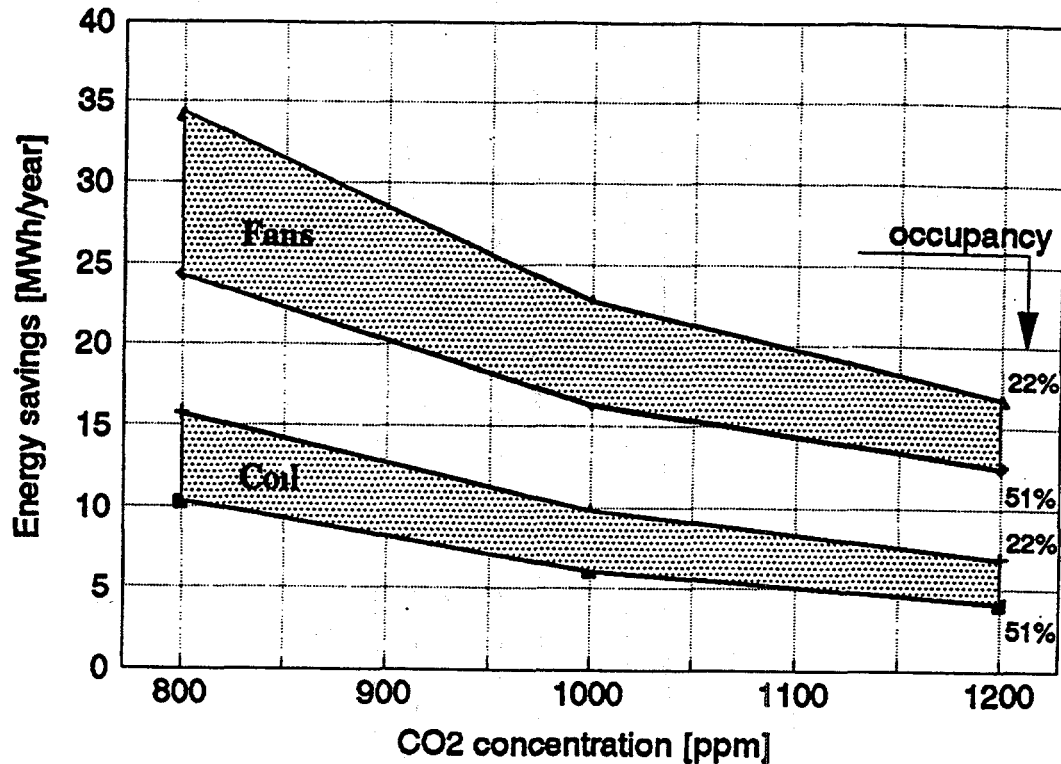

© OECD/ IEA 1992

Figure 7.1 Energy savings in an auditorium (University of Trondheim, Norway) as a function of the allowable CO₂ concentration (IEA 1992b, reproduced with permission).

Figure 7.2 shows a strong correlation between CO₂ and VOCs concentrations from a study in a lecture hall. Due to the high occupant density, the occupants may have been the dominant source of VOCs as well as the dominant source of CO₂.

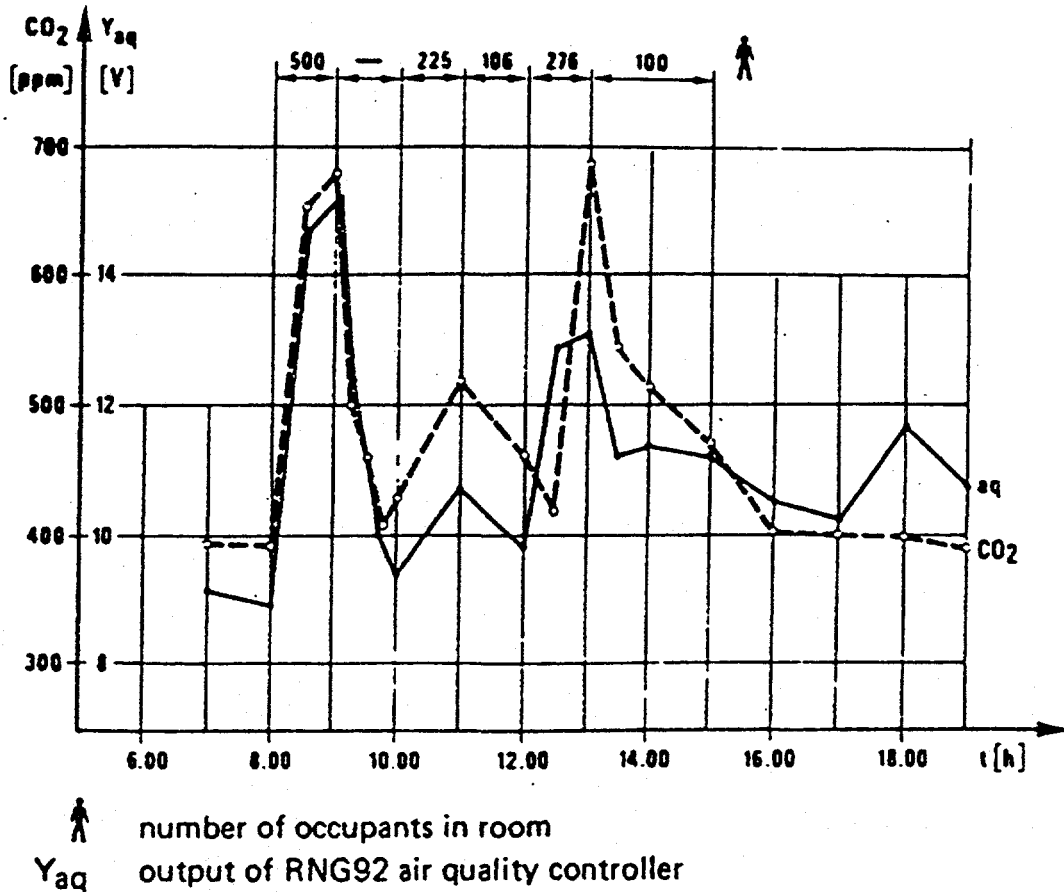

© OECD/ IEA 1990

Figure 7.2 Comparative measurements with a CO₂ sensor and a mixed gas sensor (VOCs) in a lecture hall of Trondheim University Norway (IEA 1990, paper 87/e, reproduced with permission)

Office buildings: Seven studies involved office buildings. Three of these studies (IEA 1993) involved conference or board rooms (10-20 persons) within office buildings. In one of the buildings, several ventilation control strategies were evaluated (manual, timer, infrared occupancy sensor, and CO₂ ventilation control) and the users preferred CO₂ control². CO₂ ventilation control reportedly gave good results in these experiments, but may not be cost-effective due to the small amount of energy used to ventilate small conference rooms.

² The document does not indicate how user preferences were determined.

The other five case studies (Meckler 1994, Haghghat 1993, two case studies in IEA 1990, and Carpenter 1996) involved the primary office areas of large office buildings, featuring also CO₂ ventilation control. All the case studies reported significant energy savings leading to payback times range from 0.4 years to 2.2 years. Two of the case studies (Meckler 1994, Carpenter 1996) were based on computer simulations. Meckler (1994) simulated a large 10-story office building in five different locations (Miami, Atlanta, Washington, D.C., New York, Chicago). The simulation results indicate significant heating (gas) savings and modest electricity savings. The predicted payback times for the five cities are in the range 1.4-2.2 years.

Carpenter (1996) performed one of the most comprehensive simulation-based studies of CO₂ - based DCV in office buildings. His simulations involved several climates and HVAC system types (single-zone roof-top systems, central multizone dual-duct systems, and central VAV systems) and different outside air control strategies. Energy performance and indoor CO₂ and formaldehyde concentrations were predicted. For the Chicago climate (results are reportedly similar in other climates), this simulation study indicates that savings in cooling energy are negligible to a few percent while savings in heating energy are about 5% to 30%. Cooling energy savings are less than initially expected because the DCV system tends to provide higher quantities of outside air in the afternoons when outdoor temperatures are higher. The predictions of indoor formaldehyde concentrations in this study are overly simplistic, since the formaldehyde source strength was considered constant (see Section 2.5). However, the predicted differences between formaldehyde concentrations with and without CO₂ control should indicate the expected impact of this type of ventilation control system on concentrations of other indoor-generated pollutants that have a relatively constant emission rate. Predicted indoor formaldehyde concentrations during occupancy were substantially higher (by a factor of 1.5 to 3) when the CO₂ control system was used. The higher time-average formaldehyde concentrations during occupancy were a consequence of the high concentrations in the mornings before CO₂ concentrations exceeded the control-system setpoint and the supply of outside air was started. These predictions illustrate that overly-simplistic ventilation control strategies (e.g., no outside air supply until CO₂ levels reach a set point) could cause IAQ problems. Carpenter (1996) recommended a morning purge cycle with outside air to prevent these problems.

Bank: In the bank building subject to CO₂ ventilation control, the reported reduction in total HVAC energy consumption was 8%, resulting in an estimated payback time of 2-3 years.

University restaurant: One large university restaurant (550 persons capacity) with CO₂ ventilation control showed significant energy savings with an estimated payback of only a few months. The reference was conventional time-clock control with ventilation provided 12 hours per day at a rate sufficient for full occupancy. In the restaurant area there is smoking and cooking activities. For CO₂ concentrations above about 750 ppm, a good correlation was found between the outputs of the CO₂ and mixed gas sensors (Meier 1993).

Schools: Two studies of schools subject to the application SBDCV were reviewed. In a Swedish study (IEA 1993), passive infra-red occupancy sensors were used sense occupancy and provide the control signal for adjustments of supply air dampers that increased or decreased the ventilation rate. The control system was evaluated for two different ventilation system types

(displacement and mixing). Displacement ventilation required 25% less energy than mixing ventilation to achieve the same CO₂ concentration. The application of SBDCV reduced ventilation energy requirements by approximately 50% with a payback time of approximately 4.5 years. In one of the first investigations of SBDCV (IEA 1990), computer simulations were used to evaluate SBDCV in typical U.S. school buildings. The simulations resulted in estimated payback periods of three to four years.

Primary and secondary schools are not ideal for SBDCV as the level of occupancy during class time is not subject to strong variations. In many schools, timer control might be more cost effective for ventilation control. However, timer control systems will fail if the building operators do not maintain proper timer settings.

University library: The application of CO₂ -based SBDCV in an university library produced modest results. There were significant differences in IAQ the different parts of the building leading the investigators to recommend that CO₂ analyzers be installed on each floor. Based on simulations, the estimated payback time was 6.3 years.

A library has a variable pollutant load associated with occupancy, but the pollutant load associated with library materials (books, photocopiers and furniture) may be dominant. This study did not determine if CO₂ control resulted in acceptable concentrations of other pollutants.

Dwellings: Ten case studies of SBDCV in dwellings were examined: one in Belgium, one in Canada, three in France, one in Germany, one in Italy, two in Netherlands and one in Florida, USA. Some of these case studies involved multiple dwellings. The experience of the case studies can be summarized as follows:

Most of the case studies (8 out of 10) used only relative humidity (RH) sensors for ventilation control due to their low cost. In general the performance of these sensors was reported as satisfactory in terms of avoiding condensation and mold growth, although these studies did not clearly show that condensation and mold problem would have occurred in the absence of SBDCV. The reported energy savings range from 0% to 60%. This very wide range reflects different types of dwellings, ventilation types, and climates. The use of ventilation with heat recovery significantly reduced the savings. The reported cost-effectiveness of RH ventilation control was poor. Even in the case study where 50-60% energy savings were estimated, the estimated payback was 5-6 years. In dwellings, RH is poorly correlated with occupancy, thus, controlling ventilation based on RH will not necessarily result in increased ventilation when occupants are present.

The successful application of SBDCV in energy-efficient airtight dwellings would ideally benefit from a low cost combined sensor able to sense CO₂, VOCs, and humidity. Spence Associates (Spence 1995) are developing a low cost sensor aiming at those goals, with a digital output (ventilation on or off) and a target price of \$50.

7.4 Summary

The majority of case studies of SBDCV have focused on the use of CO₂ sensors. The case studies indicate that energy savings and payback periods can vary widely. In ideal; applications (such as assembly rooms), CO₂-based SBDCV can result in large HVAC energy savings and payback periods of only a few years. The simulations by Carpenter (1996) illustrate that, without proper precautions such as early morning ventilation purges, CO₂-based SBDCV could lead to significant increases in exposures to pollutants released by building materials and furnishings.

8. DEMAND CONTROLLED VENTILATION IN LABORATORY FACILITIES

8.1 Introduction

Some industrial and research activities require special environmental conditions, such as low concentrations of particles and of certain types of gaseous chemical pollutants. Facilities with these activities are designated in this report as **laboratories**, and include cleanrooms and other laboratories with stringent environmental requirements. Laboratories are used for several industrial fields including: semiconductor manufacturing; pharmaceutical production, biotechnology; aerospace; production of magnetic and optical storage media; optics; medical instruments; automotive (painting shops); food processing (e.g. yogurt, aseptic preservation of meat, fruit juice and milk); and high quality printing. Similar environmental requirements are found in research facilities from universities and other R&D institutions working in the above mentioned areas and in physics, chemistry, biochemistry, molecular biology, and precision engineering.

Laboratories are characterized by large energy intensities reaching up to 300 W/ft². Major loads are the process equipment, cooling and air movement. Increasingly tight environmental controls, concerning the contaminant concentrations, result in very large and increasing energy demands for environmental control of cleanrooms.

A dramatic example of the increasingly tight environmental requirements is the semiconductor industry which is now working with product design features with a size of 0.25 microns; however, by the year 2003 design features are expected to decrease to 0.1 micron. If a particle with 1/10 of the size of the design feature deposits on an integrated circuit surface, it can cause the failure of the silicon chip. This shows the critical importance of maintaining increasingly lower concentrations of submicron particles in cleanrooms.

In cleanrooms of Class 100 or better (in a class 100 cleanroom there are less than 100 particles >0.5 micron per each cubic foot of air) the recirculation air flow rate may be as high as 600 air changes per hour, which is about 100 times larger than in a normal HVAC for a commercial building. The use of high efficiency particulate air (HEPA) filters, required to reduce particle concentration to acceptable levels, also leads to large pressure drops (typically a few hundred Pascal). Both aspects lead to large fan power requirements. The mechanical energy associated with the air movement ends up converted into heat, and if the motor is in the air stream (such as

in direct drive axial fans) the motor losses also contribute to heat the air. The heating of the airstream leads to additional energy consumption for cooling purposes.

The minimization of fan power depends upon a synergistic combination of the following methods:

- Reduction of the pressure drop (for a given air flow), which is achieved by optimal design of the air circuit, by choice of the filters, and by proper maintenance (namely by replacing dirty and clogged filters).

- Selection of energy-efficient motors and fans.

- Reduction of the air flow rate to the minimum required to maintain acceptable environmental conditions both for the occupants (safety considerations) and for the process. Application of energy-efficient techniques for variable air volume control is also desirable. Demand-controlled ventilation is a strategy that can be used to reduce significantly air flow.

8.2 The Rationale for SBDCV in Laboratories

Laboratories, especially cleanrooms, normally operate 24 hours per day, 365 days of the year. Even if production is not continuous, the ventilation is not stopped. In many laboratories (excluding cleanrooms), the ventilation system supplies 100% outside air so that pollutants from one room are not recirculated into other rooms.

During periods of non-occupancy or periods of low level of process activity, the ventilation rates can be reduced. Additionally, laboratory ventilation rates are designed for worst-case conditions. Even during some normal production periods, the design ventilation rates may be excessive.

If the rate of generation of the most offensive pollutants as a function of time is well-known, both in qualitative and quantitative terms, a programmable time-clock can be used to control the ventilation rates. However, in most cases the rate of pollutant generation is variable and cannot be predicted. For these type of applications, SBDCV can be used (when suitable sensors are available) to modulate the ventilation rates in order to meet the occupant safety and process requirements while minimizing energy consumption.

8.3 Pollutant Sources of Laboratories

The pollutants which are of major concern in laboratories are particles (including bioaerosols and microorganisms) and chemicals. These pollutants may be released as a consequence of the production or research activities within the laboratory and may also enter the laboratory with outside air. Carbon dioxide and other gaseous bioeffluents and volatile organic compounds (VOCs) from the building fabric and furnishings will normally be much less important in laboratories compared to offices. The high ventilation rates of laboratories should generally lead to low concentrations of these pollutants from occupants, building materials, and furnishings.

The sources of pollutants in laboratories can be aggregated into two groups - external and internal:

External sources: Pollutants enter the conditioned space from the outside via air infiltration through doors, windows and wall penetrations and also enter with mechanically-supplied outside air. If the conditioned space is well sealed and is kept slightly pressurized, infiltration of pollutants will be minimal. The largest external source is the mechanically-supplied outside air entering the air conditioning system. Outside make-up air needs to be cleaned to remove particles, and sometimes to remove gaseous pollutants, with suitable filters.

In an unoccupied cleanroom with the HVAC system operating, the indoor particle concentration should be correlated with the particle concentration in the outside air. Therefore the outside air flow rate should be reduced to minimum during periods without occupancy. This minimum rate of outside air supply must be above the values specified in existing codes and standards and sufficient to maintain cleanroom pressurization.

Internal sources: There are several potential sources of contaminants inside laboratories, such as people, building materials, process equipment, and the manufacturing or research process. Of major importance to laboratories are the particles generated by all the sources listed above and the chemicals which may be released by the manufacturing or research process. In many applications, occupants are the main source of internal particles. The use of special cleanroom garments and use of an airflow wash can decrease the amount of particles generated by occupants.

8.4 Pollutant Mitigation in Laboratories

To control pollutant concentrations in laboratories, the internal generation of pollutants should be reduced to the degree practical. When elimination of pollutant sources is impractical, the indoor concentration of pollutants can be controlled by combination of several techniques including filtration, dilution with outside air, and direct exhaust venting with devices such as fume hoods.

Filtration: Both outside and inside air can be cleaned to remove particles and some gaseous pollutants at a cost, both in terms of fan power and filter cost. Chemical cleaning of air with gaseous filters (various sorbents) can be performed at additional cost. In applications such as cleanrooms requiring very low particle concentrations, high-efficiency particle air (HEPA) filters or ultra low penetration air (ULPA) filters can be used (see section 1.3).

Dilution with outside air: The concentration of some pollutants can be reduced by dilution with outside air, provided that the outside concentration is smaller than the inside concentration.

Direct venting with a local exhaust: In locations where dangerous chemicals are produced, direct venting, normally through a fume hood, is carried out.

8.5 Sensors for Control of Ventilation Rates in Laboratories

The monitoring and control of pollutant concentrations can be achieved with several types of sensors (see section 6), including:

-Particle counters can be used to monitor particle concentrations, especially in cleanrooms.

-Chemical gas sensors can monitor the concentration of gaseous pollutants. Chemical gas sensors can be supplied as mixed gas sensors and specific sensors. Mixed gas sensors, although they are inexpensive, suffer of several important limitations (see section 6) including inadequate sensitivities. Specific gas sensors often use electrodes which react in a selective way with the gas whose concentration needs to be monitored. This equipment is costly and the electrodes may also require periodic calibration.

-Occupancy sensors may be used to monitor the presence of workers in the laboratories. In many laboratories, the types of chemical pollutants generated vary over time making it difficult to select specific pollutant sensors. Usually pollutant generation (and the need to maintain low pollutant concentrations) is connected to occupancy, which makes occupancy sensors cost effective for this kind of application, specially in situations when only two ventilation levels are required - one higher level for occupied periods, and a lower level otherwise.

8.6 Application of SBDCV in Laboratories

If the dominant pollutants are known and suitable sensors are available, SBDCV can be applied in a cost effective way in applications where the ventilation requirements are variable and unpredictable. It must be emphasized that reduction of the ventilation rates must maintain the required environmental conditions, both for the occupants and the process, at all times. Also, in laboratories with 100% outside air, the minimum rate of air supply may be constrained by the air requirements for thermal conditioning and laboratory pressurization or depressurization.

SBDCV can be applied to minimize energy consumption in lab-type facilities in several ways:

a) Control of rate of air recirculation through filters

The air is recirculated at a high rate through filters or air cleaners in some industries, such as the semiconductor and biotechnology industries. The amount of recirculation, thus the fan power, can be adjusted taking into account the information provided by the relevant sensors.

The large potential savings in cleanrooms associated with the control of the air recirculation rate is subject to constraints. First, to maintain the desired uni-directional air flow pattern in cleanrooms, minimum air velocities of approximately 80 feet per minute are required. This minimum velocity sets a lower limit on recirculation air flow rates. Second, in large production cleanrooms with a variety of activities at different locations, the air velocities in the entire room must be similar to prevent undesired cross flows. In these cleanrooms, multiple sensors would be required with the minimum air flow controlled by the pollutant concentration at the most

critical location. Therefore, demand controlled ventilation is easier to apply in small irregularly-used cleanrooms (e.g., research cleanrooms) without multiple simultaneous activities.

b) Control of outside for dilution of indoor pollutants

Demand controlled ventilation can control the amount of outside air admitted into laboratories taking into account the need to dilute the gaseous pollutants (e.g. VOCs) generated in the selected areas. This process leads to savings in space cooling/heating energy and fan energy and also leads to a reduction of outside particles brought into the controlled area, which further reduces the fan power for recirculation of air through filters.

Typically when laboratories are not occupied and pollutants are only generated at a low rate (e.g. night-time periods), the exhaust air may be reduced to 25-50% of the rate during daytime operation. In small laboratories, with non-critical requirements this may also be achieved in an inexpensive way with timers (if occupancy schedule is not variable) or with occupancy controls.

c) Control of economizer operation

Demand controlled ventilation can also be used to control the intake of outside air as a function of the outdoor pollutant concentration, for example of particles. In periods when a high outdoor pollutant concentration is measured, the intake of outdoor air can be reduced to a minimum (by overriding normal economizer operation) to ensure the required indoor air quality for processes and occupants.

d) Fume hood control

Fume hoods are used for direct exhaust of hazardous fumes and vapors. Fume hoods can use a substantial amount of energy, directly because of the fan power used and indirectly because they increase the need for thermal conditioning of outside make-up air. In fume hoods the face velocity (velocity of air in the plane that defines the opening of the hood) is a critical parameter. The required minimum face velocity is often approximately 100 feet per minute. Energy-efficient operation of fume hoods can be achieved by the following strategies:

Automatic flow control: In a form of SBDCV, variable air volume (VAV) fume hoods automatically adjust the air flow rate so that the minimum face velocity is maintained regardless of the sash opening. This control can be carried out by measuring the face velocity in the wall of the fume hood with an air speed sensor. The measured velocity is used to estimate the average face velocity. Another technique for VAV operation of fume hoods, uses a sensor to measure the sash opening. The exhaust air flow requirements are calculated by multiplying the sash opening by the face velocity set point.

User control: Even with a constant volume fume hood, the total air flow and fan power will decrease as the hood sash is closed. The occupants can save energy by reducing the opening of the hood sash to the minimum required for the tasks carried out in the hood.

Although the reduction of the fume hood exhaust air flow leads to energy savings, there are some minimum required air velocities out of the roof stacks in order to limit reentrainment of pollutants back into the building. Additionally, the hood exhaust control system must be

interfaced with controls on the air supply to the laboratory in order to maintain the required laboratory depressurization.

8.7 Air Flow Control Methods

Control of recirculation air flow can be achieved through the use of several techniques. Electronic variable speed drives, although they are more costly, allow continuous modulation of the fan speed and provide efficient operation at all load levels. In situations requiring only a few discreet speeds, multi-speed motors may be more cost-effective.

In some cleanrooms, several small fans are used in parallel to provide the desired air flow rate. When several fans are operating in parallel with the same speed they can be driven by the same variable speed controller (provided that it is a voltage-source inverter or pulse-width modulation type of unit). This choice can significantly decrease the investment costs, as the speed controller costs per horsepower drop with the horsepower size, as shown in Table 3.1.

8.8 Case Studies in Laboratories

Industrial research laboratory: In a large industrial research laboratory - IBM Almaden Research Center, San Jose, California - 120 laboratory fume hoods were retrofitted from constant volume to variable air volume operation, through the installation of air velocity controllers in each of the hoods (Reed 1994). Instead of using contaminant gas sensors, which would have to respond to a variety of chemicals, and, thus, be expensive, thermal anemometers were mounted in the side of the hoods to measure an air velocity that can be related to the hood face velocity. The anemometer signal is used to control a blade damper in the exhaust duct above the hood. In this way, the damper position is varied as a function of the opening of the hood, the air velocity being kept constant. If the air speed drops below the minimum value (100 fpm), an alarm will sound.

The variable air volume operation of the fume hoods led to a reduction of 32% of the fan horsepower. Additionally, the air velocity sensing also reduces the need for periodic calibration of the fume hoods leading to additional savings. The payback time for this retrofit was 2.2 years.

Cleanroom for microelectronics activities: Cleanroom facilities in industries, such as semiconductor and biotechnology industries, are very energy intensive due to the need to recirculate very large air flows through high efficiency particle filters that are characterized by a large pressure drop. Since the rate of pollutant production in cleanrooms is variable and unpredictable, sensor based controlled ventilation also appears potentially attractive.

To validate this idea, a pilot demonstration project was carried out in an intermittently used Class 100 microelectronics cleanroom at Lawrence Berkeley National Laboratory (Faulkner et al. 1996). A laser-based optical particle counter was used to monitor particle concentration at a critical location in the laboratory and the recirculation air flow was controlled with electronic variable speed drives in order to keep the particle concentration below the Class 100 level. The study results show that demand controlled ventilation reduced fan power by around two thirds,

while maintaining acceptable cleanroom conditions. These results show that research cleanroom applications seem very promising for the application of demand controlled ventilation.

8.9 Benefits of Demand Controlled Ventilation in Laboratories

Demand controlled ventilation can be utilized in laboratories to ensure that the existing codes and standards are met at all times while providing a reduction in the energy costs. The following benefits can be gained from a proper application of sensor based demand controlled ventilation in lab-type facilities:

-Proper environmental conditions for occupants and processes are ensured through on-line monitoring of existing conditions.

- Energy consumption can be reduced significantly. Because fan power increases with the cube of the air flow rate, even a modest reduction of 20% in the air flow, translates into a 50% savings of fan power. Since heat generated by fans and fan motors is one of the main contributors to the cooling load, a reduction in the fan power translates into further savings in air conditioning

-Reducing flow rates increases the lifetime of air filters, thus reducing the maintenance costs.

9. CONCLUSIONS AND RECOMMENDATIONS

9.1 Conclusions

Sensor-based demand controlled ventilation (SBDCV) appears to be an increasingly attractive technology option to achieve two important goals: (1) improvement of the indoor air quality (IAQ), and (2) minimization of energy use and costs. The air quality improvements may result in decreased adverse health effects and increases in productivity.

Based on the review of literature and theoretical considerations, the application of SBDCV is generally cost-effective in applications with the following characteristics:

1) A single or small number of pollutants dominate, so that ventilation sufficient to control the concentration of the dominant pollutants provides effective control of all other pollutants. A typical example is a building with a high occupant density and low pollutant emission rates from the building and the furnishings.

2) The occupancy schedule and occupancy level, or the activities carried out by occupants which generate pollutants, are variable and unpredictable.

3) Additionally, the energy savings which can be achieved are larger in climates with higher space heating and cooling requirements. Conversely, if heat recovery units or economizers are already used, the energy savings of SBDCV will be more modest.

If the above conditions apply, SBDCV may be attractive in the following building types: assembly rooms (e.g., auditoriums), large stores, banks, hospital outpatient areas, hotel atriums, industrial buildings and laboratories, and office buildings.

There is a limited number of well-documented case studies that quantify the energy savings and the cost-effectiveness of SBDCV. The case studies reviewed suggest that in appropriate applications, SBDCV produces significant savings with a payback period typically of a few years.

A large number of office buildings with a variable and unpredictable occupancy may benefit from the application of SBDCV. Additionally, SBDCV can also be used to improve the current practice of in the control of outside-air ventilation in office buildings, by providing a feedback loop to monitor and control occupant-generated bioeffluents (e.g., CO₂). SBDCV can increase ventilation in buildings or building zones with poor ventilation and can reduce ventilation in buildings or zones with excessive ventilation.

The cost-effectiveness of each application of SBDCV needs to be assessed as the energy savings are a function of the occupancy level and schedule (including occupant activities), climatic conditions, HVAC type, building type and size, pollutant generation rates, and the cost of the control system. To decide about the application of SBDCV in a building, a simulation is recommended to estimate the energy savings and the corresponding cost-effectiveness.

The application of SBDCV in dwellings requiring mechanical ventilation can provide some energy savings, but this application will often not be cost-effective due to the high cost of SBDCV controls and the modest air flow rates in dwellings.

The price of reliable IAQ sensors and of the associated ventilation controls is a key constraint to improve cost-effectiveness of many possible applications of SBDCV. If the price of sensors and hardware drops sharply and the quality improves, the potential applications of SBDCV can be extended significantly to include small commercial buildings and residences with mechanical ventilation.

In buildings with a variable but predictable indoor pollutant generation rate, time-clock control may be more cost-effective than SBDCV. Other low cost strategies, such as manual and occupancy controls, may also be applied to control ventilation, although they offer less flexibility than SBDCV.

Energy management systems (EMS) which can control loads in a continuous manner in response to real-time prices have been recently developed. The application of SBDCV coupled with those types of EMS can be used to modulate the ventilation load by controlling the temperature, VOCs, and carbon dioxide levels within a window of acceptance, whose limits may be adjusted as a function of the real-time prices. This strategy can not only deliver energy savings but also substantial peak power savings. Large commercial buildings with long thermal time constants, low pollutant emission from the building materials, furnishings and consumer products, as well

as having a large volume of air per occupant, are the most attractive for this type of ventilation control.

Several industrial activities of increasing relevance (semiconductors, pharmaceuticals, biotechnology, aerospace, optics) have strict environmental requirements (regarding particles, microorganisms, and chemicals), leading to very high ventilation energy consumption. SBDCV can be applied to reduce energy consumption in industrial buildings by controlling the recirculation air flow rate, and the rate of outside air brought into the building as function of the pollutant concentration and the process requirements.

9.2 Recommendations for R&D

The potential applications for SBDCV and the corresponding energy savings can be enhanced if the following R&D activities are carried out in the future:

1) In the last few decades there has been a dramatic improvement in the technologies for monitoring and control, mainly due to the developments in the field of microelectronics. However the area of environmental sensors still requires substantial progress. There is an urgent need to develop inexpensive, robust, sensitive, selective, accurate and stable real-time sensors which can measure the pollutants found in the indoor environment. This is particularly pressing for the different relevant VOCs. Silicon microstructures appear to be promising for these types of sensors.

2) Real-time particle counters are already available although at still fairly high prices, especially to count particles smaller than 0.3 microns. Due to the increasingly demanding requirements of the semiconductor and pharmaceutical industries, there is a need to develop low cost and reliable particle counters for smaller size particles. The semiconductor industry forecasts that by the year 2003 it will be using 0.1 micron design rules, leading to the need to count very small particles. Another desirable goal, although posing difficult challenges, is the chemical classification and counting by type ("speciation") of particles.

3) Both the long-term and short term health effects of indoor air pollutants are inadequately understood, leading to controversy on the acceptable pollutant concentrations. There is a need to further investigate these health effects, considering both the individual impact of each pollutant as well as the effects of pollutant mixtures likely to be found in the indoor environment.

4) The development of building materials, furniture and cleaning products featuring low pollutant emission is required in order to reduce the required base ventilation rate and, thus, to expand the opportunities for SBDCV systems that are based on occupant-generated pollutants.

5) Research is needed to further the development of high efficiency and long-life active air cleaners which can be used to remove reactive gaseous pollutants (such as VOCs, NO_x, and carbon monoxide) from indoor air and from outside air brought into the building. The use of these air cleaners could be coupled with a sensor-based control that diverts the incoming outside

air through the cleaner, if the outside pollutants are above a set threshold. This need is especially relevant for buildings located in densely populated urban areas.

6. Research is needed on the development of improved computer based HVAC monitoring and control systems taking advantage of the inputs of different sensor types (VOCs, CO₂, CO, humidity, particles) and on improved man-machine interfaces that are sufficiently flexible to be applied in different building types.

7) The development of an inexpensive and reliable "electronic nose", that replicates the response of average human beings also would be a very welcome contribution to improve building ventilation control. The "electronic nose", based on inexpensive and readily available gas sensors, would need to be supplemented by sensors for important pollutants not sensed by humans.

8) There is limited experience in the application of SBDCV to several building types in different climates. The implementation of research and demonstration projects in several building types (e.g. auditoriums, courtrooms, shopping malls, stores, offices, outpatients areas of hospitals, hotel atriums, residences) featuring irregular and unpredictable pollutant generation will provide a valuable insight on energy savings. The assessment of occupants' ratings is an important evaluation criteria and should be included in future case studies. The results of these projects can contribute to a more accurate evaluation of the application of SBDCV to new and existing buildings.

9) The evaluation and demonstration of SBDCV with Energy Management Systems responding to real-time price signals in large commercial buildings (e.g. hotels, offices) is needed. This control strategy which may prove very attractive both to utilities and consumers to reduce peak demand and save energy.

10) There is very limited experience in the use of SBDCV in industrial buildings. There is a need to evaluate and demonstrate SBDCV in industries with large and unpredictable ventilation requirements. The ventilation requirements may be mainly due to needs of the process (e.g. clean rooms in the semiconductor industry) or they may be due to need to provide adequate IAQ to operators (e.g. chemical industries).

11) Research is needed to define the required number and the location of pollutant sensors in different building types.

12) A variety of control strategies (e.g., algorithms) can be used to translate sensor output signals into the control signals sent to fans and dampers. Research is needed to evaluate the benefits of a variety of control strategies.

13) Airtight dwellings normally require mechanical ventilation. Most residential fans and motors have a very poor energy efficiency. There is a need to develop efficient fans and motors for residential ventilation with integrated variable speed controls connected to low cost IAQ sensors (Small high-efficiency pumps with integrated speed controls are already in the market). The

appearance on the market of such a product would enable the large-scale application of SBDCV in the residential sector.

ACKNOWLEDGMENTS

This work was supported by the Assistant Secretary of Energy Efficiency and Renewable Energy, Office of Building Technology, State, and Community Programs, Office of Building Systems of the U.S. Department of Energy (DOE) under contract No. DE-AC03-76SF00098 and by the NATO Scientific Affairs Division.

REFERENCES

- American Conference of Industrial Hygienists (1994) *1993-1994 Threshold limit values for chemical substances and physical agents and biological exposure indices*, American Conference of Industrial Hygienists, Cincinnati.
- Arens, E and Baughman, A. (1996) "Indoor Humidity and Human Health, Part 2: Buildings and Their Systems", *ASHRAE Transactions* 102(1): 212-221.
- ASHRAE (1989) *Standard 62-1989, Ventilation for Acceptable Indoor Air Quality*, American Society of Heating, Refrigerating and Air-Conditioning Engineers, Atlanta, GA.
- ASHRAE (1993) "Physiological Principles and Comfort", *Chapter 8 in 1993 ASHRAE Handbook, Fundamentals*, American Society of Heating, Refrigerating and Air-Conditioning Engineers, Atlanta, GA.
- ASHRAE (1996) BSR/ASHRAE Standard 62-1989R, *Ventilation for Acceptable Indoor Air Quality, Public Review Draft*, American Society of Heating, Refrigerating and Air-Conditioning Engineers, Atlanta, GA
- Baughman, A. and Arens, E (1996) "Indoor Humidity and Human Health, Part 1: Literature Review of Health Effects of Humidity-Influenced Indoor Pollutants", *ASHRAE Transactions* 102(1): 193-211.
- Bischof, W. and Witthauer, J. (1993) "Mixed-Gas Sensors - Strategies in Non-Specific Control of IAQ", *Proceedings of Indoor Air 93, 6th International Conference on Indoor Air Quality and Climate*, vol. 5: 39-44, Indoor Air'93, Helsinki.
- Brysek, J. et al, (1991), "Silicon Sensors and Microstructures", Lucas Nova Sensor, Fremont, California, September 1991.
- California Air Resources Board (1991), "Supplement to Indoor Air Quality Guideline - Formaldehyde in the Home", Sacramento, California, September 1991.

- Carpenter, S.E. (1996) "Energy and IAQ Impacts of CO₂ -Based Demand-Controlled Ventilation", To be published in *ASHRAE Transactions* 102(2).
- Duffy, G., (1993), "Besides Improving IAQ, Filter Upgrades Can Save Money", *Engineered Systems*, July/August 1993, pp. 17-23.
- EPRI (1986), "Energy Management Systems for Commercial Buildings", Report EM-4195, Electric Power Research Institute, Palo Alto, California.
- EPRI (1993), "Residential Ventilation Control", Report TR-102767, Electric Power Research Institute, Palo Alto, California.
- Eto, J. (1990) "The HVAC Costs of Increased Fresh Air Ventilation Rates in Office Buildings, Part 2", *Proceedings of the Fifth International Conference on Indoor Air Quality and Climate*, vol. 4: 53-58, International Conference on IAQ and Climate, Ottawa.
- Eto, J. and Meyer, C. (1988); "The HVAC Costs of Increased Fresh Air Ventilation Rates in Office Buildings", *ASHRAE Transactions* 94(2): 331-340.
- Fahlen, P. et al, (1992), "Demand Controlled Ventilation Systems Sensor Tests", Swedish National Testing and Research Institute, Boras, Sweden, 1992.
- Faulkner, D.; Fisk, W.J., and Walton, J.T. (1996) "Energy Savings in Cleanrooms from Demand-Controlled Filtration", *Journal of the Institute of Environmental Sciences* 39(2): 21-27.
- Fehlmann, J., Wanner, H.-U., and Zamboni, M. (1993) "Indoor air quality and energy consumption with demand-controlled ventilation in an auditorium", *Proceedings of Indoor Air'93*, vol. 5, pp. 45-50. Published by Indoor Air'93, Helsinki.
- Federal Provincial Advisory Committee on Environmental and Occupational Health, (1987), "Exposure Guidelines for Residential Indoor Air Quality", Ottawa, Canada.
- Federspiel, C.C. (1996) "On-Demand Ventilation Control: A New Approach to Demand-Controlled Ventilation", *Proceedings of Indoor Air' 96*, vol. 3, pp. 935-940. SEEC Ishibashi, Inc., Japan.
- Feustel, H., (1993), "Hydronic Radiant Cooling - Overview and Preliminary Performance Assessment", Report LBL-33194, Lawrence Berkeley Laboratory, Berkeley, California.
- Fisk, W.J., Spencer, R.K., Grimsrud, D.T., Offermann, F.J., Pedersen, B. and Sextro, R. (1987) *Indoor Air Quality Control Techniques: Radon, Formaldehyde, Combustion Products*. Noyes Data Corporation, Park Ridge, New Jersey, ISBN 0-8155-1129-9

- Fisk, W.J.; Faulkner, D.; and Prill, R.J. (1991). "Air Exchange Effectiveness of Conventional and Task Ventilation for Offices." Published by ASHRAE in the *Post-Conference Proceedings of IAQ'91 "Healthy Buildings"*, pp. 30 - 34. September 4-8, Washington, D.C.
- Fisk, W.J. and Rosenfeld, A.H. (1996) "Improved Productivity and Health from Better Indoor Environments", To be published in *Indoor Air*.
- Fisk, W.J. and Grimsrud, D.T. (1993) "Indoor Air Controls." *Chapter 4 in Environmental Carcinogens, Methods for Analysis and Exposure Measurement*, vol. 12 -Indoor Air. International Agency for Research on Cancer Publication No. 109, B. Seifert, H.J. van de Wiel, B Dodet, and I.K. O'Neill, Eds. Lyon, France.
- Flood, J. (1994) Private communication, Utility Consulting Service, 8 Woodland Drive, Oak Ridge, New Jersey, 07438, Tel: (201) 697-0166.
- Gopel, W.(1993) "New materials for Gas Sensors", *Proceedings of the 7th International Conference on Solid-State Sensors and Actuators, Pacifico - Yokoama, Japan, June 7-10*, pp. 14-16.
- Grate, J.W., Wenzel, S.W, and White, R.M., (1992), "Frequency-Independent and Frequency-Dependent Polymer Transitions Observed on Flexural Plate Wave Ultrasonic Sensors", *Analytical Chemistry* 64(4): 413-423.
- Grate, J.W., Wenzel, S.W. and White, R.M, (1991), "Flexural Plate Wave Devices for Chemical Analysis", *Analytical Chemistry* 63 (15): 1552-1561
- Greenberg, S.; Harris, J.; Akbari, H.; and Almeida, A. de. (1988) "Technology assessment: Adjustable speed motors and motor drives", LBL-25080, Lawrence Berkeley National Laboratory Report, Berkeley, CA.
- Grot, R.A. and Lagus, P. (1995) "Air Change Rates in Non-Residential Buildings in California", Prepared for the California Energy Commission by Lagus Applied Technology, Inc.
- Gyorki, J. (1993), "Silicon Sensors Hit the Road", *Machine Design*, August 1993, pp. 56-60.
- Haghighat, F., Zmeureanu, R., and Donnini, G. (1993) "Energy savings in buildings by demand-controlled ventilation", *Proceedings of Indoor Air'93*, vol. 5, pp. 51-56. Published by Indoor Air'93, Helsinki.
- Health and Welfare Canada (1987) "Exposure Guidelines for Residential Indoor Air Quality". Environmental Health Directorate, Health Protection Branch, Department of National Health and Welfare, Ottawa.
- Helenelund, C.(1993), "Future of DCV - What is Economically Feasible", *Proceedings of Indoor Air'93*, vol. 5, pp. 57-62. Published by Indoor Air'93, Helsinki.

- Hori, M., Tanaka, T. (1992) "Application of Semiconductor Gas Sensors for Monitoring Indoor Air Quality", *Proceedings of IAQ 92 - Environments for People*, pp. 387-395, Published by ASHRAE, Atlanta, GA.
- International Energy Agency (1993) *Demand-controlled ventilating systems: case studies*, (editor L.-G. Mansson) Published by the Swedish Council for Building Research, Stockholm
- International Energy Agency (1992b), *Demand Controlled Ventilation Systems - Source book*, Energy Conservation in Buildings and Community Systems Programme, Published by the Swedish Council for Building Research, Stockholm, Sweden.
- International Energy Agency (1992c), *Demand Controlled Ventilation Systems - Sensor Tests*, Energy Conservation in Buildings and Community Systems Programme, distributed by the Swedish Council for Building Research, Stockholm, Sweden.
- International Energy Agency (1991) *Demand Controlled Ventilation Systems - Sensor Market Survey*, Energy Conservation in Buildings and Community Systems Programme, distributed by the Swedish Council for Building Research, Stockholm, Sweden, December 1991.
- International Energy Agency (1990) *Demand-controlled ventilating systems: state of the art review*, (editor W. Raatschen) Published by the Swedish Council for Building Research, Stockholm.
- Ke, Y.-P., and Mumma, S.A. (1997) "Using Carbon Dioxide Measurements to Determine Occupancy for Ventilation Controls", Preprint BN-97-1-1, Presented at the 1997 ASHRAE Annual Meeting, Boston, To be published in *ASHRAE Transactions*.
- Kelly, T. and Kinkead, D., (1993), "Testing of Chemically Treated Adsorbent Purifiers", *ASHRAE Journal*, 35(7), pp. 14-23.
- Kesselring, J. et al. (1993), "Evaluation of Residential Ventilation Controller Technology", *Proceedings of Indoor Air'93*, vol. 5, pp. 73-78. Published by Indoor Air'93, Helsinki.
- Knoll, B. (1993), "Advanced Ventilation Systems - State of the Art and Trends", Technical Note AVIC 35, Air Infiltration and Ventilation Centre, Coventry, U.K.
- Larson, E. and Nilsson L., (1991), "Electricity Use and Efficiency in Pumping and Air-Handling Systems", *ASHRAE Transactions* 97(2): 363-377.
- Levenhagen, J. (1992), "Control Systems to Comply with ASHRAE Standard 62-1989", *ASHRAE Journal*, 34(9), pp. 40-44.
- Lizardos, E., (1993), "Indoor Air Quality Design Primer", *Engineered Systems*, July-August 1993, pp. 25-34.

- Maliniak, D. (1994) "Nose-on-a-Chip Sensor Could Give Computers the Ability to Smell", *Electronic Design*, April 1994, pp. 40.
- Matthews, T.G., Dreibelbis, W.G., Thompson, C.V., and Hawthorne, A.R. (1986) "Preliminary Evaluation of Formaldehyde Mitigation Studies in Unoccupied Research Homes", *Proceedings of the Air Pollution Control Association Specialty Conference on Indoor Air Quality in Cold Climates*, April 29-May 1, Ottawa, pp. 389-401.
- Meckler, M. (1994) "Demand-Controlled Ventilation Strategies for Acceptable IAQ", *Heating, Piping, and Air conditioning*, May 1994, pp. 71-74.
- Meckler, M. (1993), "Evaluating Demand Control Strategies for VAV Supplementary Bypass Systems", *Proceedings of Indoor Air'93*, vol. 5, pp. 79-84. Published by Indoor Air'93, Helsinki.
- Meckler, M. (1992) "Evaluating IAQ Compliance in Buildings Utilizing Carbon Dioxide Level Monitoring", *Proceedings of IAQ'92 Environments for People*, pp. 355-364, Published by ASHRAE, Atlanta, GA.
- Meckler, G. (1992b), "HVAC System Characteristics: Ventilation and Energy", *Proceedings of IAQ'92 Environments for People*, pp. 327-338, Published by ASHRAE, Atlanta, GA
- Meier, S. (1993) "Mixed gas or CO₂ Sensors as a Reference Variable for Demand-Controlled Ventilation", *Proceedings of Indoor Air'93*, vol. 5, pp. 85-90. Published by Indoor Air'93, Helsinki.
- Moffat, P. et al (1991), "Demand Controlled Ventilation", Research report by Sheltair Scientific Ltd. and SAR Engineering to Canada Mortgage and Housing Corporation.
- Mudarri, D.H. and Hall, J.D. (1993) "Increasing Outdoor Air Flow Rates in Existing Buildings", *Proceedings of Indoor Air'93*, The 6th International Conference on Indoor Air Quality and Climate, vol. 5, pp. 21 -26., Indoor Air'93, Helsinki.
- Mudarri, D.H. and Hall, J.D. (1996) "Energy Cost and IAQ performance of Ventilation Systems and Controls", *Proceedings of IAQ'96*, pp. 151-160, ASHRAE, Atlanta.
- Molhave, L., Bach, B., and Pedersen, O.F. (1986) "Human Reactions to Low Concentrations of Volatile Organic Compounds", *Environment International* 12: 167-175.
- Molhave, L., Lui, Z., Jorgensen, A.H., Pedersen, O.F., and Kjaergaard, S.K. (1993) "Sensory and Physiological Effects on Humans of Combined Exposures to Air Temperatures and Volatile Organic Compounds", *Indoor Air* 3(3), pp. 155-169.
- Molhave, L., "Volatile Organic Compounds, Indoor Air Quality and Health", *Proceedings of Indoor Air 90*, vol. 5, pp. 15-33, Published by Indoor AIR'90, Toronto.

- Morey, P. and Macphaul, D., (1987), "Rank Order Assessment of Volatile Organic Compounds in Indoor Air Quality Evaluations", Clayton Environmental Consultants Inc.
- Nazaroff, W.W., Gadgil, A.J., and Weschler, C.J. (1993) "Critique of the Use of Deposition Velocity in Modeling Indoor Air Quality", *In American Society of Testing and Materials Standard Technical Publication 1205*, ASTM, Philadelphia.
- Nero, A., (1989) "Earth, Air, Radon and Home", *Physics Today* 42: 32-39.
- Nero, A., (1988) "Controlling Indoor Air Pollution", *Scientific American* 258(5): 42-48.
- Ottney, T., (1993), "Particle Management for HVAC Systems", *ASHRAE Journal*, 35(7): 26-34.
- Persily, A. K. and Grot, R.A. (1985). "Ventilation measurements in large office buildings", *ASHRAE Transactions* 91(2a): 488-502.
- Persily, A., (1993) "Ventilation, Carbon Dioxide and ASHRAE Standard 62-1989", *ASHRAE Journal*, 35(7): 40-44.
- Persily, A. and Dols, W.S. (1990) "The Relation of CO₂ Concentration to Office Building Ventilation", *ASTM Standard Technical Publication 1067-1990*, pp. 77-91, American Society for Testing and Materials, Philadelphia.
- Reed, M. (1994) "Conversion to VAV Hood Exhaust Slashes Fan Horsepower", *Heating, Piping and Air Conditioning*, January 1994, pp. 68-74,.
- Roberts, J. (1991) "Outdoor Air and VAV Systems", *ASHRAE Journal*, 33(9): 26-30.
- Shah, B. (1994) Personal Communication with B. Shah, Bell Communications Research, Red Bank, NJ
- Shandle, J. (1993), "Sensors Start to Catch with System Needs", *Electronic Design*, June 24, 1993, pp. 55-67.
- Sheltair Scientific Ltd., (1991) "Demand-Controlled Ventilation - Final Report", Canada Mortgage and Housing Corporation, Montreal.
- Smith, S. (1993) "Thermal storage HVAC System Retrofit Provides Economical Air Conditioning", *ASHRAE Journal*, 35(3): 28-30.
- Spence Associates (1995), private communication, 359 Lake Avenue, St. James, N.Y., 11780, September 1995.

- Steele, T. and Brown, M. (1990) "ASHRAE Standard 62-1989: Energy, Cost, and Program Implications", DOE/BP-1657, Bonneville Power Administration, Portland OR.
- Svennberg, S. (1993) "Demand Controlled Ventilation in an Auditorium in Tyreso", *Proceedings of the 14th AIVC Conference*, pp. 1-18, Energy Impact of Ventilation and Air Infiltration, Published by the Air Infiltration and Ventilation Centre, Coventry, Great Britain.
- Tellaire (1994), "Application Guide for Carbon Dioxide Measurement and Control", Tellaire Systems, Goleta, California.
- Ten Brinke, J. (1995) "Development of New VOC Exposure Metrics and Their Relationship to Sick Building Syndrome Symptoms", Lawrence Berkeley National Laboratory Report, LBL-37652, Berkeley, CA.
- Turk, B.H. et al 1987. "Indoor Air Quality and Ventilation Measurements in 38 Pacific Northwest Commercial Buildings, Volume 1 : Measurement Results and Interpretation", Lawrence Berkeley Laboratory Report, LBL-22315 1/2, Berkeley, CA.
- Usibelli, A., et al (1985) "Commercial Sector Conservation Technologies", Lawrence Berkeley Laboratory Report LBL-18543, Berkeley, CA.
- Ventresca, J.A. (1991) "Operations and Maintenance for Indoor Air Quality: Implications from Energy Simulations of Increased Ventilation", *Proceedings of IAQ'91*: 375-378, Published by ASHRAE, Atlanta.
- Wenger, J. et al, (1994) "A Sensor Array for Measurement of Indoor Air Quality", *Proceedings of Indoor Air: An Integrated Approach*, November 27 - December 1, Gold Coast, Australia, Elsevier Science.
- Woods, J., (1981), "Ventilation Control - Review of the State of the Art", Department of Mechanical Engineering, Iowa State University.
- World Health Organization. (1987) *Air Quality Guidelines for Europe*. WHO Regional Publications, European Series No. 23. Copenhagen.
- Yamazoe, N. and Miura, N. (1993) "Environmental Gas Sensing", *Proceedings of the 7th International Conference on Solid-State Sensors and Actuators*, Pacifico - Yokoama, Japan, June 7-10, pp. 340-345.
- Zamboni, M., Berchtold, O., Filleux, Ch., Fehlmann, J., and Drangsholt, F. (1992) "Demand-Controlled Ventilation- an Application to Auditoria", *Indoor Air 2*: 263-271.