

Lawrence Berkeley National Laboratory

Recent Work

Title

OBSERVATION OF THE LOWEST p -SHELL $T=3/2$ STATES OF ^{11}B AND ^{11}C

Permalink

<https://escholarship.org/uc/item/5mc834k6>

Authors

Cosper, S.W.
McGrath, Robert L.
Cerny, Joseph
et al.

Publication Date

1968-07-01

eg. 2

University of California Ernest O. Lawrence Radiation Laboratory

TWO-WEEK LOAN COPY

*This is a Library Circulating Copy
which may be borrowed for two weeks.
For a personal retention copy, call
Tech. Info. Division, Ext. 5545*

OBSERVATION OF THE LOWEST p-SHELL $T = 3/2$ STATES OF ^{11}B AND ^{11}C

S. W. Cospers, Robert L. McGrath, Joseph Cerny,
Creve C. Maples, George W. Goth, and Donald G. Fleming

July 1968

RECEIVED
LAWRENCE
RADIATION LABORATORY

SEP 3 1968

LIBRARY AND
DOCUMENTS SECTION

Berkeley, California

UCRL - 18366
eg. 2

DISCLAIMER

This document was prepared as an account of work sponsored by the United States Government. While this document is believed to contain correct information, neither the United States Government nor any agency thereof, nor the Regents of the University of California, nor any of their employees, makes any warranty, express or implied, or assumes any legal responsibility for the accuracy, completeness, or usefulness of any information, apparatus, product, or process disclosed, or represents that its use would not infringe privately owned rights. Reference herein to any specific commercial product, process, or service by its trade name, trademark, manufacturer, or otherwise, does not necessarily constitute or imply its endorsement, recommendation, or favoring by the United States Government or any agency thereof, or the Regents of the University of California. The views and opinions of authors expressed herein do not necessarily state or reflect those of the United States Government or any agency thereof or the Regents of the University of California.

To be submitted to Physical Review

UCRL-18366
Preprint

UNIVERSITY OF CALIFORNIA

Lawrence Radiation Laboratory
Berkeley, California 94720

AEC Contract No. W-7405-eng-48

OBSERVATION OF THE LOWEST p-SHELL $T=3/2$ STATES OF ^{11}B AND ^{11}C

S. W. Cosper, Robert L. McGrath, Joseph Cerny,
Creve C. Maples, George W. Goth, and Donald G. Fleming

July 1968

Section 53.2 Spectroscopy; Decay, Energy Levels, and Transitions.

OBSERVATION OF THE LOWEST p-SHELL $T=3/2$ STATES OF ^{11}B AND $^{11}\text{C}^*$

S. W. Cospers,^{**} Robert L. McGrath,[†] Joseph Cerny,
Creve C. Maples, George W. Goth, and Donald G. Fleming^{††}

Lawrence Radiation Laboratory and Department of Chemistry
University of California
Berkeley, California

July 1968

ABSTRACT

The ^{11}B and ^{11}C $T=3/2$ analogues of the $^{11}\text{Be}(0.32\text{ MeV})$ state have been located utilizing the $^{13}\text{C}(p, ^3\text{He})^{11}\text{B}$ and $^{13}\text{C}(p, t)^{11}\text{C}$ reactions. The new states lie at $12.94 \pm 0.05\text{ MeV}$ in ^{11}B and $12.47 \pm 0.06\text{ MeV}$ in ^{11}C and have total widths of $350 \pm 50\text{ keV}$ and $550 \pm 50\text{ keV}$, respectively; their spins and parities are found to be $1/2^-$. A check on their isospin purity is achieved by examination of their charged-particle decay properties; it is found that the major decay mode is via $L=1$ isospin-allowed proton emission.

I. INTRODUCTION

The simultaneous observation of tritons and ${}^3\text{He}$ particles resulting from the proton bombardment of $T_z = +1/2$ target nuclei has been shown to be an effective method for locating low-lying $T=3/2$ states of the $T_z = \pm 1/2$ residual nuclei.^{1,2} Within an isospin formalism these reactions forming the analogue states proceed from identical initial to final states, and in Born approximation their cross section ratio may be written:

$$\frac{d\sigma(p,t)}{d\sigma(p,{}^3\text{He})} = \frac{k_t}{k_{{}^3\text{He}}} \frac{\langle t_p^m T_T | t_t^m \rangle^2 \langle t_f^m T_T | t_i^m \rangle^2}{\langle t_p^m T_T | t_{{}^3\text{He}}^m \rangle^2 \langle t_f^m T_T | t_i^m \rangle^2} \quad (1)$$

where k_t and $k_{{}^3\text{He}}$ are wave numbers and t_p , t_t , $t_{{}^3\text{He}}$, t_i , t_f , and T are the isospins of the proton, triton, ${}^3\text{He}$, target, residual state, and transferred nucleon pair. For residual $T=3/2$ states the isospin-coupling factors cancel and the predicted cross section ratio is approximately unity since the (p,t) and $(p,{}^3\text{He})$ reaction Q -values are nearly equal in light nuclei.

We wish to report the observation of $T=3/2$ states in ${}^{11}\text{C}$ and ${}^{11}\text{B}$ which have been located using the ${}^{13}\text{C}(p,t){}^{11}\text{C}$ and ${}^{13}\text{C}(p,{}^3\text{He}){}^{11}\text{B}$ reactions. These states are unbound to isospin-allowed decay modes and lie in the proximity of various nucleon thresholds which conceivably could destroy their isospin purity (see, for example, Baz, et al.).³ In order to check this, their decay schemes have been investigated by making coincidence measurements between tritons or ${}^3\text{He}$ particles forming the states and most of the energetically allowed charged-particle decay modes.

II. EXPERIMENTAL

The triton and ^3He energy spectra and angular distribution data were simultaneously collected using both 43.7 and 50.5 MeV proton beams from the Berkeley 88-inch cyclotron focused at the center of an evacuated scattering chamber. The general beam transport system has been described elsewhere.⁴ Located at the center of the scattering chamber was a 7.6-cm diameter gas cell which was covered with 2.5 μ Havar⁵ foil and contained methane enriched to 93% in ^{13}C . The gas pressure in the cell was maintained at 21.34 and 26.25 cm of Hg in the 43.7 and 50.5 MeV investigations, respectively.

Signals from two independent three-counter telescopes consisting of a 149 μ ΔE transmission detector (phosphorous-diffused silicon), a 3060 μ E detector, and a 510 μ E-reject detector (both lithium-drifted silicon) were amplified and used to feed power-law type particle identifiers.⁶ The E-reject detector eliminated events traversing the E detector. Each telescope subtended an angle of 0.25 deg and a solid angle of 5×10^{-5} sr. A schematic diagram of one of the two systems of detectors and electronics used in these experiments is presented in Fig. 1. As indicated on the figure each total energy signal ($E_T = \Delta E + E$) was fed into a 4096-channel pulse-height analyzer and each particle identifier (PI) output was fed to a four-channel router. The gating signals generated by the four channels of the router were used to route the total energy signals into the appropriate 1024-channel quadrant of the pulse-height analyzer. In this manner energy spectra resulting from tritons, ^3He particles, and ^4He particles were stored simultaneously. (The energy spectra of particles whose PI signals fell in the region of the deuteron-triton valley were also monitored to insure that no tritons were

lost; this loss proved to be negligible in both investigations). Some of the triton and ^3He data accumulated during these experiments and pertaining to $T=1/2$ final states has been published elsewhere.⁷ The average energy resolution (FWHM) was 150 keV for tritons and 180 keV for ^3He particles. An additional 1020 μ lithium-drifted silicon detector (fixed at 27.5 deg) served as a beam energy monitor through continuous observation of ^4He particles from the $^{13}\text{C}(p,\alpha)^{10}\text{B}$ reaction. Beam energy variations throughout both experiments amounted to less than 0.1%.

The coincidence data were obtained with a 50 MeV proton beam focused to 1.5×2.5 mm on a 1.1 mg/cm^2 self-supporting carbon target, prepared from a colloidal suspension enriched to 30% ^{13}C . Two semi-conductor counter telescopes were used. They consisted of 147 μ ΔE plus 3050 μ E detectors (System I) and 37 μ ΔE plus 500 μ E plus 908 μ E-reject detectors (System II) and were mounted in coplanar positions with respect to the beam direction subtending 9.4×10^{-4} sr and 4×10^{-3} sr, respectively.

Signals from both telescopes were passed on to much the same electronics previously mentioned. Triton and ^3He energy spectra from System I which was fixed at +30 deg (near an $L=0$ maximum for transitions to the $T=3/2$ mass-eleven states as discussed below) were stored in portions of a 4096-channel pulse-height analyzer. Energy signals from both systems, along with particle identification routing signals, were fed into an analogue-buffer-multiplexer and analogue-to-digital converter coupled to an on-line computer, provided the events in each system satisfied the usual fast ($2\tau = 50$ ns)-slow coincidence requirements. System II was positioned at both -85 deg and -100 deg and was adjusted to pass proton, triton, ^3He , or ^4He events, and, in addition, events

where particles stopped in the $37\mu \Delta E$ detector. [^3He and ^4He particles, possibly emitted by the $T=3/2$ states under investigation, would have had energies less than 6.2 MeV and hence could not penetrate this ΔE detector; the kinematics permitted unambiguous identification of these events.]

III. RESULTS AND DISCUSSION

A. Energy Spectra and Angular Distributions

Figure 2 presents energy spectra of tritons and ^3He particles resulting from 50.5 MeV proton bombardment of ^{13}C . The insets in each section of the figure are an expanded portion of the complete spectrum bracketed by arrows from which the $T=1/2$ continuum background, indicated by the dashed line, has been subtracted. Broad peaks located at 12.47 ± 0.06 MeV in ^{11}C and 12.94 ± 0.05 MeV in ^{11}B with widths of 550 ± 50 and 350 ± 50 keV, respectively are apparent. The angular distributions of transitions to these two states at $E_p = 50.5$ and 43.7 MeV are shown in Fig. 3. It can be seen that the (p,t) and $(p,^3\text{He})$ angular distributions have identical shapes and that the cross sections at each angle are essentially identical within counting and background subtraction statistics; these data are consistent with the $T=3/2$ differential cross section ratio of 0.95 predicted by Eq. (1). The excitation energies of these states were established using the known excitation energies of the four lowest states of ^{11}C ⁸ and the five lowest states of ^{11}B ^{8,9} as calibration data; additional calibrations provided by ^{10}C and ^{10}B states resulting from ^{12}C target contamination were found not to alter the excitation energies.

Intermediate coupling calculations by Cohen and Kurath^{10,11} and by Boyarkina¹² predict that the lowest $T=3/2$ state in ^{11}B should lie between 12.5 and 13.7 MeV excitation. A simple Coulomb calculation predicts an excitation of 12.78 MeV for the ^{11}B $T=3/2$ state based on the ^{11}B first excited state (see below for discussion). These predictions are all consistent with the measured excitation of 12.94 ± 0.05 MeV. For the above reasons, the ^{11}B (12.94 MeV) and ^{11}C (12.47 MeV) states are assigned $T=3/2$, and are therefore analogues of a low-lying state in ^{11}Be .

Some discussion as to which state of ^{11}Be is the analogue of these new $T=3/2$ states is necessary. Using a simple shell model picture, the ^{11}Be ground state should have $J^\pi = 1/2^-$. However, it is known that the ground state has $J^\pi = (1/2; 3/2; 5/2)^+$,¹³ and that the first excited state at 0.32 MeV has $J^\pi = (1/2; 5/2; 7/2)^-$.¹⁴ Talmi and Unna have shown¹⁵ that because of residual two-body interactions, the $2s_{1/2}$ single-particle level should lie about 0.2 MeV below the $1p_{1/2}$ level in ^{11}Be , which is consistent with experiment.

Since the $^{13}\text{C}(p,t)^{11}\text{C}$ reaction is limited to $S = 0$, $T = 1$ two-neutron pickup, even (odd) angular momentum transfers in the $^{13}\text{C}(p,t)^{11}\text{C}$ reaction form negative (positive) parity states of ^{11}C . Assuming a direct pickup mechanism for the $^{13}\text{C}(p,t)^{11}\text{C}$ reaction, odd angular momentum transfer to states at moderate excitation would require $(2s)^2$ and/or $(1d)^2$ admixtures in the ^{13}C ground state. Although calculations predicting the magnitudes of these impurities are not available, they are expected to be small. The observed cross section to the $^{11}\text{C}(7.49 \text{ MeV}; 3/2^+)$ and the $^{11}\text{C}(6.90 \text{ MeV}; 5/2^+)$ states - which would require $L=1$ and $L=3$ transfers, respectively, for direct two-neutron pickup - should provide rough upper limits for such considerations.

The angular distributions to these states are shown in Fig. 4. As can be seen, the cross section to the 7.49 MeV state averages about 5 $\mu\text{b}/\text{sr}$ and that to the 6.90 MeV state averages about 10 $\mu\text{b}/\text{sr}$. In addition, neither of these angular distributions shows the oscillatory structure expected for a pure $L=1$ or 3 direct process. This evidence indicates that the $(2s)^2$ and $(1d)^2$ impurities in the ^{13}C ground state are relatively small. Hence, a ^{11}C positive parity state is not expected to be populated by the (p,t) reaction to the extent observed for the 12.47 MeV, $T=3/2$ state.

Also shown in Fig. 4 are the $^{13}\text{C}(p,t)^{11}\text{C}$ angular distributions to the 2.00 MeV states $1/2^-$ ($L=0$); the ground state, $3/2^-$ ($L=2$); and the 12.47 MeV $T=3/2$ state. The $^{11}\text{C}(12.47 \text{ MeV})$ state angular distribution looks very similar in shape to the $L=0$ distribution leading to the ^{11}C (2.00 MeV) state. The shift of the second maximum to smaller angles with increasing excitation has been seen in many $L=0$ (p,t) angular distributions.¹⁶

The $L=0$ character of the transition leading to the $^{11}\text{C}(12.47 \text{ MeV})$ state establishes these ^{11}C and ^{11}B $T=3/2$ states to be $J^\pi = 1/2^-$. Since the ^{11}Be ground state is known to have positive parity,¹³ these $T=3/2$ states in ^{11}C and ^{11}B are most probably the analogues of the $^{11}\text{Be}(0.32 \text{ MeV})$ state of known negative parity,¹⁴ which therefore would have a spin of $1/2$.

B. Decay Schemes

The data presented in Fig. 5 indicate that the $^{11}\text{B}(12.94 \text{ MeV})$ state and the $^{11}\text{C}(12.47 \text{ MeV})$ state each have only one open $T=3/2$ particle-decay mode, i.e., via emission of an $L=1$ proton to the ^{10}Be ground state and to the $^{10}\text{B}(1.74 \text{ MeV}; T=1)$ state, respectively. Except for the isospin selection rule, these states might decay via a number of other modes illustrated in the

figure. Thus a check of the isospin purity of these new mass-eleven states can be achieved by determining whether the isospin-allowed decays predominate. Coincidence events between tritons or ^3He particles forming these states and all the energetically allowed charged-particle decay modes shown in the figure, except the ^{10}B (2.15 MeV and 3.59 MeV), ^8Be (2.9 MeV), and ^7Be (4.55 MeV) states, could have been detected.

Figures 6 and 7 show portions of two-dimensional energy spectra collected with the System II telescope at -85° . Figure 6 contains a portion of the triton-proton array. The bands drawn through the data were calculated from the kinematics of the three-particle final state $t+p+^{10}\text{B}$ and are labeled by the various residual states of ^{10}B ; these bands include corrections for the finite geometry of the counters, energy losses in the target, and electronic resolution. The resolution of the System I was about 185 keV for tritons and 300 keV for ^3He particles and the proton resolution of System II was estimated to be about 100 keV. In general the Q-values of ^{12}C and ^{16}O contaminant reactions are such that they do not interfere with the ^{13}C reactions under study; the $^{16}\text{O}(p,t)^{14}\text{O}(p)^{13}\text{N}$ ground state band (not shown) partially overlaps the $^{13}\text{C}(p,t)^{11}\text{C}(p)^{10}\text{B}(0.72\text{ MeV})$ band, but the remaining ^{16}O and ^{12}C bands lie below the $^{10}\text{B}(2.15\text{ MeV})$ band (two $t+p+^9\text{B}$ contaminant bands are indicated in the figure). The calculated true-to-chance ratio for the data in Fig. 6 is 8.6 and is consistent with the few chance events lying at 24.6 MeV triton energy associated with the $^{12}\text{C}(p,t)^{10}\text{C}$ ground state contaminant reaction, which comprises the largest peak in the free triton energy spectrum. Events at about 21 MeV triton energy corresponding to the decay of the $^{11}\text{C}(12.47\text{ MeV})$ state are prominent and center on the $^{10}\text{B}(1.74\text{ MeV}; T=1)$

band as expected from the isospin selection rules.

Figure 7 shows part of the triton- ΔE array containing coincidence events between tritons and particles stopping in the ΔE detector of System II. Many of the events depositing less than 2 MeV in this detector are due to recoil ions. The calculated true-to-chance rate is 29 which is again consistent with the number of chance events lying near the top of the array. The upper band includes the $t+{}^4\text{He}+[{}^7\text{Be}$ ground and ${}^7\text{Be}$ (0.43 MeV)] final states; these are unresolved due to the ${}^4\text{He}$ energy losses in the target. No clustering of events associated with ${}^4\text{He}$ decay of the ${}^{11}\text{C}$ $T=3/2$ state is apparent in the data. The ${}^{12}\text{C}$ contaminant $t+{}^4\text{He}+{}^6\text{Be}$ ground state band is shown and other contaminant bands lie below it.

The ${}^3\text{He}$ -proton and ${}^3\text{He}$ - ΔE coincidence data are similar to those shown in Figs. 6 and 7 and contain events indicating that the ${}^{11}\text{B}$ (12.94 MeV) $T=3/2$ state decays predominantly via isospin allowed proton emission to the ${}^{10}\text{Be}$ ground state. The other coincidence arrays contain essentially no events corresponding to isospin forbidden transitions.

In order to determine the major decay modes of the $T=3/2$ states, the counts contained in the various kinematic bands in the above data were projected onto the triton and ${}^3\text{He}$ energy axes. Figure 8 shows the sum of these projections from runs with the System II telescope at -85° and -100° . Counts attributed to the decay of the $T=3/2$ states were obtained by summing these projected spectra over the shaded triton and ${}^3\text{He}$ channels marked in the figure and subtracting (A) the calculated chance background and (B) the "real" continuum background. The continuum background was assumed smooth and was estimated by averaging the observed counts in the projected spectra over all

channels not related to the $T=3/2$ events.

The resulting net coincidence counts were compared to the number predicted from the triton or ${}^3\text{He}$ singles data after transforming the isotropic decay of the intermediate spin $1/2, T=3/2$ states in the mass-eleven center of mass system to the laboratory, assuming 100% decay via a given mode. The results are tabulated in Table I where the errors include only counting statistics. Additional errors in (1) estimating the magnitude of the singles background subtraction to be made before computing the expected coincidence counts (see Fig. 2) and (2) the solid angle of System II are about 30%. Unfortunately, the large statistical errors evident in the table along with the above considerations preclude other than qualitative conclusions about the isospin purity of the mass-eleven $T=3/2$ states; however, it is clear that most of the decays proceed via the $T=3/2$ mode and hence these results support the $T=3/2$ assignment made on the basis of Eq. (1).

Another argument consistent with the conclusion that these states decay predominantly by $L=1$ proton emission can be based on the apparent agreement between the experimental ratio of their widths, $550 \pm 50 / 350 \pm 50 = 1.57 \pm 0.27$, and the calculated proton penetration factor ratio. Assuming the interaction radius is given by $1.25 (A^{1/3} + 1)\text{fm}$, this ratio is 1.33.¹⁷

In summary, two new states of ${}^{11}\text{B}$ and ${}^{11}\text{C}$ have been located at 12.94 MeV and 12.47 MeV, respectively, with $J^\pi = 1/2^-$; since these are almost certainly analogues of the 0.32 MeV state of ${}^{11}\text{Be}$, the spin of this state is also $1/2$. Using these results the mass of the unobserved ${}^{11}\text{N}$ analogue state may be predicted utilizing the isobaric multiplet mass equation.¹⁸

The mass excess of this lowest p-shell state of ${}^{11}\text{N}$ is calculated to be $25.03 \pm 0.24 \text{ MeV} (C^{12}=0)$ and hence is unbound to proton emission.

Table I. Decay modes of the ^{11}B and ^{11}C $T=3/2$ states.

	<u>Net Counts</u>	<u>Predicted Counts</u> *
$^{11}\text{B}(12.94 \text{ MeV}) \longrightarrow$	$^{10}\text{Be g.s.}+p$	25.9±5.2
	$^7\text{Li(g.s.}+0.48 \text{ MeV)}+\alpha$	1.7±4.7
$^{11}\text{C}(12.47 \text{ MeV}) \longrightarrow$	$^{10}\text{B g.s.}+p$	4±3.4
	$^{10}\text{B (0.72 MeV)}+p$	-1.1±1.7
	$^{10}\text{B (1.74 MeV)}+p$	32.4±6.3
	$^7\text{Be(g.s.}+0.43 \text{ MeV)}+\alpha$	8.2±5.4

* Counts predicted as described in the text assuming 100% decay via a given mode.

FOOTNOTES AND REFERENCES

* Work performed under the auspices of the U.S. Atomic Energy Commission.

** Present address: Physics Department, University of Southwestern Louisiana, Lafayette, Louisiana.

† Present address: Physics Department, State University of New York, Stony Brook, New York.

†† Present address: The Nuclear Structure Laboratory, University of Rochester, Rochester, New York.

1. C. Détraz, J. Cerny, and R. H. Pehl, Phys. Rev. Letters 14, 708 (1965); and J. Cerny, R. H. Pehl, G. W. Butler, D. G. Fleming, C. Maples, and C. Détraz, Phys. Letters 20, 35 (1966).
2. J. C. Hardy and D. J. Skyrme, Isobaric Spin in Nuclear Physics, ed. J. D. Fox and D. Robson (Academic Press, New York, 1966), p. 701.
3. A. I. Báz, V. I. Goldansky, and Ya. B. Zeldovich, Usp. Fiz. Nauk. 85, 445 (1965); [Trans.: Soviet Phys. Usp. 8, 177 (1965)].
4. G. W. Butler, J. Cerny, S. W. Cospser, and R. L. McGrath, Phys. Rev. 166, 1096 (1968).
5. Hamilton Watch Company, Metals Division, Lancaster, Pennsylvania.
6. F. S. Goulding, D. A. Landis, J. Cerny, and R. H. Pehl, Nucl. Instr. Methods 31, 1 (1964).
7. D. G. Fleming, J. Cerny, and N. K. Glendenning, Phys. Rev. 165, 1153 (1968).
8. F. Ajzenberg-Selove and T. Lauritsen, Nucl. Phys. A114, 1 (1968).
9. C. P. Browne and F. H. O'Donnell, Phys. Rev. 149, 767 (1966).
10. D. Kurath, Phys. Rev. 101, 216 (1956).

11. S. Cohen and D. Kurath, Nucl. Phys. 73, 1 (1965).
12. A. N. Boyarkina, Akad. Nauk. USSR 28, 255 (1964).
13. D. E. Alburger, C. Chasman, K. W. Jones, J. W. Olness, and R. A. Ristinen, Phys. Rev. 136, B916 (1964).
14. S. Hinds and R. Middleton, Phys. Letters 9, 149 (1964).
15. I. Talmi and I. Unna, Phys. Rev. Letters 4, 469 (1960).
16. J. Cerny, R. H. Pehl, and G. T. Garvey, Phys. Letters 12, 234 (1964).
S. W. Cospers, H. Brunnader, J. Cerny, and R. L. McGrath, Phys. Letters 25B, 324 (1967).
17. W. T. Sharp, H. E. Gove, and E. B. Paul, Atomic Energy of Canada Limited Report No. 268, 1955 (unpublished).
18. E. P. Wigner, Proc. R. A. Welch Foundation Conf. on Chem. Research, 1957, Vol. I, ed. by W. O. Milligan (the R. A. Welch Foundation, Houston, 1958), p. 67; S. Weinberg and S. B. Treiman, Phys. Rev. 116, 465 (1959);
D. H. Wilkinson, Phys. Letters 12, 348 (1964).

FIGURE CAPTIONS

- Fig. 1. Schematic diagram of the experimental setup of one of the semiconductor counter-telescopes.
- Fig. 2. The energy spectra of the $^{13}\text{C}(p,t)^{11}\text{C}$ and $^{13}\text{C}(p,^3\text{He})^{11}\text{B}$ reactions. The insets, showing the $T=3/2$ states, are expanded portions of the data contained between the arrows.
- Fig. 3. Angular distributions of transitions to the $T=3/2$ states arising from both 43.7 and 50.5 MeV proton bombardment.
- Fig. 4. $^{13}\text{C}(p,t)^{11}\text{C}$ angular distributions. The $1/2^-$ states of ^{11}C at 2.00 and 12.47 MeV ($T=3/2$) exhibit $L=0$ distributions and the $3/2^-$ ground state of ^{11}C has an $L=2$ pattern. Transitions to the 6.90 and 7.49 MeV positive parity states, forbidden for p-shell pickup, are shown for comparison.
- Fig. 5. Energy level diagrams for ^{11}B and ^{11}C in the vicinity of the p-shell $T=3/2$ states, including energetically permitted particle-decay modes. The single isospin-allowed transition for each $T=3/2$ state is indicated by an arrow.
- Fig. 6. Contour display of triton-proton 2-dimensional energy spectrum. The kinematic bands correspond to $(t+p+^{10}\text{B})$ and $(t+p+^9\text{B})$ three-particle final states. The events having about 21 MeV triton and 3 MeV proton energies are attributed to the isospin allowed decay of the ^{11}C $T=3/2$ state. Symbols for the number of events per channel are given in the upper right corner.
- Fig. 7. Contour display of triton- ΔE 2-dimensional energy spectrum. The kinematic bands correspond to $(t+^4\text{He}+^7\text{Be})$ and $(t+^4\text{He}+^6\text{Be})$ final states. The events below 2 MeV ΔE energy are primarily due to recoil ions.

Fig. 8. Projections onto the triton and ^3He energy axes of the data contained in the kinematic bands. The shaded channels correspond to possible decays of the $T=3/2$ states and the arrows mark the experimental spectrum cutoffs.

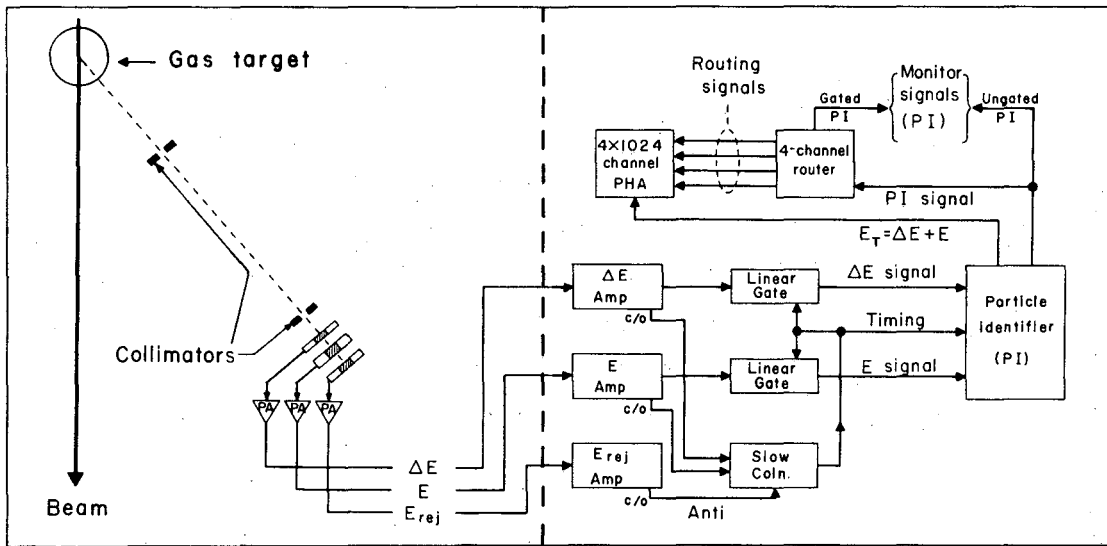

X-31 678-4476

Fig. 1.

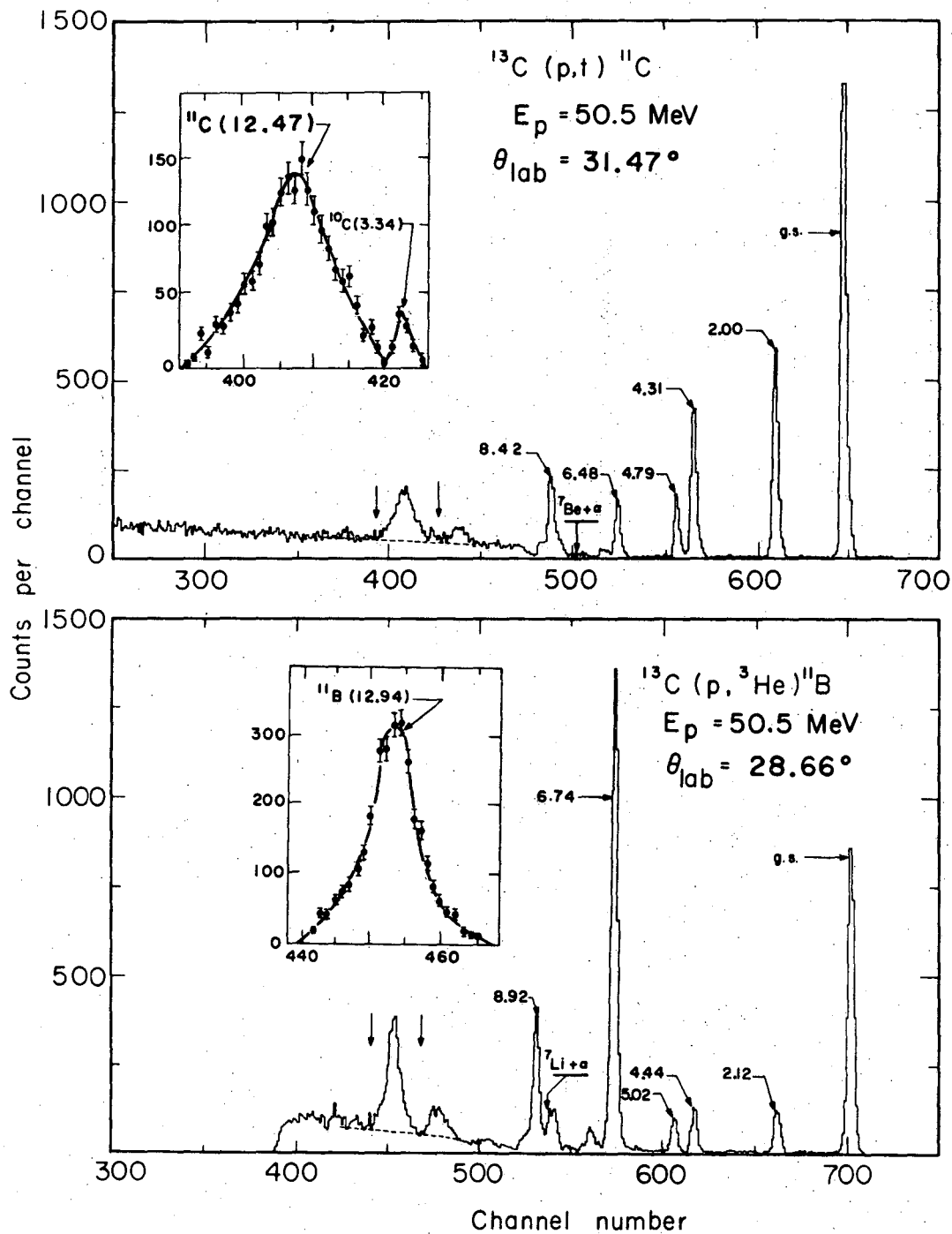

XBL6712-5947

Fig. 2.

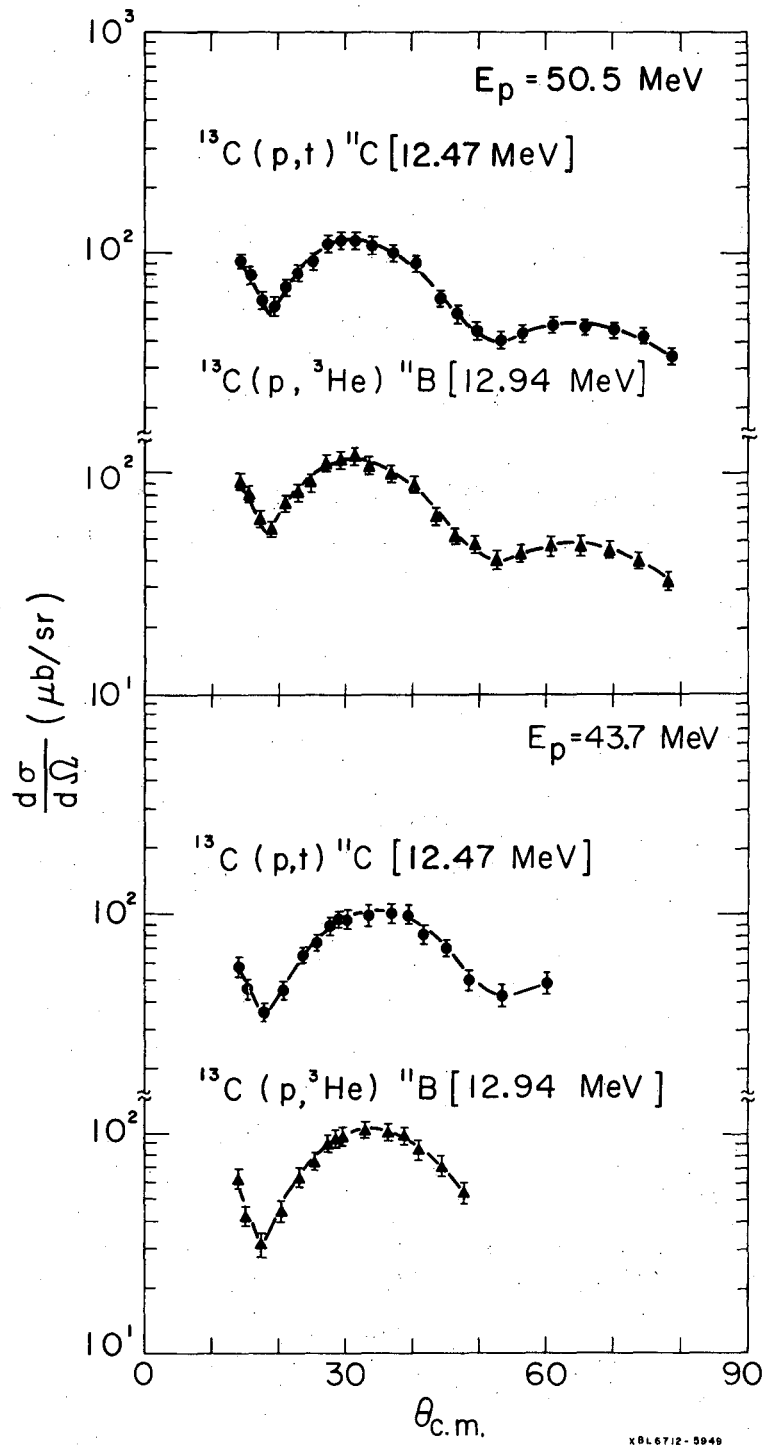

Fig. 3.

XBL 6712-5949

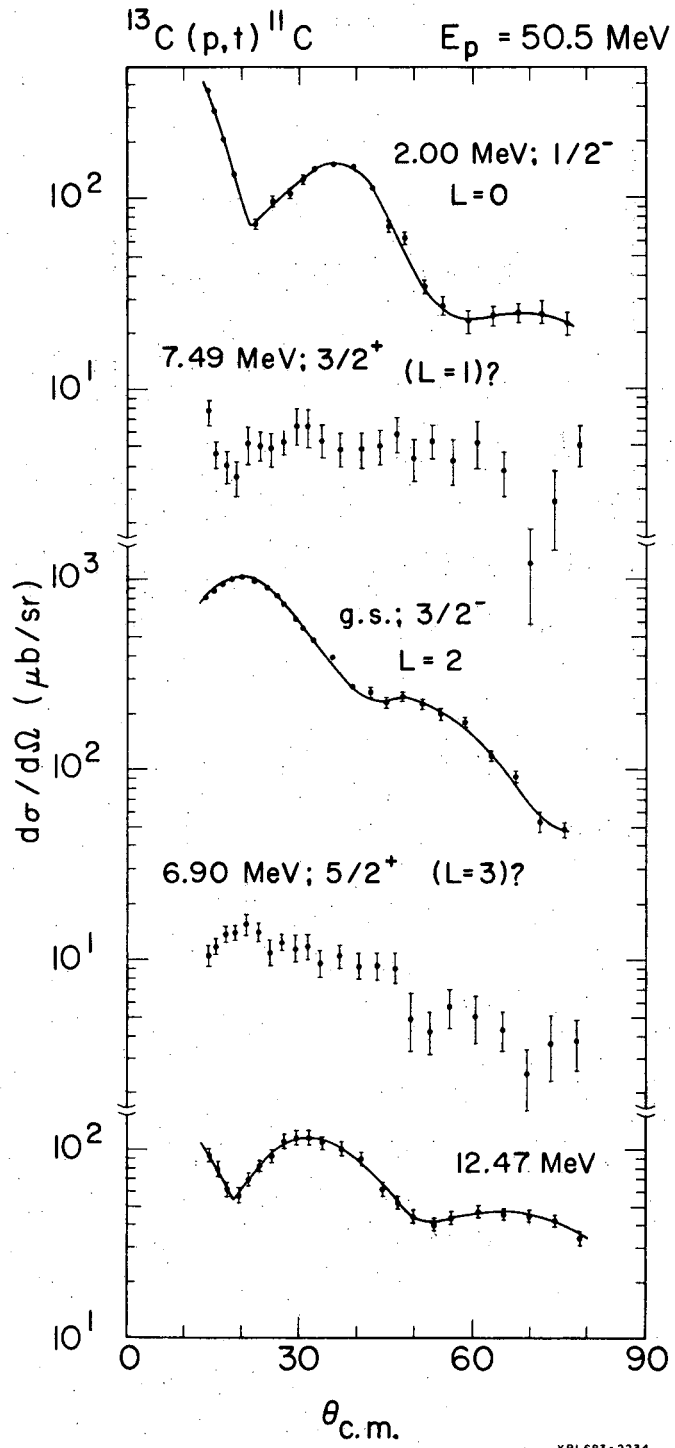
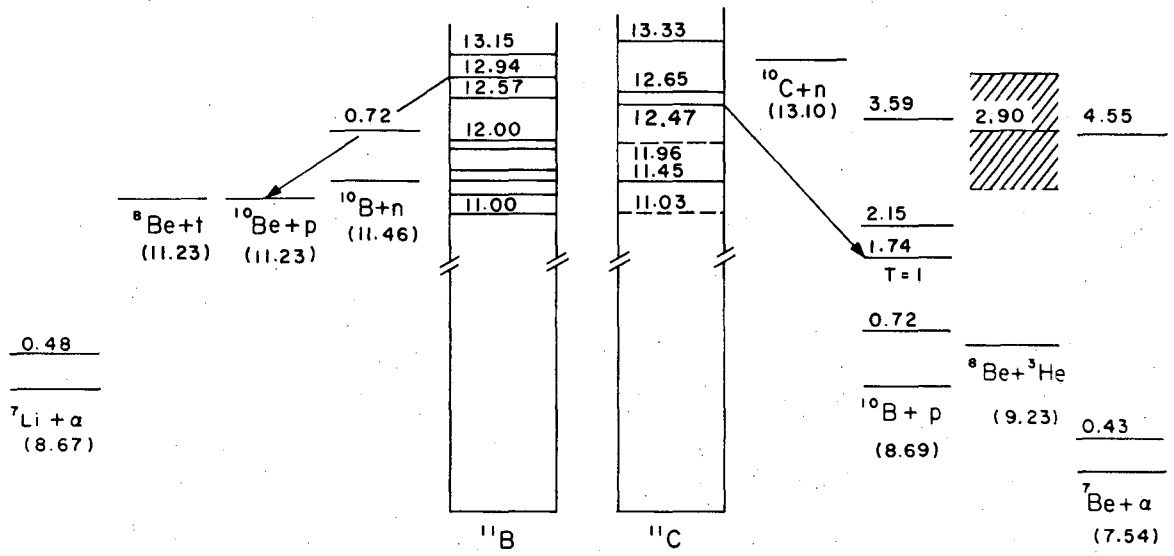
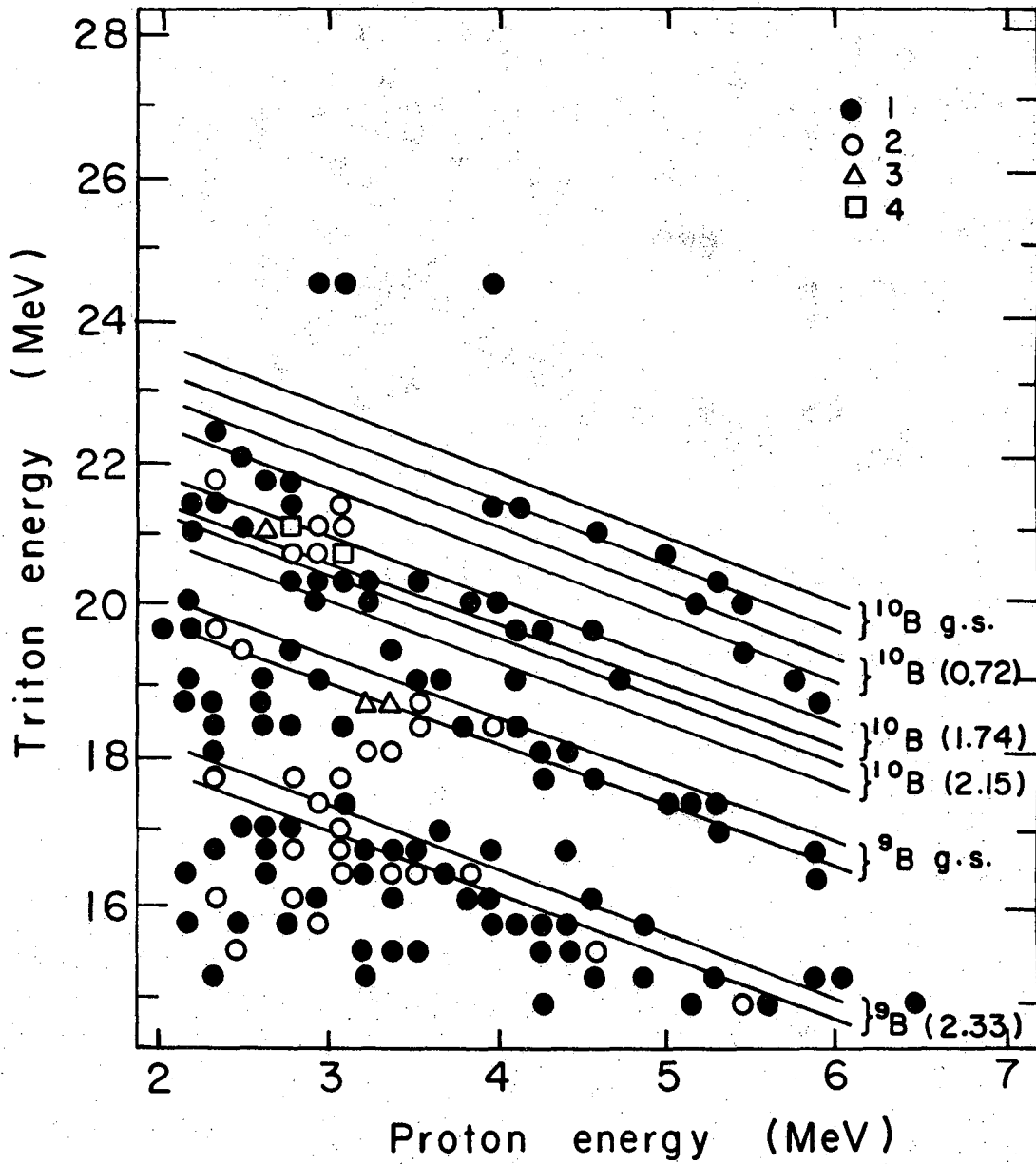

Fig. 4.



XBL 6712-5948

Fig. 5.



XBL 6712 - 5951

Fig. 6.

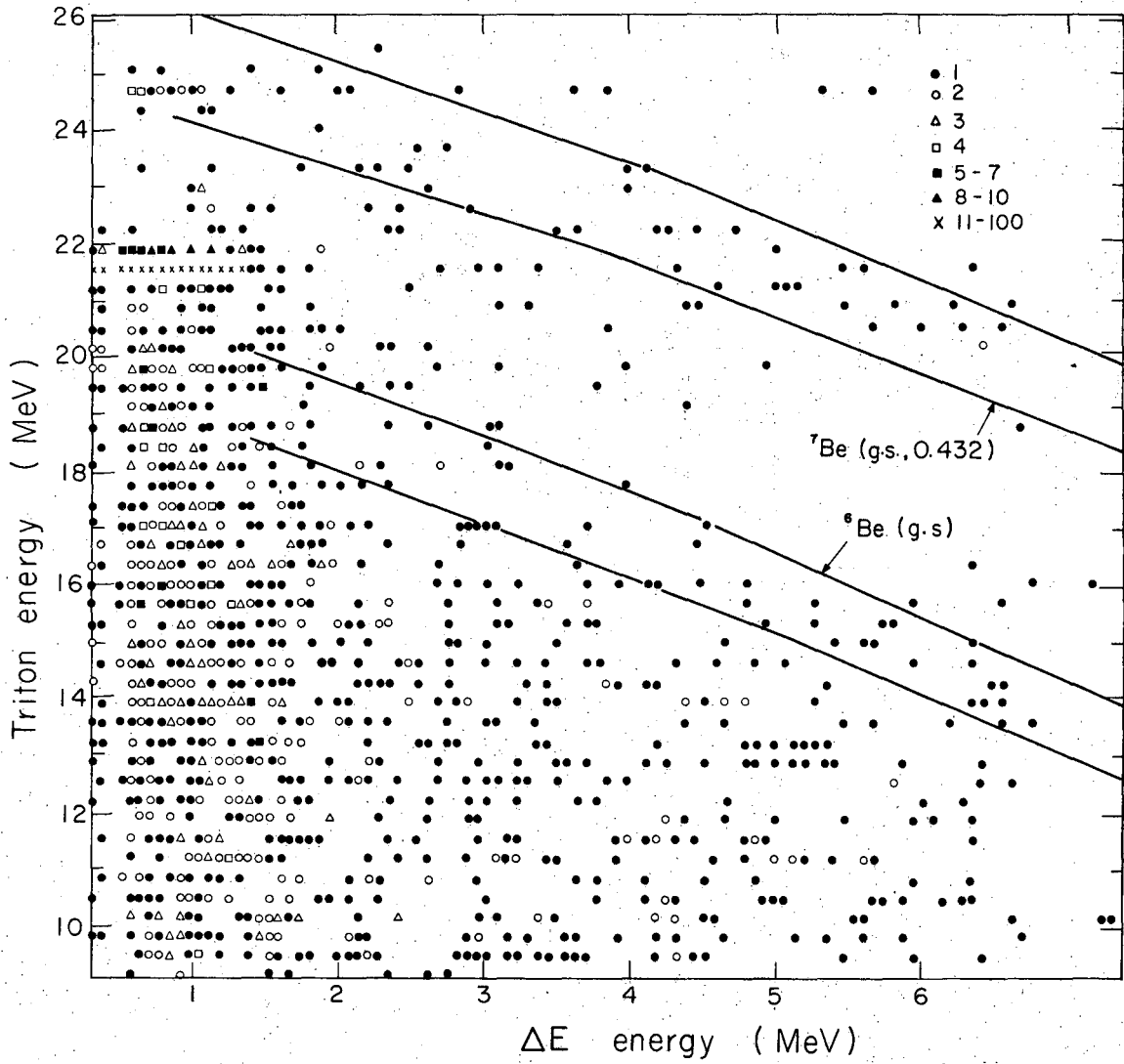
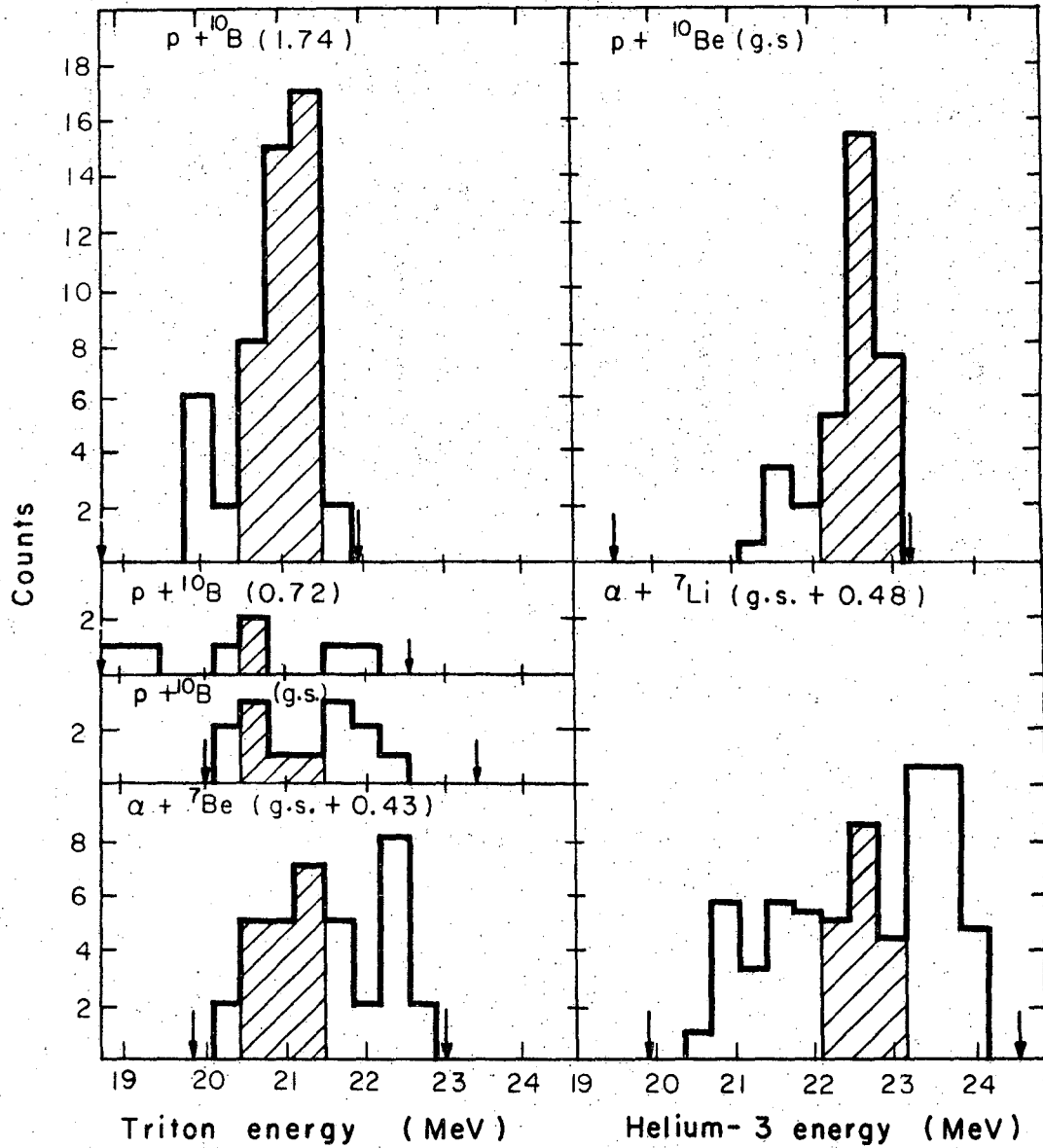

Fig. 7.



XBL 6712-5952

Fig. 8.

This report was prepared as an account of Government sponsored work. Neither the United States, nor the Commission, nor any person acting on behalf of the Commission:

- A. Makes any warranty or representation, expressed or implied, with respect to the accuracy, completeness, or usefulness of the information contained in this report, or that the use of any information, apparatus, method, or process disclosed in this report may not infringe privately owned rights; or
- B. Assumes any liabilities with respect to the use of, or for damages resulting from the use of any information, apparatus, method, or process disclosed in this report.

As used in the above, "person acting on behalf of the Commission" includes any employee or contractor of the Commission, or employee of such contractor, to the extent that such employee or contractor of the Commission, or employee of such contractor prepares, disseminates, or provides access to, any information pursuant to his employment or contract with the Commission, or his employment with such contractor.