

UC Irvine

UC Irvine Previously Published Works

Title

Development and evaluation of the Nurotron 26-electrode cochlear implant system

Permalink

<https://escholarship.org/uc/item/5hf8g668>

Authors

Zeng, FG

Rebscher, SJ

Fu, QJ

et al.

Publication Date

2015-04-01

DOI

10.1016/j.heares.2014.09.013

Peer reviewed



Review

Development and evaluation of the Nurotron 26-electrode cochlear implant system



Fan-Gang Zeng^{a,*}, Stephen J. Rebscher^b, Qian-Jie Fu^c, Hongbin Chen^d, Xiaoran Sun^d, Li Yin^d, Lichuan Ping^d, Haihong Feng^e, Shiming Yang^f, Shusheng Gong^g, Beibei Yang^h, Hou-Yong Kangⁱ, Na Gao^j, Fanglu Chi^{j,**}

^a Center for Hearing Research, University of California, Irvine, CA 92697, USA

^b Department of Otolaryngology – Head and Neck Surgery, University of California, San Francisco, CA 94143, USA

^c Department of Otolaryngology – Head and Neck Surgery, University of California, Los Angeles, CA 90095, USA

^d Nurotron Biotechnology Inc., Hangzhou, Zhejiang 310011, China

^e Shanghai Acoustics Laboratory, Institute of Acoustics, Chinese Academy of Sciences, Shanghai 200032, China

^f Department of Otolaryngology – Head and Neck Surgery, Chinese PLA General Hospital, Beijing 100853, China

^g Department of Otolaryngology – Head and Neck Surgery, Beijing Tongren Hospital of Capital Medical University, Beijing 100730, China

^h Department of Otolaryngology – Head and Neck Surgery, The Second Affiliated Hospital of Zhejiang University, Hangzhou 310000, China

ⁱ Department of Otolaryngology – Head and Neck Surgery, The First Affiliated Hospital of Chongqing Medical University, Chongqing 400016, China

^j Department of Otolaryngology – Head and Neck Surgery, The Eye and ENT Hospital of Fudan University, Shanghai 200031, China

ARTICLE INFO

Article history:

Received 17 June 2014

Received in revised form

18 August 2014

Accepted 3 September 2014

Available online 2 October 2014

ABSTRACT

Although the cochlear implant has been widely acknowledged as the most successful neural prosthesis, only a fraction of hearing-impaired people who can potentially benefit from a cochlear implant have actually received one due to its limited awareness, accessibility, and affordability. To help overcome these limitations, a 26-electrode cochlear implant has been developed to receive China's Food and Drug Administration (CFDA) approval in 2011 and *Conformité Européenne* (CE) Marking in 2012. The present article describes design philosophy, system specification, and technical verification of the Nurotron device, which includes advanced digital signal processing and 4 current sources with multiple amplitude resolutions that not only are compatible with perceptual capability but also allow interleaved or simultaneous stimulation. The article also presents 3-year longitudinal evaluation data from 60 human subjects who have received the Nurotron device. The objective measures show that electrode impedance decreased within the first month of device use, but was stable until a slight increase at the end of two years. The subjective loudness measures show that electric stimulation threshold was stable while the maximal comfort level increased over the 3 years. Mandarin sentence recognition increased from the pre-surgical 0%-correct score to a plateau of about 80% correct with 6-month use of the device. Both indirect and direct comparisons indicate indistinguishable performance differences between the Nurotron system and other commercially available devices. The present 26-electrode cochlear implant has already helped to lower the price of cochlear implantation in China and will likely contribute to increased cochlear implant access and success in the rest of the world.

This article is part of a Special Issue entitled <Lasker Award>.

© 2014 The Authors. Published by Elsevier B.V. This is an open access article under the CC BY-NC-ND license (<http://creativecommons.org/licenses/by-nc-nd/3.0/>).

* Corresponding author. 110 Medical Science E, University of California, Irvine, CA 92697-5320, USA. Tel.: +1 949 824 1539; fax: +1 949 824 5907.

** Corresponding author. 83 Fenyang Road, Xujiahui District, Shanghai 200031, China.

E-mail addresses: fzeng@uci.edu (F.-G. Zeng), chifanglu@yahoo.com.cn (F. Chi).

1. Introduction

Since the United States Food and Drug Administration (FDA) approved the first cochlear implant in 1984, more than 300,000 hearing-impaired people worldwide have used electric stimulation of the auditory nerve to derive benefits from restoring speech perception in post-lingually deafened adults to developing language in pre-lingually deafened children Clark, 2015, Hochmair,

2015, Wilson, 2015, Eisenberg, 2015, Chouard, 2015, Merzenich, 2015. Cochlear implant technology has evolved from a single-electrode analog device to multi-electrode devices with interleaved stimulation and *in vivo* neural recording. Three major companies, Cochlear Corporation in Australia, Med El in Austria and Advanced Bionics LLC in the United States, control essentially the entire market, with Cochlear Corporation being the dominating player. Despite clearly documented benefits, technological advances and commercial success, the cochlear implant is still limited to about 10% of potential candidates in developed countries and much less in developing countries (Zeng, 2007). The high cost of the cochlear implants has not changed in the last 30 years despite the increased volume and is still a major factor limiting market access. Developing a low-cost, high-performance cochlear implant system has long been recognized as an effective, perhaps the only means to increase competition and hopefully market access, particularly in developing countries (An et al., 2007; Wilson et al., 1998; Zeng, 1995).

The present article describes the conceptualization and process in developing and evaluating the Nurotron 26-electrode cochlear implant system, which started with a technology transfer from the University of California in 2006, received CFDA market approval in 2011 and CE Mark in 2012. As of July 2014, the Nurotron device has been implanted in 1500 deaf subjects in China, 2 in Columbia and 2 in India. First, the philosophy is presented on the design and development of the overall system specification. Second, specific design and verification of the system components are laid out from the external sound processor and radio frequency transmission to the internal receiver, stimulator and intracochlear electrode array. Third, systematic evaluation results are presented from objective measures to subjective functional assessments in 60 human subjects who participated in the initial CFDA clinical trial. Finally, relevant research and socio-economical impact are discussed.

2. System specifications

Cochlear implant technologies have converged in the last 30 years – from single-electrode analog stimulation to multi-electrode interleaved stimulation (e.g., Wilson et al., 2008; Zeng et al., 2008). Fig. 1 presents the functional block diagram of a contemporary cochlear implant system, consisting of an external unit, a transcutaneous radio-frequency (RF) transmission unit, an internal unit, and a fitting unit that is not worn by the user but

used only by clinicians to adjust connection and stimulation parameters for optimal performance. The external unit is often called a speech or sound processor and contains a digital signal processor (DSP) to control signal flow from environmental sounds to RF transmission. The internal unit includes a hermetically sealed application-specific-integrated-circuit (ASIC) that derives power and decodes information from the RF signal, while delivering electrical stimulation to the electrodes, measuring feedback signals from the electrodes and transmitting these measurements back to the sound processor or the clinical fitting system.

The Nurotron cochlear implant system was developed based on the following design philosophy. First, the device should meet technical specifications that are critical to safety and performance of a contemporary cochlear implant. The European standard EN 45502-2-3 (2010) and additional modern practices were followed to conform to safety considerations; multi-channel, multi-stimulation strategies were employed to meet performance needs. Second, the device should have a flexible architecture to meet future needs such as virtual channels or fine structure encoding that could improve speech recognition in noise, tonal language understanding and music appreciation. With this philosophy in mind, the ASIC contained 4 current sources to provide simultaneous stimulation of 2 or 3 electrodes to potentially produce 47 or more spectral channels. Third, the device should have the capacity to support other neural prosthetics applications such as auditory nerve implants, auditory brainstem implants, retinal implants, or deep brain stimulation. To provide this level of expandability, the design included 2 reference electrodes and 24 active stimulating outputs that could be configured as 2×12 , 3×8 , or 4×6 surface electrodes or penetrating bundles.

Fig. 2 illustrates the Nurotron cochlear implant system. Panel A shows the behind-the-ear sound processor that contains dual microphones, control buttons, display lights, battery case, and an RF transmission coil. A body-worn sound processor (not shown) is also available for extended battery life or as preferred by some user groups. Panel B shows the internal components of the system that contains a gold RF receiving coil, a removable magnet (with “X” sign in the middle of the coil to designate polarity), a titanium case, a plate platinum reference electrode (beside the logo in the case), a ring platinum reference electrode (at the exit of the electrode array), and a straight 24-contact electrode array. The following section describes specific design and verification for the Nurotron cochlear implant system.

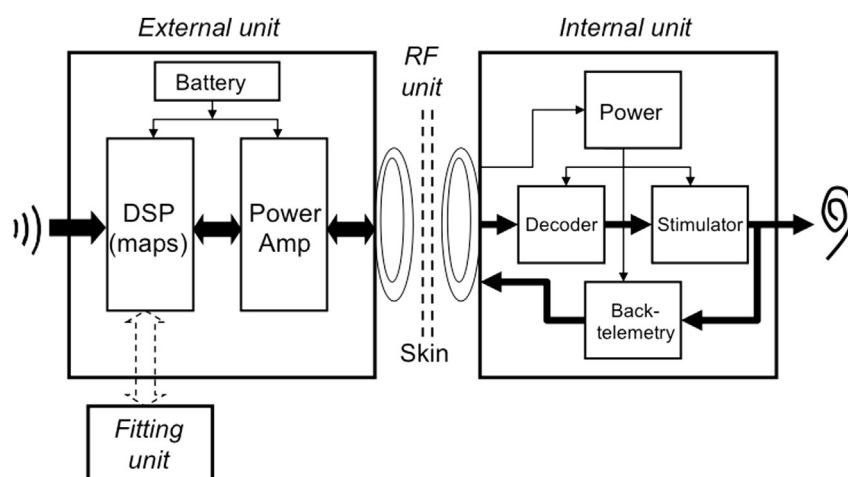

Fig. 1. A functional block diagram of the Nurotron 26-electrode cochlear implant.

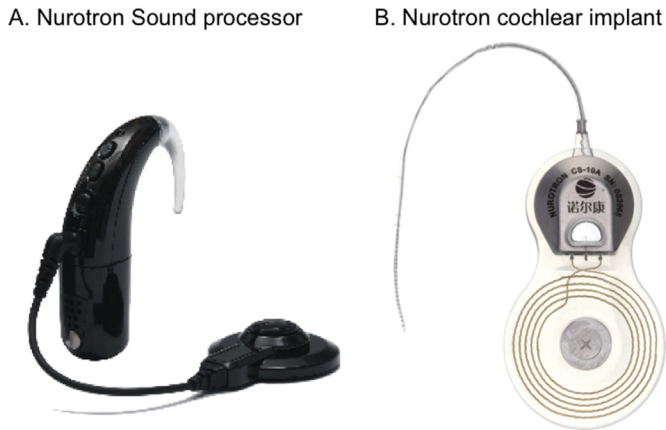

Fig. 2. The Nurotron cochlear implant system: The sound processor (A) and the internal unit containing the receiver, stimulator and electrode array (B).

3. Design and verification

3.1. Sound processing

Advanced sound processing is critical to cochlear implant performance. First, sound pre-processing is needed to ensure audibility and clarity of speech sounds. The Nurotron standard pre-processing includes sensitivity control, automatic gain control, single microphone noise reduction, and mixed input selection. Second, sound processing needs to convert analog sound into electrical pulses. The Nurotron DSP employs 3 processing strategies, including continuous-interleaved-sampling (CIS), advanced peak selection (APS) and virtual channel (Symphony) strategies. The CIS strategy employs a fixed number of analysis and stimulation channels, with the actual number being determined by the number of a subject's usable electrodes up to 24. The APS strategy is similar to an "n-of-m" strategy, with the maximum number of analysis channels being 24 while the number of stimulation channels being typically 6 to 8, dependent on the energy distribution of the input sound and the number of available electrodes. The APS strategy increases stimulation rate for improved representation of temporal fine structure. The Symphony strategy combines virtual channel and peak selection strategies to additionally improve the spectral fine structure, in which simultaneous stimulation of two electrodes is used to generate intermediate pitch percepts between two these two electrodes.

Fig. 3 shows the spectrum (upper panel) and electrodiagram (lower panel) of a Mandarin sentence of "今天你去那里?(Where are you going today?)". In this example, the electrodiagram shown is the output generated by the APS strategy, which divides a continuous frequency band between 100 and 8000 Hz into 128 linearly-spaced frequency bands. The 128 frequency bands are then combined into 24 analysis bands based on the Greenwood map spacing, of which 8 channels with peak energy are selected to deliver electrical stimulation to the appropriate electrode sites. The APS was the default strategy used to produce performance data reported in the user performance result section of this study.

3.2. Radio frequency transmission

The RF unit serves 4 functions, including (1) providing power to the implant circuit with reasonable transmission efficiency, (2) transmitting data to the implant circuit with high reliability, (3) synchronizing between the external processor and the implant circuit while providing timing for the latter, and (4) transmitting

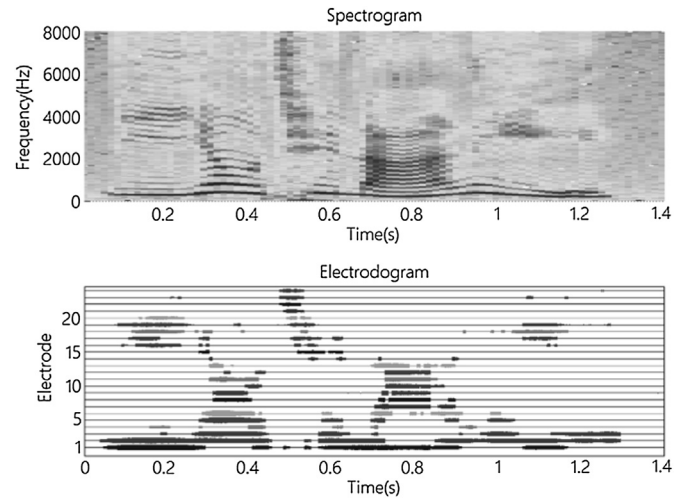

Fig. 3. The spectrogram (upper panel) and its corresponding electrodiagram of the Nurotron device (lower panel) for a Mandarin sentence "今天你去那里?(Where are you going today?)".

feedback signals to monitor the implant circuit power and status and to measure electrode impedance and neural responses to electric stimulation. To accomplish these functions, the Nurotron external processor employs Pulse Width Modulation (PWM) to encode digital signals and Amplitude Shift Keying (ASK), a method of amplitude modulation, to balance transmission efficiency and reliability. A 16-MHz sinusoid is chosen as the carrier frequency. A Class-E amplifier is employed to achieve high efficiency by maintaining the loaded RF circuit in a quasi-resonant status.

Fig. 4A shows the use of pulse width modulation to encode "0s" and "1s", in which bit "0" is coded by 5 RF cycles whereas bit "1" by 10 RF cycles. Fig. 4B shows the actually received 16-MHz RF waveform (yellow traces) in the implant circuit. Due to the Class-E amplifier's resonance status, rising ramps and post-modulation ringing are apparent in the received waveform. In addition, environmental interferences, variations in scalp thickness, and relative movement between the external and internal coils all distort the received RF signal. Therefore, a robust decoder is needed to reliably retrieve the digital information. Hysteresis trigger levels are employed so that signal patterns with 3–7 RF cycles are all decoded as bit "0", whereas that with 8–12 cycles as bit "1". Fig. 4B shows the recovered envelope of the PWM-coded "0" and "1" (green traces). This PWM-coded bit signal also provides a 1-MHz clock for the implant circuit. For back telemetry, a load modulation method, as commonly used in RFID, uses the same pair of coils to transmit the implant related data to the external processor. The implant related data include internal status of the ASIC, compliance voltage, stimulation waveform, impedance and neural responses.

3.3. Receiver and stimulator

The implant circuit receives RF signals to derive power, then to decode data and command frames to produce electric stimulation. Common techniques such as parity check, cyclic redundancy check, data boundary check, and handshaking protocols are used to validate data transmission integrity. Fig. 5A shows the layout of the Nurotron ASIC receiver and stimulator. The die size is $3594 \times 2499 \mu\text{m}^2$. The core is a hybrid CMOS chip with mixed digital and analog circuit. The chip contains 4 current sources, ensuring reliability and enabling both interleaved and simultaneous stimulation, including two-intracochlear-electrode

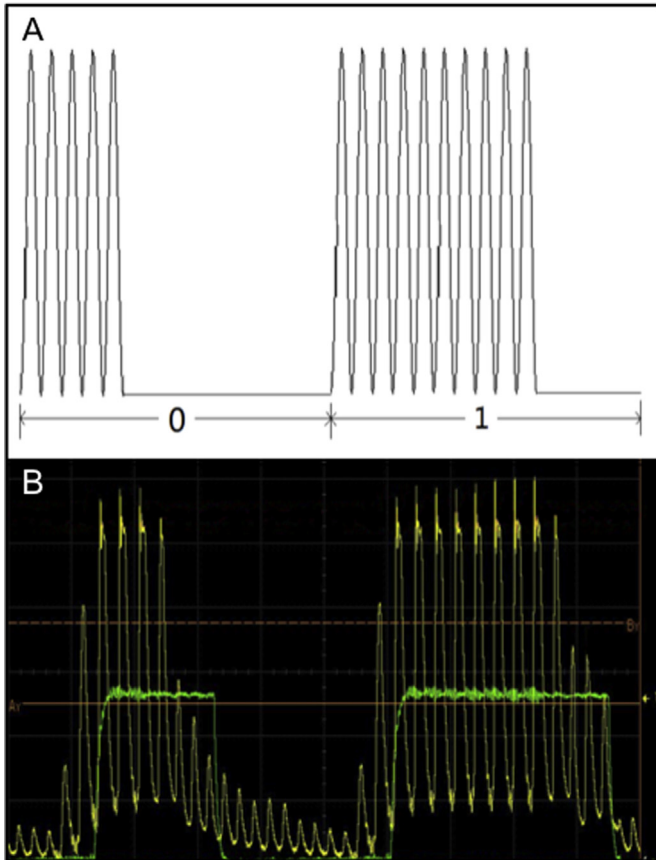

Fig. 4. The Nurotron RF encoding scheme: Panel A shows the use of pulse width modulation to encode “0s” and “1s” (Panel A) and Panel B shows the actually received 16-MHz RF waveform (yellow traces) and the recovered “0” and “1” temporal envelopes (green traces).

stimulation with the same or opposite polarity at the same time as well as tripolar stimulation involving three intracochlear electrodes.

Fig. 5B shows two biphasic pulse trains interleaved between two channels. Fig. 5C shows detailed waveform of a cathodic-leading biphasic pulse, with 25- μ s phase duration and 2- μ s inter-phase gap. Fig. 5D shows current units (x coordinates) and their corresponding current levels (y coordinates) in term of predicted values (line) and measured values (circles; from 14 current sources in 7 chips or 2 arbitrarily selected sources per chip). To take advantage of perceptual electric amplitude coding (Zeng et al., 1994), 4 different current resolutions (2, 4, 8, and 16 μ A) are used to encode the actual current ($I = 0\text{--}1904 \mu\text{A}$) into 256 clinically used Current Units (CU) that are roughly perceptually equal.

$$I(\mu\text{A}) = \begin{cases} 2CU & 0 \leq CU < 64 \\ 4(CU - 64) + 128 & 64 \leq CU < 128 \\ 8(CU - 128) + 384 & 128 \leq CU < 192 \\ 16(CU - 192) + 896 & 192 \leq CU < 256 \end{cases} \quad (1)$$

The accuracy of the current sources is estimated to be $8.0 \pm 2.6\%$ as the percent difference between the specified and measured current levels. The tolerance of the current sources is estimated to be $3.0 \pm 1.3\%$ as the ratio between the standard deviation and the mean of the measured 14 current sources. These two verification measures suggest that no individual calibration be needed in the amplitude-fitting program.

Several measures have been implemented in the ASIC to ensure safe electric stimulation. First, biphasic pulse stimulation should be charge balanced, resulting in less than 100 nA DC bias current (EN 45502-2-3: 2010). Fig. 5E shows accumulated DC current level as a function of biphasic pulse current level. Without an active discharge circuit in the ASIC, the DC level exceeds the 100-nA safe limit at 800- μ A current level and above. With the discharge circuit, the DC level was at 33 nA or less over the entire pulse current level. Second, to further balance residual charge that may be applied to tissues, a capacitor is serially connected to each of the electrodes. Third, to avoid overstimulation causing tissue damage, maximal charge of any phase is hardware limited to 250 nC (Shannon, 1992). Fig. 5F shows overstimulation protection model (dashed line) and actually measured maximal charges under different pulse duration and current level combinations (circles). Under no circumstance, does the implemented maximal charge exceed 250 nC.

Implemented on the ASIC chip is a programmable gain amplifier with a maximal gain of 60 dB and a 12-bit analog-to-digital convertor for back telemetry. As a result, a 10 μ V change can be detected to support recording of neural responses. Electrode impedance can be measured with 5% tolerance.

3.4. Electrodes (24 + 2)

A final step towards cochlear implant hearing is electric stimulation of the auditory nerve via a 24-intracochlear-electrode array. Optimally, this electrode-nerve interface should support high levels of subject performance, minimize the occurrence and severity of insertion related trauma, and demonstrate excellent long-term reliability. The physical characteristics of individual cochlear implant electrode designs have been clearly associated with the incidence of intracochlear trauma in studies using human cadaver temporal bones (Rebscher et al., 2008, 1999; Wardrop et al., 2005a; Wardrop et al., 2005b) and intracochlear trauma has been correlated with significant reductions in subject performance (Aschendorff et al., 2007; Carlson et al., 2011; Finley et al., 2008). Based on these studies, it is important for the electrode array to be sufficiently small to fit within the wide variety of scala tympani dimensions. Additionally, the Nurotron electrode array incorporates greater stiffness in the vertical plane of the cochlear spiral than in the horizontal plane which has been shown to be one successful strategy to minimize the occurrence of vertical deviation into the scala media or scala vestibuli.

The Nurotron electrode consists of an injection molded silicone elastomer carrier supporting 24 intracochlear stimulating contacts and 2 extracochlear reference electrodes. Fig. 6A shows the flexible tip and 7 most distal electrode contacts. The active contacts have an exposed surface area of 0.2 mm^2 and are located at intervals of 0.8 mm on the inner surface of the electrode to be oriented toward target neurons in the modiolus. The maximum charge density is 1.25 $\mu\text{C}/\text{mm}^2$ ($=250 \text{ nC}/0.2 \text{ mm}^2$). Taking into account that a platinum contact with smooth surface has a roughness factor of 1.4, the actual maximum charge density is more likely 0.9 $\mu\text{C}/\text{mm}^2$, well below the safety limit of electric stimulation (Brummer et al., 1983). Fig. 6B shows the contact sites and leads from the opposite side of the array. The tapered ends of each contact are securely embedded in the silicone carrier. Fig. 6C illustrates the coiled wire lead cable. The total recommended insertion length of the array is 22.0 mm, corresponding to an insertion depth of roughly 400° by a straight electrode array in an average-sized cochlea (e.g., Franke-Triegeer et al., 2014). These 24 active intracochlear contacts and the relatively deep insertion support high levels of subject performance as reported below. To accommodate the size of the human scala tympani, the Nurotron electrode array is 0.70(H) \times 0.56 mm(W) at

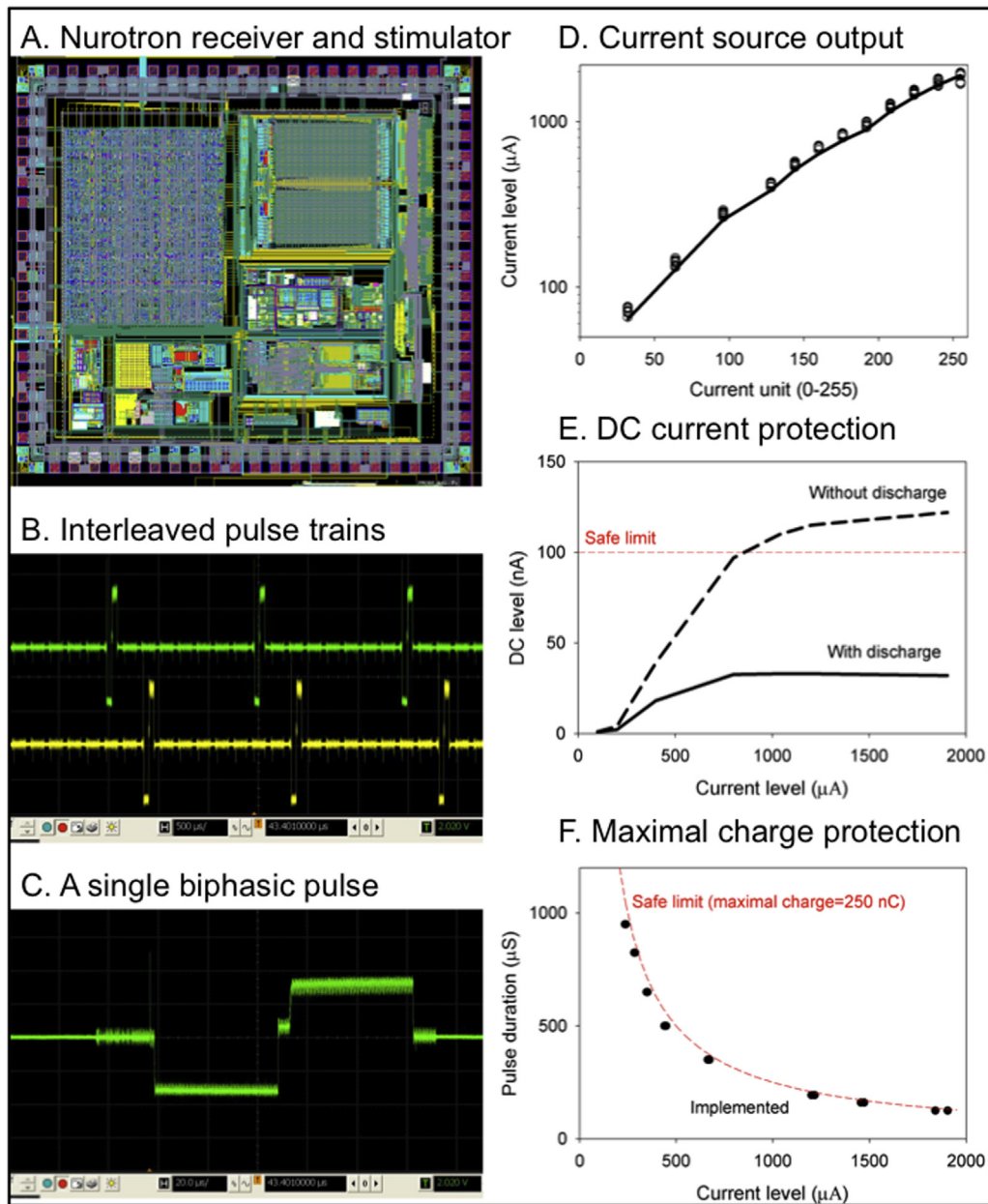

Fig. 5. The Nurotron receiver and stimulator. Panel A shows the ASIC die configuration. Panel B shows two interleaved biphasic pulse trains. Panel C shows detailed waveform of a cathodic-leading biphasic pulse, with 25- μ s phase duration and 2- μ s inter-phase gap. Panel D shows current units as a function of current levels in term of predicted values (line) and measured values (circles; from 14 current sources in 7 chips). Panel E shows accumulated DC current level as a function of biphasic pulse current level, with (solid line) and without (dashed line) an active discharge circuit. Panel F shows overstimulation protection implementation suggested by the model (dashed line) and measured by different pulse duration and current level combinations (circles).

the tip and 0.93 mm(H) \times 0.68 mm(W) at the base, which fits within all documented human scala tympani cross sections (Rebscher et al., 2008). Fig. 6D shows that the Nurotron electrode array fits within the outlines of a set of randomly selected human scala tympani cross sections in the base (90°) and near the electrode tip at 360°.

As described above, the Nurotron electrode is mechanically stiffened in the vertical plane as a strategy to reduce the incidence of damage resulting from vertical deviation of the electrode tip. Physical measurements of the array indicate a ratio of 2.5–3.0 between vertical stiffness and horizontal stiffness, similar to that reported for other electrode designs which have demonstrated significant reduction in insertion associated trauma (Rebscher et al., 2008; Wardrop et al., 2005a). Preliminary temporal bone

studies, and post-surgical clinical radiography, have confirmed that the Nurotron array can be reliably inserted to the 22 mm recommended insertion depth without significant trauma. To validate reliability, connection of the electrode array to the implanted stimulator, repetitive flex testing of the spiral coiled interconnect cable and the intracochlear electrode itself have been conducted to meet the European standard (EN 45502-2-3: 2010). A final design consideration in reducing traumatic insertions, which have been associated with poor cochleostomy placement, incomplete visualization of the basal scala tympani, angular misdirection of the electrode tip or a combination of these three factors, is to facilitate a simplified insertion technique. The Nurotron electrode is shaped as a straight array with moderate overall

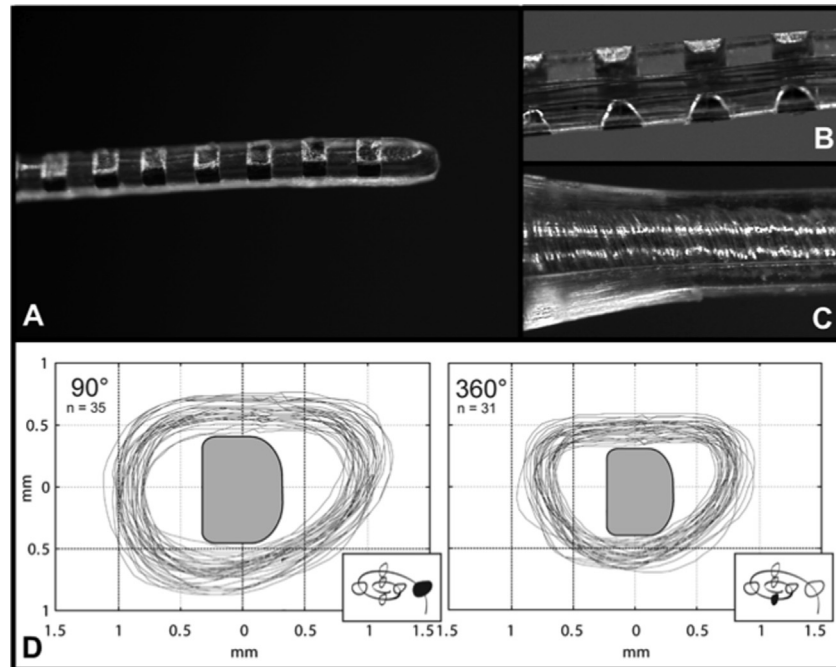

Fig. 6. The Nurotron 24 channel intracochlear electrode array. Fig. 6A shows the flexible tip of the electrode array and 7 distal sites of the 24 stimulating contacts, being equally distributed with a pitch of 0.8 mm along the 22.0 mm array and with each contact having a surface area of 0.2 mm². Fig. 6B shows the contact sites and leads from the opposite side of the array. The tapered ends of each contact are securely embedded in the silicone carrier. The organized vertical arrangement of the wire leads is also visible in this image. Fig. 6C illustrates the coiled wire lead cable. A critical factor in minimizing insertion related trauma is the fit of the electrode array within the confined cavity of the scala tympani. To ensure that the Nurotron array would safely fit in the range of cochlear dimensions observed across the subject population, the design was modeled in a series of cochlear cross section outlines (Fig. 6D) measured at 90° (35 bones) and 360° (31 bones) intervals (Rebscher et al., 2008). These measurements indicate that the Nurotron array occupies approximately 25–30% of the cross sectional area of the scala tympani at each location evaluated and fit within all scala tympani profiles previously documented.

stiffness to allow uncomplicated insertion without the need for an insertion tool or stylet.

3.5. Packaging and MRI compatibility

Twenty-five platinum feedthroughs are placed in the bottom of the titanium case and connected to an internal PCB on one end, the 24-intracochlear electrodes and the ring reference electrode on the other. The titanium case has a volume of 12.8 ml (36.4 × 33.0 × 6.9 mm³), but with only 3.9-mm spacing being expected between the skin and the mastoid surface because a 3-mm deep recess is routinely drilled in the bone to securely house the implant and minimize its movement. Three additional platinum feedthroughs on the sidewall of the case are connected to the two ends of the RF coil and the plate reference electrode, respectively. Silicone coating and molding form and shape the final package of the implant. Biocompatibility tests were performed and approved by the CFDA testing facility before human clinical trial. Hermetic seal, measured by the helium-gas leakage rate, is less than 1×10^{-9} atm cm³/second (EN 45502-2-3: 2010).

MRI compatibility at 1.5T has been verified for the Nurotron cochlear implant. In the heat generation test, the implant without the magnet, was placed into a 15-ml container filled with 9 g/l saline. An identical container without the implant served as control. 15-min MRI scan produced no significant difference in temperature between the two containers, with a temperature rise in the implant case or at the electrode tip being less than 2 °C. In addition, the MRI scan produced a charge of 0.06 nC, less than the 10-nC safe limit (EN 45502-2-3: 2010). Finally, the 15-min MRI operation produced no noticeable change in function and performance of the implant device.

4. System evaluation

4.1. Methods

4.1.1. Subjects

Sixty subjects participated in the Nurotron cochlear implant clinical trial from December 2009 to October 2010. They were 34 males and 26 females, with a mean age of 26 ± 12 years old (range = 6–59 years old). The cochlear implantation candidacy criteria followed the standard issued by Chinese Ministry of Health (Chinese Ministry of Health, 2007). The mean duration of deafness, defined as bilateral pure-tone-average thresholds (0.5, 1, 2 and 4 kHz) greater than 85 dB HL, was 7 ± 5 years (range = 0.3–15 years). The actual pre-surgical pure-tone-average thresholds were 107 ± 11 dB HL. The etiologies included ototoxicity ($n = 31$), enlarged vestibular aqueduct syndrome (7), sudden onset hearing loss (5), meningitis (2), noise exposure (2), and unknown causes (13). These subjects were from 18 provinces in China. Each subject and his or her family consented to participate in the clinical trial, with a protocol that was approved by the local Human Research Ethics Committee of each of the five participating hospitals, including Shanghai Fudan University ($n = 23$), Beijing PLA General Hospital (15), Beijing Tongren Hospital (10), Zhejiang University (7), and Chongqing Medical University (5). At the end of the first year, 3 subjects dropped out the clinical trial, with 2 being unable to be tested at the 4- and 6-month periods and 1 being disqualified for having a pre-surgical pure-tone-average threshold that was 5 dB lower than the 85 dB HL inclusion criterion. The one-year clinical trial data were submitted to Chinese FDA and received its approval on August 19, 2011. However, follow-up continued with data being collected in 48 subjects until the end of the third year; the additional 9 subjects dropped out due to their inability or unwillingness to be tested at the specified times.

4.1.2. Surgery

Twelve neurotologists, who all had prior experience in cochlear implant surgery, used a soft surgical approach to perform mastoidectomy and cochleostomy in the 60 participants. An incision was made in the skin behind the ear. A 0.44-mL, or 440-mm³, bed was created to securely house the receiver and stimulator case before entry into the middle ear. The facial recess was opened, and the bone anterior to the facial nerve was removed to provide wide exposure of the round window niche. A small cochleostomy hole was made in a position inferior and anterior to the round window niche with a 1.0- or 0.5-mm diamond burr. The cochleostomy hole was drilled until the blue lining of the endosteum became visible. A small amount of sodium hyaluronate was gently injected into the scala tympani to prevent fluid leak and entry of foreign bodies such as bone dust. Suction was prohibited at this stage to avoid loss of perilymphatic fluid. The electrode array was then inserted into the scala tympani. The cochleostomy was then sealed with a small amount of connective tissue. After implantation, electrode impedance and electrically evoked stapedius reflex were typically measured to verify device integrity and functionality. The total time of implantation ranged from 30 to 120 min, dependent on surgeon's experience and subject's condition. Although all 12 surgeons encountered no significant difficulty in inserting the electrode array, 4 recommended an insertion tool be used in the future.

To estimate the electrode position and insertion depth (Verbist et al., 2010; Xu et al., 2000), 48 subjects had X-ray of the cochlear implant after their surgeries. The average insertion depth was 449°, with a standard deviation of 79°, which was slightly deeper than the designed insertion depth of 400°. Of these 48 subjects, 37 had all of the 24 electrodes properly placed in the cochlea (e.g. Fig. 7A), whereas 11 had a buckled or mislocated electrode array, especially near the round window (e.g., Fig. 7B), indicating the need for further evaluation of the electrode design and surgical procedure. The effect of a buckled or mislocated electrode array will be addressed in the discussion section.

4.1.3. Stimuli

Two open-set tests of Mandarin sentence recognition were used for evaluation of the Nurotron cochlear implant performance. The House sentence recognition test included 10 lists of 10 phonetically-balanced sentences with each containing 7 key words (Fu et al., 2011). The 301 sentence recognition test included 12 lists of 11 sentences with each containing 6–8 key words, for a total of 57 words (Xi et al., 2012). Percentage of correctly identified words was used as the open-set sentence recognition score. Because no statistical difference was found between the two tests, the averaged scores were used in data analysis and reported here. In addition, 3 closed-set tests of Mandarin consonants, vowels, and tones were used, in which each test had four alternatives and the subject had to choose one of them (<http://www.tigerspeech.com>).

The default speech processing was the multi-peak APS strategy. The default stimulation was monopolar mode using both reference electrodes (MP1 + 2). Electrode impedance was estimated by a single biphasic pulse with a 40-μs pulse duration. The threshold and comfort loudness levels were estimated by a 500-ms, 1000-Hz biphasic pulse train. The pulse duration was either 25 or 50 μs/phase. Speech stimuli were presented to the subject at 65 dB SPL in a sound field condition.

4.1.4. Procedures

As part of the informed consent, all subjects agreed to participate in a pre-surgical test and 5 post-surgical tests at 1, 2, 4, 6 and 12 months. The additional tests at 24 and 36 months were voluntary. During each test, the subject went through a full battery of audiometric tests including air-conducted pure-tone thresholds, electric impedance, threshold (T) and comfortable (C) levels for each electrode, and both closed-set phoneme and open-set sentence recognition. In addition, the subject went through a full physical examination, including vital signs, blood and urine tests, electrocardiogram, thoracic roentgenoscopy, visual examination for surgical complications such as swelling, infection, facial paralysis, and hematoma. All tests were performed independently by

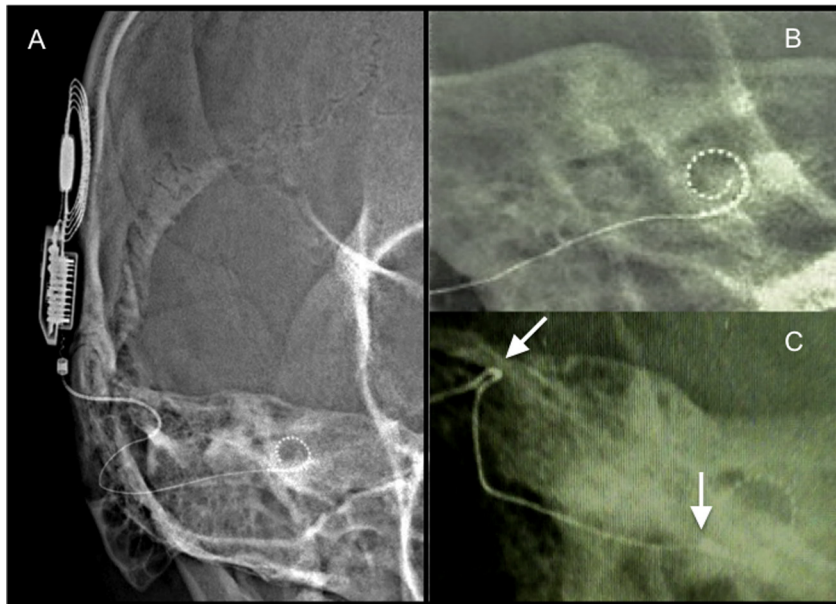

Fig. 7. *In vivo* high-resolution X-ray pictures of the Nurotron cochlear implant device. A. A user with a proper placement of the receiver, stimulator and intra-cochlear electrode array. The profile of the receiving coil, magnet, case, and feedthroughs are seen on the left side of the picture, while the electrode cable ("z" shaped in the picture) and the coiled 24-electrode contacts are seen in the lower part of the picture. B. A user with a smooth electrode cable and electrode contacts near round window. C. A user with a buckled electrode cable (upper arrow) and knotted electrode contacts near round window (lower arrow). The buckled cable was likely due to improper pinch by surgical tweezers while the knotted contacts were due to forceful insertion. This subject had 6 unusable electrode contacts and a 73% correct sentence recognition score.

audiologists and physicians, under supervision of a certified contract research organization.

4.2. Results I: objective measures

During the first year clinical trial period, 6 adverse events were noted, including 2 possibly related to surgery (swelling in the eyelid and swelling in the surgery area) and 4 unrelated to the surgery or the device (2 mild fatty liver cases, 1 acute nephritis, and 1 upper respiratory tract infection). The physicians determined that none of these adverse events was directly related to the Nurotron device.

Fig. 8 shows impedance as a function of electrode position at the device switch-on time (upper panel) and as a function of the implant usage time (lower panel). At the time of switch on, electrode impedance was 13 ± 3 k Ω , which was not significantly different as a function of electrode position [$F(23,771) = 0.7, p > 0.05$; univariate ANOVA]. However, the impedance averaged over the entire electrode array changed significantly with implant use [$F(23,242) = 20.2, p < 0.01$]. The average impedance decreased significantly by 6 k Ω from switch on to 1 month, stayed unchanged over the 12-month period ($p > 0.05$), and increased significantly by 2 k Ω at the 24-month evaluation ($p < 0.05$; *Post Hoc* tests with Bonferroni correction for these and other comparisons in the remainder of the results section).

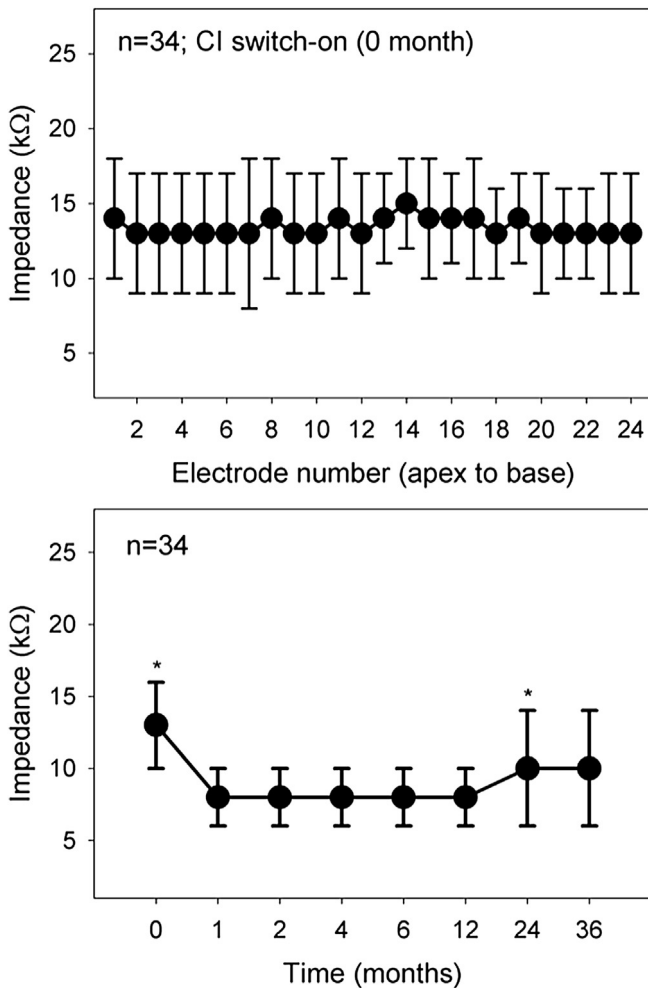

Fig. 8. Average electrode impedance as a function of electrode position at the device switch-on time (upper panel) and as a function of device usage time (lower panel). The “*” symbol indicates significance at $p < 0.05$ level.

4.3. Results II: psychophysical measures

The upper panel of Fig. 9 shows threshold (T) and comfortable (C) levels as a function of electrode position at the device switch-on time. Both T and C levels showed a significantly increasing trend as a function of electrode position at the time of switch on [$F(23,711) = 3.1, p < 0.01, F(23,717) = 3.3, p < 0.01$, for T and C levels respectively]. Compared with the most apical electrode (#1), post-hoc analysis revealed significant higher T levels for electrode 23 and 24 and higher C levels for electrodes 22, 23 and 24 ($p < 0.05$). Note that these different T and C levels cannot be attributed to electrode impedance, which was not significantly different between electrodes (Fig. 8).

The lower panel of Fig. 9 shows the averaged T and C levels over the entire electrode array as a function of the implant usage time. The T level had been stable over the 36 month period [$F(7,226) = 0.4, p > 0.05$]. Interestingly, the C level increased over time [$F(7,226) = 2.3, p < 0.05$], with the C level at 36 months being significantly greater than that at the time of switch on [$p < 0.05$]. This increased C level possibly reflects the increased tolerance to electric stimulation of the auditory nerve (Zeng, 2013).

4.4. Results III: functional measures

Fig. 10 shows that sentence recognition varied greatly among subjects (dotted lines) but improved significantly as a function of implant usage over the 36-month period [$F(7,426) = 132, p < 0.01$].

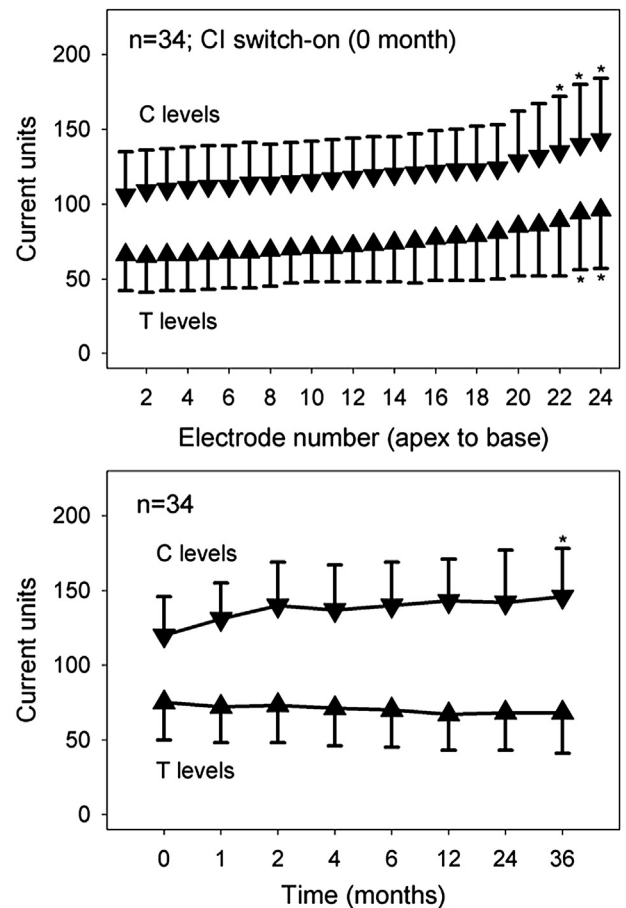

Fig. 9. Average T and C levels as a function of electrode position at the device switch-on time (upper panel) and as a function of device usage time (lower panel). The “*” symbol indicates significance at $p < 0.05$ level.

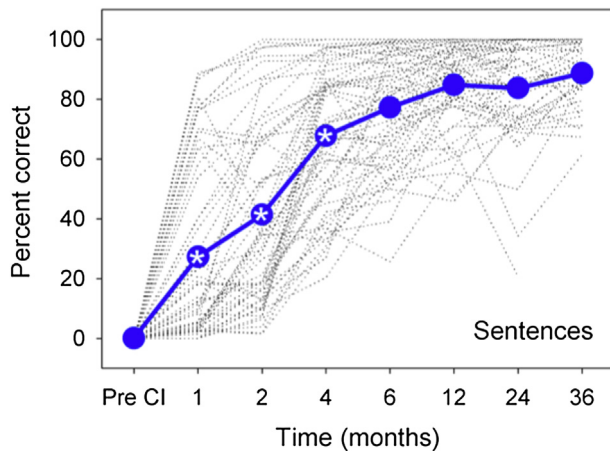

Fig. 10. Individual (dotted lines) and average (circles connected by a solid line) sentence recognition scores as a function of device usage time. The "*" within the circle represents a significant difference over the previous test time.

Post-hoc analysis revealed significant improvement from an average score of 0.03% correct before cochlear implantation to 27%, 41% and 68% correct at the 1-, 2- and 4-month test time, respectively ($p < 0.05$). The cochlear implant performance reached a plateau after 6 months, with the highest recognition of 89% at the 36-month evaluation.

Using the same format, Fig. 11 shows percent correct recognition as functions of time for consonants (upper panel), vowels (middle panel) or tones (lower panel). Overall, phoneme recognition was similar to sentence recognition (Fig. 11), varying greatly among subjects (dotted lines) and improved significantly as a function of time [$F(7,426) > 45, p < 0.01$]. Different from sentence recognition, consonant and vowel recognition reached a plateau after only 4-month usage. Similar to sentence recognition, tone recognition reached a plateau after 6-month usage, reinforcing the importance of tone recognition in Mandarin speech recognition (Fu et al., 1998).

5. Discussion

In this section, the Nurotron device is compared against other devices from both technical and performance perspectives. Several relevant studies using the Nurotron device are also summarized and discussed. Finally, the socio-economical impact of the present developmental effort is discussed.

5.1. Technical comparison

Table 1 compares key technical parameters of the Nurotron cochlear implant against presently available devices by the three major cochlear implant manufacturers. Although the Nurotron device was conceived in 2005 and developed into a product in 2008, it is still technically comparable by today's standards. A reason for this comparability is that cochlear implant advances in the last decade have been mostly in pre-processing and cosmetics, with little changes in speech processing strategies, RF transmission and receiver and electrode arrays.

In terms of the external unit, all devices, including the Nurotron device, have similar technical parameters from a relatively wide input dynamic range (75–80 dB) and a frequency range (~8000 Hz) to the default processing strategy (CIS-like) and the number of maps in the processor (4–5). Note that the Nurotron processor has the shortest battery life, reflecting a lack of design consideration for optimal power consumption. Also note that the Nurotron processor

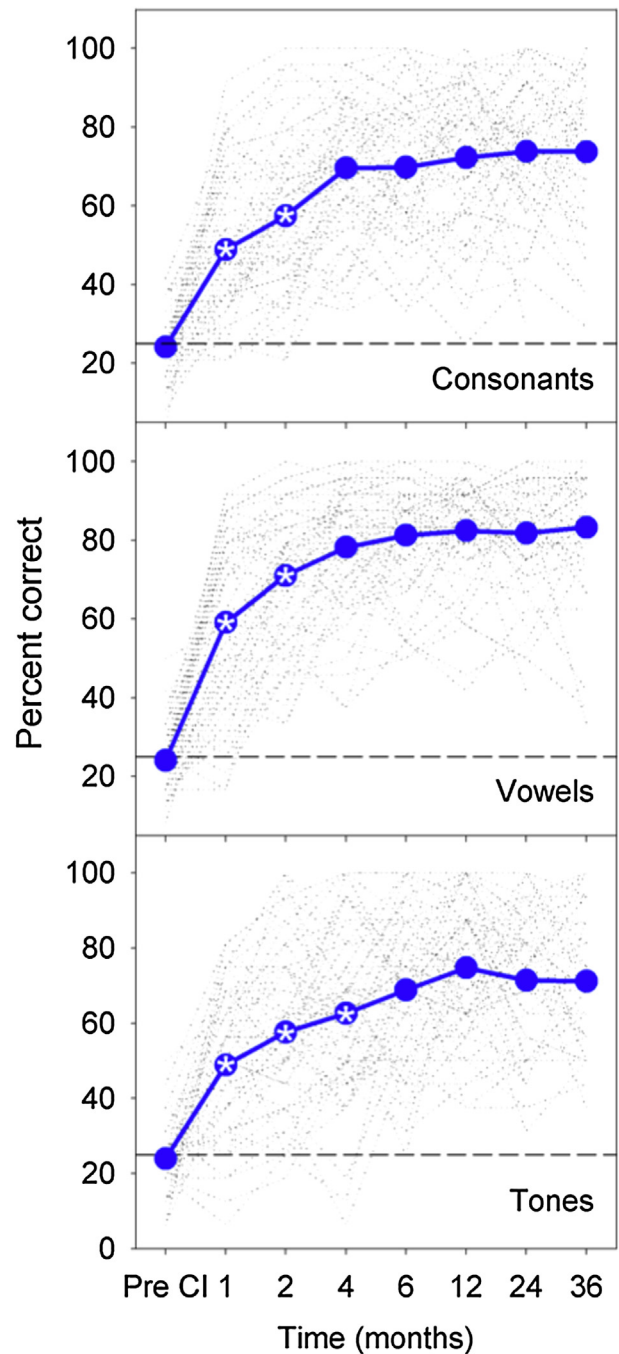

Fig. 11. Individual (dotted lines) and average (circles connected by a solid line) recognition scores as a function of device usage time for consonants (upper panel), vowels (middle panel) and tones (lower panel). The "*" within the circle represents a significant difference over the previous test time.

lacks wireless connectivity, reflecting design priority considerations in 2005. Both power consumption and connectivity problems are being addressed by Nurotron, but are beyond the scope of discussion for the present study.

Although there is no manufacturer-specific systematic report on *in vivo* electrode array status, buckled or mislocated electrode arrays are believed to be present in all devices, e.g., as high as 40% electrodes mislocated in scala vestibuli in some cases (Holden et al., 2013; Kong et al., 2012; Skinner et al., 2007; Wardrop et al., 2005a, 2005b). It is unclear whether the incidence of the presently

Table 1

System specifications of the Nurotron 26-electrode cochlear implant compared with other three major cochlear implant systems. Data Sources: Cochlear N6 (User Guide and Technical Specifications from www.cochlear.com); Clarion HiRes 90 K (www.bionicear.com); Med El Maestro implant system (Hochmair et al., 2006). Additional information from. <http://cochlearimplantonline.com>

System units	Parameters	Nurotron Venus	Nucleus N6	AB HiRes 90 K	Med-El MAESTRO
External unit	Name and key features	Venus: Omni or directional mics	N6: Omni or directional mics	Harmony: T-mic	OPUS2: Omni mic
		IDR (75 dB)	IDR (–75 dB)	Dual-loop AGC	Dual-loop AGC
		Freq range: 100–8000 Hz	Freq range: 100–8000 Hz	IDR (20–80 dB)	IDR (–75 dB)
		Li-Ion or 3 Zinc Air batteries (8–24 h)	2 Zinc Air or recharge. batteries (18–60 h)	Freq range: 150–8000 Hz	Freq range: 70–8500 Hz
Processing strategies	CIS	SPEAK	CIS	CIS+	
	APS	ACE	MPS	HD CIS	
	Virtual channel	Hi-ACE	HiRes Fidelity 120	FSP	
Number of maps	4	4	5	4	
Connectivity	Direct Audio Input	Direct Audio Input	Direct Audio Input	Direct Audio Input	
	Wireless	Wireless	Wireless	Wireless	
RF unit	RF carrier	16 MHz	5 MHz	49 MHz	12 MHz
	Data rate	0.9 MB/Sec	0.5 MB/Sec	1 MB/Sec	0.6 MB/Sec
Internal unit	Total stimulation rate	40 KHz	32 KHz	83 KHz	51 KHz
	Number of current sources	4	1	16	24
	Max current	1.9 mA	1.75 mA	1.9 mA	1.2 mA
	Number of intracochlear electrodes	24	22	16	12
	Number of reference electrodes	2	2	2	2
	Simultaneous stimulation	Yes	No	Yes	Yes
	Fitting unit	Impedance measure	Yes	Yes	Yes
	Chinese Interface	Yes	No	No	No

reported 11 cases of buckled electrodes is comparable to other devices, and whether these cases are due to the inexperience of some of the surgeons themselves, or their unfamiliarity with a new device. Nevertheless, post-surgical analysis showed that the average number of unusable electrodes is 4 (range = 0–13) in subjects with buckled or mislocated arrays, compared with 1 (range = 0–10) in other subjects. The corresponding average sentence recognition score was $70 \pm 18\%$, compared with $79 \pm 19\%$ correct. Neither the difference in the number of unusable electrodes nor that in the sentence recognition score reaches a statistically significant level ($p > 0.05$), possibly due to the relatively small sample size. To highlight the complicated subject and device interactions, the subject with the most unusable electrodes (=13) actually had one of the highest sentence recognition score (=92%).

Except for having the most intracochlear electrodes, the key technical parameters for the Nurotron RF and internal units are roughly in the middle of other currently available devices. For example, the 16-MHz RF carrier is lower than the 49-MHz AB device but higher than the 5-MHz Nucleus and 12-MHz Med El devices; the 40-KHz total stimulation rate is higher than the 32-KHz Nucleus device but lower than the 83-KHz AB and 51-KHz Med El devices; the 4 current sources are more than the 1-source Nucleus device but less than the 16-source AB and 24-source Med El devices. As can be seen from the remainder of the discussion, these differences in technical parameters reflect philosophical differences in design but have not produced any measurable differences in performance.

5.2. Performance comparison

The Nurotron device has produced similar performance to other devices in terms of basic objective and subjective measures. The present electrode impedance (Fig. 8) and stimulation level (Fig. 9) effects are generally consistent with a large body of existing studies from other cochlear implant devices (e.g., Henkin et al., 2003, 2005, 2006; Hughes et al., 2001; Mosca et al., 2014; van Wermeskerken et al., 2006). In addition to a larger sample size and longer

observation time (3 years vs. 1–2 years), the present study extends previous studies in the following ways. First, the absence of electrode position effect on impedance (Fig. 8A) suggests that electrode impedance reflects mostly the electrode physical properties such as area and the dynamic interplay between electrode and nearby tissues in electric stimulation (e.g., Clark et al., 1995), whereas the presence of electrode position effect on loudness levels (Fig. 9A) suggests that behavioral measures reflect more the overall electric field property, the survival nerve extent and distribution, and central factors (e.g., Tang et al., 2011). The non-monotonic function of impedance versus time (Fig. 8B) and the monotonic function of loudness versus time (Fig. 9B) lend further support for the idea that increased loudness tolerance with prolonged electric stimulation reflects more a decreased central gain in the brain rather than changes in electric properties in the cochlea (Zeng, 2013). The greater amount of this loudness change in children than in adults (e.g., Henkin et al., 2003, 2005, 2006; Hughes et al., 2001) is consistent with greater plasticity in the developing brain.

The Nurotron device has produced functionally indistinguishable performance from other devices in speech recognition measures. Fig. 12A shows comparison in sentence recognition between 4 cochlear implants. The Advanced Bionics data were from 51 subjects who had used the HiRes processing strategy for 3 months after prior 3-month experience with conventional strategies, CIS or SAS (Koch et al., 2004). The Med El data were 14 subjects who had used the fine structure processing strategy after an average 1-year experience with the CIS strategy (Arnoldner et al., 2007). The Cochlear data were from 55 subjects who participated in the Nucleus Freedom North America clinical trial and had used the Freedom device for 6 months (Balkany et al., 2007). As a comparison, the Nurotron data were from the 6-month performance, which was significantly higher than the 3-month performance but lower than, although not significantly different from, the 1-year performance (Fig. 10). Despite the fact that Advanced Bionics and Cochlear used English sentences, Med El used German sentences and Nurotron used Mandarin sentences, and additionally these clinical trials were conducted by different researchers and under

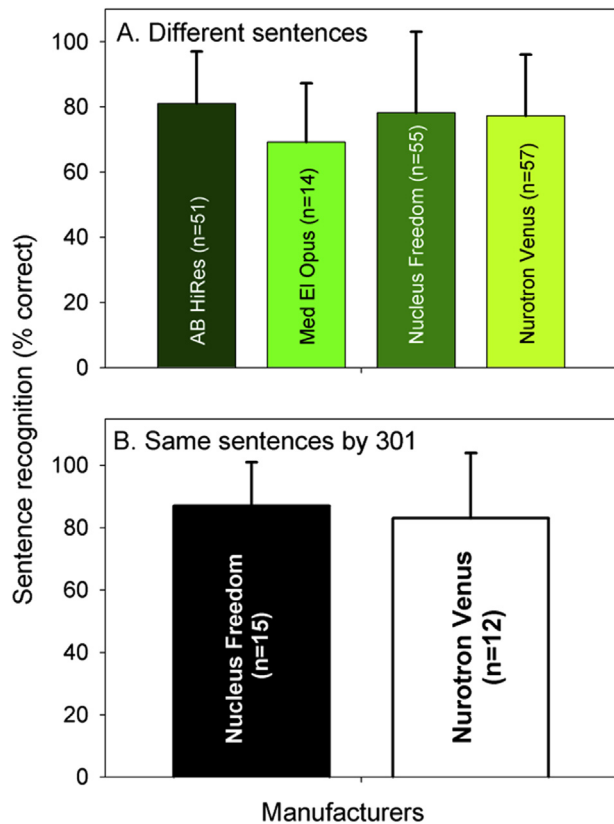

Fig. 12. Sentence recognition between the Nurotron device and the other three devices using different test materials and protocols (upper panel) and sentence recognition between the Nurotron and Cochlear devices using the same test materials and protocols (lower panel).

different protocols, all 4 devices produced functionally equivalent performance between 60 and 80% correct for sentence recognition in quiet.

In a more tightly controlled study, researchers at Beijing 301 Hospital (Li et al., 2014) directly compared performance between Nucleus and Nurotron devices by recruiting two groups of subjects who were matched in age (29 ± 13 vs. 25 ± 9 years old), duration of deafness (7 ± 5 vs. 7 ± 4 years), gender (9 males and 6 females vs. 10 males and 5 females), and other audiological and etiological factors. Using the same surgical and evaluation protocols including the same Mandarin speech test materials, they found no statistically difference in performance between these two devices. Fig. 12B replots the subjects' sentence recognition data after 2-year usage of their respective Nucleus and Nurotron devices. The Nucleus users produced $87 \pm 14\%$ correct score while the Nurotron users produced $83 \pm 21\%$ score. The high level of speech performance by the Nurotron device as well as its ability to improve quality of life has been independently verified by other researchers at Beijing Tongren Hospital (Liu et al., 2014), Central South University Xiangya Hospital (Yu, 2013), and China Rehabilitation Research Center for Deaf Children (Yu, 2013).

5.3. Socio-economical impact

Thanks to pioneers such as William House, Blair Simmons, Robin Michelson (Eisenberg ref and Merzenich ref in this issue), as well as the three 2013 Lasker Award winners: Graeme Clark, Ingeborg Hochmair and Blake Wilson, the cochlear implant has helped restored partial hearing to more than 300,000 adults and

children worldwide. Unfortunately, only a fraction of the current cochlear implant users reside in developing countries, despite the fact that these countries boast more than 80% of the world population. While a lack of competition, a lack of awareness and a lack of access all contribute to some extent, high price is the prohibitive factor limiting the widespread use of the cochlear implant (Zeng, 2007).

To our knowledge, the Nurotron cochlear implant represents the first time an implantable, active medical device has ever been developed and manufactured in a developing country. Although the commercial operation is still in infancy, the successful development of the Nurotron device, as shown here, has not only broken technical barriers, but also produced a significant socio-economical impact. Thanks to this emerging product and the competition it has brought about, at present, 3 deaf children in China can benefit from the cochlear implant for the price that would allow only child to receive a device several years ago. It is expected that the cochlear implant will continue to drop in cost while improving performance, benefitting hearing-impaired people living in both developed and developing countries.

6. Summary

The present article describes the development and evaluation of a 26-electrode Nurotron cochlear implant that is comprised of an external sound processor, a radio-frequency transmission link and an internal receiver and stimulator. The default sound processing strategy uses multi-peak interleaved stimulation, while the default mode is monopolar stimulation with an active electrode being one of the 24 intracochlear electrodes and both extra-cochlear electrodes being the reference. Sixty severe-to-profoundly hearing-impaired subjects had participated in a 1-year clinical trial with some of them being continuously followed up for 3 years. Similar to other commercially available cochlear implants, the Nurotron device showed a decrease in electrode impedance within the first month implant use, a stable threshold level, and an increased comfort level over the 3-year period. Mandarin speech recognition significantly improved from the pre-implantation level to 4-month usage, reaching a plateau high-level performance of about 80% correct after 6-month usage. Both indirect and direct comparisons indicated that the Nurotron 26-electrode cochlear implant and other commercially available devices produced indistinguishable performance.

Acknowledgement

We thank our scientific advisory board members, Robert Shannon, Jay Rubinstein, Van Harrison, Keli Cao, Qin Gong, Demin Han, Weijia Kong, Qiujiu Wang, Xiaoqin Wang, Zhengmin Wang, Li Xu, and Limei Yu for their advice and encouragement. We also thank Guofang Tang, Wenhe Tu, Tom Lu, Van Harrison, and Alex Hetherington for their help and support. We would like to dedicate this study to the 60 courageous human subjects and their families who trusted our work and participated in the clinical trial of the Nurotron cochlear implant. The work presented was supported in part by the Chinese Ministry of Science and Technology (The 11.5 Key Project of the National Science and Technology Pillar Program 2008BAI50B08).

References

- An, S.K., Park, S.I., Jun, S.B., Lee, C.J., Byun, K.M., Sung, J.H., Wilson, B.S., Rebscher, S.J., Oh, S.H., Kim, S.J., 2007. Design for a simplified cochlear implant system. *IEEE Trans. Biomed. Eng.* 54, 973–982.

- Arnoldner, C., Riss, D., Brunner, M., Durisin, M., Baumgartner, W.D., Hamzavi, J.S., 2007. Speech and music perception with the new fine structure speech coding strategy: preliminary results. *Acta Otolaryngol.* 127, 1298–1303.
- Aschendorff, A., Kromeier, J., Klenzner, T., Laszig, R., 2007. Quality control after insertion of the nucleus contour and contour advance electrode in adults. *Ear Hear* 28, 755–795.
- Balkany, T., Hodges, A., Menapace, C., Hazard, L., Driscoll, C., Gantz, B., Kelsall, D., Luxford, W., McMenomy, S., Neely, J.G., Peters, B., Pillsbury, H., Roberson, J., Schramm, D., Telian, S., Waltzman, S., Westerberg, B., Payne, S., 2007. Nucleus Freedom North American clinical trial. *Otolaryngol. Head. Neck Surg.* 136, 757–762.
- Brummer, S.B., Robblee, L.S., Hambrecht, F.T., 1983. Criteria for selecting electrodes for electrical stimulation: theoretical and practical considerations. *Ann. N. Y. Acad. Sci.* 405, 159–171.
- Carlson, M.L., Driscoll, C.L., Gifford, R.H., Service, G.J., Tombers, N.M., Hughes-Borst, B.J., Neff, B.A., Beatty, C.W., 2011. Implications of minimizing trauma during conventional cochlear implantation. *Otol. Neurotol.* 32, 962–968.
- Chinese Ministry of Health, 2007. Technical standard of cochlear implant in clinical practice. *Chin. J. Otorhinolaryngol. Head Neck Surg.* 42, 323.
- Clark, G.M., Shute, S.A., Shepherd, R.K., Carter, T.D., 1995. Cochlear implantation: osteoneogenesis, electrode-tissue impedance, and residual hearing. *Ann. Otol. Rhinol. Laryngol.* 104, 40–42.
- European, 2010. EN 45502-2-3:2010 Active Implantable Medical Devices – Part 2-3: Particular Requirements for Cochlear and Auditory Brainstem Implant Systems.
- Finley, C.C., Holden, T.A., Holden, L.K., Whiting, B.R., Chole, R.A., Neely, G.J., Hullar, T.E., Skinner, M.W., 2008. Role of electrode placement as a contributor to variability in cochlear implant outcomes. *Otol. Neurotol.* 29, 920–928.
- Franke-Trieger, A., Jolly, C., Darbinjan, A., Zahnert, T., Murbe, D., 2014. Insertion depth angles of cochlear implant arrays with varying length: a temporal bone study. *Otol. Neurotol.* 35, 58–63.
- Fu, Q.J., Zhu, M., Wang, X., 2011. Development and validation of the Mandarin speech perception test. *J. Acoust. Soc. Am.* 129, EL267–273.
- Fu, Q.J., Zeng, F.G., Shannon, R.V., Soli, S.D., 1998. Importance of tonal envelope cues in Chinese speech recognition. *J. Acoust. Soc. Am.* 104, 505–510.
- Henkin, Y., Kaplan-Neeman, R., Muchnik, C., Kronenberg, J., Hildesheimer, M., 2003. Changes over time in electrical stimulation levels and electrode impedance values in children using the Nucleus 24M cochlear implant. *Int. J. Pediatr. Otorhinolaryngol.* 67, 873–880.
- Henkin, Y., Kaplan-Neeman, R., Kronenberg, J., Migirov, L., Hildesheimer, M., Muchnik, C., 2005. Electrical stimulation levels and electrode impedance values in children using the Med-El Combi 40+ cochlear implant: a one year follow-up. *J. Basic Clin. Physiol. Pharmacol.* 16, 127–137.
- Henkin, Y., Kaplan-Neeman, R., Kronenberg, J., Migirov, L., Hildesheimer, M., Muchnik, C., 2006. A longitudinal study of electrical stimulation levels and electrode impedance in children using the Clarion cochlear implant. *Acta Otolaryngol.* 126, 581–586.
- Hochmair, I., Nopp, P., Jolly, C., Schmidt, M., Schosser, H., Garnham, C., Anderson, I., 2006. MED-EL Cochlear implants: state of the art and a glimpse into the future. *Trends Amplif.* 10, 201–219.
- Holden, L.K., Finley, C.C., Firszt, J.B., Holden, T.A., Brenner, C., Potts, L.G., Gotter, B.D., Vanderhoof, S.S., Mispagel, K., Heydebrand, G., Skinner, M.W., 2013. Factors affecting open-set word recognition in adults with cochlear implants. *Ear Hear* 34, 342–360.
- Hughes, M.L., Vander Werff, K.R., Brown, C.J., Abbas, P.J., Kelsay, D.M., Teagle, H.F., Lowder, M.W., 2001. A longitudinal study of electrode impedance, the electrically evoked compound action potential, and behavioral measures in nucleus 24 cochlear implant users. *Ear Hear* 22, 471–486.
- Koch, D.B., Osberger, M.J., Segel, P., Kessler, D., 2004. HiResolution and conventional sound processing in the HiResolution bionic ear: using appropriate outcome measures to assess speech recognition ability. *Audiol. Neurootol.* 9, 214–223.
- Kong, W.J., Cheng, H.M., Ma, H., Wang, Y.J., Han, P., 2012. Evaluation of the implanted cochlear implant electrode by CT scanning with three-dimensional reconstruction. *Acta Otolaryngol.* 132, 116–122.
- Li, J., Ji, F., Chen, W., Zhao, H., Han, D., Yang, S., 2014. Analysis of the performance of post-lingually deafened patients with Nurotron(R) Venus cochlear implants. *Acta Otolaryngol.* 134, 609–614.
- Liu, B., Dong, R., Chen, X., Gong, S., Li, Y., Qi, B., Zheng, J., Han, D., 2014. Lexical tone perception and quality of life in nurotron cochlear implant users. *J. Clin. Otorhinolaryngol. – Head Neck Surg.* 28, 232–237 (in Chinese).
- Mosca, F., Grassia, R., Leone, C.A., 2014. Longitudinal variations in fitting parameters for adult cochlear implant recipients. *Acta Otorhinolaryngol. Ital.* 34, 111–116.
- Rebscher, S., Hetherington, A., Bonham, B., Wardrop, P., Whinney, D., Leake, P.A., 2008. Considerations for design of future cochlear implant electrode arrays: electrode array stiffness, size and depth of insertion. *J. Rehab. Res. Dev.* 45, 731–747.
- Rebscher, S.J., Heilmann, M., Bruszewski, W., Talbot, N.H., Snyder, R.L., Merzenich, M.M., 1999. Strategies to improve electrode positioning and safety in cochlear implants. *IEEE Trans. Biomed. Eng.* 46, 340–352.
- Shannon, R.V., 1992. A model of safe levels for electrical stimulation. *IEEE Trans. Biomed. Eng.* 39, 424–426.
- Skinner, M.W., Holden, T.A., Whiting, B.R., Voie, A.H., Brunson, B., Neely, J.G., Saxon, E.A., Hullar, T.E., Finley, C.C., 2007. In vivo estimates of the position of advanced bionics electrode arrays in the human cochlea. *Ann. Otol. Rhinol. Laryngol. Suppl.* 197, 2–24.
- Tang, Q., Benitez, R., Zeng, F.G., 2011. Spatial channel interactions in cochlear implants. *J. Neural Eng.* 8, 046029.
- Union, T.E., 2010. EN 45502-2-3:2010 Active Implantable Medical Devices – Part 2-3: Particular Requirements for Cochlear and Auditory Brainstem Implant Systems.
- van Wermeskerken, G.K., van Olphen, A.F., Smoorenburg, G.F., 2006. Intra- and postoperative electrode impedance of the straight and Contour arrays of the Nucleus 24 cochlear implant: relation to T and C levels. *Int. J. Audiol.* 45, 537–544.
- Verbist, B.M., Skinner, M.W., Cohen, L.T., Leake, P.A., James, C., Boex, C., Holden, T.A., Finley, C.C., Roland, P.S., Roland Jr, J.T., Haller, M., Patrick, J.F., Jolly, C.N., Faltys, M.A., Briaire, J.J., Frijns, J.H., 2010. Consensus panel on a cochlear coordinate system applicable in histologic, physiologic, and radiologic studies of the human cochlea. *Otol. Neurotol.* 31, 722–730.
- Wardrop, P., Whinney, D., Rebscher, S.J., Luxford, W., Leake, P., 2005a. A temporal bone study of insertion trauma and intracochlear position of cochlear implant electrodes. II: comparison of Spiral Clarion and HiFocus II electrodes. *Hear. Res.* 203, 68–79.
- Wardrop, P., Whinney, D., Rebscher, S.J., Roland, J.T.J., Luxford, W., Leake, P.A., 2005b. A temporal bone study of insertion trauma and intracochlear position of cochlear implant electrodes. I: comparison of nucleus banded and nucleus contour electrodes. *Hear. Res.* 203, 54–67.
- Wilson, B.S., Dorman, M.F., 2008. Cochlear implants: a remarkable past and a brilliant future. *Hear. Res.* 242, 3–21.
- Wilson, B.S., Rebscher, S., Zeng, F.G., Shannon, R.V., Loeb, G.E., Lawson, D.T., Zerbi, M., 1998. Design for an inexpensive but effective cochlear implant. *Otolaryngol. Head. Neck Surg.* 118, 235–241.
- Xi, X., Ching, T.Y., Ji, F., Zhao, Y., Li, J.N., Seymour, J., Hong, M.D., Chen, A.T., Dillon, H., 2012. Development of a corpus of Mandarin sentences in babble with homogeneity optimized via psychometric evaluation. *Int. J. Audiol.* 51, 399–404.
- Xu, J., Xu, S.A., Cohen, L.T., Clark, G.M., 2000. Cochlear view: postoperative radiography for cochlear implantation. *Am. J. Otol.* 21, 49–56.
- Yu, L.M., 2013. Rehabilitative effects of the nurotron cochlear implant on children. *Chin. Med. News Rev. – Otolaryngol.* 28, 247–248.
- Zeng, F.G., 1995. Cochlear implants in China. *Audiology* 34, 61–75.
- Zeng, F.G., 2007. Cochlear implants: why don't more people use them? *Hear. J.* 60, 48–49.
- Zeng, F.G., 2013. An active loudness model suggesting tinnitus as increased central noise and hyperacusis as increased nonlinear gain. *Hear. Res.* 295, 172–179.
- Zeng, F.G., Shannon, R.V., 1994. Loudness-coding mechanisms inferred from electric stimulation of the human auditory system. *Science* 264, 564–566.
- Zeng, F.G., Rebscher, S., Harrison, W., Sun, X., Feng, H.H., 2008. Cochlear implants: system design, integration and evaluation. *IEEE Rev. Biomed. Eng.* 1, 115–142.