

Lawrence Berkeley National Laboratory

LBL Publications

Title

Small Radius Coarse Field Cage Insulation

Permalink

<https://escholarship.org/uc/item/5bj5w3dv>

Author

Perry, Fred

Publication Date

1981



Lawrence Berkeley Laboratory

UNIVERSITY OF CALIFORNIA

Engineering & Technical Services Division

RECEIVED
LAWRENCE
BERKELEY LABORATORY
APR 1 1982
LIBRARY AND
DOCUMENTS SECTION

For Reference

Not to be taken from this room

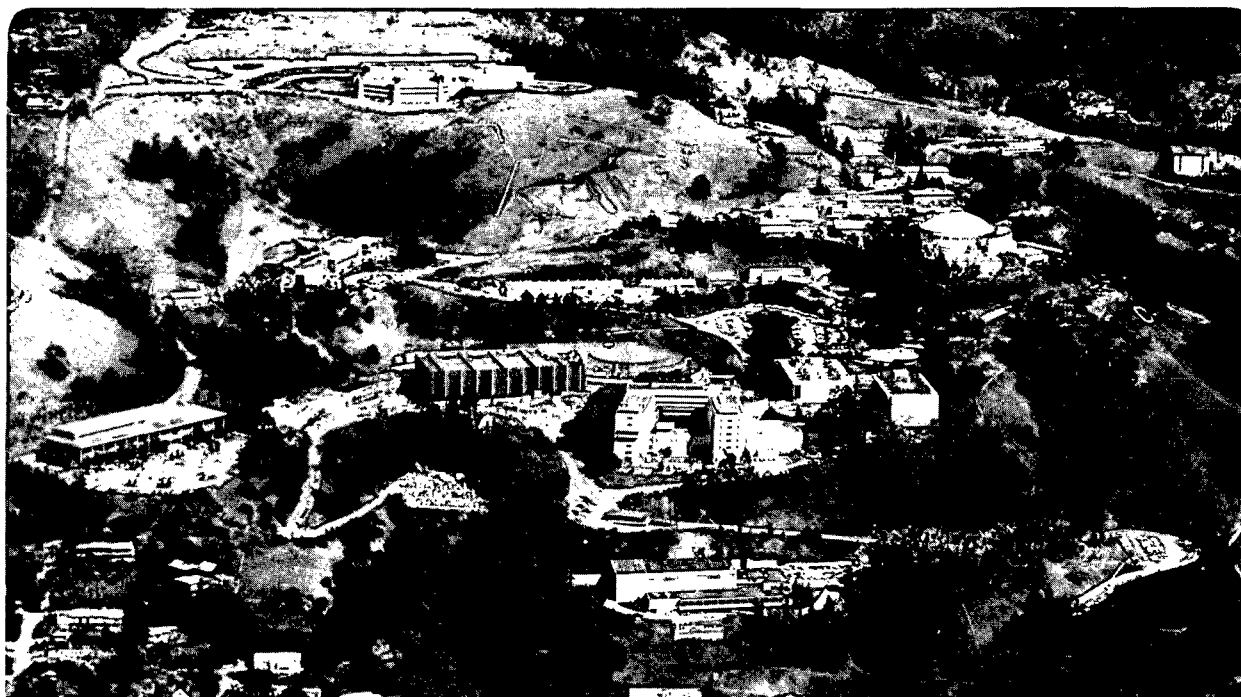

LBID-345 Rev.
c.1

DISCLAIMER

This document was prepared as an account of work sponsored by the United States Government. While this document is believed to contain correct information, neither the United States Government nor any agency thereof, nor the Regents of the University of California, nor any of their employees, makes any warranty, express or implied, or assumes any legal responsibility for the accuracy, completeness, or usefulness of any information, apparatus, product, or process disclosed, or represents that its use would not infringe privately owned rights. Reference herein to any specific commercial product, process, or service by its trade name, trademark, manufacturer, or otherwise, does not necessarily constitute or imply its endorsement, recommendation, or favoring by the United States Government or any agency thereof, or the Regents of the University of California. The views and opinions of authors expressed herein do not necessarily state or reflect those of the United States Government or any agency thereof or the Regents of the University of California.

ENGINEERING NOTE

CODE

P40406

SERIAL

M-5653 A

PAGE

1 of 40

AUTHOR

FRED PERRY

DEPARTMENT

Mechanical Engineering

LOCATION

Berkeley

DATE

22 January 1981

PROGRAM - PROJECT - JOB

PEP-4

FIELD CAGES

TITLE

SMALL RADIUS COARSE FIELD CAGE INSULATION

A Revision 11/12/81 *D.D.M.*

Subject: Manufacture of Small Radius Insulator

- (1) Subsequent pages are a document of Sheldahl Incorporation North Field Minnesota Manufacture of the insulation for small radius coarse field cage. This document describes the method and processes that were used to install the small radius insulation.
- (2) This note also contains L.B.L. participation in construction and gives detail information of problems that were encountered and methods and processes that were used to construct the insulation for the small radius field cage.

Drawing No. that pertain to construction of insulation at Sheldahl are listed below:-

Nos.: 19Q2804
 19Q2796
 19Q2784

/nyc

REVISIONS

LTR	SHT	DESCRIPTION	ECO	DATE	ENG APPR	DOC APPR
-	ALL	FOR PRODUCTION RELEASE		11-7-80	<i>[Signature]</i>	<i>[Signature]</i>
A	ALL	Revised and retyped.	21266	11/29/80	<i>[Signature]</i>	<i>[Signature]</i>

JAN 21 1981

CUSTOMER USE ONLY

SHT	1	2	3	4	5	6	7	8	9	10	11	12	13	14						
REV	A	A	A	A	A	A	A	A	A	A	A	A	A	A						
SHT																				
REV																				

SIGNATURE		DATE	 Sheldahl Northfield, Minnesota 55057	TITLE			
PREP <i>[Signature]</i>		11-7-80		GRADED INSULATION INSTALLATION ON SMALL RADIUS MANDREL			
CHKD <i>[Signature]</i>			SPECIFICATION				
APPR <i>[Signature]</i>		11-7-80	CLASSIFICATION	CODE IDENT	SPECIFICATION NO.	SHT 1 OF 14	
APPR			PROPRIETARY	53824	P000958	REV A	

1.0 SCOPE

This specification is generated to identify the procedures that will be used to prepare the small radius strongback mandrel for winding of laminate and the procedure that will be used for the actual winding itself. This procedure is founded on a customer furnished specification that was mutually agreed upon prior to manufacture.

The desired finished dimensions are as follows:

OD of G-10 strongback cylinder - 15.91" (404 mm)

Circumference of G-10 strongback cylinder - 49.98"

Thickness of graded insulation - 11.3 mm

OD of graded insulation - 16.80" (426.6 mm)

Circumference of graded insulation - 52.76" (1340.2 mm)

Approximate number of turns - 57

Approximate length of laminate - 245'

2.0 EQUIPMENT REQUIRED

2.1 Winder/Laminator

A special laminator was fabricated to perform the operation as shown in Figure #4. Its purpose is to provide web handling capability, heat and pressure to bond the laminate to the mandrel at a uniform winding speed.

2.2 Cut-off Tool

This device is used to trim the starting edge of the laminate to a 15° bevel to minimize the potential for an air gap under the first wrap.

2.3 Hand held Pyrometer - 200°F to 400°F range

2.4 Soldering Pencils - 40 watt

2.5 Steel scale, 8', graduated in 0.01"

2.6 Scissors, miscellaneous paint brushes and rollers, rags, razor blades and other hand tools as required.

2.7 Spray paint cartridge and paint bottle

2.8 Hand iron, 125 watt, Wells Automatic

3.0 MATERIAL REQUIREMENTS

- 3.1 Laminate G155500 approximately 400' minimum
- 3.2 Adhesive, A025800, 2 gallons @ 20% solids
- 3.3 Methylene Chloride, C000100, approximately 5 gallons
- 3.4 Butyl Acetate, 1 gallon
- 3.5 Silver Paint, SC-13
- 3.6 Silver Paint, CC-2
- 3.7 Isopropyl alcohol, 1 gallon
- 3.8 3 mil Kapton x 1 oz copper laminate, cut to a size of 22 13/16" wide x 80" long, 2 each.
- 3.9 3 mil Kapton x 1 oz copper laminate cut to a size of 3.9" wide x 80" long, 1 each.
- 3.10 Electronic solder, Kester "44" rosin core solder.
- 3.11 2 mil Teflon, FEP, 48" wide x 30' long approximately.
- 3.12 Small gauge (#26 AWG) thin bare wire, approximately 5'.
- 3.13 3/16" drill bit, quantity 1, plus drill motor.
- 3.14 3 mil Kapton approximately 1 ft².
- 3.15 1 oz (1.2 mil) copper approximately 1 ft².
- 3.16 Approximately 1 mil aluminum foil, 1 ft².

4.0 PROCEDURE

4.1 Mandrel Preparation

- 4.1.1 Wipe the entire G-10 mandrel with clean, lint free rags dampened with alcohol. Repeat several times using clean rags. Cover with clean Teflon until needed. Mask the outside edges to the cylinder with Teflon tape to avoid any bond from the wrapping process in this area. From the centerline of the mandrel, the tape edge should be 39.8" \pm .13_{.00} in each direction.

Sheldahl
Northfield, Minnesota 55057

CLASSIFICATION:

CODE IDENT
53824

SPECIFICATION NO.
P000958

SHT 3
REV *A*

- 4.1.2 Position the copper/Kapton laminate (3.8, 3.9) on a clean, flat surface, using a roller applicator, apply 1 mil of A025800 (3.2) adhesive to the Kapton side of the laminate. The A025800 should be at approximately 8-10% solids, 2 coats preferred for a 1 mil coat. This should guarantee no voids. Allow to air dry for 8 hours minimum. Roller coat the G-10 cylinder with 1 mil of A025800 adhesive. Two coats of 10% solids adhesive is required. A minimum of 1/2 hour drying time per coat with 5 heat lamps (250 w) at 1' distance, with drum rotating at 2 fpm \pm 1.
- 4.1.3 Lay up one piece of 22 13/16" copper/Kapton (3.8) x 80" long from 4.1.2 with the adhesive coated side against the G-10 mandrel (Kapton side). Position as shown on Figure #1. Using a hot roll temperature of 340°F \pm 10°F and a pressure of 120 psig \pm 10 psig and mandrel speed of 1.5 fpm \pm .1 fpm, laminate the piece of copper/Kapton to the mandrel. Starting at the center of the sheet and laminating to one edge and then the other. Lay up the second piece of copper/Kapton laminate (3.8) butt jointed to previous pieces, as shown in Figure #1, and laminate using same settings and procedure, again with the adhesive coated Kapton side toward mandrel.
- 4.1.4 Using a 3.9" x 80" piece of coated copper/Kapton (3.9), position as shown in Figure #1 and laminate using same settings as in 4.1.3.
- 4.1.5 Using electronic solder, (customer furnished) and bare, thin gauge wire, solder the bare thin wire across the butt joints established in 4.1.3 and 4.1.4. A wire shall be soldered every 5-8" along the 80" length. This will mean approximately 22 wires and 44 solder points. Caution must be used to use a small amount of solder to keep the surface very smooth.
- 4.1.6 Coat, using A025800, 10% solids, each solder joint using a small paint brush.
- 4.1.7 At each end of the mandrel drill three pairs of 2 holes, through the copper/Kapton and G-10 mandrel (not through the metal cylinder) using a 3/16" (.187") diameter drill bit. Figures #2A and #2B describe the location of these holes. (12 holes total).
- 4.1.8 Mark the edge of the cylinder with azimuthal positions of the holes drilled in paragraph 4.1.7.
- 4.1.9 Cut six 1" squares of 1 mil thick copper and solder over the drilled holes of 4.1.7. The 1" squares are to be located symmetrically over the holes and soldered entirely around the perimeter. Brush coat over these 1" squares and the solder with A025800-100 adhesive. (The -100 is 10% solids content.) The solder must be 60-40 rosin core solder. Any clean up necessary will be done with ethanol.

 **Sheldahl**
Northfield, Minnesota 55057

CLASSIFICATION:

CODE IDENT

53824

SPECIFICATION NO.

P000958

SHT 4

REV A

- 4.1.10 Coat the 3 mil Kapton (paragraph 3.15) with 1 mil of A025800 adhesive. (1 ft² will suffice.) Cut the coated 3 mil into 1 1/2" squares, 6 are required. Using a hand iron (paragraph 2.8) set @ 315°F ± 10°F, laminate these coated Kapton squares to the 1" square soldered pieces installed in 4.1.9. Again, attempt to keep smooth.
- 4.1.11 Along the entire length across the cylinder, mask off an area 2" wide, using Teflon tape as shown on Figure #3. Mark center of G-10 cylinder on the copper surface, all around the circumference.
- 4.1.12 Coat the exposed copper surface and G-10 mandrel with 1 mil of A025800 adhesive. Use 2 roller coats for application. Allow to air dry for a minimum of 4 hours. Remove the Teflon tape from paragraph 4.1.11 after drying is complete. This will leave a 2" wide strip of bare copper exposed. To expedite the adhesive drying time, use heat lamps and rotate at 1-1.5 fpm for 1 hour after each coat.
- 4.1.13 Mount laminate on unwind of laminator per Figure #4. Align outer black guide stripe with edge guide and center the laminate on the center of the G-10 cylinder. Add teflon sheet to prevent the polyethylene from sticking to the hot nip roll.
- 4.1.14 Thread the web up between the nip roll and the G-10 mandrel making certain a metalized Kapton curtain is kept between the laminate and the "hot" nip roll. (The metalized side should always be against the nip roll.) Allow the adhesive on the web to block to the adhesive on the cylinder.
- 4.1.15 Leaving the nip roll open, set the speed @ 1.0 fpm, brakes per parameters listed below and rotate for 2 turns approximately to verify alignment and even out tension. Do not let laminate wrap on itself. (Remove laminate from back side of cylinder while it is rotating.) Repeat if unsatisfactory results are attained.

WINDER/LAMINATOR PARAMETERS

Standby Conditions

Nip Roll Pressure	120 psi ± 10
Nip Roll Temperature	345°F + 5°F
Laminate Roll Brake	100 psi ± 20 psi
Idler Roll Brake	Minimum to spread web
Winding Speed	1.5 fpm ± .1 fpm

WINDER/LAMINATOR PARAMETERS (continued)

Main Temperature Control Settings

Emittance	0.72
Reset	~ 50%
Manual Adjustment	0%
Set point	~ 45%
S2 Switch	Automatic interval
Prop Band	7%
Hand Held Pyrometer reading at center bottom of nip roll.	335°F ± 10°F

Allow temperature to stabilize prior to starting. (This is approximately 3 hours from cold start-up).

4.2 Winding

4.2.1 Tape a piece of 2 mil Teflon along the entire length of the cylinder as shown in Figure #5. This will determine the start point of mandrel to laminate bonding. The Teflon piece should be between 10" to 12" wide, with straight edges, and 82" long.

4.2.2 Close nip roll on the Teflon sheet and start mandrel drive. Verify all conditions and parameters at this point before proceeding with this step.

IMPORTANT: IT IS IMPORTANT TO CLOSE THE NIP ROLL
PRIOR TO STARTING MANDREL DRIVE. IT IS
ALSO IMPORTANT TO STOP THE MANDREL DRIVE
PRIOR TO OPENING THE NIP ROLL.

4.2.3 Allow mandrel to rotate 1/2 turn. Stop mandrel drive, open nip, insert the reflective curtain. Cut the leader (unbonded laminate tail) off 4" from the bond line. Using the 15° angle cutting tool (paragraph 2.2) cut a pointed end on the laminate as shown below. Seal the unbonded trim to the copper surface using hand iron set @ 315°F ± 10°F. Brush coat 2-3 coats of A025800-100 over 15° angle cut. Dry for 5 minutes with hot air pistol.

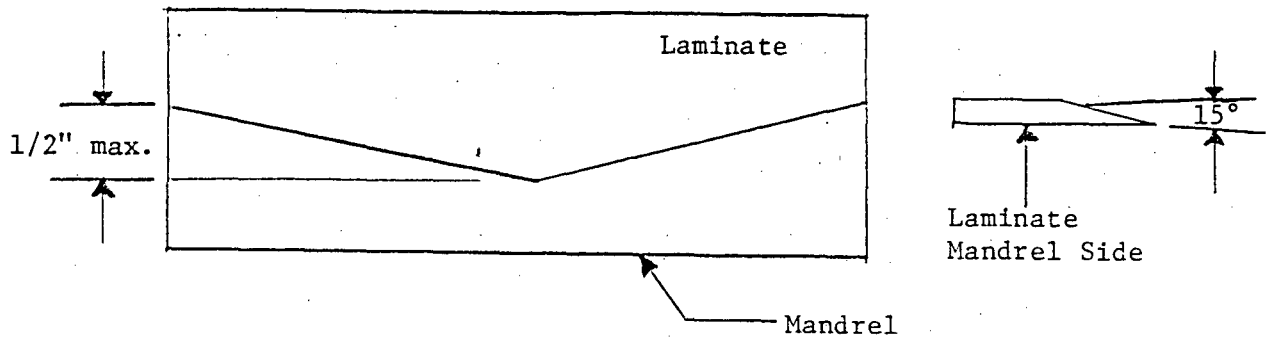

Must not extend into the copper/Kapton gap area.

- 4.2.4 Coat the first 2" of the bonded laminate with CC-2 silver paint. Mask on either side of the 2" area to avoid overspray on the rest of the laminate or mandrel. Dry, using low heat on hot-air pistol for 4 minutes minimum (Figure #6).
- 4.2.5 Using SC-13 silver paint (3.5) as the bonding agent, attach 3 pieces of 1 mil aluminum foil, 1/4" wide, as shown on the sketch in figure below. These should be attached at 1/4, 1/2, and 3/4 distances along the length of the mandrel. It is necessary to shake the SC-13 in a paint shaker (or equivalent) for 5 minutes minimum prior to use. The center piece of aluminum foil should extend up past the silver paint and onto the stripe on the laminate.

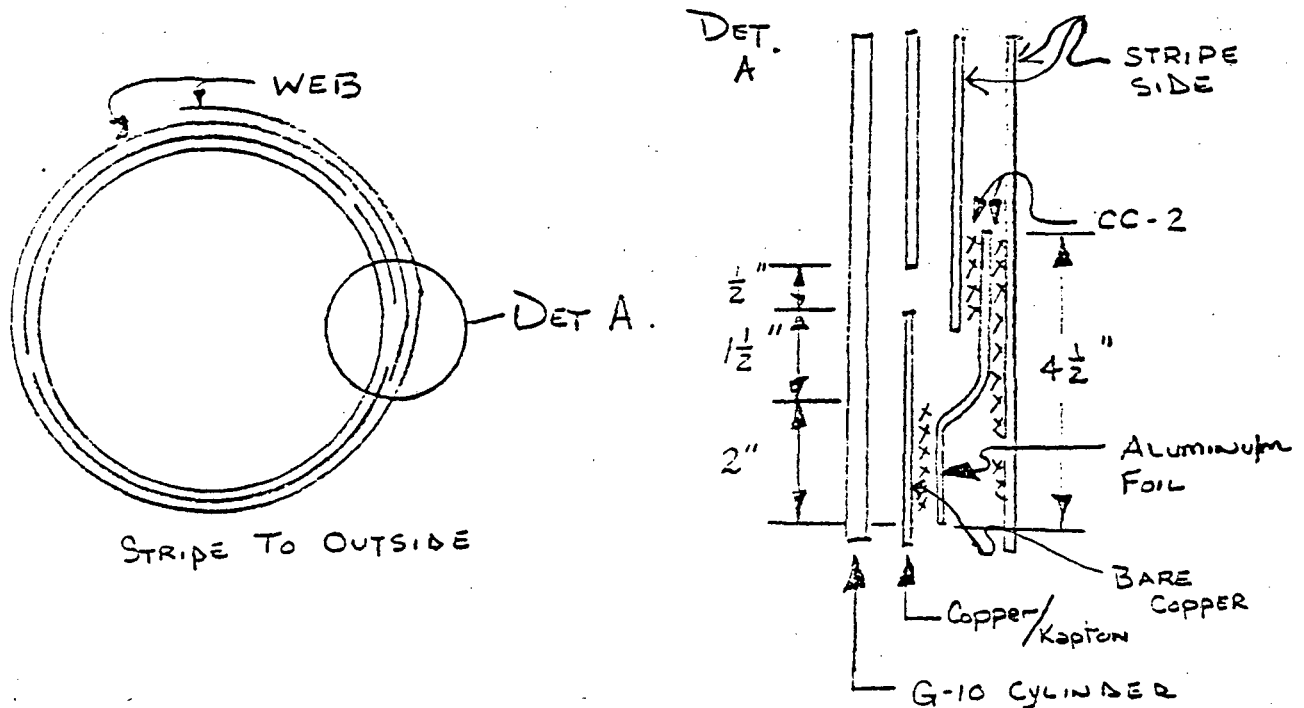

- 4.2.6 Measure back from start point of bond line 47 1/2". Coat a 4 1/2" wide strip across the web from the 47 1/2 point to the 52" point. The coating is CC-2 silver paint and must be applied on the adhesive side of the web. Dry the paint with a hot air pistol for 2 minutes or until dry. This approximate location is shown on Figure #6. The correct configuration will end up with the CC-2 applied in 4.2.4 will be covered with the CC-2 applied in this step (4.2.6) when the next laminated turn is completed.
- 4.2.7 Check all machine settings prior to start up on winding again; allow to stabilize.
- 4.2.8 Before closing nip roll, reverse the drive on the mandrel and rotate approximately 1 inch on the circumference. This allows the nip roll to close on a surface where material has previously been laminated and avoids any tendency for trapping blisters in the adhesive. Turn mandrel drive back to winding direction.
- 4.2.9 Close nip roll and restart drive for mandrel. Turn main heater control down to $310^{\circ}\text{F} \pm 5^{\circ}\text{F}$ after 1 1/2 turns of nip roll. From this time on, the hand held pyrometer at center bottom of nip roll shall read $335^{\circ}\text{F} \pm 10^{\circ}\text{F}$. This, and all other machine parameters will be read and recorded at 10 minute intervals initially. After all temperatures have stabilized, these readings and recordings will be done at 10 minute intervals.
- 4.2.10 After 2 or 3 wraps have been wound on the mandrel, engage the edge cutters on each side of the machine to trim off the laminate edges where excessive adhesive and polyurethane would otherwise cause a build-up on the mandrel. Approximately 1/2 inch can be trimmed from each edge depending on the width of the laminate. Do not trim the laminate closer than 40" from center of mandrel in both directions.
- 4.2.11 Manually remove polyethylene and Teflon and discard as they become accessible on the back side of the mandrel. Watch continuously for any of the central stripe to come off with the polyethylene. Touch up if necessary.
- 4.2.12 If there is any need for stopping during the winding procedure, the machine parameters will be returned to standby conditions and 4.2.8 and 4.2.9 will be followed. Always install reflective curtain when stopped.
- 4.2.13 Continue winding and laminating until insulator thickness is 11.3 mm (approximately 57 turns). At this point, stop the mandrel drive, open nip roll, and install reflective curtain. It is preferred that the end of the bonded laminate be located within the A to B to C side of the cylinder. (Fig. 2A) It is more important to not have a jog in the printed stripe on the

 **Sheldahl**
Northfield, Minnesota 55057

CLASSIFICATION:

CODE IDENT

53824

SPECIFICATION NO.

P000958

SHT 8

REV *A*

last wrap. Any conflict caused by this paragraph shall be settled by the customer.

- 4.2.14 Cut the laminate away at a distance of a few inches from where it was last bonded.
- 4.2.15 Install a narrow strip of 1 mil aluminum over the central stripe using SC-13 silver paint to temporarily bond. Cover the entire unbonded area with Teflon and run through the nip roll again using the procedures laid out in paragraph 4.2.7 and 4.2.9.
- 4.2.16 Cover the entire mandrel with 2 mil Teflon (paragraph 3.12) and tape in (Teflon tape) place. Make effort to keep wrinkles out of Teflon.
- 4.2.17 Repeat paragraph 4.2.7. Close nip roll and start drive of mandrel. Adjust per paragraph 4.2.9 after 1 1/2 nip roll revolutions. Continue to rotate for 10 complete mandrel revolutions. Turn off heaters and continue revolving until the nip roll temperature is less than 125°F. Stop mandrel, open nip, and leave Teflon on. Rotate at same speed as winding was accomplished.
- 4.2.18 Measure and record the circumference of the insulator at 5 equally spaced places across the mandrel.
- 4.2.19 Wrap the finished insulator with 4 layers of bubble poly and install the shipping shaft inside the mandrel and package in shipping container.

5.0 QUALITY ASSURANCE PROVISIONS

A Quality Control Inspector will monitor all machine settings and manual operations to insure compliance with this specification. The inspector will be responsible for recording all information collected during the winding operation.

 Sheldahl Northfield, Minnesota 55057	CLASSIFICATION:	CODE IDENT	SPECIFICATION NO.	SHT 9
		53824	P000958	REV <i>A</i>

Copper/Kapton
22 $\frac{13}{16}$ " (P 3.8)

BUTT JOINT

3.9" Copper/Kapton
(P 3.9)

.50" REF. START

G-10
CYLINDER

BUTT JOINT

Copper/Kapton
22 $\frac{13}{16}$ " (P 3.2)

- KAPTON SIDE TOWARDS
G-10 MANDREL

FIGURE 1

 Sheldahl Northfield, Minnesota 55057	CLASSIFICATION:	CODE IDENT	SPECIFICATION NO.	SHT 10
		53824	P000958	REV <i>A</i>

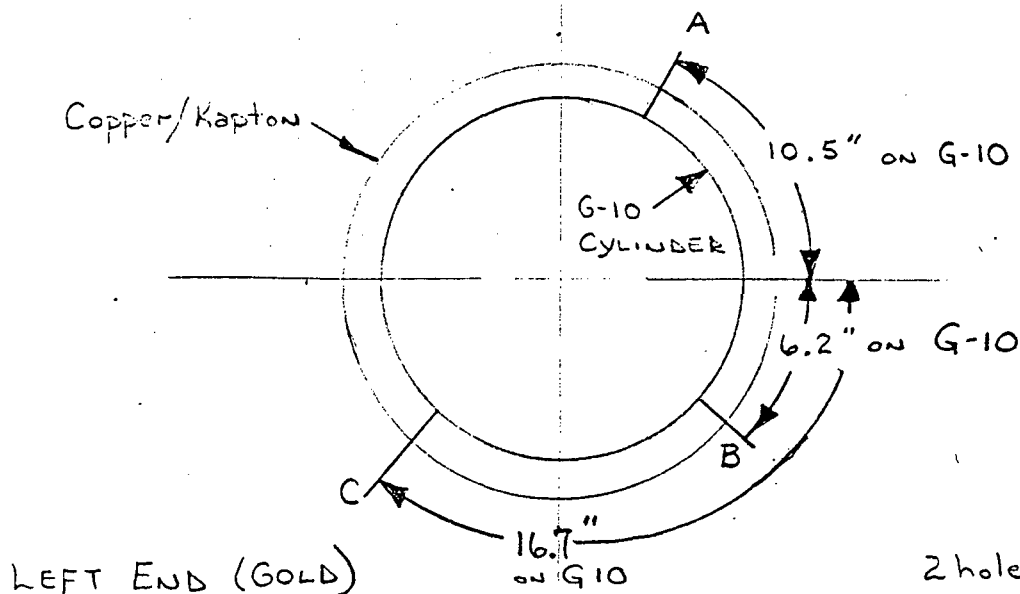
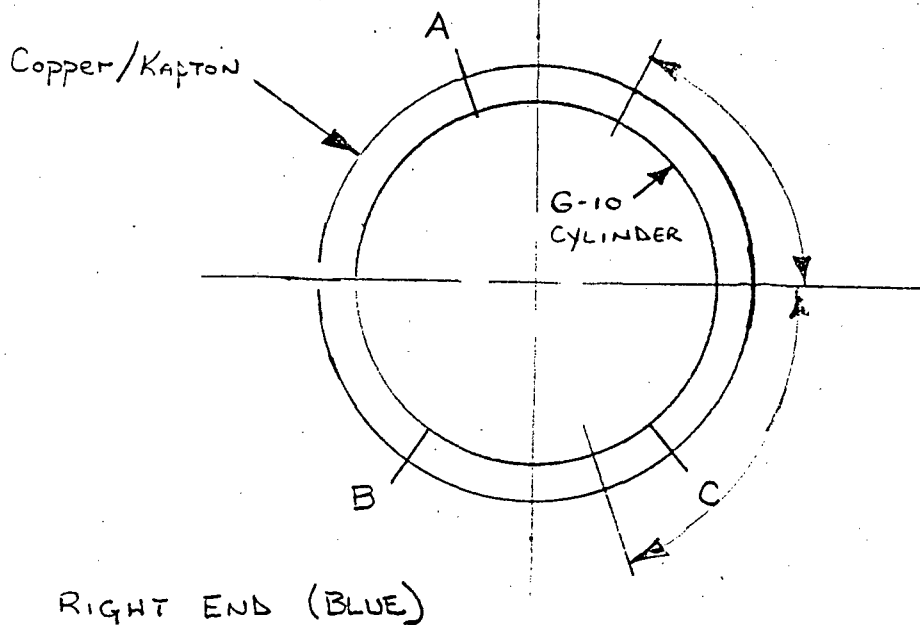

2 holes at A
 2 holes at B
 2 holes at C
 — see figure 2B
 to locate horizontally.
 — both ends

FIGURE 2 A

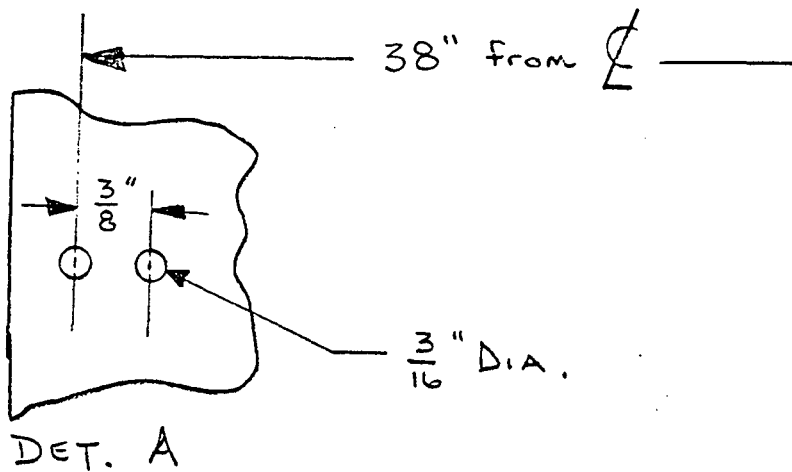
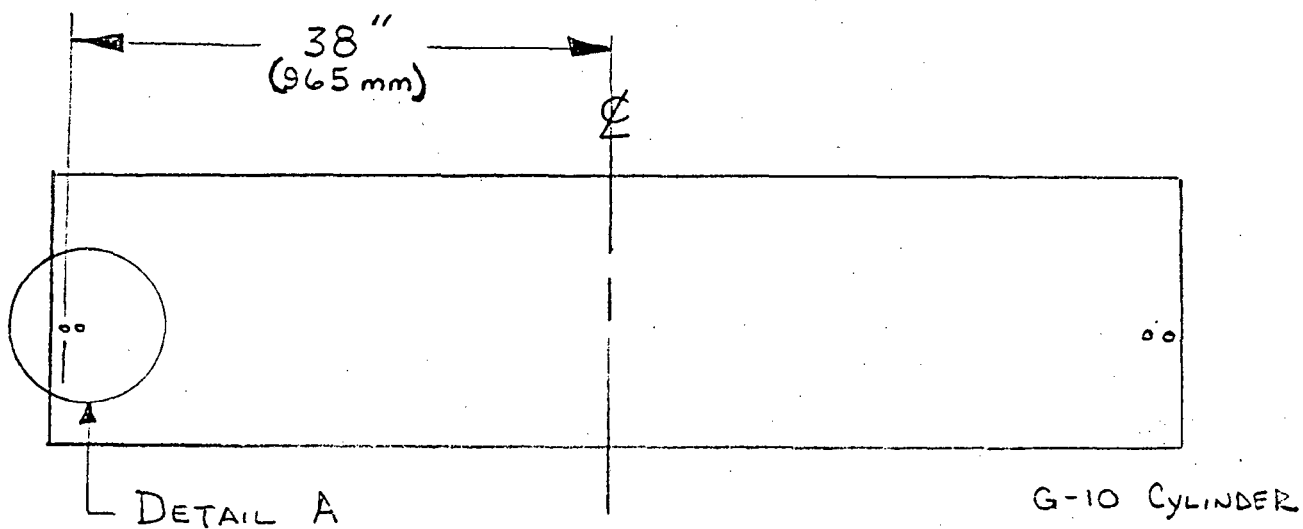

FIGURE 2B

<p>Sheldahl Northfield, Minnesota 55057</p>	<p>CLASSIFICATION:</p>	<p>CODE IDENT 53824</p>	<p>SPECIFICATION NO. P000958</p>	SHT 12
				REV

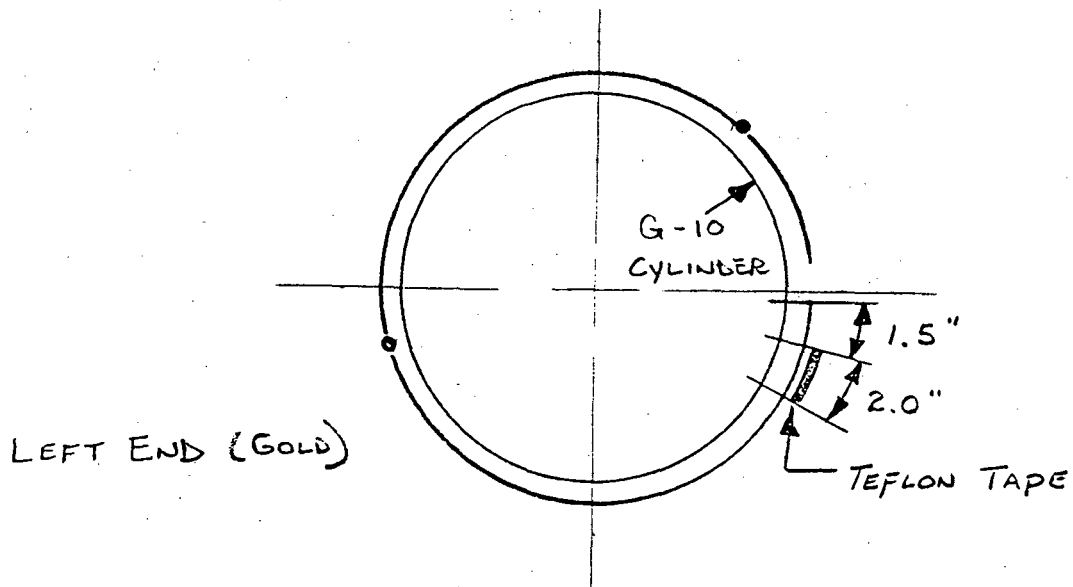

FIGURE 3

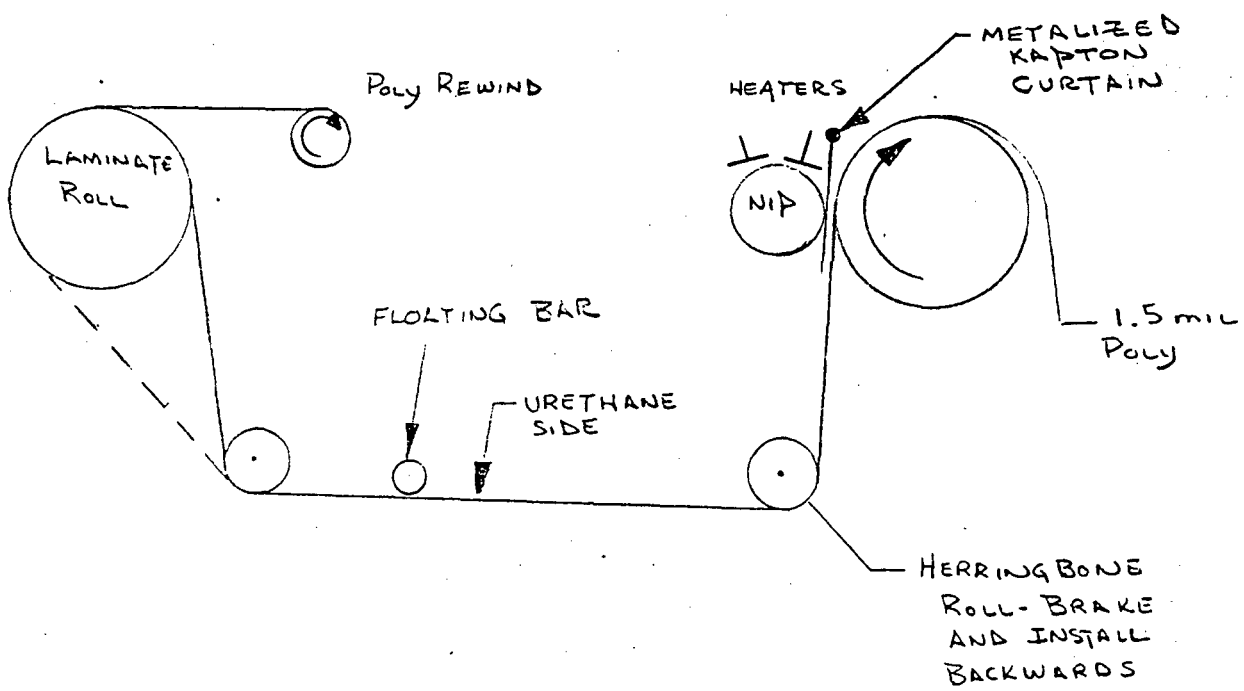
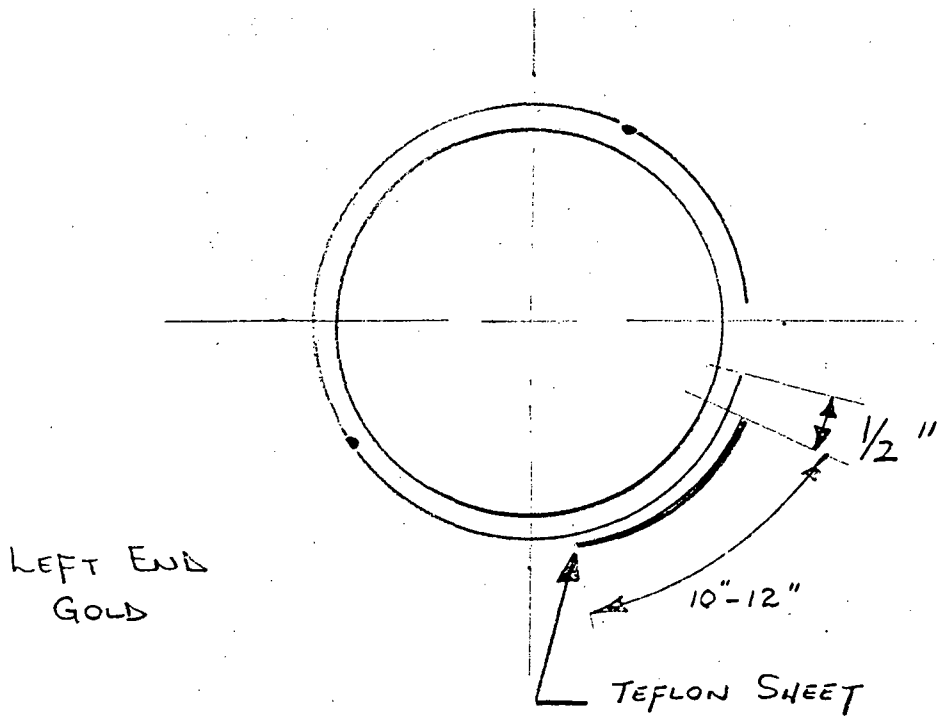

FIGURE 4

 Northfield, Minnesota 55057	CLASSIFICATION:	CODE IDENT	SPECIFICATION NO.	SHT	13
		53824	P000958	REV	A



USE TEFLON TAPE FOR ATTACHING
 FIGURE 5

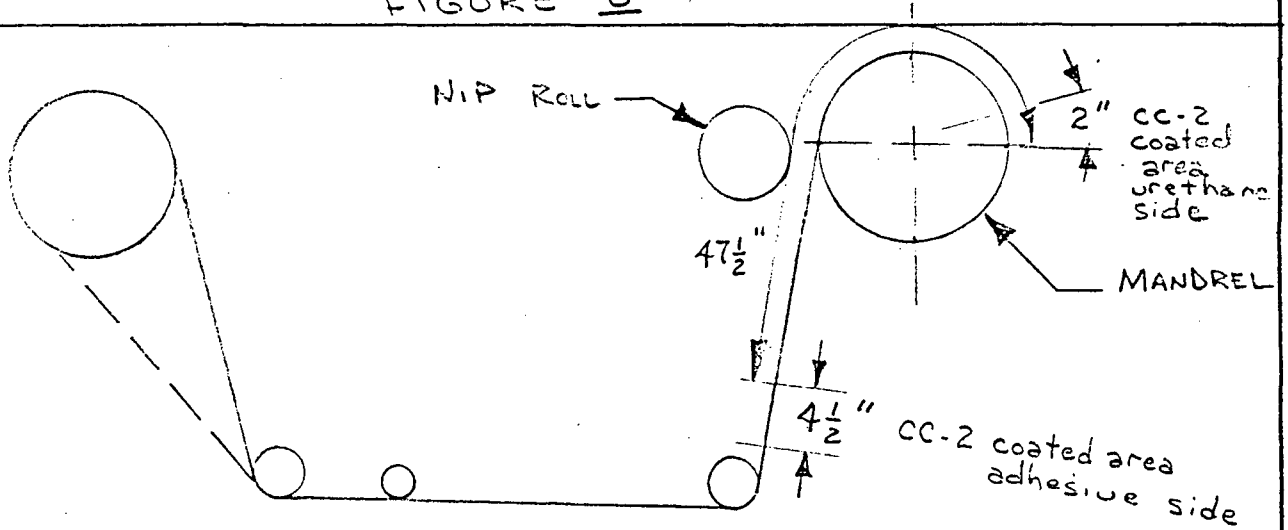

FIGURE 6

November 19, 1979

To: Distribution

From: Ron Madaras

Subject: Trip Report for Visit to Sheldahl on November 12-17, 1979

Norm Parrish went with me on this trip. At Sheldahl we met with John Corrigan, Terry Origer and Dean Lembke. The purpose of this trip was to observe the fabrication of the TPC Small-Radius High-Voltage Graded Insulation, per LBL specification M569. As will be explained in the details below, a large part of the fabrication was accomplished, but not all of it.

- 1) In the fabrication of the Small-Radius Graded Insulation, the laminate is wound such that the resistive stripes are on the outside of the cylinder, and thus they come in contact with the hot nip roll. To prevent the stripes from transferring to the nip roll, Sheldahl covered the nip roll with a 20 mil thick teflon shrink sleeve, and did tests with the old 40" wide prototype laminate to show that the stripes did not transfer. But when they tried the new 80" wide small-radius insulation laminate, the stripes did transfer to the teflon covered nip roll. It is not known why. The laminate has a polyethylene covering on each side to prevent it from sticking to itself. During the winding operation these polyethylene coverings are pulled away as the laminate goes thru the winding machine. The solution to the problem of the stripes transferring to the nip roll was solved by not removing the polyethylene covering on the striped side of the laminate until after the laminate passed by the nip roll. In the course of working out this solution the teflon sleeve around the nip roll developed holes (because of excessive temperatures) and had to be removed. Also, the laminate in this solution is fed up to the nip roll from below, so that the G-10 strongback and mandrel rotate clockwise as viewed from the left end of the winding machine. Thus the left end of the graded insulation unit is what we call the "South (or gold, if you prefer) End."
- 2) For the next three days another problem took up our time: the laminate would wrinkle when it was wound and laminated around the G-10 strongback cylinder. Many things were tried to solve it: installation of a herringbone idler roll, installation and adjustment of a mechanical brake on the idler roll, adjustment of the brake on the roll supplying the laminate, adjustment of the lamination pressure and temperature, and prayer. The final thing that worked was removing the teflon sheet which was wrapped around the G-10 strongback cylinder to prevent the laminate from bonding to it during the trial runs. There were no wrinkles after that.
- 3) In the course of solving the wrinkles problem it was found that the ends of the nip roll were not as hot as the center, so additional heating lamps were installed. The center and ends were then maintained at about 320° F.

-2-

- 4) Finally the actual fabrication of the graded insulation unit began, following the step-by-step procedures in my note of October 19, 1979.
- 5) A total of 47-1/2 layers of laminate were wound and bonded around the G-10 strongback. The actual winding took about four hours. The thickness is 11.8 mm.
- 6) The laminate was initially aligned with the center of the G-10 strongback cylinder to within 1 mm. The edge guide system kept the side-to-side motion of the laminate during the winding operation to ± 1 mm. Unfortunately the last (outer) layer of laminate shifted by 1 mm with respect to the layers underneath it.
- 7) Occasionally some of the ink from the minor resistive stripes on each end of the laminate would transfer to the polyethylene cover as it was being pulled away from the laminate (as described in section 1 above). This happened about 15 times. We would then stop the winding machine and touch up the resistive stripe with some silver paint. There didn't seem to be any problem with this procedure.
- 8) After the winding was done the laminate was cut away and the graded insulation unit was covered with polyethylene to protect the stripes. Then the graded insulation continued to turn with the hot nip roll pressed against it. This was done to eliminate any voids that might lead to blisters and bubbles on the surface. After about 20 minutes of this it was noticed that the polyethylene had shriveled up and destroyed about 5-7 minor resistive stripes at each end. The center position was okay. It appears that the heat and pressure had worked the polyethylene into the stripes and destroyed them. The heat lamps were turned off, and the graded insulation continued to turn with the nip roll against it until the temperature of the nip roll dropped to 125° F (about 3 hours). No additional damage was done after the heat was turned off. The following procedure will be used to correct this problem:

a) Remove the remains of the resistive stripes which are outside of the stripes' original dimensions.

b) Mask on either side of where the stripe should be.

c) Paint in the stripes by hand.

Since these stripes on the last (outer) layer of laminate are in contact with the coarse field cage rings, the value of the resistance of these stripes is not important. This work will be done November 21.

- 9) After the winding was done, it was also found that the center portion of the laminate was not bonded very well, and that there were voids that went down for at least a few layers. It appears that under the load of 100 lbs/inch during the lamination the nip roll or mandrel bowed, and there was less pressure on the laminate at the center. This is a very serious problem. The tentative procedure to solve this problem is to create a

-3-

crown on the nip roll with teflon film sheet or teflon tape, and re-laminate the center area thoroughly. This will be done on November 19-20. This problem will also be a serious one for the fabrication of the large-radius graded insulation.

- 10) The kapton with the 5 mm lines was not laminated around the graded insulation because of the problems described in sections 8 and 9. It will be done on November 26.
- 11) Again I was impressed by the dedication and committment that the people at Sheldahl have for our graded insulation project. They worked very hard while we were there, they were responsive to our suggestions, and I am very pleased with their work.
- 12) One of the most distressing things I learned on this visit was that the restaurant Les Quatre Amis was moving out of Northfield and up to Minneapolis after Christmas. If we don't finish the large-radius graded insulation by then we'll have to cancel the contract and find a company in Minneapolis to do it.

Ron

Ron Madaras

RM/jrb

Distribution:

Alan Bross
Larry Brown
Owen Chamberlain
John Corrigan (Sheldahl)
Dave Fancher
Bill Gorn
Paul Hernandez
Sy Horowitz
Bob Hootman
Jay Marx
Dale Nesbitt
Dave Nygren
Norm Parrish
Fred Perry
Gerry Przybylski

December 20, 1979

TO: Distribution

FROM: Ron Madaras

SUBJECT: Trip Report - Visit to Sheldahl on December 16-19, 1979

Alan Bross was also at Sheldahl for this trip. At Sheldahl we met with Gus Myran and Dean Lembke. The purpose of this trip was to observe the last part of the fabrication of the TPC Small-Radius High-Voltage Graded Insulation, per LBL Specification M569. As will be explained in the details below, this was not accomplished, and a new Small-Radius Insulator will be made.

- 1) Alan Bross left LBL with the Large-Radius High-Voltage Field Cage and Mandrel on December 14, and arrived at Sheldahl on December 17. The Field Cage and Mandrel were squeezed thru the door at Sheldahl (with 1 inch clearance), and then unboxed. The Field Cage and Mandrel appeared to be in good condition. The motor which turns the Mandrel was tested, and it works. Alan Bross then worked with me on the problems with the Small-Radius Graded Insulation described below.
- 2) First we measured the total resistance of the central stripe, by putting 100 VDC on the (normally) ground end of the insulator and measuring the current ($\sim 1\text{nA}$) in the Central Stripe with a Keithley 610 electrometer. We found the central stripe resistance to be $\sim 10^{11} \Omega$. The resistance should be $\sim 10^{10} \Omega$, which is the resistance of one field cage resistor string. Thinking that there might be a break in the stripe as it came out from under the end of the laminate on the outside surface, we lifted up the end a little bit and squeezed in some silver conductive paint. There was no change in the measured resistance of the stripe. Then using a small grinding tool we cut thru the top 9 mil layer of laminate, at a point ~ 1 inch from the end of the laminate, to make a connection to the stripe before it got to the end of the laminate. The central stripe resistance was then measured to be $5.2 \times 10^{10} \Omega$. Thinking that perhaps the whole last turn of central stripe was damaged during the extra re-bonding done on December 10, we then used a scapel to cut thru the top 9 mil layer of laminate on the other side of the laminate end (i.e. at a point $C-1$ inches along the laminate from the end, where C = circumference of the graded insulation), in order to make a connection to the stripe before its last turn. The measured central stripe resistance was then $5.0 \times 10^{10} \Omega$ (consistent with the last turn being as good as the other turns). We don't know why the resistance is 5-10 times higher than expected. Perhaps the value of the resistive ink was wrong (in spite of our extensive tests), or maybe the resistance of the ink changed under the higher temperatures and pressures of the re-bonding process.
- 3) Next we measured the resistance of the minor stripes, in essentially the same way as above. We found that the resistance of a minor stripe was $\sim 10^{12} \Omega$.

-2-

This is 10 times smaller than the value determined by the requirement that the loading on the field cage be less than 2%, and about 100 times smaller than expected on the basis of our previous tests of the resistive ink. Again, perhaps the value of the resistive ink was wrong, or maybe the resistance of the ink changed during the re-bonding process (since the central and minor stripe resistive inks are quite different, it is possible that they could change in different directions under extreme heat and pressure). Since in the previous step a connection was made to the central stripe before the last turn, similar connections were made now to all the minor stripes in order to eliminate any extra voltage gradient between the stripes. This did not significantly change the resistance of the minor stripes.

- 4) Careful examination of the surface of the graded insulation indicated that the re-bonding process did not satisfactorily eliminate the voids in the insulator. On the right end of the insulator, there were voids running alongside about four of the minor stripes. In the center area, there were what appeared to be many very small bubbles packed together between the minor stripes. They were concentrated in the valleys between the stripes, but did extend to the stripes. They were all around the circumference. After it was decided not to use this insulator (see below), a portion of the insulator was cut out and it was confirmed that what we were seeing were actually bubbles. Perhaps some of the voids in the center were just broken apart into many little bubbles during the rebonding process, instead of being squeezed out.
- 5) The above problems were communicated to Owen Chamberlain and Dave Nygren on December 18. After an afternoon of discussion and calculations, it was decided that the following units should be made:
 - a) A new Small-Radius Insulator using non-striped laminate. The present insulator will be cut away and removed from the small-radius G-10 strongback and mandrel.
 - b) A Large-Radius Insulator using non-striped laminate and the field cage delivered on December 17.
 - c) A Prototype Insulator using non-striped laminate. LBL will cut away and remove the existing laminate from one of our old prototypes and send Sheldahl the prototype field cage for this new prototype.
- 6) The reasons for the above decisions are:
 - a) The resistive stripes have continually caused us problems with their unpredictable resistance. The low resistance of the present minor stripes in the Small-Radius insulator will cause about a 25% loading of the field cage which, though possible to compensate for, is not very easy to do. It is difficult to predict what the loading for the Large-Radius Insulator would be if we continued to use striped laminate.
 - b) The resistive stripes make the bonding more difficult because they build up with resulting peaks and valleys, and thus contribute to the formation of unacceptable voids in the insulator.

-3-

c) Calculations indicate that without the resistive stripes the leakage current of the Mylar is large enough to establish the proper voltage pattern in the insulator.

d) The resistive stripes were on the laminate not only to generally establish the proper voltage pattern but to protect abnormal areas of Mylar from building up excessive voltages and sparking thru. It appears that this second advantage of the resistive stripes is outweighed by their disadvantages (see 6a, b).

e) It is believed that the insulators made with non-striped laminate will operate reliably at 100 KVDC. It was agreed that the TPC could operate at this voltage if it had to. A prototype insulator (see part 5c) using non-striped laminate will be made after the small and large final units are made, so that the final units are delayed as little as possible. The prototype will then be tested and used to determine what maximum high voltage the final units (and thus the TPC) can reliably be run at.

7) Sheldahl is now doing the following:

a) Making 900-1200 feet of new non-striped laminate. (We already have 1100 feet of laminate. The large-radius insulator uses 1200 feet, the small-radius unit uses 225 feet, and the prototype uses 150 feet). This will be done by December 26.

b) Removing the striped laminate from the small-radius insulator they made last month. They hope to have this done by December 21.

c) They will wind and bond a new small-radius insulator using non-striped laminate the last week in December and first week in January.

d) They are modifying their winding machine for the fabrication of the large-radius insulator. They hope to start the actual fabrication during the third week of January.

8) I am continually impressed by the dedication and commitment that the people at Sheldahl have for our high-voltage insulation project. They worked very hard while we were there, including working late each night. I am very pleased with their performance on this job.

9) Now that Les Quatre Amis is moving out of Northfield, it is time to document some other eating spots for future visitors to Sheldahl:

a) Quarterback Club - best place for breakfast (2 eggs, 4 pieces of toast, jelly, and 3 pieces of bacon for \$1.55!)

b) Angelo's - best pizza in town (try their pepperoni, mushroom and green pepper pizza)

c) Bridgeman's - best ice cream in town (the ice cream cones have bigger helpings than the dishes for the same price, and you can get two different flavors as well; what-a-deal!).

RM/jrb

-4-

Distribution:

Alan Bross
Larry Brown
Owen Chamberlain
John Corrigan (Sheldahl)
Dave Fancher
Bill Gorn
Paul Hernandez
Sy Horowitz
Bob Hootman
Jay Marx
Gus Myran (Sheldahl)
Dale Nesbitt
Dave Nygren
Terry Origer (Sheldahl)
Norm Parrish
Fred Perry
Gerry Przybylski

January 21, 1980

TO: Distribution

FROM: Ron Madaras

SUBJECT: Trip Report for Visit to Sheldahl on January 14-18, 1980

Alan Bross and Norm Parrish also went to Sheldahl on this trip. At Sheldahl we worked with Gus Myran and Terry Origer, with the assistance of John Corrigan, Dean Lembke, Al Simpson and Jeff Solberg.

The purpose of this trip was to observe the fabrication of a new TPC Small-Radius High-Voltage Graded Insulation with Coarse Field Cage. As will be explained in the details below, the fabrication of the Insulator using laminate having only a central resistive stripe was successful, but the addition of the kapton Coarse Field Cage was not successful.

- 1) As on past visits, I was again impressed by the dedication and commitment that the people at Sheldahl have for our high-voltage insulation project. Gus Myran and others worked very hard while we were there, including working late each night (twice until 11:30 p.m.). They were very responsive to our suggestions and cooperated with us fully, and I am very pleased with their work.
- 2) There were again problems with the laminate wrinkling when one attempted to wind and bond it around the G-10 Strongback cylinder. These problems were solved after the following two things were done:
 - a) The herringbone idler roll was reversed so that the pattern of the grooves pointed "down" (to an observer in front of the winding machine). In operation, it was observed that the laminate under the idler roll partially slid on the idler, because it was traveling faster than the idler was turning.
 - b) In setting up the laminate on the G-10 cylinder, the cylinder was turned for at least a half of a turn with the laminate in contact with the surface of the cylinder, so that the forces on the laminate could be evenly distributed.
- 3) There were also some problems with the polyethylene (which protects the central stripe and polyurethane from the nip roll) sticking to the hot nip roll. This was caused initially because the nip roll got too hot and melted the polyethylene, and then it continued on subsequent tries because the melted polyethylene could not be removed well enough from the surface of the nip roll. The solution was to let the nip roll cool down overnight, and give it a thorough cleaning with Scotchbright and alcohol the next morning.

-2-

- 4) Finally the Insulator was wound, with a total of 56 layers of laminate:
- a) The winding speed was 1.5 feet/minute ("27" on the dial).
 - b) The whole winding (including stops) took 5 hours.
 - c) The temperature of the hot nip roll was maintained at about 320° F ("Set-point" at 270 while running, and 310 when stopped).
 - d) Nip roll pressure was 120 psi.
 - e) Supply roll brake was 140 psi, except right at the beginning when it was 120 psi (This caused some wrinkles to occur on the second turn at the right end of the insulator. The wrinkles were not very large and were confined to the second turn only, so it was decided to continue.).
 - f) Several times we had to stop to remove some large (~1/2 inch) pieces of dirt in the laminate. Usually they were between the polyurethane and Mylar, but once they were between the two layers of Mylar (fortunately near the ground end, so the two surgeons could successfully remove them). More care should be taken next time in the fabrication of the laminate to prevent these pieces of dirt from getting in. (An engineering problem!)
 - g) The electric eye guide system performed very poorly this time, and the laminate moved from side-to-side during the winding operation by up to ±1/4 inch. This was because the line it was guiding on was put too near the edge of the laminate, where the laminate isn't clear and smooth. Also, perhaps the line wasn't dark enough. This should be improved before the winding of the prototype and large unit. (Another engineering problem!)
 - h) The rough, uneven, wrinkled edges of the laminate were not trimmed before the winding operation, and they started to build up on top of each other during the winding, causing the nip roll to exert an uneven pressure on the cylinder. A knife was installed on the winding machine to cut off the left edge (which was the worst) on the fly. This worked, but was complicated by the problem described in "g" above. The bad edges of the laminate for the prototype and large units should be trimmed off before winding these units. (Yes, you're right, another one!)
 - i) After the winding was done the laminate was cut away and the graded insulation unit was covered with teflon (and not polyethylene, as was learned in November). Then the insulator continued to turn with the hot nip roll pressed against it for 30 minutes. Then the heaters were turned off, and the insulator continued to turn with the nip roll against it until the temperature of the nip roll dropped to about 120° F (about 3-1/2 hours). There was no damage to the central stripe or the polyurethane.

-3-

- j) The central stripe resistance was measured to be about 4×10^{10} ohms, which is close enough to the value of one field cage resistor string (1×10^{10} ohms) to be acceptable.
 - k) The outside diameter of the finished insulator ranges between 16.74 and 16.77 inches, except at the right end where the wrinkles are. There it goes up to 16.80 inches. The specifications say that the maximum o.d. of the insulator should be 16.80 inches, so the thickness of the insulator is acceptable.
 - l) A small piece of aluminum foil was placed on the central stripe where the end of the laminate occurs on the outside surface of the cylinder, so that the central stripe connection is not broken at that edge. Since half of the aluminum is under the edge and half is sticking out, care must be taken during future operations with the unit so that it is not broken off.
 - m) The 18" wide piece of kapton-polyurethane laminate which goes underneath the coarse field cage terminal board was bonded to the insulator.
- 5) When we tried bonding the 1 mil kapton (with 1/2 mil x 20 mil copper lines at 5 mm spacing) onto the surface of the insulator as part of the coarse field cage, we found two major problems:
- a) It was incredibly difficult to get the proper alignment of the copper lines around the cylinder by eye. The problem was that the kapton would block on the surface of the insulator, and even with the addition of two temporary layers of teflon between the kapton and the insulator it was not possible to slide the kapton around. We finally succeeded on one piece, but it took five hours.
 - b) When we finally did get one piece of kapton aligned, we found that it was not possible to smooth out all the bubbles and wrinkles. Then when it was laminated to the surface of the insulator with the hot (240° F) nip roll, the kapton developed many small (~1/2-1 inch long) creases and wrinkles. Some of them seemed to contain voids.

It was decided that an acceptable field cage could not be made as planned.

- 6) It was decided in consultation with Owen Chamberlain, Larry Brown and Dave Nygren that after cleaning up the outside of the insulator, Sheldahl will send it to LBL, where the G-10 terminal boards (with copper lines at 5 mm spacing) will be epoxied on, and wires will be wound around the insulator and soldered to the terminal boards to form a coarse field cage. Sheldahl said that they will ship the small-radius insulator to LBL on January 21.
- 7) Two new (to us) eating spots have been discovered on this visit:
 - a) Rueb'N'Stein, for the best sandwiches in town.

-4-

- b) Evergreen Knoll Club, for the best dinners in town now that Les Quatre Amis has left. Actually it's not really in Northfield, but in Faribault, which is about 10 miles away (unless you get on the freeway by mistake and go an extra 12 miles!).

Ron

Ron Madaras

RM/jrb

Distribution:

Alan Bross
Larry Brown
Owen Chamberlain
John Corrigan (Sheldahl)
Bill Gorn
Paul Hernandez
Sy Horowitz
Bob Hootman
Jay Marx
Andy McElheney
Gus Myron (Sheldahl)
Dale Nesbitt
Dave Nygren
Terry Origer (Sheldahl)
Norm Parrish
Fred Perry
Gerry Przybylski

LAWRENCE BERKELEY LABORATORY
Bldg.:50B Room: 5233 Ext.: 4410

January 30, 1980

TO: Distribution

FROM: Ron Madaras

SUBJECT: Trip Report for Visit to Sheldahl on January 28-30, 1980

Alan Bross and Norm Parrish also went to Sheldahl on this trip. At Sheldahl we worked with Gus Myran, with the assistance of John Corrigan, Dean Lembke, Al Simpson and Jeff Solberg.

The purpose of this trip was to observe the winding and bonding of new prototype graded insulation laminate (having only a central resistive stripe which jogs back and forth about the center) around one of our prototype field-cages. The fabrication was successful, with no major problems.

- 1) The prototype graded insulation has 28 complete turns of laminate, which is half the number of turns in the Small-Radius insulator.
- 2) The initial alignment of the laminate on the cylinder was off to the left by about 1/2 mm. During the first turn the laminate drifted to the right by about 1-1/2 mm. The central stripe on the laminate did not touch the first (from center) ring of conductive epoxy in the cylinder, but it came close (about 1-1/2 mm). The drifting of the laminate will have to be solved for the fabrication of the Large-Radius insulator, where one turn is about 21 feet.
- 3) After the first half-turn the winding machine was stopped and the leader part of the laminate was cut off at an angle of 15° using a special cutting bar that Sheldahl made. The edge was then bonded down with a hand iron, and two coats of adhesive were applied to the edge. These measures were taken in order to eliminate the voids that occur at the edge of the laminate when it is cut off at 90°, as the laminate is 9 mils thick and would form a step.
- 4) Winding machine parameters during the winding and bonding operation:
 - Nip roll pressure: 60 psi
 - Nip roll temperature: 310° F (set point of 265)
 - Supply roll brake: 60 psi
 - Winding speed: 1.4 feet/minute ("12" to "14" on the dial)
 - Winding time: 2 hours (4 minutes/turn)
 - Mandrel temperature: 120° F (after 8 turns); 133° F (after 28 turns)
- 5) After the winding was done and the laminate was cut away, several pieces of aluminum foil were placed underneath the edge of the laminate

-2-

where we had previously sprayed silver paint. This was done to insure that the ground connection of the laminate was brought out under the edge. The unit was then covered with teflon and continued to turn with the hot nip roll pressed against it for 30 minutes (7 turns). Then the heaters were turned off and the insulator continued to turn with the nip roll against it until the temperature of the nip roll dropped to about 130° F (about 2-1/4 hours). At that time the insulator temperature was about 90° F.

- 6) The prototype insulator was cut to a length of 1010 mm (about 4-1/8" from each end of the G-10 cylinder).
 - 7) The prototype insulator is scheduled to be air-shipped to LBL on January 31, 1980.
 - 8) The whole winding operation went without any major problems (the first time since the first prototype unit was made on May 2, 1979). The winding machine worked very well, and the people at Sheldahl worked hard to give us a good prototype insulator. I am very happy with their performance on this job.
 - 9) It appears that Sheldahl has not yet done much work in getting the Large-Radius Field Cage ready for the winding machine. Now that the Small-Radius Insulator and Prototype Insulator are out of the way, I hope that this work can proceed rapidly.
 - 10) If Dupont can deliver the Mylar to Sheldahl next week, then Gus has the 84" laminator scheduled beginning February 12 to make and stripe the new laminate for the Large-Radius Insulator.
 - 11) Just look at the daily specials that you can get for only \$2.95 at the Quarterback Club in downtown Northfield:
 - Monday - Clam Dinner
 - Tuesday - Steak Platter
 - Wednesday - Pork Chop Dinner
 - Thursday - All the chicken you can eat!
 - Friday - All the fish you can eat!
- Since there are no specials on Saturday or Sunday, you can now see why we are reluctant to stay there over the weekend.
- 12) On our first morning in Northfield on this trip, the temperature was -11° F (without the wind chill factor for you non-Californians). On the second morning it warmed up to 0° F, but then it was snowing!

Ron
Ron Madaras

RM/jrb

-3-

Distribution:

Alan Bross
Larry Brown
Owen Chamberlain
John Corrigan (Sheldahl)
Bill Gorn
Paul Hernandez
Sy Horowitz
Bob Hootman
Jay Marx
Andy McElheney
Gus Myran (Sheldahl)
Dale Nesbitt
Dave Nygren
Terry Origer (Sheldahl)
Norm Parrish
Fred Perry
Gerry Przybylski

May 3, 1979

TO: Distribution

FROM: Ron Madaras

SUBJECT: Sheldahl Trip Reports: April 10-11 Trip & May 1-2 Trip

April 10-11 Trip to Sheldahl

Norm Parrish went with me on this trip. At Sheldahl I had contact with John Corrigan and Dean Lembke. The main purpose of this trip was to observe the striping of the laminate for the TPC prototype graded insulation with the resistive paint.

1) 820 feet of laminate was successfully striped with the resistive and conductive paint.

2) Three "blemishes" occurred during the striping:

a) at 170 feet: a discontinuity and blob of paint on center stripe. The discontinuity was caused by inattention of the operator (who was talking with Sheldahl visitors). The blob was caused by an attempt to "blow" more paint into the system to correct the discontinuity. This mode of correction will not be tried again.

b) at 412 feet: a discontinuity in one of the conductive silver stripes. This could be fixed with a paint brush and silver paint, if required, at the time of lamination around the cylinder.

c) at 729 feet: a small sliver of Mylar was found lying across a minor stripe. It is about 2 cm long. This could be fixed, if required, by removing the sliver and using a little silver paint to insure continuity of the minor stripe, at the time of lamination around the cylinder.

3) The solids content of the R10KM5 minor stripe ink was determined to be $(34.0 \pm 0.5)\%$, after boiling away the solvent in the ink for 15-20 minutes. The solids content of the minor stripe ink stayed constant within 1% during the 4-1/2 hour striping operation. This is due to: a) low evaporation rate of the ink, b) the system containing the ink had covers, c) fresh ink was continually added to the system.

4) Four and one-half cans (each 900 ml) of minor stripe ink were used to stripe the 820 feet of laminate.

5) Preliminary measurements at Sheldahl indicated that the widths, thicknesses and positions of the stripes met the specifications. A sample of the striped laminate was brought back to LBL, and precise measurements confirm the preliminary measurements.

-2-

- 6) At LBL the resistance of the stripes was measured on a sample of the striped laminate sent by Sheldahl. The resistance of the central stripe is as expected, but the resistance of the minor stripes seems lower than expected by a factor of 5-10. These measurements were done on a sample which wasn't laminated. More precise measurements will be done on four laminated samples, to be prepared and sent to LBL by Sheldahl. These laminated samples will be taken from right before and after that part of the laminate used to produce our two prototype graded insulations. John Corrigan says there will be no additional charge for the samples.
- 7) A piece of the striped laminate was held against one of the LBL supplied prototype field cages. The resistive stripes on the laminate and the inlaid rings of conductive epoxy on the cylinder lined up to within 0.5 mm.
- 8) I was very pleased with the striping operation. I thought it went very well, and produced a very nice looking striped laminate.
- 9) I discussed with John Corrigan the specification for the thickness of the finished graded insulation for the final units. LBL is making the large-radius coarse field cage thicker than in the specifications, and thus wants to reduce the thickness of the large-radius graded insulation. We agreed that it would be acceptable to specify the final thickness of the large-radius and small-radius graded insulations to be $(11.8 \pm 1.0^{0.0})$ mm, with the understanding that LBL desires the thickness to be as close to 11.8 mm as possible. This will require about 50 turns of laminate. I will formalize this new specification thru Purchasing at a later date.
- 10) There was much discussion about stress relieving the small-radius mandrel with a groove, and adding counterweights to it. See Norm Parrish's trip report about this.
- 11) I brought back several samples to LBL:
- a) A lamination of the regular laminate and some adhesive coated mylar, with a coating of a conducting silver paint on the polyurethane (Emerson & Cuming CC-2). The adhesion is good, and the sample is acceptable. This is an acceptable alternative to using conductive adhesive on the last turn of the graded insulation.
 - b) A lamination of the regular laminate and some adhesive coated mylar, with a coating of the CC-2 silver paint on the adhesive (which is on the mylar). The adhesion is good, and the sample is acceptable. This is an acceptable alternative to using conductive adhesive on the last turn of the graded insulation.
 - c) A sample showing how well a stripe of conductive silver paint bonds to, and makes contact with, a stripe of resistive paint. Thus contact between the central resistive stripe on the laminate and the central conductive ring on the field-cage can be made by painting a line of conductive silver paint on the central ring.

-3-

d) A sample showing how well a stripe of semiconductive adhesive bonds to, and makes contact with, a stripe of resistive paint. Thus contact between the central resistive stripe on the laminate and the central conductive ring on the field-cage can be made by painting a line of semiconductive adhesive on the central ring.

e) A sample splice (without stripes), using 1/2 mil Mylar with a pressure sensitive adhesive to make the splice. It was agreed that more samples would be made with no bubbles in the pressure sensitive adhesive, and with electrically connected stripes showing good continuity.

May 1-2 Trip to Sheldahl

Larry Brown went with me on this trip. At Sheldahl I had contact with John Corrigan and Dean Lembke. The main purpose of this trip was to observe the winding and laminating of the TPC prototype graded insulation laminate around the prototype field-cage, in order to produce one non-spliced prototype high-voltage graded insulation.

- 1) One non-spliced prototype high-voltage graded insulation was successfully fabricated while we were there.
- 2) The graded insulation has a total of 26 turns of laminate. This is a change from the specifications (which say 22 turns), made at my request. John Corrigan says there will be no additional charge for this change. Dave Peterson in LBL Purchasing was informed of the change before the unit was made. With this change, the prototype has about half the active layers of insulation as the final units will have.
- 3) The initial alignment of the laminate on the cylinder was good everywhere within 1 mm.
- 4) The winding machine which winds the laminate around the cylinder was stopped about half-way through the operation to remove the Mylar sliver discussed on page 1 (section 2c) of this report. This corrective action was successful. Starting up the winding machine after stopping does not cause any problem.
- 5) Due to the edge guide system, the laminate moved from side-to-side during the operation by less than ± 1 mm.
- 6) After completion, a piece of unlaminated laminate material was held against the laminated graded insulation, and the stripes lined up within 1/2 mm, showing that there was no appreciable shrinkage of the laminate as it was laminated to the cylinder.

-4-

7) Pressure used during the laminating was 50 psi for the first two turns and then 60 psi for the rest of the operation (in each 6 inch diameter cylinder). Thus the pressure on the laminate during most of the winding was about 77 pounds/linear inch. The nip roller had 40 durometer rubber on its surface.

8) Before we arrived at Sheldahl, they made a trial run by laminating some old striped pre-prototype laminate around the 16 inch diameter small-radius metal mandrel. Measurements made on this sample indicate:

a) 22-23 layers laminated together are 5.2 mm thick. Thus each layer takes 9.1 ± 0.2 mils. (The laminate is nominally 9 mils thick, excluding stripes.)

b) The peaks due to the stripes lying on top of each other is ~ 6 mils after 22-23 layers, which is less than 3% of the total thickness.

c) The side-to-side motion of the laminate is less than ± 1 mm, which is very good.

This sample was cut away from the mandrel. When free, it closes upon itself, and the edges overlap by $\sim 1/2$ inch. This trial sample will be sent to LBL.

9) The winding machine which winds the laminate around the cylinder works beautifully. It keeps the laminate aligned very well, laminates uniformly along the whole length, and can be re-started without problems after stopping.

10) The non-spliced prototype graded insulation will be air shipped to LBL on May 4.

11) The spliced prototype graded insulation will be wound and laminated on May 9.

12) I have been very impressed with the quality of the work Sheldahl is doing for us, and with the committment that their people have to producing a good product for us.

Ron

 Ron Madaras

RM/jrb

Distribution:

T. Beales
 L. Brown
 O. Chamberlain
 J. Corrigan (Sheldahl)
 D. Fancher
 P. Hernandez
 J. Marx
 D. Nygren
 N. Parrish
 D. Peterson
 W. Gorn

May 11, 1979

TO: Distribution

FROM: Ron Madaras

SUBJECT: Report -- Visit to Sheldahl on May 9-10, 1979

Norm Parrish went with me on this trip. At Sheldahl I had contact with John Corrigan, Terry Origer and Dean Lembke. The main purpose of this trip was to observe the winding and laminating of a spliced prototype graded insulation laminate around a prototype field-cage cylinder.

- 1) One spliced prototype high-voltage graded insulation was successfully fabricated (This is the second prototype graded insulation made by Sheldahl - a non-spliced graded insulation was done last week. See my trip report for that May 1-2 visit).
- 2) The spliced prototype graded insulation has a total of 26 turns of laminate.
- 3) A serious problem was found (and solved) during the fabrication of the graded insulation this week. At the very start of the winding and lamination operation the beginning end of the laminate would not be smoothly laminated to the cylinder, but would develop many wrinkles as the hot nip (pressure) roll laminated it to the cylinder. This happened on the first two tries to fabricate the graded insulation, but not on the third try.

a) The first try was done on the morning of May 9. When the problem was noticed, the operation was stopped. There were 1-1/3 turns of laminate which were already laminated to the cylinder. The good laminate was cut away from the cylinder, and the laminate on the cylinder was removed by passing it by the hot nip (pressure) roll in the opposite direction from which it was wound. The resistive stripes stayed on the adhesive on the cylinder, and had to be cleaned off with butyl acetate (a most unpleasant operation). After a thorough cleaning, additional adhesive was applied to the cylinder, and it was prepared for another try at winding.

b) The second try was done late in the afternoon of May 9. The initial start-up procedure was modified in order to eliminate the wrinkles, but it didn't work. Again, the laminate was removed from the cylinder, and the adhesive on the cylinder was cleaned with the butyl acetate. It appeared, however, that the adhesive on the cylinder contained many tiny bits of carbon from the resistive stripes which could not be cleaned away. In addition, small ridges in the adhesive (caused by wrinkles in a piece of Teflon used during the preparation of the cylinder for winding) also contained bits of carbon. Since this carbon might reduce the resistivity of the adhesive to an unacceptable value, it was decided

-2-

to strip all the adhesive off of the surface of the cylinder. This was a very tedious operation. Three of us worked at it until midnight of May 9, and three more (actually two more plus one of the mid-nighters) started at 6 a.m. on May 10, and finally finished at about 9 a.m. The cylinder was then thoroughly cleaned, new adhesive was applied to its surface, and it was prepared for another try at winding.

c) The third try was done about noon on May 10, and it was successful (to our great relief!). Based on the first two tries, and an extra trial try, it seemed to us that perhaps the cool cylinder under the first layer of laminate was preventing the adhesive from reaching the appropriate temperature during the lamination, and that under the pressure of the nip roll the leading edge of the laminate would wrinkle. Thus on the third try the nip roll was brought against the cylinder about 9 inches before the edge of the laminate (which is similar to what was done last week; this was not tried on the second try this week because we initially thought it would make the wrinkles worse), and the speed was reduced to 1.2 feet/min for the first two turns (the normal laminating speed being 2.3 feet/min). These efforts to warm the cylinder were successful, because there was only one tiny wrinkle at the leading edge of the laminate on the third try (this seemed to be induced by a wrinkle in the 1/2 mil Teflon sheet which is put over the leading edge of the laminate to prevent it from sticking to the nip roll. Perhaps a narrower Teflon sheet with no wrinkles can be used when the final units are fabricated).

4) After winding and laminating 15 turns of laminate around the cylinder, the winding machine was stopped and a successful splice was made in the laminate. The two halves of the splice are held together by a 1 inch wide strip of 1 mil Mylar which was coated with adhesive. The Mylar strip was laminated to the polyurethane side of the two halves using a small hand iron. Electrical continuity of the resistive and conductive stripes across the top of the splice was made using silver conductive paint. The whole splicing operation took about 1-1/2 hours, and it went very well.

5) The initial alignment of the laminate on the cylinder was good everywhere within 1 mm. Due to the excellent edge guide system, the laminate moved from side-to-side during the winding operation by less than ± 1 mm.

6) Samples of the laminate were saved for measurements of the resistance of the resistive stripes. Sheldahl will laminate these samples and then send them to LBL.

7) I brought back seven 35 mm color slides (and 7 color prints) showing the striping of the prototype laminate with the resistive ink, and 34 slides showing the winding and laminating of the non-spliced prototype graded insulation. These were taken by Sheldahl for LBL at my request.

8) I was again impressed by how well the winding machine which winds and laminates the laminate around the cylinder works. Sheldahl did a very good job on it.

-3-

9) I was also impressed by the dedication and commitment that the people at Sheldahl have for our graded insulation project. They worked extremely hard while we were there, they were very responsive to our suggestions, and I am very pleased with their work.

10) The spliced prototype graded insulation will be shipped to LBL during the week of May 14.

11) Try seat 11-H on a Northwest Airlines DC-10. You'll like it!



Ron Madaras

RM/jrb

Distribution:

T. Beales
L. Brown
O. Chamberlain
J. Corrigan (Sheldahl)
D. Fancher
W. Gorn
P. Hernandez
J. Marx
D. Nygren
N. Parrish
D. Peterson

LAWRENCE BERKELEY LABORATORY
Bldg.: 50B Room:5239 Ext.: 4410

November 14, 1980

TO: Distribution

FROM: Ron Madaras

SUBJECT: Trip Report for Visit to Sheldahl on November 10-13, 1980

Larry Brown also went to Sheldahl on this trip. At Sheldahl we worked with Gene Haak, Gus Myran, Dean Lembke, Jeff Solberg and Dave Knudsen.

The purpose of this trip was to observe the striping and winding of laminate for a new Small-Radius Insulator for the TPC. The striping of the laminate was successful, but during the winding and bonding of the laminate around our fiberglass cylinder, the central stripe was damaged, and it is not electrically continuous from beginning to end.

- 1) As on past visits, I was again impressed by the committment that the people at Sheldahl have for doing the best possible job for us. They worked very hard -- working until 8:00 p.m. one night, and working through the next night until 5:00 a.m. in the morning.
- 2) The striping was done with 90% R31 and 10% R41 Microcircuits ink (% by weight). After the printing, the solids content of the ink in the fill tube was 27.4%, and a sample of the mixed ink from the supply can was 28.0%. Measurements of the resistance of unbonded samples of the striped laminate gave 7×10^4 ohms/mm. A total of 340 feet of laminate (all that was available) was striped.
- 3) The small-radius insulator was fabricated using the step-by-step procedures in Sheldahl specification P000958 (which is based on a set of suggested procedures I wrote on 10/19/79 for the first small-radius insulator and updated on 9/26/80 for this one).
- 4) There were no problems with the laminate wrinkling when winding and bonding it around the fiberglass cylinder. The web was nice and tight, and all the tensions evenly distributed. For the historical record it should be noted that the herringbone idler roll pointed "up" (to an observer in front of the winding machine), and it did not have a brake on it.
- 5) One of the most challenging tasks was the set up of the counter which keeps track of the number of turns. Everybody had their own favorite solution!
- 6) There was a problem again this time with the polyethylene (which protects the laminate) sticking to the hot nip roll. It was solved by interleaving 4' wide, 2 mil teflon sheet between the polyethylene and the nip roll on a continuous basis.

-2-

- 7) After 15 turns, a strip of laminate and polyethylene that was being cut away by the edge cutter got tangled in the web and was laminated between two layers. This was on the right (blue) end. It was decided to cut away part of the top layer to remove the strip, as it might provide a channel for gas if it remained. So a 6 inch (max axial dimension) by 18 inch (azimuthal dimension) piece of the top layer at the end was removed, and the edges of the area coated twice with adhesive.
- 8) During the winding, parts of the central stripe would sometimes stick to the polyethylene. Also the teflon would wrinkle and transfer creases to the central stripe. These problem areas were fixed with a little dab of silver paint, without stopping the winding.
- 9) The mandrel heated up quite a bit during the winding. After ~10-15 turns its temperature was ~150° F. Local cooling with methylene chloride helped the problem of the central stripe transferring to the polyethylene, but several times it was necessary to stop and let the mandrel cool down.
- 10) The finished small radius insulator has 54 layers of laminate. It is 11.3 mm thick.
- 11) The measured OD of the finished insulator ranged from 16.75 to 16.79 inches. The specifications say that the OD should be 16.80 inches or less, so the size is perfectly acceptable.
- 12) When the insulator was finished, we attempted to measure the total resistance of the central stripe, expecting to find $\sim 1 \times 10^{10}$ ohms on the basis of our previous measurements of the laminate. We found that the resistance was greater than our Keethley 610 electrometer could measure (10^{14} ohms). We also found that we couldn't measure any current when 400 V was applied to the insulator. This indicates that the central stripe was damaged during the winding -- that it has small cracks at one or more places. The cracks could have been caused by any (or all) of the following ways:
 - a) The herringbone idler roll was located farther back this time, so that the web did not come straight down from the point of contact between the nip roll and the mandrel, but came down at an angle. When the winding was temporarily stopped for various reasons, and the nip roll opened, the web would tend to pull away from the mandrel, taking part of the central stripe with it. This was discovered after the winding was complete, when the excess web was being cut away.
 - b) Before restarting after a stop, the system was reversed for ~1 inch, to allow the nip roll to close on a surface where material was previously laminated (to avoid trapping blisters). However, this probably aggravated the problem described in a) above.

-3-

c) Perhaps not all the problems described in 8) above were caught and fixed (i.e., when parts of the central stripe stuck to the polyethylene, or were creased by the teflon).

- 13) The insulator will be shipped to LBL where we can do further tests on it.
- 14) Yes, it was snowing in Northfield when we were leaving.
- 15) Thanks Angelo's Pizza, for helping us with the all-nighter at Sheldahl.
- 16) Thanks Quarterback Club, for those special blueberry pancakes that I can't get here in California.
- 17) La La Palooza Sundae -- a super sundae at Bridgeman's Ice Cream Parlour. "A combination of pineapple slices, cherries, eight scoops of ice cream, a whole banana, double serving of nuts, generous amounts of butterscotch, pineapple and strawberry toppings, plus whipped cream and a cherry."

Yes, I ate the whole thing, as Larry made me an offer I couldn't refuse! And Larry polished off a La La Palooza Jr. at the same time. Just ask to see our medals!



Ron Madaras

RM/jrb

Distribution:

Alan Bross
 Larry Brown
 Owen Chamberlain
 John Corrigan (Sheldahl)
 Bill Gorn
 Gene Haak (Sheldahl)
 Paul Hernandez
 Jay Marx
 Andy McElheney
 Ken Mirk
 Gus Myran (Sheldahl)
 Dale Nesbitt
 Dave Nygren
 Terry Origer (Sheldahl)
 Norm Parrish
 Fred Perry
 Gerry Przybylski
 Lee Wagner

27 February 1981

MEMORANDUM

Trip Report - Sheldahl, November 10 - 13
L.E. Brown

The laminate printing went without incident.

The parameters for winding were re-established based on earlier work and were essentially unchanged.

The winding process went about five turns without incident when it was noted that small flecks of the black central stripe were beginning to adhere to the polyethylene interleaving sheet.

The problem with ink transfer was attacked immediately by painting silver bridges across the breaks.

By the time that fourteen turns had been wound onto the laminate the temperature of the assembly was declared to be excessive and ink transfer was becoming serious. Winding was stopped.

When re-starting after a cool down, a method of keeping the ink cool was developed; methylene chloride dampened rags were held over the ink stripe.

Winding proceeded with ten more turns and then interrupted again for a cool down.

Four such interruptions were necessary before the 56 turns were completed. The highest temperatures measured were in excess of 150°F, measured on the exterior surface of the laminate.

When the winding machine was stopped for cooldown or for alignment the heated pressure roll was retracted from the assembly. We had discovered on the large radius assembly that we had to back up (rotate in the opposite direction) about one inch on the azimuth in order to get a good bond when starting to wind again. Unfortunately, this may have caused a break in the conductive stripe.

The end result is an insulator with an open circuit in the voltage gradient controlling black stripe.

The assembly got much hotter than earlier assemblies. This happened because we took the adhesive into the liquid phase. The latent heat released back into the assembly as the adhesive cooled to solid phase caused a serious accumulation of heat.

The reason that the earlier assemblies (up through the small radius coarse field cage now ready for assembly) did not exhibit this temperature rise is probably because the adhesive didn't really change phase.

Trip Report-Sheldahl
L.E. Brown

27 February 1981
Page 2

The reason for that the large radius coarse field cage did not show this run-away condition was the fact that it had five times the surface area on both the inside surface and the outside surface. The winding process for the large assembly took twenty hours using the same machine parameters.

The remedy proposed is to develop a conductive material which will not transfer to the polyethylene and will not be brittle. Also, the winding machine should be re-configured to avoid the back-up restart requirement.

Sheldahl is working on a conductive adhesive. A limited R & D effort should lead to a successful recipe.

LB/nyc

This report was done with support from the Department of Energy. Any conclusions or opinions expressed in this report represent solely those of the author(s) and not necessarily those of The Regents of the University of California, the Lawrence Berkeley Laboratory or the Department of Energy.

Reference to a company or product name does not imply approval or recommendation of the product by the University of California or the U.S. Department of Energy to the exclusion of others that may be suitable.

TECHNICAL INFORMATION DEPARTMENT
LAWRENCE BERKELEY LABORATORY
UNIVERSITY OF CALIFORNIA
BERKELEY, CALIFORNIA 94720