

Lawrence Berkeley National Laboratory

LBL Publications

Title

SMP-1 Scanning and Measuring Projector

Permalink

<https://escholarship.org/uc/item/5b26473v>

Authors

Alvarez, Luis W

Davey, Peter

Hulsizer, Robert

et al.

Publication Date

1962-04-01

Copyright Information

This work is made available under the terms of a Creative Commons Attribution License, available at <https://creativecommons.org/licenses/by/4.0/>

UCRL 10109

University of California
Ernest O. Lawrence
Radiation Laboratory

TWO-WEEK LOAN COPY

*This is a Library Circulating Copy
which may be borrowed for two weeks.
For a personal retention copy, call
Tech. Info. Division, Ext. 5545*

SMP-1 SCANNING AND MEASURING PROJECTOR

Berkeley, California

DISCLAIMER

This document was prepared as an account of work sponsored by the United States Government. While this document is believed to contain correct information, neither the United States Government nor any agency thereof, nor the Regents of the University of California, nor any of their employees, makes any warranty, express or implied, or assumes any legal responsibility for the accuracy, completeness, or usefulness of any information, apparatus, product, or process disclosed, or represents that its use would not infringe privately owned rights. Reference herein to any specific commercial product, process, or service by its trade name, trademark, manufacturer, or otherwise, does not necessarily constitute or imply its endorsement, recommendation, or favoring by the United States Government or any agency thereof, or the Regents of the University of California. The views and opinions of authors expressed herein do not necessarily state or reflect those of the United States Government or any agency thereof or the Regents of the University of California.

UCRL-10109
UC-37 Instruments
TID-4500 (17th Ed.)

UNIVERSITY OF CALIFORNIA
Lawrence Radiation Laboratory
Berkeley, California

Contract No. W-7405-eng-48

SMP-1 SCANNING AND MEASURING PROJECTOR
Luis W. Alvarez, Peter Davey, Robert Hulsizer,
James Snyder, Arnold J. Schwemin, and Ronald Zane

April 10, 1962

SMP-1 SCANNING AND MEASURING PROJECTOR

Contents

Abstract	v
1. Introduction	1
2. General Description	2
2.1 Projector	4
2.2 Scanning and Measuring Table	4
3. Electronics	8
3.1 x_c/y_c Digitizers, Scalers, and Registers	8
3.2 $\delta x/\delta y$ Pickup, Scalers, and Registers	9
3.3 Strobe Generation	9
3.4 Indicative Data	11
3.5 Measurement-Permitting Condition	11
3.6 Direct Data Connection to the IBM 709	12
4. Coordinate Computation by Computer	12
4.1 Computer Input (Word Lengths)	12
4.2 Localization of Bench Mark	13
4.3 Computation of Coordinate	13
4.4 Electronic Flow Chart	13
5. Performance Tests on SMP-1	17
5.1 Measurement of the Shadow of a Straight Wire	17
5.2 Measurement of Actual Particle Tracks on Film	19
6. Computer Programs for Use of the SMP as an On-Line Measuring Device	23
Appendix	31

SMP-1 SCANNING AND MEASURING PROJECTOR

Luis W. Alvarez, Peter Davey, Robert Hulsizer,
James N. Snyder, Arnold J. Schwemin, and Ronald Zane

Lawrence Radiation Laboratory
University of California
Berkeley, California

April 10, 1962

ABSTRACT

A novel instrument for scanning and measuring bubble chamber film, the SMP (described at the 1960 conference on high-speed film measuring devices), has been built and tested. The design of this prototype is described herein as well as a proposal for a data analysis system that would use several SMP's connected on-line to a high-speed computer. The prototype has several features, that were developed since the Brookhaven Conference, that have simplified its operation. Tests of the prototype connected to an IBM 709 computer have demonstrated the feasibility of this mode of operation, have shown that the instrument is capable of detecting bubbles even on low-quality film, and have shown the measurement accuracy to be 1μ in determining the position of a fine wire and 6μ in determining the location of a 6-mm-long segment of a bubble chamber track whose bubbles are 30μ in diameter. The organization of a computer program is described that is capable of ingesting, checking, and analyzing the data from at least three SMP's simultaneously operating on-line to an IBM 709 computer.

SMP-1 SCANNING AND MEASURING PROJECTOR

Luis W. Alvarez, Peter Davey, Robert Hulsizer,
James N. Snyder, Arnold J. Schwemin, and Ronald Zane

Lawrence Radiation Laboratory
University of California
Berkeley, California

April 10, 1962

1. INTRODUCTION (Luis W. Alvarez)

This report gives the first description of the SMP hardware and the design of a bubble chamber data-analysis system based on its use. The basic philosophy of the design of the data-analysis system was outlined in UCRL Physics Note 326. The basic philosophy of the design of the instrument itself was set down in UCRL Physics Note 223, entitled "A Proposed Device for the Rapid Measurement of Bubble Chamber Film." That latter document was written while the ideas were being formulated, in order to have a written description of the machine available for the meeting in November 1960, on high-speed film-measuring devices, at Brookhaven. With one exception, the present machine embodies ideas that were outlined in Physics Note 223. The exception has to do with the way in which the projected image and the bench-mark plate are made to move relative to each other. The original proposal was to have two plates executing oscillatory motions in time and space quadrature, with the image fixed relative to the table. Later in the writing of that report, as the ideas developed, the two plates were combined into a single plate, which executed a circular type of motion. At the meeting, but too late to be included in the document, the author described a variation in which the plate was kept fixed, but the image was rotated in the same manner relative to the table and to the stationary benchmark plate. (See Appendix.) With that proposal, the "shaky table" ceased to have vibrational problems.

On returning to Berkeley, the author found that Mr. Arnold J. Schwemin had independently devised a way to produce the relative motion of image and stationary bench-mark plate. It did away with the earlier need for four filters to distinguish the various signals, and to "find the name" of the bench mark being used. Mr. Schwemin's solution to the relative-motion problem was so clearly superior to any previous proposals by the author that we abandoned the earlier work on oscillating bench-mark plates (which was described at the Brookhaven meeting), and proceeded with the developments described in the body of this report.

All the other basic ideas in Physics Note 223 have been incorporated in the present machine:

- (a) the coarse digitizer to identify the bench mark (an analog sensor was proposed, but a picket-fence two-way counter is used);
- (b) A movable hole in a "double window shade" (this was the better of the two schemes proposed);

(c) The lucite bench-mark plate, with light pipes leading to photomultipliers ("frosted" bench-mark circles were suggested, but polished conical indentations have proved to be more efficient in "capturing the light")

(d) fine digitizers on the rotating mechanism, and addition of coarse and fine coordinates to give the accurate position of a segment of track;

(e) multiple tables on line to a single computer.

The rest of this report is a description of work done by Arnold J. Schwemin, Ronald Zane, and their co-workers. They have asked me to write this introduction as a bridge between the original report and this new report of theirs. (For a more detailed description of the basic design philosophy, the reader is referred to Physics Note 223.) I am greatly indebted to them for the ingenuity they have brought to bear on this problem, and for the convincing manner in which they have shown that a somewhat theoretical proposal could be turned into a working reality.

2. DESCRIPTION OF THE SMP

Before an outline is given of the techniques used to extract the bubble coordinates from the film, it will be easier for the reader if he is familiar with the general description of the machine.

A film projector with a long-throw or slightly divergent light path is mounted above the scanning table, giving a $16\times$ projection ratio. A moving curtain mounted on rails and rollers becomes the scanning table. This curtain has a moving hole which the operator or scanner drives along a track that he wishes to digitize. Under the hole is a small rotating magnetic drum and optical system. The drum is driven at 1800 rpm by a small pancake synchronous hysteresis motor. The outer surface of the drum has a coated surface of magnetic material on which are permanently recorded four tracks of δx and δy coordinates. A four-track pickup head is used to read these out. The axis of the rotating drum is drilled out to 1 cm diam, forming the iris on the curtain top. A periscope is mounted beneath the iris. This periscope consists of two small first-surface mirrors mounted at 45° . The displacement of the system is approximately 3.2 cm from the drum axis. When the drum is rotating, the section of the track in the iris rotates at 1800 rpm with a diameter of approximately 6.4 cm. Directly below the rotating optical system is placed a bench-mark plate. The plate serves two purposes. It contains accurately spaced marks separated by 1-cm intervals in both x and y coordinates. Second, it acts as a light pipe. When the rotating image of a track is swept over a bench mark, the bench mark acts as a slit as customarily used on data reduction devices. The light is trapped in the plate and directed to a multiplying phototube. See Fig. 1.

A metal frame encloses the bench-mark plate and photomultipliers to keep out extraneous light and to serve as a frame on which are mounted the curtains and coarse digitizers.

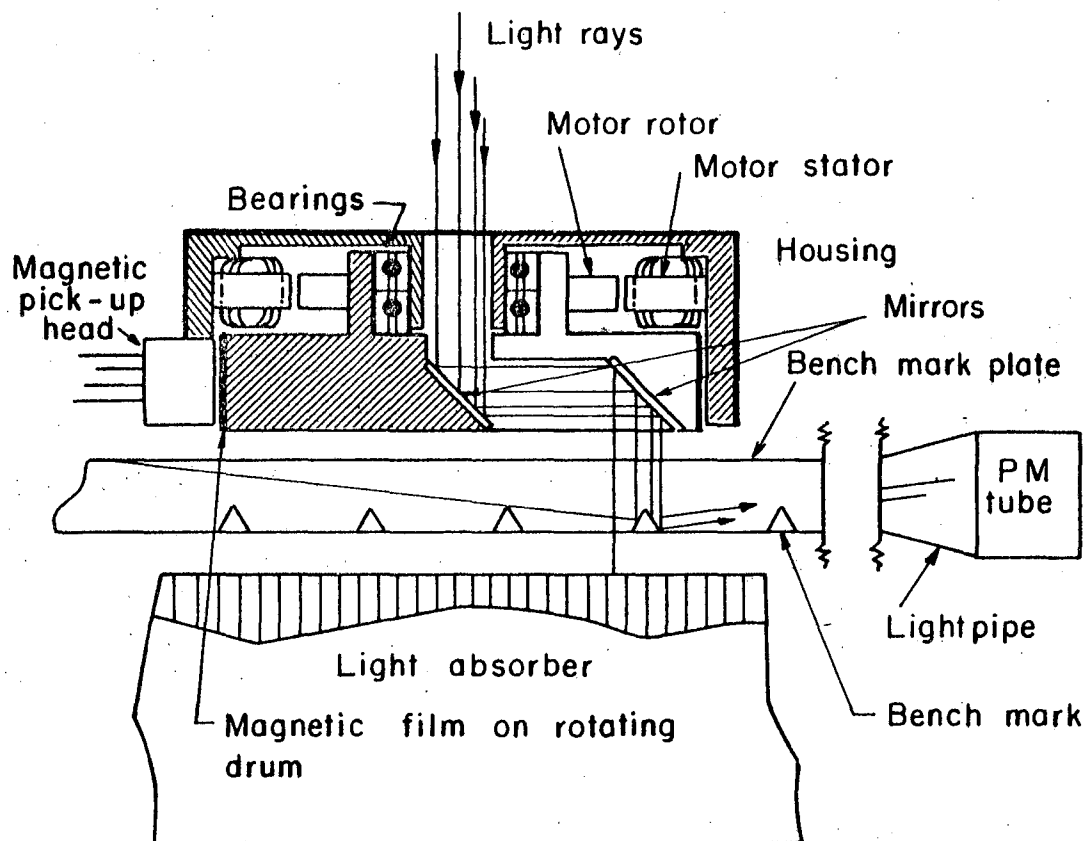

MUB-1134

Fig. 1. Cross-sectional sketch of drum, optics, and light pipe.

2.1 Film Projector

The projector used is a modified Bensen-Lerner "Oscar" film projector. The original projection lenses were removed and a Wollensak 8.5-in. f 2.5 projection lens substituted. A hole 12 in. square was cut in the ceiling and the image projected through this hole to the top of the scanning table. The projector mounts horizontally and is rigidly supported approximately 4 feet above the ceiling by a wooden frame. The negatives used were on 35-mm film from the 15-inch bubble chamber, since the projector handles only this size. (Tests on 72-in. bubble chamber film were made by placing the film manually under the film platen.) The projector is remotely controlled from the operator's console. The distance from the projector to the scanning table top is 12 feet. With $\times 16$ magnification, tracks through the 15-inch bubble chamber are approximately 17 in. long. The principal reasons for the mounting arrangement used are:

first, with a long projection throw the depth of focus at the image plane is great enough to focus on the bench-mark plate and at the same time have a well-focused and clear image on the scanning table top;

second, no mirrors are used to fold up the light path, thus eliminating one of the principal causes of distortion of the image;

third, the long projection throw gives an image produced by light that is only slightly divergent ($3\text{-}1/2^\circ$ at the beginning and end of a 17-in.-long track).

The small angle of divergence is necessary in the present design in order to eliminate parallax cutoff through the optical system under the moving mask.

2.2 The Scanning and Measuring Table

This table consists of six basic parts:

- | | |
|-------------|-------------------------------|
| a. frame, | d. bench-mark plate, |
| b. rails, | e. x and y coarse digitizers, |
| c. curtain, | f. rotating drum. |

2.2.a. Frame

The frame was designed to serve both as a rigid member on which are mounted the rails, curtain, curtain rollers, bench-mark plate, etc., and as a lighttight box. The box is made from 1/4-in. aluminum plate that is heliarc welded on all seams. It measures 17.5 in. high, 23 in. long, and 22.5 in. wide. The top is left open and the aluminum plate edges are machined flat and square. There are two access doors on the box, both having labyrinth light seals on their edges. One door on the bottom is for access to the photomultipliers and associated electronics and the other on the front for placement of a light absorber. The box was sandblasted on the inside and painted a dull black. Four metal desk-type legs are bolted to the bottom corners of the box and anchored to the concrete floor by lag screws in lead plugs (Fig. 2). Rigidity measurements were made by mounting a dial indicator on the top lip of the box. A force of approximately 30 lb was applied to the

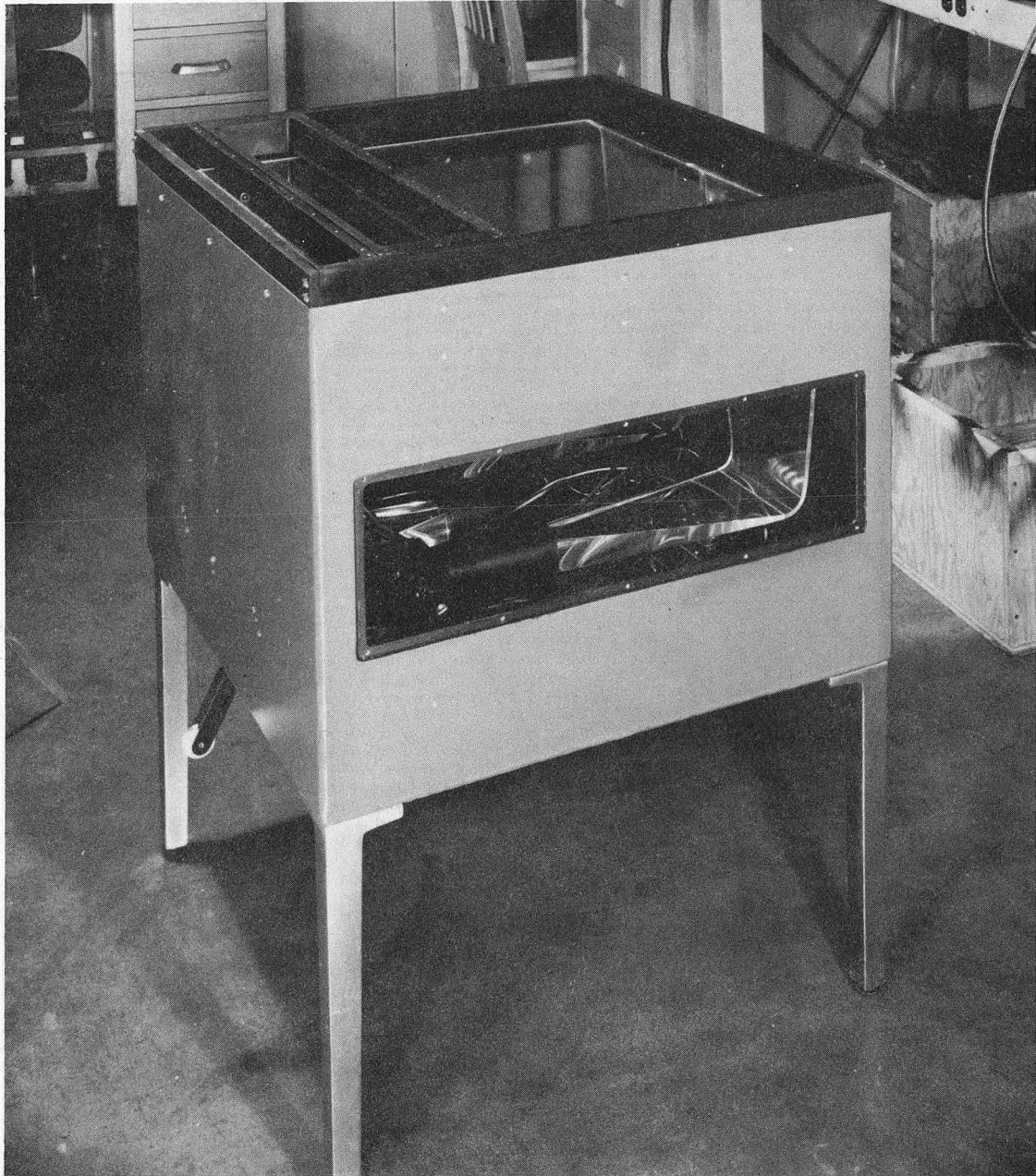

ZN-3096

Fig. 2. The scanning and measuring table.

opposite side of the box to obtain 0.005 in. deflection. Since the normal pressure exerted on the box under operating conditions is on the order of 3 to 4 oz, the horizontal deviation would be extremely small.

2.2.b. Rails

There are two sets of rails used to carry the curtains and drum. One set is mounted on the machined surface on the top of the box. These rails are for motion in the x coordinate direction. The second set of y coordinate rails is made to roll in the first set of rails. The second set is used to carry the drum and optics. Both sets of rails contain 1/32-in. slits 1/4 in. deep in which the curtains slide. These work satisfactorily as light barriers. Both sets of rails are machined from hard aluminum and black-anodized. The wheels used on the rails are 3/8-in. o.d. ball bearings with 1/8 in. inside diameter. The bearings are spring-loaded against the rails to remove all mechanical shifts. Horizontal pressure on the order of 5 lb is required to overcome the spring loading on the bearings.

2.2.c. Curtain

Since we wish to measure with respect to a single bench mark at a time, we must keep light from reaching the bench-mark plate except in the vicinity of a particular bench mark. The most obvious way to do this is to have a "two-dimensional focal-plane shutter" arranged as shown in Fig. 3.

The curtain is a thin sheet of Mylar. The sheet is first made opaque by aluminizing in a vacuum coater. The top is then painted white to give a good scanning table surface and the bottom is painted black to become a light absorber. The total thickness, after painting, is on the order of 0.006 in. The curtains are cut to proper size and attached to the moving rails and drum housing with a lighttight seal. Rollers are provided on the edges of the box to permit the curtain to roll over the edge without scraping or being damaged.

2.2.d. Bench mark plate

This plate measures $19 \times 19 \times 3/16$ in. The material is plexiglass selected to be free from scratches and polished on all four edges.

Four light pipes attach the plate to four photomultipliers. The light pipes are folded to reduce the physical size of the table. The bench marks are highly polished cones machined in the plexiglass with a specially made engraving cutter. The cone angle is 82° so that the polished edge is less than critical to light rays entering the plate from the projection system. This system directs the light picked up from the bench marks at an angle inside the plate that requires a minimum number of bounces before reaching the photomultipliers. The direct light from the projector when striking the plate is not trapped in the plate but merely passes through it and is absorbed below. Only where the light strikes a cone or mark is it trapped in the plate. The bench marks are machined on a 1-cm-square grid over the entire area of the plate to an accuracy of 25 microns. The diameter of the bench marks is 0.023 in., or slightly less than the track width or size of a bubble on the table. Because of the high expansion coefficient of plexiglass (7.5×10^{-5} per $^\circ C$)

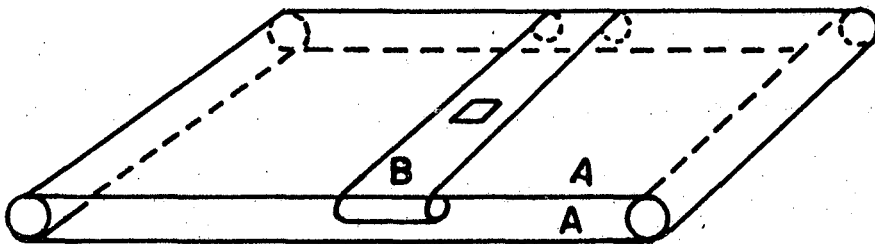

MU-27012

Fig. 3. Two-dimensional curtain (focal-plane shutter).

it is necessary to maintain the plate at a fairly even temperature during the drilling process. Since the expansion is the same in both x and y directions, no temperature stability requirements are needed when measuring since measurements are done in space from the coordinates of the fiducial marks on the film.

2.2.e. Coarse digitizers

There are two coarse digitizers attached to the moving rails to give a rough position for the center of the optical aperture or mask. The digitizers are picket fences photographed on a Mylar-base film and glued to a piece of 1/32-in. plexiglass. The fences are 1/3 in. wide with 16 pickets per cm. This corresponds to eight opaque and eight clear strips. Two small pin-lite bulbs, 0.020 in. in diameter and 1/16 long, act as a slit light source. Directly below each pin lite under the picket fence are placed 1N2175 photodiodes. The pin lites and photodiodes are separated by 1/4 in. The mountings for the pin lite and photodiodes are made so they can be rotated a few degrees in order to change the phase angle of the output signals.

2.2.f. Rotating drum

The magnetic drum is contained in the housing which rolls on the x and y coordinate rails. The motor that rotates the drum is of the synchronous hysteresis type. It is a single-phase 2-pole 1800-rpm motor built to have a very low temperature rise. After the motor comes up to synchronous speed the voltage is reduced to keep the IR heating to a minimum. The drum is turned from a solid piece of hard aluminum and coated with an epoxy-base magnetic film which is ground to a thickness of 0.002 in. The drum contains a pocket in which the optical periscope is mounted. A five-track magnetic pickup (and writing) head is mounted to the outside frame. The magnetic head is adjusted to a 0.5-mil gap by means of shims. (See Fig. 1.)

3. ELECTRONICS

The electronics portion of the machine consists of: Instrumentation to roughly measure the x and y coordinates (x_c and y_c) of the "hole" or "iris" center; instrumentation to produce the instantaneous x and y coordinates (δx and δy) of the periscope-translated iris center relative to the real iris center; circuitry to produce a "strobe" on some portion of a track; a means of entering requisite indicative information; and a means of preventing redundant remeasurement of the same points, along with other controls.

3.1 x_c/y_c Digitizers, Scalers, and Registers

The output currents from the photodiodes of the x_c and y_c digitizers are fed into d. c. amplifiers which in turn feed d. c. bistable multivibrators. The 90° phase-shifted signals are used to drive a Ferranti-type reversible scaler 11 bits in length. Resetting of both x_c and y_c reversible scalers is accomplished by translating the drum and iris assembly to the

lower right corner of the SMP table, whereupon a microswitch is actuated which causes the scalers to reset to a number corresponding to the iris displacement from the lower right-hand corner bench mark. Provision is made for the introduction of a strobe to transmit the contents of the x_c and y_c scalers into registers provided for this purpose.

Simple linear gratings and reversible scalers were chosen for coarse digitization rather than a coded parallel read-out because the linear grating greatly simplified the alignment and dimensional problems associated with the digitizing pickup head assembly.

3.2 $\delta x/\delta y$ Pickup, Scalers, and Registers

The δx and δy are in reality trigonometric functions. They are $R \cos \theta$ and $R \sin \theta$, respectively, where R is the radius of the rotating periscope and θ is the instantaneous angle at which it is situated. The smallest incremental value of δx and δy is chosen to correspond to the "least count" of the device. This "least count" is approximately 1/128 cm or 78 microns. δx and δy are generated by driving two reversible scalers with a train of pulses from each of two tracks on a magnetic emulsion on the surface of the drum assembly. These pulses are spaced according to a sine function and are shifted 1/4 revolution in order to distinguish between sine and cosine. Two other tracks on the same emulsion contain pulses to identify quadrants, thus producing information which causes the δx and δy scalers to reverse at the proper time and simultaneously produces signals depending on the quadrant. The scalers are 9 bits in length. Provision is made for the introduction of a strobe to transmit the contents of the δx and δy scalers into registers provided for this purpose. Alignment of the optical center radius arm with the $\delta x/\delta y$ recordings is simplified by merely mounting the periscope in a slightly advanced position and performing the final critical adjustment electronically by introducing a precise delay (100 to 200 μ sec) into the pulse center strobe circuitry.

3.3 Strobe Generation

The light signals which are transmitted through the rotating periscope are swept by the rotating periscope across one bench mark at a time. Since the bench marks are smaller than the tracks (or the same size, 0.020 inch), the light transmitted by the bench-mark plate through the light pipes and into the four photomultipliers is interrupted whenever a bench mark is not under the end of the rotating periscope or whenever the light is obscured by the image of a track. The signals out of the photomultiplier amplifiers are similar to those shown in Fig. 4.

Three different methods of generating a "strobe" for track centers have been developed:

a. The first method involves the use of three comparators and two stores. The first comparator is used to sense the flexion away from the fixed baseline at the leading edge of a pedestal and enable the first store circuit to store the pedestal level. The second comparator is used to sense the inflection of

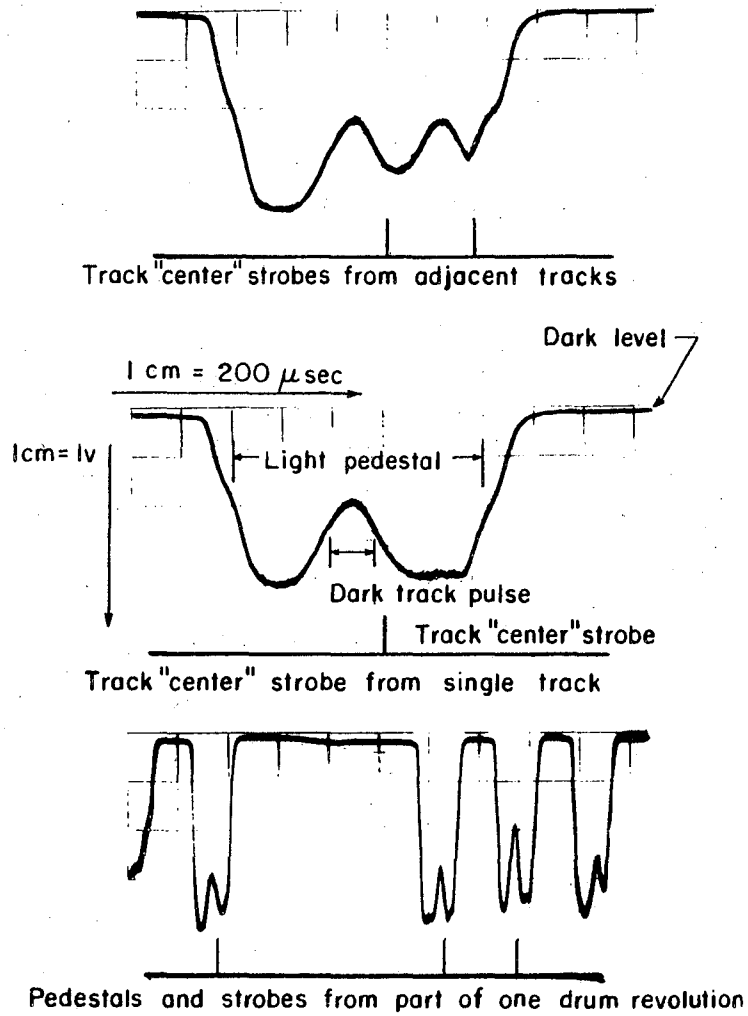

MU-27013

Fig. 4. Typical photomultiplier signals.

a track leading edge and enable the second store circuit to store the track-signal peak level. The third comparator is used to sense the flexion of the track pulse following the peak. The third comparator output constitutes the track-center strobe.

b. The second track-pulse-center finder is one of a class for which it is assumed that the pulse outline is symmetrical about its center of area. The center, therefore, is taken as the point midway between a "start" edge, generated when the pulse exceeds some arbitrary level, and a "stop" edge, generated when the pulse falls below the same level. A strobe pulse can be generated a fixed time after this midpoint if a ramp of fixed slope is started at the "start" edge and doubled in slope at the "stop" edge. The strobe is given when the final ramp crosses the zero level. The ramp generator "times out" without doubling its slope if the "stop" pulse does not occur within a predetermined time dependent on the voltage swing, and slope, of the ramp generator. This can be used to advantage to prevent strobes from being given for abnormally long track pulses or for the long dark spaces between the pedestals.

c. A third circuit accomplishes the strobe generation by delaying the photo-multiplier output signals by $100\mu\text{sec}$ and then using a comparator to sense the intersection of the delayed and undelayed signals. The intersection occurs midway between the delayed and undelayed pulse centers if the pulses are symmetrical.

At present, tests are being conducted to determine which circuit will produce the best results under a wide variety of signal conditions.

3.4 Indicative Data

The necessary indicative data is now provided by eight octal switches and some other operator-controlled switches. In a proposed computer-controlled system, described below, these data will be provided on a typewriter keyboard.

3.5 Elimination of Redundant Measurement

If no "lockout" were provided, the rotation of the drum might produce five or more coordinate measurements per revolution regardless of whether or not the iris was being translated to new locations. Therefore it is necessary to monitor the x_c and y_c scalars to allow measurement of one revolution of measured data each time x_c or y_c changes by a preset amount. The operator is provided with a lockout override in case multiple measurements are required. Other operator controls are provided as deemed necessary, but it is not desirable to enumerate them in detail in this report.

3.6 Direct Data Connection to IBM 709

Provision has been made to enable the IBM 709 to sample the output registers of the SMP at its convenience following a signal indicating that new data have been transmitted to the output registers. Present plans call for operation of a multiple measuring-machine system under the direct control of an IBM 709 or 7090. The use of an "on line" computer is not necessary to operate the measuring machine as a simple operator-oriented system with data storage on paper or magnetic tape.

4. COORDINATE COMPUTATION BY COMPUTER

4.1 Computer Input Data

The computer should receive the following information:

- a. indicative information,
- b. x_c and y_c (9 bits each),
- c. x and y (9 bits each).

Items b, c, and d may be for either track or fiducial measurements. The computer's first job is to convert items b and c into x and y coordinates of the track or fiducial mark being measured. The significance of the data is described in the table.

Measure- ment (cm)	32	16	8	4	2	1	$\frac{1}{2}$	$\frac{1}{4}$	$\frac{1}{8}$	$\frac{1}{16}$ ^a	$\frac{1}{32}$ ^a		
x_c and y_c	A	B	C	D	E	F	G	H	I	J	K		
Measure- ment (cm)					2	1	$\frac{1}{2}$	$\frac{1}{4}$	$\frac{1}{8}$	$\frac{1}{16}$	$\frac{1}{32}$	$\frac{1}{64}$	$\frac{1}{128}$ ^b
δx and δy					E	F	G	H	I	J	K	L	M and sign bit

^a J and K discarded as unnecessary

^b $1/128$ cm = .00781 cm = least count.

4.2 Localization of Bench Mark

The first step in establishing the real coordinates of the track in question consists in establishing the identity of the bench mark which has "seen" the track. This is accomplished as follows (see Fig. 5).

(The procedure is described for x coordinates only, as an exactly similar procedure is followed for y coordinates.)

- a. x_c and δx are added together to produce a number which is $q_x \pm 0.3$ cm (where q_x is the coordinate of the bench mark in question and 0.3 cm is the radius of the aperture of the periscope).
- b. To the number obtained in step (a) is added 0.5 cm; thus we have $q_x \pm 0.3$ cm + 0.5 cm or $q_x + .2$ cm / $q_x + .8$ cm; this number is clearly larger than q_x and smaller than $q_x + 1$ cm. (The addition of 0.5 cm is actually performed by causing the coarse scalers to read 0.5 cm high at all times.)
- c. Since q_x is known to consist of whole-centimeter increments and is known to be more accurate than the least count of the machine, we may throw out the fractional portion of the number found in step (b), retaining only that portion to the left of the final point and assuming the fractional portion to be zero. The number remaining is q_x , the coordinate of the bench mark that produced the data strobe.

4.3 Computation of Track Coordinate

Since q_x/q_y (bench-mark coordinate) is now known, the only remaining step is to calculate the coordinates of the point on the track whose crossing of the bench mark at q_x , q_y produced the data strobe. By considering the geometry of the situation (see Fig. 6) one sees that these coordinates are simply

$$X = q_x - \delta x,$$

$$Y = q_y - \delta y,$$

where x and y are the coordinates on the track.

4.4 Electronic Flow Chart

Sequences and interrelations are shown in Fig. 7.

Scaler X_C	A	B	C	D	E	F	G	H	I	J	K		
Scaler δ_x				Sign bit	E	F	G	H	I	J	K	L	M
Funct.	Transfer to registers and thence to computer												
X_C	A_1	B_1	C_1	D_1	E_1	F_1	G_1	H_1	I_1	J			
				Sign bit	E_1	F_1	G_1	H_1	I_1	J_1	K_1	L_1	M_1
$9q^{+12}$ $9q^{+18}$	$X_C + \delta_x + 1/2 \text{ c.m.}$												
	A'_1	B'_1	C'_1	D'_1	E'_1	F'_1	G'_1	H'_1	I'_1	J'_1	K'_1	L'_1	M'_1
$9q$	Set fractional part to zero												
	A'_1	B'_1	C'_1	D'_1	E'_1	F'_1	0	0	0	0	0	0	0
	$q_x - \delta_x$												
X	A''_1	B''_1	C''_1	D''_1	E''_1	F''_1	G''_1	H''_1	I''_1	J''_1	K''_1	L''_1	M''_1
Signifi- cance	32 c.m.	16	8	4	2	1	1/2	1/4	1/8	1/16	1/32	1/64	1/128
	Binial Point												

MUB-II35

Fig. 5. Coordinate data computation.

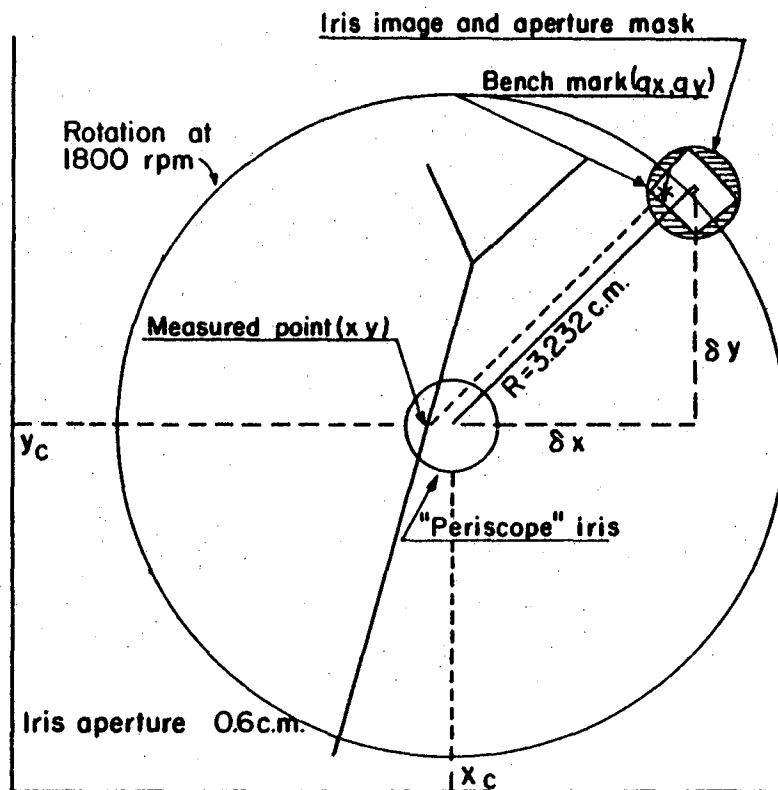

MU-27014

Fig. 6. Geometry for coordinate computation.

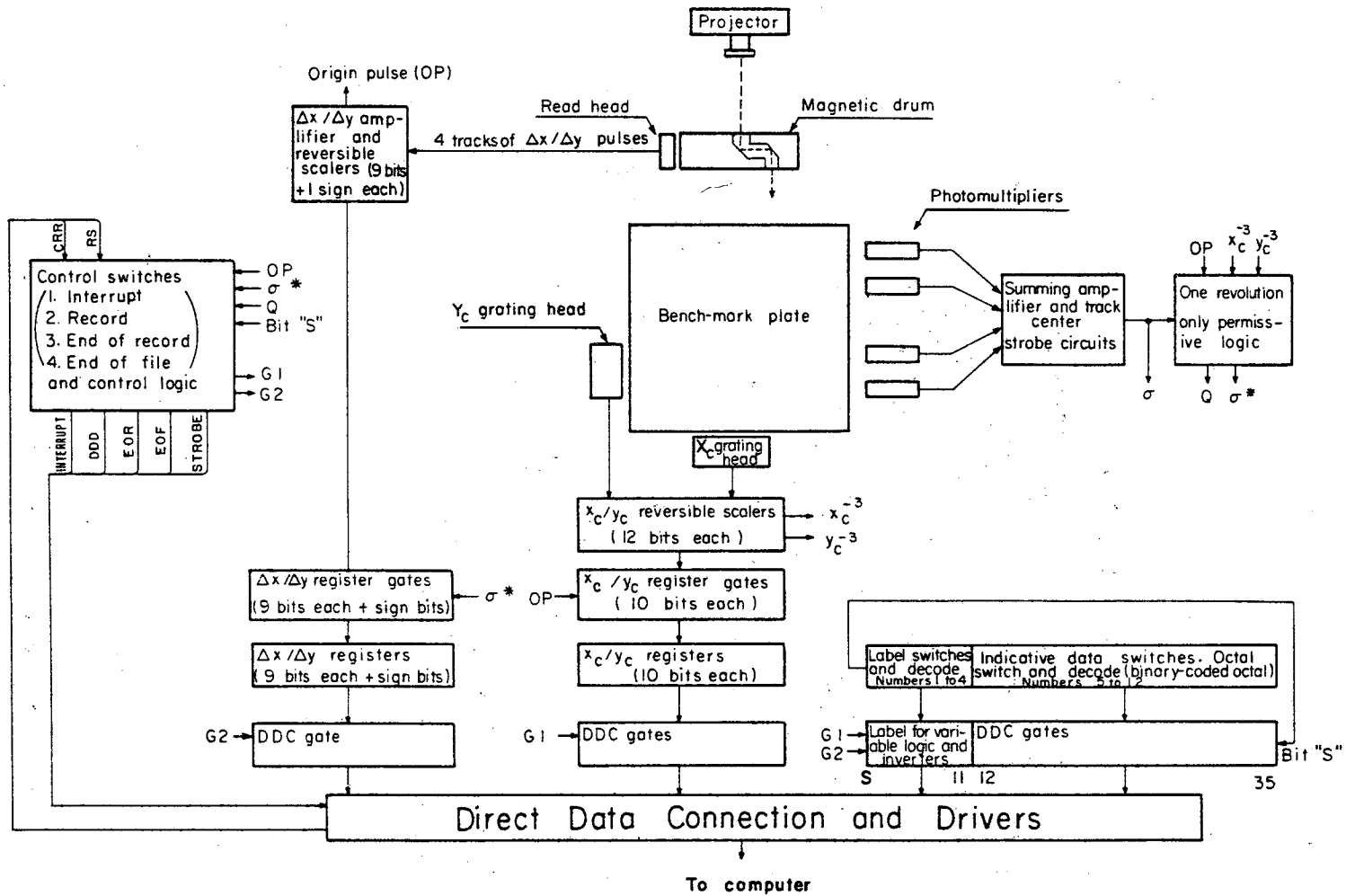

Fig. 7. Flow chart.

MUB-796

5. PERFORMANCE TESTS ON SMP-1

The main sources of error in the machine are as follows.

- (a) Optical distortion in the projection system.
- (b) Deviation of the bench mark cones from a true 1-cm grid, due to machining error. (Note that the effects of any isotropic expansion or contraction of the grid do not affect accuracy, for the reason given in 2.2.d above.)
- (c) Errors due to asymmetrical absorption of light from the bench mark giving a track "strobe" signal
- (d) Errors in locating the center of the dark pulse "seen" by the photomultipliers attached to the bench-mark plate, due to photomultiplier and circuit noise, etc.
- (e) Timing errors in reading the δx and δy pulses from the drum.
- (f) Error due to misalignment of the periscope mirrors with the axis of rotation.
- (g) Quantizing error due to the least count of the scalers counting δx and δy pulses.

The tests made on SMP-1 so far were designed (1) to estimate the combined magnitude of errors c through g above (and to some extent b also), and (2) to establish how many true track points, as distinguished from points due to dirt on film, crossing tracks, etc., were obtained on bubble chamber film, especially when the wanted track was weakly ionized.

Error b was checked independently by using a microscope during the manufacture of the bench-mark plate. The worst deviation between any two marks measured was within ± 25 microns.

Error a is expected to be small and to change slowly over the area of the table. It can conveniently be allowed for, along with the optical distortions in the bubble chamber itself, in a computer program.

5.1 Measurement of the Shadow of a Straight Wire

Since the divergence of light falling on the measuring table is small, a wire stretched about 1 cm above the table top throws a sharp image on the benchmark plate. In this way, errors b through g can be measured independently of a. A 10-cm-long copper wire was used, stretched beyond the yield point to make it as straight as possible, and kept under tension. It was roughly 500 microns in diameter--about the same as a bubble when projected on the table. An area of clear film was left in the projector to provide a background of normal brightness.

Figure 8 shows the result of a series of tests in which the strobe circuit 3.3.b was used and the amount of strobe delay (see 3.2 above) was varied. For each measurement about 40 points were obtained, and the computer calculated their standard deviation from straightness. The graph

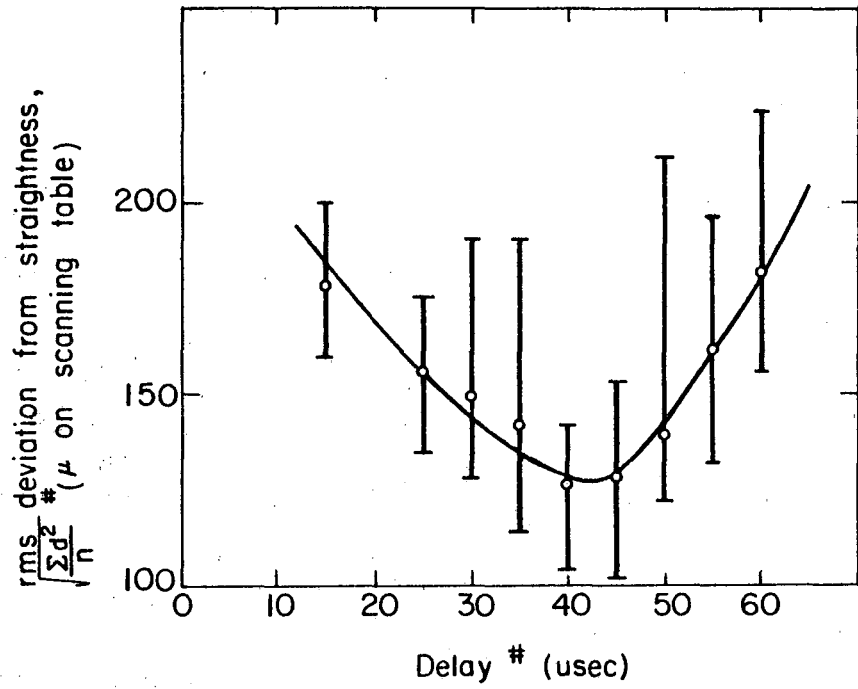

MU-27015

Fig. 8. Results of test measurements on straight 500- μ wire.

shows the mean, and also the spread, of standard deviations (as measured on the table) for each delay setting. At a delay of about 36 μ sec the standard deviations are least, and lie in the range 100 to 150 microns--corresponding to 6.2 to 9.4 microns in the film plane. This delay corresponds to correct alignment of the electrical signals from the $\delta x \delta y$ recording with the optical axis of the periscope.

As a check on the computer program, and to discover the shape of the distribution of points, all points from two measurements were plotted by hand from the x, y coordinates printed out by the computer. The better of these plots is shown in Fig. 9. The standard deviation was calculated by hand, and agreed with the value obtained by the computer within 5%.

Figure 9 shows that in the ideal case of a continuous 500-micron-wide shadow, all points obtained by SMP-1 lay within the shadow and half lay within a band 200 microns wide. Since the wire was stretched nearly parallel to the x axis, the points in the figure are quantized in y according to the least count of the δy scaler.

If it is assumed that the distribution of points is Gaussian (see histogram in Fig. 9), follows that a section of track containing n points having a standard deviation of σ microns can be located with an accuracy of σ/\sqrt{n} microns. Thus an average 1-cm length of the wire measured in Fig. 8 for which $n = 4$ and $\Sigma = 100$, is located within about 50 microns on the table, or 3.1 microns in the film plane. This indicates that the ultimate accuracy of future SMP's will probably depend on the magnitude of error b .

5.2 Measurement of Actual Particle Tracks on Film

Tests on film show that the three types of strobe circuit (described in 3.3. a, b, and c) produce an average of two to six points per cm of track, depending on its density, using 1/4-cm permissive measurement. Circuit 3.3. a collects many strobes even on weak tracks, but also gives an appreciable number of strobes due to dirt and other clutter in "clear" areas of film. Circuit 3.3. b was designed to discriminate against background clutter as much as possible, at the expense of producing fewer strobes from very weakly ionized tracks. Circuit 3.3. c, which is still being developed, may combine the advantages of the other two. In any case, it seems likely that a filtering program will have little difficulty in distinguishing a weak track from clutter, even if as many as 25% of the points are due to clutter.

Figure 10 shows a reproduction of a rather dirty frame of 72-inch bubble chamber film, and for comparison Fig. 11 is a hand plot of the 190 points obtained from the computer after the event in this frame was measured by using strobe circuit 3.3. b. This shows that rather few points are contributed by crossing tracks, and apparently none by stray spots on the film.

ERROR ANALYSIS OF SMP MEASURING SHADOW OF STRAIGHT WIRE

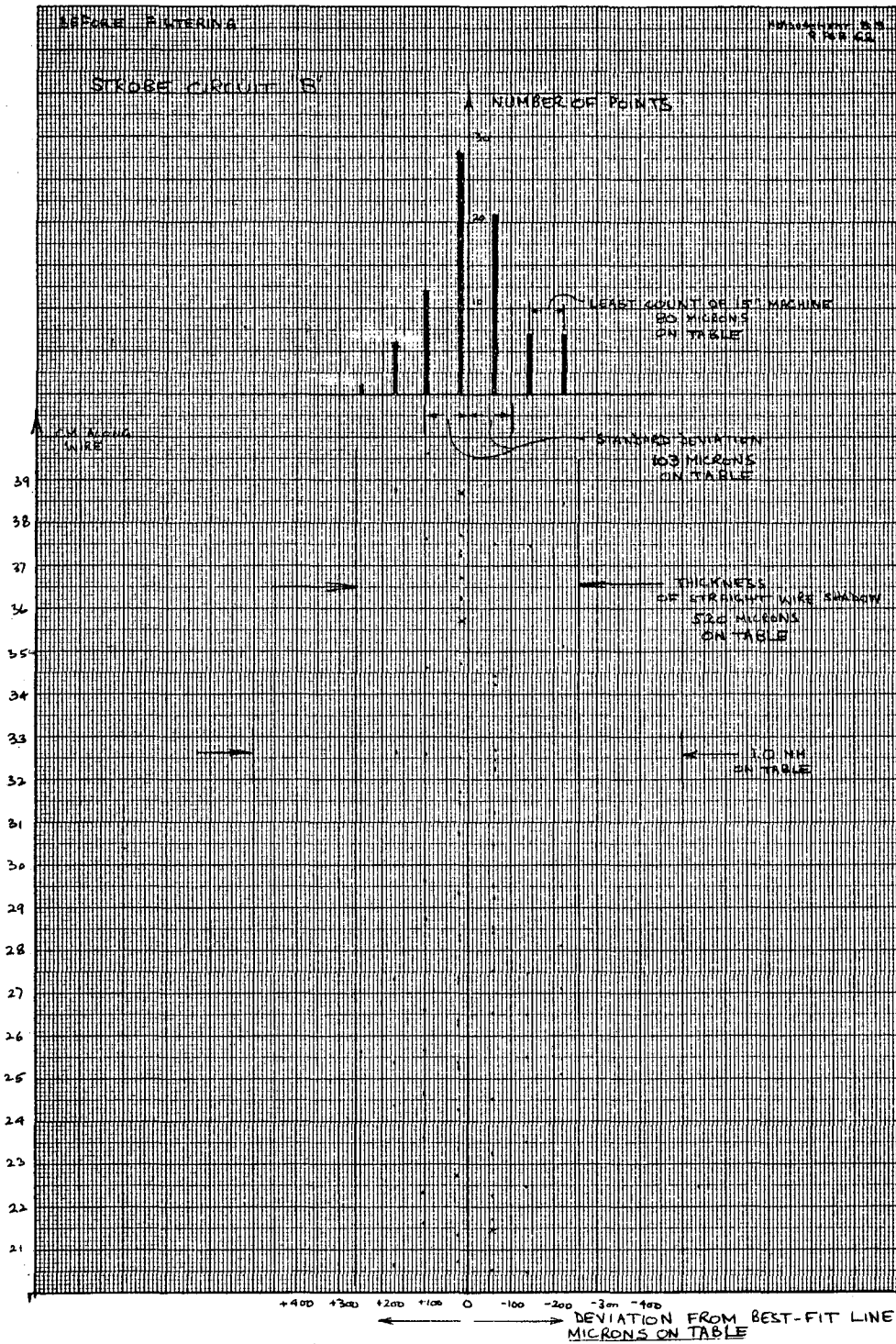

MUB-1101

Fig. 9. Chart of error analysis for SMP measurements on straight wire. Before filtering.

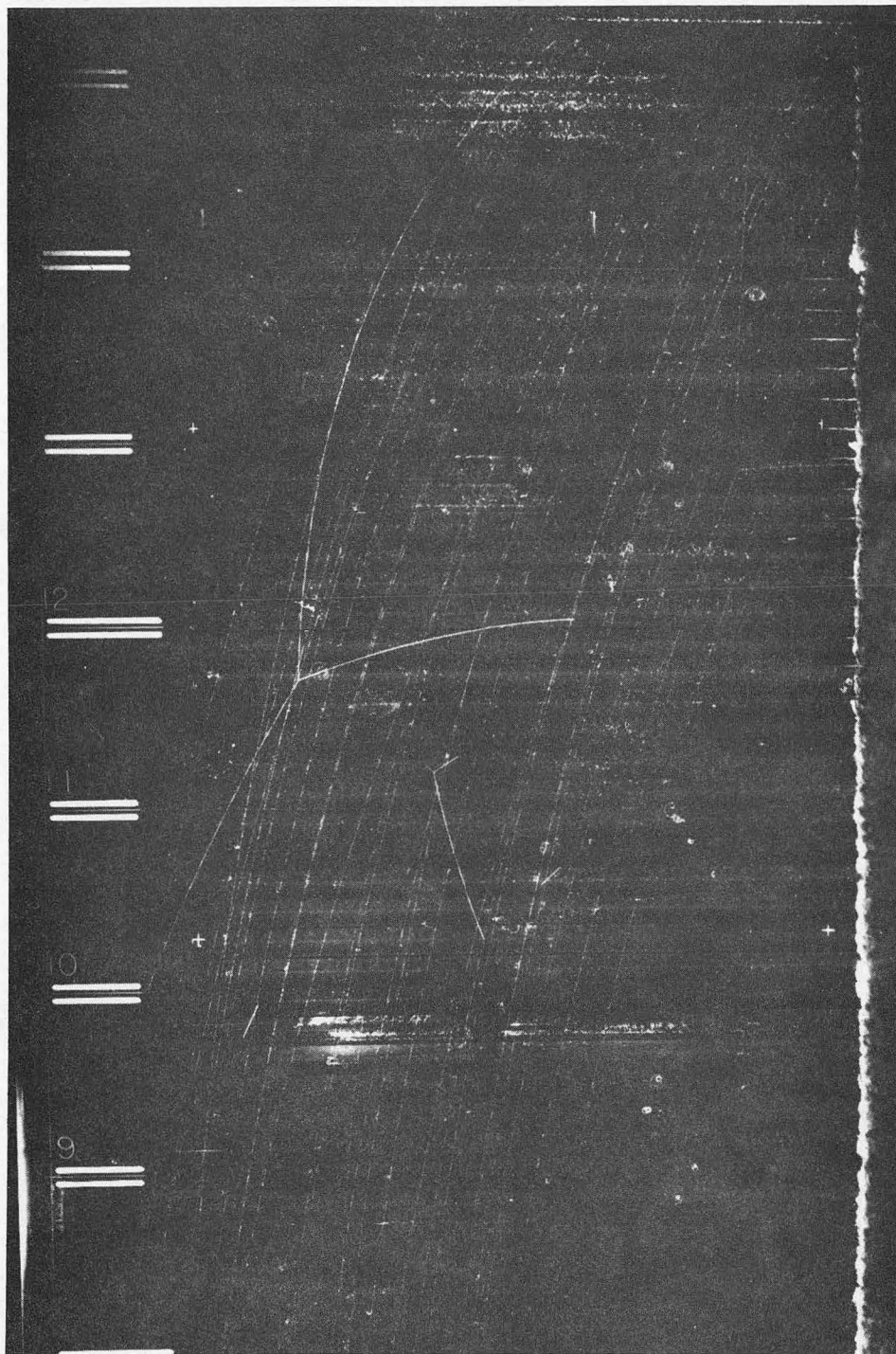

ZN-3097

Fig. 10. Section of film from 72-inch bubble chamber.

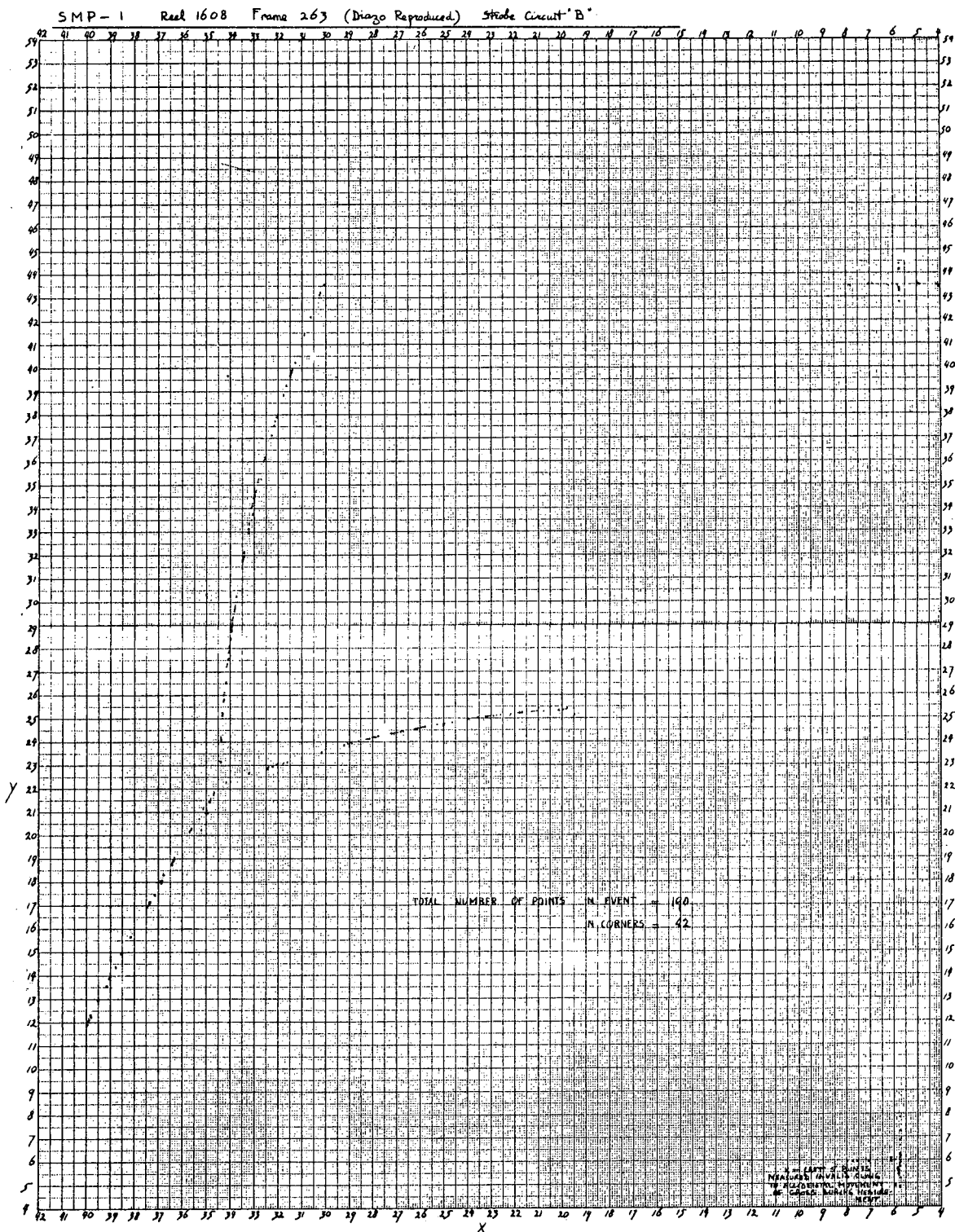

MUB-1102

Fig. 11. Hand plot of event photographed in Fig. 10.

6. COMPUTER PROGRAMS FOR USE OF THE SMP AS AN ON-LINE MEASURING MACHINE

In the summer after the invention of the SMP, one of the authors (JNS) studied the possible ways in which a data-analysis system could be designed to take advantage of the simplicity of the SMP and of the fact that both scanning and measuring can be done on the same machine. The result of this investigation was the proposal that the SMP, with its operator, be regarded as an on-line facility of the computer in which the overall data analysis is being done.¹

It was proposed that each SMP that is connected to the computer be provided with a CRT or typewriter with which the computer program could ask for information needed in carrying out the data analysis. Ancillary information such as roll number, frame number, event type, etc., would be supplied to the computer by an on-line typewriter keyboard. Measurements of fiducial marks and of tracks, when requested, would be fed directly from the SMP digitizers into the computer memory via the direct data channel as the operator moved the periscope along the image of the desired fiducial or track. The computer program would take the ancillary data and make up a scan list for the library and would process the measurements with the space-reconstruction and kinematical analysis programs to prepare a magnetic tape of kinematic and statistical quantities for further examination by the experimenter. In the process of making up the scan list and performing the analysis computations, various checks are made on the data. If any of these checks revealed errors or defects in the scanning or measurement, a request for rescan, or remeasurement, would be made to the operator before he was instructed to go on to the next event or next frame. If a measurement persistently failed the standard tests, a physicist working at the SMP table could call for special tests or for modified forms of analysis to explore the cause of failure and to study the event in more detail. This would be a Physicist's Quest mode of operation as contrasted to the production mode outlined above. On a high-speed computer like the IBM 7090, the required analysis for an event requires only a few seconds of computer time, so that it is practical to consider processing the data while the operator waits for the results.

The time-sharing and computing problems have been studied and it is estimated that an IBM 709 could handle the output of three on-line SMP's while an IBM 7090 could handle about ten on-line SMP's.

In order to test these ideas two levels of programming activity are under way. One involves a set of small independent programs to test various individual operations; the other involves an executive program that will handle the time-sharing and integrated activity of the computer (the IBM 709 for now) and three SMP's.

The first small program is a test of the idea of on-line scanning. A Flexowriter typewriter was connected to the direct data channel of the 709 for two-way operation and a program was written (CHIT-CHAT) that asks

1. J. N. Snyder, Some Remarks on a Data-Analysis System Based upon the Scanning Measuring Projector (SMP), UCRL Physics Note 326, Aug. 25, 1961.

the scanner those questions that would enable the program to compile the type of scan-card list used in Experiment 11 of the Alvarez group.² (K^- p interactions from 0 - 250 Mev/c). The scanner is to read the question written on the typewriter by the computer, examine the film for the answer, and type it on the typewriter. The typed characters go into the computer memory. After the scanner has checked his answer for typographical errors (it is typed on his paper along with the computer's questions), he touches an interrupt switch which signals the computer to test his answer, store it if correct, and give him the next question. If the answer fails to meet the test, the computer responds, "ERROR," and he attempts to supply the correct answer. A copy of a typical sheet of questions and answers is shown in Fig. 12. At present there are still errors in the program; when these are removed, experienced scanners will scan some Experiment 11 film to compare this mode of scanning with the present off-line scanning.

The second small program ingests measurements from the SMP, displays the measured points on the CRT and, for test purposes, determines their standard deviation from a straight line. This program has been used to test the accuracy of the SMP in measuring images of straight wires as described above in Sec. 5.

The third test program takes the raw data in the computer memory, filters out the points that do not fit on a smooth curve through the assembly of points (the desired track), and prints out a set of smoothed points each of which represents an estimate of the transverse coordinate of a 6-mm segment of the track. To date, this program has "filtered" the data from a few simple tracks, but has not been exhaustively tested. Figure 13 shows the raw data points from a bubble chamber track and the smoothed points produced by the program.

Two more short programs are being written. One corrects the smoothed points for optical distortion produced by the projection lens of the SMP. The second prepares the optically corrected data in a format suitable for direct comparison with Franckenstein measurements of the same track. When these are done, the accuracy of measurements of actual bubble chamber tracks by the SMP and by Franckenstein will be directly compared.

The overall executive program is now being written for operation of three SMP's on-line to the IBM 709. There appeared to be many ways of solving this problem; the particular approach chosen will serve as a means of testing the system and may be revised as a result of experience.

Signals from the computer to the typewriter and from the typewriter to the computer are carried on the sense lines. The printing of a typewriter character interrupts the computer either to ask for another character of a message from the computer or to ask the computer to store a character in a message from the operator to the computer. A special character indicates to the computer that a message from the operator is complete and ready to be tested and stored. Another special character indicates that the operator has finished measuring a fiducial mark or a track.

²W. E. Humphrey and R. Ross, Scanning Instructions for Experiment 11, Low-Energy K^- + p; UCRL Physics Note 251, Jan. 9, 1961.

```
YOUR NUMBER          77
ROLL NUMBER          3031
DATE                 32762
IS DOT FILM-IN FRONT YES
IS MASK ALIGNED     YES
DO YOU HAVE CUT-OFF AND STOPPING TEMPLATES YES
GO TO VIEW 4, PUT THE MASK-DOWN, GO TO THE FIRST FRAME TO-BE SCANNED
FRAME NUMBER        C01
NUMBER OF ENTERING K IN VIEW 3 OR 4 C1
TRACK C1            T
ERROR
TRACK C1            T CC
RAISE MASK
DO YOU HAVE ANY COMMENTS LARGE DELTA RAY ON TRACK
GO TO VIEW 4, PUT THE MASK DOWN AND GO TO THE NEXT FRAME
FRAME NUMBER        C02
NUMBER OF ENTERING K IN VIEW 3 OR 4 C3
TRACK C1            T CC
TRACK C2            2X 14
TRACK C3            2X-1 20
RAISE MASK
DO YOU HAVE ANY COMMENTS NO
GO TO VIEW 4, PUT THE MASK DOWN AND GO TO THE NEXT FRAME
FRAME NUMBER        C03
NUMBER OF ENTERING K IN VIEW 3 OR 4 C0
RAISE MASK
DO YOU HAVE ANY COMMENTS DELETE FRAME
GO TO VIEW 4, PUT THE MASK-DOWN AND GO TO THE NEXT FRAME
FRAME NUMBER        C04
NUMBER OF ENTERING K IN VIEW 3 OR 4 C201
TRACK C1            L2 14
ERROR
TRACK C1            1X 14
RAISE MASK
DO YOU HAVE ANY COMMENTS END RUN
```

Fig. 12. Sample of CHIT-CHAT program.

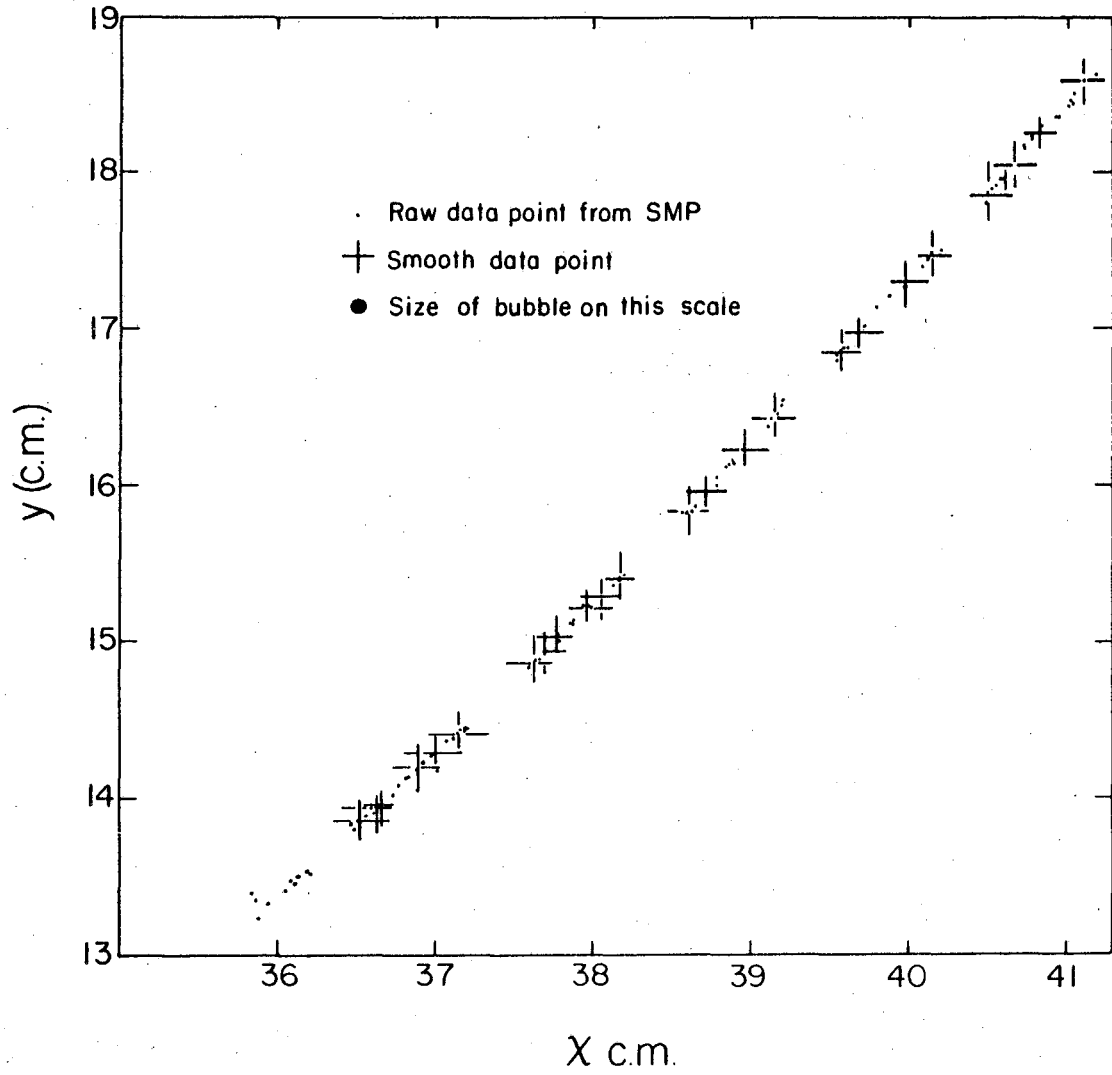

MUB-1136

Fig. 13. Data points from a bubble chamber track.

Measurement data from all the SMP's go through the direct data channel to the computer memory without interrupting the computer program unless the space for data storage is full, whereupon the computer program is interrupted to set up a new data-storage space and start clearing out the now full space.

These connections are indicated in Fig. 14.

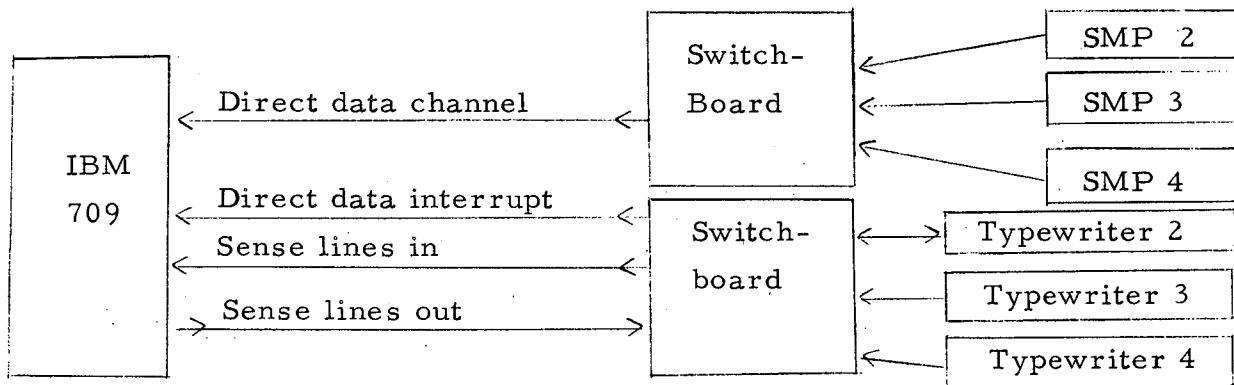
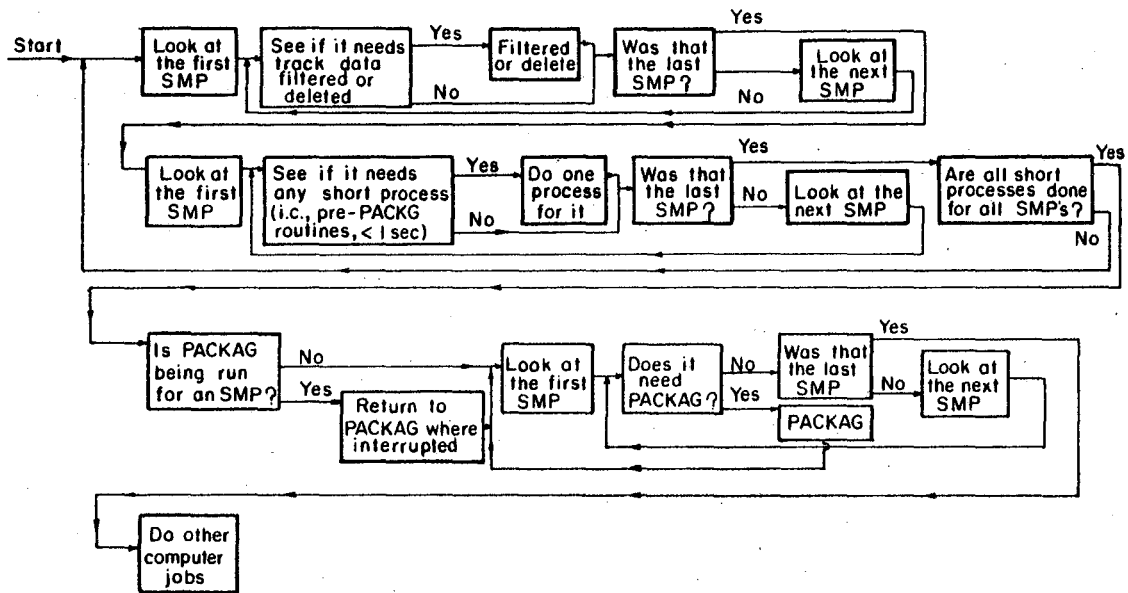

Fig. 14. Schematic diagram of data flow in SMP data-analysis system.

The logical structure of the executive program and processing routines is shown in Fig. 15. Each time the program is entered, a search is made to see if any filtering or deleting of raw measurements in the raw data buffer needs to be done. If not, then a search is made to see if any short processes need to be done. Examples of short processes are corrections for optical distortion produced by the SMP projector, formatting of data for entry into PACKAG, or tests on quality of the filtered track data. These processes should be broken into separate steps that can be executed in 1 second so that completing one such step for each SMP will allow the program to return to the filter-delete loop within 3 seconds. After filtering and short processing is done for all SMP's then the program runs the analysis program, PACKAG, for one SMP at a time. If no PACKAG work needs to be done the computer can sit idle or do other work, assuming memory space is available or can be made available.

Figure 16 shows the trapping sequences. A channel trap occurs when the raw-data buffer is full of SMP data. The buffer address must be reset to zero and the trap re-enabled within 300 μ sec in order not to miss any data. A bookkeeping routine guarantees that no instruction to measure will be given to an operator unless there is enough room in the buffer to hold his data. The filter and delete subroutines empty the buffer, and this is the reason they are given highest priority in the main sequence of the executive program.

The direct data trap is energized whenever the typewriter has a character for the computer. One of these characters signifies that the typewriter has completed typing a character and is ready for another. The next character is sent out to the typewriter on the sense lines. If the program had been trapped out of the filter, delete, or short processing routines, it returns to whatever it was doing when it was interrupted. If the program was trapped out of a long computation like PACKAG, or some other task, the program returns to the beginning of the executive routine in order to see if any higher-priority programs need execution as a result of the action that produced the trap.



MUB-1137

Fig. 15. Sequence of operations in SMP executive program.

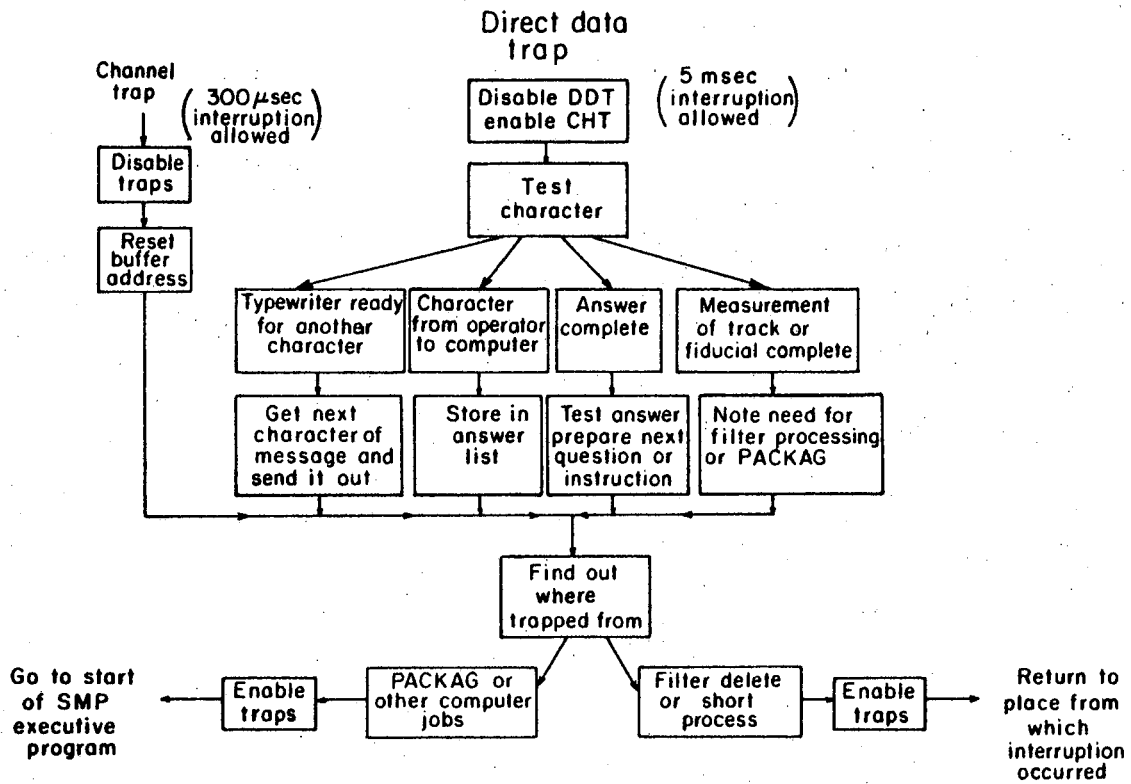

MUB-1138

Fig. 16. Trapping sequence for SMP program.

If the character is part of a message to the computer from the operator, it is stored in the answer list. If the character signifies the end of an answer, the answer is tested and the next message to the operator is set up. If the character signifies that a measurement of a track or fiducial mark has been completed, the need for filtering, deletion, or further processing is noted. As with the first type of character, the program returns to the appropriate place after the trap. The reason for the 5-msec limit on the direct data trap routines is that each typewriter presents its code for a character to the sense lines for only 20 msec, and since there are three typewriters, each one must be accommodated in 5 msec in order not to lose a character in the worst case.

The act of "noting need for filter, processing, or PACKAG" when a measurement has been completed assumes that when the executive program searches for jobs that the SMP's need to have done, they will be done as soon as possible. The reason for desiring a short cycle time for servicing each SMP on short processes is that the operator will not be instructed to proceed on measurement until there is room in the buffer for his new data, hence filtering must be done quickly. PACKAG, on the other hand, is run only after an event has been completely measured and the operator can then be asked to wait for a short time (about 20 seconds on the 709) to have his event processed and checked before he proceeds to measure the next event, or re-measure this one. On the 7090, PACKAG will run in 3 to 5 seconds, and presumably even less than that on the 7094.

This executive program is being coded in skeletal form to have something with which to test the three SMP's now being built.

APPENDIX

Luis W. Alvarez

The proposal made at the Brookhaven meeting was the following: The bench-mark plate was kept fixed, but the image (in green, yellow, orange, and red) was rotated in the same manner relative to the table and to the fixed bench-mark plate. This rotating image was not visible to the eye, because it did not cause the top surface of the "window shade" to fluoresce. A stationary image in blue and violet was to be projected through the filtered center of the lens, and this would produce the stationary tracks visible to the scanner through the fluorescence process. The longer-wavelength image, which passed through a rotating annular prism (covering the outside section of the lens) would activate the photoelectric detectors, but be invisible to the eye, because of the lack of fluorescence. The short-wavelength image, which passed through the center of the lens, would produce the visible image for the scanner, but would be undetected by the electronic circuits.

This report was prepared as an account of Government sponsored work. Neither the United States, nor the Commission, nor any person acting on behalf of the Commission:

- A. Makes any warranty or representation, expressed or implied, with respect to the accuracy, completeness, or usefulness of the information contained in this report, or that the use of any information, apparatus, method, or process disclosed in this report may not infringe privately owned rights; or
- B. Assumes any liabilities with respect to the use of, or for damages resulting from the use of any information, apparatus, method, or process disclosed in this report.

As used in the above, "person acting on behalf of the Commission" includes any employee or contractor of the Commission, or employee of such contractor, to the extent that such employee or contractor of the Commission, or employee of such contractor prepares, disseminates, or provides access to, any information pursuant to his employment or contract with the Commission, or his employment with such contractor.