

Lawrence Berkeley National Laboratory

Lawrence Berkeley National Laboratory

Title

Numerical simulation of premixed turbulent methane combustion

Permalink

<https://escholarship.org/uc/item/58v5x02q>

Authors

Day, Marc S.
Bell, John B.
Almgren, Ann S.
et al.

Publication Date

2003-06-14

Numerical Simulation of Premixed Turbulent Methane Combustion

Marc Day

MSDay@lbl.gov

Center for Computational Sciences and Engineering

Lawrence Berkeley National Laboratory, USA

<http://seesar.lbl.gov/ccse/>

Presented at: Second M.I.T. Conference on Computational Fluid and Solid Mechanics
Massachusetts Institute of Technology
Cambridge, MA
June 2003

Collaborators: J. Bell, A. Almgren, V. Beckner, M. Lijewski, R. Cheng, I. Shepherd, M. Johnson

Objective

Simulate laboratory-scale turbulent pre-mixed combustion using detailed kinetics and transport without subgrid models for turbulence or turbulence-chemistry interaction

Application: Turbulent laboratory flames

- Fundamental flame dynamics
- Pollutant (NO_x) formation

Traditional approach: Compressible DNS

- High-order explicit finite-differences
- At least $O(10^9)$ zones
- At least $O(10^6)$ timesteps

Premixed Low-Swirl Burner



Rod-stabilized Flame



Photo courtesy R. Cheng

Approach

With traditional methods, laboratory-scale simulations with detailed chemistry and transport are intractable for the near future

Observation:

- Laboratory turbulent flames are low Mach number
- Regions requiring high-resolution are localized in space

Our approach:

- Low Mach number formulation
 - Eliminate acoustic time-step restriction while retaining compressibility effects due to heat release
 - Cost: Linear algebra associated with elliptic constraint
- Adaptive mesh refinement
 - Localize mesh where needed
 - Cost: Complexity from synchronization of elliptic solves
- Parallel architectures
 - Distributed memory implementation using BoxLib framework
 - Cost: Dynamic load balancing of heterogeneous work load

Low Mach Number Combustion

Low Mach number model, $M = U/c \ll 1$ (Rehm & Baum 1978, Majda & Sethian 1985)

$$p(\vec{x}, t) = p_0(t) + \pi(\vec{x}, t) \quad \text{where} \quad \pi/p_0 \sim \mathcal{O}(M^2)$$

- p_0 does not affect local dynamics, π does not affect thermodynamics
- Acoustic waves analytically removed (or, have been “relaxed” away)
- \vec{U} satisfies a divergence constraint, $\nabla \cdot \vec{U} = S$

Conservation equations:

$$\rho \frac{D\vec{U}}{Dt} + \nabla \pi = \nabla \cdot \tau$$

$$\frac{\partial \rho Y_\ell}{\partial t} + \nabla \cdot (\rho Y_\ell \vec{U}) = \nabla \cdot \vec{F}_\ell + \rho \dot{\omega}_\ell$$

$$\frac{\partial \rho h}{\partial t} + \nabla \cdot (\rho h \vec{U}) = \nabla \cdot \vec{Q}$$

- Y_ℓ mass fraction
- \vec{F}_ℓ species diffusion, $\sum \vec{F}_\ell = 0$
- $\dot{\omega}_\ell$ species production, $\sum \dot{\omega}_\ell = 0$
- h enthalpy $h = \sum Y_\ell h_\ell(T)$
- \vec{Q} heat flux
- $p = \rho R T \sum Y_\ell / W_\ell$

Fractional Step Approach

- Operator-split Integration:
- Explicit advection
 - Semi-implicit diffusion
 - Implicit chemistry

Time Advance Summary:

1. Preliminary U^* update using lagged $\nabla\pi$, ignore divergence constraint.
2. Update species, enthalpy and temperature. Compute updated S .
3. Decompose U^* to extract the component satisfying $\nabla \cdot U = S$.

Decomposition achieved by solving a linear elliptic equation for ϕ

$$\nabla \cdot \left(\frac{1}{\rho} \nabla \phi \right) = \nabla \cdot U^* - S^{n+1}$$

Final U and π update using ϕ :

$$U = U^* - \frac{1}{\rho} \nabla \phi \quad \text{and} \quad \pi^{n+1/2} = \pi^{n-1/2} + \phi$$

Properties of the methodology

1. Overall formulation is second-order accurate in space and time.
2. Godunov discretization provides robust advective transport.
3. Strictly conserves species, mass and energy.
4. Ideal gas equation of state only approximately satisfied

$$p_o \neq \rho RT \sum_m \frac{Y_m}{W_m}$$

Modified divergence constraint minimizes drift from EOS

AMR Grid Structure

Block-structured hierarchical grids

Each grid patch (2D or 3D)

- Logically structured, rectangular
- Refined in space and time by evenly dividing coarse grid cells
- Dynamically created/destroyed to track time-dependent features

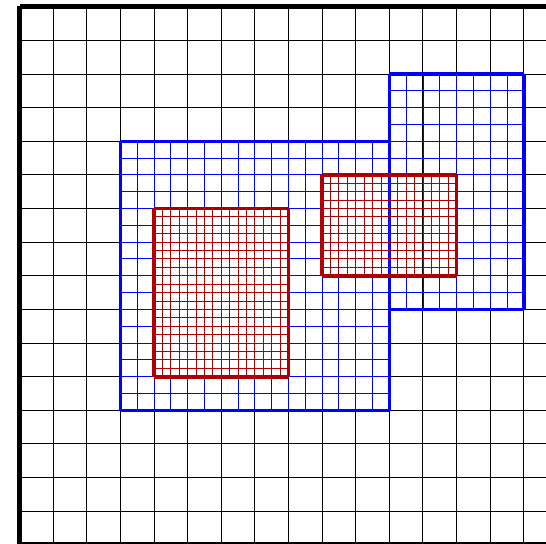

2D adaptive grid hierarchy

Subcycling:

- Advance level l , then
 - Advance level $l + 1$
level l supplies boundary data
 - Synchronize levels l and $l + 1$

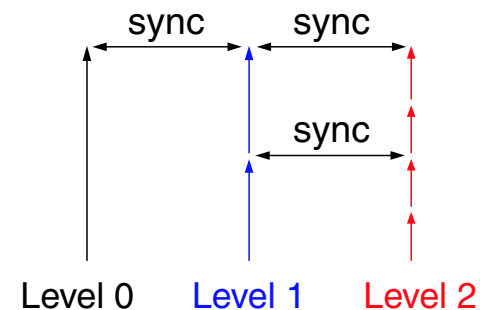

Preserves properties of single-grid algorithm

AMR Level Operations

Organize grids by refinement level, couple through “ghost” cells

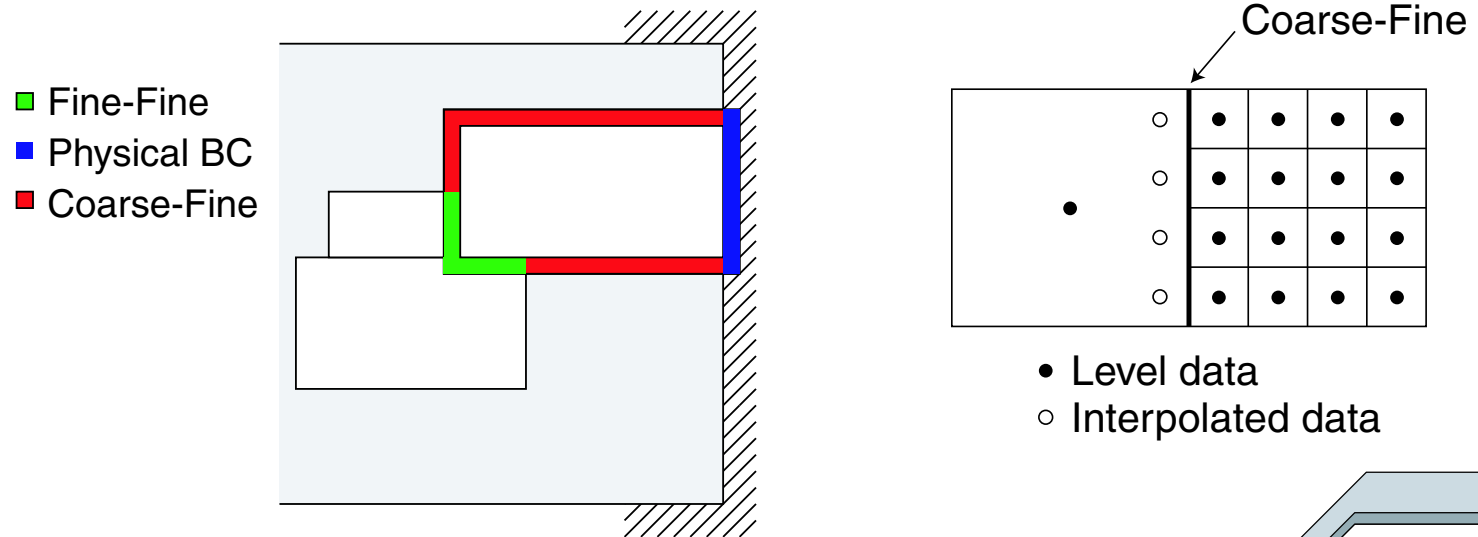

On the coarse-fine interface:

- **Fine:** Boundary cells filled from coarse data
 - Interpolated in space and time
- **Coarse:** Incorporate improved fine solution
 - “Synchronization”

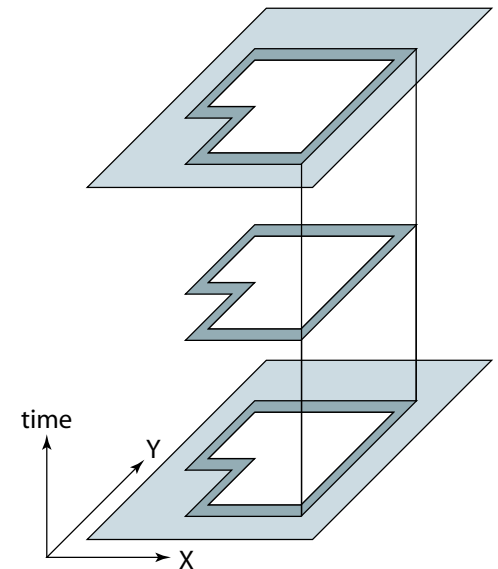

Dynamic Load-Balancing

Approach: Estimate work per grid, distribute using heuristic KNAPSACK algorithm

Cells/grid often a good work estimate, but chemical kinetics may be highly variable

- Monitor chemistry integration work
- Distribute chemistry work based on this work estimate

Parallel Communication: AMR data communication patterns are complex

- Easy: distribute grids at a single level, minimize off-processor communication
- Hard: Incorporate coarse-fine interpolation (also, “recursive” interpolation)

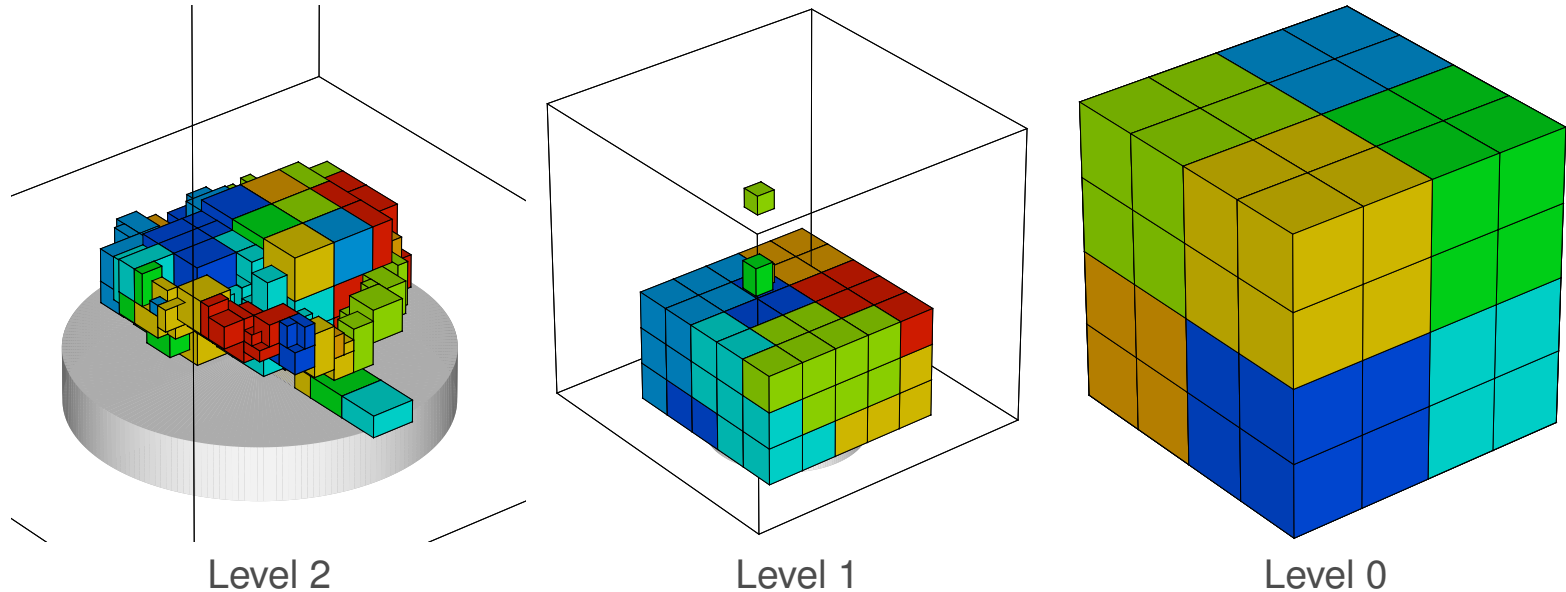

Full-Scale Simulations

Strategy: Use separate nonreacting (in)compressible simulations to characterize flow into domain from nozzle

Nozzle simulations:

- For swirl burner, compressible effects important ($U_{max} \sim 0.4C_s$)
- For V-flame, all flow is low speed, use incompressible model
- Create inflow field for 3D reacting low Mach number model
 - Shaped synthetic turbulence or
 - Direct data input

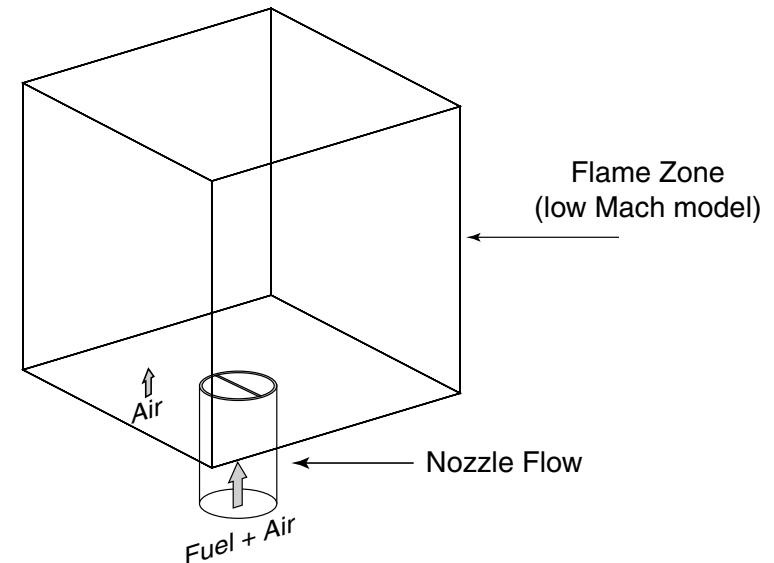

Laboratory-Scale Application

LBL EETD laboratory turbulent premixed methane flames
(In collaboration with R. Cheng, I. Shepherd and M. Johnson)



Rod-stabilized V-flame

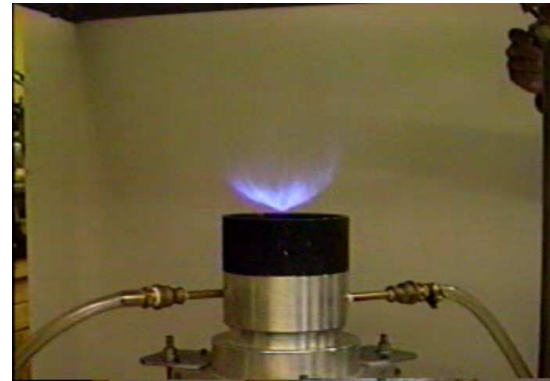

Low-swirl burner

Common Features: Large equivalent turbulent flame speed.
(Presumably due to highly wrinkled flame)

Diagnostics: P.I.V. images give instantaneous planar flame shape and 2D velocity map

Configuration



Burner assembly

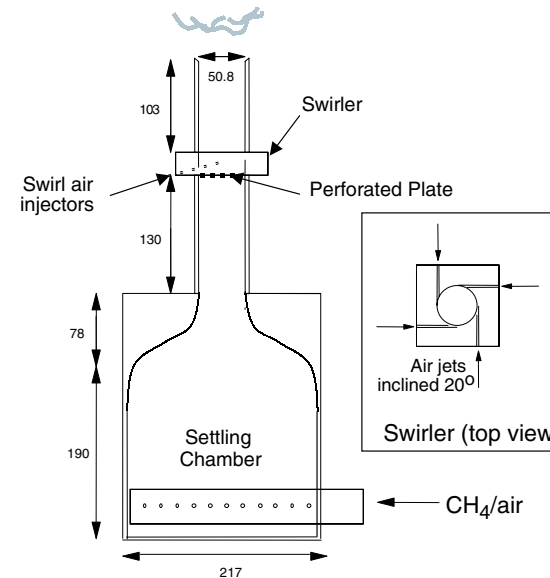

Experiment schematic

- Tangential air jets: $\dot{m}_{air}/\dot{m}_{fuel} \sim .5/12.5$
(Swirl number $S \sim 1.16$)
- V-flame ($\dot{m}_{air} \equiv 0$): rod ~ 1 mm
- Turbulence plate: 3 mm holes on 5 mm center
generates $l_t \sim 3.5$ mm, $u' \sim 0.18$ m/s

V-flame Nozzle Flow

Observe: Within nozzle turbulence plate minimizes boundary effects

Suggests: Fluid evolution across nozzle equivalent to boundary-free Lagrangian evolution over mean nozzle transit period.

Procedure: Incompressible model, triply-periodic domain. Initially opposed jets represent flow through plate holes. Evolve for $t = L/\bar{U}$.

Results: ℓ_t and u' consistent with experimental observation

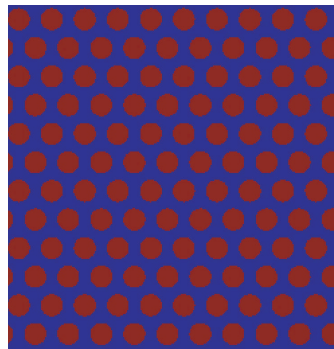

Initial u_z (-3,+4.5) m/s - zero net flow

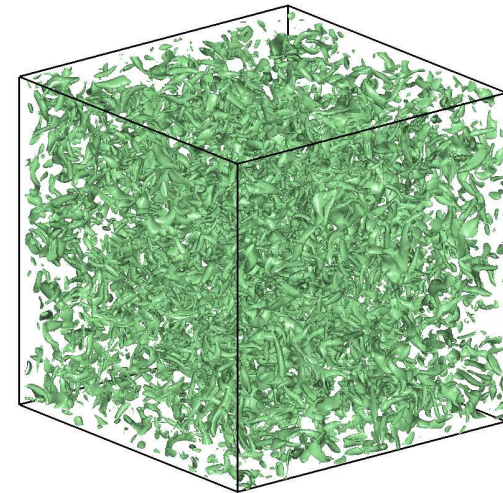

Simulated vorticity, $t = .03$ sec.

Shape resulting field to $u' \rightarrow 0$ as $r \rightarrow R_f$ (and over rod), flow into bottom.

Low Mach Number V-Flame Simulation

- DRM-19 methane mechanism (20 species, 84 reactions)
- Species-dependent mixture-averaged transport
- Initialize premixed flame near rod, evolve until quasi-steady
- Adapt grid to track flame surface (HCO) and high vorticity

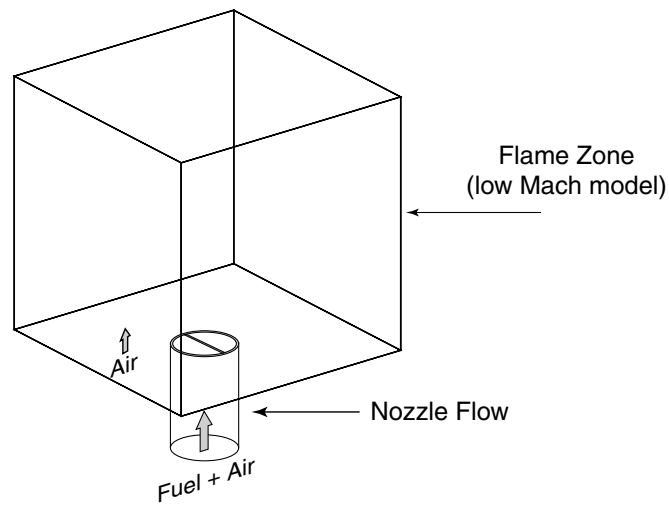

Computational domain (12 cm)³

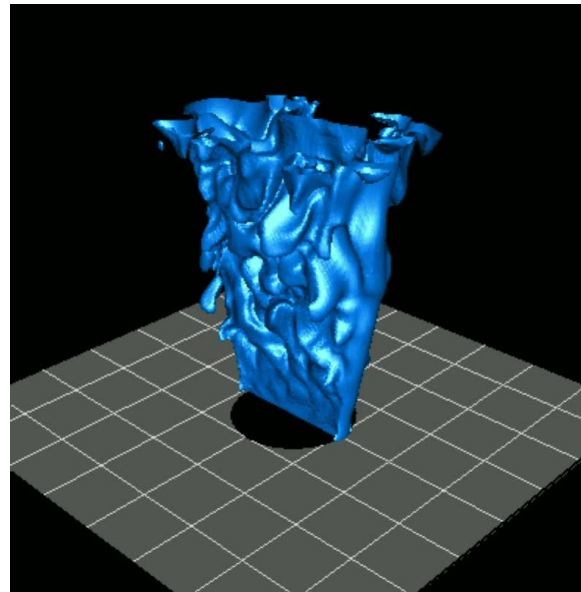

Quasi-steady simulated V-flame

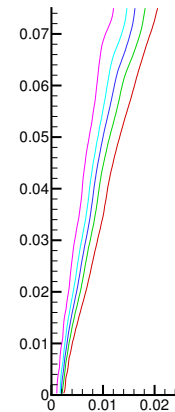

\bar{c} (progress variable)

Total simulation time = .136 sec (3.5 times thru domain at 3 m/s)

$\Delta x_{finest} = 117 \mu\text{m}$ over 15% of domain

V-flame Validation - Work-In-Progress

Instantaneous flame location

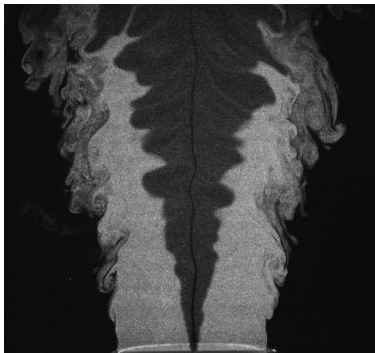

Expt: PIV image

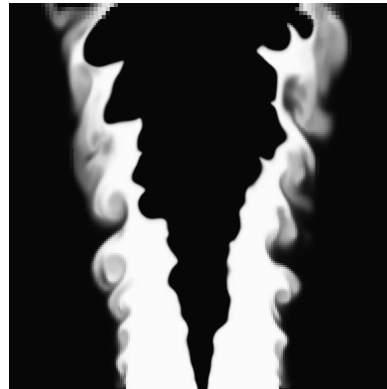

Simulation: $X(\text{CH}_4)$

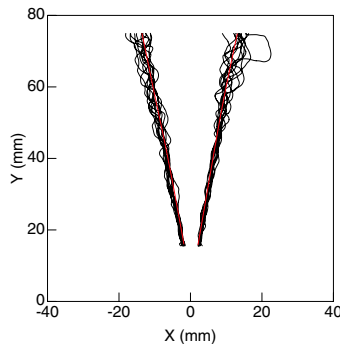

Expt: Vertical cuts

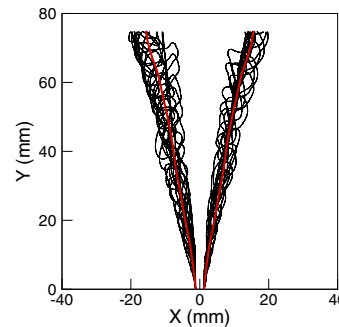

Simulation: Vertical cuts

Observe:

- Good qualitative agreement
- Features invariant to $2x$ grid resolution ($\Delta x = 59 \mu\text{m}$)
- Turbulent flame speed ($\dot{\omega}_{\text{CH}_4}$) enhancement $S_t = 1.9S_L$
- Area enhancement due to wrinkling $A_t = 1.25A_L$

In Progress:

- Quantitative validations
- 2D vs. 3D flame stats
- Turb/chem interaction analysis using $59 \mu\text{m}$ data

Low-Swirl Simulations - Inlet



Observation: Earlier scheme invalid since compressibility/wall effects significant with air jets $\sim 40\%$ sound speed.

Levels of Simulation Detail:

1. Synthetic turbulence (isotropic/decaying), with “tophat” shaping, combined with axisymmetric guess for swirl/fuel profiles
2. Synthetic turbulence with mean and fluctuating components derived from a full, compressible nozzle simulation
- \implies 3. Coupled solution with full 3D time-dependent inflow boundary data

Compressible Flow with Geometry

Model geometry as front embedded in regular Cartesian grid

- Volume fractions
- Area Fractions

Finite volume discretization (Chern and Colella)

- Conservative update unstable in small cells
- Update with stable fraction
- Distribute remainder to neighboring cells

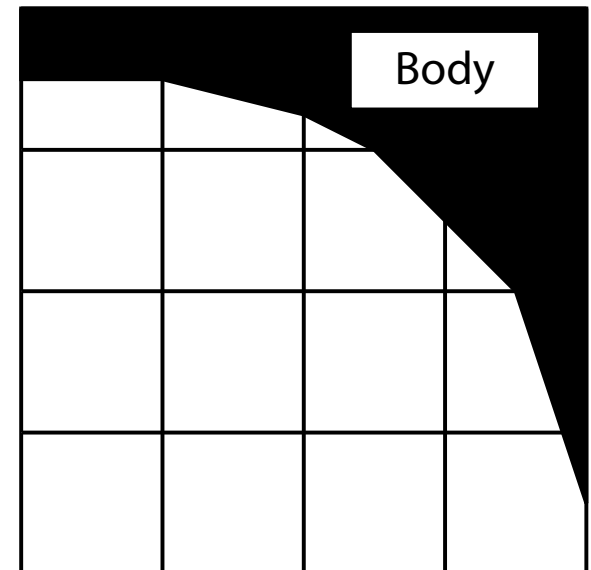

Adaptive, parallel, 3D, ...

Pember et al., JCP, 1995

Nozzle Geometry

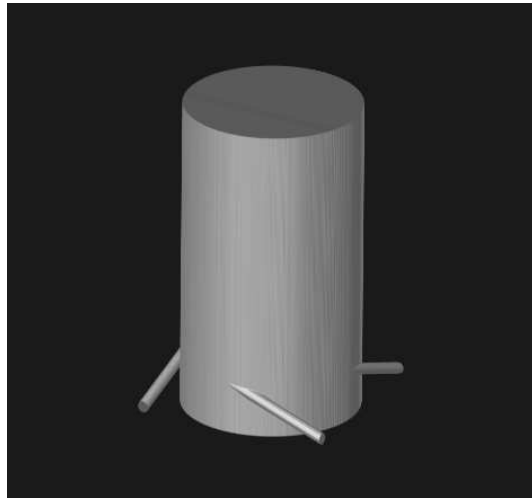

Flow domain for swirl nozzle

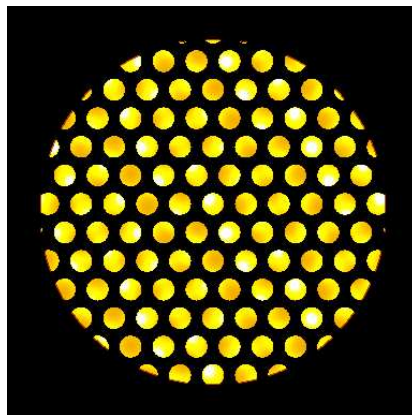

Turbulence plate for nozzle inlet

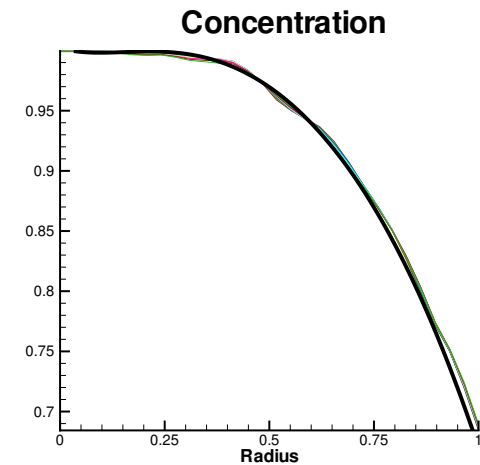
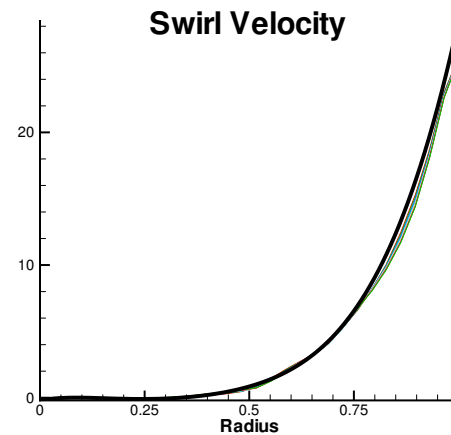
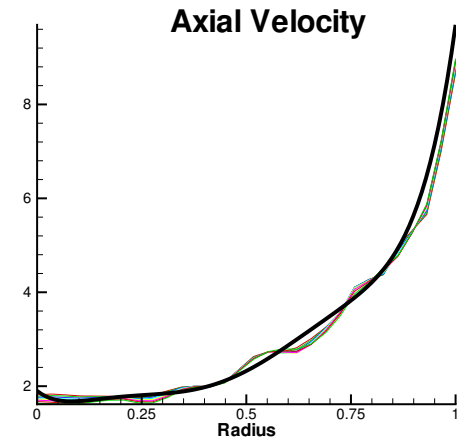
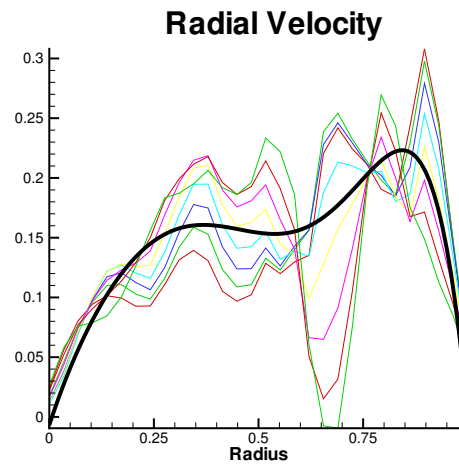

Simulated mean profiles

Swirling Nozzle Flow

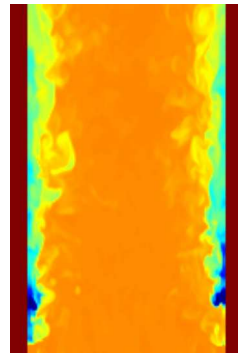

Fuel (orange) and air (blue)
inside nozzle

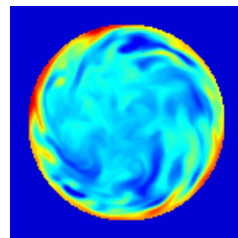

Axial velocity at nozzle exit

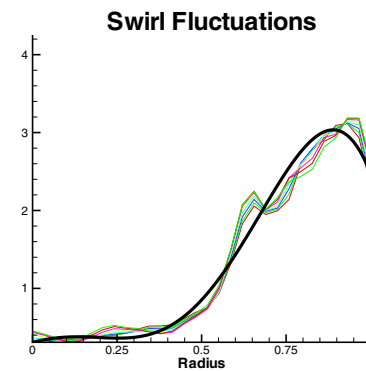
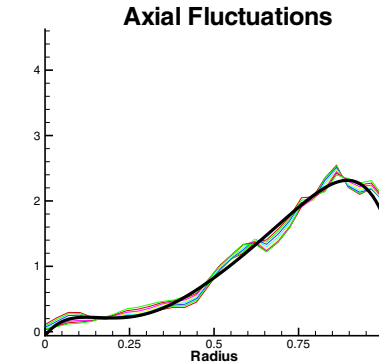
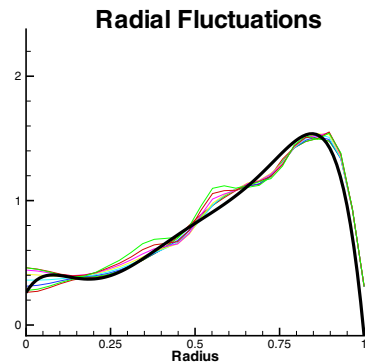

Fluctuation profiles from compressible simulation

Observe: Significant radial fluctuations
Large u_z, u_θ in air boundary layer
Considerable azimuthal activity

Low Swirl Burner - Preliminary Results

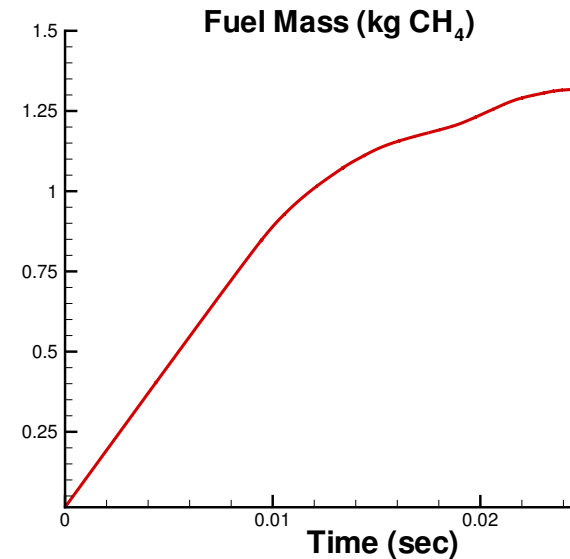
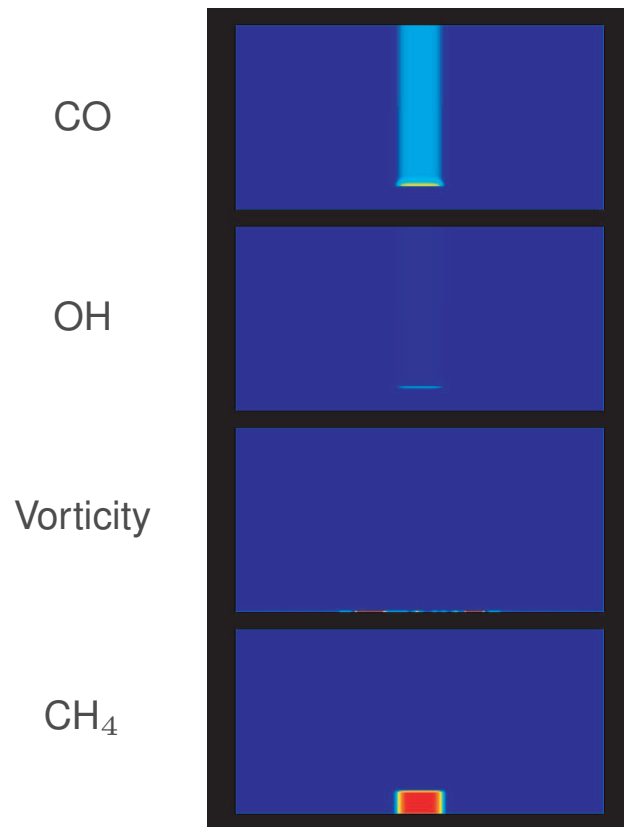

Observe:

1. $\int_{\Omega} \rho Y_{\text{CH}_4} d\Omega$ has reached quasi-steady value
2. Qualitatively correct flame, flow field shape

Summary and Future Work

Algorithm for low Mach number combustion

- Adaptive
- Conservative
- Second-order in time and space
- Parallel

Application to laboratory-scale turbulent premixed combustion

- Rod-stabilized V-flame
- Low-swirl burner
- Auxiliary compressible/incompressible simulations provide inlet boundary data from turbulent nozzle

Future Work

- Further validations
- Quantitative comparison with experiment
- Characterize turbulent flame propagation properties
- Investigate turbulent flame chemistry