

Lawrence Berkeley National Laboratory

LBL Publications

Title

Control algorithms for dynamic windows for residential buildings

Permalink

<https://escholarship.org/uc/item/58s1h2bx>

Authors

Firląg, Szymon
Yazdanian, Mehrangiz
Curcija, Charlie
[et al.](#)

Publication Date

2015-12-01

DOI

10.1016/j.enbuild.2015.09.069

Peer reviewed



Lawrence Berkeley National Laboratory

Control algorithms for dynamic windows for residential buildings

Mehrangiz Yazdanian

Charlie Curcija

Christian Kohler

Simon Vidanovic

Robert Hart

Stephen Czarnecki

Windows and Envelope Materials Group,
Lawrence Berkeley National Laboratory

Energy Technologies Area
Dec, 2015

DOI: <https://doi.org/10.1016/j.enbuild.2015.09.069>.

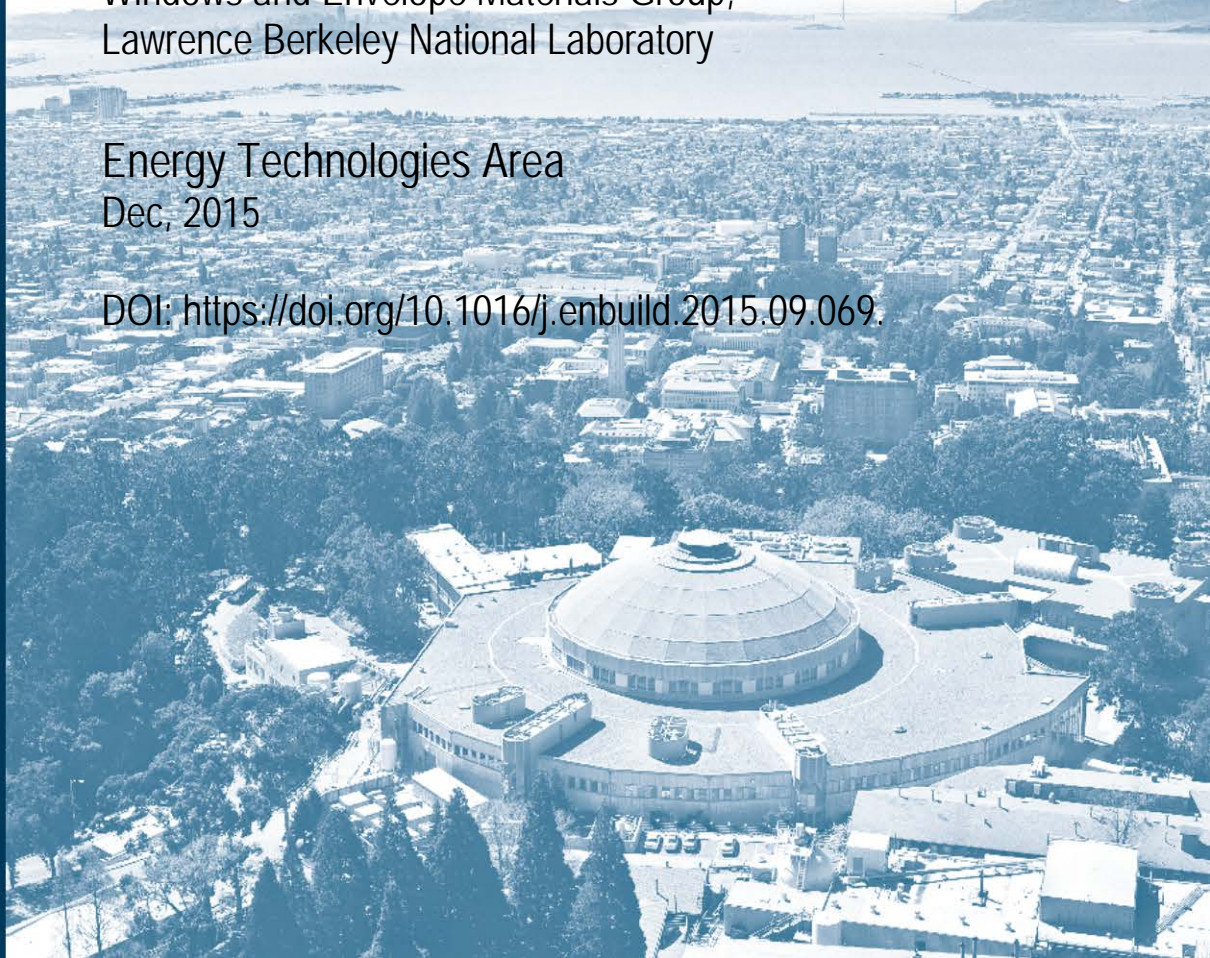

Disclaimer:

This document was prepared as an account of work sponsored by the United States Government. While this document is believed to contain correct information, neither the United States Government nor any agency thereof, nor the Regents of the University of California, nor any of their employees, makes any warranty, express or implied, or assumes any legal responsibility for the accuracy, completeness, or usefulness of any information, apparatus, product, or process disclosed, or represents that its use would not infringe privately owned rights. Reference herein to any specific commercial product, process, or service by its trade name, trademark, manufacturer, or otherwise, does not necessarily constitute or imply its endorsement, recommendation, or favoring by the United States Government or any agency thereof, or the Regents of the University of California. The views and opinions of authors expressed herein do not necessarily state or reflect those of the United States Government or any agency thereof or the Regents of the University of California.

Acknowledgement:

This work was supported by the Assistant Secretary for Energy Efficiency and Renewable Energy, Building Technologies Office, of the U.S. Department of Energy under Contract No. DE-AC02-05CH11231.

Control algorithms for dynamic windows for residential buildings

Szymon Firląg s.firlag@il.pw.edu.pl, Faculty of Civil Engineering, Warsaw University of Technology,

Mehrangiz Yazdanian M.Yazdanian@lbl.gov, Charlie Curcija DCCurcija@lbl.gov, Christian Kohler CJKohler@lbl.gov, Simon Vidanovic DVVidanovic@lbl.gov, Robert Hart RGHart@lbl.gov, Stephen Czarnecki SCzarnecki@lbl.gov, Windows and Envelope Materials Group, Lawrence Berkeley National Laboratory

Keywords:

shading control; dynamic window; energy consumption; NZEB; daylight access; residential buildings

Abstract

The present study analyzes the influence of control algorithms for dynamic windows on energy consumption, daylight access and shade operations in residential buildings. Five different control algorithms – heating/cooling, simple rules, perfect citizen, heat flow and predictive weather were developed and compared. The proposed algorithms can work with any window, not only dynamic - standard window with dynamic attachment or window with dynamic glazing, in new or renovated buildings. Results of the calculations were compared with base cases – no shade, always shaded, half shade and observed manual shade operations.

Evaluation of different control algorithms for dynamic windows was based on whole building energy simulation. The performance of a typical residential building was modelled with EnergyPlus. The program Widow was used to generate a Bi-Directional Distribution Function (BSDF) for two window configurations – double low solar gain with external roller blinds and triple glass high solar gain with between glass cellular shading. The BSDF was exported to EnergyPlus using the IDF file format. The Energy Management System (EMS) feature in EnergyPlus was used to develop custom control algorithms.

The calculations were made only for USA but they include four locations with diverse climates. Atlanta has a humid subtropical climate (hot and humid summers and cool but variable winters), Phoenix has a subtropical desert climate (extremely hot summers and warm winters), Minneapolis has a continental climate (winters are cold and snowy, while summers are mild and can be humid) and Washington DC is in the humid subtropical climate (spring and fall are warm, winter is cool, summers are hot and humid).

The results showed that: a) manual operation of shade has on average no effect on site (final) energy consumption in comparison to windows without shade; use of automated shading with proposed control algorithms can reduce on average the site energy in the range of 11.6% to 13.0%; in regard to source (primary) energy, manual operation of shade reduces on average the consumption by 8.6%, while automatically controlled in the range of 20.1% to 21.6%, b) automatic shade operation is more effective in cooling dominated climates, c) the differences between algorithms in regard to energy savings are not high, d) use of windows with low U-value and high SHGC is not appropriate in all climates, e) the differences between algorithms in regard to daylight access are visible, f) the control

algorithms have a strong influence on shade operation and oscillation of shade can occur, g) additional energy consumption caused by motor, sensors and a small microprocessor in the analyzed case is very small.

1. Introduction

Windows are a very important part of the envelope influencing the energy consumption and the functionality of residential buildings. Inoue et al. [1] found that people want windows primarily for daylight and secondarily for the view. At the same time windows have a significant impact on the energy balance of buildings. In hot climate, the solar gains transferred through glazing are increasing cooling demand [2, 3]. In continental climate, with cold winters, solar gains can decrease energy demand for heating. In the case of nearly zero energy buildings (nZEB) windows can be responsible for 40% of total heat losses and solar gains can provide 33% coverage to them [4]. However the solar gains, especially in nZEB, can lead to overheating during summer [5] even in continental climate.

In order to reduce the energy demand and risk of overheating, different shading systems are used. Oleskowicz-Popiel and Sobczak [6] have shown that the external roller blind causes about 45% and internal textile roller blind about 33% of energy savings during the heating season. In the case of the double-glazed window having glass panes coated with low emissivity layers, the relevant energy savings are about 29% for internal blinds, and about 44% for external blinds. An experimental study in Montreal [7] showed that the use of automated venetian blinds can decrease the energy cost by 30% during the winter and by 50% during the summer. The effect on cooling energy requirements is similar for a house located in Toronto [2]. In comparison with a house that has no shading, the addition of controlled outdoor blinds decreases annual cooling energy requirement by up to 57%.

Based on this experience a new product was created - the dynamic window. Usually it is a window with integrated automatic shading or window with dynamic glazing [8, 9]. The dynamic windows can change the thermal and optical properties to adjust to outside and indoor conditions, thus reducing energy costs related to heating and cooling [10]. The introduction of such a solution is vital to lower the energy demands further than what is possible with un-shaded windows. [11] Study of Dussault et al. [8] has shown that the dynamic window can reduce energy consumption for east, south and west oriented glazed façades, respectively, from 8% to 52%, 10% to 53% and 11% to 51%. For the north façade results have shown that this kind of technology does not improve building energy efficiency compared to the best passive windows available in the market.

Efficiency of dynamic windows or automated shading depends on the control strategy. Van Moeseke et al. [12] stated that complex control, including internal temperature and solar irradiation appears to be the most effective to balance comfort and energy savings. On basis of an extensive experimental study Lee et al. [13] concluded that automatically controlled Venetian blinds could achieve energy savings of 7–15% and 19–52% for cooling and lighting energy, respectively, compared to a fixed 45° angle. The study was conducted at a full-scale private office in Oakland, CA over a 1.5 year period. Tzempelikos and Shen [14] have compared four dynamic shading control strategies with constant and variable set points for office buildings. Differences in annual source energy consumption between the four shading control strategies range from 10.1% to 34.4% for analyzed cases.

Most of the analyzed control algorithms and studies concerned office buildings. The developed algorithms are not always suitable to residential buildings with different a use schedule, priorities, input data available and requirements. The most important aspect for

the residents is the reduction of energy consumption (heating and cooling) and daylight access. Energy demand for lighting is not as important as in office buildings.

The paper describes and analyzes five different control algorithms dedicated to residential buildings. The proposed algorithms can work with any window not only dynamic - standard window with dynamic attachment or window with dynamic glazing, in new or renovated buildings. They can be implemented inside the window or attached on a microprocessor. Algorithms only require a few input values from local sensors integrated in the window or building systems to determine the optimal shading operation. The fully automated operation, that maximizes net useful solar gains in heating mode, and minimizes solar gain in cooling mode can save significant energy in residential buildings. The algorithms can be applied to any location, orientation and climate.

2. Methodology

2.1. Building modeling assumptions

Evaluation of different control algorithms for dynamic windows was based on whole building energy simulation. The aim of the calculations was to check how the algorithms are influencing the annual energy consumption and visual comfort. The performance of a building was modeled with EnergyPlus which is used worldwide, and is a tested and validated program. This energy analysis and thermal load simulation tool was developed to help professionals in the optimization of the building design. The simulations of the whole year, were made with version 8.1 and a 15 min time step.

The EnergyPlus model of typical residential buildings was developed from the U.S. Department of Energy (DOE) EnergyPlus Residential Prototype Building Models [15]. This model was updated from the past residential models used for calculating energy effects of windows, because the DOE2.1E engine used for those calculations was no longer supported by the DOE, and EnergyPlus is now a tool being actively developed by DOE. More significantly, the advanced modeling capabilities of optically complex window systems have been developed for and implemented in EnergyPlus only.

A typical residential building (average 223m²) consists of two storeys, with an unconditioned attic. There are four 4,15m² windows per floor, distributed evenly on each façade and centered on the wall. The double-wing windows are vertically divided. A summary table with modeling assumptions is presented in Table 1. A more detailed description of assumptions, comparisons with prior models, etc. can be found in LBNL study [16].

Table 1. Detailed list of assumptions for typical house

Parameter	Residential building model
Floor Area	223m ² (2x10,6m x 10,6m)
House Type	2-story – one core and four perimeter zones
Foundation	slab-on-grade
Insulation	envelope insulation levels are based on location (IEEC 2012)
Infiltration	n ₅₀ =5 for climate zone 1 & 2 n ₅₀ =3 for all other climates
Window Area (% Floor Area)	15% (% floor area)
Window Size	2,8m x 1,5m (windows divided vertically into two equal halves)
Window Distribution	4 windows per floor, distributed evenly and centered on the wall
HVAC System	furnace & A/C

HVAC System Sizing	for each climate, system was sized for the base window option (no shade)
HVAC Efficiency	AFUE=0.78 for gas furnace, A/C SEER=13.0
Part-Load Performance	new part-load curves for DOE2 [17]
Thermostat Settings	heating: 21°C, cooling: 26°C no setback
Cooling Setup	N/A
Internal Loads	number of people = 3 hardwire lights = 1,22 W/m ² plug-in lights = 0,478 W/m ² refrigerator = 91,01 W – design level misc. electrical equipment = 2,46 W/m ² clothes washer = 29,6 W – design level clothes dryer = 222,1 W – design level dish washer = 68,3 W – design level misc. electrical load = 182,5 W – design level gas cooking range =248,5 W – design level misc. gas load = 0,297 W/m ² exterior lights = 58 W – design level garage lights = 9,5 W – design level
Weather Data	All TMY3
Number of locations	4 US cities: Atlanta, Phoenix, Minneapolis, Washington DC
Calculation Tool	EnergyPlus version 8.1
Energy Code	IEEC 2012

The second-story floor (first-story ceiling) is assumed to be adiabatic. Infiltration was calculated using the Sherman-Grimsrud infiltration model [15] which uses Effective Leakage Area coupled with the outdoor air temperature to calculate the infiltration load.

For this study, one foundation option was considered - slab-on-grade and also, one HVAC system - gas furnace and electric A/C. In order to size the HVAC system, 8 EnergyPlus autosize runs were made (4 locations, two windows types – Table 2.). The sizing parameters were: air flow rate in m³/sec, cooling capacity in W, rated sensible heat ratio and heating capacity in W.

After the HVAC system was sized for each of 8 unique combinations, the sizing values were used for attachment runs. This approach represents a typical situation in which the original HVAC system is not replaced or modified when attachments are added to windows.

Another important task was to accurately calculate the ground temperatures for foundation models. It is difficult to link ground heat transfer calculations to EnergyPlus, since the conduction calculations in EnergyPlus are one-dimensional and the ground heat transfer calculations are two or three-dimensional. This causes severe modeling problems for the ground heat transfer calculation. In order to compute appropriate ground temperatures at the exterior side of any surface that is in contact with the ground, two utility programs were used, Slab.exe and Basement.exe, included with EnergyPlus distribution, to calculate monthly outside boundary conditions (temperature) for a particular surface in contact with the ground. These schedules were calculated for all 4 locations and were added to the input file.

Figure 1. shows the models used in this study. Part (a) of this Figure shows an image of a two story residential building. Part (b) shows the inside of the building. Even though the house looks like it is perimeter and core zoned (i.e., 5 zones), the division inside is done to simulate internal partitions that prevent solar radiation transmitted from one window reaching the back side of another window. The house has single HVAC zone (single thermostat). The envelope insulation levels are based on location and adopted in accordance with the requirements of IEEC 2012 [18].

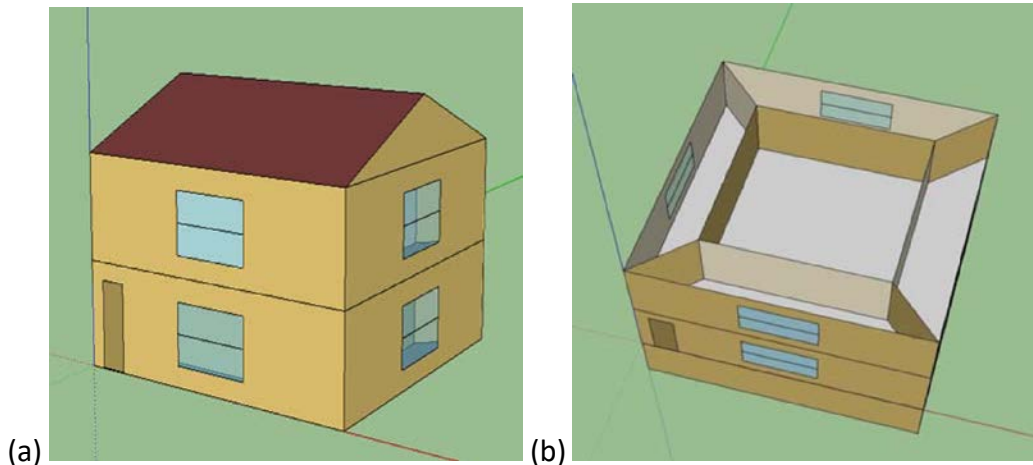

Figure 1. Illustration of EnergyPlus residential building model: (a) side view (b) internal partitions

The EnergyPlus input file (IDF file) was divided into several files, to allow for parameterization of the EnergyPlus runs. Macro parameters, needed for parametric runs, were also added to those input files. More details about the modeling assumptions are presented in Table 1.

2.2. Control algorithms modeling

The typical residential building model was used to calculate the influence of different control algorithms on the energy consumption and visual comfort. The energy consumption included:

- heating site energy (final energy), GJ,
- cooling site energy (final energy), GJ,
- fan site energy (final energy), GJ,
- total source energy (primary energy), kWh/m²a.

The control algorithms were created in order to minimize the energy consumption and were compared mainly from the point of view of total source energy (primary energy). In order to calculate the source energy, the following conversion factors were used: 3,167 for electricity and 1,084 for natural gas.

The visual comfort for residential building was expressed as a percentage of time that the shade is open during daylight hours. The number of daylight hours in each location was evaluated and compared with the number of hours the shades were open. The study determines how various shading control algorithms affect the amount of time that the shade is open. The ideal algorithm should guarantee not only minimum energy consumption but also maximum visual comfort.

The Energy Management System (EMS) feature in EnergyPlus was used to develop custom control algorithms. EMS provides high-level, supervisory control to override selected aspects of EnergyPlus modeling. In the case of this study it was the position of the shade. The shade state is either completely up or completely down. No intermediate states were included in the control algorithms, e.g. half-open or percent-open. Only observed manual shade operation include the half-open state. Each of the eight windows was controlled individually in the EMS. As a result the position of the shade was depending on local conditions, e.g. solar radiation and could be different for the windows in the building at the same time step. A small programming language called EnergyPlus Runtime Language (Erl) was used to describe the control algorithms. EnergyPlus interprets and executes your Erl program as the model is being run.

2.3. Window modeling

Energy consumption for different control algorithms, windows and window attachments was modeled in EnergyPlus using the typical residential building described in the previous section. EnergyPlus can model a wide range of shading and otherwise complex systems when the complex optical radiation distribution is calculated in the WINDOW 7.1 program [19]. WINDOW can generate a Bi-Directional Distribution Function (BSDF) which can be exported to EnergyPlus using the IDF file format. BSDF files define a discrete set of incident and outgoing angles, which fully describe the optical performance of any system, simple or complex, limited only by the resolution of the angular discretization. In this method each layer, as well as the whole system, is described by a matrix of incident and outgoing angles. Further details about the BSDF method and its implementation in WINDOW and EnergyPlus software tools can be found in [20, 21, 22].

The simulations were made for two types of windows with the following glazing: double low solar gain low-e argon and triple glass (double high solar gain low-e argon plus single high solar gain low-e). The first window represents the standard solution in USA and the second one, the new construction dedicated specially for high solar gains, and low thermal transmittance with an integrated shading system [23]. The triple glazed window has a lower U_w -factor and higher SHGC in order to reduce heat losses and maximize solar heat gains. Both windows have different types of shading. The window with double glazing is equipped with external roller blinds and the triple glazed with cellular shading between the glass. The choice of the attachments was due to the following reasons:

- high energy efficiency - both systems are clearly decreasing the U_w -factor of the window [24, 25],
- significant reduction of SHGC [24, 25],
- control possibility,
- ability to integrate the window with the shading – dynamic window.

Room side shading elements were not included due to lower energy efficiency and smaller reduction of SHGC [24,26].

WINDOW was used to calculate the thermal and optical performance of the window system. Because of the nature of the BSDF methodology, the result of these calculations is a large matrix of thermal and optical properties, which are exported to EnergyPlus for accurate calculation of energy use in variable environmental conditions. However, in order to summarize the results, a single angle of incidence (normal incidence) and a single set of environmental and room conditions (NFRC [27] standard conditions) were used to express results in terms of a single U_w -factor and SHGC for both types of windows with shades up and down.

Table 2. U_w -factors and SHGC for whole windows (glazing and frame) with attachment and different position of the shade

Glazing system	Attachment type	U_w -factor, W/m ² K		SHGC	
		shade up	shade down	shade up	shade down
double low solar gain (Low-e)	external roller blinds	1.74	1.41	0.30	0.09
triple glass high solar gain (Hi-R)	cellular shading between glass	0.85	0.75	0.49	0.18

2.4. Dynamic window

Integration of a window, shading, motor, sensors and control algorithm can be called a dynamic window. Such a new product will be a very good solution for NZEB in which the reduction of energy consumption is very important. Between glass and external shading not only decreases the heat losses during winter but also reduces the solar heat gains during summer. In order to maximize the energy effectiveness of the dynamic window and guarantee a high level of visual comfort, control algorithms have to be used. Most of the algorithms need additional input data regarding e.g. internal and external environmental conditions. The data can come from external sources e.g. meteorological station, weather forecast or obtained on site.

Four sensing types are integrated into the dynamic window: exterior temperature, interior temperature, solar radiation and motion. The intent of the motion sensor is to determine when an occupant is home, or near the window, and therefore remain in a manual override state if placed into one. The remaining three sensors are utilized to determine the direction of net heat flow through the window. With knowledge of the heat flow, we can develop a control algorithm to put the shade into the most energy efficient position.

Table 3. Window sensor list

Sensor		Description
T_{ext}	Exterior temperature	behind exterior cladding, shielded from direct solar
T_{in}	Interior temperature	in interior air at head, shielded from direct solar
I	Solar radiation	at edge of exterior glass, measures integrated solar irradiance
O	Motion	on interior window head, occupancy detection

Table 3. shows a summary of the four sensor types and Figure 2. shows their location on the window. With exception to the motion sensor, all readings are a moving average of the prior 30 seconds. The exterior temperature, T_{ext} , is a thermistor located behind the exterior aluminum cladding at the head. The head is likely to be shaded more often than the sill so should see less influence from solar loads. The interior temperature, T_{in} , is a thermistor located at the head next to the frame. Solar radiation, I, is measured with a phototransistor mounted to the edge of the exterior most pane of glass. This location is meant to capture a signal from the total internally reflected solar energy across the entire glass surface. This integrated approach should reduce erroneous readings due to local solar shading of a point sensor. The sensor has a spectral response curve tuned to the solar spectrum and minimal sensor response is expected from interior or exterior lighting. The passive infrared motion sensor is placed at the interior head where it is least likely to be covered or obstructed by furniture. It's sensing distance is up to 20 feet.

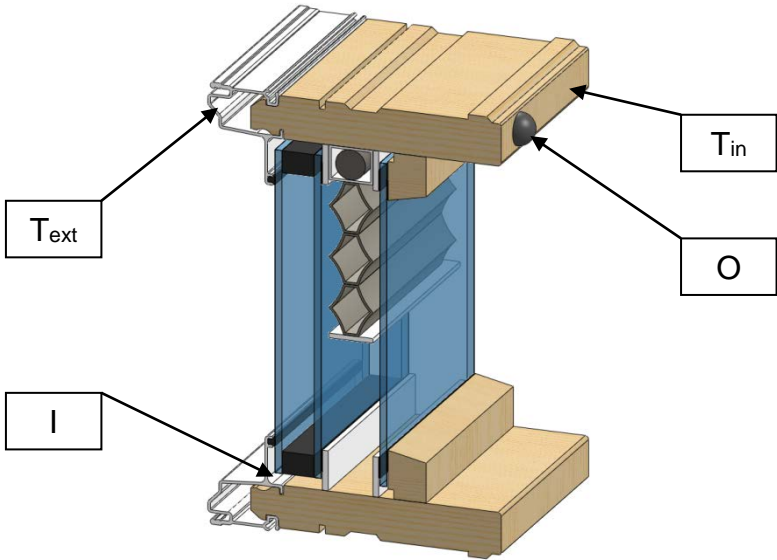

Figure 2. Dynamic window - sensor locations

2.5. Limitations of the methodology

The proposed calculation methodology has some limitations in regard to climate conditions, the building and HVAC model, window and shading types. The main aim of the study is to compare different control algorithms which can be used in residential buildings especially, low-energy buildings. The calculations were made only for USA but they include four locations with diverse climates. Atlanta has a humid subtropical climate (hot and humid summers and cool but variable winters), Phoenix has a subtropical desert climate (extremely hot summers and warm winters), Minneapolis has a continental climate (winters are cold and snowy, while summers are mild and can be humid) and Washington DC is in the humid subtropical climate (spring and fall are warm, winter is cool, summers are hot and humid). Calculations made for the above locations will help to check how the algorithms are behaving in different climates and how the energy balance of the building is changing. One building and HVAC model ensures that the results will be influenced only by the control algorithms. Of course the size of energy reduction will be various for each building but the relation between individual results will stay similar. Chosen windows and shading types are suitable for NZE residential buildings. The calculations have shown that low U-factors and high SHGC are not an advantage in all climates. The inclusion of two dynamic windows types, four locations and nine control strategies have resulted in 72 calculation variants. The large number of cases could cause the results to be difficult to present and understand.

3. Type of algorithms

The study includes nine different types of shade operations. There are three base cases e.g. no shade, one manual operation schedule and five automatic control algorithms. The algorithms were developed in the EMS feature in EnergyPlus independently for each window (there are eight windows, two on each orientation). As a result the shade operation can be different for each window.

3.1. Base cases

The base cases include three positions of shade:

- no shade – this case assumes that the window is always in the high solar transmittance state (ie no roller blind),
- always shaded – this case assumes the window is always in the low solar transmittance state (ie roller blind closed all year),
- half shade – upper sash of the window is always in the low solar transmittance state and the lower sash in the high solar transmittance state (ie roller blind closed at upper sash all year).

Results of the calculations were used as baseline energy consumption and as an input data to the observed manual shade operation.

3.2. Observed manual shade operation

The deployment schedule for window attachments was developed from the results of a behavioral study, funded jointly by DOE and the Window Attachment Industry [28]. Based on the results of the survey of 2,467 households in 12 markets (see Parametrics section of 28 for the list of cities), a deployment schedule was developed for 3 periods during the day, for two seasons, and for the three distinct climatic regions in the country. Of the 2,467

households surveyed, 397 households were removed from the dataset due to issues with data quality, leaving 2,100 households for analysis. The behavioral study considered three different attachment deployments and identified the percentage of products that were in one of these three positions at different times of day:

- **O**: open,
- **H**: half-open,
- **C**: closed.

The periods of day considered were:

- **M**: morning, including work hours (6:00 a.m. to 12:00 p.m.),
- **A**: afternoon (12:00 p.m. to 6:00 p.m.),
- **N**: evening/night (6:00 p.m. to 6.00 a.m.).

The manual shade operation was included in the study in order to compare it to automatic control algorithms. The comparison shows which strategy is better and what the differences are.

3.3. Heating/cooling

This simple shade position algorithm is responding to the state of the heating or cooling system in the space. The shade position (state) is either completely up, if the heating is on or completely down, if the cooling is on. If none of the systems are working the shade stays up. This algorithm assumes that the solar energy transmitted through the unshaded window will reduce the energy consumption for heating. During the time when the cooling system is working shading stays down to reduce the solar gains. The algorithm does not include indoor or outdoor environment conditions and the difference in U-values for shaded and unshaded windows. To implement such a solution data for heating and cooling the system must be sent to a window control system.

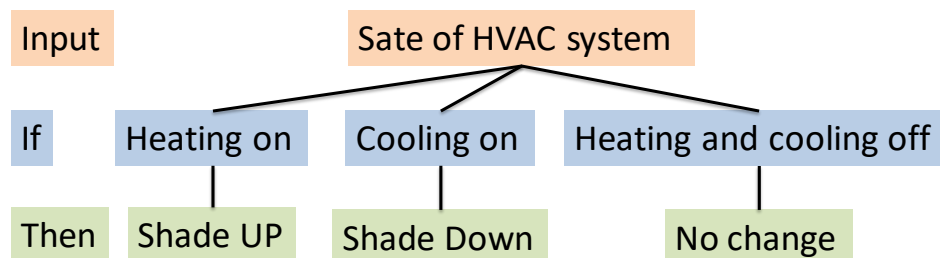

Figure 3. Simple control algorithm responding to the state of HVAC system

3.4. Simple rules

This algorithm operation is based on external temperature (T_{ext}) and solar radiation (I) measurement. A simple threshold temperature (T_{lim}) determines in combination with the solar radiation what the shade state should be. It was assumed that when $T_{ext} \leq T_{lim}$ the heating system is working and solar gains are needed. As a result the shade is up all the time. When $T_{ext} > T_{lim}$ cooling may be needed so the solar gains should be reduce. The shade is down during the day ($I > 1 \text{ W/m}^2$) and up during the night ($I \leq 1 \text{ W/m}^2$). The threshold temperature (T_{lim}) was set to 17°C but it can be change e.g. by the user.

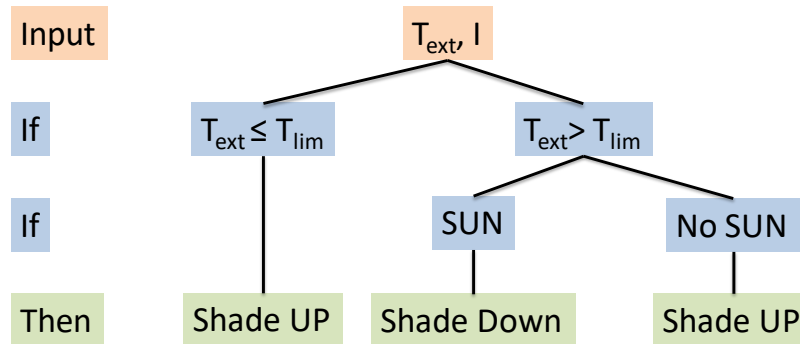

Figure 4. Simple control algorithm based on external temperature (T_{ext}), solar radiation (I) and threshold temperature (T_{lim})

3.5. Perfect citizen

The simple control algorithm ignored the indoor temperatures, which meant that the algorithm was not able to respond to the state of the heating or cooling system in the space. The next algorithm incorporates additional changes in the shade state relative to the heating (T_{heat}) and cooling (T_{cool}) thermostat set points. The algorithm works like a “perfect citizen” who determines the proper state of the shade in a way to reduce the energy consumption of the building. The position of shade depends on external temperature (T_{ext}), solar radiation (I) internal temperature (T_{in}) and set points. Assumptions regarding the set points are made for the whole day and are shown in Table 4. These values can be adjusted for specific installations. If the thermostat state (heating/cooling/idle) is available to the algorithm directly, then these thermostat set point temperatures are not needed.

Table 4. Thermostat set points used in control algorithm

Set point	Temperature (°C)
T_{heat}	21
T_{cool}	26

In cases where the interior room temperature is higher than the cooling set point, or lower than the heating set point, the position of shade can be easily determined. The proper shade states for these cases are shown in the second and third branches of the tree in Figure 5.

The time when interior temperature is between the thermostat set points represents the time when energy is not being used to maintain home temperature. Therefore, the shade state algorithm should be designed to maximize time spent in this zone. Several different control options were considered in order to extend the time between set points. The chosen one uses the average temperature (T_{ave}) calculated on a basis of heating and cooling set points ($T_{heat} = 21^{\circ}\text{C}$, $T_{cool} = 26^{\circ}\text{C}$ then $T_{ave} = 23,5^{\circ}\text{C}$). The average temperature is compared to internal temperature (T_{in}). If $T_{in} \leq T_{ave}$ space is in the heating mode (closer to the heating) and if $T_{in} > T_{ave}$ space is in the cooling mode (closer to the cooling). The shade position in both modes is determined in the same way as for cooling and heating.

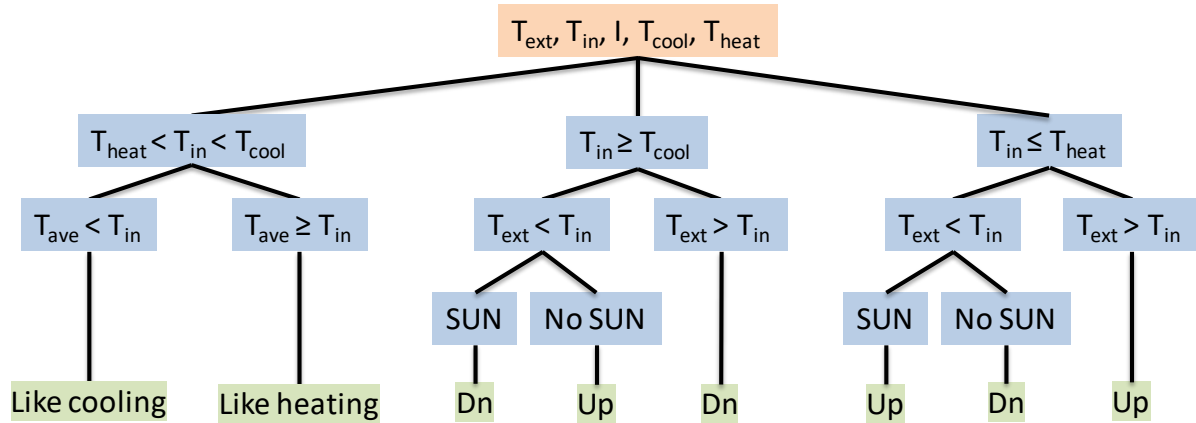

Figure 5. Perfect citizen control algorithm

3.6. Heat flow

The heat flow based algorithm controls the shades position from the energy point of view. In regard to the heating/cooling algorithm, it not only reduces the solar or heat gains when the space is in cooling mode, it is also maximizing the heat losses (through transition). In heating mode the solar gains are maximized and the heat losses reduced. The algorithm is based on the net heat flow through the window, which can be determined with the simple equation:

$$q = U_w * (T_{ext} - T_{in}) + SHGC * I$$

Where U_w and SHGC are properties of the window itself and depend on the shade state. The algorithm uses the NFRC standard U_w and SHGC (Table 2.), so these values never change once they have been determined. In reality, U_w and SHGC are properties that vary depending on the boundary conditions. For example U_w value in winter conditions is different than U_w value in summer conditions.

The T_{ext} , T_{in} , and I , are read from the integrated window sensors. This net heat flow equation is very useful because it directly looks at the conditions local to the window, and evaluates how to optimize the local net heat flow. If the space is in heating mode the heat flow should be maximized, while in the cooling mode minimized. The position of the shade can change the heat flow because the U_{window} and SHGC depend on it. If the shade is up the values are higher from those with shade down (Table 2.). That is why two net heat flows can be calculated q_{up} and q_{down} for the same local conditions:

$$q_{up} = U_{w,up} * (T_{ext} - T_{in}) + SHGC_{up} * I$$

and

$$q_{down} = U_{w,down} * (T_{ext} - T_{in}) + SHGC_{down} * I$$

The position of the shade is determined on a basis of the HVAC system state and on the relation between q_{up} and q_{down} . If the space is in heating mode and $q_{up} > q_{down}$ the shade will go up to maximize solar heat gains. For $q_{up} < q_{down}$ and heating mode the shade will go down to minimize heat losses (e.g. during the night where there is no sun). In cooling mode the principle will be opposite – the position of the shade should minimize heat gains or maximize heat losses. The state HVAC or space (when the HVAC is off) is based on the comparison of indoor air temperature T_{in} with heating and cooling set point temperatures. The average temperature T_{ave} is calculated in the same way as in the perfect citizen algorithm and

compared to T_{in} . If $T_{in} \leq T_{ave}$ the space is in heating mode (closer to the heating) and if $T_{in} > T_{ave}$ the space is in cooling mode (closer to the cooling). In comparison to the perfect citizen the heat flow algorithm has a simpler decision structure.

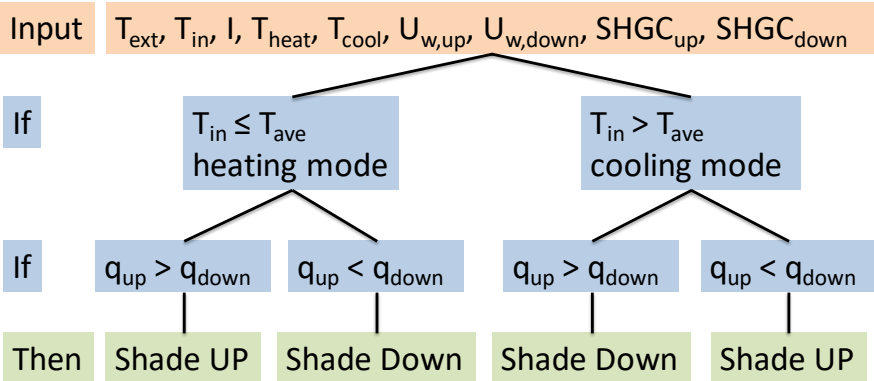

Figure 6. Heat flow control algorithm

3.7. Predictive - weather forecast based

The predictive weather based algorithm is the evolution of the heat flow algorithm. It uses the same methodology of shade state control but tries to predict what will happen in the future. The future in this case means the state of the HVAC system. The algorithm concentrates on the time when the HVAC is off – the $T_{in} > T_{heat}$ and $T_{in} < T_{cool}$. The use of a simple T_{ave} can be in some cases ineffective, e.g. during winter the solar gains should be maximized to “load” the building. If the shade control algorithm will know that the outdoor temperature will decrease during the next couple of days (heating will be needed) it can maximize the heat flow even if the space is in the cooling mode ($T_{cool} > T_{in} > T_{ave}$). Conversely when the outdoor temperature and radiation will increase the heat flow through the window can be minimized even in heating mode ($T_{heat} < T_{in} \leq T_{ave}$). Such a solution can cause additional energy savings due to the larger use of solar gains during the heating season and faster reduction of them during the cooling season.

The future state of the HVAC system can be predicted on the basis weather data. Outdoor air temperature and solar irradiation can be used to calculate the steady state energy balance of the building. However, this is too difficult of a task for the shade control algorithm because a model of the whole building is needed. A proposed simpler solution consists of calculating future temperature differences for indoor-outdoor and future heat flow through the window. It was assumed that heat flow can be minimized in the heating mode ($T_{heat} < T_{in} \leq T_{ave}$) when the future temperature difference is greater than zero ($T_{ext,f} - T_{in} > 0$). This means a situation in which heat gains will occur not only through windows, but also through other building elements in contact with outdoor air, e.g. external walls. The heat flow can be maximized in the cooling mode ($T_{cool} > T_{in} > T_{ave}$) when the future heat flow for windows without shading will be lower than zero ($q_{up,f} < 0$). This means a situation in which the transition heat losses through windows are higher than solar heat gains.

The predictive algorithm was checked on the basis of a perfect weather forecast. The future outdoor temperature ($T_{ext,f}$) and solar irradiation (I_f) came from a weather data file. Comparative calculations have shown that the results are best for 24 hour weather predictions. In real applications the weather data could be downloaded via the internet from free websites.

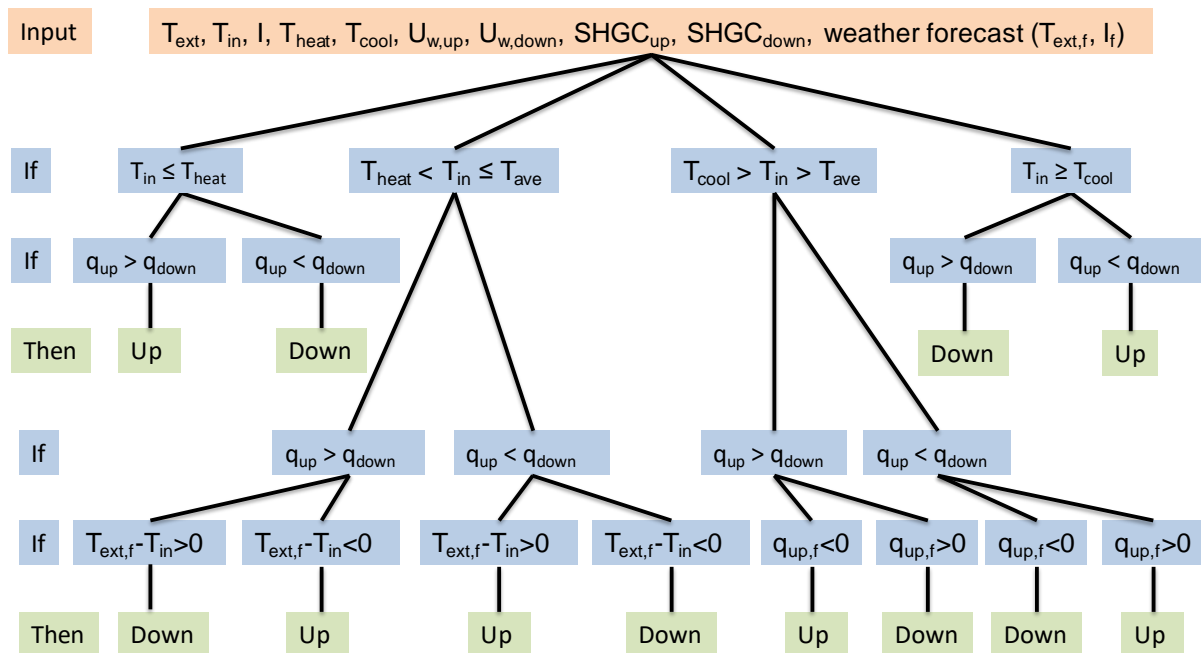

Figure 7. Predictive control algorithm

4. Challenges

The process of the control algorithm’s evaluation had to face several different challenges. Some of them are caused by the use of EnergyPlus, e.g. EMS time delay issue, others by the algorithms itself, e.g. oscillation of shade or use of NFRC standard U_w and SHGC values. Implementation of the algorithms in dynamic windows will also cause additional problems, like the need for integrated sensors or additional energy use. Discussing and solving of the above mentioned issues was part of the work.

4.1. Oscillation of shade, frequency of blinds adjustment

The use of control algorithms for dynamic windows can cause oscillation of the shade. Such a situation can occur when changes in the shades position are changing at the same time as the mode of the zone, e.g. from heating to cooling and opposite. As a result the frequency of the blinds adjustment is increasing. This is a negative effect because it can be annoying for the users when the blinds are going up and down very often. The Figure 8 shows how the shade position is being changed by the predictive algorithm during one day in December. In the worst case the blinds are going up only for 15 min (time step), resulting from the solar gains from a West oriented window. When the $T_{in} > T_{ave}$ mode of the zone is changing from heating to cooling - the gains have to be reduced, so the blinds are lowered. Frequency of blind adjustments for this algorithm depends on the difference between set temperatures $T_{heating}$ and $T_{cooling}$. If the difference is small the position of shade will be changed very often. Oscillation of shade will also increase energy consumption of the motor and can cause oscillation of HVAC system.

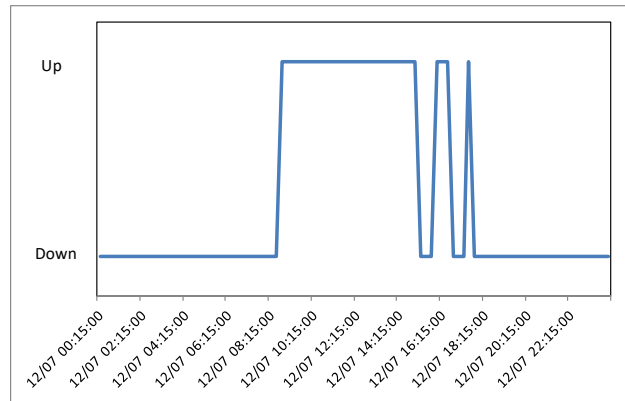

Figure 8. Change of shade position at 7th of December for Atlanta - predictive algorithm, West oriented, double low-e window with external roller blinds

In real applications the problem could be solved by defining the maximum number of changes per hour or the minimum time difference between them. Such a solution would reduce the frequency of blind adjustments but could increase the energy consumption of the building. These restrictions could be considered only during occupation hours. During unoccupied hours, we could imagine as many shade position changes as necessary (up to the point where the shade motor energy consumption becomes higher than the energy we try to save for heating/cooling). The shade operation for various algorithms was described precisely in section 5.3.

4.2. Use of average U_w and SHGC instead of real values

Some of the algorithms, like heat flow and predictive, use the U_w factor and SHGC to calculate the net heat flow through a window. The real values of those factors depend on environmental conditions and change during the year. EnergyPlus uses the BSDF methodology to calculate them precisely (2.3). Implementation of such a solution was not possible in the case of control algorithms, because the EMS calculations were done before window calculation. The state of the shade is part of the input data and must be known before. The BSDF methodology would make the algorithms much more complicated and less applicable. In real applications the U_w factor could be specified for each window in accordance with standard ISO 15099:2003 [29] and SHGC set on basis of glazing and shade type.

For the purpose of the study a single angle of incidence (normal incidence) and single set of environmental and room conditions (NFRC standard conditions) were used to calculate the single U_w factor and SHGC for each of the combinations of shades and baseline windows. The values resulting from this calculation are shown in Table 2.

4.3. Integrated sensor and additional electrical energy consumption

The dynamic window is an integration of window, shading, motor, sensors and control algorithms. The integration of all those elements can cause some problems, for example with sensor readings. The dynamic window has four sensing types: exterior temperature, interior temperature, solar radiation and motion. Window montage or local conditions can influence the measured parameters, e.g. curtains or drapes can cover the motion sensor or change the temperature near the window. The solar radiation sensor can be covered by

snow and the exterior temperature reading can depend on color of the frame. Such problems could be solved by including dynamic windows in BMS (Building Management System) and using of data from sensors located in representative places. The external conditions could be downloaded from web pages with weather forecasts or from local meteorological stations. The irradiation would be calculated for each orientation taking into consideration natural shading elements.

The use of a motor, sensors and a small microprocessor causes additional electrical energy consumption. The motor used in a dynamic window needs to be less than 150mA at 12V (~2W) for raising about 1m² of internal cellular shading. There is a very brief surge required to start the motor, about 2-3 times the steady current. The total time to raise and lower the shade is about 14 seconds, which gives about 8mWh per one cycle with 1 m² shade. One window in the building model has 4,2m² (2,8m x 1,5m). For 3 cycles per day (like in Figure 8.) we get 101mWh/day. The sensors and microprocessor need 100μA at 3V which gives about 72mWh/day. It was assumed that the energy will be supplied from 8 AA alkaline batteries so the voltage has to be converted from 12V to 3V. Consumption of sensors and microprocessors was increased by 25% to include inefficiency for voltage conversion. The total energy consumption is 191mWh/day and 69,72Wh/year. For eight windows in the building we get about 0,56kWh/year.

However the amount of energy we can allow (or block) through the window, makes this pale in comparison. If the SHGC is 0.18 with the shade down, and 0.49 with the shade up, and we assume 500 W/m² of solar irradiation on the window, then the difference between having the shade up or down is 368 W through the one window. This means that in 1 hour and 31 minutes, the window transmits (or blocks) as much solar energy, as the motor and electronics used in a full year in the entire building. The energy consumption from heavier external roller blinds would go up to 2-3 times higher but it is still very low in comparison to difference in solar gains. Electrical energy could be also supplied from integrated PV panels. Such a solution would make a dynamic window more energy independent.

5. Results

The results of the calculations, made for different control algorithms, include the following parameters:

- energy consumption (site and source energy),
- number of hours of retracted shades during daylight,
- shade operation on a two typical days.

The comparison was made not only for different algorithms but also for various climate zones and windows configurations.

5.1. Annual energy consumption

The annual energy consumption includes energy for heating, cooling and the energy used by fans. The site energy (final energy) was given in GJ and the total source energy (primary energy) in kWh/m²a. The GJ can be used for calculating the energy cost and the kWh/m²a (more commonly used in Europe) for evaluation of the environmental impact. According to the EPBD Recast [30] the definition of the nZEB must include “a numerical indicator of primary energy use expressed in kWh/m² per year.” The balance methods presented by

Bourrelle et al. [31] also use primary energy for assessing buildings at the design or operation stage.

Table 5. Annual site (final) energy results for four climates, two window configurations and various control algorithms (Low-e - double low solar gain, Hi-R - triple glass high solar gain, green - best in climate, red - worst in climate)

City	Window type	Total site (final) energy, GJ								
		No shade	Always shaded	Half shade	Heating /cooling	Manual operation	Simple rules	Perfect citizen	Heat flow	Predictive weather
Atlanta	Low-e	24.0	25.4	24.2	20.0	24.7	20.2	19.7	19.7	19.8
	Hi-R	23.1	21.3	21.8	18.5	21.9	18.6	18.6	18.6	18.6
Minneapolis	Low-e	67.8	74.3	70.6	65.3	71.2	65.3	63.7	63.8	63.8
	Hi-R	56.1	61.0	58.1	53.0	58.7	53.2	52.6	52.6	52.6
Phoenix	Low-e	28.5	23.0	25.3	21.3	24.6	21.3	21.2	21.3	21.3
	Hi-R	33.3	25.4	29.2	25.4	27.9	25.7	25.3	25.3	25.3
Washington DC	Low-e	36.7	41.3	38.5	33.7	39.4	33.8	32.9	33.0	33.0
	Hi-R	30.7	32.7	31.3	27.2	31.9	27.3	27.2	27.3	27.3

Results of the analysis clearly show that the shade operation should be controlled in an automatic way. Shading of the windows constantly increases final energy consumption in three of the climates. Only in the cooling dominated climate of Phoenix is the situation opposite.

In regard to windows without shade the reduction rates of final energy range from 6,3% for Minneapolis (both window configurations) to 25,6% for Phoenix (double low-e). Automatic shade operation will be more effective in cooling dominated climates.

The highest reduction was achieved using the perfect citizen algorithm - on average 13,0%. The heat flow and predictive algorithm reduced the site energy by 12,9%. For the heating/cooling algorithm it was 12,0% and for simple rules 11,6%. The difference between various algorithms is not large but visible. Manual operation of shade had on average no effect on energy consumption. Use of even simple control algorithms is recommended.

The results are showing that use of windows with low U-values and high SHGC is not appropriate in all climates. A change from double low-e to triple glass (no shade case) has caused reduction of total site energy by 17% for Minneapolis, 16% for Washington DC and 4% for Atlanta. In the case of Phoenix an increase of 17% was noted. The increase was observed because of the higher SHGC of the triple glass option (SHGC = 0.49) compared to the double glass option (SHGC = 0.30).

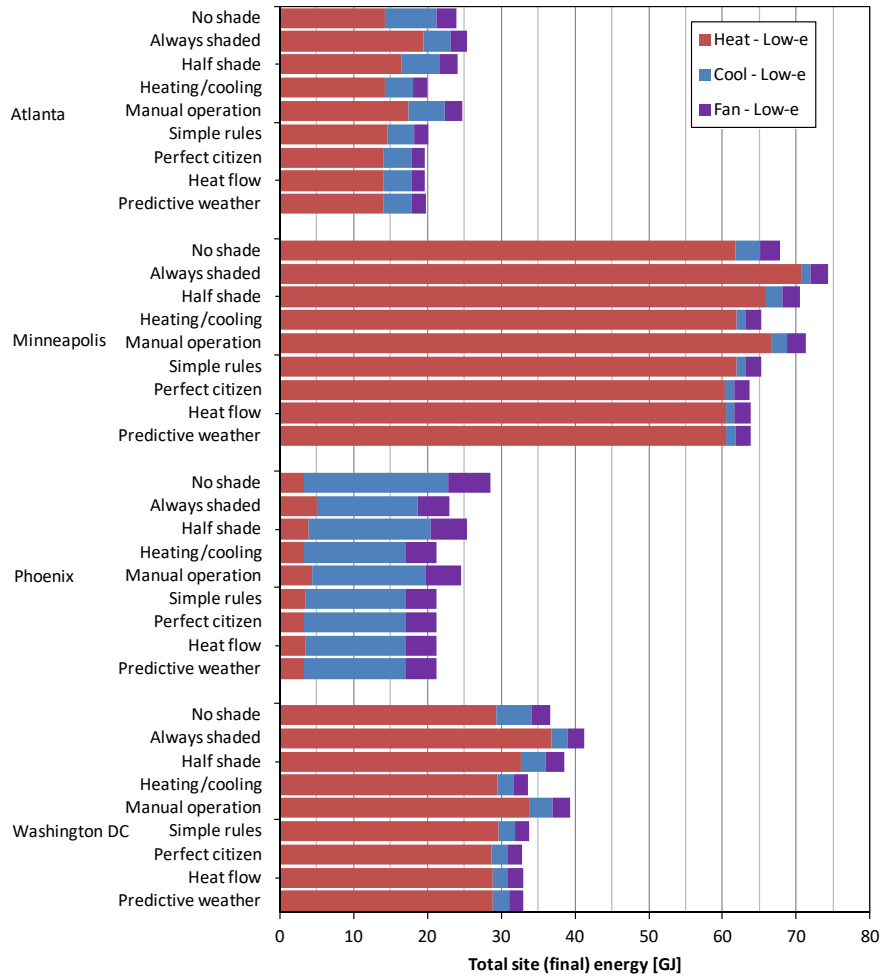

Figure 9. Structure of annual site (final) energy consumption for four climates, various control algorithms and double low solar gain

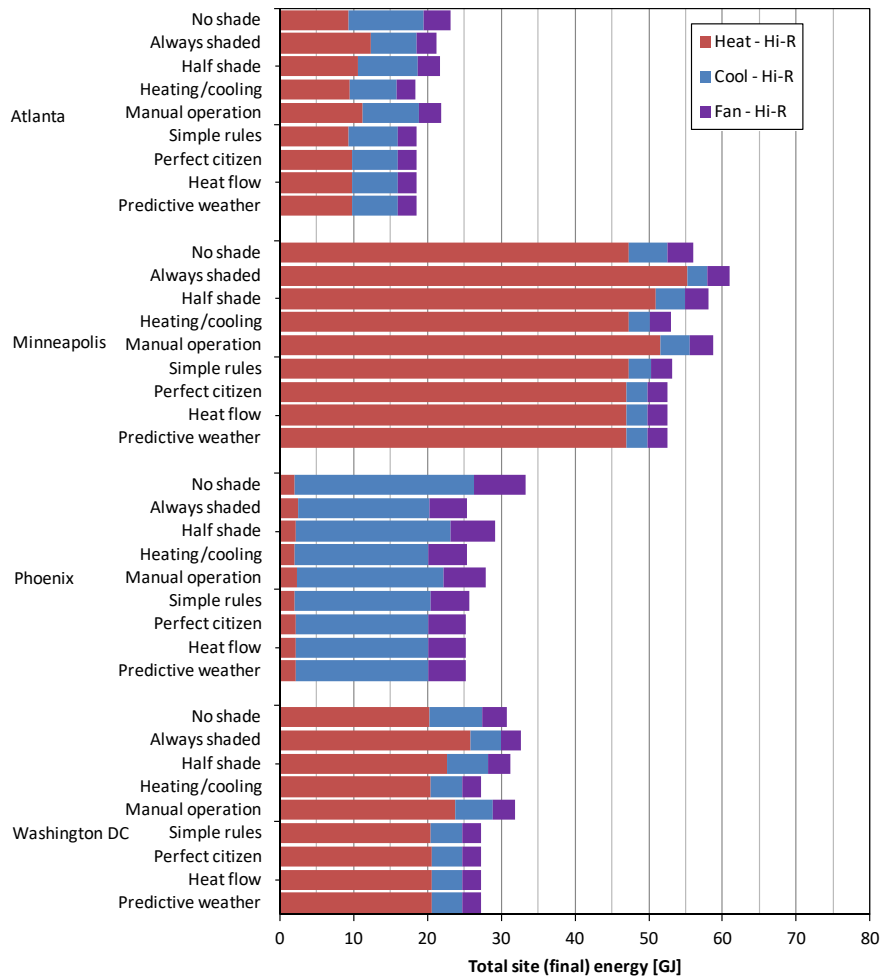

Figure 10. Structure of annual site (final) energy consumption for four climates, various control algorithms and triple glass high gain

The structure of site (final) energy consumption depends on the climate. The heating share (no shade) is changing from 91% for Minneapolis double low-e to 6% for Phoenix triple glass. The cooling share (no shade) is changing in the opposite way, from 73% for Phoenix triple glass to 5% for Minneapolis double low-e. The share of fan energy (no shade) is not as small and changes from 4% for Minneapolis double low-e to 21% Phoenix triple glass.

Use of control algorithms decreases mainly the cooling energy, for example by 64% in case of Minneapolis (double low-e argon). The cooling energy for all climates is almost the same as for constantly shaded windows, thanks to automatic shade operation. The heating energy is more or less constantly decreasing slightly. Lower energy for heating and cooling reduces fan energy. What is interesting, the results for manual operation are similar to those for half shade.

Table 6. Annual source (primary) energy results for four climates, two window configurations and various control algorithms (Low-e - double low solar gain, Hi-R - triple glass, green - best in climate, red - worst in climate)

City	Window type	Total source (primary) energy, kWh/m ² a								
		No shade	Always shaded	Half shade	Heating /cooling	Manual operation	Simple rules	Perfect citizen	Heat flow	Predictive weather
Atlanta	Low-e	57.7	49.7	52.6	41.7	52.5	41.8	41.1	41.2	41.4
	Hi-R	67.0	51.8	58.5	48.0	57.5	48.8	47.9	47.9	48.0
Minneapolis	Low-e	107.0	109.7	107.4	96.9	108.0	96.9	94.6	94.7	94.8
	Hi-R	98.8	97.5	97.3	86.0	97.6	87.2	85.3	85.3	85.4
Phoenix	Low-e	104.0	77.7	89.8	75.4	85.7	75.1	75.1	75.1	75.2
	Hi-R	126.2	93.8	109.6	94.6	104.0	96.1	94.0	94.1	94.1
Washington DC	Low-e	68.5	67.5	67.0	56.4	67.6	56.5	55.1	55.3	55.5
	Hi-R	68.5	62.0	64.3	54.2	64.3	54.7	54.0	54.0	54.1

Use of window attachments and control algorithms decreases the source (primary) energy consumption in all climates. In comparison to site energy the average size of reduction is almost two times higher. This is caused by high conversion factors for electricity (3,167) and mainly reduced cooling energy (produced from electricity).

In regard to windows without shade the reduction ranges from 12% for Minneapolis double low-e to 29% for Atlanta also double low-e. The source energy was decreased on average by 21,6% for perfect citizen, 21,5% for heat flow, 21,4% for predictive weather, 20,7% for heating/cooling and 20,1% for simple rules algorithm. Use of even simple control algorithm increases the savings more than double in regard to manual operation (average reduction of 8,6%).

The results show that use of windows with low U-values and high SHGC is not appropriate in all climates. It is more evident than for site energy. The change from double low-e to triple glass (no shade case) has caused a reduction in total source (primary) energy by 8% only in the case of Minneapolis (heating dominated climate). In a case of Washington DC there is no difference but the share of energies is changing. With the double low-e, most of the energy is used for heating, while with the high solar gain triple glass, heating and cooling are evenly split. The increase was noted for Atlanta by 16% and Phoenix by 21%. This analysis confirms that one glazing type is not ideal for all climates.

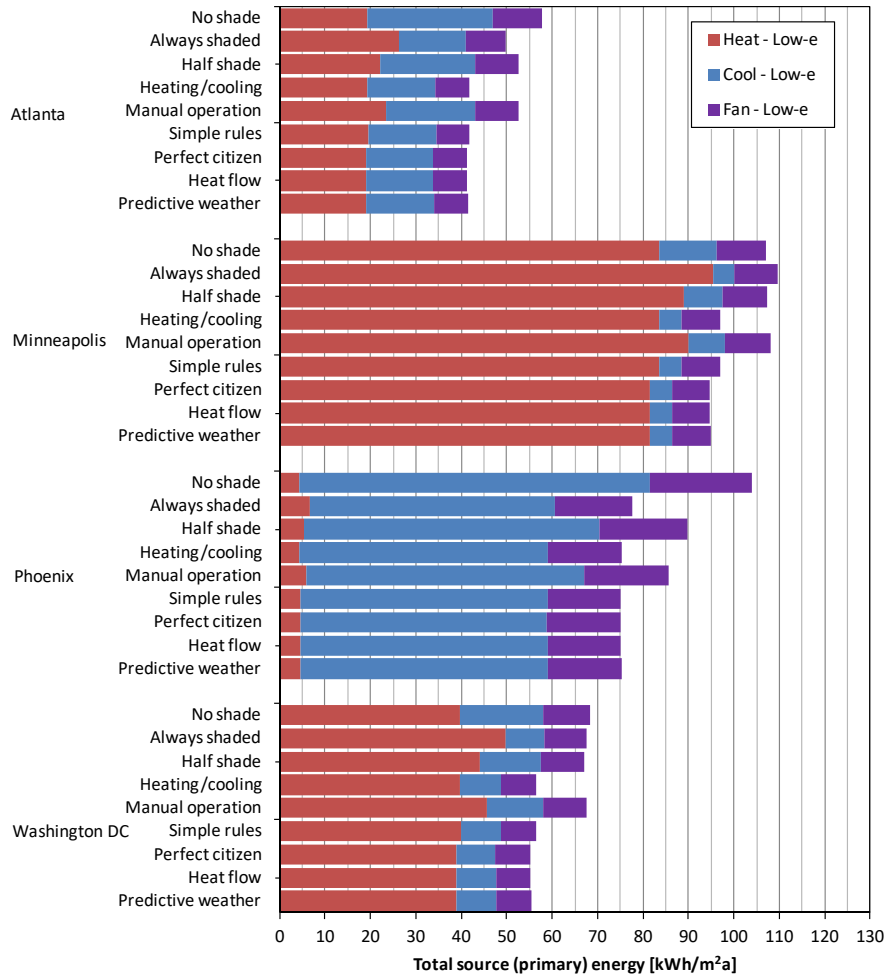

Figure 11. Structure of annual source (primary) energy consumption for four climates, various control algorithms and double low solar gain

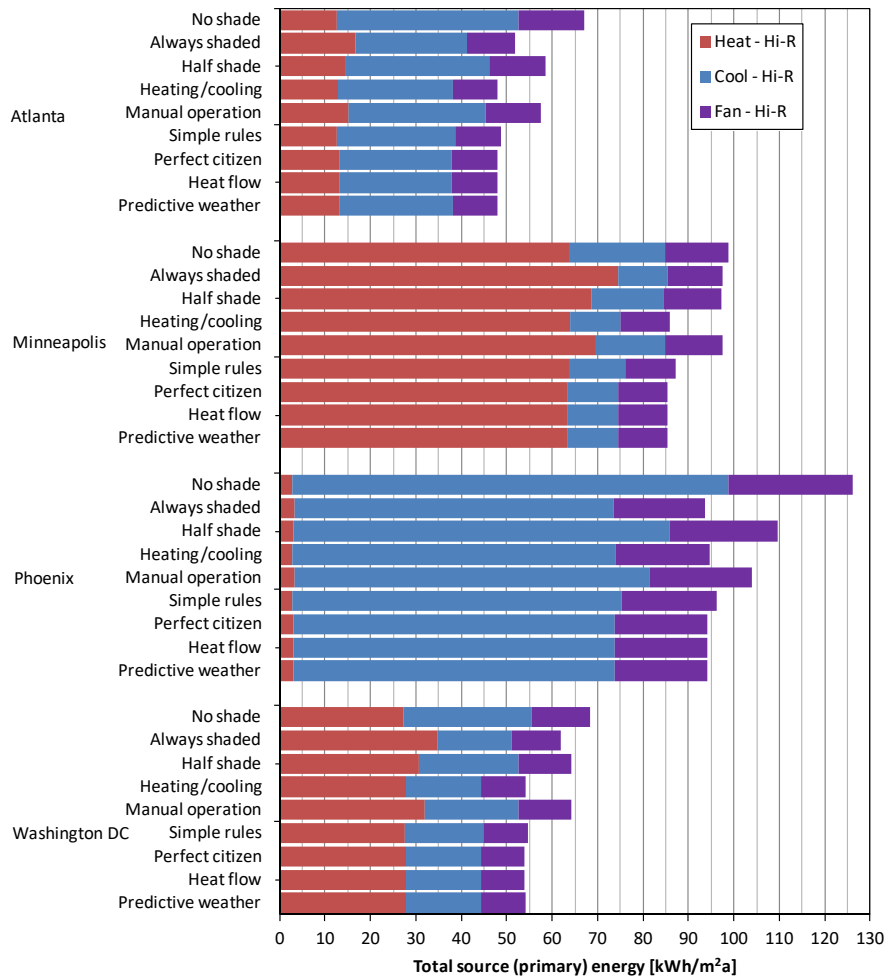

Figure 12. Structure of annual source (primary) energy consumption for four climates, various control algorithms and triple glass

The structure of source energy consumption is changing in regard to site energy because of conversion factors. A cooling system and fans use electrical energy (3,167) and a heating system natural gas (1,084). As a result the share of heating is decreasing while share of cooling and fans increasing. Even in the climate of Minneapolis cooling and fans are responsible for 22% of source energy consumption for clear double low-e and 35% for triple glass. Use of windows with low U-values and high SHGC increases the share of these energies even in cooling dominated climate.

Influence of control algorithms on the structure of source energy consumption is very visible. For example in Phoenix (triple glass, no shade) total source energy consumption, 126,2kWh/m²a, consists of 2,7 kWh/m²a for heating, 96,2kWh/m²a for cooling and 27,3kWh/m²a for fans. When the shade operation is controlled with the perfect citizen algorithm the total consumption is 94,0kWh/m²a and consists of 2,9 kWh/m²a for heating, 70,8kWh/m²a for cooling and 20,3kWh/m²a for fans. The use of shade and control algorithms reduces mainly the electrical energy consumption, which is very good from the ecological (high conversion factor) and economical (high price) point of view.

5.2. Daylight access

According to Inoue et al.[1] people want windows primarily for daylight (83% of respondents) and secondarily for the view (70% of respondents). The automatic control algorithm should ensure not only energy savings but also maximum access to daylight. In residential buildings the aspect of glare is not as important as in public utility buildings. That is why windows should be open whenever it is possible from the energy point of view. The comparison of different control algorithms was based on percentage of time with the shade down. The results were compared with Average User Control curve, which is based on behavioral a survey by D&R International [28]. The percentage of time with the shade up for manual operation depends on the climate zone. It is on average 43% for North climate zones, 38% for Central and 31% for South. It was assumed that Atlanta and Phoenix are located in South zone, Washington DC in Central and Minneapolis in North. It was assumed that the artificial lighting system operates according to a fixed schedule and the change of energy consumption for lighting was not considered.

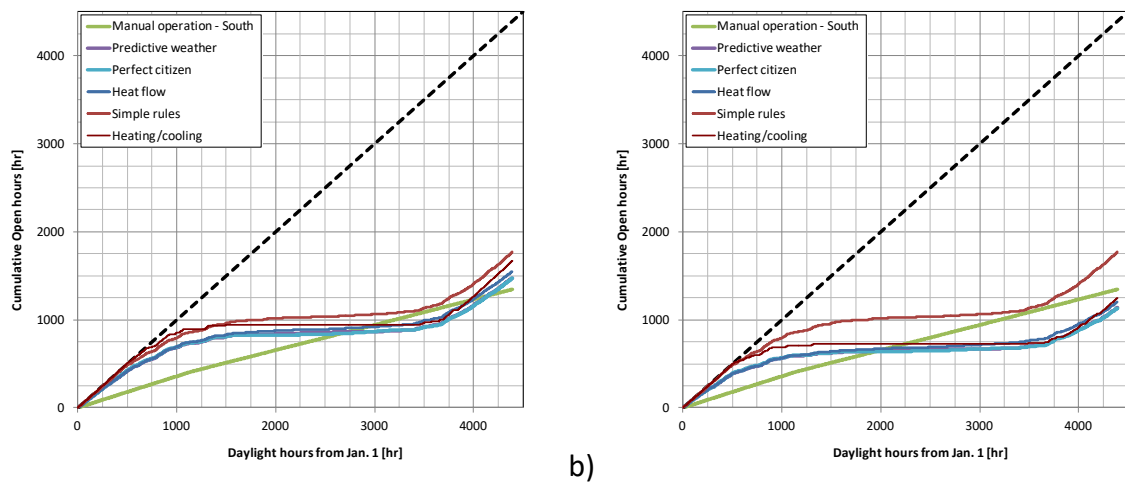

a) b)
Figure 13. Number of hours of retracted shades during daylight for Atlanta, various control algorithms and two window configurations: a) double low solar gain, b) triple glass high solar gain. Average User Control curve is based on behavioral survey by D&R International [28]. Dashed line represents 100% open.

In the humid subtropical climate (hot and humid summers and cool but variable winters) of Atlanta, use of control algorithms increases the daylight access (from 34% to 40% comparing to 31%) for low solar gain windows. In the case of triple glass only the simple rules algorithm (40%) is better than manual operation. For other algorithms the percentage of time with the shade down is decreasing because of higher a SHGC value. It is not influencing the simple rules algorithm, because its operation is based only on external temperature (T_{ext}) and solar radiation (I) measurement.

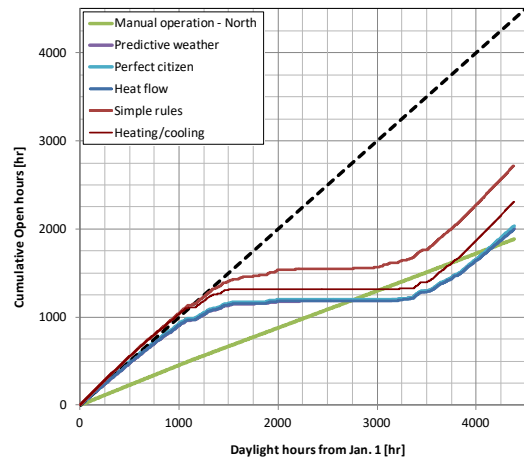
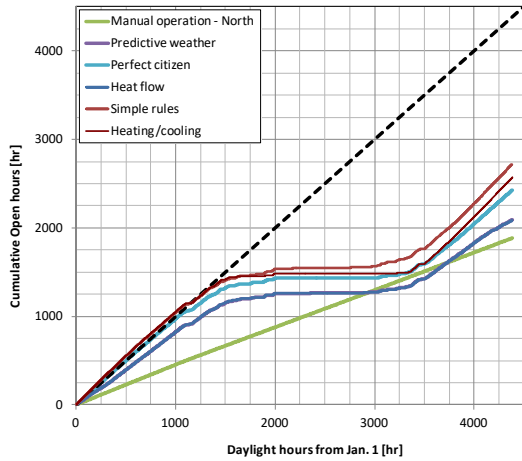

a)

b)

Figure 14. Number of hours of retracted shades during daylight for Minneapolis, various control algorithms and two window configurations: a) double low solar gain low-e argon, b) triple glass high solar gain. Average User Control curve is based on behavioral survey by D&R International [28]. Dashed line represents 100% open.

In the continental climate (winters are cold and snowy, while summers are mild and can be humid) of Minneapolis, the use of control algorithms increases the daylight access. For the best case - simple rules, the percentage of time with shade up is 62% for both windows. Other algorithms are also better than manual operation, e.g. heating/cooling 59%, perfect citizen 55%, heat flow and predictive weather 48% (double low-e argon). The shape of the curves shows that the shade will be mainly down during cooling season and up during heating season.

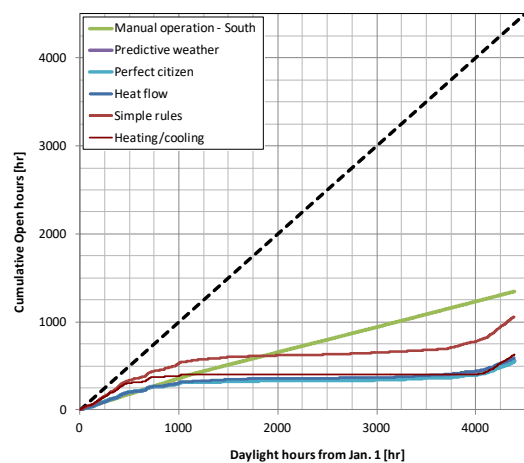
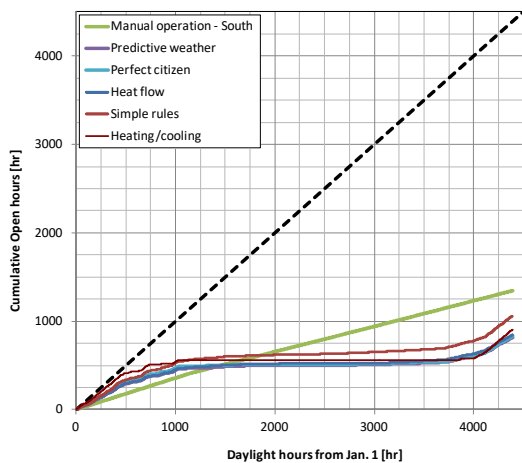

a)

b)

Figure 15. Number of hours of retracted shades during daylight for Phoenix, various control algorithms and two window configurations: a) double low solar gain low-e argon, b) triple glass high solar gain. Average User Control curve is based on behavioral survey by D&R International [28]. Dashed line represents 100% open.

In the subtropical desert climate (extremely hot summers and warm winters) of Phoenix use of control algorithms strongly decreases the daylight access. For double low-e argon the percentage of time with shade up is from 24% to 19% and for triple glass a higher SHGC value from 24% to 12%. The differences between control algorithms (beyond simple rules)

are very small. The change of windows form double low-e to triple glass decreases the number of hours of retracted shades by an average 270 hours (except simple rules).

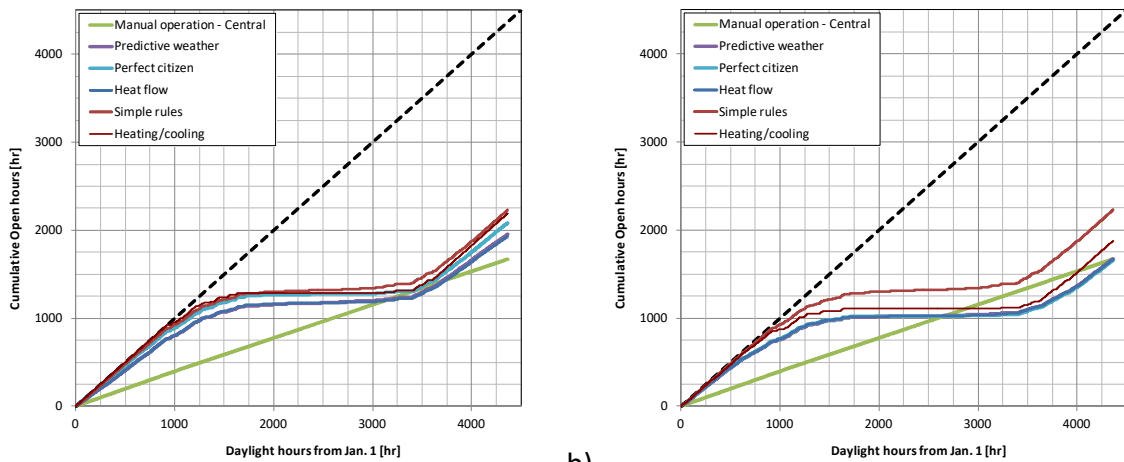

a) b) Figure 16. Number of hours of retracted shades during daylight for Washington DC, various control algorithms and two window configurations: a) double low solar gain low-e argon, b) triple glass high solar gain. Average User Control curve is based on behavioral survey by D&R International [28]. Dashed line represents 100% open.

In the humid subtropical climate (spring and fall are warm, winter is cool, summers are hot and humid) of Washington DC use of control algorithms increases (double low solar) or does not change (triple glass) the daylight access. Similarly, as for other climates, the higher SHGC decreases the cumulative open hours for most of the algorithms. Increased solar heat gains result in the shade having to be lowered much more often during spring and autumn.

Table 7. Percentage of time with the shade off for four climates, two window configurations and various control algorithms (Low-e - double low solar gain, Hi-R - triple glass high solar gain, green - best in climate, red - worst in climate).

City	Window type	Percentage of time with shade off, %					
		Manual operation	Heating /cooling	Simple rules	Perfect citizen	Heat flow	Predictive weather
Atlanta	Low-e	31	38	40	34	35	34
	Hi-R	31	28	40	26	27	26
Minneapolis	Low-e	43	59	62	55	48	48
	Hi-R	43	53	62	46	46	46
Phoenix	Low-e	31	21	24	19	19	19
	Hi-R	31	14	24	12	13	13
Washington DC	Low-e	38	50	51	48	44	45
	Hi-R	38	43	51	38	38	38

Comparison of all results shows that the simple rules algorithm is the most suitable from the point of view of daylight. Some cases are especially interesting, e.g. Phoenix, double low-e argon. The percentage of time with the shade up is 5% higher for simple rules than for perfect citizen. At the same time the total site (final) energy is respectively 21,3GJ (simple rules) and 21,2GJ (perfect citizen) – best result. The annual source (primary) energy is equal for both algorithms. For other window configurations and climates the differences in energy

consumption for these two algorithms are also not high. While the difference in access to daylight can be 16% - Minneapolis, triple glass, 14% - Atlanta, triple glass, 13% - Washington DC, triple glass and 12% - Phoenix, triple glass. In cooling dominated climates use of control algorithms can decrease the number of hours of retracted shades during daylight, in comparison to manual operation. While in heating dominated climates the situation is opposite.

5.3. Shade operation

Differences in shade operation for various algorithms influence the energy consumption and daylight access. The precise analysis of two days, 3rd of January for Minneapolis and 25th of May for Phoenix, shows how the shade operates during heating and cooling season. The percentage of open window areas changes from 0% to 100%. The value of 50% means that only half of the windows in the building are shaded.

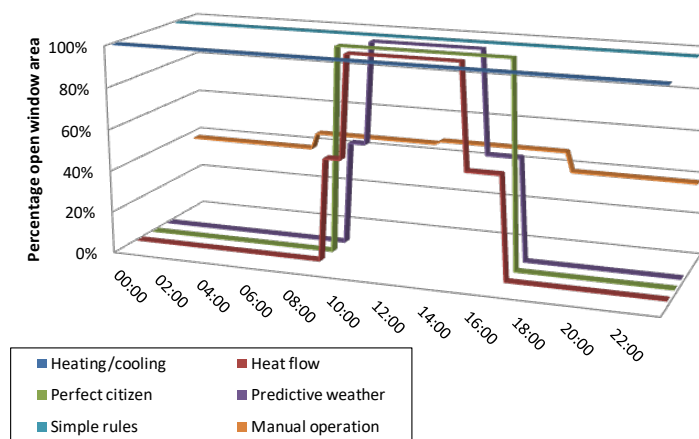

Figure 17. Shade operation during 3rd of January (heating season) for Minneapolis, double low-e argon and various control algorithms

The comparison of shade operations during the heating season shows, firstly that some algorithms are working centrally and others locally. Algorithms like heating/cooling, simple rules and perfect citizen will change the position of shade in the whole building, whereas heat flow and predictive weather give separate commands for each orientation. When solar radiation during heating season is very low, it might be better to put the shade down on part of the windows and reduce transition losses. It is very visible on Figure 17. because in the morning shade goes up initially only for 50% of windows. A similar situation can be seen in the evening. In the case of the perfect citizen algorithm the shade goes up and down at the same time for the entire building.

The next visible difference is the frequency of shade operation. It stays up the whole time for simple algorithms like heating/cooling and simple rules. So in the whole year the number of cycles will be smaller than for an advanced one, but the energy consumption will be a little bit higher. The manual operation differs from others and the percentage of open window areas does not change much during the whole day. Around 60% of area is shaded all the time which is not an optimal solution.

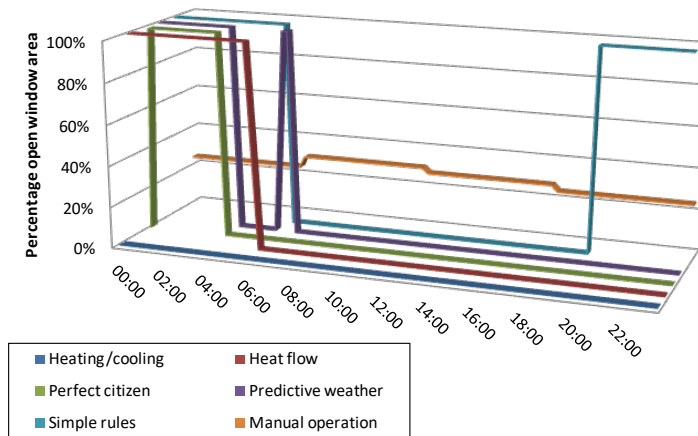

Figure 18. Shade operation during 25th of May (cooling season) for Phoenix, double low-e argon and various control algorithms

The situation during the cooling season is opposite to the heating season. The shade goes up during the night and down during the day. The differences between algorithms are also visible. In the case of heating/cooling the shade stays down the whole day. It will stay down even if the cooling system is off. The perfect citizen keeps the shade up only from 00:15 to 03:30, similar to predictive weather. The second algorithm puts the shade up from 05:45 (50%) to 06:15 (100%) as well. The heat flow and simple rules keep the shade up till 05:30 but only the second one exposes the windows again at 19:45. This can explain the highest number of hours of retracted shades for simple rules in cooling dominated climates. The manual operation differs from others and the percentage of open window areas does not change much during the 24h time period. It is increasing during the daytime, which is bad solution an energy point of view. In regard to heating dominated climate the percentage of open window areas is about 10% smaller.

6. Discussion

The results of the analysis can be used in a practical way. First of all they can be important from the point of view of building codes and utility suppliers. Potential energy saving may be an incentive for changes in the requirements or policy. Secondly companies which are offering windows with integrated shading can improve their products.

6.1. Predictability of savings

The IEEC 2012 [18] specifies the requirements for fenestration in residential buildings. Main of them is U-factor and SHGC. No internal or external shading is required. The same refers to the automatic control of shade operations. Whereas the calculations have shown that such solution can save up to 26% of site (final) energy and up to 29% of source (primary) energy. Confirmation of these results could be a catalyst to changes in the requirements.

The EPBD Recast [30] and EED [32] are the EU's main legislation when it comes to reducing the energy consumption of buildings. According to EPBD Recast "all new buildings must be nearly zero energy buildings (nZEB) by 31 December 2020 (public buildings by 31 December 2018)". Each EU country must set minimum energy performance requirements for nZEB. They were calculated with cost-optimal methodology separately for each country. Available calculation reports show that subject of windows was considered only for the U-factor and SHGC perspective. No automatic shading devices in residential buildings were included. Whereas the calculations have shown that use of them can improve the energy efficiency. This effect is especially visible in the case of cooling dominated climate and primary (source) energy consumption. Smart dynamic windows would help reach the nZEB standard.

The proportion of such a solution can also be an element of a utility suppliers' policy. Reduction of energy consumption and an increase in energy efficiency is the target of EED. According to the directive "energy distributors or retail energy sales companies have to achieve 1.5% energy savings per year through the implementation of energy efficiency measures". Encouraging users to install smart dynamic windows could help in meeting these requirements.

6.2. Market potential and user acceptance

It seems that the use of dynamic windows with control algorithms has a big market potential. Many windows in residential building are equipped with different kinds of shading devices. It can be external roller blinds, internal venetian blinds, internal roller blinds or other similar devices. The calculation results have shown that manual operation of shade is less effective than automatic from the energy and daylight point of view. The automatic control algorithms are guaranteeing that the advantages of shading devices will be used in an optimal way. The next advantage is integration of three different elements into one product. The clients do not have to buy and install windows, shading devices and control systems separately. They are supplied by one company giving the guarantee for the whole product.

The disadvantage of the dynamic windows will be: a higher price, higher probability of failures and the use of additional electrical energy. A problem of energy supply can be solved by integration of small PV panels on the external surface of a window frame. Energy stored in the batteries could be used by the motor and control system. Higher prices and failure probability will decrease with the popularization of solutions.

Another problem could be user acceptance. Automatic control of shade operation can be in some situations annoying. Figure 8. shows that the position of shade can change very often in case of some algorithms - the blinds are going up only for 15 min (time step). Figure 18. shows that the shade can move during the night which can produce a noise or change the illumination e.g. in the bedroom. Solutions to these problems include a "user button". Pressing the button will cause the change of a shade's position to another state - if it is up → down, if it is down → up. The shade will stay like that till sunrise ($I > 1 \text{ W/m}^2$) or sunset ($I \leq 1$

W/m²). After that automatic control will return. Additionally the maximum number of changes per hour or the minimum time difference between them could be defined.

7. Conclusions

The presented analysis included: two different window configurations, nine different types of shade operations, including five control algorithms and four climates. This all gives 72 variants for which the energy consumption, number of hours of retracted shades during daylight and shade operation was determined. With these results, we were able to make following conclusions:

- Manual operation of shades has on average no effect on site (final) energy consumption in comparison to windows without shade. Use of automated shading with proposed control algorithms can reduce on average the site energy in the range of 11.6% to 13.0%. In regard to source (primary) energy manual operation of shade reduces on average the consumption by 8.6% while automatically controlled in the range of 20.1% to 21.6%. It can be concluded that the analyzed types of attachments - external roller blinds and between glass cellular shading, should always be automatically controlled. Designing of low energy and comfortable buildings can be impossible without appropriate control systems [12].
- Automatic shade operation is more effective in cooling dominated climates. In the case of Phoenix the site (final) energy consumption can be maximally reduced by 25.6% and source (primary) energy by 27.8% in regard to a window without shade. While for Minneapolis the reductions are respectively 6.3% site energy and 13.6% primary energy.
- The differences between algorithms in regard to energy savings are not high. The best results were obtained for perfect citizen, average reduction of site (final) energy 13,0% and average reduction of source (primary) energy 21,6%. The worst for simple rules, average reduction of site (final) energy 11,6% and average reduction of source (primary) energy 20,1%. The changes were calculated in regard to windows without shading. Use of even a simple control algorithm is recommended.
- Obtained results have confirmed that that use of windows with low U-values and high SHGC are not appropriate in all climates. Windows with triple glass high solar gain glazing are appropriate for heating dominated climates. In cooling dominated climates reduction of solar heat gains should be achieved first of all by decreasing the SHGC value. Use of automated shading is the next step.
- Comparison of the algorithms from the point of view of daylight access, shows higher differences than in the case of energy consumption. The highest, average percentage of time with shade of during daylight 44.3% was observed for simple rules algorithm. The lowest 33.4% for predictive weather. The algorithms like predictive weather, perfect citizen (34.8%) and heat flow (33.9%) were on average worse than manual operation (35.7%). If we take into consideration the energy consumption and the daylight access the simple rules algorithms seems to be a very solution.
- The control algorithms have a strong influence on shade operation. Some of them can include local conditions and give separate commands for each orientation - heat flow and predictive weather. Others will change the position of shade in whole building, e.g. heating/cooling. From the practical point of view the same control strategies should be used in different orientations.

- The problem that can occur in case of automated shading is shade oscillation. It can decrease user acceptance and increase energy consumption. The algorithms which use interior parameters, like predictive weather, perfect citizen and heat flow, as impute values are more sensitive. Oscillation can also occur when the difference between set point temperatures for heating and cooling is very small, e.g. 21°C and 24°C instead of 20°C and 26°C. The small dead band can also increase the energy consumption. The increase will be caused not only by the change of set points but also by less effective use of heat and cooled [33], e.g. buildings will be heated in the morning and cooled in the afternoon.
- Additional energy consumption caused by motor, sensors and a small microprocessor in the analyzed case is very small. In 1 hour and 31 minutes, one window transmits (or blocks) as much solar energy (by 500 W/m² of solar irradiation), as the motor and electronics use in a full year in whole building.

Next steps

Further studies on control algorithms should lead to implementation of new intelligent solutions, as well as integration of dynamic windows with other building systems, e.g. ventilation. These studies should focus on:

- Implementation of Model Predictive Controls (MPC) based on a resistance-capacitance (RC) circuit model. The challenge with these algorithms is that they need to learn or be trained to function optimally, which can result in somewhat unpredictable shade operation behavior in the first period after installation.
- Windows in the case of natural or mechanical exhaust ventilations are usually the sources of fresh air. Many air inlets are dedicated for windows and are installed on them. Simultaneous control of the shade position and airflow rate could lead to further reduction of energy consumption, e.g. thanks to night ventilation [12]. The ventilation of the window also has a significant impact on its performance [9].
- Reduction of energy consumption can be also achieved through relaxing the thermal comfort requirements [34]. This solution together with automatic shading can lead to situation in which cooling systems in some of the climates (heating dominated) will be not needed.

References

1. T. Inoue, Y. Matsuo, T. Ibamoto, Study on the thermal performance of ventilation window. Proceedings of International Symposium on Thermal Application of Solar Energy. pp. 221-226. 1985,
2. S. Nikoofard, V. I. Ugursal, I. Beausoleil-Morrison, Technoeconomic assessment of the impact of window shading retrofits on the heating and cooling energy consumption and GHG emissions of the Canadian housing stock, Original Research Article, Energy and Buildings, Volume 69, February 2014, Pages 354-366,
3. J. Carmody, S. Selkowitz, D. Arasteh, L. Hescong, Residential Windows: a Guide to new Technologies and Energy Performance, W.W. Norton & Company, New York (2007),
4. W. Feist, J. Schnieders, V. Dorer, A. Haas, Re-inventing air heating: convenient and comfortable within the frame of the Passive House concept, Energy and Buildings, 37 (2005), pp. 1186–1203,

5. S. Firląg, Reducing risk of overheating of passive buildings: Ciepłownictwo, Ogrzewanie, Wentylacja, Wydawnictwo SIGMA - N O T Sp. z o.o., vol. 44, nr 3, 2013, ss. 111-116,
6. C. Oleskowicz-Popiel, M. Sobczak, Effect of the roller blinds on heat losses through a double-glazing window during heating season in Central Europe, Original Research Article, Energy and Buildings, Volume 73, April 2014, Pages 48-58,
7. S. Rheault, E. Bilgen, Experimental study of full-size automated Venetian blind windows, Solar Energy, 44 (1990), pp. 157–160,
8. J.-M. Dussault, L. Gosselin, and T. Galstian, Integration of smart windows into building design for reduction of yearly overall energy consumption and peak loads, Sol. Energy, vol. 86, no. 11, pp. 3405–3416, Nov. 2012,
9. M. C. Skaff, L. Gosselin: Summer performance of ventilated windows with absorbing or smart glazings, Solar Energy, Volume 105, July 2014, Pages 2–13,
10. B. P. Jelle, A. Hynd, A. Gustavsen, D. Arasteh, H. Goudey, R. Hart, Fenestration of Today and Tomorrow: A State-of-the-Art Review and Future Research Opportunities. Solar Energy Materials and Solar Cells. vol. 96 (1). 2012,
11. S. Grynning, A. Gustavsen, B. Time, B. P. Jelle, Windows in the Buildings of Tomorrow; Energy Losers or Energy Gainers?. Energy and Buildings. vol. 61. 2013,
12. G. van Moeseke, I. Bruyère, A. De Herde, Impact of control rules on the efficiency of shading devices and free cooling for office buildings, Original Research Article, Building and Environment, Volume 42, Issue 2, February 2007, Pages 784-793,
13. E.S. Lee, D.L. DiBartolomeo, S.E. Selkowitz, Thermal and daylighting performance of an automated Venetian blind and lighting system in a full-scale private office, Energy and Buildings 29 (1998) 47–63.
14. A. Tzempelikos, H. Shen, Comparative control strategies for roller shades with respect to daylighting and energy performance, Original Research Article, Building and Environment, Volume 67, September 2013, Pages 179-192,
15. DOE. 2012. Residential Prototype Building Models. U.S. Department of Energy, Energy Efficiency and Renewable Energy, Office of Building Technologies. http://www.energycodes.gov/development/residential/iecc_models,
16. Energy Savings from Window Attachments, October 2013, Lawrence Berkeley National Laboratory,
17. H. Henderson, The Impact of Part Load Air Conditioner Operation on Dehumidification Performance: Validating a Latent Capacity Degradation Model, Presented at IAQ & Energy 1998. New Orleans, LA. October 1998,
18. ICC IECC (2012): International Energy Conservation Code (January 1, 2012),
19. LBNL. 2013. WINDOW 7.1: A PC Program For Calculating Thermal and Optical Performance of Windows, 2013, Lawrence Berkeley National Laboratory,
20. J. H. Klems, A New Method for Predicting the Solar Heat Gain of Complex Fenestration Systems: I. Overview and Derivation of the Matrix Layer Calculation. ASHRAE Trans. 100(pt.1): 1073-1086. 1994,
21. J. H. Klems, A New Method for Predicting the Solar Heat Gain of Complex Fenestration Systems: II. Detailed Description of the Matrix Layer Calculation. ASHRAE Trans. 100(pt.1): 1073-1086. 1994
22. EnergyPlus version 8.0 Engineering Reference. U.S. Department of Energy.

23. R. Hart, C. Kohler, S. Selkowitz, C. Curcija, Highly insulating Residential Windows Using Smart Automated Shading, Lawrence Berkeley National Laboratory, September 30 2013,
24. Energy Savings from Window Attachments, October 2013, Lawrence Berkeley National Laboratory,
25. R. Hart, C. Kohler, S. Selkowitz, C. Curcija, Highly insulating Residential Windows Using Smart Automated Shading, Lawrence Berkeley National Laboratory, September 30 2013,
26. G. Kim, H. S. Lim, T. S. Lim, L. Schaefer, J. T. Kim, Comparative advantage of an exterior shading device in thermal performance for residential buildings, Original Research Article, Energy and Buildings, Volume 46, March 2012, Pages 105-111,
27. National Fenestration Rating Council. 2010. NFRC-100-2010E0A1. Procedure for Determining Fenestration Product U-factors,
28. DRI. 2013. Residential Windows and Window Coverings: A Detailed View of the Installed Base and User Behavior, D&R International, Ltd. Silver Spring, MD. February 2013,
29. ISO 15099:2003 Thermal performance of windows, doors and shading devices - Detailed calculations,
30. Directive 2010/31/EU of the European Parliament and of the Council of 19 May 2010 on the energy performance of buildings (recast),
31. J. S. Bourrelle, I. Andresen, A. Gustavsen, Energy payback: An attributional and environmentally focused approach to energy balance in net zero energy buildings. Energy and Buildings. vol. 65. 2013,
32. Directive 2012/27/EU of the European Parliament and of the Council of 25 October 2012 on energy efficiency,
33. M. Sourbron , R. De Herdt, T. Van Reet, W. Van Passel, M. Baelmans, L. Helsén, Efficiently produced heat and cold is squandered by inappropriate control strategies: A case study; Energy and Buildings 41 (2009) 1091–1098,
34. M. Sourbron, L. Helsén; Evaluation of adaptive thermal comfort models in moderate climates and their impact on energy use in office buildings; Energy and Buildings 43 (2011) 423–432.