

# Lawrence Berkeley National Laboratory

## Lawrence Berkeley National Laboratory

### **Title**

Microgrids: An emerging paradigm for meeting building electricity and heat requirements efficiently and with appropriate energy quality

### **Permalink**

<https://escholarship.org/uc/item/54b7r66j>

### **Authors**

Marnay, Chris  
Firestone, Ryan

### **Publication Date**

2007-04-10

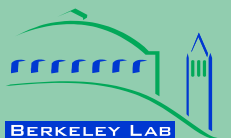

## ERNEST ORLANDO LAWRENCE BERKELEY NATIONAL LABORATORY

---

# Microgrids: An emerging paradigm for meeting building electricity and heat requirements efficiently and with appropriate energy quality

*Chris Marnay and Ryan Firestone*

Environmental Energy  
Technologies Division

**April 2007**

[http://eetd.lbl.gov/ea/EMS/EMS\\_pubs.html](http://eetd.lbl.gov/ea/EMS/EMS_pubs.html)

*Paper to be presented at the European Council for an Energy Efficient Economy 2007 Summer Study, La Colle sur Loup, France, 4-9 June 2007.*

The work described in this report was funded by the Office of Electricity Delivery and Energy Reliability, Distribution System Integration Program of the U.S. Department of Energy under Contract No. DE-AC02-05CH11231.

## **Disclaimer**

This document was prepared as an account of work sponsored by the United States Government. While this document is believed to contain correct information, neither the United States Government nor any agency thereof, nor The Regents of the University of California, nor any of their employees, makes any warranty, express or implied, or assumes any legal responsibility for the accuracy, completeness, or usefulness of any information, apparatus, product, or process disclosed, or represents that its use would not infringe privately owned rights. Reference herein to any specific commercial product, process, or service by its trade name, trademark, manufacturer, or otherwise, does not necessarily constitute or imply its endorsement, recommendation, or favoring by the United States Government or any agency thereof, or The Regents of the University of California. The views and opinions of authors expressed herein do not necessarily state or reflect those of the United States Government or any agency thereof, or The Regents of the University of California.

Ernest Orlando Lawrence Berkeley National Laboratory is an equal opportunity employer.

# Microgrids: An emerging paradigm for meeting building electricity and heat requirements efficiently and with appropriate energy quality

Chris Marnay  
Berkeley Lab MS 90R4000  
1 Cyclotron Rd  
BERKELEY CA 94720-8136  
U.S.A.  
Email: [C\\_Marnay@lbl.gov](mailto:C_Marnay@lbl.gov)

Ryan Firestone  
Berkeley Lab MS 90R4000  
1 Cyclotron Rd  
BERKELEY CA 94720-8136  
U.S.A.  
Email: [RMFirestone@lbl.gov](mailto:RMFirestone@lbl.gov)

## Keywords

combined cooling, heating and power, commercial buildings, community energy systems, microgrids, engine generators, gensets, on-site generation, photovoltaic, power quality and reliability

## Abstract

The first major paradigm shift in electricity generation, delivery, and control is emerging in the developed world, notably Europe, North America, and Japan. This shift will move electricity supply away from the highly centralised universal service quality model with which we are familiar today towards a more dispersed system with heterogeneous qualities of service. One element of dispersed control is the clustering of sources and sinks into semi-autonomous *μgrids* (microgrids). Research, development, demonstration, and deployment (RD3) of *μgrids* are advancing rapidly on at least three continents, and significant demonstrations are currently in progress. This paradigm shift will result in more electricity generation close to end-uses, often involving combined heat and power application for building heating and cooling, increased local integration of renewables, and the possible provision of heterogeneous qualities of electrical service to match the requirements of various end-uses. In Europe, *μgrid* RD3 is entering its third major round under the 7<sup>th</sup> European Commission Framework Programme; in the U.S., one specific *μgrid* concept is undergoing rigorous laboratory testing, and in Japan, where the most activity exists, four major publicly sponsored and two privately sponsored demonstrations are in progress. This evolution poses new challenges to the way buildings are designed, built, and operated. Traditional building energy supply systems will become much more complex in at least three ways: 1. one cannot simply assume gas arrives at the gas meter, electricity at its meter, and the two systems are virtually independent of one another; rather, energy conversion, heat recovery and use, and renewable energy harvesting may all be taking place simultaneously within the building energy system; 2. the structure of energy flows in the building must accommodate multiple energy processes in a manner that permits high overall efficiency; and 3. multiple qualities of electricity may be supplied to various building functions.

## Introduction

This paper examines the role of the *μGrid* (microgrid) paradigm in revolutionising the current universal centralised model of electricity generation and delivery. Then it provides a survey of several international research projects that pioneer research, development, demonstration, and deployment (RD3) of *μgrid* concepts as an alternative approach to integrating small-scale (< 1 MW) distributed energy resources (DER) into commercial buildings with peak electrical loads of less than about 2 MW or into multi-family buildings or housing estates. A *μgrid* is a grouping of generating sources and loads operating semi-independently of the legacy power system, or *macrogrid*, typically interconnected at a single point of common coupling (PCC). The *μgrid* may include traditional reciprocating engine generators (gensets), microturbines, fuel cells, photovoltaic modules (PV) or other small-scale renewables, heat recovery from thermal generation and use, electrical and heat storage devices, and controllable end-use loads. Three likely *μgrid* features are: 1. efficiently meeting total system energy requirements, often by including combined heat

**paper to be presented at the European Council for an Energy  
Efficient Economy 2007 Summer Study, La Colle sur Loup, France,  
4-9 June 2007**

and power (CHP) technology, especially for building heating and/or cooling, 2. providing heterogeneous levels of electricity security, quality, reliability and availability (SQRA) that match the requirements of various end-uses, thereby potentially lowering expectations for improvements in the macrogrid to meet the needs of a digital society, and 3. appearing to the macrogrid as a controlled entity, akin to a current local utility customer, or conversely akin to a small embedded generation source, if the  $\mu$ grid exports. The materials presented are based on presentations at a series of international symposiums held in the U.S. in 2005, in Canada in 2006, and a third in Nagoya, Japan, in April 2007. Materials from these events can be found at <http://der.lbl.gov>

## Dispersed Generation Paradigm Shift

Trends emerging in the power system suggest that the highly centralized paradigm that has dominated power systems for the last century may eventually be replaced, or at least diluted, by an alternative. In the new paradigm, control is more dispersed, and universal SQRA is replaced by heterogeneous service tailored to the requirements of highly diverse classes of end-uses. This shift may be thought of as comparable to the replacement of centralised computing by desk and laptop computers, or the switch from land based telecommunications to mobile devices. Our current power delivery paradigm has been in place worldwide for a long time, i.e. since the emergence of polyphase AC systems around the turn of the last century. SQRA targets are consistent virtually all across vast regions, e.g. all of North America, and where standards cannot be met, it is usually the result of a local technical difficulty and not the outcome of a deliberate attempt to deviate from the norm. Emerging changes on the demand-side include our seemingly unquenchable thirst for electricity, in large part driven by the increasingly dominant role of commercial building use in post-industrial economies, by an emerging digital age that is significantly tightening our SQRA requirements, by the emergence of viable small-scale fossil generation often with power electronics and CHP, and by an urgent need to incorporate small-scale renewable generation to abate carbon emissions. Meanwhile, on the supply-side, concerns about terrorism, restrictions on system expansion, and the uncertainties of volatile markets in energy-short times bring our ability to maintain current SQRA standards into doubt.

## Two Visions of the Future Grid

Two alternative visions in current currency of how the power system might be retooled to provide high SQRA are a *supergrids* view and a *dispersed* paradigm. These are obviously only two of many possible paths and full justice cannot be given here to the technical intricacies of any specific vision. The intent is only to contrast in a comprehensible way the central theme of two divergent alternatives. For more detail on a supergrids view, see Gellings *et al* (2004), Amin (2005), or Amin and Wollenberg (2005). A comprehensible vision for a dispersed grid is presented by the European Commission (2006), or, for other voices from the dispersed camp, see Lasseter (2006) or Marnay and Venkataramanan (2006), but these are by no means the only contributors to this ongoing debate.

### Supergrids Vision

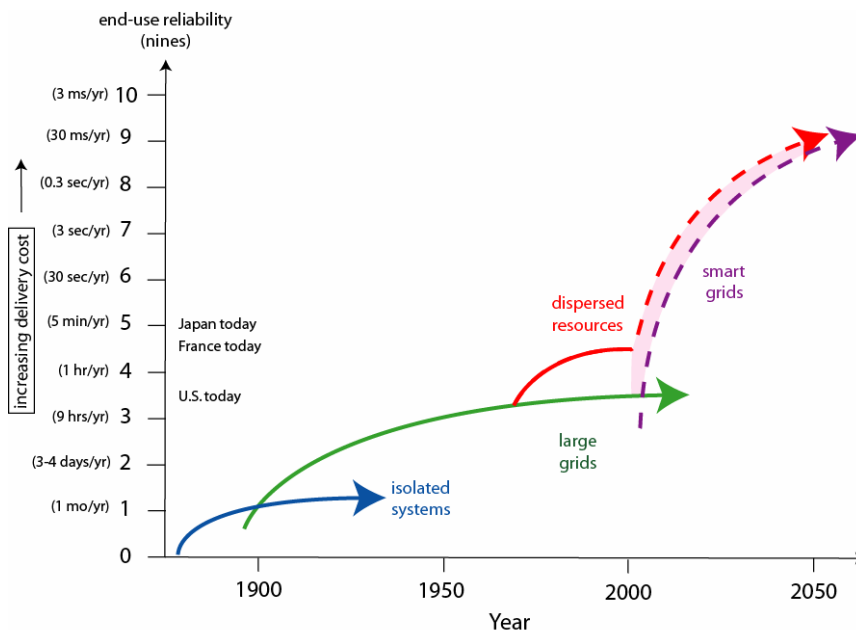
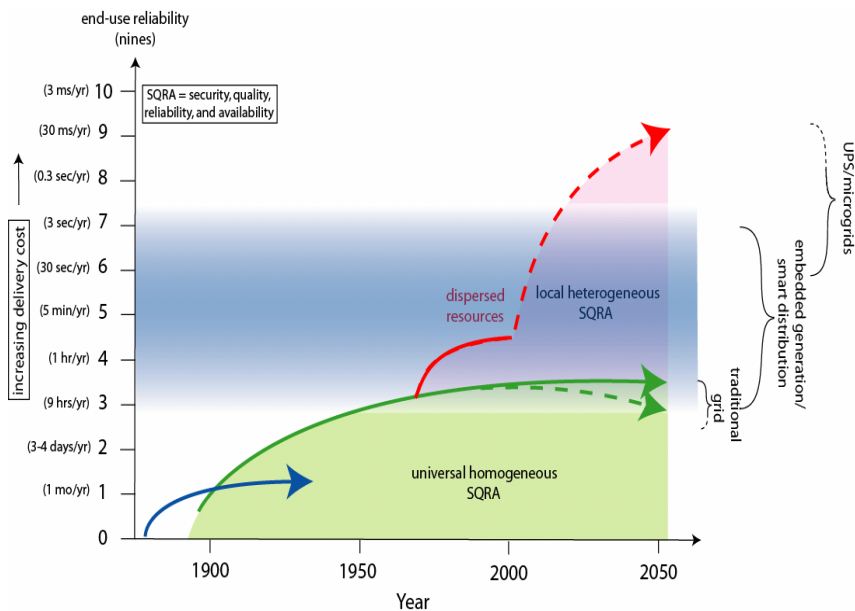

**Figure 1. Schematic of a Supergrids Vision**

A supergrids vision is shown in Figure 1. The x-axis of Figure 1 shows the history of the current centralised paradigm, and the y-axis reliability expresses as nines, e.g. 3 nines implies 99.9% availability. The equivalent annual expected outage times are shown for reference. The SQRA of delivered electricity has multiple dimensions, e.g. voltage swells and sags, harmonic distortion, etc. Reliability is used here as a representative dimension because it is much more easily comprehended than others, and we have some intuitive sense of its historical trajectory, as shown. In the early days of centralized power systems, electricity was supplied by small local stations with only very few generators to a limited number of customers, in the very early days using DC. These highly unreliable systems were consolidated by ones covering large areas based on Nikola Tesla's concepts for large-scale AC systems. This interconnection naturally improved reliability because many more generators were simultaneously available. The green arrow shows how this process, together with significant and steady technological progress, resulted in steadily improving reliability, reaching the levels experienced in North America today; however, note that reliability is considerably better in western Europe, and better still in some Asian countries, notably Japan. The red arc reflects the great concern in North America following the huge New York blackouts of the 1970s that backup gensets or other emergency sources be provided to critical loads, and such requirements became embedded in building codes. Thus, over the last quarter century or so, a separate higher reliability service has been introduced by installing generation close to sensitive loads.

The supergrids camp holds that deployment of diverse suites of new technologies can significantly improve the performance of all elements of power systems built around the traditional paradigm; i.e., delivered SQRA can be dramatically improved within the existing framework. In the schematic, this is shown by the arcing curves into the future. While much of the improvement inevitably must come in the distribution system because most outages and power quality problems occur there, over 90% of interruptions in the case of North America. Distribution represents the most vulnerable link in the delivery chain because of its sheer size and dispersion, as well as its exposure to the myriad hazards of extreme weather, accidents, and mischief. Even in the supergrids view, inevitably there will be end-uses that require SQRA beyond even the performance of the much enhanced delivery chain, but these can be kept to a minimum; i.e., the gap between dashed curves can be kept small. This vision imagines massive investments in new technologies for electricity delivery, such as superconducting lines, etc.

**Dispersed Grid Vision**



**Figure 2. Schematic of a Dispersed Vision**

In this view, traditional universal service upstream of the substation is not improved significantly but rather holds steady at current levels, as seen in Figure 2 as *universal homogeneous SQRA*. In other words, operation of the high voltage transmission system and everything upstream of it are operated as now, with similar rules and conventions, and similar SQRA standards. Sensitive loads are then increasingly served locally in two ways: first, improvements

**paper to be presented at the European Council for an Energy Efficient Economy 2007 Summer Study, La Colle sur Loup, France, 4-9 June 2007**

in the distribution system are deployed to improve on the existing system's weakest link; and second, widespread use of supply and other resources close to sensitive loads protect them at the levels they demand. This is shown in the figure as *local heterogeneous SQRA*. In other words, end-uses are serviced with SQRA tailored to their requirements. In a sense, this vision is one of increasingly heterogeneous SQRA downstream in the power system. The traditional universal SQRA is retained in the high voltage meshed grid, but the distribution network has differing levels of investment in equipment to enhance SQRA, and finally within customer sites, SQRA is ultimately matched to end-uses by means of segregated circuits or by provision of high quality service at the point of end-use, either by microgrids or power conditioning equipment. In this dispersed paradigm,  $\mu$ grids enter in two ways, as coordinated groupings within the distribution network that can operate semi-autonomously of the high voltage meshed grid upstream of substations, and downstream of the meter where sources and sinks are organized to jointly provide heat and electrical energy, as well as heterogeneous SQRA.

## Europe

Early  $\mu$ grid RD3 in Europe occurred within the 5<sup>th</sup> Framework Programme (1998-2002). A Consortium led by the National Technical University of Athens (NTUA) included 14 partners from 7 EU countries, including utilities, e.g. Électricité de France, equipment manufacturers, e.g. the German power electronics company SMA, and research institutions and universities, e.g. Labein. The main objectives were to study high renewable and other microsource penetration into the grid,  $\mu$ grid islanding operation, and  $\mu$ grid controls. Several levels of centralized and decentralized control were explored at several laboratories, notably the Institut für Solare Energieversorgungstechnik at the University of Kassel, the University of Manchester, and the National Technical University of Athens. A follow up project was completed within the 6<sup>th</sup> Framework Programme (2002-2006), again led by NTUA but with a somewhat different, although diverse, group of partners. This effort focused on new micro-sources, storage, and control. There was also considerable effort on network design, protocols, and the benefits and costs of  $\mu$ grids (Hatzigiorgiou 2006). A new round of projects will soon begin under the 7<sup>th</sup> Framework.

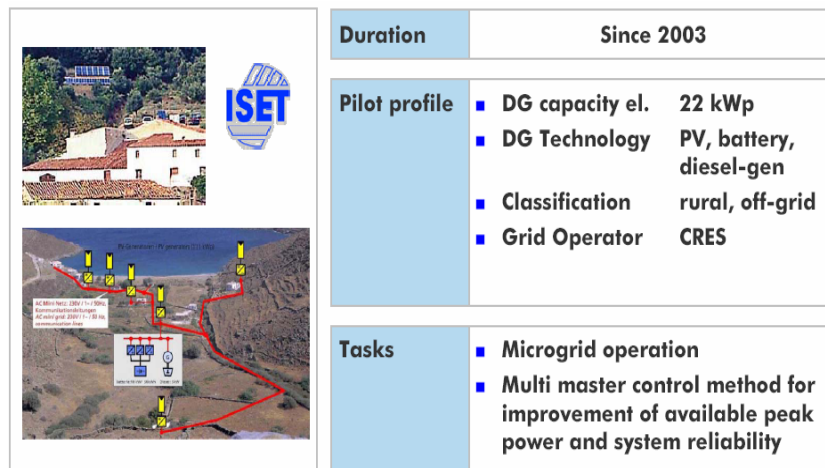

**Figure 3. The Kythnos Microgrid**

Several pilot  $\mu$ grid installations have been completed. As shown in Figure 3, twelve houses in a small valley on Kythnos Island in the Cyclades Archipelago of Greece are supplied by a  $\mu$ grid composed of 10 kW of PV, a 53 kWh battery bank, and a 5 kW diesel genset. The  $\mu$ grid includes 3 SMA3.6 kW inverters connected in parallel to form one strong single-phase circuit in a master slave configuration. The most innovative aspect of this system is that the battery inverters operate in frequency droop mode without fast electrical controls. This approach passively allows information flow to  $\mu$ grid devices, in a manner similar to the Consortium for Electric Reliability Technology Solutions (CERTS) approach used in the U.S. demonstration, described below (Engler 2006/7).

A second demonstration has been conducted at the Continuum holiday camp in the Netherlands, which has more than 200 cottages equipped with a total of 315 kW of PV modules, interconnected by inverters. The cottages are connected to a distribution transformer through four feeders, each about 400 m. Using a power electronic flexible AC distribution system and storage, islanded operation of the  $\mu$ grid and power quality control will soon be tested. A third project in Germany, shown in Figure 4, at the 400-inhabitant Am Steinweg residential estate has 69 kW of DER including a 28 kW CHP plant, 35 kW of PV, and an 880 Ah battery bank. Other projects include an ecological estate in Mannheim-Wallstadt, as shown in Figure 4, and projects in Denmark, Portugal, Spain, and Italy. In

**paper to be presented at the European Council for an Energy Efficient Economy 2007 Summer Study, La Colle sur Loup, France, 4-9 June 2007**

addition to these EC projects, relevant European demonstrations are also being conducted at the national or local government levels.

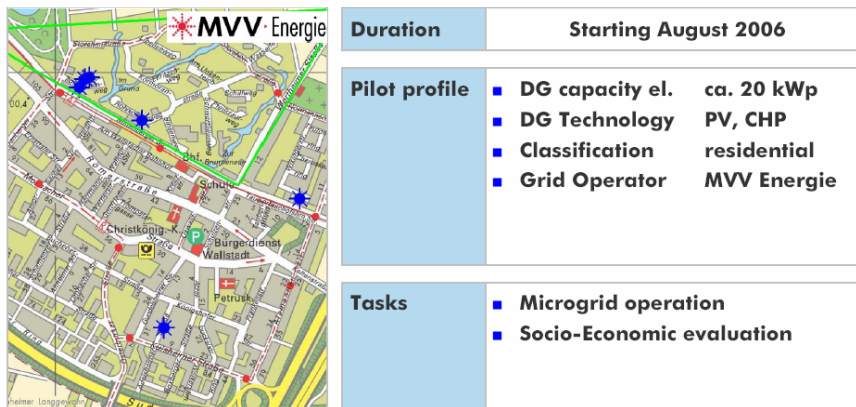

**Figure 4. Mannheim-Wallstadt Microgrid**

### North America

The U.S. has a slowly expanding  $\mu$ grid research program, supported both by the U.S. Department of Energy under the Office of Electricity Delivery and Energy Reliability, and by the California Energy Commission through its Public Interest Energy Research Program. The most well known effort has been pursued under the Consortium for Electric Reliability Solutions (CERTS, <http://certs.lbl.gov>), which was established in 1999 to explore implications for power system reliability of emerging technological, economic, regulatory-institutional, and environmental influences. From its inception, the likely emergence of DER was recognized as an important factor affecting reliability, and it has consistently been a feature of the CERTS RD3 portfolio.

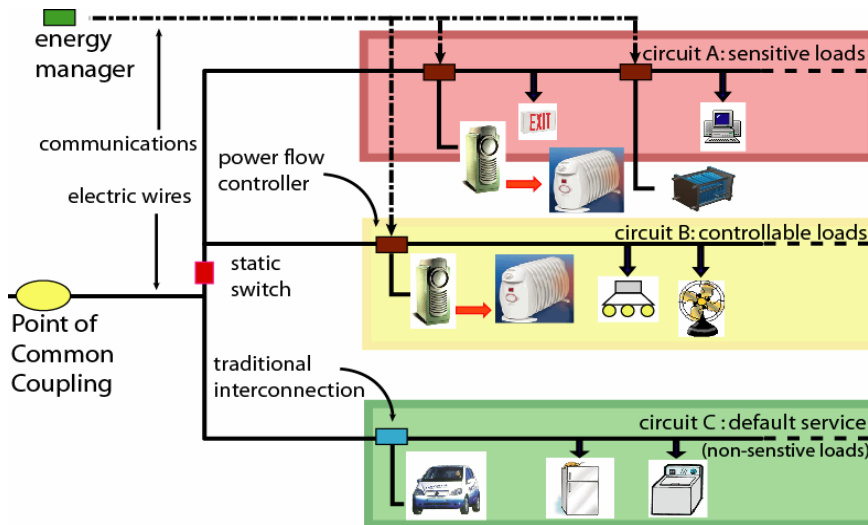

**Figure 5 Schematic of the CERTS Microgrid**

The specific concept of the CERTS Microgrid (CM) shown in Figure 5 was fully developed by 2002, and was described in a white paper presented at a CEC workshop on 2 May 2002, after which building physical examples was undertaken (Lasseter *et al* 2003). As with most  $\mu$ grid paradigms, the CM is intended to seamlessly separate from normal utility service at a single *point of common coupling* (PCC) during a disruption and continue to serve its critical internal loads until acceptable utility service is restored. As in the Kythnos demonstration, the CM provides this function for relatively small sites without need for costly fast electrical controls or expensive site specific engineering. Unlike Kythnos, no single device is essential for operation, creating a robust system. To the utility, the CM appears as a single controlled load, and it is *explicitly designed to provide heterogeneous SQRA* as varying



**paper to be presented at the European Council for an Energy  
Efficient Economy 2007 Summer Study, La Colle sur Loup, France,  
4-9 June 2007**

reliability on circuits. In the event of a grid disturbance, a static switch opens and the CM serves critical loads in islanded operation until grid power is again adequate, and reconnection occurs. This switching technology is critical to the CM and many other  $\mu$ grid concepts, and has been the focus of intensive RD3 in the past few years (Lynch, et al, 2006). Several technologies are available for fast switching, but at considerable cost. The CM is also a *dispersed plug-and-play system*, i.e. no custom engineering is required for interconnection of any single device, as long as it has CM capability, making system configuration flexible and variable. Sources may not only be spread across circuits, they may be physically placed around the site, quite possibly co-located with convenient heat sinks that offer economically attractive CHP opportunities. Finally, the CM has *generic slow controls*. The CM is currently undergoing testing at the Dolan Technology Center in Columbus, OH, using three reciprocating engine gensets as prime movers, as shown in Figure 6. If this test is successful, a full-scale field demonstration will follow.

One notable feature of the CM project has been simultaneous RD3 into necessary tools for  $\mu$ grid deployment, other than the actual electrical hardware. Two major products of this unified approach are the  $\mu$ Grid Analysis Tool, under development at the Georgia Institute of Technology, and the Distributed Energy Resources Customer Adoption Model (DER-CAM) in use at Berkeley Lab and several other R&D facilities worldwide. DER-CAM is discussed further below. The CM is quite explicitly designed around CHP applications and hence analysis of CHP applications in buildings is a central part of the CERTS RD3 program.



**Figure 6. Layout of the CERTS Microgrid Test at the Dolan Technology Centre**

In Canada,  $\mu$ grid RD3 activities concentrate on the medium-voltage (25-170 kV) distribution network (Katiraei and Iravani 2007). For example, the Fortis, Alberta, distribution system is a grid-interface microgrid composed of a 25 kV distribution network that is normally connected to the substation. One approach to maintain the supply during substation maintenance periods or subsequent to faults in the main grid is to temporarily connect the distribution system to an alternative 25kV feeder. Another approach to supply the load is to form an island on either the entire or a portion of the distribution feeder, depending on adequate availability of power from local DER units. At a notable example in British Columbia, the Hydro Boston Bar system uses a planned islanding option.

## Japan

Worldwide,  $\mu$ grid RD3 is most active in Japan. To increase potential renewable energy harvesting near demand centres, Japan's  $\mu$ grid RD3 focuses on utilising controllable prime movers, such as natural or biogas fired gensets, to compensate for variable demand and local small-scale intermittent renewable supply. The New Energy and Industrial Technology Development Organisation (NEDO), the research funding arm of the Ministry of Economy, Trade and Industry, has started four demonstrations, as shown in Figure 7 (Funabashi and Yokoyama 2006).

**paper to be presented at the European Council for an Energy Efficient Economy 2007 Summer Study, La Colle sur Loup, France, 4-9 June 2007**

As shown in Figure 8, the first of Japan's  $\mu$ grid demonstration projects started during the 2005 World Exposition, using a combination of varied chemistry fuel cells, 270 kW and 300 kW Molten Carbonate Fuel Cells (MCFC), four 200 kW Phosphoric Acid Fuel Cells, and a 25 kW Solid Oxide Fuel Cell (SOFC). The MCFCs use a gas derived from wood waste and plastic bottles. Experimental intentional islanding has also been conducted. Recently, the system was permanently moved to the Central Japan Airport City in Nagoya, where it will supply a Tokoname City office and a sewage treatment plant using a private feeder.

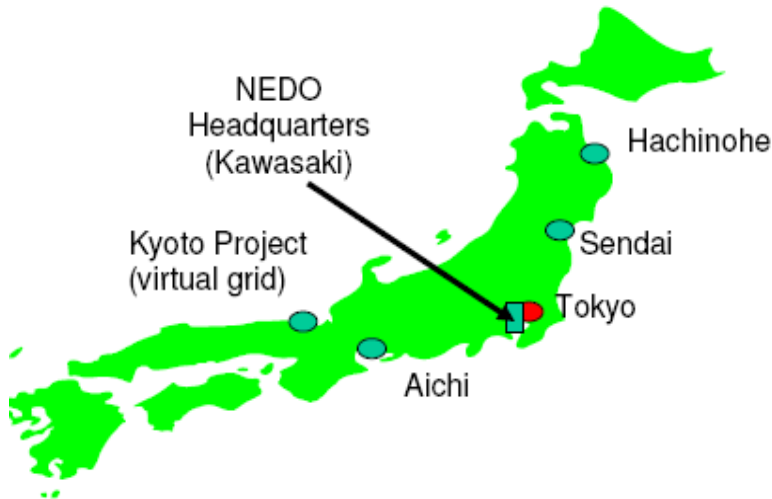

**Figure 7. Locations of the NEDO Microgrid Demonstration Projects**

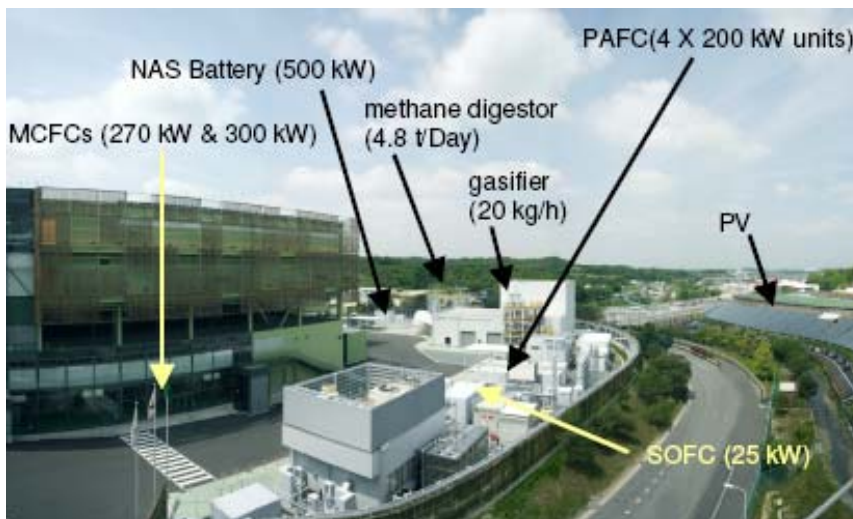

**Figure 8. The Aichi Microgrid Installed at the 2005 World Exposition**

The Hachinohe, Aomori Prefecture, project began operation in October 2005 and is being evaluated for SQRA, cost effectiveness, and carbon emissions reduction over its demonstration period stretching through March 2008. The  $\mu$ grid has PV and wind turbines totalling 100 kW, 510 kW of controllable engine gensets supplied by digester gas from a sewage plant, and a 100 kW lead-acid battery bank. Seven Hachinohe City buildings are supplied via a private 6 kV, 5.4 km distribution feeder, with the whole system connected to the commercial grid at a single point. Test islanding operation is also planned for this project.

In a third NEDO project, the municipal government of Kyotango City, north of Kyoto, leads a virtual  $\mu$ grid demonstration. The DER included are 50 kW each of PV and wind turbines, five 80 kW biogas engines, a 250 kW MCFC, and 100 kW of battery back-up. In this project, an energy centre communicates with the DER over the existing utility network to coordinate demand and supply. Imbalances between supply and demand are resolved within five minutes.

**paper to be presented at the European Council for an Energy  
Efficient Economy 2007 Summer Study, La Colle sur Loup, France,  
4-9 June 2007**

Finally, NEDO sponsors an ambitious and interesting multiple SQRA demonstration project in Sendai, Miyagi Prefecture, shown in Figure 9. This  $\mu$ grid demonstrates multiple SQRA on adjoining rest home, high school, university, and waste treatment facilities. The energy centre and a dedicated distribution line are connected at a single PCC. The main DER are a 250 kW MCFE, two 350 kW natural gas-fired gensets, 50 kW of PV, and batteries. These should be apparent in the figure. The lead organization for this project is NTT Facilities, an arm of Japan's telecom giant. Because of this industry's expertise in the high SQRA DC systems that have always powered telephone service worldwide, the Sendai demonstration features direct service to DC telecom loads. As well as DC, multiple qualities of standard AC service are delivered from the clean power building marked in the rear of the compound, creating an outstanding example of heterogeneous SQRA. In fact, this  $\mu$ grid supplies AC to the nearby buildings at *four* different service qualities. A premium quality A service for critical loads is never interrupted, and waveform correction is performed on it. When the utility grid has a momentary voltage sag or outage, the three B quality circuits receive SQRA. The B service is further subdivided into three different types. During outages, the higher quality B1 service is backed up by storage, while B2 is backed up by distributed power, i.e. slower responding backup, while B3 service is not backed up and experiences grid SQRA (Hirose et al 2006). Note the similarity between this arrangement and the multiple SQRA on the various circuits of the CM



**Figure 9. The Sendai Multiple SQRA Microgrid Demonstration**

In addition to the government-sponsored projects described above, there are significant research activities in Japan's private sector. Shimizu Corporation, a large construction company, is developing a  $\mu$ grid control system at its Tokyo test facility. Also, Tokyo Gas, together with the University of Tokyo, plans to establish a  $\mu$ grid to supply three-level power quality to a building of the Yokohama Research Institute.

## Building CHP

While this paper has focused on  $\mu$ grid demonstrations around the world, and primarily on their SQRA aspects, equally important from the buildings perspective is the CHP opportunities that  $\mu$ grids will create. The importance of the commercial sector in electricity consumption in developed countries can be seen by three multiplicative factors. 1. The share of all energy being consumed as electricity increases, e.g. in the U.S. from 13% in 1980 to about 20% today. 2. The commercial sector uses a growing share of all electricity, e.g. in the U.S. from 27% in 1990 to 35% in 2005. And 3., typically an increasing share of electricity is generated thermally as carbon-free hydro sources are fully exhausted, although the shares of carbon-free nuclear vary widely across grids. The product of these factors means the carbon footprint of commercial buildings can grow rapidly, but changes in the fuel mix, e.g. more natural gas fired generation, can also have a big effect. Further, in warm climates such as most of the U.S. and Japan, and for an increasing share of Europe, commercial sector cooling is a key driver of peak load growth, and hence the stress to and investment in the wider power system. Consequently, deployment of  $\mu$ grids to serve buildings, especially ones applying CHP technologies for cooling, is central to containing the growth of electricity consumption and its associated carbon emissions. DER-CAM has been developed as part of the CM RD3 project specifically to analyze the economics of building-scale  $\mu$ grids.

## DER-CAM

DER-CAM identifies optimal technology-neutral  $\mu$ grid investments and operating schedules at a given site, based on available equipment options and their associated capital and O&M costs, customer load profiles, energy tariff structures, and fuel prices. The Sankey (Spaghetti) diagram in Figure 10 shows partially disaggregated site end-uses on the right-hand side, and energy inputs on the left. As an example, the refrigeration and cooling load may be met in one of multiple ways, including standard electrically powered compressor cooling, direct fire or waste heat activated cooling, or direct engine powered compressor cooling. DER-CAM solves this entire problem optimally and systemically. Figure 11 shows a high level schematic of inputs to and outputs from the model.

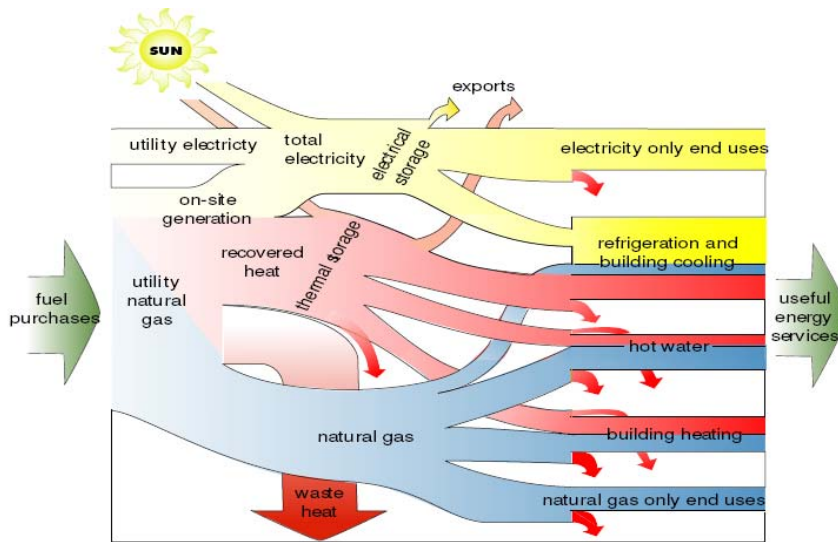

**Figure 10. Spaghetti Diagram of Energy Flows Through a Building**

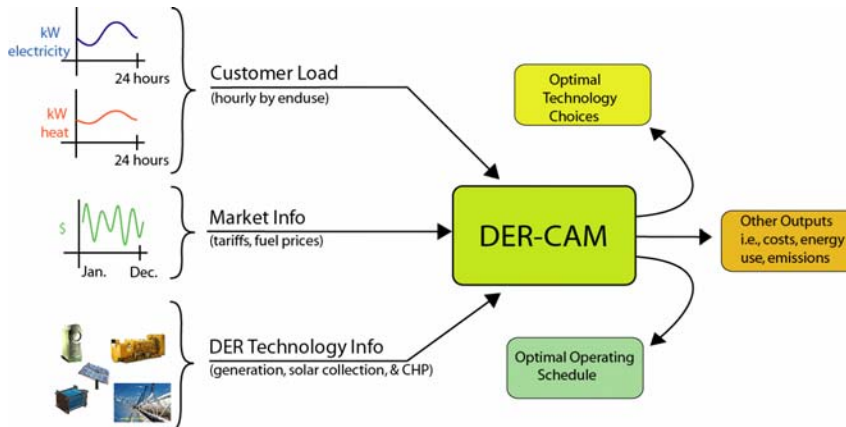

**Figure 11. Schematic of DER-CAM Data Inputs and Outputs**

As can be seen in Figure 11, DER-CAM picks its optimal combination of  $\mu$ grid equipment using hourly building end-use loads and careful consideration of the detailed tariffs the building faces. The choice of technologies can include a broad range of  $\mu$ grid technologies. DER-CAM is particularly suited to evaluating  $\mu$ grid CHP opportunities since it selects the optimal combination of investment options, fully taking their interdependence into account; e.g., if there is a trade-off between thermally activated cooling and on-site genset capacity, DER-CAM obtains the combination of the two that minimizes cost. Thus, optimal combinations of equipment involving PV, thermal generation with heat recovery, solar thermal collection, and thermally activated cooling can be identified in a way that would be intractable by trial-and-error testing of all possible combinations. However, DER-CAM currently has only very limited capabilities for evaluating the SQRA benefits of  $\mu$ grids. Such benefits can be considered only if a

known cost, e.g., added equipment performance, can be directly traded off against a known benefit. Work is currently under way to incorporate more SQRA capabilities.

### Example DER-CAM Analysis

Technology options in DER-CAM are categorized as either discretely or continuously sized to reflect how closely to the optimal installed  $\mu$ grids size is physically possible. This distinction is important to the economics of  $\mu$ grids because equipment typically becomes more expensive in small sizes. Discretely sized technologies are those which would be available to customers only in a limited number of sizes, and DER-CAM must choose an integer number of units, e.g., gensets. Continuously sized technologies are available in such a large variety of sizes that it can be assumed capacity close to the optimal could be acquired, e.g. battery storage.

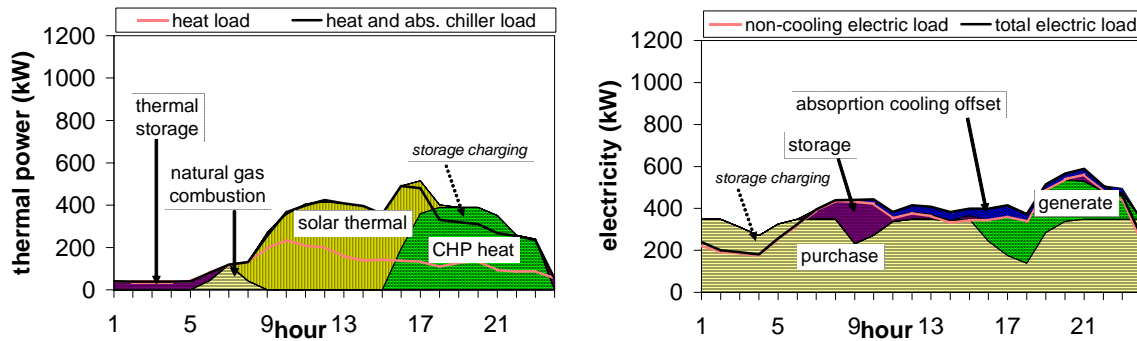

**Figure 12. Meeting Thermal and Electricity Loads On a January Day**

An example analysis was completed of a prototypical San Francisco hotel operating in 2004, under the tariffs of the Pacific Gas and Electric Company. This hypothetical facility has 23 000 m<sup>2</sup> of floor space and a peak electricity load of 690 kW. In this example, storage proved unattractive at current costs. To exercise the model, both avoidable electrical and thermal storage costs are set to zero plus an avoidable US\$40/kWh cost.<sup>1</sup>

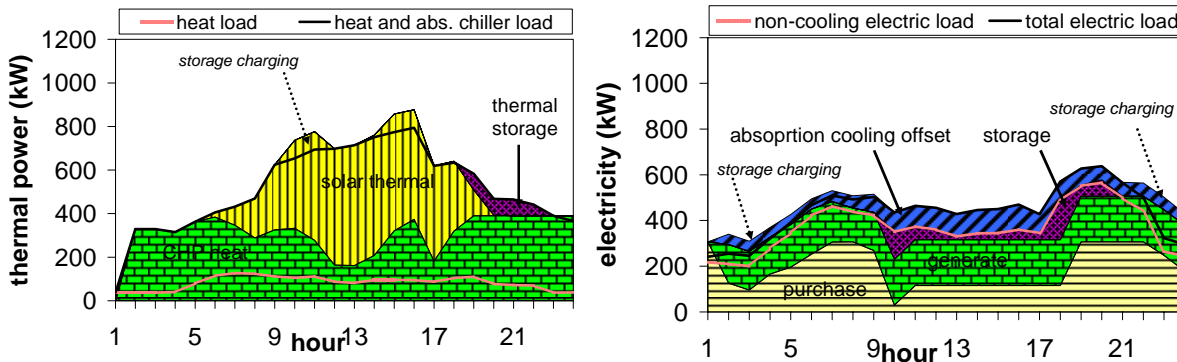

**Figure 13. Meeting Thermal and Electricity Loads On a July Day**

The chosen optimal system consists of a natural gas-fired genset, solar thermal collectors, an absorption chiller and both electrical and heat storage. Relative to a standard utility energy supply-only case, the expected annual savings for the optimal  $\mu$ grid are \$53 000/a (11.5%), and the elemental carbon emissions reduction is 59 t/a (10.4%). Note that utility electricity supply in San Francisco is relatively low carbon because of the preponderance of natural gas as the marginal generation fuel, which limits carbon savings from on-site generation. Figures 12 and 13 show example DER-CAM operating results for the thermal and electrical balances of the hotel on typical days in January and July 2004. Note that the optimal technologies are a 200 kW reciprocating engine, a 585 kW (166 refrigeration tons) absorption chiller, 722 kW of solar thermal collectors, 1100 kWh of electrical storage, and 299 kWh of

<sup>1</sup> At time of writing, 1 US\$ = 75 EUR cents

**paper to be presented at the European Council for an Energy  
Efficient Economy 2007 Summer Study, La Colle sur Loup, France,  
4-9 June 2007**

thermal storage. While the economics of this case are not compelling, even with heavily subsidized storage, it is presented in detail to demonstrate the scheduling capability of DER-CAM.

The area underneath the solid black line in these figures is the hourly energy demand. Area above the solid black line indicates storage charging. The various patterns in the graphs indicate the source of the energy. For electrical loads the lower profile indicates the portion of the electric load that can be met by only electricity, whereas the solid line above it is the total electric load, including cooling. Note that electric cooling loads can be offset by the absorption chiller. For thermal loads, the lower line indicates the heat required for heating, whereas the solid black line indicates the total thermal load, including heat required for the absorption chiller.

## Conclusions

Researchers worldwide are recognizing the promise of  $\mu$ grids to provide heterogeneous SQRA to serve sensitive loads, to improve energy efficiency by moving thermal generation close to possible uses. This would permit waste heat recovery and use, and better integration of small-scale dispersed renewables into the energy supply infrastructure. Nonetheless, it is also clear that development of  $\mu$ grid concepts and capabilities will require considerable RD3 resources, and efforts are currently underway, in Europe, North America, and Japan, intended to demonstrate  $\mu$ grid concepts, operation, and economic viability. Close cooperation and exchange of information among these disparate activities can deliver the most efficient RD3 agenda overall. The international Microgrids Symposia held so far have offered a highly beneficial forum for exchange of relevant research results. Further, coordinated joint RD3 efforts among the major countries are emerging and are expected to provide further mutual benefits in the historic effort to achieve the biggest paradigm shift in electricity generation and delivery in a century or so, one that can accelerate lowering the carbon footprint of electricity supply and simultaneously meet developed countries' growing requirements for high SQRA service.

This power supply evolution poses new challenges to the way buildings are designed, built, and operated. Traditional building energy supply systems will become much more complex in at least three ways. First, architects and building engineers cannot assume that as now gas will arrive at the gas meter, electricity at its meter, and within the structure, the two systems are virtually independent of one another. Rather, energy conversion, heat recovery and use, and renewable harvesting may all be taking place simultaneously at various locations within the building energy system. Second, the structure of energy flows in the building must accommodate multiple energy processes in a manner that permits high overall efficiency. In other words, the building must be designed around its energy flows and energy equipment to ensure efficiency. And third, multiple qualities of electricity may be supplied to various building functions, and their placement and supply must be considered.

DER-CAM, developed as part of the CERTS Microgrid RD3 programme is intended to permit economic analysis of possible building  $\mu$ grids. DER-CAM finds the optimal combination of equipment to install in a building-scale  $\mu$ grid, given the requirements for useful energy services in the building, the local economic environment, e.g. utility tariffs, and a menu of available equipment. This approach allows a quite new type of building energy analysis that directly delivers a desirable equipment choice taking the potential interactions between heat (including cooling) and on-site generating equipment into account.

## References

- Amin, Massoud, 2005, Powering the 21<sup>st</sup> Century: We Can and Must Modernize the Grid, IEEE Power & Energy Magazine, March-April 2005.
- Amin, Massoud and Bruce Wollenberg, 2005, Toward a Smart Grid, IEEE Power & Energy Magazine, September-October 2005.
- Engler, Alfred, 2006/2007, Applicability of Droops in Low Voltage Grids, International Journal of Distributed Energy Resources, special issue on microgrids, December-January.
- European Commission, 2006, European Smart Grids Technology Platform, Vision and Strategy for Europe's Electricity Networks of the Future, April.
- Funabashi, Toshihisa, and Ryuichi Yokoyama, 2006, Microgrid Field Test Experiences in Japan, paper presented at the IEEE Power Engineering Society General Meeting, Montréal, June.
- Gellings, Clark, Marek Smotyj, and Bill Howe, 2004, The Future's Smart Delivery System: Meeting the Demands for High Security, Quality, Reliability, and Availability, IEEE Power & Energy Magazine, September-October.

**paper to be presented at the European Council for an Energy  
Efficient Economy 2007 Summer Study, La Colle sur Loup, France,  
4-9 June 2007**

- Hatziargyriou, Nikos (ed.), 2006/2007, International Journal of Distributed Energy Resources, special issue on microgrids, December-January.
- Hirose, Keiichi. T. Takeda, and S. Muroyama, 2006, Study on Field Demonstration of Multiple Power Quality Levels System in Sendai, International Telecommunications Energy Conference, Rome, September.
- Katiraei, Farid, and Reza Iravani, 2007, Power Management Strategies for a Microgrid with Multiple Distributed Generation Units, paper TPWRD-00620-2005, accepted for publication in the IEEE Transactions on Power Systems.
- Lasseter, Robert, Abbas Akhil, Chris Marnay, John Stevens, Jeff Dagle, Ross Guttromson, A. Sakis Meliopoulos, Robert Yinger and Joe Eto, 2003, Integration of Distributed Energy Resources: The CERTS Microgrid Concept, CEC, P500-03-089F, October.
- Lasseter, Robert, 2006, Dynamic Distribution Using (DER): Distributed Energy Resources, paper presented at the IEEE Power Engineering Society T&D Meeting, Dallas, May.
- Lynch, Jonathan, V. John, S.M. Danial, E. Benedict, I. Vihinen, B. Kroposki, and C. Pink, 2006, Flexible DER Utility Interface System: Final Report, National Renewable Energy Laboratory, NREL/TP-560-39876, August.
- Marnay, Chris and Giri Venkataramanan, 2006, Microgrids in the Evolving Electricity Generation and Delivery Infrastructure,” paper presented at the IEEE Power Engineering Society General Meeting, Montréal, June.

## Acknowledgements

The work described in this report was funded by the Office of Electricity Delivery and Energy Reliability, Distribution System Integration Program of the U.S. Department of Energy under Contract No. DE-AC02-05CH11231, and by the California Energy Commission, Public Interest Energy Research Program, under Work for Others Contract No. 500-03-024. The author recognizes the significant contributions of the group that in part organized the Microgrids Symposiums and have provided much of the material used in this paper, Hiroshi Asano, University of Tokyo, Nikos Hatziargyriou, National Technical University of Athens, and Reza Iravani, University of Toronto. The author also thanks the many participants in the three completed Microgrids Symposiums. The paper also builds on prior work the author has completed together with Giri Venkataramanan, University of Wisconsin, Madison, Afzal S Siddiqui, University College, London, Michael Stadler, Center for Energy and Innovative Technologies, Yspertal, Austria, plus Kristina Hamachi LaCommare, and Judy Lai of Berkeley Lab.

## Glossary

AC	alternating current
Berkeley Lab	Ernest Orlando Lawrence Berkeley National Laboratory, Berkeley CA
CERTS	Consortium for Electric Reliability Technology Solutions
CHP	combined heat and power
CM	CERTS Microgrid
DC	direct current
DER	distributed energy resources
DER-CAM	DER Customer Adoption Model
genset	traditional reciprocating engine powered generator
ISET e.V.	Institut für Solare Energieversorgungstechnik, Kassel, Germany
kV	kilovolt
kW	kilowatt
MCFC	molten carbonate fuel cell
MW	megawatt
NAS	sodium-sulphur (battery)
NEDO	New Energy and Industrial Technology Development Organisation, RD3 branch of the Japan's economy ministry
NREL	National Renewable Energy Laboratory, Golden CO
NTT	Nippon Telegraph and Telephone Corp., the dominant Japanese telecom
NTUA	National Technical University of Athens
O&M	operating and maintenance
PAFC	phosphoric-acid fuel cell

**paper to be presented at the European Council for an Energy  
Efficient Economy 2007 Summer Study, La Colle sur Loup, France,  
4-9 June 2007**

PCC	point of common coupling
PV	photovoltaic
RD3	research, development, demonstration, and deployment
SMA	SMA Technologie AG, a power electronics manufacturer based in Niestetal, Germany
SOFC	solid oxide fuel cell
SQRA	security, quality, reliability, and availability