

Lawrence Berkeley National Laboratory

Lawrence Berkeley National Laboratory

Title

Development of an abort gap monitor for the large hadron collider

Permalink

<https://escholarship.org/uc/item/53z5x55x>

Authors

Beche, J.-F.

Byrd, J.

De Santis, S.

et al.

Publication Date

2004-07-01

DEVELOPMENT OF AN ABORT GAP MONITOR FOR THE LARGE HADRON COLLIDER*

J.-F. Beche, J. Byrd, S. De Santis, M. Placidi, W. Turner, M. Zolotarev,
LBNL, Berkeley, CA 94720, USA

Abstract

The Large Hadron Collider (LHC), presently under construction at CERN, requires monitoring the parasitic charge in the 3.3 ms long gap in the machine fill structure. This gap, referred to as the abort gap, corresponds to the raise time of the abort kickers magnets. Any circulating particle present in the abort gap at the time of the kickers firing is lost inside the ring, rather than in the beam dump, and can potentially damage a number of the LHC components. CERN specifications indicate a linear density of $6 \cdot 10^6$ protons over a 100 ns interval as the maximum charge safely allowed to accumulate in the abort gap at 7 TeV.

We present a study of an abort gap monitor, based on a photomultiplier tube with a gated microchannel plate, which would allow for detecting such low charge densities by monitoring the synchrotron radiation emitted in the dedicated diagnostics port. We show results of beam test experiments at the Advanced Light Source (ALS) using a Hamamatsu 5961U MCP-PMT, which indicate that such an instrument has the required sensitivity to meet LHC specifications.

INTRODUCTION

The LHC is characterized by a very high energy stored in its beams (up to 350 MJ/beam) and extensive use of superconducting magnets. Such magnets, as well as other sensitive components, can easily be damaged by even a very small fraction of the beam, should it be hitting them. A special beam dump line, capable to absorb such a high stored energy is placed along each ring together with dump extraction kicker magnets which can steer the entire beam to be lost in the dump in case of irregular operations. It is standard practice to leave a gap, longer than the abort kicker raise time, in the ring fill pattern to avoid dispersing particles on other machine components during the kicker firing. It is vital to assure that no particles accumulate in the gap since those would receive only a kick of reduced strength, when the dump system is activated, and would hit machine components. The maximum charge density admissible in the gap can be calculated taking into account the machine energy and the damage threshold of the most sensitive components. The abort gap needs then to be monitored continuously in order to dump the beam or activate gap clearing procedures in the event the safety threshold is reached.

Several phenomena can cause the gap to become populated: timing errors at injection; drifting of

unbunched particles; diffusion of particles between RF buckets; debunching due to glitches in the RF. The time scale of such phenomena is varied, going from practically instantaneous for injection errors to tens of thousands of turns for slow diffusion mechanisms.

In this paper we present a preliminary study of a simple instrument, based on a gated photomultiplier, suitable to be included in a ring's interlock chain. Experimental tests have been carried out at the Advanced Light Source and their results are also reported here

OUTLINE OF THE ABORT GAP MONITOR

The LHC design features a synchrotron light port, dedicated to transverse and longitudinal diagnostics, in the Insertion Region 4. A 5 T superconducting undulator and a separator magnet provide synchrotron radiation through two movable extraction mirrors. The characteristics of the photon flux provided at various energies and wavelengths are reported in [1].

CERN specifications [2] require an abort gap monitor to be able to detect a charge density of 60 p/ps over a 100 ns long portion of the abort gap at 7 TeV, with a 50% accuracy. At the injection energy of 450 GeV the requirement is relaxed due to the lower energy and the maximum allowable charge density in a 100 ns observation window is $4 \cdot 10^4$ p/ps. These numbers, together with the photon fluxes reported in [1], yield an estimated 3 photons/turn/0.1% bandwidth emitted by a 100 ns long uniform charge distribution of 60 p/ps in the 500 nm wavelength region at 7 TeV. The corresponding number of photons emitted at 450 GeV by the threshold charge density is ~ 1 photon/turn/0.1%.

The fundamental component of the instrument presented in this paper is a gated microchannel plate photomultiplier tube (MCP-PMT) which we use for measuring the synchrotron radiation emitted by the circulating particles. By selecting an appropriately long observation window and shifting it along the abort gap, it is possible to monitor the presence of particles continuously and to estimate their longitudinal density. Commercially available MCP-PMTs [3] are the ideal instrument for such a task due to their high gain, fast gate, low noise and variety of peak wavelength of their spectral response. Also the low voltage required for gating and their reduced dimensions (Fig.1) are other beneficial features that make the use of such a device particularly simple.

* Work supported by the U.S. Department of Energy under Contract No. DE-AC03-76SF00098.

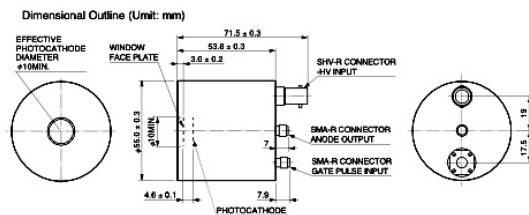

Figure 1. Hamamatsu gateable microchannel plate photomultiplier R5916U-50 Series.

The minimum gate width for our Hamamatsu R5916U-50 MCP-PMT is 5 ns, with a gate raise time of 1 ns. These numbers are entirely suitable for use in the LHC, where the sampling window is 100 ns and the distance between RF bucket is 2.5 ns, so that it is possible to gate out filled buckets nearby the abort gap.

Time resolution for the measurement is dominated by the Transit Time Spread (which can be estimated as equal to the Instrument Response Function). Figure 2 shows that for our device that is roughly equal to 100 ps, again well below our resolution requirements.

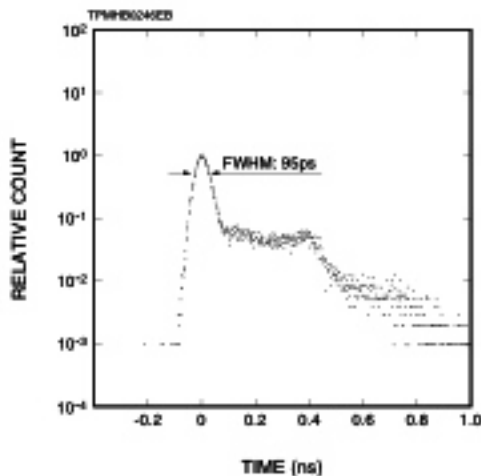

Figure 2. Instrument Response Function for the R5916U-50 MCP-PMT.

Given the device maximum duty factor of 1%, different strategies are possible for mapping the abort gap. The most immediate one is using a 100 ns gate width, which allows taking one measurement every turn. To cover the entire abort gap 33 such measurements are necessary, with the timing of the gate continuously shifted to move the observation window along the gap. The 100 ms allowable integration time, as per specification, permits to accumulate 34 measurements of each individual sample. The number of photons emitted in an integration time by a 100 ns portion of the abort gap, containing the average maximum allowable proton density, therefore goes from 100 at 7 TeV to 30 at 450 GeV in a 0.1% bandwidth centered at 500 nm.

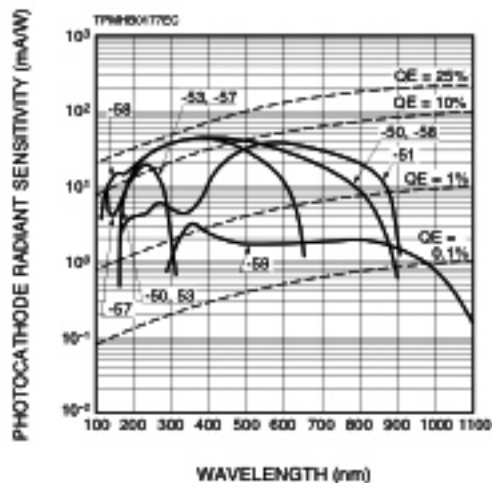

Figure 3. Sensitivity and constant quantum efficiency curves for different MCP-PMT models.

Figure 3 shows the spectral response for different models of the Hamamatsu tube available. Conservatively, we can assume a 5% quantum efficiency over a 10% bandwidth at 500 nm. This yields an integrated photon count in the $1.5\text{-}5 \cdot 10^3$ range, depending on the machine energy. This number can still be increased at the price of a marginally higher complexity in the MCP-PMT signal treatment. A 890 ns gate is the longest still allowing to take one measurement per turn. The information on individual 100 ns samples has to be extracted from this longer measurement, but we have seen that the tube has a far better resolution than required. With this gate width, the light from each 100 ns portion of the abort gap is sampled around 300 times in an integration time increasing the accumulated photon counts by almost a factor of 10.

With such high fluxes it is conceivable to use attenuate the light using a pinhole (which would also leave the synchrotron radiation available for other diagnostic instruments) and operate in single-photon counting mode with extremely low noise.

EXPERIMENTAL RESULTS AT THE ALS

Some parameters of the ALS storage ring make it a good place for testing a possible utilization of a MCP-PMT as an abort gap monitor for the LHC: similar distance between RF buckets and a gap length equal to the length of an LHC sample. The ALS ring also features a special high current bunch (referred to as *camshaft*) in the middle of its fill gap which is followed by very low current parasitic bunches due to diffusion of electrons from the camshaft into the following RF buckets. This is particularly interesting from the point of view of studying eventual saturation phenomena in the MCP-PMT, which could interfere with the detection of a low charge density next to a much larger one.

Our experimental station is at the ALS diagnostic beamline (BL 3.1) which uses the synchrotron radiation generated in a bending dipole (1.3 T).

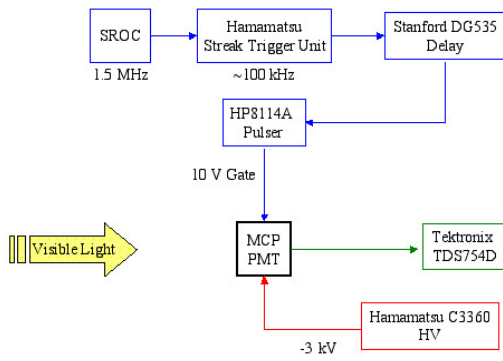

Figure 4. Block diagram of the experimental setup at the ALS.

Figure 4 shows the block diagram of our experimental setup at BL 3.1. The 10 V gating pulse, synchronized to the ring orbit clock (SROC), can be shifted around using a delay box and the internal pulser capabilities.

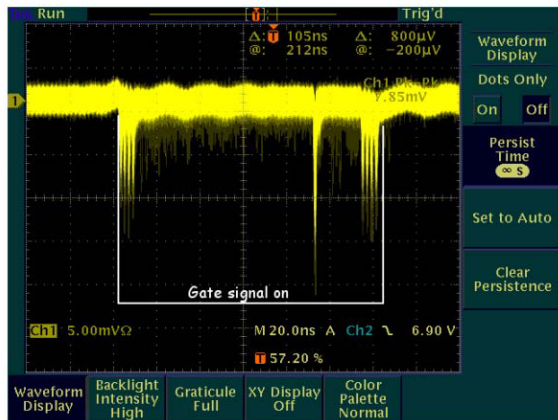

Figure 5. The 104 ns long ALS fill gap with camshaft.

Figure 5 shows an image of the entire ALS fill gap. Four regularly filled bunches can be seen at the beginning and at the end of the gap and the camshaft is the larger signal between them. This picture was obtained setting the oscilloscope on an infinite persistence time, so that we are indeed observing data accumulated over a very large number of turns.

Figure 6 gives an idea of the instrument time resolution. This image was taken with no averaging and individual bunches are easily resolved.

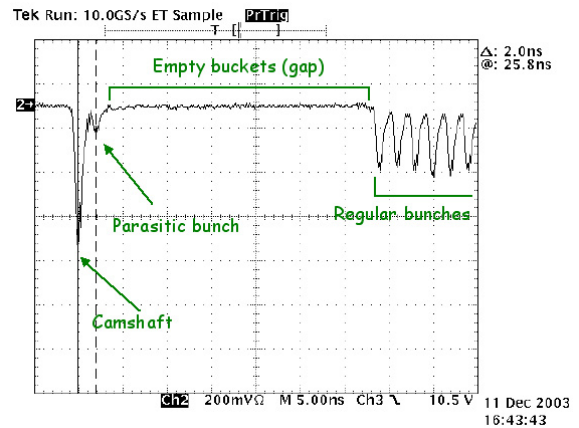

Figure 6. Image of the camshaft, trailing parasitic bunch and first 6 bunches of the ALS fill train. Averaging is off.

In Fig.7 we show how it is possible to detect very low intensity bunches simply by gating out nearby large signals. The two parasitic bunches after the first one (which is also visible in Fig.7a) shown in Fig.7b have an estimated population of roughly 1% of a regular bunch, showing that photocathode saturation is not an issue.

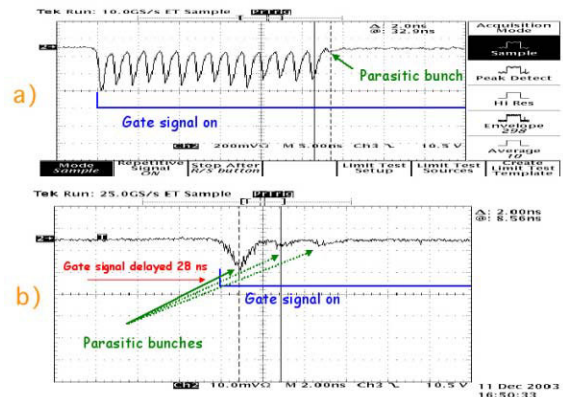

Figure 7. a) Beginning of the ALS gap and nearby 14 bunches. b) Filled RF buckets are gated out by shifting the gate signal

CONCLUSIONS

A MCP-PMT based abort gap monitor is a viable choice for the LHC. The simplicity of the scheme proposed makes it suitable to be included in the interlock chain and estimated photon counts satisfy the design specifications at both injection and collision energies.

REFERENCES

- [1] M. Facchini and R. Jung, "Longitudinal Diagnostics Mirror Configuration for the LHC Beam", AB-BI Note, April 3, 2003.
- [2] C. Fischer, LHC-B-ES-0005, 2003.
- [3] <http://www.hamamatsu.com>