

Lawrence Berkeley National Laboratory

LBL Publications

Title

The Path of Carbon in Photosynthesis .XXI. The Cyclic Regeneration of Carbon Dioxide Acceptor

Permalink

<https://escholarship.org/uc/item/4wk2f09j>

Authors

Bassham, J A

Benson, A A

Kay, Lorel D

et al.

Publication Date

1953-10-01

Copyright Information

This work is made available under the terms of a Creative Commons Attribution License, available at <https://creativecommons.org/licenses/by/4.0/>

UCRL 2369

UNCLASSIFIED

UNIVERSITY OF
CALIFORNIA

*Radiation
Laboratory*

TWO-WEEK LOAN COPY

This is a Library Circulating Copy
which may be borrowed for two weeks.
For a personal retention copy, call
Tech. Info. Division, Ext. 5545

BERKELEY, CALIFORNIA

DISCLAIMER

This document was prepared as an account of work sponsored by the United States Government. While this document is believed to contain correct information, neither the United States Government nor any agency thereof, nor the Regents of the University of California, nor any of their employees, makes any warranty, express or implied, or assumes any legal responsibility for the accuracy, completeness, or usefulness of any information, apparatus, product, or process disclosed, or represents that its use would not infringe privately owned rights. Reference herein to any specific commercial product, process, or service by its trade name, trademark, manufacturer, or otherwise, does not necessarily constitute or imply its endorsement, recommendation, or favoring by the United States Government or any agency thereof, or the Regents of the University of California. The views and opinions of authors expressed herein do not necessarily state or reflect those of the United States Government or any agency thereof or the Regents of the University of California.

UCRL-2369

Unclassified - Chemistry Distribution

UNIVERSITY OF CALIFORNIA

Radiation Laboratory

Contract No. W-7405- eng - 48

THE PATH OF CARBON IN PHOTOSYNTHESIS .XXI.
THE CYCLIC REGENERATION OF CARBON DIOXIDE ACCEPTOR

J. A. Bassham, A. A. Benson, Lorel D. Kay,
Anne Z. Harris, A. T. Wilson and M. Calvin

October, 1953

Berkeley, California

THE PATH OF CARBON IN PHOTOSYNTHESIS. XXI.

THE CYCLIC REGENERATION OF CARBON DIOXIDE ACCEPTOR

J. A. Bassham,* A. A. Benson, Lorel D. Kay,
Anne Z. Harris, A. T. Wilson and M. Calvin

Radiation Laboratory and Department of Chemistry
University of California, Berkeley, California**

October, 1953

ABSTRACT

Photosynthesizing plants have been exposed to $C^{14}O_2$ for short periods of time (0.4 to 15 sec.) and the products of carbon dioxide reduction analyzed by paper chromatography and radioautography.

Methods have been developed for the degradation of ribulose and sedoheptulose. These sugars, obtained as their phosphate esters from the above $C^{14}O_2$ exposures and from other experiments, have been degraded and their distribution of radiocarbon determined.

The distribution of radiocarbon in these sugars, and other data, indicate that sedoheptulose phosphate and ribulose diphosphates are formed during photosynthesis from triose and hexose phosphates, the latter being synthesized, in turn, by the reduction of 3-phosphoglyceric acid.

* This paper was presented before the Division of Biological Chemistry, American Chemical Society at the 124th National Meeting, Chicago, Illinois, September 1953.

** The work described in this paper was sponsored by the U. S. Atomic Energy Commission.

Further evidence has been found for the previously proposed carboxylation of ribulose diphosphate to phosphoglyceric acid. Free energy calculations indicate this step would proceed spontaneously if enzymatically catalyzed.

The efficiency of this cycle for reduction of CO_2 to hexose would be 0.9 if the reduction of each molecule of PGA requires the concurrent conversion of one molecule of ATP and one of DPN (red) to ADP, inorganic phosphate, and DPN (ox.). This mechanism, together with an assumed mechanism for the photolysis of water, would lead to an efficiency of about 0.5 for the overall photosynthetic reaction and a requirement of about six quanta of light per molecule of CO_2 reduced to carbohydrate.

THE PATH OF CARBON IN PHOTOSYNTHESIS. XXI.

THE CYCLIC REGENERATION OF CARBON DIOXIDE ACCEPTOR

J. A. Bassham, A. A. Benson, Lorel D. Kay,

Anne Z. Harris, A. T. Wilson and M. Calvin

Radiation Laboratory and Department of Chemistry
University of California, Berkeley, California¹

Previously reported tracer studies of the path of carbon in photosynthesis² led to the conclusion that carbon is incorporated by a carboxylation reaction leading to phosphoglyceric acid (PGA)³ which is then reduced and condensed to fructose and glucose phosphates by a series of reactions similar to a reversal of glycolysis. These conclusions were supported by the observations that when carbon-14 is administered to the photosynthesizing plant as C¹⁴O₂, the first radioactive compound isolated is carboxyl-labeled PGA, followed shortly by dihydroxyacetone phosphate (DHAP), fructose monophosphates (FMP) and glucose monophosphate (GMP), both hexoses being 3,4-labeled. After longer exposures of the plant to C¹⁴O₂, radiocarbon appears in other carbon atoms of PGA and hexose and the distribution of activity is in agreement with the above conclusions.

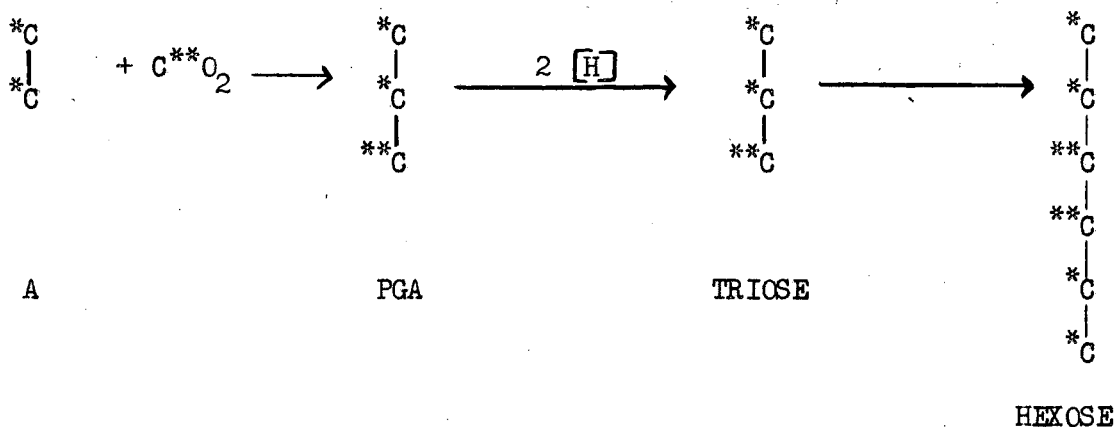

Observations on the rate and distribution of labeling of malic acid^{4,5,6} showed it to be the eventual product of a second carboxylation reaction which is accelerated during photosynthesis, and it was proposed that this second carboxylation played a part in the reduction of carbon in photosynthesis, leading eventually to the formation of the two-carbon CO₂ acceptor (A, above). Malic acid, itself, was apparently precluded as an actual intermediate by inhibition studies,⁷ but was thought to be an indicator of an unstable intermediate which was actually the first product of the second carboxylation. The discovery⁸ of rapidly labeled sedoheptulose monophosphate (SMP) and ribulose diphosphate (RDP) led to their inclusion in the proposed carbon reduction cycle leading to the two-carbon CO₂ acceptor.

The reciprocal changes in reservoir sizes of RDP and PGA observed when algae were subjected to light and dark periods⁹ indicated a close relationship, perhaps identity, between the RDP and the two-carbon CO₂ acceptor.

In order to test these conclusions, it was necessary to design experiments involving very short exposures of the plant to C¹⁴O₂. In some of these experiments, the C¹⁴ was administered during "steady state" photosynthesis, the environmental conditions (light, carbon dioxide pressure, etc.) being kept as nearly constant as possible for the hour preceding and the time during the experiment. Degradation methods have been developed for sedoheptulose and ribulose and complete distributions of radioactivity within these sugars obtained.

The results of these experiments seem to obviate the possibility that the second carboxylation reaction (leading to malic acid) is a step in carbon reduction during photosynthesis. Since no new evidence has been found for the second "photosynthetic" carboxylation, it would appear that a carbon reduction cycle involving only one carboxylation (leading to PGA) is more likely than the previously proposed two-carboxylation cycle.

Experimental Procedure

Short "Steady State" Experiments. — Algae (Scenedesmus obliquus) were grown under controlled conditions,⁵ centrifuged from the growth medium, and resuspended in a 1% by volume suspension in distilled water. This suspension was placed in a rectangular, water-jacketed illumination chamber 6 mm. thick, through which was passed a continuous stream of 4% CO₂-in-air. (Figure 1). From the bottom of the changer, a transparent tube led to a small transparent pump constructed of appropriately placed glass valves and two 5 cc. glass syringes mounted on a lever arm in such a position that the syringe plungers moved in and out reciprocally about 5 mm. when the lever arm was moved back and forth by a motor-driven eccentric. The output of the pump was divided, the major portion being returned to the illumination chamber and a smaller portion (20 ml./minute) forced to flow through a length of transparent "Transflex" tubing of about 1mm. diameter and thence into a beaker containing boiling methanol. This solvent was

found to have an apparent killing time of less than 0.2 sec. as determined by the cessation of carbon fixation during photosynthesis. The linear flow rate of algal suspension in the tube was about 57 cm./second. A solution of $C^{14}O_2$ in water (0.0716 M, 110 μ c./ml.) in a 30 cc. syringe was injected through a fine hypodermic needle into the Transflex tubing at a point a selected distance from the end of the tubing. From the known flow rate of algal suspension in the Transflex tubing and distance of flow from the point of injection of $C^{14}O_2$ to the killing solution, the time of exposure of the algae to C^{14} was calculated. The flow of the $C^{14}O_2$ -containing solution was controlled by driving the syringe plunger with a constant speed motor, and the flow rate was 0.5 ml./minute. The resultant dilution of the algal suspension was 2.5% and the increment in total CO_2 concentration less than 15%.

Since the flow of algal suspension in the tubing was not turbulent, some difference in rates of flow at the center and at the edge of the tubing was unavoidable. The extent of this difference was approximately determined by injecting a concentrated dye solution for about 0.5 sec. through the hypodermic needle while the flow rate in the tubing was 20 ml./minute and observing the spreading of color during its travel through the tubing. For the longest length of tubing used, the dye was seen to reach the end of the tubing between 14 and 17 seconds, and at a shorter time between 9 and 11 seconds, so that the spread of flow in time appeared to be about 20% of the flow time. The times given are average times of exposure of the algae to C^{14} . Use of the dye also permitted observation of the mixing of $C^{14}O_2$ solution with algal suspension and mixing time appeared to be about 0.2 sec.

The entire apparatus was illuminated from each side by a nine-tube bank of 40-watt fluorescent lights (white) giving a uniform intensity of about 2000

footcandles from each side. During an experiment the algal suspension was illuminated for an hour or more with 4% CO₂ before the start of the flow C¹⁴ exposures. Exposures to C¹⁴O₂ ranging from 1.0 to 16 sec. were then carried out and the products of C¹⁴O₂ reduction analyzed in the usual way¹⁰ by paper chromatography and radioautography.

Short Soy Bean Experiments. -- A single excised trifoliate leaf from a soy bean plant (var. Hawkeye) was placed in a circular flat illumination chamber with a detachable face. The chamber was equipped with two tubes, the lower one leading through a stopcock to an aspirator and the upper one through a two-way stopcock to a loop containing C¹⁴O₂. A loosely tied thread led from the leaf stem under the detachable face gasket, thence through a boiling ethanol bath and a glass tube to a weight. The illumination chamber was partially evacuated, both stopcocks were closed, and clamps removed from the chamber, the detachable face remaining in position through atmospheric pressure. With the opening of the upper stopcock, the C¹⁴O₂ was swept into the chamber by atmospheric pressure, the detachable face fell off and the leaf was pulled into boiling ethanol. An estimated exposure time of 0.4 sec. was obtained. The radioactive products were extracted and analyzed in the usual way. In other experiments, longer exposure times were obtained by holding the detachable face in position.

Degradation of Sugars. -- The reactions used for the degradation of the radioactive ribulose and sedoheptulose are as follows:

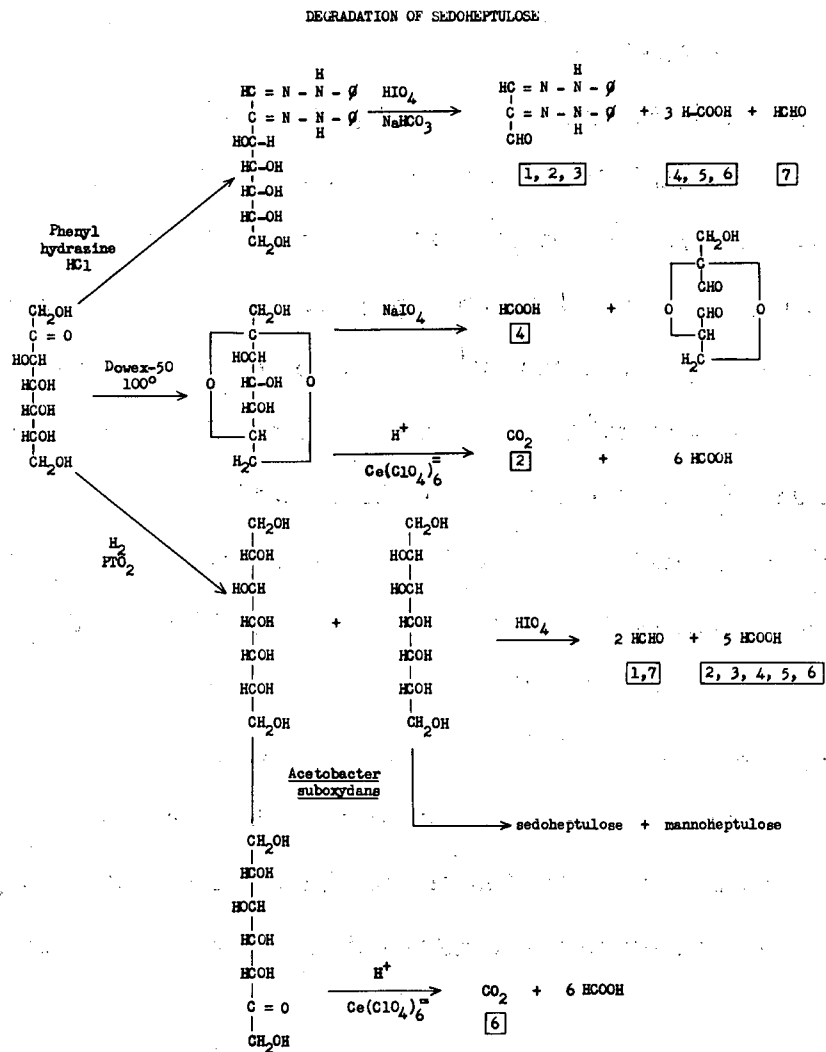

DEGRADATION OF RIBULOSE

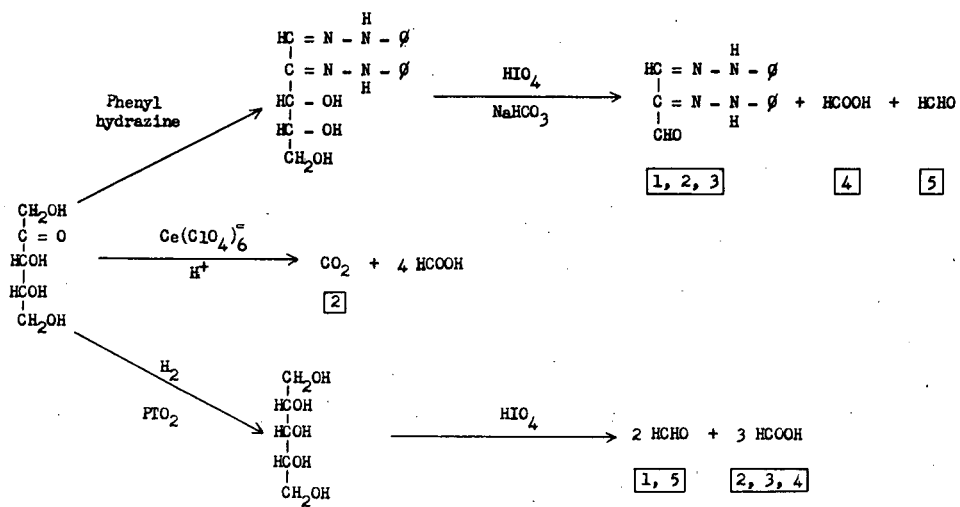

All radioactive material was purified on two-dimensional paper chromatograms.¹⁰ Radioactive sedoheptulose was converted to the anhydride by heating at 100° with acid-treated Dowex-50 for one hour, followed by chromatography to separate the resulting equilibrium mixture.

Formation of the Osazones. — The hexose and heptose osazones were made in the usual manner with phenylhydrazine hydrochloride, sodium acetate and acetic acid. Usually about 25 mg. of sugar carrier was used for the reaction. Sedoheptulose osazone co-crystallized with glucosazone sufficiently well for fructose to be used as carrier with sedoheptulose activity.

The radioactive arabinosazone was made by the method of Haskins, Hann and Hudson¹¹ with 10 mg. of arabinose carrier. The osazone was recrystallized once and diluted, as desired for each degradation, with pure crystalline, non-radioactive arabinosazone from a similar large-scale preparation.

Oxidation of Osazones. — The recrystallized osazones were treated with periodate in bicarbonate buffer as described by Topper and Hastings.¹² The reaction mixture was fractionated to obtain all the products by centrifuging and thoroughly washing the mesoxaldehyde osazone; distilling the supernate plus washings to dryness in vacuo and treating the distillate with dimedon to obtain the formaldehyde derivative; and acidifying and vacuum-distilling the residue to obtain the formic acid, which was counted as barium formate. All products were recrystallized before counting.

Cerate Oxidation of Ketoses. — The oxidation of the carbonyl carbon of a ketose to CO₂ by cerate ion was performed according to the method described by Smith.¹³ To a solution of an aliquot portion of radioactivity plus weighed carrier (sedoheptulosan or fructose) was added a slight excess of 0.5 M cerate ion¹⁴ in 6 N perchloric acid, the final concentration of acid being 4 N. The resultant CO₂ was swept with nitrogen into CO₂-free sodium hydroxide. The

reaction was allowed to proceed for one hour at room temperature and then the CO₂ was precipitated and counted as barium carbonate. In all cases the theoretical amount of carbon dioxide was evolved.

Formation and Oxidation of Sugar Alcohols. --- The radioactive sugars were hydrogenated with platinum oxide as described previously⁸ and chromatographed on paper for purification. Carrier ribitol or volemitol was added to an aliquot of radioactive alcohol and a slight excess of para periodic acid was added. The reaction was allowed to stand at room temperature for 6-7 hours. Then the formic acid and formaldehyde were distilled off in vacuo. After the formic acid was titrated with barium hydroxide, the formaldehyde was redistilled and precipitated as formyldimedon. Both the residue of barium formate and the formyldimedon were recrystallized before plating and counting.

Bacterial Oxidation of Hepitols from the Reduction of Sedoheptulose. --- The radioactive reduction products of sedoheptulose gave only one spot on chromatography. After elution these were oxidized by Acetobacter suboxydans in a small-scale modification of the usual method.¹⁵ Two mg. of volemitol and about 100 μ l. of solution of radioactive heptitols were placed in a 7 mm. diameter vial. An amount of yeast extract sufficient to make a 0.5% solution was added. The vial was sterilized, then inoculated from a 24-hour culture of Acetobacter and left for a week at room temperature in a humid atmosphere.

When the bacteria were centrifuged from the incubation mixture and the supernatant solution was chromatographed, three radioactive spots were obtained. The two major spots were mannoheptulose and sedoheptulose, the oxidation products of volemitol. The third had R_f values very similar to those of fructose and cochromatographed with authentic gulchoeptulose¹⁶ (R_f in phenol = .47; R_f in butanol-propionic acid-water = .24). After treatment with Dowex-50 in the acid form at 100°C for one hour, this third compound gave a new compound which

cochromatographed with guloheptulosan (R_f in phenol = .62; R_f in butanol-propionic acid-water = .30). It thus appeared that the radioactive heptitols are volemitol and β -sedoheptitol which cochromatograph in the solvents used.

Both mannoheptulose and guloheptulose have carbon chains inverted from the original sedoheptulose. In the small-scale fermentations, however, the oxidation appeared to be incomplete. The original alcohol did not separate chromatographically from mannoheptulose. Therefore, the easily purified guloheptulose was used for subsequent degradations with cerate ion, despite its much poorer yield.

Oxidation of Sedoheptulose. --- The radioactive sample and carrier were treated with sodium periodate as described by Pratt, Richtmeyer and Hudson¹⁷ and allowed to stand at room temperature for 3-4 days to give time for most of the formate to be released from the intermediate ester. Then the mixture was acidified with iodic acid and the formic acid was distilled in vacuo. This was then counted as barium formate.

Results

In Figure 2, the radiocarbon fixed in a "steady state" photosynthesis with Scenedesmus is shown as a function of time of exposure of the plant to $C^{14}O_2$. The rate of incorporation of $C^{14}O_2$ appears to be reasonably constant over the period of the experiment. The distribution of radioactivity among various labeled compounds is shown in Figure 3. The curve for the sugar diphosphates,

principally ribulose diphosphate, is not shown but lies between the glucose monophosphate curves although individual points are more erratic, probably due to the relative instability of the ribulose diphosphate.⁸ The appearance of compounds other than PGA with a finite rate of labeling at the shortest times is demonstrated in Figure 4 in which the percentage distributions of PGA and of the total sugar phosphates are shown. The extrapolations of the PGA and sugar phosphates to zero time would give about 75% and 17%, respectively. The remaining eight per cent not shown is distributed among malic acid (3%), free glyceric acid (2%) and phosphoenolpyruvic acid (3%).⁹ The percentage distribution among the sugar phosphates is shown in Figure 5 where it is seen that no single labeled sugar phosphate predominates at the shortest times.

These data alone do not permit assignment of an order of precedence of the various labeled compounds in the path of carbon reduction. In order to make such an assignment it would be necessary to measure the relative rates of increase in specific activity of the various compounds. If the slopes of the curves shown in Figure 3 are measured between 2 and 10 sec., rates of increase in total radioactivity are obtained. If these rates are divided by the cellular concentration of the compounds involved, rates of specific activity increase are obtained. This has been done using measurements of concentrations made by two independent^{9,18} methods which agreed fairly well in relative order (i.e., PGA concentration: GMP concentration = 4:1). The resulting values ranged from 0.3 for GMP to 1.0 for PGA, with FMP, DHAP, RDP and SMP falling between these values when the rates for these compounds were divided by 2, 1, 2, 1, 1, and 3, respectively, to allow for the number of carbon atoms which degradation data reported below show to be labeled significantly at these short times. This calculation is quite approximate, the concentration of compounds involved being measured in experiments with algae photo-

synthesizing under somewhat different conditions (i.e., 1% CO₂ instead of 4%). However, such a calculation does show more clearly the rapidity with which radio-carbon is distributed among the principally labeled carbon/atoms and the difficulty in assigning an order of precedence of labeled compounds on the basis of labeling rates alone.

The fact that compounds besides PGA have finite initial labeling slopes (which results in their percentage activity not extrapolating to zero at zero time) might be explained in several ways. One possibility is that during the killing time some of the enzymatic reactions (in this case reduction of PGA and rearrangement of the sugars) may not be stopped as suddenly as others (the carboxylation to give PGA) or may even be accelerated by the rising temperature prior to enzyme denaturation.

Another explanation is that some of the labeled molecules may be passed from enzyme to enzyme without completely equilibrating with the active reservoirs which are actually being measured. This sort of enzymatic transfer of radiocarbon could invalidate precedence assignments based on rates of increase in specific activities since the reservoirs would no longer be completely in the line of carbon transfer. That the equilibration between reservoirs and enzyme-substrate complexes is rapid compared to the carbon reduction cycle as a whole is indicated by the fact that all the reservoirs become appreciably labeled before there is an appreciable label in the α - and β -carbons of PGA, the 1,2,5 and 6 carbons of the hexoses, etc.. In any event, it would appear to be safer to establish the reaction sequences from qualitative differences in labeling within molecules (degradation data) and changes in reservoir sizes due to controlled changes in one environmental variable rather than from quantitative interpretations of labeling rate data.

Table I shows the results of degradations on sugars obtained from the soy bean series. The first column shows the variation in labeling of carbon number four of sedoheptulose obtained from soy bean leaves exposed to $C^{14}O_2$ for very short periods. These soy bean leaf experiments are, of course, not intended to represent "steady state" photosynthesis since the carbon dioxide is depleted just prior to the administration of $C^{14}O_2$. Included in the table is a complete degradation of a sedoheptulose sample from Sedum spectabile grown in radioactive carbon dioxide for two days (kindly supplied by N. E. Tolbert, Oak Ridge National Laboratory). Assuming this sample is uniformly labeled, its degradation indicates the probable limits of accuracy of the other degradations — about $\pm 10\%$ of the obtained value, mainly due to plating and counting errors resulting from the low amount of radioactivity available for degradation. The five degradations on sedoheptulose make it possible to obtain separate values for all the carbon atoms. Although the carbon-fourteen labels of carbon atoms 1 and 6 were not determined in the case of the Scenedesmus experiments, they were assumed small and approximately equal to carbon-fourteen labels found in carbons 2 and 7, by analogy with the soy bean leaf experiments where the labels of all carbon atoms of the sedoheptulose were determined. The label in each carbon atom of the ribulose can be obtained individually from the three degradations performed. The distributions in Table II should be interpreted as a clear qualitative picture of the position of the radioactivity within the molecule rather than as a quantitative picture. Fewer points were taken in this "steady state" flow experiment than in the one described earlier in order to obtain more labeled sugar per point for degradation purposes.

Table I

RADIOACTIVITY DISTRIBUTION IN SUGARS
 SEDOHEPTULOSE AND HEXOSE FROM SOY BEAN LEAVES

Time, seconds	Sedoheptulose							Hexose	
	C-4	C-1,2,3	C-4,5,6	C-7	C-2	C-1,7	C-6	C-1,2,3	C-4,5,6
0.4	8	33	57	0				47	52
0.8	18	43	60	2				48	51
1.5	24								
3.5	26					3			
5.0	29	36	64	2	4	4	4		
8.0	24								
10.0	28								
20.0	21	44	—	5	7				
300	14				12.5				
Sedum	12	37	35	12	12.5	28	15		

Table II

RADIOACTIVITY DISTRIBUTION IN COMPOUNDS

FROM FLOW EXPERIMENTS

(ALGAE)

5.4 Seconds				8.5 Seconds	
Glyceric Acid	Fructose	Sedoheptulose	Ribulose	Sedoheptulose	Ribulose
		2			
	3	2		3	
	3	28	11		11
	43	24	10		11
82	42	27	69		64
6	3	2	5		8
6	3	2	3		5

In other experiments¹⁹ the Scenedesmus have been kept at a steady state of light, temperature, CO₂ pressure, etc., and constant C¹⁴O₂ specific activity until successive samplings of the suspension showed uniform labeling ("saturation") of all the common photosynthetic reservoirs (PGA, RDP, GMP, etc.). The total CO₂ pressure was then rapidly changed from 1% CO₂-in-air to 0.003% in air, all other environmental conditions, including the specific activity of C¹⁴O₂, being kept constant. The conditions of this experiment were, therefore, similar to those used previously⁹ to study changing steady state except that CO₂ pressure was changed instead of illumination. In the case where CO₂ pressure was lowered (Figure 6), the initial effects on the reservoir sizes of PGA and RDP were just the opposite of those observed when the illumination was stopped. Lowered CO₂ pressure resulted in an increase in the reservoir size of RDP and a decrease in that of PGA. After a time the reservoir of RDP passed through a maximum and dropped to a lower level but the new steady state RDP reservoir was now greater relative to that of PGA. The labeled glycolic acid present, though rather a small percentage of total activity, increased many fold when the CO₂ pressure was lowered. The reservoir of glycolic acid increased much more slowly than that of the RDP and did not pass through a corresponding maximum, thus eliminating the possibility that most of the labeled glycolic acid was formed by thermal decomposition of RDP subsequent to killing of the cells.

1. Origin of PGA

It has been suggested that RDP is the compound which supplies the two-carbon atoms for the carboxylation reaction leading to PGA.⁹ If the reactions of these compounds are represented by

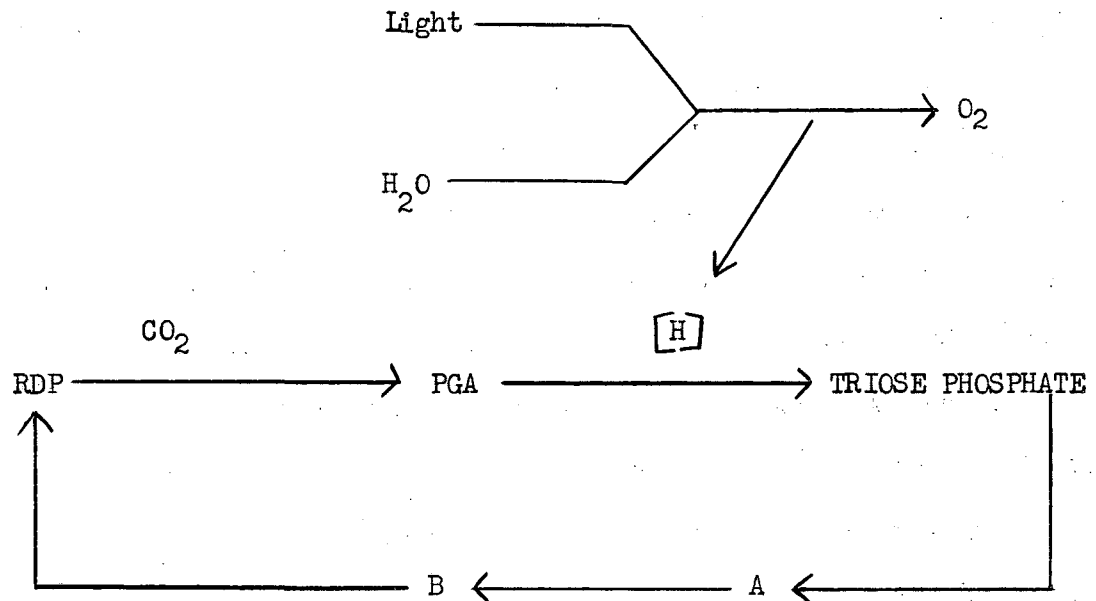

Sugar Rearrangements

then the initial changes in reservoir sizes which would accompany changes in light or CO₂ pressure can be predicted. When the light is turned off, reducing power [H] decreases, so the reservoir at PGA would increase and that of RDP decrease. If CO₂ pressure decreases, then the reservoir of RDP would increase and that of PGA would decrease. Both effects, as well as those opposite effects which would be expected to accompany a resumption of light or increase in CO₂ pressure, have been observed. These results support the proposal of a carboxylation of RDP to give two molecules of PGA or the reductive carboxylation to give one molecule of PGA and one of phosphoglyceraldehyde as the first step in the path of carbon dioxide reduction.

It is also possible that the products of this carboxylation might be phosphoglyceraldehyde and 3-phosphohydroxypyruvate. In this case subsequent reduction of the phosphohydroxypyruvate would give first PGA and then phosphoglyceraldehyde. The reaction of phosphoglyceraldehyde with hydroxypyruvate to give ribulose monophosphate and CO_2 has been demonstrated by Racker²⁰ to take place under the influence of the transketolase enzyme. However, the increase in PGA concentration which is observed on stopping the illumination of photosynthesizing algae,⁹ would probably not be seen if a reduction of hydroxypyruvate were required to form PGA since the reducing agent would presumably no longer be formed in the dark. Moreover, paper chromatographic analysis should detect either phosphohydroxypyruvate or its decarboxylation product, phosphoglycolaldehyde, and neither have been found in our experiments. When C^{14} -labeled hydroxypyruvate was administered to algae in this laboratory, the labeled acid was metabolized to give a variety of compounds, similar to those formed from labeled pyruvate or acetate, which were related more closely to the tricarboxylic acid cycle and fat synthesis than to the compounds usually associated with carbon reduction in photosynthesis.

There remains the possibility that the RDP first splits to give a three-carbon molecule and a free two-carbon fragment which is then carboxylated. However, if the glycolic acid is an indication of the free two-carbon fragment, then the observation that its increase in concentration (following reduction in CO_2 pressure) is not as rapid as the increase in RDP concentration suggests that the C_2 compound is not as closely related to the carboxylation reaction as the RDP.

2. Origin of Ribulose Diphosphate

If one considers the principal labeling at short times of PGA,² RDP, SMP and the two hexose monophosphates² as, respectively,

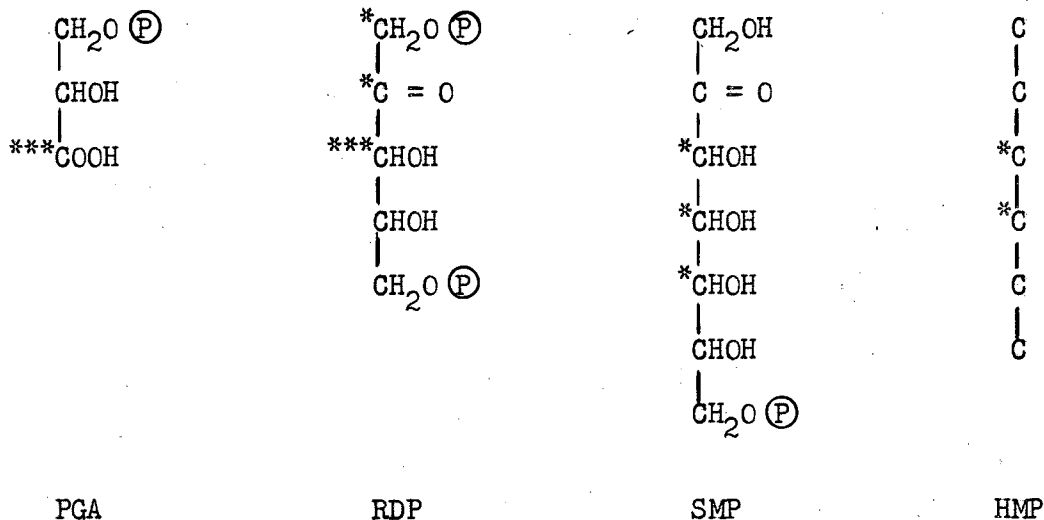

it appears that the ribulose is not derived entirely from a $\text{C}_6 \rightarrow \text{C}_1 + \text{C}_5$ split or a $\text{C}_7 \rightarrow \text{C}_2 + \text{C}_5$ split. No five carbon fragment of the hexose or the heptose molecules contains the same distribution of radiocarbon as ribulose. The combination of C_3 with a labeled C_2 fragment could account for the observed radioactivity. However, some mechanism for the labeling of the C_2 fragment would be required. One such mechanism would be the breakdown of hexose simultaneously into three C_2 fragments,²¹ and since carbon atoms 3 and 4 of hexose are labeled, a labeled C_2 fragment might thus be obtained. To our knowledge there exists no precedent as yet for this type of reaction.

Another way of accounting for the observed distribution of radioactivity which seems quite plausible in view of the rapidly accumulating enzymatic evidence for the reverse reaction^{20, 22 - 24} is the formation of ribulose from sedoheptulose and triose. This reaction could result in the observed labeling in the

following way:

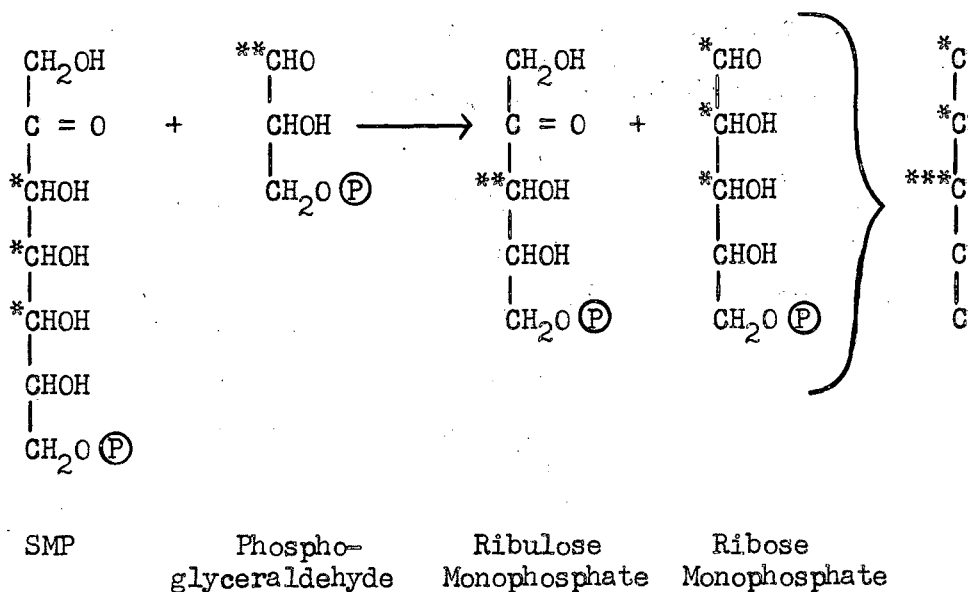

If the ribose-5-phosphate and ribulose-5-phosphate are then converted to RDP the resulting distribution of label would be that observed (carbon skeleton at right of reaction).

3. Origin of Sedoheptulose

The degradation data appear to eliminate the possibility of formation of sedoheptulose by a simple 6 + 1 or 5 + 2 addition, if we assume that no special reservoirs of pentose and hexose exist with distributions of radioactivity different from those measured. A reverse of the reactions proposed above for formation of RDP would require segregation of ribose and ribulose distributions as well as some other mechanism for labeling the ribose in the manner shown. It does seem likely that all the reactions involving rearrangements of sugars and perhaps those involving reduction of PGA as well are at least partially reversible in the time of these experiments. If all these compounds are intermediates in a cycle of carbon reduction, then during steady state photosynthesis

there will be a net "flow" of radiocarbon in the "forward" direction, but the possibility that the distribution of radiocarbon in later intermediates may reflect to some extent that of earlier intermediates cannot be entirely ignored.

The condensation of a triose with a C₄ fragment would give the observed distribution if the C₄ fragment is labeled in the carbon atoms 1 and 2:

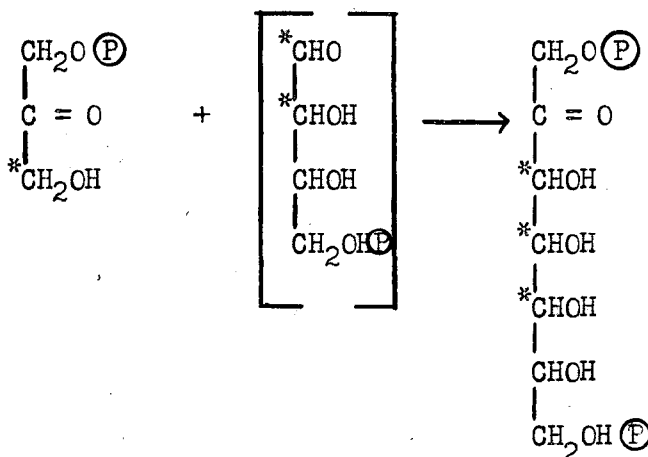

DHAP

Enzymatic evidence for this reaction and its reverse has been reported.^{23,25}

4. Origin of the Four-Carbon Fragment

Two possible modes of formation of the four-carbon fragment with the above labeling are a C₁ + C₃ addition, and a C₆ \longrightarrow [C₂] + [C₄] split. The C₁ + C₃ addition which leads to malic acid produces a C₄ fragment labeled in the two terminal positions.⁶ Therefore, the reduction of the dicarboxylic acid formed as a precursor to malic acid could not result in a C₄ fragment with the C¹⁴ distribution required for the formation of 3,4,5-C¹⁴-labeled sedoheptulose. The rapid introduction of radiocarbon into malic acid in earlier experiments⁴ can be accounted for if it is assumed that the reservoir size of malic acid, depleted during the air flushing prior to the addition of HC¹⁴O₃⁻, was increasing after

the addition of radiocarbon due to the increase in total CO_2 pressure. Also, after the carboxyl group of PGA and phosphoenolpyruvic acid have become appreciably labeled, the malic acid is doubly labeled.

It is interesting to note that in the long term "steady state" experiments in which the light was turned off,⁹ the malic acid concentration dropped when the light was turned off rather than increasing as PGA concentration increased. If malic acid were an indicator of a four-carbon intermediate in carbon reduction, the product of a second carboxylation, then one would expect its concentration to increase in the dark for two reasons. First, there no longer is reducing power which would reduce the carboxylation product to sugar if this product were an intermediate in CO_2 reduction. Second, the rate of formation of malic acid should increase since this rate depends on the CO_2 concentration (which remains constant), and the concentration of phosphoenolpyruvic acid (which increases paralleling the PGA concentration. The decrease in malic acid concentration could be easily explained on the basis of the proposed light inhibition of pyruvic acid oxidation.⁹ The cessation of illumination should permit increased pyruvic acid oxidation, thus providing more acetyl-CoA, which can react with oxaloacetic acid derived from malic acid.

It is possible that there is a different "second carboxylation" ($\text{C}_1 + \text{C}_3$) leading eventually to a four-carbon fragment which can react with triose to give sedoheptulose, but there seems to be no evidence whatever for such a reaction at present. Moreover, such a reaction should lead in short times to a four-carbon fragment somewhat more labeled in the terminal carbon position than in the second carbon position due to dilution of the carbon introduced in the first carboxylation reaction by the PGA and triose reservoirs. This is not the case -- in fact in the very shortest times the terminal carbon position of the hypothetical C_4 fragment (carbon four of sedoheptulose) is actually less labeled.

than the second position, at least in the soy bean experiments.

The most likely source of the C₄ fragment seems to be a C₆ \longrightarrow [C₄] + [C₂] split. Trioses could then react with [C₄] and [C₂] to give sedoheptulose and ribulose, respectively. One possible formulation of these reactions would be the following:

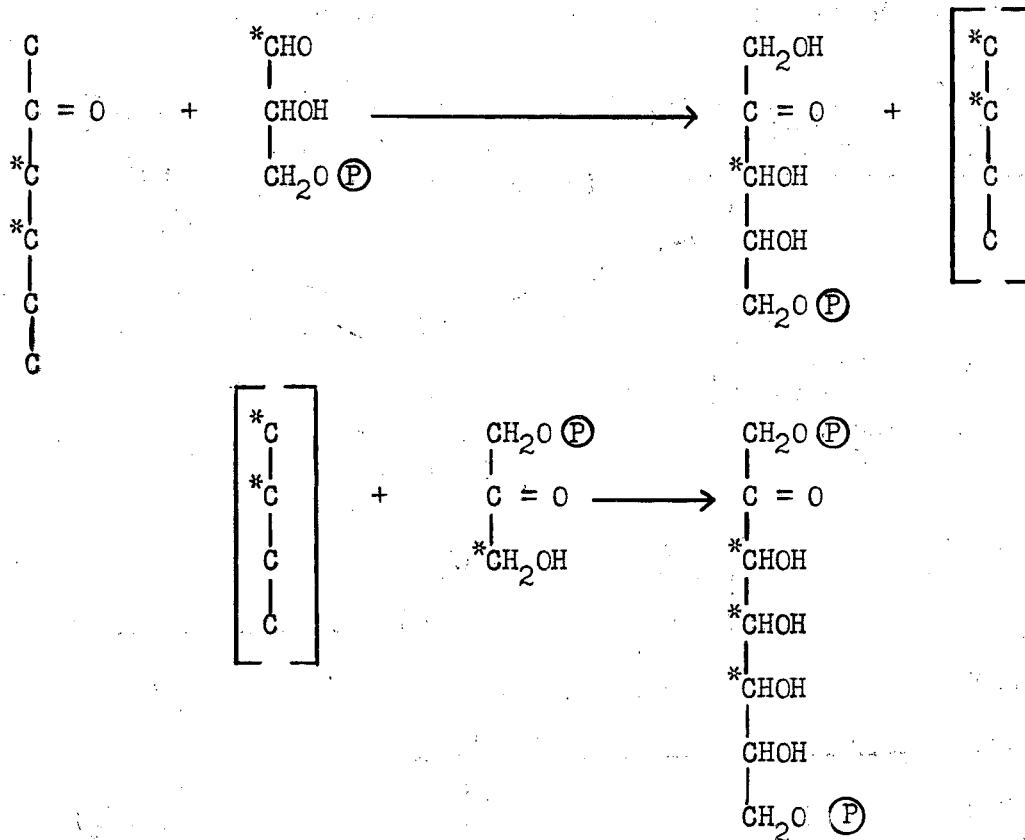

The first reaction as written above would be a transketolase reaction of the type reported by Racker, et al.,²⁰ who found that this enzyme splits ribulose-5-phosphate, leaving glyceraldehyde-3-phosphate and transferring the remaining two-carbon atoms to an acceptor aldehyde phosphate of 2, 3, or 5 carbon atoms. No mention was made of the effect of transketolase on ribose-5-phosphate with erythrose-4-phosphate which would result in the formation of fructose phosphate by a reaction

Combining these reactions with others already proposed we have the following cyclic path of carbon reduction during photosynthesis. The carbon fragments specified only by the number of carbon atoms in their chains are all at the sugar level of reduction:

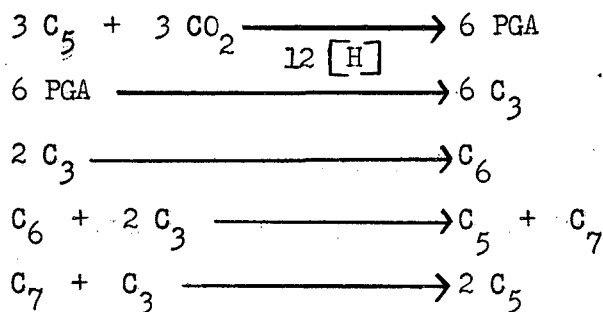

The net reaction for each turn of the cycle is

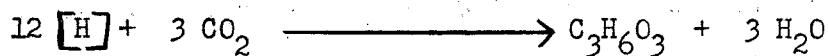

The operation of this cycle is illustrated in Figure 7.

5. Energetics of the Carbon Reduction Cycle

That the enzymatic rearrangements of sugars requires no additional supply of energy in the form of ATP or other sources seems to be indicated by the experiments with isolated and partially purified enzyme preparations in which such rearrangements have been carried out without the addition of energy donors. The free energy change of the carboxylation reaction can be roughly estimated. Estimating the free energy of formation of ribose as about -180 Kcal. and assuming an energy difference between ribose-5-phosphate and RDP equal to that between GMP and fructose diphosphate, the free energy change for the reaction below is about -7 Kcal.^{27,28}

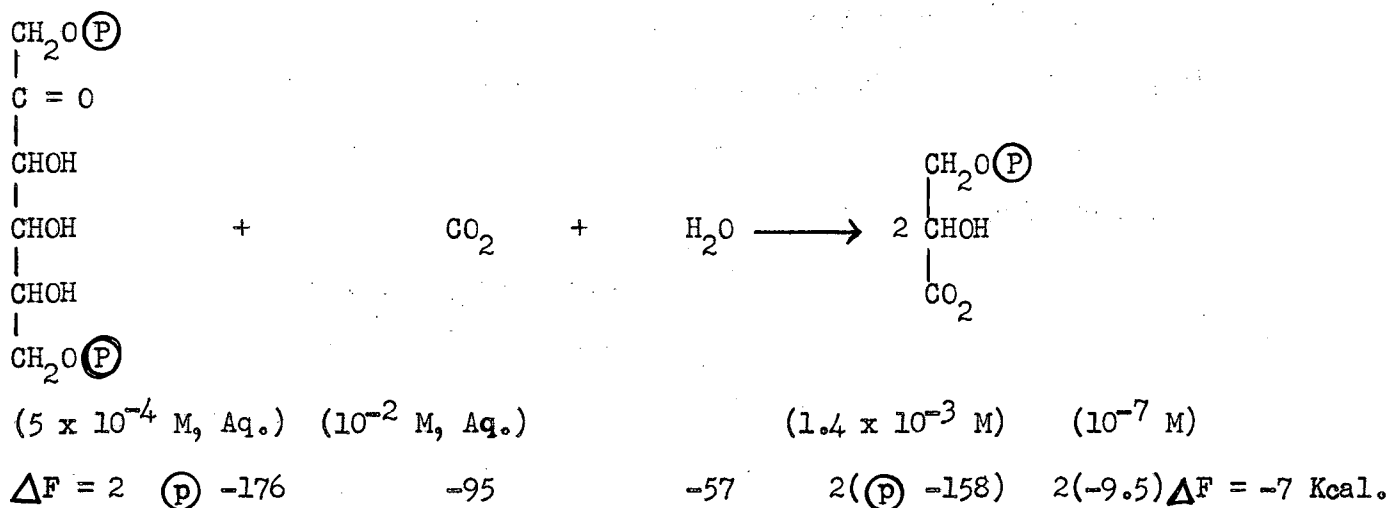

In the above calculation the concentrations of RDP and PGA measured with Scenedesmus during photosynthesis with 1% CO₂⁹ are used. The mechanism of the reaction may consist of the addition of CO₂ to the 2,3-enediol sugar formed by enolization of the RDP. The intermediate compound would be 2-carboxypentulose-3. The free energy for the formation of the ion of this acid and H⁺ (pH 7) from CO₂ and RDP is estimated as zero when the concentration of the intermediate acid is 10⁻⁹ M. Subsequent hydrolytic splitting of this compound to two molecules of PGA and another hydrogen ion would proceed with a free energy change of -7 Kcals.

The energy required to maintain the operation of the proposed carbon reduction cycle might be supplied entirely in the reduction of PGA to triose phosphate. If this reduction were accomplished by a reversal of the enzymatic reaction usually written, each "turn" of the cycle would be represented by three times the reaction:

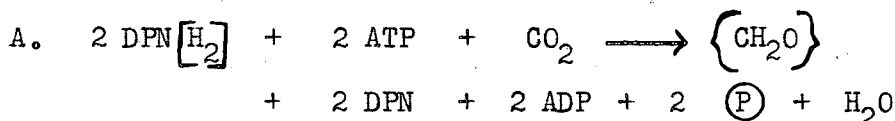

This is the sum of the reactions:

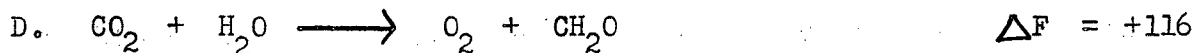

The efficiency of the transfer of energy of reactions B and C to reaction D is $116/(21 + 101) = 0.96$.

However, additional energy might be supplied to the operation of the cycle by phosphorylation reactions in which additional molecules of ATP are required. One such reaction may well be the phosphorylation of ribulose monophosphate to give ribulose diphosphate. In this case, one additional molecule of ATP would be required per molecule of CO_2 reduced. The efficiency of the net reaction (A') would then be $116/132.5 = 0.88$.

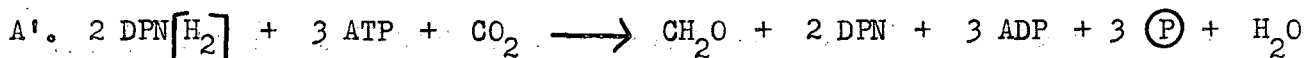

The overall efficiency of photosynthesis would be the product of 0.96 or 0.88 and the efficiency of the process by which water is photolyzed to give oxygen with the production of reducing power, followed by the conversion of the energy of this reducing power to $\text{DPN} \left[\text{H}_2 \right]$ and ATP.

If the mechanism for photolysis of water involves thioctic acid, as has been proposed,²⁹ the energetics of the photochemical and following steps can be estimated:

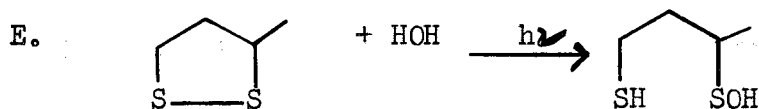

(where the symbol --- represents the side chain: $-(\text{CH}_2)_4\text{CO}_2\text{H}$)

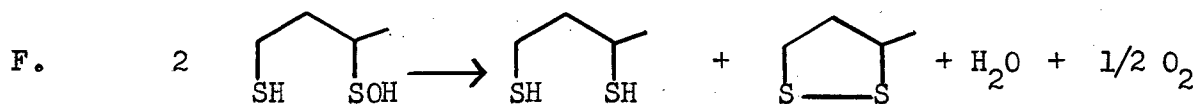

In this process, two quanta are required for each dithiol molecule formed. The stored energy is the sum of the energies of the two following half reactions:

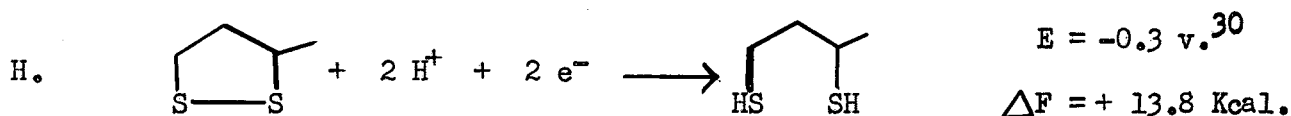
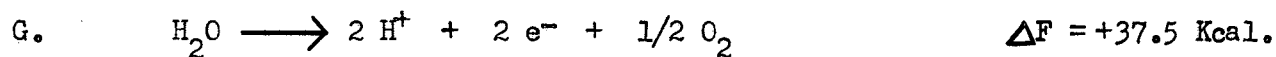

which is

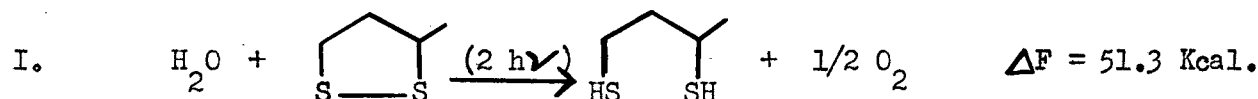

Since the energy available from two light quanta at 7000 Å is 2 x 40.7 or 81.4 Kcal., the efficiency of this process would be 51.3/81.4 = 0.63.

If Co-I is used in the reduction of PGA, the reduced coenzyme could be formed with high efficiency from the dithiol

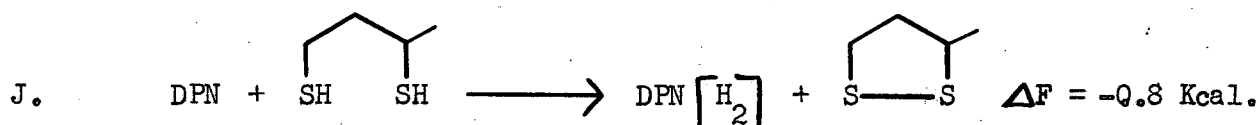

The required ATP could be formed in some way by oxidation of or DPN[H₂] by an energetic coupling of the following reactions:

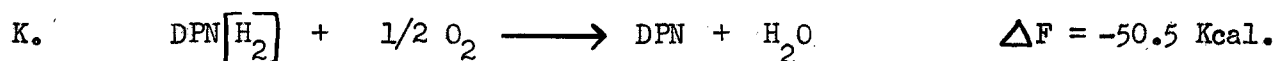



Since from one to four molecules of ATP might be formed per DPN[H₂] oxidized, a wide range of efficiencies would be possible. A value of three has been suggested³¹ and if this is used, the resulting coupling reaction could be written:

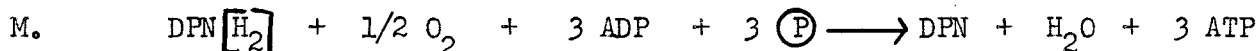

Multiplying reaction J by 3 and combining with reaction M we have

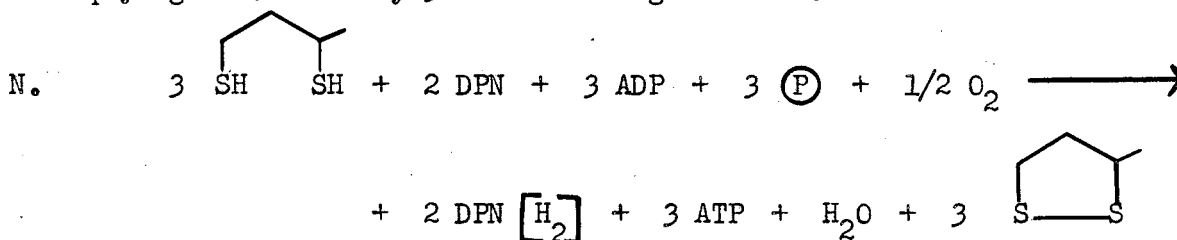

in which the stored energy is 132.5 Kcal. and the energy expended is times reaction H = 154 Kcals. The efficiency of the energy transfers represented by reaction N is then $132.5/154 = 0.86$.

Combining the efficiencies of reactions A', I, and N results in a calculated overall efficiency for photosynthesis of $0.88 \times 0.63 \times 0.86 = 0.48$. Since the mechanism outlined above would require six quanta for each molecule of carbon dioxide reduced (two quanta for each molecule of dithiol used in reaction N) this efficiency can be obtained directly from the energy of these quanta (244 Kcal.) and the energy of reaction D: $116/244 = 0.48$.

Higher apparent efficiencies would be obtained at low light intensities where the dark internal conversion of prior storage products (involving no net uptake of oxygen or evolution of CO₂) would supply appreciable amounts of ATP, DPNH, reduced thiocetic acid and possibly intermediates of the O₂ evolution chain as well.²⁷

Since reaction I as written stores only 51.3 Kcal. of 81.4 Kcal. available, it is possible that some mechanism may exist for the storage of some of this energy in the form of either additional reducing power or high energy phosphate. In this case, the overall efficiency would be higher.

6. Other Biological Evidence

The interconversions of the five-, and seven-carbon sugars are being investigated by several laboratories. The postulated cyclic reactions which our data suggest are consistent with the observations of these various groups. Both the work of Axelrod, et al.²² with spinach preparations and the results reported by Dische and Pollaczek³² with hemolysates demonstrate the sequence ribose phosphate \longrightarrow heptulose phosphate + triose phosphate \longrightarrow hexose phosphate.

Recently studies have been made of the distribution of C^{14} in products resulting from conversion of $l-C^{14}$ labeled pentoses. Neish³³ has studied the products of bacterial metabolism of several pentoses while Wolin, et al.³⁴ investigated the products of enzymatic conversion of ribose-5-phosphate. In both cases, the distribution of radioactivity in the products could be accounted for by a reversal of the reactions herein suggested earlier, although a limited number of other interpretations of their data are possible.

Summary³⁵

Photosynthesizing plants have been exposed to $C^{14}O_2$ for short periods of time (0.4 to 15 sec.) and the products of carbon dioxide reduction analyzed by paper chromatography and radioautography.

Methods have been developed for the degradation of ribulose and sedoheptulose. These sugars, obtained as their phosphate esters from the above $C^{14}O_2$

exposures and from other experiments, have been degraded and their distribution of radiocarbon determined.

The distribution of radiocarbon in these sugars, and other data, indicate that sedoheptulose phosphate and ribulose diphosphates are formed during photosynthesis from triose and hexose phosphates, the latter being synthesized, in turn, by the reduction of 3-phosphoglyceric acid.

Further evidence has been found for the previously proposed carboxylation of ribulose diphosphate to phosphoglyceric acid. Free energy calculations indicate this step would proceed spontaneously if enzymatically catalyzed.

The efficiency of this cycle for reduction of CO_2 to hexose would be 0.9 if the reduction of each molecule of PGA requires the concurrent conversion of one molecule of ATP and one of DPN (red) to ADP, inorganic phosphate, and DPN (ox.). This mechanism, together with an assumed mechanism for the photolysis of water, would lead to an efficiency of about 0.5 for the overall photosynthetic reaction and a requirement of about six quanta of light per molecule of CO_2 reduced to carbohydrate.

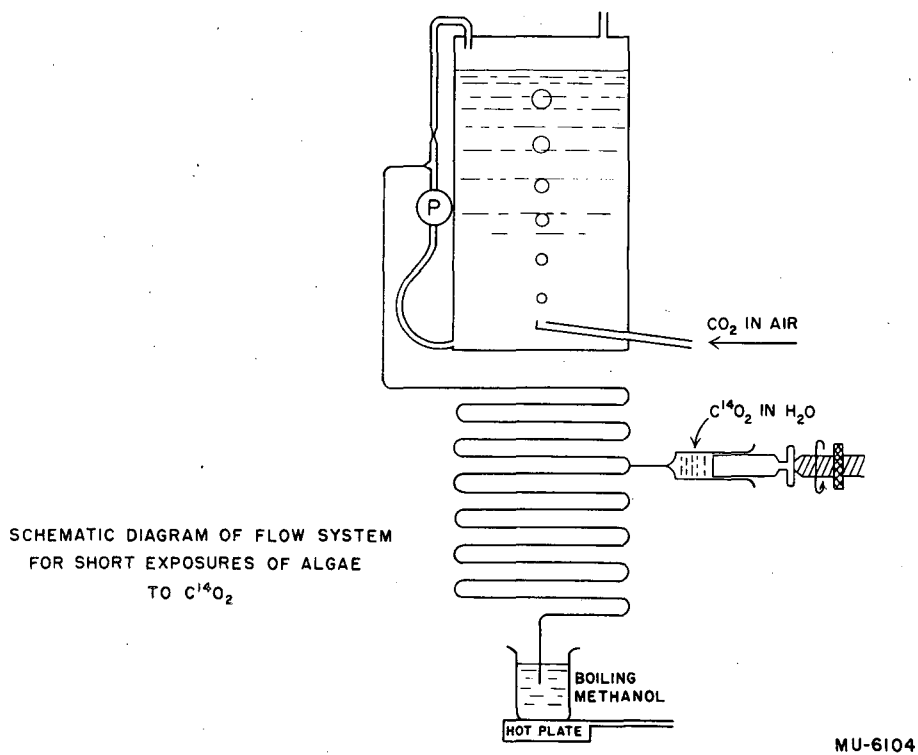
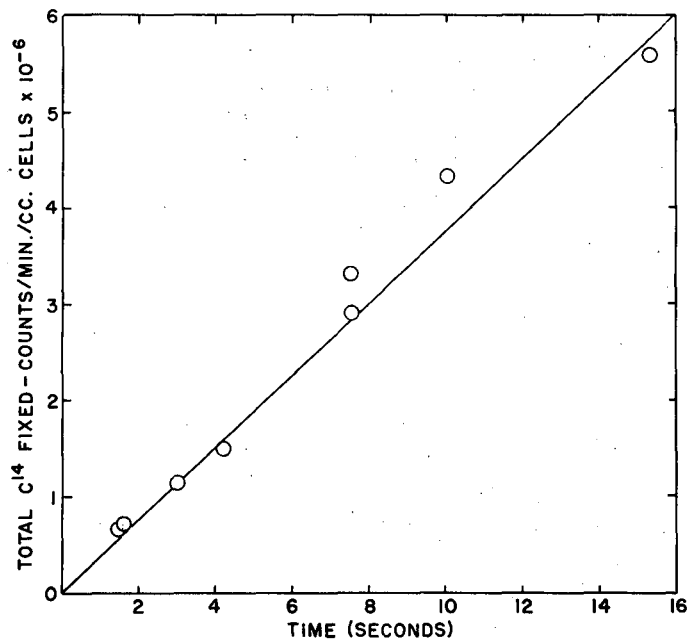

Fig. 1

RADIOACTIVITY INCORPORATED IN
"STEADY STATE" PHOTOSYNTHESIS WITH SCENEDESMUS



MU-6114

Fig. 2

DISTRIBUTION OF RADIOACTIVITY
AMONG COMPOUNDS FORMED DURING
"STEADY STATE" PHOTOSYNTHESIS WITH SCENEDESMUS

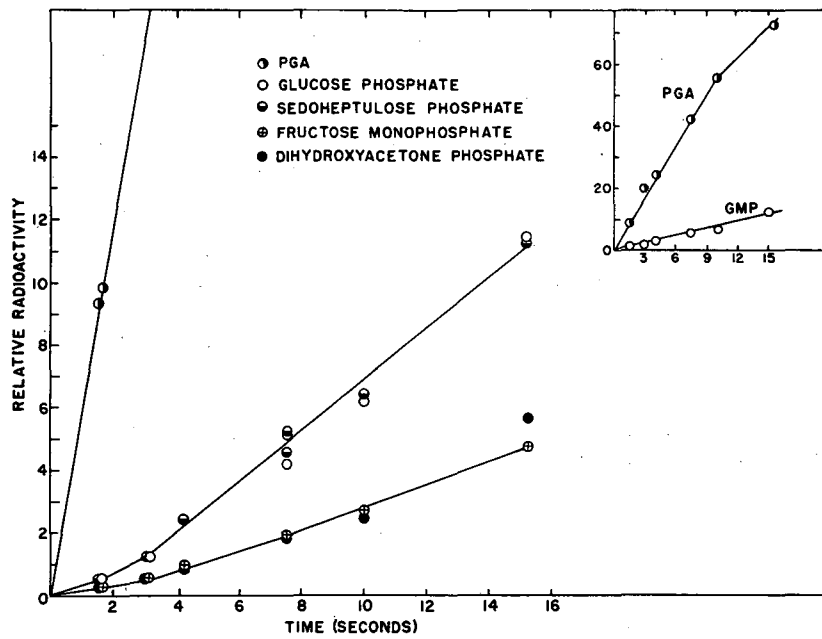

MU-6115

Fig. 3

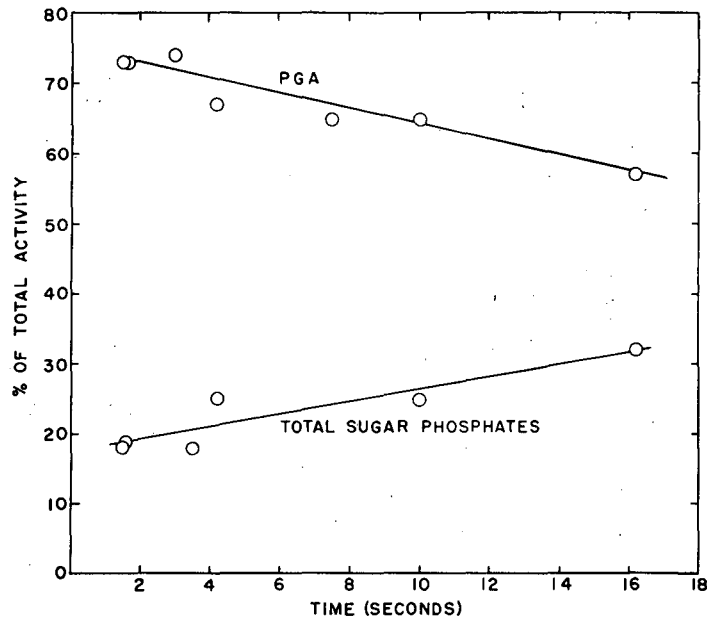

MU-6103

DISTRIBUTION OF ACTIVITY IN
"STEADY STATE" SCENEDESMUS

Fig. 4

DISTRIBUTION OF RADIOACTIVITY INCORPORATED
IN "STEADY STATE" PHOTOSYNTHESIS WITH SCENEDESMUS

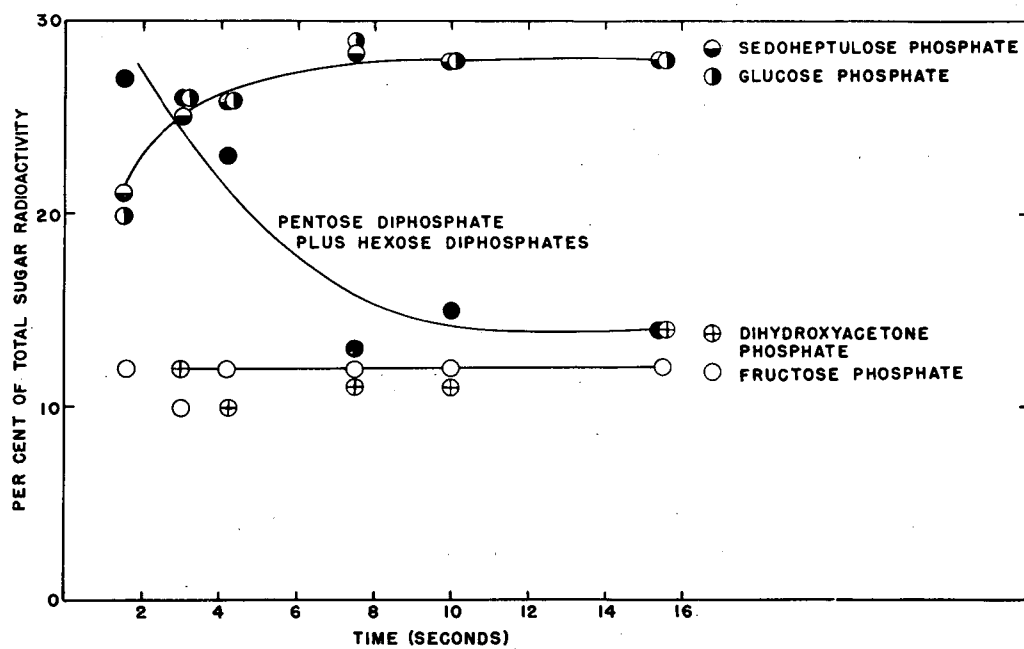

MU-8116

Fig. 5

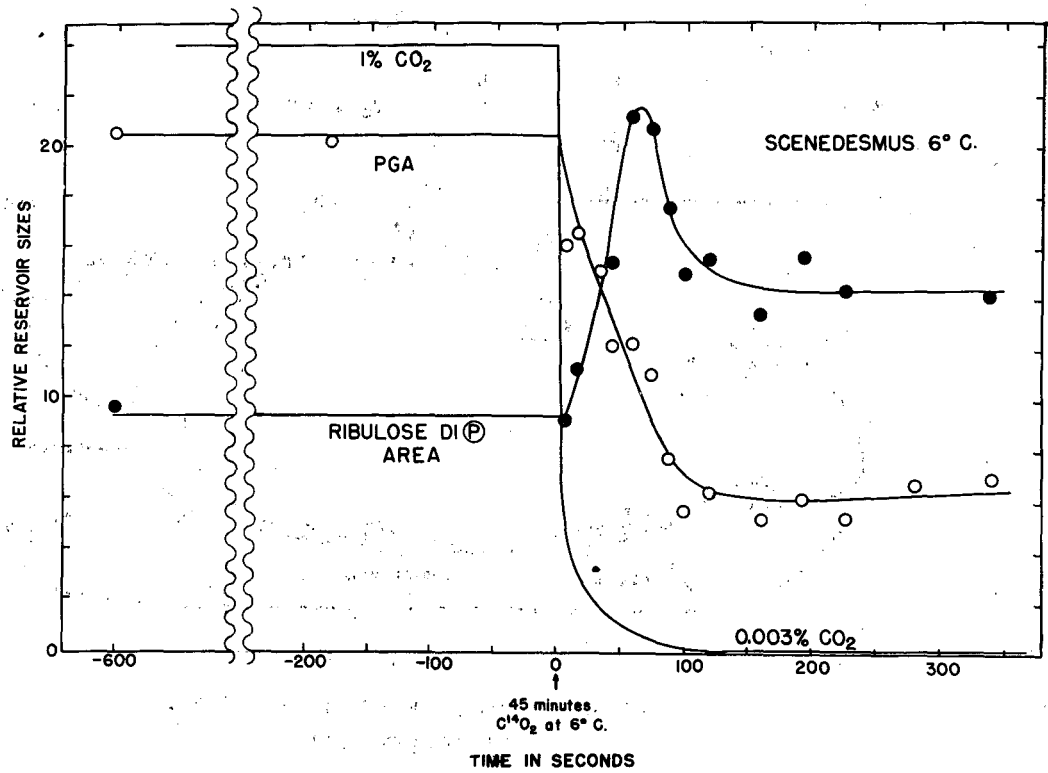

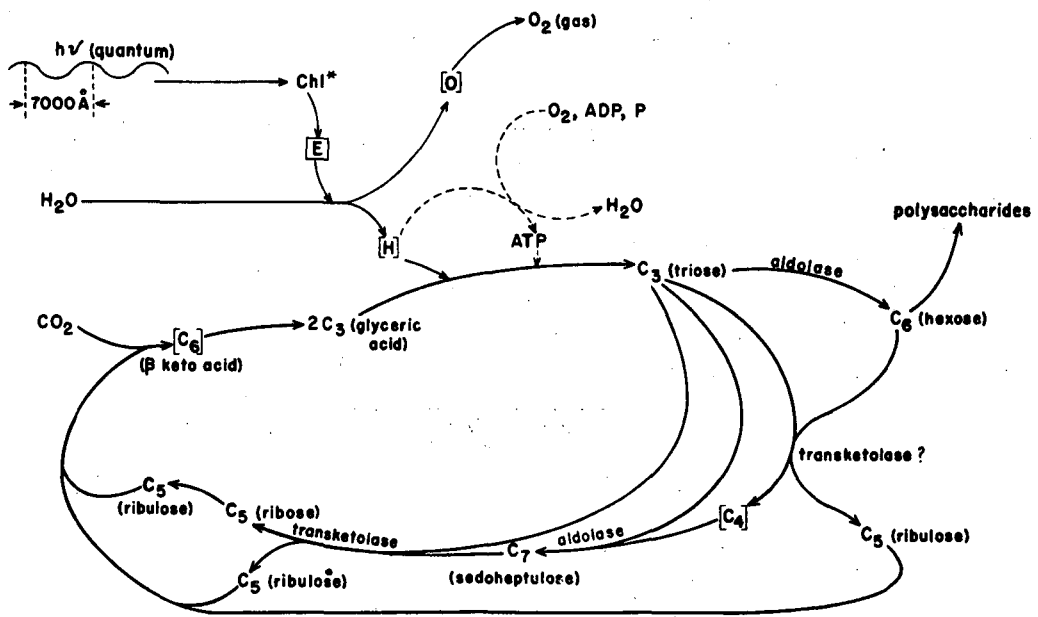

PROPOSED CYCLE FOR CARBON REDUCTION
IN PHOTOSYNTHESIS

MU-6600

References

- (1) The work described in this paper was sponsored by the U. S. Atomic Energy Commission.
- (2) M. Calvin "The Harvey Lectures," 1950-51, Charles C. Thomas Publishing Company, page 218.
- (3) The following abbreviations will be used throughout this paper: PGA, phosphoglyceric acid; DHAP, dihydroxyacetone phosphate; FMP, fructose monophosphate; GMP, glucose monophosphate; SMP, sedoheptulose monophosphate; RDP, ribulose diphosphate; ADP, adenosine diphosphate, ATP, adenosine triphosphate; DPN, diphosphopyridine nucleotide (Coenzyme I), oxidized form; DPN $\left[H_2 \right]$, diphosphopyridine nucleotide, reduced form.
- (4) A. A. Benson, S. Kawaguchi, P. M. Hayes and M. Calvin, J. Am. Chem. Soc., 74, 4477 (1952).
- (5) A. A. Benson, et al., "Photosynthesis in Plants," Iowa State College Press, Ames, Iowa (1949), page 381.
- (6) D. W. Racusen and S. Aronoff, Arch. Biochem. Biophys., 42, 25 (1953).
- (7) J. A. Bassham, A. A. Benson and M. Calvin, J. Biol. Chem., 185, 781 (1950).
- (8) A. A. Benson, et al., J. Biol. Chem., 196, 703 (1952).
- (9) M. Calvin and Peter Massini, Experientia, 8, 445 (1952).
- (10) A. A. Benson, et al., J. Am. Chem. Soc., 72, 1710 (1950).
- (11) W. T. Haskins, R. N. Hann and C. S. Hudson, J. Am. Chem. Soc., 68, 1766 (1946).
- (12) Y. J. Topper and A. B. Hastings, J. Biol. Chem., 179, 1255 (1949).
- (13) G. Frederick Smith, "Cerate Oxidimetry," G. Frederick Smith Chemical Company, Columbus, Ohio (1942).

- (14) We are indebted to Prof. John C. Speck, Jr., of Michigan State College, East Lansing, Michigan, for valuable data and suggestions regarding the use of cerate in these oxidations.
- (15) (a) L. C. Stewart, N. K. Richtmyer and C. S. Hudson, J. Am. Chem. Soc., 74, 2206 (1952). (b) We wish to express our appreciation to Dr. R. Clinton Fuller for his development of the micro-fermentation.
- (16) We wish to thank Dr. N. K. Richtmyer for his generous gift of crystalline gulchoeptulosan.
- (17) J. W. Pratt, N. K. Richtmyer and C. S. Hudson, J. Am. Chem. Soc., 74, 2200 (1952).
- (18) A. A. Benson, Zeit. f. Elektrochem., 56, 848 (1952).
- (19) A. T. Wilson, Thesis, to be submitted as partial fulfillment of requirements for the degree of Doctor of Philosophy, University of California.
- (20) E. Racker, G. de la Haba and I. G. Leder, J. Am. Chem. Soc., 75, 1010 (1953).
- (21) H. Gaffron, E. W. Fager and J. L. Rosenberg, "Carbon Dioxide Fixation and Photosynthesis," Symposia of the Society for Experimental Biology (Great Britain), Vol. V, Cambridge University Press (1951).
- (22) B. Axelrod, R. S. Bandurski, C. M. Greiner and R. Jang, J. Biol. Chem., 202, 619 (1953).
- (23) B. L. Horecker and P. Z. Smyrniotis, J. Am. Chem. Soc., 74, 2123 (1952).
- (24) B. L. Horecker and P. Z. Smyrniotis, J. Am. Chem. Soc., 75, 1009 (1953).
- (25) B. L. Horecker and P. Z. Smyrniotis, J. Am. Chem. Soc., 75, 2021 (1953).
- (26) Since this was written, a private communication from Dr. Racker has informed us that he has observed this reaction with F-6-P.

- (27) The internal energy of the $-\text{PO}_3\text{H}^-$ group, exclusive of the energy of bonding to the remainder of the molecule is here denoted by $\textcircled{\text{P}}$ and assumed constant throughout.
- (28) J. A. Bassham, Thesis, submitted as partial fulfillment of requirements for the degree of Doctor of Philosophy, University of California, 1949.
- (29) J. A. Barltrop, P. M. Hayes and M. Calvin, to be published.
- (30) I. C. Gunsalus, Symposium on "Mechanism of Enzyme Action," McCollum-Pratt Institute, Johns Hopkins University, 1953, to be published.
- (31) A. L. Lehninger, "Phosphorus Metabolism, Vol. I," Johns Hopkins University Press (1951), page 344.
- (32) Z. Dische and E. Pollaczek, paper presented at Second International Congress of Biochemistry, Paris, France, 1952.
- (33) A. C. Neish, paper presented at American Society of Bacteriologists meeting, San Francisco, 1953.
- (34) H. B. Wolin, B. L. Horecker, M. Gibbs and H. Klenow, paper presented at meeting of American Institute of Biological Sciences, Madison, Wisconsin, 1953.
- (35) This paper was presented before the Division of Biological Chemistry, American Chemical Society at the 124th National Meeting, Chicago, Illinois, September, 1953.