

eScholarship

Combinatorial Theory

Title

Three Fuss-Catalan posets in interaction and their associative algebras

Permalink

<https://escholarship.org/uc/item/4s55d1j5>

Journal

Combinatorial Theory, 2(1)

ISSN

2766-1334

Authors

Combe, Camille
Giraud, Samuele

Publication Date

2022

DOI

10.5070/C62156878

Supplemental Material

<https://escholarship.org/uc/item/4s55d1j5#supplemental>

Copyright Information

Copyright 2022 by the author(s). This work is made available under the terms of a Creative Commons Attribution License, available at <https://creativecommons.org/licenses/by/4.0/>

Peer reviewed

THREE FUSS–CATALAN POSETS IN INTERACTION AND THEIR ASSOCIATIVE ALGEBRAS

Camille Combe¹ and Samuele Giraud²

¹*Institut de Recherche Mathématique Avancée UMR 7501, Université de Strasbourg et CNRS, Strasbourg, France
combe@math.unistra.fr*

²*LIGM, Université Gustave Eiffel, CNRS, ESIEE Paris, Marne-la-Vallée, France
samuele.giraud@u-pem.fr*

Submitted: Nov 19, 2020; Accepted: Dec 14, 2021; Published: Mar 31, 2022

© The authors. Released under the CC BY license (International 4.0).

Abstract. We introduce δ -cliffs, a generalization of permutations and increasing trees depending on a range map δ . We define a first lattice structure on these objects and we establish general results about its subposets. Among them, we describe sufficient conditions to have EL-shellable posets, lattices with algorithms to compute the meet and the join of two elements, and lattices constructible by interval doubling. Some of these subposets admit natural geometric realizations. Then, we introduce three families of subposets which, for some maps δ , have underlying sets enumerated by the Fuss–Catalan numbers. Among these, one is a generalization of Stanley lattices and another one is a generalization of Tamari lattices. These three families of posets fit into a chain for the order extension relation and they share some properties. Finally, in the same way as the product of the Malvenuto–Reutenauer algebra forms intervals of the right weak Bruhat order of permutations, we construct algebras whose products form intervals of the lattices of δ -cliff. We provide necessary and sufficient conditions on δ to have associative, finitely presented, or free algebras. We end this work by using the previous Fuss–Catalan posets to define quotients of our algebras of δ -cliffs. In particular, one is a generalization of the Loday–Ronco algebra.

Keywords. Poset, Tamari lattice, Fuss–Catalan objects, Malvenuto–Reutenauer algebra, Loday–Ronco algebra

Mathematics Subject Classifications. 05E99, 06A07, 06A11, 16T30

Introduction

The theory of combinatorial Hopf algebras takes a prominent place in algebraic combinatorics. The Malvenuto–Reutenauer algebra FQSym [MR95, DHT02] is a central object in this theory. This structure is defined on the linear span of all permutations and the product of two permutations has the notable property to form an interval of the right weak Bruhat order. Moreover, FQSym admits a lot of substructures, like the Loday–Ronco algebra of binary trees PBT [LR98,

[HNT05] and the algebra of noncommutative symmetric functions Sym [GKL⁺95]. Each of these structures brings out in a beautiful and somewhat unexpected way the combinatorics of some partial orders, respectively the Tamari order [Tam62] and the Boolean lattice, playing the same role as the one played by the right weak Bruhat order for FQSym . To be slightly more precise, all these algebraic structures have, as common point, a product \cdot which expresses, on their so-called fundamental bases $\{F_x\}_x$, as

$$F_x \cdot F_y = \sum_{x / y \preceq z \preceq x \setminus y} F_z, \quad (0.1)$$

where \preceq is a partial order on basis elements, and $/$ and \setminus are some binary operations on basis elements (in most cases, some sorts of concatenation operations).

The point of departure of this work consists in considering a different partial order relation on permutations and ask to what extent analogues of FQSym and a similar hierarchy of algebras arise in this context. We consider here first a very natural order on permutations: the componentwise ordering \preceq on Lehmer codes of permutations [Leh60]. A study of these posets $\text{Cl}_1(n)$ appears in [Den13]. Each poset $\text{Cl}_1(n)$ is an order extension of the right weak Bruhat order of order n . To give a concrete point of comparison, the Hasse diagrams of the right weak Bruhat order of order 3 and of $\text{Cl}_1(3)$ are respectively

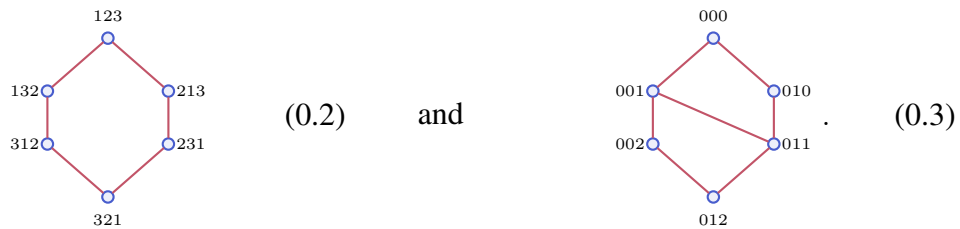

As we can observe, the right weak Bruhat order relation on permutations of size 3 is included into the order relation of $\text{Cl}_1(3)$.

In this work, we consider a more general version of Lehmer codes, called δ -cliffs, leading to distributive lattices Cl_δ . Here δ is a parameter which is a map $\mathbb{N} \setminus \{0\} \rightarrow \mathbb{N}$, called range map, assigning to each position of the words a maximal allowed value. The linear spans Cl_δ of these sets are endowed with a very natural product related to the intervals of Cl_δ . Some properties of this product are implied by the general shape of δ . For instance, when δ is so-called valley-free, Cl_δ is an associative algebra, and when δ is weakly increasing, Cl_δ is free as a unital associative algebra. The particular algebra Cl_1 is in fact isomorphic to FQSym , so that for any range map δ , Cl_δ is a generalization of this latter. For instance, when δ is the map \mathbf{m} satisfying $\mathbf{m}(i) = (i - 1)m$ with $m \in \mathbb{N}$, then all Cl_m are free associative algebras whose bases are indexed by increasing trees wherein all nodes have $m + 1$ children.

In the same way as the Tamari order can be defined by restricting the right weak Bruhat order to some permutations, one builds three subposets of Cl_δ by restricting \preceq to particular δ -cliffs. This leads to three families Av_δ , Hi_δ , and Ca_δ of posets. When δ is the particular map \mathbf{m} defined above with $m \geq 0$, the underlying sets of all these posets of order $n \geq 0$ are enumerated by the n -th m -Fuss–Catalan number [DM47]

$$\text{cat}_m(n) := \frac{1}{mn + 1} \binom{mn + n}{n}. \quad (0.4)$$

These posets have some close interactions: when δ is an increasing map, Hi_δ is an order extension of Ca_δ , which is itself an order extension of Av_δ . Besides, Hi_m (resp. Ca_m) generalizes for any $m \geq 0$ the Stanley lattice [Sta75, Knu04] (resp. Tamari lattice), which occurs when $m = 1$. Our generalization of Tamari lattices is different from the classical one introduced in [BPR12]. Besides, from these posets Hi_m and Ca_m , one defines respectively two quotient algebras \mathbf{Hi}_m and \mathbf{Ca}_m of \mathbf{Cl}_m . Notably, The algebra \mathbf{Ca}_1 is isomorphic to PBT, and the other ones \mathbf{Ca}_m , $m \geq 2$, are not free as associative algebras.

This paper is organized as follows.

Section 1 is intended to introduce δ -cliffs and to set some notations and recalls about poset theory. As a by-product in the process of establishing links between the posets $\text{Cl}_\delta(n)$ and the weak Bruhat order, we introduce an alternative poset $(\text{Cl}_\delta(n), \preceq')$ when δ satisfies some particular conditions. We prove that when $\delta = 1$, the obtained poset is the weak Bruhat order and we conjecture that for all authorized range maps δ , the posets $(\text{Cl}_\delta(n), \preceq')$ are semi-distributive lattices. Besides, even if the posets $\text{Cl}_\delta(n)$ have a very simple structure, they contain interesting subposets $\mathcal{S}(n)$. To study these substructures, we establish a series of sufficient conditions on $\mathcal{S}(n)$ for the fact that these posets are EL-shellable [BW96, BW97], are lattices (and give algorithms to compute the meet and the join of two elements), and are constructible by interval doubling [Day79]. Moreover, under some precise conditions, each subposet $\mathcal{S}(n)$ can be seen as a geometric object in \mathbb{R}^n . We call this the geometric realization of $\mathcal{S}(n)$. We introduce here the notion of cell and expose a way to compute the volume of the geometrical object.

Next, in Section 2, we study the posets Av_δ , Hi_δ , and Ca_δ . For each of these, we provide some general properties (EL-shellability, lattice property, constructibility by interval doubling), and describe its input-wings, output-wings, and butterflies elements, that are elements having respectively a maximal number of covered elements, covering elements, or both properties at the same time. We observe a surprising phenomenon: some posets Av_δ , Hi_δ , or Ca_δ are isomorphic to their subposets restrained on input-wings, output-wings, or butterflies elements. Moreover, a notable link among other ones is that the subposet of $\text{Ca}_m(n)$ is isomorphic to the subposet of $\text{Hi}_{m-1}(n)$ restrained to its input-wings. We also study further interactions between our three families of Fuss–Catalan posets: there are for instance bijective posets morphisms (but not poset isomorphisms) between Av_δ and Ca_δ , and between Ca_δ and Hi_δ , when δ is increasing.

Finally, Section 3 presents a study of the algebra \mathbf{Cl}_δ . We start by introducing a natural coproduct on \mathbf{Cl}_δ in order to obtain by duality a product, associative in some cases. Three alternative bases of \mathbf{Cl}_δ are introduced, including two that are multiplicative and are defined from the order on δ -cliffs. We then rely on these bases to give a presentation by generators and relations of \mathbf{Cl}_δ . When δ is valley-free and is 1-dominated (that is a certain condition on range maps), \mathbf{Cl}_δ admits a finite presentation (a finite number of generators and a finite number of nontrivial relations between the generators). When δ is weakly increasing, \mathbf{Cl}_δ is free as an associative algebra. We end this work by constructing, given a subfamily \mathcal{S} of Cl_δ , a quotient space $\mathbf{Cl}_\mathcal{S}$ of \mathbf{Cl}_δ isomorphic to the linear span of \mathcal{S} . A sufficient condition on \mathcal{S} to have moreover a quotient algebra of \mathbf{Cl}_δ is introduced. We also describe a sufficient condition on \mathcal{S} for the fact that the product of two basis elements of $\mathbf{Cl}_\mathcal{S}$ is an interval of a poset $\mathcal{S}(n)$. These results are applied to construct and study the two quotients $\mathbf{Hi}_m := \mathbf{Cl}_{\text{Hi}_m}$ and $\mathbf{Ca}_m := \mathbf{Cl}_{\text{Ca}_m}$ of \mathbf{Cl}_m . The algebra \mathbf{Ca}_1 is isomorphic to the Loday–Ronco algebra and the other algebras \mathbf{Ca}_m , $m \geq 2$, provide

generalizations of this later which are not free. On the other hand, for any $m \geq 1$, all \mathbf{Hi}_m are other associative algebras whose dimensions are also Fuss–Catalan numbers and are not free.

This paper is an extended version of [CG20] containing the proofs of the presented results and presenting new ones as the geometrical aspects of the studied posets.

General notations and conventions

For any integers i and j , $[i, j]$ denotes the set $\{i, i + 1, \dots, j\}$. For any integer i , $[i]$ denotes the set $[1, i]$ and $\llbracket i \rrbracket$ denotes the set $[0, i]$. Graded sets are sets decomposing as a disjoint union $S = \bigsqcup_{n \geq 0} S(n)$. For any $x \in S$, the unique $n \geq 0$ such that $x \in S(n)$ is the degree $|x|$ of x . A graded subset of S is a graded set S' such that for all $n \geq 0$, $S'(n) \subseteq S(n)$. The generating series of S is the series $\mathcal{G}_S(t) := \sum_{x \in S} t^{|x|}$. The empty word is denoted by ϵ . If P is a statement, we denote by $\mathbb{1}_P$ the indicator function (equals to 1 if P holds and 0 otherwise).

1. δ -cliff posets and general properties

This section is devoted to introduce the lattices of δ -cliffs and to set some notations and definitions about posets and lattices. Then, we will review some properties of its subposets, like EL-shellability, constructibility by interval doubling, and geometric realizations.

1.1. δ -cliffs

We introduce here δ -cliffs, their links with Lehmer codes, permutations, and particular increasing trees.

1.1.1 First definitions

A *range map* is a map $\delta : \mathbb{N} \setminus \{0\} \rightarrow \mathbb{N}$. We shall specify range maps as infinite words $\delta = \delta(1)\delta(2)\dots$. For this purpose, for any $a \in \mathbb{N}$, we shall denote by a^ω the infinite word having all its letters equal to a . We say that δ

- is *rooted* if $\delta(1) = 0$;
- is *weakly increasing* if for all $i \geq 1$, $\delta(i) \leq \delta(i + 1)$;
- is *increasing* if for all $i \geq 1$, $\delta(i) < \delta(i + 1)$;
- has an *ascent* if there are $1 \leq i_1 < i_2$ such that $\delta(i_1) < \delta(i_2)$;
- has an *descent* if there are $1 \leq i_1 < i_2$ such that $\delta(i_1) > \delta(i_2)$;
- has a *valley* if there are $1 \leq i_1 < i_2 < i_3$ such that $\delta(i_1) > \delta(i_2) < \delta(i_3)$;
- is *valley-free* (or *unimodal*) if δ has no valley;
- is *j -dominated* for a $j \geq 1$ if there is $k \geq 1$ such that for all $k' \geq k$, $\delta(j) \geq \delta(k')$.

For any $n \geq 0$, the n -th dimension of δ is the integer $\dim_n(\delta) := \#\{i \in [n] : \delta(i) \neq 0\}$.

Given a range map δ , a word u of nonnegative integers of length n is a δ -cliff if for any $i \in [n]$, $u_i \in \llbracket \delta(i) \rrbracket$. The size $|u|$ of a δ -cliff u is its length as a word, and the weight $\omega(u)$ of u is the sum of its letters. The graded set of all δ -cliffs where the degree of a δ -cliff is its size, is denoted by Cl_δ . In the sequel, for any $m \geq 0$, we shall denote by \mathbf{m} the range map satisfying $\mathbf{m}(i) = (i - 1)m$ for any $i \in \mathbb{N} \setminus \{0\}$. For instance,

$$\text{Cl}_1(3) = \{000, 001, 002, 010, 011, 012\}, \tag{1.1a}$$

$$\text{Cl}_2(3) = \{000, 001, 002, 003, 004, 010, 011, 012, 013, 014, 020, 021, 022, 023, 024\}. \tag{1.1b}$$

Let us denote respectively by $\bar{0}_\delta(n)$ and by $\bar{1}_\delta(n)$ the δ -cliffs 0^n and $\delta(1) \dots \delta(n)$.

It follows immediately from the definition of δ -cliffs that the cardinality of $\text{Cl}_\delta(n)$ satisfies

$$\#\text{Cl}_\delta(n) = \prod_{i \in [n]} (\delta(i) + 1). \tag{1.2}$$

The first numbers of \mathbf{m} -cliffs are

$$1, 1, 1, 1, 1, 1, 1, 1, \quad m = 0, \tag{1.3a}$$

$$1, 1, 2, 6, 24, 120, 720, 5040, \quad m = 1, \tag{1.3b}$$

$$1, 1, 3, 15, 105, 945, 10395, 135135, \quad m = 2. \tag{1.3c}$$

Last sequence is Sequence **A001147** of [Slo].

1.1.2 Lehmer codes and permutations

There is a classical correspondence between permutations and so-called *Lehmer codes* [Leh60], that are certain words of integers. Here, we consider a slight variation of Lehmer codes, establishing a bijection between the set of 1-cliffs of size n and the set of permutations of the same size. Given a permutation σ of size n , let the 1-cliff u such that for any $j \in [n]$, u_j is the number of values i such that $i < j$ while $\sigma^{-1}(i) > \sigma^{-1}(j)$. We denote by $\text{leh}(\sigma)$ the 1-cliff thus associated with the permutation σ . For instance, $\text{leh}(436512) = 002323$.

1.1.3 Weakly increasing range maps and increasing trees

Given a rooted weakly increasing range map δ , let $\Delta_\delta : \mathbb{N} \setminus \{0\} \rightarrow \mathbb{N}$ be the map defined by $\Delta_\delta(i) := \delta(i + 1) - \delta(i)$. For instance, for any $a \geq 0$, $\Delta_{a^\omega} = 0^\omega$, and for any $m \geq 0$, $\Delta_{\mathbf{m}} = m^\omega$. A δ -increasing tree is a planar rooted tree where internal nodes are bijectively labeled from 1 to n , any internal node labeled by $i \in [n]$ has arity $\Delta_\delta(i) + 1$, and every children of any node labeled by $i \in [n]$ are leaves or are internal nodes labeled by $j \in [n]$ such that $j > i$. The size of such a tree is its number of internal nodes. The leaves of a δ -increasing tree are implicitly numbered from 1 to its total number of leaves from left to right.

Observe that, regardless of any particular condition on δ , any δ -cliff u of size $n \geq 1$ recursively decomposes as $u = u'a$ where $a \in \llbracket \delta(n) \rrbracket$ and u' is a δ -cliff of size $n - 1$. Relying on this observation, when δ is rooted and weakly increasing, let tree_δ be the map sending any δ -cliff

u of size n to the δ -increasing tree of size n recursively defined as follows. If $n = 0$, $\text{tree}_\delta(u)$ is the leaf. Otherwise, by using the above decomposition of u , $\text{tree}_\delta(u)$ is the tree obtained by grafting on the $(a + 1)$ -st leaf of the tree $\text{tree}(u')$ a node of arity $\Delta_\delta(n) + 1$ labeled by n . For instance,

$$\text{tree}_2(0230228) = \begin{array}{c} \textcircled{1} \\ \swarrow \quad \searrow \\ \textcircled{4} \quad \textcircled{2} \\ \swarrow \quad \searrow \quad \swarrow \quad \searrow \\ \textcircled{5} \quad \textcircled{7} \quad \textcircled{3} \\ \swarrow \quad \searrow \quad \swarrow \quad \searrow \\ \textcircled{6} \quad \square \quad \square \quad \square \end{array} \quad (1.4)$$

and for $\delta := 0233579^\omega$, one has $\Delta_\delta = 2102220^\omega$, and

$$\text{tree}_\delta(021042) = \begin{array}{c} \textcircled{1} \\ \swarrow \quad \searrow \\ \textcircled{4} \quad \textcircled{3} \quad \textcircled{2} \\ \swarrow \quad \searrow \quad \swarrow \quad \searrow \\ \textcircled{6} \quad \textcircled{5} \\ \swarrow \quad \searrow \quad \swarrow \quad \searrow \\ \square \quad \square \quad \square \quad \square \end{array} \quad (1.5)$$

Proposition 1.1. *For any rooted weakly increasing range map δ , tree_δ is a one-to-one correspondence from the set of all δ -cliffs of size $n \geq 0$ and the set of all δ -increasing trees of size n .*

Proof. Let us first prove that tree_δ is a well-defined map. This can be done by induction on n and arises from the fact that, for any $u \in \text{Cl}_\delta(n)$, the total number of leaves of $\text{tree}_\delta(u)$ is $1 + \delta(n + 1)$. This is a consequence of the fact that

$$1 + \delta(n) - 1 + \Delta_\delta(n) + 1 = 1 + \delta(n + 1). \quad (1.6)$$

Therefore, there is in $\text{tree}_\delta(u)$ a leaf of index $a + 1$ for any value $a \in \llbracket \delta(n + 1) \rrbracket$. Hence, and due to the fact that by construction, $\text{tree}_\delta(u)$ is a δ -increasing tree, the map tree_δ is well-defined.

Now, let ϕ be the map from the set of all δ -increasing trees of size n to $\text{Cl}_\delta(n)$ defined recursively as follows. If \mathfrak{t} is the leaf, set $\phi(\mathfrak{t}) := \epsilon$. Otherwise, consider the node with the maximal label in \mathfrak{t} . Since \mathfrak{t} is increasing, this node has no children. Set \mathfrak{t}' as the δ -increasing tree obtained by replacing this node by a leaf in \mathfrak{t} , and set a as the index of the leaf of \mathfrak{t}' on which this maximal node of \mathfrak{t} is attached (this index is 1 if \mathfrak{t}' is the leaf). Then, set $\phi(\mathfrak{t}) := \phi(\mathfrak{t}')(a - 1)$. The statement of the proposition follows by showing by induction on n that ϕ is the inverse of the map tree_δ . \square

In [CP19], s -decreasing trees are considered, where s is a sequence of length $n \geq 0$ of nonnegative integers. These trees are labeled decreasingly and any internal node labeled by $i \in [n]$ has arity s_i . As a consequence of Proposition 1.1, any s -decreasing tree can be encoded by a δ -increasing tree where δ is a rooted weakly increasing range map satisfying $\delta(i) = \sum_{1 \leq j \leq i-1} s_{n-j+1}$ for all $i \in [n + 1]$. The correspondence between such s -decreasing trees and δ -increasing trees consists in relabeling by $n + 1 - i$ each internal node labeled by $i \in [n]$. A consequence of all this is that δ -cliffs can be seen as generalizations of s -decreasing trees by relaxing the considered conditions on δ .

1.2. δ -cliff posets

We endow now the set of all δ -cliffs of a given size with an order relation, give some recalls about poset and lattice theory, and establish a link between the poset of 1-cliffs and the weak Bruhat order of permutations.

1.2.1 First definitions

Let δ be a range map and \preceq be the partial order relation on Cl_δ defined by $u \preceq v$ for any $u, v \in \text{Cl}_\delta$ such that $|u| = |v|$ and $u_i \leq v_i$ for all $i \in [|u|]$. For any $n \geq 0$, the poset $(\text{Cl}_\delta(n), \preceq)$ is the δ -cliff poset of order n . Figure 1.1 shows the Hasse diagrams of some δ -cliff posets.

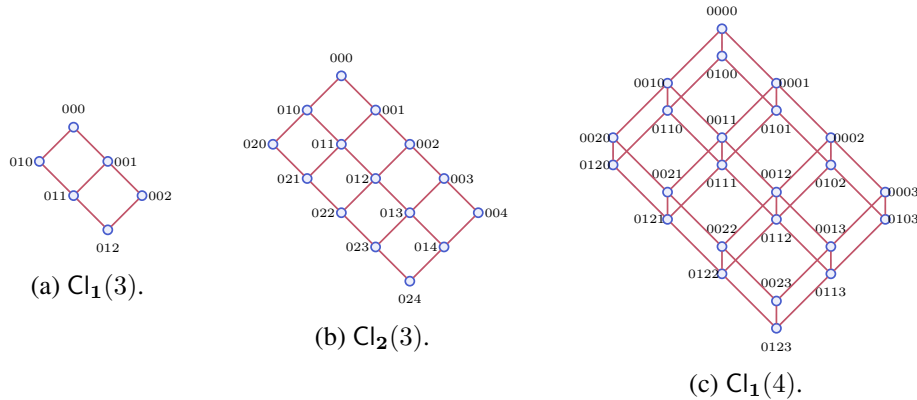

Figure 1.1: Hasse diagrams of some δ -cliff posets.

Let us introduce some notation about δ -cliffs. For any $u \in \text{Cl}_\delta(n)$ and $i \in [n]$, let $\downarrow_i(u)$ (resp. $\uparrow_i(u)$) be the word on \mathbb{Z} of length n obtained by decrementing (resp. incrementing) by 1 the i -th letter of u . Let also, for any $u, v \in \text{Cl}_\delta(n)$, $D(u, v) := \{i \in [n] : u_i \neq v_i\}$ be the set of all indices of different letters between u and v . For any $u, v \in \text{Cl}_\delta(n)$, let $u \wedge v$ be the δ -cliff of size n defined for any $i \in [n]$ by $(u \wedge v)_i := \min\{u_i, v_i\}$. We also define $u \vee v$ similarly by replacing the min operation by max in the previous definition. For any $u, v \in \text{Cl}_\delta(n)$, the *difference* between v and u is the word $v - u$ on \mathbb{Z} of length n defined for any $i \in [n]$ by $(v - u)_i := v_i - u_i$. Observe that when $u \preceq v$, $v - u$ is a δ -cliff. The δ -complementary $c_\delta(u)$ of $u \in \text{Cl}_\delta(n)$ is the δ -cliff $\bar{1}_\delta(n) - u$. For instance, by setting $u := 0010$, if u is seen as a 1-cliff, then $c_1(u) = 0113$, and if u is seen as a 2-cliff, then $c_2(u) = 0236$. This map c_δ is an involution.

1.2.2 First properties and recalls

A study of the 1-cliff posets appears in [Den13]. Our definition stated here depending on δ is therefore a generalization of these posets. The structure of the δ -cliff posets is very simple since each of these posets of order n is isomorphic to the Cartesian product $[\delta(1)] \times \dots \times [\delta(n)]$, where $[k]$ is the total order on $k + 1$ elements. It follows from this observation that each δ -cliff poset is a lattice admitting respectively \wedge and \vee as meet and join operations. Recall that a lattice $(\mathcal{L}, \wedge, \vee)$ is *distributive* if for all $x, y, z \in \mathcal{L}$, $x \wedge (y \vee z) = (x \wedge y) \vee (x \wedge z)$. Recall also that all distributive lattices are modular and graded [Sta11]. Since total orders are distributive and the distributivity is preserved by the Cartesian product of posets, $\text{Cl}_\delta(n)$ is a distributive lattice.

Recall that the *covering relation* of a poset \mathcal{P} is the set of all pairs $(x, y) \in \mathcal{P}^2$ such that the interval $[x, y]$ has cardinality 2. It follows immediately from the definition of \preceq that the covering relation \prec of $\text{Cl}_\delta(n)$ satisfies $u \prec v$ if and only if there is an index $i \in [n]$ such that $v = \uparrow_i(u)$.

Moreover, these posets $\text{Cl}_\delta(n)$ are graded, and the rank of a δ -cliff u is $\omega(u)$. The least element of the poset is $\bar{0}_\delta(n)$ while the greatest element $\bar{1}_\delta(n)$.

Let us make some reminders about poset morphisms used thereafter. If $(\mathcal{P}_1, \preceq_1)$ and $(\mathcal{P}_2, \preceq_2)$ are two posets, a map $\phi : \mathcal{P}_1 \rightarrow \mathcal{P}_2$ is a *poset morphism* if for any $x, y \in \mathcal{P}_1$, $x \preceq_1 y$ implies $\phi(x) \preceq_2 \phi(y)$. We say that \mathcal{P}_2 is an *order extension* of a poset \mathcal{P}_1 if there is a map $\phi : \mathcal{P}_1 \rightarrow \mathcal{P}_2$ which is both a bijection and a poset morphism. A map $\phi : \mathcal{P}_1 \rightarrow \mathcal{P}_2$ is a *poset embedding* if for any $x, y \in \mathcal{P}_1$, $x \preceq_1 y$ if and only if $\phi(x) \preceq_2 \phi(y)$. Observe that a poset embedding is necessarily injective. A map $\phi : \mathcal{P}_1 \rightarrow \mathcal{P}_2$ is a *poset isomorphism* if ϕ is both a bijection and a poset embedding.

1.2.3 Links with the weak Bruhat order

Let \mathfrak{S} be the graded set of all permutations where the degree of a permutation is its length as a word. A *coinversion* of a permutation σ is a pair (σ_j, σ_i) such that $\sigma_j < \sigma_i$ and $i < j$. For any $n \geq 0$, the *weak Bruhat order* of order n is a partial order $(\mathfrak{S}(n), \preceq_{\mathfrak{S}})$ wherein for any $\sigma, \nu \in \mathfrak{S}(n)$, $\sigma \preceq_{\mathfrak{S}} \nu$ if the set of all coinversions of σ is contained in the set of all coinversions of ν . By denoting by s_i , $i \in [n-1]$, the i -th elementary transposition, the covering relation $\prec_{\mathfrak{S}}$ of this poset satisfies $\sigma \prec_{\mathfrak{S}} \sigma s_i$ for any $\sigma \in \mathfrak{S}(n)$ and any $i \in [n-1]$ such that $\sigma_i < \sigma_{i+1}$.

When δ is a rooted weakly increasing range map, let us consider the binary relation \prec' on $\text{Cl}_\delta(n)$ defined as follows. Let $u, v \in \text{Cl}_\delta$ and $\mathfrak{t} := \text{tree}_\delta(u)$. We have $u \prec' v$ if there is an index $i \in [n]$ such that $v = \uparrow_i(u)$ and all the children of the node labeled by i of \mathfrak{t} are leaves, except possibly the first of its brotherhood. For instance, for $\delta := 0233579^\omega$ and the δ -cliff $u := 021042$, since

$$\text{tree}_\delta(u) = \begin{array}{c} \textcircled{1} \\ \swarrow \quad \downarrow \quad \searrow \\ \textcircled{4} \quad \textcircled{3} \quad \textcircled{2} \\ \swarrow \downarrow \searrow \quad \swarrow \downarrow \searrow \\ \textcircled{6} \quad \textcircled{5} \\ \swarrow \downarrow \searrow \quad \swarrow \downarrow \searrow \\ \square \quad \square \quad \square \quad \square \quad \square \quad \square \end{array}, \quad (1.7)$$

we observe that all the children of the nodes labeled by 2, 3, 5 and 6 are leaves, except possibly the first ones. For this reason, u is covered by $\uparrow_3(u) = 022042$ and by $\uparrow_6(u) = 021043$, but not by $\uparrow_2(u) = 031042$ since this word is not a δ -cliff.

The reflexive and transitive closure \preceq' of this relation is an order relation. By Proposition 1.1, this endows the set of all δ -increasing trees with a poset structure. It follows immediately from the description of the covering relation \prec of $\text{Cl}_\delta(n)$ provided in Section 1.2.2 that \prec' is a refinement of \prec . For this reason $(\text{Cl}_\delta(n), \preceq')$ is an order extension of $(\text{Cl}_\delta(n), \preceq)$. Figure 1.2 shows an example of a Hasse diagram of such a poset.

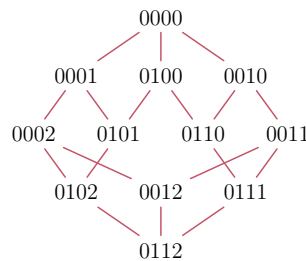

Figure 1.2: The Hasse diagram of the poset $(\text{Cl}_{0112^\omega}(4), \preceq')$.

Proposition 1.2. *For any $n \geq 0$, the poset $(Cl_1(n), \preceq')$ is isomorphic to the weak Bruhat order on permutations of size n .*

Proof. Let ϕ be the map from the set of all words u of size n of integers without repeated letters to the set of increasing binary trees of size n where internal nodes are bijectively labeled by the letters of u , defined recursively as follows. If σ is the empty word, then $\phi(\sigma)$ is the leaf. Otherwise, σ decomposes as $\sigma = waw'$ where a is the least letter of σ , and w and w' are words of integers. In this case, $\phi(\sigma)$ is the binary tree consisting in a root labeled by a and having as left subtree $\phi(w')$ and as right subtree $\phi(w)$ —observe the reversal of the order between w and w' . Now, by induction on n , one can prove that for any permutation σ of size n , the binary trees $\phi(\sigma)$ and $tree_1(\text{leh}(\sigma))$ are the same.

Assume that σ and ν are two permutations such that $\sigma \leq_{\mathfrak{S}} \nu$. Thus, by definition of $\leq_{\mathfrak{S}}$, σ decomposes as $\sigma = wabw'$ and ν as $\nu = wba w'$ where a and b are letters such that $a < b$, and w and w' are words of integers. By definition of ϕ , since a and b are adjacent in σ , the right subtree of the node labeled by b of $\phi(\sigma)$ is empty. Therefore, due to the property stated in the first part of the proof, and by definition of the map $tree_1$ and of the covering relation \leq' , one has $\text{leh}(\sigma) \leq' \text{leh}(\nu)$. Conversely, assume that u and v are two 1-cliffs such that $u \leq' v$. Thus, by definition of \leq' , v is obtained by changing a letter $u_i, i \geq 2$, in u by $u_i + 1$, and in $tree_1(u)$, the right subtree of the node labeled by i is empty. Let $\sigma := \text{leh}^{-1}(u)$ and $\nu := \text{leh}^{-1}(v)$. Since $\phi(\sigma)$ and $tree_1(u)$ are the same increasing binary trees, we have, from the definition of the map ϕ , that $u_{i-1} < u_i$. Finally, by definition of $\leq_{\mathfrak{S}}$, one obtains $\sigma \leq_{\mathfrak{S}} \nu$.

We have shown that the bijection leh between $\mathfrak{S}(n)$ and $Cl_1(n)$ is such that, for any $\sigma, \nu \in \mathfrak{S}(n)$, $\sigma \leq_{\mathfrak{S}} \nu$ if and only if $\text{leh}(\sigma) \leq' \text{leh}(\nu)$. For this reason, leh is a poset isomorphism. □

Therefore, Proposition 1.2 says in particular that the 1-cliff poset is an extension of the weak Bruhat order. Besides, for all rooted weakly increasing range maps δ , one can see $(Cl_{\delta}(n), \preceq')$ as generalizations of the weak Bruhat order. Supported by some computer experiments, we state the following conjecture.

Conjecture 1.3. *For any rooted weakly increasing range map δ and any $n \geq 0$, the poset $(Cl_{\delta}(n), \preceq')$ is a semi-distributive lattice.*

1.3. Subposets of δ -cliff posets

Despite their simplicity, the δ -cliff posets contain subposets having a lot of combinatorial and algebraic properties. If \mathcal{S} is a graded subset of Cl_{δ} , each $\mathcal{S}(n), n \geq 0$, is a subposet of $Cl_{\delta}(n)$ for the order relation \preceq . We denote by $\leq_{\mathcal{S}}$ the covering relation of each $\mathcal{S}(n), n \geq 0$.

We say that \mathcal{S} is

- *spread* if for any $n \geq 0, \bar{0}_{\delta}(n) \in \mathcal{S}$ and $\bar{1}_{\delta}(n) \in \mathcal{S}$;
- *straight* if for any $u, v \in \mathcal{S}$ such that $u \leq_{\mathcal{S}} v, \#D(u, v) = 1$;
- *coated* if for any $n \geq 0$, any $u, v \in \mathcal{S}(n)$ such that $u \preceq v$, and any $i \in [n - 1], u_1 \dots u_i v_{i+1} \dots v_n \in \mathcal{S}$;

- *closed by prefix* if for any $u \in \mathcal{S}$, all prefixes of u (that are words $u_1 \dots u_k$ where $k \in \llbracket |u| \rrbracket$) belong to \mathcal{S} ;
- *minimally extendable* if $\epsilon \in \mathcal{S}$ and for any $u \in \mathcal{S}$, $u0 \in \mathcal{S}$;
- *maximally extendable* if $\epsilon \in \mathcal{S}$ and for any $u \in \mathcal{S}$, $u\delta(|u| + 1) \in \mathcal{S}$.

Observe that when \mathcal{S} is spread, each poset $\mathcal{S}(n)$, $n \geq 0$, is *bounded*, that is it admits a least and a greatest element. Observe also that if \mathcal{S} is both minimally and maximally extendable, then \mathcal{S} is spread.

Lemma 1.4. *Let δ be a range map and \mathcal{S} be a coated graded subset of Cl_δ . Then, \mathcal{S} is straight.*

Proof. Let $n \geq 0$ and $u, v \in \mathcal{S}(n)$ such that $u \preceq v$ and $\#D(u, v) \geq 2$. Set $j := \max D(u, v)$ and $w := u_1 \dots u_{j-1} v_j v_{j+1} \dots v_n$. Since \mathcal{S} is coated, w belongs to \mathcal{S} , and moreover, since j is maximal, $w := u_1 \dots u_{j-1} v_j u_{j+1} \dots u_n$. Therefore, $\#D(u, w) = 1$. This proves that there exists a $w' \in \mathcal{S}(n)$ such that $u \preceq_{\mathcal{S}} w' \preceq w$ and $\#D(u, w') = 1$. Thus, \mathcal{S} is straight. \square

We use here the notion of n -th dimension of range maps, defined in Section 1.1.1. In the case where \mathcal{S} is straight, we define the graded set of

- *input-wings* as the set $\mathcal{I}(\mathcal{S})$ containing any $u \in \mathcal{S}$ which covers exactly $\dim_{|u|}(\delta)$ elements;
- *output-wings* as the set $\mathcal{O}(\mathcal{S})$ containing any $u \in \mathcal{S}$ which is covered by exactly $\dim_{|u|}(\delta)$ elements;
- *butterflies* as the set $\mathcal{B}(\mathcal{S})$ being the intersection $\mathcal{I}(\mathcal{S}) \cap \mathcal{O}(\mathcal{S})$.

Equivalently, $u \in \mathcal{S}$ is an input-wing (resp. output-wing) if it is possible to decrement (resp. increment) all values at all positions $i \in \llbracket |u| \rrbracket$ such that $\delta(i) \neq 0$. Observe also that if there is an $i \geq 1$ such that $\delta(i) = 1$, there are no butterfly in $\mathcal{S}(n)$ for all $n \geq i$.

We present now general results about subsets $\mathcal{S}(n)$, $n \geq 0$, of δ -cliff posets.

1.3.1 EL-shellability

Let $(\mathcal{P}, \preceq_{\mathcal{P}})$ and $(\Lambda, \preceq_{\Lambda})$ be two posets, and $\lambda : \preceq_{\mathcal{P}} \rightarrow \Lambda$ be a map (here $\preceq_{\mathcal{P}}$ is seen as the set of all pairs (u, v) such that v covers u in \mathcal{P}). For any saturated chain $(x^{(1)}, \dots, x^{(k)})$ of \mathcal{P} , by a slight abuse of notation, we set

$$\lambda(x^{(1)}, \dots, x^{(k)}) := (\lambda(x^{(1)}, x^{(2)}), \dots, \lambda(x^{(k-1)}, x^{(k)})). \quad (1.8)$$

We say that a saturated chain of \mathcal{P} is *λ -increasing* (resp. *λ -weakly decreasing*) if its image by λ is an increasing (resp. weakly decreasing) word w.r.t. the partial order relation \preceq_{Λ} . We say also that a saturated chain $(x^{(1)}, \dots, x^{(k)})$ of \mathcal{P} is *λ -smaller* than a saturated chain $(y^{(1)}, \dots, y^{(\ell)})$ of \mathcal{P} if the image by λ of $(x^{(1)}, \dots, x^{(k)})$ is smaller than the image by λ of $(y^{(1)}, \dots, y^{(\ell)})$ for the lexicographic order induced by \preceq_{Λ} . The map λ is an *EL-labeling* of \mathcal{P} if there exist such a poset Λ and a map λ such that for any $x, y \in \mathcal{P}$ satisfying $x \preceq_{\mathcal{P}} y$, there is exactly one λ -increasing saturated chain from x to y which is minimal among all saturated chains from x to y w.r.t. the

order on saturated chains just described. The poset \mathcal{P} is *EL-shellable* [BW96, BW97] if \mathcal{P} is bounded and admits an EL-labeling.

The EL-shellability of a poset \mathcal{P} implies several topological and order theoretical properties of the associated order complex $\Delta(\mathcal{P})$ made of all the chains of \mathcal{P} . For instance, one of the consequences for \mathcal{P} for having at most one λ -weakly decreasing chain between any pair of its elements is that the Möbius function of \mathcal{P} takes values in $\{-1, 0, 1\}$. In an equivalent way, the simplicial complex associated with each open interval of \mathcal{P} is either contractile or has the homotopy type of a sphere [BW97].

For the sequel, we set Λ as the poset \mathbb{Z}^2 wherein elements are ordered lexicographically. For any straight graded subset \mathcal{S} of Cl_δ , let us introduce the map $\lambda_{\mathcal{S}} : \leq_{\mathcal{S}} \rightarrow \mathbb{Z}^2$ defined for any $(u, v) \in \leq_{\mathcal{S}}$ by $\lambda_{\mathcal{S}}(u, v) := (-i, u_i)$ where i is the unique index $i \in \llbracket u \rrbracket$ such that $D(u, v) = \{i\}$. Observe that the fact that \mathcal{S} is straight ensures that $\lambda_{\mathcal{S}}$ is well-defined.

Theorem 1.5. *Let δ be a range map and \mathcal{S} be a coated graded subset of Cl_δ . For any $n \geq 0$, the map $\lambda_{\mathcal{S}}$ is an EL-labeling of $\mathcal{S}(n)$. Moreover, there is at most one $\lambda_{\mathcal{S}}$ -weakly decreasing chain between any pair of elements of $\mathcal{S}(n)$.*

Proof. By Lemma 1.4, the fact that \mathcal{S} is coated implies that \mathcal{S} is also straight. Let $u, v \in \mathcal{S}(n)$ such that $u \preceq v$. Since \mathcal{S} is straight, the image by $\lambda_{\mathcal{S}}$ of any saturated chain from u to v is well-defined.

Now, let $(u = w^{(0)}, w^{(1)}, \dots, w^{(k)} = v)$ be the sequence of elements of $\mathcal{S}(n)$ defined in the following way. For any $i \in \llbracket k - 1 \rrbracket$, the word $w^{(i+1)}$ is obtained from $w^{(i)}$ by increasing by the minimal possible value $a \geq 1$ the letter $w_j^{(i)}$ such that j is the greatest index satisfying $w_j^{(i)} < v_j$. By construction, for any $i \in \llbracket k - 1 \rrbracket$, each $w^{(i+1)}$ writes as $w^{(i+1)} = u_1 \dots u_{j-1} (u_j + a) v_{j+1} \dots v_n$, where a is some positive integer. There is at least one value a such that $w^{(i)}$ belongs to $\mathcal{S}(n)$ since by hypothesis, \mathcal{S} is coated. For this reason, the considered sequence is a well-defined saturated chain in $\mathcal{S}(n)$. This saturated chain is also $\lambda_{\mathcal{S}}$ -increasing by construction. Moreover, since \mathcal{S} is straight, if one consider another saturated chain from u to v , this chain passes through a word obtained by incrementing a letter which has not a greatest index, and one has to choose later in the chain the letter of the smallest index to increment it. For this reason, this saturated chain would not be $\lambda_{\mathcal{S}}$ -increasing.

Assume now that there exists in \mathcal{S} a $\lambda_{\mathcal{S}}$ -weakly decreasing saturated chain of the form $(u = w^{(0)}, w^{(1)}, \dots, w^{(k)} = v)$. By definition of $\lambda_{\mathcal{S}}$ and of the poset Λ , for any $i \in \llbracket k - 1 \rrbracket$, the word $w^{(i+1)}$ is obtained from $w^{(i)}$ by increasing by the minimal possible value the letter $w_j^{(i)}$ such that j is the smallest index satisfying $w_j^{(i)} < v_j$. If it exists, this saturated chain is by construction the unique $\lambda_{\mathcal{S}}$ -weakly decreasing saturated chain from u to v . \square

1.3.2 Meet and join operations, sublattices, and lattices

Here we give some sufficient conditions on \mathcal{S} for the fact that each $\mathcal{S}(n)$, $n \geq 0$, is a lattice.

First, when \mathcal{S} is spread and, for any $n \geq 0$ and any $u, v \in \mathcal{S}(n)$, $u \wedge v \in \mathcal{S}$ (resp. $u \vee v \in \mathcal{S}$), by [Sta11], each $\mathcal{S}(n)$ is a lattice. Moreover, when both $u \wedge v \in \mathcal{S}$ and $u \vee v \in \mathcal{S}$, each $\mathcal{S}(n)$ is a sublattice of $\text{Cl}_\delta(n)$. Again by [Sta11], $\mathcal{S}(n)$ is in this case distributive and graded.

Second, assume instead that \mathcal{S} is minimally extendable. For any $n \geq 0$, the *\mathcal{S} -decrementation map* is the map $\Downarrow_{\mathcal{S}} : \text{Cl}_{\delta}(n) \rightarrow \mathcal{S}(n)$ defined recursively by $\Downarrow_{\mathcal{S}}(\epsilon) := \epsilon$ and, for any $ua \in \text{Cl}_{\delta}(n)$ where $u \in \text{Cl}_{\delta}$ and $a \in \mathbb{N}$, by $\Downarrow_{\mathcal{S}}(ua) := \Downarrow_{\mathcal{S}}(u) b$ where

$$b := \max\{b \leq a : \Downarrow_{\mathcal{S}}(u) b \in \mathcal{S}\}. \quad (1.9)$$

Observe that the fact that \mathcal{S} is minimally extendable ensures that $\Downarrow_{\mathcal{S}}$ is a well-defined map. Let also, for any $n \geq 0$ and $u, v \in \mathcal{S}(n)$, $u \wedge_{\mathcal{S}} v := \Downarrow_{\mathcal{S}}(u \wedge v)$.

When \mathcal{S} is maximally extendable, we denote by $\Uparrow_{\mathcal{S}}$ the *\mathcal{S} -incrementation map* defined in the same way as the \mathcal{S} -decrementation map with the difference that in the previous definitions, the operation \max is replaced by the operation \min and the relation \leq is replaced by the relation \geq . Here, the fact that \mathcal{S} is maximally extendable ensure that $\Uparrow_{\mathcal{S}}$ is well-defined. We also define the operation $\vee_{\mathcal{S}}$ in the same way as $\wedge_{\mathcal{S}}$ with the difference that in the previous definitions, the map $\Downarrow_{\mathcal{S}}$ is replaced by $\Uparrow_{\mathcal{S}}$ and the operation \wedge is replaced by the operation \vee .

Theorem 1.6. *Let δ be a range map and \mathcal{S} be a closed by prefix and minimally (resp. maximally) extendable graded subset of Cl_{δ} . The operation $\wedge_{\mathcal{S}}$ (resp. $\vee_{\mathcal{S}}$) is, for any $n \geq 0$, the meet (resp. join) operation of the poset $\mathcal{S}(n)$.*

Proof. Let us show the property of the statement of the theorem in the case where \mathcal{S} is minimally extendable. The other case is symmetric. We proceed by induction on $n \geq 0$. When $n = 0$, the property is trivially satisfied. Let $n \geq 1$ and $u, v \in \mathcal{S}(n)$. Since \mathcal{S} is closed by prefix, one has $u = u'a$ and $v = v'b$ with $u', v' \in \mathcal{S}(n-1)$ and $a, b \in \mathbb{N}$. Since \mathcal{S} is minimally extendable,

$$u \wedge_{\mathcal{S}} v = u'a \wedge_{\mathcal{S}} v'b = \Downarrow_{\mathcal{S}}((u' \wedge v') \min\{a, b\}) = \Downarrow_{\mathcal{S}}(u' \wedge v') c \quad (1.10)$$

where $c := \max\{c \leq \min\{a, b\} : \Downarrow_{\mathcal{S}}(u' \wedge v') c \in \mathcal{S}\}$. Now, by induction hypothesis, we obtain

$$\Downarrow_{\mathcal{S}}(u' \wedge v') c = (u' \wedge_{\mathcal{S}} v') c \quad (1.11)$$

where $\wedge_{\mathcal{S}}$ is the meet operation of the poset $\mathcal{S}(n-1)$. First, we deduce from the above computation that for any $i \in [n]$, the i -th letter of $u \wedge_{\mathcal{S}} v$ is nongreater than $\min\{u_i, v_i\}$, and that $u \wedge_{\mathcal{S}} v$ belongs to $\mathcal{S}(n)$. Therefore, $u \wedge_{\mathcal{S}} v$ is a lower bound of $\{u, v\}$. Second, by induction hypothesis, $w' := u' \wedge_{\mathcal{S}} v'$ is the greatest lower bound of $\{u', v'\}$. By construction, since c is the greatest letter such that $c \leq a$, $c \leq b$, and $w'c \in \mathcal{S}$ holds, any other lower bound of $\{u, v\}$ is smaller than $w'c$. This prove that $w'c$ is the greatest lower bound of $\{u, v\}$ and implies the statement of the theorem. \square

1.3.3 Join-irreducible elements

Recall that an element x of a lattice \mathcal{L} is *join-irreducible* (resp. *meet-irreducible*) if x covers (resp. is covered by) exactly one element in \mathcal{L} . We denote by $\mathbf{J}(\mathcal{L})$ (resp. $\mathbf{M}(\mathcal{L})$) the set of join-irreducible (resp. meet-irreducible) elements of \mathcal{L} . These notions are usually considered specially for lattices but we can take the same definitions even when \mathcal{L} is just a poset.

Proposition 1.7. *Let δ be a range map and \mathcal{S} be a straight graded subset of Cl_{δ} . For any $n \geq 0$, $u \in \mathcal{S}(n)$ is a join-irreducible (resp. meet-irreducible) element of $\mathcal{S}(n)$ if and only if there is a $k \geq 1$ and a unique $i \in [n]$ such that $\Downarrow_{\delta}^k(u) \in \mathcal{S}(n)$ (resp. $\Uparrow_{\delta}^k(u) \in \mathcal{S}(n)$).*

Proof. Assume first that u is a join-irreducible element of $\mathcal{S}(n)$. Then, there is exactly one element u' of \mathcal{S} such that $u' \prec_{\mathcal{S}} u$. Since \mathcal{S} is straight, $\#D(u', u) = 1$, implying that u satisfies the stated condition.

Conversely, assume that u satisfies the stated condition. Assume that there are $u', u'' \in \mathcal{S}(n)$ such that $u' \prec_{\mathcal{S}} u$ and $u'' \prec_{\mathcal{S}} u$. Since \mathcal{S} is straight, there exist $i', i'' \in [n]$ and $k', k'' \geq 1$ such that $u' = \downarrow_{i'}^{k'}(u)$ and $u'' = \downarrow_{i''}^{k''}(u)$. Due to the property satisfied by u , $i' = i''$, so that $u' = u''$ since u' and u'' are both covered by u . Therefore, u is join-irreducible.

The part of the statement of the proposition concerning the meet-irreducible elements is symmetric. \square

1.3.4 Constructibility by interval doubling

We denote by $\mathbf{2}$ the poset $\{0, 1\}$ endowed with the natural order relation on integers. Let (\mathcal{P}, \preceq) be a poset and I one of its intervals. The *interval doubling* of I in \mathcal{P} is the poset $\mathcal{P}[I] := (\mathcal{P} \setminus I) \sqcup (I \times \mathbf{2})$, having \preceq' as order relation, which is defined as follows. For any $x, y \in \mathcal{P}[I]$, one has $x \preceq' y$ if one of the following assertions is satisfied:

- (i) $x \in \mathcal{P} \setminus I, y \in \mathcal{P} \setminus I$, and $x \preceq y$;
- (ii) $x \in \mathcal{P} \setminus I, y = (y', b) \in I \times \mathbf{2}$, and $x \preceq y'$;
- (iii) $x = (x', a) \in I \times \mathbf{2}, y \in \mathcal{P} \setminus I$, and $x' \preceq y$;
- (iv) $x = (x', a) \in I \times \mathbf{2}, y = (y', b) \in I \times \mathbf{2}$, and $x' \preceq y'$ and $a \leq b$.

This operation has been introduced in [Day92] as an operation on posets preserving the property to being a lattice. On the other way round, we say that \mathcal{P} is obtained by an *interval contraction* from a poset \mathcal{P}' if there is an interval I of \mathcal{P} such that $\mathcal{P}[I]$ is isomorphic as a poset to \mathcal{P}' [CLCdPBM04].

A lattice \mathcal{L} is *constructible by interval doubling* (spelled as “*bounded*” in the original article) if \mathcal{L} is isomorphic as a poset to a poset obtained by performing a sequence of interval doubling from the singleton lattice. It is known from [Day79] that such lattices are semi-distributive. Recall that a finite lattice \mathcal{L} is constructible by interval doubling if and only if it is *congruence uniform*, and then in particular, the number of join-irreducible elements of \mathcal{L} determines the number of interval doubling steps needed to create \mathcal{L} (see [Day79] and [Müh19]).

The aim of this section is to introduce a sufficient condition on a graded subset \mathcal{S} of Cl_{δ} for the fact that each $\mathcal{S}(n), n \geq 0$, is constructible by interval doubling. We shall moreover describe explicitly the sequence of interval doubling operations involved in the construction of $\mathcal{S}(n)$ from the trivial lattice.

Let \mathcal{P} be a nonempty subposet of $\text{Cl}_{\delta}(n)$ for a given fixed size $n \geq 1$. Let us denote by $m(\mathcal{P})$ the letter $\max\{u_n : u \in \mathcal{P}\}$. For any $a, b \in [\delta(n)]$, let $\mathcal{P}_a := \{u \in \mathcal{P} : u_n = a\}$ and $\mathcal{P}_{a,b} := \{ub : ua \in \mathcal{P}_a\}$. Observe that \mathcal{P}_a is a subposet of \mathcal{P} while $\mathcal{P}_{a,b}$ may contain δ -cliffs that do not belong to \mathcal{P} . The *derivation* of \mathcal{P} is the set

$$D(\mathcal{P}) := \mathcal{P}_0 \cup \mathcal{P}_1 \cup \dots \cup \mathcal{P}_{m(\mathcal{P})-1} \cup \mathcal{P}_{m(\mathcal{P}),m(\mathcal{P})-1}. \tag{1.12}$$

In other words, $\mathcal{D}(\mathcal{P})$ is the set of all the cliffs obtained from \mathcal{P} by decrementing their last letters if they are equal to $m(\mathcal{P})$ or by keeping them as they are otherwise. Observe that $\mathcal{D}(\mathcal{P})$ is not necessarily a subposet of \mathcal{P} . Nevertheless, $\mathcal{D}(\mathcal{P})$ is still a subposet of $\text{Cl}_\delta(n)$. Observe also that $m(\mathcal{D}(\mathcal{P})) \leq m(\mathcal{P}) - 1$. For instance, by considering the subposet

$$\mathcal{P} := \{0000, 0111, 0002, 0112, 0103, 0104, 0004\} \quad (1.13)$$

of $\text{Cl}_2(4)$, we have $\mathcal{P}_{2, m(\mathcal{P})} = \{0004, 0114\}$ and

$$\mathcal{D}(\mathcal{P}) = \{0000, 0111, 0002, 0112, 0103, 0003\}. \quad (1.14)$$

The subposet \mathcal{P} is *nested* if it is nonempty and

(N1) for any $a \in \llbracket m(\mathcal{P}) \rrbracket$, the δ -cliff $0^{n-1}a$ belongs to \mathcal{P} ;

(N2) for any $a \in \llbracket m(\mathcal{P}) \rrbracket$, $\mathcal{P}_{a, m(\mathcal{P})}$ is both a subset and an interval of \mathcal{P} .

This definition still holds when $m(\mathcal{P}) = 0$. Observe that any δ -cliff $0^{n-1}a$, $a \geq 1$, of \mathcal{P} covers exactly the single element $0^{n-1}(a-1)$ of \mathcal{P} . This element exists by (N1). Therefore, when \mathcal{P} is a lattice, these δ -cliffs are join-irreducible.

Lemma 1.8. *Let δ be a range map and \mathcal{P} be a nonempty subposet of $\text{Cl}_\delta(n)$ for an $n \geq 1$. If \mathcal{P} is nested, then for any $a \in \llbracket m(\mathcal{P}) \rrbracket$, \mathcal{P}_a is an interval of \mathcal{P} .*

Proof. First, by (N1), \mathcal{P}_a admits $0^{n-1}a$ as unique least element. It remains to prove that \mathcal{P}_a has at most one greatest element. By contradiction, assume that there are in \mathcal{P}_a two different greatest elements ua and va , where $u, v \in \text{Cl}_\delta(n-1)$. Then, by setting $b := m(\mathcal{P})$, in $\mathcal{P}_{a,b}$ the δ -cliffs ub and vb are still incomparable. Since these two elements are also greatest elements of $\mathcal{P}_{a,b}$, this implies that $\mathcal{P}_{a,b}$ is not an interval in \mathcal{P} . This contradicts (N2). \square

Lemma 1.9. *Let δ be a range map and \mathcal{P} be a nonempty subposet of $\text{Cl}_\delta(n)$ for an $n \geq 1$. If $m(\mathcal{P}) \geq 1$ and \mathcal{P} is nested, then $\mathcal{D}(\mathcal{P})_{m(\mathcal{D}(\mathcal{P}))} = \mathcal{P}_{m(\mathcal{P}), m(\mathcal{P})-1}$.*

Proof. Let $b := m(\mathcal{P})$, $\mathcal{P}' := \mathcal{D}(\mathcal{P})$, and $b' := m(\mathcal{P}')$. First, since \mathcal{P} satisfies (N1), $b' = b - 1$. Moreover, directly from the definition of the derivation operation \mathcal{D} , we have $\mathcal{P}'_{b'} = \mathcal{P}_{b,b'} \cup \mathcal{P}_{b'}$. By (N2), $\mathcal{P}_{b',b}$ is a subset of \mathcal{P}_b , so that $\mathcal{P}_{b'}$ is a subset of $\mathcal{P}_{b,b'}$. Therefore, $\mathcal{P}'_{b'} = \mathcal{P}_{b,b'}$. \square

Lemma 1.10. *Let δ be a range map and \mathcal{P} be a nonempty subposet of $\text{Cl}_\delta(n)$ for an $n \geq 1$. If $m(\mathcal{P}) \geq 1$ and \mathcal{P} is nested, then $\mathcal{D}(\mathcal{P})$ is nested.*

Proof. Let $b := m(\mathcal{P})$, $\mathcal{P}' := \mathcal{D}(\mathcal{P})$, and $b' := m(\mathcal{P}')$. First, since \mathcal{P} satisfies (N1), $b' = b - 1$. Moreover, in particular, for any $a \in \llbracket b' \rrbracket$, $0^{n-1}a \in \mathcal{P}$. Hence, $0^{n-1}a \in \mathcal{P}'$, so that \mathcal{P}' satisfies (N1). Let $a \in \llbracket b' - 1 \rrbracket$. By (N2), $\mathcal{P}_{a,b}$ is an interval of \mathcal{P}_b . Due to the fact $a \leq b - 1$, one has $\mathcal{P}_a = \mathcal{P}'_a$, so that $\mathcal{P}'_{a,b}$ is an interval of \mathcal{P}_b . This is equivalent to the fact that $\mathcal{P}'_{a,b'}$ is an interval of $\mathcal{P}_{b,b'}$. By Lemma 1.9, the relation $\mathcal{P}'_{b'} = \mathcal{P}_{b,b'}$ holds and leads to the fact that $\mathcal{P}'_{a,b'}$ is an interval of $\mathcal{P}'_{b'}$. Therefore, \mathcal{P}' satisfies (N2). \square

Lemma 1.11. *Let δ be a range map and \mathcal{P} be a nonempty subset of $\text{Cl}_\delta(n)$ for an $n \geq 1$. If $m(\mathcal{P}) \geq 1$ and \mathcal{P} is nested, then \mathcal{P} is isomorphic as a poset to $\mathcal{D}(\mathcal{P})[I]$ where I is the interval $\mathcal{P}_{m(\mathcal{P})-1}$ of $\mathcal{D}(\mathcal{P})$.*

Proof. Let $b := m(\mathcal{P})$, $\mathcal{P}' := \mathcal{D}(\mathcal{P})$, and $b' := m(\mathcal{P}')$. By (N1), $b' = b - 1$. Let us first prove that $I = \mathcal{P}_{b'}$ is an interval of \mathcal{P}' . Let $u, v \in \mathcal{P}_{b'}$ such that $u \preceq v$. Assume that there exists $w \in \mathcal{P}'_{b'}$ such that $u \preceq w \preceq v$. Let us denote by u' (resp. v' , w') the prefix of size $n - 1$ of u (resp. v , w). By (N2), $u'b$ and $v'b$ belong to \mathcal{P}_b . Moreover, by Lemma 1.9, since $\mathcal{P}'_{b'} = \mathcal{P}_{b,b'}$, $w \in \mathcal{P}_{b,b'}$. Therefore, $w'b$ belongs to \mathcal{P}_b . Again by (N2), this leads to the fact that $w \in \mathcal{P}_{b'}$. This shows that the set $\mathcal{P}_{b'}$ is closed by interval in $\mathcal{P}'_{b'}$. Since finally, by Lemma 1.8, $\mathcal{P}_{b'}$ is an interval of \mathcal{P} , $\mathcal{P}_{b'}$ has a unique least and a unique greatest element. This implies that $\mathcal{P}_{b'}$ is an interval of \mathcal{P}' .

Since I is an interval of \mathcal{P}' , we can now consider the poset $\mathcal{P}'[I]$. By definition of the interval doubling operation, $\mathcal{P}'[I] = (\mathcal{P}' \setminus \mathcal{P}_{b'}) \sqcup (\mathcal{P}_{b'} \times \mathbf{2})$. Let $\phi : \mathcal{P}'[I] \rightarrow \mathcal{P}$ be the map defined by

$$\phi(ua) := ua, \quad \text{if } ua \in \mathcal{P}' \setminus \mathcal{P}_{b'} \text{ and } a \neq b', \tag{1.15a}$$

$$\phi(ub') := ub, \quad \text{if } ub' \in \mathcal{P}' \setminus \mathcal{P}_{b'}, \tag{1.15b}$$

$$\phi((ub', 1)) := ub', \quad \text{if } (ub', 1) \in \mathcal{P}_{b'} \times \mathbf{2}, \tag{1.15c}$$

$$\phi((ub', 2)) := ub, \quad \text{if } (ub', 2) \in \mathcal{P}_{b'} \times \mathbf{2}. \tag{1.15d}$$

This map ϕ is well-defined because, respectively, one has $\mathcal{P}'_a = \mathcal{P}_a$ for any $a \in \llbracket b' - 1 \rrbracket$, Lemma 1.9 holds, I is in particular a subset of \mathcal{P} , and \mathcal{P} satisfies (N2). Let now $\psi : \mathcal{P} \rightarrow \mathcal{P}'[I]$ be the map satisfying

$$\psi(ua) = ua, \quad \text{if } ua \in \mathcal{P} \text{ and } a \in \llbracket b' - 1 \rrbracket, \tag{1.16a}$$

$$\psi(ub) = ub', \quad \text{if } ub' \in \mathcal{P}' \setminus \mathcal{P}_{b'}, \tag{1.16b}$$

$$\psi(ub) = (ub', 2), \quad \text{if } ub' \in \mathcal{P}_{b'}, \tag{1.16c}$$

$$\psi(ub') = (ub', 1), \quad \text{if } ub' \in \mathcal{P}_{b'}. \tag{1.16d}$$

By similar arguments as before, this map ψ is well-defined. Moreover, by construction, ψ is the inverse of ϕ . Therefore, ϕ is a bijection. The fact that ϕ is a poset embedding comes by definition of ϕ and from the fact that, due to the property of \mathcal{P} to be nested, for any $ub' \in \mathcal{P}' \setminus \mathcal{P}_{b'}$, all elements greater than ub' in \mathcal{P}' do not belong to $\mathcal{P}_{b'}$. Thus, $\mathcal{P}'[I]$ is isomorphic as a poset to \mathcal{P} . \square

By assuming that \mathcal{P} is nested, the *sequence of derivations* from \mathcal{P} is the sequence

$$(\mathcal{P}, \mathcal{D}(\mathcal{P}), \mathcal{D}^2(\mathcal{P}), \dots, \mathcal{D}^{m(\mathcal{P})}(\mathcal{P})) \tag{1.17}$$

of subsets of $\text{Cl}_\delta(n)$. Observe that due to (N1), for any $k \in [m(\mathcal{P}) - 1]$, $m(\mathcal{D}^k(\mathcal{P})) \geq 1$, so that $\mathcal{D}^{k+1}(\mathcal{P})$ is well-defined.

Given a graded subset \mathcal{S} of Cl_δ , we say by extension that \mathcal{S} is *nested* if for all $n \geq 0$, the posets $\mathcal{S}(n)$ are nested.

Theorem 1.12. *Let δ be a rooted range map and \mathcal{S} be a nested and closed by prefix graded subset of Cl_δ . For any $n \geq 1$, $\mathcal{S}(n)$ is constructible by interval doubling. Moreover,*

$$\begin{aligned} \mathcal{S}(n) &\rightarrow \mathcal{D}(\mathcal{S}(n)) \rightarrow \cdots \rightarrow \mathcal{D}^{\text{m}(\mathcal{S}(n))}(\mathcal{S}(n)) \simeq \mathcal{S}(n-1) \\ &\rightarrow \mathcal{D}(\mathcal{S}(n-1)) \rightarrow \cdots \rightarrow \mathcal{D}^{\text{m}(\mathcal{S}(n-1))}(\mathcal{S}(n-1)) \simeq \mathcal{S}(n-2) \\ &\rightarrow \cdots \rightarrow \mathcal{S}(0) \simeq \{\epsilon\} \end{aligned} \quad (1.18)$$

is a sequence of interval contractions from $\mathcal{S}(n)$ to the trivial lattice $\{\epsilon\}$.

Proof. We proceed by induction on $n \geq 0$. If $n = 0$, since δ is rooted, we necessarily have $\mathcal{S}(0) \simeq \{\epsilon\}$, and this poset is by constructible by interval doubling. Assume now that $n \geq 1$ and set $\mathcal{P} := \mathcal{S}(n)$. Since \mathcal{S} is nested, the sequence of reductions from \mathcal{P} is well-defined. By Lemmas 1.10 and 1.11, by setting $\mathcal{P}' := \mathcal{D}^{\text{m}(\mathcal{P})}(\mathcal{P})$, \mathcal{P} is obtained by performing a sequence of interval doubling from the poset \mathcal{P}' . Now, due to the definition of the derivation algorithm \mathcal{D} , \mathcal{P}' is made of the δ -cliffs of \mathcal{P} wherein the last letters have been replaced by 0. This poset \mathcal{P}' is therefore isomorphic to the poset \mathcal{P}'' formed by the prefixes of length $n-1$ of \mathcal{P} . Since \mathcal{S} is closed by prefix, \mathcal{P}'' is thus the poset $\mathcal{S}(n-1)$. By induction hypothesis, this last poset is constructible by interval doubling. Therefore, $\mathcal{S}(n)$ also is. All this produces the sequence (1.18) of interval contractions. \square

1.3.5 Elevation maps

We introduce here a combinatorial tool intervening in the study of the three Fuss–Catalan posets introduced in the sequel.

Let \mathcal{S} be a closed by prefix graded subset of Cl_δ . For any $u \in \mathcal{S}$, let

$$F_{\mathcal{S}}(u) := \{a \in \llbracket \delta(|u|+1) \rrbracket : ua \in \mathcal{S}\}. \quad (1.19)$$

By definition, $F_{\mathcal{S}}(u)$ is the set of all the letters a that can follow u to form an element of \mathcal{S} . For any $n \geq 0$, the *\mathcal{S} -elevation map* is the map $e_{\mathcal{S}} : \mathcal{S}(n) \rightarrow \text{Cl}_\delta(n)$ defined, for any $u \in \mathcal{S}(n)$ and $i \in [n]$, by

$$e_{\mathcal{S}}(u)_i := \#(F_{\mathcal{S}}(u_1 \dots u_{i-1}) \cap \llbracket u_i - 1 \rrbracket) \quad (1.20)$$

for any $i \in [n]$. From an intuitive point of view, the value of the i -th letter of $e_{\mathcal{S}}(u)$ is the number of cliffs of \mathcal{S} obtained by considering the prefix of u ending at the letter u_i and by replacing this letter by a smaller one. Remark in particular that e_{Cl_δ} is the identity map. Besides, we say that any $u \in \mathcal{S}$ is an *exuvia* if $e_{\mathcal{S}}(u) = u$.

Let $\mathcal{E}_{\mathcal{S}}$ be the graded set wherein for any $n \geq 0$, $\mathcal{E}_{\mathcal{S}}(n)$ is the image of $\mathcal{S}(n)$ by the \mathcal{S} -elevation map. We call this set the *\mathcal{S} -elevation image*. Observe that $\mathcal{E}_{\mathcal{S}}$ is a graded subset of Cl_δ . Note also that for any $u \in \mathcal{S}$, $e_{\mathcal{S}}(u) \preceq u$.

Proposition 1.13. *Let δ be a range map and \mathcal{S} be a closed by prefix graded subset of Cl_δ . For any $n \geq 0$, the \mathcal{S} -elevation map is injective on the domain $\mathcal{S}(n)$.*

Proof. We proceed by induction on n . When $n = 0$, the property is trivially satisfied. Let $u, v \in \mathcal{S}(n)$ such that $n \geq 1$ and $e_{\mathcal{S}}(u) = e_{\mathcal{S}}(v)$. Since \mathcal{S} is closed by prefix, we have $u = u'a$

and $v = v'b$ where $u', v' \in \mathcal{S}(n - 1)$ and $a, b \in \mathbb{N}$. By definition of $e_{\mathcal{S}}$, we have $e_{\mathcal{S}}(u'a) = e_{\mathcal{S}}(u')c$ and $e_{\mathcal{S}}(v'b) = e_{\mathcal{S}}(v')c$ where $c \in \mathbb{N}$. Hence, $e_{\mathcal{S}}(u') = e_{\mathcal{S}}(v')$ which leads, by induction hypothesis, to the fact that $u' = v'$. Moreover, we deduce from this and from the definition of the \mathcal{S} -elevation map that there are exactly c letters a' smaller than a such that $u' a' \in \mathcal{S}$ and that there are exactly c letters b' smaller than b such that $v' b' \in \mathcal{S}$. Therefore, we have $a = b$ and thus $u = v$, establishing the injectivity of $e_{\mathcal{S}}$. \square

Lemma 1.14. *Let δ be a range map and \mathcal{S} be a closed by prefix graded subset of Cl_{δ} . The \mathcal{S} -elevation image is closed by prefix.*

Proof. Let $n \geq 0$ and $v \in \mathcal{E}_{\mathcal{S}}(n)$. Then, there exists $u \in \mathcal{S}(n)$ such that $e_{\mathcal{S}}(u) = v$. Let v' be a prefix of v . Since \mathcal{S} is closed by prefix, the prefix u' of u of length $n' := |v'|$ belongs to $\mathcal{S}(n')$. Moreover, by definition of $e_{\mathcal{S}}$, we have $e_{\mathcal{S}}(u') = v'$. Therefore, $v' \in \mathcal{E}_{\mathcal{S}}$, implying the statement of the lemma. \square

Proposition 1.15. *Let δ be a range map and \mathcal{S} be a closed by prefix graded subset of Cl_{δ} such that for any $u, v \in \mathcal{S}$, $u \preceq v$ implies $F_{\mathcal{S}}(v) \subseteq F_{\mathcal{S}}(u)$. For any $n \geq 0$, the map $e_{\mathcal{S}}^{-1}$ is a poset morphism from $\mathcal{E}_{\mathcal{S}}(n)$ to $\mathcal{S}(n)$.*

Proof. First, by Proposition 1.13, the map $e_{\mathcal{S}}^{-1}$ is well-defined. We now proceed by induction on n . When $n = 0$, the property is trivially satisfied. Let u and v be elements of $\mathcal{E}_{\mathcal{S}}(n)$ such that $n \geq 1$ and $u \preceq v$. By Lemma 1.14, we have $u = u'a$ and $v = v'b$ where $u', v' \in \mathcal{E}_{\mathcal{S}}(n - 1)$ and $a, b \in \mathbb{N}$. By definition of $e_{\mathcal{S}}^{-1}$, we have $e_{\mathcal{S}}^{-1}(u'a) = e_{\mathcal{S}}^{-1}(u')c$ and $e_{\mathcal{S}}^{-1}(v'b) = e_{\mathcal{S}}^{-1}(v')d$ where $c, d \in \mathbb{N}$. Since $u \preceq v$, one has $u' \preceq v'$ so that, by induction hypothesis, $e_{\mathcal{S}}^{-1}(u') \preceq e_{\mathcal{S}}^{-1}(v')$. Moreover, $u \preceq v$ implies that $a \leq b$. Due to the fact that $F_{\mathcal{S}}(v') \subseteq F_{\mathcal{S}}(u')$, one has by definition of $e_{\mathcal{S}}^{-1}$ that $c \leq d$. Therefore, $e_{\mathcal{S}}^{-1}(u')c \leq e_{\mathcal{S}}^{-1}(v')d$, which implies the statement of the proposition. \square

Proposition 1.15 says that when \mathcal{S} is closed by prefix, for any $n \geq 0$, the poset $\mathcal{S}(n)$ is an order extension of $\mathcal{E}_{\mathcal{S}}(n)$.

1.3.6 Geometric cubic realizations

Let \mathcal{S} be a graded subset of Cl_{δ} . For any $n \geq 0$, the *realization* of $\mathcal{S}(n)$ is the geometric object $\mathfrak{C}(\mathcal{S}(n))$ defined in the space \mathbb{R}^n and obtained by placing for each $u \in \mathcal{S}(n)$ a vertex of coordinates (u_1, \dots, u_n) , and by forming for each $u, v \in \mathcal{S}(n)$ such that $u \prec_{\mathcal{S}} v$ an edge between u and v . Remark that the posets of Figure 1.1 represent actually the realizations of δ -cliff posets. We will follow this drawing convention for all the next figures of posets in all the sequel. When \mathcal{S} is straight, every edge of $\mathfrak{C}(\mathcal{S}(n))$ is parallel to a line passing by the origin and a point of the form $(0, \dots, 0, 1, 0, \dots, 0)$. In this case, we say that $\mathfrak{C}(\mathcal{S}(n))$ is *cubic*.

As a side remark, we would like to stress that the present notion of geometric realization of a poset differs from the usual one saying that it consists in the geometric realization of the simplicial complex of the chain of the poset.

Let us assume from now that \mathcal{S} is straight. Let $u, v \in \mathcal{S}(n)$ such that $u \preceq v$. The word u is *cell-compatible* with v if for any word w of length n such that for any $i \in [n]$, $w_i \in \{u_i, v_i\}$,

then $w \in \mathcal{S}$. In this case, we call *cell* the set of points

$$\langle u, v \rangle := \{x \in \mathbb{R}^n : u_i \leq x_i \leq v_i \text{ for all } i \in [n]\}. \quad (1.21)$$

By definition, a cell is an orthotope, that is a parallelotope whose edges are all mutually orthogonal or parallel. A point x of \mathbb{R}^n is *inside* a cell $\langle u, v \rangle$ if for any $i \in [n]$, $u_i \neq v_i$ implies $u_i < x_i < v_i$. A cell $\langle u, v \rangle$ is *pure* if there is no point of $\mathcal{S}(n)$ inside $\langle u, v \rangle$. In other terms, this says that for all $w \in [u, v]$, there exists $i \in [n]$ such that $u_i \neq v_i$ and $w_i \in \{u_i, v_i\}$. Two cells $\langle u, v \rangle$ and $\langle u', v' \rangle$ of $\mathfrak{C}(\mathcal{S}(n))$ are *disjoint* if there is no point of \mathbb{R}^n which is both inside $\langle u, v \rangle$ and $\langle u', v' \rangle$. The *dimension* $\dim \langle u, v \rangle$ of a cell $\langle u, v \rangle$ is its dimension as an orthotope and it satisfies $\dim \langle u, v \rangle = \#D(u, v)$. The *volume* $\text{vol} \langle u, v \rangle$ of $\langle u, v \rangle$ is its volume as an orthotope and it satisfies

$$\text{vol} \langle u, v \rangle = \prod_{i \in D(u, v)} v_i - u_i. \quad (1.22)$$

For any $k \geq 0$, the *k-volume* $\text{vol}_k(\mathfrak{C}(\mathcal{S}(n)))$ of $\mathfrak{C}(\mathcal{S}(n))$ is the volume obtained by summing the volumes of all its all its cells of dimension k , computed by not counting several times potential intersecting orthotopes. The *volume* $\text{vol}(\mathfrak{C}(\mathcal{S}(n)))$ of $\mathfrak{C}(\mathcal{S}(n))$ is defined as $\text{vol}_k(\mathfrak{C}(\mathcal{S}(n)))$ where k is the largest integer such that $\mathfrak{C}(\mathcal{S}(n))$ has at least one cell of dimension k .

Figure 1.3 shows examples of these notions. Figure 1.3a shows a cubic realization wherein 00

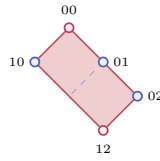

(a) A cubic realization of a subset of the 2^ω -cliffs of order 2.

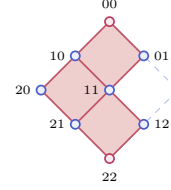

(b) A cubic realization of a subset of the 2^ω -cliffs of order 2.

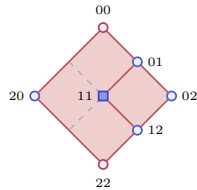

(c) A cubic realization of a subset of the 2^ω -cliffs of order 2.

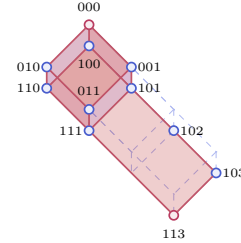

(d) A cubic realization of a subset of the 113^ω -cliffs of order 3.

Figure 1.3: Some cubic realizations of straight subsets of posets of δ -cliffs for certain range maps δ .

is cell-compatible with 12. Hence, $\langle 00, 12 \rangle$ is a cell. The point $(\frac{1}{2}, \frac{3}{2}) \in \mathbb{R}^2$ is inside $\langle 00, 12 \rangle$, and since there are no elements of the poset inside the cell, this cell is pure. Figure 1.3b shows a cubic realization wherein 00 is not cell-compatible with 22 because 02 does not belong to the poset.

Nevertheless, $\langle 00, 11 \rangle$, $\langle 10, 21 \rangle$, and $\langle 11, 22 \rangle$ are pure cells of dimension 2. Figure 1.3c shows a cubic realization wherein $\langle 00, 22 \rangle$ is a non-pure cell. Indeed, the δ -cliff 11 is an element of the poset and is inside this cell. Finally, Figure 1.3d shows a cubic realization having 1 as volume since there is exactly one cell $\langle 000, 111 \rangle$ of maximal dimension (which is 3) and of volume 1. Its 2-volume is 8 since this cubic realization decomposes as the seven disjoint cells $\langle 000, 011 \rangle$, $\langle 000, 101 \rangle$, $\langle 000, 110 \rangle$, $\langle 001, 111 \rangle$, $\langle 010, 111 \rangle$, $\langle 100, 111 \rangle$, and $\langle 101, 113 \rangle$ of respective volumes 1, 1, 1, 1, 1, 1, and 2.

There is a close connection between output-wings (resp. input-wings) of $\mathcal{S}(n)$, $n \geq 0$, and the computation of the volume of $\mathfrak{C}(\mathcal{S}(n))$: if $\langle u, v \rangle$ is a cell of maximal dimension of $\mathfrak{C}(\mathcal{S}(n))$, then due to the fact that \mathcal{S} is straight, u (resp. v) is an output-wing (resp. input-wing) of $\mathcal{S}(n)$. When for any $n \geq 0$,

- (i) there is a map $\rho : \mathcal{O}(\mathcal{S})(n) \rightarrow \mathcal{I}(\mathcal{S})(n)$;
- (ii) all cells of maximal dimension of $\mathfrak{C}(\mathcal{S}(n))$ express as $\langle u, \rho(u) \rangle$ with $u \in \mathcal{O}(\mathcal{S})(n)$;
- (iii) all cells of $\{\langle u, \rho(u) \rangle : u \in \mathcal{O}(\mathcal{S})(n)\}$ are pairwise disjoint;

then the volume of $\mathfrak{C}(\mathcal{S}(n))$, $n \geq 0$, writes as

$$\text{vol}(\mathfrak{C}(\mathcal{S}(n))) = \sum_{u \in \mathcal{O}(\mathcal{S})(n)} \text{vol} \langle u, \rho(u) \rangle. \tag{1.23}$$

When some cells of $\{\langle u, \rho(u) \rangle : u \in \mathcal{O}(\mathcal{S})(n)\}$ intersect each other, the expression for the volume would not be as simple as (1.23) and can be written instead as an inclusion-exclusion formula. Of course, the same property holds when ρ is instead a map from $\mathcal{I}(\mathcal{S})(n)$ to $\mathcal{O}(\mathcal{S})(n)$ by changing accordingly the previous text.

Recall that the *order dimension* [Tro92] of a poset \mathcal{P} is the smallest nonnegative integer k such that there exists a poset embedding of \mathcal{P} into (\mathbb{N}^k, \preceq) where \preceq is the componentwise partial order. Recall that the *hypercube* of dimension $n \geq 0$ is the poset \mathcal{H}_n on the set of the subsets of $[n]$ ordered by set inclusion. It can be shown that the order dimension of \mathcal{H}_n is n .

Proposition 1.16. *Let δ be a range map and \mathcal{S} be a straight graded subset of Cl_δ . If, for an $n \geq 0$, $\mathfrak{C}(\mathcal{S}(n))$ has a cell of dimension $\text{dim}_n(\delta)$, then the order dimension of the poset $\mathcal{S}(n)$ is $\text{dim}_n(\delta)$.*

Proof. First, since $\mathcal{S}(n)$ is a subposet of $\text{Cl}_\delta(n)$, $\mathcal{S}(n)$ is a subposet of the Cartesian product \mathbb{N}^k where $k := \#\{i \in [n] : \delta(i) \neq 0\}$. This poset has order dimension $\text{dim}_n(\delta)$, so that the order dimension of $\mathcal{S}(n)$ is at most $\text{dim}_n(\delta)$. Besides, since \mathcal{S} is straight, the notion of cell is well-defined in the cubic realization of $\mathcal{S}(n)$. By hypothesis, $\mathcal{S}(n)$ contains a cell $\langle u, v \rangle$ of dimension $\text{dim}_n(\delta)$. Thus, there is a poset embedding of $\mathcal{H}_{\text{dim}_n(\delta)}$ into the interval $[u, v]$ of $\mathcal{S}(n)$. Therefore, the order dimension of $\mathcal{S}(n)$ is at least $\text{dim}_n(\delta)$. \square

As a particular case of Proposition 1.16, the order dimension of $\text{Cl}_\delta(n)$ is $\text{dim}_n(\delta)$. This explains the terminology of “ n -th dimension of δ ” for the notation $\text{dim}_n(\delta)$ introduced in Section 1.1.1.

2. Some Fuss–Catalan posets

We present here some examples of subposets of δ -cliff posets. We focus in this work on three posets whose elements are enumerated by m -Fuss–Catalan numbers for the case $\delta = \mathbf{m}$, $m \geq 0$. We provide some combinatorial properties of these posets like among others, a description of their input-wings, output-wings, and butterflies, a study of their order theoretic properties, and a study of their cubic realizations. We end this section by establishing links between these three families of posets in terms of poset morphisms, poset embeddings, and poset isomorphisms. We shall omit some straightforward proofs (for instance, in the case of the descriptions of input-wings, output-wings, butterflies, meet-irreducible and join-irreducible elements of the posets—the descriptions of these two families use Proposition 1.7).

We shall use the following notation conventions: poset morphisms are denoted through arrows \rightarrow , poset embeddings through arrows \gg , and poset isomorphisms through arrows \Rightarrow .

2.1. δ -avalanche posets

We begin by introducing a first Fuss–Catalan family of posets. As we shall see, these posets are not lattices but they form an important tool to study the next two families of Fuss–Catalan posets.

2.1.1 Objects

For any range map δ , let Av_δ be the graded subset of Cl_δ containing all δ -cliffs u such that for all nonempty prefixes u' of u , then $\omega(u') \leq \delta(|u'|)$. Any element of Av_δ is a δ -avalanche. For instance,

$$\text{Av}_2(3) = \{000, 001, 002, 003, 004, 010, 011, 012, 013, 020, 021, 022\}. \quad (2.1)$$

Proposition 2.1. *For any weakly increasing range map δ , the graded set Av_δ is*

- (i) *closed by prefix;*
- (ii) *is minimally extendable;*
- (iii) *is maximally extendable if and only if $\delta = 0^\omega$.*

Proof. Point (i) is an immediate consequence of the definition of δ -avalanches. Let $n \geq 0$ and $u \in \text{Av}_\delta(n)$. Since $\delta(n+1) \geq \delta(n)$, $u0$ is a δ -avalanche. This establishes (ii). Finally, we have immediately that Av_{0^ω} is maximally extendable. Moreover, when $\delta \neq 0^\omega$, there is an $n \geq 1$ such that $\delta(n) \geq 1$ and $\delta(n') = 0$ for all $1 \leq n' < n$. Therefore, $0^{n-1}\delta(n)$ is a δ -avalanche but $0^{n-1}\delta(n)\delta(n+1)$ is not. Therefore, (iii) holds. \square

Proposition 2.2. *For any $m \geq 0$ and $n \geq 0$, $\#\text{Av}_m(n) = \text{cat}_m(n)$.*

Proof. This is a consequence of Proposition 2.11 coming next. Indeed, by this result, $\text{Av}_m(n)$ is the image by the elevation map of a graded set of objects enumerated by m -Fuss–Catalan numbers. Since this set of objects satisfies all the requirements of Proposition 1.13, the elevation map is injective, implying that it is a bijection. \square

Therefore, by Proposition 2.2, the first numbers of m -avalanches by sizes are

$$1, 1, 1, 1, 1, 1, 1, 1, \quad m = 0, \tag{2.2a}$$

$$1, 1, 2, 5, 14, 42, 132, 429, \quad m = 1, \tag{2.2b}$$

$$1, 1, 3, 12, 55, 273, 1428, 7752, \quad m = 2. \tag{2.2c}$$

The second and third sequences are respectively Sequences **A000108** and **A001764** of [Slo].

2.1.2 Posets

For any $n \geq 0$, the subposet $\text{Av}_\delta(n)$ of $\text{Cl}_\delta(n)$ is the δ -avalanche poset of order n . Figure 2.1 shows the Hasse diagrams of some m -avalanche posets.

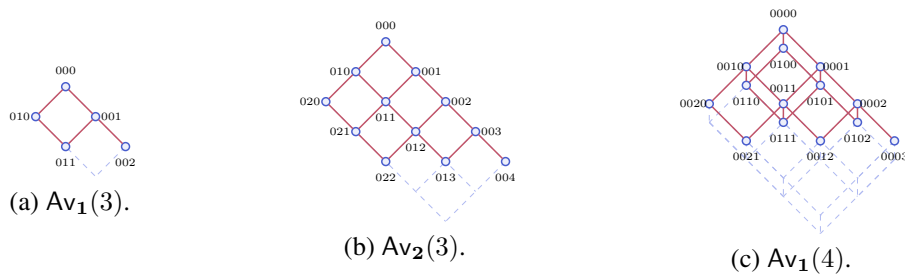

Figure 2.1: Hasse diagrams of some δ -avalanche posets.

Let δ be a weakly increasing range map. Notice that in general, $\text{Av}_\delta(n)$ is not bounded. Since for all $u \in \text{Av}_\delta(n)$, $\omega(u) \leq \delta(n)$, we have $u \in \max_{\preceq} \text{Av}_\delta(n)$ if and only if $\omega(u) = \delta(n)$. Moreover, due to the fact that any δ -cliff obtained by decreasing a letter in a δ -avalanche is also a δ -avalanche, the poset $\text{Av}_\delta(n)$ is the order ideal of $\text{Cl}_\delta(n)$ generated by $\max_{\preceq} \text{Av}_\delta(n)$. Finally, as a particular case, we shall show as a consequence of upcoming Proposition 2.16 that for any $m \geq 0$ and $n \geq 1$, $\# \max_{\preceq} \text{Av}_m(n) = \text{cat}_m(n - 1)$.

Proposition 2.3. For any weakly increasing range map δ and $n \geq 0$, the poset $\text{Av}_\delta(n)$

- (i) is straight, where $u \in \text{Av}_\delta(n)$ is covered by $v \in \text{Av}_\delta(n)$ if and only if there is an $i \in [n]$ such that $\uparrow_i(u) = v$;
- (ii) is coated;
- (iii) is graded, where the rank of an avalanche is its weight;
- (iv) admits an EL-labeling;
- (v) is a meet semi-sublattice of $\text{Cl}_\delta(n)$;
- (vi) is a lattice if and only if $\delta = 0^\omega$.

Proof. Points (i), (iii), (v), and (vi) are immediate. If u and v are two δ -avalanches of size n such that $u \preceq v$, then for any $i \in [n - 1]$, $\omega(u_1 \dots u_i) \leq \omega(v_1 \dots v_i)$. Therefore, the δ -cliff $u_1 \dots u_i v_{i+1} \dots v_n$ is a δ -avalanche. For this reason, (ii) checks out. Point (iv) follows from (ii), and Theorem 1.5. \square

Proposition 2.4. For any $m \geq 1$,

- (i) the graded set $\mathcal{I}(\text{Av}_m)$ contains all the \mathbf{m} -avalanches u satisfying $u_i \neq 0$ for all $i \in [2, |u|]$;
- (ii) the graded set $\mathcal{O}(\text{Av}_m)$ contains all the \mathbf{m} -avalanches u satisfying $\omega(u') < \mathbf{m}(|u'|)$ for all prefixes u' of u of length 2 or more;
- (iii) the graded set $\mathcal{B}(\text{Av}_m)$ contains all the \mathbf{m} -avalanches u satisfying $u_i \neq 0$ for all $i \in [2, |u|]$, and $\omega(u') < \mathbf{m}(|u'|)$ for all prefixes u' of u of length 2 or more.

The four posets of avalanches, input-wings, output-wings, and butterflies are linked in the following way.

Theorem 2.5. For any $m \geq 1$ and $n \geq 0$,

$$\text{Av}_{m-1}(n) \xrightarrow{\varphi_1} \mathcal{I}(\text{Av}_m)(n) \xrightarrow{\varphi_2} \mathcal{O}(\text{Av}_m)(n) \xrightarrow{\varphi_1} \mathcal{B}(\text{Av}_{m+1})(n) \quad (2.3)$$

is a diagram of poset embeddings or isomorphisms, where the maps φ_1 and φ_2 are defined, for any $u \in \mathbb{N}^n$ and $i \in [n]$, by $\varphi_1(u)_i := \mathbb{1}_{i \neq 1} (u_i + 1)$ and $\varphi_2(u)_i := \mathbb{1}_{i \neq 1} (u_i - 1)$.

Proof. This follows from the descriptions of the input-wings, output-wings, and butterflies of $\text{Av}_m(n)$ provided by Proposition 2.4. \square

Figure 2.2 gives an example of the poset isomorphisms or embeddings described by the statement of Theorem 2.5. As a consequence of Theorem 2.5, for any $m \geq 1$ and $n \geq 0$, the

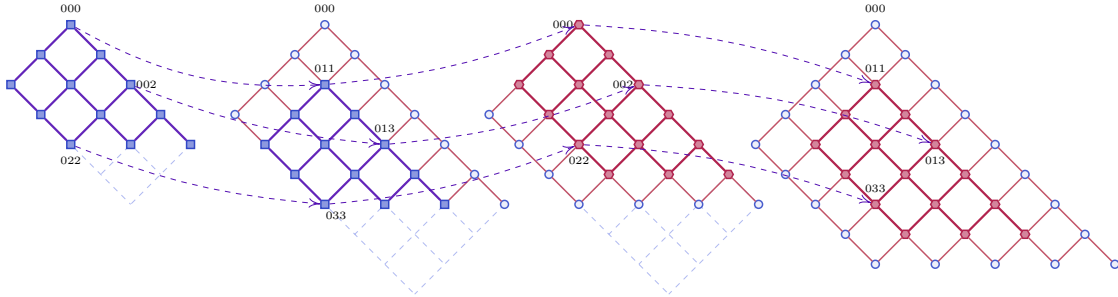

Figure 2.2: From the top to bottom and left to right, here are the posets $\text{Av}_2(3)$, $\text{Av}_3(3)$, $\text{Av}_3(3)$, and $\text{Av}_4(3)$. All these posets contain $\text{Av}_2(3)$ as subposet by restricting on input-wings, output-wings, or butterflies.

number of input-wings in $\text{Av}_m(n)$ is $\text{cat}_{m-1}(n)$.

Let us define for any $m \geq 0$ and $n \geq 1$ the n -th *twisted m -Fuss–Catalan number* by

$$\text{cat}'_m(n) := \frac{1}{n} \binom{n(m+1) - 2}{n-1}. \quad (2.4)$$

Proposition 2.6. For any $m \geq 1$ and $n \geq 1$, $\#\mathcal{O}(\text{Av}_m)(0) = 1$ and $\#\mathcal{O}(\text{Av}_m)(n) = \text{cat}'_m(n)$.

Proof. By Proposition 2.4, the set $\mathcal{O}(\text{Av}_m)(n)$ is in one-to-one correspondence with the set of all \mathbf{m} -cliffs v of size n such that for any $i \in [2, n]$, $v_{i-1} \leq v_i < \mathbf{m}(i)$. A possible bijection between these two sets sends any $u \in \mathcal{O}(\text{Av}_m)(n)$ to the \mathbf{m} -cliff v of the same size such that for any $i \in [n]$, $v_i := u_1 + \dots + u_i$. These words are moreover in one-to-one correspondence with indecomposable m -Dyck paths with $n \geq 1$ up steps, that are m -Dyck paths which cannot be written as a nontrivial concatenation of two m -Dyck paths. A possible bijection is the one described in upcoming Section 2.2.1. Let us denote by $\mathcal{G}(t)$ (resp. $\mathcal{G}'(t)$) the generating series of m -Dyck paths (resp. indecomposable m -Dyck paths) enumerated w.r.t. their numbers of up steps. By convention, $\mathcal{G}'(t)$ has no constant term. Since any m -Dyck path decomposes in a unique way as a concatenation of indecomposable m -Dyck paths, one has $\mathcal{G}(t) = (1 - \mathcal{G}'(t))^{-1}$. Now, by using the fact that $\mathcal{G}(t)$ satisfies $\mathcal{G}(t) = 1 + t\mathcal{G}(t)^{m+1}$, we have

$$\mathcal{G}'(t) = \frac{\mathcal{G}(t) - 1}{\mathcal{G}(t)} = t\mathcal{G}(t)^m = t\left(\frac{1}{1 - \mathcal{G}'(t)}\right)^m \tag{2.5}$$

This relation satisfied by $\mathcal{G}'(t)$ between the first and last members of (2.5) is known to be the one of the generating series of twisted m -Fuss–Catalan numbers (see [Slo] for instance). \square

By Proposition 2.6, the first numbers of output-wings of $\text{Av}_m(n)$ by sizes are

$$1, 1, 1, 1, 1, 1, 1, 1, \quad m = 0, \tag{2.6a}$$

$$1, 1, 1, 2, 5, 14, 42, 132, \quad m = 1, \tag{2.6b}$$

$$1, 1, 2, 7, 30, 143, 728, 3876, \quad m = 2. \tag{2.6c}$$

The fourth sequence is Sequence **A006013** of [Slo]. As a side remark, for any $m \geq 1$, the generating series of the graded set $\mathcal{O}(\text{Av}_m)$ is 1 plus the inverse, for the functional composition of series, of the polynomial $t(1 - t)^m$.

Proposition 2.7. For any $m \geq 1$ and $n \geq 1$,

(i) the set $\mathbf{M}(\text{Av}_m(n))$ contains all \mathbf{m} -avalanches $u = u'a$ where $u' \in \max_{\leq} \text{Av}_m(n - 1)$ and $a \in \llbracket m - 1 \rrbracket$;

(ii) the set $\mathbf{J}(\text{Av}_m(n))$ contains all \mathbf{m} -avalanches having exactly one letter different from 0.

By Proposition 2.7 and by upcoming Proposition 2.16, the number of meet-irreducible elements of $\text{Av}_m(n)$ satisfies, for any $m \geq 1$ and $n \geq 2$, $\#\mathbf{M}(\text{Av}_m(n)) = m\text{cat}_m(n - 2)$ and the number of join-irreducibles elements of $\text{Av}_m(n)$ satisfies, for any $m \geq 1$ and $n \geq 1$, $\#\mathbf{J}(\text{Av}_m(n)) = m\binom{n}{2}$.

2.1.3 Cubic realization

The map φ_2 introduced in Theorem 2.5 is used here to describe the cells of maximal dimension of the cubic realization of $\text{Av}_m(n)$, $m \geq 1$, $n \geq 0$.

Proposition 2.8. For any $m \geq 1$, $n \geq 0$, and $u \in \mathcal{I}(\text{Av}_m)(n)$,

- (i) the \mathbf{m} -avalanche $\varphi_2(u)$ is cell-compatible with the \mathbf{m} -avalanche u ;
- (ii) the cell $\langle \varphi_2(u), u \rangle$ is pure;
- (iii) all cells of $\{\langle \varphi_2(u), u \rangle : u \in \mathcal{I}(\text{Av}_m)(n)\}$ are pairwise disjoint.

Proof. Let v be an \mathbf{m} -cliff of size n satisfying $v_i \in \{\varphi_2(u)_i, u_i\}$ for all $i \in [n]$. By definition of φ_2 , $v_1 = 0$ and $v_i \in \{u_i - 1, u_i\}$ for all $i \in [2, n]$. Since u is an input-wing of Av_m , $\varphi_2(u)$ is an \mathbf{m} -avalanche, and due to the definition of \mathbf{m} -avalanches, any \mathbf{m} -cliff obtained by decrementing some letters of u is still an \mathbf{m} -avalanche. Thus, $v \in \text{Av}_m$ and (i) holds. Points (ii) and (iii) are consequences of the fact that there is no element of $\text{Av}_m(n)$ inside a cell $\langle \varphi_2(u), u \rangle$. Indeed, since for any $i \in [n]$, $|\varphi_2(u)_i - u_i| \leq 1$, we have $v_i \in \{\varphi_2(u)_i, u_i\}$ for all $v \in \langle \varphi_2(u), u \rangle \cap \text{Av}_m(n)$. \square

As shown by Proposition 2.8, the cells of maximal dimension of the cubic realization of $\text{Av}_m(n)$ are all of the form $\langle \varphi_2(u), u \rangle$ where the u are input-wings of $\text{Av}_m(n)$.

Proposition 2.9. For any $m \geq 1$ and $n \geq 0$, $\text{vol}(\mathfrak{C}(\text{Av}_m(n))) = \text{cat}_{m-1}(n)$.

Proof. Proposition 2.8 describes all the cells of maximal dimension of $\mathfrak{C}(\text{Av}_m(n))$ as cells $\langle \varphi_2(u), u \rangle$ where u is an input-wing of $\text{Av}_m(n)$. Since all these cells are pairwise disjoint, the volume of $\mathfrak{C}(\text{Av}_m(n))$ expresses as (1.23). Moreover, observe that the volume of each cell $\langle \varphi_2(u), u \rangle$ where u in an input-wing is by definition of φ_2 equal to 1. Therefore, $\text{vol}(\mathfrak{C}(\text{Av}_m(n)))$ is equal to the number of input-wings of $\text{Av}_m(n)$. The statement of the proposition follows now from Theorem 2.5. \square

2.2. δ -hill posets

We now introduce δ -hills and δ -hill posets as subposets of δ -cliff posets. As we shall see, some of these posets are sublattices of \mathbf{m} -cliff lattices.

2.2.1 Objects

For any range map δ , let Hi_δ be the graded subset of Cl_δ containing all δ -cliffs such that that for any $i \in [|u| - 1]$, $u_i \leq u_{i+1}$. Any element of Hi_δ is a δ -hill. For instance,

$$\text{Hi}_2(3) = \{000, 001, 011, 002, 012, 022, 003, 013, 023, 004, 014, 024\}. \quad (2.7)$$

Proposition 2.10. For any weakly increasing range map δ , the graded set Hi_δ is

- (i) closed by prefix;
- (ii) is minimally extendable if and only if $\delta = 0^\omega$;
- (iii) is maximally extendable.

Proof. Point (i) is an immediate consequence of the definition of δ -hills. We have immediately that Hi_{0^ω} is minimally extendable. Moreover, when $\delta \neq 0^\omega$, there is an $n \geq 1$ such that $\delta(n) \geq 1$. Therefore, $\bar{1}_\delta(n)$ is a δ -hill but $\bar{1}_\delta(n)0$ is not. This establishes (ii). Finally, since for any $n \geq 0$, $\delta(n+1) \geq \delta(n)$, one has $\delta(n+1) \geq u_n$ for any $u \in \text{Hi}_\delta(n)$. This shows that $u\delta(n+1)$ is a δ -hill. Therefore, (iii) holds. \square

For any $m \geq 0$, an *m -Dyck path* of size n is a path in from $(0, 0)$ to $((m+1)n, 0)$ in \mathbb{N}^2 staying above the x -axis, and consisting only in steps of the form $(1, -1)$, called *down steps*, or steps of the form $(1, m)$, called *up steps*. We denote by Dy_m the graded set of all m -Dyck paths. There is a one-to-one correspondence between $\text{Hi}_m(n)$ and $\text{Dy}_m(n)$ wherein an m -Dyck path w of size n is sent to the m -hill u of size n such that for any $i \in [n]$, u_i is the number of down steps to the left of the i -th up step of w . For instance, the 2-Dyck path



is sent to the 2-hill 02366. Since m -Dyck paths of size n are known to be enumerated by m -Fuss–Catalan numbers, one has $\#\text{Hi}_m(n) = \text{cat}_m(n)$.

Proposition 2.11. *For any range map δ and any $n \geq 0$, $\mathcal{E}_{\text{Hi}_\delta}(n) = \text{Av}_\delta(n)$.*

Proof. First, since Hi_δ is by Proposition 2.10 closed by prefix, the Hi_δ -elevation map and the Hi_δ -elevation image are well-defined. Let $u \in \text{Hi}_\delta(n)$ and $v := e_{\text{Hi}_\delta}(u)$. By definition of δ -hills and of the Hi_δ -elevation map, we have $v_1 = u_1$ and, for any $i \in [2, n]$, $v_i = u_i - u_{i-1}$. Therefore, for any prefix $v' := v_1 \dots v_j$, $j \in [n]$, of v , we have

$$\omega(v') = u_1 + (u_2 - u_1) + (u_3 - u_2) + \dots + (u_j - u_{j-1}) = u_j. \tag{2.9}$$

Since u is in particular a δ -cliff of size n , then $u_j \leq \delta(j)$, so that $v \in \text{Av}_\delta(n)$. This shows that $\mathcal{E}_{\text{Hi}_\delta}(n)$ is a subset of $\text{Av}_\delta(n)$.

Now, let u be an δ -avalanche of size n . Let us show by induction on $n \geq 0$ that there exists $v \in \text{Hi}_\delta(n)$ such that $e_{\text{Hi}_\delta}(v) = u$. When $n = 0$, the property is trivially satisfied. When $n \geq 1$, since Av_δ is, by Proposition 2.1, closed by prefix, one has $u = u'a$ for a $u' \in \text{Av}_\delta(n-1)$ and an $a \in \mathbb{N}$. By induction hypothesis, there exists $v' \in \text{Hi}_\delta(n-1)$ such that $e_{\text{Hi}_\delta}(v') = u'$. Now, let $b := a + v'_{n-1}$ and set $v := v'b$. By using what we have proven in the first paragraph, $\omega(u') = v'_{n-1}$. Since $\omega(u') + a = \omega(u) \leq \delta(n)$, we have that $b \leq \delta(n)$. Therefore, since moreover $b \geq v'_{n-1}$, v is a δ -hill and it satisfies $e_{\text{Hi}_\delta}(v) = u$. \square

2.2.2 Posets

For any $n \geq 0$, the subposet $\text{Hi}_\delta(n)$ of $\text{Cl}_\delta(n)$ is the *δ -hill poset* of order n . Figure 2.3 shows the Hasse diagrams of some m -hill posets. The 1-hill posets are sometimes called Stanley lattices [Sta75, Knu04]. The δ -hill posets can be seen as generalizations of these structures.

Proposition 2.12. *For any weakly increasing range map δ and $n \geq 0$, the poset $\text{Hi}_\delta(n)$ is*

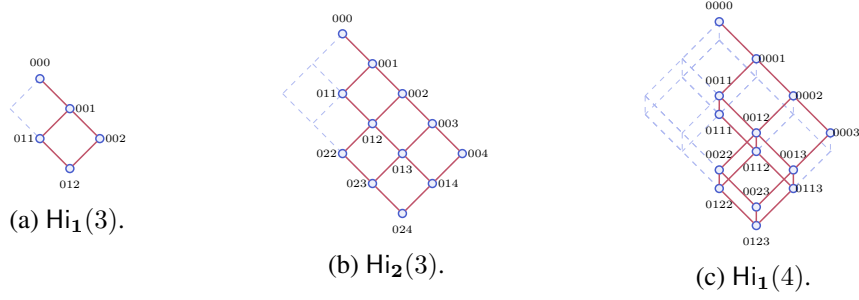
Figure 2.3: Hasse diagrams of some δ -hill posets.

- (i) *straight*, where $u \in \text{Hi}_\delta(n)$ is covered by $v \in \text{Hi}_\delta(n)$ if and only if there is an $i \in [n]$ such that $\uparrow_i(u) = v$;
- (ii) *coated*;
- (iii) *nested*;
- (iv) *graded*, where the rank of a hill is its weight;
- (v) *EL-shellable*;
- (vi) *a sublattice of $\text{Cl}_\delta(n)$* ;
- (vii) *constructible by interval doubling*.

Proof. Points (i), (ii), (iii), (iv), and (vi) are immediate. Point (v) follows from (ii) and Theorem 1.5. Point (vii) is a consequence of Theorem 1.12 since (iii) holds and, from Proposition 2.10, of the fact that Hi_δ is closed by prefix. Alternatively, (vii) is implied by (vi) and the fact that any sublattice of a lattice constructible by interval doubling is constructible by interval doubling [Day79], which is indeed the case for $\text{Cl}_\delta(n)$. \square

Proposition 2.13. *For any $m \geq 0$,*

- (i) *the graded set $\mathcal{I}(\text{Hi}_m)$ contains all the \mathbf{m} -cliffs u satisfying $u_1 < \dots < u_{|u|}$;*
- (ii) *the graded set $\mathcal{O}(\text{Hi}_m)$ contains all the \mathbf{m} -cliffs u satisfying $u_1 \leq u_2 < \dots < u_{|u|}$ and for all $i \in [2, |u|]$, $u_i < \mathbf{m}(i)$;*
- (iii) *the graded set $\mathcal{B}(\text{Hi}_m)$ contains all the \mathbf{m} -cliffs u satisfying $u_1 < \dots < u_{|u|}$ and for all $i \in [2, |u|]$, $u_i < \mathbf{m}(i)$.*

The four posets of hills, input-wings, output-wings, and butterflies are linked in the following way.

Theorem 2.14. For any $m \geq 1$ and $n \geq 0$,

$$\begin{array}{ccc}
 \text{Hi}_{m-1}(n) & \xrightarrow{\varphi_3} & \mathcal{I}(\text{Hi}_m)(n) & \xrightarrow{\varphi_2} & \mathcal{O}(\text{Hi}_m)(n) \\
 & & \downarrow \text{I} & & \\
 & & \mathcal{B}(\text{Hi}_{m+1})(n) & &
 \end{array} \tag{2.10}$$

is a diagram of poset embeddings or isomorphisms, where the map φ_3 is defined for any $u \in \mathbb{N}^n$ and $i \in [n]$ by $\varphi_3(u)_i := u_i + i - 1$, I is the identity map, and φ_2 is the map defined in the statement of Theorem 2.5.

Proof. This follows from the descriptions of the input-wings, output-wings, and butterflies of $\text{Hi}_m(n)$ provided by Proposition 2.13. \square

Figure 2.4 gives an example of the poset isomorphisms or embeddings described by the statement of Theorem 2.14. As a consequence of Theorem 2.14, for any $m \geq 1$ and $n \geq 0$, the

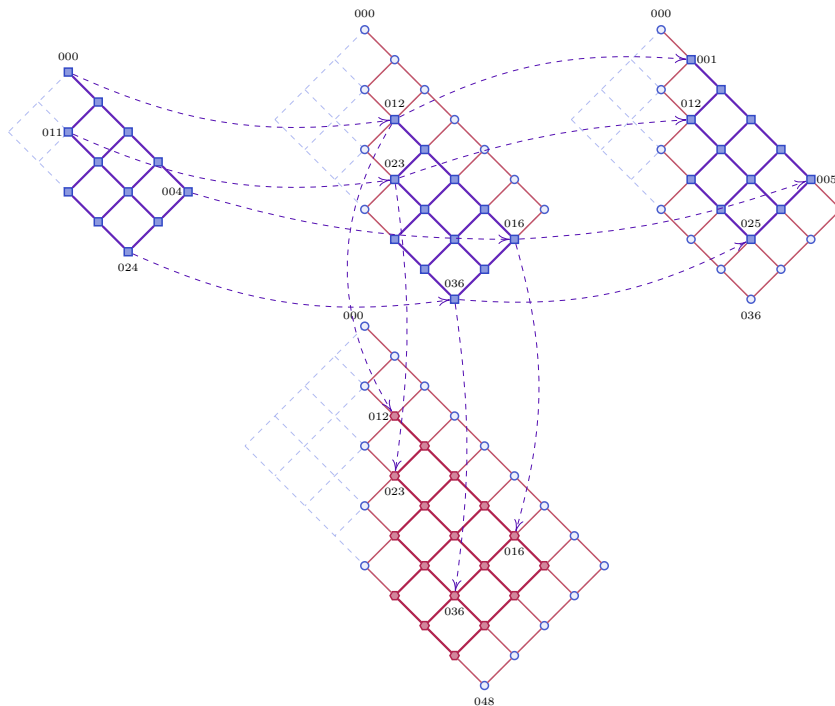

Figure 2.4: From the top to bottom and left to right, here are the posets $\text{Hi}_2(3)$, $\text{Hi}_3(3)$, $\text{Hi}_3(3)$, and $\text{Hi}_4(3)$. All these posets contain $\text{Hi}_2(3)$ as subposet by restricting on input-wings, output-wings, or butterflies.

number of input-wings in $\text{Hi}_m(n)$ is $\text{cat}_{m-1}(n)$.

Proposition 2.15. For any $m \geq 1$ and $n \geq 1$, $\#\mathcal{B}(\text{Hi}_m)(0) = 1$ and $\#\mathcal{B}(\text{Hi}_m)(n) = \text{cat}'_{m-1}(n)$.

Proof. By Proposition 2.13, the set $\mathcal{B}(\text{Hi}_m)(n)$ contains all \mathbf{m} -cliffs u of size n satisfying $u_1 < \dots < u_n$ and for any $i \in [2, n]$, $u_i < \mathbf{m}(i)$. By setting $\mathbf{m}' := \mathbf{m} - 1$, this set is in one-to-one correspondence with the set of all \mathbf{m}' -cliffs v of size n satisfying $v_{i-1} \leq v_i < \mathbf{m}'(i)$. A possible bijection between these two sets sends any $u \in \mathcal{B}(\text{Hi}_m)(n)$ to the \mathbf{m}' -cliff v of the same size such that for any $i \in [n]$, $v_i = u_i - i + 1$. We have already seen in the proof of Proposition 2.6 that these sets are in one-to-one correspondence with $(m-1)$ -Dyck paths which cannot be written as a nontrivial concatenation of two $(m-1)$ -Dyck paths. Therefore, the statement of the proposition follows. \square

Proposition 2.16. *For any $m \geq 0$ and $n \geq 1$, the map $\rho : \max_{\leq} \text{Av}_m(n) \rightarrow \text{Hi}_m(n-1)$ such that any $u \in \max_{\leq} \text{Av}_m(n)$, $\rho(u)$ is the prefix of size $n-1$ of $\mathbf{e}_{\text{Hi}_m}^{-1}(u)$, is a bijection.*

Proof. First, since Hi_m is by Proposition 2.10 closed by prefix, by Proposition 1.13, \mathbf{e}_{Hi_m} is an injective map. This implies that the map ρ , defined by considering the inverse of \mathbf{e}_{Hi_m} is a well-defined map. Let $\rho' : \text{Hi}_m(n-1) \rightarrow \max_{\leq} \text{Av}_m(n)$ be the map defined for any $v \in \text{Hi}_m(n-1)$ by $\rho'(v) := \mathbf{e}_{\text{Hi}_m}(va)$ where $a := m(n-1)$. As pointed out before, $u \in \max_{\leq} \text{Av}_m(n)$ if and only if $\omega(u) = m(n-1)$. This implies that $\rho'(v)$ belongs to $\max_{\leq} \text{Av}_m(n)$. Moreover, due to the respective definitions of ρ and ρ' , both $\rho \circ \rho'$ and $\rho' \circ \rho$ are identity maps. Therefore, ρ is a bijection. \square

Proposition 2.17. *For any $m \geq 1$ and $n \geq 1$, the set $\mathbf{J}(\text{Hi}_m(n))$ contains all \mathbf{m} -hills u such that $u = 0^k a^{n-k}$ such that $k \in [n-1]$ and $a \in [km]$.*

Proposition 2.18. *For any $m \geq 0$ and $n \geq 0$, the map \mathbf{e}_{Hi_m} is a bijection between $\mathbf{J}(\text{Hi}_m(n))$ and $\mathbf{J}(\text{Av}_m(n))$.*

Proof. This is a straightforward verification using the descriptions of join-irreducible elements of $\text{Hi}_m(n)$ and $\text{Av}_m(n)$ brought by Propositions 2.17 and 2.7. \square

By Proposition 2.17 (or also by Propositions 2.7 and 2.18), the number of join-irreducibles elements of $\text{Hi}_m(n)$ satisfies, for any $m \geq 1$ and $n \geq 1$, $\#\mathbf{J}(\text{Hi}_m(n)) = m \binom{n}{2}$. Since by Proposition 2.12, $\text{Hi}_m(n)$ is constructible by interval doubling, this is also the number of its meet-irreducible elements [GW16].

2.2.3 Cubic realization

The map φ_2 introduced in Theorem 2.14 is used here to describe the cells of maximal dimension of the cubic realization of $\text{Hi}_m(n)$, $m \geq 1$, $n \geq 0$.

Proposition 2.19. *For any $m \geq 1$, $n \geq 0$, and $u \in \mathcal{I}(\text{Hi}_m)(n)$,*

- (i) *the \mathbf{m} -hill $\varphi_2(u)$ is cell-compatible with the \mathbf{m} -hill u ;*
- (ii) *the cell $\langle \varphi_2(u), u \rangle$ is pure;*
- (iii) *all cells of $\{\langle \varphi_2(u), u \rangle : u \in \mathcal{I}(\text{Hi}_m)(n)\}$ are pairwise disjoint.*

Proof. Due to the similarity between the maps φ_2 and the map φ_1 introduced in the statement of Theorem 2.5, the proof here is very similar to the one of Proposition 2.8. \square

As shown by Proposition 2.19, the cells of maximal dimension of the cubic realization of $\text{Hi}_m(n)$ are all of the form $\langle \varphi_2(u), u \rangle$ where the u are input-wings of $\text{Hi}_m(n)$.

Proposition 2.20. For any $m \geq 1$ and $n \geq 0$, $\text{vol}(\mathfrak{C}(\text{Hi}_m(n))) = \text{cat}_{m-1}(n)$.

Proof. Proposition 2.19 describes all the cells of maximal dimension of $\mathfrak{C}(\text{Hi}_m(n))$ as cells $\langle \varphi_2(u) \rangle, u$ where u is an input-wing of $\text{Hi}_m(n)$. Since all these cells are pairwise disjoint, the volume of $\mathfrak{C}(\text{Hi}_m(n))$ expresses as (1.23). Moreover, observe that the volume of each cell $\langle \varphi_2(u), u \rangle$ where u in an input-wing, is by definition of φ_2 equal to 1. Therefore, $\text{vol}(\mathfrak{C}(\text{Hi}_m(n)))$ is equal to the number of input-wings of $\text{Hi}_m(n)$. The statement of the proposition follows now from Theorem 2.14. \square

2.3. δ -canyon posets

We introduce here our last family of posets. They are defined on particular δ -cliffs called δ -canyons. As we shall see, under some conditions these posets are lattices but not sublattices of δ -cliff lattices.

2.3.1 Objects

For any range map δ , let Ca_δ be the graded subset of Cl_δ containing all δ -cliffs such that $u_{i-j} \leq u_i - j$, for all $i \in [|u|]$ and $j \in [u_i]$ satisfying $i - j \geq 1$. Any element of Ca_δ is a δ -canyon. For instance

$$\text{Ca}_2(3) = \{000, 010, 020, 001, 002, 012, 003, 013, 023, 004, 014, 024\}. \tag{2.11}$$

As a larger example, the 2-cliff $u := 020100459002301$ is a 2-canyon. Indeed, by picturing an m -canyon u by drawing for each position $i \in [|u|]$ a segment from the point $(i - 1, 0)$ to the point $(i - 1, u_i)$ in the Cartesian plane, the previous condition says that one can draw lines of slope 1 passing through the x -axis and the top of each segment without crossing any segment. For instance, the previous u is drawn as

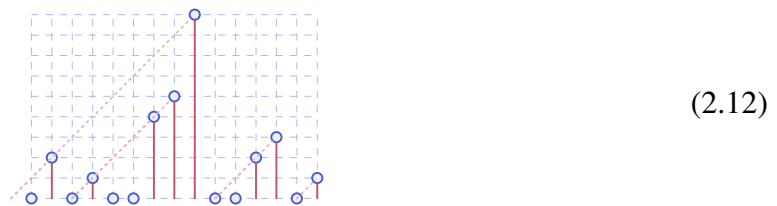

and one can observe that none of its diagonals, drawn as dotted lines, crosses a segment. Besides, if u is a δ -cliff of size n and $i, j \in [n]$ are two indices such that $i < j$, one has the three following possible configurations depending on the value $\alpha := u_j - (j - i)$:

- If $\alpha < 0$, then we say that i and j are *independent* in u (graphically, the diagonal of u_j falls under the x -axis before reaching the segment of u_i);

- If $\alpha \in \llbracket u_i - 1 \rrbracket$, then we say that j is *hindered* by i in u (graphically, the diagonal of u_j hits the segment of u_i);
- If $\alpha \geq u_i$, then we say that j *dominates* i in u (graphically, the segment of u_i is below or on the diagonal of u_j).

By definition, a δ -cliff u is a δ -canyon if no index of u is hindered by another one.

Proposition 2.21. *For any range map δ , the graded set Ca_δ is*

- (i) *closed by prefix;*
- (ii) *is minimally extendable;*
- (iii) *is maximally extendable if δ is increasing.*

Proof. Let u be a δ -canyon of size $n \geq 0$. Immediately from the definition of the δ -canyons, it follows that $u0$ is a δ -canyon of size $n + 1$, and that for any prefix u' of u , u' is a δ -canyon. Therefore, Points (i) and (ii) check out. Let us now consider the δ -cliff $u' := u\delta(n + 1)$. If δ is increasing, for all $j \in [n]$, $u_{n+1-j} \leq u_{n+1} - j$. Therefore, u' is a δ -canyon. Therefore, (iii) holds. \square

Let us now introduce a series of definitions and lemmas in order to show that the sets $\text{Ca}_\delta(n)$ and $\text{Hi}_\delta(n)$ are in one-to-one correspondence when δ is an increasing range map.

For any δ -canyon u of size n , let $d(u)$ be the δ -canyon obtained by changing for each index $i \in [n]$ the letter u_i into 0 if i is dominated by another index $j \in [i + 1, n]$. For instance, when $\delta = \mathbf{m}$ with $m = 2$, $d(020050012) = 000050002$. Observe that $u \in \text{Ca}_\delta$ is an exuvia (see Section 1.3.5) if and only if $d(u) = u$.

Lemma 2.22. *For any range map δ and any δ -canyon u , $F_{\text{Ca}_\delta}(u) = F_{\text{Ca}_\delta}(d(u))$.*

Proof. Assume that u is of size n and set $w := d(u)$. Assume that ua is a δ -canyon for a letter $a \in \mathbb{N}$. Then, the index $n + 1$ is hindered by no other index in ua . Since w is obtained by changing to 0 some letters of u , the index $n + 1$ remains hindered by no other index in wa . Therefore, wa is also a δ -canyon. Conversely, assume that wa is a δ -canyon for a letter $a \in \mathbb{N}$. Then, the index $n + 1$ is hindered by no other index in wa . By contradiction, assume that ua is not a δ -canyon. This implies that the index $n + 1$ is hindered by an index i in ua . Let us take i maximal among all indices satisfying this property. Due to the maximality of i , i is dominated by no other index in u so that we have $u_i = w_i$. This implies that $n + 1$ is hindered by i in wa , which contradicts our hypothesis. Therefore, ua is a δ -canyon. \square

Lemma 2.23. *Let δ be a range map and u be a δ -canyon of size $n \geq 0$. Then,*

$$F_{\text{Ca}_\delta}(u) = \llbracket \delta(n + 1) \rrbracket \setminus \bigsqcup_{\substack{i \in [n] \\ d(u)_i \neq 0}} [n + 1 - i, n + d(u)_i - i]. \quad (2.13)$$

Proof. Let w be a δ -canyon of size n and let $w := d(u)$. For any letter $a \in \llbracket \delta(n+1) \rrbracket$, the δ -cliff wa is a δ -canyon if and only if the index $n+1$ is hindered by no index in wa . Now, for any $i \in [n]$ such that $w_i \neq 0$, the index i hinds the index $n+1$ in wa if and only if $a \in [n+1-i, n+w_i-i]$. By definition of d , all indices of w are pairwise independent. Therefore, for any $i, i' \in [n]$ such that $i \neq i'$ and $w_i \neq 0 \neq w_{i'}$, the sets $[n+1-i, n+w_i-i]$ and $[n+1-i', n+w_{i'}-i']$ are disjoint. Lemma 2.22 and the fact that d is an idempotent map imply the stated formula. \square

Lemma 2.24. *Let δ be a range map and u be a δ -canyon. Then, $\omega(e_{Ca_\delta}(u)) = \omega(d(u))$.*

Proof. This follows by induction on the size of u , by using the relation $d(u) = e_{Ca_\delta}(d(u))$, and by using Lemma 2.22. \square

Proposition 2.25. *For any increasing range map δ and any $n \geq 0$, $\mathcal{E}_{Ca_\delta}(n) = Av_\delta(n)$.*

Proof. First, since Ca_δ is by Proposition 2.21 closed by prefix, the Ca_δ -elevation map and so the Ca_δ -elevation image are well-defined.

By Lemmas 2.23 and 2.24, and since δ is increasing, for any δ -canyon u of size $n \geq 0$, one has

$$\#F_{Ca_\delta}(u) = 1 + \delta(n+1) - \omega(e_{Ca_\delta}(u)). \tag{2.14}$$

Let us proceed by induction on n to prove that for any $u \in Ca_\delta(n)$, $e_{Ca_\delta}(u)$ is a δ -avalanche. If $n = 0$, the property holds immediately. Let $u = u'a$ be a δ -canyon of size $n+1$ where $u' \in Ca_\delta(n)$ and $a \in \mathbb{N}$. By induction hypothesis, $e_{Ca_\delta}(u')$ is a δ -avalanche. Therefore, in particular, $\omega(e_{Ca_\delta}(u')) \leq \delta(n)$. Moreover, by (2.14), we have

$$\begin{aligned} \omega(e_{Ca_\delta}(u'a)) &= \omega(e_{Ca_\delta}(u')) + \#(F_{Ca_\delta}(u') \cap \llbracket a-1 \rrbracket) \\ &\leq \omega(e_{Ca_\delta}(u')) + 1 + \delta(n+1) - \omega(e_{Ca_\delta}(u')) - 1 = \delta(n+1), \end{aligned} \tag{2.15}$$

showing that $u'a$ is a δ -canyon.

Conversely, let us prove by induction on n that for any $v \in Av_\delta(n)$, there exists a δ -canyon u such that $e_{Ca_\delta}(u) = v$. If $n = 0$, the property holds immediately. Let $v = v'b$ be a δ -avalanche of size $n+1$ where $v' \in Av_\delta(n)$ and $b \in \mathbb{N}$. By induction hypothesis, there is $u' \in Ca_\delta(n)$ such that $e_{Ca_\delta}(u') = v'$. Since v is a δ -avalanche, $b \leq \delta(n+1) - \omega(v')$. Now, by (2.14), since there are $1 + \delta(n+1) - \omega(v')$ different letters a such that $u'a$ is a δ -canyon, there is in particular a δ -canyon $u = u'a$ such that $e_{Ca_\delta}(u) = v$. \square

Proposition 2.26. *For any increasing range map δ and any $n \geq 0$, the map $e_{Hi_\delta}^{-1} \circ e_{Ca_\delta}$ is a bijection between $Ca_\delta(n)$ and $Hi_\delta(n)$.*

Proof. First, since δ is increasing, by Propositions 2.10 and 2.21, both Hi_δ and Ca_δ are closed by prefix. Therefore, the maps e_{Hi_δ} and e_{Ca_δ} are well-defined. By Proposition 1.13, the maps e_{Ca_m} and e_{Hi_m} are injective, and by Propositions 2.11 and 2.25, they both share the same image $Av_m(n)$. This implies that e_{Ca_m} is a bijection from Ca_m to $Av_m(n)$, and that $e_{Hi_m}^{-1}$ is a well-defined map and is a bijection from $Av_m(n)$ to $Hi_m(n)$. Therefore, the statement of the proposition follows. \square

As a consequence of Proposition 2.26, for any $m \geq 0$, m -canyons are enumerated by m -Fuss–Catalan numbers.

2.3.2 Posets

For any $n \geq 0$, the subposet $\text{Ca}_\delta(n)$ is the δ -canyon poset of order n . Figure 2.5 shows the Hasse diagrams of some m -canyon posets. The 1-canyons are also known as Tamari diagrams and have

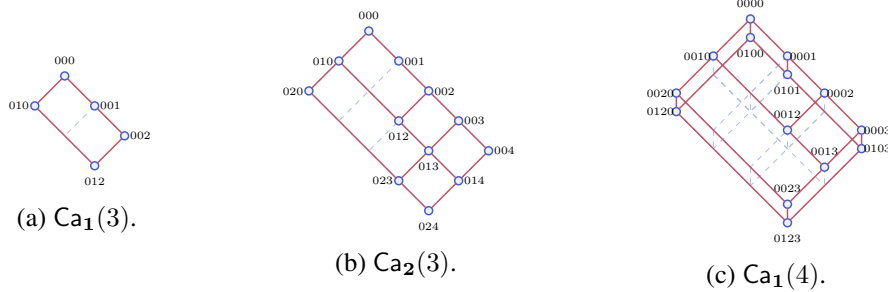

Figure 2.5: Hasse diagrams of some δ -canyon posets.

been introduced in [Pal86]. The set of these objects of size n is in one-to-one correspondence with the set of binary trees with n internal nodes. It is also known that the componentwise comparison of Tamari diagrams is the Tamari order [Pal86]. Recall that the Tamari order admits, as covering relation, the right rotation operation in binary trees. It has also the nice property to endow the set of binary trees of a given size with a lattice structure [HT72]. Besides, a study of the posets of the intervals of the Tamari order, based upon a generalization of Tamari diagrams, has been performed in [Com19]. The Tamari posets admit a lot of generalizations, for instance through the so-called m -Tamari posets [BPR12] where $m \geq 0$, and through the ν -Tamari posets [PRV17] where ν is a binary word. Our δ -canyon posets can be seen as different generalizations of Tamari posets. For any $m \geq 2$, the m -canyon posets are not isomorphic to the m -Tamari posets. Moreover, we shall prove in the sequel that for any increasing map δ , Ca_δ is a lattice. As already mentioned, Tamari posets have the nice property to be lattices [HT72], are also EL-shellable [BW97], and constructible by interval doubling [Gey94]. The same properties hold for m -Tamari lattices, see respectively [BMFPR11] and [Müh15] for the first two ones. The last one is a consequence of the fact that m -Tamari lattices are intervals of 1-Tamari lattices [BMFPR11] and the fact that the property to be constructible by interval doubling is preserved for all sublattices of a lattice [Day79]. As we shall see here, the δ -canyon posets have the same three properties.

Proposition 2.27. *For any increasing range map δ and $n \geq 0$, the poset $\text{Ca}_\delta(n)$ is*

- (i) *straight*;
- (ii) *coated*;
- (iii) *nested*;
- (iv) *EL-shellable*;
- (v) *a meet semi-sublattice of $\text{Cl}_\delta(n)$* ;

(vi) a lattice;

(vii) constructible by interval doubling.

Proof. Point (iii) is immediate. Assume that u and v are two δ -canyons of size n such that $u \preceq v$. Let $k \in [n - 1]$ and consider the δ -cliff $w := u_1 \dots u_k v_{k+1} \dots v_n$. Now, since for any $i \in [k]$, $w_i = u_i \leq v_i$, and for any $i \in [k + 1, n]$, $w_i = v_i \geq u_i$, the fact that u and v are δ -canyons implies that for any $i \in [n]$ and $j \in [w_i]$ such that $i - j \geq 1$, the inequality $w_j \geq w_{i-j} + j$ holds. Thus, w is an δ -canyon, so that (ii) holds. Now, by Lemma 1.4, (i) checks out, and by Theorem 1.5, (iv) also. Let u and v be two δ -canyons of size n and set w as the δ -cliff $u \wedge v$. For all $j \in [w_i]$ such that $i - j \geq 1$, $w_{i-j} \leq w_i - j$. Indeed, either $w_{i-j} = u_{i-j}$ or $w_{i-j} = v_{i-j}$, and in the two cases $w_{i-j} \leq (u \wedge v)_{i-j}$. For this reason, w is a δ -canyon. This shows (v). Besides, due to the fact that by Proposition 2.21, Ca_δ is closed by prefix and is maximally extendable, Theorem 1.6 implies (vi). Point (vii) is a consequence of Theorem 1.12 since (iii) holds and Ca_δ is closed by prefix. \square

One can observe that $\text{Ca}_m(n)$ is not a join semi-sublattice of the lattice of δ -cliffs. Indeed, by setting $u := 0124$ and $v := 0205$, even if u and v are $\mathbf{2}$ -canyons, $u \vee v = 0225$ is not. By Proposition 2.27, the posets $\text{Ca}_m(n)$ are lattices and Theorem 1.6 provides a way to compute the join of two of their elements. For instance, in Ca_1 , one has

$$00120 \vee_{\text{Ca}_1} 00201 = \uparrow_{\text{Ca}_1}(00120 \vee 00201) = \uparrow_{\text{Ca}_1}(00221) = 00234, \tag{2.16}$$

and, in Ca_2 , one has

$$0124 \vee_{\text{Ca}_2} 0205 = \uparrow_{\text{Ca}_2}(0124 \vee 0205) = \uparrow_{\text{Ca}_2}(0225) = 0235. \tag{2.17}$$

These computations of the join of two elements are similar to the ones described in [Mar92] (see also [Gey94]) for Tamari lattices.

Besides, as pointed out by Proposition 2.27, when δ is an increasing range map, each $\text{Ca}_\delta(n)$ is constructible by interval doubling. Figure 2.6 shows a sequence of interval contractions performed from $\text{Ca}_2(4)$ in order to obtain $\text{Ca}_2(3)$.

Proposition 2.28. For any $m \geq 0$,

- (i) the graded set $\mathcal{I}(\text{Ca}_m)$ contains all the \mathbf{m} -cliffs u satisfying $u_i < u_{i+1}$ for all $i \in [|u| - 1]$;
- (ii) the graded set $\mathcal{O}(\text{Ca}_m)$ contains all the \mathbf{m} -cliffs u satisfying, for all $i \in [2, |u|]$, $u_i < \mathbf{m}(i)$, and, for all $i \in [|u|]$, if $u_i \neq 0$, then for all $j \in [i - 2]$, $u_{i-j} < u_i - j$;
- (iii) the graded set $\mathcal{B}(\text{Ca}_m)$ contains all the \mathbf{m} -cliffs u satisfying $1 \leq u_i < \mathbf{m}(i)$ for all $i \in [2, |u|]$, and $u_i - u_{i-1} \geq 2$ for all $i \in [3, |u|]$.

Remark that, from the definition of \mathbf{m} -canyons and the description of $\mathcal{I}(\text{Ca}_m)$ brought by Proposition 2.28, for any $u \in \mathcal{I}(\text{Ca}_m)$, all \mathbf{m} -canyons v such that $u \preceq v$ are also input-wings of Ca_m . For this reason, for any $n \geq 0$, $\mathcal{I}(\text{Ca}_m)(n)$ is an order filter of $\text{Ca}_m(n)$.

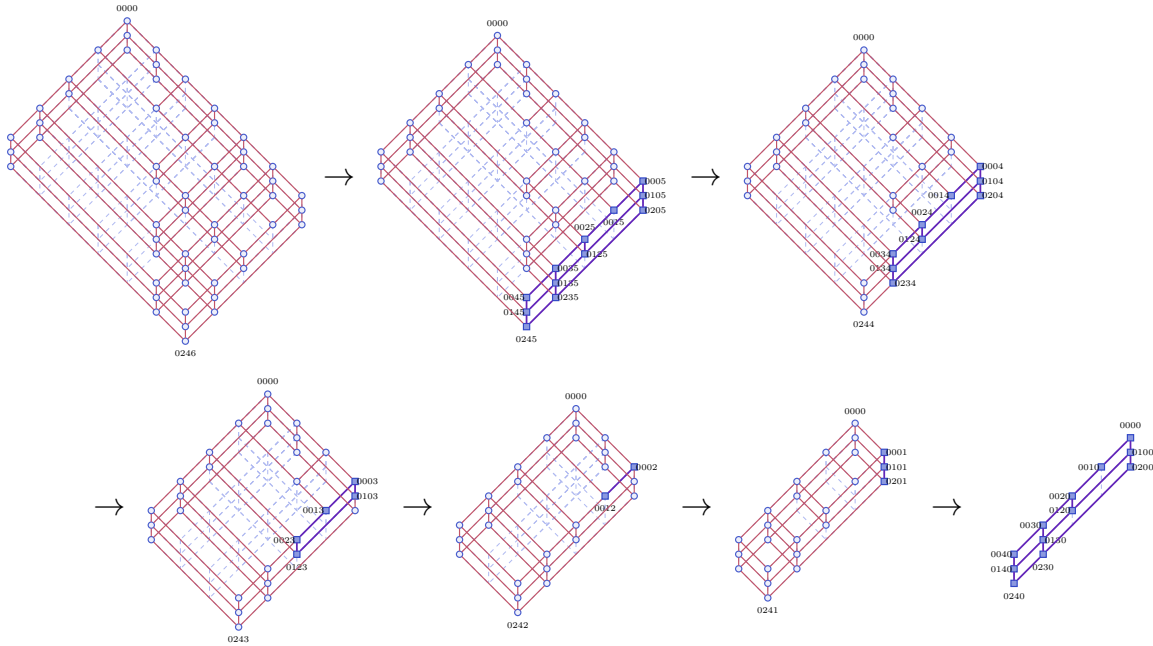

Figure 2.6: A sequence of interval contractions from $\text{Ca}_2(4)$ to a poset isomorphic to $\text{Ca}_2(3)$. These interval contractions are poset derivations as introduced in Section 1.3.4. The marked intervals are the ones involved in the interval doubling operations.

Proposition 2.29. *For any $m \geq 1$ and $n \geq 1$, the set $\mathbf{J}(\text{Ca}_m(n))$ contains all \mathbf{m} -canyons having exactly one letter different from 0.*

By Proposition 2.29, the number of join-irreducibles elements of $\text{Ca}_m(n)$ satisfies, for any $m \geq 1$ and $n \geq 1$, $\#\mathbf{J}(\text{Ca}_m(n)) = m \binom{n}{2}$. Since by Proposition 2.27, $\text{Ca}_m(n)$ is constructible by interval doubling, this is also the number of its meet-irreducible elements [GW16].

2.3.3 Cubic realization

Let $m \geq 1$ and $n \geq 0$. For any output-wing u of $\text{Ca}_m(n)$, we define $\rho(u)$ as the \mathbf{m} -canyon $\uparrow_{\text{Ca}_m}(u')$, where u' is the \mathbf{m} -cliff obtained by incrementing by 1 all letters of u except the first one. For instance, the output-wing 01007 of $\text{Ca}_2(5)$ is sent by ρ to the $\mathbf{2}$ -canyon $\uparrow_{\text{Ca}_2}(02118) = 02348$. We call $\rho(u)$ the *left-to-right increasing* of u . This map is not a poset embedding because, for $\mathbf{m} := 2$ and $n := 3$, $\rho(010) = 023 \preceq 013 = \rho(002)$ but $010 \not\preceq 002$.

Proposition 2.30. *For any $m \geq 1$, $n \geq 0$, and $u \in \mathcal{O}(\text{Ca}_m)(n)$,*

- (i) *the map ρ is a poset morphism and a bijection between $\mathcal{O}(\text{Ca}_m)(n)$ and $\mathcal{I}(\text{Ca}_m)(n)$;*
- (ii) *the \mathbf{m} -canyon u is cell-compatible with the \mathbf{m} -canyon $\rho(u)$;*
- (iii) *the cell $\langle u, \rho(u) \rangle$ is pure;*

(iv) all cells of $\{\langle u, \rho(u) \rangle : u \in \mathcal{O}(\text{Ca}_m)(n)\}$ are pairwise disjoint.

Proof. Let us first prove that ρ is a well-defined map. By Proposition 2.28, since for all $i \in [2, n]$, $u_i < m(i)$, the word u' obtained by incrementing by 1 all its letters except the first one is an m -cliff. Moreover, since by Proposition 2.21, Ca_m is maximally extendable, $v := \uparrow_{\text{Ca}_m}(u')$ is a well-defined m -canyon. Since by construction, for all $i \in [2, n]$, $v_i \neq 0$, each word obtained by replacing by 0 a letter v_i in v is an m -canyon. Therefore, v covers $n - 1$ elements of $\text{Ca}_m(n)$. These elements are obtained by decreasing v_i by some value, due to the fact that by Proposition 2.27, Ca_m is straight. For this reason, v is an input-wing, showing that ρ is a well-defined map from $\mathcal{O}(\text{Ca}_m)(n)$ to $\mathcal{I}(\text{Ca}_m)(n)$. Let us now define the map $\rho' : \mathcal{I}(\text{Ca}_m)(n) \rightarrow \mathcal{O}(\text{Ca}_m)(n)$ as follows. For any $v \in \mathcal{I}(\text{Ca}_m)(n)$, $u := \rho'(v)$ is the m -cliff satisfying $u_i = \uparrow_{i \neq 1} \uparrow_{u_{i-1} \leq u_{i-2}} (u_i - 1)$ for any $i \in [n]$. It is straightforward to prove that ρ' is a well-defined map. Moreover, by induction on $n \geq 0$, one can prove that both $\rho \circ \rho'$ and $\rho' \circ \rho$ are identity maps. This establishes (i).

Let v be an m -cliff satisfying $v_i \in \{u_i, \rho(u)_i\}$ for any $i \in [n]$. Since ρ' is the inverse map of ρ , this is equivalent to the fact that $v_i \in \{\rho'(w)_i, w_i\}$ for all $i \in [n]$, where w is the input-wing $\rho(u)$ of $\text{Ca}_m(n)$. Therefore, by definition of ρ' , $v_1 = 0$ and $v_i \in \llbracket w_i - 1 \rrbracket$ for any $i \in [2, n]$. The fact that w is an input-wing implies, by Proposition 2.28, that $u_i < u_{i+1}$ for all $i \in [n - 1]$. This implies that v is an m -canyon, so that (ii) checks out.

Point (iii) follows directly from the definition of ρ : since $\rho(u)$ is obtained by incrementing all the letters of u , except the first, in a minimal way so that the obtained m -cliff is an m -canyon, there cannot be any m -canyon inside the cell $\langle u, \rho(u) \rangle$.

Finally, assume that there are two input-wings v and w of $\text{Ca}_m(n)$ such that there is a point $x := (x_1, \dots, x_n) \in \mathbb{R}^n$ such that x is inside both the cells $\langle \rho'(v), v \rangle$ and $\langle \rho'(w), w \rangle$. By contradiction, let us assume that $v \neq w$ and let us set $i \in [2, n]$ as the smallest position such that $v_i \neq w_i$. Therefore, we have in particular

$$\rho'(v)_i < x_i < v_i \quad \text{and} \quad \rho'(w)_i < x_i < w_i. \tag{2.18}$$

Without loss of generality, we assume that $v_i < w_i$. Now, if $v_i - 2 \geq v_{i-1}$, then $\rho'(v)_i = v_i - 1$ and $\rho'(w)_i = w_i - 1$. It follows from (2.18) that $v_i = w_i$. Otherwise, when $v_i - 2 < v_{i-1}$, we have $\rho'(v)_i = 0$ and $\rho'(w)_i = w_i - 1$. It follows again, from (2.18), that $v_i = w_i$. This contradicts our hypothesis and shows that $v = w$. Therefore, (iv) holds. \square

This algorithm ρ brought by Proposition 2.30 describes the cells of maximal dimension of the cubic realization of $\text{Ca}_m(n)$. The definition of ρ is inspired by an analogous algorithm introduced by the first author in [Com19] to describe the cells of a geometric realization of the lattices of Tamari intervals. Figure 2.7 shows some examples of images of output-wings of $\text{Ca}_m(n)$ by ρ .

The three posets of the input-wings, output-wings, and butterflies of canyon posets are linked in the following way.

Theorem 2.31. For any $m \geq 1$ and $n \geq 0$,

$$\mathcal{O}(\text{Ca}_m)(n) \xrightarrow{\rho} \mathcal{I}(\text{Ca}_m)(n) \xrightarrow{\varphi_4} \mathcal{B}(\text{Ca}_{m+1})(n) \tag{2.19}$$

is a diagram of poset morphisms or isomorphisms, where the map φ_4 is defined, for any $u \in \mathbb{N}^n$ and $i \in [n]$, by $\varphi_4(u)_i := \uparrow_{i \neq 1} (u_i + i - 2)$.

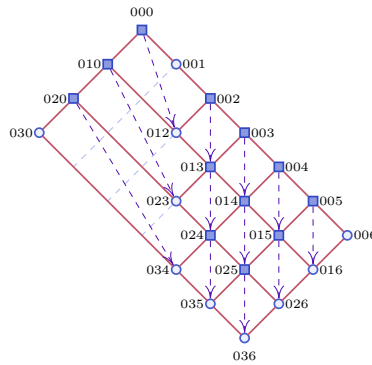

Figure 2.7: The poset $\text{Ca}_3(3)$ wherein output-wings are marked. The arrows connect these elements to their images by the bijection ρ .

Proof. This follows from Point (i) of Proposition 2.30 and from the descriptions of the input-wings, output-wings, and butterflies of $\text{Ca}_m(n)$ provided by Proposition 2.28. \square

Figure 2.8 gives an example of the poset morphisms or isomorphisms described by the statement of Theorem 2.31.

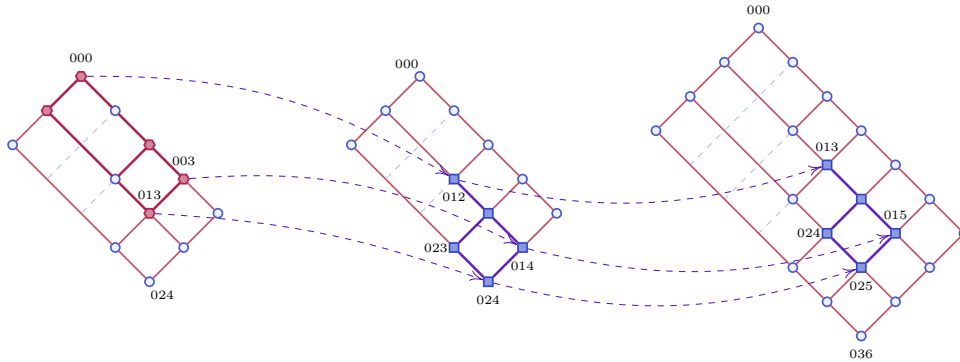

Figure 2.8: From the top to bottom and left to right, here are the posets $\text{Ca}_2(3)$, $\text{Ca}_2(3)$, and $\text{Ca}_3(3)$. The two last posets contain $\mathcal{I}(\text{Hi}_1)(3)$ as subposets. There is a poset morphism between the output-wings of the first one and the input-wings of the second one.

Proposition 2.32. For any $m \geq 1$ and $n \geq 1$,

$$\text{vol}(\mathfrak{C}(\text{Ca}_m(n))) = \text{vol}(\mathfrak{C}(\text{Cl}_m(n))) = m^{n-1}(n-1)!. \tag{2.20}$$

Proof. Directly from the definition of \mathbf{m} -canyons, one has that the \mathbf{m} -canyon $\bar{0}_m(n)$ is cell-compatible with $\bar{1}_m(n)$. Therefore, $\langle \bar{0}_m(n), \bar{1}_m(n) \rangle$ is a cell of $\mathfrak{C}(\text{Ca}_m(n))$. Since all others cells of this cubic realization are contained in this one, one obtains that $\mathfrak{C}(\text{Ca}_m(n))$ is an orthotope. This leads to the stated expression for the volume of the cubic realization of $\text{Ca}_m(n)$. \square

2.4. Poset morphisms and other interactions

The purpose of this part is to state the main links between the three posets Av_δ , Hi_δ , and Ca_δ when δ is an increasing range map. We shall also consider their subposets formed by their input-wings, output-wings, and butterflies elements in the particular case where $\delta = \mathbf{m}$ for an $m \geq 0$.

2.4.1 Order extensions

Observe that the map e_{Ca_δ} is not a poset morphism. Indeed, for instance in Ca_1 one has $002 \preceq 012$ but $e_{Ca_1}(002) = 002 \not\preceq 011 = e_{Ca_1}(012)$. Nevertheless, by composing this map on the left with the inverse of the Hi_δ -elevation map, we obtain a poset morphism, as stated by the next theorem.

Lemma 2.33. *Let δ be a range map, and u and v be two δ -canyons of size n . If $u \preceq v$, then $\omega(e_{Ca_\delta}(u)) \leq \omega(e_{Ca_\delta}(v))$.*

Proof. First, since by Proposition 2.21, Ca_δ is closed by prefix, e_{Ca_δ} is well-defined. By considering the contrapositive of the statement of the lemma and by Lemma 2.24, we have to show that for any δ -canyons u and v of size n , $\omega(d(u)) > \omega(d(v))$ implies that there exists $i \in [n]$ such that $u_i > v_i$. We proceed by induction on n . If $n = 0$, the property holds immediately. Assume now that $u = u'a$ and $v = v'b$ are two δ -canyons of size $n + 1$ such that $\omega(d(u'a)) > \omega(d(v'b))$ where u' and v' are δ -canyons of size n and $a, b \in \mathbb{N}$. If $\omega(d(u')) > \omega(d(v'))$, then by induction hypothesis, there is $i \in [n]$ such that $u'_i > v'_i$. Since $u_i = u'_i$ and $v_i = v'_i$, the property holds. Otherwise, $\omega(d(u')) \leq \omega(d(v'))$. Since $\omega(d(u)) > \omega(d(v))$ and by definition of the map d , we necessarily have $a > b$. Therefore one has $u_{n+1} > v_{n+1}$, showing that the property holds. \square

Theorem 2.34. *For any increasing range map δ and any $n \geq 0$, the map $e_{Hi_\delta}^{-1} \circ e_{Ca_\delta}$ from $Ca_\delta(n)$ to $Hi_\delta(n)$ is a poset morphism.*

Proof. First of all, by Proposition 2.26, the map $\phi := e_{Hi_\delta}^{-1} \circ e_{Ca_\delta}$ is well-defined. By definition of the maps e_{Hi_δ} and e_{Ca_δ} , for any δ -canyon w of size n and any $i \in [n]$, $\phi(w)_i = \omega(e_{Ca_\delta}(w_1 \dots w_i))$. Assume now that u and v are two δ -canyons of size n such that $u \preceq v$. Then, for any $i \in [n]$, $u_1 \dots u_i \preceq v_1 \dots v_i$. By Lemma 2.33, this implies $\omega(e_{Ca_\delta}(u_1 \dots u_i)) \leq \omega(e_{Ca_\delta}(v_1 \dots v_i))$. Moreover, by the above remark, this implies $\phi(u)_i \leq \phi(v)_i$. Therefore, we have $\phi(u) \preceq \phi(v)$, establishing the statement of the theorem. \square

Even if, by Proposition 2.26, $e_{Hi_\delta}^{-1} \circ e_{Ca_\delta} : Ca_\delta(n) \rightarrow Hi_\delta(n)$ is a bijection, this map is not a poset isomorphism. This is the case since there does not exist for instance a poset isomorphism between $Ca_1(3)$ and $Hi_1(3)$ —their Hasse diagrams are not superimposable. Moreover, as a consequence of Theorem 2.34, for any $n \geq 0$, $Hi_\delta(n)$ is an order extension of $Ca_\delta(n)$. Furthermore, it is possible to show by induction on the length of the δ -canyons and by using Lemma 2.23 that Ca_δ satisfies the prerequisites of Proposition 1.15. Therefore, $Ca_\delta(n)$ is an order extension of $Av_\delta(n)$.

To summarize the situation, when δ is an increasing range map, the three families of Fuss–Catalan posets fit into the chain

$$Av_\delta(n) \xrightarrow{e_{Ca_\delta}^{-1}} Ca_\delta(n) \xrightarrow{e_{Hi_\delta}^{-1} \circ e_{Ca_\delta}} Hi_\delta(n) \tag{2.21}$$

of posets for the order extension relation. This phenomenon is analogous to the one stating that Stanley lattices are order extensions of Tamari lattices, which in turn are order extension of Kreweras lattices [Kre72] (see for instance [BB09]). In the present case, avalanche posets play the role of the Kreweras lattices, canyon posets play the role of the Tamari posets, and hill posets play the role of Stanley posets. The difference is that for $\delta = 1$, even if canyon lattices coincide with Tamari lattices and hill lattices coincide with Stanley lattices, the avalanche posets are not isomorphic to Kreweras lattices. Figure 2.9 gives an example of an instance of (2.21).

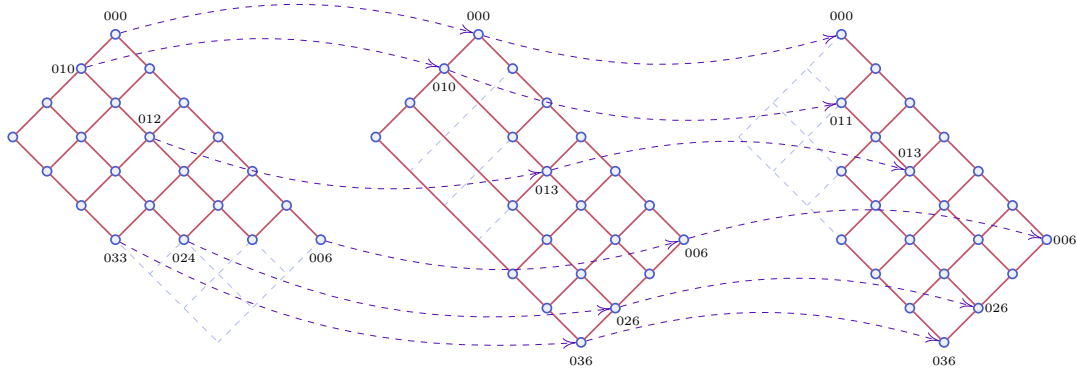

Figure 2.9: From the left to the right, here are the posets $\text{Av}_3(3)$, $\text{Ca}_3(3)$, and $\text{Hi}_3(3)$. The poset on the right is an order extension of the one at middle, which is itself an order extension of the one at the left.

2.4.2 Isomorphisms between subposets

There is a link between the hill and the canyon posets, as stated by the following result.

Theorem 2.35. *For any $m \geq 1$ and $n \geq 0$,*

$$\text{Hi}_{m-1}(n) \xrightarrow{\varphi_3} \mathcal{I}(\text{Ca}_m)(n) \quad (2.22)$$

is a poset isomorphism, where φ_3 is the map defined in the statement of Theorem 2.14.

Proof. This follows from the description of the input-wings of $\text{Ca}_m(n)$ provided by Proposition 2.28. \square

Figure 2.10 gives an example of the poset isomorphism described by the statement of Theorem 2.35. A consequence of Theorem 2.35 is that, for any $m \geq 2$ and $n \geq 0$, the image by φ_3^{-1} of $\text{Ca}_{m-1}(n) \cap \mathcal{I}(\text{Ca}_m)(n)$ is $\text{Hi}_{m-2}(n)$. Indeed, the set $\text{Ca}_{m-1}(n) \cap \mathcal{I}(\text{Ca}_m)(n)$ is nothing but the set $\mathcal{I}(\text{Ca}_{m-1})(n)$.

To summarize the whole situation of the links between the three studied Fuss–Catalan posets stated by Theorems 2.5, 2.14, 2.31, 2.34, 2.35, and Proposition 1.15, one has for any $m \geq 1$ and

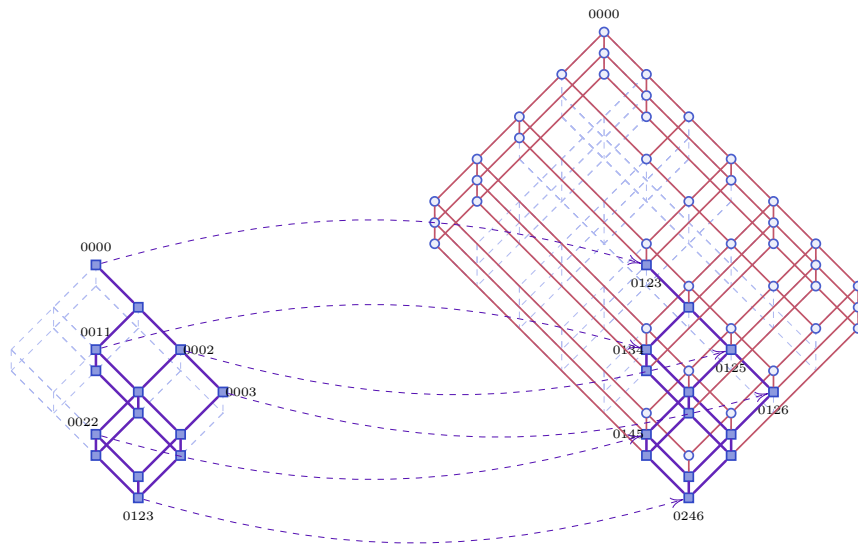

Figure 2.10: The subset of $Ca_2(4)$ formed by its input-wings is isomorphic to $Hi_1(4)$.

$n \geq 0$ the diagram

$$\begin{array}{ccccc}
 & & Av_{m-1}(n) & \xrightarrow{\varphi_1} & \mathcal{I}(Av_m)(n) & \xrightarrow{\varphi_2} & \mathcal{O}(Av_m)(n) & \xrightarrow{\varphi_1} & \mathcal{B}(Av_{m+1})(n) \\
 & & \downarrow e_{Ca_{m-1}}^{-1} & & \downarrow e_{Hi_{m-1}}^{-1} \circ e_{Ca_{m-1}} & & & & \\
 \mathcal{O}(Ca_m)(n) & & Ca_{m-1}(n) & & & & & & \\
 \rho \downarrow & & \downarrow & & & & & & \\
 \mathcal{I}(Ca_m)(n) & \xleftarrow{\varphi_3} & Hi_{m-1}(n) & \xrightarrow{\varphi_3} & \mathcal{I}(Hi_m)(n) & \xrightarrow{\varphi_2} & \mathcal{O}(Hi_m)(n) & & \\
 \varphi_4 \downarrow & & & & \downarrow I & & & & \\
 \mathcal{B}(Ca_{m+1})(n) & & & & \mathcal{B}(Hi_{m+1})(n) & & & &
 \end{array} \tag{2.23}$$

of poset morphisms, embeddings, or isomorphisms.

3. Associative algebras of δ -cliffs

This part of the work is devoted to endow the sets of δ -cliffs with algebraic structures. We describe a graded associative algebra on δ -cliffs motivated by a connection with the δ -cliff posets. Indeed, the product of two δ -cliffs is a sum of δ -cliffs forming an interval of a δ -cliff poset. This property is shared by a lot of combinatorial and algebraic structures. For instance, the algebra FQSym of permutations is related to the weak Bruhat order [DHT02, AS05], the algebra PBT of binary trees is related to the Tamari order [LR02, HNT05], and the algebra Sym of integer compositions is related to the hypercube [GKL+95].

3.1. Coalgebras and algebras

We introduce here a cograded coalgebra structure on the linear span of all δ -cliffs and then, by considering the dual structure, we obtain a graded algebra. When δ satisfies some properties, this gives an associative algebra.

From now, \mathbb{K} is the ground field (of characteristic zero) of all algebraic structures to be defined next. For any graded vector space \mathcal{V} , we denote by $\mathcal{H}_{\mathcal{V}}(t)$ the Hilbert series of \mathcal{V} .

We use here the notions of valleys in range maps and of valley-free range maps, defined in Section 1.1.1.

3.1.1 Coalgebras of δ -cliffs

For any range map δ , let \mathbf{Cl}_{δ} be the linear span of all δ -cliffs. This space is graded and decomposes as $\mathbf{Cl}_{\delta} = \bigoplus_{n \geq 0} \mathbf{Cl}_{\delta}(n)$, where $\mathbf{Cl}_{\delta}(n)$, $n \geq 0$, is the linear span of all δ -cliffs of size n . By definition, the set $\{F_u : u \in \mathbf{Cl}_{\delta}\}$ is a basis of \mathbf{Cl}_{δ} , and we shall refer to it as the *fundamental basis* or as the *F-basis*. Let also $c : \mathbf{Cl}_{\delta} \rightarrow \mathbb{K}$ be the linear map defined by $c(F_{\epsilon}) := 1$ and by $c(F_u) := 0$ for any $u \in \mathbf{Cl}_{\delta} \setminus \{\epsilon\}$.

For any $n \geq 0$, the *δ -reduction map* is the map $r_{\delta} : \mathbb{N}^n \rightarrow \mathbf{Cl}_{\delta}(n)$ defined for any word $u \in \mathbb{N}^n$ and any $i \in [n]$ by $(r_{\delta}(u))_i := \min\{u_i, \delta(i)\}$. For instance, $r_1(212066) = 012045$ and $r_2(212066) = 012066$.

Let $\Delta : \mathbf{Cl}_{\delta} \rightarrow \mathbf{Cl}_{\delta} \otimes \mathbf{Cl}_{\delta}$ be the cobinary coproduct defined, for any $w \in \mathbf{Cl}_{\delta}$, by

$$\Delta(F_w) := \sum_{\substack{u, v \in \mathbb{N}^* \\ w=uv}} F_u \otimes F_{r_{\delta}(v)}, \quad (3.1)$$

where \mathbb{N}^* denotes the set of all words on \mathbb{N} . This coproduct is well-defined since any prefix of a δ -cliff is a δ -cliff and the image of a word on \mathbb{N} by the δ -reduction map is by definition a δ -cliff. For instance, for $\delta := 1221013^{\omega}$, we have in \mathbf{Cl}_{δ} ,

$$\Delta(F_{1021}) = F_{\epsilon} \otimes F_{1021} + F_1 \otimes F_{021} + F_{10} \otimes F_{11} + F_{102} \otimes F_1 + F_{1021} \otimes F_{\epsilon}, \quad (3.2)$$

and

$$\begin{aligned} \Delta(F_{1211010}) &= F_{\epsilon} \otimes F_{1211010} + F_1 \otimes F_{111000} + F_{12} \otimes F_{11010} + F_{121} \otimes F_{1010} \\ &\quad + F_{1211} \otimes F_{010} + F_{12110} \otimes F_{10} + F_{121101} \otimes F_0 + F_{1211010} \otimes F_{\epsilon}. \end{aligned} \quad (3.3)$$

Theorem 3.1. *Let δ be a range map. The space \mathbf{Cl}_{δ} endowed with the coproduct Δ and the counit c is a counital cograded coalgebra. Moreover, Δ is coassociative if and only if δ is valley-free.*

Proof. The first part of the statement is a direct consequence of the definition of Δ .

To establish the second part, let us compute the two ways to apply twice the coproduct Δ on a basis element of \mathbf{Cl}_{δ} . For any $w \in \mathbf{Cl}_{\delta}$, we have

$$(\Delta \otimes I)\Delta(F_w) = \sum_{\substack{x, y, z \in \mathbb{N}^* \\ w=xyz}} F_x \otimes F_{r_{\delta}(y)} \otimes F_{r_{\delta}(z)} \quad (3.4)$$

and

$$(I \otimes \Delta)\Delta(F_w) = \sum_{\substack{u,v \in \mathbb{N}^* \\ w=uv}} \sum_{\substack{y',z' \in \mathbb{N}^* \\ r_\delta(v)=y'z'}} F_u \otimes F_{y'} \otimes F_{r_\delta(z')} = \sum_{\substack{x,y,z \in \mathbb{N}^* \\ w=xyz}} F_x \otimes F_{r_\delta(y)} \otimes F_{r_{\delta_{|y|}}(z)}, \quad (3.5)$$

where for any $k \geq 0$, δ_k is the range map satisfying $\delta_k(i) = \min\{\delta(i), \delta(k+i)\}$ for any $i \geq 1$. The second equality of (3.5) comes from the two following facts. First, for any $i \in [|y'|]$, $y'_i = r_\delta(v)_i = r_\delta(y)_i$ where y is the factor $w_{|u|+1} \dots w_{|u|+|y'|}$ of w . Second, we have for any $j \in [|z'|]$, $z'_j = r_\delta(v)_{|y'|+j} = \min\{v_{|y'|+j}, \delta(|y'|+j)\}$, so that for any $i \in [|z'|]$, $r_\delta(z')_i = \min\{z'_i, \delta(i)\} = \min\{v_{|y'|+i}, \delta(|y'|+i), \delta(i)\} = r_{\delta_{|y'|}}(z)_i$, where z is the suffix of length $|z'|$ of w .

Let us now prove that (3.4) and (3.5) are different if and only if δ has a valley. These two elements are different if and only if there exists a factorization $w = xyz$ with $x, y, z \in \mathbb{N}^*$ such that $r_\delta(z) \neq r_{\delta_{|y|}}(z)$. This is equivalent to the fact there exists an index $i \in [|z|]$ such that $r_\delta(z)_i \neq r_{\delta_{|y|}}(z)_i$. Since z is a suffix of w , there exists a $j \in [|x| + |y| + 1, |w|]$ such that $z = w_j w_{j+1} \dots w_{|w|}$. Now, we have

$$r_\delta(z)_i = \min\{w_{j+i-1}, \delta(i)\} \neq \min\{w_{j+i-1}, \delta(|y|+i), \delta(i)\} = r_{\delta_{|y|}}(z)_i. \quad (3.6)$$

To have this difference, we necessarily have $\delta(|y|+i) < z_i$ and $\delta(|y|+i) < \delta(i)$. Now, since w is in particular a δ -cliff, we have $z_i = w_{j+i-1} \leq \delta(j+i-1)$. Therefore, we obtain $\delta(i) > \delta(|y|+i) < \delta(j+i-1)$. Since $j \geq |y|+1$, this leads to the fact that δ has a valley. This establishes that Δ is coassociative if and only if δ is valley-free. \square

3.1.2 Algebras of δ -cliffs

Let $\cdot : \text{Cl}_\delta \otimes \text{Cl}_\delta \rightarrow \text{Cl}_\delta$ be the binary product defined as the dual of the coproduct Δ introduced in Section 3.1.1, where the graded dual space Cl_δ^* is identified with Cl_δ . By duality, this product \cdot satisfies, for any $u, v \in \text{Cl}_\delta$,

$$F_u \cdot F_v = \sum_{w \in \text{Cl}_\delta} \langle F_u \otimes F_v, \Delta(F_w) \rangle F_w, \quad (3.7)$$

where, for any $w \in \text{Cl}_\delta$, $\langle F_u \otimes F_v, \Delta(F_w) \rangle$ is the coefficient of $F_u \otimes F_v$ in $\Delta(F_w)$. Therefore,

$$F_u \cdot F_v = \sum_{\substack{v' \in r_\delta^{-1}(v) \\ uv' \in \text{Cl}_\delta}} F_{uv'}, \quad (3.8)$$

where $r_\delta^{-1}(v)$ is the fiber of v under the map r_δ . For instance, in Cl_1 ,

$$F_{00} \cdot F_{011} = F_{00011} + F_{00021} + F_{00031} + F_{00111} + F_{00121} + F_{00131} + F_{00211} + F_{00221} + F_{00231}, \quad (3.9)$$

in Cl_2 ,

$$F_{00} \cdot F_{011} = F_{00011} + F_{00111} + F_{00211} + F_{00311} + F_{00411}, \quad (3.10)$$

and in Cl_δ , where $\delta = 01312^\omega$, we have both

$$F_{00} \cdot F_{011} = F_{00011} + F_{00111} + F_{00211} + F_{00311} \quad (3.11)$$

and

$$F_{00} \cdot F_{013} = 0. \quad (3.12)$$

By Theorem 3.1, the product \cdot admits the linear map $\mathbb{1} : \mathbb{K} \rightarrow \text{Cl}_\delta$ satisfying $\mathbb{1}(1) = F_\epsilon$ as unit, and is graded. Moreover, again by this last theorem, \cdot is associative if and only if δ is valley-free. For instance, for $\delta := 101^\omega$, δ has a valley and since

$$(F_0 \cdot F_0) \cdot F_0 - F_0 \cdot (F_0 \cdot F_0) = F_{000} - (F_{000} + F_{001}) = -F_{001} \neq 0, \quad (3.13)$$

the product \cdot of Cl_δ is not associative.

We now establish a link between this product \cdot on the F-basis of Cl_δ and the posets $\text{Cl}_\delta(n)$, $n \geq 0$, introduced and studied in the previous sections. For this, let for any $n_1, n_2 \geq 0$ the two binary operations $/, \setminus : \text{Cl}_\delta(n_1) \times \text{Cl}_\delta(n_2) \rightarrow \mathbb{N}^{n_1+n_2}$ defined, for any $u, v \in \text{Cl}_\delta$, by $u/v := uv$ and $u \setminus v := uv'$ where v' is the word on \mathbb{N} of length $|v|$ satisfying, for any $i \in [|v|]$,

$$v'_i = \begin{cases} \delta(|u| + i) & \text{if } v_i = \delta(i), \\ v_i & \text{otherwise.} \end{cases} \quad (3.14)$$

For instance, for $\delta = 112334^\omega$, $010/1021 = 0101021$ and $010 \setminus 1021 = 0103041$. For $\delta = 210^\omega$, $21 \setminus 11 = 2110$. Observe that this last word is not a δ -cliff.

Lemma 3.2. *Let δ be a range map and $u, v \in \text{Cl}_\delta$. If the word u/v is a δ -cliff, then $u \setminus v$ also is.*

Proof. Assume that $w := u/v \in \text{Cl}_\delta$. Hence, for any $i \in [|w|]$, $w_i \leq \delta(i)$. In particular, this implies that for any $i \in [|v|]$, $v_i = w_{|u|+i} \leq \delta(|u| + i)$. By definition of the operation \setminus , the word $w' := u \setminus v$ satisfies $w'_{|u|+i} \in \{v_i, \delta(|u| + i)\}$. Moreover, the fact that u is a δ -cliff implies that for any $i \in [|u|]$, $u_i = w'_i \leq \delta(i)$. Therefore, w' is a δ -cliff. \square

Lemma 3.3. *A range map δ is weakly increasing if and only if for any $u, v \in \text{Cl}_\delta$, u/v is a δ -cliff.*

Proof. Assume that δ is weakly increasing and let $w := u/v$ where $u, v \in \text{Cl}_\delta$. Hence, since v is a δ -cliff, for any $i \in [|v|]$, $w_{|u|+i} = v_i \leq \delta(i)$. Since δ is weakly increasing, we have $\delta(i) \leq \delta(|u| + i)$. This implies that $w_{|u|+i} \leq \delta(|u| + i)$. Moreover, the fact that u is δ -cliff implies that, for any $i \in [|u|]$, $w_i = u_i \leq \delta(i)$. Therefore, u/v is a δ -cliff.

Conversely, assume that all $w := u/v$ are δ -cliffs for all $u, v \in \text{Cl}_\delta$. In particular, this holds for $u := 0$ and $v := \bar{1}_\delta(n)$ for any $n \geq 0$. We have $\delta(i-1) = v_{i-1} = w_i \leq \delta(i)$ for any $i \in [2, n+1]$. Therefore, δ is weakly increasing. \square

Let $\chi_\delta : \mathbb{N}^* \rightarrow \mathbb{K}$ be the map defined for any $u \in \mathbb{N}^*$ by $\chi_\delta(u) := \mathbb{1}_{u/v \in \text{Cl}_\delta}$.

Theorem 3.4. For any range map δ , the product \cdot of Cl_δ satisfies, for any $u, v \in \text{Cl}_\delta$,

$$F_u \cdot F_v = \chi_\delta(u/v) \sum_{w \in [u/v, u \setminus v]} F_w \tag{3.15}$$

where $[u/v, u \setminus v]$ is an interval of the poset $\text{Cl}_\delta(|u| + |v|)$.

Proof. Assume first that $w := u/v \in \text{Cl}_\delta$. By Lemma 3.2, $u \setminus v \in \text{Cl}_\delta$. By (3.8), for any $w' \in \text{Cl}_\delta$, $F_{w'}$ appears in $F_u \cdot F_v$ if and only if there is $v' \in r_\delta^{-1}(v)$ such that $uw' = w'$. This implies that $r_\delta(v') = v$ and, by definition of the δ -reduction map, for any $i \in [|v|]$, $v'_i \geq v_i$. Moreover, since w' is a δ -cliff, we have for any $i \in [|v|]$, $v'_i = w'_{|u|+i} \leq \delta(|u| + i)$. Therefore, for all $i \in [|v|]$, $v_i \leq v'_i \leq \delta(|u| + i)$. This is equivalent to the fact that $u/v \preceq w' \preceq u \setminus v$ and leads to the expression of the statement of theorem.

Assume finally that $w := u/v \notin \text{Cl}_\delta$. Since u and v are δ -cliffs, there exists an index $i \in [|v|]$ such that $w_{|u|+i} > \delta(|u| + i)$. Since $w_{|u|+i} = v_i$, this implies that $v_i > \delta(|u| + i)$. Observe that by definition of the δ -reduction map, for all $v' \in r_\delta^{-1}(v)$ and $j \in [|v|]$, $v'_j \geq v_j$. Therefore, no uv' can be a δ -cliff. By inspecting Formula (3.8) for the product \cdot , we obtain that the sum is empty, so that $F_u \cdot F_v = 0$. \square

For instance, for $\delta := 01120^\omega$,

$$F_{01} \cdot F_{010} = F_{01010} + F_{01020} + F_{01110} + F_{01120},$$

and, since $01/011 = 01011 \notin \text{Cl}_\delta$,

$$F_{01} \cdot F_{011} = 0.$$

In particular when δ is weakly increasing, Lemma 3.3 and Theorem 3.4 state that any product of two elements of the F-basis of Cl_δ is a sum of elements of the F-basis ranging in an interval of a δ -cliff poset.

3.2. Bases and algebraic study

We construct alternative bases for Cl_δ and establish several properties of this structure w.r.t. properties of the range map δ . The main results are summarized in Table 3.1. We also provide

Properties of δ	Properties of Cl_δ
None	Unital graded magmatic algebra Products on the F-basis are intervals in δ -cliff posets
Valley-free	Associative algebra
Valley-free and 1-dominated	Finite presentation
Weakly increasing	Free as unital associative algebra

Table 3.1: Properties of the algebras Cl_δ implied by properties of range maps δ .

a classification of all associative algebras Cl_δ in four classes, depending on properties of the valley-free range map δ .

We use here the notion of j -dominated range maps, defined in Section 1.1.1.

3.2.1 G-basis

For any $u \in \text{Cl}_\delta$, let

$$G_u := F_{c_\delta(u)}, \quad (3.16)$$

where $c(u)$ is the complementary of u as defined in Section 1.2.1. Due to the fact that c is an involution, the set $\{G_u : u \in \text{Cl}_\delta\}$ is a basis of Cl_δ , called *G-basis*.

We now consider that δ is a weakly increasing range map. We need, to state the next result, to introduce for any $n_1, n_2 \geq 0$ the two binary operations $\dashv, \vdash : \text{Cl}_\delta(n_1) \times \text{Cl}_\delta(n_2) \rightarrow \mathbb{N}^{n_1+n_2}$ defined, for any $u, v \in \text{Cl}_\delta$, by $u \dashv v := uv'$ where v' is the word on \mathbb{N} of length $|v|$ satisfying, for any $i \in [|v|]$,

$$v'_i = \begin{cases} \delta(|u| + i) - \delta(i) + v_i & \text{if } v_i \neq 0, \\ 0 & \text{otherwise,} \end{cases} \quad (3.17)$$

and by $u \vdash v := uv'$ where v' is the word on \mathbb{N} of length $|v|$ satisfying, for any $i \in [|v|]$,

$$v'_i = \delta(|u| + i) - \delta(i) + v_i. \quad (3.18)$$

For instance, for $\delta = 112334^\omega$, $010 / 1021 = 0103042$ and $010 \setminus 1021 = 0103242$. Observe that in the case where $\delta = \mathbf{m}$ for an $m \geq 0$, $u \dashv v$ is the word obtained by concatenating u and v and by incrementing by $m|u|$ the letters coming from v that are different from 0, and $u \vdash v$ is the word obtained by concatenating u and v and by incrementing by $m|u|$ all the letters coming from v .

Lemma 3.5. *For any weakly increasing range map δ and any $u, v \in \text{Cl}_\delta$,*

$$u \dashv v = c_\delta(c_\delta(u) \setminus c_\delta(v)), \quad \text{and} \quad u \vdash v = c_\delta(c_\delta(u) / c_\delta(v)).$$

Proof. These identities follow by straightforward computations based upon the definitions of the operations $/, \setminus, \dashv, \vdash$, and c_δ . \square

Notice that, by Lemmas 3.5, 3.2, and 3.3, if δ is weakly increasing and u and v are δ -cliffs, both $u \dashv v$ and $u \vdash v$ are δ -cliffs.

Proposition 3.6. *For any weakly increasing range map δ , the product \cdot of Cl_δ satisfies, for any $u, v \in \text{Cl}_\delta$,*

$$G_u \cdot G_v = \sum_{w \in [u \dashv v, u \vdash v]} G_w. \quad (3.19)$$

where $[u \dashv v, u \vdash v]$ is an interval of the poset $\text{Cl}_\delta(|u| + |v|)$.

Proof. By Lemma 3.5, we have

$$G_u \cdot G_v = F_{c_\delta(u)} \cdot F_{c_\delta(v)} = \sum_{w \in [c_\delta(u) / c_\delta(v), c_\delta(u) \setminus c_\delta(v)]} F_w = \sum_{w \in [c_\delta(c_\delta(u) \setminus c_\delta(v)), c_\delta(c_\delta(u) / c_\delta(v))]} G_w. \quad (3.20)$$

Now, again by Lemma 3.5, we obtain the stated expression. \square

For instance, in Cl_1 ,

$$G_{01} \cdot G_{010} = G_{01030} + G_{01031} + G_{01032} + G_{01130} + G_{01131} + G_{01132} + G_{01230} + G_{01231} + G_{01232}, \quad (3.21)$$

and in Cl_2 ,

$$\begin{aligned} G_{01} \cdot G_{010} = & G_{01050} + G_{01051} + G_{01052} + G_{01053} + G_{01054} + G_{01150} + G_{01151} + G_{01152} \\ & + G_{01153} + G_{01154} + G_{01250} + G_{01251} + G_{01252} + G_{01253} + G_{01254} + G_{01350} \\ & + G_{01351} + G_{01352} + G_{01353} + G_{01354} + G_{01450} + G_{01451} + G_{01452} + G_{01453} \\ & + G_{01454}. \end{aligned} \quad (3.22)$$

3.2.2 E and H-bases

By mimicking the construction of bases of several combinatorial spaces by using a particular partial order on their basis element (see for instance [DHT02, HNT05]), let for any $u \in Cl_\delta$,

$$E_u := \sum_{\substack{v \in Cl_\delta \\ u \preceq v}} F_v, \quad (3.23) \qquad H_u := \sum_{\substack{v \in Cl_\delta \\ v \preceq u}} F_v. \quad (3.24)$$

By triangularity, the sets $\{E_u : u \in Cl_\delta\}$ and $\{H_u : u \in Cl_\delta\}$ are bases of Cl_δ , called respectively *elementary basis* and *homogeneous basis*, or respectively *E-basis* and *H-basis*. For instance, for $\delta := 1021^\omega$,

$$E_{10010} = F_{10010} + F_{10011} + F_{10110} + F_{10111} + F_{10210} + F_{10211}, \quad (3.25)$$

and

$$H_{10010} = F_{10010} + F_{10000} + F_{00010} + F_{00000}. \quad (3.26)$$

Proposition 3.7. *For any range map δ , the product \cdot of Cl_δ satisfies, for any $u, v \in Cl_\delta$,*

$$E_u \cdot E_v = \chi_\delta(u/v) E_{u/v} \quad (3.27)$$

Proof. By (3.8), we have

$$E_u \cdot E_v = \sum_{\substack{u', v' \in Cl_\delta \\ u \preceq u' \\ v \preceq v'}} \sum_{\substack{v'' \in r_\delta^{-1}(v') \\ u'v'' \in Cl_\delta}} F_{u'v''} = \sum_{\substack{u' \in Cl_\delta \\ u \preceq u'}} \sum_{\substack{v'' \in \mathbb{N}^* \\ v \preceq r_\delta(v'') \\ u'v'' \in Cl_\delta}} F_{u'v''} = \sum_{\substack{u' \in Cl_\delta \\ u \preceq u'}} \sum_{\substack{v'' \in \mathbb{N}^{|v|} \\ \forall i \in [|v|], v_i \preceq v''_i \\ u'v'' \in Cl_\delta}} F_{u'v''}. \quad (3.28)$$

The equality between the third and the last member of (3.28) is a consequence of the fact that for any $v'' \in \mathbb{N}^*$, one has $v \preceq r_\delta(v'')$ if and only if $v_i \preceq v''_i$ for all $i \in [|v|]$. By definition of the E-basis provided by (3.23), the last member of (3.28) is equal to the stated formula. \square

Proposition 3.8. *For any range map δ , the product \cdot of Cl_δ satisfies, for any $u, v \in Cl_\delta$,*

$$H_u \cdot H_v = H_{r_\delta(u \setminus v)}. \quad (3.29)$$

Proof. By (3.8), we have

$$H_u \cdot H_v \sum_{\substack{u', v' \in \text{Cl}_\delta \\ u' \preceq u \\ v' \preceq v}} \sum_{\substack{v'' \in r_\delta^{-1}(v') \\ u' v'' \in \text{Cl}_\delta}} F_{u' v''} \sum_{\substack{u' \in \text{Cl}_\delta \\ u' \preceq u}} \sum_{\substack{v'' \in \mathbb{N}^* \\ r_\delta(v'') \preceq v \\ u' v'' \in \text{Cl}_\delta}} F_{u' v''} \sum_{\substack{u' \in \text{Cl}_\delta \\ u' \preceq u}} \sum_{\substack{v'' \in \mathbb{N}^{|v|} \\ \forall i \in [|v|], v_i < \delta(i) \Rightarrow v_i'' \preceq v_i \\ u' v'' \in \text{Cl}_\delta}} F_{u' v''}. \quad (3.30)$$

The equality between the third and the last member of (3.30) is a consequence of the fact that for any $v'' \in \mathbb{N}^*$, one has $r_\delta(v'') \preceq v$ if and only if for all $i \in [|v|]$, $v_i < \delta(i)$ implies $v_i'' \preceq v_i$. By definition of the H-basis provided by (3.24), and since $F_{r_\delta(u \setminus v)}$ is the element with the greatest index appearing in the last member of (3.30), this expression is equal to the stated formula. \square

3.2.3 Presentation by generators and relations

A nonempty δ -cliff u is δ -prime if the relation $u = v/w$ with $v, w \in \text{Cl}_\delta$ implies $(v, w) \in \{(u, \epsilon), (\epsilon, u)\}$. The graded collection of all these elements is denoted by \mathcal{P}_δ . For instance, for $\delta := 021^\omega$, among others, the δ -cliffs 0, 01, and 021111 are δ -prime, and $0210 = 021/0$ and $011101 = 0111/01$ are not.

Proposition 3.9. *For any range map δ , the set $\{E_u : u \in \mathcal{P}_\delta\}$ is a minimal generating family of the unital magmatic algebra $(\text{Cl}_\delta, \cdot, \mathbb{1})$.*

Proof. Let us call G the set of the elements of Cl_δ appearing in the statement of the proposition. We proceed by proving that any E_u , $u \in \text{Cl}_\delta$, can be expressed as a product of elements of G by induction on the size n of u . Since for any $\lambda \in \mathbb{K}$, $\mathbb{1}(\lambda) = \lambda E_\epsilon$, E_ϵ is the unit of Cl_δ . Since moreover E_ϵ is generated by the empty product of elements of G , the property is true for $n = 0$. Assume now that u is a nonempty δ -cliff satisfying $u = u^{(1)}/\dots/u^{(k-1)}/u^{(k)}$ where $k \geq 1$ is maximal and the $u^{(i)}$, $i \in [k]$, are some nonempty δ -cliffs. If $k = 1$, since k is maximal, u is δ -prime and therefore E_u belongs to G . Otherwise, by setting $u' := u^{(1)}/\dots/u^{(k-1)}$, we have $u = u'/u^{(k)}$ where u' and $u^{(k)}$ are both nonempty δ -cliffs. Then, by Proposition 3.7, $E_u = E_{u'/u^{(k)}} = E_{u'} \cdot E_{u^{(k)}}$. Since the degrees of u' and of $u^{(k)}$ are both smaller than n , by induction hypothesis, $E_{u'}$ and $E_{u^{(k)}}$ are generated by G . Therefore, E_u also is.

It remains to prove that G is minimal w.r.t. set inclusion. For this, let any $u \in \mathcal{P}_\delta$ and set $G' := G \setminus \{E_u\}$. Since by definition of δ -prime elements, and due to the product rule on the E-basis provided by Proposition 3.7, E_u cannot be expressed as a product of elements of G' , E_u is not generated by G' . Therefore, G is minimal. \square

Lemma 3.10. *Let δ be a range map. If u is a nonempty δ -cliff, then u admits as suffix a unique δ -prime δ -cliff.*

Proof. Assume by contradiction that there are two different suffixes w and w' of u which are δ -prime. Therefore, $|w| \neq |w'|$, and the shortest word among w and w' is the suffix of the other. Assume without loss of generality that w' is shorter than w . This implies that there is a nonempty word $v \in \mathbb{N}^*$ such that $w = vw'$. Now, since by hypothesis w is a δ -cliff, and since any prefix of a δ -cliff is a δ -cliff, we obtain that v is a δ -cliff. Therefore, $w = v/w'$ where v and w' are both nonempty δ -cliffs. This implies that w is not δ -prime, which is in contradiction with our assumptions. \square

Let $\mathbb{A}_{\mathcal{P}_\delta}$ be the alphabet $\{a_u : u \in \mathcal{P}_\delta\}$. We denote by $\mathbb{K}\langle \mathbb{A}_{\mathcal{P}_\delta} \rangle$ the free associative algebra generated by $\mathbb{A}_{\mathcal{P}_\delta}$. By definition, the elements of this algebra are noncommutative polynomials on $\mathbb{A}_{\mathcal{P}_\delta}$. For any $u \in \text{Cl}_\delta$, we denote by a^u the monomial $a_{u^{(1)}} \dots a_{u^{(k)}}$ where $(u^{(1)}, \dots, u^{(k)})$, $k \geq 0$, is the unique sequence of δ -prime δ -cliffs such that $u = u^{(1)} / \dots / u^{(k)}$. By Lemma 3.10, this definition is consistent since any δ -cliff admits exactly one factorization on δ -prime δ -cliffs.

Proposition 3.11. *For any valley-free range map δ , the unital associative algebra $(\text{Cl}_\delta, \cdot, \mathbb{1})$ is isomorphic to $\mathbb{K}\langle \mathbb{A}_{\mathcal{P}_\delta} \rangle / \mathcal{R}_\delta$ where \mathcal{R}_δ is the subspace of $\mathbb{K}\langle \mathbb{A}_{\mathcal{P}_\delta} \rangle$ defined as the linear span of the set*

$$\{a_{u^{(1)}} \dots a_{u^{(k)}} : k \geq 1, \text{ for all } i \in [k], u^{(i)} \in \mathcal{P}_\delta, \text{ and } u^{(1)} \dots u^{(k)} \notin \text{Cl}_\delta\}. \tag{3.31}$$

Proof. Let us prove that \mathcal{R}_δ is an ideal of $\mathbb{K}\langle \mathbb{A}_{\mathcal{P}_\delta} \rangle$. Let $u := u^{(1)} \dots u^{(k)}$ such that for all $i \in [k]$, $u^{(i)} \in \mathcal{P}_\delta$, and $u \notin \text{Cl}_\delta$. Let also $v := v^{(1)} \dots v^{(\ell)}$ such that for all $i \in [\ell]$, $v^{(i)} \in \mathcal{P}_\delta$, and $v \in \text{Cl}_\delta$. Therefore, we have $a_{u^{(1)}} \dots a_{u^{(k)}} \in \mathcal{R}_\delta$ and $a_{v^{(1)}} \dots a_{v^{(\ell)}} \in \mathbb{K}\langle \mathbb{A}_{\mathcal{P}_\delta} \rangle$. Since $u \notin \text{Cl}_\delta$, there is an index $j \in [|u|]$ such that $u_j > \delta(j)$. This implies that $(uv)_j = u_j > \delta(j)$, so that $uv \notin \text{Cl}_\delta$. Hence, $a_{u^{(1)}} \dots a_{u^{(k)}} a_{v^{(1)}} \dots a_{v^{(\ell)}} \in \mathcal{R}_\delta$. Now, assume by contradiction that $vu \in \text{Cl}_\delta$. Since $u \notin \text{Cl}_\delta$, there is an index $j \in [|u|]$ such that $u_j > \delta(j)$. This letter u_j appears at a certain position j' of a factor $u^{(i)}$, $i \in [k]$, of u . Since $u^{(i)} \in \text{Cl}_\delta$, we have $u_j = u_{j'}^{(i)} \leq \delta(j')$. Besides, since $vu \in \text{Cl}_\delta$, we have $u_j = (vu)_{|v|+j} \leq \delta(|v| + j)$. Therefore, we obtain $\delta(j') > \delta(j) < \delta(|v| + j)$, and since $j' < j < |v| + j$, this leads to the fact that δ has a valley, which is in contradiction with our hypothesis. Hence, $vu \notin \text{Cl}_\delta$ so that $a_{v^{(1)}} \dots a_{v^{(\ell)}} a_{u^{(1)}} \dots a_{u^{(k)}} \in \mathcal{R}_\delta$. This shows that \mathcal{R}_δ is an ideal of $\mathbb{K}\langle \mathbb{A}_{\mathcal{P}_\delta} \rangle$.

Let the linear map $\phi : \text{Cl}_\delta \rightarrow \mathbb{K}\langle \mathbb{A}_{\mathcal{P}_\delta} \rangle / \mathcal{R}_\delta$ satisfying $\phi(E_u) = a^u$ for any $u \in \text{Cl}_\delta$. Recall that Lemma 3.10 implies that a^u is a well-defined monomial of $\mathbb{K}\langle \mathbb{A}_{\mathcal{P}_\delta} \rangle / \mathcal{R}_\delta$. Recall also that since δ is valley-free, by Theorem 3.1, Cl_δ is a unital associative algebra. Hence, it remains to prove that ϕ is a unital associative algebra isomorphism. First, ϕ is an isomorphism of spaces since it establishes a one-to-one correspondence between basis elements E_u , $u \in \text{Cl}_\delta$, of Cl_δ and basis elements $\phi(E_u) = a^u$ of $\mathbb{K}\langle \mathbb{A}_{\mathcal{P}_\delta} \rangle / \mathcal{R}_\delta$. Let $u, v \in \text{Cl}_\delta$. By Proposition 3.7, when $u / v \in \text{Cl}_\delta$, we have

$$\phi(E_u \cdot E_v) = \phi(E_{u/v}) = a^{uv} = a^u a^v = \phi(E_u)\phi(E_v). \tag{3.32}$$

Moreover, when $u / v \notin \text{Cl}_\delta$, we have

$$\phi(E_u \cdot E_v) = \phi(0) = 0 = a^u a^v = \phi(E_u)\phi(E_v) \tag{3.33}$$

since $a^u a^v \in \mathcal{R}_\delta$. Finally, we have $\phi(E_\epsilon) = a^\epsilon = 1$. This shows that ϕ is a unital associative algebra morphism. □

Let \leq_s be the partial order relation on the monomials of $\mathbb{K}\langle \mathbb{A}_{\mathcal{P}_\delta} \rangle$ wherein for any monomials $a_{u^{(1)}} \dots a_{u^{(k)}}$ and $a_{v^{(1)}} \dots a_{v^{(\ell)}}$ of $\mathbb{K}\langle \mathbb{A}_{\mathcal{P}_\delta} \rangle$, one has $a_{u^{(1)}} \dots a_{u^{(k)}} \leq_s a_{v^{(1)}} \dots a_{v^{(\ell)}}$ if the word $u^{(1)} \dots u^{(k)}$ is a suffix of $v^{(1)} \dots v^{(\ell)}$. Given a set M of monomials of $\mathbb{K}\langle \mathbb{A}_{\mathcal{P}_\delta} \rangle$, we denote by $\min_{\leq_s} M$ the set of all minimal elements of M w.r.t. the order relation \leq_s .

Proposition 3.12. *For any valley-free range map δ , the ideal \mathcal{R}_δ of $\mathbb{K}\langle \mathbb{A}_{\mathcal{P}_\delta} \rangle$ is minimally generated by the set*

$$\min_{\leq_s} \{a^u a^v : u \in \text{Cl}_\delta, v \in \mathcal{P}_\delta, \text{ and } uv \notin \text{Cl}_\delta\}. \tag{3.34}$$

Proof. Let us call G the set of monomials of $\mathbb{K}\langle\mathbb{A}_{\mathcal{P}_\delta}\rangle$ appearing in the statement of the proposition. First, since for any $a^u a_v \in G$, we have $uv \notin \text{Cl}_\delta$, by Proposition 3.11, $a^u a_v \in \mathcal{R}_\delta$. For this reason, the ideal generated by G is a subspace of \mathcal{R}_δ . Now, let $x := a_{u^{(1)}} \dots a_{u^{(k)}}$ be a basis element of \mathcal{R}_δ . Since $u^{(1)} \dots u^{(k)} \notin \text{Cl}_\delta$, there is a smallest index $\ell \in [k-1]$ such that $u' := u^{(1)} \dots u^{(\ell)} \in \text{Cl}_\delta$ and $u^{(1)} \dots u^{(\ell)} u^{(\ell+1)} \notin \text{Cl}_\delta$. Then, by setting $v' := u^{(\ell+1)}$, we have $x = a^{u'} a_{v'} u^{(\ell+2)} \dots u^{(k)}$. Therefore, x belongs to the ideal generated by G . This shows that G generates \mathcal{R}_δ as an ideal. It remains to show that G is minimal w.r.t. set inclusion. For this, assume that G is nonempty. Let any $x := a^u a_v \in G$ and set $G' := G \setminus \{x\}$. Since x is a minimal element in G w.r.t. the order relation \leq_s , there is no $a^{u'} a_v \in G$ such that $a^{u'} a_v \leq_s a^u a_v$. For this reason, x cannot be expressed as a product yx' where $x' \in G'$ and $y \in \mathbb{K}\langle\mathbb{A}_{\mathcal{P}_\delta}\rangle$. Moreover, since u is a δ -cliff and all its prefixes still are, x cannot be expressed as a product $x'y$ where $x' \in G'$ and $y \in \mathbb{K}\langle\mathbb{A}_{\mathcal{P}_\delta}\rangle$. Therefore, G' does not generate \mathcal{R}_δ . This shows the minimality of G . \square

Lemma 3.13. *Let δ be a valley-free range map. The unital associative algebra $(\text{Cl}_\delta, \cdot, \mathbb{1})$ is free if and only if δ is weakly increasing.*

Proof. We use here the fact that, by Proposition 3.11, Cl_δ is isomorphic as a unital associative algebra to the quotient $\mathbb{K}\langle\mathbb{A}_{\mathcal{P}_\delta}\rangle / \mathcal{R}_\delta$ and the description of the generating family of \mathcal{R}_δ provided by Proposition 3.12.

When δ is weakly increasing, for all $u, v \in \text{Cl}_\delta$, $uv \in \text{Cl}_\delta$. Therefore, \mathcal{R}_δ is the null space so that Cl_δ is free as a unital associative algebra. Conversely, when δ is not weakly increasing, there is an $i \geq 1$ such that $\delta(i) > \delta(i+1)$. In this case, there are $u, v \in \text{Cl}_\delta$ such that $uv \notin \text{Cl}_\delta$. By expressing u and v respectively as products of δ -prime δ -cliffs, this leads to the existence of a relation in \mathcal{R}_δ . \square

Lemma 3.14. *Let δ be a valley-free range map. The unital associative algebra $(\text{Cl}_\delta, \cdot, \mathbb{1})$ admits a finite number of generators and a finite number of nontrivial relations between the generators if and only if δ is 1-dominated.*

Proof. We use here the fact that, by Proposition 3.11, Cl_δ is isomorphic as a unital associative algebra to the quotient $\mathbb{K}\langle\mathbb{A}_{\mathcal{P}_\delta}\rangle / \mathcal{R}_\delta$ and the description of the generating family of \mathcal{R}_δ provided by Proposition 3.12.

Assume that δ is 1-dominated. The δ -cliffs $0, 1, \dots, \delta(1)$ are δ -prime. Moreover, since δ is 1-dominated, there is an $\ell \geq 0$ such that any δ -cliff u of size ℓ or more decomposes as $u = v/w$ such that $v \in \text{Cl}_\delta(\ell)$ and w is a δ -cliff having only letters nongreater than $\delta(1)$. This implies that all δ -prime δ -cliffs have ℓ as maximal size. Therefore, Cl_δ is finitely generated. Moreover, the finite number of nontrivial relations in Cl_δ is the consequence of the finiteness of the generating set of Cl_δ and the description of the relations of \mathcal{R}_δ . Indeed, there is a finite number of monomials $a^u a_v$ with $u \in \text{Cl}_\delta$, $v \in \mathcal{P}_\delta$, and $uv \notin \text{Cl}_\delta$ that are not suffixes of any other one satisfying the same description. Conversely, assume that δ is not 1-dominated. Thus, since δ is valley-free, there is an index $j \geq 1$ such that $\delta(1) = \dots = \delta(j)$ and for all $i \geq j+1$, $\delta(i) > \delta(1)$. For any $k \geq j+1$, set u as the δ -cliff of size k defined by $u_i := \delta(i)$ for all $i \in [k]$. By Lemma 3.10, there is a unique δ -prime δ -cliff u' being a suffix of u . Since u' is in particular a δ -cliff, one must have $u'_1 \leq \delta(1)$. Due to the previous description of δ , we necessarily have $u = u'$. Therefore, u is δ -prime. This shows that there are infinitely many δ -prime δ -cliffs and thus, that Cl_δ admits an infinite number of generators. \square

The set of all valley-free range maps can be partitioned into the following four classes:

- The class of *type A* range maps, containing all constant range maps;
- The class of *type B* range maps, containing all weakly increasing range maps having at least one ascent;
- The class of *type C* range maps, containing all 1-dominated range maps having at least one descent;
- The class of *type D* range maps, containing all range maps that are not 1-dominated and having at least one descent.

Theorem 3.15. *Let δ be a valley-free range map. Each unital associative algebra $(\mathbf{Cl}_\delta, \cdot, 1)$ admits the presentation $\mathbb{K} \langle \mathbb{A}_{\mathcal{P}_\delta} \rangle / \mathcal{R}_\delta$ which fits into one of the following four classes:*

- (i) *If δ is of type A, then $\mathbb{A}_{\mathcal{P}_\delta}$ is finite and \mathcal{R}_δ is the zero space;*
- (ii) *If δ is of type B, then $\mathbb{A}_{\mathcal{P}_\delta}$ is infinite and \mathcal{R}_δ is the zero space;*
- (iii) *If δ is of type C, then $\mathbb{A}_{\mathcal{P}_\delta}$ is finite and \mathcal{R}_δ is finitely generated and nonzero;*
- (iv) *If δ is of type D, then $\mathbb{A}_{\mathcal{P}_\delta}$ is infinite and \mathcal{R}_δ is infinitely generated.*

Proof. This is a consequence of the presentation by generators and relations of \mathbf{Cl}_δ provided by Propositions 3.11 and 3.12, and of the properties of the generating sets and relations spaces of \mathbf{Cl}_δ raised by Lemmas 3.13 and 3.14. □

3.2.4 Examples

We provide here some examples of unital associative algebras \mathbf{Cl}_δ for particular range maps δ and describe their structure thanks to the classification provided by Theorem 3.15.

Type A. Let δ be a range map of type A. Thus, there is a value $c \in \mathbb{N}$ such that $\delta(i) = c$ for all $i \in \mathbb{N}$. Thus, \mathbf{Cl}_δ is the free unital associative algebra generated by a_0, a_1, \dots, a_c .

Type B. For any $m \geq 1$, \mathbf{m} is of type B. Each \mathbf{Cl}_m is free as a unital algebra and its minimal generating sets are infinite.

Proposition 3.16. *For any $m \geq 0$, the generating series of the minimal generating set of \mathbf{Cl}_m satisfies*

$$\mathcal{G}_{\mathcal{P}_m}(t) = 1 - \frac{1}{\mathcal{H}_{\mathbf{Cl}_m}(t)}. \tag{3.35}$$

Proof. Since \mathbf{Cl}_m is a free unital associative algebra, its Hilbert series and the generating series of its minimal generating set satisfies the relation $\mathcal{H}_{\mathbf{Cl}_m}(t) = (1 - \mathcal{G}_{\mathcal{P}_m}(t))^{-1}$. This leads to the stated expression for $\mathcal{G}_{\mathcal{P}_m}(t)$. □

The first generators of \mathbf{Cl}_1 are

$$a_0, \quad a_{01}, \quad a_{002}, a_{011}, a_{012}, \\ a_{0003}, a_{0013}, a_{0021}, a_{0022}, a_{0023}, a_{0102}, a_{0103}, a_{0111}, a_{0112}, a_{0113}, a_{0121}, a_{0122}, a_{0123}, \quad (3.36)$$

and the first generators of \mathbf{Cl}_2 are

$$a_0, \quad a_{01}, a_{02}, \quad a_{003}, a_{004}, a_{011}, a_{012}, a_{013}, a_{014}, a_{021}, a_{022}, a_{023}, a_{024}. \quad (3.37)$$

A consequence of the freeness of \mathbf{Cl}_1 is that \mathbf{Cl}_1 is isomorphic as a unital associative algebra to FQSym [MR95, DHT02], an associative algebra on the linear span of all permutations. This follows from the fact that FQSym is also free as a unital associative algebra and that its Hilbert series is the same as the one of \mathbf{Cl}_1 . Moreover, in [NT20], the authors construct some associative algebras ${}^m\text{FQSym}$ as generalizations of FQSym whose bases are indexed by objects being generalizations of permutations. The algebras \mathbf{Cl}_m , $m \geq 0$, can therefore be seen as other generalizations of FQSym , not isomorphic to ${}^m\text{FQSym}$ when $m \geq 2$.

Type C. Let the range map $\delta := 010^\omega$ of type **C**. The unital associative algebra \mathbf{Cl}_δ admits the presentation $\mathbf{Cl}_\delta \simeq \mathbb{K} \langle a_0, a_{01} \rangle / \mathcal{R}_\delta$ where \mathcal{R}_δ is minimally generated by the elements

$$a_0 a_{01}, a_{01} a_{01}. \quad (3.38)$$

Let the range map $\delta := 0110^\omega$ of type **C**. The unital associative algebra \mathbf{Cl}_δ admits the presentation $\mathbf{Cl}_\delta \simeq \mathbb{K} \langle a_0, a_{01}, a_{011} \rangle / \mathcal{R}_\delta$ where \mathcal{R}_δ is minimally generated by the elements

$$a_0 a_0 a_{01}, a_{01} a_{01}, a_{01} a_0 a_{01}, a_{011} a_{01}, a_{011} a_0 a_{01}, a_0 a_{011}, a_{01} a_{011}, a_{011} a_{011}. \quad (3.39)$$

Let the range map $\delta := 210^\omega$ of type **C**. The unital associative algebra \mathbf{Cl}_δ admits the presentation $\mathbf{Cl}_\delta \simeq \mathbb{K} \langle a_0, a_1, a_2 \rangle / \mathcal{R}_\delta$ where \mathcal{R}_δ is minimally generated

$$a_0 a_0 a_1, a_0 a_1 a_1, a_1 a_0 a_1, a_1 a_1 a_1, a_2 a_0 a_1, a_2 a_1 a_1, a_0 a_2, a_1 a_2, a_2 a_2. \quad (3.40)$$

Type D. Let the range map $\delta := 021^\omega$ of type **D**. The unital associative algebra \mathbf{Cl}_δ admits the presentation

$$\mathbf{Cl}_\delta \simeq \mathbb{K} \langle a_0, a_{01}, a_{02}, a_{011}, a_{021}, a_{0111}, a_{0211}, a_{01111}, a_{02111}, \dots \rangle / \mathcal{R}_\delta \quad (3.41)$$

where \mathcal{R}_δ is generated by the relations

$$a_0 a_{02}, a_{01} a_{02}, a_{02} a_{02}, a_{011} a_{02}, a_{021} a_{02}, a_0 a_{021}, a_{01} a_{021}, a_{02} a_{021}, a_0 a_{0211}, \dots \quad (3.42)$$

Let the range map $\delta := 1232^\omega$ of type **D**. The unital associative algebra \mathbf{Cl}_δ admits the presentation

$$\mathbf{Cl}_\delta \simeq \mathbb{K} \langle a_0, a_1, a_{02}, a_{12}, a_{003}, a_{013}, a_{022}, a_{023}, a_{103}, a_{113}, a_{122}, a_{123}, \dots \rangle / \mathcal{R}_\delta \quad (3.43)$$

where \mathcal{R}_δ is generated by the relations

$$a_0 a_{003}, a_1 a_{003}, a_{02} a_{003}, a_{12} a_{003}, a_0 a_{013}, a_1 a_{013}, a_{02} a_{013}, a_{12} a_{013}, \dots \quad (3.44)$$

3.3. Quotient algebras

This last section of this work provides an answer to the problem set out in the introduction. This question concerns the possibility of constructing a hierarchy of substructures of \mathbf{Cl}_δ similar to that of \mathbf{FQSym} . For this, we consider quotients of \mathbf{Cl}_δ obtained by considering a graded subset \mathcal{S} of \mathbf{Cl}_δ and by equating the basis elements F_u with 0 whenever $u \notin \mathcal{S}$. As we shall see, this is possible only under some combinatorial conditions on \mathcal{S} . We describe the products of these quotient algebras and give a sufficient condition for the fact that it can be expressed by interval of the poset $\mathcal{S}(n)$ for a certain $n \geq 0$. We end this part by studying the quotients of \mathbf{Cl}_m obtained from \mathbf{m} -hills and \mathbf{m} -canyons.

3.3.1 Quotient space

Let δ be a range map. Given a graded subset \mathcal{S} of \mathbf{Cl}_δ , let $\mathbf{Cl}_\mathcal{S}$ be the quotient space of \mathbf{Cl}_δ defined by $\mathbf{Cl}_\mathcal{S} := \mathbf{Cl}_\delta / \mathcal{V}_\mathcal{S}$ such that $\mathcal{V}_\mathcal{S}$ is the linear span of the set $\{F_u : u \in \mathbf{Cl}_\delta \setminus \mathcal{S}\}$. By definition, the set $\{F_u : u \in \mathcal{S}\}$ is a basis of $\mathbf{Cl}_\mathcal{S}$.

Let us introduce here an important combinatorial condition for the sequel on \mathcal{S} . We say that \mathcal{S} is *closed by suffix reduction* if for any $u \in \mathcal{S}$, for all suffixes u' of u , $r_\delta(u') \in \mathcal{S}$.

Proposition 3.17. *Let δ be a valley-free range map and \mathcal{S} be a graded subset of \mathbf{Cl}_δ . If \mathcal{S} is closed by prefix and is closed by suffix reduction, then $\mathbf{Cl}_\mathcal{S}$ is a quotient algebra of the unital associative algebra $(\mathbf{Cl}_\delta, \cdot, \mathbf{1})$.*

Proof. Notice first that, since δ is valley-free, \mathbf{Cl}_δ is by Theorem 3.1 a well-defined unital associative algebra. We have to prove that $\mathcal{V}_\mathcal{S}$ is an associative algebra ideal of $\mathbf{Cl}_\mathcal{S}$. For this, let $F_u \in \mathcal{V}_\mathcal{S}$ and $F_v \in \mathbf{Cl}_\mathcal{S}$. Let us look at Expression (3.8) for computing the product of \mathbf{Cl}_δ . Assume that there is a cliff $uv' \in \mathcal{S}$ such that $F_{uv'}$ appears in $F_u \cdot F_v$. Then, since \mathcal{S} is closed by prefix, $u \in \mathcal{S}$, which contradicts our hypothesis. For this reason, $F_u \cdot F_v$ belongs to $\mathcal{V}_\mathcal{S}$. Moreover, let $F_u \in \mathbf{Cl}_\mathcal{S}$ and $F_v \in \mathcal{V}_\mathcal{S}$. Assume that there is a cliff $uv' \in \mathcal{S}$ such that $F_{uv'}$ appears in $F_u \cdot F_v$. Then, since \mathcal{S} is closed by suffix reduction, one has $r_\delta(v') \in \mathcal{S}$. By (3.8), $r_\delta(v') = v$, leading to the fact that $v \in \mathcal{S}$ holds, and which contradicts our hypothesis. Therefore, $F_u \cdot F_v$ belongs to $\mathcal{V}_\mathcal{S}$. This establishes the statement of the proposition. \square

Notice that the graded subset \mathbf{Av}_δ is not closed by suffix reduction. For instance, even if 00112 is an 1-avalanche, the 1-reduction of its suffix 112 is 012, which is not an 1-avalanche.

Let us denote by $\theta_\mathcal{S} : \mathbf{Cl}_\delta \rightarrow \mathbf{Cl}_\mathcal{S}$ the canonical projection map. By definition, this map satisfies, for any $u \in \mathbf{Cl}_\delta$, $\theta_\mathcal{S}(F_u) = \mathbf{1}_{u \in \mathcal{S}} F_u$.

3.3.2 Product

We show here that under some conditions of \mathcal{S} , the product in $\mathbf{Cl}_\mathcal{S}$ can be described by using the poset structure of \mathcal{S} . More precisely, we say that $\mathbf{Cl}_\mathcal{S}$ has the *interval condition* if the support of any product $F_u \cdot F_v$, $u, v \in \mathcal{S}$, is empty or is an interval of a poset $\mathcal{S}(n)$, $n \geq 0$.

Lemma 3.18. *Let δ be a range map and \mathcal{S} be a graded subset of \mathbf{Cl}_δ such that for any $n \geq 0$, $\mathcal{S}(n)$ is a meet (resp. join) semi-sublattice of $\mathbf{Cl}_\delta(n)$. For any $u, v \in \mathcal{S}$, if $u \vee v$ is a δ -cliff, then the set $[u \vee v, u \wedge v] \cap \mathcal{S}$ admits at most one minimal (resp. maximal) element.*

Proof. Assume that $\mathcal{S}(n)$ is a meet semi-sublattice of $\text{Cl}_\delta(n)$ and that $u/v \in \text{Cl}_\delta$. By Lemma 3.2, $u \setminus v \in \text{Cl}_\delta$ so that $I := [u/v, u \setminus v]$ is a well-defined interval of $\text{Cl}_\delta(n)$. Assume that there exist two δ -cliffs w and w' belonging to $I \cap \mathcal{S}$. Since $\mathcal{S}(n)$ is a meet semi-sublattice of $\text{Cl}_\delta(n)$, by setting $w'' := w \wedge w'$, one has $w'' \in \mathcal{S}$. Since u/v is a lower bound of both w and w' , we necessarily have $u/v \preceq w''$ and $w'' \in I$. This shows that when $I \cap \mathcal{S}$ is nonempty, this set admits exactly one minimal element. The proof is analogous for the respective part of the statement of the proposition. \square

When for any $n \geq 0$, $\mathcal{S}(n)$ is a lattice, we denote by $\wedge_{\mathcal{S}}$ (resp. $\vee_{\mathcal{S}}$) its meet (resp. join) operation. In this case, \mathcal{S} is *meet-stable* (resp. *join-stable*) if, for any $n \geq 0$ and any $u, v \in \mathcal{S}(n)$, the relation $u_i = v_i$ for an $i \in [n]$ implies that the i -th letter of $u \wedge_{\mathcal{S}} v$ (resp. $u \vee_{\mathcal{S}} v$) is equal to u_i .

Lemma 3.19. *Let δ be a range map and \mathcal{S} be a closed by prefix, maximally extendable, and join-stable graded subset of Cl_δ . For any $u, v \in \mathcal{S}$ such u/v is a δ -cliff, the set $[u/v, u \setminus v] \cap \mathcal{S}$ admits at most one maximal element.*

Proof. Assume that $u/v \in \text{Cl}_\delta$. By Lemma 3.2, $u \setminus v \in \text{Cl}_\delta$ so that $I := [u/v, u \setminus v]$ is a well-defined interval of δ -cliff poset. Assume that there exist two δ -cliffs w and w' belonging to $I \cap \mathcal{S}$. It follows from the hypotheses on \mathcal{S} of the statement that, by Theorem 1.6, the operation $\vee_{\mathcal{S}}$ is the join operation of the posets $\mathcal{S}(n)$, $n \geq 0$ (see Section 1.3.2). First, since $w \preceq u \setminus v$ and $w' \preceq u \setminus v$, we have $w \vee w' \preceq u \setminus v$. Moreover, by definition of the $\vee_{\mathcal{S}}$ operation, $w'' := w \vee_{\mathcal{S}} w'$ is obtained by incrementing by some values some letters of $w \vee w'$. Now, observe that due to the definitions of the operations $/$ and \setminus , w and w' write respectively as $w = ur$ and $w' = ur'$ where r and r' are some words on \mathbb{N} . Moreover, if there is an index $i \in [|r|]$ such that $r_i \neq r'_i$, then $v_i = \delta(i)$ and $(u \setminus v)_{|u|+i} = \delta(|u| + i)$. This, the definition of the $\vee_{\mathcal{S}}$ operation, and the fact that \mathcal{S} is join-stable imply that $w'' \preceq u \setminus v$. Therefore, $w'' \in I \cap \mathcal{S}$. This shows that when $I \cap \mathcal{S}$ is nonempty, this set admits exactly one maximal element. \square

Theorem 3.20. *Let δ be a valley-free range map and \mathcal{S} be a graded subset of Cl_δ closed by prefix and by suffix reduction. If at least one the following conditions is satisfied:*

- (i) *for any $n \geq 0$, all posets $\mathcal{S}(n)$ are sublattices of $\text{Cl}_\delta(n)$;*
- (ii) *for any $n \geq 0$, all posets $\mathcal{S}(n)$ are meet semi-sublattices of $\text{Cl}_\delta(n)$, maximally extendable, and join-stable;*

then $\text{Cl}_{\mathcal{S}}$ has the interval condition.

Proof. First, by Proposition 3.17, $\text{Cl}_{\mathcal{S}}$ is a well-defined unital associative algebra quotient of Cl_δ . Now, the product $F_u \cdot F_v$ in $\text{Cl}_{\mathcal{S}}$ can be computed as the image by $\theta_{\mathcal{S}}$ of the product of the same inputs in Cl_δ . By Theorem 3.4, this product is equal to zero or its support I is an interval of a δ -cliff poset. By construction of $\text{Cl}_{\mathcal{S}}$, the support of the product $F_u \cdot F_v$ in $\text{Cl}_{\mathcal{S}}$ is equal to $I' := I \cap \mathcal{S}$. If (i) holds, then by Lemma 3.18, I' admits both a minimal and a maximal element. If (ii) holds, then by Lemma 3.18, I' admits a minimal element, and by Lemma 3.19, I' admits a maximal element. In both cases, I' is an interval of a poset $\mathcal{S}(n)$, $n \geq 0$. \square

3.3.3 Examples: two Fuss–Catalan associative algebras

We define and study the associative algebras related to the m -hill posets and to the m -canyon posets.

Hill associative algebras. For any $m \geq 0$, let \mathbf{Hi}_m be the quotient $\mathbf{Cl}_{\mathbf{Hi}_m}$. This quotient is well-defined due to the fact that \mathbf{Hi}_m satisfies the conditions of Proposition 3.17. Moreover, by Proposition 2.10 and Point (i) of Theorem 3.20, \mathbf{Hi}_m has the interval condition. For instance, one has in \mathbf{Hi}_1 ,

$$F_{01} \cdot F_{01} = F_{0111} + F_{0112} + F_{0113} + F_{0122} + F_{0123}, \tag{3.45a}$$

$$F_{01} \cdot F_{00} = 0, \tag{3.45b}$$

$$F_{001} \cdot F_{0122} = F_{0011122} + F_{0011222} + F_{0012222}. \tag{3.45c}$$

In \mathbf{Hi}_2 , one has

$$F_{02} \cdot F_{023} = F_{02223} + F_{02233} + F_{02333}, \tag{3.46a}$$

$$F_{011} \cdot F_{01} = F_{01111}, \tag{3.46b}$$

$$F_{0015} \cdot F_{014} = 0. \tag{3.46c}$$

By computer exploration, minimal generating families of \mathbf{Hi}_1 and \mathbf{Hi}_2 , respectively up to degree 5 and 4, are

$$\begin{aligned} &F_0, F_{00}, F_{001}, F_{011}, F_{0002}, F_{0011}, F_{0012}, F_{0022}, F_{0112}, F_{0122}, \\ &F_{00003}, F_{00013}, F_{00023}, F_{00033}, F_{00112}, F_{00113}, F_{00122}, F_{00123}, F_{00133}, F_{00222}, \\ &F_{00223}, F_{00233}, F_{01113}, F_{01122}, F_{01123}, F_{01133}, F_{01223}, F_{01233}, \end{aligned} \tag{3.47}$$

and

$$\begin{aligned} &F_0, F_{00}, F_{01}, F_{001}, F_{002}, F_{003}, F_{012}, F_{013}, F_{022}, F_{023}, \\ &F_{0004}, F_{0005}, F_{0012}, F_{0013}, F_{0014}, F_{0015}, F_{0022}, F_{0023}, F_{0024}, F_{0025}, F_{0033}, F_{0034}, F_{0035}, \\ &F_{0044}, F_{0045}, F_{0114}, F_{0115}, F_{0122}, F_{0123}, F_{0124}, F_{0125}, F_{0133}, F_{0134}, F_{0135}, F_{0144}, F_{0145}, \\ &F_{0223}, F_{0224}, F_{0225}, F_{0234}, F_{0235}, F_{0244}, F_{0245}. \end{aligned} \tag{3.48}$$

Moreover, the sequences for the numbers of generators of \mathbf{Hi}_1 and \mathbf{Hi}_2 , degree by degree begin respectively by

$$0, 1, 1, 2, 6, 18, 59, 196, 669, \tag{3.49}$$

and

$$0, 1, 2, 7, 33, 168, 900, 4980. \tag{3.50}$$

We can observe that for any $m \geq 1$, \mathbf{Hi}_m is not free as unital associative algebra. Indeed, the quasi-inverse of the respective generating series of these elements is not the Hilbert series of \mathbf{Hi}_m , which is expected when this algebra is free.

Canyon associative algebras. For any $m \geq 0$, let \mathbf{Ca}_m be the quotient $\mathbf{Cl}_{\mathbf{Ca}_m}$. This quotient is well-defined due to the fact that \mathbf{Ca}_m satisfies the conditions of Proposition 3.17. Moreover, by Proposition 2.21, the fact that for any $m \geq 0$ and $n \geq 0$, $\mathbf{Ca}_m(n)$ is join-stable, and by Point (ii) of Theorem 3.20, \mathbf{Ca}_m has the interval condition. For instance, one has in \mathbf{Ca}_1 ,

$$F_0 \cdot F_{01} = F_{001} + F_{002} + F_{012}, \quad (3.51a)$$

$$F_0 \cdot F_{002} = F_{0002} + F_{0003} + F_{0103}, \quad (3.51b)$$

$$\begin{aligned} F_{0012} \cdot F_{0103} = & F_{00120103} + F_{00120106} + F_{00120107} + F_{00120406} + F_{00120407} \\ & + F_{00120507} + F_{00123406} + F_{00123407} + F_{00123507} + F_{00124507}. \end{aligned} \quad (3.51c)$$

In \mathbf{Ca}_2 , one has

$$F_{01} \cdot F_{0014} = 0, \quad (3.52a)$$

$$F_{01} \cdot F_{0013} = F_{010013}. \quad (3.52b)$$

$$\begin{aligned} F_{020} \cdot F_{02} = & F_{02002} + F_{02005} + F_{02006} + F_{02007} + F_{02008} + F_{02012} + F_{02015} + F_{02016} + F_{02017} \\ & + F_{02018} + F_{02045} + F_{02046} + F_{02047} + F_{02048} + F_{02056} + F_{02057} + F_{02058} + F_{02067} \\ & + F_{02068}. \end{aligned} \quad (3.52c)$$

By computer exploration, minimal generating families of \mathbf{Ca}_1 and \mathbf{Ca}_2 , respectively up to respectively up to degree 5 and 4, are

$$\begin{aligned} F_0, F_{00}, F_{000}, F_{001}, F_{0000}, F_{0001}, F_{0002}, F_{0010}, F_{0012}, \\ F_{00000}, F_{00001}, F_{00002}, F_{00003}, F_{00010}, F_{00012}, F_{00013}, F_{00020}, F_{00023}, F_{00100}, \\ F_{00101}, F_{00103}, F_{00120}, F_{00123}, \end{aligned} \quad (3.53)$$

and

$$\begin{aligned} F_0, F_{00}, F_{01}, F_{000}, F_{002}, F_{003}, F_{010}, F_{012}, F_{013}, F_{023}, \\ F_{0000}, F_{0003}, F_{0004}, F_{0005}, F_{0014}, F_{0015}, F_{0020}, F_{0023}, F_{0024}, F_{0025}, F_{0030}, F_{0034}, F_{0035}, F_{0045}, \\ F_{0100}, F_{0104}, F_{0105}, F_{0120}, F_{0124}, F_{0125}, F_{0130}, F_{0134}, F_{0135}, F_{0145}, F_{0204}, F_{0205}, F_{0230}, F_{0234}, \\ F_{0235}, F_{0245}. \end{aligned} \quad (3.54)$$

The associative algebra \mathbf{Ca}_1 is the Loday–Ronco algebra [LR98], also known as PBT [HNT05]. It is known that this associative algebra is free and that the dimension of its generators are a shifted version of Catalan numbers:

$$0, 1, 1, 2, 5, 14, 42, 132, 429. \quad (3.55)$$

The sequence for the numbers of generators of \mathbf{Ca}_2 degree by degree begins by

$$0, 1, 2, 7, 30, 149, 788, 4332. \quad (3.56)$$

We can observe that for any $m \geq 2$, \mathbf{Ca}_m is not free as unital associative algebra. It follows, from the same argument as the previous section, that \mathbf{Ca}_m is not free.

Conclusion and open questions

This work presents three new families of posets on Fuss–Catalan objects and associative algebras on their linear spans. All this are based upon δ -cliffs, a combinatorial family of words of integers satisfying some conditions. Some general properties about subposets of the posets of δ -cliffs have been presented, as well as general properties about quotients of the associative algebras defined on the linear span of δ -cliffs.

Here is a list of open questions raised by this research:

1. **(Generalization of the weak Bruhat order)** — The first open question concerns the alternative order relation on δ -cliffs introduced in Section 1.2.3. This consists in considering Conjecture 1.3 and in proving that the posets $(\text{Cl}_\delta(n), \preceq')$ are semi-distributive lattices, or at least lattices.
2. **(Coproducts and Hopf bialgebras)** — As explained above, the associative algebras Cl_1 and Ca_1 are already known algebraic structures which are in fact Hopf bialgebras. They are endowed with a coproduct satisfying some compatibility relations with the product. The question here consists in endowing Cl_δ with a coproduct where δ is a unimodal range map. We can ask also for a general definition of such a coproduct for the quotients Cl_S of Cl_δ for some subfamilies S of δ -cliffs.
3. **(Other subposets and quotient algebras)** — There are other subfamilies of δ -cliffs than δ -hills and δ -canyons which seem to lead to interesting posets and associative algebras. Among these, there are δ -dunes, which are δ -cliffs u such that $|u_i - u_{i+1}| \leq |\delta(i) - \delta(i+1)|$ for all $i \in [|u| - 1]$. For $\delta = 1$, we obtain a family in one-to-one correspondence with directed animals, which are enumerated by Sequence **A005773** of [Slo]. For $\delta = 2$, we obtain a family enumerated by Sequence **A180898** of [Slo]. This axis consists in studying in particular the posets and the associative algebras of dunes.

References

- [AS05] M. Aguiar and F. Sottile. Structure of the Malvenuto-Reutenauer Hopf algebra of permutations. *Adv. Math.*, 191(2):225–275, 2005.
- [BB09] O. Bernardi and N. Bonichon. Intervals in Catalan lattices and realizers of triangulations. *J. Combin. Theory Ser. A*, 116(1):55–75, 2009.
- [BMFPR11] M. Bousquet-Mélou, É. Fusy, and L.-F. Préville-Ratelle. The number of intervals in the m -Tamari lattices. *Electron. J. Comb.*, 18(2), 2011. Paper 31.
- [BPR12] F. Bergeron and L.-F. Préville-Ratelle. Higher trivariate diagonal harmonics via generalized Tamari posets. *J. Comb.*, 3(3):317–341, 2012.
- [BW96] A. Björner and M. L. Wachs. Shellable nonpure complexes and posets. I. *T. Am. Math. Soc.*, 348(4):1299–1327, 1996.
- [BW97] A. Björner and M. L. Wachs. Shellable nonpure complexes and posets. II. *Trans. Amer. Math. Soc.*, 349(10):3945–3975, 1997.

- [CG20] C. Combe and S. Giraudo. Three interacting families of Fuss-Catalan posets. *Formal Power Series and Algebraic combinatorics*, 2020.
- [CLCdPBM04] N. Caspard, C. Le Conte de Poly-Barbut, and M. Morvan. Cayley lattices of finite Coxeter groups are bounded. *Adv. Appl. Math.*, 33(1):71–94, 2004.
- [Com19] C. Combe. Cubic realizations of Tamari interval lattices. *Sém. Lothar. Combin.*, 82B:Article #23, 2019.
- [CP19] C. Ceballos and V. Pons. The s -weak order and s -permutahedra. *Sém. Lothar. Combin.*, 82B:Article #76, 2019.
- [Day79] A. Day. Characterizations of finite lattices that are bounded-homomorphic images of sublattices of free lattices. *Canadian J. Math.*, 31(1):69–78, 1979.
- [Day92] A. Day. Doubling constructions in lattice theory. *Canad. J. Math.*, 44(2):252–269, 1992.
- [Den13] H. Denoncourt. A refinement of weak order intervals into distributive lattices. *Ann. Comb.*, 17(4):655–670, 2013.
- [DHT02] G. Duchamp, F. Hivert, and J.-Y. Thibon. Noncommutative Symmetric Functions VI: Free Quasi-Symmetric Functions and Related Algebras. *Int. J. of Algebr. Comput.*, 12:671–717, 2002.
- [DM47] A. Dvoretzky and Th. Motzkin. A problem of arrangements. *Duke Math. J.*, 14(2):305–313, 1947.
- [Gey94] W. Geyer. On Tamari lattices. *Discrete Math.*, 133(1):99–122, 1994.
- [GKL⁺95] I. M. Gelfand, D. Krob, A. Lascoux, B. Leclerc, V. S. Retakh, and J.-Y. Thibon. Noncommutative symmetric functions I. *Adv. Math.*, 112:218–348, 1995.
- [GW16] G. Grätzer and F. Wehrung, editors. *Lattice Theory: Special Topics and Applications*, volume 2. Birkhäuser/Springer, Cham, 2016.
- [HNT05] F. Hivert, J.-C. Novelli, and J.-Y. Thibon. The algebra of binary search trees. *Theoret. Comput. Sci.*, 339(1):129–165, 2005.
- [HT72] S. Huang and D. Tamari. Problems of associativity: A simple proof for the lattice property of systems ordered by a semi-associative law. *J. Comb. Theory A*, 13:7–13, 1972.
- [Knu04] D. Knuth. *The Art of Computer Programming. Volume 4, Fascicle 4. Generating all trees — History of combinatorial generation*. Addison Wesley Longman, 2004.
- [Kre72] G. Kreweras. Sur les partitions non croisées d’un cycle. *Discrete Math.*, 1(4):333–350, 1972.
- [Leh60] D. H. Lehmer. Teaching combinatorial tricks to a computer. In *Proc. Sympos. Appl. Math., Vol. 10*, pages 179–193. American Mathematical Society, Providence, R.I., 1960.
- [LR98] J.-L. Loday and M. Ronco. Hopf Algebra of the Planar Binary Trees. *Adv. Math.*, 139:293–309, 1998.

- [LR02] J.-L. Loday and M. O. Ronco. Order structure on the algebra of permutations and of planar binary trees. *J. Algebr. Comb.*, 15(3):253–270, 2002.
- [Mar92] G. Markowsky. Primes, irreducibles and extremal lattices. *Order*, 9(3):265–290, 1992.
- [MR95] C. Malvenuto and C. Reutenauer. Duality between quasi-symmetric functions and the Solomon descent algebra. *J. Algebra*, 177(3):967–982, 1995.
- [Müh15] H. Mühle. The topology of the m -Tamari lattices. arXiv:1201.2020, 2015.
- [Müh19] H. Mühle. The core label order of a congruence-uniform lattice. *Algebr. Univ.*, 80(1):Art. 10, 22, 2019.
- [NT20] J.-C. Novelli and J.-Y. Thibon. Hopf Algebras of m -permutations, $(m + 1)$ -ary trees, and m -parking functions. *Adv. Appl. Math.*, 117, 2020.
- [Pal86] J. M. Pallo. Enumerating, ranking and unranking binary trees. *Comput. J.*, 29(2):171–175, 1986.
- [PRV17] L.-F. Prévaille-Ratelle and X. Viennot. The enumeration of generalized Tamari intervals. *Trans. Amer. Math. Soc.*, 369(7):5219–5239, 2017.
- [Slo] N. J. A. Sloane. The On-Line Encyclopedia of Integer Sequences. <https://oeis.org/>.
- [Sta75] R. P. Stanley. The Fibonacci lattice. *Fibonacci Quart.*, 13(3):215–232, 1975.
- [Sta11] R. P. Stanley. *Enumerative Combinatorics*, volume 1. Cambridge University Press, second edition, 2011.
- [Tam62] D. Tamari. The algebra of bracketings and their enumeration. *Nieuw Arch. Wisk.*, 10(3):131–146, 1962.
- [Tro92] W. T. Trotter. *Combinatorics and partially ordered sets: Dimension theory*. Johns Hopkins Series in the Mathematical Sciences. The Johns Hopkins University Press, 1992.