

# UC Berkeley

## UC Berkeley Previously Published Works

### Title

Inventing Landscapes

### Permalink

<https://escholarship.org/uc/item/4rz513dr>

### Author

Hindle, Richard L

### Publication Date

2013-08-01

Peer reviewed

“THE TERMS LANDSCAPE AND TECHNOLOGY  
IMPLY ONE ANOTHER AND ARE BEST  
UNDERSTOOD IN TANDEM.”

— DAVID E. NYE

# INVENTING LANDSCAPES

BY RICHARD L. HINDLE

FROM THE U.S. PATENT ARCHIVE, A RICH (AND LONG) HISTORY OF INNOVATION.

**M**ore than 8.3 million utility patents have been issued in the United States since the establishment of the current patent numbering system in 1836, which makes the U.S. patent archive the world's largest dossier of technological innovation and an unparalleled repository of built and unbuilt artifacts. The archive chronicles the ingenuity of millions of inventors and inventions, and illuminates the complex relations among humans, society, and the environments we make and inhabit. Each patent describes the unique function and configuration of a specific technology and protects the intellectual property and profits of the inventor. In aggregate, the patent archive portrays innovation and the evolution of technology, cultural ideas, and broader trends, and mirrors our ambitions toward the future. This evolution is particularly salient for landscape architects as progress in sustainable, ecological, and landscape urbanisms raises the need for increasingly technological solutions to ecological imperatives and has brought about a sort of industrial revolution in disguise within the “green” industries.

**OPPOSITE**  
**METHOD OF AND MEANS**  
**FOR PREPARING LAWNS**

US Patent 1,905,176.

Inventor: Edwin F. Kieckhefer.

Patented: April 25, 1933.

Several early patents for geotextiles and geogrids exist in the patent archive. The patent shown here is of particular interest as a decomposing, three-dimensional geogrid for turf establishment and slope stabilization. According to the inventor, “Intersecting strips or partition-like members are laid on the ground to be seeded.... The strips are constituted of a composition of fibers or pulp in which fertilizer is incorporated. One of the main purposes of the interfitting pulp sections is their action in retaining the surface soil against washing away due to rains and other causes. The pulp-like sections, after the grass has obtained good growth and is well rooted, slowly disintegrate or dissolve so that eventually they are completely absorbed in the earth.”

April 25, 1933.

E. F. KIECKHEFER

1,905,176

METHOD OF AND MEANS FOR PREPARING LAWNS

Filed June 13, 1932

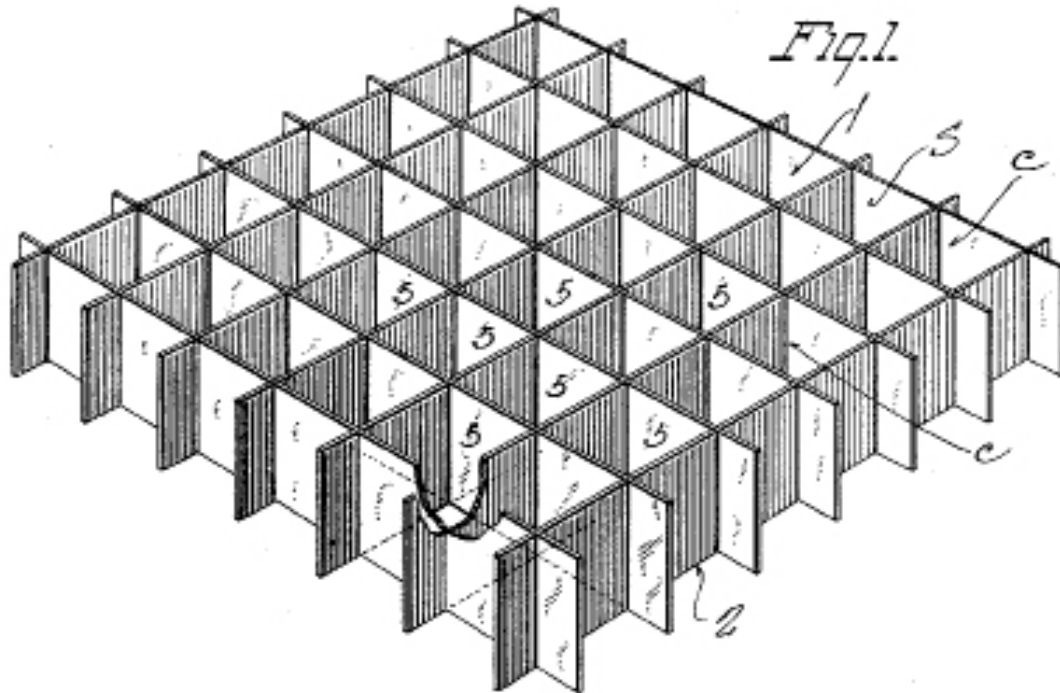

Fig. 2.

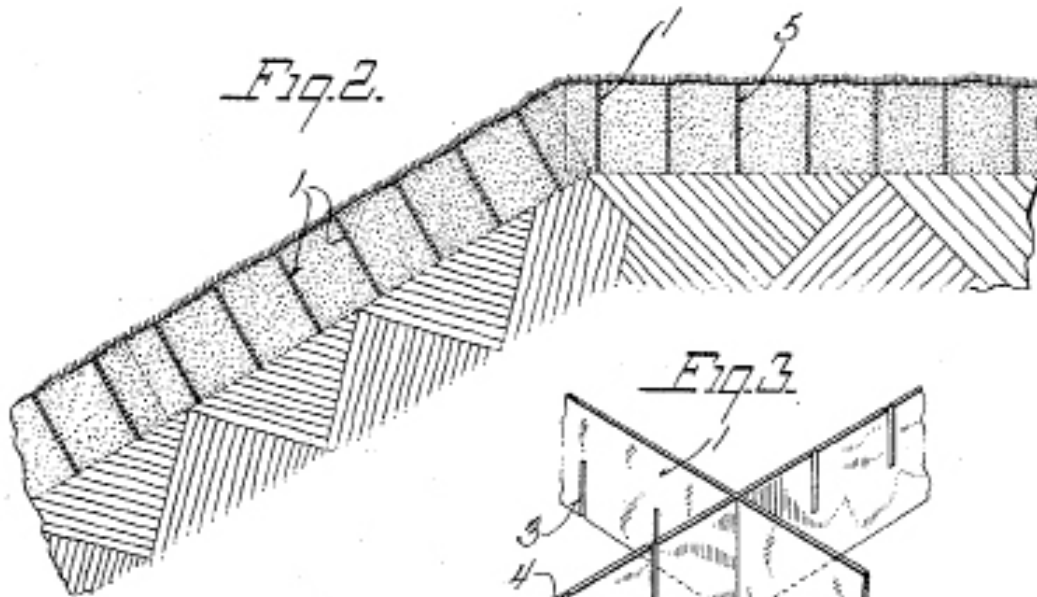
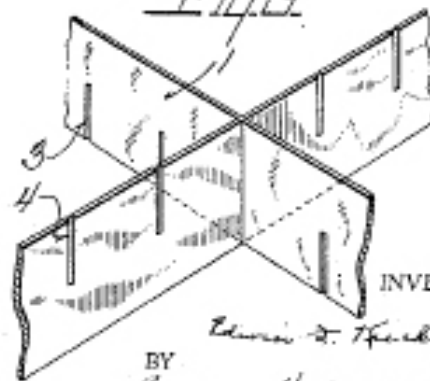

Fig. 3.



INVENTOR.

*Edwin F. Kieckhefer.*

BY  
*Buttner, Anderson, Loken,  
McCann & Mitchell*  
ATTORNEYS

The tandem history of technology and landscape dates back to the earliest anthropogenic manipulations of environments and may be traced from the first woven fences that delineated cultivated ground from wilderness to the most advanced closed-circuit television surveillance and beyond. Technology and landscape imply and in many cases reflect each other! Thinkers such as Lewis Mumford, Leo Marx, David E. Nye, Karl Marx, and Robert L. Heilbroner have convincingly argued and illustrated the profound interrelations among technology, society, environment, politics, cities, landscapes, and everyday life. Given the complex and fascinating reciprocities between technology, landscape, and other constructed ecological and cultural networks, the profession of landscape architecture can claim its own legacy of innovation in the patent archive. But the challenge remains to define this legacy and to control and advance the technologies and productive systems that underpin our increasingly complex and technically sophisticated landscapes.

Looking back into the patent archive reveals that landscape-related technologies have a rich history of innovation, with cornerstones of contemporary sustainable site and building practices evolving well before notions of sustainability and wider environmental awareness. If landscape architects of the late 19th and early 20th centuries had become early adopters of newly patented landscape technologies, the profession might have been championing and implementing an engineered lightweight green roof substrate and water retention systems in 1886 (opposite page), a precast permeable turf paver in 1940 (page 121), a decomposing geogrid for slope stabilization in 1933 (page 117), the vertical garden in 1938 (pages 122 and 123), and anchoring trees to buildings in 1932 (page 125). The existence of these technologies gives depth and breadth to the history of landscape technology, providing valuable context to contemporary innovations. More than a century before the establishment of the Sustainable Sites Initiative and LEED, Charles Carroll Gilman of Eldora, Iowa, took it upon himself in 1886 to design and patent a porous terra-cotta substrate, water retention, and drainage system to support plant growth and stormwater mitigation on a roof garden. Gilman's invention solved stormwater problems on his farm and in the local watershed; it also to this day provides landscape architects with important technological and cultural precedent for innovation in an era when schools of landscape (gardening) and architecture were wholly concerned with the stylistic rigor of the Beaux-Arts, not the design

#### OPPOSITE

#### ROOF GARDEN

US Patent 342,595.

Inventor: Charles Carroll Gilman.

Patented: May 25, 1886.

The first known U.S. patent for an engineered lightweight green roof substrate, drainage system, and integrated water retention system was granted to Charles Carroll Gilman in 1886. According to the inventor, "The object of my invention is to make a roof-garden simple in construction, relatively inexpensive, and capable of taking up a large quantity of water and retaining it for a long time. The depth of the layer of porous terra-cotta is from three to six or eight inches. I use the specified material for the reason that it is capable of absorbing a very large quantity of moisture, and that it gives up the water or moisture it has taken up in its pores very slowly."

(No Model.)

C. O. GILMAN.

ROOF GARDEN.

No. 342,595.

Patented May 25, 1886.

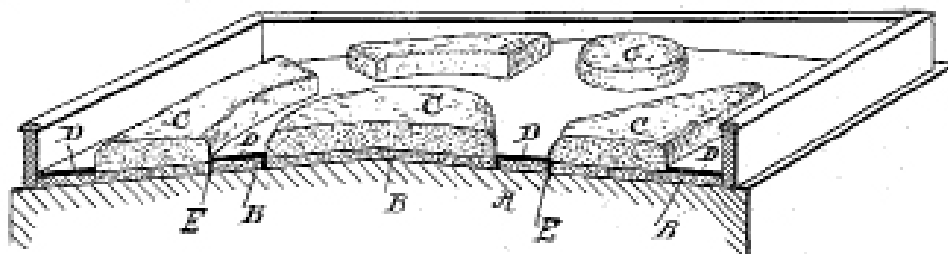

Attest:

*Geo. H. Graham*  
*Notary Public*

Inventor:

*Chas. C. Gilman,*  
*per*  
*W. C. Richmond,*  
*att'y*

# TO A TINKERER IN NEW JERSEY, A PATENT FOR A PERMEABLE SYSTEM OF PAVEMENT WAS ISSUED IN 1940.

of landscape systems and technology. How is it that the profession legally chartered with the production of landscapes is so distant from the technological innovation that underpins its materialization?

Fascinating examples of landscape-related technologies exist in the patent archive dating back to its origins, with a noted uptick in the prewar and postwar eras, when patent submissions increased rapidly in all sectors of the mechanical and technical arts. At a minimum, they are examples of environmental technologies that predate the rise of sustainability and widespread environmental awareness in landscape architecture. They also suggest a rich legacy of technological innovation born from the same environmental pragmatism and innovation that define contemporary landscape architecture. It is humbling to think that 30-plus years before the word “sustainability” found its current usage in environmental fields and the language more broadly, a tinkerer in New Jersey invented a permeable turf paver in 1940 through which the “roots of seedlings may take root, and thereby provide an interlocking connection between adjoining blocks.” Or that an inventor in Mahopac, New York, had the prescience in 1932 to devise a technique for anchoring trees to buildings and structures 80 years before they adorned the Bosco Verticale in Milan (a project currently in its final phases of construction). Or that an early innovator in the geotechnical arts integrated the process of decomposition into a slope stabilization system in 1933, many years before ideas of weathering became common to landscape practice. These inventions provide us with important antecedents to the word “sustainability” and challenge landscape architects to reevaluate the relationship among innovation, early adoption of technology, professional practice, academic research, and implementation in the built environment.

One of the most important figures in the history of innovation in landscape-related technologies is Stanley Hart White, a professor of landscape architecture at the University of Illinois from 1922 to 1959. White patented the first known vertical garden in 1938, yet the idea emerged in his writings and sketches as far back as 1931 (pages 122 and 123). His technology integrated a steel structural framework with hydroponic substrate, internal irrigation, and vegetation to provide fine sheets of greenery as a background and camouflage for the modern garden. White prototyped the “Vegetation-Bearing Architectonic Structure and System” in his Urbana garden shed more than 60 years before the emergence of the vertical garden in the contemporary built environment. A rebellious and farsighted activity ↘

## OPPOSITE LANDSCAPE PAVEMENT

US Patent 2,215,159.

Inventor: Charles H. Rothmann.

Patented: September 17, 1940.

This early patent describes the composition and configuration of a precast turf paving system that is permeable to water and allows for root growth in specially designed pockets on the long side of the pavers, which are set on a soil base. According to the inventor, “This invention relates to landscape pavement and has for one of its objects the production of a simple and efficient paving block especially designed for building roads, walks, streets, parks, and special developments where hard paving is required.... A further object of this invention is the production of a simple and efficient paving block which is so designed as to provide a pocket between the adjoining blocks whereby the roots of seedlings may take root, and thereby provide an interlocking connection between adjoining blocks.”

Sept. 17, 1940.

C. H. ROTHMANN

2,215,159

LANDSCAPE PAVEMENT

Filed April 30, 1938

Fig. 1.

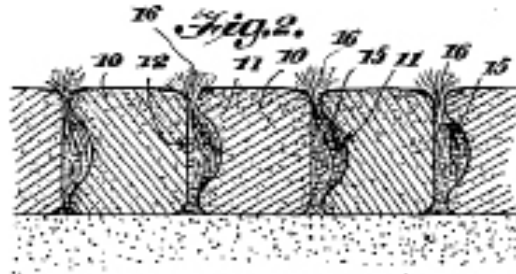
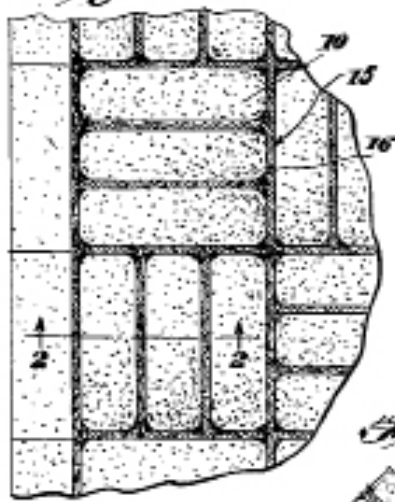

Fig. 3.

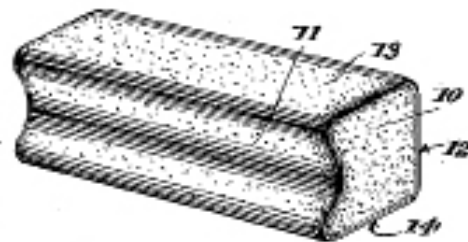

Fig. 10.

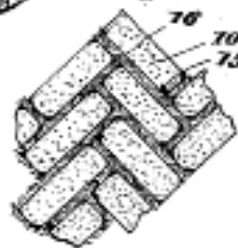

Fig. 4.

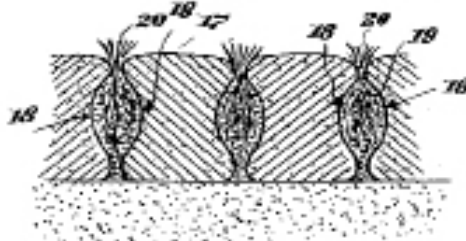

Fig. 5.

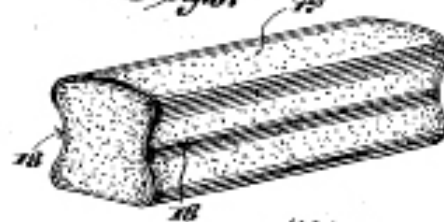

Fig. 7.

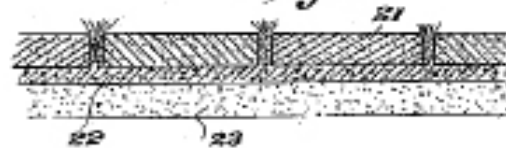

Fig. 6.

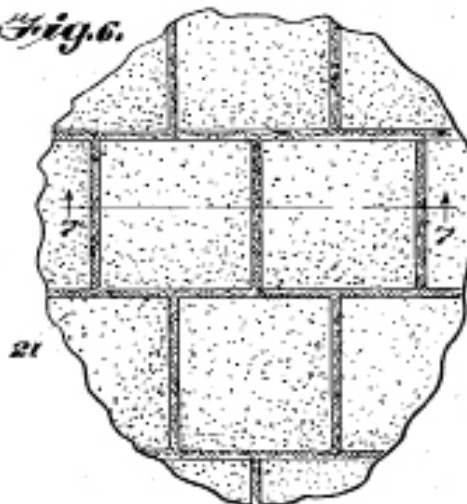
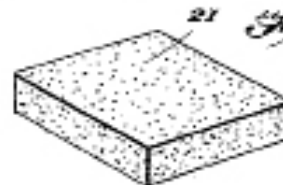

Fig. 8.



Inventor  
CHARLES H. ROTHMANN

364 Irving R. McArthur  
Attorney

VEGETATION BEARING ARCHITECTONIC STRUCTURE AND SYSTEM

Filed Aug. 18, 1937

3 Sheets-Sheet 3

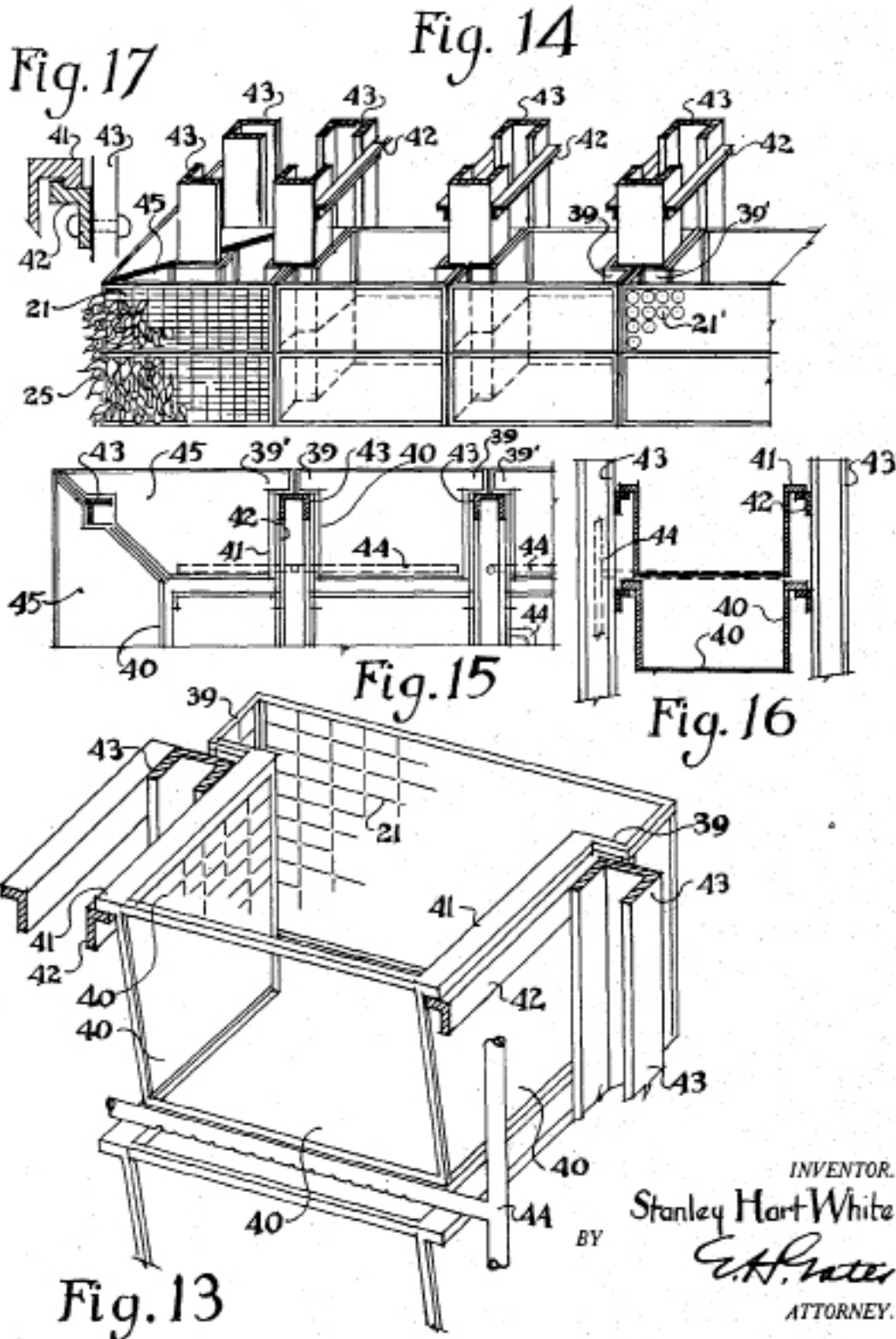

**VEGETATION-BEARING ARCHITECTONIC STRUCTURE AND SYSTEM**  
 US Patent 2,113,523.  
 Inventor: Stanley Hart White.  
 Patented: April 5, 1938.

This is the first known patent for a vertical garden with integrated hydroponics, structural system, and plants. This system was invented by the landscape architect Stanley Hart White as a response to the problem of modern garden design. According to the inventor, "This invention is believed to reveal a new art of vegetation-bearing architectonic structure. It comprehends a structural method with its related structural units and compounds. A principal object of this invention is to provide a method for producing an architectonic structure of any buildable size, shape, or height, whose visible or exposed surfaces may present a permanently growing covering of vegetation."

INVENTOR.  
 Stanley Hart White  
 BY *E.H. Prater*  
 ATTORNEY.



April 5, 1938.

S. H. WHITE

2,113,523

VEGETATION BEARING ARCHITECTONIC STRUCTURE AND SYSTEM

Filed Aug. 18, 1937

3 Sheets-Sheet 1

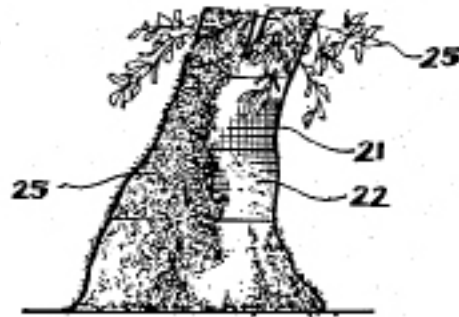

FIG. 1

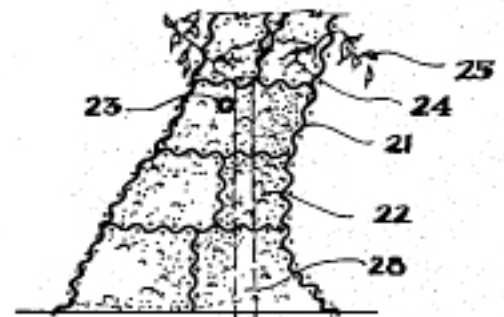

FIG. 2



FIG. 3

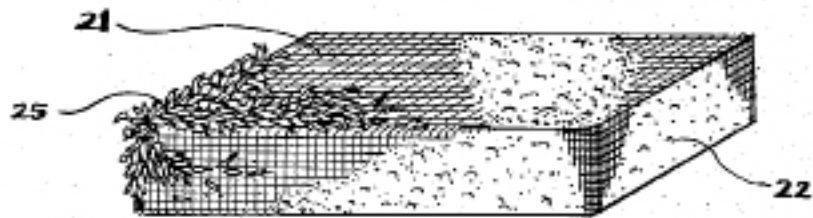

FIG. 4

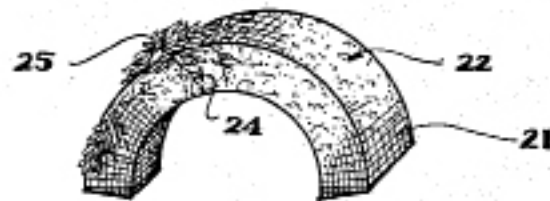

FIG. 5

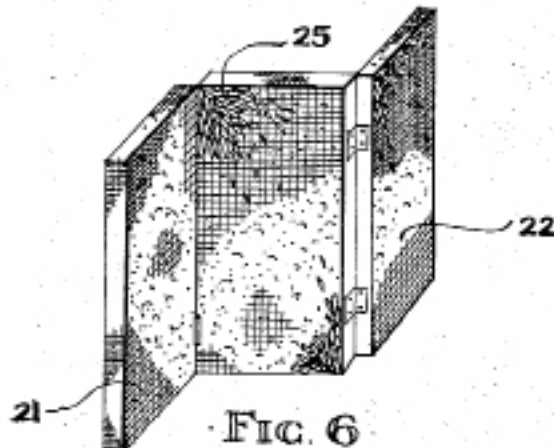

FIG. 6

**VEGETATION-BEARING ARCHITECTONIC STRUCTURE AND SYSTEM**

US Patent 2,113,523.

Inventor: Stanley Hart White.

Patented: April 5, 1938.

"The underlying principle of the present Invention is to provide the architectural profession and related industries with an efficient and inexpensive method and means for utilizing a novel medium for ornamental and useful architectonic construction, in various forms of units and compounds having vegetation-bearing surfaces. For example, one purpose of these surfaces may be to build decorative backgrounds or screens for masking eyesores or for concealing people or properties in such a way as to avoid painted camouflage or the heavy cost of ordinary hedges or camouflage, and to achieve these results, either in a few days, if permanently constructed, or in a few hours or even minutes if built up of the herein described portable units."

—Stanley Hart White

Inventor

Stanley Hart White

*E.H. Gates*

By

Attorney

# WHOEVER DEVELOPS THE TECHNOLOGY LEADS THE REALM FORWARD.

→ in the academic milieu of the early 1930s! The merits of this invention may ultimately pale in comparison to the precedent he established for a landscape architect-cum-inventor and technological innovator. White translated modern landscape theory, advances in building sciences, and emergent hydroponics into patent legalese, formulating the origins of vegetation-bearing architecture and pioneering green modernism. At that moment, landscape theory and technology converged at a 1:1 scale. It is hard to recall an instance in the annals of history when the vanguard of landscape thinking intersected so narrowly with the reification of technology, making White's simultaneous commitment to theory and technology important beyond the invention of the vertical garden.

What is the relationship between landscape architecture and technology? Are we simply purveyors and consumers legally chartered to select and specify the next best ready-made in construction documents? Is our use of computers for drawing, mapping, or rendering of future scenarios akin to true invention? Do we have a legacy of inventors and tinkerers who reify, curate, and improve the technologies that materialize our future sustainable and ecological cities? These questions are existential, as progress toward sustainable, ecological, and equitable future landscapes is in part technological determinism at work (see Robert L. Heilbroner's "Do Machines Make History?"). Whoever develops the technology that leads us forward in these realms determines, in part, the future configuration of our cities and broader society. Currently, innovation in landscape-related technology is primarily the task of disciplines tangentially oriented to landscape architecture such as material sciences, industrial design, computer science, geotechnical and civil engineering, horticulture, furniture manufacturing, fabrication, and others concerned with the technical, material, and tectonic dimensions of landscape systems. Isn't this the scope of landscape architecture? I believe it is! The patent archive now boasts thousands of landscape-related technologies, from Subsurface Upflow Wetland Systems (US Patent 8,252,182) to Reinforced Slope Planting Structures (US Patent 2013/0097927) and Segmental Bio-retention Basin Systems (US Patent 8,157,991). Innovation in this sector will continue to thrive; the question is whether or not landscape architects will lead the way. ●

RICHARD L. HINDLE IS THE EMERSON/WOMACK ASSISTANT PROFESSOR OF DESIGN AT THE ROBERT REICH SCHOOL OF LANDSCAPE ARCHITECTURE, LOUISIANA STATE UNIVERSITY.

## OPPOSITE

### METHOD AND MEANS FOR ANCHORING TRANSPLANTED TREES

US Patent 1,874,029.

Inventor: Maurice L. Condon.

Patented: August 30, 1932.

The patent drawing at right describes an early system for anchoring trees to buildings and over structures. According to the inventor, the drawings "designate a plurality of supporting beams or girders as of a roof, bridge, or the like embedded in suitable flooring material such as concrete, affording a floor or support for a layer of soil. It is preferred to include an intermediate stratum or layer of cinders or other light porous material for drainage purposes, and drain outlets.... It will be understood that the layer of soil is relatively shallow and would not itself afford a sufficient hold for a tree of any appreciable size, as the roots thereof cannot penetrate deeply. It will also be understood that trees planted in locations, as upon roofs and the like, are exposed to wind of high velocity and must be securely anchored."

Aug. 30, 1932.

M. L. CONDON

1,874,029

METHOD AND MEANS FOR ANCHORING TRANSPLANTED TREES

Filed Oct. 1, 1931

2 Sheets-Sheet 1

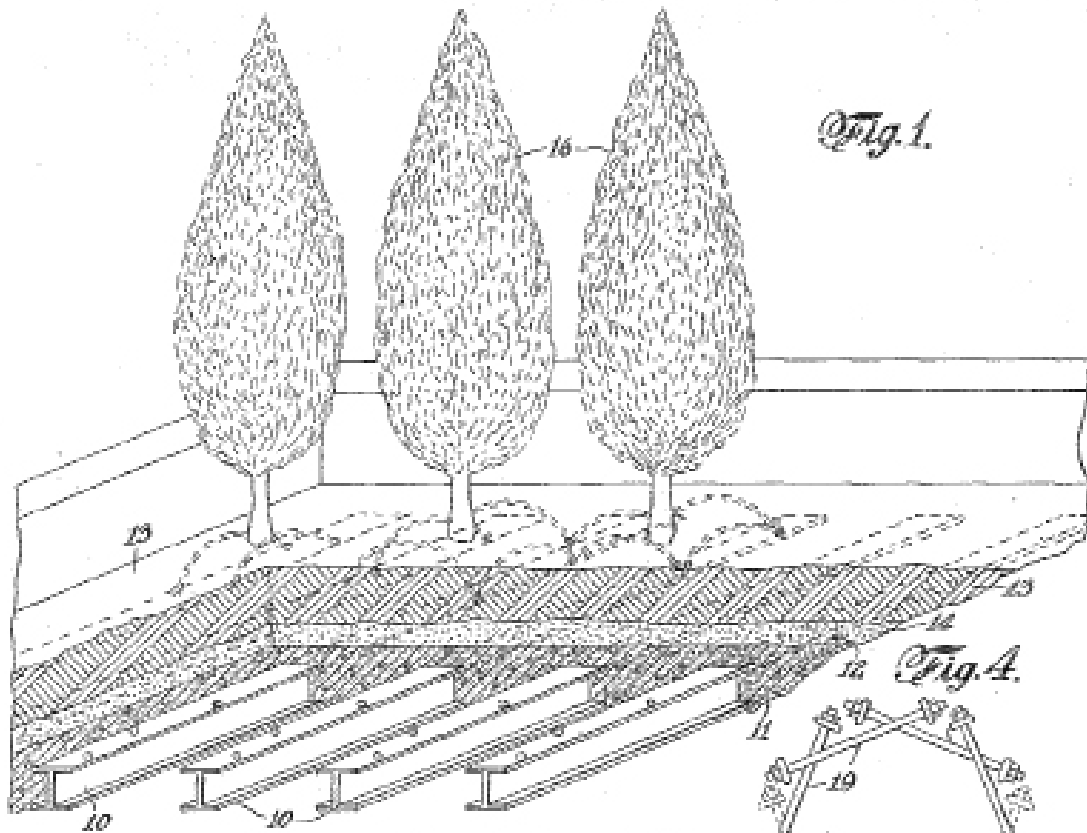

Fig. 1.

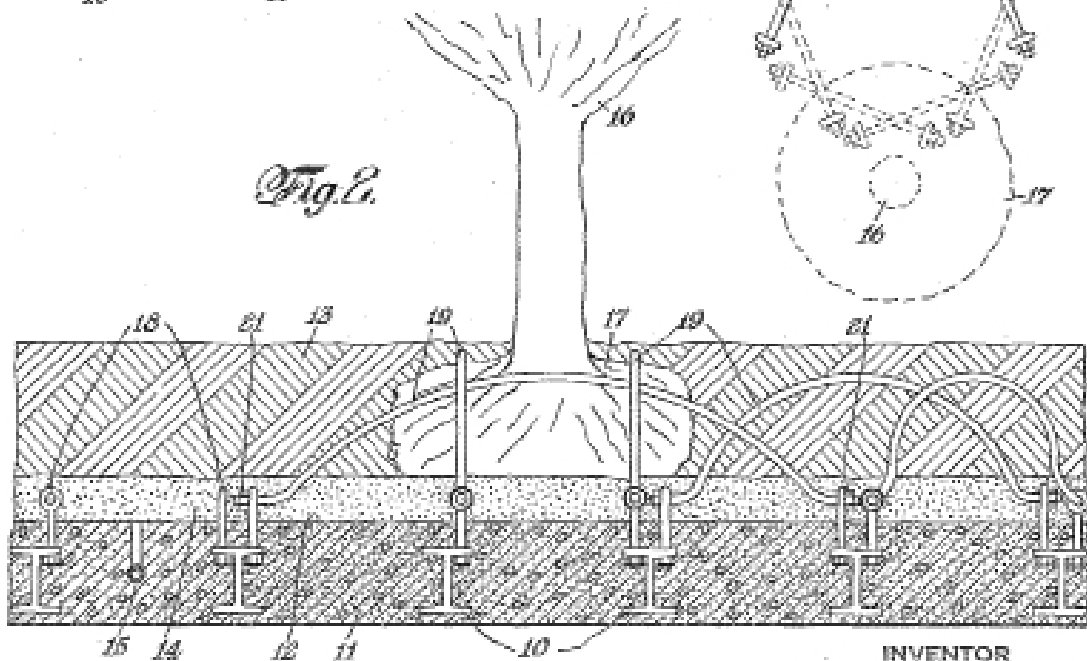

Fig. 2.

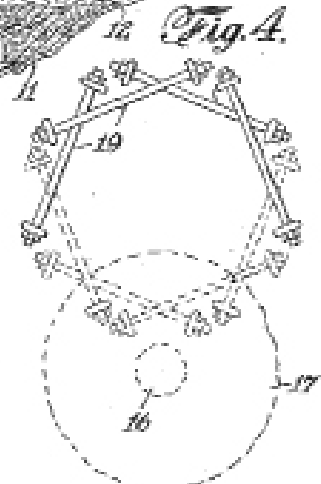

Fig. 4.

INVENTOR  
MAURICE L. CONDON  
BY *J. P. Schwartz*  
ATTORNEY