

Lawrence Berkeley National Laboratory

LBL Publications

Title

CONVECTIVE HEAT TRANSFER IN BUILDINGS: RECENT RESEARCH RESULTS

Permalink

<https://escholarship.org/uc/item/4kk0w96b>

Author

Bauman, F.

Publication Date

1982-10-01



Lawrence Berkeley Laboratory

UNIVERSITY OF CALIFORNIA

RECEIVED
LAWRENCE
BERKELEY LABORATORY

ENERGY & ENVIRONMENT DIVISION

MAY 17 1983

LIBRARY AND
DOCUMENTS SECTION

Presented at the ASHRAE Semi-Annual Meeting,
Atlantic City, NJ, January 23-27, 1983

CONVECTIVE HEAT TRANSFER IN BUILDINGS:
RECENT RESEARCH RESULTS

Fred Bauman, Ashok Gadgil, Ronald Kammerud,
Emmanuel Altmayer, and M.W. Nansteel

October 1982

TWO-WEEK LOAN COPY
*This is a Library Circulating Copy
which may be borrowed for two weeks.
For a personal retention copy, call
Tech. Info. Division, Ext. 6782.*

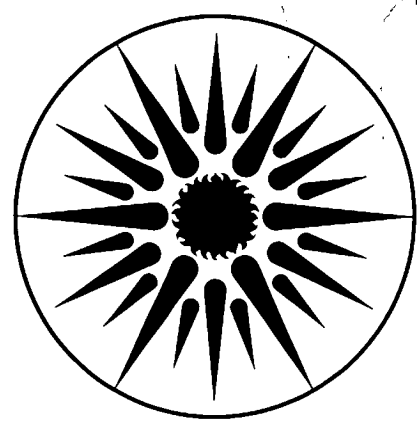

**ENERGY
AND ENVIRONMENT
DIVISION**

LBL-13883 Rev. *c.2*

DISCLAIMER

This document was prepared as an account of work sponsored by the United States Government. While this document is believed to contain correct information, neither the United States Government nor any agency thereof, nor the Regents of the University of California, nor any of their employees, makes any warranty, express or implied, or assumes any legal responsibility for the accuracy, completeness, or usefulness of any information, apparatus, product, or process disclosed, or represents that its use would not infringe privately owned rights. Reference herein to any specific commercial product, process, or service by its trade name, trademark, manufacturer, or otherwise, does not necessarily constitute or imply its endorsement, recommendation, or favoring by the United States Government or any agency thereof, or the Regents of the University of California. The views and opinions of authors expressed herein do not necessarily state or reflect those of the United States Government or any agency thereof or the Regents of the University of California.

CONVECTIVE HEAT TRANSFER IN BUILDINGS: RECENT RESEARCH RESULTS*

Fred Bauman, Ashok Gadgil, Ronald Kammerud,
Emmanuel Altmayer, and M.W. Nansteel#
Lawrence Berkeley Laboratory
University of California
Berkeley, California 94720

ABSTRACT

Recent experimental and numerical studies of convective heat transfer in buildings are described, and important results are presented. The experimental work has been performed on small-scale, water-filled enclosures; the numerical analysis results have been produced by a computer program based on a finite-difference scheme. The convective processes investigated in this research are (1) natural convective heat transfer between room surfaces and the adjacent air, (2) natural convective heat transfer between adjacent rooms through a doorway or other openings, and (3) forced convection between the building and its external environment (such as wind-driven ventilation through windows, doors, or other openings).

Results obtained at Lawrence Berkeley Laboratory (LBL) for surface convection coefficients are compared with existing ASHRAE correlations, and differences of as much as 50% are observed. It is shown that such differences can have a significant impact on the accuracy of building energy analysis computer simulations. Interzone coupling correlations obtained from experimental work reported in this paper are in reasonable agreement with recently published experimental results and with earlier published work. Numerical simulations of wind-driven natural ventilation are presented. They exhibit good qualitative agreement with published wind-tunnel data. Finally, future research needs are suggested.

INTRODUCTION

As energy costs have escalated, there has been an increasing awareness of the impact that building design decisions can have on energy consumption in the resulting structure. In addition to energy issues, the designer must also take into account aesthetic, economic, and functional requirements of the building. The most effective design solution depends on proper weighting of all relevant factors. In order for energy to have an appropriate weight in the decisions, adequate accuracy in energy calculations must be provided.

The tools that provide predictive and/or evaluative capabilities for building energy consumption may differ in complexity and form, but they must account for the three heat transfer processes (radiation, conduction, and convection) that take place within the building and between the building and the environment. While radiation and conduction in the temperature range applicable to buildings are well understood and amenable to analysis, convective heat transfer processes are typically dealt with in a crude and imprecise way. A sound understanding of the influence of convective heat transfer processes on the thermal performance of buildings is necessary to enable the designer and/or analyst to (1) predict the influence of design decisions on the energy consumption of a building and/or (2) interpret the performance of the building in order to obtain a basis for design decisions in future projects.

*This work was supported by the Assistant Secretary for Conservation and Renewable Energy, Office of Solar Heat Technologies, Passive and Hybrid Solar Energy Division, of the U.S. Department of Energy under Contract No. DE-AC03-76SF00098.

#M.W. Nansteel is currently Assistant Professor in the Department of Mechanical Engineering and Applied Mechanics at the University of Pennsylvania, Philadelphia, PA 19104.

The purpose of this paper is to report and summarize recent experimental and numerical results on convection in buildings. Experimental data are used to derive correlations for surface heat transfer coefficients and interzone convective coupling. The importance of accurate modeling

of convection in the computer simulations of building energy consumption is illustrated using the building energy analysis computer program, BLAST.* In addition, future research needs will be suggested.

BACKGROUND

The understanding of convective heat transfer processes is necessary in energy analysis in order to describe (1) the coupling between building surfaces and the adjacent air, (2) heat transfer within and between rooms due to natural and/or forced air exchange, and (3) heat transfer to/from the environment due to infiltration and natural or forced ventilation.

Heat transfer between the surfaces of a building and the adjacent air is normally modeled using the convection coefficients documented by ASHRAE.[1,2] These coefficients are largely based on experimental research conducted 40 to 50 years ago using vertical, free-standing flat-plate geometries not typical of buildings.[3-7] The experiments did not measure convective heat transfer in enclosures; as a result, the applicability of the reported convection coefficients to building heat transfer calculations is only approximate. While these pioneering experiments appear to have been carefully conducted, the temperature dependence of the reported data (e.g., Ref. 7) disagrees with more recent experimental results.[8] Furthermore, though three types of natural convective heat transfer coefficients are recommended by ASHRAE--constant values and values depending on the temperature difference between the surface and the adjacent air for laminar and turbulent conditions separately--the constant values are not consistent with the temperature-dependent values.

The extensive research in natural convection heat transfer during the last 40 years has dealt primarily with enclosure geometries that do not typify rooms in buildings.[9,10] Recently, there has been renewed interest in convective heat transfer processes in buildings. Buchberg [11]; Nielsen [12]; Honma [13] Weber [14]; Lebrun and Marret [15]; Laret, Lebrun, Marret, and Nusgens [16]; Markatos and Malin [17]; Anderson and Bejan [18]; Gosman, Nielsen, Restivo and Whitelaw [19]; Gadgil, Bauman, and Kammerud [20]; and Nansteel and Greif [21] have recently reported investigations on convective heat transfer within and between thermal zones in configurations similar to buildings. Though much of the

recent convection research does not focus on the evaluation of convection coefficients or zone coupling directly, the research methodology and analytical tools are sufficiently well developed to reconsider the past estimates of the importance of convective heat transfer processes in buildings.

CONVECTION COEFFICIENTS

Surface-to-air convection coefficients (h_{sa}) are used to determine the rate of heat transfer between a surface and the adjacent air due to natural and/or forced convection. The value of the coefficient depends primarily on the enclosure geometry, the location and orientation of the surface, the temperature difference between the surface and the air (ΔT_{sa}), and the velocity of the air near the surface. The instantaneous rate of convective heat transfer (Q) between a surface and the adjacent air is given by:

$$Q = A h_{sa} \Delta T_{sa} \quad (1)$$

where

A represents the area of the surface in contact with the surrounding air.

Recent relevant experimental and analytic research results are summarized and interpreted below.

Experimental Results

The experimental work reported by Nansteel and Greif [21] and Bauman, Gadgil, Kammerud, and Greif [22] investigates natural convective heat transfer in a small-scale rectangular enclosure containing water. Figure 1 shows a cross-sectional schematic diagram of the experimental configuration. One vertical wall is heated to a constant temperature, T_h , and the opposite vertical wall is cooled to a constant temperature, T_c . The horizontal surfaces (floor and ceiling) are well insulated. Variations in density drive the enclosed fluid up the heated wall, along the top horizontal surface, down the cooled wall, and along the bottom horizontal surface, completing the convective loop. Both flow visualization experiments and analysis demonstrate that the convective motion of the fluid is mostly confined to a thin region along all four internal surfaces, producing a rather large and fairly inactive central core region.

The purpose of the experiments was to measure the heat transfer rate between the hot and cold walls. The experimental data allowed the determination of the average natural convective heat transfer coefficients on the vertical surfaces. In order

*BLAST (Building Loads Analysis and System Thermodynamics) is trademarked by the Construction Engineering Research Laboratory, U.S. Department of the Army, Champaign, IL.

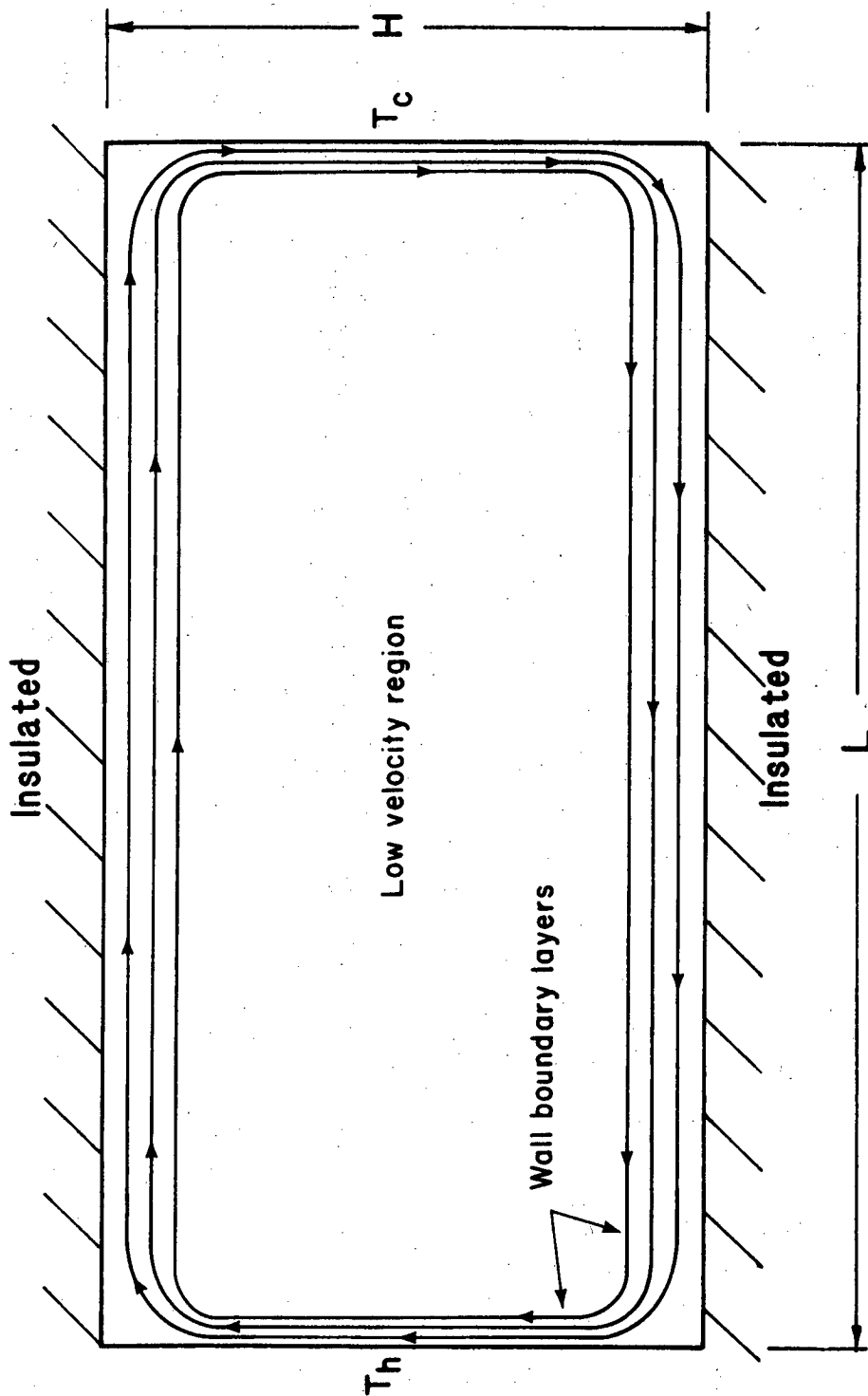

XBL 8210 - 1216

Figure 1
Schematic Diagram of Single Enclosure

to obtain two-dimensional flow conditions, the enclosure was designed to be much broader than its other two dimensions (83.8 cm >> 30.5 cm); thereby, the end-walls of the enclosure had negligible effect on the flow conditions.

The experimental configuration is appropriate for studying convection in buildings for a number of reasons. The geometric aspect ratio ($A = H/L = 15.2 \text{ cm}/30.5 \text{ cm} = 0.5$) is representative of typical room geometries. The use of water as the working fluid allows flow conditions that are found in full-scale buildings ($Ra_H > 10^9$) to be modeled in a small-scale apparatus. The opacity of water to thermal radiation allows for the measurement of the purely convective component of the heat transfer across the enclosure and from this standpoint is ideally suited for the study of convection processes.

The heat transfer data obtained from two separate experiments are presented in Fig. 2. These experiments are described in detail in Refs. 21 and 22. All data points have been adjusted to represent the natural convection of air ($Pr = 0.7$) using a correlation developed at LBL.* The data are presented in terms of the dimensionless parameters, Nusselt number (Nu_H) vs. Rayleigh number (Ra_H). The Nusselt number (see nomenclature for exact definition), which is a measure of the strength of the convective heat transfer at the wall, can be reduced to the dimensional form of a surface-to-air convection coefficient (h_{sa}). This has been done in Fig. 2 for the realistic situation of air at room temperature (21°C, [70°F]) in a full-scale room ($H = 2.7 \text{ m}$ [9 ft]). The Rayleigh number (see nomenclature) represents the relative strength of buoyancy and viscous forces and is reduced to the characteristic surface-to-air temperature difference (ΔT_{sa}). Also shown in the figure is the best overall correlation for the Nasteel data. It is noted that the Nusselt numbers reported in the earlier experiments of Bauman et al. are lower, because heat losses from the horizontal surface of the apparatus were significantly larger (6-18% for Ref. 22 as opposed to 0.5-5% for Ref. 21), and the convective heat transfer across the enclosure was correspondingly reduced.

*The approximate correlation was developed by performing numerical simulations and by analyzing all available experimental and analytical results for natural convection of any fluid in an enclosure of aspect ratio equal to 0.5. A general predictive correlation of the same form as Ref. 23 was fit to these results. The Nusselt number for air was predicted to be about 5% less than the Nusselt number measured with water. See Appendix A for details of this correlation.

For the range of conditions of interest (ΔT_{sa} greater than 0.56°C [1.0°F]), the natural convective heat-transfer from vertical surfaces in full-scale buildings corresponds to convection coefficients greater than about 1.5 W/m²°C (0.26 Btu/hr ft² °F) as seen in Fig. 2. It is well known that transition from laminar to turbulent natural convection along an isolated vertical surface begins at Rayleigh number values near 10⁹ (Ref. 24). However, due to the retarding frictional effect of the horizontal surfaces of the enclosure, transition to turbulence in an enclosure may be delayed until higher Rayleigh numbers are reached. In fact, flow visualization in the water-filled enclosure demonstrated that the flow was laminar even at the highest Rayleigh numbers ($Ra_H = 6.75 \times 10^9$) reached in the experiment. With air ($Pr = 0.7$), turbulence may be reached at a slightly lower Ra than for water. The heat transfer data for water from Ref. 21 was used to obtain a correlation for air in the general form

$$h_{sa} = 2.03 (\Delta T_{sa}/H)^{0.22} \quad (2)*$$

where

h_{sa} is the surface-to-air heat transfer coefficient (W/m²°C), $\Delta T_{sa} = (T_h - T_c)/2$ is the average-surface-to-average-air temperature difference (°C), and H is the height of the enclosure (m).

In Table 1, Eq. (2) is compared with the three calculations for natural convective heat-transfer coefficients documented by ASHRAE.† Table 1 also lists the magni-

*In order to be strictly correct, Eq. (2) would include an additional factor of $(1/H)^{0.12}$. For simplicity, this factor has been absorbed into the constant in Eq. (2) with $H = 2.74\text{m}$. This introduces a small error (less than 5%) when Eq. (2) is applied to enclosure heights in the range of 2-4 meters.

†The ASHRAE constant convection coefficient for a vertical surface is derived from Table 1, page 23.12, ASHRAE Handbook--1981 Fundamentals Volume, by subtracting out the radiative component of the total surface heat transfer coefficient. This method has been documented in Ref. 2 and the constant values are commonly used in well-known building energy analysis programs (BLAST, DOE-2). Surprisingly, these constant values are based on a 5.6°C (10°F) surface-to-air temperature difference, which is not typical for real buildings. The ASHRAE temperature-dependent convection coefficients for laminar and turbulent flow are taken from Table 5, page 2.12, 1981 Fundamentals.

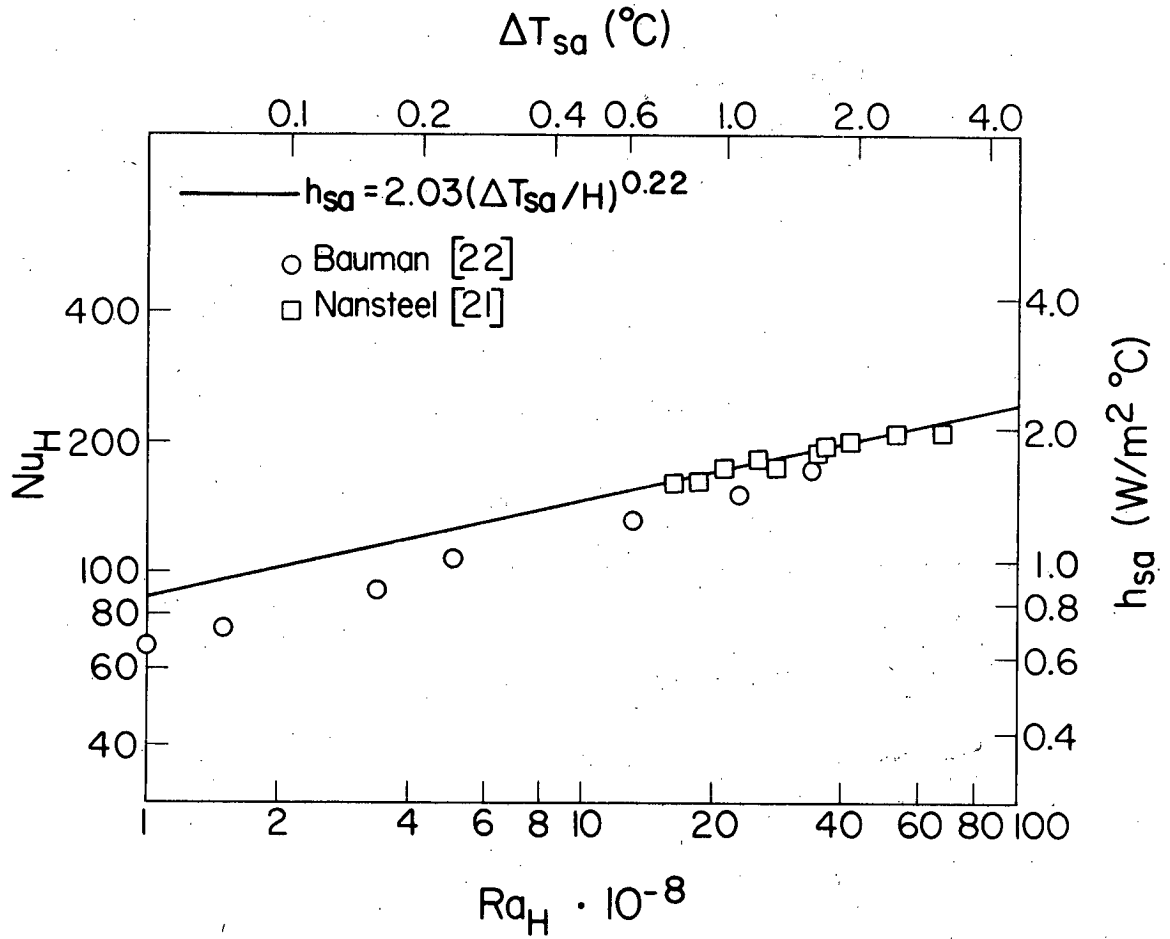

XBL 826-1407

Figure 2
Natural Convective Heat Transfer Results and Correlation;
Single-Zone Enclosure, $A = H/L = 1/2$, $Pr = 0.7$ (air)

Table 1
Comparison of Natural Convection
Surface-to-Air Heat Transfer Coefficients

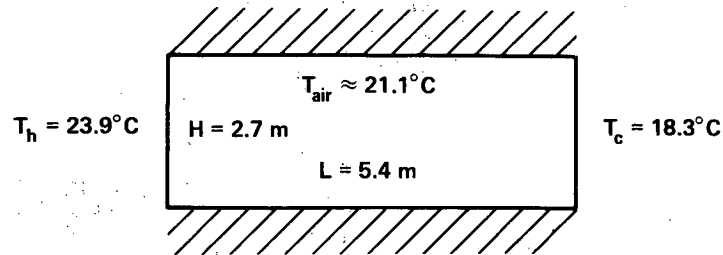

Method of calculation	Convective heat transfer from hot wall to air
ASHRAE constant convection coefficient ($h_{sa} = 3.08 \text{ W/m}^2\cdot^{\circ}\text{C}$)	$Q_1 = 23.3 \text{ W}$
LBL correlations, $h_{sa} = 2.03 (\Delta T_{sa}/H)^{0.22}$	$Q_2 = 15.5 \text{ W}$
ASHRAE temperature dependent convection coefficient (turbulent flow; $h_{sa} = 1.31 (\Delta T_{sa})^{0.33}$)	$Q_3 = 14.0 \text{ W}$
ASHRAE temperature dependent convection coefficient (laminar flow; $h_{sa} = 1.42 (\Delta T_{sa}/H)^{0.25}$)	$Q_4 = 10.8 \text{ W}$

XBL 826-1400

tudes of natural convective heat transfer from a warm wall at 23.9°C (75°F) to air 21.1°C (70°F) in the hypothetical enclosure shown in the accompanying figure. The predictions of building energy consumption, using the different correlations from Table 1, will obviously be mutually inconsistent. The ASHRAE heat transfer correlations vary among themselves by more than a factor of two. The more recent correlation compares favorably with the ASHRAE expression for turbulent flow. However, due to the experimentally observed persistence of laminar flow in an enclosure even at these large Rayleigh numbers, the LBL correlation should be compared with the ASHRAE expression for laminar flow. In this example, the ASHRAE temperature-dependent correlation underpredicts natural convective heat transfer coefficients by 30%. More seriously, the constant coefficients most often used in building energy analyses overpredict natural convection heat transfer coefficients by 50%.

Analytic Results

Computer programs that solve the full Navier-Stokes equations of motion for fluids in enclosures have been developed.[17,19,25] These programs are based on the finite-difference method, which divides the volume of interest into a large number of subvolumes; the time is also divided into discrete time-steps. The time-dependent differential equations are then integrated over the finite number of subvolumes and over each time-step to obtain a large number of simultaneous algebraic equations, which are solved by matrix inversion, for a large number of successive time-steps until steady-state flow fields are obtained. The program methodology is described in detail in Ref. 25.

The program developed at LBL is suitable for modeling both natural and forced convection in two and three dimensions, for internal and external flows. [25] In addition, the program can model any combination of obstacles (internal partitions, furniture, building exteriors), heat sources and sinks (space heating and cooling), and velocity sources and sinks (fans, windows). The program can, in principle, simulate both laminar and turbulent flow. The laminar flow calculations have been verified by comparison to data from detailed experiments performed at LBL and elsewhere.[22,26,27] The turbulence modeling capability has recently been added and is presently undergoing testing. This capability is particularly appropriate for the study of wind- and fan-driven ventilation and other forced convection phenomena.

In order to use this program, it is necessary to specify the geometric configuration, thermal and velocity boundary conditions, and the fluid properties. For

example, to obtain the solution of natural convection of air driven by different wall temperatures in a room, one must specify the room geometry, the temperatures of all room surfaces, zero air velocities at all room surfaces, and the thermophysical properties of air. The computer simulation predicts the velocities and temperature throughout the volume of interest, allowing the calculation of the heat transfer coefficients as a function of position on all the surfaces of the room.

In a preliminary study, it was shown that convection coefficients at the surfaces of an enclosure are actually quite sensitive to the temperature distributions on the surfaces (even for the same average surface temperature). [25] While the extent to which this variation in convection coefficients might influence the calculation of thermal loads in a building is unknown, one can speculate that the effect might be appreciable. Typically, the convective gains/losses by a surface in a building are roughly equal in magnitude to radiative transfers. Since the convection coefficient on the interior surface of glass contributes significantly (more than 80% for a single-pane window with an exterior wind of 5 mph) to the total thermal resistance of the window, appreciable uncertainty in the convection coefficient will be reflected strongly in the calculated conductive heat transfer through the window. Similarly, the convection coefficients can be important in determining the effectiveness of the heat gain and loss mechanisms from thermal mass in a building.

In order to further investigate the effect of dynamic variations of convection coefficients in buildings and account for both the convective and radiative exchanges, a study was performed using BLAST and the convection program [25] in an iterative process. The purpose of the study was to determine the effects of using correct convection coefficients on the calculated thermal load of a direct solar gain building. The computer program BLAST was chosen for this study because it performs a full thermal balance on all surfaces of the zone under study and the zone air. The surface thermal balance accounts for thermal radiation between zone surfaces, convection between zone air and each surface, conduction through each surface, and radiative gains from occupants, lights, equipment, and transmitted solar energy. The thermal balance on the air accounts for convective gains from surfaces, occupants, lights, and equipment and for controlled and uncontrolled ventilation.

The structure selected for this study was the south-facing zone of a well-insulated multizone building that has been thoroughly described elsewhere.[28] The zone had dimensions of 3.66 m wide x 9.14 m long x 2.44 m high (12 ft x 30 ft x 8 ft).

The only significant thermal mass in the building was contained in the concrete floor slab. A two-dimensional cross-sectional view of the zone is shown in Fig. 3. The figure also shows that the four major surfaces of the zone were each divided into three equal subsurfaces to allow for a detailed study of the variation of convection coefficients on the zone surfaces.

Simulations were performed for several different external weather conditions; the results for one specific design day are presented and discussed below. The design day chosen is representative of a clear, cold winter day (-17.8°C [0°F]) in Albuquerque, NM. Building loads were calculated by BLAST with respect to a 20°C (68°F) interior setpoint temperature. Infiltration losses were assumed to be zero.

The capability of the convection program to model heat sources (sinks) enabled it to duplicate the necessary heating (cooling) to maintain the interior air temperature at the designated setpoint. The modeling of heating (cooling) was accomplished by heat sources (sinks) of appropriate magnitude distributed uniformly throughout the interior of the zone, excluding the regions close to the zone boundaries.

BLAST and the convection program were used together in the following iterative procedure, described in detail in Ref. 20.

1. A BLAST design-day simulation generated hourly distributions of temperatures of the subsurfaces defining the zone boundary.
2. Three hours were chosen for further analysis of convection: one hour at midday when the zone is in the solar gain mode; one hour in the evening when no solar gains are present but thermal mass effects help to maintain comfort conditions in the zone; and one hour in the early morning when the zone is in the loss mode.
3. For each hour, the individual subsurface temperatures calculated by BLAST were input to the two-dimensional convection program.
4. The convection program simulated the details of the convection process and calculated natural convective heat-transfer coefficients for each subsurface.
5. These convection coefficients were then input to BLAST, and the design-day analysis was repeated in order to obtain new subsurface temperatures.

6. These temperatures were again used as input to the convection program, and the entire procedure was iterated until self-consistent results were obtained.

The results of the detailed convection analysis for 6:00 a.m. (loss mode) are summarized in Figs. 3 and 4. The surface temperatures and convection coefficients obtained both with and without the iterative procedure using the convection program are shown in these figures. The numbers in parentheses represent the results of the original BLAST design-day simulation, which used standard assumed values for convection coefficients.*

The recalculated convection coefficients are seen to be substantially different from their standard assumed values for most of the surfaces. The cold downdraft of air, after losing heat through the window, moves past the lower subsurface of the south wall and across the floor, extracting heat from these surfaces. Since the average room air temperature (20°C) is warmer than the temperature of the lower south wall (15.1°C), the heat transfer coefficient (defined with respect to the average temperature of the room air) at this surface is negative. This is the only surface in the room for which ΔT_{sa} and the surface heat flux are in opposite directions. The air current is warmed as it moves across the floor and extracts less and less heat from successive floor subsurfaces. As a result, the convective heat-transfer coefficients on the floor are seen to decrease from 3.4 W/m²°C to 0.8 W/m²°C.

In order to calculate the effect of the recalculated convection coefficient values on BLAST predictions of building loads, the BLAST design-day simulation was rerun. In this simulation, the standard assumed convection coefficient values for three eight-hour periods, surrounding the three typical hours described above, were replaced with the recalculated convection coefficients for those three hours.

Figure 5 shows a comparison of the BLAST-predicted thermal load profiles for the zone under study for three design-day simulations: the first using standard assumed convection coefficients, the second using ASHRAE temperature-dependent laminar convection coefficients, the third using the recalculated convection coefficients. The small dip at hour 1, in the recalculated load profile, has been caused by the discontinuity in the convection coefficients at transition from one eight-hour period to the next. The recalculated zone heating and cooling loads are, respec-

*Derived from Table 1, Page 23.12, ASHRAE Handbook--1981 Fundamentals Volume.

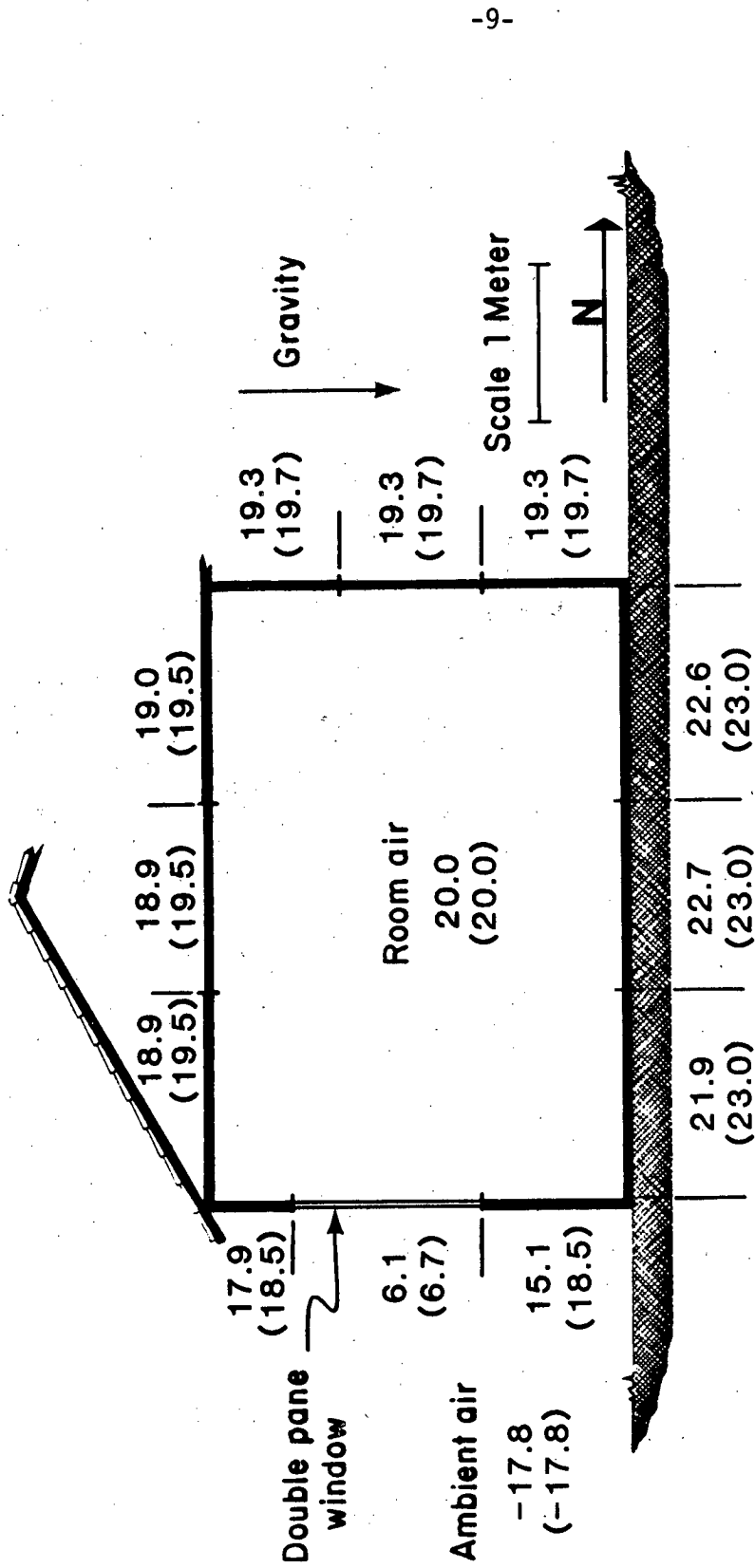

With calculated and (with standard assumed) convection coefficients.

XBL 8210 - 1217

Figure 3

Surface Temperatures (°C) on the Interior Subsurfaces of a Single Zone in a House. Steady State (6 a.m.) Heat Loss Mode.

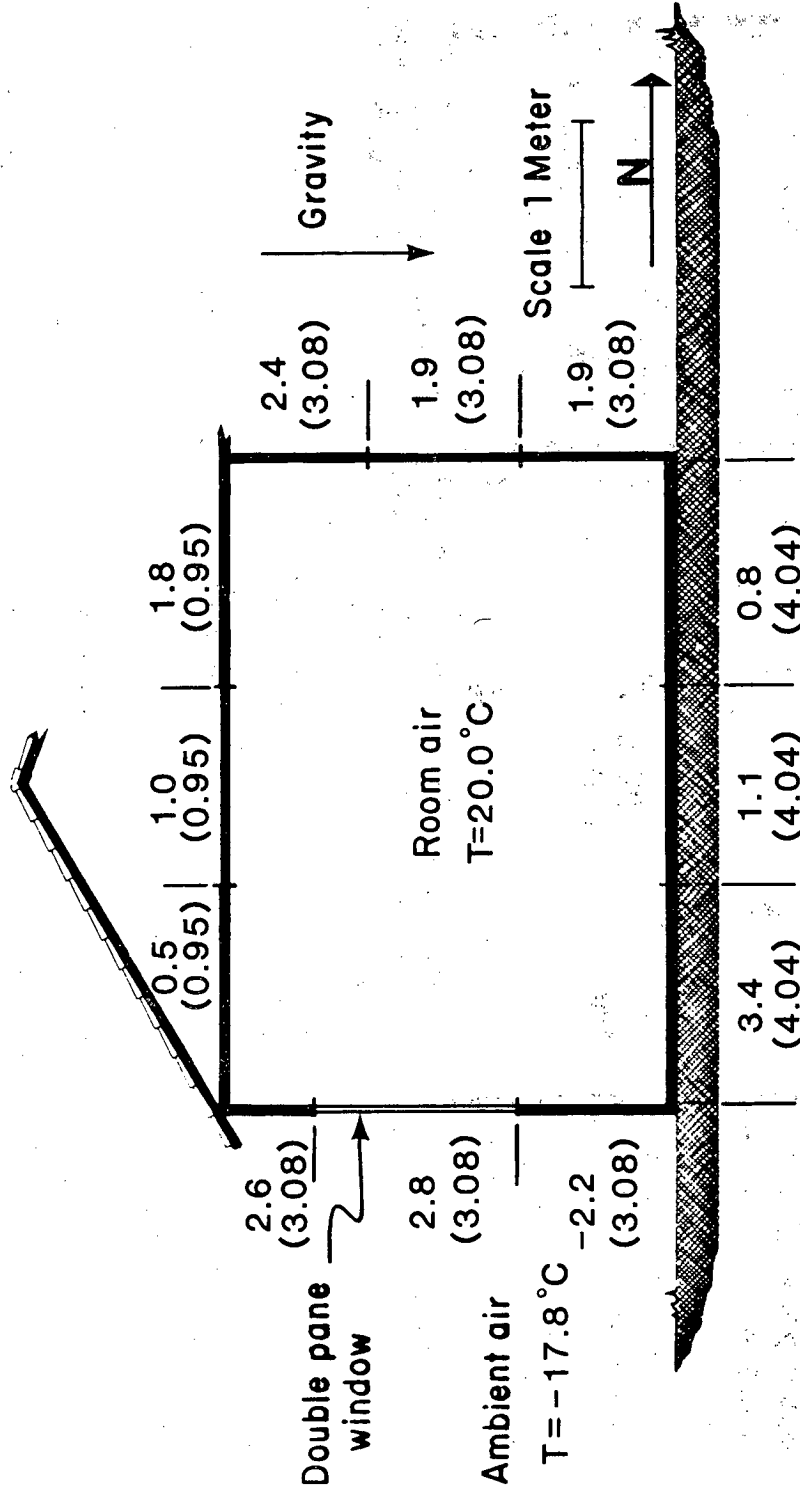

Calculated and (standard assumed) values.

XBL 8210 - 1218

Figure 4

Convection Coefficients (W/m²-°C) Between the Room Air and the Interior Surfaces of a Single Zone in a House. Steady State (6 a.m.) Heat Loss Mode.

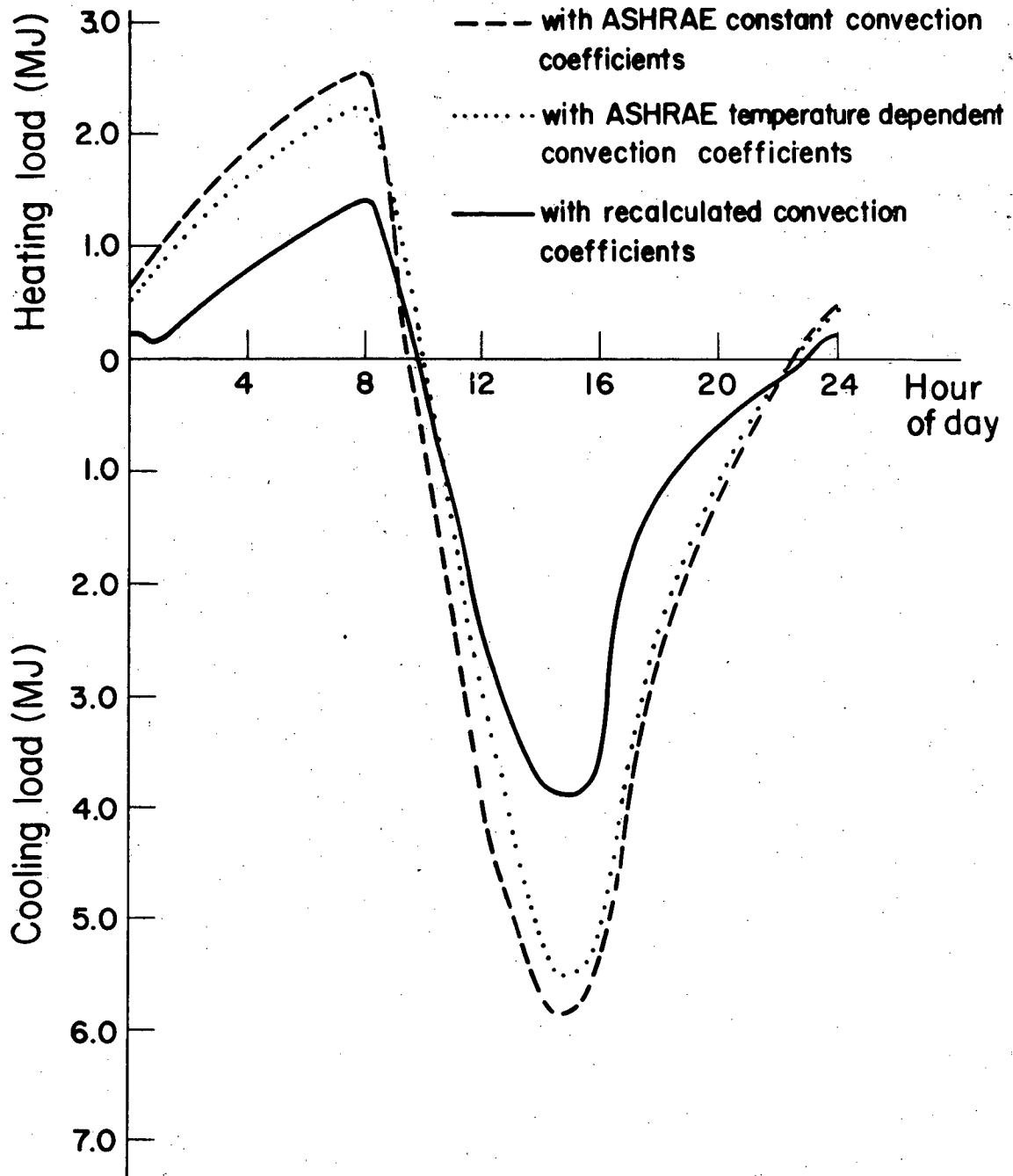

Figure 5
Load Profiles for Prototype Zone:
BLAST Predictions with
Different Convection Coefficients

XBL 826-1397

tively, 53% and 39% lower than the loads calculated using standard convection coefficient values; they are, respectively, 47% and 29% lower than the loads calculated using temperature-dependent convection coefficients. Again, it is noted that infiltration losses were assumed to be zero in the load calculation, thus somewhat exaggerating the sensitivity of the load to the convection coefficients. In spite of this, the influence of the convection coefficients on thermal load is significant.

The simulations for this study were performed for a direct gain solar structure, but in light of the large differences observed during the nighttime heat-loss period, the results have relevance to conventional building designs as well. As seen in Fig. 3, during the nighttime (heat-loss) period, with the exception of the window, surface-to-surface temperature differences are quite small, a characteristic that is typical of all nonsolar (conventional) buildings.

Interzone Coupling

The rate of heat transfer between thermal zones[#] in a building due to natural convection of air through the connecting doorway(s) or opening(s) can be described in terms of a convection coefficient. This heat transfer process often will not involve forced convection. The value of the convective interzone coupling coefficient (h_{iz}) depends on the convection processes taking place in the individual zones, an appropriately defined interzone temperature difference (ΔT_{iz}), and the shape, size, and location of the connecting opening. In this case, one has the equation

$$Q = Ah_{iz}\Delta T_{iz} \quad (3)$$

where

A represents the area of the connecting opening.

Natural and/or forced convection between zones is a largely unquantified heat transfer mechanism in buildings. Although a few experiments have been performed in studies of contaminant migration, this work has not led to even a gross ability to predict the influence of convective coupling on variability of comfort conditions in a building or on energy consumption. Recent experimental work has been undertaken to begin obtaining an improved

[#]A thermal zone is defined as a room or a collection of adjoining rooms in a building within which the air temperature (or comfort conditions) can be assumed to be constant to an adequate approximation.

understanding and quantification of these processes.

In 1980, Weber completed an experimental study of natural convection in a two-zone, small-scale enclosure at the Los Alamos National Laboratory. [14] The three-dimensional experimental configuration, representing a doorway separating two rooms, is shown in Fig. 6. As in the experiments of Bauman and Nansteel [22,21], the natural convective motion of the fluid was induced by supplying heat to one vertical wall in the warm zone and removing heat from the opposite vertical wall in the cool zone. The remaining surfaces of the two-zone enclosure were insulated, although not perfectly (heat losses were estimated by Weber to be on the order of 25%). The flow was three-dimensional, and interzone temperature differences were measured to characterize the heat transfer rate from the hot wall, through the central aperture, to the cold wall. Freon 12 gas ($Pr = 0.77$) was used as the working fluid in order to improve the quality of the similitude modeling of air ($Pr = 0.7$) in a full-scale room.

As a result of these measurements, Weber presented interzone natural convective heat transfer coefficients for the specific geometric configurations under study. Weber also compared his results with two previous important experimental investigations, as well as with his subsequent measurements in full-scale buildings, and obtained reasonable agreement.[29-31] The correlation from Weber's experiments can be rewritten in the general form (SI units) [14,31]:

$$h_{iz} = C(73)(H_a\Delta T_{aa})^{0.5} \quad (4)$$

where

h_{iz} is the interzone convection coefficient for air at room temperature, H_a is the central aperture height, and ΔT_{aa} is the interzone air temperature difference ($T_h - T_c$). C is a dimensionless constant depending on the central aperture geometry and ranges in value from 0.65 to 1.0. Weber used a value of $H = 2.44$ m (8 ft) in arriving at his correlation. [14] The accuracy of Eq. (4) for other values of H is not known to the authors.

Nansteel and Greif also report an interzone convection experiment using water as the working fluid that represents a simplified (two-dimensional) approach to the problem of natural convection between two zones in a building. [21] A well-insulated two-dimensional partition, extending the entire horizontal depth of the enclosure, is lowered from the ceiling at the midpoint between the two vertical walls to create the two zones (see Fig. 7). For interzone convection driven by a warm wall maintained

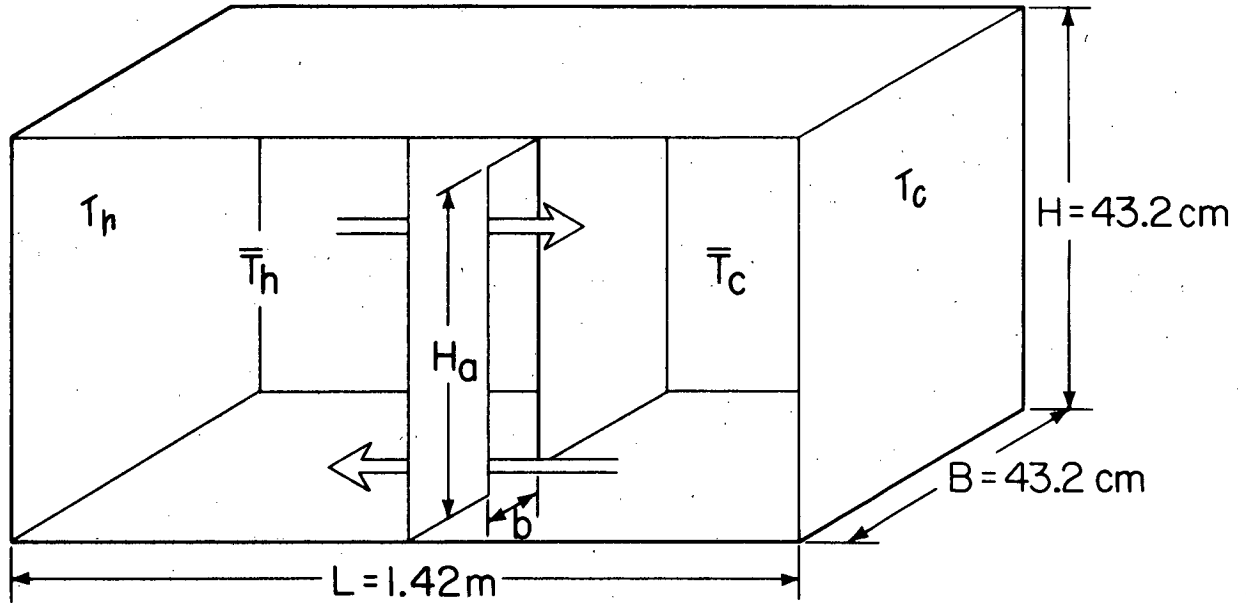
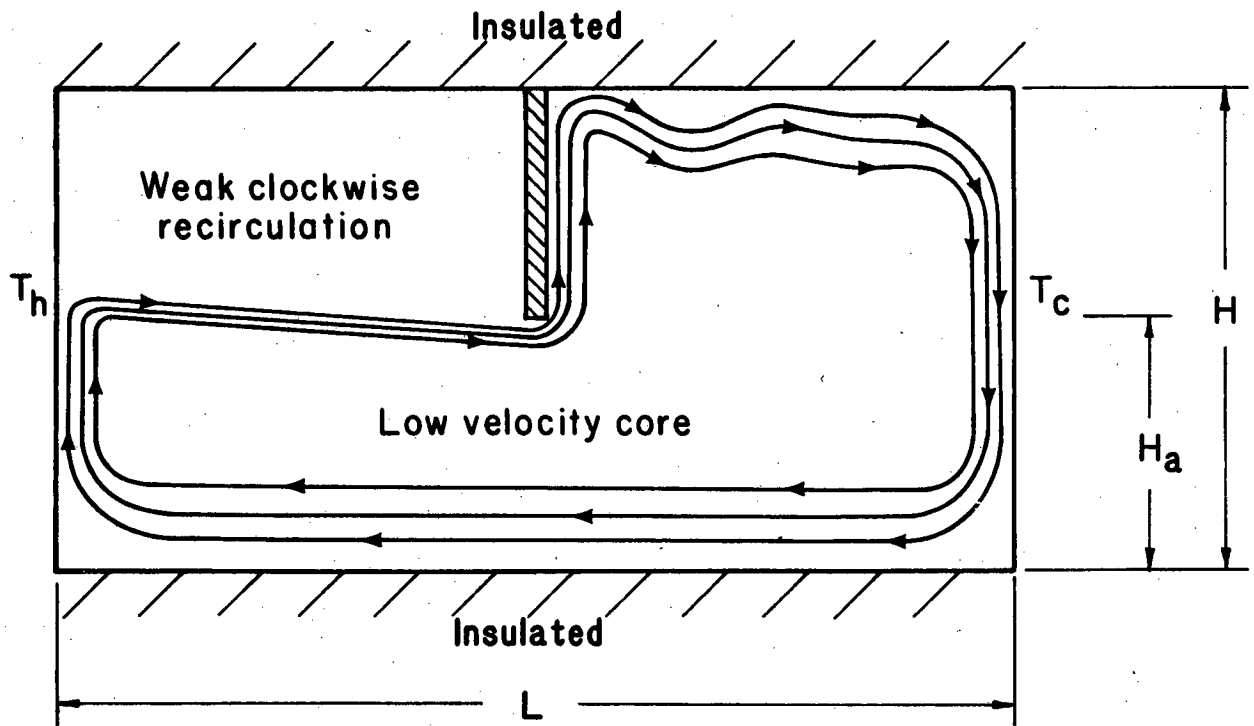

Figure 6

XBL 826-1399

Small-Scale Two-Zone Experiment (14)



XBL 8210-1219

Figure 7

Schematic Diagram of Two-Zone Enclosure

at a constant temperature, Fig. 7, based on flow visualizations, shows that the central partition effectively eliminates the upper portion of the warmer zone from any strong convective coupling with other regions of the enclosure. This feature is expected to change if the warm wall is heated with a uniform heat flux. Figure 8 presents the heat transfer data (adjusted to represent air), including for comparison the results of the single-zone (no partition) experiment described earlier. The results clearly demonstrate that decreasing the central aperture height will, as expected, produce a corresponding decrease in the amount of heat transfer across the enclosure. This trend has important implications in the use and design of transoms over doorways in buildings.

An overall correlation for these experimental data has the following form for air at room temperature in similar two-zone configurations (SI units):

$$h_{iz} = 2.03(H_a/H)^{0.47}(\Delta T/H)^{0.22} \quad (5)^\$$$

For purposes of comparison with Eq. (2), ΔT above is defined in the same way as ΔT_{sa} was earlier (i.e., $\Delta T = (T_h - T_c)/2$). For the two-zone configuration (Fig. 7), ΔT does not equal the surface-to-air temperature difference. Since the horizontal temperature gradients were extremely small across the central aperture, ΔT_{aa} was not measured in the above experiment. Note that for the limiting case of the single zone ($H_a = H$), Eq. (5) reduces to Eq. (2); for this configuration, h_{iz} and h_{sa} have the same meaning, as do ΔT and ΔT_{sa} .

It should be pointed out that the measurement of the average zone temperature (as in Ref. 14) is experimentally much more difficult than the measurement of the average temperature of an enclosure surface, which is being maintained at a very nearly constant temperature (as in Refs. 14, 21, and 22). The zone temperature measurement involves the use of a large array of temperature sensors that may disturb the local flow fields and whose outputs can be affected by local conduction and convection (and possibly radiation); additionally, the outputs must be averaged according to some appropriate volume-weighting scheme. However, even the more sophisticated building energy analysis computer programs base zone energy balance calculations on a single average zone air temperature, while a surface-temperature-dependent zone coupling algorithm appears most compatible with existing experimental techniques. Alternatively, numerical simulations of interzone coupling, with a validated computer program, could be used in conjunction with

experimental data to produce an interzone coupling algorithm based on the difference in zone air temperatures.

Recently, a series of additional experiments was completed at LBL extending the investigations reported in Ref. 21 to the three-dimensional problem of a door-shaped opening. The apparatus used was again identical to the one described earlier, with the exception that a complete partition, extending all the way to the floor and having a door-shaped opening, was placed between the heated and cooled walls (Fig. 9). In this experiment the heat transfer results were measured in terms of the temperature difference between the two opposite end walls ($T_h - T_c = 2\Delta T$).

Although Weber reported all of his results in terms of interzone temperature differences, he also monitored the two vertical end wall temperatures (T_h, T_c).^{*} This allows his results to be compared with those from the LBL experiments.

The heat transfer results from the recent experiments at LBL and Weber are shown together in Fig. 10. In order to make a meaningful comparison, all data have been adjusted in the manner described earlier to represent air and are presented in terms of ΔT . Considering the number of notable differences between the two experiments (working fluid, heat losses from the apparatus, geometry), it is significant to find agreement to within 12% for the data points that simulate doorways extending to the ceiling ($A_p = H_a/H = 1.0$). As the central opening height is reduced to a value representative of standard doorway geometries ($A_p = 0.75$), LBL results exhibit the expected reduction in heat transfer, although the net change is small (6%). Weber's measurements for $A_p = 0.82$, however, indicated an opposite effect, an increase in heat transfer rate.[#] This counterintuitive trend may result from the methodology used to calculate the heat losses from the apparatus; the true heat-loss values for the experiment may have been underestimated, resulting in an overestimation of the convective heat transfer through the doorway.

The interzone heat transfer data from

^{*}These data were obtained by personal communication with Dennis Weber, Department of Physics, Clark County Community College, Las Vegas, Nevada.

[#]Weber also made measurements at two other values of A_p (0.46 and 0.59). For $A_p = 0.82, 0.59,$ and 0.46 his results demonstrated the expected reduction in heat transfer with decreasing A_p .

[§]See earlier footnote associated with Eq. (2).

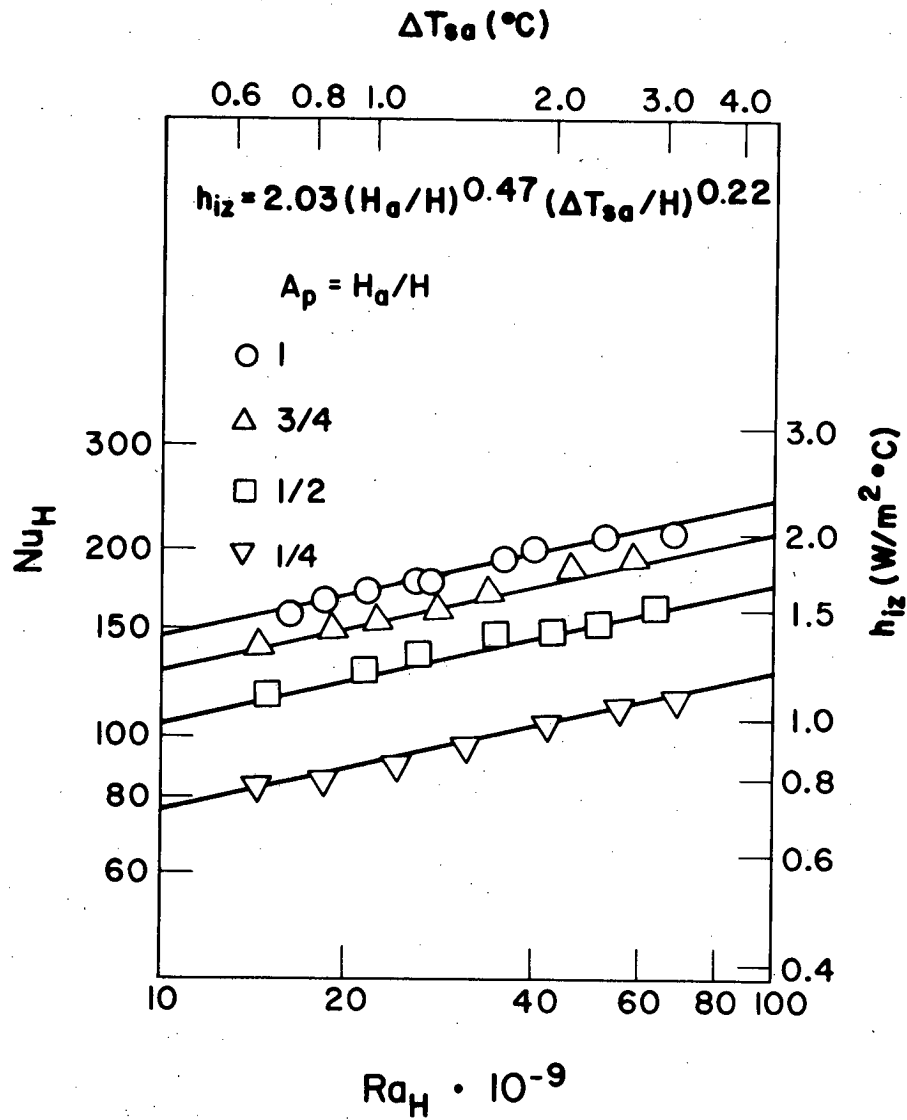
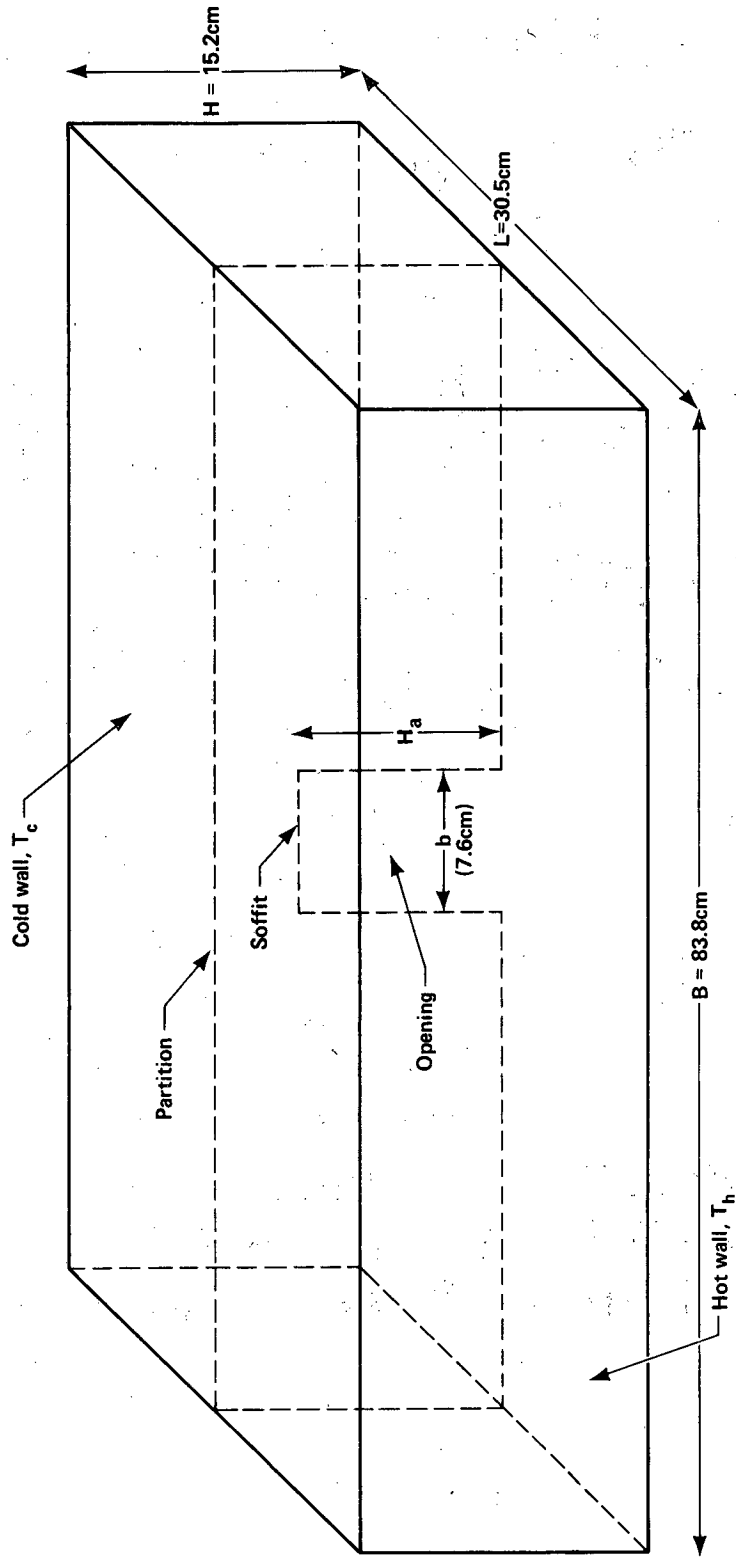

Figure 8

XBL 826-1398

**Interzone Heat Transfer Results and Correlation;
Two-Dimensional, Two-Zone Enclosure,
 $A = H/L = 1/2$, $Pr = 0.7$ (air) [8]**



XBL 825-585

**Figure 9 Small-Scale Two-Zone Experiment (LBL):
Three-Dimensional Configuration**

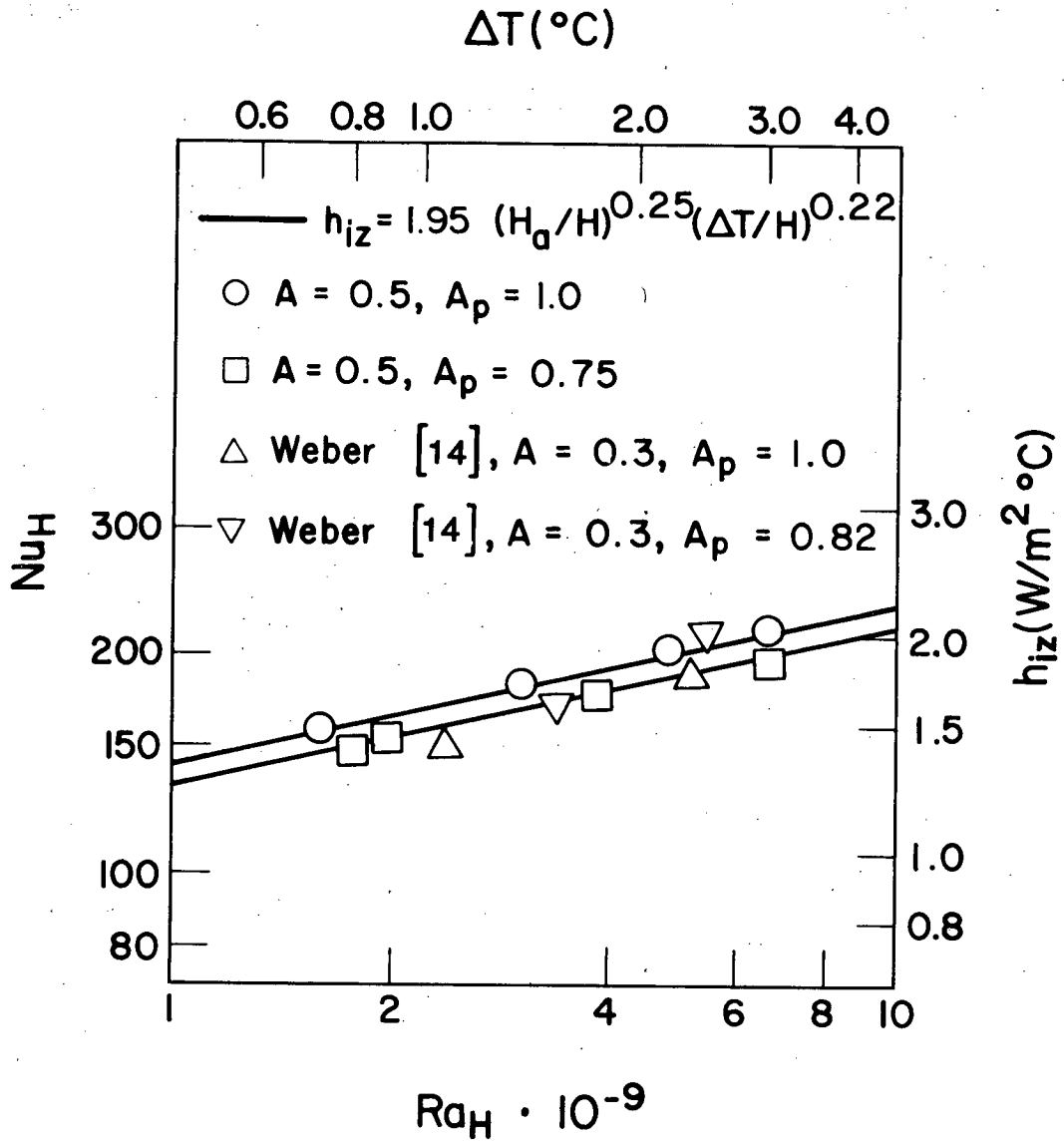

XBL 826-1406

Figure 10
Interzone Heat Transfer Results
and Correlation: Three-Dimensional,
Two-Zone Enclosure, $Pr = 0.7$ (air)

the LBL three-dimensional experiment' was correlated as follows (SI units):

$$h_{iz} = 1.95(H_a/H)^{0.25}(\Delta T/H)^{0.22} \quad (6)**$$

Note that Eq. (6) exhibits a different functional dependence of h_{iz} on ΔT compared with the dependence of h_{iz} in Eq. (4). The authors feel, however, that extracting a relationship between ΔT_{aa} and ΔT by equating Eqs. (4) and (6) is not warranted at this time due to the sparseness of the data and differences in the experimental boundary conditions.

The interzone heat transfer through a door-shaped opening (Figs. 9 and 10) has been compared with the interzone heat transfer through an opening of the same height but extending across the entire width of the enclosure (Figs. 7 and 8). The data for $A_p = 1.0$ and $A_p = 0.75$ in Fig. 11 indicate the surprising result that, for the same boundary conditions, the convective heat transfer rate through a standard doorway is almost identical to the heat transfer rate when the opening extends across the width of the enclosure; less than 3% reduction in heat transfer is seen at $A_p = 1.0$, and virtually no change is seen for $A_p = 0.75$. Clearly, increased air velocities through the doorway are tending to balance the smaller aperture area available for convection. Also, note that the similar heat transfer rates shown in Fig. 11 are based on ΔT ; this relationship is not expected to hold if the heat transfer rates are based on ΔT_{aa} .

Natural Ventilation

Natural ventilation refers to the exchange of air between the building and its environment through architecturally designed openings (windows, vents, doorways). It is generally distinguished from infiltration, which is the uncontrolled movement of air through cracks and other small openings in the building shell. Natural ventilation and infiltration are important to the indoor environment in terms of human comfort, air quality, and heat removal. Both infiltration and natural ventilation are driven by a combination of the external wind conditions and the building thermal stack effect.

Infiltration in buildings recently has been experimentally investigated by Sherman, Grimsrud, Condon, and Smith [32] (see Ref. 33 for a complete bibliography). Chandra and Fahey, at the Florida Solar Energy Center (FSEC), are presently carrying out experimental studies in natural ventilation and have recently published a thoroughly annotated bibliography on the

subject.[34] In conjunction with the FSEC experiments, a turbulence model has been developed and is being added to the numerical convection computer program described earlier. The resulting program will predict forced and natural turbulent convective effects in buildings.

The capability of the convection program to simulate wind-driven natural ventilation is demonstrated by considering laminar wind tunnel experiments carried out with a model of a square room with an internal partition and windows in opposite walls. The experimental work was carried out by Givoni, who investigated the internal flow patterns using smoke tracing and velocity measurements for several configurations.[35] The convection program was used to simulate the flow in two of these configurations. The internal flow fields predicted by the convection program are compared with those observed by Givoni in Figs. 12 and 13; the qualitative agreement is seen to be good. Each numerical simulation produces a large amount of information about the internal flow fields (e.g., air-exchange rate at any location, air-temperature distribution, surface heat-transfer coefficients).

SUMMARY AND CONCLUSIONS

A numerical convection computer program has been described that can be used to analyze natural and forced convection in buildings, pollutant migration, and heat removal by natural ventilation. The program can also predict convection coefficients for various flow configurations. These capabilities can be used for producing general algorithms for convective heat transfer in buildings.

The convection coefficients presently recommended by ASHRAE are internally inconsistent and in disagreement with recent research results. In particular, the transition to turbulence for convection in enclosures occurs at a Rayleigh number about one order of magnitude larger than is generally accepted. This means that a laminar flow correlation is applicable to a much wider range of Rayleigh numbers than previously recognized. More accurate correlations for convection coefficients are needed because they have a significant impact on predictions of building energy consumption.

Full-scale and small-scale experiments investigating interzone coupling show reasonable agreement. However, these results are necessarily of limited scope and therefore lack the needed generality upon which to base a meaningful descriptive algorithm. A comparison of Eqs. (2) and (4), (5) and (6) demonstrates that existing correlations for surface-to-air convection coefficients

**See earlier footnote associated with Eq. (2).

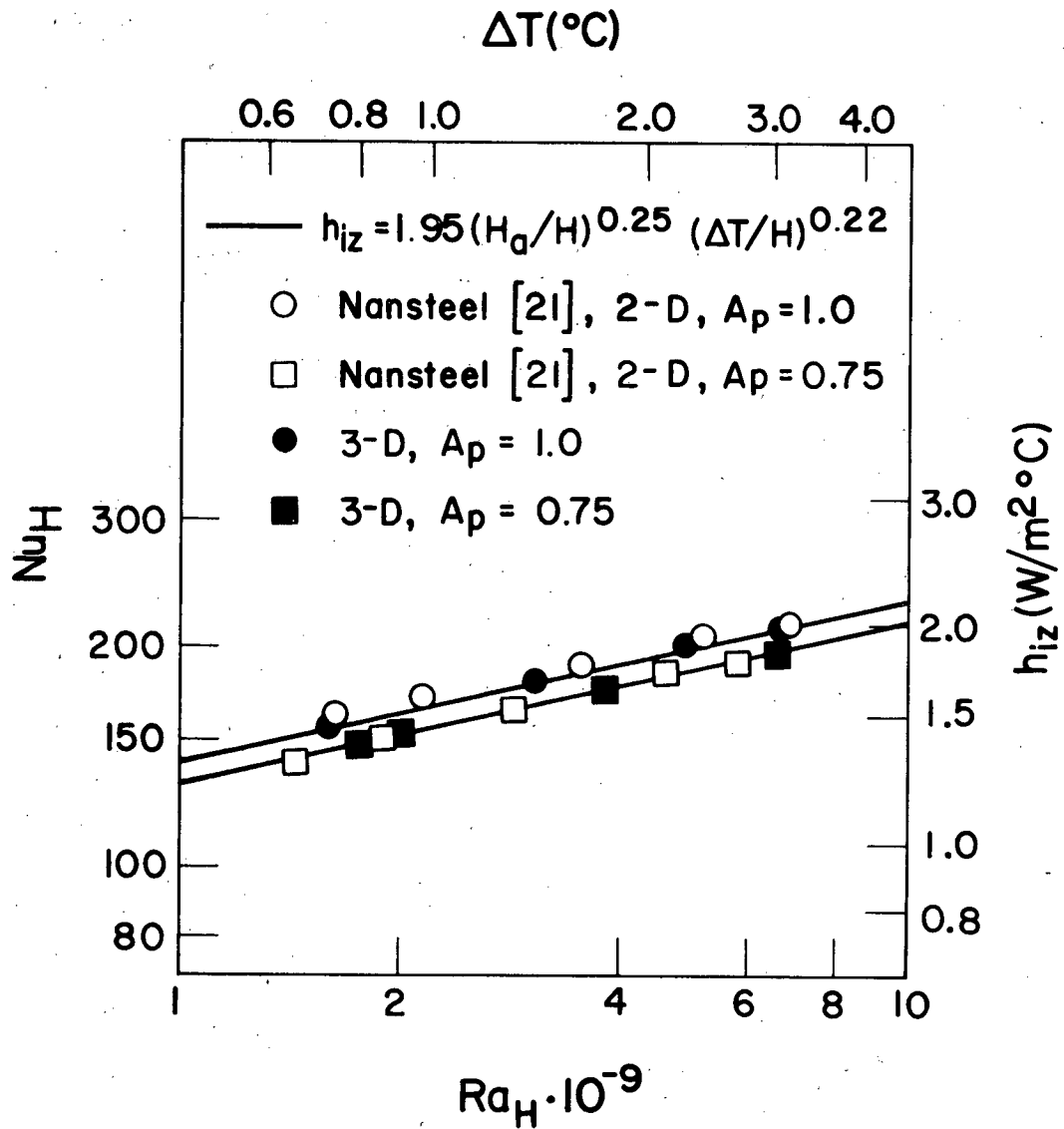

XBL 826-1405

Figure 11
Comparison of Two-Dimensional and
Three-Dimensional Interzone Heat Transfer
Results: $A = 0.5$, $Pr = 0.7$ (air)

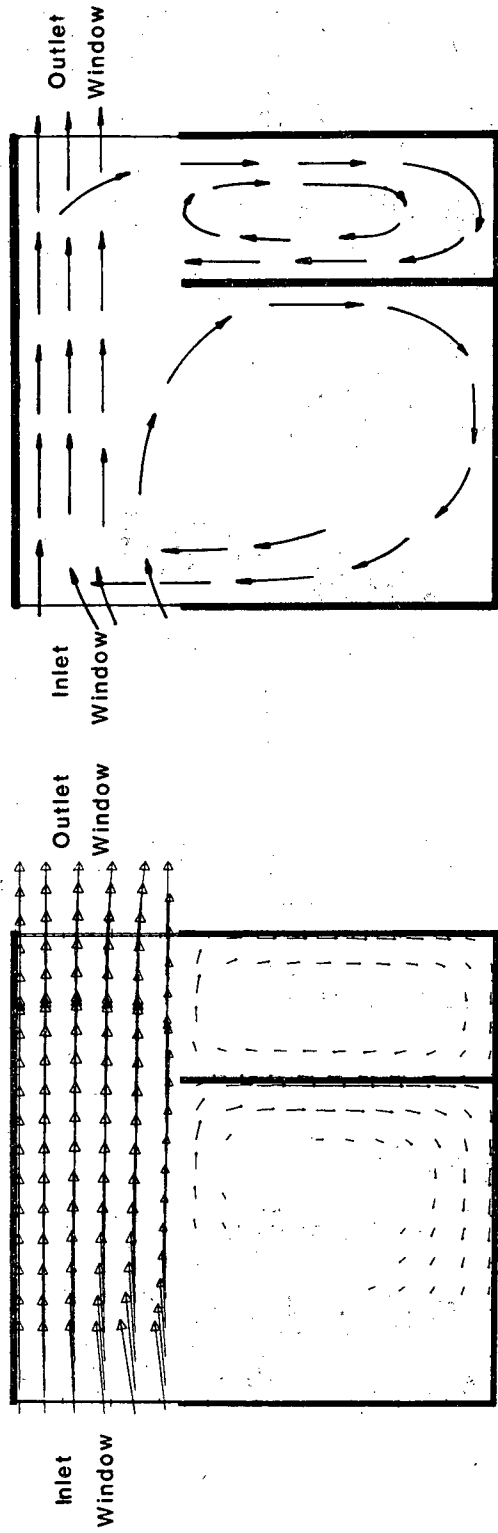

Plan View

a) Numerical Results

b) Wind Tunnel Visualization (34)

XBL 8210 - 1220

Figure 12

Air Velocity Vectors in a Square Room

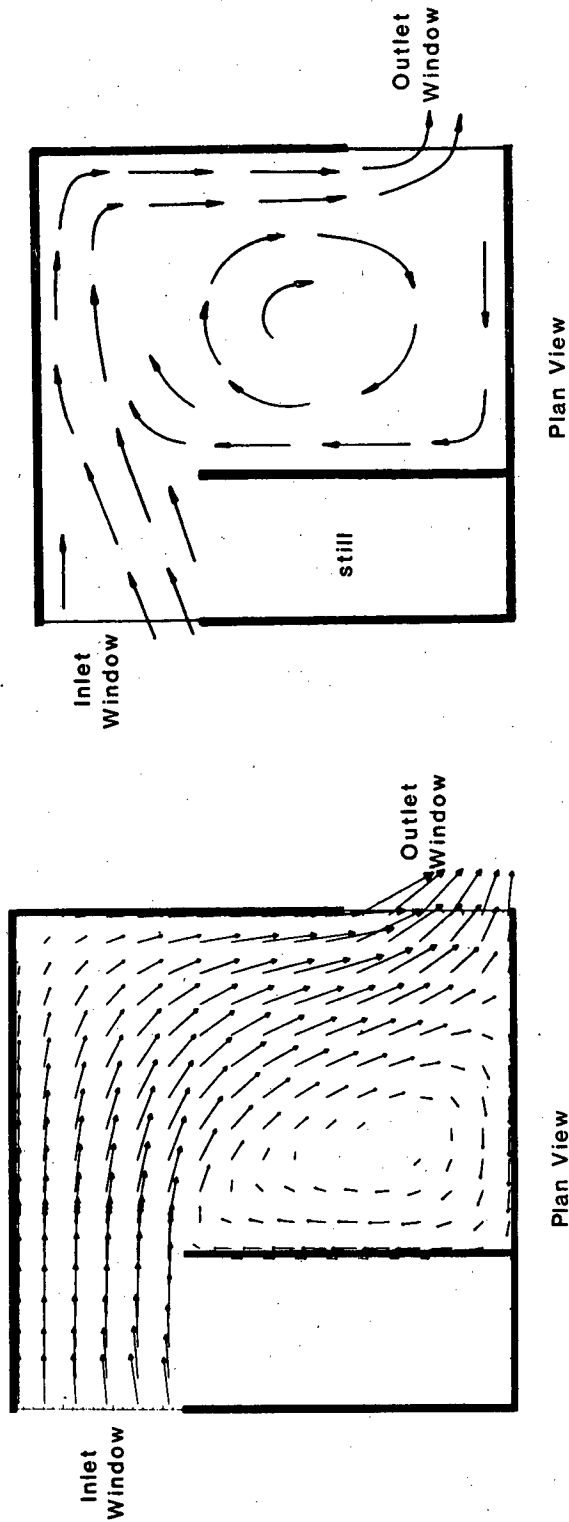

a) Numerical Results
b) Wind Tunnel Visualization (34)

XBL 8210 - 1221

Figure 13

Air Velocity Vectors in a Square Room

can not adequately represent interzone convection coefficients. As sufficient research results become available, interzone convection coefficients should be consistently and meaningfully defined, and accurate and general correlations should be developed.

Although convection coefficient correlations, such as Eq. (2) above, and interzone coupling correlations, such as Eqs. (4), (5) and (6), are being derived, there is a danger of overestimating their applicability to building energy calculations. One of the greatest limitations of the experiments discussed here is that they are based on a common boundary condition configuration typified by Fig. 7. There is a large number of other building configurations (e.g., see Figs. 14a and 14b) that are potentially of great interest to the building scientist. The extent to which the existing correlations can be extrapolated to these other configurations is unknown. These and other configurations could be examined in experiments of the type reported in Refs. 14, 21, and 22, but a well-done experiment requires a large amount of time, money, and equipment. Further, it is unrealistic to assume that all configurations of interest can be fully examined by experiment alone. Comprehensive building convection research should therefore include a detailed convection computer program that has been validated against a few carefully selected experiments. Such a program will not only allow a research effort to cover a much wider range of building configurations in a much shorter time and at less expense but will also be useful in identifying specific areas that are most suitable for experimental investigation.

In summary, most of the past research in natural convection has been oriented toward practical applications other than heat transfer in buildings. While the convection problem as it relates to building thermal performance clearly has not been solved in its entirety, research during the past few years has significantly advanced understanding of convection processes and has developed tools that will allow a vastly improved degree of quantification in the near future.

Future Research Recommendations

Both experimental research and computer modeling efforts are needed to improve the understanding of convective heat transfer processes in buildings. The selection and definition of research problems should address the requirements of current building energy analysis techniques.

Computer analysis should play a larger role in future research. Among the applications that should be performed in the

immediate future are:

- Examination of convection in a single-zone enclosure for a variety of boundary conditions in order to test the generality of Eq. (2) or to provide a data base from which a more general correlation for surface convection coefficients might be based.
- Examination of a wider variety of two-zone configurations and boundary condition combinations in order to test the generality of Eqs. (4), (5), and (6) and/or to provide a data base for a more general correlation for zone coupling.
- Validation of the analysis for velocity-driven flow and examination of natural and forced convection air-exchange rates in a building and the effect of ventilation on interzone coupling and surface convection heat transfer.

Additional experimental work is also needed before reliable convection process characterizations can be made available to the building energy analyst:

- Examination of zone coupling for vertical (multistory) configurations.
- Examination of single- and multizone configurations where dramatically different convective flow conditions can be expected in comparison to that depicted in Fig. 7. For example, a two-zone configuration with a warm floor and cool surfaces at both end walls would be typical of many building situations.
- Examination of mixed convection arising from the interaction of wind- and stack-driven infiltration and natural convection.

The combination of a few high-quality laboratory experiments supplemented by the results of analysis can, in the near future, place the understanding of convection processes in buildings on an equal footing with the understanding of conductive and radiative processes.

NOMENCLATURE

- A aspect ratio, = H/L
- A_p aperture height ratio, = H_a/H
- B enclosure breadth

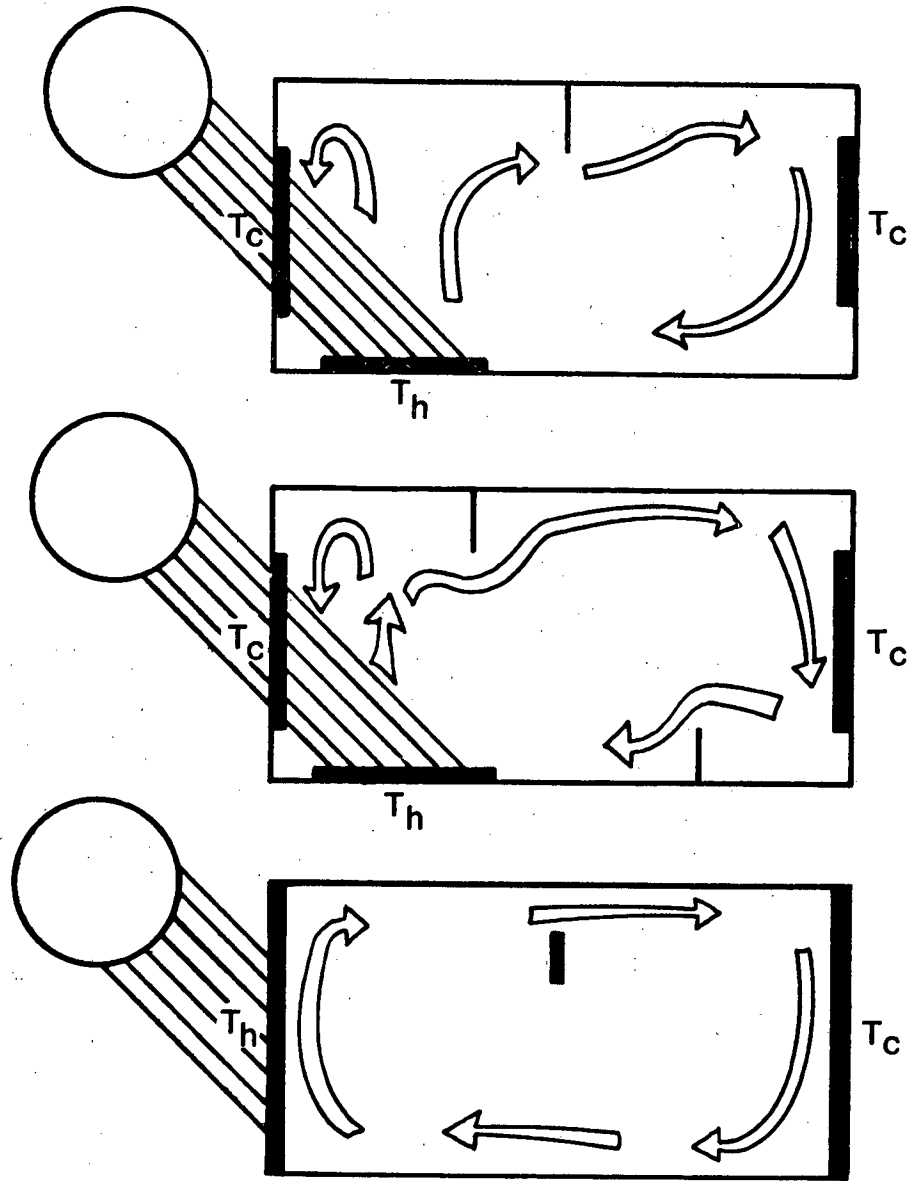

XBL 8210 - 1222

Figure 14a

**Convection Research
Unsolved Zone Coupling Problems**

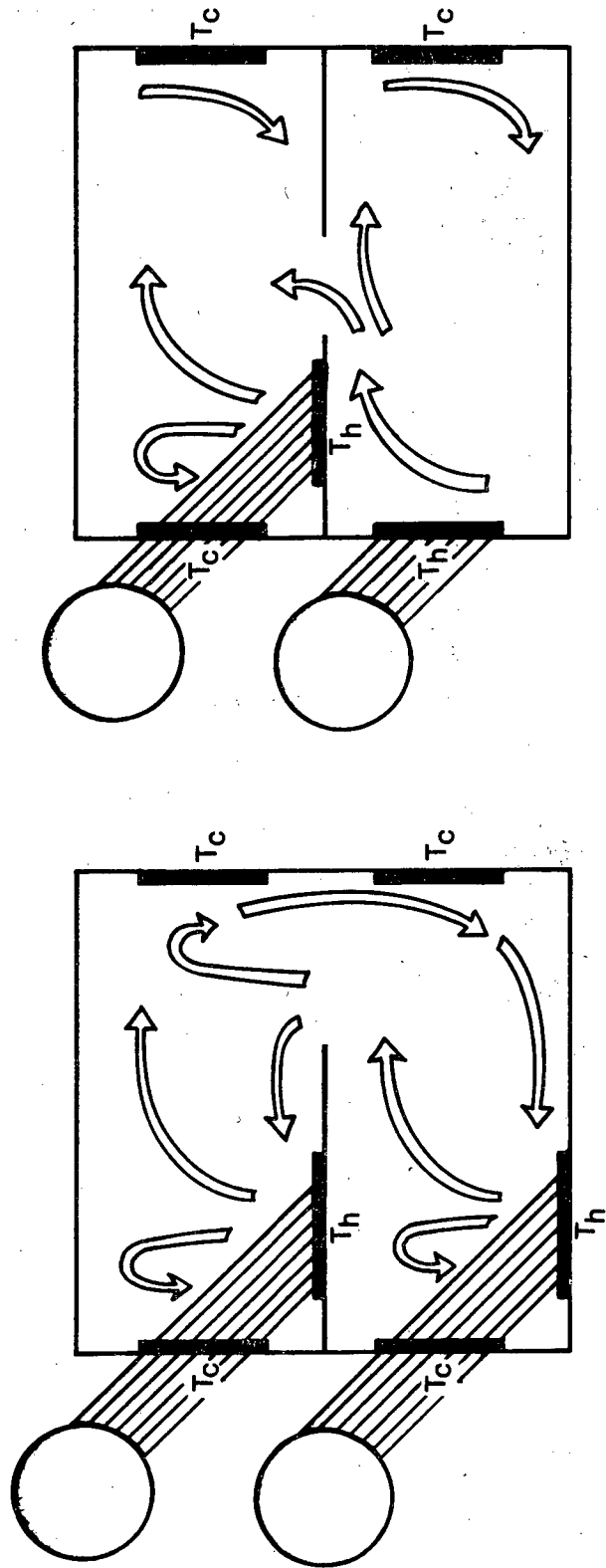

XBL 8210 - 1223

Figure 14b

Convection Research
Unsolved Multistory Configurations

g	acceleration due to gravity
H	enclosure height
H _a	height of central aperture
h	convection coefficient
h _{iz}	interzone convection coefficient
h _{sa}	surface-to-air convection coefficient
k	thermal conductivity
L	enclosure length
Nu _H	Nusselt number, = hH/k
Pr	Prandtl number, = ν/α
Ra _H	Rayleigh number, = gβΔTH ³ Pr/ν ²
T _c	average cold wall temperature
T _h	average hot wall temperature
\bar{T}_c	average cold zone air temperature
\bar{T}_h	average hot zone air temperature
α	thermal diffusivity
β	coefficient of thermal expansion
ΔT	= (T _h - T _c)/2
ΔT _{aa}	= \bar{T}_h - \bar{T}_c
ΔT _{sa}	surface-to-air temperature difference
ν	kinematic viscosity

REFERENCES

1. ASHRAE Handbook--1981 Fundamentals Volume.
2. M. Lokmanhekim, ed., Procedure for Determining Heating and Cooling Loads for Computerized Energy Calculations (New York: ASHRAE, 1976).
3. R.H. Heilman, "Surface Heat Transmission," Mechanical Engineering 51, (1929), p. 355.
4. F.B. Rowley and W.A. Eckley, "Surface Coefficients as Affected by Direction of Wind," Journal of ASHVE 3 (1931), p. 870.
5. F.B. Rowley, A.B. Algren, and J.L. Blackshaw, "Surface Conductance as Affected by Air Velocity, Temperature and Character of Surface," Journal of ASHVE 2 (1930), p. 501.
6. G.B. Wilkes and C.M.F. Peterson, "Radiation and Convection across Air Spaces in Frame Constructions," ASHVE Transactions 43 (1937), p. 351.
7. G.B. Wilkes and C.M.F. Peterson, "Radiation and Convection from Surfaces in Various Positions," ASHVE Transactions 44 (1938), p. 513.
8. J.P. Holman, Heat Transfer, (McGraw Hill, 1976) section 7-11, p. 255.
9. S. Ostrach, "Natural Convection in Enclosures," Advances in Heat Transfer, Vol. 8 (1972).
10. I. Catton, "Natural Convection in Enclosures," Proceedings, Sixth International Heat Transfer Conference, (Toronto, 1978).
11. H. Buchberg, "Sensitivity of Room Thermal Response to Inside Radiation Exchange and Surface Conductance," Building Science, 6 (1971), p. 133.
12. P.V. Nielsen, "Flow in Air Conditioned Rooms" (Lic.tech. [Ph.D.] thesis, Technical University of Denmark, 1974).
13. H. Honma, "Ventilation of Dwellings and Its Disturbances" (Ph.D. thesis, Royal Institute of Technology, Stockholm, Sweden, 1975).
14. D.D. Weber, "Similitude Modeling of Natural Convection Heat Transfer through an Aperture in Passive Solar Heated Buildings" (Ph.D. thesis, Department of Physics, University of Idaho, Moscow; also issued as Los Alamos Scientific Laboratory report LA-8385-T, 1980).
15. J. Lebrun and D. Marret, "Convection Exchange inside a Dwelling Room in Winter," Proceedings, 1976 Seminar of the International Center for Heat Mass Transfer, Heat Transfer and Turbulent Buoyant Convection (Hemisphere Publishing, 1977), pp. 417-427.
16. L. Laret, J. Lebrun, D. Marret, and P. Nusgens, "Study in an Experimental Room of the Efficiency of the Ventilation, Thermal Comfort, and Decontamination" (Report of the Thermodynamic Institute, University of Liege (Val-Benoit), B-4000, Liege,

- Belgium, 1980).
17. N.C. Markatos and M.R. Malin, "Mathematical Modeling of Buoyancy-Induced Smoke Flow in Enclosures," International Journal of Heat and Mass Transfer 25:1 (1982), pp. 63-75.
 18. R. Anderson and A. Bejan, "Heat Transfer through Single and Double Vertical Walls in Natural Convection: Theory and Experiment," International Journal of Heat and Mass Transfer 24:10 (1981), pp. 1611-1620.
 19. A.D. Gosman, P.V. Nielsen, A. Restivo, and J.H. Whitelaw, "The Flow Properties of Rooms with Small Ventilation Openings," Transactions of ASME, Journal of Fluids Engineering 102, (Sept. 1980), pp. 316-323.
 20. A. Gadgil, F. Bauman, and R. Kammerud, "Natural Convection in Passive Solar Buildings: Experiments, Analysis and Results," Passive Solar Journal, 1:1 (1982); also published as Lawrence Berkeley Laboratory report LBL-9297 Revised, 1981.
 21. M. Nansteel and R. Greif, "Natural Convection in Undivided and Partially Divided Rectangular Enclosures," Transactions of ASME, Journal of Heat Transfer, 103 (Nov. 1981), pp. 623-629.
 22. F. Bauman, A. Gadgil, R. Kammerud, and R. Greif, "Buoyancy Driven Convection in Rectangular Enclosures: Experimental Results and Numerical Calculations" (ASME paper No. 80-HT-66, presented at the 19th National Heat Transfer Conference, 27-30 July 1980, Orlando, FL; also issued as Lawrence Berkeley Laboratory Report LBL-10257, 1980).
 23. S.W. Churchill and R. Usagi, "A General Expression for the Correlation of Rates of Transfer and Other Phenomena," AIChE Journal 18:6 (1972), pp. 1121-1128.
 24. R. Cheesewright, "Turbulent Natural Convection from a Vertical Plane Surface," Transactions of ASME, Journal of Heat Transfer, February 1968, pp. 1-8.
 25. A. Gadgil, "On Convective Heat Transfer in Building Energy Analysis" (Ph.D. Thesis, Department of Physics, University of California, Berkeley (1979); also issued as Lawrence Berkeley Laboratory Report LBL-10900, 1980).
 26. G. Shiralkar, A. Gadgil, and C.L. Tien, "High Rayleigh Number Convection in Shallow Enclosures with Different End Temperatures," International Journal of Heat and Mass Transfer 24:10 (1981), pp. 1621-1629.
 27. J. Tichy and A. Gadgil, "High Rayleigh Number Laminar Convection in Low Aspect Ratio Enclosures with Adiabatic Horizontal Walls and Differentially Heated Vertical Walls," Transactions of ASME, Journal of Heat Transfer 104 (1982), pp. 103-110.
 28. W.L. Carroll, W. Place, and B. Curtis, "A Passive Solar Residential Prototype for Energy Modeling" (Lawrence Berkeley Laboratory Report LBL-10783, to be published).
 29. W.G. Brown and K.R. Solvason, "Natural Convection through Rectangular Openings in Partitions. Part I: Vertical Partitions," International Journal of Heat and Mass Transfer 5 (1962), pp. 859-868.
 30. B.H. Shaw, "Heat and Mass Transfer by Natural Convection and Combined Natural Convection and Forced Air Flow through Large Rectangular Openings in a Vertical Partition" Proceedings, International Mechanical Engineering Conference on Heat and Mass Transfer by Combined Forced and Natural Convection, Manchester, Sept. 1971, vol. C.819 (1972), pp. 31-39.
 31. D.D. Weber and R.J. Kearney, "Natural Convective Heat Transfer through an Aperture in Passive Solar Heated Buildings," Proceedings, 5th National Passive Solar Conference, Amherst, Mass., Oct. 19-26, 1980, pp. 1037-1041.
 32. M.H. Sherman, D.T. Grimsrud, P.E. Condon, and B.V. Smith, "Air Infiltration Measurement Techniques," Proceedings, First International Energy Agency Symposium of the Air Infiltration Centre, Windsor, England (1980), also issued as Lawrence Berkeley Laboratory Report LBL-10705 (1980).
 33. M. Sherman, "Air Infiltration in Buildings" (Ph.D. thesis, Department of Physics, UC Berkeley, 1980, also published as Lawrence Berkeley Laboratory report LBL-10712, 1980).
 34. S. Chandra and P. Fairey, "Passive Cooling by Natural Ventilation: A Literature Review" (contract report No. FSEC-CR-81-27(TT), prepared for DOE Contract DE-AC03-80CS11510, Nov. 10, 1981).
 35. B. Givoni, Man, Climate and Architecture (London: Elsevier Publishing Co., 1969).

APPENDIX A:

CORRELATION TO DETERMINE THE EFFECT OF PRANDTL NUMBER ON
NATURAL CONVECTIVE HEAT TRANSFER*

INTRODUCTION

Natural convective heat transfer in a two-dimensional rectangular enclosure was investigated numerically for a range of Rayleigh numbers ($1.3 \times 10^7 \leq Ra^H \leq 3.4 \times 10^9$), and for a range of Prandtl numbers ($0.3 \leq Pr \leq 100$). The enclosure, of aspect ratio $A = 1/2$, has adiabatic horizontal walls and isothermal vertical walls which are held at different temperatures. Fluid flow was assumed to be laminar. The numerical results were used to obtain a Nusselt number correlation for a range of Rayleigh and Prandtl number values.

COMPUTATIONAL TECHNIQUE

The governing equations for steady state flow of a Boussinesq fluid are:

$$\text{Continuity: } \nabla \cdot \vec{V} = 0$$

$$\text{Momentum: } (\vec{V} \cdot \nabla) \vec{V} = \nabla^2 \vec{V} - \nabla P + Gr_H \theta \hat{j}$$

$$\text{Energy: } (\vec{V} \cdot \nabla) \theta = (1/Pr) \nabla^2 \theta$$

where \hat{j} is the unit vector in the direction of gravity, and θ and \vec{V} represent the fluid temperature and velocity at a position \vec{X} . The variables θ , \vec{V} and \vec{X} are nondimensionalized with respective scales of ΔT (the temperature difference between the vertical walls), ν/H

*This appendix summarizes the results presented in the article referenced in footnote 4.

(the ratio of the fluid viscosity to the enclosure height) and H (the enclosure height). The thermal boundary conditions for vertical (end)walls are:

$$X = 0 \Rightarrow \theta = 0.5$$

$$X = \frac{1}{A} \Rightarrow \theta = -0.5$$

and for horizontal walls:

$$\left. \begin{array}{l} Y = 0 \\ Y = 1 \end{array} \right\} \Rightarrow \frac{d\theta}{dY} = 0.0$$

The velocity boundary conditions assume no slip ($\vec{V} = 0$) on all boundaries.

The above equations were solved numerically for ($1.3 \times 10^7 \leq Ra_H \leq 3.4 \times 10^9$) and ($0.3 \leq Pr \leq 100$). The numerical solution was obtained with a finite difference code¹ based on the Patankar-Spalding differencing scheme². A variable-spaced grid of 31 X 37 nodes was used. A small grid spacing ($X = 0.002$) was used near the enclosure walls, resulting in excellent resolution of the boundary layers; relatively sparse grid spacing was used in the central regions of the enclosure. Typically each simulation required 700 seconds of execution time on a CDC 7600 computer. Simulations were terminated when the fractional residues of the velocity and temperature fields are less than 10^{-5} .

¹A. Gadgil, "On Convective Heat Transfer in Building Energy Analysis," (Ph.D Thesis, Department of Physics, University of California, Berkeley (1979); also issued as Lawrence Berkeley Laboratory Report LBL-10900, 1980.

²S.V. Patankar and D.B. Spalding, Imperial College, Mechanical Engineering Department Report EF/TN/A/46 (June 1972).

RESULTS AND DISCUSSION

Numerical results for the Nusselt number are compared with the experimentally obtained values³ for an enclosure with aspect ratio = 1/2, in Fig. A-1. In each of these simulations, the Prandtl number of the fluid was assumed constant and equal to its value at a temperature midway between the end wall temperatures. The horizontal walls were assumed to be perfectly adiabatic. Agreement with the experimentally measured values is seen to be very good.

Numerically obtained results for Ra_H and Pr values in the ranges $1.3 \times 10^7 \leq Ra_H \leq 3.4 \times 10^9$ and $0.3 \leq Pr \leq 100$ for an enclosure of aspect ratio $A = 1/2$, are shown in Table A-1. This data is plotted in two different ways in Fig. A-2. The abscissa in each case is $\log_{10} Pr$; the ordinate is in one case the group $\log_{10} (NuRa^{-0.25})$ and in the second case the group $\log_{10} (NuRa_H^{-p})$ where the exponent p is given by:

$$p = 0.25 - 0.40 Ra^{-0.22}$$

This particular form of the exponent p was determined empirically from the data of Table A-1 to account for the asymptotic approach of the boundary layers on the end walls to those on free-standing vertical flat plates⁴ at high values of Ra_H .

Figure A-2 shows that there is substantial scatter in the data if plotted using the group $NuRa_H^{-1/4}$. However, for the the range of Ra_H

³M.W. Nansteel and R. Greif, "Natural Convection in Undivided and Partially Divided Rectangular Enclosures," Transactions of ASME, Journal of Heat Transfer, 103 (Nov. 1981), pp. 623-629.

⁴A. Gadgil and M.W. Nansteel, "Prandtl Number Dependence of Natural Convective Heat Transfer in an Enclosure at High Rayleigh Numbers," submitted for presentation at the ASME-AIChE Joint Heat Transfer Conference, July 24-28, 1983, Seattle, WA. Also Lawrence Berkeley Laboratory Report LBL-15307, preprint.

and Pr values investigated, the numerical data collapse reasonably well onto a single curve when plotted using the group $NuRa_H^P$. This suggests correlating the heat transfer data (for a fixed aspect ratio) with a relation of the form:

$$Nu = f(Pr)Ra_H^P .$$

The Prandtl number dependence is contained in the function $f(Pr)$, which is here taken in the form suggested by Churchill and Usagi⁵, i.e.,

$$f(Pr) = B \left[1 + (C Pr^{-1/4})^n \right]^{-1/n} ,$$

where B, C, and n are constants. The parameter values were obtained by minimizing the RMS deviation between the above equation and the group $NuRa_H^P$:

$$B = 0.363$$

$$C = 0.63$$

$$n = 3.5$$

The resulting correlation is given by:

$$Nu = 0.363 \left[1 + (0.63 Pr^{-1/4})^{3.5} \right]^{-1/3.5} \cdot Ra_H^{(0.25 - 0.40 Ra_H^{-0.22})}$$

This expression yields an RMS deviation from the Nusselt number data of Table A-1 of 0.55 and is plotted in Fig. A-2 as the dashed curve. It is noted, in conclusion, that this correlation displays the limiting behavior suggested by Le Fevre⁶ for isothermal vertical

⁵S.W. Churchill and R. Usagi, "A General Expression for the Correlation of Rates of Transfer and Other Phenomena," AICHE Journal, 18:6 (1972), pp. 1121-1128.

⁶E.J. Le Fevre, "Laminar Free Convection from a Vertical Plane Surface," in Proceedings, Ninth International Congress on Applied Mechanics, Brussels, 4, p. 168 (1956).

plates, e.g., $f(\text{Pr})$ approaches $\text{Pr}^{1/4}$ as Pr tends to zero and approaches a constant as the Prandtl number tends to infinity.

NOMENCLATURE

B dimensionless constant

C dimensionless constant

$f(\text{Pr})$ dimensionless function of Pr

$\text{Gr}_H = g\beta\Delta T H^3 / \nu^2$ Grashof number based on height

g acceleration due to gravity

n dimensionless constant

P pressure (nondimensionalized with $\rho\nu^2/H^2$)

p global power dependence of Nu on Ra

T temperature ($^{\circ}\text{C}$)

T_c average cold wall temperature

T_h average hot wall temperature

V fluid velocity (nondimensionalized with ν/H)

X horizontal distance (nondimensionalized with H)

Y vertical distance (nondimensionalized with H)

Greek symbols

θ dimensionless temperature, $= (T - (T_h + T_c)/2) / \Delta T$

ρ fluid density, $= (\text{Kg}/\text{m}^3)$

β coefficient of thermal expansion

ν kinematic viscosity

$\Delta T = (T_h - T_c) / 2$

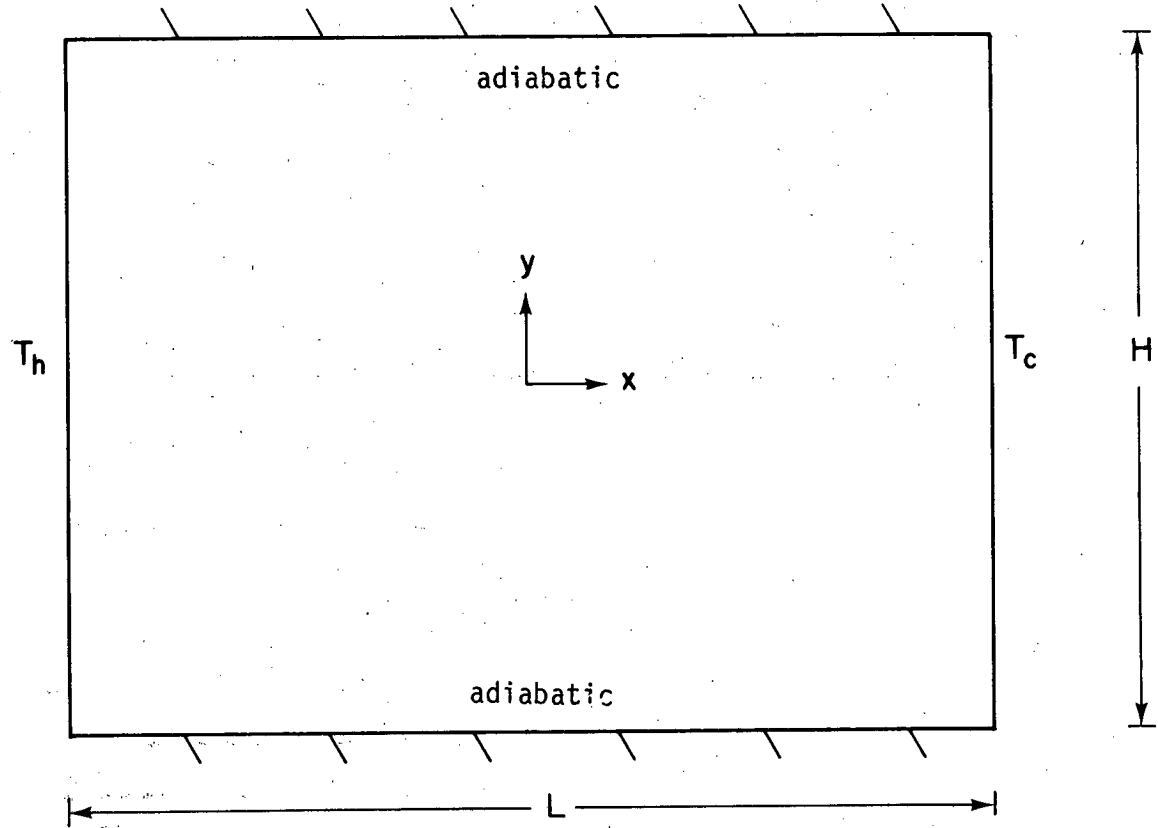

XBL 827 - 918

Figure A-1. Schematic Diagram of Two-Dimensional Enclosure

Table A-1. Aspect Ratio A = 1/2

Pr	Nu		
	Ra = 1.25 x 10 ⁷	Ra = 2.5 x 10 ⁸	Ra = 3.4 x 10 ⁹
0.32	16.08	35.47	72.77
1.0	16.93	38.10	78.43
3.16	18.01	40.03	81.17
10.0	18.08	40.29	81.55
31.62	18.21	40.33	81.64
100.0	17.94	40.81	82.11

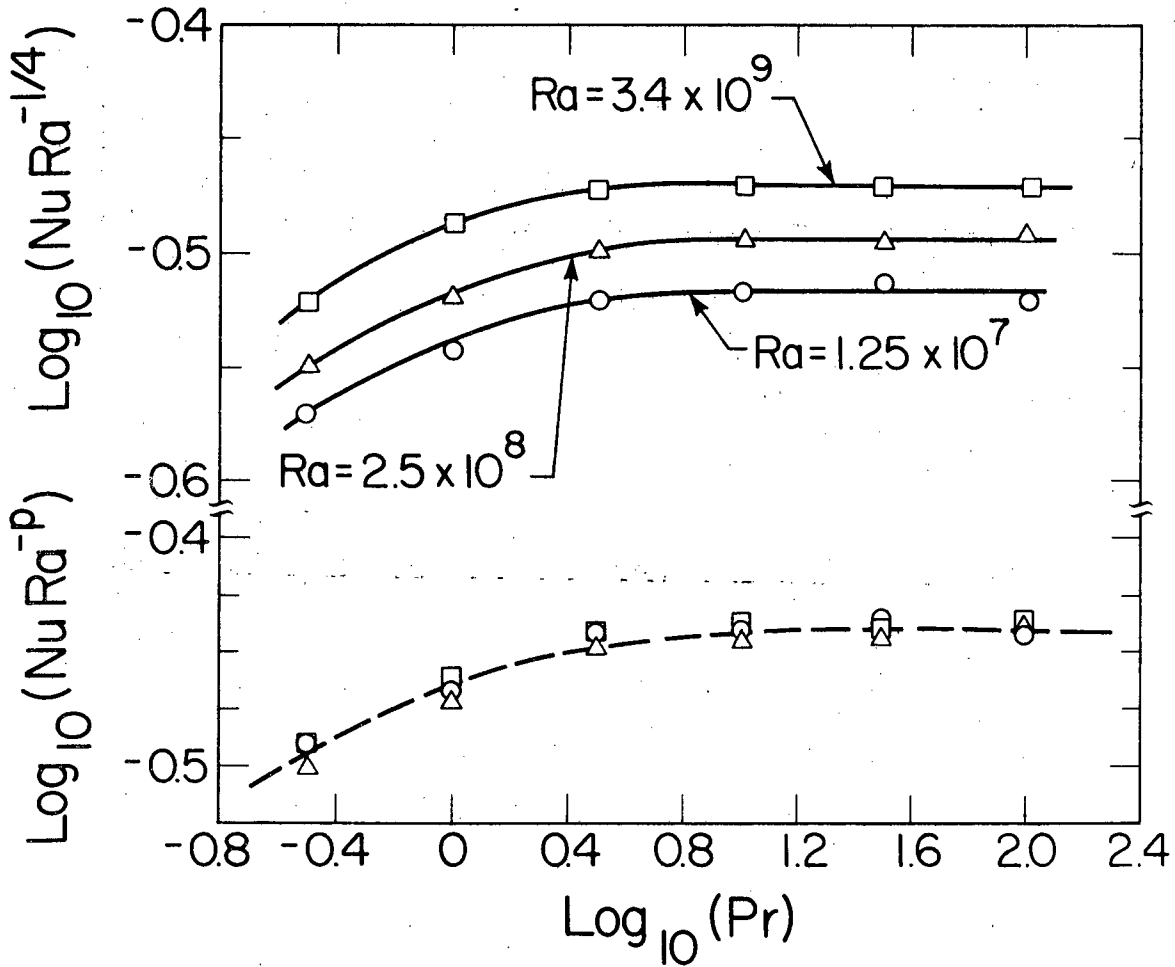

XBL 831-1036

Figure A-2. Dependence of Nu on Pr and Ra for A = 1/2

This report was done with support from the Department of Energy. Any conclusions or opinions expressed in this report represent solely those of the author(s) and not necessarily those of The Regents of the University of California, the Lawrence Berkeley Laboratory or the Department of Energy.

Reference to a company or product name does not imply approval or recommendation of the product by the University of California or the U.S. Department of Energy to the exclusion of others that may be suitable.

TECHNICAL INFORMATION DEPARTMENT
LAWRENCE BERKELEY LABORATORY
UNIVERSITY OF CALIFORNIA
BERKELEY, CALIFORNIA 94720