

# Lawrence Berkeley National Laboratory

## Lawrence Berkeley National Laboratory

### **Title**

High pressure HCl conversion of cellulose to glucose

### **Permalink**

<https://escholarship.org/uc/item/4ds4x3rk>

### **Authors**

Antonoplis, Robert Alexander

Blanch, Harvey W.

Wilke, Charles R.

### **Publication Date**

1981-08-01

c.2



# Lawrence Berkeley Laboratory

UNIVERSITY OF CALIFORNIA

## ENERGY & ENVIRONMENT DIVISION

RECEIVED  
LAWRENCE  
BERKELEY LABORATORY

JUL 15 1982

LIBRARY AND  
DOCUMENTS SECTION

HIGH PRESSURE HCl CONVERSION OF CELLULOSE  
TO GLUCOSE

Robert Alexander Antonoplis\*, Harvey W. Blanch,  
and Charles R. Wilke  
(\*M.S. thesis)

August 1981

### TWO-WEEK LOAN COPY

*This is a Library Circulating Copy  
which may be borrowed for two weeks.  
For a personal retention copy, call  
Tech. Info. Division, Ext. 6782.*

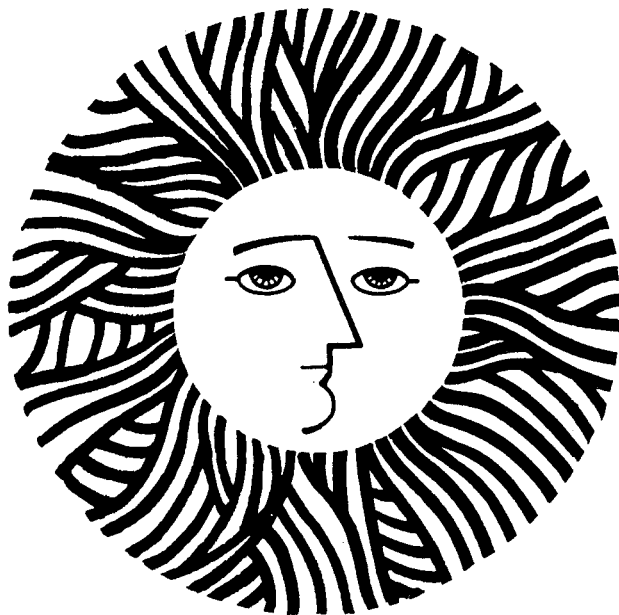

LBL-14221

c.2

HIGH PRESSURE HCl CONVERSION OF CELLULOSE TO GLUCOSE

Robert Alexander Antonoplis<sup>\*</sup>,  
Harvey W. Blanch and Charles R. Wilke

<sup>\*</sup>M.S. Thesis

August 1981

Energy and Environment Division  
Lawrence Berkeley Laboratory  
University of California  
Berkeley, CA 94720

This work was supported by the Director, Office of Energy Research,  
Office of Basic Energy Sciences, Division of Chemical Science  
Processes and Techniques Branch of the U.S. Department of Energy  
under Contract Number DE-AC03-76SF00098.

## Abstract

The production of ethanol from glucose by means of fermentation represents a potential long-range alternative to oil for use as a transportation fuel. Today's rising oil prices and the dwindling world supply of oil have made other fuels, such as ethanol, attractive alternatives. It has been shown that automobiles can operate, with minor alterations, on a 10% ethanol-gasoline mixture popularly known as gasohol.

Wood has long been known as a potential source of glucose. Glucose may be obtained from wood following acid hydrolysis. In this research, it was found that saturating wood particles with HCl gas under pressure was an effective pretreatment before subjecting the wood to dilute acid hydrolysis. The pretreatment is necessary because of the tight lattice structure of cellulose, which inhibits dilute acid hydrolysis. HCl gas makes the cellulose more susceptible to hydrolysis and the glucose yield is doubled when dilute acid hydrolysis is preceded by HCl saturation at high pressure.

The saturation was most effectively performed in a fluidized bed reactor, with pure HCl gas fluidizing equal volumes of ground wood and inert particles. The fluidized bed effectively dissipated the large amount of heat released upon HCl absorption into the wood. Batch reaction times of

one hour at 314.7 p.s.i.a. gave glucose yields of 80% and xylose yields of 95% after dilute acid hydrolysis. A non-catalytic gas-solid reaction model, with gas diffusing through the solid limiting the reaction rate, was found to describe the HCl-wood reaction in the fluidized bed.

HCl was found to form a stable adduct with the lignin residue in the wood, in a ratio of 3.33 moles per mole of lignin monomer. This resulted in a loss of 0.1453 lb. of HCl per pound of wood. The adduct was broken upon the addition of water.

A process design and economic evaluation for a plant to produce 214 tons per day of glucose from air-dried ground Populus tristi gave an estimated glucose cost of 15.14 cents per pound. This would correspond to \$2.54 per gallon of ethanol if the glucose were fermented. Key factors contributing to the cost of glucose production were unrecovered HCl, which contributed 5.70 cents per pound of glucose, and the cost of wood, which at \$25 per ton contributed 4.17 cents per pound.

## Acknowledgements

I would like to thank Dr. Charles R. Wilke and Dr. Harvey W. Blanch for their assistance and guidance throughout my tenure at the University of California. I would also like to thank Aldo Sciamanna and Warren Harnden for their invaluable expert technical assistance. Finally, I would like to thank my parents, Mr. and Mrs. Robert G. Antonoplis, for all their love and support, and I dedicate this work to them.

This work was supported by the Director, Office for Energy Research Office of Basic Energy Sciences, Division of Chemical Science Processes and Techniques Branch of the U.S. Department of Energy under Contract DE-ACO3-76SF00098.

## Table of Contents

	<u>Page</u>
1. Introduction and Background	1
1.1 Structure of Wood	1
1.2 The Chemical Composition of Wood	5
1.3 Theory of Cellulose Acid Hydrolysis	12
1.4 Previous Work on Acid Hydrolysis of Wood	21
1.4.1 Processes Using Concentrated Sulfuric Acid	23
1.4.2 Dilute Sulfuric Acid Processes	24
1.4.3 Processes Using Concentrated HCl	26
1.4.4 Processes Using HCl Gas	30
1.4.5 Previous Work with HCl Gas at Elevated Pressures	31
1.4.6 Hydrolysis Research with Other Hydrogen Halides	34
References	36
2.1 Experimental Procedures	38
2.1.1 D.N.S. Determination of Sugar Concentration	38
2.1.2 Assay by High Pressure Liquid Chromatography	39
2.1.3 Glucose Assay by G.O.P.	39
2.1.4 Chloride Ion Assay	40
2.2 Experimental Apparatus and Materials	40
2.2.1 Reagents and Reactants	40
2.2.2 Apparatus for High Pressure HCl Reaction	41
2.2.3 Other Apparatus	42

	<u>Page</u>
3.1 Experimental Results and Discussion	43
3.1.1 High Temperature Dilute Acid Hydrolysis	43
3.1.2 Effect of Wood Moisture Content on Conversion	44
3.1.3 Effect of Moisture Content, Glass Beads, and Fluidization on the Dissipation of Heat Released by HCl Absorption	46
3.1.4 Effect of HCl Partial on Conversion	49
3.1.5 Factors Affecting Fluidization of Glass Bead-Wood Mixtures	49
3.1.6 Analysis of Wood Saturation by HCl Gas by a Pressurized Fluidized Bed	51
3.1.7 Effect of Vacuum on Retention of HCl in Wood	58
References	62
4. Process Economics and Evaluation	63
4.1 Process Description	63
4.2 Process Economics	68
References	78
Summary and Conclusions	79
Appendix	82
References	92



## 1. Introduction and Background

### 1.1 Structure of Wood

Woods are divided into two groups: hardwoods, which are mostly deciduous trees, and softwoods, which are largely comprised of evergreen trees. Softwoods are also known as conifers, since all native species of softwoods bear cones of some type. It should be noted that the terms hardwood and softwood have no direct connotation to the hardness of the wood; some hardwoods, such as cottonwood, are softer than white pine and other softwoods.

The bulk of wood consists of dead cells, without protoplasm or nuclei. These dead cells account for 90-95% of the wood mass. All the cells in wood are affixed firmly in place by a thin layer, the middle lamella. The cells in hardwood trees are shorter by a factor of three than the cells in conifers.

The cell walls are composed of carbohydrates, which account for roughly 65-75% or more of the wood mass. Hydrolysis of the total carbohydrate fraction yields mainly simple sugars, primarily glucose. In softwoods, mannose and xylose are next in quantity after glucose. Hardwood hydrolyzates, in addition to containing 55-75% glucose, are relatively rich in xylose (20-40%), with minor amounts of mannose, galactose, and arabinose.

The main substance in the cell walls is cellulose, chains of glucose monomers joined through 1,4- $\beta$ -glucosidic linkages. Figure 1 shows the structure of cellulose. The structure of the cellulose fibers in the cell walls is complex, but it can be partially described as comprised of chains of several thousand glucose monomers, displaying a full tridimensional degree of ordering (the crystalline cellulose), surrounded by unordered cellulose fibers (the amorphous cellulose). Crystalline cellulose is resistant to chemical attack, while the amorphous cellulose hydrolyzes much more easily. The amorphous fraction is sometimes referred to as the "easily hydrolyzable" cellulose or as the hemicellulose. The amorphous cellulose has been estimated to comprise about 22% of the total amount of cellulose.

The middle lamella, which cements the cells together, is largely composed of lignin. Lignin is also found in the outer cell walls. Lignin is a complex polymer, based primarily on a substituted phenyl propane unit. Lignin is felt to be formed enzymatically inside the tree from three main precursors: trans-coniferyl, trans-sinapyl, and trans-paracoumaryl alcohol. These compounds are shown in Figure 2. Lignin is a highly complex molecule whose structure has not been fully elucidated. It is known that hardwood and softwood lignins differ, and it is felt that each tree species has its own characteristic lignin.

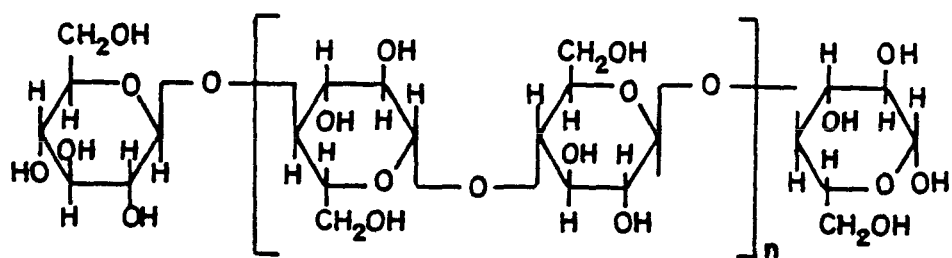

XBL 817- 6171

Figure 1. The Structure of Cellulose.

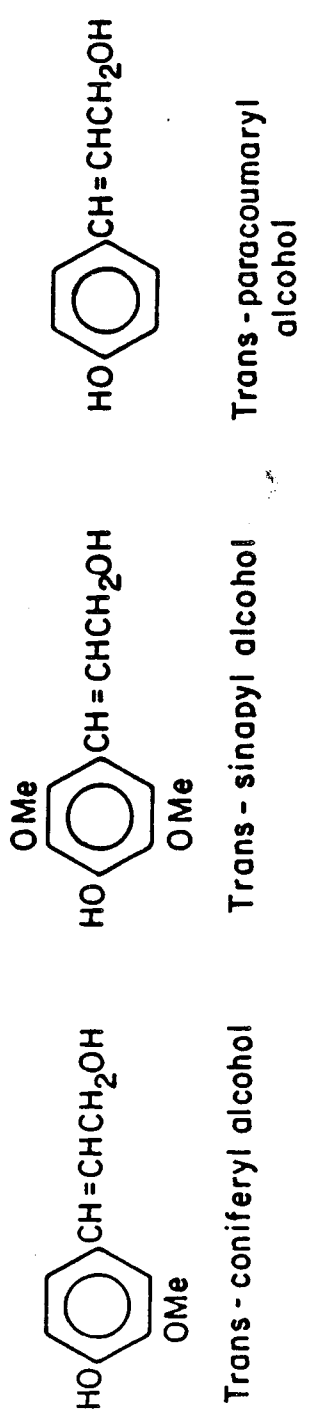

XBL 817-6172

Figure 2. Lignin Precursors

The lignin molecules show no orderly deposition in the middle lamella. About 90% of the total lignin is found in the middle lamella, with the remainder deposited in the outer cell walls. The cell walls of hardwoods are less lignified than the cell walls of conifers. Lignin is highly resistant to dilute acid hydrolysis, while this readily hydrolyzes cellulose. Lignin comprises about 30% of the total wood weight.

## 1.2 The Chemical Composition of Wood

Completely dry wood, surprisingly, has a very similar elementary composition for all species. Table 1 shows an elemental breakdown for several species of trees:

Species	C	H	O
Oak	49.4	6.1	44.5
Beech	48.5	6.3	45.2
Birch	48.6	6.4	45.0
Maple	49.8	6.3	43.9
Elm	50.2	6.4	43.4
Ash	49.4	6.1	44.5
Lime	49.4	6.9	43.7
Poplar	49.7	6.3	44.0
Pine	49.6	6.4	44.0
Larch	50.1	6.3	43.6

Table 1: Elemental Composition of Trees (2)

Wood contains about 49.5% carbon, 44.2% oxygen, and 6.3% hydrogen. There are other elements present in trace amounts in wood as well. Between 0.2 and 1% of wood is ash, minerals extracted from the soil and carried upward through the tree by water. Between 10-25% of the ash is water soluble, with sodium and potassium carbonate comprising the bulk. In fact, potash was once produced on an industrial basis from wood. The insoluble ash is mainly comprised of oxides. Table 2 gives a breakdown of the insoluble ash content for several trees:

Table 2  
Ash content in % of air-dry wood (2)

Species	Total ash %	Composition of ash						
		K <sub>2</sub> O	Na <sub>2</sub> O	MgO	CaO	P <sub>2</sub> O <sub>5</sub>	SO <sub>3</sub>	SiO <sub>2</sub>
Beech	0.55	0.09	0.02	0.06	0.31	0.03	0.01	0.03
Birch	0.26	0.03	0.02	0.02	0.15	0.02	0.01	0.01
Larch	0.27	0.04	0.02	0.07	0.07	0.03	0.01	0.01
Oak	0.51	0.05	0.02	0.02	0.37	0.03	0.01	0.01
Pine	0.26	0.04	0.01	0.03	0.14	0.02	0.01	0.04

Ash and the other chemical constituents of wood are not distributed evenly throughout the tree. It has been found that leaves, bark, and the lower parts of roots are substantially higher in ash content. This is because these

are the parts of the tree most active in the nutrition assimilation process, and these would have a higher concentration of material extracted from the soil. It is hardest to obtain hydrolyzable sugars from these parts of the tree. Table 3 gives an elemental breakdown for the various parts of a mature tree:

Table 3  
Elementary Composition of a 30 year old  
Pear Tree (in %) (2)

Part of Tree	C	H	O + N	Ash
Leaves .....	45.01	6.97	40.91	7.11
Tops of branches:				
bark .....	52.50	7.31	36.73	3.46
wood .....	48.35	6.60	44.73	0.30
Middle part of branches:				
bark .....	48.85	6.34	41.12	3.68
wood .....	49.90	6.61	43.35	0.13
Lower part of branches:				
bark .....	46.87	5.57	44.65	2.90
wood .....	48.00	6.47	45.17	0.35
Trunk				
bark .....	46.27	5.93	44.75	2.66
wood .....	48.92	6.46	44.32	0.30
Upper part of roots:				
bark .....	49.08	6.02	44.76	1.13
wood .....	49.32	6.29	44.11	0.23
Middle part of roots				
bark .....	50.37	6.07	41.92	1.64
wood .....	47.39	6.26	46.12	0.22
Lower part of roots	45.06	5.04	43.50	5.01

The other main chemical constituents in wood are known as the organic extractive materials. These compounds are numerous and almost impossible to list in their entirety. The classes of compounds under which they can be included are aliphatic and aromatic acids and hydrocarbons, terpenes, phenols and other alcohols, aldehydes, ketones, quinones, esters, and protein residues from the cell cytoplasm. Some woods also contain essential oils, fixed oils, sterols, tannins, cyclotols, and alkaloids.

Table 4 gives the chemical compound breakdown for Populus tristis, the wood that is used in the large-scale plant design for sugar production described later. This wood is 56% carbohydrate, of which 0.64 is glucan. Upon hydrolysis, one pound of Populus tristis would theoretically yield 0.4 lb. of glucose. 30% of the wood is lignin, with 8% being the above described extractive materials and 1% being ash. It should be noted that 5% of the wood is unaccounted for in the analysis.

One very important property of wood is its ability to readily absorb water. Dry wood is very hygroscopic; its hygroscopicity is comparable to sulfuric acid. The amount of moisture absorbed by wood is solely a function of the temperature and the relative humidity of the air. Figure 3 shows the relationship between temperature, relative humidity, and the equilibrium moisture content of



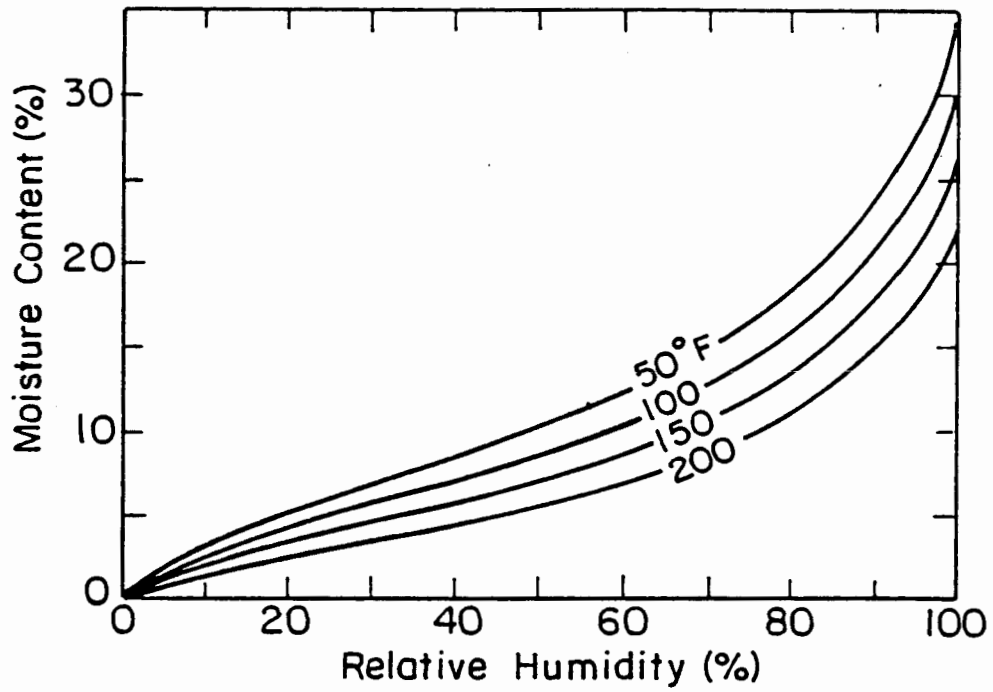

XBL817-6165

Figure 3. Moisture Content of Wood vs. Relative Humidity at Various Drying Temperatures.

Table 4

Chemical Breakdown of Populus Tristi

(%) Carbohydrate	(%) Sugar Equivalent
36 Glucan	40 Glucose
11 Xylan	13 Xylose
2 Arabinan	2 Arabinose
7 Other Carbohydrate	8 Other Carbohydrate
56 $\Sigma$ Carbohydrate	63 $\Sigma$ Sugar Equivalent
20 Lignin	
1 Ash	
6 Azeotropic Benzene/Alcohol Extractives	
2 Other Acid Insolubles (Organic)	
10 Acid Soluble Lignin	
5 By Difference (Material Balance)	

wood. (3) The amount of organic extractives has an effect on the amount of moisture absorbed. Woods with a higher amount of those compounds tend to absorb lesser amounts of moisture.

The moisture in green wood is found in the cell cavities, as well as absorbed in the cell walls. When wood is dried and in equilibrium with the surrounding air, all moisture in the wood is associated in the cell walls; the cell cavities are virtually empty. The moisture content

at which the walls are saturated and the cavities empty is called the fiber saturation point. The fiber saturation point of most common woods is between 25 and 35%.

At low relative humidities the absorption is believed to be due to the interaction of water with accessible hydroxyl groups found on the lignin and on the amorphous cellulose. At higher humidities the absorption is believed to occur in response to a tendency for the cellulose chains and lignin residues to disperse themselves, making more hydroxyl groups available. The differential heat of absorption of dry wood, about 260 calories per gram of water absorbed, illustrates the high affinity for moisture of dry wood.

The calorific values of various oven-dried woods vary only slightly and can be considered to be about 5000 cal/g. Table 5 lists the heats of combustion of several species of wood. The heat content of the lignin residue is slightly higher, about 6300 cal/g.

Table 5  
Calorific Value of Various  
Tree Species  
(Oven-dry wood) (2)

Species	Heat of combustion, cal.
Alder .....	5047
Birch .....	4968
Aspen .....	4953
Pine .....	4907-4952
Spruce.....	4857

Wood is considered to be a poor conductor of heat. Though it increases slightly with increased moisture, the heat capacity is only about  $0.33 \text{ cal/g-}^{\circ}\text{C}$ , a nearly constant value for a wide variety of woods.

The density of wood is about  $1.5 \text{ g/cm}^3$ . However wood has substantial void volume, so the overall density of dried wood is about  $0.5 \text{ g/cm}^3$ . This corresponds to a void volume of about 67%.

### 1.3 Theory of Cellulose Acid Hydrolysis

Cellulose is hydrolyzed to its glucose monomers by water in the presence of acid. This reaction is shown in Figure 4. (4) Upon further heating in the presence of acid, glucose is dehydrated to form 5-hydroxymethfurfural. This reaction is shown in Figure 5. By analogy, xylose is dehydrated under identical conditions to form furfural. The furfurals formed condense with phenols to give characteristic colored products often used in colormetric analyses of sugars.

Perhaps the finest work on the mechanics and kinetics of wood saccharification and decomposition was done by Saeman and co-workers at the U.S. Forest Products Laboratory in Madison, Wisconsin. (5) In their work, the kinetics of wood hydrolysis and subsequent sugar decomposition in dilute acid and elevated temperatures was examined. Saeman used acid concentrations of around 1% on a weight basis and temperatures in excess of  $170^{\circ}\text{C}$  ( $338^{\circ}\text{F}$ ) in his studies.

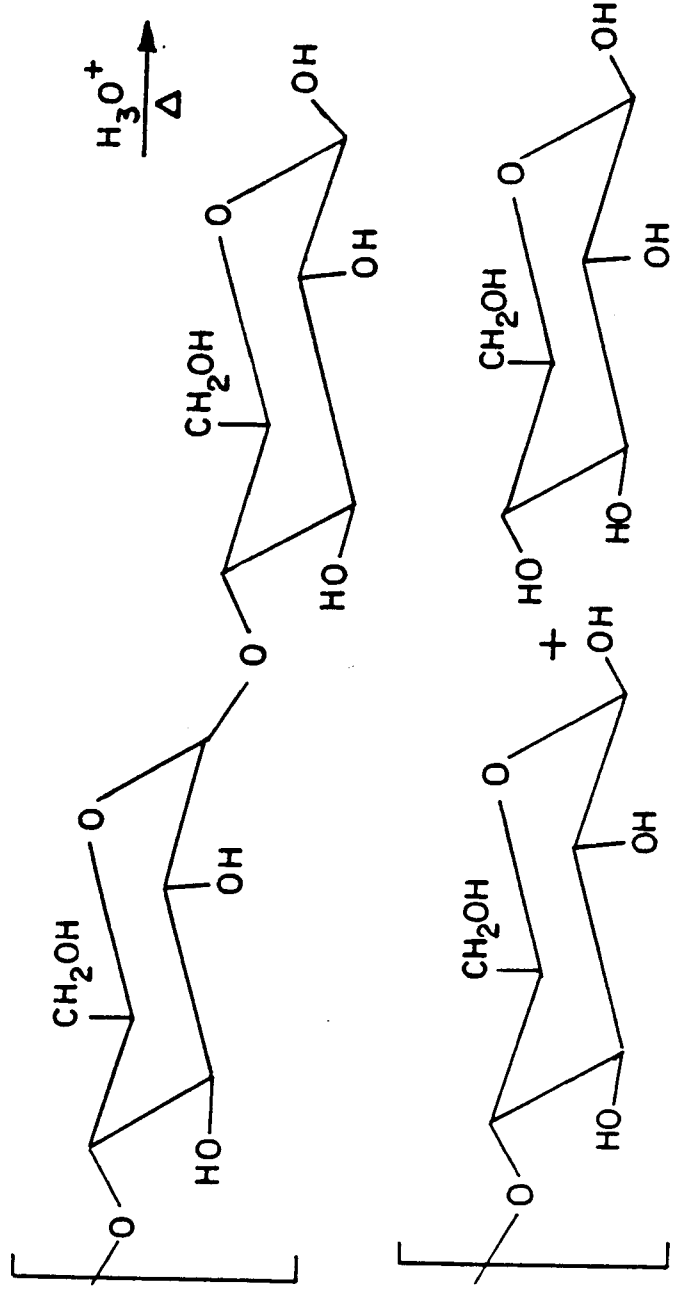

XBL817-6173

Figure 4. Hydrolyzation of cellulose to Glucose.

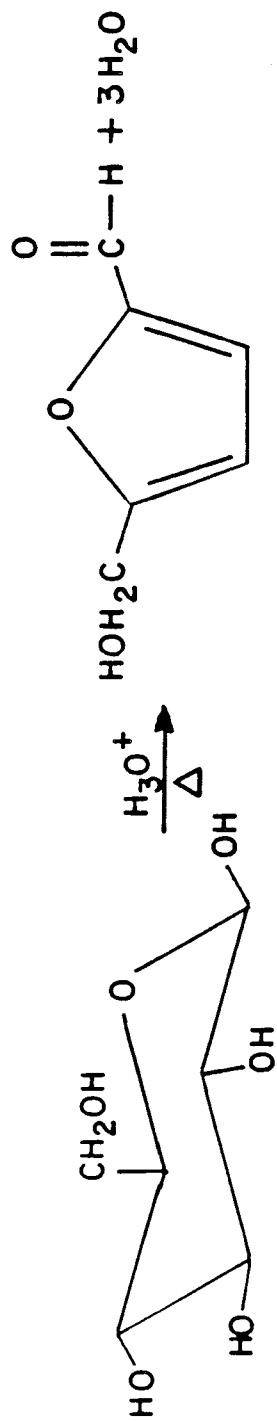

XBL 817-6174

Figure 5. Dehydration of Glucose to 5-hydroxymethylfurfural.

Saeman determined, with twenty different woods, ground from 20 to 200 mesh, that the hydrolysis of cellulose followed the laws of a first order reaction, and that the first order reaction rate constant increased with both temperature and acid concentration. Table 6 shows the variations of the rate constant with hydrolysis conditions:

Table 6

Hydrolysis of Douglas Fir in 0.4, 0.8 and 1.6% Sulfuric Acid at 170°, 180°, and 190°C. (5)

Temp., °C	H <sub>2</sub> SO <sub>4</sub> Concn., %	1st-Order Reaction Constant, k(Min. <sup>-2</sup> )		Obsvd. Half Life of Resistant Cellulose, Min.
		Obsvd.	Calcd.	
170	0.4	0.00355	0.00348	195.0
	0.8	0.00886	0.0080	78.2
	1.6	0.0222	0.0223	31.2
180	0.4	0.00995	0.0102	69.6
	0.8	0.0258	0.0258	26.8
	1.6	0.0664	0.0655	10.4
190	0.4	0.0299	0.0288	23.2
	0.8	0.0725	0.0730	9.36
	1.6	0.183	0.185	3.78

Assuming the hydrolysis rate had an Arrhenius temperature dependence, Saeman was able to determine the activation energy for the reaction as a function of the acid strength. As acid strength increased from 0.4 to 1.6% H<sub>2</sub>SO<sub>4</sub>, the

activation energy decreased slightly from 43,100 to 43,700 calories. Knowing this, he approximated that a 10°C temperature rise over the range of temperatures studied increased the reaction rate by 186%.

By extrapolating the residual sugar versus reaction time data to time zero, shown in Figure 6, he was able to empirically determine the amount of amorphous cellulose in Douglas fir samples. Knowing the wood had a total of 66.6% potential sugars, and that the resistant, or crystalline cellulose extrapolated to 44% at zero time, he determined the amorphous cellulose comprised about 22% of the total cellulose in the wood sample. This agreed with the findings of others. (6) Figure 6 also showed that decreasing the particle size from 20 to 200 mesh resulted in an insignificant increase in overall conversion.

Saeman also conducted kinetic studies on the decomposition of sugars as well. Like the hydrolysis of cellulose, he found that sugar decomposition was a first order reaction as well. Table 7 lists the first order reaction rate constants for five sugars, at 0.8% H<sub>2</sub>SO<sub>4</sub> and 180°C:

Table 7  
Decomposition rate constants (5)

Sugar	First-Order Reaction Rate k (Minutes <sup>-1</sup> )	Half Life, Minutes
d-Glucose	0.0241	23.6
d-Galstose	0.0273	26.4
d-Mannose	0.358	18.4
d-Arabinose	0.4721	16.4
d-Xylose	0.0720	9.6



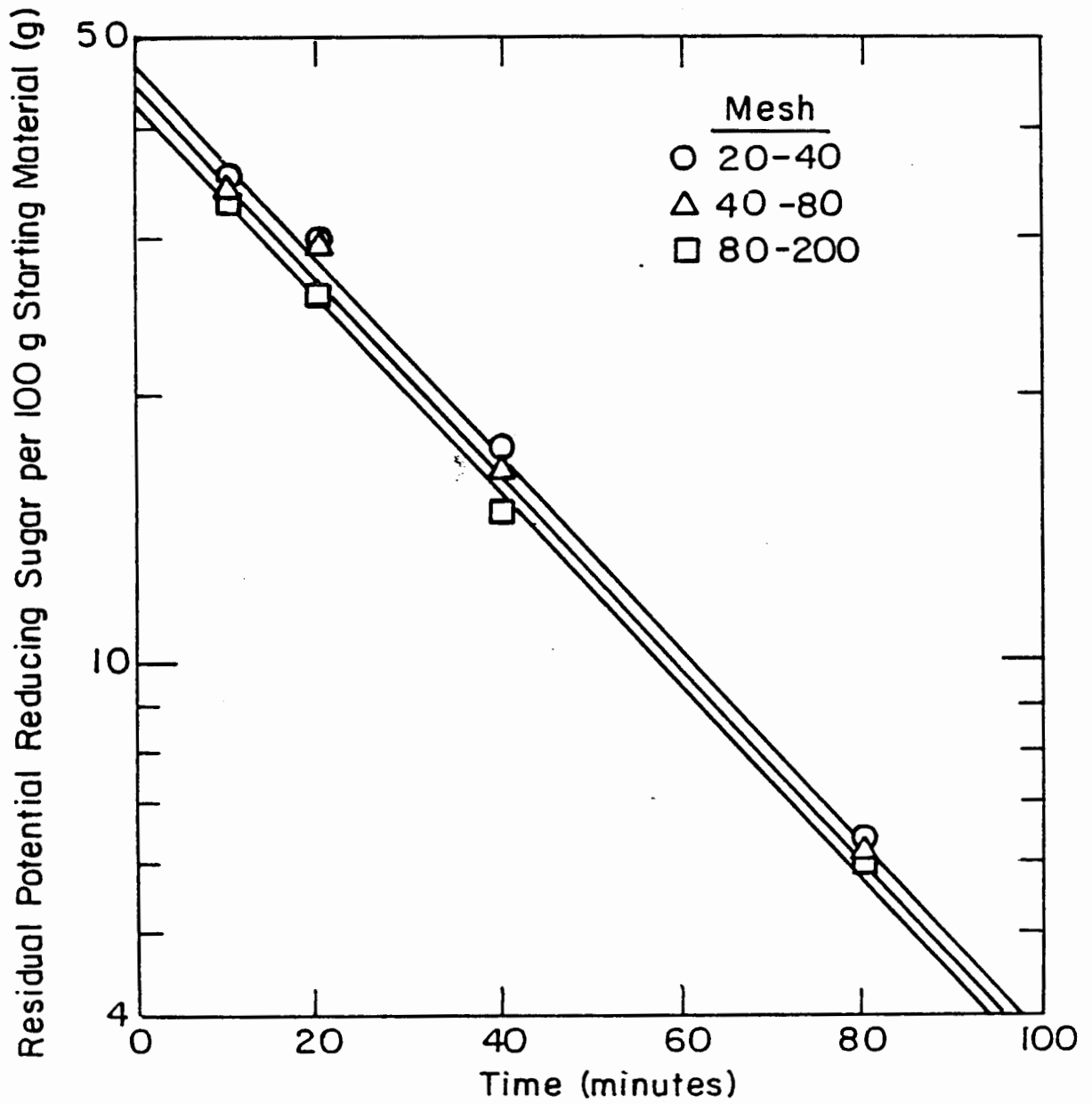

XBL 817-6166

Figure 6. Hydrolysis of Douglas Fir of Various Particle Sizes (5)

Further studies determined the effect of increasing temperature and acid concentration on the decomposition reaction. The experiments showed that the rate increased as temperature and acid strength increased, as shown in Table 8:

Table 8

Decomposition of Glucose in 0.4, 0.8 and 1.6% Sulfuric Acid at 170°, 180°, and 190° C (5)

Temp. (°C)	H <sub>2</sub> SO <sub>4</sub> concn. (%)	First Order Reaction Constant (Min <sup>-1</sup> ) Half Life		
		Observd.	Calc.	Min.
170	0.4	0.00539	0.00539	130.0
	0.8	0.01057	0.0108	65.8
	1.6	0.0223	0.0221	31.1
180	0.4	0.0123	0.0123	56.3
	0.8	0.0242	0.0243	23.6
	1.6	0.0606	0.0604	12.7
190	0.4	0.0270	0.0268	25.6
	0.8	0.0536	0.0545	13.0
	1.6	0.107	0.110	6.4

Analysis of these data yielded an activation energy for glucose decomposition ranging from 33,100 calories for 0.4% acid to 32,100 calories for 1.6% acid. Thus a 10°C temperature rise in this range resulted in a 125% increase in the rate of glucose decomposition.

By applying the theory of consecutive first order reactions (reviewed by Levenspiel (7)), Saeman was able to optimize the reaction scheme cellulose  $\xrightarrow{k_1}$  sugars  $\xrightarrow{k_2}$  decomposition products. First of all, Saeman experimentally showed that the consecutive reaction theory was valid, as shown in Figure 7. Other experimentors have shown this as well. (8)

The consecutive first order reaction theory represents the residual potential sugar concentration  $C_A$ , the net sugar concentration  $C_B$ , and the sugar decomposition product concentration  $C_C$  as follows:

$$\begin{aligned}
 C_A &= C_o e^{-k_1 t} & C_B &= \frac{C_o k_1}{k_2 - k_1} \left( e^{-k_1 t} - e^{-k_2 t} \right) & C_C &= \\
 & & &= C_o \left[ 1 - \frac{1}{k_2 k_1} \left( k_2 e^{-k_1 t} - k_1 e^{-k_2 t} \right) \right] & &
 \end{aligned} \tag{1}$$

where  $C_o$  is the initial concentration of potential sugar and  $k_1$  and  $k_2$  are the reaction rate constants for the hydrolysis and decomposition reactions, respectively.

As shown in Figure 7,  $C_B$  goes through a maximum, and the time when this maximum occurs can be calculated by the relation

$$t_{\max} = \frac{\ln k_2 - \ln k_1}{k_2 - k_1} \tag{2}$$

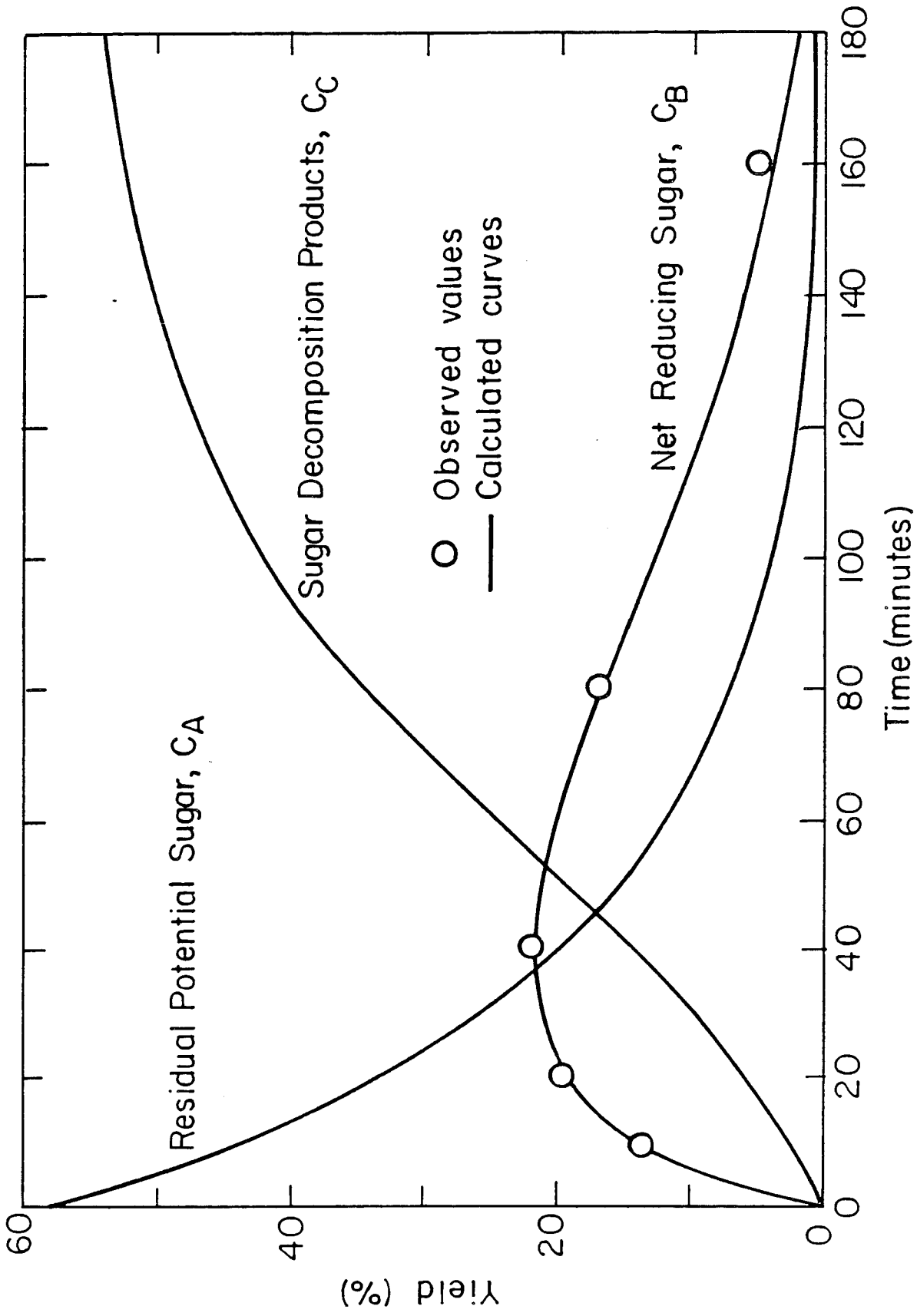

XBL817-6167

Figure 7. Saccharification of Hemicellulose-Free Hydrolyzed Wood Residue at 180°C in 0.8% H<sub>2</sub>SO<sub>4</sub> (5)

and the sugar concentration at  $t = t_{\max}$  can be found by the relation

$$C_{B_{\max}} = \left( \frac{k_2}{k_1} \right)^{k_2/k_1 - k_2} \quad (3)$$

Saeman substituted the experimentally determined rate constants into the above equation and drew one very important conclusion, illustrated in Figure 8, namely that increasing acid strength and temperature resulted in increasing the efficiency of the conversion of cellulose to sugar. This effect occurred as the rate of hydrolysis increased faster than the rate of decomposition, as acid strength and temperature were raised, he determined that  $t_{\max}$  occurred sooner.

#### 1.4 Previous Work on Acid Hydrolysis of Wood

For years it has been known that wood represents a viable source of energy in the form of fermentable sugars, and considerable work has been channelled in this area. However, past work has been hampered by the inability of wood sugar fuels to compete economically with petroleum fuels. Today's dwindling oil supplies have made wood sugar fuels a potentially attractive long range alternative, and a recent estimate states that 15-20% of the current U.S. energy consumption could be met by high development of wood and other biomass sugar production. (9)

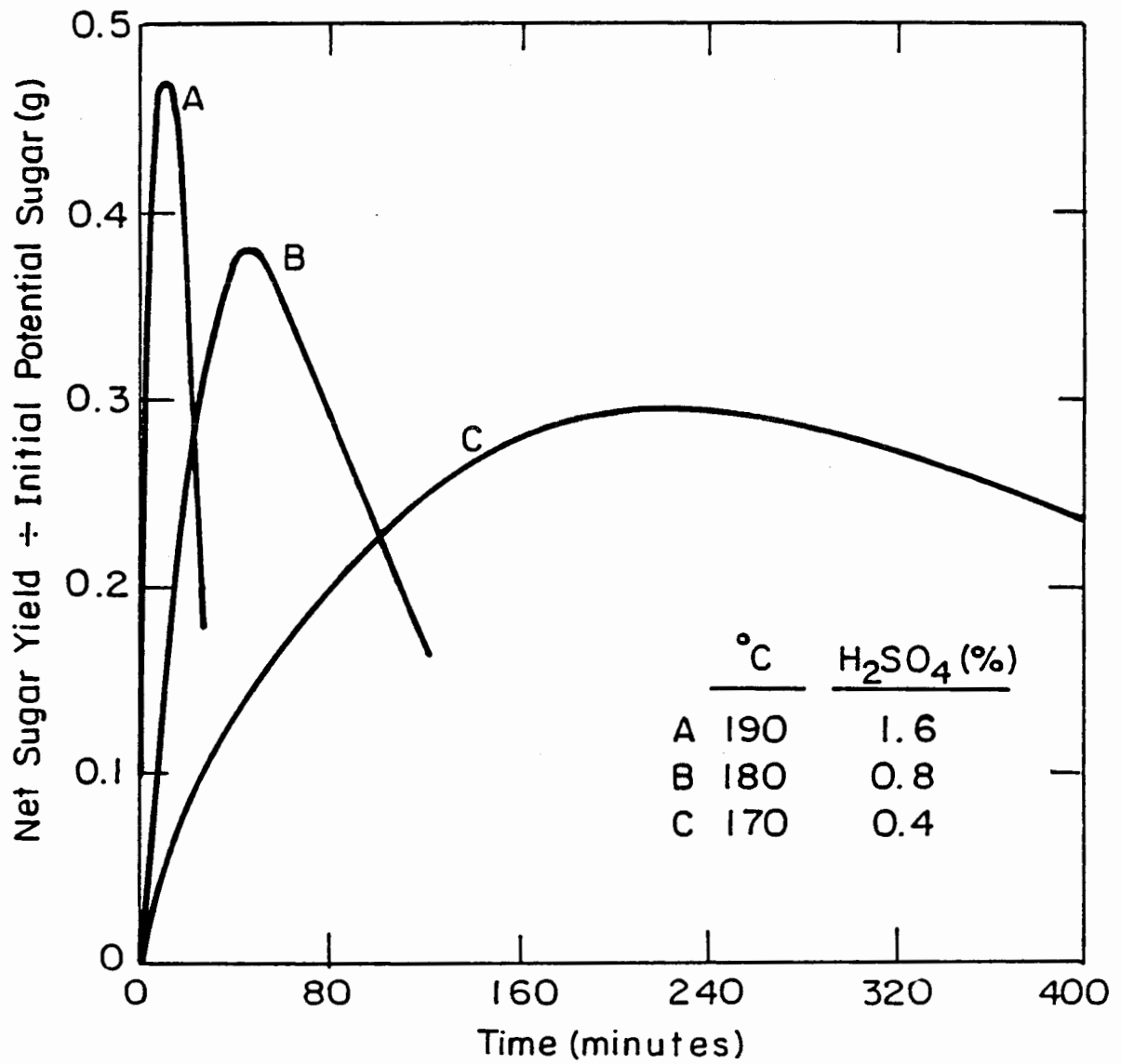

XBL 817-6168

Figure 8. Calculated Net Sugar Yields from Hemicellulose-Free Wood at Certain Acid Concentrations and Temperatures as Function of Time (5).

Others, especially the Germans, Russians, and the Japanese have applied considerable effort in the past into production of fuels from wood. They have used several hydrolyzing agents, including dilute and concentrated sulfuric acid, dilute and concentrated hydrochloric acid, and anhydrous HCl gas. Much of this work was concentrated around the time of World War II, when fuels were at a premium in those countries.

#### 1.4.1 Processes Using Concentrated Sulfuric Acid

Wood is virtually totally hydrolyzed by sufficient amounts of concentrated sulfuric acid. The biggest advantage to using a concentrated  $H_2SO_4$  system is that hardly any of the produced sugars are decomposed at the reaction conditions. However, the key problem with using concentrated sulfuric acid is that the acid is very hard to recover. Sulfuric acid and sugars are both soluble in water, and since they are both non-volatile, they cannot be separated effectively by distillation. Failure to recover 10% of the acid severely restricts the economic feasibility of the process, especially if one is aiming to produce sugars at a cost of around \$0.10/lb.

The best known of the concentrated sulfuric acid hydrolysis systems is the Hokkaido process, developed in Japan around 1948. (10) In this process, wood chips are first pre-hydrolyzed by reacting the wood with 0.25 N

sulfuric acid at 140-150°C, then drying and crushing the chips into a powdery state. The pre-hydrolyzed wood powder is then contacted with 90% sulfuric acid at room temperature for 30 seconds. After filtration and washing, the acid-sugar solution passes through a dialysis membrane, where 80% of the H<sub>2</sub>SO<sub>4</sub> is recovered. About 2% of the sugars are lost during dialysis. To insure total hydrolysis, the solution is then heated to 100°C for ten minutes. The Hokkaido process claimed about 83-85% of the theoretical glucose was obtained; however their ability to recover only 80% of the acid doomed the process to be economically unfavorable.

A modification of the Hokkaido process, called the "Thorough Drying Process," was developed by Kobayashi (10) to eliminate the power consumption needed to mix the concentrated sulfuric acid and the crushed wood particles. In this process, the pre-hydrolyzed wood is dried by hot air at 50°C after the wood chips are removed from the dilute acid bath. The main hydrolysis occurs as the wood is dried, because the sulfuric acid becomes more concentrated as the drying progresses. The modification claimed the same yields as the Hokkaido, but with lower power consumption and construction costs.

#### 1.4.2 Dilute Sulfuric Acid Processes

Processes using dilute sulfuric acid were developed because economic recovery of concentrated H<sub>2</sub>SO<sub>4</sub> could not



be achieved. The main drawback to using dilute sulfuric acid was that the reaction required elevated temperatures, which initiate the degradation of the sugars to furfurals.

One dilute sulfuric acid system was developed at the Forest Products Laboratory in Madison, Wisconsin. (10) Here wood was ground as small as possible in order to facilitate the permeation of acid into the wood. The hemicellulose was first removed by prehydrolyzing the wood with 0.05 N  $H_2SO_4$  at  $140^{\circ}C$  for one hour. The main hydrolysis occurred when 0.05 N  $H_2SO_4$  was added under pressure at the top of the reactor and continuously removed from the bottom. The time of reaction was three hours, and the temperature was raised from  $150$  to  $190^{\circ}C$  during the course of the reaction. Yields as high as 75% were claimed for the process.

Using the kinetics outlined by Saeman, Grethlein (11) developed a continuous hydrolysis process for wood using dilute sulfuric acid. Here a ground wood slurry was pumped to a reactor, contacted with 50%  $H_2SO_4$ , and steam was injected to initiate the reaction. The reaction was carried out at  $230^{\circ}C$ , with a residence time of only 11.4 seconds. The reaction ended when the material was expanded in a flash tank, with yields in excess of 80%.

A variation of the dilute  $H_2SO_4$  systems was developed by Brenner (12) at New York University. In his continuous system, twin-screw extruders, developed for the plastics industry, were used to develop a wood slurry by continuous

shearing and compressing. A schematic of this process is shown in Figure 9. In this process, wood particles were cram-fed into the co-rotating screws, where they were sheared, which subsequently made the cellulose fibers more accessible to hydrolysis. The screw thread configuration was such that water was continuously removed from the ground wood, and the cellulose was compressed into a dense plug. During the compression steps, superheated steam was added, heating the slurry to 450°F. When the plug reached the end of the extruder barrel, 0.5% sulfuric acid was injected and the reaction occurred. The time of reaction was only 20 seconds. The reaction was quenched by the sudden cooling which occurred when the hydrolyzed slurry exited the extruder through the ball valve. Brenner claimed 60% yields with the extruder system. A one-ton-per-day demonstration plant based upon this design was built in N.Y.U.'s Westbury, N.Y. laboratory.

#### 1.4.3 Processes Using Concentrated HCl

The Chief advantage to using hydrochloric acid over sulfuric acid are that HCl permeates the wood more easily than  $H_2SO_4$ , and that HCl is a volatile compound, which assists in the crucial acid recovery steps.

The Germans around the time of World War II did considerable research in the area of wood saccharification

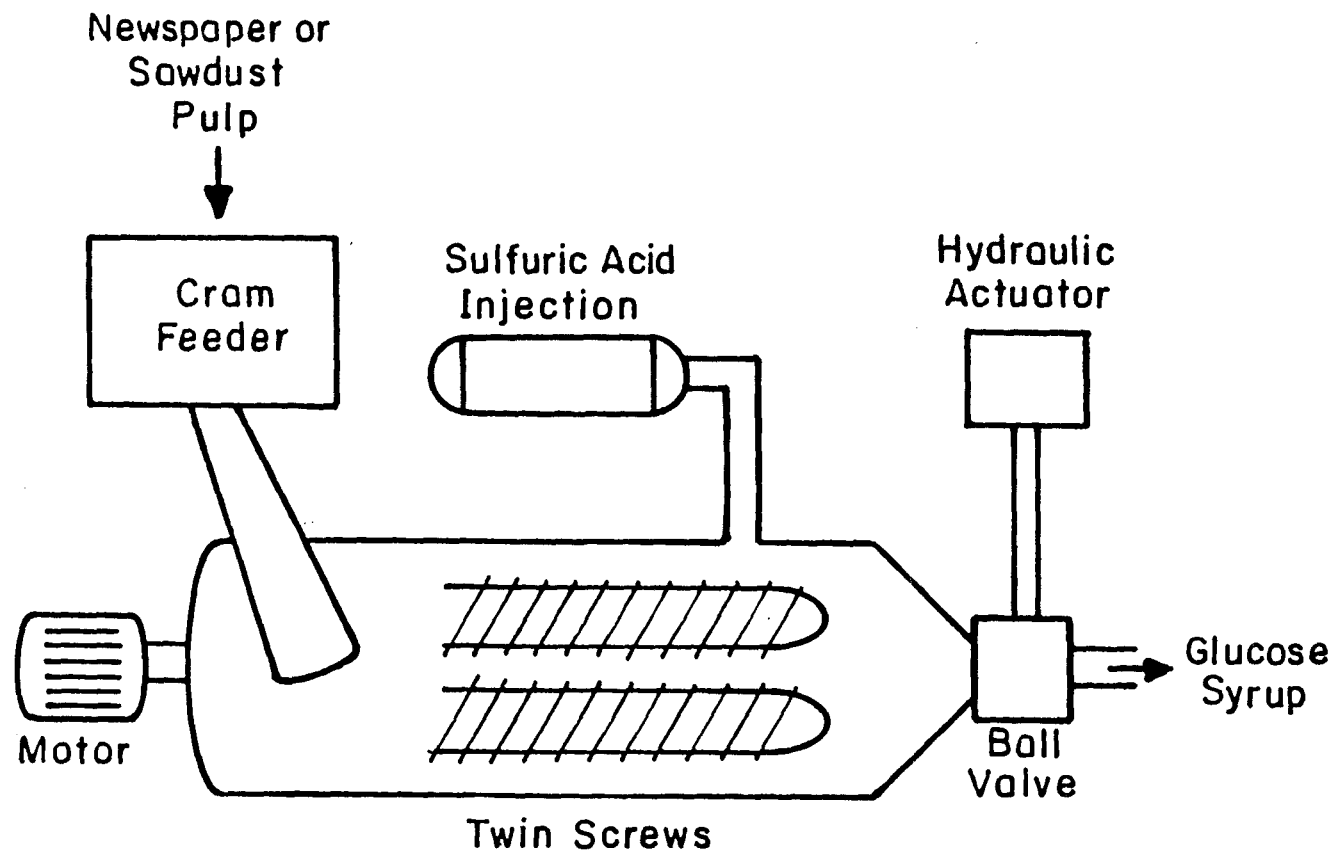

XBL817-6169

Figure 9. Schematic of Extruder Screw Hydrolysis System (12).

with concentrated HCl. Their most successful ventures were the Bergius-Rheinau (10) and the Udic-Rheinau (6) processes.

The Bergius-Rheinau process was the first commercial process using concentrated HCl. In this process, wood was hydrolyzed by contacting it with 20% HCl, which produced a 10% sugar solution. By recycling the acid-sugar solution to hydrolyze fresh wood, the sugar concentration was built up to 40%. The 40% solution was then distilled at 36°C at reduced pressures to recover 80% of the HCl as a gas. The 55% solution resulting from the distillation was then spray-dried to expel the remaining HCl. This process proved to be economically unfeasible, due to the recovery of only 82% of the HCl.

The Udic-Rheinau process was an attempt to make the Bergius-Rheinau process economically advantageous. This process was designed to yield crystalline glucose, and a flow sheet for this process is shown in Figure 10. In the improved process, the wood was first prehydrolyzed in 1% at 130°C to remove the hemicellulose. The wood was then dried and subsequently hydrolyzed with 40% HCl at 70°F for 10 hours. After washing the lignin residue with dilute HCl, the HCl was recovered by vacuum distillation. The resulting solution contained some oligosaccharides, so it was diluted to a 10% sugar solution and post-hydrolyzed. Subsequent neutralization, de-ionization, concentration, and crystallization yielded the desired crystalline glucose. The authors claimed

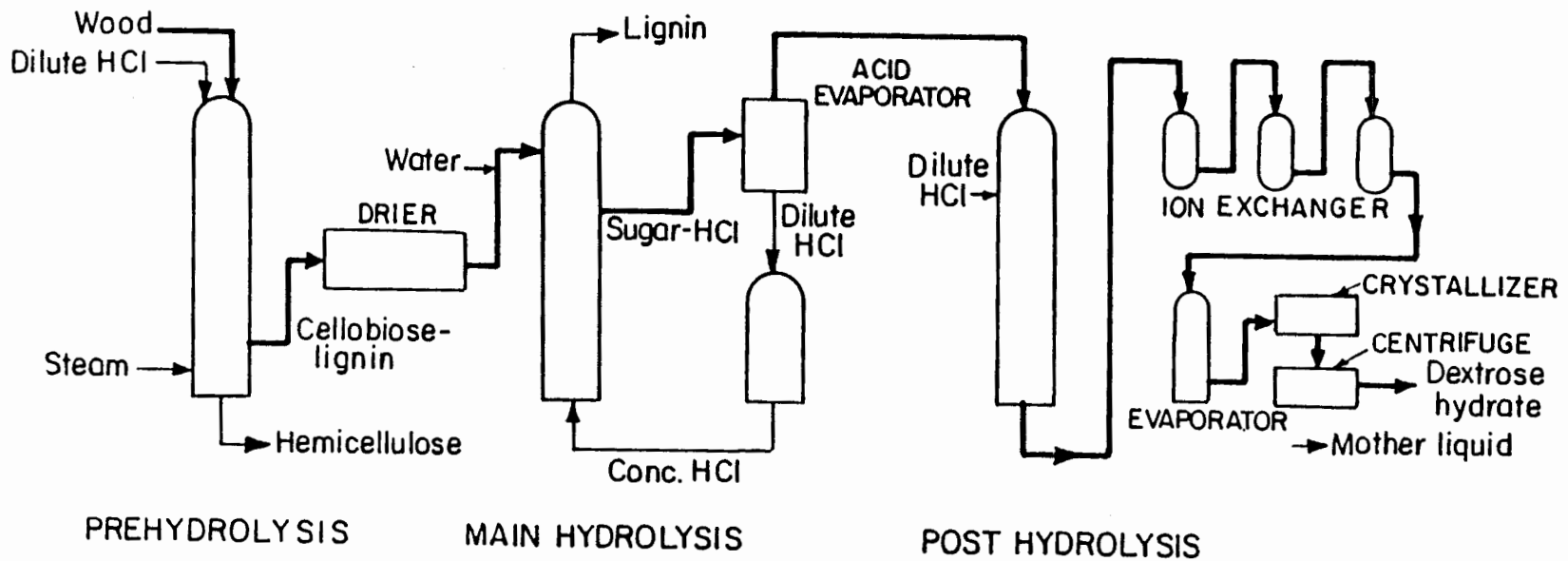

XBL 817-6170

Figure 10. Flow Sheet for Udic-Rheinau Process (6).

HCl losses dropped to 6%, thus making it more economically feasible than the previous German process.

#### 1.4.4 Processes Using HCl Gas

Several processes have been developed using HCl gas to hydrolyze wood chips. An early attempt was the Darboven process (10), which suspended wood particles in  $\text{CCl}_4$  and bubbled in HCl gas. Hydrolysis took place as the concentration of the acid increased in the wood particles. The  $\text{CCl}_4$  was used to absorb the high heat of solution of HCl into the wood (about 18 kcals/mole HCl absorbed). This process yielded little success.

A process developed by Hermeng (10) combined the use of hydrochloric acid and HCl gas. In his process, undried wood chips were mixed with 30% hydrochloric acid and flowed down a column equipped with inclined trays. This prehydrolysis took about 45 minutes. The acid-sugar solution was separated from the wood chips and recycled until the sugar concentration reached 20-25%. At this point HCl gas was introduced at the bottom of the reactor and the solution absorbed HCl until it reached full strength. Main hydrolysis then occurred. The hydrolyzed solution removed from the reactor bottom was sent to a drying chamber, where it was dried by hot HCl gas. The solid sugar was then re-dissolved and post-hydrolyzed

to break up any oligosaccharides present. Yields in excess of 75% were realized.

A Japanese process, the Noguchi Chisso process (10) was similar to Herneng's, except the wood particles were dried following the prehydrolysis, and the HCl gas was absorbed into the dried particles to initiate the main hydrolysis. In this process, prehydrolyzation occurred by the introduction of steam at 100-130°C. A counter-current water stream extracted the hemicellulose sugars, and the wood particles were then flash-dried by hot air. Contacting the dried particles with cold HCl gas brought the acid concentration in the wood to 42%, triggering the main hydrolysis. The particles were heated to 45°C to complete the hydrolysis while still being contacted with HCl gas. This process claimed to obtain 90% of the theoretical sugars.

#### 1.4.5 Previous Work with HCl Gas at Elevated Pressures

The most comprehensive work of high pressure HCl wood hydrolysis has been done by Russian investigators. Sharkov, et.al., (13) in 1971 studied the effects of HCl on a softwood pine, varying the pressure, temperature, and the moisture content of the starting material.

Sharkov determined that HCl at high pressures (10 to 40 atm.) altered the cellulose to an easier hydrolyzable state. However, they determined that severe decomposition

of the wood occurred if the wood temperature rose higher than  $45^{\circ}\text{C}$  during HCl saturation; therefore they studied the effect of varying saturation temperature on conversion, and determined that conversion decreased insignificantly (6%) as saturation temperature rose from  $-20^{\circ}\text{C}$  to  $25^{\circ}\text{C}$ . They concluded that decomposition due to the heat of solution of HCl into the wood was the single greatest factor that needed to be controlled; therefore they added HCl in small increments to control the temperature of the reaction.

Sharkov determined that increasing the pressure from 15 to 25 atmospheres increased the overall conversion by 10% in experiments determining the effect of varying pressure on conversion. In the same experiments they varied the time of reaction as well, and found a definite levelling-off of the conversion after reaction times of one hour. They concluded that increasing the reaction time from one to two hours had no significant effect on the overall conversion.

Perhaps Sharkov's most significant study was on optimizing the moisture content of the starting material. Initially, Sharkov was using totally dried wood in the studies, but Sharkov noted that slightly moist cellulose was more reactive than totally dry cellulose. However, increasing the moisture content also increased the amount of HCl gas absorbed, which leads to greater wood decomposition, so the researchers felt there was an optimum moisture content.



Setting up experiments with woods of varying moistures, Sharkov drew these conclusions: 1) The presence of a small amount of moisture (5%) promoted the hydrolysis of the crystalline cellulose. 2) Moisture contents greater than 10% were undesirable because of heat released due to the increased amount of HCl absorbed and 3) the optimum moisture content was between 5-10%, concentrations that could be achieved by air-drying.

Though Sharkov did not explore the prospect of HCl recovery, Russian researchers Leschuk, et. al., (14) did investigate if complexes are formed between HCl and the various components of wood. Leshchuk concluded that HCl does form a stable adduct with the available hydroxyl groups on the lignin and cellulose. Leshchuk claimed two monomers of cellulose complexed with three HCl molecules, and each monomer of lignin complexed with two HCl molecules

Research in this country on high pressure HCl conversion of cellulose has been conducted by Wilke, et. al., (15) at the University of California, Berkeley. Using glass ampoules and glass-lined steel bombs, as well as a single-stage vacuum distillation set-up, the optimum amount of HCl needed for hydrolysis, and the amount of residual HCl left in the wood particles were studied. As a cellulose source, Freitas used 2 mm. Wiley milled Populus tristis.

Freitas determined that the optimum hydrolysis efficiency occurred when 132 parts of HCl were added to 100 parts of

wood. At this point the minimum amount of HCl usage per amount of sugar produced occurred. Upon vacuum distillation at 40°C, he concluded that 86% of the HCl could be recovered, with the remainder clinging to the wood as a stable adduct, which is subsequently broken upon addition of water.

Though Freitas used pressurized batch reactions times of five hours or greater, it appeared that a considerable decrease in reaction time and an increase in yield could occur if some sort of agitation could be applied to the wood particles while they were being hydrolyzed under pressure with HCl. To overcome the problem of dissipating the heat of solution of the HCl into the wood, Freitas spread the wood particles in a thin layer over a gold-plated flange. Yields around 75% were achieved.

#### 1.4.6 Hydrolysis Research with Other Hydrogen Halides

Selke, et. al., (16), at Michigan State University in East Lansing, Michigan have investigated the saccharification of wood by pure hydrofluoric acid. Selke claimed a high conversion of sugars using HF, and since HF is highly volatile, Selke postulated HF could be easily recovered using low temperature heat to evaporate the HF from the reaction products.

Using batch reaction times of one hour, and loadings of 10 ml. HF to 1 gram of wood, Selke obtained yields ranging

from 45% at 0°C and 25% wood moisture. For evacuation times of two hours at 100°C, Selke found that only 5-10 mg. of HF were retained per gram of wood. Finally, a fermentation study showed successful fermentation by the yeast Sacchaomyces cerevisiae, which could ferment in fluoride concentrations as high as 100 ppm.

## References

1. Sarkanen, K and C. Ludwig, Lignins: Occurrence, Formation, Structure, and Reactions, Wiley-Interscience, N.Y., 1971
2. Nikitin, N., The Chemistry of Cellulose and Wood, translated by J. Schmorak, Israel Program for Scientific Translations, Jerusalem, 1966.
3. Encyclopedia of Chemical Technology, Kirk, R. and D. Othmer, eds., Vol. 15, The Interscience Encyclopedia, Inc., N.Y., 1956.
4. Lehninger, A., Biochemistry, Worth Publishers, Inc., N.Y., 1970.
5. Saeman, J., "Kinetics of Wood Saccharification," Ind. and Eng. Chem., Vol. 37, No. 1, pp. 43-52.
6. "Wood Challenges Corn as Dextrose Source," Chem. Eng., Feb. 1954, pp. 140-142.
7. Levenspiel, O., Chemical Reaction Engineering, Wiley and Sons, N.Y., 1972.
8. Luers, H., Z. angew. Chem., No. 43, 1930, p. 455.
9. Congress of the United States, Office of Technology Assesment, "Energy from Biological Processes," July 1980.
10. "Design, Fabrication, and Operation of a Biomass Fermentation Facility," first quarterly report prepared for U.S. Dept. of Energy by Georgia Institute of Technology, 1978.
11. Grethlein, H., "Acid Hydrolysis of Cellulose Biomass," from Proceedings of the Second Annual Fuel from Biomass Symposium, Rensselaer Polytechnic Inst., Troy, N.Y., June 20-22, 1978.
12. "Continuous Cellulose to Glucose Process," Chem. and Eng. News, Oct. 8, 1979 p. 19.
13. Sharkov, V., et. al., "Conversion of Difficulty-Hydrolyzed Wood Polysaccharides into a Ready-Hydrolyzed State," Report 3, Vsesoizni Nauchno-Issledo vatel'skii, 21, 1971, pp. 65-74, translated by G. Shalimoff.

14. Leschuk, A., et. al., "Composition of a Molecular Complex of Hydrogen Chloride with Products of the Hydrolytic Degradation of Pinewood by Hydrochloric Acid," Khim. Drev., 1, 1978, pp. 76-78, translated by G. Shalimoff.
15. Wilke, C. and H. Blanch, "Process Development Studies on Bioconversion of Cellulose and Production of Ethanol," progress report prepared for U.S. Dept. of Energy, LBL-9220, June 1979.
16. Selke, S., et. al., "Chemical from Wood Via HF," presented at A.C.S. meeting, Atlanta, Ga., March 23, 1981.

## 2.1 Experimental Procedures

### 2.1.1 D.N.S. Determination of Sugar Concentration

D.N.S. (3, 5-dinitrosalicylic acid) reagent is prepared in the following manner:

1. 24 g of NaOH are dissolved in 200 ml. of H<sub>2</sub>O
2. 8 g of D.N.S. are dissolved in 500 ml. of H<sub>2</sub>O
3. 5 g of phenol are dissolved in 80 ml. of H<sub>2</sub>O
4. Add 15 ml. of (1) to (3) and mix
5. Slowly add remainder of (1) to (2) and mix
6. Add 200 g of NaK tartate to (5) and mix until no further gas bubbles escape.
7. Add 5 g of NaHSO<sub>3</sub> to (4) and dissolve
8. Add (7) to (6) and mix. Bring up volume to 1 liter with water
9. Filter through glass wool and add 5 additional grams of NaHSO<sub>3</sub>
10. Store in dark, dry cabinet

To assay for sugars in a solution, quantitatively transfer 0.5 ml. of sugar solution, of estimated concentration between 0.5 and 2.5 mg/ml, to a test tube, add 1.5 ml. D.N.S. reagent, vortex and cover with a steel cap. After being placed in boiling water for 5 minutes and cooled, add 10 ml. of water and vortex. Sugar concentrations are determined colormetrically by absorption at 600 nm and 0.03 slit width, after a standardization curve has been established. The D.N.S. assay cannot differentiate between specific sugars; all sugars present are reduced during the assay.

### 2.1.2 Assay by High Pressure Liquid Chromatography (LC)

The concentrations of specific sugars can be determined by high pressure liquid chromatography. A Partsil Pac column for carbohydrate determination (from Whatman, Inc.) was used with a solution of 84% acetonitrile and 16% H<sub>2</sub>O as the carrier solvent.

### 2.1.3 Glucose Assay by G.O.P.

The G.O.P. (glucose oxidase-peroxidase) reagent is prepared in the following manner:

1. Add 1 ml. of liquid glucose oxidase (Sigma Chem #G-6500, Type V) to 100 ml. of tris buffer. The tris buffer is prepared by dissolving 72 g of tris (hydroxymethyl) aminomethane in 800 ml. of water, adding concentrated HCl until solution is neutralized, diluting to 1 liter with water and filtering through glass wool
2. Add 3 mg. of peroxidase powder (Sigma Chem #P-8250, Type II) to (1)
3. Add 1 ml. of 0.166 M (in methanol) o-dianisidine to (2)
4. Mix and filter through 0.5  $\mu$ M polycarbonate filter. Use reagent as quickly as possible.

To assay for glucose, add 0.1 ml. of sample to 1 ml. of 0.025M acetate buffer. Then add 5 ml. of G.O.P. reagent, mix, cap, and place in 40°C bath for 30 minutes. After removing from the bath, add 3 drops of concentrated HCl, vortex, and let stand for 15 minutes so color can develop. Glucose concentration is determined colormetrically at 400 nm. Glucose standards should be run in the range

of 0.25 to 2.2 mg/ml, and samples should be diluted to fall within the range.

#### 2.1.4 Chloride Ion Assay

Chloride ions were assayed for by titration. A 0.1 M  $\text{AgNO}_3$  solution was added dropwise to sugar solutions, precipitating  $\text{AgCl}$ , and the endpoint was determined by titrating against dichlorofluorescein indicator. The indicator was in a 0.2% solution in ethanol, and changed from yellow to pink upon detection of excess silver ions.

## 2.2 Experimental Apparatus and Materials

### 2.2.1 Reagents and Reactants

The wood particles used in the study were 2 mm. Wiley milled Platanus occidentalis, commonly known as the hardwood sycamore. The wood was grown for five years in Jackson County, Georgia, and was harvested in 1977. The wood was supplied by the School of Forest Resources at the University of Georgia. Also used in one experiment were particles of Populus alba, in sizes ranging from 6 mm. to less than 1 mm Wiley milled. This wood was from the University of California, Berkeley.



The inert particles used as the fluidizing medium were 44 to 70 $\mu$ M diameter glass beads, supplied by Smith Industrial Supply of San Francisco, California, and the anhydrous HCl was technical grade (99.0% purity) supplied by Matheson.

### 2.2.2 Apparatus for High Pressure HCl Reaction

The high pressure HCl reactions were performed in both bomb reactors and in pressurized fluidized bed reactors. The bomb reactor was a 25 ml glass-lined stainless steel reactor, capable of handling up to 10 grams of wood particles. It was equipped with a pressure gauge and a thermocouple port to monitor the reactions conditions.

The pressurized fluidized bed was a 3 inch ID monel and ceramic coated 316 stainless steel tube with end flanges and a window port sealed by a Viton O-ring. Valves at the inlet and outlet controlled the HCl flow and thus the pressure, and temperature were monitored continuously. The exiting HCl was absorbed in a 4 inch packed column.

The gas distributor for the fluidized bed was a 3-layer porous polyethylene sandwich. The distributor was Eimco's PO-801RF 1/1 plain monofilament polyethylene filter, with a pore size of less than 10  $\mu$ M, supported by Eimco's POPR-898 and PO-808 filters.

### 2.2.3 Other Apparatus

A cryogenic pumping system was used to study HCl retention in wood particles. The trap was immersed in liquid nitrogen, and a 0.5 h.p. vacuum pump was used.

The dilute acid hydrolyses were performed in a 21 gallon autoclave, where the temperature reached 260°F and the pressure about 15 p.s.i.g.

### 3.1 Experimental Results and Discussion

In order to efficiently hydrolyze wood with HCl at elevated pressures, three main problems needed to be addressed. They were 1) dissipation of the large amounts of heat released when HCl is absorbed into wood, 2) determination of the optimum moisture content of the wood particles to facilitate the HCl absorption. These problems were resolved by use of a fluidized bed reactor, fluidizing equal volumes of air-dried wood particles and glass beads.

#### 3.1.1 High Temperature Dilute Acid Hydrolysis

The conversion of HCl-impregnated wood particles to sugars takes place in the high temperature dilute acid hydrolysis step. Subjecting wood particles to HCl gas under pressure makes the particles more susceptible to acid hydrolysis, but virtually none of the crystalline cellulose is converted to monomer sugars by HCl gas under pressure. Wood particles subjected to HCl gas at 314.7 p.s.i.a. for one hour and not subsequently hydrolyzed in dilute acid yielded only 20.5% sugar conversion (DNS). The sugars formed are most likely from the amorphous cellulose, which comprises 22% of the total potential sugar.

The effect of acid strength on the dilute acid hydrolysis was studied. Acid strengths ranging from 0.08N

to 1.40N were used, and the results are shown in Figure 11. The data shows no significant increase in conversion as acid strength is increased beyond 0.20N. At 1.40N the conversion decreased by about 5%, suggesting some sugar decomposition took place due to the higher acid concentration. Acid concentrations of 0.35 to 0.70N are optimum for the hydrolysis, and these concentrations can be achieved by addition of water to HCl-impregnated wood particles, without further addition of acid.

Glucose yields of 39.8% (LC) were achieved when wood particles were subjected to 0.60N HCl hydrolysis for one hour at 121<sup>o</sup>C, without high pressure HCl pretreatment. Evaluation of the pretreatments cannot be determined unless followed by dilute acid hydrolysis; therefore 39.8% conversion is considered to be the conversion at time zero in subsequent analyses of high pressure HCl pretreatments.

### 3.1.2 Effect of Wood Moisture Content on Conversion

The effect of varying wood moisture content from 6.32% (air-dried) to 40% on cellulose conversion was studied. These reactions were run at 314.7 p.s.i.a. for one hour, and the temperature was kept constant at 27<sup>o</sup>C. The moisture contents were achieved by adding stoichiometric amounts of water to wood particles and tumbling overnight to achieve equilibration. The results, shown in Table 1, showed that

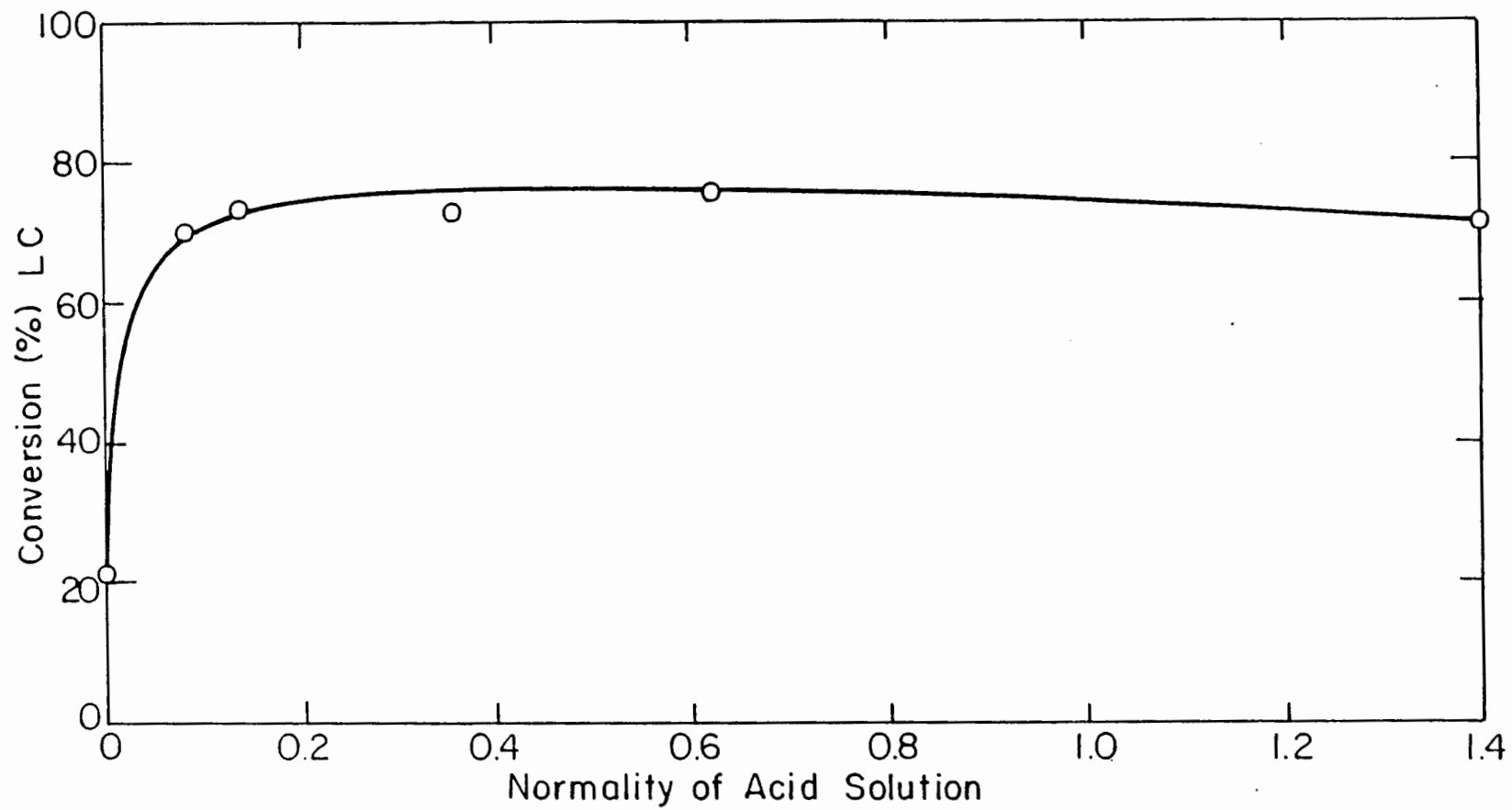

XBL 817-6157

Figure 11. Conversion as a Function of Acid Strength in Dilute Acid Hydrolysis at 120°C for 1 Hour.

changing the moisture content had an insignificant effect on conversion.

Table 1  
Conversion vs. Moisture Content

% Moisture	% Conversion (LC)
6.32	72.35
15.00	70.17
25.01	73.44
39.98	74.22

The results agreed with the findings of Sharkov (1) and Selke (2), who found that moisture contents achieved by air-drying were optimum.

### 3.1.3 Effect of Moisture Content, Glass Beads, and Fluidization on the Dissipation of Heat Released by HCl Absorption

Severe decomposition of wood, regardless of moisture content, occurs when wood is subjected to HCl gas under pressure. Wood of 40% moisture reached 83°C upon HCl addition, decomposing the wood to a black char. Air-dried wood (6.32% moisture) reached 72°C; furthermore it was noted that the temperature rose instantaneously and reached a maximum within a minute, suggesting the absorption of HCl was instantaneous.

Mixing glass beads (40 to 70 $\mu$ M in diameter) with the wood particles proved to be effective in dissipating the heat. The effect of varying ratios of glass beads to wood particles on the maximum temperature increase was studied, and the results are shown in Figure 12. These experiments were performed in the 25 m. bomb reactor. The results show that adding equal volumes of glass beads and wood particles (10% wood on a weight basis) reduced the temperature increase by over 30 $^{\circ}$ C for both 40% and 6.32% moist wood, thus substantiating the effect of glass bead addition on the heat dissipation.

Pressurized fluidization of the glass bead-wood mixture had a more pronounced effect on the heat dissipation. At elevated pressures, there is significant bulk transfer of the heat through the gas phase due to the increased heat capacity of the gas. Also as the pressure increases within the bed, the overall heat transfer coefficient increases. At 200 p.s.i.a. Botteril and Desai (3) measured the coefficient to be 150 B.T.U./hr-ft<sup>2</sup>-F $^{\circ}$ . The increased heat transfer coefficient occurs because fluidization is more uniform at higher pressures, reducing the temperature fluctuations between the inlet and the outlet and reducing the amount of bubble breakthrough. (4)

An equivolume mixture of glass beads and wood particles fluidized at 214.7 p.s.i.a. produced a maximum temperature increase of only 2 $^{\circ}$ C. With the reaction

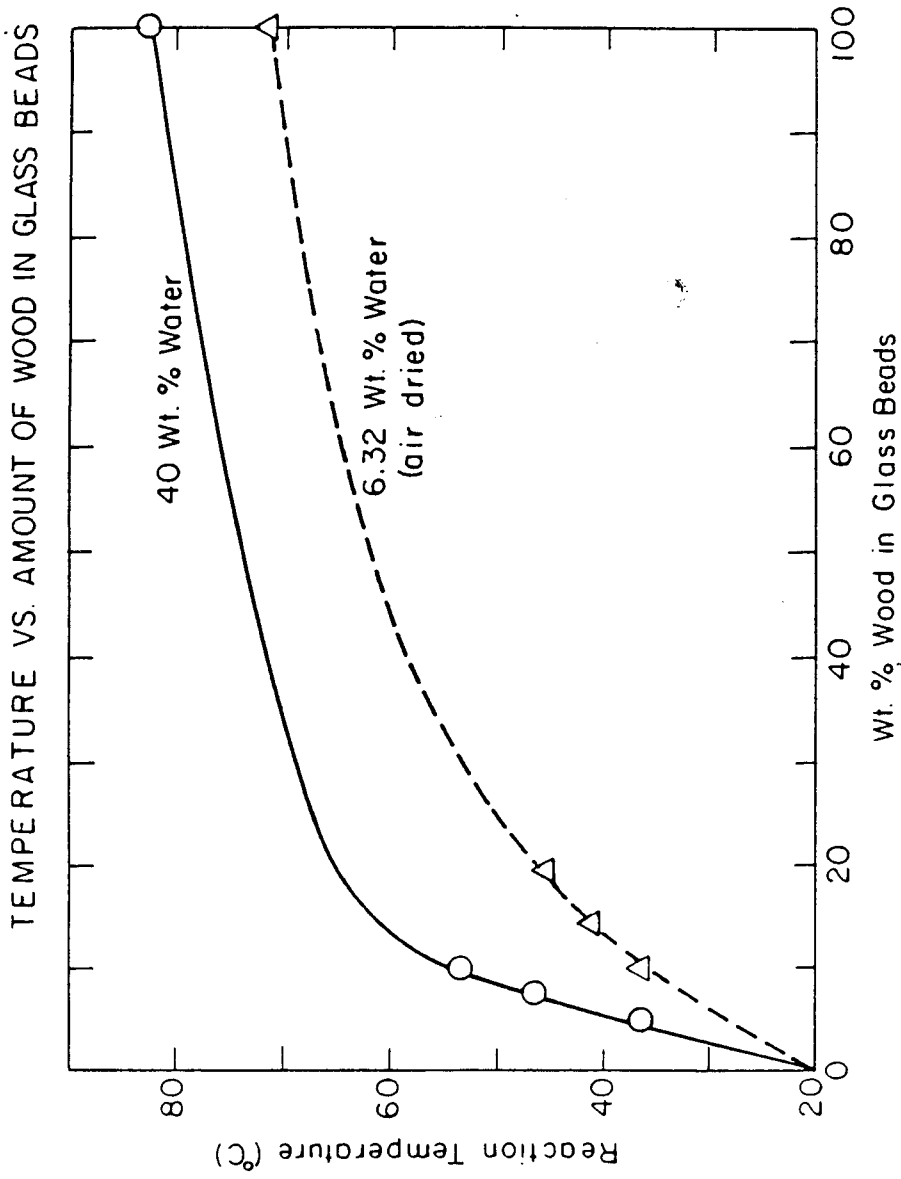

XBL812-5302

Figure 12. Temperature vs. Weight Fraction of Wood in Glass Beads.



temperature near room temperature, no wood decomposition occurred in the fluidized bed reactor.

#### 3.1.4 Effect of HCl Partial Pressure on Conversion

The effect of mixing nitrogen with HCl gas on conversion was studied as a possibility for cutting HCl usage during the high pressure step. These results are shown in Figure 13. Nitrogen in amounts as small as 17% (mole basis) decreased the conversion by 20%; the partial pressure of HCl was not high enough to promote adequate saturation of the wood. Therefore it was concluded that pure HCl gas was needed for the high pressure step.

#### 3.1.5 Factors Affecting Fluidization of Glass Bead-Wood Mixtures

Wood particles do not fluidize satisfactorily unless mixed with substances which fluidize readily, such as glass beads. Wood particles by themselves tend to agglomerize and rise when fluidization is attempted. Smooth, bubbling fluidization is achieved when up to 20% wood particles in glass beads are fluidized. If the beads are properly sized, no separation of the wood from the beads occurs as fluidization progresses. Glass beads 40-70  $\mu$ m diameter were used to fluidize the 2 mm. Wiley milled wood particles.

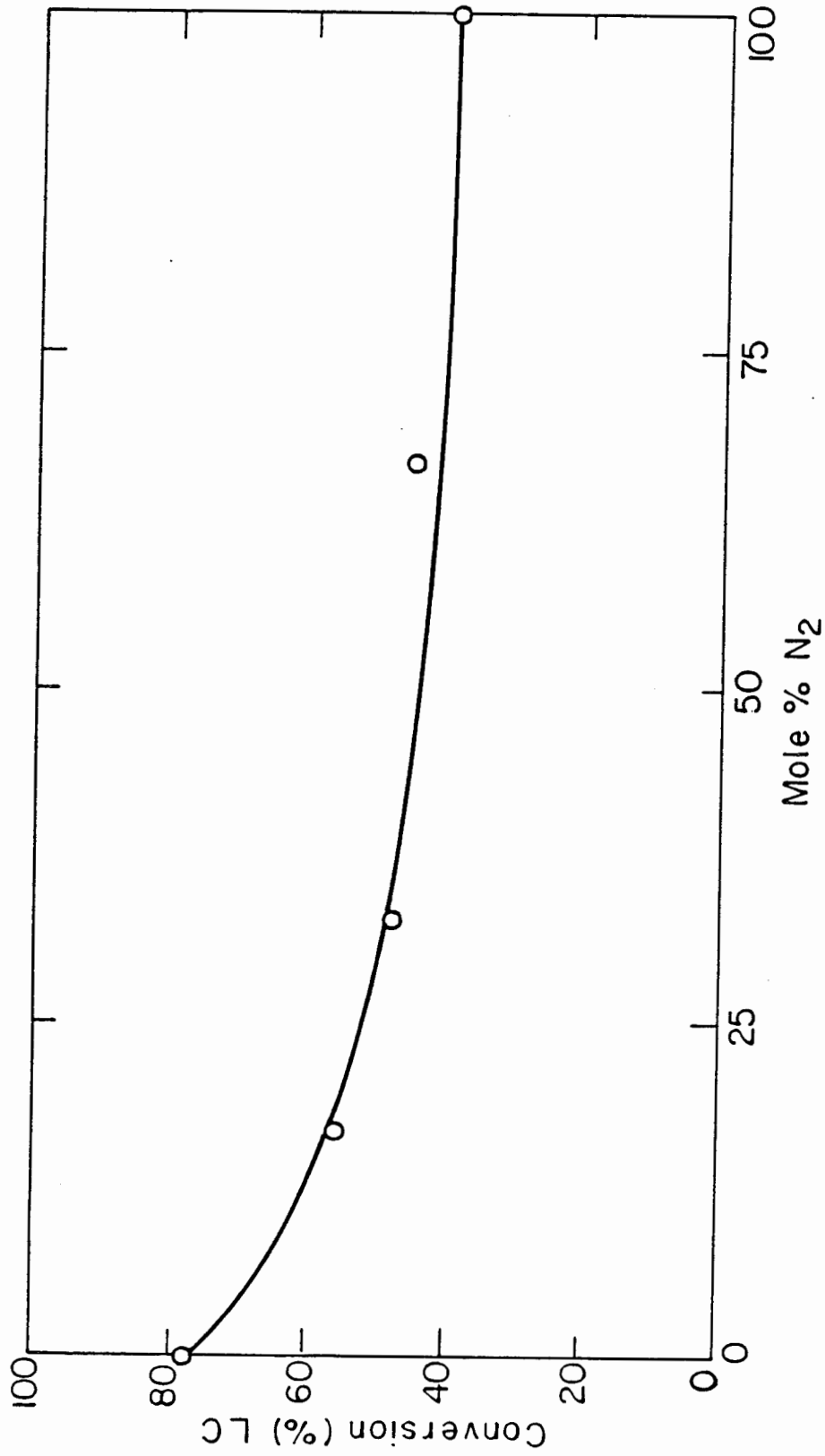

XBL 817-6158

Figure 13. Conversion vs. Mole % N<sub>2</sub> in HCl Gas.

Wood particles with moisture contents greater than 15% were found not to fluidize satisfactorily when mixed with glass beads. Agglomeration of the moist wood with the beads occurs when fluidization is attempted. It was found that drier wood fluidized more smoothly, thus air-dried wood was used in all high pressure fluidizations by HCl gas.

Using the fluidization models of Kunii and Levenspiel (5), it was determined that the minimum fluidizing velocity by HCl gas at 300 p.s.i.a. for a bed of glass beads and wood particles was 2.69 cm./sec. The maximum fluidizing velocity before entrainment occurred was calculated to be 12.57 cm./sec. The experimental fluidization velocity was measured to be 10.10 cm./sec. At this velocity no particle entrainment occurred. The pressure drop across the bed under these conditions was about 7 p.s.i.

#### 3.1.6 Analysis of Wood Saturation by HCl Gas by a Pressurized Fluidized Bed

The effect of pressure and time on conversion were studied in a 3 inch ID fluidized bed reactor, with pure HCl being the fluidizing medium. The wood-glass bead ratio was 10% wood (weight basis) in all cases. Pressure equilibrated within 30 seconds in every run, and the maximum temperature increase was never more than 2°C.

Pressures ranging from 74.7 to 454.7 p.s.i.a. were studied, and the conversions were determined after dilute acid hydrolyses at 0.60N. The results are given in Figure 14. The linear relationship signifies the reaction is first order with respect to HCl gas concentration. It also showed that increased pressure did not decompose or affect the cellulose, since conversion increased linearly over the range of pressures studied. The results indicate that increasing the HCl pressure allows the gas to permeate the wood particles more causing a greater conversion to sugars upon dilute acid hydrolysis.

Figure 15 shows the effect of reaction time on conversion. Times ranging from five minutes to two hours were observed, and all reactions were run at 214.7 p.s.i.a. The results show that reactions longer than 60 minutes were unnecessary, since conversion increased insignificantly when the reaction time was increased from one to two hours.

Figure 16 shows the same data plotted on semi-logarithmic paper. The straight line indicates the reaction is first order, the result Saeman also found. (6) The rate constant was calculated to be  $0.003 \text{ min.}^{-1}$ , nearly the same value Saeman found for dilute acid hydrolysis at  $170^{\circ}\text{C}$  and 0.4% (0.08 N)  $\text{H}_2\text{SO}_4$ , with no pressurized HCl pretreatment. With the HCl pretreatment, the same rate constant was nearly achieved with dilute acid hydrolysis at  $121^{\circ}\text{C}$  and 0.60N acid.

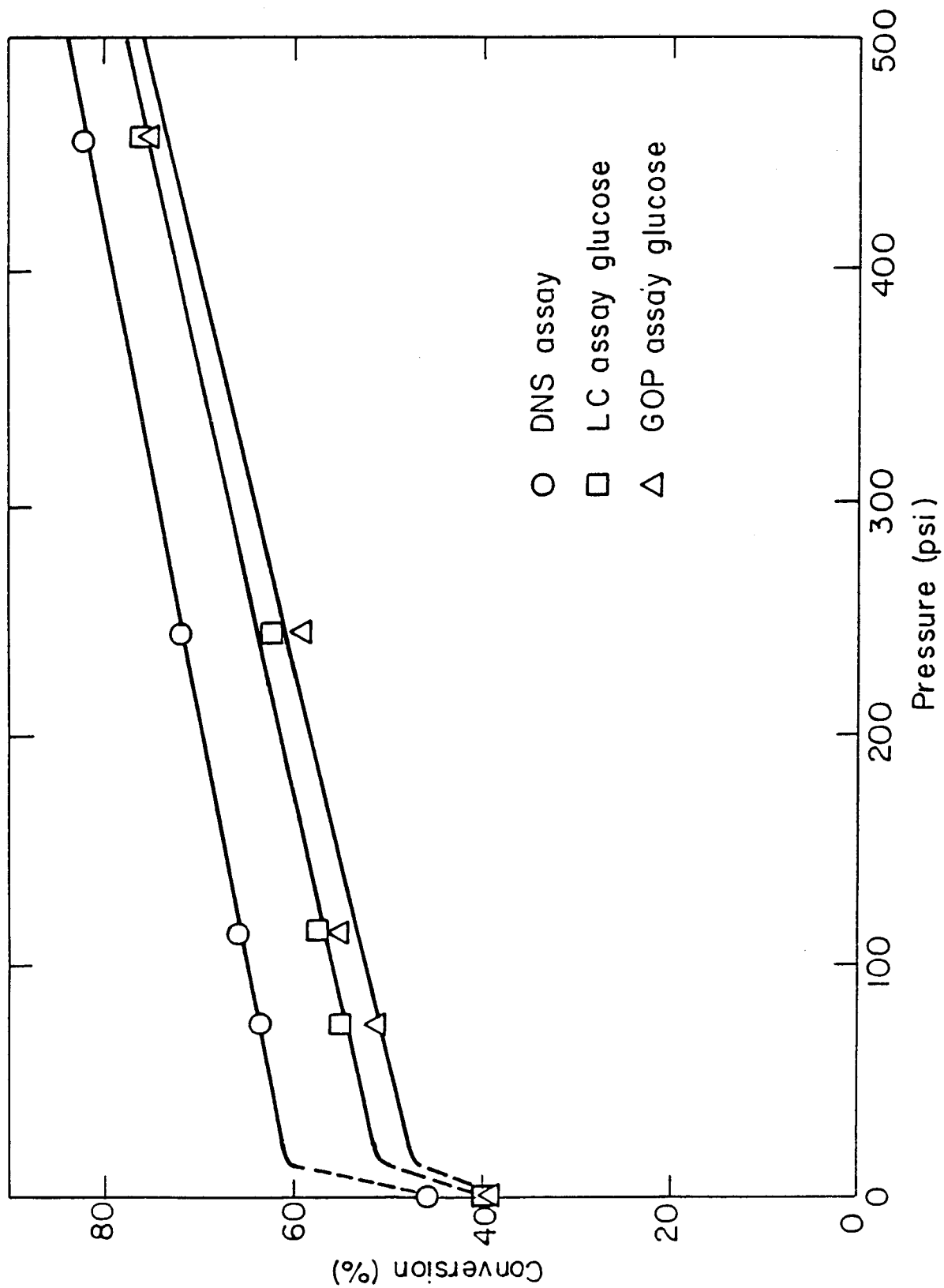

XBL 817-6159

Figure 14. Sugar Conversion vs. Reaction Pressure.

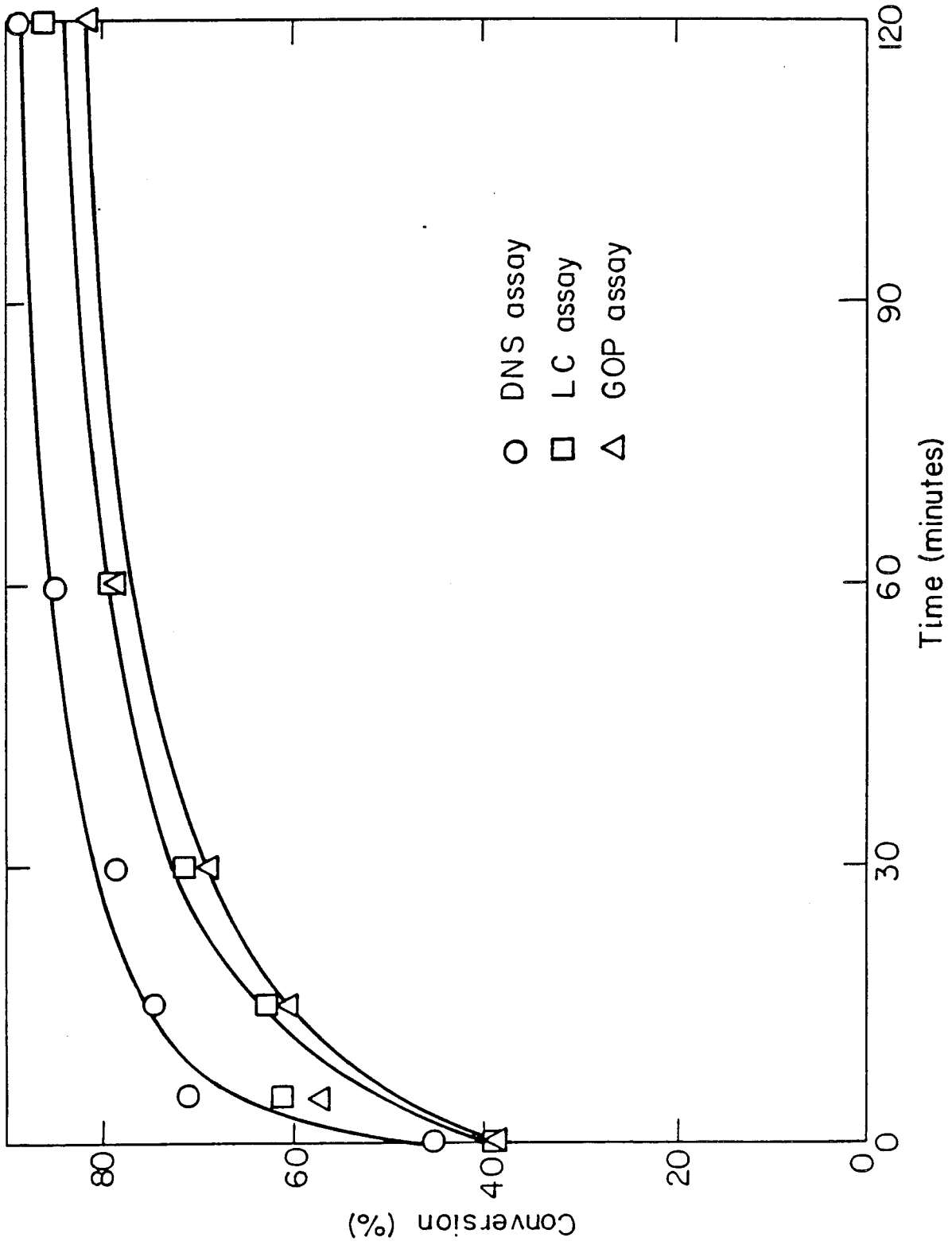

XBL817-6160

Figure 15. Sugar Conversion vs. Time of Reaction.

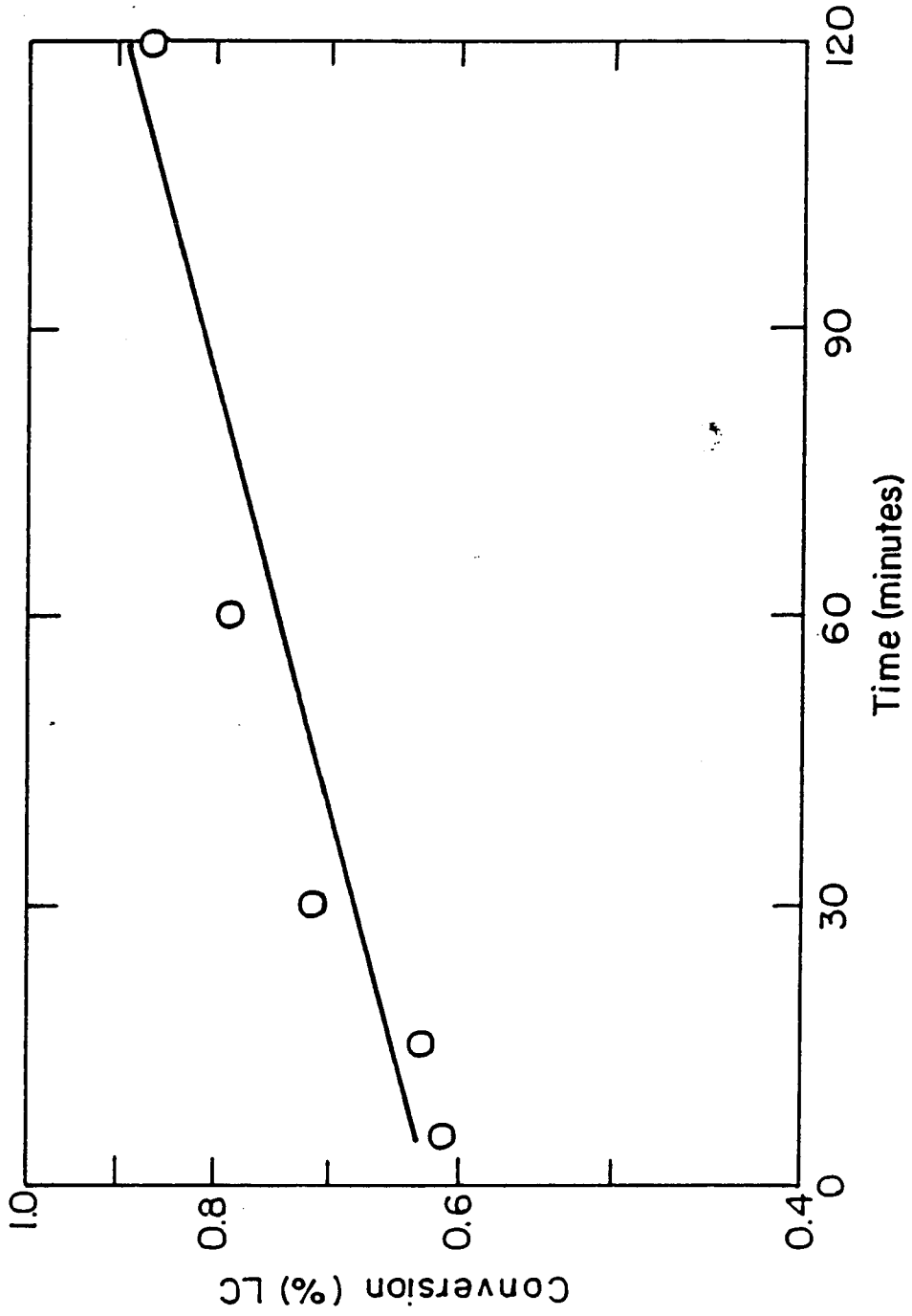

XBL817-6161

Figure16. Sugar Conversion vs. Time of Reaction.

The unreacted core model for spherical particles of unchanging size, with diffusion through the solid limiting the gas-solid reaction, adequately describes the hydrolyzing of wood particles by HCl under pressure. This model was first developed by Yagi and Kunii in 1955. (7) Assumptions of the model are outlined in full by Levenspiel. (8)

The model develops this relationship between the time of reaction and conversion:

$$\frac{t}{\tau} = 1 - 3(1 - x_B)^{2/3} + 2(1 - x_B) \quad (1)$$

where  $x_B$  is the net conversion,  $t$  is the reaction time, and  $\tau$  is the time required for complete particle conversion, found by the relation

$$\tau = \frac{\rho_B d_p^2}{24D C_g} \quad (2)$$

where  $\rho_B$  is the particle density,  $d_p$  is the particle diameter,  $D$  is the diffusion coefficient of the gas through the solid, and  $C_g$  is the gas concentration.

Insertion of the experimental data into Equation (1) yielded a value of 964.94 minutes for the complete time of reaction  $\tau$ . This corresponded to a diffusion coefficient of  $7.898 \times 10^{-8}$  cm.<sup>2</sup>/sec., suggesting HCl permeates the wood by a Knudsen diffusion mechanism, based on the magnitude of the diffusion coefficient. Figure 17 shows a comparison



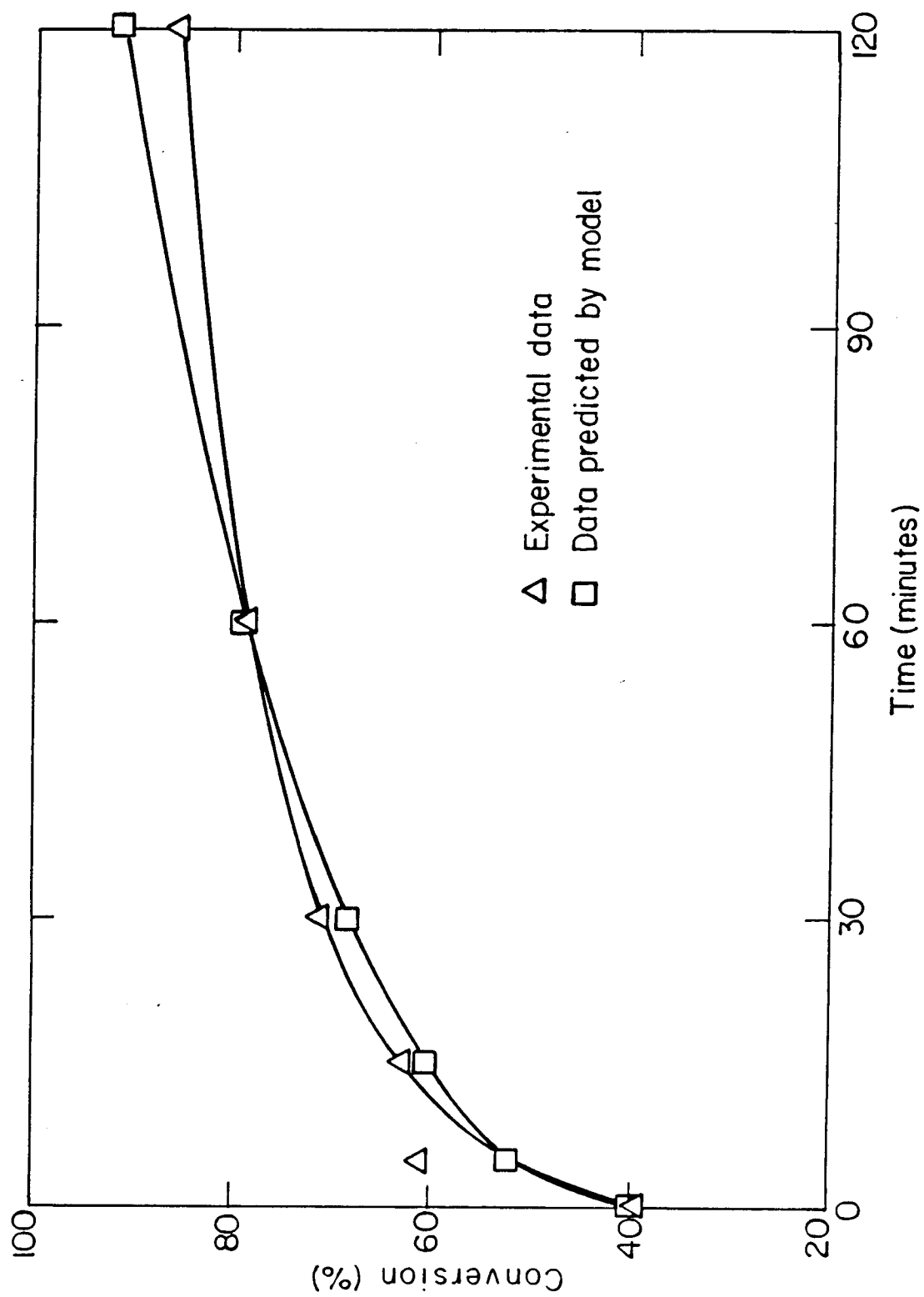

XBL817-6162

Figure 17. Comparison of Reaction Model with Experimental Data.

between the empirical data and the data predicted by the model.

A further test of the model was performed with wood particles of varying sizes. Particles ranging from 0.1 to 0.2 cm. in diameter were used to test the particle size dependence on  $\tau$  in the reaction model. Figure 18 shows a comparison of the experimental data with the predicted conversions for the various particle sizes. The results appear to confirm the validity of the model for the high pressure HCl reaction.

### 3.1.7 Effect of Vacuum on Retention of HCl in Wood

Recovery of HCl gas from the wood particles is critical to the economic feasibility of the process. If no recovery is attempted, 0.2686 g of HCl is lost per gram of wood, resulting in a cost of 9.86 cents per pound of glucose produced, assuming 90% conversion and an HCl cost of \$235/ton. This would render the process impracticable.

Due to the minute amounts of HCl in the dilute acid hydrolysis solution, and the fact that HCl and water form an azeotrope at 20.2% HCl, the most opportune time to recover HCl from the wood particles is before they are subjected to dilute acid hydrolysis.

Wood particles exposed to HCl gas for one hour at 314.7 p.s.i.a. were placed in a vacuum formed by a

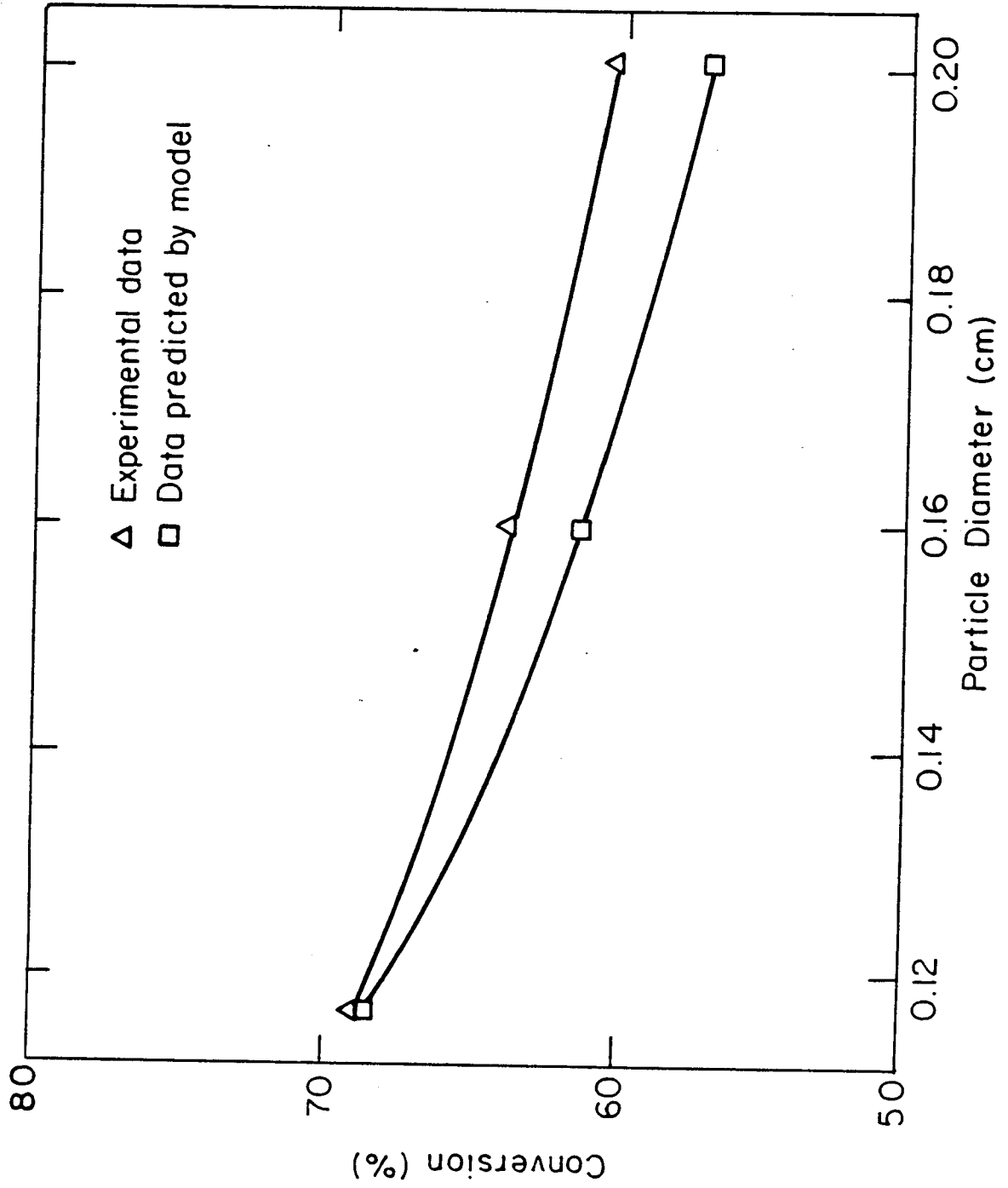
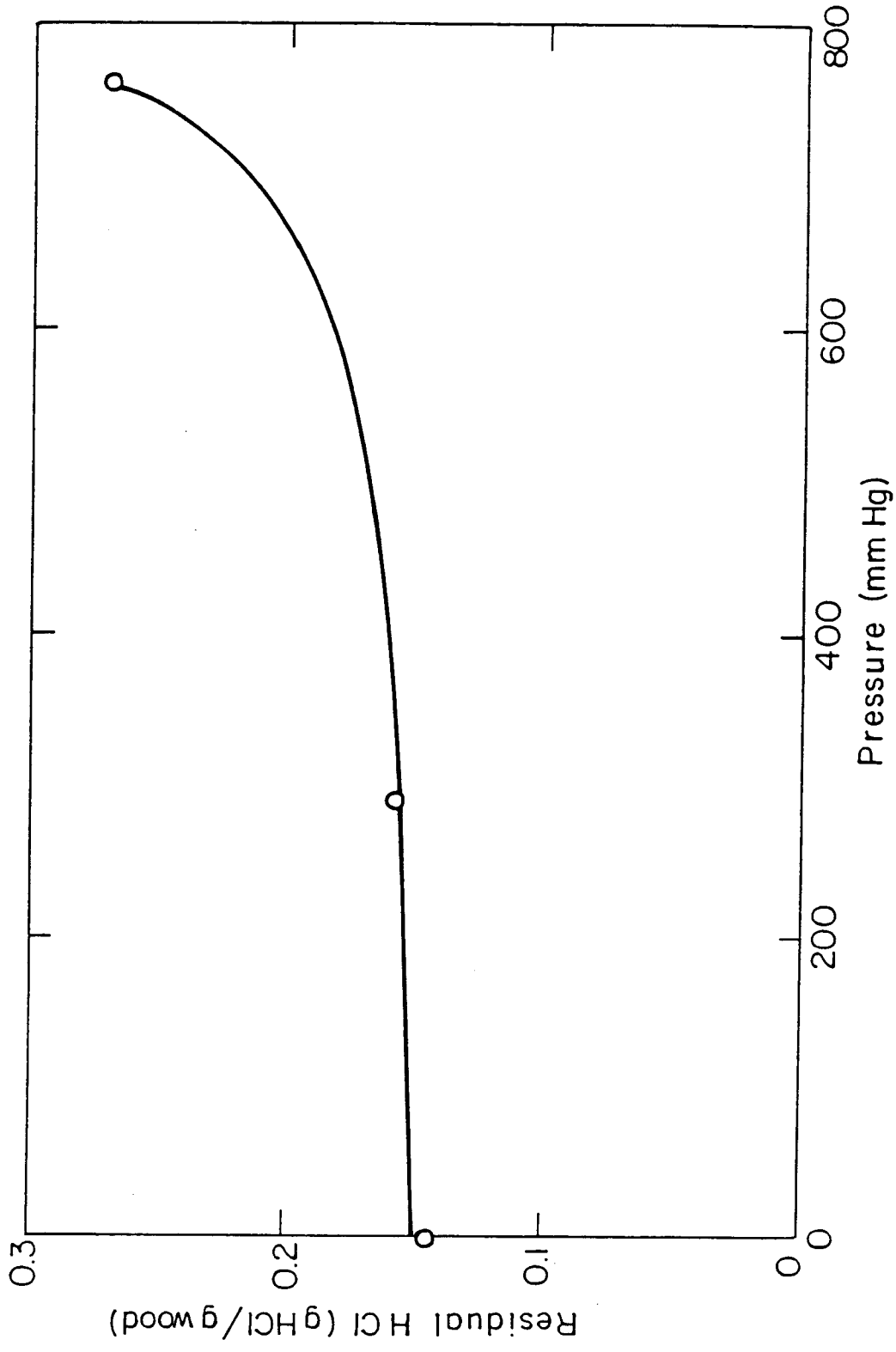

Figure 18. Conversion vs. Wood Particle Size.

XBL 817-6163

cryogenic pumping system where the pressure dropped to 15 microns of mercury. After 30 minutes no more HCl was removed by the vacuum. Upon addition of water the wood particles were exhaustively hydrolyzed for three hours at 121°C, releasing all residual HCl into the solution. Analysis by Sciamanna (9) determined no chloride remained in the wood particles following exhaustive hydrolysis. Analysis of the post-hydrolysis solution for chloride ions yielded the amount of residual HCl in the wood particles. It was determined that 0.1453 g of HCl per gram of wood remained in the wood, most likely in the form of stable adducts formed with the lignin. Assuming the average weight of the lignin monomers is 180, this resulted in 3.33 moles of HCl per mole of substituted phenylpropane unit, not far from that determined by Leschuk, et. al. (10) This loss corresponds to 5.70 cents per pound of glucose produced.

Wood particles were also subjected to a vacuum of 291.3 mm. of Hg. for 30 minutes, yielding results quite similar to those obtained at 15 microns of Hg. vacuum. The residual HCl was found to be 0.1573 g HCl per gram of wood. A plot of residual HCl vs. vacuum pressure is shown in Figure 9. Figure 9 suggests that vacuums formed by ordinary industrial equipment would suffice in an HCl recovery system.



XBL 817-6164

Figure 19. Residual HCl vs. Pressure.

## REFERENCES

1. Sharkov, V., et. al., "Conversion of Difficultly-Hydrolyzed Wood Polysaccharids into a Ready-Hydrolyzed State," Report 3, Vsesoizni, Nauchno-Issledo vatel skii, 21, 1971 pp. 65-71. (translated by G. Shalimoff).
2. Selke, S., et. al., "Chemicals from Wood Via HF," presented at A.C.S. meeting, March 23, 1981, Atlanta, Ga.
3. Botteril, J. and S. Desai, "Heat Transfer Coefficients in Pressurized Fluidized Bed Reactors," Powder Technology, July 1972 p.231
4. Rabinovich, L. and G. Sechenov, Khim. Prom. 43 (a) 1962 p. 703-5.
5. Levenspiel, O. and D. Kunii, Fluidization Engineering, Wiley and Sons, N.Y. 1971
6. Saeman, J., "Kinetics of Wood Saccharification," Ind. and Eng. Chem., Vol. 37, No. 1, pp. 43-52.
7. Yagi, S., and Kunii, D., 5th Symposium (International) on Combustion, Reinhold, N.Y., 1955, p. 231.
8. Levenspiel, O. Chemical Reaction Engineering, Wiley and Sons, N.Y., 1972.
9. Sciamanna, A., private communication.
10. Leshchuk, A.E., E.A. Nagalyuk, N.V. Chalov; "Composition of a Molecular Complex of Hydrogen Chloride with Products of Hydrolytic Degradation of Pinewood by Hydrochloric Acid," Khimiya Drevesiny (Wood Chemistry) 1, 76 (1978). Russian, Translated by G. Shalimoff.

#### 4. Process Economics and Evaluation

##### 4.1 Process Description

The experimental results discussed in the previous chapter were used to design a plant capable of producing 214 tons per day of glucose from air-dried wood particles. The wood used was Populus tristi, a tree native to North America in large numbers. Populus tristi wood is 40% glucose by weight. 214 tons per day of glucose could produce 10,000,000 gallons of ethanol per year if fermented. A plant of this capacity was felt to be adequate to determine the economic feasibility of the process.

Figure 20 shows a preliminary flow sheet for the plant. 357 tons per day of ground wood and 1743 tons per day of inert particles are fed into two fluidized bed reactors (R1 and R2) by rotary screw feeders. The reactors are 20,000 gallons apiece, with a height of 23.88 feet and a diameter of 11.94 feet, based on a 2:1 height-to-diameter ratio used in fluidized bed design. The sizing of all the equipment is described in detail in the Appendix. Each reactor is equipped with a porous gas distributor plate and a cyclone separator to prevent particle elutriation.

Pure HCl at 2226 c.f.m., based upon the experimentally determined fluidizing velocity of 19.88 feet per minute is fed into the first fluidized bed R1. During plant startup

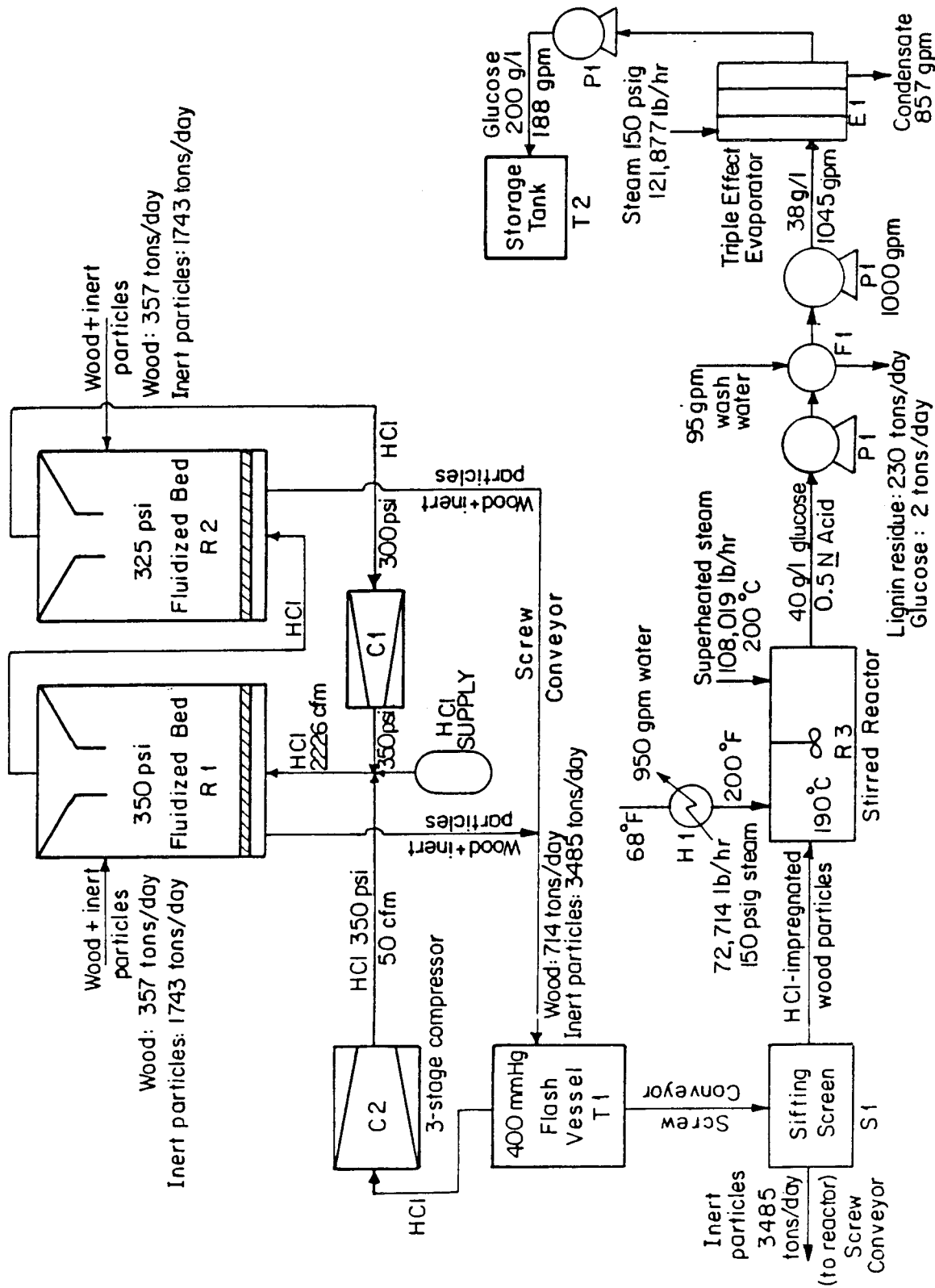

XBL817-6156

Figure 20. Flow Sheet of Fluidized Bed Process.



the HCl is fed directly from a compressed HCl supply; otherwise the HCl recycled from the second reactor (R2) is used to fluidize the bed.

Fluidized bed R1 operates at a pressure of 350 p.s.i.a. Experimental results showed that conversion increased linearly with pressure up to 500 p.s.i.a., and that adequate wood saturation (greater than 70% glucose yields) first occurred at 200 p.s.i.a. The median between these two pressures, 350 p.s.i.a. was used as the design pressure, though a higher pressure could have been used. The residence time in both reactors is 45 minutes, based upon the one hour batch reaction time at 350 p.s.i.a. corresponding to a yield of 80%.

Since the pressure drop across the first reactor is only 25 p.s.i., the HCl exiting the first reactor is piped directly to second fluidized bed without being compressed. The HCl exiting the second fluidized bed is compressed to 350 p.s.i.a. by a 600 horsepower compressor (C1) and recycled to the first reactor.

The wood-inert particles exit the fluidized beds through rotary cutoff valves to prevent excessive HCl leakage, and are fed by screw conveyors to a 21,700 gallon flash vessel T1. HCl is pumped off and compressed to 350 p.s.i.a. by a 328 horsepower three-stage compressor (C2) and recycled at a rate of 50 c.f.m. to fluidized bed reactor R1. The flash vessel operates at an experimentally

determined optimum pressure of 400 mm. Hg., with a residence time of 30 minutes, based upon experimental findings.

HCl losses totalling 0.1453 lb. per pound of wood are not recovered because of the stable adducts formed between the HCl and the wood.

The wood-inert particle mixture exits the flash vessel through an enclosed rack and pinion gate, chosen for its air-tight operation, and are fed by screw conveyor onto a 50 ft.<sup>2</sup> vibrating sifting screen S1. The screen separates the smaller (by a factor of four) inert particles from the wood. The particles are sent by screw conveyor back to the fluidized beds.

Since HCl is corrosive only in the presence of water, and the fluidized beds, compressors, flash vessel, and screen are all operated anhydrously, these pieces of equipment are all constructed of carbon steel.

The wood particles are screw-conveyed into a 7000 gallon continuous stirred reactor (R3) for dilute acid hydrolysis. Water is heated to 200<sup>o</sup>F in heat exchanger H1 and added in a ratio of 8 ml. per gram of wood (950 gallons per minute), the lowest ratio which enables the wood to be sufficiently wet and still be able to be readily agitated. The reaction temperature is raised to 190<sup>o</sup>C by the addition of superheated steam. The water breaks the HCl-wood adducts, creating an acid strength of 0.5 N HCl. The residence time is seven minutes, based upon the  $t_{\max}$  calculated from

Saeman's kinetic data on the consecutive first order hydrolysis and decomposition reactions at 190°C. The reactor is constructed of monel to prevent HCl corrosion. The conversion is 80% of the theoretical glucose. The solution exits the reactor at 40 grams per liter of glucose.

The lignin residue is filtered off and washed in a 713 ft.<sup>2</sup> vertical leaf filter (F1), chosen for its large handling capacity. 1% glucose losses in the residue are assumed in the filtering stage, based upon experimental findings of Dunning and Lathrop in their hydrolysis work (1). 230 tons per day (dry basis) of residue is filtered off. The residue is to be air-dried before it is combusted in the steam boilers. 95 gallons per minute of wash water is used, diluting the filtrate to 36 grams per liter of glucose.

The solution is then pumped to a 8000 ft.<sup>2</sup> triple-effect evaporator, where it is concentrated to 200 grams per liter, the desired concentration for fermentation. The filter, pumps, and evaporator are constructed of monel to prevent corrosion.

A 35 tons per day mill is used to grind the wood, and the wood particles and lignin are air-dried on the plant site. The plant should be located in an area of low year-round humidity and precipitation to facilitate the drying, and preferably near the lumber industry. Ideal locations would be the semi-arid areas of eastern Oregon or Washington.

It was estimated to take three days to dry the ground wood particles, based on wood particle drying data for a one-half inch layer from Sciamanna (2).

A 10,000,000 gallon storage tank is used to store 20 days supply of dry wood particles. A 20 days supply of raw materials is considered necessary for plant operation (3), especially if inclement weather inhibits the air-drying.

#### 4.2 Process Economics

Table 1 lists the purchase costs for the equipment used in the process. Cost estimating data were taken from Peters and Timmerhaus (4), Baasel (5), Happel and Jordan(6), Guthrie (7), and Valle-Riestra (3). Cost estimating procedures are shown in full detail in the Appendix. The total purchase cost was estimated to be \$4,420,680.

Table 2 lists the associated costs for the plant development, such as installation, construction, and contractors' fees. These costs were summed to determine the direct fixed capital expenditure, which totalled \$22,905,488.

Table 3 lists the consumption and costs of raw materials and utilities for one year. The cost of wood was set at \$25 per ton, based upon the cost of wood chips shipped less than 50 miles determined by Georgia Tech (8). 232,007 tons of wood are needed per year, at a cost of

\$5,800,168. 33,711 tons of HCl are unrecovered per year. At the current HCl cost of \$235 per ton, this totals \$7,921,986, about \$2 million more than the yearly expenditure for wood. Thus the raw materials cost total \$13,722, 154 per year.

2.36 billion pounds of steam are needed per year by the evaporator, water heater, and hydrolysis vessel. Table 3 lists the steam consumption for each piece of equipment. The cost of steam was set at \$0.40 per 1000 pounds, about 10 times lower than normal, because of the energy received from the air-dried lignin combustion in the steam boilers. Yang and Wilke (9) estimated steam to cost \$0.33 per 1000 pounds in 1978 when substantial amounts of lignin residue is burned to create steam. The energy received from the air dried lignin exceeds the steam energy requirement by 46%. No cost is assumed for air-drying the lignin. At \$0.40 per 1000 pounds, the yearly steam cost is \$944,137.

529,308,000 gallons of water per year are needed for hydrolysis, interstage cooling, and for the filter wash stream. Table 3 lists the individual consumption for all three process steps. At a cost of \$0.14 per 1000 gallons, this totals \$74,103 per year.

The electrical requirement was estimated to be 3,000,000 kw-hr per year. At a cost of 2.4 cents per kw-hr, this amounts to \$72,000 per year. The yearly utility

Table 1  
Equipment List

	Capacity	Material	Number	Purchase Cost (Feb 1981)
1. Fluidized bed reactors (R1, 2)	20,000 gal	carbon steel	2	\$ 366,273
2. Distributor plates	12 ft. radius	carbon steel	2	5,135
3. Cyclone separators	2226 cfm	carbon steel	2	7,440
4. Single stage compressor (C1)	600 hp	carbon steel	2 (1 backup)	444,986
5. 3-stage compressor (C2)	328 hp	carbon steel	2 (1 backup)	333,616
6. Flash vessel (T1)	21,700 gal	carbon steel	1	133,505
7. Sifting screen (S1)	50 ft. <sup>2</sup>	carbon steel	1	33,690
8. Hydrolysis reactor (R3)	7000 gal	monel	1	301,204
9. Agitation for R3	35 hp	monel	1	80,984
10. Vertical leaf filter (F1)	713 ft. <sup>2</sup>	monel	2 (1 backup)	215,306
11. Centrifugal pump (P1)	1100 g.p.m.	monel	6 (3 backup)	186,822
12. Triple-effect evaporator (E1)	8000 ft. <sup>2</sup>	monel	1	1,064,770
13. Water heater (H1)	600 ft. <sup>2</sup>	carbon steel	1	10,829
14. Storage tank (T2)	1,000,000 gal	carbon steel	1	133,839

Table 1: Equipment List (cont.)

	Capacity	Material	Number	Purchase Cost (Feb 1981)
15. grinder	35 tons/day	carbon steel	1	\$ 26,719
16. inert particles	---	ceramic, silicon dioxide	1	121,104
17. Wood storage	10,000,000 gallons	carbon steel	1	922,573
18. Screw conveyors	100 ft total	carbon steel	-	31,885
				\$ 4,420,680

Table 2  
Costs for Plant Construction

	Cost
Purchase cost (PC)	\$ 4,420,680
Installation (0.45 PC)	1,989,306
Process piping (0.285 PC)	1,259,894
Instrumentation (0.15 PC)	663,102
Electrical facilities (0.11 PC)	486,275
Process buildings (0.255 PC)	1,127,273
Land Improvement (0.16 PC)	707,309
Auxiliary facilities (0.15 PC)	663,102
<b>Total Plant Indirect Cost (TPIC)</b>	<b>\$ 11,316,941</b>
Engineering (0.25 TPIC)	\$ 2,829,235
Construction (0.35 TPIC)	3,960,929
<b>Total Plant Cost (TPC)</b>	<b>\$ 18,107,105</b>
Contractors (0.065 TPC)	\$ 1,176,962
Contingency (0.30 TPC)	3,621,421
<b>DIRECT FIXED CAPITAL (DFC)</b>	<b>\$ 22,905,488</b>



Table 3  
Raw Materials and Utility  
Costs for One Year

	Unit Price	Consumption	Cost/Yr
<u>Raw Materials:</u>			
Wood	\$ 25/ton	232,007 ton/yr	\$ 5,800,168
HCl	235/ton	.1453 tons/ton wood	7,921,986
TOTAL			\$13,722,154
<u>Utilities:</u>			
Electricity	2.4¢ kw-hr	3,000,000 kw-hr/yr	\$ 72,000
Water:	\$0.14/1000 gal		
Interstage Cooling		40,248,000 gal/yr	
Hydrolysis Reaction		444,600,000 gal/yr	
Wash Stream		44,460,000 gal/yr	
TOTAL			\$ 74,103
<u>Steam:</u>			
Preheater		567,153,600 lb/yr	
Hydrolysis Reaction		842,548,200 lb/yr	
Evaporator		950,640,600 lb/yr	
TOTAL			\$ 944,137
TOTAL			\$ 1,090,240

cost for electricity, water, and steam was estimated to be \$1,090,240.

Table 4 lists the yearly operating expenses, such as labor, maintenance, and taxes. Twenty-four operators at a mean salary of \$22,000 were estimated to comprise the labor force. The methods and utility costs of Valle-Riestra were used to estimate the expenses in Tables 2, 3, and 4, and the methods are outlined in those tables.

The costs of manufacture (C.O.M.) of glucose was estimated in the following manner, based on 325 days per year of plant operation:

$$\begin{aligned}
 \text{C.O.M. glucose} &= \frac{\begin{aligned} &(\text{operating expenses/yr}) \\ &+ (\text{raw material cost/yr}) \\ &+ (\text{utility costs/yr}) \end{aligned}}{(\text{lbs. of glucose produced/yr})} \\
 &= \frac{\$6,368,517 + \$13,722,154 + \$1,090,240}{(214) (2000) (325)} \\
 &= 15.23 \text{ cents per pound}
 \end{aligned}$$

The cost of manufacture is most sensitive to the cost of wood. If wood costs rose to \$50 per ton, the C.O.M. of glucose would rise to 19.41 cents per pound. The C.O.M. of glucose can be quickly estimated by the following equation:

$$\text{C.O.M. glucose} = 0.167C_w + 11.06$$

Table 4

## Yearly Operating Expenses

	cost/yr
Labor Salaries (24 men @ \$22,000/yr) (LS)	\$ 528,000
Fringe benefits (.22 LS)	116,160
Clerical, Supervision (.18 LS)	95,040
Operating supplies (.10 LS)	52,800
Laboratory (.15 LS)	79,200
Maintenance (.06 DFC)	1,374,329
Depreciation (.10 DFC)	2,290,549
Insurance (.01 DFC)	229,055
Local Taxes (.02 DFC)	458,110
Factory expenses (.05 DFC)	1,145,274
<b>TOTAL</b>	<b>\$ 6,368, 517</b>

where  $C_w$  is the cost of wood in dollars per ton and C.O.M. is in cents per pound. HCl losses represent 5.70 cents per pound of glucose produced.

The cost of ethanol fermentation can be estimated by the following equation, originally developed by Cysewski, and updated to 1981 cost (10):

$$C_E = 0.145C_G + 0.35 \quad (1)$$

where  $C_G$  is the cost of glucose in cents per pound, and  $C_E$  is the cost of ethanol production in dollars per gallon. Ethanol fermented from glucose costing 15.23 cents per pound costs \$2.56 a gallon, which is not competitive with gasoline prices in 1981. The major contributors to the cost are HCl losses and the cost of wood. HCl losses add 83 cents per gallon to the cost of ethanol. Even with no HCl losses, wood would have to cost less than \$10 per ton to produce ethanol which is competitive with gasoline. Wood at \$16 per ton would produce ethanol at \$1.50 per gallon, assuming 100% HCl recovery.

A by-product of the reaction is xylose, whose production totals 26,847 tons per year, or 82.6 tons per day. The xylose can either be dehydrated to form furfural, or fermented to ethanol. No by-product credit was given for xylose in the process economics, due to its inability to be as efficiently fermented as glucose.

The xylose could be dehydrated to form furfural; however the xylose solution may be too dilute for furfural production to be economically feasible. Future work on the economics of furfural production from dilute xylose solutions would be beneficial.

Another possible handling of the xylose stream would be subjecting it to anaerobic bacterial digestion, resulting in the formation of methane gas. This could be a feasible way to handle the organic waste streams originating in the process. No economics were done on handling waste streams in this manner.

## References

1. Dunning, J. and E. Lathrop, "The Saccharification of Agricultural Residues," Ind. and Eng. Chem, Vol 37, 1945 p. 24.
2. Sciamanna, A., private communication.
3. Valle-Riestra, J., class notes, Chem. Eng. 263, Univ. of California, Fall 1980.
4. Peters, M. and K. Timmerhous, Plant Design and Economics for Chemical Engineers, 3rd Ed., McGraw-Hill Book Co., N.Y., 1980.
5. Baasel, W., Preliminary Chemical Engineering Plant Design, Elsevier North Holland, Inc., N.Y., 1976.
6. Happel, J. and G. Jordan, Chemical Process Economics, 2nd Ed., Wiley and Co., N.Y., 1975
7. Guthrie, K., "Capital Cost Estimating," Chem. Eng., March 24, 1969, p. 114.
8. O'Neil, D., et. al., "Design, Fabrication, and Operation of a Biomass Fermentation Facility," progress report prepared for U.S. Dept. of Energy, December 1978.
9. Yang, R. and C. Wilke, et. al., "Raw Materials Evaluation and Process Development Studies for Conversion of Biomass to Sugars and Ethanol," UCLB-7847, June 1978.
10. Cyzewski, G., "Fermentation Kinetics and Process Economics for the Production of Ethanol," Filed as a Ph.D. thesis, University of California, 1976.

## Summary and Conclusions

The fluidized bed reactor proved to be an efficient way to saturate wood with HCl has under pressure as a pretreatment for HCl acid hydrolysis. The reactor dissipated virtually all of the heat released upon HCl absorption, which prevented severe decomposition of the wood particles. Yields of glucose were 80% with batch reaction times of one hour at 314.7 p.s.i.a., and xylose yields under the same conditions were 95%.

The kinetics of the reaction between HCl and wood was found to be a first order reaction with respect to HCl concentration. The first order reaction rate constant was calculated to be  $0.003 \text{ min.}^{-1}$ . It was found that reaction times longer than 60 minutes were unnecessary for saturation.

The HCl-wood reaction mechanism was described by the unreacted core model for spherical particles of unchanging size, with diffusion of the gas through the solid limiting the reaction rate. According to the model, the factors which affect the conversion the greatest are particle size and reaction pressure. The model enabled the prediction of the diffusion coefficient of HCl gas through the wood. The coefficient was calculated to be  $7.898 \times 10^{-8} \text{ cm.}^2/\text{sec.}$ , which suggested HCl saturates the wood by a Knudsen pore diffusion mechanism.

It was found that HCl gas forms a stable adduct with the lignin residue in the wood. 0.1453 grams of HCl per gram of wood is retained by the wood after pressurized HCl saturation. This corresponded to 3.33 moles of HCl per mole of lignin monomer. The adduct is broken upon the addition of water.

The glucose formed could be fermented to form ethanol. Glucose costing 15.23 cents per pound to produce results in an ethanol production cost of \$2.56 per gallon, which is not competitive with gasoline prices at this time if the ethanol is to be used in gasohol.

Two factors contributed to the high cost of glucose production. HCl losses totalled 5.70 cents per pound of glucose, or 38% of the total production costs. This loss contributes 83 cents per gallon to the cost of ethanol. The other factor is the cost of wood. At \$25 per ton, wood costs amount to 4.17 cents per pound of glucose, or 28% of the total manufacturing cost. At \$50 per ton, wood costs comprise 43% of the total cost.

HCl must be recovered from the post-hydrolysis dilute acid solution (0.5N HCl) to make the process more economically feasible. Little research has been done in this area, and future research on this project should be directed toward HCl recovery from dilute acid solutions. Assuming no cost for wood, ethanol production costs are



\$1.94 per gallon; with 100% HCl recovery, the cost drops to \$1.11 per gallon. With wood at \$25 per ton, the cost is \$1.73 per gallon when all the HCl is recovered.

Wood prices would have to be lower than \$25 per ton to make the ethanol competitive with gasoline in 1981, even with 100% HCl recovery. At \$16 per ton ethanol costs \$1.51 per gallon to produce; therefore wood would have to cost less than \$10 per ton to make the ethanol competitive with gasoline as an alternative fuel.

## Appendix

## 1. Size and Cost of fluidized bed reactors R1 and R2:

The volume of the fluidized beds were estimated by the following equation:

$$V = \tau F \quad (1)$$

where  $\tau$  is the residence time and  $F$  is the volumetric flow rate for the 17% wood-inert particle mixture.  $\tau$  was estimated to be 45 minutes, and  $F$  was calculated by measuring the volume of the wood-inert particle to be 0.73 gallons per pound of wood, and knowing wood was being fed at 495.8 pounds per minute; thus  $F$  equals  $(495.8)(0.73) = 361.9$  gallons per minute. This yielded a reactor volume of 16,300. This was raised to 20,000 gallons (a 23% increase) to account for bed expansion upon fluidization and to allow space for the cyclones. The dimensions of the reactors are 23.88 feet high and 11.94 feet in diameter, based on a 2:1 height to diameter ratio used for fluidized bed reactor design.

The cost was estimated by the cost formula for pressurized process vessels from Happel and Jordan (1):

$$\text{cost, (July 1970)} = 22(V)^{0.82} \text{ for carbon steel} \quad (2)$$

where  $V$  is the reactor volume in gallons, and the cost in dollars. The cost was updated to February 1981 costs by use of the Marshall and Stevens cost indices, which were 124.1 for fabricated equipment in July, 1970, and 307.1 for February 1981. The reactor cost amounted to:

$$22(20,000)^{0.82}(307.1)/(124.1) = \$183,137$$

The total for both reactors came to \$366,273

## 2. Size and cost of compressors C1 and C2:

The horsepower requirement for compressor C1 was calculated by the following equation, taken from Peters and Timmerhaus (2),

$$\text{h.p.} = \frac{(3.03 \times 10^{-5})(k)(p_1)(q_1)}{k-1} \left[ \left( \frac{p_2}{p_1} \right)^{k-1/k} - 1 \right] \quad (3)$$

where  $k$  is the ratio of the specific heat of the gas at constant pressure to the specific heat at constant volume (assumed to 1.4, the value for an ideal gas),  $p_1$  is the intake pressure and  $p_2$  the delivery pressure in  $\text{lb./ft.}^2$ , and  $q_1$  the gas flow at intake conditions in cubic feet per minute. For C1,  $p_1 = 43,200 \text{ lb./ft.}^2$ ,  $p_2 = 50,400 \text{ lb./ft.}^2$ , and  $q_1 = 2597 \text{ c.f.m.}$ , yielding a brake horsepower requirement

of 536 horsepower. This was raised to 600 horsepower by assuming the standard compressor efficiency of 90%.

The cost of C1 was estimated from Figure 13-50 in Peters and Timmerhaus (2). The graph yielded a January 1979 purchase cost of \$160,000 for a 600 h.p. centrifugal motor compressor. This was updated to February 1981 costs by the ratio of the cost indices for pumps and compressors for the two dates (374.9/269.6). This yielded a February 1981 purchase cost of \$222,493.

The power requirement for the three-stage compressor C2 was found by the following equation, taken from Peters and Timmerhaus (2)

$$\text{h.p.} = \frac{(3.03 \times 10^{-5})(k)(N_s)(p_1)(q_1)}{k - 1} \left[ \left( \frac{p_2}{p_1} \right)^{k-1/kN_s} - 1 \right] \quad (3)$$

where  $N_s$  is the number of stages, and the other quantities defined as before. The intake pressure was 1113.1 lb./ft.<sup>2</sup>, the delivery pressure was 50,400 lb./ft.<sup>2</sup>, and  $q_1$  equaled 1931.3 c.f.m., yielding a total power requirement of 328 horsepower.

The cost of C2 was estimated from Figure 13-45 in Peters and Timmerhaus (2) to be \$120,000 in January 1979 and \$166,808 in February 1981.

3. Size and cost of flash vessel T1

T1 was sized in the same manner as the fluidized beds, with  $\tau$  equal to 30 minutes and F equal to 723.8 gallons per minute, yielding a vessel volume of 21,700 gallons.

The cost was estimated by the cost formula for unpressurized process vessels from Happel and Jordan (1)

$$\text{cost, (July 1970)} = 15(V)^{0.82} \text{ for carbon steel} \quad (4)$$

where V is the reactor volume in gallons and the cost in dollars. This yielded a July 1970 purchase cost of \$53,950, and a February 1981 cost of \$133,505.

4. Size and cost of sifting screen S1

No direct way of estimating screen size is available, so the size was placed at 50 ft.<sup>2</sup>, large for a vibrating screen. The purchase cost of the single deck screen, obtained from Figure 13-89 in Peters and Timmerhaus (2), was \$28,000 in January 1979. Multiplying by the cost indices ratio of 290.7/241.6 for process machinery yielded a February 1981 cost of \$33,690.

5. Size and cost of dilute acid hydrolysis reactor R3

The size was estimated by the relation  $V = \tau F$ , used in estimating the size of the fluidized beds. The residence time  $\tau$  for the reactor is 7 minutes and the flow rate  $F$  of water into the reactor is 950 gallons per minute, yielding a reactor volume of 6,650 gallons. The cost was calculated using the same formula which determined the cost of the fluidized beds, yielding a July 1970 cost of \$31,290 for carbon steel construction. Monel construction is needed to prevent corrosion, thus a monel cost multiplier of 3.89, recommended by Guthrie (3) raised the cost to \$121,717. Updating to February 1981 costs by the ratio 307.1/124.1 gave a purchase cost of \$301,204.

The power requirement for agitation was estimated to be 35 horsepower, based upon an agitation power requirement of 5 horsepower per 1000 gallons of vessel volume recommended by Happel and Jordan (1). The cost of agitation was found by the formula, also from Happel and Jordan (1)

$$\text{cost (July 1970)} = 1,070(P)^{0.58} \text{ for carbon steel} \quad (5)$$

where  $P$  is the power requirement in horsepower. This yielded a cost of \$8,413. Monel construction (3.89 multiplier) raised the cost to \$32,726, and updating to February 1981 by the ratio 307.1/124.1 gave a purchase cost of \$80,984.

## 6. Size and cost of filter F1

The size of the filter was estimated by the equation

$$A = Q/R \quad (6)$$

where Q is the volumetric flow rate into the filter, R is the filtration rate of the filter, and A is the area of the filter. R was estimated to be 80 gallons per square foot of filter area per hour, the mean filtration rate for water with solids recommended by the Chemical Engineer's Handbook (4). With Q equal to 950 gallons per minute, the filter area was estimated to be 713 ft.<sup>2</sup>

The purchase cost of the vertical leaf filter, chosen for its large handling capacity, was estimated from Figure 13-64 in Peters and Timmerhaus to be \$23,000. Monel construction raised the cost to \$89,470, and updating to February 1981 costs by the ratio 290.7/241.6 yielded a cost of \$107,653.

## 7. Size and cost of pump P1

The total flow rate entering the centrifugal pump, chosen for its ability to deliver fluids at uniform pressure and for its simple construction, was 1045 gallons per minute. At a discharge pressure of 100 p.s.i.g.,

normal for a pump of this size, the purchase cost including motor was estimated from Figure 13-41 of Peters and Timmerhaus (2) to be \$8,000 in January 1979. The pump needs monel construction, so multiplying the cost by 2.80, the monel construction multiplier for pumps (2) raised the cost to \$22,400. Updating the costs to February 1981 by the cost indices ratio for pumps and compressors (374.9/269.7) yielded a purchase cost of \$31,137.

#### 8. Size and cost of evaporator E1

The size of the triple-effect evaporator was found by heat and material balances over each of the three effects. These balances are outlined in McCabe and Smith (5). The overall heat transfer in each effect was assumed to be 500 BTU/ft.<sup>2</sup> -hr -°F. The entering and exiting glucose concentrations were 36 and 200 grams per liter, respectively. The feed rate was 1045 gallons per minute, and the evaporation rate was 7150 lb. H<sub>2</sub>O/min. Successive approximations to equate the areas in each effect yielded a total heat transfer area of 7960 ft.<sup>2</sup>

The cost of the vertical tube evaporator was found by the relation (4)

$$\text{cost (June 1968)} = 1200(A)^{0.53} \text{ for carbon steel} \quad (7)$$

where A is the heat transfer surface area. The evaporator cost was estimated to be \$140,546. The evaporator needs to



to be constructed of monel, so multiplying the cost by 3.65, the monel construction multiplier for heat exchangers (3), raised the cost to \$512,993. Updating the cost to February 1981 by the ratio 241.6/116.4 for process machinery gave a purchase cost of \$1,064,770.

9. Size and cost of water heater H1

950 gallons per minute of water are heated from 68°F to 200°F by 150 p.s.i.g. steam in a heat exchanger, requiring 68,629,608 B.T.U. per hour heat input. The heat exchanger area was estimated by the equation

$$A = Q/U\Delta T_{ln} \quad (8)$$

where Q is the heat required,  $\Delta T_{ln}$  is the log mean temperature difference, and U is the overall heat transfer coefficient. U was estimated to be 500 BTU/ft.<sup>2</sup> -hr -°F, the mean value for an exchanger heating water with steam, and  $\Delta T_{ln}$  was calculated to be 219.4°F. The heat exchanger area was calculated to be 571 ft.<sup>2</sup> 72,712 pounds per hour of 150 p.s.i.g. steam are required.

The January 1979 cost was estimated from Figure 14-15 from Peters and Timmerhaus (2) to be \$9000 for carbon steel construction. The February 1981 cost was found by the cost indices multiplier 290.7/241.6 to be \$10,829.

10. The size and cost of storage tank T2

The January 1979 cost of the 1,000,000 gallon cone roof storage tank was estimated from Figure 13-60 of Peters and Timmerhaus (2) to be \$110,000. Updating the cost to February 1981 by the ratio  $307.1/252.4$  for fabricated equipment yielded a cost of \$133,839. The cost of the large 10 million gallon storage tank for the 20 day supply of wood was estimated in the same manner to be \$922,573.

11. The size and cost of screw conveyors

The January 1979 cost of the two 20 ft. screw conveyors moving the wood-inert particle mixture from the reactors to the flash vessel (12 in screw diameter, 100 ton/hr capacity) was estimated from Figure 13-92 of Peters and Timmerhaus (2) to be \$4500 apiece. The February 1981 cost was found by the cost indices  $290.7/241.6$  to be \$10,829.

The February 1981 cost of the 20 ft screw conveyor moving the mixture from the flash vessel to the sifting screen (16 in. screw diameter, 250 tons/hr capacity) was estimated in the same manner to be \$9,024.

The February 1981 cost of the screw conveyor (40 ft section, 14 in screw diameter, 160 tons/hr capacity) was estimated in the same manner to be \$12,032.

12. The size and cost of cyclone separators

The cost of the cyclones was estimated by the relation recommended by Baasel (8):

$$\text{cost (June 1968)} = 3(Q)^{0.80} \quad (9)$$

where Q is the gas flow rate through the cyclone (c.f.m.). The HCl flow rate is 2226 c.f.m., yielding a June 1968 cost of \$1,429 apiece. The February 1981 cost was found by the multipliers 290.7/111.7, yielding a cost of \$7440 for both cyclones.

Note: The costs of the rotary valves and the rack-and-pinion gates were too small to be included in the major equipment list. Their cost was accounted for in the process piping cost calculated in Table 2 of Chapter 4.

## References

1. Happel, J. and G. Jordan, Chemical Process Economics, 2nd ed., Wiley and Co., N.Y., 1975.
2. Peters, M. and K. Timmerhaus, Plant Design and Economics for Chemical Engineers, 3rd ed., McGraw-Hill Book Co., N.Y., 1980.
3. Guthrie, K., "Capital Cost Estimating," Chem. Eng., March 20, 1969, p. 114.
4. Chemical Engineers' Handbook, Perry, R. and C. Chilton, eds., 5th ed., McGraw-Hill Book Co., N.Y., 1973.
5. McCabe, W. and J. Smith, Unit Operations of Chemical Engineering, 3rd ed., McGraw-Hill Book Co., N.Y., 1976.
6. Baasel W., Preliminary Chemical Engineering Plant Design, Elsevier North Holland, Inc., N.Y., 1976.