

UC Berkeley

Controls and Information Technology

Title

Technical review of residential programmable communication thermostat implementation for Title 24

Permalink

<https://escholarship.org/uc/item/43q4s9vj>

Authors

Do, Alexander
Burke, William J
Auslander, David M
et al.

Publication Date

2007-11-26

Peer reviewed



CENTER FOR ENVIRONMENTAL DESIGN RESEARCH

Draft Report – Version 0.1
November 26, 2007

Do not cite or reference

TECHNICAL REVIEW OF RESIDENTIAL PROGRAMMABLE COMMUNICATING THERMOSTAT IMPLEMENTATION FOR TITLE 24-2008

Alexander Do,
William J. Burke,
David M. Auslander (Professor of the Graduate School),
Richard M. White (Professor in the Graduate School), and
Paul K. Wright (A. Martin Berlin Chair in Mechanical Engineering)

Abstract

A research team at the University of California, Berkeley was tasked with addressing technical questions arising from the implementation of residential programmable communicating thermostats (PCTs) in California to meet updates to Title 24 building code related to PCTs. The purpose of the project was to perform research, development, and demonstration tasks to: validate the California Energy Commission's PCT vision, answer technical issues related to system integration and implementation, recommend a suitable technology for a statewide one-way communication system for PCTs, and develop a methodology to study the impact of PCTs on electrical demand. The team performed several tasks to achieve these goals.

The team validated the Energy Commission's vision by concluding that it was possible for manufacturers to develop PCTs that: met the proposed Title 24 system interface requirements, could be sold at a retail price less than \$100, and could be manufactured within the Energy Commission's planned Title 24 timeline. This conclusion was the result of a concept for a minimum functionality PCT that was published as a bill of materials and validated with a working proof-of-concept demonstration.

The team researched PCT system interfaces and identified technical issues related to system integration and implementation that should be considered as part of the policy, technology, and system design related to PCT implementation.

The team reviewed technologies that could be used for statewide PCT communication and recommended the Radio Data System (RDS) technology as a suitable solution. The team demonstrated the feasibility of this technology and developed a site survey tool and methodology to study its real-world performance.

Finally, the team developed a load group simulation to characterize the result of PCT pricing and control signals and used the simulation to study certain demand response scenarios. The team found that rebound peak from demand response events can be significant and that strategies to manage this peak should be investigated further.

DISCLAIMER

This report was prepared as the result of work sponsored by the California Energy Commission. It does not necessarily represent the views of the Energy Commission, its employees or the State of California. The Energy Commission, the State of California, its employees, contractors and subcontractors make no warrant, express or implied, and assume no legal liability for the information in this report; nor does any party represent that the uses of this information will not infringe upon privately owned rights. This report has not been approved or disapproved by the California Energy Commission nor has the California Energy Commission passed upon the accuracy or adequacy of the information in this report.

Acknowledgements

The authors would like to thank all those who contributed to the research and development conducted in this project. Specifically, the authors recognize the following individuals who participated as invaluable members of the project team, without whom this work would not have been possible:

- Charles Glorioso
- Ed Koch
- Leonid Vaynberg
- Xin Yang

Additionally, the authors appreciate the support and contributions of the following individuals and organizations:

- The staff at the Center for Environmental Design Research, UC Berkeley
- Charlie Huizenga, UC Berkeley
- Tho Nguyen, UC Berkeley
- Dan Chapman, UC Berkeley
- Joseph J. Tavormina, Tavormina and Associates Inc.
- e-Radio Inc.

Finally, the authors express gratitude for the faithful support of the project's advisors:

- Ron Hofmann, California Institute for Energy and Environment, Consultant
- Gaymond Yee, California Institute for Energy and Environment

This is a draft report. Please do not cite or reference.

Preface

The Public Interest Energy Research (PIER) Program supports public interest energy research and development that will help improve the quality of life in California by bringing environmentally safe, affordable, and reliable energy services and products to the marketplace.

The PIER Program, managed by the California Energy Commission (Energy Commission), conducts public interest research, development, and demonstration (RD&D) projects to benefit California.

The PIER Program strives to conduct the most promising public interest energy research by partnering with RD&D entities, including individuals, businesses, utilities, and public or private research institutions.

PIER funding efforts are focused on the following RD&D program areas:

- Buildings End-Use Energy Efficiency
- Energy Innovations Small Grants
- Energy-Related Environmental Research
- Energy Systems Integration
- Environmentally Preferred Advanced Generation
- Industrial/Agricultural/Water End-Use Energy Efficiency
- Renewable Energy Technologies
- Transportation

Technical Review of Residential Programmable Communicating Thermostat Implementation for Title 24-2008 is the final report for the Programmable Communicating Thermostat (PCT): Prototype Development for Title 24 project conducted by the University of California, Berkeley and managed by the California Institute for Energy and Environment. The information from this project contributes to PIER's Energy Systems Integration Program.

For more information about the PIER Program, please visit the Energy Commission's website at www.energy.ca.gov/pier or contact the Energy Commission at 916-654-5164.

Table of Contents

| | |
|--|----|
| Acknowledgements..... | 3 |
| Preface..... | 4 |
| Abstract..... | 11 |
| Executive Summary | 13 |
| 1.0 Introduction..... | 17 |
| 1.1. The Programmable Communicating Thermostat | 17 |
| 1.2. California Energy Commission Vision of PCT System Interfaces | 17 |
| 1.3. Technical Questions to Be Answered | 19 |
| 1.4. Project Objectives..... | 19 |
| 1.5. Report Organization..... | 22 |
| 2.0 Project Approach..... | 25 |
| 2.1. PCT System Interfaces, Minimum Functionality PCT Concept, and Support of Title 24 PCT Technical Working Group..... | 25 |
| 2.2. PCT Proof-of-Concept (POC)..... | 26 |
| 2.3. RDS Site Survey Tool | 27 |
| 2.4. PCT Systemic Control Research | 28 |
| 2.5. Recommendation for One-Way Interface..... | 28 |
| 3.0 Summary of Project Outcomes..... | 31 |
| 3.1. Preliminary Research | 31 |
| 3.2. Task 1.1: Investigate PCT System Interfaces..... | 31 |
| 3.3. Task 1.2: Minimum Functionality PCT Concept | 31 |
| 3.4. Task 1.3: PCT Proof-of-Concept..... | 32 |
| 3.5. Task 2.1: Demonstrate RDS One-Way Communication..... | 32 |
| 3.6. Task 2.2: Demonstrate Two-Way Communication..... | 32 |
| 3.7. Task 2.4: RDS Site Survey Tool..... | 33 |
| 3.8. Task 2.5: PCT Systemic Control Research | 33 |
| 3.9. Task 2.6: Support the Title 24 PCT Technical Working Group | 33 |
| 3.10. Task 2.7: Recommendation for One-Way Interface | 33 |
| 4.0 Preliminary Research | 35 |
| 4.1. PCT Stakeholders..... | 35 |
| 4.2. Use Scenarios..... | 38 |
| 4.3. Functional Requirements and Constraints..... | 41 |

| | | |
|-------|--|-----|
| 5.0 | Technology Survey | 47 |
| 5.1. | Approach | 47 |
| 5.2. | Communication Interface | 47 |
| 5.3. | Expansion Interface | 49 |
| 5.4. | Human-Machine Interface..... | 54 |
| 5.5. | HVAC Interface..... | 55 |
| 6.0 | PCT Communication Interface Questions and Issues | 57 |
| 6.1. | Objective..... | 57 |
| 6.2. | Approach | 57 |
| 6.3. | Universal Questions and Issues for the Communication Interface | 59 |
| 6.4. | Additional two-Way Specific Issues | 62 |
| 6.5. | Results for One-Way Primary Candidates..... | 64 |
| 6.6. | Recommendations and Conclusions..... | 80 |
| 7.0 | Key Technical Issues..... | 81 |
| 7.1. | Objective..... | 81 |
| 7.2. | Expansion Interface | 81 |
| 7.3. | Human-Machine Interface..... | 85 |
| 7.4. | HVAC Interface..... | 88 |
| 7.5. | System Design..... | 93 |
| 8.0 | PCT System Interfaces and Minimum Functionality PCT Concept | 99 |
| 8.1. | Background..... | 99 |
| 8.2. | Objective..... | 101 |
| 8.3. | Approach | 101 |
| 8.4. | Results | 103 |
| 8.5. | Conclusion and Recommendations | 107 |
| 8.6. | Epilogue | 108 |
| 9.0 | PCT Proof-of-Concept..... | 109 |
| 9.1. | Objective..... | 109 |
| 9.2. | Approach | 109 |
| 9.3. | Phase 1 Proof-of-Concept | 110 |
| 9.4. | Phase 2 Proof-of-Concept | 132 |
| 9.5. | Conclusions | 135 |
| 10.0 | RDS Site Survey Tool..... | 137 |
| 10.1. | Background..... | 137 |

| | | |
|-------|---|-----|
| 10.2. | Objective..... | 137 |
| 10.3. | System Architecture and Components..... | 138 |
| 10.4. | Key Questions | 141 |
| 10.5. | Proposed Methods..... | 142 |
| 10.6. | Preliminary Testing and Results..... | 148 |
| 10.7. | Conclusions and Recommendations..... | 154 |
| 11.0 | PCT Systemic Control | 155 |
| 11.1. | Background..... | 155 |
| 11.2. | Objective..... | 155 |
| 11.3. | Simulation Overview | 155 |
| 11.4. | Simulation Results..... | 165 |
| 11.5. | Discussion..... | 170 |
| 11.6. | Conclusions and Recommendations..... | 174 |
| 12.0 | Wide Area Network One-Way Interface Recommendation..... | 175 |
| 12.1. | Background..... | 175 |
| 12.2. | Objective..... | 175 |
| 12.3. | Key Evaluation Criteria (Approach)..... | 176 |
| 12.4. | Results | 176 |
| 12.5. | Conclusion and Recommendation | 179 |
| 12.6. | Contact Information for Known Players | 179 |
| 13.0 | Conclusions and Recommendations..... | 181 |
| 13.1. | Conclusions | 181 |
| 13.2. | Recommendations | 182 |
| 13.3. | Benefits to California..... | 184 |
| | References..... | 185 |
| | Glossary of Acronyms and Definitions | 188 |
| | Acronyms | 188 |
| | Definitions..... | 191 |
| | Appendix A: Minimum Functionality PCT Bill of Materials | |
| | Appendix B: Human Machine Interface Scenarios | |
| | Appendix C: TranRunC | |
| | Appendix D: RDS Receiver | |
| | Appendix E: RDS Demo Protocol and Transmitter | |
| | Appendix F: PCT Slug Setup | |

List of Figures

| | |
|--|-----|
| Figure 2.1. Design flow for axiomatic design process, as used in this project..... | 26 |
| Figure 3.1. PCT proof-of-concept | 32 |
| Figure 3.2. Comparison of air conditioning load between a DR event and base load..... | 33 |
| Figure 4.1. Stakeholder map | 38 |
| Figure 6.1. Example FLEX paging subsystem implementation. Source: CIC92800 FLEXchip Technical Data Manual V2.0..... | 78 |
| Figure 8.1. Functional decomposition of PCT functions and components..... | 102 |
| Figure 8.2. Cost overview of communication interface..... | 103 |
| Figure 8.3. Cost overview of human-machine interface | 104 |
| Figure 8.4. Cost overview of HVAC interface | 104 |
| Figure 8.5. Cost overview of expansion interface | 105 |
| Figure 8.6. Summary of bill of materials for minimum functionality PCT | 106 |
| Figure 8.7. Advertisement from Home Depot® from April 2006 showing retail prices of programmable thermostats..... | 107 |
| Figure 8.8. PCT proof-of-concept | 108 |
| Figure 9.1. Phase 1 PCT proof-of-concept..... | 110 |
| Figure 9.2. Phase 1 proof-of-concept system architecture | 111 |
| Figure 9.3. Radio receiver and decoder | 113 |
| Figure 9.4. Human Machine Interface | 114 |
| Figure 9.5. HVAC Interface, rear of wall-mount..... | 115 |
| Figure 9.6. Connection between PCT proof-of-concept and simulated system..... | 116 |
| Figure 9.7. PCT task diagram..... | 119 |
| Figure 9.8. Goal Seeker states..... | 120 |
| Figure 9.9. User Interface states..... | 122 |
| Figure 9.10. Supervisor states | 125 |
| Figure 9.11. Coordinator state diagram..... | 126 |

Figure 9.12. HVAC state diagram 128

Figure 9.13. Phase 2 proof-of-concept being demonstrated at the California ISO. 132

Figure 9.14. Radio Switching 135

Figure 10.1. RDS Field Kit Diagram..... 138

Figure 10.2. Components of RDS Data Logger..... 139

Figure 10.3. Signal Strength ADC conversion levels. Source: TEA5764HN Product Datasheet. 144

Figure 10.4. Diagram of data logger location within test house 149

Figure 10.5. a) Data logger mounted below existing thermostat; b) Data logger mounted in basement next to washing machine, seen with dipole antenna mounted near ceiling 150

Figure 10.6. Groups received for furnace closet receiver on 88.5 MHz 154

Figure 11.1. Load Group Simulation Task Diagram..... 156

Figure 11.2. PCT Task Diagram 160

Figure 11.3. Base Simulation: Well Insulated 162

Figure 11.4. Base Simulation: Poorly Insulated..... 162

Figure 11.5. Simulation Extents: Well Insulated 163

Figure 11.6. Simulation Extents: Poorly Insulated 164

Figure 11.7. Population Testing..... 165

Figure 11.8. Static DR Event..... 166

Figure 11.9. Single Message Ramped Setpoint Profile 167

Figure 11.10. Multi Message Ramped Setpoint Profile 167

Figure 11.11. Single Message Ramped Exit..... 168

Figure 11.12. Ramped Exit Comparison – 240min Ramp 169

Figure 11.13. Random End Time 170

Figure 11.14. Effective Time Comparison 171

Figure 11.14. Comparison: Daily Energy 172

Figure 11.15. Comparison: Max Power 172

Figure 11.16. Comparison: Discomfort..... 173

Figure 11.17. Recovery: 240 min Ramp v. Random Comparison 173

List of Tables

| | |
|--|-----|
| Table 1.1. Mapping of task assignments to relevant report chapters..... | 23 |
| Table 1.2. Mapping of terms used to describe PCT interfaces | 23 |
| Table 3.1. Summary of minimum functionality PCT bill of materials | 31 |
| Table 4.1. Summary of key functional requirements and constraints..... | 42 |
| Table 5.1. Comparison of Expansion Interface Main Candidates..... | 53 |
| Table 5.2. Comparison of HVAC Interface Main Candidates | 56 |
| Table 6.1. Mapping of OSI 7-layer Model to PCT Discussion Framework..... | 58 |
| Table 8.1. Mapping of terms used to describe PCT interfaces | 101 |
| Table 8.2. Summary of minimum functionality PCT costs..... | 106 |
| Table 9.1. Sample DR message | 118 |
| Table 9.2. Thermal Model Variables | 129 |
| Table 10.1. Summary of Field Kit Cost | 141 |
| Table 10.2. Data loss percentage from each node on 12/11/2006 and 12/12/2006 | 151 |
| Table 10.3. Valid groups received for 94.9 MHz, % of ideal rate..... | 153 |
| Table 10.4. Valid groups received for 101.3 MHz, % of ideal rate..... | 153 |
| Table 11.1. Thermal Model Variables | 157 |
| Table 11.2. House Extents Testing..... | 163 |
| Table 12.1. Estimated Infrastructure, Operation, and BOM Costs per PCT..... | 179 |

Abstract

A research team at the University of California, Berkeley was tasked with addressing technical questions arising from the implementation of residential programmable communicating thermostats (PCT's) in California to meet updates to Title 24 building code related to PCT's. The purpose of the project was to perform research, development, and demonstration tasks to: validate the California Energy Commission's PCT vision, answer technical issues related to system integration and implementation, recommend a suitable technology for a statewide one-way communication system for PCT's, and develop a methodology to study the impact of PCT's on electrical demand. The team performed several tasks to achieve these goals.

The team validated the Energy Commission's vision by concluding that it was possible for manufacturers to develop PCT's that: met the proposed Title 24 system interface requirements, could be sold at a retail price less than \$100, and could be manufactured within the Energy Commission's planned Title 24 timeline. This conclusion was the result of a concept for a minimum functionality PCT that was published as a bill of materials and validated with a working proof-of-concept demonstration.

The team researched PCT system interfaces and identified technical issues related to system integration and implementation that should be considered as part of the policy, technology, and system design related to PCT implementation.

The team reviewed technologies that could be used for statewide PCT communication and recommended the Radio Data System (RDS) technology as a suitable solution. The team demonstrated the feasibility of this technology and developed a site survey tool and methodology to study its real-world performance.

Finally, the team developed a load group simulation to characterize the result of PCT pricing and control signals and used the simulation to study certain demand response scenarios. The team found that rebound peak from demand response events can be significant and that strategies to manage this peak should be investigated further.

Keywords: programmable communicating thermostat, PCT, demand response, Title 24, residential air conditioning, PCT systems integration interface, technology survey, minimum functionality PCT, PCT bill of materials, PCT proof-of-concept, RDS site survey tool, PCT systemic control, load group simulation, PCT one-way interface.

Executive Summary

Introduction

The California Energy Commission is proposing updates to Title 24 building code for 2008 that will require *programmable communicating thermostats (PCT's)* in all new residential construction and retrofits. A PCT is a programmable thermostat with a communication interface that allows it to receive *demand response* signals and respond by reducing air conditioning load during peak periods. This capability is of tremendous value to the State of California because of the load reduction potential that could be used to address electrical system imbalance. During peak periods in 2005, residential air conditioning accounted for 21% of California's electrical demand (Demand Analysis Office, California Energy Commission 2007).

The Energy Commission proposed standardization of four system integration interfaces between residential thermostats and the outside world to achieve demand response objectives, maximize flexibility, and minimize cost:

- **Communication Interface** – Standard information model for PCT communication, including embedded mandatory one-way receiver to support a statewide network.
- **Human Machine Interface** – Minimum user input and output indicators to support demand response functionality.
- **HVAC Interface** – Standard electrical interface for HVAC appliances.
- **Expansion Interface** – Standard interface to support a two-way communication module.

Many questions about the cost, feasibility, reliability, safety, and security of the Energy Commission's vision for a statewide PCT system needed to be addressed.

Purpose

In January 2006 the PIER Program funded the project team to address technical questions related to the Energy Commission's PCT vision. The team performed research, development, and demonstration tasks to address questions in four key areas:

1. **California Energy Commission's PCT Vision** - Is the Energy Commission's PCT vision technically feasible? Can PCT's that support the Title 24 policy objectives be developed within the Energy Commission's timeline? Can a device that meets this vision be sold at a retail price less than \$100?
2. **Technical Issues** - What are the important technical issues that need to be considered for proper and effective policy, technology, and system design related to PCT's?
3. **Statewide One-Way Communication System** - What technology is considered the most appropriate to use for a statewide one-way communication system? Will the technology be reliable enough for this application? What research and development tasks need to be performed to implement this system?

4. **Systemic Control** - What impact will PCT's actually have on the system? Are there possible unforeseen and unintended consequences of using PCT's for demand management? What control strategies should be considered for demand response?

Project Objectives

The team addressed the technical questions stated previously by accomplishing the following assigned project objectives:

- **Investigate PCT System Interfaces**
- **Publish a Bill of Materials for a Minimum Functionality PCT**
- **Develop a PCT Proof-of-Concept**
- **Demonstrate RDS Communication with PCT's**
- **Demonstrate Two-Way Communication with PCT's**
- **Develop an RDS Site Survey Tool**
- **Develop a Methodology to Study Systemic Control of PCT's**
- **Support the Title 24 PCT Technical Working Group (Technical Working Group)**
- **Issue a Recommendation for a One-Way Communication Interface**

Key Project Outcomes

The team researched each of the PCT system interfaces and identified candidate technologies that could support the functional requirements of the interfaces. In addition, the team identified technical issues necessary for consideration in the design of policy, technology, and supporting system related to this application.

The research team chose low-cost, ubiquitous, commercially available off-the-shelf technologies that could be used as system interfaces in a minimum-functionality PCT. A bill of materials estimating a thermostat manufacturer's assembled costs of the minimum functionality PCT concept was published. The total bill of materials cost for this PCT concept was estimated to be \$20.20. A working PCT proof-of-concept was developed to show feasibility of the minimum functionality PCT concept and validity of the bill of materials.

A site survey tool was developed to measure the real-world reliability of RDS in residential settings. The tool was successfully field tested to verify its viability for this application. Preliminary testing yielded some insight into the reception characteristics of RDS within a residence.

The research team constructed and verified a complex dynamic simulation of an advanced load management system. The model simulates the thermodynamics of a random group of houses under the control of individual PCT's and measures the resulting air-conditioning power consumption. Simulation tests were performed to study the response of the load group to various demand response messages, and two event-exit strategies were also tested.

Conclusions

The minimum functionality PCT concept and accompanying bill of materials verify that it is possible for a manufacturer to sell, in volume, a minimum functionality PCT that can receive radio dispatches anywhere in the state, interface with any utility's advanced metering system, control most installed HVAC appliances, and interact with the customer during demand response events for a retail price less than \$100. Because the technologies recommended by the team are all readily available off-the-shelf solutions, the team believes that Title 24-compliant PCT's can be developed before April 2009, the effective date for Title 24-2008.

As a result of preliminary technical analysis of both FLEX paging and RDS, the team concludes that both technologies are viable for the PCT standard one-way communication interface.

The RDS site survey tool and methodology developed are considered viable for studying the real-world performance of RDS in residential settings. Early test results indicate that multiple FM radio stations per area will be needed for some, if not all, regions of the state to provide reliable demand response communication. The results also indicate that the location of a PCT receiver within a house, the type of antenna used, and orientation of any direction antenna can all significantly affect the reliability of RDS communication.

The load group simulation developed provides a valid means of characterizing aggregate air conditioning load and the thermal model it is based upon is considered valid. The team has shown that rebound peaks occurring after demand response events have ended can be significant and that there is a need to incorporate mitigation of the rebound peak into load management strategies. The most important finding from the simulations is that it will take the system approximately *four hours* to recover from a 4°F, 2-hour PCT demand response event.

Recommendations

The team recommends further study in the systemic control of PCT networks to study the impact of currently accepted load management strategies and to identify and characterize other possible strategies. For reliability (non-overrideable) events, the team recommends the consideration of alternative event-exit strategies, such as ramped setpoint return, to random setpoint return. The team strongly believes that continued investigation is required to determine effective control signals (i.e. price, price tier, price ratio, duty cycle, setpoint) for managing economic (overrideable) events. Further research may also provide feasible load management strategies that more intelligently manage peak demand throughout the entire event, including entry, peak, and exit.

The team recommends that further investigation efforts of the embedded one-way interface be focused on RDS over FLEX paging for several reasons: RDS is more attractive in terms of longevity (it can practically be guaranteed), ubiquity (it is an open standard and technology) and costs to the manufacturer/vendors. The team has identified the following action items that need be completed before a statewide RDS system can be developed for PCT communication:

- **Study the real-world behavior of the RDS to properly develop reliable end-to-end communications.**

- **Finalize development of a security scheme for authentication of the RDS signal.**
- **Develop a communication protocol for demand response over RDS.**

The team has identified two remaining issues that need to be resolved in *Reference Design for Programmable Communicating Thermostats Compliant with Title 24-2008* (shall be referred to as “the PCT Reference Design”) before manufacturers can begin product development of PCT’s:

- **Completion of expansion interface specification**

The Title 24 PCT Technical Working Group needs to complete a specification for the communication profile for this interface, and it should include a mechanism for the PCT configuration (address and possibly security code). In addition, it is recommended that the Technical Working Group propose a best practice for the physical expansion area available to the plug-in to prevent physical incompatibilities between PCT’s and plug-in modules.

- **Configuration of PCT address code**

A minimum requirement to support the configuration and verification of the PCT address code and possibly security code need to be included as mandatory in the PCT Reference Design.

Primary Benefits to California

The results of this project produced many benefits to California, but three in particular are considered most noteworthy:

- **Minimum Functionality PCT Concept**

The minimum functionality PCT concept presented has benefited the state by providing a reasonable solution to accomplish the Energy Commission’s PCT vision while meeting the price target established by the regulators. The team believes that the bill of materials, once published, removed critical doubt from key stakeholders and served as a catalyst to facilitate progress in policy and technology development.

- **RDS Site Survey Tool**

Since it is critical that RDS communication works reliably for demand response, the site survey tool and methodology developed can benefit the state by assisting the development of the communication network, receivers, and protocol.

- **Systemic Control Research**

The systemic control research performed by the team is of enormous benefit to the electrical utilities and Energy Commission regulators in providing a way to predict the system impact of PCT control signals. Continued research with the load group simulation tool could benefit the regulators, utilities, and customers by uncovering valuable load management strategies that could prevent costs associated with peak electricity use and also by preventing potential costs of unforeseen consequences of load control actions such as system instabilities.

1.0 Introduction

1.1. The Programmable Communicating Thermostat

One strategy being investigated in California for managing electricity demand during peak periods or emergencies is the concept of a *programmable communicating thermostat* (PCT). The PCT adds a communication interface to the functionality of a traditional programmable thermostat (PT), allowing it to receive information from an external source. During critical periods, a *demand response* (DR) signal could be sent to PCT's, which would then automatically respond to the signal with an action such as raising the cooling setpoint of the air conditioner. Because PCT's connect directly to central air conditioning systems, they offer a mechanism to dramatically reduce electrical demand during critical periods with minimal alteration to residential infrastructure. This capability is of tremendous value to the State of California because of the load reduction potential that could be used to address electrical system imbalance. During peak periods in 2005, residential air conditioning accounted for 21% of California's electrical demand (Demand Analysis Office, California Energy Commission 2007).

Since late 2005, the California Energy Commission has been in the process of proposing updates to Title 24 building code for 2008 that will require PCT's in all new residential construction and retrofits. While such a provision could prevent the need for rotating outages (also known as "rolling blackouts") as a final measure to mitigate excessive peak demand, there are a number of technical, economic, and social issues that need to be investigated and addressed before PCT's can be implemented on a statewide scale. In the technical area, there exist many questions about such a system's cost, feasibility, reliability, safety, and security. A discussion of how the policy, technology, and PCT system should be designed will require these technical questions to be addressed.

1.2. California Energy Commission Vision of PCT System Interfaces

Since the energy crises experienced in California in 2000 and 2001, various advanced metering and load management technologies have been investigated as mechanisms for achieving demand response. Advanced metering infrastructure (AMI) technologies that support two-way communication can provide interval electricity metering and a communication channel to deliver pricing and/or control signals to a utility customer. Load management technologies control end-use electrical demand and can act in response to pricing or control information. The California Energy Commission recognized that these two categories of technologies would need to work hand-in-hand to achieve the state's demand response goals – but the Energy Commission also recognized that these technologies operated in entirely different environments. The development of advanced metering and communication infrastructures by the investor-owned utilities is a regulated process, and the infrastructure is owned and operated by the utilities. In contrast, devices that provide load control, such as EMCS systems, thermostats, and lighting systems, are developed in a generally unregulated manner and are owned and operated by the utility customer.

One particular area where the relationship between metering and load management needed to be addressed was in PCT's. The Energy Commission viewed the use of residential PCT's as a

viable strategy to reduce summer peak air conditioning loads and considered requiring their installation in new residential construction and retrofitted residences through Title 24 building code. Concern about the compatibility and cost of these devices has been a long-standing issue: thermostats designed to operate with differing and incompatible utility-specific communication systems could limit customer choice and increase costs due to limited manufacturing volume. The Energy Commission envisioned that the *lowest cost* and *greatest flexibility* could be achieved if the *system interfaces* between metering and load management technologies were defined as open standards.

The Energy Commission held a workshop on November 29, 2005 to discuss system integration for demand response in the context of PCT's. Ron Hofmann, a PIER consultant, presented the Energy Commission's system integration goals at the workshop (Hofmann 2005):

- One PCT systems integration interface for all of California (and possibly the United States)
- Common signaling throughout California
- Works with any minimum AMI system
- Compatible with legacy technologies

The Energy Commission believed that by leveraging Title 24 to standardize system integration interfaces for thermostats installed in California, PCT's could eventually be sold that interfaced with any utility's particular AMI system, controlled any installed residential HVAC system, effectively interacted with residential customers, and could be priced at a small premium over standard PT's. Additionally, the Energy Commission sought to establish a statewide one-way signaling system as a means of providing universal PCT communication until two-way communication with utility networks became the norm. This was important to the Energy Commission because two-way technologies were not expected to become ubiquitous for some time. Investor-owned utility communication networks are not expected to be widely deployed until 2012 and municipal utilities are not expected to develop advanced communication infrastructure. In the same presentation, Mr. Hofmann presented a conceptual strawman proposal for four, low-cost, standard system integration interfaces for programmable communicating thermostats that could possibly support the Energy Commission's system integration goals:

- **Input/Output** – RJ-45-like wiring interface between the PCT and HVAC appliances
- **Communications** – AM or FM receiver to receive statewide or local emergency events
- **Human** – lights to indicate DR information and PCT status to the resident and buttons to allow user configuration and operation
- **Expansion** – a USB or similar I/O port to add two-way communication, download of audit data, and other functionality to the PCT

At a workshop on February 16, 2006, a follow-up to the November 2005 session, Maziar Shirakh of the Energy Commission presented a refined vision for PCT's (Shirakh 2006):

- **Statewide system** – PCT’s should support out-of-the-box demand response by working with a statewide communication system.
- **Plug-and-play** – PCT’s should be compatible with existing and future HVAC and communications infrastructure.
- **Independent of OEM and retail channels** – PCT’s should be the same regardless of how they end up in the customer’s residence.
- **Friendly for contractors and occupants** – PCT’s should be simple to install and operate.
- **Able to meet Title 24 timetables** – PCT’s and associated infrastructure should be ready and available by April 2009, the effective date of Title 24-2008.

While the Energy Commission believed that their vision for PCT’s was feasible, several stakeholders had doubts. Several parties expressed concern that these kinds of PCT’s would be unduly expensive. Utility companies did not view one-way communication as an effective measure for demand response. Manufacturers were concerned about product development challenges and the limitation of mandating technologies in Title 24. In general, the major stakeholders agreed with the Energy Commission that programmable communicating thermostats would be beneficial devices but they did not necessarily agree with the Energy Commission’s system integration goals or implementation timeline.

1.3. Technical Questions to Be Answered

In January 2006 the PIER Program funded the project team to address many of the technical questions related to the Energy Commission’s PCT vision. Over the course of the project, the team performed research, development, and demonstration tasks to address questions in four key areas:

1. **California Energy Commission’s PCT Vision** - Is the Energy Commission’s PCT vision technically feasible? Can a device that meets this vision be sold at a retail price less than \$100? Can PCT’s that support the Title 24 policy objectives be developed within the Energy Commission’s timeline?
2. **Technical Issues** - What are the important technical issues that need to be considered for proper and effective policy, technology, and system design related to PCT’s?
3. **Statewide One-Way Communication System** - What technology is considered the most appropriate to use for a statewide one-way communication system? Will the technology be reliable enough for this application? What research and development tasks need to be performed to implement this system?
4. **Systemic Control** - What impact will PCT’s actually have on electrical demand? Are there possible unforeseen and unintended consequences of using PCT’s for demand management? What control strategies should be considered for demand response?

1.4. Project Objectives

The PIER contract was awarded to the research team in two phases. The first phase of the project was a very short-term four-month phase focused on validating the Energy Commission’s PCT vision (point 1 in the previous section). The second phase of the project was

much longer, lasting 16 months. During this time, the team primarily focused research and development efforts in the remaining areas previously mentioned (points 2, 3, and 4). The following two sections discuss each of the tasks assigned to the team by the PIER project advisor, Ron Hofmann. The tasks are numbered for reference purposes to simplify presentation of the project outcomes.

1.4.1. Phase 1 Project Objectives

In Phase 1, the team determined the feasibility of the Energy Commission's PCT vision by investigating commercial, off-the-shelf technologies that could be used for each interface and developing a concept for a minimum functionality PCT that incorporated appropriate technologies as system interfaces. The team was asked to publish a reference design for the minimum functionality PCT concept that could be reviewed and implemented by industry vendors. Given the timeline available for Phase 1 and the resources available, this task was modified to publishing a bill of materials rather than a complete reference design. To show that the minimum functionality concept and bill of materials presented were feasible, the team developed a PCT proof-of-concept. The proof-of-concept was used both as a means for demonstration and as a test-bed for evaluating various PCT system interface technologies.

The tasks assigned in the Phase 1 statement of work are presented below:

- **Task 1.1: Investigate PCT System Interfaces**
 - Investigate I/O and power interface connectors (similar to an RJ-45 Ethernet connector) that could be used to replace the current HVAC terminal strip. The maximum number of HVAC wires will be limited to those that support combinations of residential electric central air-conditioning equipment, electrical and gas furnaces, and electric heat pumps.
 - Investigate a one-way communications broadcast (e.g., AM and/or FM) receiver interface that can receive periodic signals. The signals are expected to occur hourly but the evaluation should explore a variety of message structures including signal amplitude (e.g., price) and duration (e.g., time over which the signal amplitude applies) at each periodic broadcast; signal amplitude and implied duration for the next period; and other structures of interest.
 - Investigate the minimal set of human interface elements (e.g., lights, buttons, and fixed-character displays) for presenting information related to receiving signals, PCT operating status and function. The purpose of this task is to augment existing thermostat information not replace it. The evaluation should concentrate on the additional information (e.g., signal reception, time, etc.) that is fundamentally new because the thermostat is receiving periodic signals.
 - Investigate the addition of an expansion port for adding memory fobs, transceiver sticks, and other useful application extensions. The minimum set of applications to be explored should include audit trail downloads, enabling WAN and LAN options, and sensor-network extensions.

- **Task 1.2: Publish a Bill of Materials for a Minimum Functionality PCT**
 - Publish a reference design for the platform so that thermostat manufacturers can utilize interfaces with their technology. This will require detailed functional information that allows vendors to map the interface specifications to their designs.
- **Task 1.3: Develop a PCT Proof-of-Concept**
 - Develop a microprocessor-based platform using off the shelf hardware and software (and custom software) that can be used to simulate a basic PCT of the type being considered by current Title 24 proceedings and can be used to evaluate the system integration and interfaces.
 - Perform tests that validate the functions of the four PCT system interfaces.

1.4.2. Phase 2 Project Objectives

In Phase 2 of the project, the team’s scope of research and development was greatly expanded. The PCT proof-of-concept (POC) was updated to use electronics components more closely resembling those which would actually be used in production PCT’s, including the use of RDS technology for one-way communication and IEEE802.15.4 for two-way communication.

The tasks assigned in the Phase 2 statement of work are presented below:

- **Task 2.1: Demonstrate an RDS one-way communication infrastructure using the PCT POC platform developed in Phase 1.** The goal of this task is to test a commercially available digital FM receiver and RDS decoder chip using the PCT POC platform developed in Phase I. The FM/RDS chip would be tuned and controlled by the POC platform core processor to locate a carrier channel with RDS message content. The test would demonstrate the strength of the signal reception in different locales and enable further testing of the RDS system as a DR signaling method.
- **Task 2.2: Demonstrate the use of a two-way (either WI-FI, Zigbee or other) wireless communication interface through the expansion port of the PCT POC platform.** The goal of this task is to test the expansion port to support a 2-way transceiver “bob” for either 2-way WAN or LAN communications.
- **Task 2.3: Write a report summarizing the Phase 1 and 2 research, including but not limited to:**
 - Technology survey of candidate interface solutions
 - Summary of technical issues, including those which could require further research
 - Testing results for all performed experiments
- **Task 2.4: Develop standalone RDS-based “stoplight” devices to test FM/RDS signal reception in locations within a structure away from the location of the PCT POC platform.** The goal of this task is to test RDS signal strength at locations where major appliances, pool pumps, and other non-thermostat-related control devices might receive

DR signals. The standalone “stoplight” device that will be developed will independently log RDS messages and indicate signal quality with a series of LED indicators (stoplight).

- **Task 2.5: Develop a rigorous approach for understanding the interaction between system and local control requirements when dispatching PCTs.** The goal of this task is to create a controls methodology for developing temperature setup specifications for a dispatchable DR A/C thermostat system.
- **Task 2.6: Support the Title 24 PCT Technical Working Group (Technical Working Group).** Support the Technical Working Group’s efforts to create a reference design document for PCT’s compliant with Title 24. Facilitate discussion by providing technical documents for review.
- **Task 2.7: Research in detail RDS and FLEX paging for use as a PCT standard and issue a recommendation to focus on one of the two technologies to the California Energy Commission and the Technical Working Group.**

1.5. Report Organization

Because so many research and development objectives were completed over the course of the project, the report is designed as a modular collection of independent chapters that are each focused on specific research and development tasks. Chapters 4 through 12 consist of documents that stand alone and can be read independently of the larger report. These chapters are generally all presented in the same form as “sub-reports,” organized, where appropriate, as follows:

- Background
- Objective
- Approach/Methods
- Results
- Conclusions and Recommendations

The tasks assigned to the team are mapped to relevant chapters of the report that discuss them in Table 1.1.

It should be noted that during the research process, the team revised the terms used to refer to the four system interface concepts that Mr. Hofmann originally presented, but did not change the intended function of the interfaces. This was done because the team felt that the revised terms either more effectively communicated the intention or were more commonly used in the industry. The mapping from the terms originally presented to those used in the report is shown in Table 1.2.

Table 1.1. Mapping of task assignments to relevant report chapters

| Task Number | Relevant Chapter |
|---|-------------------------|
| 1.1: Investigate PCT System Interfaces | Chapters 3, 4, 5, 6, 7 |
| 1.2: Minimum Functionality PCT Concept | Chapter 8 |
| 1.3, 2.1, 2.2: PCT Proof of Concept | Chapter 9 |
| 2.3: Report | N/A |
| 2.4: RDS Site Survey Tool | Chapter 10 |
| 2.5: PCT Systemic Control | Chapter 11 |
| 2.6: Support Title 24 PCT Technical Working Group | N/A |
| 2.7: One-Way Communication Interface Recommendation | Chapter 12 |

Table 1.2. Mapping of terms used to describe PCT interfaces

| Original Term | Revised Term |
|----------------------|---------------------|
| Input/Output | HVAC |
| Communications | Communication |
| Human | Human-Machine |
| Expansion | Expansion |

A brief description of each chapter is presented below:

1.0 Introduction

2.0 Project Approach

This chapter discusses the approach taken to complete the tasks assigned in the project contract.

3.0 Summary of Project Outcomes

This chapter briefly summarizes the results of each of the assigned tasks.

4.0 Preliminary Research

This chapter presents initial non-technical research performed by the team to provide necessary background information for the technical research and development objectives.

5.0 Technology Survey

This chapter presents a survey of low-cost, ubiquitous technologies that were considered for the PCT system interfaces.

6.0 PCT Communication Interface Questions and Issues

This chapter presents a framework of technical questions and issues that should be raised for any candidate technology considered for the PCT communication interface. Additionally, the chapter presents analysis, using the framework, for the two primary one-way communication interface candidates, RDS and FLEX paging.

7.0 Key Technical Issues

This chapter presents a set of important technical questions and issues that need to be considered for the human-machine, HVAC, and expansion interfaces. In addition, a number of questions and issues are discussed related to the entire system design.

8.0 PCT System Interfaces and Minimum Functionality PCT Concept

This chapter presents a concept for a minimum functionality PCT that utilizes standard system interface technologies and meets the Energy Commission's policy objectives, timeline, and cost target.

9.0 PCT Proof-of-Concept

This chapter describes the PCT proof-of-concept developed to demonstrate the feasibility of the minimum functionality PCT concept and function as a test-bed for PCT system interface technology.

10.0 RDS Site Survey Tool

This chapter presents a tool developed by the team to study the real-world performance of RDS as a communication technology for demand response.

11.0 PCT Systemic Control

This chapter presents a load group simulation developed to predict the effects of PCT control signals and discusses conclusions and recommendations resulting from the research.

12.0 Wide-Area Network One-Way Interface Recommendation

This chapter presents a recommendation for the statewide one-way communication technology.

13.0 Conclusions and Recommendations

This chapter presents a summary of the major conclusions and recommendations resulting from each of the project tasks and the project's benefits to the State of California.

2.0 Project Approach

This chapter discusses the approach taken by the research team to address the assigned objectives. The following sections discuss the approach taken for each of the major research and development tasks completed in this project.

2.1. PCT System Interfaces, Minimum Functionality PCT Concept, and Support of Title 24 PCT Technical Working Group

To investigate the PCT system interfaces and develop a minimum functionality PCT concept, the team followed a simple design methodology derived from Nam P. Suh's concept of axiomatic design (Suh 1990). Reduced to its simplest definition, the axiomatic design process consists of four stages: *stakeholder assessment*, *functional requirements*, *design parameterization*, and *production*. In stakeholder assessment, the involved stakeholders for a given problem are studied and their needs and motivations are characterized. Part of this phase includes formulation of typical *use scenarios* related to the given design problem. Given the information resulting from the stakeholder assessment, a set of *functional requirements* is documented which will satisfy the needs of the stakeholders. Additionally, *constraints* are placed on the design to make it more compatible with the stakeholders and the environment in which it (the final product or service) will reside. Once the requirements and constraints have been established, concepts for how to meet these requirements can be researched. Within the design engineering process, the technical issues arising from design concepts are investigated and some evaluative methodology is undertaken in order to identify and engineer the most suitable solution from the available concepts. This process is referred to as *design parameterization* because any number design features (parameters) can be mapped to fulfill individual functional requirements while working within the constraints. In the final stage, *production*, it is determined how to best fabricate and deliver the intended product or service to the customer or stakeholders.

In this project, research of PCT stakeholder assessment, documentation of functional requirements and constraints, and identification of technical implementation issues was performed. A minimum functionality PCT concept was formulated as a strawman for the design parameterization exercise. This concept was in no means a final design that was ready for production. Instead, the minimum functionality PCT concept was offered to the Title 24 PCT Technical Working Group (Technical Working Group) as a basis for technical review and discussion. The technical issues identified by the team were presented to the Technical Working Group as part of the development process of the document, *Reference Design for Programmable Communicating Thermostats Compliant with Title 24-2008* (Title 24 PCT Technical Working Group 2007) (this shall be referred to as "the PCT Reference Design"). Additionally, the UC Berkeley team played a role as a supporting member of the Technical Working Group. The team dedicated human resources to reviewing documentation and providing added analysis of issues such as the requirements of the PCT information model or the possible security vulnerabilities of the PCT system. Over the course of six months, the Technical Working Group created a reference design document that outlined required system integration interfaces and provided best practices for PCT design and implementation. The PCT Reference Design is available at the Technical Working Group website:

<http://sharepoint.californiademandresponse.org/pct/default.aspx>. Figure 2.1 illustrates the design process adopted by the team for these research and development objectives.

Engaging in the last phase of the axiomatic design process, production, some vendors are already beginning to design Title 24 compliant PCT's for production in 2009 based on the specifications in the PCT Reference Design. However, some issues critical to final implementation of a statewide PCT system remain to be addressed in the PCT Reference Design; a set of recommendations for necessary research and development tasks is presented at the end of the report.

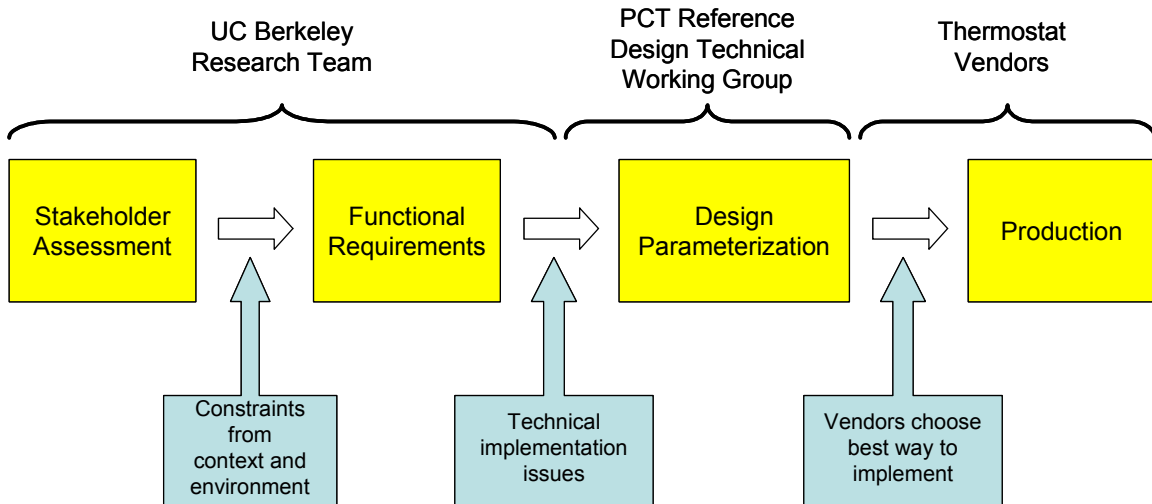

Figure 2.1. Design flow for axiomatic design process, as used in this project

2.2. PCT Proof-of-Concept (POC)

In the first phase of the project, the team had a 14-week development timeline to create a basic demonstration of how the minimum functionality PCT concept would work and show that the concept was technically feasible. To accomplish this goal, the research team designed an advanced and flexible thermostat platform from the ground up. This task included the complete development of PCT software from scratch.

The team started by developing a C-based task/state control software for a programmable communicating thermostat. The task/state approach was appropriate for this application because it can easily serve a PCT's control functions, provides an easy-to-understand computing model, and allows for flexible and modular software development. The C computing language provides legitimacy that similar software could be developed for microprocessors appropriate for commercial PCT's. The team ran the software on an embedded computing platform that provided a reasonable proof-of-concept for PCT microprocessors and also served as host to which many system interfaces could be connected. The software and the computing platform were essentially the core of the POC system.

Next, prototype interfaces demonstrating the PCT system interfaces were developed using technologies that reasonably proved feasibility of the suggestions outlined in the minimum functionality PCT concept. A low data-rate serial communication link was implemented over a

consumer FM radio transmitter and receiver to demonstrate the one-way communication interface. A very basic information model and messaging format for PCT communication were developed to demonstrate basic demand response functionality over this interface. Alert LED's and a piezoelectric sounder, which were suggested as interface solutions in the minimum functionality PCT concept, were included with an LCD display and keypad to demonstrate the human-machine interface. A USB port and USB flash memory module were used to demonstrate expansion interface. A DB-9 connector, also a solution that proposed in the minimum functionality PCT concept, connected the POC to a simulated HVAC system. While the POC was functional enough to drive an actual residential HVAC system, the team also developed a simulated target system that the PCT could "operate" in lieu of an actual physical plant. The simulated system consists of a computer model of a house that provides an indoor air temperature measurement, calculates the effects of heating and air conditioning, and accounts for outdoor temperature.

The Phase 1 POC and demonstration were first shown to PCT stakeholders at a meeting at the California Energy Commission on April 18, 2006. The demonstration showed how an operator, playing the role of a distribution utility or government agency, could send an overrideable economic event or a non-overrideable reliability event to the proof-of-concept over a radio broadcast interface, and that the proof-of-concept automatically responded to that event appropriately. The demonstration also showed how the technologies suggested by the team (in the minimum functionality PCT concept) for the human-machine interface, HVAC interface, and expansion interface could be used to support demand response.

In the second phase of the project, the proof-of-concept was redeveloped to utilize electronics components that more closely resembled those which would be integrated into an actual production PCT. The one-way communication interface was replaced with an actual RDS receiver unit capable of extracting data from commercial FM broadcasts and a test communication protocol was developed to support the information model outlined in *Reference Design for Programmable Communicating Thermostats Compliant with Title 24-2008* (Title 24 PCT Technical Working Group 2007) (this shall be referred to as "the PCT Reference Design"). Additionally, a two-way communication interface using a 2.4 GHz IEEE802.15.4 radio was added via the USB expansion port. The central PCT computing platform was moved from a relatively expensive, advanced development platform to an inexpensive (<\$100) consumer electronics device capable of running Linux. The Phase 2 POC was installed at the California ISO, along with a commercial-grade FM radio transmitter, in July 2007 in a long-term demonstration of California demand response technologies.

2.3. RDS Site Survey Tool

The team developed an "RDS field kit" of "wireless FM sensors" that, when installed at various locations within a residence, can collect reception statistics. Each sensor unit, or data logger, consists of a microcontroller, an FM receiver, and a wireless link. The microcontroller is used to manage the FM receiver and collect data samples, and a wireless link is used to transmit the data samples back to a central computer database. A laptop runs control and monitoring software that coordinates the data loggers and records data.

The field kit can be used to evaluate the performance of RDS in situ by collecting data from commercial and educational FM stations that are currently enabled with RDS. FM stations that have RDS capabilities send data blocks, the elemental data units of the transmission protocol, 100% of the time over the air regardless of whether or not actual payload data is being transmitted. Data statistics, such as block counting and error counting, can be collected from this constant stream. With a significant number of data samples, any number of statistical procedures can be performed to test various hypotheses and develop predictive models.

A database that contains information about the receivers, site, and FM transmitters in addition to the sample data can be used to test statistical hypotheses about factors which affect reception and reliability. The advantage of a database such as MySQL is that queries can be performed to generate specific data subsets for analysis. Statistical analysis tools such as the “R” software can be used to test statistical hypotheses and generate regression models to identify key factors that are likely have an effect on overall reliability.

2.4. PCT Systemic Control Research

The researchers focused on the questions arising when a large network of PCT controlled homes act in concert. Since sufficiently large experiments would be costly, the analysis was completed on a computer simulation written in the C programming language. The goal of the *load group simulation* is to accurately model the average air conditioning power consumption of a large group of houses. It was built on top of an accurate thermal simulation of a house controlled by a full PCT.

Using the new simulation tool, static thermostat setback response was studied first, and the huge rebound peaks that occur at the end of events make the need for rebound mitigation obvious. Random end times and ramped setpoint exits were studied as two possible mitigation strategies, and a number of analysis tools using power and homeowner comfort were developed to analyze the experiments.

2.5. Recommendation for One-Way Interface

Two technologies, RDS and FLEX paging, were evaluated for the PCT wide-area network one-way interface. The following criteria were identified as the most critical in evaluating each one-way technology for use in the PCT:

- **Longevity:** Will it be around for at least 10 years?
- **Reliability:** Is the reliability of the infrastructure and the medium sufficient for this application?
- **Ubiquity:** Is the technology widely used enough that there are a large number of vendors available to provide equipment and support the interface?
- **Infrastructure Cost:** What is the cost to add PCT functionality to the existing infrastructure?
- **Operation and Maintenance Cost:** What is the annual cost to maintain the system on a statewide level?

- **Cost to the Manufacturer/Vendor:** What is the additional cost to the bill-of-materials (BOM) for the communications subsystem?

Based on a review of how each technology fared against these criteria, the team was able to determine if either technology was feasible and practical for this application. The team was also able to make a recommendation for the Energy Commission and Technical Working Group to focus resources on further investigation of one solution (RDS) since it showed advantages over the other.

3.0 Summary of Project Outcomes

3.1. Preliminary Research

Preliminary background research was performed that resulted in: a PCT stakeholder map, a list of functional requirements and constraints, and a set of PCT use scenarios. This research was not assigned as an objective, but was performed to provide necessary background information before the team could proceed with technical research. This work is discussed in Chapter 4, *Preliminary Research*.

3.2. Task 1.1: Investigate PCT System Interfaces

The team investigated PCT system interfaces, resulting in a set of candidate technologies for each interface (Chapter 5, *Technology Survey*), a number of technical questions and issues for each interface (Chapter 6, *PCT Communication Interface Questions and Issues*; Chapter 7, *Key Technical Issues*). In addition, the team identified and discussed technical issues related to the PCT system design, such as addressing and security requirements; this work is also presented in Chapter 7.

3.3. Task 1.2: Minimum Functionality PCT Concept

The team developed a concept for a minimum functionality PCT that incorporated ubiquitous, low-cost, commercially available off-the-shelf technologies (Chapter 8, *PCT System Interfaces and Minimum Functionality PCT Concept*). The team presented the minimum functionality PCT concept to the PCT stakeholder community as a bill of materials. Table 3.1 presents a summary of the bill of materials, and the complete spreadsheet presentation of the bill of materials is presented in Appendix A, *Minimum Functionality PCT Bill of Materials*.

Table 3.1. Summary of minimum functionality PCT bill of materials

| | | |
|---|----------------------|---------|
| Equivalent Programmable Thermostat | | \$12.70 |
| Added Interfaces | Communication | \$3.45 |
| | Human-Machine | \$0.15 |
| | HVAC | \$2.15 |
| | Expansion | \$1.75 |
| Total Bill of Materials | | \$20.20 |

3.4. Task 1.3: PCT Proof-of-Concept



Figure 3.1. PCT proof-of-concept

A PCT proof-of-concept was developed to demonstrate the feasibility of the minimum functionality PCT concept. The proof-of-concept, pictured in Figure 3.1, had the basic functionality of a programmable thermostat and completely functional PCT system interfaces. The proof-of-concept was also used in a number of demonstrations to communicate the Energy Commission’s PCT vision to various audiences. The proof-of-concept is described in detail in Chapter 9, *PCT Proof-of-Concept*.

3.5. Task 2.1: Demonstrate RDS One-Way Communication

The team successfully demonstrated RDS for PCT communication by:

- Leasing a commercial grade RDS encoder/transmitter and developing software to interface with the transmitter,
- Developing a test communication protocol to implement the PCT communication interface information model presented in the PCT Reference Design,
- Developing an RDS receiver unit that integrated an actual PCT-candidate receiver chip, and
- Integrating the RDS receiver unit with the PCT proof-of-concept.

This outcome is discussed specifically in Section 9.4.1.

3.6. Task 2.2: Demonstrate Two-Way Communication

The team integrated two-way communication with the PCT proof-of-concept by connecting a commercially available 2.4 GHz IEEE802.15.4 radio device to the expansion interface of the proof-of-concept (Section 9.4.2). Additionally, the team tested and demonstrated communication interface switching logic between the one-way and two-way interfaces required by Title 24.

3.7. Task 2.4: RDS Site Survey Tool

The team developed a site survey tool to measure the real-world performance of RDS in residential settings. The tool was tested in the field and considered viable for this application. Early testing provided preliminary results regarding the reliability of RDS within a home. This work is discussed in Chapter 10, *RDS Site Survey Tool*.

3.8. Task 2.5: PCT Systemic Control Research

The research team constructed and verified a complex dynamic simulation of an advanced load management system. The model simulates the thermodynamics of a random group of houses under the control of individual PCT's and measures the resulting air-conditioning power consumption. Simulation tests were performed to study the response of the load group to various demand response messages, such as a 4°F, 2-hour reliability (non-overrideable) event (pictured in Figure 3.2). Two event-exit strategies were also tested: random recovery and ramped-setpoint recovery. This work is discussed in Chapter 11, *PCT Systemic Control*.

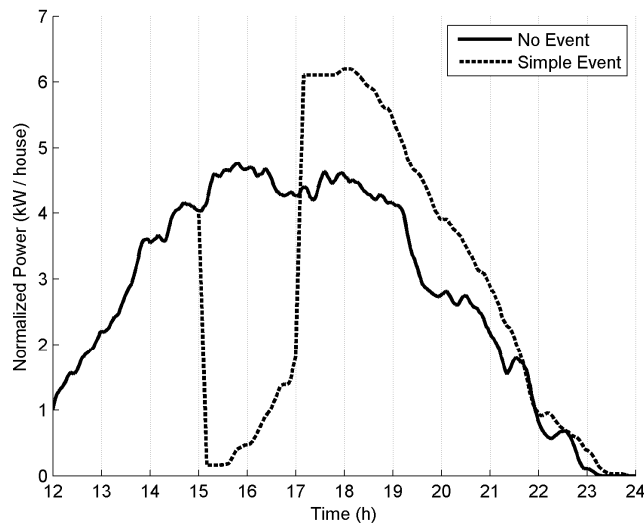

Figure 3.2. Comparison of air conditioning load between a DR event and base load

3.9. Task 2.6: Support the Title 24 PCT Technical Working Group

The result of this work is evident in the PCT Reference Design, available from the Technical Working Group website: <http://sharepoint.californiademandresponse.org/pct/default.aspx>.

3.10. Task 2.7: Recommendation for One-Way Interface

The primary candidates of the PCT wide-area network one-way interface, FLEX paging and RDS, were analyzed using the analysis framework presented in Chapter 6. The results of the RDS research are presented in Section 6.5.1 and the results of the paging research are presented in Section 6.5.2. Based on this information, the team issued a recommendation to focus investigation efforts on RDS; this recommendation is presented in Chapter 12, *Wide-Area Network One-Way Interface Recommendation*.

4.0 Preliminary Research

The team performed a “stakeholder assessment” to provide necessary background information prior to engaging in technical research of a minimum functionality programmable communicating thermostat. First, the team identified stakeholders that have an interest in thermostats in California, noting their general function and motivations. After these stakeholders and their relationships were understood, a very general set of use scenarios was developed to outline the functions that the PCT would perform. The use scenarios, combined with knowledge learned about the stakeholders, were used to develop a set of functional requirements and design constraints for each PCT system interface. The results of this preliminary research – the stakeholder analysis, use scenarios, and functional requirements and constraints – are presented in this chapter.

4.1. PCT Stakeholders

Presented here is a list of the primary and some of the secondary stakeholders that would be affected by Title 24 PCT standards and PCT operation:

- **Scheduling Coordinators**

Scheduling coordinators are energy suppliers who bid electricity supply into the California ISO’s wholesale market. Scheduling coordinators can be owners of generation resources and in the future may also include aggregators of managed demand response (these parties would bid negative load into the market).

- **Distribution Utilities**

Distribution utilities sell and deliver electricity to end-use customers and maintain the distribution system connecting the end-use points with the transmission system and generation resources. There are two general classes of distribution utilities: privately owned (referred to as investor-owned) and publicly owned.

- **Investor-Owned Utilities (IOU’s)**

The investor-owned utilities are privately owned distribution utilities that are regulated by the California Public Utilities Commission. The IOU’s purchase electricity from wholesale suppliers for resale and delivery to end-use customers. The IOU’s need mechanisms to manage residential electrical demand if generating capacity (supply) is unavailable or if local outages and failures occur. The IOU’s would like PCT’s to support two-way networking with their utility communication infrastructure through a utility communication gateway or home-area network. Title 24 PCT interface standards need to support the reality that IOU communication infrastructure and home-area networking solutions are still in development and are likely to use different architectures and communication technologies for each utility. The IOU’s serve approximately 78% of the residential customers in California (California Energy Commission 2004), with municipal utilities and cooperatives accounting for the remainder.

- **Publicly Owned Utilities (POU’s)**

Publicly owned (electricity) utilities are distribution utilities that consist of

municipal utilities, public agencies regulated by local government, and utility cooperatives, associations owned by customers. The publicly owned utilities in California serve the same general purpose of electricity distribution as the IOU's, but with a key distinction: POU's are not necessarily ISO wholesale market participants. Most POU's manage their own generation resources and/or wholesale supply contracts with generators (the IOU's divested a majority of these resources following electrical utility deregulation in 1996). Some POU's are ISO market participants or have interconnection agreements with the ISO to supply or receive power to/from ISO-operated transmission infrastructure. The majority of POU's are currently not planning to invest in advanced communication and home-area networking technology, necessitating a statewide infrastructure to ensure universal PCT communication.

- **Independent System Operator (ISO)**

The independent system operator manages the wholesale market for electricity and is responsible for overseeing electricity transactions, monitoring available capacity, and maintaining grid reliability. When operating reserves, available generating capacity over the demand, are low, the ISO calls upon the distribution utilities to reduce demand to keep the statewide grid within safe operating limits. The ISO eventually plans to have a mechanism to market demand response as an available resource for distribution utilities, but would also appreciate a networked system capable of dispatching mandatory curtailments during statewide emergencies.

- **Data Network Operators**

Data network operators can manage DR data between distribution utilities and the physical communication infrastructure. This function can possibly be served by the distribution utilities, the owner of the communication infrastructure, or a third party, depending on the strategy employed and the fragmentation of the market. For example, older radio-based load management systems installed in the 1970's were owned and operated by the IOU's, so the IOU's also managed the data link between the back-office and the radio transmitters. In the case of air-conditioning load management systems now being used that employ paging technology, the paging infrastructure is owned by the paging companies and the data link is built centrally into the architecture of their system. In the case of commercial and educational FM radio stations however, the stations own the transmitting infrastructure but are generally independently operated. In this case, a third party data network operator can be contracted to manage the communication between utility and physical infrastructure. The data network operators would be concerned with managing the security of the system and routing of dispatch messages.

- **Communication Infrastructure Operators**

This party represents the entity that maintains the physical communication infrastructure for interfacing with PCT's. In many cases the distribution utilities own and operate their own communication infrastructures, but commercial operators of FM radio stations and paging networks could also be involved in transmitting DR

dispatches. Utilizing third party communication infrastructure can reduce the cost of the PCT system for three reasons:

- The utilities would not need to make capital investments,
 - The party owning the infrastructure (capital) could utilize it for (revenue-generating) purposes other than utility communication, since total data capacity requirements for demand response communication are relatively low, and
 - A party specializing in the given technology would perform operations and maintenance.
- **PCT Manufacturers**

The manufacturers are responsible for design and production of PCT's. The manufacturers are motivated by being able to produce PCT's in volume. As a result, they are interested in technology that will allow maximum compatibility in hardware being designed for use in different markets: IOU and POU service territories and residences in other states. The manufacturers also want a solution that supports the wide variety of installed HVAC equipment. Also, the manufacturers would like to see Title 24 specifications as simple and inexpensive to implement as possible.
 - **Installers/Distributors**

Installers and distributors are the various channels by which residential customers acquire PCT's for their homes. This may include contractors that install thermostats for new developments or direct retail sales such as from Home Depot®. These parties are motivated to maintain a simple sales and installation (including configuration) process for PCT's. The professional contractors are likely to be responsible for proper configuration of PCT's that are being installed in new homes. These stakeholders are also a common first point-of-contact if the resident perceives that a PCT is not operating properly. It should be noted that the manufacturer of the RiteTemp® brand of thermostats also operates a 7 days/week call center to support thermostat installation and troubleshooting that could also be employed to support PCT-specific installation and troubleshooting, such as network addressing setup.
 - **Residential Customers**

Residents purchase electricity from the distribution utilities and operate the PCT's. The residents have the obvious needs of maintaining thermal comfort within their homes balanced against the costs of running HVAC appliances. Since the residents are also the primary operators of the PCT, they are motivated by simplicity in interaction with the PCT and will need to develop a mental model of a PCT's autonomous and manipulated behavior during price or emergency events.

Figure 4.1 illustrates the general relationships between each of the stakeholders.

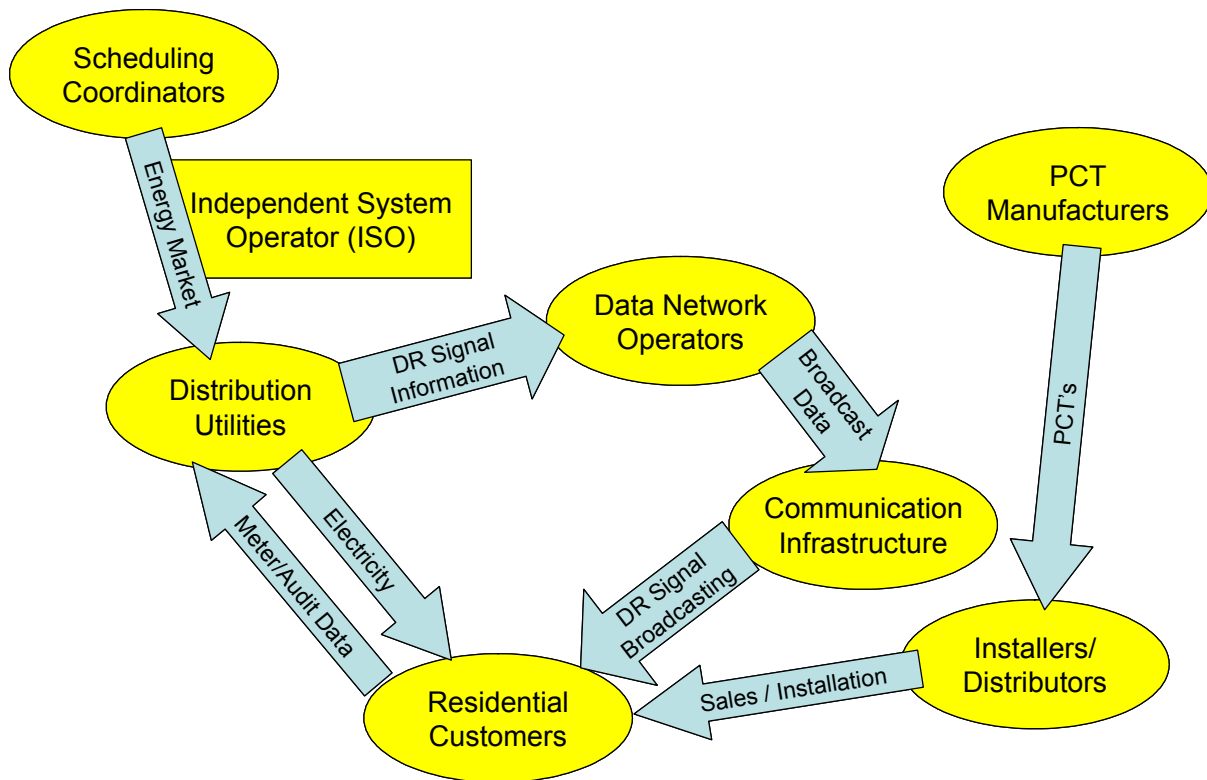

Figure 4.1. Stakeholder map

4.2. Use Scenarios

Use scenarios were developed which reflect the functions of each of the PCT system interfaces. Here is a summary of the envisioned *primary* function of each PCT interface:

1. **Communication interface**
The PCT receives a DR dispatch through the communication interface and responds automatically by appropriately adjusting the air conditioning load.
2. **Expansion interface**
The expansion interface supports a plug-in module¹ providing 2-way radio communication with a compatible home-area network and/or utility gateway.
3. **HVAC interface**
The HVAC interface standardizes the connection between residential HVAC wiring and the PCT for ease of thermostat replacement.
4. **Human-machine interface**
The human-machine interface is used to communicate to the resident that a curtailment event is either eminent or in progress, and allows or prevents user override as is appropriate.

¹ When referring to a specific type of expansion upgrade, such as communication module, the words “module” and “plug-in” shall be used interchangeably from here on.

Complete scenarios of primary and secondary (and variations thereof) interface functions are presented in the following sections. Note that content within braces { } indicate parameters that are either flexible or have yet to be agreed upon by Title 24 stakeholders.

4.2.1. Communication Interface

Primary: DR Signal

1. A distribution utility forms a DR event with the following information:
 - a. Address: e.g., source utility, DR group, geographic location, substation ID
 - b. Event type: e.g., reliability response (no override allowed), economic response (override allowed), display message, synchronize clock
 - c. Start time
 - d. Duration
 - e. Event information: e.g., setpoint change, price, display message, time
2. The utility sends the DR information to a network operator for broadcast through a radio transmission (or other) infrastructure.
3. Broadcasters either send the signal immediately or at scheduled (synchronized) communication intervals.
4. Within {5 minutes} of signal transmission, PCT devices receive the signals and decode the message.
5. PCT devices display the incoming event, alert the customer, and automatically respond to the signal.

Variations

- Transmission congestion
 - ISO requests DR from utilities to prevent brownouts from occurring
 - Asynchronous transmission, immediate response, no override, large target area
- Substation failure
 - Distribution utility needs local DR to reduce load around affected area
 - Asynchronous transmission, immediate response, no override, locally targeted area
- Economic demand response
 - Distribution utility issues pricing event for voluntary load reductions
 - Scheduled transmission, start time scheduled in advance, override allowed, targeted customer groups
- Clock synchronization
 - Scheduled transmission, system-wide transmission

4.2.2. Expansion Interface

Primary: Enable Two-way Networking

1. The resident purchases a PCT upgrade at Home Depot® to work with a home-area wireless network.
2. The upgrade plugs into the expansion port, and the PCT recognizes the new device as a communication module.

3. The PCT disables the embedded one-way communication interface and uses the plug-in communication module.
4. The PCT uses the home Internet gateway to transmit acknowledgement and audit data back to the distribution utility.

Variation: Record Audit Data to Memory Card

1. A customer notes a discrepancy on their bill, and calls the utility to ask about the charge.
2. The utility sends the customer a memory plug-in through the mail.
3. The customer inserts the plug-in into the PCT expansion interface, and the PCT recognizes the device as an external memory module that is configured for auditing
4. The PCT displays a prompt that says {"export audit for 12-04-06 to 03-07-07?"}
5. The customer clicks the {OK} button while the PCT uploads data to the memory module:
 - a. Device ID
 - b. Software revision
 - c. Audit data
6. When the upload is finished, a prompt displays telling the customer it is okay to remove the card.
7. The customer inserts the card into their computer and accesses the utility provider's website to upload the PCT history.
 - a. OR
8. The customer places the plug-in in a utility-addressed envelope and drops the package into the mailbox for physical delivery.

Secondary: System Firmware Upgrade

1. The customer receives a memory plug-in in the mail from the manufacturer or utility.
2. The customer inserts the plug-in into the PCT expansion interface, and the PCT recognizes the device as an external memory module that contains a software update.
3. The PCT displays a prompt that says {"Update PCT Software?"}
4. The customer clicks the {OK} button while the PCT downloads the software update from the memory module.
5. When the download is finished, a prompt displays telling the customer the PCT will restart after installation, but if there are any problems to call the manufacturer/utility.
6. The PCT finishes installation and restarts.

4.2.3. Human-Machine Interface

Primary: Resident Override of Price Event

1. The PCT confirms that the device is "connected" and that it can receive DR signals.
2. The PCT receives an incoming signal to reduce load for a price event.
3. The PCT {flashes lights and beeps} – a message scrolling across the screen informs the customer that a peak price will occur at {3 PM}.
4. The customer selects {Override}, and receives a warning prompt about {higher prices}.
5. The customer acknowledges the warning and the PCT operates normally.

Variation: Emergency Event

1. The PCT receives an incoming signal to reduce load for an emergency event.

2. The PCT {flashes lights and beeps} – a message scrolling across the screen informs the customer that an emergency event is now occurring.
3. The customer selects {Override}, and receives a prompt disallowing any setpoint changes during emergency periods.
4. The PCT operates in emergency mode until the event is over.

4.2.4. HVAC Interface

Primary: Retrofit Installation of PCT

1. A customer has elected to upgrade their existing thermostat to a PCT.
2. An installer from arrives to update the mounting panel.
3. The installer disconnects the old terminal strip, hooking up the existing color-coded wires into a {new interconnect}.
4. The {interconnect} is screwed into the wall and becomes the mounting plate for the new PCT.
5. The PCT simply snaps onto the mounting plate and is ready for configuration
6. The PCT {setup menu} is opened and the installer adds the appliance types which are installed in the house:
 - a. Air Conditioner
 - b. Gas furnace
 - c. Electric fans
7. The installer configures the PCT address by selecting {numbers} to enter a {six-digit address code}.
8. The PCT is ready to run as it receives {time/date} information over the air from the broadcast communication network.

Secondary: Upgrade of HVAC Equipment for a PCT-Connected Home

1. A house is being renovated to become more energy efficient; double-paned glass, a new water heater, and a digitally controlled A/C are part of the renovation.
2. The old A/C unit is removed and the existing A/C wires are used for the control signal.
3. The PCT mounting plate is rewired so that the lines are moved to the digital part of the {interconnect}.
4. The PCT is reconnected to the mounting plate, and the {firmware update for control logic} is applied via the expansion port.
5. The PCT reboots, and the {setup menu} is opened and configured for the new type of A/C device.

4.3. Functional Requirements and Constraints

A set of functional requirements and constraints was derived for each interface based on the use scenarios and other stakeholder assessment exercises. In commonly accepted design methodology, such as axiomatic design (Suh 1990), functional requirements conventionally refer to functions (i.e., “what it does”) that enable the end-user to achieve his/her goals. An example of a PCT functional requirement is the function of maintaining the temperature in the resident’s house, which enables the resident’s goal of being comfortable. Constraints differ from functional requirements because they are imposed to make the solution fit within a

particular environmental context. An example of a PCT constraint is to maintain compatibility with existing wiring conventions for HVAC appliances. While this compatibility requirement is necessary for interfacing with hardware that could be installed in any given resident’s house, it does not directly accomplish any of the resident’s personal goals.

From these functional requirements and constraints, technologies that serve the functions while satisfying the constraints were identified. A technology survey of possible candidate technologies is presented in Chapter 5, *Technology Survey*. The team imposed a general pair of requirements (constraints) which applied to all of the interfaces: that the technologies used to satisfy each interface should be *ubiquitous* and relatively *low in cost*. An example is that organic LED display technology could satisfy many of the PCT human-machine interface requirements, but being a nascent technology it is neither ubiquitous nor low in cost when compared to other display technologies. **The requirements of ubiquity and cost are not explicitly stated in the rest of this chapter and should be understood as implied for all interfaces.**

A summary of novel or key requirements for each interface is presented in Table 4.1. The complete list of functional requirements and constraints that were identified for a minimum functionality PCT is presented in Sections 4.3.1 – 4.3.4. Note that in those sections **boldface** indicates functions that are novel or particularly key to the PCT.

Table 4.1. Summary of key functional requirements and constraints

| | Functional Requirements | Constraints |
|----------------------|---|---|
| Communication | <ol style="list-style-type: none"> 1. Receive signals/messages (bytes) <ol style="list-style-type: none"> a. asynchronous signals (rec'd. within 1 minute) b. event information 2. Send use history data periodically to IOU or service provider (kilobytes) | <ol style="list-style-type: none"> 1. Works throughout the state 2. Demand response dispatch should be addressable 3. Low power use by PCT |
| Expansion | <ol style="list-style-type: none"> 1. Support two-way communications 2. Read/write data from/to flash memory | <ol style="list-style-type: none"> 1. Low power 2. Small form factor |
| HVAC | <ol style="list-style-type: none"> 1. Interface with residential furnace and central air system 2. Interface with digital HVAC appliances | <ol style="list-style-type: none"> 1. Single physical interconnect for HVAC connection |
| Human-machine | <ol style="list-style-type: none"> 1. Convey DR signal to occupant 2. Display connection status, receiving signal indicator 3. Input commands <ol style="list-style-type: none"> a. Temporarily override price event b. Download stored usage data to memory device | |

4.3.1. Communication Interface

Functionality

One-way Functionality

- 1. Receive signals/messages (bytes)**
 - a. Asynchronous signals (received within one minute)**
 - b. Synchronous signals (hourly)
 - c. Event information**
 - i. Event type
 1. Reliability response (no override possible)
 2. Economic response (override allowed)
 3. Time synchronization
 4. Message
 - ii. Start time
 - iii. Event duration
 - iv. Event information
 1. Display message
 2. Price
 3. Time

Two-way Functionality

- 1. Acknowledge incoming message data**
- 2. Send use history data periodically to IOU or service provider (kilobytes)**

Though the minimum functionality PCT is expected to utilize a one-way communication receiver, adjudication of a customer's bill for event response will require a mechanism for sending some information back to the distribution utility. The two-way functionality may be accomplished by an "out-of-band" mechanism and need not be restricted to the receiving technology. For example, an audit of message logs and event overrides could be exported to a memory card that can be mailed back to the service provider or uploaded to a computer and sent back over the Internet.

Constraints

- 1. Works throughout the state**
 - a. Can be purchased in San Diego and work in San Francisco
- 2. Demand response dispatch should be addressable**
 - a. Source utility must be identified
 - b. Resolution to the level of substation feeder area is ideal
 - c. Targeting customers enrolled in pricing programs/groups should be considered
- 3. Interface doesn't preclude/interfere with future communication and dispatch strategies (i.e. interface with AMI or residential energy monitoring & control system)**
- 4. Low power use by PCT – doesn't impact battery life**

5. Interface should support downlink authentication (validate source of DR dispatch) and uplink security (protect confidential data)

4.3.2. Expansion Interface

Functionality

1. Add functionality through external connection
 - a. Share data with other devices
 - i. Support two-way communications plug-in
 - ii. Read/write data from/to flash memory
 - iii. Connect PCT with PC or other host device
2. Update software through external connection

Constraints

1. Low power
2. Small form factor

4.3.3. Human-Machine Interface

Functionality

1. Communicate information
 - a. Convey DR signal information to occupant
 - i. Type of event
 1. Reliability event (Override not possible)
 2. Economic event (Override allowed)
 3. Display message
 - ii. Information of DR signal
 1. Event time (start time, stop time, duration if known)
 2. Setpoint/Price
 3. Message content
 - b. Connection, receiving signal indicator
 - c. Display current temperature
 - d. Display current status
 - e. Mode (Heat, cool, auto, off)
 - f. Equipment State (Heat on, AC on, Fan on)
 - g. Current program (Home, Away, Asleep)
 - h. Override of setpoint schedule (if occupant overrode current setpoint)
 - i. **Override of price event (if occupant ignores price event)**
 - j. Display time
 - k. Display heating and cooling setpoints
2. Input user commands
 - a. Set time and day
 - b. Set schedule (Home, Home/Away during day, Away)
 - c. Set temperature setpoints
 - d. Set equipment mode (Heat, cool, auto, off, Fan-on, fan-auto)
 - e. Temporarily override temperature setpoint

- f. Temporarily override price event
- 3. Use memory modules
 - a. Download stored usage data to memory module
 - b. Update software from memory module
- 4. Set up device
 - a. Installed equipment
 - i. Type (gas furnace, AC)
 - ii. Hardware interface (24VAC, digital)
 - b. Address
 - i. Source utility
 - ii. Zone or location
 - iii. Price/Program enrollment
 - c. Set economic response to price event
 - d. Cycle rate
 - e. F vs. C display on Thermostat

Constraints

There are no specific constraints noted for this interface.

4.3.4. HVAC Interface

Functionality

- 1. Interface with residential furnace equipment
- 2. Interface with central house fans
- 3. Interface with central air conditioning equipment
- 4. **Interface with digital HVAC appliances**

Constraints

- 1. Single physical interconnect for HVAC connection

5.0 Technology Survey

As part of developing the concept for a minimum functionality PCT, the group identified a number of possible technologies that could be used for each interface. This technology survey process was intended to generate a large set of ideas for how the minimum functionality PCT could work. Following this survey process, the group reviewed the candidate technologies to select a technical solution for each PCT interface. The technologies chosen by the team as an initial strawman recommendation are presented in Chapter 8, *PCT System Interfaces and Minimum Functionality PCT Concept*. This chapter describes the technologies identified in the survey process, presents candidates the team considered as primary (main), and presents a brief comparison of these main candidates.

5.1. Approach

For each interface, the team reviewed the requirements and identified a list of possible technologies that could meet the functional requirements. Based on the identified constraints (especially ubiquity and cost) the team identified a pair of main candidates for all interfaces except the human-machine interface. For the human-machine interface a different approach was taken: the team did a survey of commercially available input and display/alert technologies that were possible technical solutions, and outlined a list without doing a comparative analysis. This is because there are no system compatibility issues with the human-machine interface. For the HVAC and expansion interfaces the team identified a general set of metrics for comparative analysis between the main candidates. The communication interface was analyzed in greater detail than the other interfaces to serve the needs of the California Energy Commission. This analysis is presented in the Chapter 6, *PCT Communication Interface Questions and Issues*.

5.2. Communication Interface

5.2.1. Candidates

Main Candidates

Two technologies have been identified as primary candidates for the PCT 1-way Communication Interface because of their maturity, availability, and practicality (including cost and engineering feasibility): RDS and FLEX paging. Here is a brief description of each technology.

- **RDS via FM Broadcast**

The Radio Broadcast Data System (RBDS) as it is known in the United States, or Radio Data System (RDS) as it has been implemented in Europe², is a subcarrier of digital data which commercial radio stations can add to their broadcast signal. The technology is currently used commercially in automobiles to display song titles and report highway

² Radio Data System (RDS) has been a standard in Europe for over 20 years. The United States version of the standard, Radio Broadcast Data System (RBDS) is technically compatible with the European standard but adds a marginal amount of technical functionality. For the purpose of discussion, the terms are interchangeable.

traffic information. Chipmakers such as NXP and Silicon Laboratories offer low-power FM receivers with integrated RDS decoders for use in automobile radios and portable consumer electronics. The detailed RBDS Specification offers a complete description of the technology, and is available from the National Radio Systems Committee: <http://www.nrscstandards.org/Standards.asp>.

- **FLEX 1-Way Paging**

Paging networks have been used for professional communications (emergency workers, medical and healthcare, etc.) for several decades and a large infrastructure was built up in the 1980's and 1990's for this technology. There are two different types of paging protocols in the United States which will each meet the basic PCT needs: FLEX and POCSAG. POCSAG is an older and open standard which is supported by regional carriers, but the only two national paging companies, US Mobility and American Messaging offer FLEX and do not plan to invest in any POCSAG infrastructure. FLEX is a proprietary paging standard developed by Motorola which uses a time-synchronized TDMA scheme to support a large number of users (addressable units) on the network and conserve battery life. Because of the licensing costs, FLEX hardware is more expensive than POCSAG hardware.

Other Possible Candidates

Other communications technologies were discussed as part of the brainstorming process and are documented here. While these technologies are not currently considered serious candidates for PCT's (largely because of cost and power-use), they may be eventually supported in the PCT by expansion modules or used in home-area monitoring, control, and communication networks.

Commercial Broadcast Services

- **Digital TV**

In February 2009, all television broadcast will be completely migrated from analog to digital broadcast. The FCC will allow each broadcaster 6 MHz of bandwidth. Television stations may utilize their entire bandwidth allocation to broadcasting HD-quality video or choose to utilize some of the bandwidth for subcarrier data such as weather and DR information. No low-power digital TV receivers exist yet and subcarrier data applications on the TV band have not been commercialized in the US. Some general information about digital TV is available from the FCC's digital TV website: <http://www.dtv.gov/>.

- **MSN SPOT Service**

Microsoft developed a proprietary subcarrier communication technology very similar to RDS for communicating data such as weather and stock market information to "SPOT" devices (*smart personal objects technology*). The subcarrier is referred to as "DirectBand," and plans are in place to eventually migrate the service to HD Radio (*see next technology below*). Receivers have been integrated into SPOT products such as watches, weather stations, and GPS devices, though they are not nearly as ubiquitous as RDS. A SPOT enthusiasts' website lists known devices: <http://www.spotstop.com/price/>.

- **HD Radio**

The iBiquity Digital Corporation (<http://www.ibiquity.com>) created a standard for digital radio, called “HD Radio,” which was chosen by the FCC in 2005 as the current standard for hybrid (digital and analog) radio broadcast. HD Radio will offer digital subchannels that would work similarly to RDS. Automotive and home HD Radio receivers are already being sold to the public.

Two-Way Capable

- **Wide-area or broadband gateway to local network**

Each of the technologies listed below is used by consumer electronic devices for network communication and could route data between a wide-area network, such as broadband Internet or a utility communication infrastructure (UCI), and a PCT.

- **Ethernet (local 802.3 or TCP/IP)**
- **WLAN (802.11)**
- **WPAN (Bluetooth, 802.15.4)**

- **Two-way paging networks**

Motorola’s ReFLEX 2-way paging system has been used in PCT’s by Honeywell and Carrier.

- **Cell-phone networks**

Cell-phone technology is becoming increasingly used in telemetry applications for electronic devices.

Powerline

- **Homeplug/Insteon/X10**

There is a number of powerline communications technologies which establish local communications (within a home) for lighting and appliance control. Such a technology may be used to connect a PCT to a residential meter or other broadband gateway.

However, this would require connecting the thermostat to the house’s electrical wiring.

5.2.2. Metrics and Analysis

Because the PCT 1-way communication interface is so pivotal to the California Energy Commission’s desired PCT functionality, a technology recommendation and comparative summary was presented to CEC as an individual document that is available in the report in Chapter 12, *Wide Area Network One-Way Interface Recommendation*. The recommendation and summary are based on detailed analyses of the two primary one-way candidate technologies. Chapter 6, *PCT Communication Interface Questions and Issues*, presents much of this analysis, outlining key technical questions for the interface and answering many of them for FLEX paging and RDS.

5.3. Expansion Interface

5.3.1. Candidates

Main Candidates

- **SDIO/MMC**

SDIO is an acronym for *SecureDigital™ (SD) Input/Output* and is an industry standard for I/O expansion plug-ins based on the form factor of MMC (MultiMedia Card) memory modules. SDIO, SD, and MMC slots are widely used in digital cameras, MP3 players, PDA's, cell phones, and even laptops. The SDIO physical (regarding pin configuration) and logical standard (regarding data transaction) is a superset of the SD standard, which is a superset of the MMC standard.

- **USB host, low power**

The USB host specification allows a device, such as a laptop, to interact with USB client devices, such as memory cards, wireless networking adapters, printers, and other peripherals. USB, as is currently predominantly implemented in the market, must function in a master-slave relationship. A low power implementation allows hosts to provide for reduced amounts of peak current, making it practical for use in portable computing devices.

Other Possible Candidates

Several off-the-shelf and developing candidates exist to meet expansion requirements of the PCT. They are all described briefly in the following section. They are not considered primary candidates due to one of the following characteristics:

- size of plug and/or jack
- power requirements
- hardware/software overhead
- number of supported devices
- availability / ubiquity

Serial

- **USB OTG**

The USB "On-the-Go" protocol is a revision to USB 2.0 which allows for a device to be both a peripheral (client) and a limited host. It uses less power than the standard host specification (8 mA vs. 100 mA), a single interconnect jack (USB miniAB) for both host and peripheral use, and does not require the large number of drivers of a standard PC host. At the time of this writing USB OTG has not been developed in consumer peripherals but standard use of the miniAB jack in newer electronic devices suggests that it could be a popular serial interface in the future.

- **RS-232**

RS-232 is a very mature and widely used physical-layer standard for signaling serial binary data between two electronic devices. The standard became widespread in PC's when used for external modems. While RS-232 is now legacy in consumer PC uses, it remains widespread in specialty electronic devices that do not require high-speed communications, such as point-of-sale devices, LCD display units, and simple electromechanical devices (i.e., simple computer-controlled devices with moving parts). Because of its maturity, chips for communicating over RS-232 are very inexpensive.

- **RS-485**
RS-485 is a serial physical-layer standard that uses differential voltage signals and allows for multiple devices to be connected in a network. The standard has been used in building automation and low-speed control systems. RS-485 has been used as the physical layer for communication protocols such as Modbus and SCSI.
- **Ethernet**
Ethernet over Category 5 wiring remains one of the most reliable, low-cost, and prevalent networking technologies around. An Ethernet connection on the PCT could support “expansion” capabilities by interfacing with other devices on the network.
- **PC, SPI, 1-wire**
These industry standard serial communication protocols are primarily used as interfaces in embedded systems between microcontroller units (MCU’s) and digital integrated circuits (IC’s). For example, SPI is the preferred connection interface between an embedded processor and an SDIO device such as a wireless network adapter. While these are mainly communications protocols that do not coincide with a physical specification, they can be supported as standard interfaces between a PCT and its expansion plug-ins.

Parallel

- **CompactFlash**
CompactFlash is a parallel interface designed to reduce the size of the common PCMCIA interface (now PC Card) used in laptop computers. CompactFlash is primarily used for non-volatile memory modules (flash or hard drive) in portable electronics, but has also been used as an expansion interface for several types of I/O modules, including Ethernet and wireless network cards.

Wireless

- **Zigbee**
Zigbee is a standard for low-power networking over the IEEE802.15.4 (2.4 GHz or 900 MHz) physical layer standard that was developed with residential and commercial HVAC applications in mind. The standard itself specifies multiple levels of interoperability, defining a device or platform as Zigbee Compliant, Zigbee Network Capable, or Zigbee Product Certified.
- **WiFi**
The wireless local area networking protocols defined in IEEE802.11 (2.4 GHz) have been adopted largely in homes, office buildings, and public gathering places for devices such as laptops, printers, mobile phones, and handheld video games. WiFi could be integrated into a PCT to allow Internet access through a residential gateway, and added services through local-area communications with a PC or other device.
- **WUSB**
Wireless USB (WUSB) is an extension of the USB 2.0 protocol targeted toward consumer electronic devices over the WiMedia ultra wideband (UWB) radio interface. Since the

specification was recently released in May 2005, there are not any consumer products available on the market just yet. However, as an extension of the standard USB 2.0 protocol, WUSB may show rapid market adoption.

- **Bluetooth**

Bluetooth is a low-power networking standard used by consumer electronic devices such as voice/audio headsets, digital cameras, and computer I/O peripherals. The technology operates on standard unlicensed 2.4 GHz channels and employs frequency-hopping spread spectrum (FHSS) as an interference rejection mechanism. Bluetooth 3.0, like WUSB, will use UWB as well to increase transmission speed and robustness.

5.3.2. Metrics

- Cost
- Size
 - Connector size
 - Size of peripheral devices
- Overhead
 - Software stack or interface chip
 - Power
- Availability
 - Licensing or propriety issues?
- Supported applications
- Data rate

5.3.3. Summary Comparison

Table 5.1. Comparison of Expansion Interface Main Candidates

| | USB Host Low-Power | SDIO |
|-------------------------------|---|--|
| Cost | Connector: \$0.50 Plug-ins: dollars to tens of dollars | Connector: \$0.30 - \$1.50 (spring-loaded multi-card compatible) Plug-ins: dollars to tens of dollars |
| Size | Connector: approx 25 mm L x 15 mm W x 10mm H, enclosure will need an opening 15 mm W x 8 mm H Flash memory: 30mm L x 16 mm W x 8mm H Additional peripherals typically unconstrained in size | Connector: approx 30 mm L x 25 mm W x 5 mm H, enclosure will need an opening 25 mm W x 3 mm H Flash memory: 32mm L x 24mm W x 2.5mm H Peripherals constrained in width and thickness to SD-card size, though some (i.e. GPS, FM tuner) are wider/thicker outside of SD slot |
| Overhead | Stack/Interface: Implementing a host controller into a PCT would require an advanced processor to handle the state handling, data transmission, power management, and other functions specified in the USB standard. Power: <ul style="list-style-type: none"> • Supply Voltage: 4.4V min – 5.25V max • Min current: 100 mA • Signal Input Voltage: 0.8V – 3.6V, depending on operational mode | Stack/Interface: The SDIO protocol has a simple bus topology and supports the standard SPI interface for data transactions; a simple 8 or 16-bit MCU running the thermostat with SPI support could run the interface. Power: <ul style="list-style-type: none"> • Operating Voltage: 1.6V – 3.6V, depending on operational mode • Min current: <ul style="list-style-type: none"> ○ 50 mA for SDIO ○ 100 mA for combo cards |
| Availability | Components are readily available off-the-shelf. USB slave devices are ubiquitous. The USB specification is an open standard with no licensing. | Components are readily available off-the-shelf. Memory cards for the interface are ubiquitous, and a variety of peripheral devices using SDIO are on the market. Yearly licensing (\$1500 – \$2500) is required of an MFR to use the full protocol, while no licensing is required to use MMC and some derivative (non-standard) serial communication. |
| Supported Applications | <ul style="list-style-type: none"> • WLAN (Wifi) / WPAN (Bluetooth, Zigbee) Radio • External flash, hard drive, and optical storage • External input devices • GPS • Printers | <ul style="list-style-type: none"> • Radio / TV tuner • WLAN (Wifi) / WPAN Radio (Bluetooth) • External flash memory <ul style="list-style-type: none"> ○ security layer added into SD standard • GPS |
| Data Rate | Low-speed: 1.5 Mbps Full-speed: 12 Mbps High-speed (USB 2.0): 480 Mbps | Min: under control of t-stat processor Max: 100 Mbps using 4 parallel lines |

5.4. Human-Machine Interface

For this particular interface, the group simply identified existing off-the-shelf technologies which could be used for input and output of information between the resident and PCT. The team did not perform comparative analysis since standardization of particular technology is not required as there are no interoperability issues with this interface. Ultimately, the PCT vendors should be able to innovate with their human-machine interface designs as long as minimum requirements specified in the *Title 24 PCT Manufacturer's Specification*³ are satisfied. At the time of this writing, it is believed that the Manufacturer's Specification will refer to standard nomenclature for PCT states and types of information and require the manufacturers to demonstrate or describe a mapping of these states/data to device features in their user manuals.

As stated in Chapter 4, the key novel functions of the human-machine interface in PCT's are to convey DR event information and network connectivity to the resident and allow inputs to override events and for downloading audit data. It is believed that the new inputs can be achieved with technology on existing programmable thermostats (usually buttons). Signal status can be indicated by a part of the display area of current programmable thermostats (usually liquid crystal displays). To convey the DR event information, the group recommends adding alert LED's and a sounder to indicate pending price and reliability events. These particular technologies are very low in cost and are effective at capturing attention of end users.

5.4.1. Candidates

Possible candidate technologies which can be used to perform various input and output functions are listed here:

- Output
 - Information Display
 - LCD
 - OLED
 - Network streaming to computer, mobile phone, or television display
 - Alert
 - LEDs (Green = Low price, Yellow = Med price, Red = High price, Blue flashing = Event)
 - Speaker (Rising pitch = start of higher price period or reliability event, Falling pitch = end of higher price period or reliability event)

³ At the time of this writing, this document does not yet exist; however, the Energy Commission expects to create a document that outlines mandatory implementations for each interface. The document is expected to refer to the Title 24 PCT Technical Working Group's *Reference Design for Programmable Communicating Thermostats Compliant with Title 24-2008*, declaring specific interface implementations presented in the PCT Reference Design as mandatory.

- Piezoelectric buzzer (rising pulse modulation = event start, falling pulse modulation = event end)
- Input
 - Buttons
 - Touch-sensitive screen
 - Switches
 - Dial selector
 - Computer input (through web-based or software interface) – in conjunction with wireless or physical connection to device
 - Mobile phone input – in conjunction with wireless connection to device

5.5. HVAC Interface

5.5.1. Candidates

Main Candidates

- D-Sub 9
- Straight pin header

Other COTS (commercial off-the-shelf) connectors that exist, such as mil-spec or medical-device grade, are cost and size prohibitive, and not ubiquitous enough for practical application. The commonly used RJ-45 connector was also considered, but it is not listed as a main candidate because it cannot safely meet the power requirements of most 24VAC switched HVAC systems.

5.5.2. Metrics

- Cost
- Availability
- Current rating
- Wire gauge acceptance
- Size
- Mechanical stability/durability
 - Alignment/orientation

5.5.3. Summary Comparison

Table 5.2. Comparison of HVAC Interface Main Candidates

| | Straight Pin Header | D-Shell |
|--|--|--|
| Cost | Pins + screw terminals: \$0.50 PCB Receptacle: tens of cents | Connector + screw terminals: \$0.25 PCB: \$0.25 |
| Availability | Readily available off-the-shelf | Readily available off-the-shelf |
| Current rating | The pins can be sized such that there are no current capacity limitations in the connectors | Typical: 1 A (adequate for legacy HVAC) Max (limited by pins of PCB connector): ~5A |
| Wire Gauge Acceptance | Pin headers themselves have no direct terminations to wire, so a custom screw terminal block would be needed. | Connectors do exist which would allow the direct termination of 20-ga wire to a DB male or female plug. However, a custom screw terminal would likely be needed for this type of connector as well, either because 18-ga wire is present/needed or direct termination to the connector is impractical during retrofit. |
| Size | Flexible, though depth is likely to be ~10 mm | 31 mm W x 12 mm H x 11mm D |
| Mechanical Stability/Durability | High friction connectors are available, and thicker pins are less susceptible to bending. Keyed housings or other alignment mechanisms are available to prevent improper connection. | DB-9 connector housing enforces alignment (good for safety) and prevents damage to pins. Additional mechanical security (e.g., locking tab) is required to prevent disconnection. |

6.0 PCT Communication Interface Questions and Issues

6.1. Objective

The UC Berkeley team identified key technical questions that need to be answered and issues that need to be dealt with in implementation of any solution proposed for a PCT communication interface. The primary objective of this chapter is to raise these issues and questions. The team seeks to benefit PCT stakeholders by offering the resulting framework of questions and issues as a basis for discussion and investigation of any solution proposed for communication with PCT's. Using this framework, an analysis of a candidate solution should turn up any red flags that would prevent it from functioning viably for demand response.

Additionally, the team sought to address as many of these questions and issues as possible for RBDS (alternatively referred to as "RDS"⁴) and FLEX paging technologies, the primary candidates for a PCT embedded one-way interface. The team conducted initial technical research for these technologies because the California Energy Commission determined that they would choose a one-way communication technology as a statewide standard for basic, emergency, demand response in PCT's and mandate an embedded, non-removable receiver to be included in all Title 24-compliant PCT's. Where the team was not able to answer questions to adequate detail, bounded estimates and/or recommendations for further research are outlined.

6.2. Approach

The team began by building a framework to organize technical issues that immediately came to mind and assist in uncovering new ones. The team started with the Open Systems Interconnection (OSI) 7-layer reference model for open communications, which has been adopted by the computing industry as a standard thought-model for designing communications and networking systems, and simplified it to three layers for reasons of simplicity:

- **Application**
Issues related to exchanging data for the PCT application, including demand response functionality and security (*amalgamating the OSI Application and Presentation layers*)
- **Network**
Issues related to topology of PCT operation and the transport of information (*in some way including OSI Session, Transport, and Network layers*)
- **Physical**
Issues stemming from physical connection to the network (*amalgamating OSI Data Link and Physical layers*)

⁴ Radio Data System (RDS) has been a standard in Europe for over 20 years. The United States version of the standard, Radio Broadcast Data System (RBDS) is compatible with the European standard but adds some features specific to the United States.

Table 6.1, adapted from a table commonly used in networking literature to illustrate the function and data unit of each OSI layer, shows the mapping between the 7-layer model and the simplified discussion framework.

Table 6.1. Mapping of OSI 7-layer Model to PCT Discussion Framework

| OSI Model | | | PCT Discussion Framework |
|------------------|--------------|--|--------------------------|
| <i>Data Unit</i> | <i>Layer</i> | <i>Function</i> | |
| Data | Application | Network process to application | Application |
| | Presentation | Data representation and encryption | |
| | Session | Inter-host communication | Network |
| Segments | Transport | End-to-end connections and reliability | |
| Packets | Network | Path determination and logical addressing (IP) | |
| Frames | Data link | Physical addressing (MAC & LLC) | Physical |
| Bits | Physical | Media, signal and binary transmission | |

The group envisioned a one-way, broadcast-based, communication system working to provide demand response messaging to a residential PCT and brainstormed a variety of technical questions and issues that would be critical to ensure the reliable operation of the system. While considering these issues, the group organized and reworked them into the 3-layer framework for clarification and consideration of new issues. The resulting analytical framework, presented in Section 6.3, serves as a minimum set of critical questions and issues and can be applied to any solution used for PCT communication, independent of whether it is one-way or two-way.

The group also considered technical issues and questions that were specific to two-way communication with residential PCT's. In addition to providing the minimum one-way demand response functionality, a two-way network can enable the collection of additional resident data and value-added services, but also presents additional issues pertaining to security and network topology. The two-way specific questions and issues are presented in Section 6.4.

The one-way and two-way questions and issues were reviewed by an established consultant in the wireless communication industry.

Once the formulation of the analytical framework was completed, the team began researching answers to these issues for the RDS and FLEX paging technologies. The team contacted

technical representatives from device manufacturers, major receiver chip vendors, data network operators, radio broadcasters, and service companies using the communication technologies for applications similar to demand response to obtain interview data to address the raised questions and issues. Where possible, the team reviewed primary documentation about the protocols and hardware involved in each interface. Where detailed answers could not be obtained, the team calculated a bounded estimate, dismissed the issue as non-impacting, or recommended further research.

6.3. Universal Questions and Issues for the Communication Interface

Presented in this section are the questions and issues universal to one-way and two-way communication for residential demand response. The questions and issues are numbered, so that analysis can be presented for specific communication solutions in separate documents.

1. Application

a. Downlink Security: *What are ways in which DR data can be authenticated and possibly protected (encrypted)?*

The solution for this interface must provide some kind of mechanism to authenticate the source of the DR signal and possibly protect its contents. It is assumed that for most emergency and economic dispatches, additional security above authentication is not needed, although some utility-specific DR programs and value-added services may require confidentiality.

b. Information Model

A common information model (CIM) for DR dispatch functionality must be developed and agreed upon by the manufacturers and distribution to ensure interoperability and minimum functionality. Specific communication profiles implementing this information model, accounting for the security requirements, must be standardized into a protocol for each specific approach and/or underlying physical technology.

2. Network

a. Infrastructure, Operational, and Maintenance Costs

Is the infrastructure necessary to support PCT receivers at the traditional location of use (on a wall inside the residence) already existing or must it be built up or expanded?

What is the cost to build or expand this infrastructure? What is the cost to operate and maintain the infrastructure 24 hours/day x 7 days/week x 365 days/year, and can it be supported for the next ten years?

b. Network Capacity

How much data needs to be carried by the network to support DR dispatch, system health (i.e., heartbeat signals), and other data applications (e.g., clock synchronization, pricing information, etc.)?

c. Connectivity

The PCT should be able to determine if it is not connected to the broadcast network so that a resident can be alerted that there is a problem. One common method of achieving this is to transmit a “heartbeat” signal. If a PCT does not receive this periodically transmitted signal, then it can alert the resident that there is a failure.

d. Error Detection and Correction

What is the overall strategy for error detection and correction (i.e., will there be rebroadcasts and multiple attempts to communicate with all PCT’s)?

e. Membership: *How can various manufactured appliances and devices establish membership?*

The PCT needs to understand its membership to parent entities to obtain a desired granularity of demand response. This membership information can be accounted for through network addressed routing or address information embedded in a universal broadcast. For this application, a membership hierarchy that matches the topology of the electricity distribution system is desired. Title 24 requires one primary level of membership identification:

- i. With the distribution substation (by implication, membership to the distribution utility is accomplished)

Additional PCT membership properties may be desired:

- ii. With the feeder
- iii. With program enrollments (various DR and load control programs offered by the distribution utilities for economic response)
- iv. With the residence (HAN/AMI/EMCS system)

3. Physical

a. Frequency Band and Channel Plan

For a wireless system, a frequency band must be chosen within licensed (e.g., AM radio, FM radio, television, PCS communications, paging) or unlicensed ISM bands (e.g., 900 MHz, 2.4 GHz, 5.8 GHz). The bands will have different attenuation/reflection characteristics and sources of interference, each addressed in separate sections below. The unlicensed ISM bands for wireless communication are limited to a fixed number of channels, which must be distributed among the broadcast infrastructure in 1-way applications. Though the primary 1-way candidates already leverage existing infrastructure that has already been built to address channel plan issues, there are still questions to be answered. For example, in the FM scenario, the minimum number of carrier channels per geographic region must be considered, and then the PCT receiver must be able to identify the best channel to use.

b. Radio

i. Cost

What is the additional cost to the bill of materials (BOM) of the radio subsystem, accounting for required components and processor upgrades?

ii. Overhead

What is the computing and software burden to the PCT's core processor?

iii. Data Rate

What is the practically attainable rate of data transfer for this radio? Will this be sufficient for dispatching demand response events?

iv. Receive Sensitivity

The receive sensitivity specifies how faint a signal (low in power) can get to be successfully received. The smaller the receive sensitivity the better. The receive sensitivity, combined with knowledge of the transmitter strength, path loss, and transmitting and receiving antenna gains, gives a general indication of radio range.

v. Range

What is the maximum free-space radio range (signal power falls off as R^2)? What is the practical radio range in the target environment, given sources of signal attenuation such as concrete or other building materials (signal power falls off as R^4 in urban outdoor environments, or even faster within buildings)? What is the standard deviation signal power vs. distance in the target environment?

vi. Power Use (accounting for duty-cycle assumptions)

Power use will depend on network configuration as well as the receiver hardware. *Under certain scenarios for powering on the receiver, what is the expected average power use for the receiver?*

c. Antenna

A practically realizable, inexpensive PCT antenna at the correct frequency and with the required bandwidth (including manufacturing tolerances) will be needed to make the system work. As the frequency of the signal increases, the wavelength, and consequently ideal antenna size, decreases. Another variable is the antenna gain that is needed to make the system work properly. In general, gain decreases with size, from +6 dBi for a half-wavelength antenna to about -10 to -20 dBi for an antenna that is a tenth of a wavelength in length.

d. Noise, Reflections, and Interference

Sources of electromagnetic interference and signal reflections will affect the signal-to-noise ratio. Reflections of a radio transmission can lead to multiple signals arriving at the receiver with some level of multi-path delay between them. This can lead to inter-symbol interference, which can impair radio operation. However, both the FM broadcast and the IEEE802.15.4 radio systems

are quite accommodating of multi-path propagation and delay spread. Common sources of electromagnetic interference, such as cordless phones, microwave ovens, WiFi radio transmitters, and iPods with FM converters can also be cause for concern. A noise rejection scheme can be chosen – frequency hopping spread spectrum vs. direct sequence spread spectrum vs. ultra wideband – to improve the system performance. *How will the PCT be affected by sources of interference, how will it know it is experiencing radio interference, and how will it notify the resident?*

6.4. Additional two-Way Specific Issues

In addition to the issues mentioned above, two-way systems present an additional set of key questions and issues that are documented in this section.

1. Application

- e. **Uplink Security:** *In two-way applications, what are the ways in which data collected from PCTs are validated and protected from malicious spoofing and are kept private and protected from data theft?*

Whereas downlink DR data represents “one-to-many” transmission of information from a single (trusted) source, uplink radio transmissions from PCTs represent “many-to-one” (or in mesh networks, “many-to-many”) transmissions of information that may need to be validated at each point of entry into the communication network. The desire to transmit data over the two-way link to support the utility business case adds considerable complexity to security and privacy issues, beyond the use of two-way just to confirm receipt of commands and their implementation at the PCT. Privacy laws and cyber security standards will have a considerable influence on the system design for transmission of residential use data. For example, particular North American Electric Reliability Corporation (NERC) Critical Infrastructure Protection (CIP) standards that outline access control requirements for automatic load shedding systems capable of shedding 300 MW or more may apply to utility communication systems⁵.

2. Network

- f. **Network Capacity for Uplink**

Some solutions may be asymmetric in the data capacity for downlink vs. uplink transmission. *How much data needs to be carried in two-way (uplink as well as downlink) applications?*

- g. **Network Topology**

Is the network topology a star, a structured mesh, an ad-hoc mesh, or other? Are successful data transmissions dependent on the relay of data packets through secondary

⁵ Investor-owned utilities are currently evaluating whether NERC CIP will apply to AMI systems. CIP-002 through CIP-005 outline security measures such as access control and detection & alerting of attempted or actual unauthorized access.

radio nodes? If so, are these nodes part of the communication infrastructure, or not? How are secondary relay nodes powered? How does the relay of data packets affect battery life?

h. Error Detection and Correction for Uplink

How are errors in data transmission detected and corrected? Are acknowledgements of correct data transmission needed (in two-way applications)? Will the PCT make multiple attempts to transmit to the gateway?

3. Physical

e. Channel Plan

How many separate non-overlapping radio channels can be used to create sub-networks (particularly in two-way applications)? What geographic separation is needed in order for radio channels to be reused in different regions?

f. Access Method

Is the radio access method (for two-way applications) based on reserved capacity (e.g., time slots), or is random access based on contention (and the possibility of packet collisions) employed? How does the access method affect network capacity, overhead in data transmission, latency and the likelihood of successful data transmission?

g. Radio (Uplink)

i. Transmit Power

In a two-way application, the radio will consume a considerable amount of power for transmission. Generally, the power to the transceiver in wireless nodes is held constant, while the duty cycle is adjusted to meet the power budget.

ii. Range

Given the transmit power and antenna gain, what is the maximum range for uplink transmissions?

iii. Power Use (accounting for duty-cycle assumptions)

Power use will depend on network configuration as well as the receiver hardware. Under certain assumptions for data transmission, what is the expected average power use for uplink transmissions?

6.5. Results for One-Way Primary Candidates

6.5.1. RDS Analysis

Application

1.a. Downlink Security

Authenticated communication is not inherently provided by the RDS transport layer and a message authentication and tamper detection scheme needs to be built into the transmitted data. The Title 24 PCT Technical Working Group (Technical Working Group) is responsible for defining acceptable solutions for these requirements, and at the time of this writing has recommended the use of a key-hashed message authentication code (HMAC) for message authentication and tamper detection. An HMAC is similar to a digital signature attached to the end of a message that allows verification of authenticity through the use of an encryption key. Additionally, an HMAC provides a method to determine if the original message has been altered in any way during transmission to the recipient. A more detailed discussion of the Technical Working Group's security recommendations is available in Section 4.6 of *Reference Design for Programmable Communicating Thermostats Compliant with Title 24-2008* (Title 24 PCT Technical Working Group 2007) (shall be referred to as "the PCT Reference Design").

1.b. Information Model

A protocol has not yet been developed for PCT communication over RDS. An implementation of the high-level data model created by the Technical Working Group will have to be mapped into a digital format for use on RDS networks by the network operator or some industry alliance. The mapping should be done as efficiently as possible in regard to bit-lengths in consideration of the data rate limitations of RDS. A test RDS protocol developed by the team (see Appendix E, *RDS Demo Protocol and Transmitter*) is being used to demonstrate functionality and evaluate the information model presented in the PCT Reference Design.

Network

2.a. Infrastructure, Operational, and Maintenance Costs

- **Infrastructure**

When discussing infrastructure, one needs to consider two segments of the network: the physical, transmitting infrastructure, and the data network that delivers data to the transmitters or transmitting stations.

Physical Infrastructure

The physical infrastructure for the RDS solution is not expected to be of significant cost to the state. RDS leverages the existing commercial FM radio infrastructure that already covers almost all populated areas of the state, possibly excepting small groups of residents in remote mountainous areas. By default, a particular FM broadcaster may not have the capability to transmit dynamic RDS data. This is enabled with the addition of a special encoding unit and wide-area connection to a data stream. According to e-Radio Inc., the retrofit of a broadcaster that does not have RDS capability is estimated to cost

\$10,000 to \$15,000 (Boland 2006), though depending on existing equipment it is believed that the upgrade costs may be considerably less. Market data about the penetration of RDS among existing operators has been difficult to obtain, but a frequency scan from Berkeley, CA revealed 18 Class B⁶ operators in the San Francisco Bay Area (and at least 4 more local, lower-power, Class A operators) with at least basic (static) RDS functionality, implying that physical infrastructure upgrades for the primary media markets could be largely unnecessary. Class B FM stations have FCC interference-protected service areas that generally reach up to 40 miles from the transmitter⁶ and in practical reception can go much farther. It has been estimated by Jackson Wang of E-Radio USA that 90% of the 596 licensed FM stations (Federal Communications Commission 2007) in California already have static RDS functionality. At least 22 of Clear Channel's FM stations in California already use dynamic RDS data (which is remotely managed) for sending highway traffic information to automobiles.

One option that could possibly extend the physical infrastructure into remote areas would be to retransmit the FM band over cable television, and re-radiate the FM signal within the residence through a small transmitter, such as those used for portable audio players. Some cable television operators are known to retransmit the FM band over cable lines, though in some cases the carrier may be translated from the original broadcast frequency. While specific re-transmitting hardware would be required, this would provide a guaranteed link to residences in areas with little or poor commercial radio reception. This option would provide a small additional cost to the consumer and an unknown cost to the state from the cable television operators.

The existing physical infrastructure is believed to be highly robust and reliable; commercial FM transmitters are heavily secured, can withstand some types of natural disasters and have on-site redundant power generation in case of power outages. Many broadcast stations also have auxiliary transmitters that can be used if the primary transmitters fail or are undergoing maintenance. The communications link from the broadcast station to its transmitter is also built with redundancy. Major transmitters are believed to have triple-redundancy, employing a T-1 line as the primary link and using microwave line-of-sight, optical line-of-sight, and satellite communications as backups.

Data Network Infrastructure

The data network for this solution is less well-defined and poses a potentially multi-million dollar cost to the state. Radio stations may not have a broadband data link to an external source, and the demand response data will need to be managed and routed to the stations by a central entity. The most practical solution is to hire a large data operator that can and/or has explicitly built a private network accessing a large collection of affiliate transmitting stations. e-Radio USA is one company which has built

⁶ Class B is the highest power transmitting class allowed in California. The FCC defines FM Station Classes on this webpage: <http://www.fcc.gov/mb/audio/fmclasses.html>.

IP-based networks that allow them to route and manage data appropriately through separately owned radio stations. Some larger radio networks, such as Clear Channel, have built up their own internal networks. Either of these kinds of companies can develop a secure socket or portal connection for CA utilities to submit DR data for transmission and handle the routing and network management transparently for the utilities. The capital outlay costs for a network operator's access to the stations are expected to be factored into the operational prices quoted to the state or utilities. Early order-of-magnitude estimates are listed in the further on under *Operation and Maintenance*.

The solution of contracting with a single, large data network operator for the state may not be acceptable if the Public Utilities Commission would like more players to get involved, or if smaller, local stations necessary for extending coverage to remote areas are unwilling or unable to partner with a private network. In this case, the state, through some agency, could elect to create an open, Internet-based, client-server architecture for exchanging DR message data so that any individual radio broadcaster or large network operator may participate. The concept is similar the architecture of the Demand Response Automation Server (DRAS) system currently being developed at the Demand Response Research Center at Lawrence Berkeley National Laboratory⁷. A secure server hosts DR status data which is updated in real-time by the distribution utilities. Clients can be installed at any involved broadcast station that poll the server and automatically re-transmit the appropriate dispatches over RDS when necessary. In this manner, a State agency could independently contract FM stations (regardless of affiliation) and equip each one with a client that links the station to a central source. This option effectively achieves the same functionality as the first strategy, but with added benefit and complication. The benefit is that any independent broadcaster in the state would be able to participate. The complication is that some particular state agency would then be charged with maintaining a *secure* network service and a number of contracts with a potentially large number of independent station operators. This option also poses an unknown, yet significant – possibly multi-million dollar – cost to the state.

- **Operation and Maintenance**

The estimated costs for operation are primarily dependent on the number of stations required to support the application statewide. It is believed that data requirements (RDS utilization is discussed in further on in *2.b. Network Capacity*) are so low that network access to the station is the primary driver for cost. According to industry experts, the cost of TMC/Navteq's station access, which demands 20-25% utilization of a station's RDS data capacity, for a single station is in the low tens-of-thousands of dollars per year. E-Radio USA has estimated that 30 to 35 stations could be required across the state, preliminarily estimated to cost \$5 Million per year to support (Boland 2006). This

⁷ More information about the DRAS system is available at the DRRC website:

<http://drcc.lbl.gov/dras/index.html>.

estimate is considerably more than the cost of station access, likely because it includes data and security management. A more accurate estimate would be possible once the security requirements of the system have been finalized and the actual number of required transmitting stations is determined. The research team has introduced a field study tool that can assist in determining some of the requirements for network and protocol design by providing a means to study real-world performance of RDS in residential settings. This tool and a proposed methodology for experimentation are presented in Chapter 10, *RDS Site Survey Tool*.

2.b. Network Capacity

The required network capacity is expected to average less than 1% of RDS utilization annually. This estimate has been derived from estimates of the three primary communication functions: DR dispatch, clock-synchronization, and heartbeat. The total network utilization is primarily determined by the heartbeat function due to its high frequency.

The RDS medium uses a “group” as a basic transport mechanism for data. A group can carry as much as 37-bits fully loaded. In our assumptions, we are using each group to carry 4-bytes of raw data and using the rest of the capacity for fragmentation overhead. The medium is capable of 11.4 groups per second, and assumptions about data requirements for the PCT application in terms of required groups is presented in this section.

Authentication and tamper detection will add to the data requirements since they have to be handled within the data payload for each message issued. A proposed HMAC system would add a number of bits to each message, depending on the desired level of security. The larger the HMAC, the more difficult it would be to break the encryption algorithm used in the HMAC. At the time of this writing, security experts in the Technical Working Group estimate that a reasonable HMAC size for this application is at least 128, or 16 bytes. This would add 4 additional RDS groups to each PCT command. A 256 bit HMAC would be much more secure than a 128 bit system, but would add substantial burden to the PCT data requirements.

- **Dispatch**

The primary use for the DR signal will be to curtail loads, and it is expected that the frequency of these events is rather low (5 days per year). When a curtailment *is* required, it is estimated that the raw command could occupy as much as 20 bytes, or 5 groups. This size can be reduced if the RDS implementation of the PCT Reference Design is fully enumerated and compacted to a set of “fixed” command codes, as opposed to free-format data. Adding the security overhead, an average PCT dispatch is anticipated to require 10 groups for transmission. Depending on localization requirements (for example one radio transmitter might support as many as 100 different load groups), multiple permutations of a dispatch message could increase network utilization. Also, to ensure reliability, re-transmission of the dispatches may be required. Even accounting for all of the data involved in a dispatch, these events are of such low frequency that they do not affect general network utilization requirements on an ongoing basis. However the broadcast contracts need to give these types of data

priority over other data in the system queue. DR dispatches may require highest-priority network utilization for 10 to 20 minutes during critical periods to ensure reliable transmission.

- **Clock-synchronization**

Clock-synchronization is required by the DR application and also serves as a non-cryptographic security measure to mitigate system exploitation. The update frequency will depend on the recommendations of the Technical Working group as a result of detailed security analysis. The RDS specification does have a built-in clock update function that many stations currently use on a frequent basis, meaning that no additional data capacity could be required. However, if any existing difference between the utility's and ISO's system time and the broadcaster's time is unacceptable, then additional network utilization of approximately 10 groups per clock synchronization would be required. While the security analysts have not yet issued a recommendation at the time of this writing, the frequency could range from once per day, to once per hour, to once per five minutes. A higher frequency of clock updates would also improve the ease of PCT setup after installation.

- **Heartbeat**

It is expected that this function will dominate the data capacity requirements of the network. A system "DR" heartbeat is required for two functions: so that the PCT can identify connectivity status, and so that the PCT can identify appropriate FM stations during initial setup. Frequencies of 4 to 60 times per hour have been discussed for this. More frequent heartbeats will help the installer or resident determine if the device is working during the installation process. One proposal is to issue heartbeats frequently between 8 AM and 8 PM, and then dramatically reduce the frequency (once per hour or less) outside of those times. PCT-specific clock updates (not the type provided in the RDS specification) could possibly be used as heartbeats to combine functionality. The RDS specification also has a built-in group for advertising supported RDS applications that can be used as a heartbeat. These "3A"-type groups could identify that a particular station supports the DR application and could also carry additional information about supported utilities or substations, allowing for radio station diversity within geographic areas. By using 3A groups, a heartbeat frequency of 1 group per minute represents 0.15% network utilization.

2.c. Connectivity

PCT's using RDS must scan the FM band to find RDS-enabled stations that are carrying DR functionality during some kind of initialization or setup phase. The receivers can identify very quickly whether or not connectivity to any stations in the band can be established by checking signal strength and RDS block statistics. To identify connectivity with DR-carrying stations, the receiver must reliably receive the heartbeat signal. This can be done with the use of "3A" ODA group identification blocks built into the RDS specification.

2.d. Error Detection and Correction

RDS natively handles some amount of error detection and correction within the protocol. Each block in the protocol consists of a 16-bit data segment and a 10-bit checkword. The checkword allows the RDS decoder to identify an error, and determine whether it is capable of 1-bit, 2-bit, or 5-bit error correction or if the data block is unrecoverable.

The RBDS Specification (National Radio Systems Committee 1998) outlines the error-checking algorithms:

The error-protecting code has the following error-checking capabilities:

- a) Detects all single and double bit errors in a block.
- b) Detects any single error burst spanning 10 bits or less.
- c) Detects about 99.8% of bursts spanning 11 bits and about 99.9% of all longer bursts.

The code is also an optimal burst error correcting code and is capable of correcting any single burst of span 5 bits or less.

2.e. Membership

Membership for the 1-way RDS system is expected to be accomplished through addressing at the data layer (refer to the PCT Reference Design). The RDS specification also contains a “radio paging” function but it is not believed to be viable for DR applications. The membership function is highly dependent on the installation scenario, but it is likely that the installer or resident will need to introduce an activation/registration code to the PCT which sets the utility identification code, substation code, and possibly feeder and billing codes. The retail customer could possibly use a sequence of button presses or an expansion plug-in to set up the code, while a contractor would have the option to batch process the codes for given neighborhoods using a connection through the expansion interface.

Physical

3.a. Frequency Band and Channel Plan

Since RDS leverages commercial FM radio, the overall frequency band and channel issues are accounted for in FCC procedures. There are 101 channels allocated for FM transmission in the US, from 87.9 MHz to 107.9 MHz. One key question which will affect the final system design is, ‘what number and characteristics of (distance, power, antenna height above average terrain, etc.) FM stations are needed to support a given geographic region?’ Preliminary testing by UC Berkeley of RDS receivers installed at a residential dwelling implies that some level of station diversity may be required for locations with poor FM reception to mitigate variations in performance within a particular site (e.g., a particular station might be received well in the kitchen but not in the living room). An in-depth study for network planning is recommended if RDS is selected by the State as the one-way DR standard.

3.b.i. Radio Cost

The additional BOM cost for an RDS subsystem is expected to cost less than \$3 per PCT. This includes an integrated tuner/receiver/decoder chip, a crystal, passive components, and an antenna. This budgetary pricing of an RDS chip at 1-million pieces is \$1.70 (Wong 2006), and the external components are expected to total an additional \$0.20 - \$0.30 (at lower volumes, these costs are expected to be higher). Smaller, and therefore lower-cost, integrated receiver/decoder chips are expected to be produced by NXP and other chip-makers such as Silicon Laboratories, Comlent, and RDA in coming quarters. For example, NXP recently released their TEA5766 RDS chip, which reduced the PCB surface area from their previous model (TEA5764) from 70 mm² to 36 mm² and reduced the number of external components from 20 to 11 (NXP 2006).

3.b.ii. Radio Overhead

The radio subsystems currently available (mentioned in 3.b.i.) tend to require a host processor that can support standard digital communication protocols such as I²C or SPI. The RDS chip itself is not expected to be a processing constraint on the host processor, as cryptographic capabilities required will dominate this requirement. NRE efforts will need to go into developing a radio interface driver that manages the operation of the RDS chip but the software storage area necessary for this code should not pose a major burden to the PCT.

3.b.iii. Radio Data Rate

The RDS system operates at 1187.5 bps, but has a large amount of overhead for error correction and radio station information. The achievable data rate, after accounting for this overhead, is closer to 300 bps.

3.b.iv. Radio Receive Sensitivity

Information about the generally required dBm (power) or dBuV (field strength) for practical RDS performance could not be determined. RF propagation models used by radio broadcasters, such as the Longley-Rice and FCC F(50,90) model, attempt to predict electric field strength at given distances using various parameters as function inputs. A statistical study correlating RDS performance to field strength and/or against propagation models would be valuable to the RDS network planning task. The site survey tool developed by the team can possibly be used to support this task because it can provide a coarse (4-bit) measurement of electric field strength in addition to RDS reception measurements.

3.b.v. Radio Range

The practically achieved range of licensed FM radio transmission ranges vastly from 1 to 100 miles and is primarily dependent upon the location and height (both relative to ground and average terrain) of the transmitting antenna and the transmitting power, and also varies with local topography from geological and manmade features. The areas of primary interest for A/C load curtailments with PCT's, the Central Valley, have mostly flat terrain and can therefore support a large service territory. One particular station located near Fresno, KSKS, has a protected service contour extending over 70 miles in some directions (FCC 2007), yielding an approximate 15,000 sq. miles of coverage and could possibly support nearly 300,000 housing

units (United States Census Bureau 2003).

FM radio, part of the VHF spectrum, is understood to have generally good penetration into residential settings. Wood frame buildings will not attenuate or reflect the signal as much as those made with concrete and steel.

3.b.vi. Radio Power Use

The RDS chips available typically use 16 mA at 2.7 V while powered on. Title 24 requires 24VAC power available to the PCT, so synchronized communication for power efficiency is only a concern when the PCT is running in battery backup mode. The PCT processor could cycle the power of the receiver if the DR dispatches are broadcast in established intervals; the RDS protocol includes a clock synchronization scheme that is accurate to the second and can be leveraged for this purpose. This may be of use as a channel for emergency communication to residents during a power outage or natural disaster.

3.c. Antenna

Integrated antennas that do not extend beyond the PCT enclosure have also been developed in the industry and are currently being evaluated for performance. Though internal antennas would have less gain than external antennas, existence proofs for functioning, commercially reliable, internal antennas are available in traffic information (RDS-TMC) products from Cobra⁸ and MSN SPOT watches⁹. e-Radio USA has also been developing an RDS in-home display unit, primarily aimed at receiving alerts and information from the local utility companies, which uses a proprietary internal antenna. Their testing data is not publicly available, but preliminary testing showed that the antenna performed satisfactorily for this application. In addition to internal antennas, external wire antennas can be used as well. It may be possible to extend the antenna wiring into the wall so that it is hidden from the resident. Another scheme which may also be possible is to capacitively couple to the thermostat wiring as an antenna.

3.d. Noise, Reflections, and Interference

Since the commercial FM radio spectrum is licensed and protected by the FCC, major sources of noise and interference are not typical. While each FM channel is separated by 200 KHz, the FCC avoids licensing stations on adjacent channels within geographic regions. Synchronized FM booster stations, which re-transmit the same signal on the same channel but are required to operate within the service contour of the primary transmitter, can be a possible source of multipath interference in certain areas. Reflections of signals that cause multipath interference are also serious concern. Common FM receivers are designed with noise rejection techniques to mitigate the effects of multipath interference, such as switching from high-side to low-side injection.

⁸ Cobra Nav One 4500 with TMC, <http://www.cobra.com/navone/4500page.htm>

⁹ Online database of SPOT devices from SpotStop.com, <http://www.spotstop.com/price/>

Possible near-band sources of interference exist on both sides of the FM band. On the lower end of the band, TV Channel 6 operates from 82 – 88 MHz (audio is broadcast at 87.75 MHz). The FCC manages its licensing of Channel 6 in order to protect non-commercial educational stations that are given licenses from 88.1 MHz to 91.9 MHz, but interference can occur near in regions located between competing transmitters. In California, there are only three high-power broadcasters (100 kW) on Channel 6 – KSBY in San Luis Obispo, KVIQ in Eureka, and KVIE in Sacramento. On the upper end of the FM band, near 107.9 MHz, VOR aircraft navigation systems can be a source of radio interference. According to Paul Harvey of Codified Electronics, there are three mitigating factors for this: that interference is localized to areas near airports, that effective radiated power (ERP) is generally less than 200 watts, and that GPS technology may eventually replace VOR.

Within the home, appliances and building materials can contribute to reflections and attenuations that create a “swiss cheese effect.” Signals received clearly in one location may not be well received in another part of the house. Thermostats are stationary and will not need to continue receiving a signal while in motion. However, some time-based fading may occur where signals are not very strong. The team has discussed the issues of the locational and temporal fading with radio analysts, and both parties believe that with an adequate amount of station overlap in areas with poor reception the RDS system should be tolerant to these effects. Further study in this area is recommended for network planning.

6.5.2. Paging Analysis

The information in this section, which addresses the Communication Interface Questions and Issues for the FLEX paging technology, was obtained from a combination of technical documentation and interview with industry representatives and experts.

Application

1.a. Downlink Security

Authenticated communication is not inherently provided by the paging transport layer and a message authentication and tamper detection scheme needs to be built into the transmitted data. The Technical Working Group is responsible for defining acceptable solutions for these requirements, and at the time of this writing has recommended the use of a key-hashed message authentication code (HMAC) for message authentication and tamper detection. An HMAC is similar to a digital signature attached to the end of a message that allows verification of authenticity through the use of an encryption key. Additionally, an HMAC provides a method to determine if the original message has been altered in any way during transmission to the recipient. A more detailed discussion of the Technical Working Group’s security recommendations is available in Section 4.6 of the PCT Reference Design.

1.b. Information Model

A protocol has not yet been developed for PCT communication over paging. An implementation of the high-level data model created by the Technical Working Group will have to be mapped into a digital format for use on the paging networks by the network operator or some industry alliance.

Network

2.a. Infrastructure, Operational, and Maintenance Costs

- **Infrastructure**

As with the RDS solution, the physical, transmitting infrastructure and the data network need to be considered as separate aspects of the infrastructure.

Unlike the RDS infrastructure, the data network for paging operators is inherently built into the system design since the transmitters are all owned by the paging company. The paging companies offer telemetry services to large clients and are experienced in offering a socket or portal-based connection for external data sources. An existence proof is Ambient Devices, which generates data about local conditions such as weather for broadcast through the paging network. NRE costs associated with developing data interfaces for the utilities or other agency/agencies are expected to be factored into the rate design for system operation.

The larger question with paging involves the physical infrastructure. There are only two national paging companies in existence, USA Mobility and American Messaging, and their coverage maps for the State are available online¹⁰. At the time of this writing, several gaps in coverage can be seen in the Central Valley. Smaller local providers are known to exist in California but such market data has not been researched.

Physical infrastructure investments could cost the state into the millions of dollars in order-of-magnitude. The cost of building out infrastructure is believed to average about \$12,000 per transmitter and is dependent primarily on the lease agreement for the installation site. It is unknown how much build out would be required to satisfy the needs of continuing development in the Central Valley or if increased density in existing service areas is required for reliability purposes. A mitigating factor in building out infrastructure is that a substantial cache of unutilized transmitting equipment is believed to exist which was previously taken out of service as a result of industry consolidation. What this means is that if the system requires infrastructure build out, the paging companies would be able to quickly establish communication in deficient areas. If the paging companies see potential demand in developing areas, they would be willing to expand their infrastructure without cost to the state. However, the state may need to invest money to provide coverage in less populated areas.

The reliability of the overall paging infrastructure is dependent upon the site of each transmitter. A large paging network consists of a large number of distributed ground-based transmitters, which have transmission range anywhere from hundreds of yards (for example a low-power transmitter on top of a hospital) to tens of miles (for example a high-power transmitter on top of a mountain). The transmitters simultaneously

¹⁰ USA Mobility's CA coverage: http://www.usamobility.com/check_coverage/index.html. American Messaging's CA coverage: http://www.americanmessaging.net/paging/coveragemaps_default.asp?service=1way.

broadcast the same data stream on the same radio frequency. The original signal is sent from the paging company through a redundant network connection to a satellite uplink, which is also highly reliable. A satellite relays the signal to ground-based transmitters, which translate the signal to the paging carrier's particular frequency for local transmission. The ground-based stations may be susceptible to failure if for some reason they are unable to receive the satellite signal, or more likely, lose power. The power redundancy of the transmitters is entirely dependent upon measures employed at the site, since the towers are installed at leased locations. Hospitals, for example, have backup power generation available – and paging transmitters at those locations would receive the benefit of power redundancy. Due to the “simulcast” (simultaneous broadcasting) nature of this system, individual losses of smaller ground-based transmitters would not severely affect reliability in densely populated areas. Overall, the system should be reliable except under regional catastrophes such as large natural disasters or broad power loss.

- **Operation and Maintenance**

Estimates of operational costs at this scale are subject to negotiation and difficult to achieve. Some information indicates that annual operational costs could be in the hundreds of thousands of dollars, while knowledge of utility programs similar to the PCT application indicates that annual operational costs could be in the millions of dollars. It is difficult to compare the differing estimates obtained for the cost of the paging system because of the possible differences in implementation (e.g., one paging program may be using individual addressability, while another is using a shared capcode for group addressing). A more precise estimate will require a detailed request-for-quote (RFQ) process with the paging vendors, taking into consideration the reliability and security requirements of the system.

- **Estimate based on existing rate design**

In the existing rate design, a system identifier called a capcode is the dominant factor in estimating the total cost of this system. Publicly available information from the paging companies about basic volume contracts indicated that initial registration for each capcode would cost \$1 to \$2 per code, and each message sent would cost between \$0.02 to \$0.10 per code (cost depends on message size, time of use, and total number of codes contracted).

Capcodes are unique registration numbers in the FLEX protocol that specify the individual device address and necessary parameters that configure when and how the device listens for messages within the TDMA frame cycle. With FLEX, individual device addressability can be inherently built into the network by using unique capcodes (FLEX can allocate up to 5-billion unique codes on a system) but presents an exceptional cost in both initial outlay and ongoing operation under the current rate design. The paging system could also be used in a more familiar broadcast mode, where a capcode is shared by a large set of devices (known as a group call) and any addressing resolution beyond the capcode is done within the data payload. Currently, PG&E is working with the

national paging company American Messaging to set a system like this for their load control devices; all of the switches listen to a group capcode and cycle the air conditioners only if the message is specifically addressed to the individual switch. The paging companies are able to consider special rate designs tailored to these types of applications, but information about what new rates may look like are dependent on specific details, and will require a detailed discussion between CEC and the paging companies. A single PCT can also support multiple capcodes to allow layered addressability – for example a PCT may use a statewide capcode, a substation capcode, and a utility-specific program capcode to achieve membership and addressability functions.

In general, one can assume four options for capcode scenarios: a single capcode for the entire state, tens of capcodes for regions (based on climate or load topology), thousands of capcodes for substations, and millions of capcodes for individual PCT's. The use scenarios for one-way communication on the PCT do not likely warrant the extreme costs of individual capcodes for every PCT. Conversely, the paging companies will not likely offer their standard rates in a statewide contract for data management based on a single capcode. More likely, it is appropriate to reserve thousands of capcodes to support regional addressing for each substation. A quick cost estimate for a single PCT can be calculated based on heartbeat messages as the predominant cost driver: 12 heartbeats per hour (every 5 minutes) for half of the day (8 AM to 8 PM to support installers), and one heartbeat per hour for the other half (at night). Rounding up to account for DR and other maintenance-related dispatches, this yields roughly 5,000 messages per year, at an approximate cost of \$100 per year per capcode. This is comparable to the existing proof-of-concept for FLEX paging in PCT's. With Ambient Devices' Weather Watcher¹¹ the cost of premium service, which delivers localized weather information, is \$80 per year. Multiplying this figure out by 3,000 capcodes¹² to support the entire state, the the setup costs will be \$3,000 to \$6,000 and the annual operational costs will be \$300,000. Additional reliability, security, and liability requirements will likely increase the cost of this estimate. It is the team's suspicion that because of the network load and reliability requirements, the cost estimates would not decrease dramatically if using less than 3,000 capcodes.

- **Estimates based on existing utility applications**
Knowledge of existing utility applications, such as previous paging-based PCT

¹¹ <http://www.ambientdevices.com/cat/index.html>

¹² This is a number that has been discussed with CA ISO as a number of distribution substations which are of interest in this context, though the MRTU full network model accounts for about 10,000 substations.

trials and load control applications, suggests that costs could be anywhere from \$1 to \$10 per year per thermostat.

2.b. Network Capacity

The required network capacity is expected to average approximately 0.1% of total network utilization. As with RDS, this has been estimated from the three primary functions: dispatch, clock-synchronization, and heartbeat. The paging medium is estimated to be an order of magnitude faster than RDS. The paging transceivers, while capable of operating at 6400 bps, primarily operate at 3200 bps for higher reliability. The FLEX system can adjust communication speed on the fly. When the system has lots of pending traffic, the speed is increased to 6400 bps. The FLEX protocol has some amount of overhead for addressing, error-correction, and maintenance, so the realizable data rate is expected to be less. The amount of overhead in the FLEX protocol could not be determined, but is not believed to have a significant impact for this context.

Since FLEX does not also natively handle authenticated communication, security overhead will add to the data requirements of each message. As discussed for the RDS solution, a reasonable HMAC size for the paging solution is estimated to be 128 bits, or 16 bytes.

- **Dispatch**

The amount of raw data required to issue a PCT dispatch is estimated to be about 20 bytes per capcode. Adding security, the total message size becomes roughly 40 bytes. The dispatch events do not affect average network utilization requirements because of their low frequency, but they can have an impact on instantaneous network utilization. Because the paging system operates on a simulcast, addressed messages pertaining to specific load groups cannot be routed to the appropriately located transmitters and must be repeated across the entire network. At a minimum, one message must be sent to each active capcode. Assuming 3,000 capcodes carrying 40 bytes of data, it would take the system anywhere from 3 to 10 minutes to send a message to every capcode in the state. While it is likely that in practical use the messages will be distributed over a period of time, it is important to take this operating constraint into consideration.

- **Clock-synchronization**

The FLEX protocol also has a built-in clock update function, which means that no additional data capacity is required. However, if any existing difference between the utility's or ISO's system time and the broadcaster's time is unacceptable, then additional network utilization of approximately 50 to 300 messages per code per day would be required, depending on the recommendations for clock updating issued by the Technical Working Group's security analysis.

- **Heartbeat**

A heartbeat function could dominate the average data capacity requirements of the network. Connectivity status to the broadcast source is built into the receiver in the FLEX system, because of the synchronized communication scheme. However, even if the receiver is connected to a FLEX network, it may not mean that connectivity to a

distribution utility has been established. Though connection to the broadcast source has a high-probability implication of connection to the utility-data, there is a chance that the capcode or frequency settings could be misconfigured, preventing the PCT from receiving DR messages. In this case, even if the address is not correctly configured, if a PCT can identify a heartbeat signal then it is at least capable of supporting emergency demand response.

Frequencies of 4 to 60 times per hour have been discussed for this, though the primary requirement will be driven by the installation scenario. One proposal is to issue heartbeats every five minutes between 8 AM and 8 PM, and then dramatically reduce the frequency (once per hour or less) outside of those times.

2.c. Connectivity

See “Heartbeat” directly above.

2.d. Error Detection and Correction

The FLEX protocol has a built-in error correction scheme that is similar to RDS. A check character embedded in each FLEX “word” allows for one or two-bit error correction.

2.e. Membership

While the underlying mechanism for providing addressability may be implemented differently in FLEX paging than in RDS, the impact to the resident and installer is the same. A retail customer would need to introduce the address code to the PCT through a sequence of button presses or an expansion plug-in, and an contract installer would have the option to use a direct connection to the expansion interface to configure the code.

Internally, the PCT could use the FLEX capcode to achieve addressability to the substation-level and possibly lower (feeder, PCT). The PCT host processor can configure its FLEX capcode or codes (a device can use multiple capcodes) based on the PCT address to listen to the correct TDMA frames. If addressing is not handled at the FLEX transport layer, it can be handled in the data layer like in the RDS implementation.

Physical

3.a. Frequency Band and Channel Plan

Similarly to RDS, FLEX paging operates on licensed frequencies above 900 MHz. The FCC licenses 49 channels (unique frequencies) around 929 and 931 MHz which are typically used for FLEX paging. Within those channels, a number are allocated specifically for national, regional, and local use to independent operators. Each operator owns the license to operate on a specific frequency, and typically FLEX receivers are pre-configured to operate on a single channel before purchase. Older technology required that the frequency be set in hardware (through a crystal) but newer receivers allow the receiver to set the frequency in software, allowing for possible redundancy of carriers.

In the case of the PCT application, it must be determined how many carriers will be required for this operation. There are only two paging companies that offer statewide coverage, and each

operates on a different frequency. If a single operator were supported, then the frequency could be hard-coded into the PCT before purchase and installation so that it could work statewide. However, if using multiple paging operators, the PCT would need to automatically or manually select from a pre-configured list of supported frequencies during installation or registration, especially those that are specific to rural regions outside the coverage of the two national operators. A generic “frequency scan” throughout all the paging channels to search for supported DR carriers would be possible but intensive because of simultaneous, multiphase transmission that is supported by FLEX. The most practical result is that before PCT’s can be programmed for distribution and shipping, they need to know which FLEX operator(s) will be supported.

3.b.i. Radio Cost

The cost of integrating a FLEX receiver into a PCT is expected to be relatively high compared to RDS, at \$5-10 additional cost to the BOM over a regular PT. These estimates were provided by industry device designers. FLEX subsystems are proprietary and detailed estimates of the subsystem requirements are difficult to obtain without non-disclosure agreements.

3.b.ii. Radio Overhead

According to industry manufacturers, implementation of the FLEX stack is non-trivial and presents a large overhead for an electronic device. The FLEX stack can either be integrated heavily at the core microprocessor or within a special FLEX decoder chip. In either scenario, the protocol and stack are proprietary so licensing costs will apply. In addition, no fully integrated solutions are known to exist on the marketplace. The block diagram in Figure 6.1 shows the architecture of components required in the system.

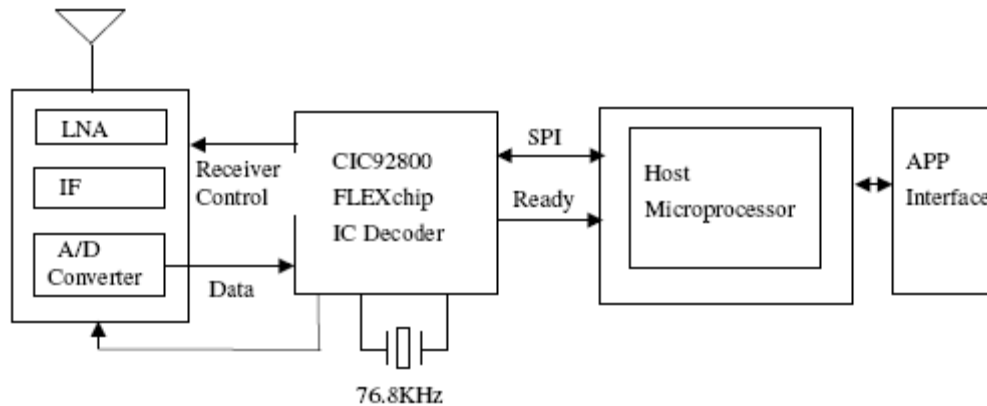

Figure 6.1. Example FLEX paging subsystem implementation. Source: CIC92800 FLEXchip Technical Data Manual V2.0

3.b.iii. Radio Data Rate

The FLEX protocol allows operation at multiple speeds: 1600 bps, 3200 bps, and 6400 bps. The protocol can change transmission speed on-the-fly through overhead information transmitted at the beginning of a frame. For reliable performance, the national companies typically run at 3200 bps, since bit errors are more likely to happen at higher speeds. The actual throughput is

restricted by addressing and error-correcting overhead, but could not be determined by the research team. This is not expected to have a significant impact.

Another parameter affecting the realized data rate is the receiver collapse value, which specifies the number of frames within a cycle that the receiver will listen to. The range of allowable collapse values makes the receive latency anywhere from seconds to four minutes.

3.b.iv. Radio Receive Sensitivity

Information about the required dBm or dBuV for reliable performance could not be found. This is not considered a serious issue. Paging company RF engineers have a significant amount of experience in configuring the various transmitter towers to increase reception and minimize multipath interference and are capable of working with paging system manufacturers in planning the system.

3.b.v. Radio Range

The range of paging transmission is predominantly determined by the transmitter's location, power, and antenna configuration. The range can vary drastically, from hundreds of yards to 20 miles. Since paging operates within the UHF spectrum, it is known to have more signal attenuation through building materials than the FM system. Concrete and steel structures will attenuate and reflect the signal more than wood-frame structures will. The placement and power levels of paging transmitters are configured carefully by the paging companies to ensure a reliable signal for a given area. A transmitter on top of a hospital may be configured to primarily provide penetration specifically for that building, while a transmitter on top of a mountain (such as San Bruno Mountain in the Bay Area) can reach multiple cities.

3.b.vi. Radio Power Use

FLEX subsystems are believed to use a comparable amount of power as RDS subsystems when they are running, estimated to be anywhere from 15 to 20 mA. Title 24 requires 24VAC power available to the PCT, so synchronized communication for power efficiency is only a concern when the PCT is running in battery backup mode. The PCT processor could cycle the power of the receiver if the DR dispatches are broadcast in established intervals; the RDS protocol includes a clock synchronization scheme that is accurate to the second and can be leveraged for this purpose. This may be of use as an alternate channel for emergency communication to residents during a power outage or natural disaster.

3.c. Antenna

Consumer pagers typically use a wire-loop antenna that runs the perimeter of the enclosure. Greater gain can be achieved with an external antenna, which will provide better signal levels. In densely populated areas, the small embedded antennas are believed to be sufficient to reliably receive a signal. Within buildings in rural areas, external antennas may be required. Since paging operates around 929-931 MHz, the size of the wavelength is roughly 1/10 that of FM radio. Consequently, corresponding antenna designs for this system can be approximately 1/10 the size; a quarter-wave antenna would be about 3" long and a half-wave 6" long.

3.d. Noise, Reflections, and Interference

Commercial paging, like FM radio, operates in a licensed band. In-band sources of interference may be caused by other paging operators broadcasting on an adjacent channel, or by another paging transmitter within the network on the same channel (simulcast interference). Modern paging receivers are designed to reject image, adjacent channel, and spurious noise interference.

Well-designed paging receivers can also use multipath signals to fill in if the direct signal is weak or absent.

In addition to commercial experience, some of the academic research performed in the 1990's studying propagation models, reflections, noise and interference for cellular telephone systems operating in the 900 MHz range can be applied to pagers. In particular, T.S. Rappaport is considered a leading expert in the area and has written several key publications (Rappaport 1995) on the topic. Real-world reliability studies within residences are recommended if this solution is chosen for the one-way system.

6.6. Recommendations and Conclusions

The team identified critical questions and issues that need to be addressed for any proposed PCT communication interface solution. The framework should be a benefit to any PCT stakeholder considering a particular one-way or two-way communication technology as an initial basis for review.

Using this framework, the team analyzed the two primary candidates for the embedded one-way PCT receiver, RDS and FLEX paging. As a result of this process, no "red flags" were found with either system and both are considered by the team to be feasible for PCT communication.

Some questions and issues need to be addressed for each of these systems. The largest remaining question specific to RDS that needs to be addressed is to study reception characteristics to aid in network planning. Results characterizing RDS reception could be used to support a preliminary network planning exercise, using established propagation models. This process will refine the cost estimates for infrastructure build-up and operation and maintenance. The paging system, like the RDS systems, also requires further research in reception statistics. The cost estimates for paging infrastructure build-up and operation and maintenance require further investigation, as accurate data could not be satisfactorily obtained. Either system, if chosen, will require a security mechanism to be designed and specified for one-way authentication and tamper detection. The final system will also need a demand response protocol to be developed for PCT communication. The device manufacturers will not be able to finalize product design until the security mechanism is defined and the protocol is published.

7.0 Key Technical Issues

7.1. Objective

This chapter addresses key technical issues in the design and implementation of the PCT. The technical questions and issues raised in this section are considered important for the proper and effective design of policy, technology, and system related to PCT's. The questions and issues raised here should be considered by PCT stakeholders that have an influence in these areas. The PCT research team contributed these questions and issues to the Title 24 Technical Working Group (Technical Working Group) as a basis for discussion for each interface. The questions and issues were considered carefully during the development of the *Reference Design for Programmable Communicating Thermostats Compliant with Title 24-2008* (Title 24 PCT Technical Working Group 2007); this document shall be referred to as "the PCT Reference Design".

7.2. Expansion Interface

The interface was a difficult subject during discussions among the CEC regulators, electricity distribution utilities, and manufacturer community for the following reasons:

- Utility requirements for use of this interface had not been fully defined¹³
- Processing and power requirements on the PCT could be excessively burdensome
- Concerns about the additional cost of the interface to the BOM and non-recurring engineering costs
- Concerns about physical space requirements and added size of the thermostat
- Concerns about being able to meet Title 24 timeline

The definition for the expansion interface must address issues in four key categories:

- **Electrical/Mechanical**

The idea of an "expansion interface" invokes thoughts of some kind of electrical connector, form factor, and power requirements. These issues are addressed as electrical and mechanical requirements that must be defined as a standard to ensure interoperability.

- **RF Requirements**

The primary use of the expansion port is envisioned to support a wireless two-way communication module. Because the proposed wireless solutions discussed to date (Zigbee, Wi-fi, Paging, FM Radio) employ different types of technologies, there are many technical issues that result from defining an interface to support this variety.

- **Hardware Abstraction**

A large concern in the thermostat manufacturer community is the burden on the PCT

¹³ After the PCT Reference Design Process was initiated, a national coalition of distribution utilities formed the UtilityAMI Working Group to define detailed use case scenarios and requirements that would support integration of AMI systems with home-area networks and devices such as PCT's.

host processor of supporting different types of hardware. A model which was discussed by the UC Berkeley team and others has been to emulate the first PC peripherals, such as modems, which handled hardware management natively (within the unit) and communicated with the host over a simple serial interface. This approach minimizes the performance and storage requirements on the PCT processor, since every new communications device is responsible for its own computational support.

- **Application Interface**

At the highest level of interoperability, the Technical Working Group has proposed an information model which defines a standard set of DR functions and related operations to be supported through the embedded communication interface and on any installed plug-ins. A standard digital implementation of the transaction model for this information model must be developed.

The technical issues are discussed in the following sections for each of the four categories defined.

7.2.1. Electrical / Mechanical

- **Standard Connector**

An electrical connector must be chosen that will support the mechanical and electrical requirements of the chosen signaling protocol and power requirements of expansion modules. An ideal connector for this application is one that is low in cost and small in size. Size is an issue for the manufacturers since they would like to adapt existing programmable thermostat platforms to support Title 24 requirements and do not want to radically increase the size of the thermostat.

- **Physical Expansion Area**

How much volume can be set aside within, adjacent to, or behind the primary thermostat to accommodate the different types of modules that should be supported? Is it necessary to standardize on the physical expansion area, in addition to standardizing the connector? An idea that has been raised by Michael Kuhlmann of RCS to alleviate design constraints to the manufacturers is to use the sub-base as an expansion area for the upgraded communication module and define the connector to the thermostat.

- **Digital Communication Interface to the PCT Host Processor**

A standard digital communication protocol and/or bus must be chosen which will support communication between the PCT host processor and the plug-in module. Examples of such standards include TTL/RS-232, Serial Peripheral Interface (SPI), which can be used for MMC and SDIO, Inter-Integrated Circuit (I²C), and Dallas 1-Wire. The protocol should support the requirements of the transaction/data transfer requirements of expansion applications.

- **Power Requirements**

Will the thermostat be able to provide enough current and stored energy to power expansion modules? Thermostat manufacturers must usually design around constrained battery power, since line power from thermostat wiring cannot be guaranteed. Radio communication modules can use more than 100 mW of power. As a result of concerns

about two-way radio communication modules inserted into the expansion interface, the Energy Commission agreed to require line power from thermostat wiring (usually 24VAC from the HVAC transformer) as part of the Title 24 revisions. Even with line power available, minimizing power use through this interface should be considered as a best practice.

7.2.2. RF Requirements

- **Antenna Requirements**

At present, wireless communications technologies employing frequencies from 100 MHz (FM Radio) to 2.4 GHz (Zigbee, WiFi) have been discussed for the PCT. It is even possible to consider 5.8 GHz as well, as it is among the unlicensed ISM bands. The nearly two orders of magnitude spanned in frequency correlate directly to two orders of magnitude of antenna sizes (holding gain constant) which could be required. *How can these different antennas be accommodated by the plug-in communication module, external to the PCT, within the physical expansion area, or in some other area within the PCT?*

- **Shielding and Electromagnetic Field (EMF)**

Placement of the antenna and radio components of the communication receiver relative to the other components in the thermostat (binding posts for thermostat wires, batteries, relay coils, etc.) will affect the sensitivity and performance of the receiver. This issue needs to be considered during the product design and testing process.

7.2.3. Hardware Abstraction

- **Processing on the Plug-In**

If the PCT core is required to implement a hardware driver or stack in order to operate an expansion module, several factors – the wide array of possible plug-ins (wireless receiver/transceiver, flash memory module, programming/debugging interface), their complexity, and the required processing power and software storage – would make this a difficult task. Instead, if a standard hardware abstraction model or host-to-host transaction model is implemented with the specialty driver or stack being implemented in a separate microcontroller or IC on the plug-in, then all the PCT would need are a command/data parser and a serial interface. The PCT can issue simple standard commands to the plug-in over the serial interface and receive standard data structures in return and vice versa. The vendor community is already accepting of a command/data parser necessary for interfacing with the embedded one-way communications receiver, implying that all that is necessary to address their concerns about the expansion interface is to develop an abstraction model and choose an appropriate serial link.

- **Transaction Model**

Given the above scenario, a transaction model could be developed to support a standard set of services (get/send data, transfer file, etc.) through the embedded communication interface or expansion modules. In this manner, the data structures developed in the PCT Reference Design could be used for both the communication and expansion interfaces.

7.2.4. Application Interface – “Information Model”

- **Minimum Title 24 Functionality**

The Technical Working Group developed a data structure to support the *minimum functional requirements* of Title 24 with respect to one-way communication. Such examples include data structures for economic and reliability events, setpoint changes, and timestamp/clock update functions. The key question for this process was: “*what functions and data are needed to satisfy the Title 24 code as it has been written?*” The result of this process is applicable to data exchange through the expansion interface as well. The manufacturers are expected to support the information model for minimum Title 24 functionality as mandatory for implementation

- **Data Model Superset to Support Additional Utility Services**

The Working Group has also defined a richer superset of data structures to support additional demand response and value-added services. Examples include data structures to support advanced pricing programs, A/C load cycling, message acknowledgement, and user-display messages (to the resident). The IOU’s, the vendor community, and the UC Berkeley team all contributed to this process, asking: “*what types of information and functions are extremely valuable in implementing demand response through PCT’s?*” Though Title 24 is not expected to make this superset of the PCT information model mandatory for implementation, it is expected to be designated as a best practice in the PCT Reference Design.

- **Extensibility and Upgradeability**

Under the current proposition, once the first set of PCT’s are sold to customers, the information model as implemented will be fixed and the communication protocol used must support this model. While the communication protocol and model can be extended to support richer functionality, a key question is: “*how can a PCT upgrade its understanding of the information model once installed?*” Supporting a change in the information model implies that core programming in the PCT processor will need to be changed. A manufacturer may wish to use some type of bootloader, which supports software upgrades through the expansion interface. Upgrades through the interface could be introduced by way of a communication module, a flash memory module, or a direct connection to a PC or other host.

One possible solution to support global updates, which apply to all PCT’s regardless of model or vendor, is to employ a standard application virtual machine within the PCT, similar to Java’s virtual machine. A virtual machine allows the same application software to function within the virtual machine environment, which manages the hardware specific to the PCT. Without a standard virtual machine each manufacturer will have to implement their own information model upgrade, for each of their independent PCT platforms. It is perceived that with current technology this solution would price the devices out of acceptable levels by increasing hardware requirements and engineering costs. In the future however, as embedded systems decrease in cost and electronic devices become more powerful, this tactic would be able to support evolving functionality through global software updates.

7.2.5. Recommendations for Implementation

SDIO (SecureDigital™ Input/Output) represents an existing, fully defined hardware interface that already supports similar applications in embedded systems and commercial products. For PCT's, it is a more appropriate technology than USB due to power requirements, connector cost, and system overhead. However, SDIO is a licensed technology, and hosting a completely functional SDIO interface adds a considerable amount of complexity to the PCT host. It is possible to individually specify the mechanical, electrical, and logical aspects for the expansion interface to simplify it for device vendors. There are three general options that will work:

1. Require use of the full SDIO protocol. This provides memory, I/O, and data security, which could be beneficial to IOU's, POU's, and aggregators.
2. Use the MMC connector with MMC memory card format to store data, and SPI mode to accomplish I/O. The MMC specification has a definition for SPI communication with compatible microprocessors. SPI communication is frequently supported in hardware by processors of the class used for thermostats. SPI can be used as a simple serial interface for communication with a two-way radio module, a memory device, and any other type of plug-in developed for the PCT.
3. Use the standard mechanical and electrical interface of SDIO with a nonstandard protocol implementation. The SDIO connectors and electrical specifications are public knowledge, and should not require the vendors to post licensing fees for usage. This solution would prevent a customer from operating a standard card or I/O solution plugged into the PCT connector and would also prevent access to data stored on a "PCT-specific card" from a personal computer.

7.3. Human-Machine Interface

As mentioned in the Technology Survey chapter, the additional functional requirements of the human-machine interface are minimal. The resident should be alerted to pending and current events with some kind of lights or other visual indicator, information about the time, price, and class of the event should be presented on the display, and system connection status should be indicated. The key issues for this interface are those that impact common preexisting methods of interaction with programmable thermostats.

7.3.1. Communication Status

It is critical that the PCT indicate the state of communication connectivity to the resident. A resident may be billed for non-compliance with economic or emergency events, or may not receive important messages from the utility. A crucial time for this is during device installation, as the installer or resident will need to know that the PCT is connected with either the one-way or two-way system before considering the installation complete. If a system heartbeat is used to provide a means of detection for connectivity, the minimum heartbeat frequency carried by any one-way or two-way transmitter must be defined in the communication protocol so that a manufacturer can use a clock and counter to determine if the PCT is connected and communicating properly.

Consistency with familiar applications for this indicator is recommended; most cellular phone models tend to use similar icons depicting antennas and vertical bars to indicate signal strength, and a diagonal line over an antenna to indicate an unavailable connection. Reuse of this model in PCT's will aid user understanding.

7.3.2. Emergency Response

The Energy Commission has stipulated that PCT emergency response cannot be overridden by the resident. It is important that the PCT indicate when it is acting in emergency mode so that the resident understands why their inputs to the device are being ignored. Unclear indication of emergency response can cause user confusion and may lead to belief that the device is broken or functioning improperly.

7.3.3. Price Response

Adding economic response to programmable thermostats will require an input for response preferences for each price level. While it is anticipated that initial pricing programs will use a tiered "low-medium-high" model, the PCT Information Model in the PCT Reference Design can support three different types of price data: price tier, price percentage relative to the base rate, and absolute price in \$/kWh. *How can the user preferences be established for these different types of price?*

Further complicating this is the Title 24 requirement of absolute temperature price response (i.e., setting 85°F for high-price periods) as an alternative to offset price response (i.e., increasing the setpoint by 4°F during high-price periods). According to the policy language, the resident should have the option of increasing temperature by so many degrees *or* going to a pre-established temperature setpoint during a high-price period. The resident must be able to determine which approach they would like to use, and be able to implement it. This situation is further complicated by mapping customer preferences to the various types of price data that could be used: price tiers (i.e., low/medium/high), absolute price (i.e., \$/kWh), and price ratio (i.e., ratio relative to normal).

7.3.4. Hold Functionality

Several manufacturers and research colleagues cited that users of programmable thermostats commonly ignore programming capability and operate the thermostat in "Hold" mode at a single setpoint temperature. In programmable thermostats, the Hold button differs from momentary overrides. Momentary temperature overrides are cancelled at the beginning of the next programmed setpoint period, while a setting under Hold will remain until the resident manually disables it.

It is important that the manufacturers are consistent in response to economic or emergency events that occur while the thermostat is in Hold mode so that residents have a consistent experience between vendors. *In an emergency event that uses offset temperature response, should the thermostat offset the temperature from the programmed setpoint or the Hold setpoint? In an economic event, should the PCT disregard the event while in Hold mode, offset from the Hold temperature setting,*

or offset from the programmed setting? What if the user has chosen absolute response to economic events – should the PCT set to those temperatures or disregard the event and stay at the Hold temperature?

7.3.5. PCT Address Configuration

It is envisioned that the PCT will respond to regional emergency events out-of-the-box with no customer configuration required; if the PCT is within range of an FM transmitter issuing the event then it will respond. To achieve more granular response for local reliability or economic events, the PCT will need to be configured with a specific address code that will need to be introduced to the PCT externally. The address code will provide the PCT information such as its host utility, pricing/incentive program, substation, feeder, and unique ID¹⁴.

One mechanism for address configuration is to use the expansion interface. If AMI with two-way communication to the PCT is in place, the address can be introduced to the PCT through the AMI system. Another simple way of introducing the address into the PCT is to use a low-cost memory plug-in that uploads the proper address to the PCT upon insertion.

In the worst case, a user input mechanism will be required to configure the address. The team suggests a possible scheme for address configuration through the human-machine interface:

1. A customer wishes to enroll his/her PCT in an incentive program and calls the utility.
2. The utility representative requests the customer's account number, found on the bill, and offers an option for an incentive pricing program.
3. The utility representative reads a numeric code to the customer.
4. The customer writes down the code.
5. The customer presses a small, recessed, button on the PCT for address setup and the PCT blinks "0."
6. The customer uses the up and down arrow buttons to change the blinking "0" to the first digit of the code. The customer presses "Enter" when the digit is correct, and the PCT displays another blinking "0," and the customer continues for each digit.
7. After entering all of the numerals, the PCT displays a scrolling sequence of numbers on the display, followed by the prompt "OK?" The customer presses "Cancel" if the code is incorrect and starts again. If the code is correct, the customer presses "OK."

Finally, it is important that the resident has a means to determine if the address configured into the PCT is correct. An improperly configured address may cause a PCT to respond to signals for programs in which the resident did not enroll.

¹⁴ At the time of writing, PCT addressing schemes for one-way and two-way networks have not yet been adopted by PCT stakeholders. The most recent proposal for the one-way system in the PCT Reference Design recommended host utility ID, pricing/incentive program, substation, and feeder as addressing options.

7.4. HVAC Interface

The key issues for the HVAC interface are concerned with maintaining compatibility with existing, installed HVAC equipment and providing a future means of interfacing with digitally-controlled HVAC appliances. The team has also identified safety issues that need to be considered for this interface.

7.4.1. Installed Base of HVAC Systems

The types of residential HVAC appliances that are currently installed in the state must be characterized to identify the technical issues that result from connecting with and controlling them.

- **Taxonomy of HVAC Systems**

The primary set of residential **central** HVAC systems installed in California can be classified in the following classes:

- **24VAC Control w/o Heat Pump**

This type of system uses a single 24VAC line and three independent call lines for furnace (standing pilot or electric ignition), compressor, and fan control. The HVAC devices are operated by shorting the call lines (with relays) to the 24VAC supply line. This system can support up to five wires, though typically only four wires are installed. The fifth wire is the 24VAC common that can be used for powering a thermostat directly off the 24VAC.

- **24VAC Control w/ Single Stage Heat Pump**

Another type of HVAC device, called a heat pump, can either cool or heat depending on which way the refrigerant runs through the system. This type of system is controlled similarly to the standard 24VAC without heat pumps. While there is only one heating/cooling device, two wires are still needed – one to call the device and another to define which direction to run the refrigerant (changeover). Since the heaters in these devices are not very powerful, it is a standard to add an additional (fifth) wire for an auxiliary heat source, such as an electric heater. Again, by adding a 24VAC common a total of six wires would be ideal, though only five is necessary.

- **24 VAC Control w/ Multi-Stage Heat Pump**

Some heat pumps have dual-stage compressors which allow for multiple cooling levels. The extra stage requires another wire – bringing the total to seven when including the common wire, but six at a minimum.

- **Millivolt Heating Control**

Some older gas furnaces, often wall heaters, are controlled by a pilot valve that is switched by extremely low voltage signals from a thermocouple assembly heated by the pilot light rather than a 24VAC transformer that is line powered. The switching element in the thermostat must be designed so that it works with this very low supply voltage. Many modern electronic thermostats can support both standard 24VAC systems and millivolt furnaces.

- **Baseboard Heaters**
Some electric heaters produce heat by directly powering heating elements with 220VAC. These systems usually require a special type of thermostat capable of switching the 220VAC.
- **Advanced Multi-stage and/or Multi-zone Systems**
A number of advanced, high-end residential HVAC systems control multiple zones in the house to separate setpoints and employ advanced levels of control such as multiple heating/cooling stages and variable damping or fan speed. These systems usually considered “closed systems” in that the thermostat or HVAC controllers are designed specifically to interface with that HVAC system.
- **Space Conditioners**
Electric air conditioners that cool a single room or area are sometimes used in residences which do not have central air and/or may not require conditioning for most of the year. These units are usually not controlled to setpoint temperatures, instead running at fixed duty cycles and fan speeds, and usually do not have thermostats for control.
- **Installed Base**
The primary motivation of the PCT is to address air conditioning loads. Given that, industry professionals suggest that most of the thermostat-controlled air conditioning in the state is comprised of 24VAC central air (non-heat pumps). The *California Statewide Residential Appliance Saturation Survey (California Statewide Residential Appliance Saturation Survey 2004)* indicates that:
 - 41% of all residential dwellings use central air conditioning
 - 77% of all new homes (after 1996) use central air conditioning
 - 2% of all dwellings use heat pumps for heating
 - 1% of all new homes use heat pumps

It is important to note that no assumptions can be made about the thermostat wiring for a given home, even when the type of HVAC appliances are known. This is because contractors may often install the minimum number of wires needed to run the installed equipment, and often ignore color conventions commonly used. Wiring is discussed in further detail in a following section.

Based on the cited data, and discussion with appliance vendors, it is believed that five wires is the absolute minimum to be supported for HVAC control of the majority of installed systems in California. The fifth wire, 24VAC common, would enable the widespread use of radio communications in the thermostat without stressing the energy budget of battery power and is recommended for requirement in Title 24. Discussion with industry experts leads the team to believe that adding a sixth wire would support heat pumps and would likely cover 90% of the installed systems in the state. It is also believed that increasing the wiring interface from 6 to 15 conductors would support 97% of the residential HVAC systems in the state.

7.4.2. Code Requirements and Safety Issues

Consideration of safety codes by the National Fire Protection Association, Underwriter's Laboratories, or other certifying authorities is necessary to ensure the HVAC interface is fully compliant.

It is not believed that any building or fire codes exist that affect the design of the HVAC interface. Some safety codes that apply to the thermostat wires were found: UL CL2, UL 13, and NEC 725. UL CL2 and UL 13 are standards that refer to fire resistance and jacketing used around the wire conductors. NEC 725 is the electrical code for low-voltage applications that essentially requires UL CL2 jacketed wire to be used in walls and raceways.

NEMA DC-3 is another industry specification regarding electrical characteristics of thermostats. DC-3 specifies standard labeling and color of wiring connectors and the minimum distance between conductors of the electrical connector used in the thermostat. RJ-45, or similar, connectors have been suggested as a possible candidate for the interface, but they would not meet the DC-3 specification due to the small spacing between pins.

7.4.3. Wiring and Current Carrying Requirements

- **Electrical Current Required for Switching**

Mechanical relays used for switching HVAC appliances require a high current, affecting the specifications of wiring and interconnect within the HVAC interface. Older ignition systems for gas furnaces require the highest current, sometimes using nearly 1 full amp. Some contractors have mentioned that they use anywhere from 400 to 750 ma, **but the system must be able to withstand surges of several amps.**

- **Wire Gauge and Ampacity**

There are no requirements about the actual wires used for thermostats apart from specification of fire resistance of the jacketing materials. A convention currently used for thermostat wire is to pull at least 20-gauge solid copper, and for longer pulls (>100 ft.) 18-gauge is used. The reason for this convention is to handle the current requirements of HVAC devices.

The ampacity, or current-carrying limit, of a wire depends on both the resistivity of the conducting material and the thermal insulation around the wire. 20-gauge solid copper wire has a resistance of 2.08 Ohms per 100 feet (Herrington and Meacher 1968). Ampacities for 20-gauge copper wire have been reported as low as 3.3A to as high as 9A. A conservative estimate available from The *Handbook of Electronic Tables and Formulas* (Herrington and Meacher 1968) states the maximum current for power transmission over solid 20-gauge copper as 1.5 A.

One the appealing reasons why RJ-45 was initially suggested as a possible candidate for the interface is that pre-terminated Category 5 cables can be pulled during new construction, simplifying the wiring process. Category 5 cable, however, would not likely be able to support the switching currents of HVAC appliances. Power-over-Ethernet (PoE) is a standard for using Category 5 cable to transmit power, and the PoE specification defines a 350ma maximum rating. Directly calculating the ampacity of

Category 5 cable based on reference data from the *Handbook of Electronic Tables and Formulas* yields conservative maximum load estimates for solid AWG 24 copper wire at 577ma and stranded (7x32) AWG 24 at 637 ma. Another issue with Category 5 cable is potential voltage drop over a long length of cable that could affect operation of the HVAC equipment.

- **Current Bottleneck in the Switching Circuit**

The entire switching circuit of the 24VAC control line should be able to handle switching currents of the appliance relay and sustain electrical surges. For safety concerns the bottleneck in current capacity should not be in the wire or the termination/connector.

To ensure safety, the connector chosen for the HVAC interface must be able handle several amps of current. DB-9 connectors can meet this requirement, though the ratings vary with the type of insulating material used and junction (PCB solder, wire-crimp, solder bucket). Typical ratings for DB-9 connectors are around 3 to 5 amps, while some higher-end connectors can handle as much as 9 amps. Straight pin headers come in a variety of thicknesses and can easily be specified to support these current requirements. RJ-45 connectors are not likely to work for this application, since their ratings are well below the expected 1.5 amps.

7.4.4. Contractor Processes

Of greater impact to the design of an HVAC interconnect and wiring standard for the PCT is the contractor installation process during new construction and retrofit. Thermostat vendors have shared many anecdotes about incorrectly colored wires or not enough wires being pulled in development projects. Contractors installing HVAC systems and thermostats need to be considered seriously when discussing the thermostat's HVAC interface.

- **Wiring**

One reason given why not all five wires are pulled during new construction is that during drywall or sheetrock installation, nails can sometimes be driven through the thermostat wire. If the fifth, common, wire is pulled, a nail could cause a short that could damage HVAC equipment or spark a fire. Another reason is that contractors may often pull the minimum number of wires required by the installed appliances, which in many cases is two wires. Though color conventions are commonly used, and specified in NEMA DC-3, contractors may use whichever color of wire jacketing that they have in stock at the time of installation.

- **Mounting and Interconnect**

An issue of importance during both new installation and retrofit is contractor familiarity with wires and termination. Often contractors are hesitant to terminate wires unless there is an explicit color code that can be correlated from the wire to the termination block or strip. In the case where additional wires or changing the termination from standard screw terminals is proposed, this process must be completely simplified for the contractor. One solution is to provide pre-terminated wires of standard lengths for new construction so that the contractors are not spending time terminating connectors with which they might not be familiar. Another is to provide a termination adaptor, with a

simple color-coded screw terminal on one end, and the replacement interconnect (i.e. RJ-45, DB-9) on the other end so that retrofit is very simple.

7.4.5. Digital Control of Future HVAC Systems

It is believed by many industry experts that residential HVAC appliances will be controlled with digital communications in the future, such that high-current wires, relays, and transformers will become legacy artifacts. The PCT's HVAC interface could be made "future proof" for such appliances if the communication requirements are understood. The team assumes that wired, digital communication between HVAC appliances, control systems, and thermostats will be bi-directional communication over low-voltage, and is likely to be serial rather than parallel.

When looking at bi-directional serial communication there are three main factors:

- 1. Synchronous versus Asynchronous**

Synchronous communications requires a separate clock signal to clock the data bits. SPI is an example of this. Typically all the data signals use a common clock signal.

- 2. Single Ended versus Differential**

The voltage levels for single ended communications are all in reference to a common ground and a signal can be transmitted on a single wire; examples include RS-232. Differential communication requires a pair of wires for each signal in which the signal voltage is taken to be a "difference" between the two wires; examples include RS-485. Differential typically has better noise rejection and allows for higher speed communications. Standards such as RS-485 also have an added benefit of being able to create multi-drop networks that allow the creation of a communications bus with multiple nodes instead of the simple point-to-point communication that is typically used with RS-232.

- 3. Full Duplex versus Half Duplex**

Half duplex communications mean that only one party ever talks at a time while full duplex allows both parties to talk simultaneously. Full duplex requires that there be two signal paths for transmitting data, i.e. one for each direction. Half duplex may use a common signal path for both the reception and transmission of data. This can be done using something like RS-485. RS-485 (differential) is not that uncommon, and if full duplex communications were desired then four wires would be required. On the other hand, RS-485 also allows for a half-duplex communications interface that uses a common signal path for the transmission and reception of data and thus only two wires are required.

The team believes four wires are the most that would ever be needed and could be used to satisfy all the different combinations of approaches above, while three wires will probably cover the vast majority. In practice, the most common scenario would likely be a full duplex, single ended, asynchronous, communication scheme such as RS-232. For this scenario, two data lines and a common ground are required for three wires total. Combined with the five-wire

requirement of the current HVAC devices, this yields a minimum of eight wires, though nine could also be utilized to support differential communication.

Another issue is how digital communication may be impacted by the electrical characteristics of the interface. Signal attenuation in the cable could be an issue for certain digital communication protocols; this is a function of both speed and length of the cable. If a multi-drop network is used then it is also a function of line reflections that are governed by stub lengths and line terminations at the end of the multi-drop cable. However, in this application, the multi-drop scenario can be safely ignored and the communication speed will likely be low enough such that signal slew rates do not become an issue. Most likely, anything shorter than 50' should not be an issue. At longer lengths, the bit-rate and signaling type (i.e., RS-232 versus RS-485, etc.) must be investigated against the electrical properties of the wire and interface connectors.

7.4.6. Safety Issues in Using Standard Plugs & Jacks

One large safety issue in implementation in the case of using a plug that has already been standardized for other applications is the consequence if a homeowner attempts to plug in a device other than a PCT to the interface. For example, if a DB-9 connector were used, one could attempt to connect an RS-232 device (Laptop or PC) to the wall plate – potentially leading to disastrous results for the person and the HVAC equipment. The PCT application has large enough volume to support a minor variation of a standard connector that would make it non-compatible and avoid this risk. For instance, if eight conductors are determined to be adequate to the PCT application, the ninth pin position in the female connector can be replaced with a solid plug, and the ninth pin in the male connector can be removed totally. This minor change would create a connector pair that could prevent interfacing with other devices.

7.5. System Design

In addition to technical issues related to the four PCT system interfaces, the research team identified key technical issues related to the design of the PCT communication and control system. The two key issues presented here are related to addressability supported by the system and securing the system against misuse.

7.5.1. Addressability Requirements

Membership vs. Localization

Part of the Energy Commission's initial requirements and vision for PCT's is that they would be "regionally addressable" to provide some granularity in communications. Early objections from the utilities that signals from neighboring utilities would communicate with the wrong PCT's provoked further discussion of addressability requirements. This section discusses issues related to addressability that should be considered by the PCT stakeholders when identifying requirements and defining addressing for PCT communication protocols.

The team views the function of "addressability" for PCT's as a means of identifying two separate forms of information: membership and localization. Membership functionality allows the PCT to understand how it is connected topologically to the network – for example, "*who is my distribution utility?*" or "*what is my host substation?*" Localization allows the PCT to

understand to some precision where it is located geographically – for example, “*what county am I located in?*” Sometimes, membership information can be used to determine localization information, and vice versa. For example, if a host distribution substation is known, then the PCT can be confined to some general geographic area.

For membership functionality, the team has come up with three key questions, which can generally be applied to any strawman solution proposed.

- ***How detailed does the membership information need to be?***

As stated, membership is a topology descriptor – it has information about connectivity, ownership, and enrollment to varying levels. At a minimum, it is crucial that the PCT must identify its parent distribution utility, but it may be necessary to understand relationships at higher and lower levels than just the utility:

 - **Independent System Operator (ISO) or Regional Transmission Operator (RTO)**

Across regional transmission grid borders, would it be necessary for the PCT to identify connectivity to a particular ISO/RTO?
 - **Distribution Utility**

The importance of identifying a parent distribution utility (includes IOU’s and POU’s) is well understood. How should the PCT deal with multiple utility memberships, as may be the case for natural gas service?
 - **Substation**

Substation connectivity is *not* a geographic property, but a topological property.
 - **Feeder**

Within the substation, it may be valuable to identify the specific feeder circuit serving the PCT.
 - **Programs**

It is conceivable that IOU’s will offer a variety of incentive pricing programs, into which a customer may enroll their PCT. It is also conceivable that a customer may be enrolled in multiple programs.
- ***What equipment is necessary to make it work?***
- ***What are the consequences if the PCT is misconfigured?***
 - ***What are the opportunities to get it wrong?***
 - ***What is the protection to ensure proper configuration?***

The team has also come up with three questions for localization that should be considered.

- ***Can this be determined through a membership property (i.e., substation) or is it necessary to use a geographic property (i.e., region, city block, latitude/longitude)?***

Fully detailed identification of topological relationships will provide a high level of functionality in maintaining the electrical grid, but may come at a high cost of identification. A known issue is related to the topic of abnormal switching, when residences are switched to different feeders or substations for maintenance or repair. It

is known that often times the circuits are left switched to the new substation or feeder following the physical work. This is an opportunity for PCT addressing to become out of sync with the actual topological relationship. One-way communications infrastructures therefore may need to complement lack of inherent topology information with additional geography information that would not change, such as county, city, district, or latitude/longitude information.

- ***What precision is needed?***

This could be ~10 meters (this house), ~100 meters (this block), ~1 kilometer (this neighborhood), ~10 km (this city), ~100 km (this state), etc.

- **Geographically speaking, what is the communication infrastructure capable of providing?**

Depending on the technology, the communication infrastructure itself may provide a geographic level of addressability. A DR signal could be localized to particular radio transmitters to provide geographic targeting of the signal. Conversely, the system may also be used to identify to the PCT its geographic location. For example, an FM receiver can sweep and identify signal strength for each channel in the band. Since the signal strength for a given station is a result of distance and topography (hills, buildings, etc), and there are multiple fixed transmission points, the resulting signal strength vector becomes a unique location property. The DR signal can target a specific geographic area by specifying a response only if the signal strength spectrum is within a certain tolerance to this “location vector.” Local, low power transmitters installed at locations like substations can work like GPS satellites to simplify or complement this process.

Section 7.3.5 of this chapter, *PCT Address Configuration*, has already discussed means of introducing the address into the PCT. It should be noted that the utilities can be capable of providing all of the membership or localization information necessary for addressing to the manufacturer (factory configuration), installer (contract installation), or resident (self installation). Based on the address of a residence or development, substation and feeder information can be determined by utility records. If a customer is enrolling in a pricing program, a telephone or internet based customer response portal can take in a customer’s account number and then return the proper address configuration code, embedded with the required membership and localization information, to be configured into the PCT.

Address Code

The length of the numeric code that would be required to support one-way addressing has not yet been determined, but can be estimated. The address size defined in the information model defined in the PCT Reference Design is 40 bits when using allotments for utility (8 bits), pricing program (8 bits), substation (16 bits), and feeder codes (8 bits)¹⁵. This entire address space is greatly exceeds the actual requirements of the one-way system, however. A 40-bit address space provides approximately 1 trillion unique addresses, while there are only 116 million residences nationwide (United States Census Bureau 2003). A specific addressing

¹⁵ The one-way system is not expected to be used to address individual PCT’s.

implementation for the RDS communication protocol can significantly reduce the size of a PCT address code. A more efficient scheme would account for the number of PCT's that can receive a signal from a *given* one-way transmitter. Additional network addressing, unseen by the PCT, can be used on the backend communication network to route PCT messages to specific FM transmitters, thereby reducing the address size requirements between the transmitter and PCT.

An example of a compacted address scheme is presented here. The scheme assumes that the worst case is a single FM station supporting the State of California, even though FM stations in California have their coverage limited by the FCC to regional areas in the state. In other parts of the country, FM stations have a significantly larger coverage than in the coastal states, but do not serve nearly as dense populations as those in the coastal states. If every substation in California is uniquely identified, then the host distribution utility can be determined by implication, since no substations are ever operated by more than one utility. The California Energy Commission's database of electricity substations in California lists over 2,300 registered substations in California (California Energy Commission 2007). There are typically 4 feeders per substation, although some substations may only have a single output and others may have as many as 8. A reduced address base allotting 4,096 substation codes, 16 feeders per substation, and 16 pricing program codes for the one-way address base will require 20 bits. **This reduced 20-bit address base used for the one-way communication protocol would require 7 decimal characters, or 5 hexadecimal characters, or 4 alphanumeric characters.** It is likely possible to compact this example by two or three bits, reducing the address code to 6 decimal characters, though hexadecimal or alphanumeric address code implementations would not be reduced.

7.5.2. Security

A key concern of the one-way PCT communication system is that it be secured against malignant misuse by an outside party. A misuse scenario feared by several PCT stakeholders would be if a terrorist could broadcast their own message with a local FM transmitter to send false emergency events or recall an actual demand response event. The primary security function that needs to be considered to prevent this scenario is authentication of the message source; a PCT should be able to verify the authenticity of any message before taking action.

There are several established cryptography methods that can be employed to prevent this scenario. A common method of providing authentication is to use a *message authentication code* (MAC). The MAC certifies that a message was sent by a particular party by using cryptographic keys to generate a unique code. In symmetric incarnations, if a receiver can decode a MAC then it can also generate a MAC for any other message. This poses a risk in the PCT application, so it is necessary to consider an asymmetric system where the sender uses a private, encrypting key, and the receiver uses a public, decrypting key to verify the message authenticity. It is also important to consider tamper detection to ensure that a message from a legitimate source has not been altered during transit. A *keyed hash message authentication code* (HMAC) is an asymmetric signing scheme that can provide both authentication and tamper detection. A particular complication of the one-way PCT system is that there are expected to be

several utilities sending messages to thermostats made by several vendors. Management and distribution of key pairs becomes a critical issue for the PCT security scheme.

In addition to cryptography, non-cryptographic measures can be employed at various layers of the system to prevent and/or mitigate misuse. For example, logic in the PCT can prevent overloading of the system by only accepting PCT commands that *reduce* the power consumption of the HVAC. The data layer can minimize impact by pre-coding enumerated, acceptable values for temperature commands as opposed to freeform dictation. In other words, acceptable temperatures for emergency setback will be predefined as individual message codes in the protocol rather than specified as a free-format value in the message. Monitoring and detection systems installed at the physical level can detect a rogue transmitter operating on a licensed frequency. Commercial broadcasters have vested financial interest in control of their radio band and use the enforcement resources of the FCC to shut down anyone operating an unlicensed transmitter. A detailed analysis of possible security vulnerabilities and the cryptographic & non-cryptographic measures employed for prevention and mitigation was completed by the Technical Working Group and is available upon request.

8.0 PCT System Interfaces and Minimum Functionality PCT Concept

8.1. Background

Since the energy crises experienced in California in 2000 and 2001, various advanced metering and load management technologies have been investigated as mechanisms for achieving demand response. Advanced metering infrastructure (AMI) technologies that support two-way communication can provide interval electricity metering and a communication channel to deliver pricing and/or control signals to a utility customer. Load management technologies control end-use electrical demand and can act in response to pricing or control information. The California Energy Commission recognized that these two categories of technologies would need to work hand-in-hand to achieve the state's demand response goals – but the Energy Commission also recognized that these technologies operated in entirely different environments. The development of advanced metering and communication infrastructures by the investor-owned utilities is a regulated process, and the infrastructure is owned and operated by the utilities. In contrast, devices that provide load control, such as EMCS systems, thermostats, and lighting systems, are developed in a generally unregulated manner and are owned and operated by the utility customer.

One particular area where the relationship between metering and load management needed to be addressed was in PCT's. The Energy Commission viewed the use of residential PCT's as a viable strategy to reduce summer peak air conditioning loads and considered requiring their installation in new residential construction and retrofitted residences through Title 24 building code. Concern about the compatibility and cost of these devices has been a long-standing issue: thermostats designed to operate with differing and incompatible utility-specific communication systems could limit customer choice and increase costs due to limited manufacturing volume. The Energy Commission envisioned that the *lowest cost* and *greatest flexibility* could be achieved if the *system interfaces* between metering and load management technologies were defined as open standards.

The Energy Commission held a workshop on November 29, 2005 to discuss system integration for demand response in the context of PCT's. Ron Hofmann, a PIER consultant, presented the Energy Commission's system integration goals at the workshop (Hofmann 2005):

- One PCT systems integration interface for all of California (and possibly the United States)
- Common signaling throughout California
- Works with any minimum AMI system
- Compatible with legacy technologies

The Energy Commission believed that by leveraging Title 24 to standardize system integration interfaces for thermostats installed in California, PCT's could eventually be sold that interfaced with any utility's particular AMI system, controlled any installed residential HVAC system, effectively interacted with residential customers, and could be priced at a small premium over standard PT's. Additionally, the Energy Commission sought to establish a statewide one-way signaling system as a means of providing universal PCT communication until two-way communication with utility networks became the norm. This was important to the Energy Commission because two-way technologies were not expected to become ubiquitous for some time. Investor-owned utility communication networks are not expected to be widely deployed until 2012 and municipal utilities are not expected to develop advanced communication infrastructure. In the same presentation, Mr. Hofmann presented a conceptual strawman proposal for four, low-cost, standard system integration interfaces for programmable communicating thermostats that could possibly support the Energy Commission's system integration goals:

- **Input/Output** – RJ-45-like wiring interface between the PCT and HVAC appliances
- **Communications** – AM or FM receiver to receive statewide or local emergency events
- **Human** – lights to indicate DR information and PCT status to the resident and buttons to allow user configuration and operation
- **Expansion** – a USB or similar I/O port to add two-way communication, download of audit data, and other functionality to the PCT

At a workshop on February 16, 2006, a follow-up to the November 2005 session, Maziar Shirakh of the Energy Commission presented a refined vision for PCT's (Shirakh 2006):

- **Statewide system** – PCT's should support out-of-the-box demand response by working with a statewide communication system.
- **Plug-and-play** – PCT's should be compatible with existing and future HVAC and communications infrastructure.
- **Independent of OEM and retail channels** – PCT's should be the same regardless of how they end up in the customer's residence.
- **Friendly for contractors and occupants** – PCT's should be simple to install and operate.
- **Able to meet Title 24 timetables** – PCT's and associated infrastructure should be ready and available by April 2009, the effective date of Title 24-2008.

While the Energy Commission believed that their vision for PCT's was feasible, several stakeholders had doubts. Several parties expressed concern that these kinds of PCT's would be unduly expensive. Utility companies did not view one-way communication as an effective measure for demand response. Manufacturers were concerned about product development challenges and the limitation of mandating technologies in Title 24. In general, the major stakeholders agreed with the Energy Commission that programmable communicating thermostats would be beneficial devices but they did not necessarily agree with the Energy Commission's system integration goals or implementation timeline.

8.2. Objective

To address concerns and doubt within the PCT stakeholder community, PIER funded the UC Berkeley research team in January 2006 to answer many of the questions about the Energy Commission’s PCT strawman. One of the initial, primary, tasks of the team was to investigate the four system interface concepts presented in the conceptual strawman and to determine the costs and general design requirements involved in manufacturing a PCT that satisfied the Energy Commission’s vision. One key question the team needed to determine was whether a device supporting this vision could be sold at a retail price less than \$100. In summary, the research team was asked to provide a design concept for a basic, *minimum functionality PCT* that could be sold and operated at minimum cost (including infrastructure), provide maximum flexibility, allow customer choice, and support reliability and economic signaling.

8.3. Approach

The team began by conducting preliminary research into the stakeholder needs, functional requirements, and technical issues associated with programmable communicating thermostats. The results of this work are discussed in the earlier chapters of this report.

The team built the minimum functionality PCT concept from the “outside-in,” developing the overall design concept by first starting with the system interfaces. It should be noted that during the research process, the team revised the terms used to refer to the four system interface concepts that Mr. Hofmann originally presented, but did not change the intended function of the interfaces. This was done because the team felt that the revised terms either more effectively communicated the intention or were more commonly used in the industry. The mapping from the terms originally presented to those used in the report is shown in Table 8.1. The team reviewed each of the candidate solutions for each interface (discussed in Chapter 5, *Technology Survey*) and decided on the most appropriate choices to satisfy the functional requirements. A priority was given to technology solutions that were of low cost and easily obtainable off-the-shelf. In addition to each of the interfaces, the team reviewed the software and type of core microprocessor that would be required to run the thermostat. The team reviewed the technical issues for each interface (discussed in Chapter 6, *PCT Communication Interface Questions and Issues*, and Chapter 7, *Key Technical Issues*) to ensure that it would be possible to employ the technologies chosen for each interface.

Table 8.1. Mapping of terms used to describe PCT interfaces

| Original Term | Revised Term |
|----------------|---------------|
| Input/Output | HVAC |
| Communications | Communication |
| Human | Human-Machine |
| Expansion | Expansion |

Once the design concept for a feasible minimum functionality PCT began to take shape, the team started to develop a bill of materials. A bill of materials is a document that lists the components required to build a particular product or system and can be used for cost and

materials planning. The team chose to present the deliverable minimum functionality PCT concept as a bill of materials because it effectively communicates the concept to thermostat manufacturers and provides a fair estimate for the assembled cost of the product. Two team members in particular led the development of the bill of materials for the minimum functionality PCT concept. These two members are industry consultants with a combined 65 years of experience designing and manufacturing electronic devices. The team started the process for the bill of materials by performing a functional decomposition of the thermostat's internal and external functions and the components that performed these functions. This process would lead to an understanding of the general architecture of the device. Figure 8.1 shows a diagram of the functional decomposition of the minimum functionality PCT. This process also ensured that the team developed a complete bill of materials, accounting for all of the areas specified in the functional decomposition. The team estimated costs for each of the components based on prior experience and budgetary pricing quotes. The team created a spreadsheet to track the component costs. Within the spreadsheet, the team identified example parts that could be sourced for some of the novel or critical components of the thermostat. The spreadsheet was also used to estimate the power budget for the device, as it was initially expected to primarily run on batteries.

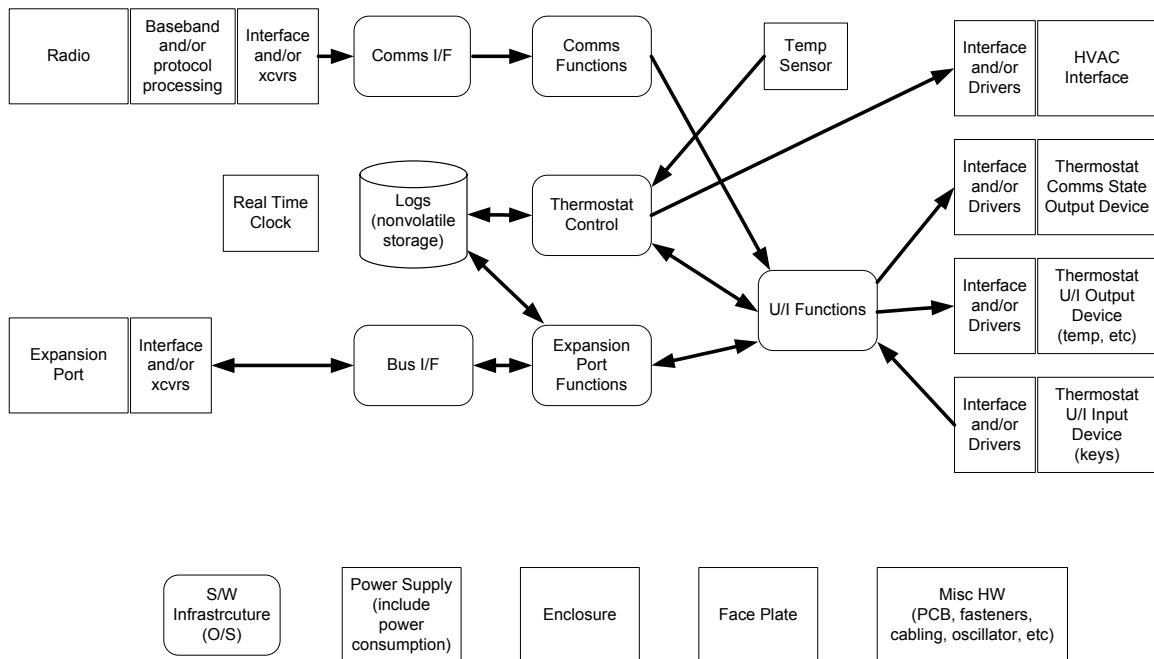

PCT Functional Decomposition

Figure 8.1. Functional decomposition of PCT functions and components

8.4. Results

The team was able to identify technologies that could be used for the PCT system interfaces. The team successfully produced a minimum functionality PCT design concept, and created a bill of materials describing the design and estimating the cost of materials for a minimum functionality PCT.

8.4.1. Communication Interface

The communication interface chosen consists primarily of an RDS radio receiver. The receiver chip and the components required to complete the subsystem were originally estimated to cost a total of \$3.45.¹⁶ The technology leverages the existing infrastructure of commercial FM radio broadcast stations, and is currently used in automobiles to display song titles and display real-time traffic conditions. Fully integrated receiver, tuner, and decoder chips are available at relatively low cost as a result of proliferation of automobile radios and portable audio players, such as MP3 players, that are small in size and have limited battery power. The additional external components required include standard passive components such as capacitors, resistors, and an antenna. Figure 8.2 illustrates the interface concept.

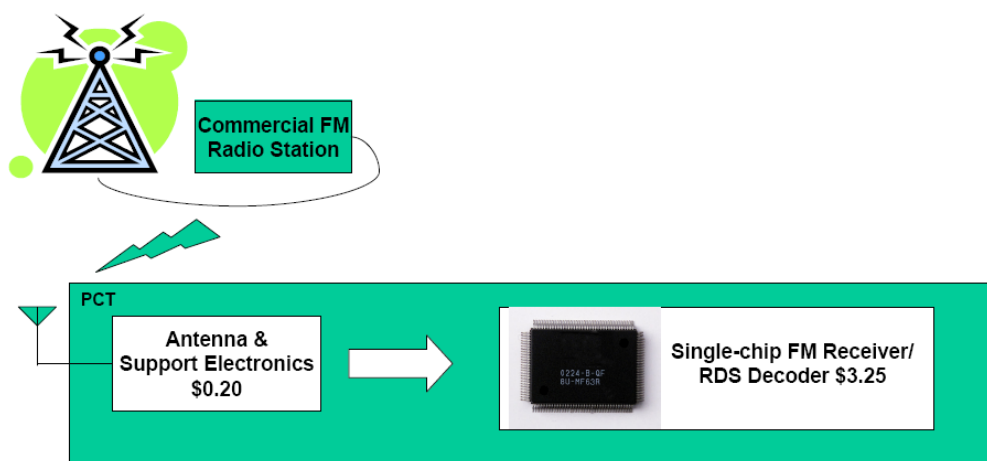

Figure 8.2. Cost overview of communication interface

8.4.2. Human-Machine Interface

The human-machine interface chosen consists of an alert light-emitting diode (LED) and an alert sounder that are estimated to cost a total of \$0.15. Liquid crystal displays (LCD's) currently used in programmable thermostats were determined to be adequate for displaying reliability and economic demand response event information. The LED would add notification functionality of pending and current events by visually capturing attention and being discernable from a distance. The alert sounder consists of a piezoelectric buzzer that could capture attention when the resident is not looking at or is not in the same room as the thermostat. Buttons used on current programmable thermostats would be adequate for user

¹⁶ Since the original publication of the bill of materials in April 2006, prices for RDS receiver chips have been reduced. Depending on volume, the cost for the RDS subsystem is believed to be between \$2 to \$3.

input related to demand response functionality. Figure 8.3 shows an illustration of how the human-machine interface could be implemented.

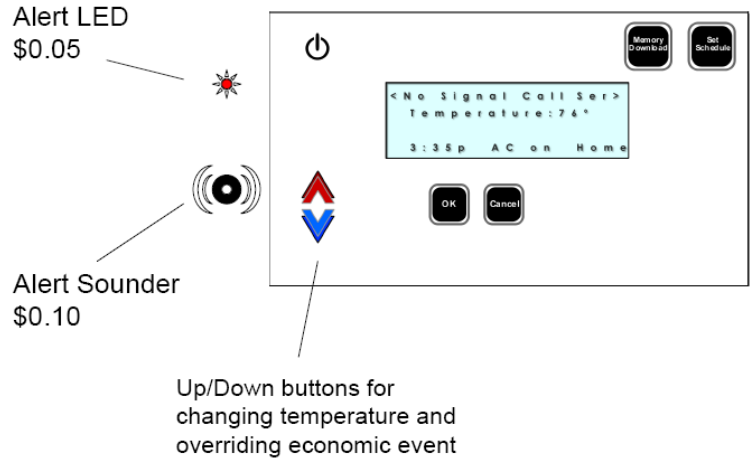

Figure 8.3. Cost overview of human-machine interface

8.4.3. HVAC Interface

The HVAC interface chosen consists of a pair of DB-9 connectors; one connector would be positioned on the back of the thermostat and another connector would be installed to a mounting plate on the wall. The entire assembly is estimated to cost \$2.15. The DB-9 connector was a commonly used connector for personal computing peripherals but has since become a legacy connector. Due to its continued use in industrial products, it is still a ubiquitous, low-cost connector and it meets the functional requirements of the HVAC interface. Five of the nine pins could be used for 24VAC HVAC appliances, and three of the pins could be used for digital communication with future HVAC appliances. Figure 8.4 shows the HVAC interface concept.

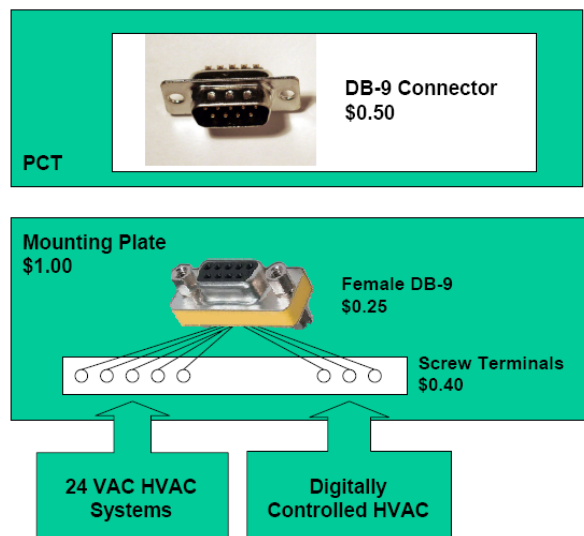

Figure 8.4. Cost overview of HVAC interface

8.4.4. Expansion Interface

The expansion interface chosen consists of an SDIO connector, an acronym for *secure digital input/output*. The connector itself is estimated to cost \$1.00. In addition to the connector, a flash memory module is needed to provide storage for audit logs that could be downloaded for accounting, compliance, or debugging purposes. The flash memory module is estimated to cost \$0.75.

SDIO has become a nearly ubiquitous interface in consumer electronics and can be found in personal digital assistants and cellular phones. The interface could be used to support two-way radios that could communicate with utility communication infrastructure (UCI) gateways or residential home-area networks. Two-way SDIO modules are already commercially available for wireless communication technologies such as Bluetooth™, 802.11b, and 802.15.4. The interface can also read and write data from/to removable flash memory modules, useful for performing audits or system upgrades. Figure 8.5 shows the interface components with examples of three commercial SDIO products of relevance to the PCT application.

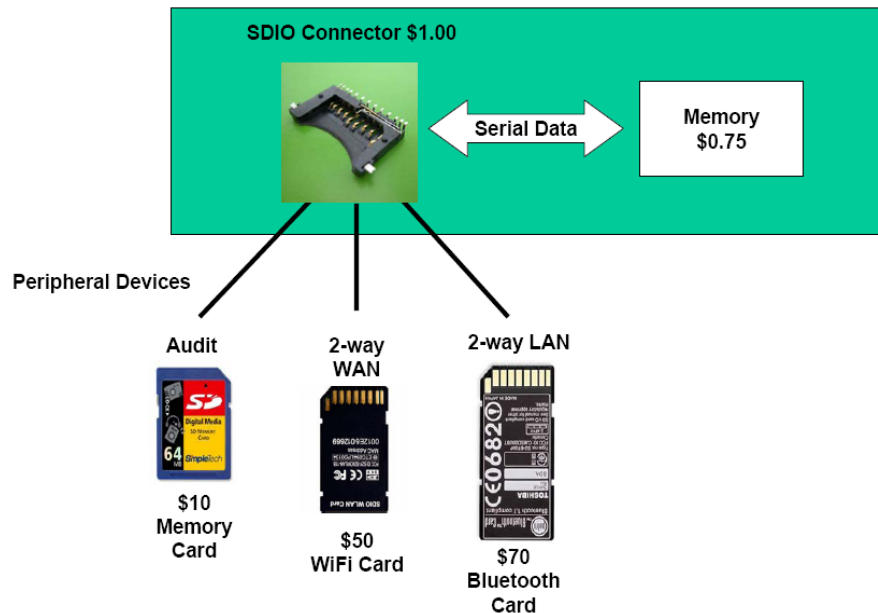

Figure 8.5. Cost overview of expansion interface

8.4.5. Software and Core Microcontroller

The team determined that a 16-bit microcontroller, costing approximately \$5.00, could be used as the core processor of a minimum functionality PCT. The processor would require an SPI interface for the communication and expansion interfaces, digital I/O for the HVAC and human-machine interfaces, and an LCD driver for the display screen.

The team estimated that a 16-bit microcontroller running at 8 MHz, with 4KB of memory and 64KB of flash memory would be adequate to support the software requirements of the minimum functionality PCT. To predict the computing and software overhead to the microcontroller, the team developed a PCT proof-of-concept and estimated the overhead based on the proof-of-concept software. The team determined that an actual PCT product would be

developed in either a C-based programming language or an assembly-level language. For this reason, the team wrote the PCT proof-of-concept software in the C language. The developed software was then analyzed for processing load and code size.

8.4.6. Summary of Minimum Functionality PCT Costs

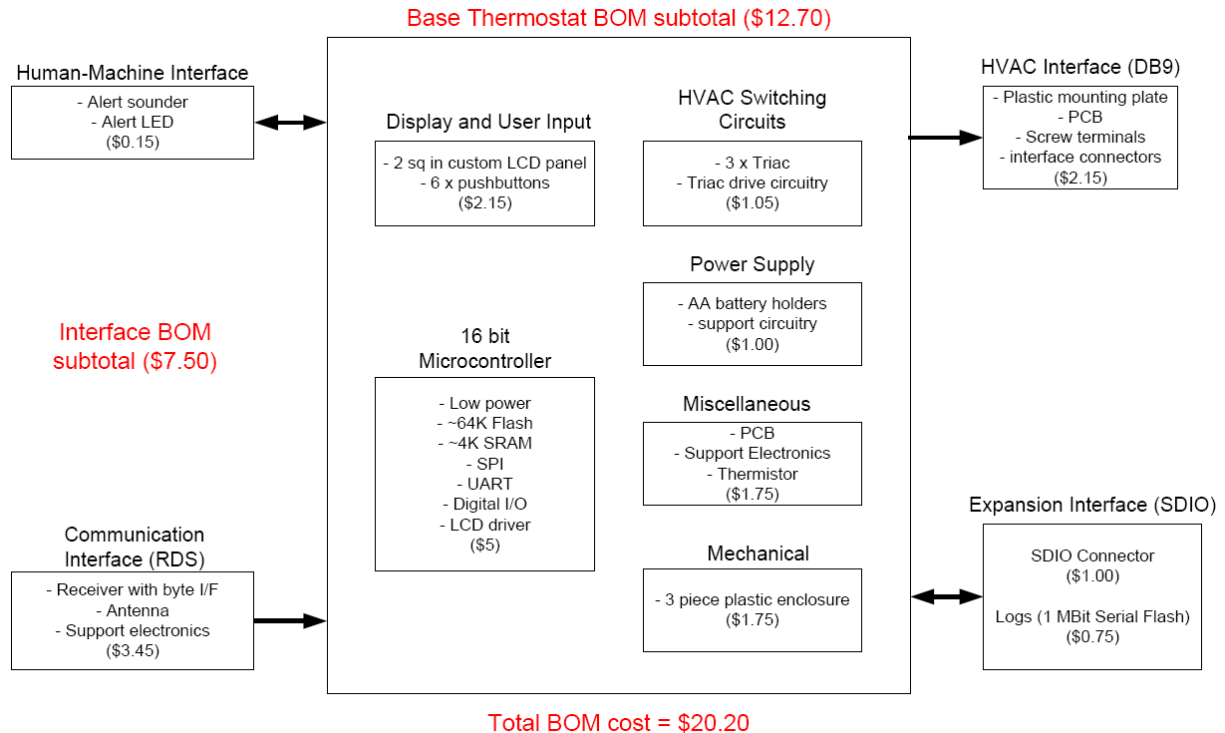

Interface BOM subtotal (\$7.50)

Communication Interface (RDS)

- Receiver with byte I/F
- Antenna
- Support electronics (\$3.45)

Expansion Interface (SDIO)

- SDIO Connector (\$1.00)
- Logs (1 MBit Serial Flash) (\$0.75)

Figure 8.6. Summary of bill of materials for minimum functionality PCT

Table 8.2. Summary of minimum functionality PCT costs

| | | |
|---|----------------------|----------------|
| Equivalent Programmable Thermostat | | \$12.70 |
| Added Interfaces | Communication | \$3.45 |
| | Human-Machine | \$0.15 |
| | HVAC | \$2.15 |
| | Expansion | \$1.75 |
| Total Bill of Materials | | \$20.20 |

The group estimates that a minimum functionality PCT could be built for a material cost of \$20.20. Figure 8.6 presents a summary of the bill of materials for the minimum functionality PCT. A complete bill of materials in spreadsheet form is presented in Appendix A, *Minimum Functionality PCT Bill of Materials*.

In developing the bill of materials, the team separated costs for components that would be novel to traditional programmable thermostats from those that would normally be included.

Table 8.2 summarizes the bill of materials cost for an *equivalent programmable thermostat* at \$12.70, and shows the itemized costs for the additional interfaces summing to \$7.50.

Current retail costs of programmable thermostats confirmed that the team’s estimates were reasonable. Figure 8.7 is a scanned image of a mailer advertisement showing retail prices for thermostats from Home Depot™ in April 2006. It is an accepted rule of thumb in the consumer goods industry that a retail price for a product will commonly be between three to four times the bill of materials cost. Using the estimate of the equivalent programmable thermostat components of \$12.70, the team’s bill of materials predicts that retail prices for such a product should be in the neighborhood of \$38.10 to \$50.80. The programmable thermostat models shown in Figure 8.7 are very close to the predicted retail prices arising from the bill of materials estimate.

Using the same three-to-four-times estimator, the team’s bill of material predicts that minimum functionality programmable *communicating* thermostats (PCT’s) could eventually be sold at retail prices in the neighborhood of \$60.60 to \$80.80. Initial retail prices may be higher, as thermostat manufacturers would be investing non-recurring engineering (NRE) costs in adding technology they may not have experience with to their product lines, such as radio communication and device expansion. Still, the team expected that retail prices for such a product could be less than \$100 when initially released. This estimate was later confirmed by a product manufacturer planning to enter the market with a base-model PCT, supporting the Title 24 interfaces, retailing at about \$100.



Figure 8.7. Advertisement from Home Depot® from April 2006 showing retail prices of programmable thermostats

8.5. Conclusion and Recommendations

The team determined that it was possible for a manufacturer to sell, in volume, a minimum functionality PCT that could receive radio dispatches anywhere in the state, interface with any of the utility’s advanced metering systems, control legacy analog and future digital HVAC

appliances, and interact with the customer during demand response events for a retail price less than \$100. The minimum functionality PCT design concept and bill of materials addressed the questions of cost, feasibility, and flexibility concerned with PCT system interface standardization. This information was presented, along with a PCT proof-of-concept system demonstrating the viability of each of the technologies, to the Energy Commission and other PCT stakeholders on April 18, 2006. The proof-of-concept is shown in Figure 8.8 and discussed in detail in Chapter 9, *PCT Proof-of-Concept*. Because the technologies chosen all consisted of readily available off-the-shelf solutions, the team believes that PCT's could be developed between April 2006 and April 2009, the effective date for Title 24-2008.



Figure 8.8. PCT proof-of-concept

8.6. Epilogue

Following the team's presentation, PIER funding was issued to form the industry-based Title 24 PCT Technical Working Group (Technical Working Group) to create a PCT Reference Design (Title 24 Technical Working Group 2007). The reference design would be referenced in Title 24, with particular interface technologies specified as mandatory in residential thermostats installed in new construction or retrofit housing. The Berkeley research team was a member the Technical Working Group, and offered the technologies used in the minimum functionality PCT design concept as an initial basis for discussion in developing the statewide PCT reference design. The technology suggestions for the communication interface and expansion interface were adopted in the reference design as mandatory.

9.0 PCT Proof-of-Concept

9.1. Objective

The team developed a PCT proof-of-concept (POC) to demonstrate to the PCT stakeholder community the general feasibility of the minimum functionality PCT concept presented in Chapter 8, *PCT System Interfaces and Minimum Functionality PCT Concept*. The proof-of-concept, developed in two phases, is completely built from commercial, off-the-shelf (COTS) technology, provides a working demonstration of each PCT system interface, and performs the functions of a basic programmable thermostat. In addition to providing a working demonstration, the proof-of-concept also serves as a test-bed for other proposed PCT system interface technologies.

9.2. Approach

In the first phase of the project, the team had a 14-week development timeline to create a basic demonstration of how the minimum functionality PCT concept would work and show that the concept was technically feasible. To accomplish this goal, the research team designed an advanced and flexible thermostat platform from the ground up. This task included the complete development of PCT software from scratch.

The team started by developing a C-based task/state control software for a programmable communicating thermostat. The task/state approach was appropriate for this application because it can easily serve a PCT's control functions, provides an easy-to-understand computing model, and allows for flexible and modular software development. The C computing language provides legitimacy that similar software could be developed for microprocessors appropriate for commercial PCT's. The team ran the software on an embedded computing platform that provided a reasonable proof-of-concept for PCT microprocessors and also served as host to which many system interfaces could be connected. The software and the computing platform were essentially the core of the POC system.

Next, prototype interfaces demonstrating the PCT system interfaces were developed using technologies that reasonably proved feasibility of the suggestions outlined in the minimum functionality PCT concept. A low data-rate serial communication link was implemented over a consumer FM radio transmitter and receiver to demonstrate the one-way communication interface. A very basic information model and messaging format for PCT communication were developed to demonstrate basic demand response functionality over this interface. Alert LED's and a piezoelectric sounder, which were suggested as interface solutions in the minimum functionality PCT concept, were included with an LCD display and keypad to demonstrate the human-machine interface. A USB port and USB flash memory module were used to demonstrate expansion interface. A DB-9 connector, also a solution that proposed in the minimum functionality PCT concept, connected the POC to a simulated HVAC system. While the POC was functional enough to drive an actual residential HVAC system, the team also developed a simulated target system that the PCT could "operate" in lieu of an actual physical plant. The simulated system consists of a computer model of a house that provides an indoor air temperature measurement, calculates the effects of heating and air conditioning, and accounts for outdoor temperature.

The Phase 1 POC and demonstration were first shown to PCT stakeholders at a meeting at the California Energy Commission on April 18, 2006. The demonstration showed how an operator, playing the role of a distribution utility or government agency, could send an overrideable economic event or a non-overrideable reliability event to the proof-of-concept over a radio broadcast interface, and that the proof-of-concept automatically responded to that event appropriately. The demonstration also showed how the technologies suggested by the team (in the minimum functionality PCT concept) for the human-machine interface, HVAC interface, and expansion interface could be used to support demand response.

In the second phase of the project, the proof-of-concept was redeveloped to utilize electronics components that more closely resembled those which would be integrated into an actual production PCT. The one-way communication interface was replaced with an actual RDS receiver unit capable of extracting data from commercial FM broadcasts and a test communication protocol was developed to support the information model outlined in *Reference Design for Programmable Communicating Thermostats Compliant with Title 24-2008* (Title 24 PCT Technical Working Group 2007) (this shall be referred to as “the PCT Reference Design”). Additionally, a two-way communication interface using a 2.4 GHz IEEE802.15.4 radio was added via the USB expansion port. The central PCT computing platform was moved from a relatively expensive, advanced development platform to an inexpensive (<\$100) consumer electronics device capable of running Linux. The Phase 2 POC was installed at the California ISO, along with a commercial-grade FM radio transmitter, in July 2007 in a long-term demonstration of California demand response technologies.

9.3. Phase 1 Proof-of-Concept



Figure 9.1. Phase 1 PCT proof-of-concept

The Phase 1 PCT proof-of-concept, shown in Figure 9.1, was laid out onto a large (61 cm x 91 cm) white plastic board to prevent unintended communication of industrial design connotations and focus the presentation on the functionality and technology of each interface – in simpler terms, the intent of the layout was to get audience members to think about *technological capabilities* rather than *thermostat design*. The physical components for each interface are mounted to yellow plastic panels in the four corners of the main board. Mounted behind center panel of the board is the embedded computing system. For demonstration purposes, the HVAC interface was connected to a simulated target system that allowed for a time-accelerated demonstration.

Sections 9.3.1 to 9.3.4 explain in detail the POC system architecture, the Phase 1 information model and communication protocol, the PCT software, and the simulated HVAC system.

9.3.1. System Architecture

Figure 9.2 is a complete schematic of the Phase 1 proof-of-concept, showing the logical and physical interfaces between each component. The four system interfaces and embedded computing system are discussed in detail in the following subsections.

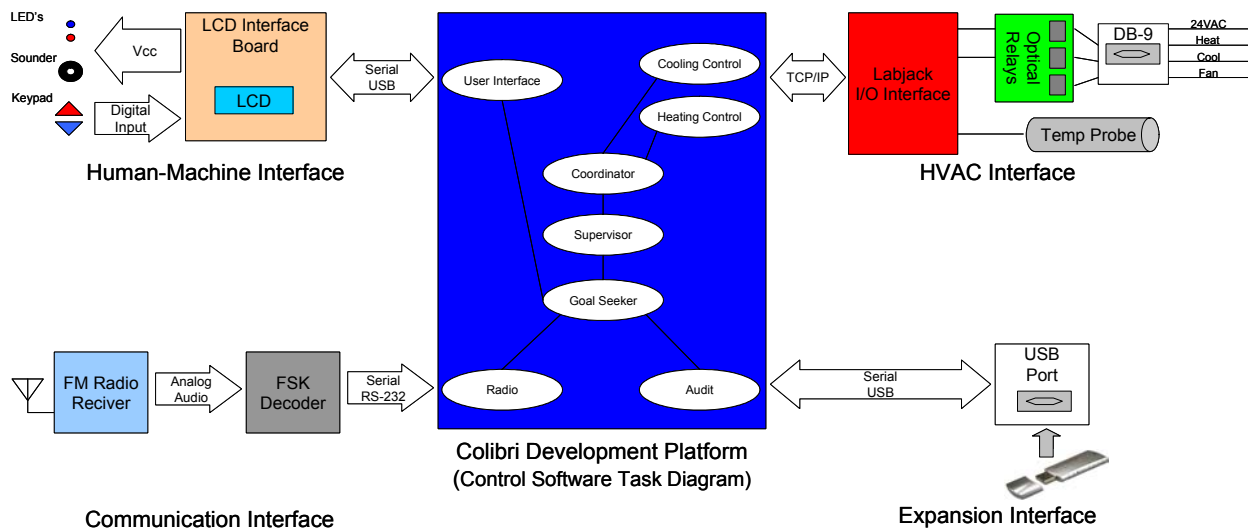

Figure 9.2. Phase 1 proof-of-concept system architecture

Colibri Development Platform

The team used a Colibri PXA270 from Toradex® as the central development platform for the PCT proof-of-concept. The Colibri PXA270 is a very small (67.6 x 36.7 mm) single-board computer system using an Intel/Marvell XScale® PXA270 ARM5 processor which can run Linux or Microsoft® Windows CE. The Colibri PXA270 installs into a larger evaluation board (200 x 200 mm) that provides access to the many computer hardware interfaces supported by the Colibri (e.g., USB, TCP/IP, RS-232, MMC, VGA, etc.). The Linux operating system was installed on the Colibri to simplify software access to the hardware.

The Colibri is considerably more powerful and expensive than the processors typically used in standard digital thermostats, but it still serves as a valid proof-of-concept for a PCT microprocessor because it is based on the same fundamental processor architecture (in this case,

ARM) that can be used in a digital thermostat. The Colibri was chosen over other embedded computing systems because the large variety of computer hardware interfaces available on the evaluation board greatly simplified development efforts. In addition, this variety of hardware interfaces allows the platform to function as a test-bed for any technology proposed as a PCT system interface solution.

Communication Interface

The communication interface developed to validate the concept of RDS over FM radio is a low data-rate serial communication link implemented over analog FM radio. The communication link consists of a custom-built, frequency-shift keying (FSK) encoder (1), an FM transmitter (2), an FM receiver (3), and a custom-built decoder (4). Each component is described in detail:

1. **RS-232-to-tone Converter (Encoder)**

The team built a circuit board that accepts serial data over an RS-232 interface and converts the binary data to an FSK signal. A digital “0” is represented by a few voltage cycles at 800 Hz, and a digital “1” is represented by several voltage cycles at 1200 Hz. An audio output containing the FSK signal was sent to the FM transmitter.

2. **FM Transmitter**

The team used a commercial product (Monster Cable RadioPlay FM Transmitter) for FM transmission that is designed to transmit audio from a portable audio player to a car’s radio system. The audio signal from the RS-232-to-tone converter is broadcast in low power over FM radio on one of several possible frequencies from 88.1 to 89.5 MHz.

3. **FM Receiver**

A RadioShack battery-powered handheld FM radio was used to receive the signal. The receiver tunes to the appropriate frequency and the analog mono audio output is connected to the tone-to-RS-232 converter for decoding.

4. **Tone-to-RS-232 Converter (Decoder)**

Complementing the encoder, the team built a circuit board to convert the audio signal back to a serial RS-232 data stream. The circuit employs a phase-locked-loop to lock onto either the 800 Hz or the 1200 Hz signals from the audio signal and produces a corresponding binary signal output over RS-232. The FM radio and decoder are shown in Figure 9.3.



Figure 9.3. Radio receiver and decoder

In the demonstration, a laptop computer was connected to the encoder and transmitter to send demand response messages, and the radio and decoder were connected to the Colibri through one of the RS-232 serial ports on the evaluation board. The DR messages sent by the “DR broadcasting laptop” used a framed communication protocol developed by the team to demonstrate demand response functionality. The information model for this protocol is discussed in Section 9.3.2.

This communication link was a good proof-of-concept for RDS technology because it demonstrated a form of digital communication over broadcast FM radio. Additionally, the data-rate of the prototype was coincidentally the same as the useable data rate of RDS: 300 baud.

Expansion Interface

To demonstrate the expansion interface, the team used one of the USB ports on the Colibri evaluation board. The native USB support of the Linux operating system allowed the team to demonstrate auditing capability by mounting a USB flash drive and copying audit data to the drive. In the demonstration, whenever a “Download Memory” button on the human-machine interface was pressed, the POC copied a full audit history of the received DR event messages and customer-override setpoint changes to the flash drive.

USB proves that the SDIO concept is feasible because both are low-cost serial interfaces that support flash memory and two-way radio modules.

Human-Machine Interface

The human-machine interface was prototyped with an off-the-shelf LCD display with a membrane keypad, LED's, and a piezoelectric buzzer. The LCD/keypad unit used was a Matrix Orbital MX401 20-character by 4-line display that came pre-assembled with a 15-button keypad and could be interfaced with a USB or TTL connection. The Matrix Orbital unit supports several current-limited, general-purpose outputs (GPO) that were used to drive the LED's and the buzzer. A blue LED was used to indicate reliability events versus a red LED for economic events. The buzzer was used to indicate pending events and the start and stop of an event. In addition to displaying information about pending and current demand response events, the LCD was used to display standard thermostat-related information, such as the current temperature, temperature setpoint, HVAC equipment status, time of day, and current program mode.

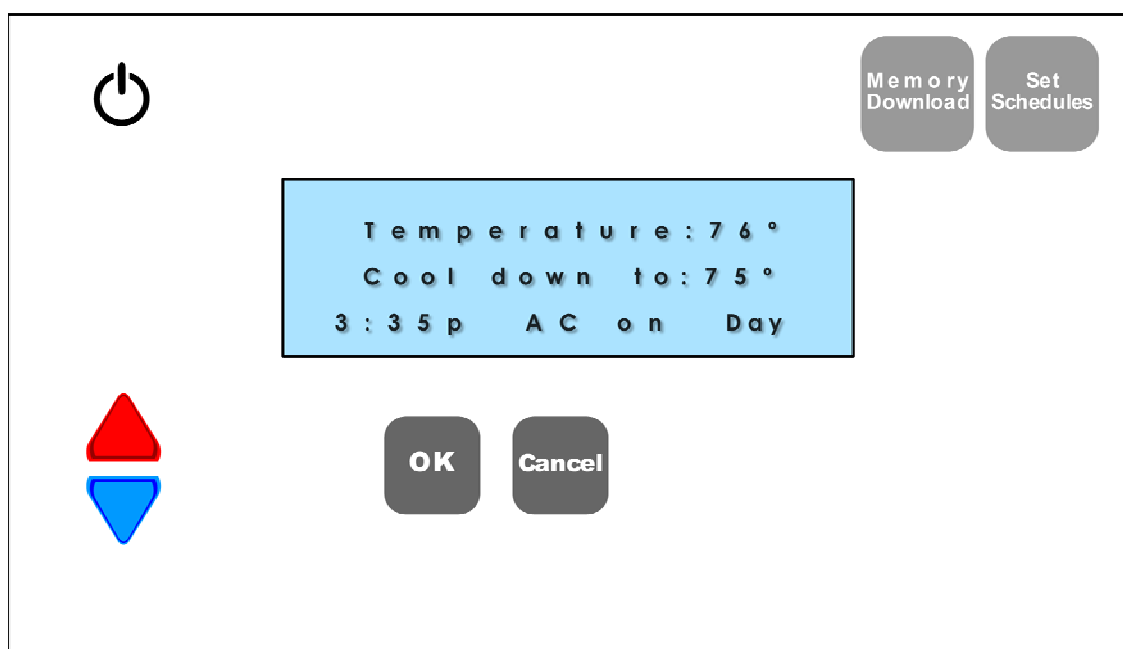

Figure 9.4. Human Machine Interface

Five of the keypad buttons were used to provide user input: on/off, a pair of up/down buttons used for temperature control, OK, Cancel, and a “Memory Download” button. The team printed an overlay on glossy paper that showed a rendition of a PCT interface to label the prototyped buttons and mask the default keypad configuration. Shown in Figure 9.4 are the overlay and an example display prompt. Also seen on the overlay is a “Set Schedules” button that was intended to provide a mechanism for the resident to program the setpoint schedules but was not implemented in the proof-of-concept because it would not demonstrate any new Title 24 functionality.

The complete scenarios explaining how the prototyped interface operates in response to events and button presses are listed in the in Appendix B, *Human Machine Interface Scenarios*.

The implementation of this interface in the POC consisted of technologies that could all be used in production PCT's.

HVAC Interface

For the HVAC interface, the team implemented the exact technology which was proposed in the minimum functionality PCT concept. The interface consists of a female DB-9 connector attached to a mounting plate on the wall and connected to the HVAC system through traditional thermostat wire. The PCT would have a counterpart male DB-9 connector on its backside that would plug into the wall plate. The rear of the wall plate used for the POC, showing thermostat wire terminated to the back of the connector, is shown in Figure 9.5. On the front of the wall plate all that is visible is a standard female DB-9 connection.

Implementation of the HVAC interface in the proof-of-concept was complicated drastically by the lack of digital and analog I/O on the Colibri evaluation board. To cope with this, the team added a LabJack UE9 I/O module to the POC. The LabJack UE9 device provides a computer interface for digital and analog I/O and is controlled via either TCP/IP or USB. TCP/IP was used in the proof-of-concept because of its readily available support in the Linux operating system. Digital output lines on the LabJack were used to provide actuation signals for heating and cooling, and an analog input was used to measure temperature with an active temperature probe from LabJack Corporation (EI-1022). In a digital thermostat, the low-current signals from the microcontroller cannot directly switch 24VAC HVAC controls; the signals must be coupled to the power electronics with a switching device such as a relay. To promote realism of the prototyped HVAC interface, the team connected the digital outputs from the LabJack to an array of optocouplers (NAiS AQV252G) that are capable of switching up to 60VAC at 2.5A – more than enough for common HVAC circuits.



Figure 9.5. HVAC Interface, rear of wall-mount

Further complicating implementation of this interface was the need to connect with a simulated target system instead of an actual HVAC system. The simulated system consists of a computer model of a house with an HVAC system, and is described in Section 9.3.4. A LabJack UE9 was also used on the computer running the simulation to provide an I/O interface. In the

demonstration configuration, the optocoupler array of the POC was not used and the POC LabJack and simulation computer LabJack were directly connected through the DB-9 interface, as shown in Figure 9.6. The air conditioning and heater control outputs from the POC LabJack were wired to corresponding digital inputs on the simulation computer LabJack. The simulation LabJack provided the indoor air temperature measurement to the POC by outputting a voltage on an analog output corresponding to the temperature-voltage curve of the EI-1022 temperature probe; this line simply replaced the EI-1022 on the POC LabJack.

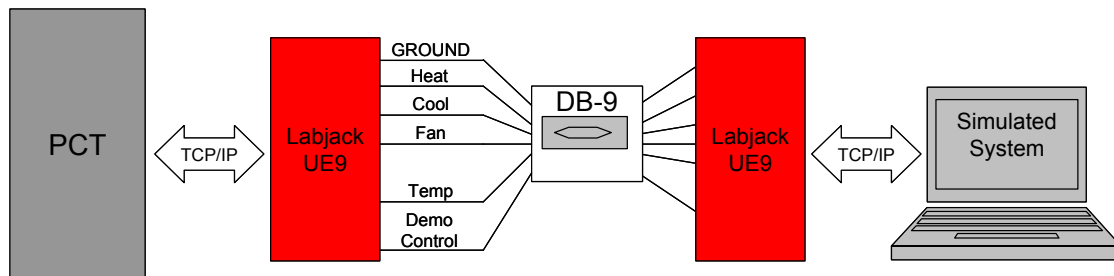

Figure 9.6. Connection between PCT proof-of-concept and simulated system

The connection of the LabJacks also allowed for time synchronization of the demonstration. Synchronization of both the time scale (ratio of virtual simulation time to actual time) and the start time between the POC and house simulation were necessary to ensure that the thermodynamic response of the simulation to a daily outdoor temperature profile and heating/cooling actuations were realistically reflected on the PCT display. For example, if the PCT were to display the indoor air temperature peaking at 4 AM and reaching its low at 12 PM, the audience would dismiss the demonstration as unrealistic. The POC used one digital output line on the LabJack to indicate the timescale mode and another digital line to restart the simulation at 10 AM. For demonstration, the thermostat and simulation can be run in either a “fast time” mode, in which one virtual hour in the house simulation goes by in approximately 15 actual seconds, or a “slow time” mode, in which one virtual hour goes by in approximately one real minute.

9.3.2. Information Model and Communication Protocol

The information model and communication protocol for the Phase 1 proof-of-concept are described together in this section. The information model is very basic and does not support functionality such as transmitting temperature values for emergency events or addressing of PCT’s. However, the information model does allow the most basic demand response functions of scheduling the start time and duration of a demand response event, and differentiating between an emergency event and eight levels of economic response. The information model also supports a number of commands that are specific to running demonstrations on the PCT proof-of-concept (the demonstration of the entire system, including both the PCT proof-of-concept and the simulated system, is controlled by the user interface on the DR broadcasting laptop).

The demonstration protocol is a framed communication protocol occurring over serial RS-232. Each frame consists of 22 ASCII bytes of payload, plus 4 HEX bytes for framing and CRC. Each component of the data frame is described below.

1. Start: 1 HEX byte

“7E” is used as a reserved character to indicate the start of a data frame.

2. MsgID: 2 ASCII bytes

This is a sequential integer used to ID message for redundancy. The message can be retransmitted multiple times over the serial link. Valid values range from “00” to “99.”

3. Command: 1 ASCII byte

This field contains a specific set of commands related to running the POC demonstration.

a. “0” – Null

POC ignores field and looks at rest of message.

b. “1” – Reset quick

POC resets to 10 AM and runs in “fast time” (and resets simulation to 10 AM on fast time)

c. “2” – Reset long

POC resets to 10 AM and runs in “slow time” (and resets simulation to 10 AM on slow time)

d. “3” – Display radio broken message

The POC mimics how it would behave if communication is non-operational.

This is to demonstrate to the audience what would happen if a real PCT is not receiving DR signals.

4. Month: 2 ASCII bytes

Day: 2 ASCII bytes

Year: 4 ASCII bytes

Month, day, and year refer to the effective date of a DR event which is being issued.

Characters indicating standard calendar dates are used.

5. Strength: 1 ASCII byte

This field is used to indicate the magnitude of an event’s severity.

a. “0-8” – economic event, where 0 is the least expensive and 8 is the most expensive

b. “9” – reliability event

In the demonstration, only two values were used: “0” for an economic (overrideable) event and “9” for a reliability (non-overrideable) event.

6. Event Start Time – 5 ASCII bytes

This indicates the time that an event will become effective. The hour, from “00” to “23,” and minute, from “00” to “59” are indicated like so: “HH.MM”

7. Event Duration – 5 ASCII bytes

This indicates the duration of the event and is specified in the same format as Event Start Time.

8. Stop: 1 HEX byte

“7D” is used as a reserved character to indicate the end of a data frame.

9. CRC Hi: 1 HEX byte
CRC Lo: 1 HEX byte

The CRC used is a CRC-16-IBM 0xA001 polynomial of the form $X^{16} + X^{15} + X^2 + 1$

A sample message is shown in Table 9.1.

Table 9.1. Sample DR message

| Start | MsgID | | Command | Month | | Day | | Year | | | | Strength |
|-------|-------|---|---------|-------|---|-----|---|------|---|---|---|----------|
| 7E | 0 | 0 | 0 | 0 | 3 | 2 | 9 | 2 | 0 | 0 | 7 | 9 |

(continued below)

| Start Time | | | | Duration | | | | Stop | CRC Hi | CRC Lo |
|------------|---|---|-----|----------|---|---|-----|------|--------|--------|
| 1 | 2 | . | 0 0 | 0 | 2 | . | 0 0 | 7D | 4C | 5D |

9.3.3. PCT Software

The PCT software for the proof-of-concept was written in the C programming language to best demonstrate its legitimacy. Inexpensive programmable thermostats generally make use a somewhat anemic 8 or 16-bit microprocessor and software development for this class of processor generally takes place using assembly code or a C-based programming language. Arguably, the C programming language is the most widely used, and C compilers have been written for nearly every type of processor, which would allow the PCT software to be ported to a simpler processor. Additionally, C was a beneficial choice for the team because it is a full-featured and powerful language that has a number of free, open source, compilers and development environments.

The software was constructed using the task/state architecture as outlined *Control Software for Mechanical Systems: Object-Oriented Design in a Real-Time World* (Auslander et al. 2002), specifically using the TranRunC architecture recently developed by David Auslander and explained in Appendix C, *TranRunC: Realizing Task/State Mechanical System Control Software in C*. The TranRunC architecture lays out an object oriented approach to software development that uses the C language as its backbone. Since C is not a true object oriented language, like its successor C++ or the popular Java, TranRunC code is simply written using an object-oriented style. This style provides for a great deal of modularization and code reuse.

Following a strict task/state hierarchy, Figure 9.7 illustrates the overall structure of the PCT software. Each task only communicates with other tasks linked directly to it, which produces clear and easy-to-track data flow.

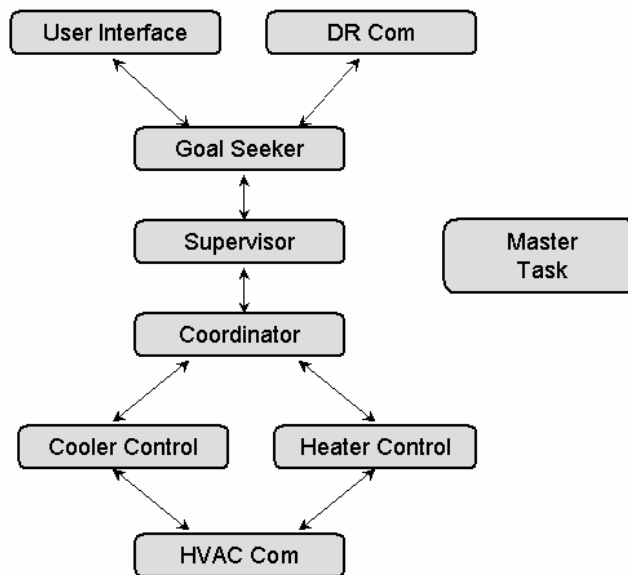

Figure 9.7. PCT task diagram

The following subsections completely describe the details of each task (such as the state transition logic), but a brief overview of the general function of each task is described here:

- The Goal Seeker Task performs the decision making related to meeting the DR-related goals.
- The User Interface Task controls the LCD display and relays user button presses.
- The DR Communication Task manages the radio and parses data from the received messages.
- The Supervisor Task stores setpoint tables and relays the current setpoint to the Coordinator Task.
- The Coordinator Task manages the operation of the HVAC controllers, deciding whether to operate the air conditioner, heater, or neither.
- The Cooler Control and Heater Control Tasks perform hysteresis control on their respective HVAC units. The modular, object-oriented, nature of TranRunC allows the same code to be used for both control tasks yet be maintained as two separate Task objects.
- The HVAC Communication Task relays the signals from the Control Tasks to the HVAC system and measures the air temperature.

Goal Seeker Task

The Goal Seeker Task makes decisions based upon its current DR-related state (see Figure 9.8). The Goal Seeker operates in the Normal state when no DR event is currently occurring, and when a DR event begins, the Goal Seeker moves into one of two states based on the DR

message: Economic state or Reliability state. It has direct communication with the User Interface Task, DR Communication Task, and Supervisor Task.

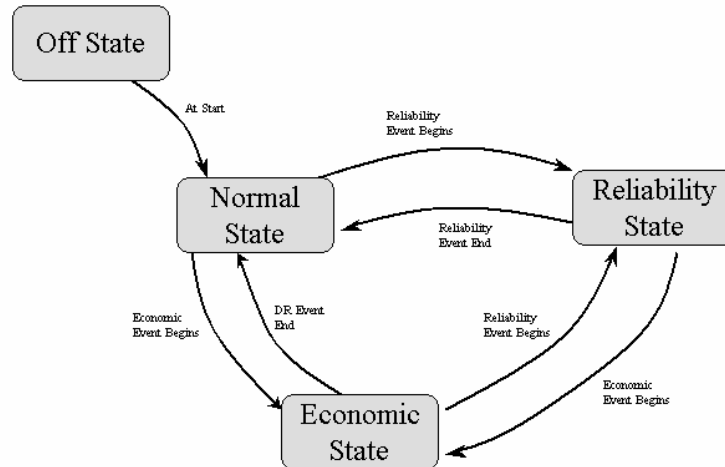

Figure 9.8. Goal Seeker states

The Goal Seeker controls the User Interface Task and the Supervisor Task. It passes all information to the User Interface, such as current time, temperature, setpoint, and any necessary user messages. Further, it controls operation of the HVAC system by turning the Supervisor on and off and can make modifications to the setpoints through the Supervisor.

The DR Communication Task passes DR messages to the Goal Seeker Task. The messages consist of an event identification number, start date, time of the DR event, duration in hours, and strength of the event. Due to data capacity limitations, the DR strength is represented as a single digit integer (0 to 9). In this scheme, “9” represents a reliability event and any other integer represents an economic event. A DR message can be relayed a few hours, or even longer, before the start of the event, but the transition to the Reliability or Economic states does not occur until the start of the DR event.

In the Normal state, the PCT acts like any other programmable thermostat. Setpoint changes occur along their normal schedule, and the resident can, at any time, make modifications to the current setpoint. The only exception to this is that as soon as a new DR message has been received, the Goal Seeker will direct the User Interface to warn the resident that a DR event will be commencing shortly.

A transition to the Economic state occurs at the start of an economic DR event (0-8 strength). The Economic state modifies the setpoint based on a simple formula using the DR strength variable (S_{dr}) and a user defined DR profile variable (T_{max}) indicating the maximum setpoint offset the user desires (Equation 1). In this state, the setpoint modification can be overridden,

but when an override is desired, the Goal Seeker directs the User Interface to ask the user for a confirmation of the action. Otherwise, the PCT acts like a normal programmable thermostat – scheduled setpoint changes continue to occur with the modification applied.

$$T_{\text{mod}} = T_{\text{max}} \frac{S_{dr}}{8} \quad (1)$$

During the Reliability state (DR strength of 9), the thermostat moves into a mandatory power-saving mode. In this mode, the Goal Seeker directs the HVAC system to shut down by issuing a very large (e.g. 100°F) setpoint modification. In actual PCT implementation, the setpoint modification will be specified in the DR message (such as a 4°F setpoint offset). In the Emergency state the resident cannot override the setpoint, and if a change is requested, the Goal Seeker directs the User Interface to display a “no overrides during emergency” message to the resident.

A couple of actions can occur during any of the states except the Off state. First, whenever a new message comes in from the DR Communication Task, a radio malfunction may be indicated. This functionality was included in the demonstration to provide a means of showing what might happen if the communication interface was not connected to the network. In this case, the Goal Seeker will set a flag in the User Interface Task to indicate the radio malfunction and display an appropriate message until a signal comes from the DR Communication task clearing the malfunction. Second, the User Interface Task can make true a ‘download memory’ flag at any time to indicate the user input has occurred. Upon receiving this signal, the Goal Seeker writes the contents of its stored memory to a file on the memory stick. It then clears the memory and resets the flag to logical false.

User Interface Task

The User Interface Task displays information from the Goal Seeker on the Matrix Orbital LCD display and relays commands back to the Goal Seeker. The complex state diagram in Figure 9.9 illustrates the state transition logic.

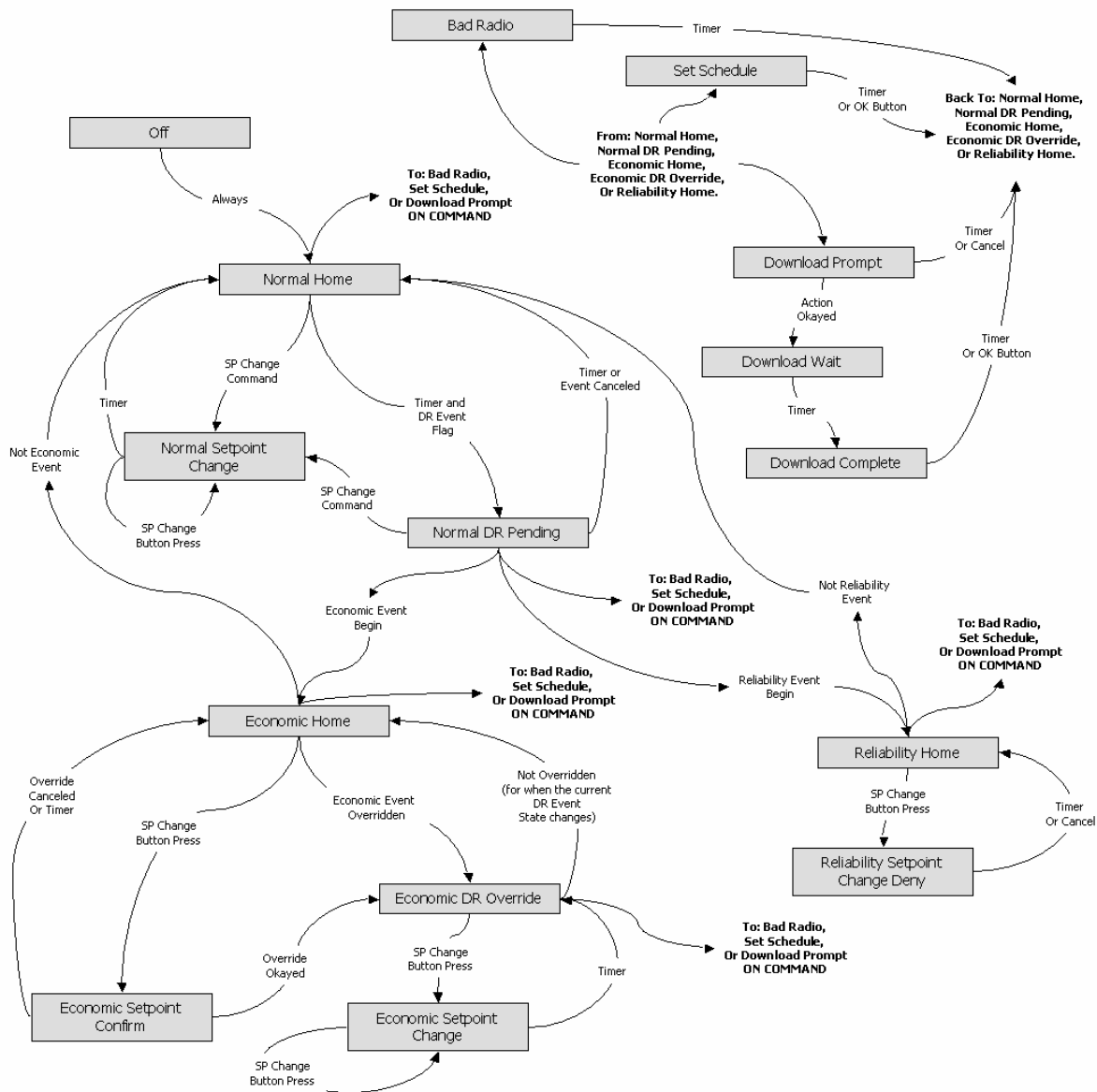

Figure 9.9. User Interface states

After the software has initialized but before the program has started, the display shows the Off state message to indicate its current status. The Off state always transitions to the Normal Home state once the program commences.

The User Interface operates in the Normal Home state when the Goal Seeker is in its Normal state and the resident has not touched any buttons. This state displays the current time, temperature, and the current setpoint description.

A 'DR Event' flag is modified by the Goal Seeker to indicate DR event status. When this flag changes to indicate anything other than 'no event', the User Interface transitions from the Normal Home state into the Normal DR Pending state. If the flag indicates that an event will occur shortly, this state displays a scrolling-style message indicating the type of pending event

and the time until it commences. Transitions to the Economic Home or Reliability Home states only occur from the Normal DR Pending state, and those transitions occur when the 'DR Event' flag indicates an economic or reliability event.

While in either the Normal Home or Normal DR Pending states, and the user presses the up or down arrow buttons on the display to indicate a desired setpoint change, the User Interface transitions into the Normal Setpoint Change state. Here, the User Interface relays a setpoint change of 1° F greater or smaller to the Goal Seeker and displays the newly modified setpoint on the LCD. The state transitions back to the Normal Home state (and consequently to the Normal DR Pending state if the 'new DR message' flag is true) after a small time, but additional button presses before the timer expires cause self-transitions (a return to the state) that again update the setpoint and reset the display timer.

When the Goal Seeker transitions to the Economic state, it triggers the User Interface to transition to the Economic Home state using the 'DR Event' variable. This state changes the display to indicate the current DR status, such as event type and time of completion.

From Economic Home, the resident can still change the setpoint, but it requires acknowledgment that they are overriding the DR event. The first time the up and down arrow buttons are pressed after the entry of the Economic Home state, the User Interface transitions into the Economic Setpoint Confirm state. Here, a message indicating that the resident will have to pay more for electricity during the economic event must be confirmed with a press of the 'OK' button before the change will be allowed. If the user presses 'Cancel' or does nothing for a specified time, the User Interface transitions back to the Economic Home state. If the user presses the 'OK' button, the Economic DR Override state becomes active and a flag indicating the overridden state is set. This state results in a scrolling-style message indicating that the economic event has been overridden. Any additional up/down arrow button presses result in a transition to the Economic Setpoint Change state. Here the setpoint is modified and displayed in a manner similar to that in the Normal Setpoint Change state except that, apart from self-transitions, it only transitions to back to the Economic DR Override state.

At the end of the economic event, as indicated by the 'DR event' variable, the User Interface transitions to the Normal Home state. If the Economic DR Override state is currently active, it first transitions to the Economic Home state, before the Normal Home state transition.

Once a reliability event has been indicated, the Normal DR Pending state will force the User Interface into the Reliability Home state. This state modifies the display to indicate the current DR status. Initiation of a setpoint change results in the transition to the Reliability Setpoint Change Deny state. A message indicating that reliability events cannot be overridden shows on the LCD. After 'DR event' no longer indicates reliability event, the User Interface transitions to the Normal Home state.

The PCT required three more functions from the User Interface in order to meet the design goals. The Bad Radio state warns the resident about a radio malfunction by displaying a message on the LCD. The Set Setpoint state acts as a placeholder for setpoint programming, and it simply displays a message that indicates that the function has yet to be implemented.

The Download Prompt, Download Wait, and Download Complete states step the user through downloading a log file to the plug-in memory module. These states are accessible from any of the resident state, Normal Home, Normal DR Pending, Economic Home, Economic DR Override, and Reliability Home, using dedicated commands.

Transition to the Bad Radio state occurs when the 'bad radio flag' gets set to logical true by the Goal Seeker. Transition back to the former state occurs after a software timer expires. The former state then transitions back to the Bad Radio state after a software timer in the state expires. This process of flipping back and forth from the Bad Radio state and the previous state continues until the 'bad radio flag' becomes logical false.

The Set Setpoint state becomes active when the user presses the appropriate button on the Matrix Orbital panel. After a software timer expires or the OK button gets pressed, transition back to the previous state occurs. As mentioned previously, this function was not implemented because it did not add to the demonstration of the PCT interfaces and it would have taken valuable development time away from more critical tasks.

Download Prompt becomes active when the user presses the Download button on the Matrix Orbital. In this state a message is displayed indicating that the resident should plug in the memory stick and press OK. If OK does not get pressed within a certain time limit or the Cancel button is pressed instead, the previous state becomes active again, and the download is aborted. Upon pressing the OK button the Download Wait state activates, a message indicating that the download is in process displays, and the Goal Seeker is asked to commence a memory download. After a software timer expires, the Memory Download Complete activates and displays a message stating completion. The previously resident state activates after another timer expires or a press of the OK button.

DR Communication Task

The DR Communication Task retrieves messages relayed from the communication interface over the RS-232 communication port. It constantly watches the serial port for new bits, and constructs the messages based on the framed format described in Section 9.3.2. When the message is completely received and verified as error-free (using the CRC method described in Section 9.3.2), the DR Communication Task formats the serial string into a message structure and forwards it to the Goal Seeker Task.

Supervisor Task

The Supervisor Task manages the user-programmed temperature setpoints. It consists of an Off state and a Supervise state as shown in Figure 9.10. The Off state simply relays information up and down the task hierarchy, and the Supervise state sets the temperature setpoint as specified in the setpoint tables or modified by user override and/or DR events. The Supervisor communicates with the Coordinator and the Goal Seeker. It sends the Goal-Seeker-specified HVAC mode to the Coordinator through the 'mode' flag and relays the current temperature up to the Goal Seeker. It also performs two-way communication with the Goal Seeker about the current resident-specified setpoint temperature modification in addition to receiving from the Goal Seeker a DR defined setpoint modification.

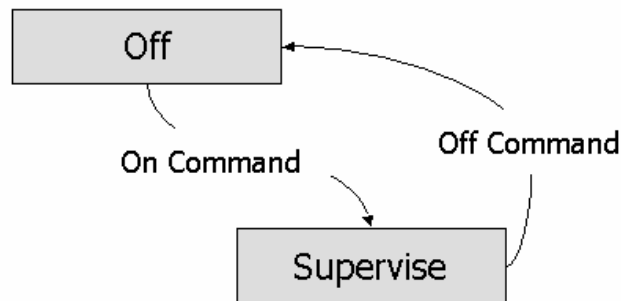

Figure 9.10. Supervisor states

Upon entry of the Off state, the Supervisor turns off the Coordinator and goes about the simple task of relaying the current indoor temperature to the Goal Seeker. When the Goal Seeker modifies the 'on' flag to true, the transition to Supervise state occurs.

In the Supervise state, the current HVAC mode (OFF, A/C ON, HEAT ON) is constantly relayed down to the Coordinator through the 'HVAC mode' flag. Again, the current indoor temperature constantly gets relayed up to the Goal Seeker. As previously stated, the Goal Seeker communicates with the Supervisor about two setpoint modification variables. More interestingly, the Supervise state monitors the setpoint tables, and passes along the setpoint based on the sum of the table value, the resident setpoint modification, and the DR setpoint modification variables. The current resident-specified setpoint modification allows the Goal Seeker to pass the intentions of the resident on to the Supervisor when it receives the command from the User Interface. This value is reset to 0° F every time the table-based value changes (the PCT enters a new program period). When a DR event occurs, the DR-based setpoint modification gets relayed from the Goal Seeker and is applied directly to the setpoint by the Supervisor.

Coordinator Task

The Coordinator Task is one of the simplest of all the tasks, and it has the mundane job of turning on or off the Heater and Cooler Control Tasks and relaying the current setpoint from the Supervisor. It consists of two states, Off state and Coordinate state, as indicated in Figure 9.11.

The PCT program loads with the Coordinator in the Off state. The Off state sets the Control Tasks to the off mode. Then it relays the current inside temperature and Control Tasks' modes to the Supervisor. The Supervisor can turn on the Coordinator by setting the 'HVAC mode' flag to something other than OFF, forcing the Supervisor into the Coordinate state.

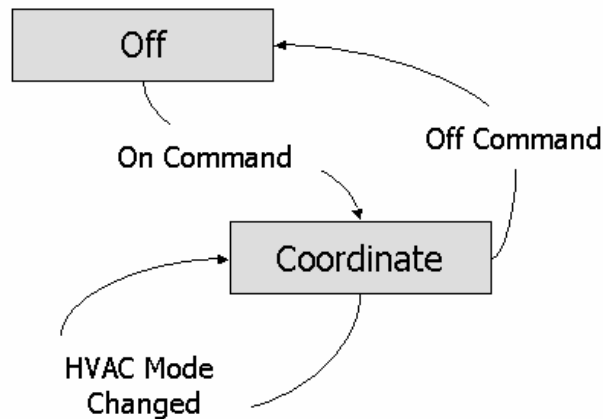

Figure 9.11. Coordinator state diagram

Upon entry of the Coordinate state, the task sets the Heater and Cooler Tasks based on the value of the 'HVAC mode' flag. Following this, the Coordinator relays the Supervisor setpoints to the Heater and Cooler Tasks and writes the current inside temperature back to the Supervisor. When the 'HVAC mode' flag changes to OFF, the Coordinate state transitions to the Off state, but when it changes to a different value (but not OFF), it self-transitions – causing a change to the Heater and Cooler Tasks.

Heater / Cooler Control Task

The Heater and Cooler Control Tasks control their respective HVAC units by maintaining an internal temperature setpoint using a non-linear hysteresis controller. Hysteresis control applies actuation when the temperature measurement is *greater* than the setpoint by some δ -value and turns off actuation when the temperature is *less* than the setpoint by some δ -value. The δ -values determine the size of the hysteresis band, and in some cases may not be symmetric. The benefit of hysteresis control is that it reduces the sensitivity of the system to sample time and results in longer equipment cycle times that produce less wear. The downside of hysteresis control is that it results in larger swings of air temperature around the setpoint temperature. Additionally, after the air conditioning unit turns off, there may still be an appreciable amount of cold air remaining in the ducts and available from the coils that will continue to cool the house as it is circulated by the fan. To compensate for this, another factor can be added to hysteresis control called the anticipator, which anticipates the effect of the cold air in the duct by cutting off the cooling actuation short of the hysteresis band. This is often referred to as "bang-bang" control, and most thermostats use this technique to maintain the setpoint in both heating and cooling modes. The pseudo-code below explains the algorithm for the cooler unit.

```

e = T_s - T_air
if u_{AC} == TRUE and e >= C_c - C_a
  then u_AC = FALSE
  
```

```
if u_{AC} == FALSE and e <= -C_h
    then u_AC = TRUE
```

The variable 'T_s' is the current setpoint temperature, 'T_air' is the current indoor temperature, and 'e' is the error between the two. U_{AC} defines the state of the air conditioner. The variable 'C_a' is the anticipator constant (0.1°F), 'C_c' and 'C_h' are the cooling and heating max bounds (0.7°F each). In simulation, the hysteresis band is about 1.2°F centered about the setpoint temperature.

Since the Heater and Cooler Control use the same basic control strategy, the team can make good use of the TranRunC architecture by reusing a single task – the Control Task. During construction, two objects are created – the Heater Task and Cooler Task – with different parameters that point to the same task/state functions to perform the processing. The task/state functions were written with enough extensibility to allow this operation.

HVAC Communication Task

The HVAC Communication Task simply passes the control signals from the Control Tasks to the heater and A/C and provides the air temperature measurement. Digital output lines specify the state (on or off) of the heater and air conditioner, and the current indoor temperature is measured by the PCT through an analog voltage input from a temperature sensor or simulated temperature sensor.

As discussed in Section 9.3.1| *HVAC Interface*, the PCT proof-of-concept communicated with the HVAC system through a LabJack UE9 data acquisition device that was interfaced through TCP/IP. A production thermostat would need to incorporate the functions of the HVAC Communication Task, but sockets programming would not be used. Instead, the program would interface the device hardware directly to actuate the equipment and measure the temperature.

9.3.4. Simulated System

The simulated system contains a thermal model for a house and HVAC equipment. The simulation is implemented on standard PC hardware using the Linux OS. All interfaces with the PCT occur through a LabJack device. The PCT modulates the A/C and heater via a couple of dedicated control lines, and it obtains the indoor temperature by reading a simulated temperature sensor signal that the simulation constantly updates.

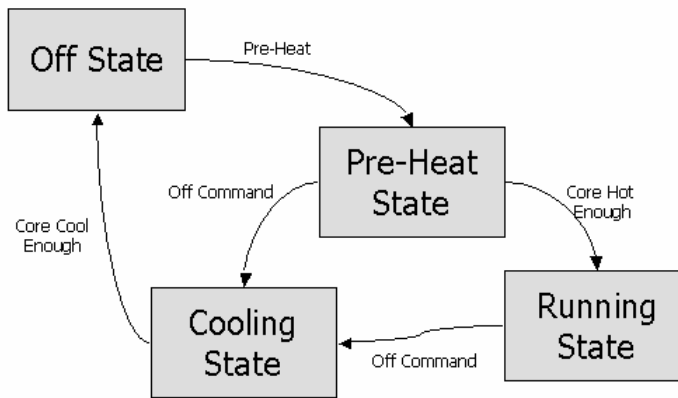

Figure 9.12. HVAC state diagram

As with a real HVAC system, a single speed blower fan is controlled independently from the heater or cooler compressor so that it extracts the energy from the still warm or cool compressor coils after the compressor has been shut off. Figure 9.12 shows the state diagram for the heater and cooler.

The thermal model includes five states and a multitude of inputs. The states are the temperatures of the indoor air, internal walls, external walls, heater mass, and cooler mass. Table 9.2 lists the key model variables with descriptions.

Table 9.2. Thermal Model Variables

| Variable | Description |
|--------------|---|
| T_{air} | Temp. of Indoor Air |
| T_{iw} | Temp. of Internal Wall |
| T_{xw} | Temp. of External Wall |
| T_{hm} | Temp. of Heater Mass |
| T_{cm} | Temp. of Cooler Mass |
| Q_{h2in} | Heater to Inlet Air Conduction |
| Q_{hloss} | Heater to Ambient Conduction |
| Q_{hin} | Heat Input to Heater (Tonnage Rating) |
| q_{h2air} | Heater Supply Air and Indoor Air Convection |
| Q_{c2in} | Cooler to Inlet Air Conduction |
| Q_{closs} | Cooler to Ambient Conduction |
| Q_{cin} | Heat Input to Cooler (Tonnage Rating) |
| Q_{cout} | Adjusted Heat Input to Cooler |
| q_{c2air} | Cooler Supply Air and Indoor Air Convection |
| Q_{int} | Internal Gains to Indoor Air Conduction |
| q_{inf} | Infiltration Air Convection |
| Q_{iw2air} | Internal Walls to Indoor Air Conduction |
| Q_{xw2air} | External Walls to Indoor Air Conduction |
| Q_{xw2out} | External Walls to Outside Conduction |
| Q_{wincon} | Through Windows to Indoor Air Conduction |
| Q_{winrad} | Through Windows to Indoor Air Radiation |
| T_{out} | Temp. of Outside Air |
| T_{amb} | Temp. of Space Where Blower Resides |
| T_{hsup} | Temp. of Heater Supply Air |
| T_{csup} | Temp. of Cooler Supply Air |
| k_{xx} | Thermal Conductivity Constants |
| m_{xx} | Mass of Item XX |
| c_{pXX} | Specific Heat of Material XX |

For the case when the fan is on, an exponential model is used to describe the heat transfer to the air moving from the inlet of the heater and cooler to the outlet (Equations 2 and 3). Further, Equation 4 accounts for thermal losses associated with the HVAC unit. The differential equation for the heater and cooler temperatures are given by Equation 5. The adjusted thermal input to the units ($Q_{hout/cout}$) takes the variation of thermal efficiency with temperature into account and is calculated using the method outlined in *Methodology for Hourly Simulation of Residential HVAC Equipment* (Huizenga and Barnaby 1984). Finally, a perfect, instantaneous mixing process provides the mode for convective heat transfer between the supply air and the indoor air (Equation 6).

$$Q_{h2in/c2in} = k_1(T_{hm/cm} - T_{air})(1 + k_3[e^{\frac{-1}{k_3}} - 1]) \quad (2)$$

$$T_{h\text{sup}/c\text{sup}} = T_{air} + (T_{hm/cm} - T_{air})(1 + e^{\frac{-1}{k_3}}) \quad (3)$$

$$Q_{h\text{loss}/c\text{loss}} = k_2(T_{hm/cm} - T_{amb}) \quad (4)$$

$$T_{hm/cm}^{\&} = \frac{Q_{hout/cout} - Q_{h\text{loss}/c\text{loss}} - Q_{h2in/c2in}}{c_{ph/pc}m_{h/c}} \quad (5)$$

$$q_{h/c} = \frac{V_{h/c}}{m_{air}}(T_{h\text{sup}/c\text{sup}} - T_{air}) \quad (6)$$

External walls exchange heat through conduction with the indoor air and outdoor air (Equations 7, 8, and 9).

$$Q_{xw2air} = k_4(T_{air} - T_{xw}) \quad (7)$$

$$Q_{xw2out} = k_4(T_{out} - T_{xw}) \quad (8)$$

$$T_{xw}^{\&} = \frac{Q_{wx2out} + Q_{wx2air}}{c_{pxw}m_{xw}} \quad (9)$$

In the model, the internal wall elements are simply used to represent the thermal storage of anything solid inside the house – furniture, floors, walls, etc. Equations 10 and 11 illustrate the conduction between the indoor air and the internal walls.

$$Q_{iw2air} = k_4(T_{air} - T_{iw}) \quad (10)$$

$$T_{iw}^{\&} = \frac{Q_{iw2air}}{c_{piw}m_{iw}} \quad (11)$$

Windows allow a great deal of heat transfer in the forms of conduction and radiation that is very important to model. Solar radiation becomes very powerful later in the afternoon when the sun strikes the windows more directly, causing more heat input than the outdoor temperature would predict. Windows also have higher thermal conductivity than walls, and therefore allow much more conduction. Equations 12 and 13 were derived directly from the *ASHRAE Fundamental Handbook* (ASHRAE 2001), which elucidates methods of accounting for heat transfer through windows. The variable C_{di} changes with the time and date to account for different solar conditions throughout the year, and it is also computed in accordance with the *ASHRAE Fundamental Handbook* (ASHRAE 2001).

$$Q_{winrad} = \frac{1}{3600} A_{win} C_{di} C_{LAC} \quad (12)$$

$$Q_{wincon} = \frac{1}{3600} A_{win} C_w (T_{out} - T_{air}) \quad (13)$$

Infiltration is the process of unconditioned outside air leaking into the house. The leaks often occur around windows and doors, and as the insulation level of homes has increased the leaks have correspondingly decreased. The convective model shown in Equation 14 accounts for the infiltration.

$$q_{inf} = \frac{V_{inf}}{m_{air}} (T_{out} - T_{air}) \quad (14)$$

Internal heat sources constitute the final input. Household objects that produce heat, usually as a by-product, constitute the internal heat sources modeled using Q_{int} . A few examples are lights, refrigerators, and computers. The computation of indoor air temperature couples all of the states together with the inputs through the windows and internal gains (Equation 15).

$$T_{air}^{\&} = q_{h2air} + q_{c2air} + q_{inf} + \frac{Q_{int} - Q_{iw2air} - Q_{xw2air}}{c_{pair} m_{air}} \quad (15)$$

9.4. Phase 2 Proof-of-Concept

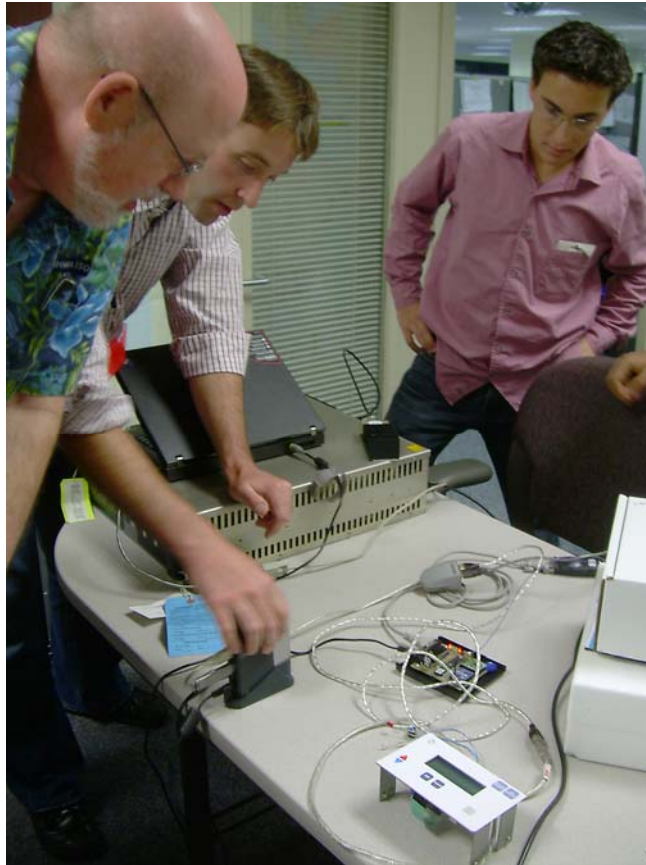

Figure 9.13. Phase 2 proof-of-concept being demonstrated at the California ISO. Seen in the photo are the human-machine interface (lower right-hand side of table), the RDS receiver (directly above HMI in photo), and PCT proof-of-concept computing platform (in hand on left). From left to right: Walt Johnson – CAISO; William Burke - UC Berkeley; Alejandro Sardi – CAISO consultant.

The PCT proof-of-concept was updated in Phase 2 to provide a more convincing argument that the minimum functionality PCT concept was feasible by integrating electronics components closer to those presented in the bill of materials in Appendix A. The top priority was to update the communication interface by integrating an RDS receiver chip that was an actual candidate for a PCT receiver. As part of this process, the team developed a test protocol for DR over RDS that used an updated information model.

Because the investor-owned utilities are primarily interested two-way communication to the PCT, a 2.4 GHz IEEE802.15.4 two-way radio was connected to the POC via the expansion interface to show that the interface could be used for that purpose. The team demonstrated the functionality of a Title 24 requirement that the one-way interface should be disabled if a two-way connection is present. The team also demonstrated that the POC could also switch back to the one-way system if the two-way network was unavailable. Unfortunately, the two-way radio functionality was not presented in a public demonstration because the team had originally integrated the two-way radio for the Phase 1 communication protocol & information model and decided to focus resources on demonstrating RDS (and the new information model) in the final months of the project. This was considered acceptable because at least two

thermostat manufacturers were known to have two-way wireless communication supported in communicating thermostats, one of which has initiated development efforts to release a product supporting two-way communication through a plug-in module in advance of the Title 24 effective date.

Finally, the core system of the POC was moved to a simpler, less expensive, and lower-power computing platform to provide a stronger proof-of-concept. A particular success of the Phase 1 proof-of-concept was that the PCT software was easily transported to run on the updated computing platform with the assistance of the proper compiler. Figure 9.13 shows a photo of the Phase 2 proof-of-concept being demonstrated during installation at the California ISO.

The following sections discuss, in order, the RDS communication interface, the two-way communication interface, and the updated computing platform.

9.4.1. RDS Communication Interface

The team had to develop a complete end-to-end communication system to demonstrate an RDS-capable PCT. To broadcast DR messages, the team leased a commercial-grade radio transmitter and wrote software to interface the transmitter. To receive the messages, a RDS receiver was developed and interfaced with the PCT. Finally, an updated PCT information model and a demonstration protocol for communicating over the RDS medium was implemented. The team tested the entire communication system by sending various demand response messages and validating them upon receipt. The team successfully transmitted DR data to the proof-of-concept, which responded to the messages as intended. This RDS demonstration was installed in a demonstration room highlighting California Demand Response technologies to various audiences at the California ISO in July 2007.

The components of the communication system are explained in greater detail in the following subsections.

Transmitter

The team used a Nautel M50 radio exciter with RDS encoding capability to broadcast DR messages over RDS. Software that runs on a Linux PC was written to communicate with the transmitter over the *universal encoder communication protocol*, or UECP. The software presents a demonstration operator with a menu-driven text interface to create a DR event message. The software then formats and sends the message to the M50 for encoding and transmission.

Receiver

To add RDS reception to the POC, the team used a custom-built RDS receiver unit that extracts DR message data from an FM transmission and relays the message to the POC over RS-232. A full description of this unit is presented in Appendix D, *RDS Receiver*. The RDS functionality of the receiver was tested and validated by successfully receiving radio station and song title information from local commercial radio stations. The team wrote custom code for the receiver that extracted demand response information from messages sent using the demonstration protocol.

Information Model

The demonstration protocol in Phase 2 was created to implement the PCT communication interface information model specified in the PCT Reference Design. Improvements over the information model from Phase 1 included the addition of a hierarchical addressing structure, more precise timing variables, and additional DR functions. Reliability events were modified to support specification of the relative setpoint change, or offset, or absolute setpoint change in the DR message. Economic events were updated to support three different pricing structures – price tiers (e.g. low/medium/high), absolute price (e.g. \$/kWh), and price ratio relative to the base rate (e.g. 200%). Appendix E, *RDS Demo Protocol and Transmitter*, explains the explicit details of the Phase 2 DR message format and protocol.

9.4.2. Two-Way Communication Interface

A 2.4 GHz IEEE802.15.4 radio product was chosen to demonstrate two-way communication because IEEE802.15.4 is commonly used in low-power wireless networking and is the underlying physical layer used in Zigbee wireless networks. The team used a MaxStream® XBee PRO™ because it offered a transparent serial communication mode over RS-232 that allowed it to work as a drop-in replacement to the Phase 1 radio link; the sending computer would use an XBee PRO to convert serial data received over the RS-232 port into a 2.4 GHz radio signal and vice versa on the receiving end. Using the Phase 1 communication protocol the team was able to receive DR messages on the POC and return acknowledgements of message receipt to the sender.

Switching Communication Interfaces

It is expected that Title 24 will require a PCT to defer to any utility-specific communication module inserted into the expansion port and ignore communication from the embedded one-way interface; however, if the utility network is unavailable for any reason, the PCT shall resume monitoring of the one-way interface. The team's objective was to demonstrate this functionality in the proof-of-concept.

Adding the logic necessary for switching communications interfaces required a good state machine and quite a bit of testing. Figure 9.14 shows the three states of PCT communication and the transition logic used to switch between the radios. The one-way and two-way radios were both connected to the POC and identified by their COM port ID's. The team did not go so far as to implement a heartbeat system or other method of determining network connectivity, so internal data flags were used to indicate to the POC the connection status of each radio during testing. The testing verified that the POC was in the proper radio state depending on the defined connection status of each radio.

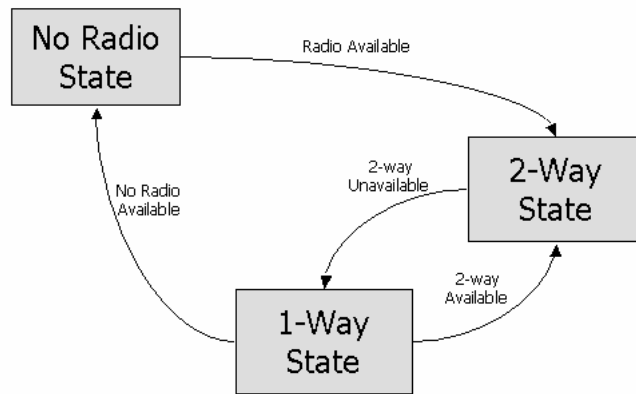

Figure 9.14. Radio Switching

9.4.3. NSLU2 Host Platform

The Linksys NSLU2 is a small (about 140 x 90 x 30mm) network attached storage device, affectionately referred to as the “Slug”, that runs a proprietary version of the Linux operating system. NSLU2’s cost less than \$100 and use an Intel/Marvell XScale® IXP400 processor. The IXP400 is very similar the PXA270 used in the Colibri, making it a perfect platform for the updated proof-of-concept.

Because the Slug was originally designed as a simple consumer device to host network attached storage, the only computer hardware interfaces installed on the device are RJ-45 jacks for TCP/IP and USB ports for connecting storage devices. Because the Slug only has two USB ports, and one is dedicated to flash memory for storage of system code, a USB hub is needed for the USB thumb drive (for PCT audit logs), USB-to-RS232 serial adapters (for the radio communication devices), and the Matrix Orbital display.

A community of hobbyists has devised ways of installing open versions of Linux in place of the proprietary version. The PCT-Slug uses the OpenSlug variant of Linux that is easily installed using the instructions in Appendix F, *PCT Slug Setup*. As mentioned previously, the PCT software was able to run on the Slug once it had been recompiled with the proper compiler.

9.5. Conclusions

The team concludes that the PCT proof-of-concept successfully demonstrated the feasibility of the minimum functionality PCT concept presented by the team. The demonstration given to the Energy Commission and PCT stakeholders on April 19, 2006 showed that a radio broadcast system could be used to send demand response data to PCT’s and that PCT’s could respond to the messages with temperature setpoint changes. The prototyped human-machine interface indicated demand response event information to the audience and allowed temperature overrides where appropriate. The DB-9 connector was shown as a viable means of connecting a PCT with an HVAC system. The team demonstrated that the expansion port could be used to return audit data to the utility in absence of two-way communication. Finally, the proof-of-

concept incorporated most of the functionality of a standard programmable thermostat, adding to its credibility.

In Phase 2 of the project, proof-of-concept was updated to better demonstrate that the technologies presented by the team in the minimum-functionality PCT concept were feasible. The team demonstrated one-way communication of demand response messages using actual RDS technology and a receiver that could actually be installed in a PCT. The team showed that the expansion interface could be used to support two-way radio communication, and that a PCT could use the proper radio interface, dependent on the network connection status of the two-way network. The proof-of-concept successfully worked as a system interface testbed, since several new technologies were used with the proof-of-concept and the information model for demand response communication was updated. Finally, a less expensive prototype platform was used, showing that a low-cost consumer product could run PCT software and perform the duties outlined in the minimum functionality PCT concept.

10.0 RDS Site Survey Tool

10.1. Background

As a result of revisions to California's Title 24 residential building code, it is envisioned that within the next few years nearly all residential thermostats installed in the state will contain an embedded radio receiver which can receive and decode messages from the electrical utility. These *programmable communicating thermostats* (PCT's) can be used to provide *demand response* during critical periods of high electricity demand by reducing air conditioning load and thereby preempting the need for rolling blackouts. This low-cost, universal, statewide one-way communication system has been intended as an interim solution for emergency demand response while utility communications systems using advanced metering infrastructures and home-area networks eventually become the norm – and also could serve as a backup system to those utility communications systems.

In 2006 the UC Berkeley research team identified RDS, also referred to in the United States as RBDS, as a candidate technology for the statewide standard. The technology uses a subcarrier of commercial and educational FM radio to transmit digital data, leveraging an existing, expansive, and robust transmission infrastructure. Following a general technical review and proof-of-concept testing, the team made a recommendation to the Energy Commission that research and development efforts of the statewide communication system should be focused on RDS as the most appropriate solution of those that the team reviewed. The general feasibility of RDS for this goal has already been demonstrated by the existing commercial application of consumer GPS-navigation systems that receive real-time traffic information from commercial FM stations in several US markets.¹⁷ While the technology has been used extensively in automotive applications in Europe for two decades, little evaluation of its performance within residential building environments exists for applications in consumer devices.

For the RDS technology to work as a universal statewide communication system, the transmitting network, PCT receivers, and communication protocol all need to be properly designed to ensure universal, reliable end-to-end communication of demand response data. An unknown number of commercial radio stations will need to be contracted to provide adequate coverage to residences across the state. Thermostat manufacturers will need to become familiar with the technology and understand what factors may affect reception performance within the home. A low-cost tool to measure RDS reception data can support these objectives by providing insight into the real-world performance of RDS in residential environments.

10.2. Objective

The team developed a measurement system to survey the performance of RDS technology in residential environments. The overall system concept is to deploy a set of FM receivers, at

¹⁷ The NAVTEQ Traffic™ system sends location-embedded data about highway traffic conditions using RDS to consumer devices such as the Cobra Portable Mobile Navigation System and automobiles such as the Mercedes S-Class vehicles.

various locations within a residence, operating as “RDS sensors” that can collect reception statistics. The primary inspiration for the system design came when the team discovered that newer FM receiver microchips, with integrated RDS decoding capability, offered digital chip-to-chip communication interfaces such as I²C and SPI. A host device could use this type of interface to query the receiver chip for data such as radio signal strength, received RDS “packets,” and any decoding errors registered. Because of the team’s prior background in wireless sensor network applications, the team immediately thought to couple an RDS receiver chip with a microcontroller unit (MCU) and a wireless data link to form a “wireless RDS sensor.” The microcontroller is used to manage the FM receiver and collect data samples, and the wireless link is used to transmit the data samples back to a central computer database. Each wireless sensor unit is low enough in cost that a number of them could easily be placed in a residence to collect data. This concept of a rapidly deployable wireless sensor network has become a popular approach to monitoring environmental conditions in a variety of research areas.

10.3. System Architecture and Components

A diagram of the field kit is shown in Figure 10.1. The kit consists of a collection of radio data loggers and a single laptop hosting control software and a local database.

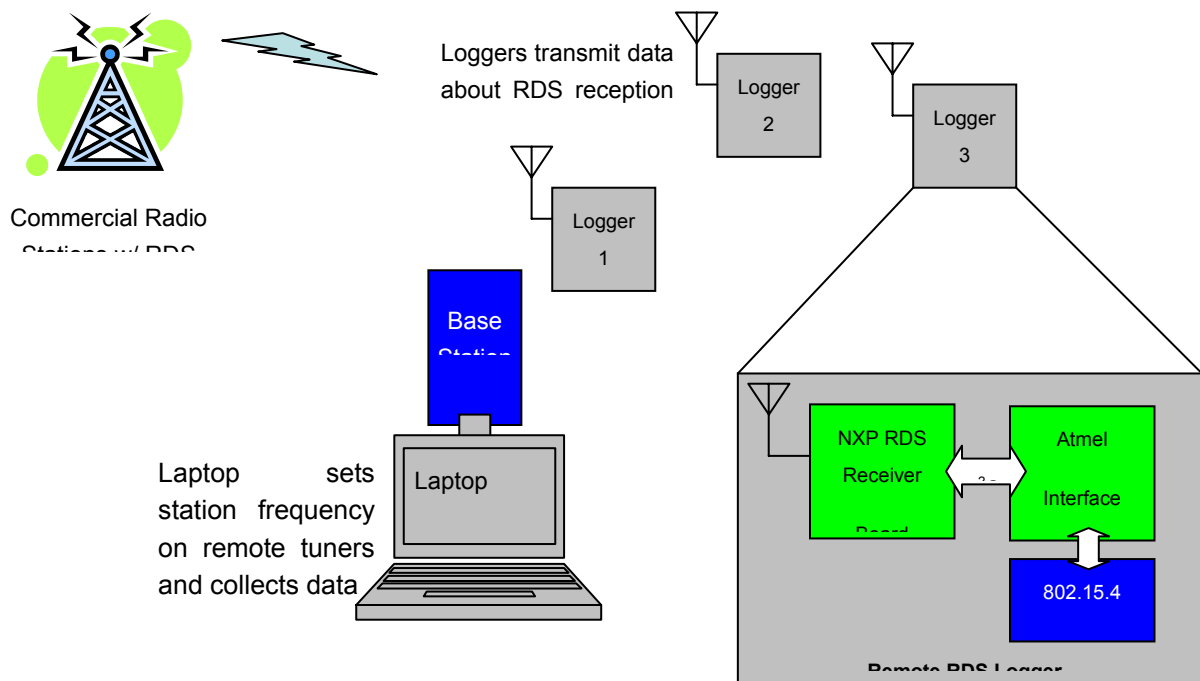

Figure 10.1. RDS Field Kit Diagram

Each logger acts as an independent sensor consisting of an FM receiver, a microcontroller host, and a wireless link back to the laptop. The laptop runs control and monitoring software that coordinates the loggers and records data. Using the wireless link, a tuning command is sent to all loggers with a specified FM frequency. Each logger tunes to the specified station and reports

reception statistics back to the laptop over the wireless link until instructed with a new command. In this manner, all of the sensors are synchronized to observe the same frequency for the same time period to provide a cross-sectional view of the site under study. A more detailed discussion of each component of the field kit is presented in the following three sections.

10.3.1. RDS Data Logger

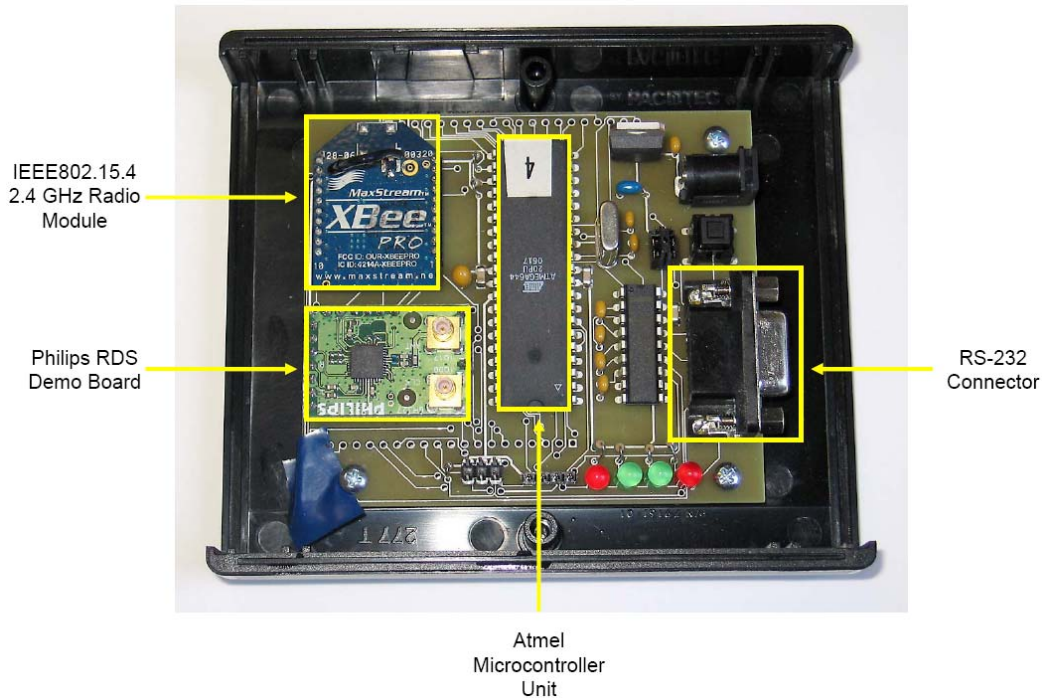

Figure 10.2. Components of RDS Data Logger

Figure 10.2 shows the layout and components of the RDS data logger. The key component to the data logger is the NXP (formerly Philips) GH327 board. The board is a reference implementation of their TEA5764HN chip – an integrated FM tuner, receiver, and RDS decoder – that was designed for demonstration and evaluation purposes. The TEA5764HN is particularly useful for this study because its I²C interface allows a variety of performance statistics to be collected by a microcontroller host. The team used the TEA5764HN for this study because it is a low-cost, low-power use chip that is an actual candidate to be used in a PCT. In addition, the GH327 board offers a standard implementation of the receiver that could be used by any party to reproduce results and normalize variations in RF sensitivity that can occur between different receiver circuit implementations.

The GH327 board has a standard SMB connector for a radio antenna. The connector allows the use of different types of antennas, such as ¼-wave wire antennas and FM dipoles. One weakness of using this pre-designed implementation is that only a single-ended antenna input is available on the GH327 board even though the receiver chipset supports a differential input.

An Atmel® 644 MCU is used to manage the TEA5764HN chip and RDS data. With a standard C-based programming interface, the Atmel is a relatively simple I²C solution to managing the

TEA5764HN. Using I²C bus registers, various reception statistics are requested from the TEA5764HN and read by the Atmel. The data collected by the Atmel is aggregated into periodic data samples which are communicated through the UART interface of the Atmel to an external serial device. The data logger was designed so that the UART could be interfaced through an RS-232 serial connector on the board or through a wireless link hosting a transparent serial connection. The wireless link is explained in detail in the next section.

Since the data logger is a single physical unit, the terms “receiver” and “data logger” will be used interchangeably for the remainder of this document to refer to the data logger device. References to the actual receiver component will use “TEA5764HN.”

10.3.2. Wireless Link

Wireless sensors have been an incredible enabling technology for instrumentation in scientific and industrial monitoring – but with any nascent technology, the experience of early adopters has been less than easy. To avoid steep learning curves and unforeseen development difficulties, it was important to select a wireless networking solution that natively handled networking and transport layer mechanisms without any embedded programming requirements. For this reason, the team selected the MaxStream® Xbee PRO™ radio as a good solution. The Xbee PRO radio is a 2.4 GHz module compliant with the IEEE802.15.4 standard. Its advantage as a wireless solution is that it offers a fully transparent serial communication mode between two hosts, natively handling routing, error detection, and error correction in firmware. The MaxStream product allowed the team to avoid embedded software development for radio communication and network management, such as programming in the TinyOS platform, which can be time-intensive. The Xbee PRO modules also allow for variable power settings between 1 mW and 100 mW; at 100 mW the manufacturer estimates that the module can transmit up to 100 m indoors and 1 mile outdoor line-of-sight.

Within the field kit, the MaxStream modules are configured in a transparent serial mode with point-to-multipoint layout (base station to loggers). Commands in the form of serial communication data sent from the laptop are received by all of the data loggers, and data sent back is received by the laptop as a serial data stream. Because the data samples sent back from the loggers are so small relative to the data rate supported by the XBee modules, it is very difficult to cause interleaving of data at the base station. Interleaving of data would cause data transmitted by one data logger to be corrupted by transmissions of another data logger. Tests conducted by the team verified that interleaving did not occur for 6 units transmitting data. The group believes that in this application there will never enough data loggers at a given test site to cause problems at the base station.

10.3.3. Laptop

Running on the PC laptop is the central control software written in Java. The team used Java so that the software could be easily ported to other devices, such as an embedded Linux platform. The control software allows the experimenter to set parameters such as a central list of FM frequencies to scan. The stream of serial data received from each of the loggers is validated and recorded into a local MySQL database running on the laptop. MySQL was used because it is an open-source database compatible with a variety of standard tools for statistical analysis. With

an Internet connection at the premises under study, the data could also be instantly uploaded to a master database elsewhere. The laptop also runs a Virtual Network Computing (VNC) software that, when coupled with an Internet connection, allows remote control and monitoring of the system.

10.3.4. Approximate System Cost

The field kit was designed with as many off-the-shelf components as possible so that any party could build their own set. Table 10.1 presents a summary of the approximate cost of a single field kit. The data logger consists of a main circuit board, the GH327 receiver board, an Xbee PRO unit, a 5VDC power supply and an enclosure. The Xbee PRO, power supply, and enclosure are standard components that can easily be purchased off-the-shelf. The main circuit board was custom designed with ease of prototyping and standard parts in mind. The approximate bill of materials cost for the main PCB was \$35 at a very low volume (10 pieces). The GH327 is not a standard product and was contract-built from gerber files (PCB layout) and a BOM list, provided by NXP, by the team for approximately \$60 per part at a very low volume. At higher volumes, the PCB assembly costs for both the main PCB and the GH327 can be reduced. The team also used a laptop for ease of operation, but, as mentioned previously, an embedded single-board computer such as a Linksys NSLU2 costing around \$100 can also be used.

Overall, the system cost for a single field kit (6 data loggers) was less than \$1500 and could easily be reduced. The team intends to make the hardware designs and software code available so that any member of the PCT stakeholder community will be able to implement this tool on their own. For more information about the field kit, please reference the research team’s website at <http://pct.berkeley.edu>.

Table 10.1. Summary of Field Kit Cost

| Component | Cost |
|---|-------------------|
| Data Logger: | |
| • Main PCB | \$35 |
| • GH327 | \$60 |
| • Xbee PRO (list price) | \$32 |
| • Power supply | \$5 |
| • Enclosure | \$7 |
| | \$150 |
| Laptop | \$500 |
| Single Field Kit: 6 loggers, 1 laptop, antennas, and miscellaneous hardware | <\$1500 |

10.4. Key Questions

The value of this measurement tool is that it can collect statistical data about the *actual performance* of RDS reception characteristics in residential environments. This data can be used to address a number of questions that will need to be answered as part of building the statewide

RDS demand response network. Here are examples of some key questions and how the tool can be used to help address them:

- **How many transmitting stations (and of what character) are required to support a given service area?**

The team will demonstrate, later in this document, that a single FM station may not be adequate to support a given service area. Knowing that multiple stations may be needed, data obtained from field kit installations can empirically determine the specific number required for a given area. A more refined approach can be taken by combining FM transmission expertise and existing propagation models with data collected from the study to help plan the transmitters needed to provide statewide coverage.

- **Does the location of a receiver within a given site (e.g., upstairs, downstairs, outside) affect the ability to receive a signal?**

The team will also show that the location of a receiver affects signal reliability by presenting data from several data loggers installed in a test residence. More substantial testing and statistical analysis may be used to obtain insight into this phenomenon.

- **How does the type, location, and orientation of a receiving antenna affect performance?**

Preliminary testing suggests that the antenna type and orientation affect reliability. The RDS measurement tool can support PCT manufacturers by providing a platform for evaluating antenna designs and finely testing the effects of antenna/receiver placement within the home.

- **Will redundant data transmission be required in the communication protocol?**

Information about general RDS data loss characteristics from a substantial field test can be analyzed to assist development of the PCT communication protocol. With this information, the appropriate level of robustness and redundancy can be designed into the demand response communication protocol.

In addition to supporting the initial communication network design, this RDS measurement system will be able to provide continued real-time monitoring from any residential location. This monitoring can be useful during system build out and to assist with ongoing maintenance of the one-way network.

10.5. Proposed Methods

10.5.1. Overview of Procedure

The field kit can be used to evaluate the performance of RDS in situ by collecting data from commercial and educational FM stations that are currently enabled with RDS. FM stations that have RDS capabilities send data blocks, the elemental data units of the transmission protocol, 100% of the time over the air regardless of whether or not actual payload data is being transmitted. Data statistics, such as block counting and error counting, can be collected from this constant stream. With a significant number of data samples, any number of statistical procedures can be performed to test various hypotheses and develop predictive models.

A database that contains information about the receivers, site, and FM transmitters in addition to the sample data can be used to test statistical hypotheses about factors which affect reception and reliability. The advantage of a database such as MySQL is that queries can be performed to generate specific data subsets for analysis. Statistical analysis tools such as the “R” software can be used to test statistical hypotheses and generate regression models to identify key factors that are likely have an effect on overall reliability.

The team suggests that the “group receive rate,” explained in further detail in the following subsection, should be used as the primary output variable under study. Factors that are suspected to have an effect on reliability can be tested against group receive rate statistics in controlled data subsets. The team has identified a number of variables that may be considered for study. The variables are categorized as properties of a specific transmitter, site, or receiver. The sample data and transmitter, site, and receiver variables are explained in the remainder of Section 10.5.

10.5.2. Sample Data

Once the data loggers receive a tuning command¹⁸ they begin to sample RDS data from the specified FM station. The sample data collected from the data loggers for storage in the database consists of the following fields:

- **NodeID**
This is a unique identification number identifying a specific physical state of a single data logger. If *any* physical modification is made to the receiver, such as a change in placement, antenna type, antenna orientation, or elevation, then a new NodeID is used. This allows for control of variables when testing statistical hypotheses.
- **Frequency**
This is the radio frequency of the station the receiver is listening to and is used as an identifier to uniquely identify a specific FM transmitter. In the highly improbable case that a receiver did not receive a new station-tuning command and becomes unsynchronized with the other receivers, the data it reports can still be analyzed or filtered out as is appropriate.
- **Signal Strength**
The TEA6764HN measures the voltage of the RF input signal using a 4-bit number, indicated as a value from 0 to 15. A single instantaneous reading of this value is used for each data sample. The ADC curve for the voltage measurement is presented in the TEA5764HN Product Datasheet (NXP 2005), as shown in Figure 10.3. The signal strength measurement can be used to approximate the electric field strength at the receiving site though instrument calibration tests. The electric field strength is a general indicator of signal strength at a given site, and is not dependent on receiver-specific

¹⁸ During the tuning command, the receivers delay for one second before beginning data collection to allow for the receiver to stabilize following a frequency change.

factors such as sensitivity and antenna gain. Electric field strength is commonly used by RF propagation models to predict the probability of signal reception.

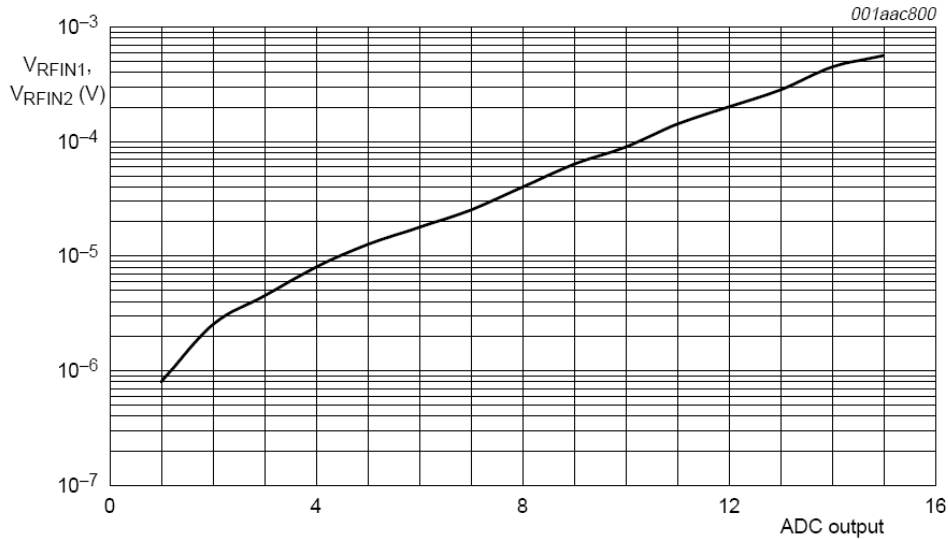

Figure 10.3. Signal Strength ADC conversion levels. Source: TEA5764HN Product Datasheet.

- **Received Blocks**

The Atmel chip can count the number of RDS blocks the TEA5764HN receives by monitoring the I²C registers. The theoretical ideal block reception rate is 45.673 blocks per second.

- **Invalid (Unidentifiable) Blocks**

There are six classes of RDS blocks, "A," "B," "C," "C'," "D," and "E." If the block contains an unrecoverable error and cannot be decoded, its class usually cannot be identified by the TEA5764HN. This data field counts the number of blocks per sample which cannot be identified.

- **Block Errors**

The RDS protocol has a built-in error detection and correction scheme using extra checkword data embedded in each block. Error corrections for **2-bit** errors and **5-bit** errors are counted per sample, in addition to those errors that are considered **unrecoverable**.

- **Valid Groups per Sample**

RDS blocks are sequenced in groups of four to contain a useable data-bearing unit known as a "group." A properly formed group must consist of a specific sequence of block types (A -> B -> C/C' -> D). The Atmel counts groups that are highly likely to be valid by counting the number of proper block type sequences that are formed within a sample. The theoretical ideal group reception rate is 11.418 groups per second. **Because proper decoding of payload data requires successful group reception, the percentage of valid groups per sample is the most important statistic to use as a measure of success and reliability.**

When the data is received by the laptop, two additional parameters are recorded into the database for each sample:

- **SiteID**
This is an identification number used for each site in the study. A site is considered a physical premises, such as a housing property or apartment complex. Each site has exactly one PC or embedded system collecting the data. With this field, a master database can be queried easily for data from all or particular sites under study. The SiteID is considered globally unique, and the combination of SiteID and NodeID makes each receiver globally unique.
- **Timestamp**
The data event is stamped as it is received with date and time. This is optimal so that the data loggers don't require any type of clock or synchronization. Synchronization of data between multiple sites can be obtained if the control PC's are using the same time server for Internet-based synchronization.

Two parameters of data collection configuration have an impact on the type of analysis that can be performed: sample time and hoptime. Together, the sample time and hoptime affect the time scales of variant behavior that can be observed.

Sample Time

The sample time is defined as the length during which discrete data events (blocks and groups) are counted by the logger. It is expected that with fading and interference, time-based variation of data will be apparent between samples. The sample time should be small enough to capture these variations. However, if the sample time is too small, then issues with edge effects and significant figures begin to occur within the sample. A sample time of 10 seconds was found to have a reasonable balance between mitigating the edge effects of counting (a group takes roughly a tenth of a second to receive) and capturing short term fading variations.

Hoptime

The hoptime is defined as the amount of time that receivers are tuned to a given frequency before switching to another station. The hoptime not only determines the number of data samples which can be observed during an interval, but also determines the amount of time before the data loggers can return to a given frequency. An appropriate hoptime setting depends on the number of stations under study. For example, if 20 to 25 stations are being monitored, a 10-minute polling interval means that 60 data samples for a given station can be collected in intervals approximately every 4 hours. A longer hoptime will provide more samples per interval, but will also increase the cycle time before a particular station is monitored again. Experimentation with different hoptime values is recommended to balance the number of samples in an interval against cycle time.

10.5.3. Transmitter Variables

Each FM transmitter has unique properties that may affect received performance. The Federal Communications Commission (FCC) maintains a database of information about every commercial and educational FM transmitter in the country, since this type of broadcast

communication is regulated. The FCC's FM Query¹⁹, a method to access the FCC's Consolidated Database System (CDBS) through an Internet browser, can be used to obtain most of the data needed for a statistical study. Within the RDS statistics database, the frequency of a transmitting station can be used to reference a data table containing information about each of the FM transmitters against the sample data.

A list of transmitter properties that may affect RDS reception includes:

- **Effective Radiated Power (ERP)**

The effective radiated power is the estimated power (in kW) of energy converted to electromagnetic radiation. In a theoretical case in free space with an isotropic radiator, the electric field strength at a given distance from the transmitting antenna is proportional to the square root of the ERP divided by the distance. In practical application, the directional lobes of the transmitting antenna, terrain properties, interference, and obstructions will affect this relationship.

- **RDS Injection**

RDS injection is the signal level relative to the main carrier. Because RDS is a subcarrier, its signal level must be balanced against all the information transmitted within a single station's bandwidth. This parameter trades off reliability of the signal versus perceived distortion in the audio signal or interference with any other subcarriers. Higher injection levels will increase the probability of receiving the RDS signal correctly. Typical values for transmitters are 3 - 4%, though some broadcasters are known to inject as low as 1.5% and as high as 10%. It should be noted that RDS injection levels are not registered with the FCC so this information must be directly obtained from the station operator.

- **Height of Antenna Above Average Terrain (HAAT)**

In 1975 the FCC introduced a "terrain roughness" unit in their propagation models which accounted for the effects of terrain topography between a transmitter and receiver, but discontinued the practice because of inconsistency in results. The FCC now uses a modified elevation metric that accounts for terrain factors in their propagation models to predict coverage. The FCC describes the height above average terrain on their website²⁰:

"The HAAT value represents an average of the terrain elevations within 16 km (10 miles) of the transmitter site, and so provides a single value on which general coverage calculations and regulatory requirements (such as station classes) may be based."

- **Height of Antenna Above Mean Sea Level (AMSL) and Height of Antenna Above Ground Level (AGL)**

AMSL and AGL are also reported in the FCC's database, though they are not commonly

¹⁹ FM Query is available online at <http://www.fcc.gov/mb/audio/fmq.html>.

²⁰ The FCC describes calculation of HAAT and offers an online calculator at the following webpage: http://www.fcc.gov/mb/audio/bickel/haat_calculator.html

used in propagation models. These data may still be useful for statistical analysis. A transmitter's AMSL can be used to calculate a figure such as net elevation difference between the transmitting antenna and the receiving site, which may affect the reception performance.

10.5.4. Site Variables

A *site* is defined as physical premises such as a house or multi-unit dwelling.

- **Distance from each transmitting antenna to the site**
Distance is expected to be a highly influential factor in performance. As mentioned previously, the ERP and distance theoretically determine the field strength at a receiving site. FM Query provides data about the latitude and longitude of the transmitting antenna. Multiple mapping software programs can calculate the distance between the transmitting antenna and site using latitude and longitude data.
- **Horizontal angle of transmission from transmitting antenna to site**
The horizontal angle of transmission is a vector drawn from the transmitting antenna to the site. It is measured clockwise with 0 degrees at true north and is important for transmitting antennas which use directional radiation patterns. FM Query can provide information about the relative (normalized) field strength of the antenna along 10° radials from 0° to 350° when broadcasters submit such specifications to the FCC. However, when stations do not submit relative field strength plots the FCC assumes the antenna produces an omni-directional radiation pattern. The horizontal angle of transmission relative to true north can be estimated using maps or mapping software.
- **Net elevation change from transmitting antenna to site**
Topographic information, available from US Geological Service maps or topographic mapping software such as Topo™, can be used to calculate the net elevation change using contour data and the coordinates of the transmitter and receiver sites. This metric may be a factor on performance under specific terrain conditions.
- **Near Booster Station**
FM boosters are a special type of broadcast translator that relay the signal from a parent station to extend the coverage area. While most translators re-broadcast on a separate frequency that is near the original frequency, boosters re-broadcast on the same frequency. This presents two challenging aspects when analyzing the data. First, even though boosters can be synchronized to the original broadcast, multi-path interference issues can result. Secondly, the protected service area of the booster must reside *within* the service area of the primary transmitter, creating a challenge in using propagation or regression models for performance. The FCC database can be checked to determine if a receiving site is within or near the noise-limited contour (approximate service area) of any booster stations for a given frequency. This parameter can be tested in statistical analysis to see if it affects performance and alters regression models.

10.5.5. Receiver Variables

Within each *site* a number of independent receivers are placed. The general factors that are important for each receiver have to do with location and antenna type.

- **Location within site**

Materials within homes can affect radio communication by attenuating or reflecting radio waves. Information can be collected through generalized observation about placement of each receiver relative to housing features, such as building materials, exterior and interior walls, refrigerators, chimneys, and basements.

- **Antenna type**

The type of antenna will affect the antenna gain and performance. Antennas that were tested included monopole, dipole, Yagi, patch, and coil antennas.

- **Antenna orientation**

Directional antennas, such as dipole or Yagi antennas, will have increased gain in some directions and decreased gain in other directions. The compass orientation of any directional antenna tested should be noted.

10.6. Preliminary Testing and Results

To ensure that the developed field kit would be a viable measurement tool, the team installed a set of 6 data loggers and one laptop at a house in the hills of the East Bay area of Northern California. The house provided a good proving ground, since FM reception in this hilly region was known by the resident to be spotty. Data was collected over a 10-day period to see if the system, as designed, could support field monitoring of RDS data.

10.6.1. Installation

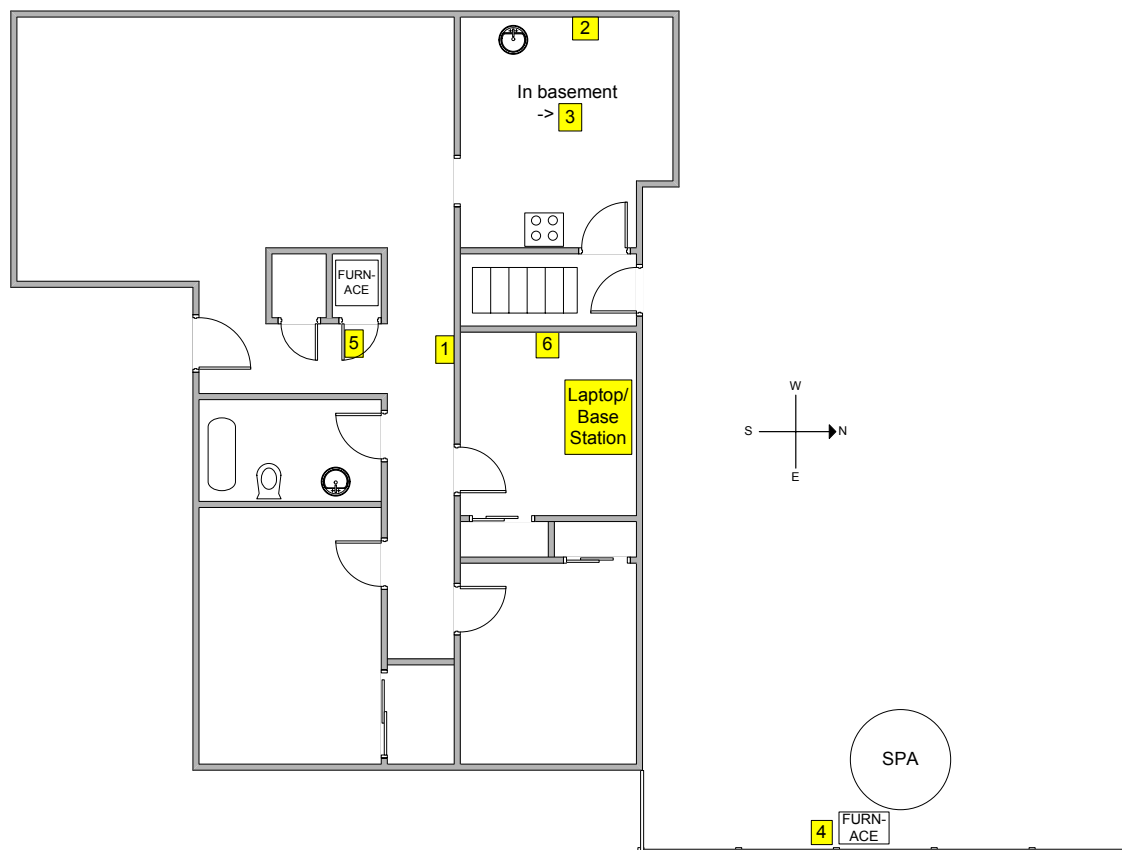

Figure 10.4. Diagram of data logger location within test house

The field kit was installed in a ~1000 sq. ft. home, made from wood frame construction with stucco exterior. The laptop was connected to the Internet connection on site, allowing remote control and monitoring through the VNC connection. Figure 10.4 shows the locations of the data loggers and laptop within the home. The laptop and wireless base station were placed in a room near the center of the home. A data logger was installed at the site of the existing thermostat in the hallway (1), in the kitchen near the microwave (2), in the basement near the washer and dryer (3), outside next to the furnace for the spa (4), in a closet next to the natural gas furnace (5), and in the office near the home computer (6). Figure 10.5 shows photographs of the data loggers at the thermostat and washing machine. The data logger at the spa was farthest from the base station, approximately 25 feet away and with one exterior wall between it and the base station. The other data loggers were between 5 and 15 feet from the base station, most of which had two interior walls between them and the base station.

Table 10.2. Data loss percentage from each node on 12/11/2006 and 12/12/2006

| Node (appliance/room) | % Data Loss |
|------------------------------|--------------------|
| Thermostat/Hallway | 0.26 |
| Microwave/Kitchen | 0.48 |
| Washer/Basement | 0.34 |
| Spa Furnace/Outside | 0.50 |
| Furnace/Closet | 0.22 |
| Computer/Office | 0.38 |

10.6.3. Hardware

The test installation proved that the mechanical and electrical design of the system was appropriate. Data loggers that were installed indoors and outdoors continued to work throughout the testing and did not malfunction. A re-closeable plastic bag successfully protected the outdoor data logger from drizzle that was encountered on one of the test days. The indoor loggers were wall-mounted with foam mounting strips with releasable adhesive that left no permanent adhesives on the walls. The antennas of the receivers were easily changed using the appropriate SMB adapters during the test. The only unforeseen challenge in hardware was finding a way to mount the dipole antennas that did not leave permanent markings or pinholes in the walls, since the plastic material on the antennas did not adhere well to the foam strips. This was simply overcome by using extra strips, though in the future it may be possible to glue an intermediate piece of firm plastic to the antenna plastic and then affix the foam to the intermediate layer.

10.6.4. Software

The central Java software successfully conducted the experimentation. The configuration file allowed for simple configuration of parameters such as the wireless base station COM port and baud rate, list of FM stations to scan, radio station hoptime, and MySQL database connection settings. The debugging window in the Eclipse programming environment provided instant feedback about whether the loggers were reporting data or not.

The MySQL database performed as expected. The Java software recorded nearly a half-million entries into the primary data table without problem. Data was exported to another computer by manually creating backup SQL files and copying them over the Internet; the VNC connection allowed this process to be performed remotely for easy data retrieval. Several types of queries were successfully run against the data once it was stored in the second computer to retrieve data subsets for analysis.

The microcontroller software on the data loggers also performed well. The devices were quite robust, recovering automatically after (intentional) power loss by receiving the next tuning command and continuing to report data. The software was designed so that the NodeID could easily be reprogrammed by the laptop and an Atmel programming board – a necessary operation when changing antennas.

10.6.5. RDS Data

A rigorous statistical review of the data collected was not performed, though the data was studied to ensure that it was properly collected. Close analysis of the data did reveal some initial programming oversights. One oversight was how the data loggers handled groups with C' and E blocks, which caused the loggers to undercount the amount of valid received groups. The other oversight was that checking of error codes had not been programmed in initially. The error codes allowed for debugging the unidentifiable block counts and valid group counts. The data presented in the remainder of this section was unaffected by these programming oversights because the stations discussed did not use C' and E blocks.

Using standard query language (SQL), the team was able to investigate specific data subsets to make observations. The group observed a known "Swiss cheese effect," in which a particular station may be received well at one location but not very well at another location nearby. In one case, for the station on 94.9 MHz, four receivers received more than 99% of the groups transmitted, while the other two received less than 30%. This data also allowed the team to observe effects of antenna type and orientation. When the antennas were switched from dipole to monopole antennas, some receivers improved performance while the performance of others degraded. Table 10.3 shows the percentage of blocks identified on 94.9 MHz for both the dipole and monopole antennas. The group counts for the receiver in the furnace closet are the most interesting to note. The dipole antenna could not be extended fully within the closet, altering its directional gain properties. Once the dipole was switched to a monopole, the same receiver showed 100% reception. The receiver in the kitchen, however, did not exhibit the same characteristics. The dipole antenna for this receiver was fully extended and oriented with maximum gain facing east-west, optimal for the FM transmitter. Once the dipole was replaced with a monopole, the receiver did not perform as well.

The early testing data summarized in Table 10.3, while not substantial enough to draw quantifiable conclusions from, does clearly demonstrate that one FM station is not enough to support this specific house. Because there will only be one PCT in the house, its location is usually not chosen by the resident, and the location is difficult to change, one RDS transmitter will not be capable of supporting DR communication to this house. There is no reason to suspect that this house is an extremely unique case, and regardless demand response communication needs to be guaranteed to all residences, so it is safe to assume that one FM station will not be sufficient to cover a given service area in this kind of terrain. Table 10.4 presents group data from a different station, 101.3 MHz, from the same receivers. The data shows a similar Swiss cheese effect as before, but for *different* receivers. For this station, the two receivers which could not receive 94.9 MHz (on dipole antennas) received over 99.9% of the groups from 101.3 MHz. Data from monopole antennas in Table 10.4 also indicates the complex nature of FM reception.

Table 10.3. Valid groups received for 94.9 MHz, % of ideal rate

| Node Location (appliance/room) | With Dipole Antenna | With Monopole Antenna |
|---|--------------------------------|----------------------------------|
| Thermostat/Hallway | 25.79 | N/A |
| Microwave/Kitchen | 100 | 92.30 |
| Washer/Basement | 99.59 | 100 |
| Spa Furnace/Outside | 99.98 | 67.81 |
| Furnace/Closet | 29.80 | 100 |
| Computer/Office | 99.99 | 100 |

Table 10.4. Valid groups received for 101.3 MHz, % of ideal rate

| Node Location (appliance/room) | With Dipole Antenna | With Monopole Antenna |
|---|--------------------------------|----------------------------------|
| Thermostat/Hallway | 99.94 | N/A |
| Microwave/Kitchen | 99.49 | 66.38 |
| Washer/Basement | 99.59 | 99.99 |
| Spa Furnace/Outside | 67.21 | 28.17 |
| Furnace/Closet | 99.94 | 95.53 |
| Computer/Office | 96.56 | 62.82 |

The data also allowed the group to observe “slow” fading of RDS reception. To illustrate this phenomenon, six days of data from the receiver in the furnace closet, on 88.5 MHz, is presented in Figure 10.6. The sample data of the valid groups counted was averaged over each 10-minute polling interval (60 samples) to indicate the general reliability for that period of time. The standard deviation of the valid groups during each interval is shown in the graph as error bars over the data points. The gap between data points, roughly 4 hours, is a result of the amount of time it took to cycle through the entire list of stations being surveyed. If the fading experienced by a receiver only occurred on a relatively fast timescale (seconds) then this plot should show relatively close data points with error bars that are generally of the same size and always overlapping. In contrast, the graph in Figure 10.6 shows some 10-minute periods with small error bars and several discontinuous jumps in received groups – evidence of changes in reception reliability that occur over several minutes or hours. The graph shows that it is important to collect reception data over a prolonged period of time. The tool can be used to study this behavior in greater detail. It is also possible to obtain a continuous data set for a specific suspect radio station, with multiple receivers in a site, simply by changing the list of stations in the software configuration file.

11.0 PCT Systemic Control

11.1. Background

Demand management, also known as load management or demand response, modifies power consumption in order to better match supply constraints. It consists of many different techniques for both commercial and residential energy customers, and Thomas Bellarmine gives a very good overview in *Load Management Techniques* (Bellarmine 2000). Heating, ventilation, and air conditioning (HVAC) systems are known to contribute heavily toward peak loads and are thus the subject of much load management study. The research team is primarily focused on reducing consumption of residential HVAC through the use of programmable communicating thermostats (PCT's). PCT's act like normal thermostats most of the time, but, when needed, a radio message can be sent to the PCT asking it to reduce energy consumption. Pilot studies of PCT's have recently been performed in the State of California (Herter et al. 2007) and PCT's will likely be mandatory in all new construction in California beginning in April 2009 as per the requirement of Title 24.

11.2. Objective

The researchers focused on the questions arising when a large network of PCT controlled houses act in concert. Since sufficiently large experiments would be costly, the analysis was completed on a computer simulation written in the C programming language. The goal of the Load Group Simulation is to accurately model the average air conditioning power consumption of a large group of houses. It was built on top of an accurate thermal simulation of a house controlled by a full PCT. Additional simulation components include measurement and communications tasks.

Using the new simulation tool static thermostat setback response was studied first, and the huge rebound peaks that occur at the end of events make the need for rebound mitigation obvious. Random end times and ramped setpoint exits were studied as two possible mitigation strategies, and a number of analysis tools using power and homeowner comfort were developed to analyze the experiments. The main conclusion is that recovery from a two-hour 4°F setback event takes at least 4 hours regardless of mitigation strategy.

11.3. Simulation Overview

A number of researchers have created simulations to evaluate the power consumption of a group of thermostatically controlled devices. In the 1980's many focused on modeling thermostatically controlled devices (HVAC, water heater, refrigerator, etc), and an excellent treatment of their work is given in *Dynamics of heating and cooling loads: models, simulation, and actual utility data* (Mortensen and Haggerty 1990). Some of the physically based models are treated in *Physically-based model of demand with applications to load management assessment and load forecasting* (Calloway and Brice 1982), *A stochastic computer model for heating and cooling loads* (Mortensen 1988), and *Physically Based Modeling of Cold Load Pickup* (Ihara and Schweppe 1981). Additionally, a Markov based approach is given in *A stochastic computer model for heating and cooling loads* (Mortensen 1988). More recently, Ning Lu et al. presented a state queuing model

for thermostatically controlled devices in *Modeling uncertainties in aggregated thermostatically controlled loads using a state queuing model* (Lu et al. 2005).

11.3.1. Simulation Construction

The load group simulation was written upon the TranRunC architecture invented by one of the authors (David Auslander) and detailed in Appendix C, *TranRunC: Realizing Task/State Mechanical System Control Software in C*. TranRunC provides an object oriented approach to programming real time systems within the C programming language. The style utilizes strict task/state hierarchy as developed in *Control Software for Mechanical Systems: Object-Oriented Design in a Real-Time World* (Auslander et al. 2002).

The simulation consists of four main tasks, as illustrated in Figure 11.1. The Neighborhood Task is the heart of the simulation, as it contains a dynamic model of a large population of independent and random PCT controlled houses. The Measurement Task performs the mundane task of aggregating the load. The Controller Task sends messages to the smart thermostats, allowing examination of demand response events. Finally, the Master Task simply makes sure the other tasks behave during startup and shutdown.

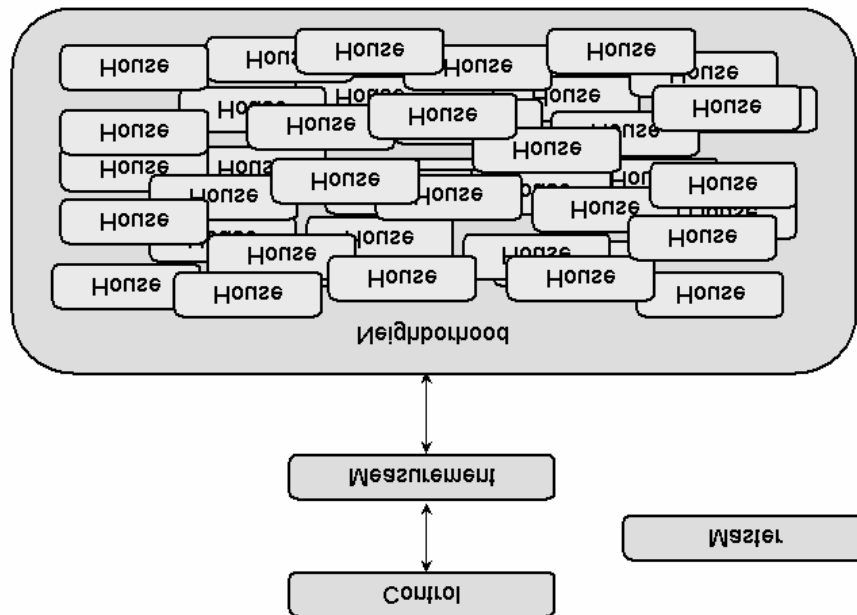

Figure 11.1. Load Group Simulation Task Diagram

Neighborhood Task

The Neighborhood Task consists of a collection of house models with each house having unique thermal parameters and individualized PCT settings. Each house is subject to the same outside temperature and solar gains, and the current simulations take place in Sacramento, California on a 101°F day in July. The temperature profile was taken from actual weather data, and as usually happens in Sacramento, the temperature drops considerably at night, to a low of 57°F.

The outdoor environment forms the only coupling between the houses, apart from the demand response messages.

The thermal model includes five states and a multitude of inputs. The states are the temperatures of the indoor air, internal walls, external walls, heater mass, and cooler mass. Table 11.1 lists the key model variables with descriptions.

Table 11.1. Thermal Model Variables

| Variable | Description |
|--------------|---|
| T_{air} | Temp. of Indoor Air |
| T_{iw} | Temp. of Internal Wall |
| T_{xw} | Temp. of External Wall |
| T_{hm} | Temp. of Heater Mass |
| T_{cm} | Temp. of Cooler Mass |
| Q_{h2in} | Heater to Inlet Air Conduction |
| Q_{hloss} | Heater to Ambient Conduction |
| Q_{hin} | Heat Input to Heater (Tonnage Rating) |
| q_{h2air} | Heater Supply Air and Indoor Air Convection |
| Q_{c2in} | Cooler to Inlet Air Conduction |
| Q_{closs} | Cooler to Ambient Conduction |
| Q_{cin} | Heat Input to Cooler (Tonnage Rating) |
| Q_{cout} | Adjusted Heat Input to Cooler |
| q_{c2air} | Cooler Supply Air and Indoor Air Convection |
| Q_{int} | Internal Gains to Indoor Air Conduction |
| q_{inf} | Infiltration Air Convection |
| Q_{iw2air} | Internal Walls to Indoor Air Conduction |
| Q_{xw2air} | External Walls to Indoor Air Conduction |
| Q_{xw2out} | External Walls to Outside Conduction |
| Q_{wincon} | Through Windows to Indoor Air Conduction |
| Q_{winrad} | Through Windows to Indoor Air Radiation |
| T_{out} | Temp. of Outside Air |
| T_{amb} | Temp. of Space Where Blower Resides |
| T_{hsup} | Temp. of Heater Supply Air |
| T_{csup} | Temp. of Cooler Supply Air |
| k_{xx} | Thermal Conductivity Constants |
| m_{xx} | Mass of Item XX |
| c_{pxx} | Specific Heat of Material XX |

As with a real HVAC system, a single speed blower fan is controlled independently from the heater or cooler compressor so that it extracts the energy from the still warm or cool compressor coils after the compressor has been shut off. For the case when the fan is on, an exponential model has been used to describe the heat transfer to the air moving from the inlet of the heater and cooler to the outlet (Equations 1 and 2). Further, Equation 3 accounts for thermal losses associated with the HVAC unit. The differential equation for the heater and cooler temperatures are given by Equation 4. The adjusted thermal input to the units ($Q_{hout/cout}$) takes the variation of thermal efficiency with temperature into account and is calculated using the method outlined in *Methodology for Hourly Simulation of Residential HVAC Equipment* (Huizenga and Barnaby 1985). Finally, a perfect, instantaneous mixing process provides the mode for convective heat transfer between the supply air and the indoor air (Equation 5).

$$Q_{h2in/c2in} = k_1 (T_{hm/cm} - T_{air}) (1 + k_3 [e^{\frac{-1}{k_3}} - 1]) \quad (1)$$

$$T_{hsup/csups} = T_{air} + (T_{hm/cm} - T_{air}) (1 + e^{\frac{-1}{k_3}}) \quad (2)$$

$$Q_{hloss/closs} = k_2 (T_{hm/cm} - T_{amb}) \quad (3)$$

$$\dot{T}_{hm/cm} = \frac{Q_{hout/cout} - Q_{hloss/closs} - Q_{h2in/c2in}}{c_{ph/pc} m_{h/c}} \quad (4)$$

$$q_{h/c} = \frac{V_{h/c}}{m_{air}} (T_{hsup/csups} - T_{air}) \quad (5)$$

External walls exchange heat through conduction with the indoor air and outdoor air (Equations 6, 7, 8).

$$Q_{xw2air} = k_4 (T_{air} - T_{xw}) \quad (6)$$

$$Q_{xw2out} = k_4 (T_{out} - T_{xw}) \quad (7)$$

$$\dot{T}_{xw} = \frac{Q_{wx2out} + Q_{wx2in}}{c_{pxw} m_{xw}} \quad (8)$$

In the model, the internal wall elements are simply used to represent the thermal storage of anything solid inside the house – furniture, floors, walls, etc. Equations 9 and 10 illustrate the conduction between the indoor air and the internal walls.

$$Q_{iw2air} = k_4 (T_{air} - T_{iw}) \quad (9)$$

$$\dot{T}_{iw} = \frac{Q_{iw2air}}{c_{piw} m_{iw}} \quad (10)$$

Windows allow a great deal of heat transfer in the forms of conduction and radiation that is very important to model. Solar radiation becomes very powerful later in the afternoon when the sun strikes the windows more directly, causing more heat input than the outdoor temperature would predict. Windows also have higher thermal conductivity than walls, and therefore allow much more conduction. Equations 11 and 12 were derived directly from *ASHRAE Fundamentals Handbook* (ASHRAE 2001), which elucidates methods of accounting for heat transfer through windows. The variable C_{di} changes with the time and date to account for different solar conditions throughout the year, and it is also computed in accordance with *ASHRAE Fundamentals Handbook* (ASHRAE 2001).

$$Q_{winrad} = \frac{1}{3600} A_{win} C_{di} C_{IAC} \quad (11)$$

$$Q_{wincon} = \frac{1}{3600} A_{win} C_w (T_{out} - T_{air}) \quad (12)$$

Infiltration is the process of unconditioned outside air leaking into the house. The leaks often occur around windows and doors, and as the insulation level of houses has increased the leaks have correspondingly decreased. The convective model shown in Equation 13 accounts for the infiltration.

$$q_{inf} = \frac{V_{inf}}{m_{air}} (T_{out} - T_{air}) \quad (13)$$

Internal heat sources constitute the final input. Household objects that produce heat, usually as a by-product, constitute the internal heat sources modeled using Q_{int} . A few examples are lights, refrigerators, and computers. The computation of indoor air temperature couples all of the states together with the inputs through the windows and internal gains (Equation 14).

$$\dot{T}_{air} = q_{h2air} + q_{c2air} + q_{inf} + \frac{Q_{int} - Q_{iw2air} - Q_{xw2air}}{c_{pair} m_{air}} \quad (14)$$

Each house in the Neighborhood Task contains thermostat software that exactly mimics a PCT. Figure 11.2 shows the task diagram for the thermostat. Starting from the bottom of the figure, the HVAC Com Task takes care of turning the simulated HVAC system on and off and relaying the current indoor temperature from the simulated air. The Heater and Cooler Control Tasks perform hysteresis control calculations and determine the running state of their respective components. The Coordinator Task ensures that the heater or cooler are on in accordance with the operating state (off, heat, cool) of the thermostat. The Supervisor Task determines the current setpoint temperature by implementing adjustable setpoint tables that can be different for every day of the week. Moving to the top of Figure 11.2, the DR Com Task receives communications over a simulated communications network, facilitating the load management experiments. The Goal Seeker Task is the most important task because it determines the

response to communications received from the DR Com Task. Finally, the Master Task simply starts all of the tasks upon initialization of the simulation.

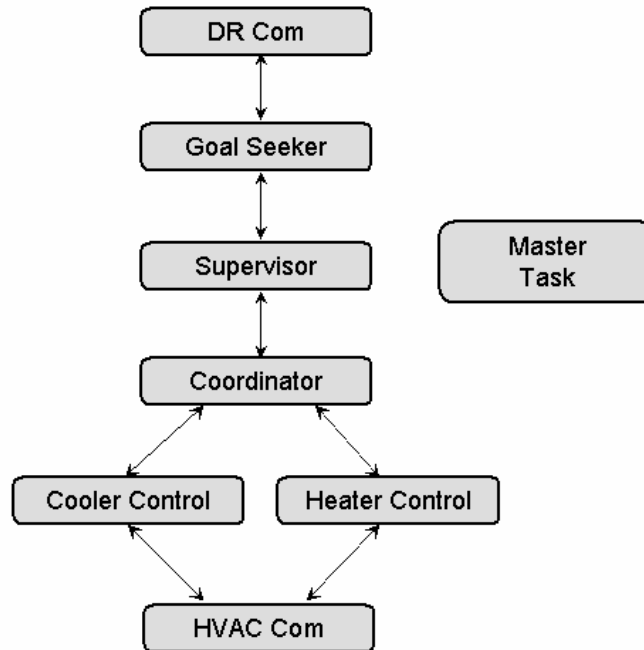

Figure 11.2. PCT Task Diagram

The Control Tasks implement an exact representation of the hysteresis control inside a thermostat. The pseudo-code below explains the algorithm for the cooler unit.

```

e = T_s - T_air
if u_{AC} == TRUE and e >= C_c - C_a
  then u_AC = FALSE
if u_{AC} == FALSE and e <= -C_h
  then u_AC = TRUE
  
```

The variable 'T_s' is the current setpoint temperature, and 'T_air' is the current indoor temperature. The variable 'C_a' is the anticipator constant (0.1°F), 'C_c' and 'C_h' are the cooling and heating max bounds (0.7°F each). In the simulation, the hysteresis band comes out to about 1.2°F centered about the setpoint temperature.

The Goal Seeker Task allows great flexibility in our response to demand response events. Static setpoint changes are the simplest form of DR message. In these, the Goal Seeker modifies the setpoint inside the Supervisor Task to the desired value for length of time specified in the message. Setpoint modification is the most commonly used message for our testing, and it consists of increasing or decreasing the Supervisor's current setpoint value, defined in the table,

by the amount specified in the message. Along these lines, dynamically changing setpoint modifications are easily implemented and allowed the testing of different exit profiles. Since each house implements a different Goal Seeker, each house's response can be different, allowing simple programming of random events, such as random end times, through a single broadcast message.

Measurement Task

The Measurement Task is meant to simulate the role of distribution substations in the power system architecture. For this testing, it simply aggregates the load from all of the houses in the Neighborhood Task on a set time interval. Using a separate task allows for easily extensible data analysis. Future extensions could encompass simple running averages to more complex frequency content analysis like Fourier transforms.

Control Task

The Control Task distributes messages to the PCT's in the neighborhood using a message structure variable. The content of the message as well as when it is sent can be controlled by this task. In general, the messages are broadcast to the entire group of PCT's, but an addressing structure can allow for individual or small group actions. The message structure variable usually contains the event start time, end time, event type identifier, and event data fields.

11.3.2. Parameter Verification

Verifying results is the major problem with simulating *only* thermostatically controlled devices. Power meters do not directly measure the HVAC, they measure the total power consumed by the house, which includes many random power sources. It is possible to instrument individual units in order to get their consumption, but this quickly becomes expensive for large groups of houses. The problem was bypassed by utilizing a widely used house/HVAC model to compare against the base case house. Following this strategy, the base parameters were tuned to closely match a known house simulation model (similar to CALRES).

Figures 11.3 and 11.4 show the indoor temperature of our base simulations and CALRES-like simulations under different conditions. It compares all permutations of well insulated (post-1991, California Title 24-compliant) house, poorly insulated (pre-1991, non-Title 24) house, A/C off all day, and A/C only on from noon to 5:00pm without shutting off. The basic house parameters can be found in Column 1 of Table 11.2. The uncooled simulations (A/C off all day) show that the thermal dynamics of the house simulation responds very much like the CALRES-like model. The cooled simulations (A/C on from noon to 5:00pm) indicate a bit more deviation from the CALRES-like model while the A/C is running. In the end, the results are very close considering the major difference in complexity between the two models.

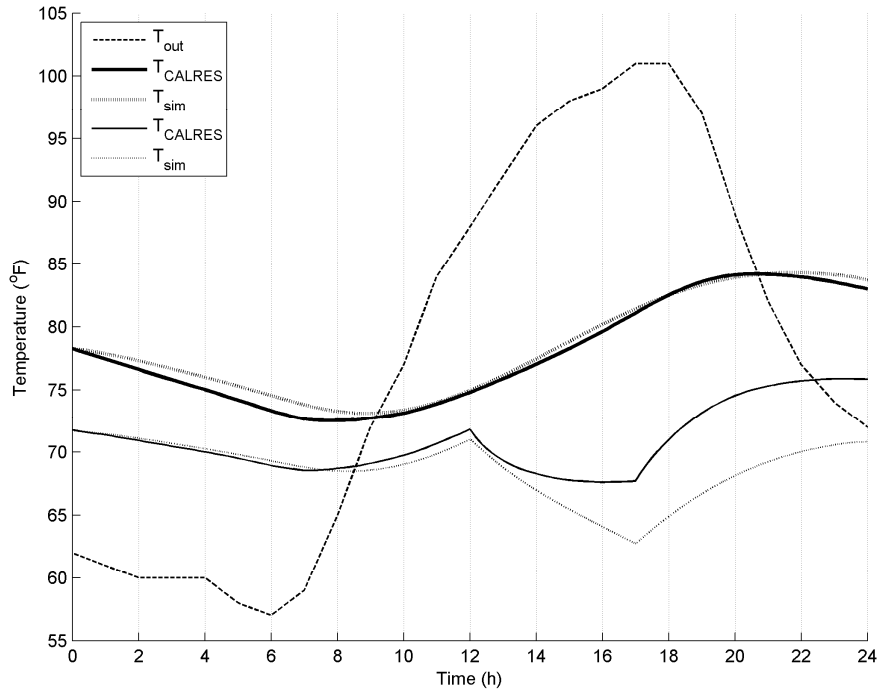

Figure 11.3. Base Simulation: Well Insulated

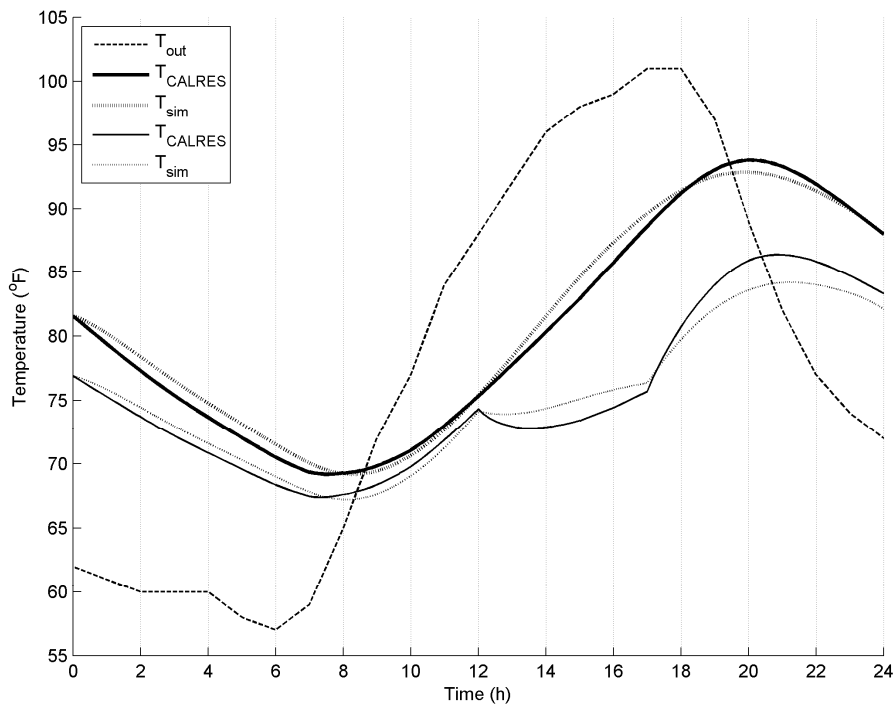

Figure 11.4. Base Simulation: Poorly Insulated

Table 11.2. House Extents Testing

| Parameter | 1 | 2 | 3 | 4 | 5 | 6 | 7 | 8 | 9 | 10 | Range |
|-----------------------|------|------|------|------|------|------|------|------|------|------|--------------|
| House Size (ft^2) | 1661 | 1661 | 1661 | 1661 | 1661 | 3222 | 3222 | 3222 | 3222 | 3222 | 1x - 2x |
| A/C Size (ton) | 4 | 2 | 2 | 5 | 5 | 8 | 4 | 4 | 10 | 10 | 0.5x - 1.25x |
| Slab (Y/N) | N | N | Y | N | Y | N | N | Y | N | Y | |

With the base case verified, the extents of the parameter range needed to be relatively simple to implement and seem reasonable compared with typical housing stock. In order to simplify the implementation, the number of degrees of freedom was reduced to four, house size, insulation level, A/C size, and slab construction, and a multiplicative modification strategy was used to obtain the variations in construction. The house size modifies the mass of indoor air, mass of interior and exterior walls, window area, A/C size, and quantity of infiltration. Insulation level modifies the conductivity of the walls, the window area (as a proxy for R-Value), and infiltration. The A/C size is then applied on top of the house size modification because many houses of the same size do not have the same size A/C. Finally, slab construction increases the mass of the internal walls to simulate the additional thermal storage associated with the slab. Table 11.2 shows the chosen range. Note that the range shown is repeated for both well and poorly insulated houses. The range was chosen independently, but it seems to fit nicely (though not exactly) with previous work done in *Evaluation of Residential HVAC Control Strategies for Demand Response Programs* (Katipamula and Lu 2006). Figures 11.5 and 11.6 show the indoor temperature of all of the houses in the data range, and it illustrates that the chosen range seems reasonable. Put simply, the A/C in some houses will be able to keep up with demand and some won't, but the well-insulated houses will do better than poorly insulated.

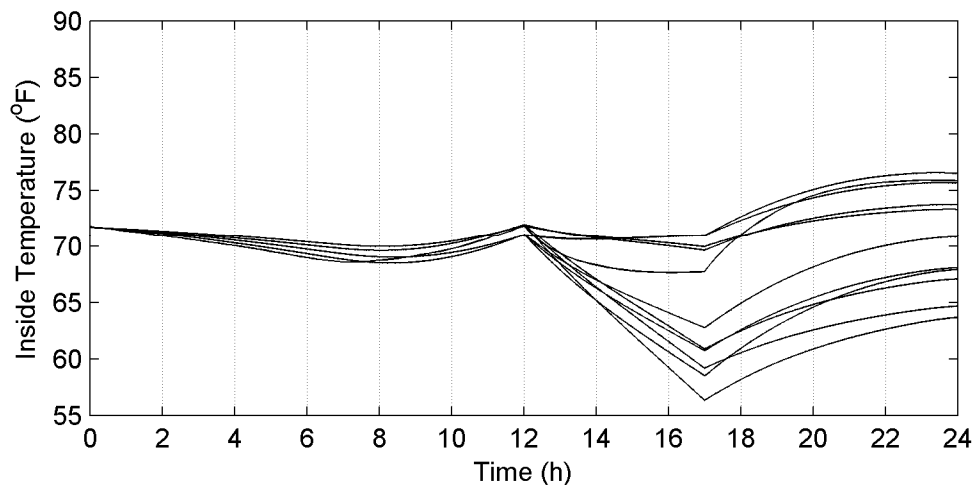

Figure 11.5. Simulation Extents: Well Insulated

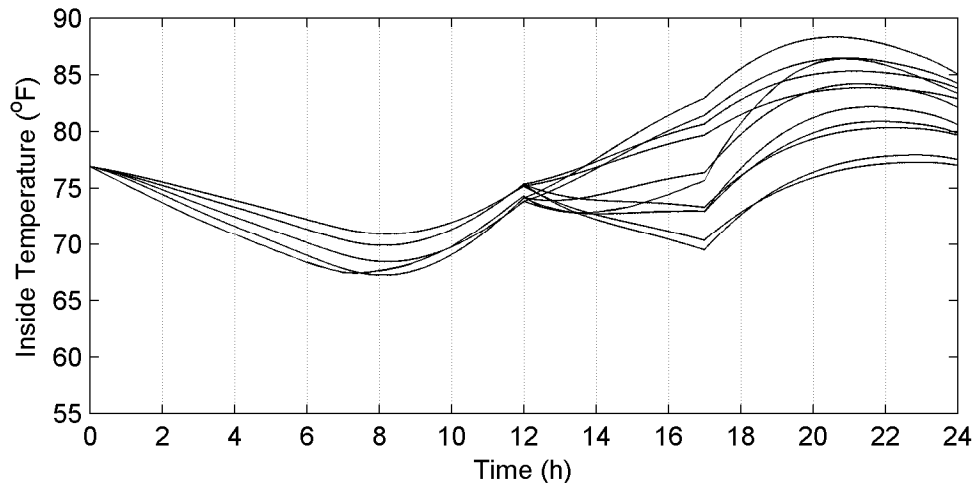

Figure 11.6. Simulation Extents: Poorly Insulated

11.3.3. Population Size

In general, the researchers did not intend to use the Load Group Simulation to perform exact simulations of particular neighborhoods (although it certainly could be used that way). They instead intended to obtain a representative sample that approximately matches average housing stock. A great deal of testing was completed to determine the best population size, and a sampling of the results can be found in Figure 11.7. The general trend is that more houses produce smoother power data but, above a certain number, do not change the basic behavior. Larger simulations take longer to complete, so it is desirable to have fewer houses. In the end, 100 house simulations were found to be a good compromise between accurate data and reasonable compute times.

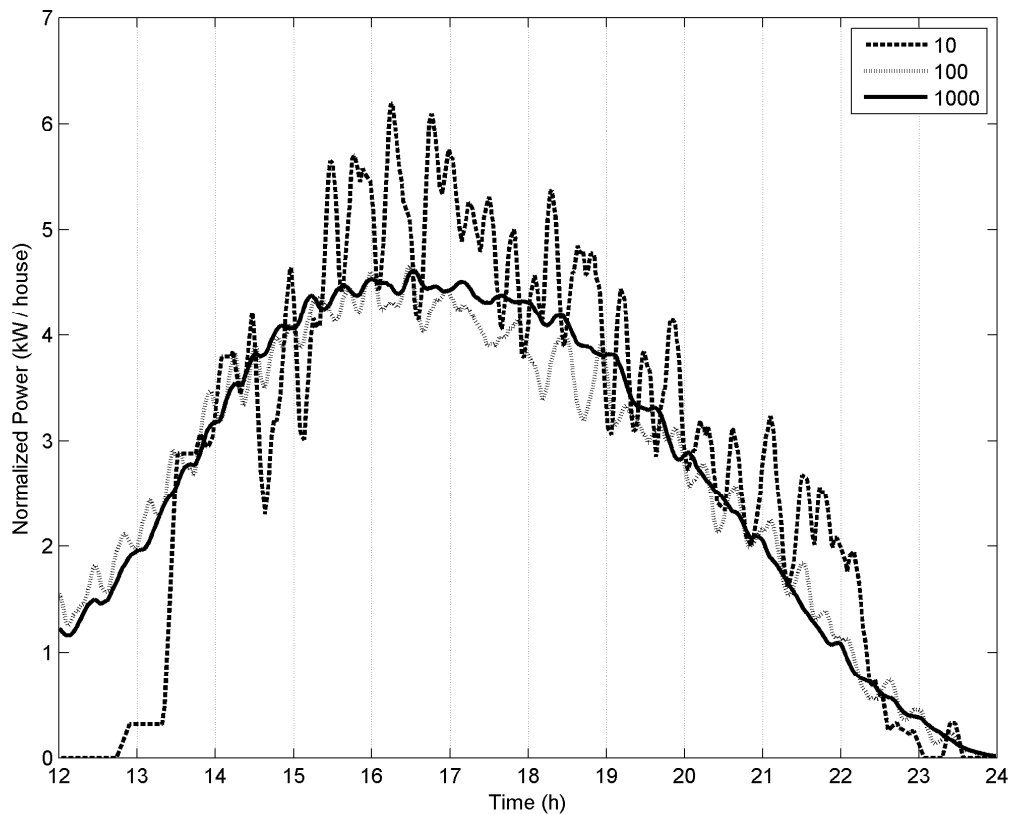

Figure 11.7. Population Testing

11.4. Simulation Results

The first step was to examine the open loop response of the neighborhood to simple DR events. Many different setback quantities and durations could easily be studied, and quite a few were examined during the course of validating the model. A popularly talked about choice for DR events is a static setback of $4^{\circ}F$. The setpoint profile of this type of event steps from the programmed value to the total setback at the beginning of the event. Scheduled setpoint changes still occur during the event, but the scheduled change is modified by the setback. At the end of the event, the setpoint steps back the normal value. In all of the cases presented the setback was applied from 3:00pm to 5:00pm. Figure 11.8 shows the simulated response to such an event.



Figure 11.8. Static DR Event

It is well known that the end of a static setback will result in a large rebound peak as all of the A/C's in the controlled area turn on simultaneously. To combat rebound, two mitigation techniques were examined in detail: ramped exit and random end time.

11.4.1. Ramped Exit Testing

A DR event using the ramped exit strategy starts like a simple event, with a two hour fixed setback. At the point when the simple event would have ended with a jump back to normal, the ramped strategies begin linearly changing the setpoint from the maximum value back to the normal value over a time window. The researchers tested two different types of ramped exit strategies – single message ramp and multi message ramp. Figures 11.9 and 11.10 show the difference between single and multi-message ramped exits.

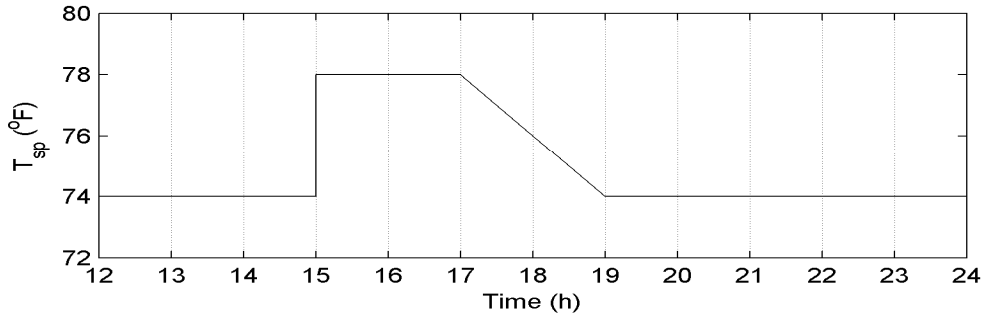

Figure 11.9. Single Message Ramped Setpoint Profile

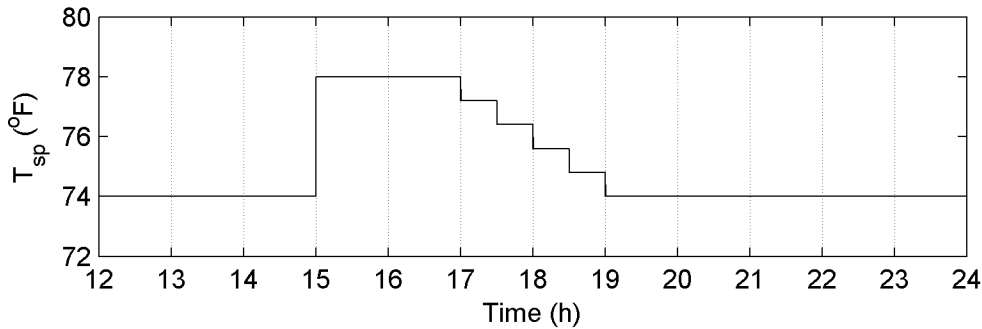

Figure 11.10. Multi Message Ramped Setpoint Profile

The changing setpoint of a single-message ramped event (Figure 11.9) is implemented by the PCT software. A special DR message that specifies the start and duration of the ramp is decoded by the DR Com Task of each PCT. From the decoded message, the Goal Seeker Task implements the ramp using a simple linear interpolation algorithm. Using fixed-point numbers in an embedded processor, a low cost PCT could easily change the setpoint by less than $0.01^{\circ}F$ yielding a very smooth ramping transition. Figure 11.11 shows a few different ramp lengths for single message ramp exits.

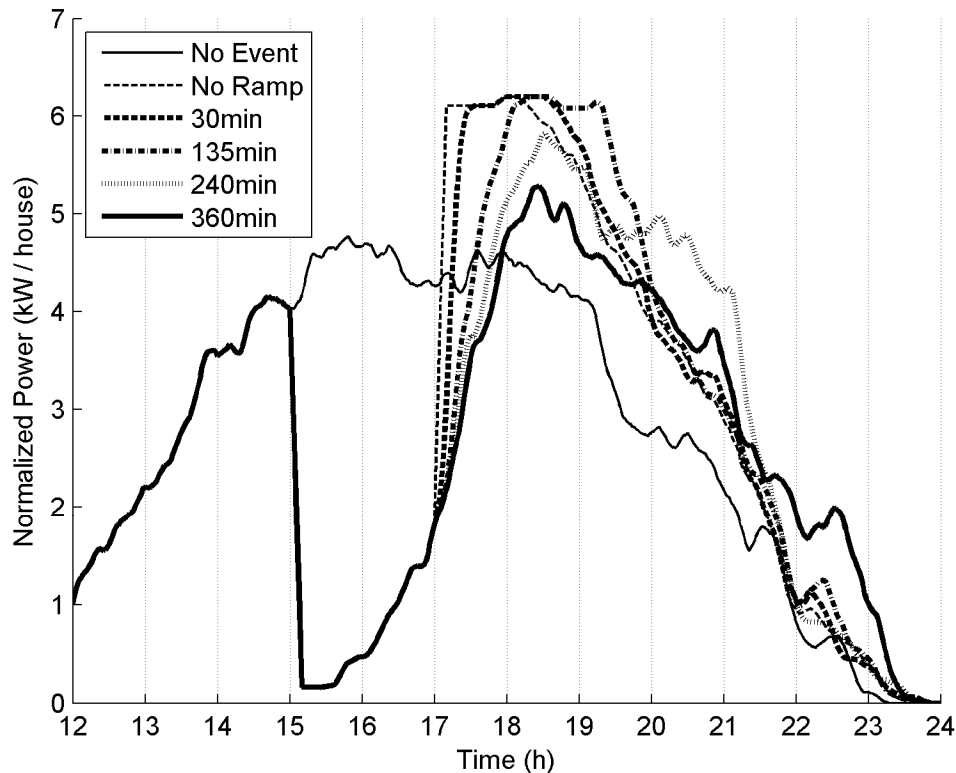

Figure 11.11. Single Message Ramped Exit

The multi-message ramp (Figure 11.10) is implemented by a series of separate DR events consisting of static setpoint modifications that occur in a sequence. To achieve an exit ramp the setback in each event should be smaller than in the previous event. The transition to a new event causes a step in the setpoint, and the time between the beginnings of each event cause the flat unchanging setpoint. Consequently, multi-message ramped setpoint events are specified by two values – setpoint step size (°F) and time between each step. If the time between each step approached zero, the multi-message strategy would approach the single message strategy.

Figure 11.12 shows characteristic results of the two types of ramps over similar time windows – 300 minutes. The large power spikes in the multi-message ramps come from the sudden jumps in thermostat setpoint. The single message ramp has no jumps because the setpoint is gradually changed during the entire window.

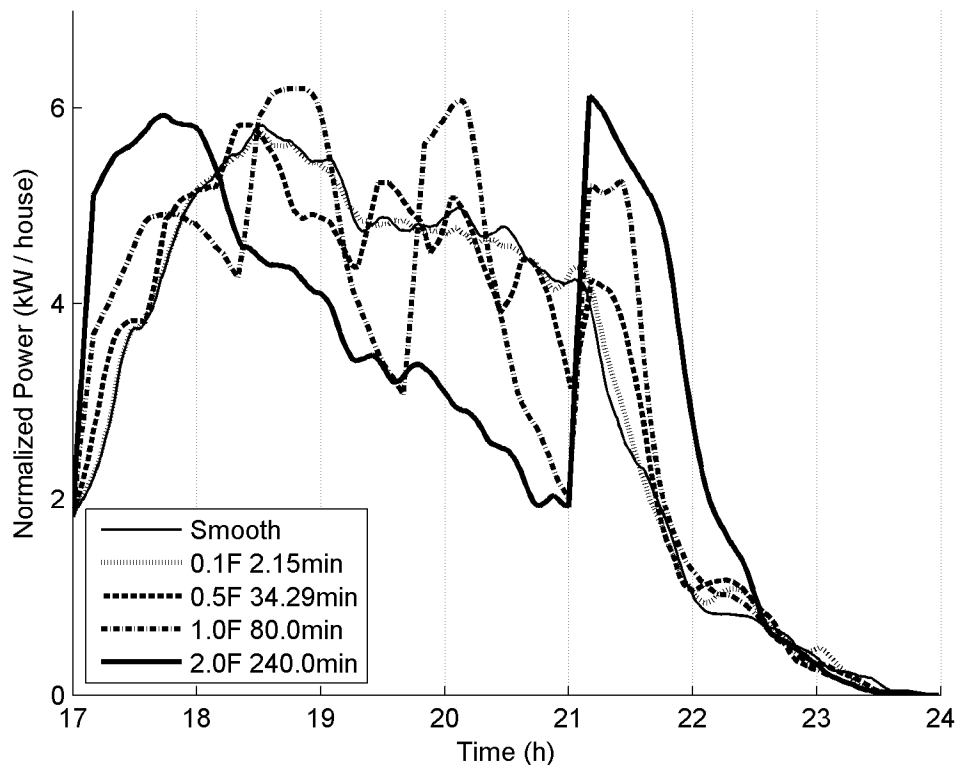

Figure 11.12. Ramped Exit Comparison – 240min Ramp

11.4.2. Random End Testing

The random end time strategy is a popularly talked about and simple method for smoothing the rebound peak. With it, a static setback DR event ends at different times for each house. It can be implemented in any number of ways, and in this case it used only one DR message that every PCT received and acted on. The message contained a field that indicated that the end time should be randomized, and then each PCT computed the end time itself. For instance, the message states that the event begins at 3:00pm with a static setback of $4^{\circ}F$, and the event officially ends at 5:00pm but has a random end time window of 120 minutes. When each PCT receives the message, it computes its own end time using a random number generator so as to fall somewhere between 5:00pm and 7:00pm. When 3:00pm comes, each PCT steps the setpoint back by $4^{\circ}F$, and waits for its personal end time to step the setpoint back to normal. So, one house in the neighborhood might reset its setpoint to normal at 5:13pm, but the house right next to it might not reset until 6:57pm. Figure 11.13 illustrates the power consumption of DR events using different length random windows.

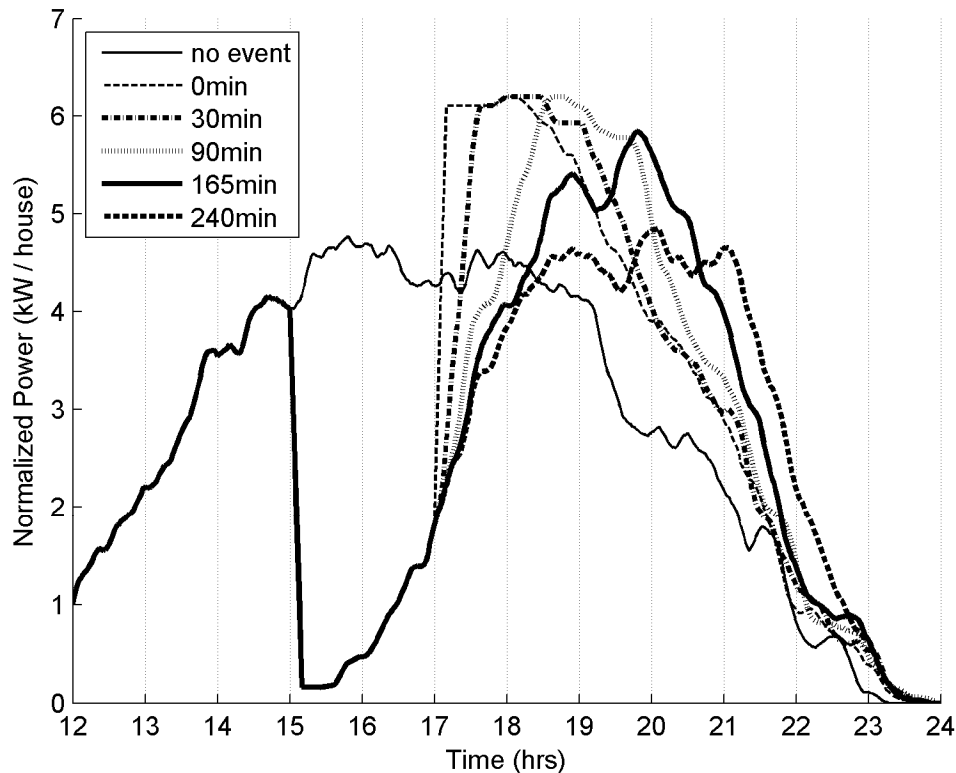

Figure 11.13. Random End Time

11.5. Discussion

From the simple DR event testing illustrated in Figure 11.8, it is obvious that some type of rebound mitigation strategy must be used because the power grid was not designed to withstand huge demand spikes. The researchers examined a couple of types of mitigation strategies, ramped exit and random end time, in relative detail.

From Figure 11.12, the multi-message ramp contains many more power oscillations than the single message variety. This is due to the PCT's setpoints stepping from the current value to the new value, shifting the hysteresis band, and causing the air conditioners to turn on. As the setback step size shrinks, the number of PCT's leaving the hysteresis band decreases, resulting in smaller power spikes, but as the step size decreases the number of messages sent must increase, creating strain on the communication infrastructure. Alternatively, the single message ramp only requires a single message to achieve very smooth performance. The downside of the single message ramp is that the PCT must be designed to implement it as opposed to being ad-hoc.

The first consideration when comparing the single message ramp versus the random end time is how to equate them. When the ramp is finished each house has been approaching its normal setpoint for the same period of time. Therefore, the inside temperature for every house should be at the normal setpoint, assuming the ramp is not too fast. On the other hand, when a

random window closes, many houses are not near the setpoint because their setpoint only recently stepped back to normal. This means that the ramped exit and random end time events cannot be compared based on their specified time window.

In order to draw comparison, an *effective exit time* was computed using the internal temperature of the simulated houses. The temperature of each house in a DR event was compared to the temperature of the same house (on the same day) without a DR event. The DR exit was considered complete when the average difference between temperatures reached $0.5^{\circ}F$. Figure 11.14 shows the effective end time with respect to the specified end time of ramped and random exits. A linear reference has been plotted for comparison.

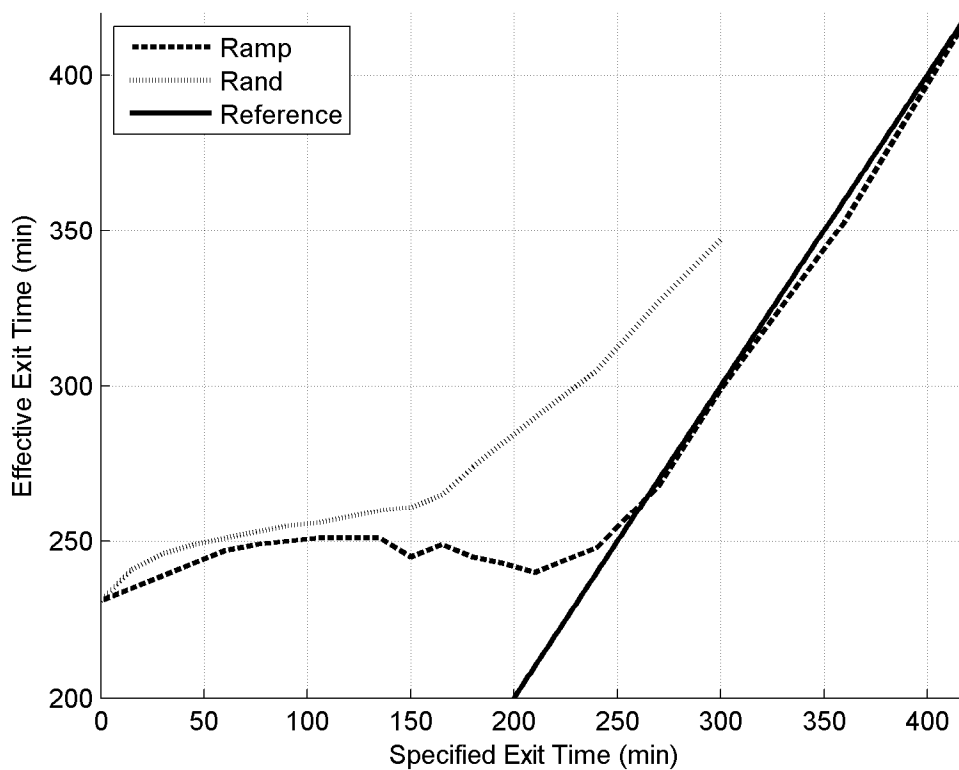

Figure 11.14. Effective Time Comparison

A couple issues become clear from Figure 11.14. It takes at least 4 hours to recover from a $4^{\circ}F$, 2 hour DR event regardless of the mitigation strategy used. As expected, all random exits are effectively much longer than the time specified by their randomization windows. Finally, the effective durations of all ramped exits shorter than 240 minutes are approximately the same (240 minutes), and longer ramps effectively last the specified ramp time.

Many factors impact the effective exit time, but the environment plays the greatest part because it largely determines the load on the air conditioning. In these simulations, the outdoor temperature drops rapidly during the recovery period, aiding in the recovery. If the

simulations were completed for a different location, like someplace without a nighttime temperature drop, the results would be very different.

Figures 11.14, 11.15, and 11.16 compare the ramp and random end events using three metrics with respect to the effective exit time. Total energy and peak power capture the needs of the power distribution system, but the homeowners are much more concerned with their own comfort. The discomfort metric computes an L_1 norm of the difference between actual indoor temperature and unmodified setpoint from the beginning of the DR exit (5:00pm) until midnight, yielding a quantity in units of $^{\circ}Fh$.

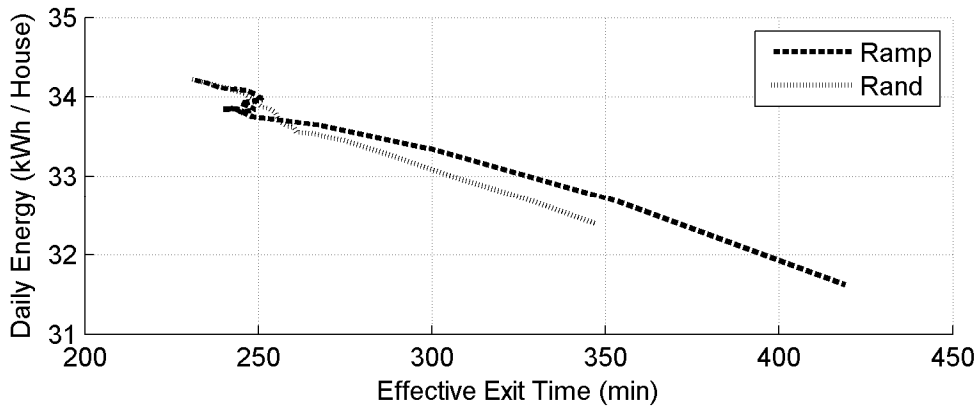

Figure 11.14. Comparison: Daily Energy

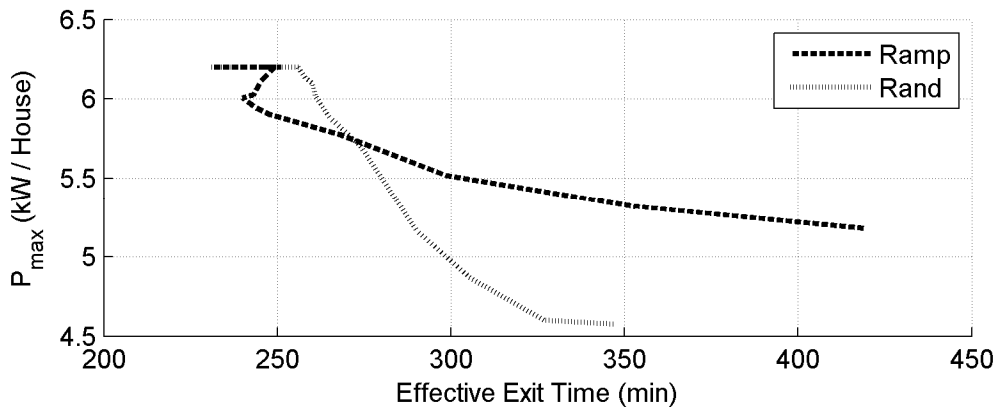

Figure 11.15. Comparison: Max Power

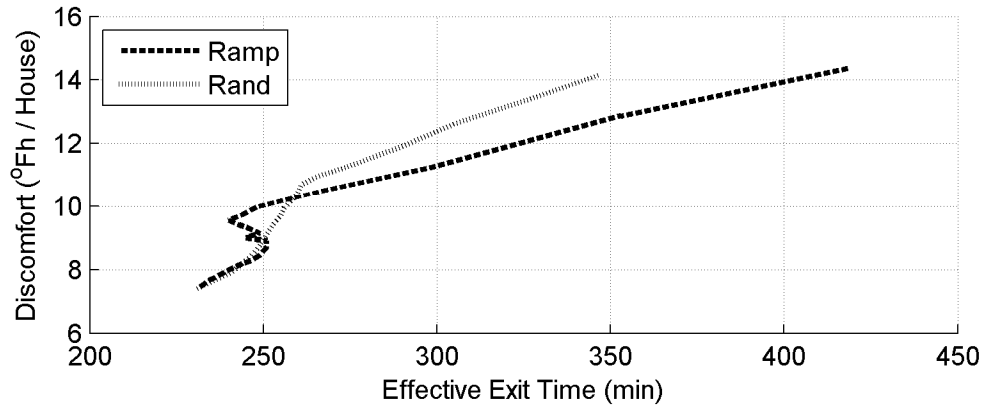

Figure 11.16. Comparison: Discomfort

To aid in understanding the power issues, Figure 11.17 compares the 240 minute ramp to various random end events. Each of the random end events effectively ends between 240 and 260 minutes and the ramped exit effectively ends at 248 minutes.

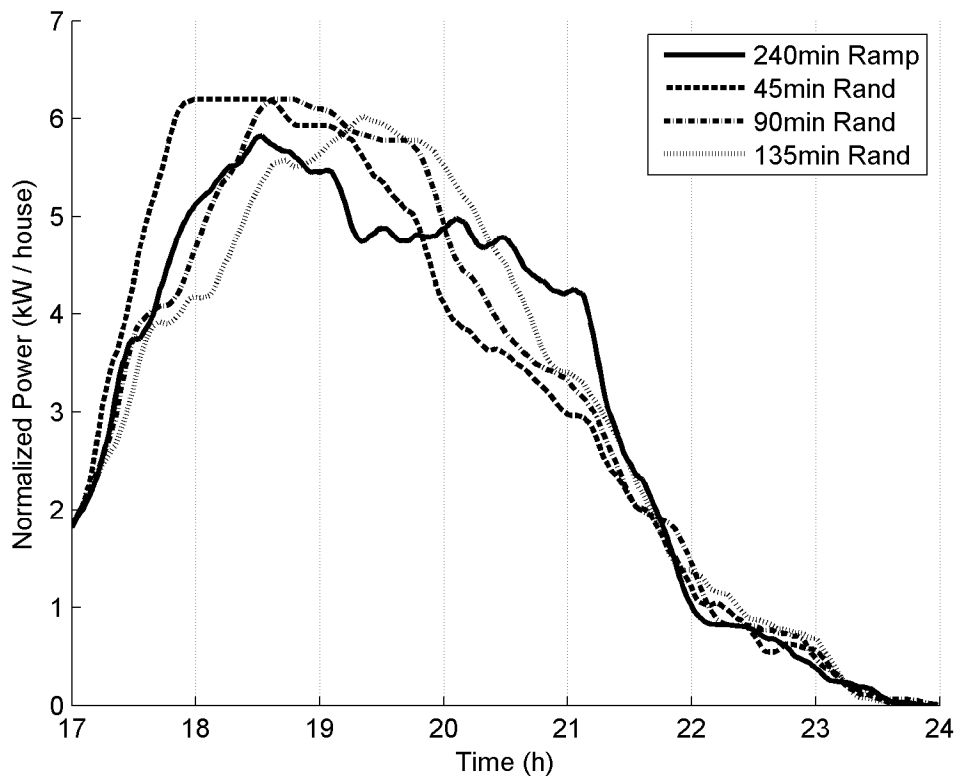

Figure 11.17. Recovery: 240 min Ramp v. Random Comparison

The quantitative analysis shown demonstrates that neither ramp nor random event exit shows a clear advantage over its competitor. Consequently, usage decisions will likely be based on less quantifiable metrics, and here the advantage goes to the ramp. Ramped exits are more equitable than random end times because everyone experiences the same discomfort as all of

their setpoints ramp at the same time. On the contrary, the random end time distributes discomfort randomly.

11.6. Conclusions and Recommendations

The research team constructed and verified a complex dynamic simulation of an advanced load management system. The model simulates the thermodynamics of a random group of houses under the control of individual programmable communicating thermostats in order to measure the characteristic power consumption. Further, the simulation tests the response of the load group to various Demand Response messages sent to the thermostats. Results clearly show that DR programs need to incorporate rebound peak mitigation strategies, and the team tested and analyzed a couple of different types.

In general, the nature of the ramp and random methods makes direct comparison difficult, but the effective exit time is a better metric than the specified exit time. It captures the customer experience closely by measuring the time it takes for the indoor temperature to return approximately to normal (within $0.5^{\circ}F$). Further, peak power, total energy, and cumulative customer discomfort were developed for use in comparison.

The main result of the analysis is that recovery from a two-hour $4^{\circ}F$ setback event takes at least 4 hours regardless of mitigation strategy used. This result only holds for the type of environment in which the simulations were conducted because A/C use is strongly dependent on the outdoor environment. Therefore, more simulations are needed to accurately estimate the recovery period for different climate zones, but given the low evening temperatures experienced in the simulation, it seems likely that warmer evenings would result in longer recovery times.

The second result is that ramped exit strategy would be best implemented using a thermostat-computed ramp specified in a single DR message. If an ad-hoc approach using multiple messages is desired, the step changes in setpoint should be around $0.1^{\circ}F$ in order to obtain a smooth profile.

Finally, the load group simulation proved to be an invaluable tool, and the team intends to continue working with the model to further examine different load management techniques. Future work could incorporate on-line system identification and closed loop control. Extensions will certainly delve into the proper type of DR signal to send, including work with real time pricing.

12.0 Wide Area Network One-Way Interface Recommendation

12.1. Background

Several technologies have been discussed as possibilities for enabling digital communication functionality in thermostats. The resulting *programmable communicating thermostats* (PCT's) could be used for dispatching load curtailment messages necessary to balance the electrical grid during peak events. These technologies include wired & wireless and one-way & two-way solutions. A list of discussed options is available in the Chapter 5, *Technology Survey*. The California Energy Commission recognizes that two-way communications from the thermostat to a utility communication infrastructure (UCI) will be an ideal solution for implementing demand response in the long term. Such implementations however have not yet been proved out on a large scale. Until these solutions have proven themselves in the marketplace, the Energy Commission, through Title 24 code, is proposing the standardization of a one-way communications technology to be embedded in PCT's.

Two particular technologies have been proposed for a standard, statewide one-way solution: RBDS (alternatively referred to as "RDS"²¹) over broadcast FM radio, and FLEX one-way paging (which will be referred to as "paging"). Both technologies have been proposed because of their maturity, practicality, and the existence of a well-developed infrastructure. Demonstrations for the general feasibility of these technologies for this application already exist in the marketplace: RBDS is used by GPS devices which receive real-time traffic information from FM broadcasts²², and paging is used in an Ambient Devices product which receives local 5-day weather forecasts over the paging network²³.

12.2. Objective

The UC Berkeley PCT Team reviewed the two candidate technologies for the PCT embedded one-way interface to recommend a solution for further research. In Chapter 6, *PCT Communication Interface Questions and Issues*, the team presents a list of technical questions regarding the interface that needed to be answered. The team researched answers to the most critical questions for both RDS and paging, and based upon that information came to a single recommendation for the one-way interface.

This chapter contains the team's recommendation and a discussion of the evaluation used to make the recommendation. Listed in the final section of this chapter are known players in various industries who have expressed interest in working with the State of California and other stakeholders to support the Title 24 PCT implementation process.

²¹ Radio Data System (RDS) has been a standard in Europe for over 20 years. The United States version of the standard, Radio Broadcast Data System (RBDS) is compatible with the European standard but adds some features specific to the United States.

²² Cobra Nav One 4500 with TMC, <http://www.cobra.com/navone/4500page.htm>

²³ Ambient Devices 5-day Weather Watcher, <http://www.ambientdevices.com/cat/index.html>

12.3. Key Evaluation Criteria (Approach)

The following criteria were identified as the most critical in evaluating each one-way technology for use in the PCT:

- **Longevity:** Will it be around for at least 10 years?
- **Reliability:** Is the reliability of the infrastructure and the medium sufficient for this application?
- **Ubiquity:** Is the technology widely used enough that there are a large number of vendors available to provide equipment and support the interface?
- **Infrastructure Cost:** What is the cost to build or upgrade the required communication infrastructure?
- **Operation and Maintenance Cost:** What is the annual cost to maintain the system on a statewide level?
- **Cost to the Manufacturer/Vendor:** What is the additional cost to the bill-of-materials (BOM) for the communications subsystem?

Based on a review of how each technology fared against these criteria, the team was able to determine if either technology was feasible and practical for this application. The team was also able to make a recommendation for the Energy Commission to focus resources on further investigation of one solution since it showed advantages over the other.

12.4. Results

Presented in this section are summarized answers for each of the key criteria identified above. A more detailed discussion of the reliability, infrastructure cost, operation and maintenance cost, and BOM cost of both paging and RDS is available in Chapter 6, *PCT Communication Interface Questions and Issues*.

12.4.1. Longevity

The RBDS system is pretty much guaranteed to be around as a communication technology for the next 10 years since it is being widely installed in automobile radios and utilizes commercial and educational FM radio. While there is a commonly held conception that the paging industry is “dead” since consumer uses have been replaced by cell phone technology, paging continues to support areas of the professional services industry, such as medical care, public safety responders, and field service technicians. Paging services are still widely supported and will be expected to be for a number of years. Paging, however, does not have nearly the same promise of longevity of broadcast FM radio.

12.4.2. Reliability

Both technologies are used in existing commercial applications that suggest that high reception reliability will be possible in PCT's. Detailed reliability studies of the factors that will likely influence in-home performance and general statistical models are not generally publicly available for either technology. However, industry expertise and added research can likely be leveraged to design PCT solutions for both technologies that will provide robust reliability. The

UCB Team has developed measurement instrumentation that could assist with the network design of an RDS solution by recording real-world performance within residences. In addition, e-Radio USA has been testing performance of in-home display prototypes using RDS originating from commercial radio stations. The paging carriers are well experienced in designing the transmission infrastructure to achieve reliable, in-home performance and as part of the RFP/RFQ process would be able to leverage this experience into the system design of a FLEX paging solution.

While the transmission infrastructures of both media are highly reliable under normal operation, the FM infrastructure is believed to be more robust and fault-tolerant than the paging infrastructure. Commercial FM radio stations tend to employ redundant communications methods between the station and the transmitter (paging uses a single satellite link), utilize power redundancy as a *de facto* standard for transmitters (paging transmitters' power redundancy is based on what is available at the transmitter's host site), and have auxiliary backup transmitters in place.

12.4.3. Ubiquity

RDS technology is growing in the United States in availability after becoming standardized in Europe roughly two decades ago. In this criterion, the technology has a clear advantage over FLEX paging because it is an open (non-proprietary) standard and more players are involved with the technology. FM radio already reaches more residents than paging, is supported by more broadcasters than paging carriers, and going forward, markets for chip makers and device manufacturers are much larger for RDS than for FLEX paging. A general summary of market ubiquity issues is presented in the following four subsections.

FM Radio Operators

The commercial and educational FM broadcast industry is fairly segmented, with very large networks such as Clear Channel, CBS Radio (Infinity Broadcasting), and Cumulus Media, smaller private networks, individual private broadcasters, and non-commercial operators such as NPR member stations and college and community radio stations. In addition to the broadcasters, there exist third-party data network operators which partner with independently-owned or network-owned stations to create a data network for distributing information. One such company is e-Radio USA. In California, there are 596 licensed FM stations (including commercial and educational), 217 of which have Class B (largest protected service territory in CA) licenses (FCC 2007). 22 of Clear Channel's 30 California stations have dynamic RDS capability that is used to broadcast automotive traffic information.

FM RDS Chip Vendors

Due to the large scale inclusion of mobile FM receivers into portable music players and car radios, a number of companies manufacture chips which serve as integrated FM receivers and RDS decoders. One company, NXP (formerly Philips Semiconductor) offers a variety of chips using the technology. Other known vendors offering integrated solutions include Silicon Laboratories, RDA, and Comlent.

Paging Carriers

In the last ten years the paging industry has undergone a considerable amount of consolidation. There are now only two known national paging carriers, though local regional carriers continue to exist. The two national paging carriers are American Messaging and USA Mobility.

Paging Chip Vendors

Motorola, the company that owns the intellectual property for the FLEX protocol, no longer makes any device hardware. Instead, a company choosing to implement the FLEX stack, in software or in hardware, must pay licensing fees to Motorola. Many companies that previously offered FLEX decoder chips have discontinued the products. One company, Renesas, a joint-venture between Hitachi and Mitsubishi, continues to manufacture integrated FLEX decoding chips. Alternately, a device manufacturer could implement the FLEX stack in the device processor, which would raise the processor complexity and cost.

12.4.4. Infrastructure Cost

The infrastructure cost for both technologies is unclear. The term “infrastructure” includes both the physical, transmitting infrastructure, and the data network that connects the system operator to the broadcast and transmission nodes. With RDS, the currently existing physical infrastructure may not need substantial investment, but the data network will need to be set up and managed. Large radio networks or RDS data operators are capable of developing this infrastructure (some of it is already existing today) and may include the upgrade costs into their contract rates or quotes. With paging, the data network is built into the carrier’s system design, but the physical infrastructure is currently deficient to several residential areas of the state. It is unclear whether the paging companies will be willing to include the necessary investments as part of their long-term market development strategy, or fold the costs into a statewide development proposal. An order of magnitude estimate for the potential infrastructure investment for either the RDS or paging system is not expected to exceed millions of dollars. These figures are based on knowledge of the cost of upgrading/installing a single transmission point and estimation of the number of points needed to support the state.

12.4.5. Operation and Maintenance Cost

Accurate cost figures for business at this scale are subject to negotiation and difficult to obtain prior to the RFP/RFQ process. The RDS system has been estimated by E-Radio USA to cost roughly \$5-million per year to operate and maintain on a statewide level. Paging vendors were unable to provide general estimates, and cost figures derived from their general one-way telemetry rates were in discrepancy with utility experiences with paging technology.

12.4.6. Cost to the Manufacturer/Vendor

The BOM cost (vendor cost per unit) of an RDS subsystem is expected to be anywhere from \$2 to \$8 less than that of a FLEX subsystem. Estimates for FLEX systems were difficult to obtain, due to the limited availability of integrated hardware solutions and proprietary nature (licensing is required to implement the stack in hardware or software) of the technology. Anecdotal estimates by experienced device manufacturers included “\$5 to \$10” and “five times more than with FM.” The BOM estimate of an RDS subsystem, according to the UCB team, ranges from \$2 to \$3.

12.4.7. Cost Comparison Summary

Assuming that the statewide system will eventually support approximately 10-million PCT's, the estimated costs are summarized in Table 12.1 as estimates *per thermostat*.

Table 12.1. Estimated Infrastructure, Operation, and BOM Costs per PCT

| | FM/RDS | FLEX Paging |
|---------------------------------|-----------|-------------|
| Infrastructure and Setup | < \$1 | < \$1 |
| Annual Operational Costs | ~\$0.50 | ? |
| BOM Costs | \$2 - \$3 | \$5 - \$10 |

12.5. Conclusion and Recommendation

Both technologies will likely work for this application. However, it is recommended that further investigation efforts be focused on RDS over paging for several reasons: RDS is more attractive in terms of longevity (it can practically be guaranteed), ubiquity (it is an open standard and technology) and costs to the manufacturer/vendors. There are remaining questions about the reliability (in terms of expected performance), infrastructure, and operation & maintenance costs for both technologies. The team recommends further research in studying the real-world reliability of the RDS signal to assist the statewide network planning process; this research will also allow the statewide infrastructure and operation & maintenance costs to be more precisely estimated.

12.6. Contact Information for Known Players

Listed here are contacts with whom the UC Berkeley team has established a relationship. Many of these individuals and companies have expressed interest in participating in DR demonstrations and long-term solutions for the State.

12.6.1. Commercial FM Radio Stations

Clear Channel

www.clearchannel.com

Contact: Rob Speicher, VP of Operations for Clear Channel Distribution Development
Clear Channel is known to have at least 22 stations in California, out about 30, hosting RDS traffic data.

Entercom

www.entercom.com

Contact: Marty Hadfield, VP of Engineering and one of the chairs of the US RBDS Committee (National Association of Broadcasters)

Entercom operates 5 stations in Sacramento and 3 in San Francisco with dynamic RDS capability and have expressed interest in partnering for a demonstration.

12.6.2. RDS / Data Network Operators

E-Radio USA

Contacts are Jackson Wang, from E-Radio Inc (Canada) and Rick Boland, from E-Radio USA

<http://www.e-radiousa.com>

E-Radio has been working with RDS technology for some time and has experience managing data networks to send secure, dynamic data such as TMC (traffic message channel) information through partner radio stations.

Jump2Go

www.jump2go.com

Contact: Allen Hartle, CTO and Founder, and one of the chairs of the US RBDS Committee (National Association of Broadcasters)

Jump2Go is a very recently-founded company which installs hardware/software to enable radio stations to send interactive data through RDS and HD Radio technology.

12.6.3. FM RDS Chip makers

NXP

www.nxp.com

Contact: Ken Wong, Marketing Manager for Portable Audio

NXP offers a low-cost, fully integrated FM receiver/RDS decoder chip and is very supportive in technical support and documentation, and have also expressed interest in partnering for a demonstration.

12.6.4. National Paging Carriers

American Messaging

www.americanmessaging.net

Contact: Cindy White, Sales Director

American Messaging has offices in Hayward and Fresno and has been working with PG&E on paging load control devices.

USA Mobility

www.usamobility.com

Contact: Nancy Green, Vice President, New Business & Product Development

12.6.5. Paging Device Manufacturers

Unication

Contact: Vic Jensen, one of the authors of the FLEX specification

Unication manufactures pagers and electronic devices with paging-embedded capability.

DavisComms

<http://www.daviscomms.com.sg>

Contact: Bob Popow, Director of Operations

DavisComms is the spinoff company of the pager manufacturing arm formerly a part of Motorola.

13.0 Conclusions and Recommendations

As a result of the project outcomes summarized in Chapter 3 and presented in Chapters 4 through 12, the team has drawn a number of conclusions and makes a number of recommendations. Sections 13.1 and 13.2 summarize these conclusions and recommendations. Additionally, the benefits of this project's outcomes to the State of California are discussed in Section 13.3.

13.1. Conclusions

13.1.1. Minimum Functionality PCT Concept

The team concludes that it is possible for a manufacturer to sell, in volume, a minimum functionality PCT that can receive radio dispatches anywhere in the state, interface with any utility's advanced metering system, control most installed HVAC appliances, and interact with the customer during demand response events for a retail price less than \$100. Because the technologies recommended by the team for the PCT system interfaces all consist of readily available off-the-shelf solutions, the team believes that Title 24-compliant PCT's can be developed before April 2009, the effective date for Title 24-2008. Further, the team validated these findings by successfully developing a PCT proof-of-concept that demonstrated the technical feasibility of the minimum functionality PCT concept presented by the team.

13.1.2. One-Way Communication Interface

As a result of preliminary technical analysis of both FLEX paging and RDS, the team concludes that both technologies are viable for the PCT standard one-way communication interface. Successful demonstration of RDS in the PCT proof-of-concept verified its feasibility for this application. Based on a number of evaluation criteria, the team has issued a number of recommendations for how to proceed with this interface (*see Section 13.2.3*).

13.1.3. RDS Site Survey Tool

The team concludes that the site survey tool developed is a viable system for measuring the real-world performance of RDS in residential settings. As a result of this development, the team believes that cost of equipment is not a prohibitive factor in performing field studies of RDS. Early results from equipment testing indicate that multiple FM radio stations per area will be needed for some, if not all, regions of the state to provide reliable coverage of the demand response signal. The results also indicate that the location of a PCT receiver within a house, the type of antenna used, and orientation of any directional antenna can all significantly affect the reliability of RDS communication.

13.1.4. PCT Systemic Control

The team concludes that the load group simulation developed provides a valid means of characterizing aggregate air conditioning load and that the thermal model it is based upon is valid. The team has shown, through simulations of large groups of random houses, that rebound peaks occurring after demand response events have ended can be significant and that there is a need to incorporate mitigation of the rebound peak into load management strategies.

Finally, the most important finding from the simulations is that it will take the system approximately *four hours* to recover from a 4°F, 2-hour PCT demand response event.

13.2. Recommendations

13.2.1. PCT System Interfaces and Minimum Functionality PCT

Following the presentation of the minimum functionality PCT concept on April 18, 2006, the industry-based Title 24 PCT Technical Working Group was formed to produce a reference design document to be referenced in Title 24. The UC Berkeley research team recommended the minimum functionality PCT concept to the Technical Working Group as the initial strawman for PCT system interfaces. In addition, the team recommended to the Technical Working Group the review of all of the key technical issues identified by the team. The resulting PCT reference design, defining all of the logical, electrical, and physical standards necessary for system integration, incorporated much of the technical input offered by the UC Berkeley research team.

The latest revision of the document, *Reference Design for Programmable Communicating Thermostats Compliant with Title 24-2008*, can be found on the Title 24 PCT Technical Working Group website, at: <http://sharepoint.californiademandresponse.org/pct/default.aspx>

13.2.2. PCT Systemic Control Research

The team recommends further study in the systemic control of PCT networks to study the impact of currently accepted load management strategies and to identify and characterize other possible strategies. For reliability (non-overrideable) events, the team recommends the consideration of alternative event-exit strategies, such as ramped setpoint return, to random setpoint return. The team strongly believes that continued investigation is required to determine effective control signals (i.e., price, price tier, price ratio, duty cycle, setpoint) for managing economic (overrideable) events. There is little present knowledge of how rate-based (i.e., TOU, CPP, or RTP pricing) or incentive-based (i.e., duty cycle management, setpoint control) demand response strategies can provide desired demand profiles while addressing customer equity issues. Further research may also provide feasible load management strategies that more intelligently manage peak demand throughout the entire event, including entry, peak, and exit. Such strategies may possibly include the use of closed loop control.

13.2.3. Wide-Area Network One-Way Interface

The team recommends that further investigation efforts of the embedded one-way interface be focused on RDS over FLEX paging for several reasons: RDS is more attractive in terms of longevity (it can practically be guaranteed), ubiquity (it is an open standard and technology) and costs to the manufacturer/vendors. The team recommends the following action items be completed before a statewide RDS system can be developed for PCT communication:

- **Study the real-world behavior of the RDS to properly develop reliable end-to-end communications.** The results of this research will assist the proper design of the PCT communication protocol, PCT radio receivers, and the statewide broadcast network. This research will also allow the statewide infrastructure and operation & maintenance costs to be more precisely estimated.

- **Finalize development of a security scheme for authentication of the RDS signal.** The Technical Working Group outlined a general strategy for securing this application in Version 1.0 of the PCT Reference Design; however, the security scheme is far from complete and thermostat manufacturers do not have the information needed to proceed with product development. In the interim, it is recommended that the Technical Working Group estimate the computing hardware requirements for a “worst-case” encryption scheme to provide manufacturers with enough information to proceed with hardware selection and design. In addition, it is recommended that a security strawman outlining specific security implementation details is created and professionally reviewed to catalyze the final development of the PCT one-way security scheme.
- **Develop a communication protocol for demand response over RDS.** The RDS communication protocol for demand response will need to be supported in all PCT’s manufactured. The Technical Working Group has developed a standard information model for the communication interface, but the actual protocol will need to be defined for final PCT software development. This protocol should include a definition of the addressing structure and a standard system heartbeat to be supported by every FM station carrying a demand response signal.

13.2.4. Other Necessary Research and Development Tasks

The team has identified two remaining issues that need to be resolved before manufacturers can begin product development of PCT’s. The team recommends that these tasks be addressed by the Technical Working Group:

- **Completion of expansion interface specification**
The electrical connector and basic signaling mechanism have been chosen for this interface but a digital communication profile defining the transaction model over the expansion interface has yet to be defined. The team recommends that the Technical Working Group complete a specification for this communication profile. The team also recommends that the communication profile should include a mechanism for the PCT configuration (address and possibly security code) to take place over the interface. In addition, the physical expansion area containing plug-in modules remains undefined in the expansion interface specification; it is recommended that the Technical Working Group propose a best practice for this description to prevent physical incompatibilities between PCT’s and plug-in modules.
- **Configuration of PCT address code**
Version 1.0 of the Reference Design does not define a minimum requirement to support the configuration and verification of the PCT address code and possibly security code. A mechanism for code verification, either through the user interface or expansion interface must be included to allow for troubleshooting of the communication interface. The team recommends that the Technical Working Group review and update the Reference Design to ensure that all manufacturers will support a minimum mechanism to configure and verify the PCT address code.

13.3. Benefits to California

Electrical utility customers, energy regulators, investor-owned utilities, thermostat vendors, and broadcast communication operators in the State of California are expected to benefit from the results of this project in the following ways:

- **Technical Questions and Issues**

The technical questions and issues identified and discussed by the team are expected to benefit the Energy Commission, IOU's, POU's, thermostat vendors, and communication network operators by presenting relevant issues that impact the policy, technology, and system design of PCT systems. The intention is that the issues raised would promote thorough investigation of design issues within the PCT stakeholder community.

- **Minimum Functionality PCT Concept**

The minimum functionality PCT concept presented has benefited the state by providing a reasonable solution to accomplish the Energy Commission's PCT vision while meeting the price target established by the regulators. The team believes that the bill of materials, once published, removed critical doubt from key stakeholders and served as a catalyst to facilitate progress in policy and technology development.

- **PCT Proof-of-Concept**

The PCT proof-of-concept has benefited the PCT stakeholder community by providing a demonstration to communicate the idea of the Energy Commission's PCT vision and by proving the feasibility of the minimum functionality PCT concept. The protocol and software developed by the team to transmit RDS messages continue to be used in Sacramento and at the California ISO to demonstrate and test demand response communication to PCT's. The proof-of-concept also provided a valuable system interface tested to support the PCT stakeholder community.

- **RDS Receiver**

The RDS receiver developed by the team has benefited and will continue to benefit vendors selling equipment in the State of California, as well as nationally, by providing a means to familiarize themselves with RDS and possibly integrate and test the technology with their products.

- **RDS Site Survey Tool**

Since it is critical that RDS communication works reliably for demand response, the site survey tool and methodology developed can benefit the state by assisting the development of the communication network, receivers, and protocol.

- **Systemic Control Research**

The systemic control research performed by the team is of enormous benefit to the electrical utilities and Energy Commission regulators in providing a way to predict the system impact of PCT control signals. Continued research with this simulation tool could benefit the regulators, utilities, and customers by uncovering valuable load management strategies that could prevent costs associated with peak electricity use and also by preventing potential costs of unforeseen consequences of load control actions such as system instabilities.

References

- Andersen, J.B., T.S. Rappaport, and S. Yoshida. 1995. Propagation Measurements and Models for Wireless Communications Channels. *IEEE Communications Magazine*, January.
- American Society of Heating, Refrigerating, and Air Conditioning Engineers (ASHRAE). 2001. *ASHRAE Fundamentals Handbook*. pp. 30.13 - 30.14. Atlanta, GA: ASHRAE.
- Auslander, D.M., J.R. Ridgely, and J.M. Ringgenberg. 2002. *Control Software for Mechanical Systems: Object-Oriented Design in a Real-Time World*. Prentice Hall PTR.
- Bellarmino, G.T. 2000. Load management techniques. *Proceedings of the IEEE, Southeastcon 2000*: pp. 139 - 145.
- Boland, Rick. 2006. Questions on AM/FM Infrastructure for Title 24 Demand Response Programs. Open letter to Title 24 PCT stakeholders, March 31.
- California Energy Commission. 2007. "Electricity Substations in California." File available for download from *California Energy Commission DATABASES*. Unknown modification date. Available online: <http://www.energy.ca.gov/database/index.html>.
- California Energy Commission. 2004. *California 2001 Electric Utility Retail Deliveries*. Webpage, last modified June 23. http://www.energy.ca.gov/electricity/utility_sales.html.
- California Statewide Residential Appliance Saturation Survey*. 2004. California Energy Commission Publication #400-04-009. <http://www.energy.ca.gov/appliances/rass/index.html>.
- Calloway T.M., and C.W. Brice. 1982. Physically-based Model of Demand with Applications to Load Management Assessment and Load Forecasting. *IEEE Transactions on Power Apparatus and Systems* 101 (12).
- Demand Analysis Office, California Energy Commission. 2007. *2005 Electricity Usage During Peak Periods*. Webpage, last modified June 19. http://www.energy.ca.gov/electricity/peak_loads.html.
- Federal Communications Commission (FCC). 2007. *FMQ FM Radio Database Query*. Online database query of the FCC *Consolidated Database System*. <http://www.fcc.gov/fcc-bin/audio/fmq.html>
- Herrington, Donald, and Stanley Meacham. 1968. *Handbook of Electronic Tables & Formulas*, 3rd Ed. Indianapolis, IN: Howard W. Sams & Co.
- Herter, K., P. McAuliffe, and A. Rosenfeld. 2007. An exploratory analysis of California residential customer response to critical peak pricing of electricity. *Energy* 32 (1).
- Hofmann, Ron. 2005. PCT System Integration Interfaces. Presentation at the California Energy Commission's *Staff Workshop on Programmable Communicating Thermostat System Interface Framework*, November 29. <http://www.energy.ca.gov/title24/2008standards/documents/index.html#112905>

- Huizenga, C., and C. Barnaby. 1985. Methodology for Hourly Simulation of Residential HVAC Equipment. *First National Conference on Microcomputer Applications for Conservation and Renewable Energy*.
- Ihara, S., and F.C. Schweppe. 1981. Physically Based Modeling of Cold Load Pickup. *IEEE Transactions on Power Apparatus and Systems* 100 (9).
- Katipamula, S., and N. Lu. 2006. Evaluation of Residential HVAC Control Strategies for Demand Response Programs. *ASHRAE Transactions* 112 (1).
- Mortensen, R.E., and K.P. Haggerty. 1990. Dynamics of heating and cooling loads: models, simulation, and actual utility data. *IEEE Transactions on Power Systems* 5 (1).
- Mortensen, R.E., and K.P. Haggerty. 1988. A stochastic computer model for heating and cooling loads. *IEEE Transactions on Power Systems* 3 (3).
- Lu, N., D.P. Chassin, and S.E. Widergren. 2005. Modeling uncertainties in aggregated thermostatically controlled loads using a state queuing model. *IEEE Transactions on Power Systems* 20 (2).
- National Radio Systems Committee. 1998. *United States RBDS Standard, April 9, 1998*.
<http://www.nrcstandards.org/Standards.asp>.
- NXP. 2006. *NXP FM stereo IC's with RDS and AM options TEA57xx for portable applications*. Online brochure, last modified October 5.
http://www.nxp.com/acrobat_download/literature/9397/75015725.pdf.
- NXP. 2005. *TEA5764HN Product Data Sheet, Rev. 02 – 9 August 2005*. Available online:
http://www.nxp.com/acrobat/datasheets/TEA5764HN_2.pdf.
- Shirakh, Mazair. 2006. Draft Energy Commission Vision. Presentation at the California Energy Commission's *Staff Workshop on Programmable Communicating Thermostat System Interface Framework*, February 16.
<http://www.energy.ca.gov/title24/2008standards/documents/index.html#021606>.
- Suh, N.P. 1990. *The Principles of Design*. New York: Oxford University Press.
- Title 24 PCT Technical Working Group. 2007. *Reference Design for Programmable Communicating Thermostats Compliant with Title 24-2008, Version 1.00*. Online document, last modified April 26. <http://sharepoint.californiademandresponse.org/pct/default.aspx>.
- United States Census Bureau. 2003. *Census 2000 Data for the United States*. Available online:
<http://www.census.gov/census2000/states/us.html>.
- Wong, Ken. 2006. Re: Budgetary pricing for TEA5764HN. Personal e-mail, sent October 20.
ken.wong@nxp.com.
- Zimmermann, Hubert. 1980. OSI Reference Model – The ISO Model of Architecture for Open Systems Interconnection. *IEEE Transactions on Communications* 28 (4).

Note: All Internet-based references should be assumed to have been last accessed at the time of report publication.

Glossary of Acronyms and Definitions

Acronyms

| | |
|--------|---|
| A/C | Air Conditioning |
| A/D | Analog to Digital |
| AC | Alternating Current |
| ADC | Analog-to-Digital Converter |
| AM | Amplitude Modulation |
| AMI | Advanced Metering Infrastructure |
| ANSI | America National Standards Institute |
| ARM | Advanced RISC Machine |
| BOM | Bill of Materials |
| CAISO | California Independent System Operator |
| CALRES | <i>See "CALRES" in Definitions</i> |
| CDMA | Code Division Multiple Access |
| CIM | Common Information Model |
| COTS | Commercial, Off-the-Shelf |
| CPU | Central Processing Unit |
| dBi | Antenna gain relative to ideal isotropic radiator (1 dBi) |
| dBm | Electric power relative to 1 mW (1 dBm) |
| dBuV | Electric field strength relative to 1 microvolt/meter (also dBuV/m) |
| DC | Direct Current |
| DR | Demand Response |
| DSL | Digital Subscriber Line |
| DSSS | Direct Sequence Spread Spectrum |
| EMF | Electromagnetic Field |
| FCC | Federal Communications Commission |
| FHSS | Frequency Hopping Spread Spectrum |
| FLEX | <i>See "Flex Paging" in Definitions</i> |

| | |
|------------------------------------|--|
| FM | Frequency Modulation |
| GPS | Global Positioning System |
| GSM | Global System for Mobile Communications |
| HAN | Home-Area Network |
| HAN | Home-Area Network |
| HD | High Definition |
| HMI | Human-Machine Interface |
| HVAC | Heating, Ventilation, and Air Conditioning |
| I/O | Input/Output |
| I ² C, I ² C | Inter-Integrated Circuit |
| IC | Integrated Circuit |
| IOU | Investor-Owned Utility |
| IP | Internet Protocol |
| ISM | Industrial, Scientific, and Medical |
| ISO | Independent System Operator |
| LAN | Local-Area Network |
| LCD | Liquid Crystal Display |
| LED | Light-Emitting Diode |
| LLC | Logical Link Control |
| LSE | Load Serving Entity |
| MAC | Media Access Control |
| MCU | Microcontroller Unit |
| MMC | MultiMedia Card |
| MRTU | Market Redesign Technology Update |
| NEC | National Electrical Code |
| NOC | Network Operating Center |
| NRE | Non-Recurring Engineering |
| ODE | Ordinary Differential Equation |

| | |
|--------|---|
| OLED | Organic LED |
| OS | Operating System |
| OSI | Open Systems Interconnection |
| PCMCIA | Personal Computer Memory Card International Association |
| PCT | Programmable Communicating Thermostat |
| PG&E | Pacific Gas and Electric |
| POC | Proof-of-Concept |
| POU | Publicly Owned Utility |
| PT | Programmable Thermostat |
| PWM | Pulse Width Modulation |
| R&D | Research and Development |
| RBDS | Radio Broadcast Data System |
| RDS | Radio Data System |
| RF | Radio Frequency |
| RFP | Request for Proposal |
| RFQ | Request for Quote |
| RTOS | Real Time Operating System |
| SCADA | Supervisory Control and Data Acquisition |
| SCE | Southern California Edison |
| SCSI | Small Computer System Interface |
| SDG&E | San Diego Gas and Electric |
| SDIO | Secure Digital Input/Output |
| SI | System Interface |
| SMUD | Sacramento Municipal Utility District |
| SPI | Serial Peripheral Interface |
| SPOT | Smart Personal Objects Technology |
| SVP | Silicon Valley Power |
| TCP/IP | Transmission Control Protocol / Internet Protocol |

| | |
|------|--------------------------------------|
| TDMA | Time Division Multiple Access |
| TOU | Time-of-Use |
| TV | Television |
| UCI | Utility Communication Infrastructure |
| UL | Underwriters Laboratories |
| UML | Unified Modeling Language |
| UNIX | <i>See "UNIX" in Definitions</i> |
| USB | Universal Serial Bus |
| UWB | Ultra Wideband |
| VAC | Volts AC |
| VDC | Volts DC |
| WAN | Wide-Area Network |
| WLAN | Wireless Local-Area Network |
| WPAN | Wireless Personal-Area Network |
| WUSB | Wireless Universal Serial Bus |
| XML | Extensible Markup Language |

Definitions

| | |
|-----------------|--|
| ANSI C12 | Series of ANSI standards that pertain to electricity metering. |
| Apparent Power | Apparent Power (Kva , kilovolts-amps) is the vector sum of the Real Power and Reactive Power. (See Real Power, Reactive Power, and Power Factor) |
| CALRES | California non-residential building simulation software released by the California Energy Commission. |
| Demand Response | Reducing demand in response to a curtailment notification or short term price signal. |
| Dynamic Tariff | A tariff in which the retail electricity rate is characterized by one or more dispatchable prices intended to reduce and/or shift peak load. (See Tariffs) |
| Firmware | Software that is embedded in the electronic device. |

| | |
|----------------------|---|
| FLEX Paging | A proprietary protocol for paging networks developed by Motorola. |
| Local-Area Network | A network consisting of nodes that are confined within a localized area. For example, a floor of a building, or the building itself. (See Wide-Area Network) |
| Modbus | An industrial serial communication protocol. |
| Modulation | Method of superimposing a signal on a carrier wave form. For example, in radio broadcasts, AM (amplitude modulation) and FM (frequency modulation) are used. |
| Multi-phase | Alternating current (AC) electricity that consists of more than one phase of current. For example, common residential 240V AC power used for electric ovens and clothes dryers is multi-phase. (See Single-phase) |
| Non-contact | No physical connection to the current-carrying wire. |
| PCT Reference Design | Refers to the document <i>Reference Design for Programmable Communicating Thermostats Compliant with Title 24-2008</i> . |
| Platform | Hardware and software with the ability to perform multiple functions |
| Power Factor | Ratio of Real Power to Apparent Power. Also the cosine of the angle between the Real Power vector and the Apparent Power vector. (See Apparent Power, Real Power, and Reactive Power) |
| Reactive Power | Electrical power (Kvar, kilovolts-amps reactive) consumed by a capacitive or inductive load. The Reactive Power vector is orthogonal to the Real Power vector. (See Apparent power, Real Power, and Power Factor) |
| Real Power | Electrical power (KW, kilowatts) consumed by a resistive load and is the power that is used for real work. The Real Power vector is orthogonal to the Reactive Power vector. (See Apparent power, Reactive Power, and Power Factor) |
| Revenue Meter | Meter that can be used for billing purposes. |
| Revenue-grade | Measuring accuracy that meets the requirements needed for billing purposes. |
| Single-phase | Alternating current (AC) electricity that consists of one phase of current. For example, common residential 120V AC power is single-phase. (See Multi-phase) |
| Soft | Can be re-programmed with new software. |

| | |
|--------------------------------------|--|
| Stranded | Made obsolete because the technology is no longer supported. |
| Tariffs | The effective rates for electricity that includes rules, rate schedules, and service area maps. |
| Title 24 | California residential and non-residential building energy efficiency codes. |
| Title 24 PCT Technical Working Group | An industry based working group tasked with establishing industry standard specifications for PCT system interfaces. |
| Title 24-2008 | Year-2008 updates to Title 24 regulations. |
| UNIX | A computer operating system originally developed at Bell Labs. |
| Web Services | A modular collection of web-protocol based applications that can be mixed and matched to provide business functionality through an internet connection. Web services use standard Internet protocols such as HTTP, XML, and SOAP to provide connectivity and interoperability between companies. |
| Wide-Area Network | A network consisting of nodes that are dispersed over a wide area. For example, nodes that are located in different buildings, or in different cities. (See Local-Area Network) |
| Wireless | No wires between source of information and receiver of the information |