

Lawrence Berkeley National Laboratory

Lawrence Berkeley National Laboratory

Title

Final Report of Project Nanometer Structures for Fuel Cells and Displays, etc.

Permalink

<https://escholarship.org/uc/item/4321v0jr>

Author

Ji, Qing

Publication Date

2012-05-18

Final Report of Project
Nanometer Structures for Fuel Cells and Displays, etc.

Qing Ji
Lawrence Berkeley National Laboratory, Berkeley, CA 94720, U. S. A.

Executive Summary

Low-energy ion beam bombardment induced self-assembly has been used to form various periodic nano-size wave-ordered structures (WOS).^{1,2} Such WOS can be used as hard etching masks to produce nanowire arrays, trenches etc., on other materials by means of traditional etching or ion sputtering. These periodic nano-size structures have a wide range of applications, including flat panel displays, optical electronics, and clean energy technologies (solar and fuel cells, lithium batteries).

In order to achieve high throughput of the above processes, a large area RF-driven multicusp nitrogen ion source has been developed for the application of nitrogen ion beam induced surface modification. An integrated ion beam system, which can house either a large area RF-driven multicusp ion source or a commercially available microwave ion source (Roth & Rau AG Tamiris 400-f) have been designed, manufactured, assembled, and tested.

Participants

DOE Laboratory:

Qing Ji
Lawrence Berkeley National Laboratory, LBNL
1 Cyclotron Road, MS05R121, Berkeley, CA,
94720-8232, USA

+1(510)486-4802
QJi@lbl.gov

US Company:

Gregory King
Wostec, Inc.

345 Edgehill Way, San-Francisco, CA, 94127, USA
+1(415)902-4721
gking@wostec.com

Russian Institute:

Dmitri A. Karpov

phone number: +7(812)462-7822

fax number: +7(812)464-4191

e-mail address: karpov@niiefa.spb.su

Leading Institute:

Federal State Unitary Enterprise "D.V. Efremov Scientific Research Institute
of Electrophysical Apparatus"

Doroga na Metallostroy 3, St. Petersburg, 196641, Russia

+7(812)464-8963
filatov@niiefa.spb.su

Introduction and Overview

One of the consequences of the well-known Moore's Law is that lesser dimensions are of the utmost importance in increasing the productivity and reducing the product cost, as demonstrated for many commercial and consumer goods.

The project primary scope is to collaborate on the development of industrial technology for formation of various periodic nano-size structures on the basis of the original WOS technology [1-2] and the wide-aperture multi-cusp ion source. These periodic nano-size structures have a wide range of applications, including flat panel displays, optical electronics, clean energy technologies (solar and fuel cells, lithium batteries), and other potential areas.

The genesis of the Project is bringing together two complementary technologies allowing for production of precise nanostructures over large area in a way that is significantly less expensive than traditional methods, such as lithography for example:

- The patent technology of nanorelief formation (Assignee: Wostec, Inc.) employing the self-forming phenomenon to create Wave Ordered Structures (WOS) by low-energy ion beam bombardment. Such a WOS nanorelief is used as hard etching masks to produce the required structures, as, for example, nanowire arrays, trenches, quantum sources, etc., on other materials by means of traditional etching or ion sputtering.
- The multi-cusp ion beam technology well adapted to formation of large-area WOS patterns. This technology has been developed over the past few decades by the LBNL Ion Beam Technology Group and deployed in several other application areas.

The Project provides an important step forward in commercialization of the WOS technology for formation of periodical nano-structures, while increasing the area of treated targets, making it possible to use this technology for manufacturing of various commercial products. WOS technology provides low-price contact-free method for creating of periodic nano-structures systems.

Project Accomplishments

- One complete-set of a universal system for $200 \times 200 \text{ mm}^2$ plates processing has been manufactured. This system can house two different ion sources to fulfill the goal of the project – one is the large area RF-driven multicusp ion source developed in LBNL, and the other is a microwave-driven ion source acquired from Roth & Rau AG (Tamiris 400-f).
- Two large area RF-driven multicusp ion sources have been manufactured in LBLN. One is kept in LBNL for local testing. The other will be delivered to WOSTEC.
- Testing and characterization of the LBNL RF ion source have been performed and completed.
- An integrated system design has been performed in LBNL, which uses a compact rectangular vacuum chamber. Drawings have been generated.
- Another design of the integrated system was performed in parallel in Efremov. The integrated design of the system including ion processing module, pumping and gas puffing sub-system, control sub-system is performed. Work drawings are generated too.
- The specifications of all the sub-systems have been formulated:
 - Linear ion source provided ion current density $\sim 1 \text{ mA/cm}^2$ with inhomogeneity $\pm 5\%$ (along ion beam), beam divergency $\pm 5\%$ and beam wide 50 mm.
 - Ion processing module (vacuum chamber; work stage, including sample holder, its movement mechanism, its inclination mechanism, its water cooling system; line of Faraday cups; vacuum chamber wall warming-up system; the protective screen).
 - Sub-system of pumping and gas puffing (forevacuum pump, high-vacuum pump, pressure control in vacuum chamber and ion source, gas-puffing into ion source).
 - Sub-system of the control and power supply.
- All the subsystems have been purchased, manufactured, and assembled.

- Testing and characterization of the system with Tamiris 400-f R&R ion source has been performed. The main characteristics of the system meet required specifications.

RF-driven multicusp ion source

A large area RF-driven multicusp nitrogen ion source has been developed in Lawrence Berkeley National Laboratory for the application of nitrogen ion beam induced surface modification. Figure 1 shows the schematic drawing of the integrated nitrogen ion beam system, including the ion source, matching network, vacuum chamber and pump, and linear translation stage etc.

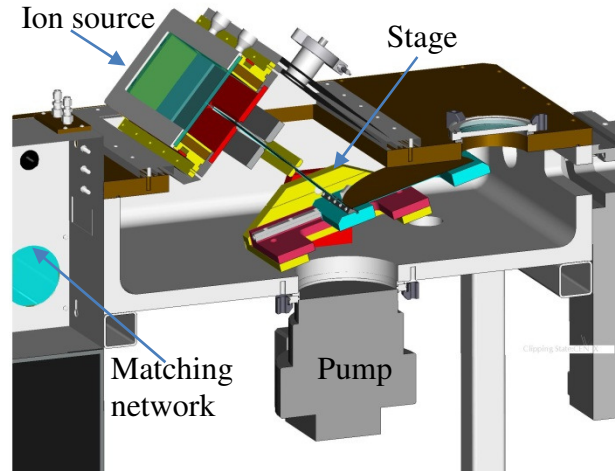
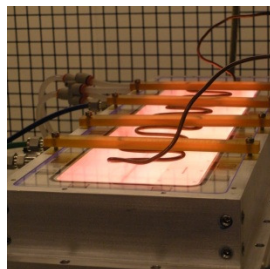

FIG. 1. Schematic drawing of the nitrogen ion beam system.

1. Large area RF-driven nitrogen ion source

1.1. Ion Source Configuration



(a)

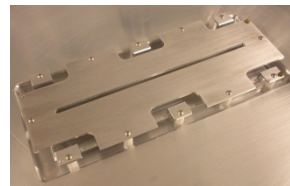

(b)

FIG. 2. (a) RF-driven multicusp nitrogen ion source and (b) 3-grid extraction system.

A large area RF-driven multicusp ion source has been developed to produce a uniform slit nitrogen ion beams for generating WOS on a 200-mm-diameter substrate with high throughput. As shown in Figure 2(a), the ion source chamber is of rectangular shape with 45 cm in length and 10 cm in width, with an air-cooled quartz window as the back plate. RF power (at 13.6 MHz) is coupled through the window to the plasma using a planar external antenna. Water-cooled permanent magnets are embedded in the rectangular wall to create the “multicusp” magnetic

configuration for improved plasma confinement. The wall material is aluminum. The quartz window is o-ring sealed directly to the chamber wall. At normal operation condition, the pressure of the ion source chamber is typically 11 mTorr. A nitrogen ion beam was extracted from a 0.2×20 cm slit and accelerated up to 6 keV using the 3-grid extraction system in Figure 2(b).

1.2. RF antenna configuration

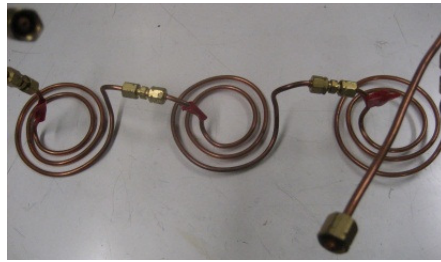

(a)

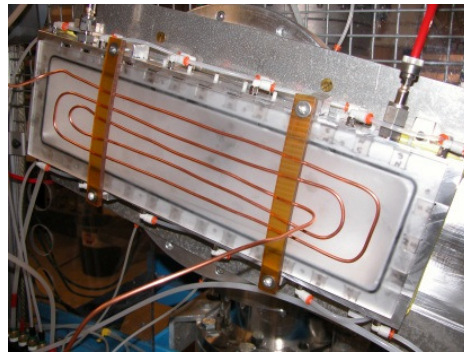

(b)



(c)

FIG. 3. Various shapes of RF antenna have been tested to achieve uniform plasma density.

As shown in Figure 3, various shapes of the RF antenna have been tested in order to achieve uniform plasma density. Langmuir probe measurements indicate that the serpentine shape in Figure 3(c) is the best among the three.

1.3. Uniformity measurement

Beam uniformity along the ion source was also measured using the following approach: ions are extracted from 17 round apertures, each of which is 1 mm in diameter and 1.25 cm apart along the 20-cm slit. A faraday cup, with a 4-mm-wide collimating slit on the top, was used to scan across the beam, as shown in Figure 6. The collimator is narrow enough so that there is no cross-talk between each beamlets.

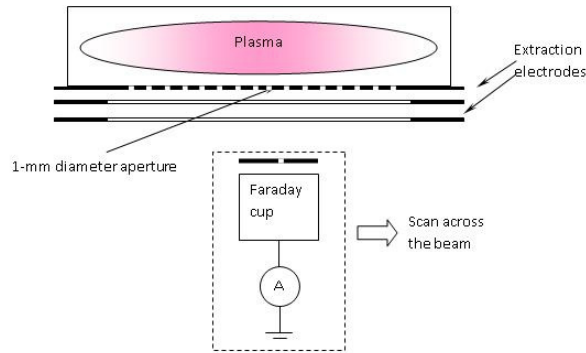

FIG. 4. Experimental setup of beam uniformity measurement.

2. EXPERIMENTAL RESULTS

2.1. Nitrogen ion species

Nitrogen was used in the experiment. The source was operated at around 11 mTorr. In nitrogen plasma, there are not only atomic ions N^+ , but also molecular ions N_2^+ . Mass spectrum of nitrogen plasma generated in this RF-driven ion source has been measured using a magnetic mass spectrometer. Figure 5 shows the fraction of both the species in the plasma as a function of input RF power. The ion source was operation in pulsed mode. At RF power of 5 kW, the atomic fraction of the nitrogen ion species is approximately 70%.

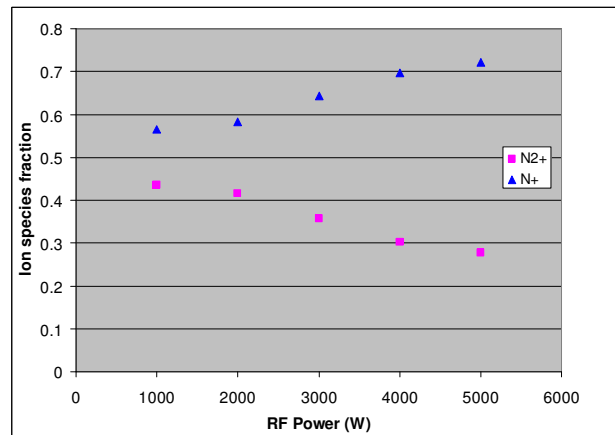

FIG. 5. Nitrogen ion species fraction vs. RF power.

2.2. Extracted current density

Ion beam were extracted through an aperture of 2 mm in diameter. The measured current density as a function of RF (13.56MHz) power is plotted in Fig. 6. The current density increases with the input RF power linearly when the power is lower than 3 kW. It falls off the linearity as the power is higher than 4 kW, which is due to the limited extraction voltage in the experimental set up. At 3000W, the extracted current density reaches approximately 100 mA/cm².

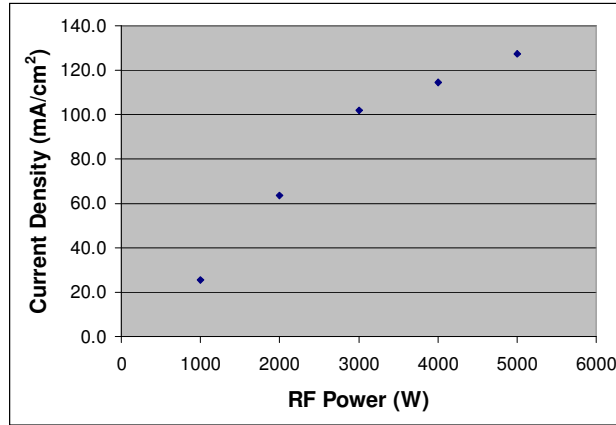

FIG. 6. Extracted ion beam current density as a function of input RF power.

2.3. Beam uniformity

The beam current distribution measured using this approach is plotted in Figure 7. The reason that the trend that the current density is higher on one side (labeled as negative) of the ion source than the other is believed to be caused by different voltage different at both ends of the antenna.

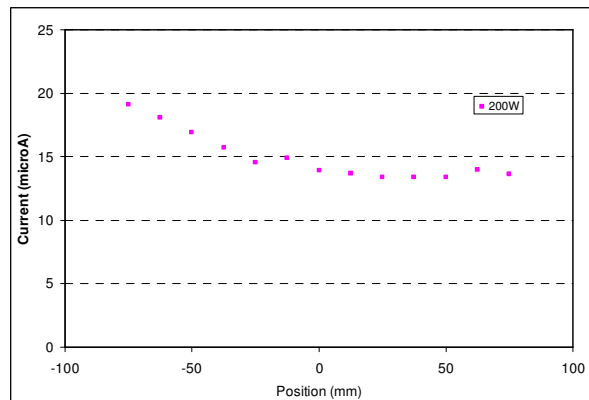

FIG. 7. Beam current distribution along the ion source.

ACKNOWLEDGEMENTS

The author would like to thank S. B. Wilde, T. McVeigh, and Glenn Jones for their technical support. This work is supported by Project LBNL-0209-RU of US Department of Energy (DOE) GIPP program under the DOE contract No. DE-AC02-05CH11231.

¹ V.K. Smirnov et al, “Wave-ordered structures formed on SOI wafers by reactive ion beams”, Nucl. Instru. and Meth. in Phys. Res. B 147, 310-315 (1999).

² V.K. Smirnov et al, “Technology for nanopericodic doping of a metal–oxide–semiconductor field-effect transistor channel using a self-forming wave-ordered structure”, Nanotechnology **14**, 709–715 (2003).

**Ion Beam Processing System featuring both RF ion source and R&R microwave ion source
(Work performed in Efremov, reported by Dmitri A. Karpov)**

3.1. Description of the system

The system includes:

- Ion processing unit;
- System of vacuum pumping and gas puffing;
- Control system
- System of technological ensuring.

The short description and work characteristics of sub-systems are given below.

3.1.1. Ion processing unit

Ion processing unit includes ion source, vacuum chamber, work stage with moving water-cooled sample holder and Faraday cups line placed under holder, block (two halogen 1 kW lamps) of warming up of the vacuum chamber inner surface, support.

Cylindrical part of the vacuum chamber is fabricated from 5 mm thickness SS (12X18H10T). The chamber has a rectangular port oriented under 25° to horizontal plane for placing of Tamiris 400-f ion source (or multi-cusp LBNL ion source through adapter), retractable flange with work stage and also vacuum-tight sockets for input/output water-cooling of sample holder and the screen of Faraday cups line, the flange for working gas and electric power inputs for neutralizers line, the flange for electrical feeding of heaters (lamps), the flange for electrical feeding of step motor of work stage and for output of Faraday cups signals etc., flanges for high voltage input to the electrodes of multi-cusp ion source extraction column, observation window. There are the socket ISO-200 in the lower part of the vacuum chamber for high vacuum pumping (turbo-pump 1000 l/s) and socket ISO-250 in the upper part of the vacuum chamber for additional high vacuum pump (App. 3.1, 3.2).

All vacuum inputs are performed with use of ECR-radiation protection seals.

The attachment Tamiris 400-f ion source flange is provided by the additional grooves for intermediate vacuumization and ECR radiation protection (with metal armour). The retractable flange is provided by the additional grooves too. Other technological vacuum seals are performed with ISO-KF and ISO-K types flange connectors with Viton seal and metal hoop. The flange DN63CF with metal seal is used for supplying neutralizer line, the flange DN40CF is used for Faraday cups signals output. Multi-pin vacuum inputs VACOM-VACUUM with metal seals are used as the electrical and water inputs as well as for thermocouple signals output.

The work stage with water cooled movable copper sample holder, frame-rocker for the variation of ion processing angle in the range $65\text{-}35^\circ$ (from normal to the sample holder plane) and the system of longitudinal movement of holder is placed on the retractable flange (App. 3.3).

The cooling of sample holder is provided by the water circulation in the copper pipe, placed in the milled-out channels and brazed to the holder.

The range of holder speed variation is 0.6 – 2.4 mm/s, the range of holder shift – 340 mm.

The Faraday cups line includes cups itself (5 pieces) placed on the 200 mm base (through 50 mm) of cups holder, SS screen with 5 holes (collimators) 6 mm in dia. and water cooling tube served as a support at the same time. The tube is mounted on the retractable flange with connecting branches (App. 3.4). Cups $\varnothing 16$ mm with cylindrical cavity $\varnothing 10$ mm are fabricated from copper. The axis of cups is oriented under 25° to horizontal line in accordance with ion beam axis inclination. The cups are open for ion beam in the extreme longitudinal positions of sample holder at any its inclinations.

3.1.2. System of vacuum pumping and gas puffing

The system is performed in accordance with requirements formulated by Wostec and LBNL on the study of conceptual design and with additional requirements called by the Tamiris 400-f ion source use.

It is accepted that a level of the vacuum 4×10^{-6} mbar is enough for realization of WOS technology.

The succession of the vacuum pumping (and gas puffing for LBNL multi-cusp ion source) is carried out by the control system of the facility. All of vacuum equipment commutations are carried out with control panel of visualization. After closing both retractable flange and air puffing valve it is turning on the oil free spiral forevacuum pump ISP-500C (Anest Iwata) for vacuum pumping up to pressure less than 0.1 mbar. The residual pressure is measured by the combined converter PKR 251 (Pfeiffer) and is displaying in real time mode in "vacuum window" on the control panel. At the achievement of the pressure level the value of 0.1 mbar the system is ready for high vacuum pumping with turbo-molecular pump TMP-1003LM (Shimadzu). The turning on and the state of turbo-pump (acceleration, work, deceleration) is displayed on control panel too. After achievement of the pressure level 4×10^{-6} mbar the chamber is ready for ion source operations.

The gas puffing into LBNL multi-cusp ion source is carried out with the mass flow controller 1179B (MKS Instruments). Current pressure measurements is carried out with baratron 626A (MKS Instruments).

Gas puffing control of Tamiris 400-f ion source is performed by the autonomous control system (after receiving the signal "Camera - OK").

After finishing ion processing procedure Tamiris 400-f ion source is turning off accordingly own scenario (For LBNL multi-cusp ion source: mass flow controller 1179B is closing and baratron 626A is switching off). Then turbo-pump TMP-1003LM is switching off. After stopping of the turbo-pump rotor, the forevacuum pump ISP-500C and converter PKR 251 are switching off and electromagnetic valve W213B (Danfoss) is switching on for puffing atmosphere into vacuum chamber. The chamber is ready for opening retractable flange.

Vacuum diagram of the facility with Tamiris 400-f ion source as well as enumeration and parameters of vacuum equipment are given in App. 3.5.

3.1.3. Control system

In the accordance with the conception of universal control system (App. 2.18) the general control rack (App. 3.6) provides control of: vacuum system, water cooling, the status of work stage, Faraday cups signals measurements and the status of retractable flange (open/closed). All of these data are displayed on the control panel (App. 3.7).

At the achievement of readiness criteria for ion processing (chamber is closed, cooling is ON, pressure is less than 4×10^{-6} mbar in the vacuum chamber, sample is in necessary position) the window "Camera - OK" of the control display become green color, and control signal goes to the Tamiris 400-f control rack. For LBNL multi-cusp ion source, the control of ion source is realized with the corresponding rack (App. 3.8), that is under high potential of the ion source body (up to 6 kV). So this rack is mounted on the insulators and power supply goes through divided transformer. The interconnection with the general control rack is carried out through opto-pairs.

3.1.4. System of technological providing

For the performance of the work on system testing and characterization it is used the laboratory water cooling system. It includes cooler machine BTXO-8-C-IIB(M) and water collector (App. 3.9).

The cool productivity (up to 10.2 kW) is enough for the cooling ion sources body, ECR generators, sample holder of work stage and vacuum pump with the required parameters ($p = 4-6$ mbar, $t = 18-20^{\circ}\text{C}$, $q = 10$ l/min).

The water collector (5 channels) is provided by the flow transducers in each channel (App. 3.10). The signals from transducers are using as blocking parameters.

One channel is used for supply of Tamiris Media-panel that controls water cooling and puffing of technological gases (App. 3.11).

3.2. Testing and characterization of the system parameters

Integration of the system with ion source Tamiris 400-f has allowed to perform the critically important works on Task 5 (Testing and characterization of the system parameters) and Task 6 (in the part of works on Sub-task 6.1. Integration, operation and data collection in first alpha level system).

It was performed test measurements of the critically important for WOS technology parameters – the spatial inhomogeneity and beam divergency. Besides it was checked also the possibility to achieve the necessary ion current density level of 1.5 mA/cm² at ion energy not less 2.5 keV.

The measurements of the spatial inhomogeneity were performed with Faraday cups line in the plane of work stage in different modes of ion source operations. It was varied ion energy, ECR radiation power in both generators of the source, nitrogen mass flow into the source. The values of inhomogeneity were

calculated with the both the standard expression σ/μ (where $\sigma = \sqrt{\frac{1}{N} \sum_{i=1}^N (x_i - \mu)^2}$ - standard deviation, μ

$= \frac{1}{n} \sum_{i=1}^n x_i$ - arithmetical mean value) and "more physical" mean deviation value $Q=(J_{\max} - J_{\min})/J_{\text{av}}$. If the

first values were varied in the range 4.5 – 8.5% (see the results in App.3.12, where values of Faraday cups currents and ion source conditions are given), the second values achieve the level of 30%. If it is real, it may lead to the local breach of the conditions of steady formation of WOS structures with given parameters.

Taking into account the possible (and known) not full reliability of such technique data it was performed additional measurements of beam inhomogeneity on the base of sputtering imprint profile data. For this aim it was used 200 mm Si plates with 500 nm SiO₂ coating. The ion beam scanning rate was 10 mm/s. The number of beam passes along plate was 30, 15 and 10 for ion energy values 1, 2 and 3 keV correspondingly.

The Tamiris 400-f ion source parameters were varied to achieve the modes with stable (without the breakdowns) work at the ion energy values of 2 – 3 keV. It was achieved at the decrease of nitrogen mass flow up to level around 10 sccm.

The summary data of longitudinal beam homogeneity and also source conditions are given in App.3.13. The corresponding data of current measurements are given here too.

The results of the treatment of the sputtering data are combined in Table 3.

Table 3

Ion energy, keV	Mean deviation	σ/μ	Remarks
1	±4.2%	±2.7%	On the length 200 mm
2	±9%	±4.3%	On the length 200 mm
	±5%	±2.8%	On the length 150 mm
3	±12%	±6.2%	On the length 200 mm
	±4.9%	±2.3%	On the length 170 mm

The curved (R = 250 mm) focusing grid were used in Tamiris 400-f ion source in order to provide necessary ion current density and wide of ion beam. But in this case the level of beam divergency (along

ion beam) is some increased ($\sim 10^\circ$) in comparison with planar focusing grid ($6 - 8^\circ$ along and across ion beam). As a compensation Roth & Rou company deliver two sets of the grids (curved and planar set). However Tamiris 400-f with the planar grids may provide ion current density up to 0.6 mA/cm^2 . So time of ion beam treatment must be some increased in this case.

On the base of these results the next conclusions are made:

1. Developed and manufactured universal system (with possibility to use Tamiris 400-f ion source as well as LBNL multi-cusp ion source) met the demands of WOS technology and demonstrated it's workability with Tamiris 400-f ion source.
2. The results of the system parameters charactrisation are shown that Tamiris 400-f parameters are fully corresponded to the work variant of key parameters co-ordinated with Wostec Inc.
3. It is accepted reasonably to prolong this activity (with Tamiris 400-f ion source as well as with LBNL multi-cusp ion source) for more detail investigation of WOS formation and optimization of industrial system design.

General view of the universal facility

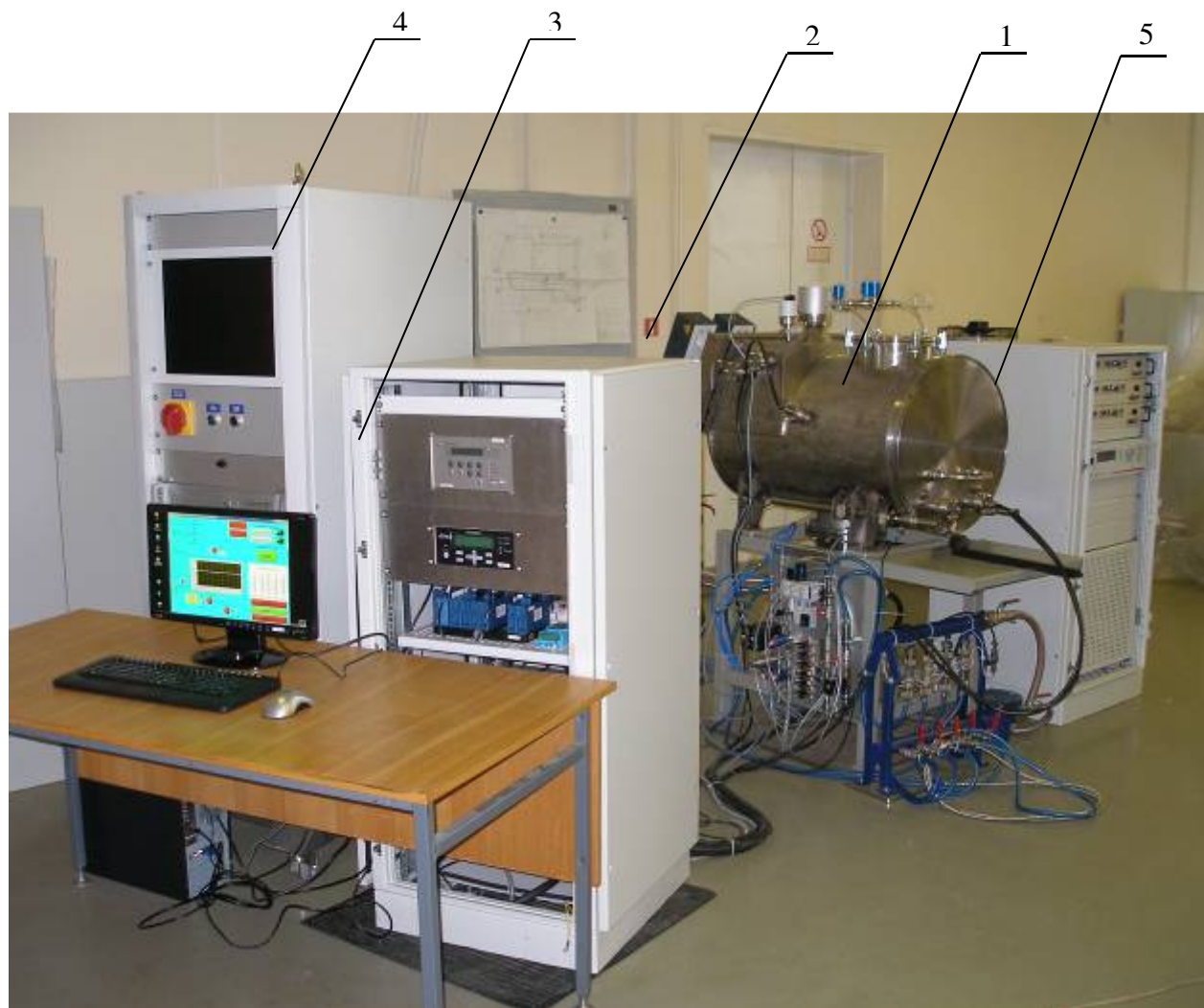

1 – vacuum chamber; 2 – ion source; 3 – general control rack;
4 – Tamiris 400-f ion source control rack; 5 – LBNL ion source control rack

Vacuum chamber

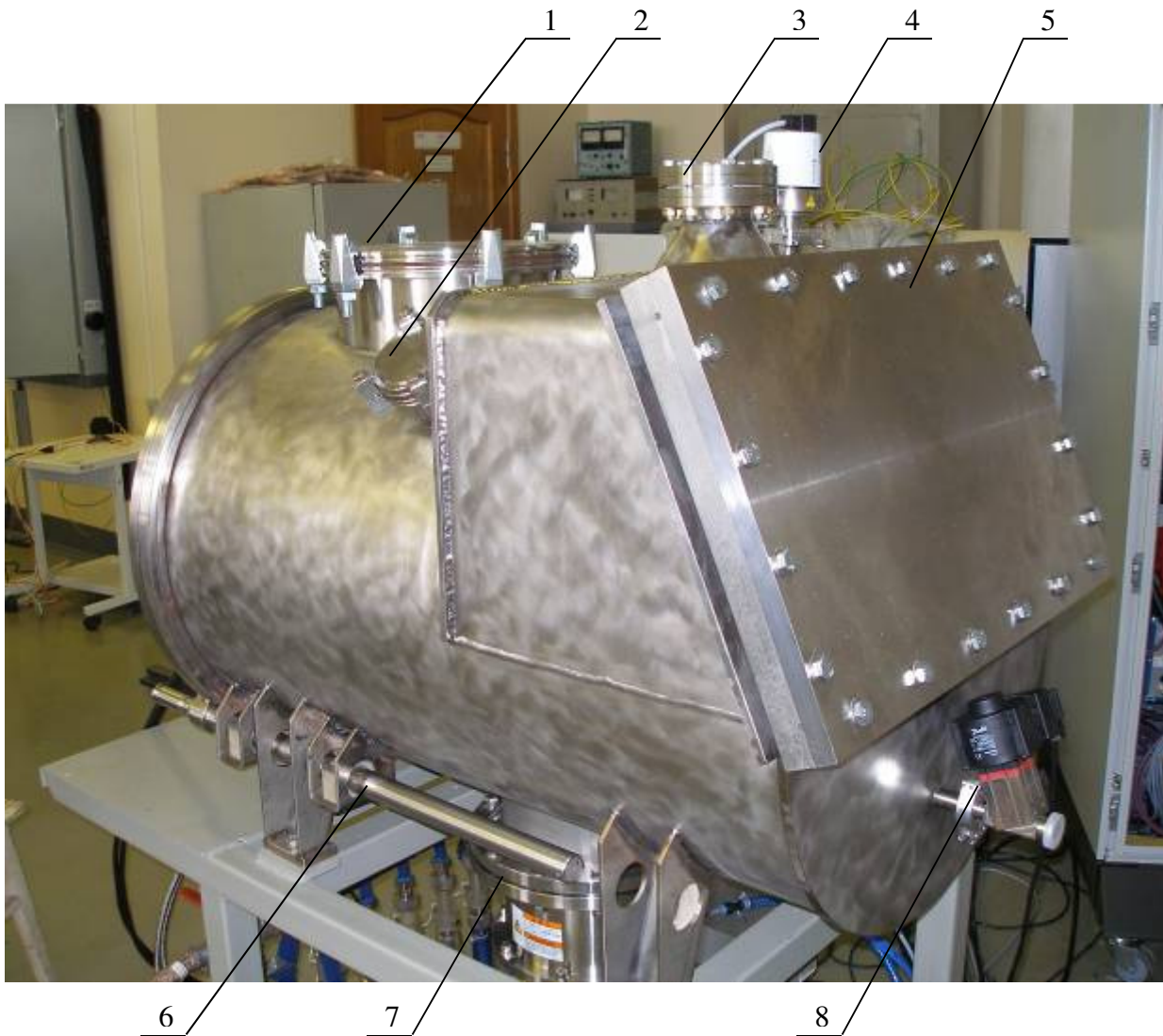

- 1 – flange for additional pump; 2 – observation window; 3 – neutralizer power socket;
4 – vacuum gauge; 5 – ion source port; 6 – rod of retractable flange drive; 7 – turbo-pump;
8 – air puffing solenoid valve

Vacuum chamber

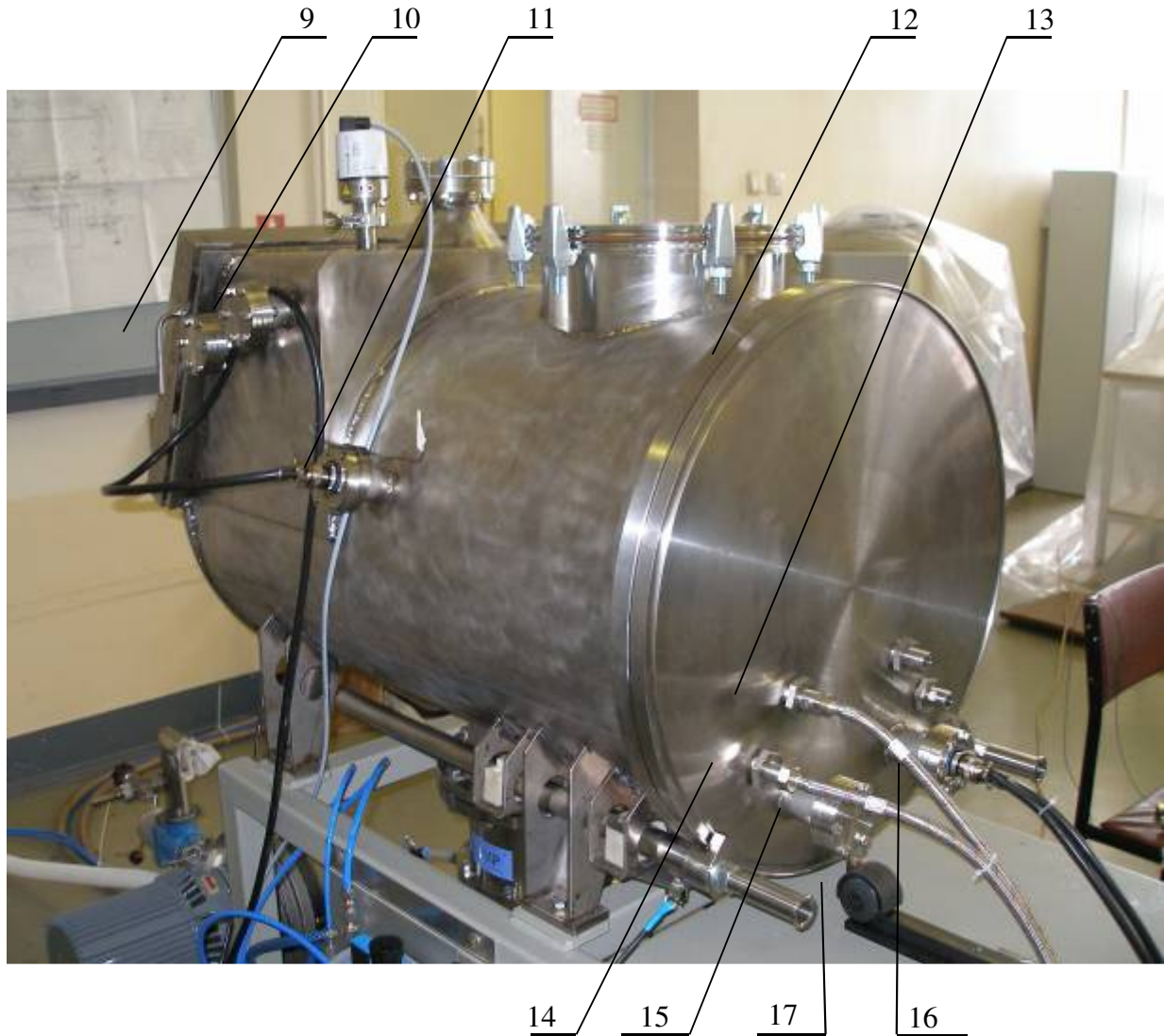

9, 10 – sockets of power supply for LBNL source extraction column; 11 – socket for power supply heating lamps; 12 – retractable flange; 13, 14 – water input/output; 15 – socket for thermocouple signal; 16 – socket of work stage communications; 17 – rolling support of retractable flange

Work stage

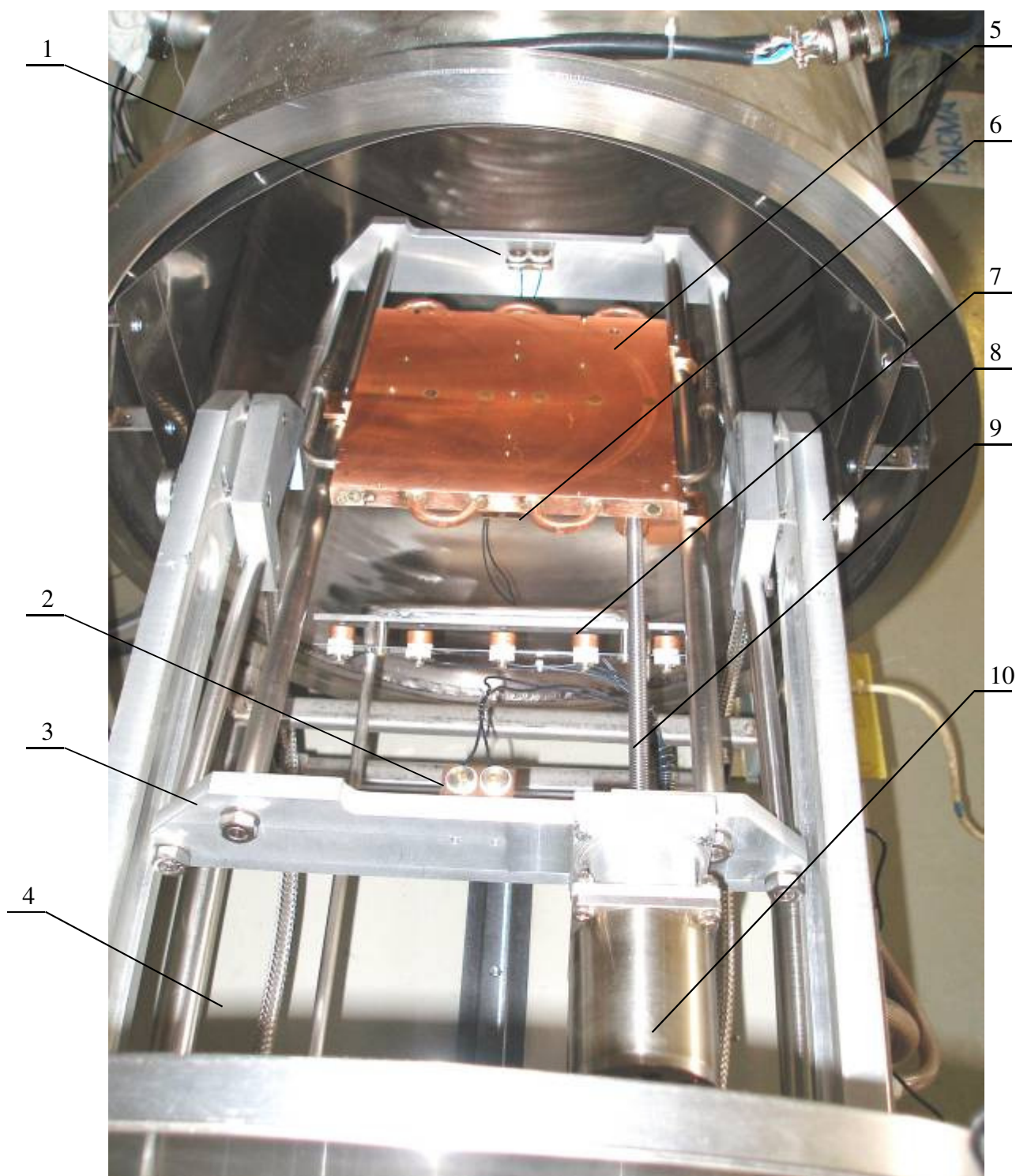

1, 2 – end switch; 3 – frame- rocker; 4 – flexible water pipe;
5 – sample holder; 6 – interconnection water pipe; 7 – Faraday cup;
8 – sample holder inclination variator; 9 – screw of sample holder moving supply;
10 – step motor

Faraday cups line



1 – input fitting; 2 – water pipe; 3 – screen; 4 – диафрагма; 5 – Faraday cup

Principal vacuum scheme with ion source Tamiris 400-f

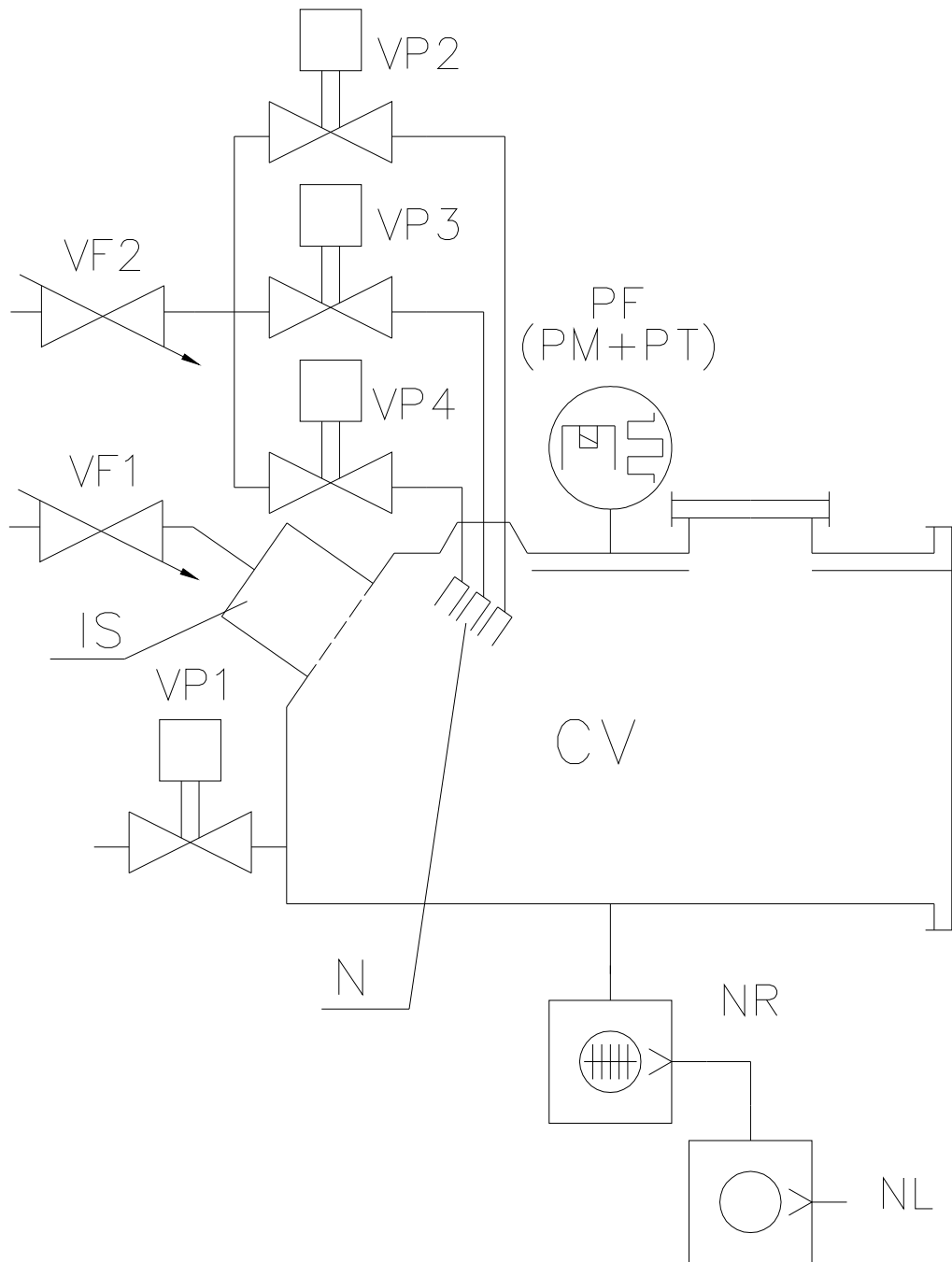

CV – vacuum chamber; IS – ion source; N – neutralizer; NL – scroll pump Anest Iwata ISP-500C; NR – turbomolecular pump Shimadzu TMP-1003LM; PF – Compact FullRange™ CC Gauge PKR 251 Pfeiffer (PM – cold cathode gauge and PT – Pirani gauge); VF1, VF2 – Mass-Flo® controller MKS Instruments Inc. 1179B; VP1 – solenoid valve Danfoss W213B; VP2...VP4 – pneumatic valve

List of vacuum equipment for pumping of the facility with ion source Tamiris 400-f

Item	Name	Description	Capability
1	NL	Scroll Pump Anest Iwata ISP-500C-SH	Pumping speed: 500 l/min, Ultimate pressure: ≤ 1 ($\leq 7,5 \times 10^{-3}$) Pa (Torr)
2	NR	Turbomolecular Pump Shimadzu TMP-1003LM Turbomolecular Pump Shimadzu TMP-1003LM with input flange ISO200-F, controller (220 VAC, 50 Hz), and connecting cable	Pumping speed (N ₂): 1080 l/s Ultimate pressure: 1×10^{-9} Pa
3	PF	Compact FullRange™ CC Gauge PKR 251 Two gauge heads (cold cathode and Pirani) in a single case (inverted magnetron), KF25	Measurement range from 5×10^{-9} to 1000 mbar
4	VF1, VF2	1179B01352CD1BV Mass-Flo® controller 1179B, (fitting KF16) and Two Channel Flow/Pressure Controller PR4000B-F2V2	Range – 50 sccm
5	VP1	Solenoid Valve W213B Danfoss Stainless Steel Inline Bellow Sealed Solenoid Pipeline Valve KF16, 220 - 240 V, 50/60 Hz, electrically opened, spring closed	Time to open 40 ms Time to close 100 ms
6	VP2...VP4	Pneumatic valve	

General control rack

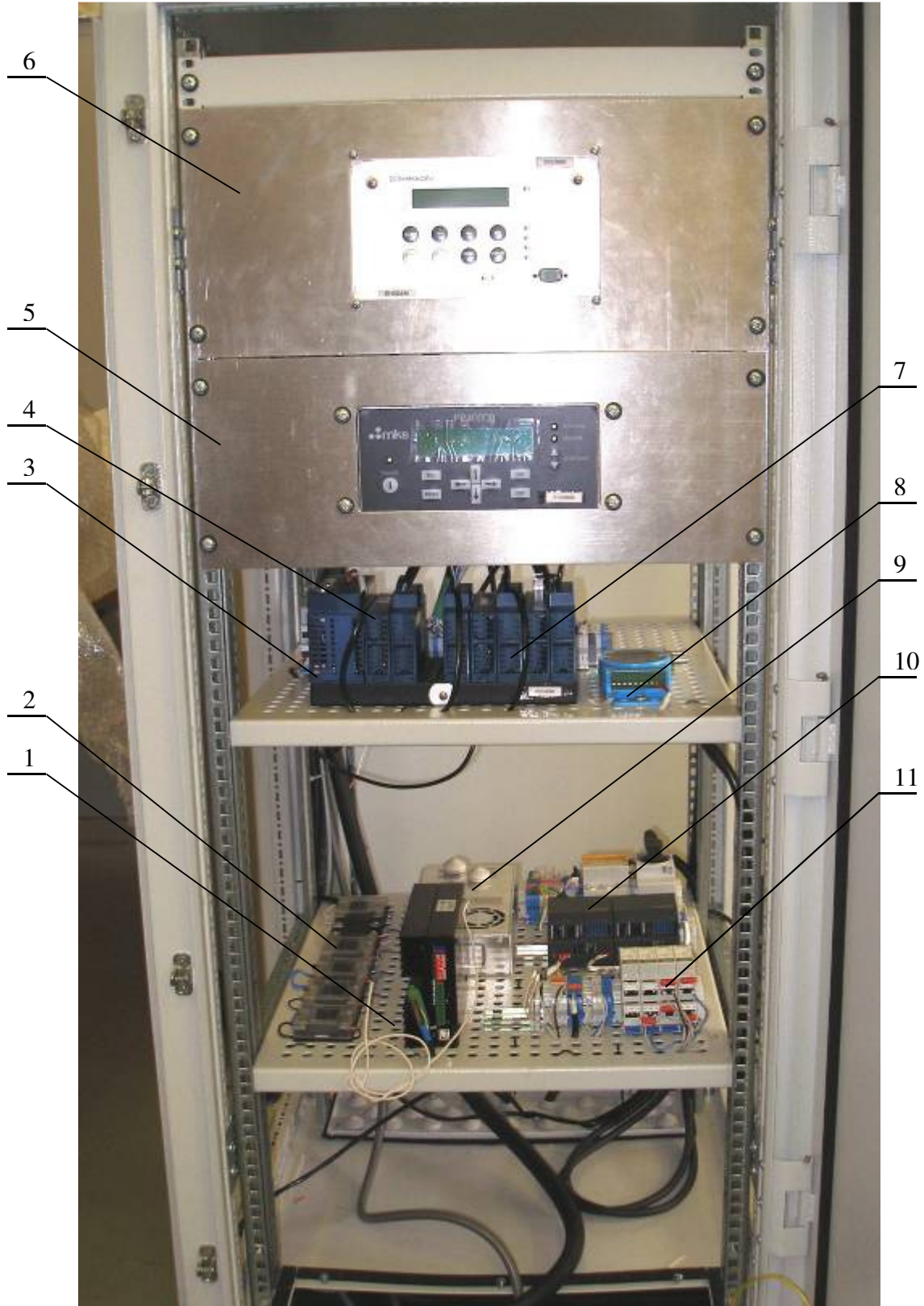

1 – TMP controller, 2 – baratron controller, 3, 7 – input/output modules,

4 – controller of control system, 5 – control relays of pumps, lamps, valves,
6 – controller of step motor, 8 – opto pair, 9 – power supply of step motor двигателя, 10 – power supplies
of controller and signal circuits, 11 – defense from measurement modules

Control panel

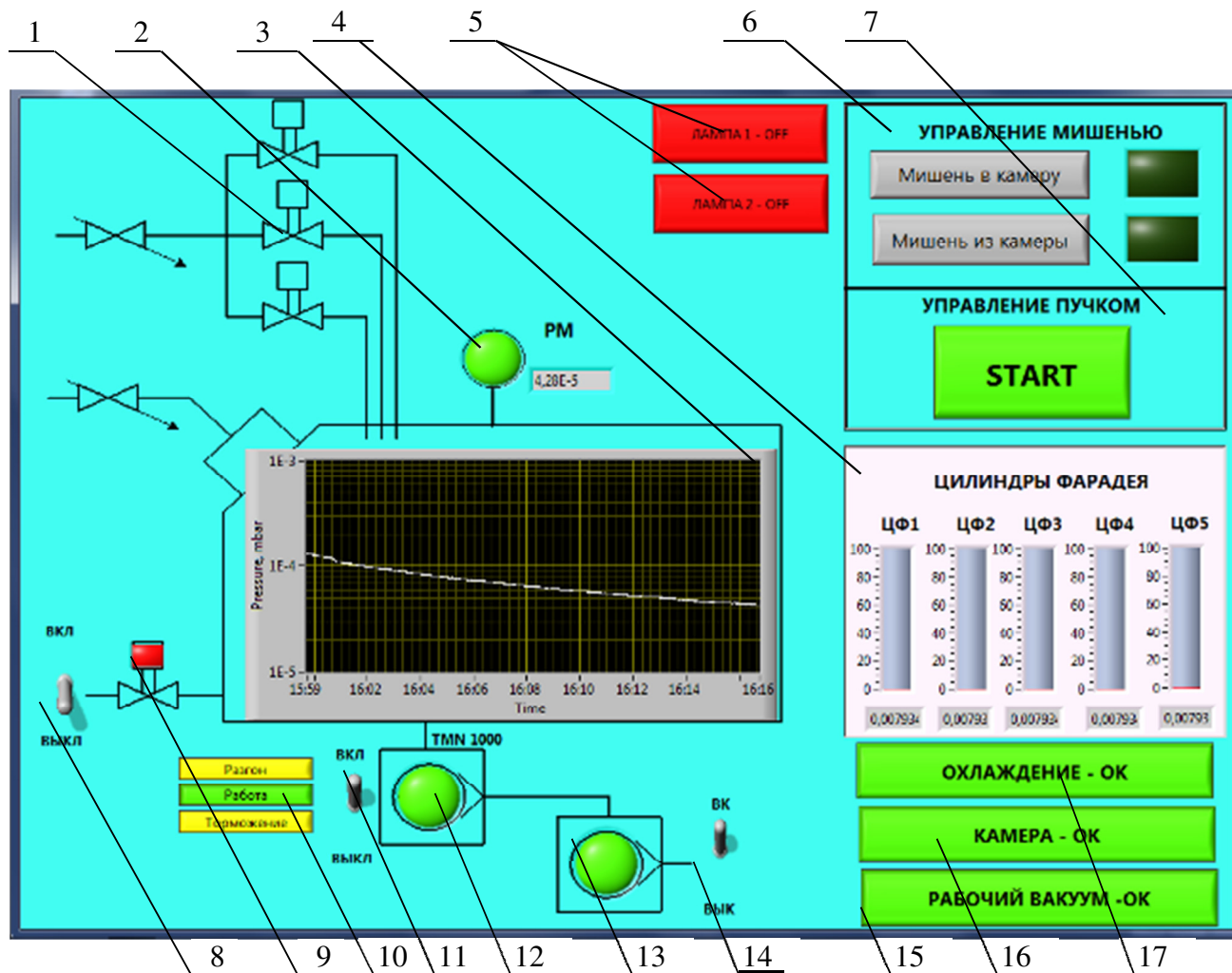

- 1 – area of multi-cusp source; 2 – vacuum gauge on/off; 3 – real time pressure in vacuum chamber; 4 – Faraday cups signals; 5 – heating lamps on/off; 6 – control of sample (into of chamber/out of the chamber; 7 – OK for ion beam; 8 – atmosphere valve on/off; 9 – indicator of valve position; 10 – turbo-pump state (acceleration/work/deceleration); 11 – turbo-pump on/off; 12 – on/off visualization (green/red); 13 - forevacuum pump on/off visualization (green/red); 14 – forevacuum on/off; 15 – work vacuum OK (green); 16 – vacuum chamber OK (green); 17 – water cooling OK (green)

Control rack of ion source LBNL

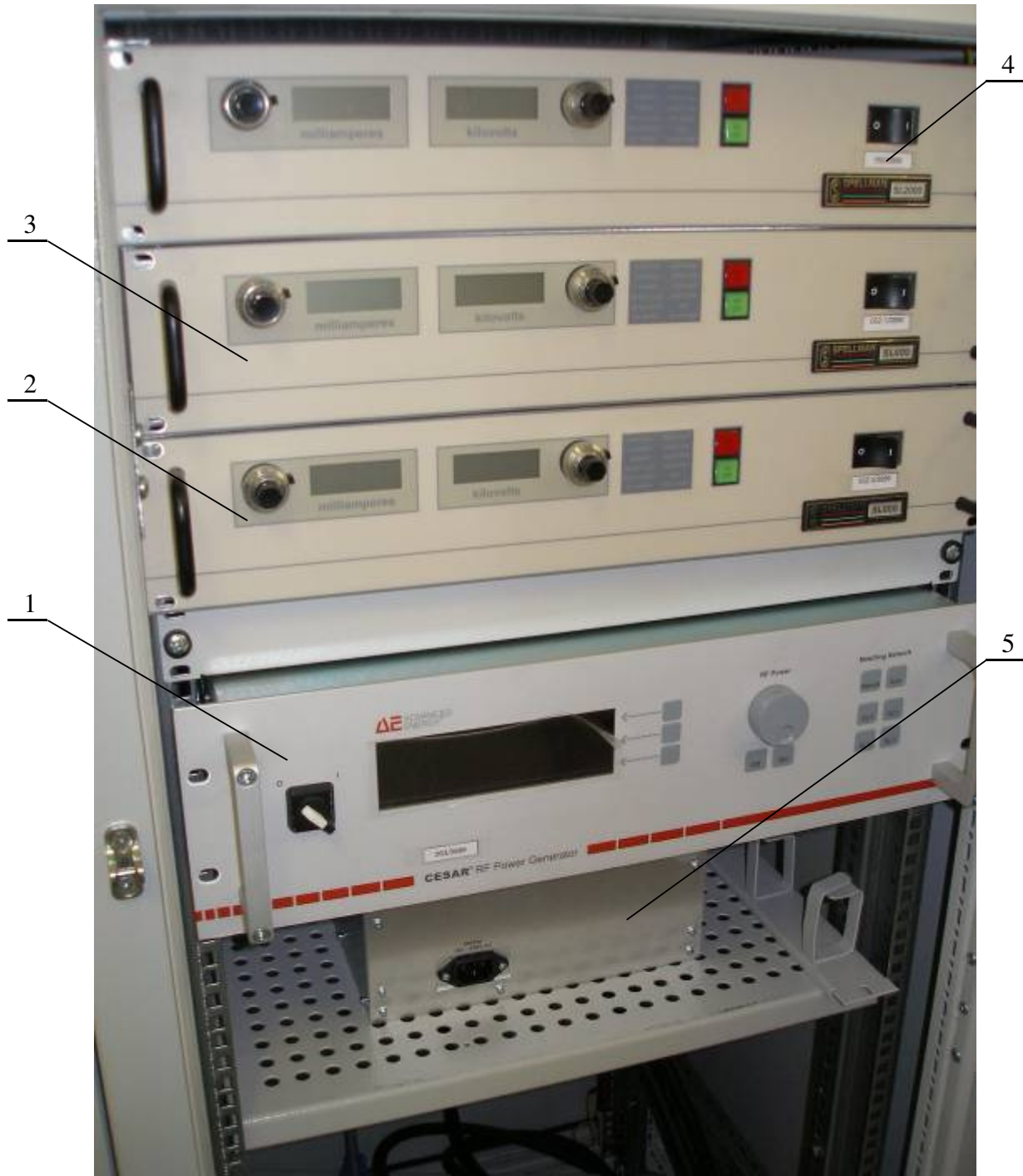

1 – RF power generator; 2, 3, 4 – HV power generators; 5 – auto-matching network

System of technological providing



1 – Tamiris 400-f media-panel; 2 – water cooler BTXO-8-C-IIB(M);
3 – water collector-distributor

Water collector-distributor

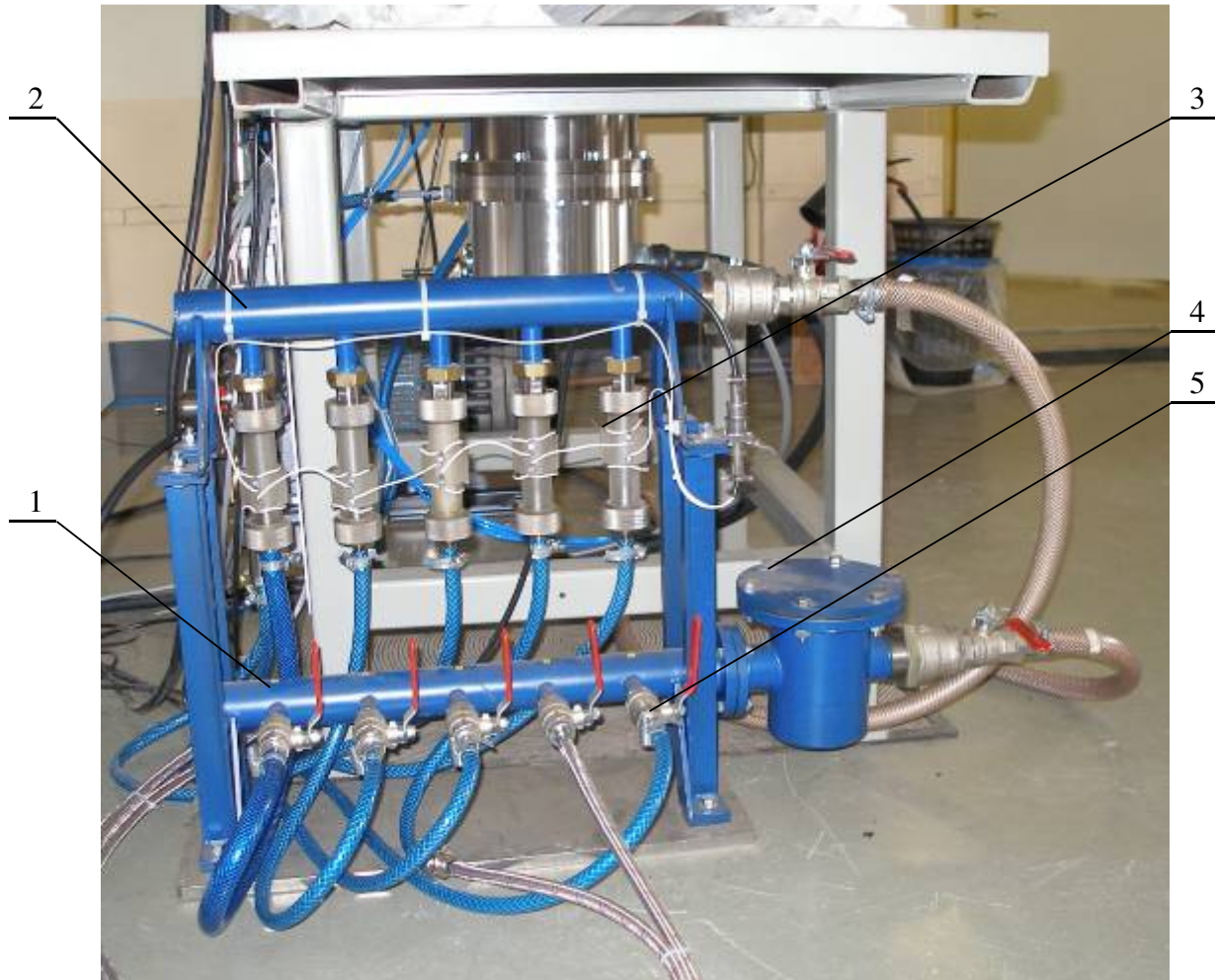

1 – consumption collector; 2 – output collector; 3 – flow sensor;
4 – filter; 5 – consumption channel

Tamiris 400-f ion source media panel

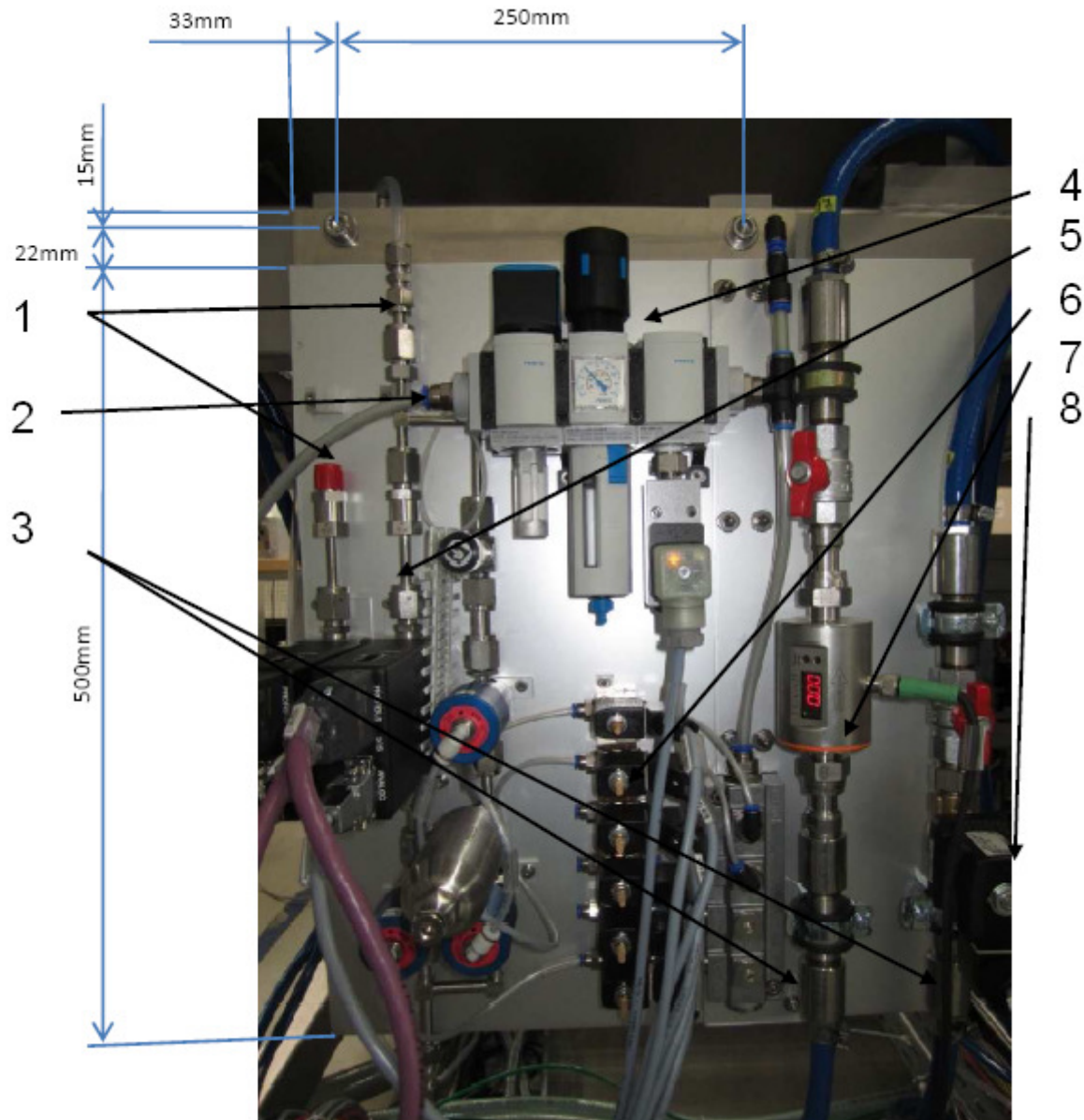

1 - Process gas connection; 4-VCR male; 2 – Compressed dry air connection: 8 mm O.D. Tube Connector (QuickStar®); 3 - Water connection (inlet+outlet), 13 mm hose; 4 – Service unit -> compressed dry air; 5 – Mass flow controller (Ar, N₂); 6 – Magnet valves to control gas valves (Ar, N₂); 7 – Water flow monitor; 8 - Magnet valve to control water

Data of ion beam homogeneity measurements
(on the length 200 mm)

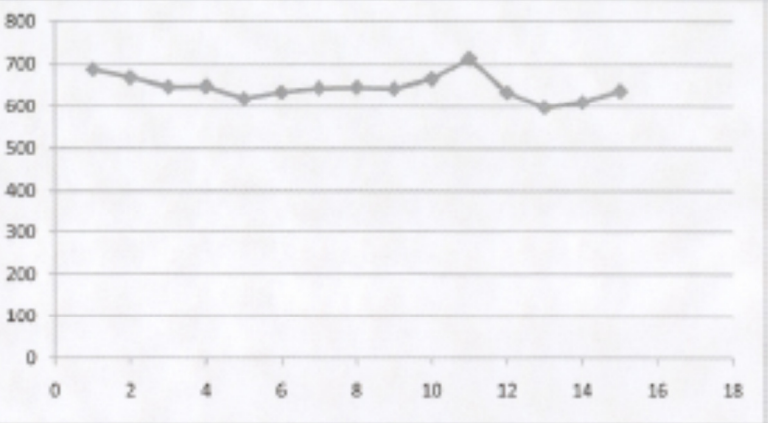
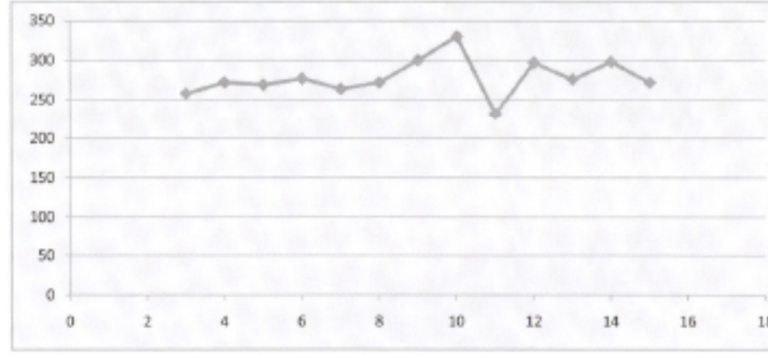
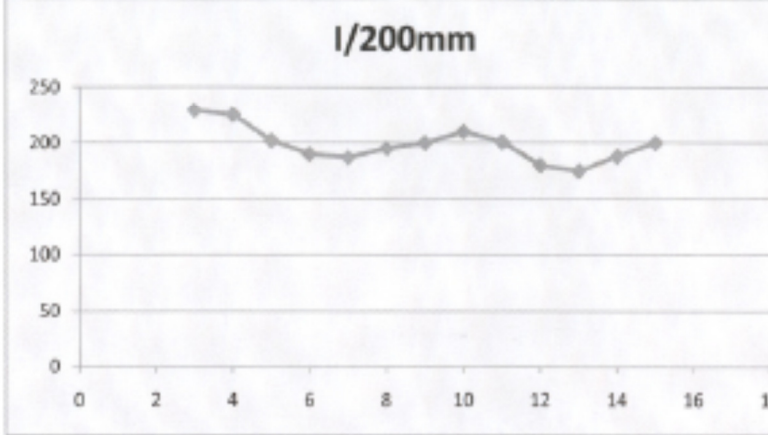
Ion source parameters	The values of currents on Faraday cups	inhomogeneity σ/μ
<p>U=1 keV P₁=400 W P₂=420 W Q=35 sccm N₂ J=2.3 mA/cm²</p>		<p>0.0452</p>
<p>U=2 keV P₁=365 W P₂=370 W Q=25 sccm N₂ J=2.7 mA/cm²</p>		<p>0.0858</p>
<p>U=3 keV P₁=215 W P₂=370 W Q=42 sccm N₂ J=1.9 mA/cm²</p>		<p>0.0797</p>

$$\sigma = \sqrt{\frac{1}{N} \sum_{i=1}^N (x_i - \mu)^2} \text{ - standard deviation,}$$

$$\mu = \frac{1}{n} \sum_{i=1}^n x_i - \text{mean arithmetical value}$$

Aggregate data of beam homogeneity measurements

<p>Ion source parameters</p>	
<p>U=1 keV P₁=340 W P₂=370 W Q=12 sccm N₂ I=400 mA</p>	<p style="text-align: center;">Distribution by 1kV beam</p> <p style="text-align: center;">Distance [mm]</p> <p style="text-align: center;"> —●— Etching depth distribution —■— Current distribution on probe array </p>
<p>U=2 keV P₁=370 W P₂=400 W Q=10 sccm N₂ I=400 mA</p>	<p style="text-align: center;">Distribution by 2kV beam</p> <p style="text-align: center;">Distance [mm]</p> <p style="text-align: center;"> —●— Etching depth distribution —■— Current distribution on probe array </p>

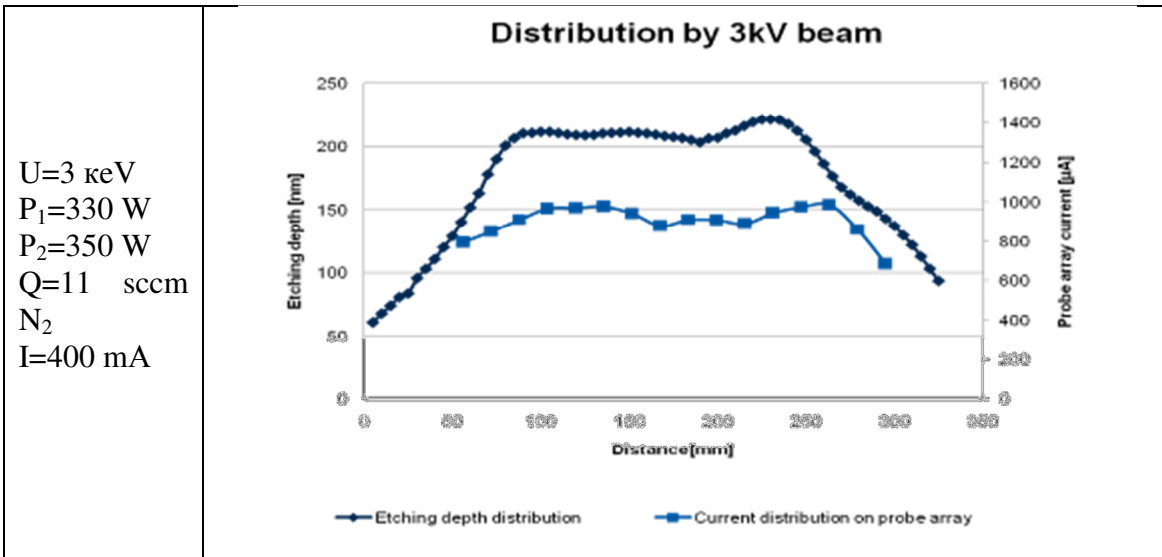

1. Conclusion

The WOS (Wave Ordered Structures) technology is a non-optical, non-contact approach for formation of periodic nano- structures over large area, providing its fundamental advantages in comparison to the existing technologies both in view of the cost and feature size (10 to 100 nm). It is important also that at the known degree it may be integrated into existing nanotechnologies.

The formed with such manner these periodic nano-size structures have a wide range of applications, including flat panel displays, optical electronics, clean energy technologies (solar and fuel cells, lithium batteries), and other potential areas.

One of the critically important question of WOS technology use in industrial scale is the possibility to form periodic nanostructures over large area processed plates.

The Project primary scope is to collaborate on the development of industrial technology for formation of various periodic nano-size structures on the basis of the original WOS technology and the wide-aperture linear ion source use.

The main task of this Project is the creation of alpha-level system for the linear (rectangular cross-section) ion beam processing of semiconductor plates moved with defined velocity.

Three teams - LBNL (USA), Efremov Institute (Russia), Wostec, Inc.- have united their efforts for this task realization. It was generated the key requirements to the structure and parameters of such system and also the technical approach to its realization.

The difficulties in development and manufacturing of LBNL multi-cusp ion source have not allowed to perform the work in accordance with Work Plan. Taking into account unquestionable reasonability of completion of all Work Plan Tasks it was accepted co-ordinated decision on the use of alternative ion source that is most suitable for WOS technology requirements. The performed co-ordinated analysis of the different variants is shown the preference of the purchase of the Tamiris 400-f (Roth & Rau AG) linear ion source. Possibility to use the planar as well as the focusing grids allow to vary the ion beam parameters and ion beam cross-section on the substrate, that increase WOS formation possibilities frame.

Due to unexpected expenses for ion source purchase and considerable system design correction for adaptation to different type of ion sources it was taken co-ordinated decision to create ONE full scale system adapted for two different types of ion sources (Tamiris 400-f ion source and LBNL multi-cusp ion source).

Developed and manufactured universal system (with possibility to use Tamiris 400-f ion source as well as LBNL multi-cusp ion source) met all demands of WOS technology and demonstrated full workability.

The results of the characterization of the system certificate practically full conformity to work variant key characteristics accepted in co-ordination with Wostec Inc., that allow to conclude about **the realization of the main task of the Project** – creation of alpha-level system on the base linear ion source adapted for WOS technology requirements.

The developed and tested technical decisions of alpha-level system elements are obviously interested for use at the WOS technology commercialization. It is important also that the following scaling increase is potentially possible with increase of quantity of ion sources modules.

DISCLAIMER

This document was prepared as an account of work sponsored by the United States Government. While this document is believed to contain correct information, neither the United States Government nor any agency thereof, nor the Regents of the University of California, nor any of their employees, makes any warranty, express or implied, or assumes any legal responsibility for the accuracy, completeness, or usefulness of any information, apparatus, product, or process disclosed, or represents that its use would not infringe privately owned rights. Reference herein to any specific commercial product, process, or service by its trade name, trademark, manufacturer, or otherwise, does not necessarily constitute or imply its endorsement, recommendation, or favoring by the United States Government or any agency thereof, or the Regents of the University of California. The views and opinions of authors expressed herein do not necessarily state or reflect those of the United States Government or any agency thereof or the Regents of the University of California.