

# UC Irvine

## UC Irvine Previously Published Works

### Title

A knock-in model of human epilepsy in Drosophila reveals a novel cellular mechanism associated with heat-induced seizure

### Permalink

<https://escholarship.org/uc/item/3qx5z32k>

### Journal

Journal of Neuroscience, 32(41)

### ISSN

0270-6474

### Authors

Sun, L  
Gilligan, J  
Staber, C  
[et al.](#)

### Publication Date

2012-10-10

### DOI

10.1523/JNEUROSCI.2932-12.2012

### Copyright Information

This work is made available under the terms of a Creative Commons Attribution License, available at <https://creativecommons.org/licenses/by/4.0/>

Peer reviewed



Published in final edited form as:

*J Neurosci.* 2012 October 10; 32(41): 14145–14155. doi:10.1523/JNEUROSCI.2932-12.2012.

## A knock-in model of human epilepsy in *Drosophila* reveals a novel cellular mechanism associated with heat-induced seizure

Lei Sun<sup>1</sup>, Jeff Gilligan<sup>2</sup>, Cynthia Staber<sup>2</sup>, Ryan J. Schutte<sup>1</sup>, Vivian Nguyen<sup>1</sup>, Diane K. O'Dowd<sup>1,\*</sup>, and Robert Reenan<sup>2,\*</sup>

<sup>1</sup>Department of Anatomy and Neurobiology; Developmental and Cell Biology, UC Irvine, Irvine CA 92697-1280

<sup>2</sup>Department of Molecular Biology, Cell Biology, and Biochemistry, Brown University, Providence, RI 02912

### Abstract

Over 40 missense mutations in the human *SCN1A* sodium channel gene are linked to an epilepsy syndrome termed genetic epilepsy with febrile seizures plus (GEFS+). Inheritance of GEFS+ is dominant but the underlying cellular mechanisms remain poorly understood. Here we report knock-in of a GEFS+ *SCN1A* mutation (K1270T) into the *Drosophila* sodium channel gene, *para*, causes a semi-dominant temperature-induced seizure phenotype. Electrophysiological studies of GABAergic interneurons in the brains of adult GEFS+ flies reveal a novel cellular mechanism underlying heat-induced seizures: the deactivation threshold for persistent sodium currents reversibly shifts to a more negative voltage when the temperature is elevated. This leads to sustained depolarizations in GABAergic neurons and reduced inhibitory activity in the central nervous system. Further, our data indicate a natural temperature-dependent shift in sodium current deactivation (exacerbated by mutation) may contribute to febrile seizures in GEFS+ and perhaps normal individuals.

### Introduction

Many human seizure disorders are caused by mutations in ion channel genes. The *SCN1A* sodium channel gene alone has in excess of 600 mutations conferring a wide spectrum of epilepsies (Claes et al., 2009; Lossin, 2009; Catterall et al., 2010). Truncating and presumed null mutations of *SCN1A* are associated with severe disorders, such as Dravet's Syndrome (DS). More conservative missense mutations generally confer more benign conditions, including over 40 that result in GEFS+, which is characterized by febrile seizures that persist in individuals past 6 years of age (Scheffer and Berkovic, 1997) (<http://www.molgen.vib-ua.be/SCN1AMutations/Mutations/Default.cfm>). The cellular mechanisms underlying seizure disorders associated with this broad array of mutations are not well understood.

Analysis of a number of *SCN1A* mutations in heterologous expression systems has revealed a variety of biophysical changes in sodium channel function that could potentially lead to seizure phenotypes, but it is unclear if these are reflective of alterations that occur in neurons (Lossin et al., 2002; Lossin et al., 2003; Escayg and Goldin, 2010). Recent results in DS and

Corresponding authors: Diane O'Dowd 112 Irvine Hall UC Irvine Irvine, CA 92697-1280 dkodowd@uci.edu Phone: 949-824-4562  
Robert Reenan 372 SFH Life Sciences Building Brown University Providence RI 02912 Robert\_Reenan@Brown.edu Phone: 401-863-6353.

\*corresponding authors contributed equally to the work

No conflict of Interest.

GEFS+ knock-in mouse models demonstrated reduced activity in GABAergic inhibitory neurons examined at room temperature (Ogiwara et al., 2007; Martin et al., 2010). However, the underlying changes in sodium channel function were different in these *SCN1A* mutants and neither channel function nor neuronal excitability were explored at high temperature. Using transgenic mice to assess channel defects for even a fraction of the known *SCN1A* mutations would be very resource intensive.

*Drosophila* is another genetically tractable animal model that has been used to study seizure disorders (Song and Tanouye, 2008). A classic forward genetic approach has identified a number of mutants with altered seizure sensitivity but none that result from mutations homologous to seizure causing *SCN1A* mutations in humans (Royden et al., 1987; Pavlidis et al., 1994; Zhang et al., 2002; Fergestad et al., 2006; Parker et al., 2011). Recent technical advances have now made it feasible to readily target and replace endogenous sequences in the fly genome using homologous recombination (Rong and Golic, 2000; Rong et al., 2002; Staber et al., 2011). Knock-in of specific disease causing mutations into the fly genome has the potential to provide a rapid and low cost platform for studying the cellular mechanisms of heritable human diseases. In addition, knock-in flies can be used in combination with forward genetic screens to identify suppressor and/or enhancer mutations, a strategy that is challenging in humans and rodent models but well established in *Drosophila* (Song et al., 2007; Song et al., 2008).

In this study, a disease-causing GEFS+ mutation (*SCN1A*, K1270T) (Abou-Khalil et al., 2001) was knocked into the *Drosophila para* sodium channel gene at the comparable position, conferring a semi-dominant temperature-sensitive seizure phenotype. Electrophysiological recordings from GABAergic neurons in brains of adult mutant flies at both permissive and high temperature revealed a temperature-dependent alteration in sodium currents. This represents a novel mechanism for altering inhibitory activity contributing to heat induced seizure.

## Methods

### Ends-out homologous recombination of the para locus

To introduce the K1270T mutation into the *para* sodium channel gene in *Drosophila* we performed ends out homologous recombination using a similar methodology to that reported previously (Maggert et al., 2008) with modifications (Staber et al., 2011). Briefly, we utilized the ends-out targeting vector p[w25.2] which contains the white+ selectable eye-color mini-gene flanked by LoxP sites allowing for subsequent removal by Cre-recombinase. Homology arms were cloned and sequence verified in pTOPO (Invitrogen). The mutation analogous to GEFS+ K1270T was introduced into arm 2 using the QuickChange mutagenesis kit (Stratagene) and the mutagenic primers:

GEFS+ F, 5'-  
GGTTATATTCTTCTTGAAATGTTAATCACCTGGTTGGCGCTCGGCTTCAA  
GTG-3' and

GEFS+ R, 5'-  
CACTTTGAAGCCGAGCGCCAACCAGGTGATTAACATTTCCAAGAAGAATAT  
A ACC-3'.

Mutagenized clones were resequenced to insure that only the desired mutation was introduced. Homology arms 1 and 2 were cloned sequentially into the multiple cloning sites of the vector to generate p[w25-*para*K1270T], which was then introduced randomly into the *Drosophila* genome by standard transgenic methods (Genetic Services Inc.).

In parallel, a wild-type substitution, K1270K, was introduced using an identical procedure to generate p[w25-*para*K1270K] which was used to create a transgenic Control line in the same genetic background.

Details of the cloning strategy were as follows, where all genomic coordinates are given by the *Drosophila melanogaster* draft (BDGP Release 5) with release 5.12 annotation provided by Flybase at the UCSC Genome Browser (<http://genome.ucsc.edu>): Arm 1 is the 5' arm of p[w25-*para*] (see Fig. 1B) and was generated by PCR amplification to incorporate cloning sites as follows; Arm 1: *Bsi*WI-16,378,805-16,376,207-*Asc*I. Arm 2 is the 3' arm of p[w25-*para*] and was generated by PCR amplification to incorporate cloning sites as follows; Arm2: *Acc*65I-16,376,130-16,373,532-*Not*I.

Targeting was performed to generate multiple independent targeting events of p[w25-*para*WT] and p[w25-*para*GEFS+] starting from independent transgenic insertions. Targeted alleles were validated for correct homologous recombination to the *para* locus by amplification using primers outside the region of targeting to sequences specific to the unique white+ selectable marker. Amplicons of targeted alleles were sequenced to verify only the presence of indicated wild-type sequences (or GEFS+ mutation). Subsequent removal of the white+ mini-gene selectable marker was achieved by performing crosses to animals expressing Cre-recombinase and re-isolation of targeted chromosomes containing a single LoxP site. PCR amplification and sequencing across the post-CRE allele was performed to validate the accuracy of the removal of white sequences.

### Fly lines

The recombinant alleles, both the mutant and control substitution, were subsequently back-crossed to the w1118 stocks, a white-eyed genetic background, for five generations. Finally, these were crossed to a stock with UAS-GFP, w+ on the second chromosome. Flies homozygous for the recombinant alleles on the X chromosome, and the UAS-GFP, w+ on the second chromosome were selected and used to establish the two strains employed in all experiments reported. The homozygous mutant (K1270T) and control (K1270K) strains are referred to as GEFS+ and Control. Heterozygotes were generated by crossing GEFS+ mutant and Control flies.

### Heat-induced seizure assay

Two-day old flies grown at room temperature (22–24°C) were isolated in individual plastic vials. Flies were allowed to accommodate to the new environment for 5–15 minutes before the vial was immersed in a water bath of 40°C for 2 min. Seizures were defined as a period of brief leg twitches, followed by failure to maintain standing posture, with wing flapping, leg twitching, and sometimes abdominal curling. The status of individual flies (seizing or not seizing) was determined at 5 sec intervals and the probability of seizing at each time point was calculated for comparison. All tests were carried out blind with respect to fly genotype.

### Whole cell recordings from LNs in isolated whole brain

All brains were obtained from adult male GEFS+ or Control flies (2-days old). The entire brain was removed from the head and prepared for recordings as previously described (Gu and O'Dowd, 2006; Gu and O'Dowd, 2007). Pipettes were visually targeted to a small subset of LNs in an anatomically distinct region of the dorsal lateral aspect of the antenna lobe. Whole cell sodium currents, depolarization-evoked action potentials and spontaneous burst of firing were recorded with standard whole cell pipettes of 10–11 M $\Omega$ . All voltages reported refer to pipette potentials at the soma.

Isolated sodium currents were recorded using a pipette solution containing (in mM) 102 D-gluconic acid, 102 CsOH, 0.085 CaCl<sub>2</sub>, 1.7 MgCl<sub>2</sub>, 17 NaCl, 0.94 EGTA, 8.5 HEPES, and 4.5 ATP. The pH was adjusted to 7.2 and osmolarity to 235 mosM. The external solution contained (in mM) 120 NaCl, 1.8 CoCl<sub>2</sub>, 0.8 MgCl<sub>2</sub>, 3 KCl, 5 glucose, 10 HEPES, 2.5 TEA, 1.0 4-AP. It also contained the synaptic receptor blockers D-tubocurarine (curarine, 20 μM) and picrotoxin (PTX, 10 μM). The pH was adjusted to 7.2 and osmolarity to 250 mosM. Data shown were corrected for the 5-mV liquid junction potential generated in these solutions. Depolarization-evoked action potentials were recorded using the same internal solution as that used for sodium currents except that cesium gluconate was replaced by potassium gluconate, and there was no TEA or 4-AP. For examination of the evoked firing properties, the membrane potential was held at -75 by injection of hyperpolarizing holding current. Spontaneous burst firing was recorded using the same internal and external solution used for depolarization-evoked action potentials, with the omission of PTX and Curarine. In some of the recordings, 0.4% biocytin was added to internal solution to label LNs.

The chamber was continuously perfused at 1 ml/minute with external solution and the temperature in the chamber was controlled and monitored using a CL-100 Bipolar Temperature Controller (Harvard Apparatus). Although there were small variations in the heating profile between individual neurons during the 2 minute heating period, there was no difference between the genotypes in the maximal temperatures examined (GEFS+ 34.7±1.4°C, Control 34.7±1.1°C, mean ± s.d.).

Data were acquired with an Axonpatch 200B amplifier, a digidata 1322A D-A converter (Molecular Devices), a Dell computer (Dimension 8200), and pClamp9 software (Molecular Devices).

### Fluorescent immunostaining

Dual staining for Nc82 and intracellular biocytin were performed at room temperature. Immediately after whole cell recording, brains were fixed in 4% paraformaldehyde in PBS for 2–4 hours at 4°C, rinsed with PBS and permeabilized with 0.2% Triton-X100 in PBS (PBST) for 40 min., followed by 4% bovine serum albumin/PBST (40 min). Brains were incubated in primary antibody (1 hr), Nc82 (mouse MAB, 1:1000, Developmental Studies Hybridoma Bank), followed by washing for 30 min in PBST (3×). Brains were incubated for 1 hr with fluorescently tagged secondary antibody (goat anti-mouse Alexa Fluor 546 (1:1000; Invitrogen; Carlsbad, CA) and streptavidin conjugated to Alexa Fluor 488 (1:1000; Invitrogen; Carlsbad, CA) to label biocytin. After incubation, brains were washed for 30 min in several changes of PBS, and mounted in Fluoromount G. Confocal fluorescence microscopy was performed on a Zeiss LSM 510 using a 40× oil-immersion objective.

Dual staining for GABA and intracellular biocytin: Above procedure modified to include overnight fixation of brains in 4% paraformaldehyde. Primary antibody incubation (anti-GABA, mouse MAB, 1:500, Sigma) for 2 hr at room temperature.

### Acute PTX Exposure

Two-day old male GEFS+ and Control flies were fasted for 6 hours prior to exposure to PTX (0–0.4mM; Sigma) in 5% sucrose solution with food coloring. Flies were fed for 15 min and only those with food coloring visible in the abdomen were selected for the heat-induced seizure assay. Heat-induced seizures were recorded 5–30 min after feeding. Experiments were conducted blind in respect to PTX concentration and genotype.

## Statistics

Comparisons between GEFS+ and Control were done with 2-tailed independent Student's *t*-test (2 genotypes) or one-way ANOVA followed by Bonferroni post hoc test (more than 2 genotypes). Comparisons between permissive and elevated temperature within the same genotype were done with paired *t*-test. Differences between mean values were considered significant at  $p < 0.05$ .

## Results

### Targeting the GEFS+ mutation using ends-out homologous recombination

The human GEFS+ mutation K1270T (Abou-Khalil et al., 2001) was chosen because it is in the highly conserved homology domain III, transmembrane domain S2 and the amino acid K is invariant in all identified *SCN1A* orthologues (Fig. 1A). The functional consequences of K1270T have not been assessed in either heterologous studies or knock-in mice, thus, presenting a potential to uncover novel mechanistic insights into epileptogenesis. Both wild-type K1270K and mutant K1270T targeting constructs were introduced into the *Drosophila* genome in multiple independent transgenic lines that were used for subsequent homologous recombination (Fig. 1B). Amplicons of targeted alleles were sequenced to verify the presence of wild-type and mutant sequences. The homozygous mutant (KT) and control (KK) strains are referred to as GEFS+ and Control.

### GEFS+ flies exhibit a heat-induced seizure phenotype

Individual flies were observed in plastic vials for 2 minutes following immersion of the vial in a 40°C water bath. Since the *para* gene is located on the X-chromosome, we assessed activity in hemizygous male (GEFS+/Y) and homozygous female (GEFS+/GEFS+) mutants separately. Both sexes exhibited an initial period of increased locomotor velocity followed by seizure activity. Seizures began 20–30 seconds after immersion in the 40°C water bath and once a seizure initiated in a GEFS+ mutant, it continued for the remainder of the 2-min period. The probability of seizing increased as a function of time and by 2 minutes >96% of flies were seizing (Fig. 2). There was no difference between males and females. When vials were removed from the water bath there was an abrupt cessation of activity. The flies remained motionless and were unresponsive to tapping of the vials for varying periods of time before showing brief periods of spontaneous movement, generally in one or two legs. Recovery of the ability to stand and resume walking/climbing behavior required 9–28 mins (females, 19.6±1.3 min; males, 11.2±0.6 min).

In the Control strain, both males and females exhibited increases in locomotor activity when vials were immersed in a 40°C water bath. However, there was no evidence of seizures during the 2-minute immersion (Fig. 2). In addition, there was no cessation of activity when the vials were removed from the water bath.

Since the human disease is dominantly inherited, we tested the temperature sensitive behavior of heterozygous females (GEFS+/Control). The time to seizure onset in GEFS+/Control was delayed and the maximal probability of seizing was less than in the homozygous GEFS+ mutants (Fig. 2). Furthermore, there was heterogeneity in the response of the heterozygotes with 21% showing no seizures. The majority (79%) did exhibit seizure activity but this could start and stop more than once during the 2 minute period. When vials were removed from the water bath, 46% of the seizing flies exhibited abrupt cessation of movement. Recovery of the ability to stand and resume normal locomotion required 7–20 minutes (mean 12.3±2.5min). The remainder of the flies resumed normal locomotion in less than a minute following removal of the vial from the water bath.

The probability of seizing after 2 minutes at 40°C was significantly different with homozygotes>heterozygotes>control ( $P<0.001$ , ANOVA Bonferroni post hoc test). These data indicate that the GEFS+ K1270T mutation in *Drosophila* is semi-dominant with variable penetrance.

### Alterations in sodium currents in GEFS+ GABAergic LNs at elevated temperature

To examine the underlying mechanism of temperature sensitive seizures caused by the K1270T mutation in sodium channels, we focused our initial study on GABAergic local neurons (LNs) in the isolated adult brain preparation of adult male flies (Gu and O'Dowd, 2006; Gu and O'Dowd, 2007). The LNs examined were in the dorsal lateral aspect of the antennal lobe and the majority (32/35) were pan-glomerular (Chou et al, 2010), projecting to the entire ipsilateral antennal lobe (Fig. 3A). Immunostaining showed most LNs in this region were GABAergic and biocytin filled neurons were co-labeled with anti-GABA antibodies (n=4 of 4, data not shown).

Isolated sodium currents in all LNs exhibited two distinct components: a large amplitude transient current ( $I_{NaT}$ ) and a smaller amplitude persistent current ( $I_{NaP}$ ) (Fig. 3B). The sodium currents were not well space-clamped in either genotype. This is consistent with most channels being located in neuronal processes, electrotonically distant from the cell body. While this precluded an accurate biophysical description of the current, comparison of current properties was used to identify differences associated with genotype and/or response to elevated temperature.

The  $I_{NaT}$  amplitudes were not significantly different in GEFS+ and Control LNs at 23°C and elevation of the temperature did not significantly affect  $I_{NaT}$  amplitude in either genotype (Fig. 3C). The threshold voltage for activating sodium currents was significantly more hyperpolarized in GEFS+ compared to Control LNs at both 23 and 35°C (Fig. 3D). However, the activation threshold did not change at elevated temperature in either Control or GEFS+.

In contrast, there were both temperature and genotype specific differences in the properties of  $I_{NaP}$ . At elevated temperature the  $I_{NaP}$  often failed to deactivate when the depolarizing voltage-step was terminated (Fig. 3C, arrow). This was seen only at high temperature and was more frequent in GEFS+ (8/17) compared to Control (3/18) neurons, thus identifying a potential alteration that could contribute to the temperature induced seizure phenotype.

A three-step protocol was used to further examine the voltage dependence of  $I_{NaP}$  deactivation (Fig. 4A, B). A prepulse to inactivate  $I_{NaT}$  was followed by a family of test pulses to increasingly hyperpolarized potentials. The threshold voltage for  $I_{NaP}$  deactivation was defined as the most depolarized test step that resulted in current deactivation. For the Control LN shown the deactivation threshold was -45 mV at 23°C. When the temperature was raised to 35°C the voltage for  $I_{NaP}$  deactivation shifted by -10 mV, from -45 to -55 mV (Fig. 4A).

In a typical GEFS+ LN, at 23°C, the deactivation threshold for the  $I_{NaP}$  was -55 mV (Fig. 4B). When the temperature was raised to 35°C, there was a larger shift in current deactivation voltage, from -55 to -75 mV (Fig. 4B). The average threshold for deactivation at 35°C in GEFS+ was significantly more hyperpolarized than Control (Fig. 4C,  $P<0.05$ ). There was no significant difference in deactivation voltage of  $I_{NaP}$  in Control and GEFS+ LNs at 23°C (Fig. 4C,  $P=0.19$ ). These data indicate that the GEFS+ mutation causes a significantly larger temperature-dependent hyperpolarizing shift in the deactivation voltage of the  $I_{NaP}$ .

In both GEFS+ and Control LNs, the amplitude of the  $I_{NaP}$  exhibited a change with test potential that was well fit by a linear regression at both 23 and 35°C (Fig. 4Ai, Bi). The slope of I–V curve, equal to the conductance of the  $I_{NaP}$  [ $I=g(V-V_R)$ ], was steeper at 35°C for both genotypes (Fig. 4Ai). However, the conductance was not different between GEFS+ and Control at either 23°C or 35°C (Fig. 4D). These data suggest that the GEFS+ mutation does not affect the magnitude or the temperature-dependent increase in conductance of  $I_{NaP}$ .

In GEFS+ neurons, the larger repolarization required to deactivate the  $I_{NaP}$  at elevated temperature, along with the more hyperpolarized activation threshold for the sodium current, results in sodium currents that are active over a greater voltage range (Fig. 4E).

### Alterations in evoked firing properties in GEFS+ LNs at elevated temperature

To investigate how the change in sodium currents affects LN excitability, we first examined firing properties in response to depolarizing current injections. To reduce the spontaneous activity in LNs, all cells were held at –75 mV and synaptic blockers PTX and curarine were added to the recording solution.

In both Control and GEFS+ LNs at room temperature, supra-threshold current injections evoked depolarizations capped by a train of small amplitude rapidly rising and decaying events termed spikelets (Fig. 5A, B). The spikelets, characteristic of action potentials recorded in the cell bodies of LNs, were blocked by TTX (data not shown) demonstrating their dependence on the activity of voltage-gated sodium channels.

When the temperature was raised to 35°C, trains of spikelets were maintained throughout the current step in Control neurons. In contrast, spikelets in GEFS+ neurons often terminated before the end of the current step. Even more striking was the appearance of sustained depolarization after the current step that ranged in duration from 50 ms to >10 seconds (Fig. 5B, arrow). The incidence of post-stimulus depolarization in GEFS+ LNs was ~10% at room temperature and this was reversibly increased to 60% at 35°C consistent with the non-deactivating  $I_{NaP}$  seen in GEFS+ LNs at elevated temperature (Fig. 5C). The incidence of post-stimulus depolarization was low in Control LNs at both 23 and 35°C (Fig. 5C).

The spikelet frequency increased steadily with increasing current injection in Control LNs at both 23 and 35°C (Fig. 5Ai). In contrast, the spikelet frequency declined in GEFS+ LNs at higher input currents (Fig. 5Bi). In addition, even though the maximal firing frequency in GEFS+ LNs was similar to Control at room temperature, it was significantly and reversibly reduced, rather than increased as in Control, when the temperature was elevated (Fig. 5D).

Together, these data indicate that the failure of the  $I_{NaP}$  to deactivate in response to normal membrane potential repolarization at elevated temperature results in prolonged post-stimulus depolarization and reduced firing frequency in GEFS+ LNs at 35°C.

### Alterations in spontaneous firing of GEFS+ LNs at high temperature

To determine if there were differences between the two genotypes under more physiological conditions, spontaneous activity in LNs was monitored in the absence of synaptic current blockers and without application of hyperpolarizing holding current. At permissive temperature, both GEFS+ and Control LNs fire regular bursts of action potentials.

The standard response of Control LNs to temperature change is illustrated in Fig. 6A. The baseline burst frequency increased briefly when the temperature began to rise. As the temperature was elevated to 35°C, the burst frequency decreased and then ceased. Normal burst firing resumed as the temperature returned to 23°C. A similar change in burst frequency was seen in GEFS+ LNs at high temperature (Fig. 6D). However, as predicted



from the changes observed in evoked firing, a significant fraction of the bursts in LNs progress into sustained membrane depolarizations at elevated temperatures (Fig. 6Bii). A sustained depolarization is defined as an event that is 1) the same amplitude as the burst prior to heating, 2) lacks spikelets, and 3) the duration is longer than the mean burst duration (>95% confidence interval) at 23°C. The duration of the sustained depolarizations in the mutant neurons measured at half amplitude, ranged from 315 ms to more than 16 seconds.

At permissive temperatures the sustained membrane depolarizations in GEFS+ occur at low frequency and represent only a small percentage of total membrane depolarizations (bursts + sustained depolarizations). In contrast, when the temperature was raised to 35°C, the frequency increased almost 3 fold (Fig. 6C) and the percentage increased from 1.3% to 23% (Fig. 6D). When the temperature returned to 23°C the duration of depolarization returned to the level seen prior to heating. In Control LNs, sustained depolarizations were not observed at 23°C and this was not significantly increased at 35°C (Fig. 6C, D).

The spikelet frequency (number of spikelets/duration of depolarization) was calculated for both genotypes. In GEFS+ LNs, the spikelet frequency decreased significantly at high temperatures (Fig. 6E). In contrast, Control LNs generated spikelet capped bursts at 35°C and the spikelet frequency increased at elevated temperature compared to room temperature, consistent with the evoked activity (Fig. 6E). In addition, spikelet threshold was 5 mV more hyperpolarized in GEFS+ compared to Control at both 23 and 35°C (Fig. 6F), consistent with the difference in sodium current activation threshold (see Fig. 3D).

The appearance of sustained depolarizations at high temperature is consistent with the post-stimulus depolarization observed in evoked firing. These data indicate that the more negative deactivation voltage of the  $I_{NaP}$  in GEFS+ LNs at elevated temperature results in sustained membrane depolarization and reduced repetitive firing.

### Blockade of GABA receptors increases sensitivity to heat-induced seizures in GEFS+ flies

Reduced repetitive firing in GEFS+ GABAergic neurons suggests that a decrease in inhibitory activity at high temperature contributes to the heat-induced seizure phenotype in GEFS+. This predicts that GEFS+ flies should be more sensitive to the GABA<sub>A</sub>R antagonist picrotoxin (PTX), an established chemiconvulsant in *Drosophila* as well as mouse (Stilwell et al., 2006). Adult males were fed sucrose solutions containing different concentrations of PTX and seizure probability assessed within 5–30 minutes. At 37°C, GEFS+ flies fed sucrose without PTX displayed very low seizure activity after two minutes (Fig. 7A). In contrast to seizures at 40°C, these seizures were short and infrequent with flies seizing on average for only a short fraction of heating period (Fig. 7B). GEFS+ seizure probability and time spent seizing when exposed to 37°C increased in a PTX dose-dependent manner (Fig. 7A, B). Control flies fed the highest dose of PTX used in these experiments did not show any seizure behavior at 37°C (Fig. 7A, B). These results support the hypothesis that the GEFS+ seizure phenotype arises from reduced inhibitory activity at elevated temperatures.

## Discussion

### Genotype-to-phenotype mapping of human sodium channel disease in *Drosophila*

To create a human epilepsy model in *Drosophila*, we used homologous recombination to introduce a specific disease-causing mutation into the equivalent *Drosophila* gene. Knock-in of the human K1270T GEFS+ *SCN1A* mutation into the *Drosophila para* sodium channel gene results in adult flies that exhibit seizures triggered by high temperature. This is consistent with the effect of the K1270T mutation in humans. GEFS+ patients heterozygous for this mutation have febrile seizures that can persist beyond childhood (Abou-Khalil et al., 2001). The temperature-sensitive (ts) seizure phenotype in mutant flies is semi-dominant:

heterozygotes exhibit seizure activity but it is reduced compared to homozygotes. Although patients homozygous for the mutation have not been reported, more severe phenotypes are expected based on the observation in the fly model.

The seizure phenotype in GEFS+ flies is distinct from phenotypes resulting from random *para* sodium channel mutations previously isolated in classic forward genetic screens. One class of *para* mutants causes a temperature-sensitive paralysis (Suzuki et al., 1971; Grigliatti et al., 1973; Siddiqi and Benzer, 1976) while a second class causes bang-sensitive seizure (Jan and Jan, 1978; Ganetzky and Wu, 1982; Parker et al., 2011). One of the previously defined *para* mutations, G1517R, is positionally orthologous to the G1306V mutation in the human *SCN4A* skeletal muscle sodium channel gene. This mutation causes a dominant cold-sensitive paralytic phenotype in *Drosophila* (Lindsay et al., 2008), reminiscent of the cold sensitive disorder paramyotonia congenita associated with the human mutation. These findings combined with our results suggest a remarkable and specific conservation of genotype-to-phenotype mapping of human sodium channel disease in *Drosophila*.

### Decreased inhibitory activity contributing to seizures in GEFS+ mutants

Studies in knock-in mouse models of a GEFS+ (R1648H) and a DS (R1407X) mutation report reduced activity in inhibitory but not excitatory neurons, suggesting that decreased inhibition contributes to seizure generation in patients with these disorders (Ogiwara et al., 2007; Escayg and Goldin, 2010; Martin et al., 2010). Does a GEFS+ mutation also differentially alter activity in inhibitory versus excitatory neurons in *Drosophila*? Our data demonstrate that the GEFS+ K1270T mutation results in reduced repetitive firing in LNs, a population of GABAergic interneurons in adult fly brain at elevated temperature. Preliminary analysis of excitatory cholinergic projection neurons (PNs) did not reveal any evidence of post-stimulus depolarization in evoked firing at either 23°C (0/15) or 35°C (0/11). This suggests that the GEFS+ mutation also has a more pronounced effect on inhibitory versus excitatory neurons in *Drosophila*. There is evidence that specificity in the mouse model arises from differential expression of *SCN1A* encoded sodium channels in these two populations (Ogiwara et al., 2007; Lorincz and Nusser, 2008; Wimmer et al., 2010). Although there is only a single sodium channel gene in *Drosophila*, there are splice variants with distinct functional properties (Lin et al., 2009; Marley and Baines, 2011) that could be differentially expressed in excitatory vs inhibitory neurons.

From the knock-in mouse models it seems likely that decreased activity in central inhibitory circuits at room temperature contributes to generation of seizures in patients with R1648H and R1047X *SCN1A* mutations (Ogiwara et al., 2007; Martin et al., 2010). However, in the absence of recording at high temperature it is not clear if additional temperature-dependent changes in activity contribute to the febrile seizure phenotype. Analysis of the K1270T mutation in *Drosophila* revealed reduced repetitive firing in GABAergic neurons suggesting a decrease in inhibitory activity but the changes in neuronal firing were primarily linked to elevation in temperature. The GEFS+ flies were also more sensitive to heat-induced seizures after feeding with the GABA<sub>A</sub>R antagonist picrotoxin (PTX), an established chemiconvulsant in animal models (Stilwell et al., 2006). These results support the hypothesis that a temperature dependent-decrease in inhibitory activity can contribute to the heat-induced seizure phenotype in GEFS+.

### A new mechanism underlying temperature sensitive seizures

In the mouse model, knock-in of the R1648H mutation, located in transmembrane segment S4 in domain IV (S4,DIV) of the sodium channel, resulted in a decrease in firing frequency in GABAergic neurons at room temperature. This was caused by constitutive changes in the  $I_{NaT}$  including a decrease in amplitude, slower recovery from inactivation, and greater use-

dependent inactivation (Tang et al., 2009; Martin et al., 2010). In contrast, the most prominent alteration observed in our fly model with the K1270T mutation located in S2,DIII was an increase in the hyperpolarizing shift in  $I_{NaP}$  deactivation when then temperature was elevated. The failure of the  $I_{NaP}$  to deactivate contributes to sustained depolarizations and reduced firing frequency in GEFS+ LNs at 35°C. There was also a negative shift in the sodium current activation threshold at both room and elevated temperature. While this is likely to contribute to increased firing at room temperature it could also lead to reduced firing and sustained depolarizations at high temperature when deactivation is impaired. These data support the hypothesis that GEFS+-causing *SCN1A* mutations located in different regions of the gene result in distinct alterations in channel function. Analysis of neuronal sodium currents in other GEFS+ mutants, at permissive and elevated temperatures, will be crucial in developing therapies targeted to particular mutations.

Temperature is known to influence kinetics of ion channel gating, but there is relatively little information about the effect of temperature on voltage-dependence of channel gating. How might temperature-sensitivity in voltage-dependent deactivation arise? In *Drosophila*, there is convincing evidence that a single sodium channel subtype can switch between different gating modes to generate both a transient and persistent Na+ current (Liu et al., 2004; Lin et al., 2009). Single channel studies in mammalian neurons indicate that a persistent sodium current can arise from late opening of a channel or an individual channel that fails to inactivate and produces a burst of openings during maintained depolarization (Alzheimer et al., 1993; Stafstrom, 2007). Our data demonstrate that repolarization to more negative voltages is required to deactivate the  $I_{NaP}$  at elevated temperatures, even in Control neurons. This suggests that the wild-type sodium channel protein undergoes a temperature-dependent structural alteration that requires more negative voltage to close the channels still active during a maintained depolarization. Since the K1270T mutation results in a more negative shift in the deactivation threshold at high temperature this suggests the mutation identifies a possible position in S2,DIII associated with the temperature-sensitive closing transition of channels underlying the  $I_{NaP}$ .

Given the small but significant change in gating seen at high temperature in Control neurons, we asked if Control flies develop seizure-like activity under more extreme conditions. At 41°C some of the Control flies displayed seizures and the seizure probability increased further at 42°C (data not shown). Thus, it appears that temperature-induced shifts in voltage-dependence of sodium current deactivation could contribute to generation of seizures even in Control flies at elevated temperatures. A recent study reported a hyperpolarizing shift in activation voltage of sodium currents in HEK293 cells expressing wild-type Nav1.2 channels when the temperature was raised from 37 to 41°C (Thomas et al., 2009). Computer simulations indicated this would increase neuronal excitability at high temperature. Together, these data suggest that temperature-induced changes in voltage-dependence of channel gating could contribute to genesis of febrile seizures even in the absence of known seizure-associated mutations.

### Genetic screen for modifiers that regulate the seizures

GEFS+ in humans is classified as an autosomal dominant syndrome. However, in GEFS+ patients carrying a single mutant allele, the seizure phenotype can vary considerably (Wallace et al., 1998). This is true in the case of the K1270T GEFS+ mutation (Abou-Khalil et al., 2001). Pedigree analysis in a large family revealed seven affected family members with febrile seizures only, 11 with febrile seizures beyond 6 years of age, and 12 family members expressed complex febrile seizures. In addition, one individual carrying this mutation had no evidence of seizures. Such results hint at a complex genetic architecture of this disease, influenced by genetic modifiers and/or environmental factors. However,

evaluating the contribution of each is difficult in light of enormous variation in genetic background and living conditions between individuals.

In the fly model, the effect of the K1270T mutation on seizure phenotype is dose-dependent. Similar to human GEFS+ patients carrying one mutant allele, the heterozygous GEFS+ flies also exhibit differences in seizure severity. In response to increased temperature, some heterozygous flies display persistent seizure, while others did not seize at all under the same experimental conditions. Therefore, it will be interesting to rear GEFS mutants under well-controlled environmental conditions, inbred flies that exhibit persistent seizures, and compare these to inbred flies that do not seizure at elevated temperature. If this results in two GEFS+ lines that breed true with respect to their seizure severity, it should be possible to identify the genetic modifiers affecting manifestation of the seizure phenotype using deep sequencing methods (Blumenstiel et al., 2009). Thus, this strategy has the potential to identify novel gene targets for development of therapies aimed at ameliorating seizure severity in GEFS+ patients.

In summary, the congruence of the genotype-to-phenotype map between flies and human paves the way for using knock-in *Drosophila* models to study the mechanisms underlying complex human genetic diseases. In addition, the ability to combine the power of low cost, large scale forward genetic screens with the knock-in strategy will be extremely useful in identifying novel genes involved in regulating human disease.

## Acknowledgments

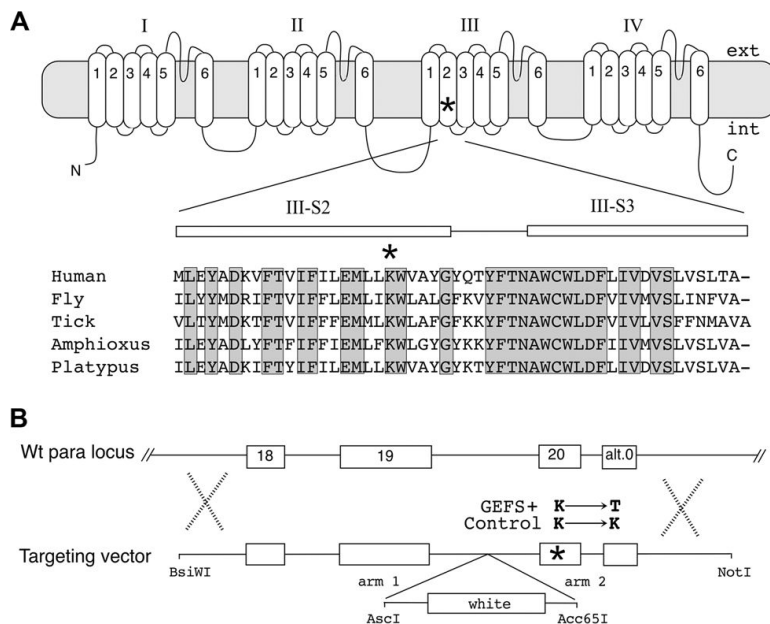
This work was supported in by NIH grant NS27501 and a grant from the Howard Hughes Medical Institute (HHMI) Professor Program to DKOD. Support was also provided by NIH grant NS074686 and an Ellison Medical Foundation Senior Scholar Award to RR.

## References

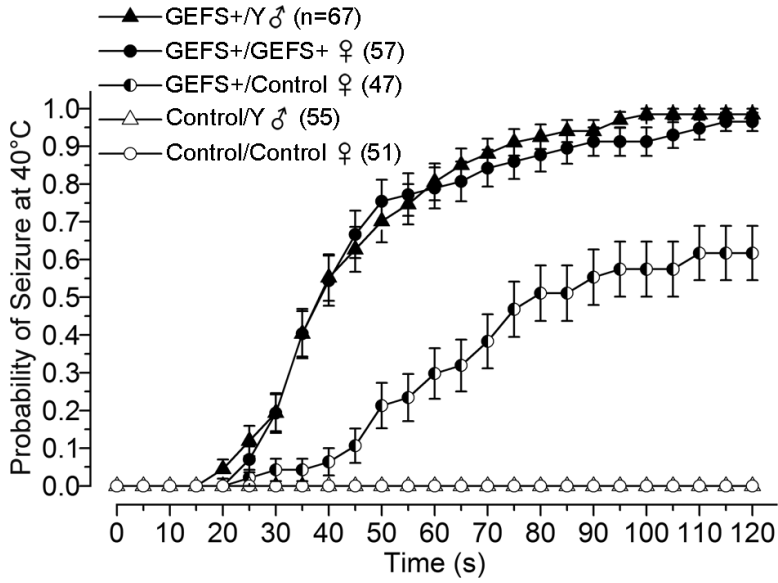
- Abou-Khalil B, Ge Q, Desai R, Ryther R, Bazyk A, Bailey R, Haines JL, Sutcliffe JS, George AL Jr. Partial and generalized epilepsy with febrile seizures plus and a novel SCN1A mutation. *Neurology*. 2001; 57:2265–2272. [PubMed: 11756608]
- Alzheimer C, Schwandt PC, Crill WE. Modal gating of Na<sup>+</sup> channels as a mechanism of persistent Na<sup>+</sup> current in pyramidal neurons from rat and cat sensorimotor cortex. *J Neurosci*. 1993; 13:660–673. [PubMed: 8381170]
- Blumenstiel JP, Noll AC, Griffiths JA, Perera AG, Walton KN, Gilliland WD, Hawley RS, Staehling-Hampton K. Identification of EMS-induced mutations in *Drosophila melanogaster* by whole-genome sequencing. *Genetics*. 2009; 182:25–32. [PubMed: 19307605]
- Catterall WA, Kalume F, Oakley JC. NaV1.1 channels and epilepsy. *J Physiol*. 2010; 588:1849–1859. [PubMed: 20194124]
- Claes LRF, Deprez L, Suls A, Baets J, Smets K, Van Dyck T, Deconinck T, Jordanova A, De Jonghe P. The SCN1A variant database: a novel research and diagnostic tool. *Human mutation*. 2009; 30:E904–E920. [PubMed: 19585586]
- Escayg A, Goldin AL. Sodium channel SCN1A and epilepsy: mutations and mechanisms. *Epilepsia*. 2010; 51:1650–1658. [PubMed: 20831750]
- Fergestad T, Bostwick B, Ganetzky B. Metabolic disruption in *Drosophila* bang-sensitive seizure mutants. *Genetics*. 2006; 173:1357–1364. [PubMed: 16648587]
- Ganetzky B, Wu CF. Indirect Suppression Involving Behavioral Mutants with Altered Nerve Excitability in *DROSOPHILA MELANOGASTER*. *Genetics*. 1982; 100:597–614. [PubMed: 17246073]
- Grigliatti TA, Hall L, Rosenbluth R, Suzuki DT. Temperature-sensitive mutations in *Drosophila melanogaster*. XIV. A selection of immobile adults. *Mol Gen Genet*. 1973; 120:107–114. [PubMed: 4631264]

- Gu H, O'Dowd DK. Cholinergic synaptic transmission in adult *Drosophila* Kenyon cells in situ. *J Neurosci*. 2006; 26:265–272. [PubMed: 16399696]
- Gu H, O'Dowd DK. Whole cell recordings from brain of adult *Drosophila*. *J Vis Exp*. 2007; 248
- Jan YN, Jan LY. Genetic dissection of short-term and long-term facilitation at the *Drosophila* neuromuscular junction. *Proc Natl Acad Sci U S A*. 1978; 75:515–519. [PubMed: 24218]
- Lin WH, Wright DE, Muraro NI, Baines RA. Alternative splicing in the voltage-gated sodium channel DmNav regulates activation, inactivation, and persistent current. *J Neurophysiol*. 2009; 102:1994–2006. [PubMed: 19625535]
- Lindsay HA, Baines R, French-Constant R, Lilley K, Jacobs HT, O'Dell KM. The dominant cold-sensitive Out-cold mutants of *Drosophila melanogaster* have novel missense mutations in the voltage-gated sodium channel gene paralytic. *Genetics*. 2008; 180:873–884. [PubMed: 18723887]
- Liu Z, Song W, Dong K. Persistent tetrodotoxin-sensitive sodium current resulting from U-to-C RNA editing of an insect sodium channel. *Proc Natl Acad Sci U S A*. 2004; 101:11862–11867. [PubMed: 15280550]
- Lorincz A, Nusser Z. Cell-type-dependent molecular composition of the axon initial segment. *J Neurosci*. 2008; 28:14329–14340. [PubMed: 19118165]
- Lossin C. A catalog of SCN1A variants. *Brain and Development*. 2009; 31:114–130. [PubMed: 18804930]
- Lossin C, Rhodes TH, Desai RR, Vanoye CG, Wang D, Carniciu S, Devinsky O, George AL Jr. Epilepsy-associated dysfunction in the voltage-gated neuronal sodium channel SCN1A. *J Neurosci*. 2003; 23:11289–11295. [PubMed: 14672992]
- Lossin C, Wang DW, Rhodes TH, Vanoye CG, George AL Jr. Molecular basis of an inherited epilepsy. *Neuron*. 2002; 34:877–884. [PubMed: 12086636]
- Maggert KA, Gong WJ, Golic KG. Methods for homologous recombination in *Drosophila*. *Methods Mol Biol*. 2008; 420:155–174. [PubMed: 18641946]
- Marley R, Baines RA. Increased persistent Na<sup>+</sup> current contributes to seizure in the slamdance bang-sensitive *Drosophila* mutant. *J Neurophysiol*. 2011; 106:18–29. [PubMed: 21451059]
- Martin MS, Dutt K, Papale LA, Dube CM, Dutton SB, de Haan G, Shankar A, Tufik S, Meisler MH, Baram TZ, Goldin AL, Escayg A. Altered function of the SCN1A voltage-gated sodium channel leads to gamma-aminobutyric acid-ergic (GABAergic) interneuron abnormalities. *J Biol Chem*. 2010; 285:9823–9834. [PubMed: 20100831]
- Ogiwara I, Miyamoto H, Morita N, Atapour N, Mazaki E, Inoue I, Takeuchi T, Itohara S, Yanagawa Y, Obata K, Furuichi T, Hensch TK, Yamakawa K. Nav1.1 localizes to axons of parvalbumin-positive inhibitory interneurons: a circuit basis for epileptic seizures in mice carrying an *Scn1a* gene mutation. *J Neurosci*. 2007; 27:5903–5914. [PubMed: 17537961]
- Parker L, Padilla M, Du Y, Dong K, Tanouye MA. *Drosophila* as a model for epilepsy: bss is a gain-of-function mutation in the para sodium channel gene that leads to seizures. *Genetics*. 2011; 187:523–534. [PubMed: 21115970]
- Pavlidis P, Ramaswami M, Tanouye MA. The *Drosophila* easily shocked gene: a mutation in a phospholipid synthetic pathway causes seizure, neuronal failure, and paralysis. *Cell*. 1994; 79:23–33. [PubMed: 7923374]
- Rong YS, Golic KG. Gene targeting by homologous recombination in *Drosophila*. *Science*. 2000; 288:2013–2018. [PubMed: 10856208]
- Rong YS, Titen SW, Xie HB, Golic MM, Bastiani M, Bandyopadhyay P, Olivera BM, Brodsky M, Rubin GM, Golic KG. Targeted mutagenesis by homologous recombination in *D. melanogaster*. *Genes Dev*. 2002; 16:1568–1581. [PubMed: 12080094]
- Royden CS, Pirrotta V, Jan LY. The *tko* locus, site of a behavioral mutation in *D. melanogaster*, codes for a protein homologous to prokaryotic ribosomal protein S12. *Cell*. 1987; 51:165–173. [PubMed: 3117373]
- Scheffer IE, Berkovic SF. Generalized epilepsy with febrile seizures plus. A genetic disorder with heterogeneous clinical phenotypes. *Brain*. 1997; 120:479–490. [PubMed: 9126059]
- Siddiqi O, Benzer S. Neurophysiological defects in temperature-sensitive paralytic mutants of *Drosophila melanogaster*. *Proc Natl Acad Sci U S A*. 1976; 73:3253–3257. [PubMed: 184469]

- Song J, Hu J, Tanouye M. Seizure suppression by top1 mutations in *Drosophila*. *J Neurosci*. 2007; 218:1015–1022.
- Song J, Parker L, Hormozi L, Tanouye MA. DNA topoisomerase I inhibitors ameliorate seizure-like behaviors and paralysis in a *Drosophila* model of epilepsy. *Neuroscience*. 2008; 156:722–728. [PubMed: 18703119]
- Song J, Tanouye MA. From bench to drug: human seizure modeling using *Drosophila*. *Prog Neurobiol*. 2008; 84:182–191. [PubMed: 18063465]
- Staber CJ, Gell S, Jepson JE, Reenan RA. Perturbing A-to-I RNA editing using genetics and homologous recombination. *Methods Mol Biol*. 2011; 718:41–73. [PubMed: 21370041]
- Stafstrom CE. Persistent sodium current and its role in epilepsy. *Epilepsy Curr*. 2007; 7:15–22. [PubMed: 17304346]
- Stilwell GE, Saraswati S, Littleton JT, Chouinard SW. Development of a *Drosophila* seizure model for in vivo high-throughput drug screening. *Eur J Neurosci*. 2006; 24:2211–2222. [PubMed: 17074045]
- Suzuki DT, Grigliatti T, Williamson R. Temperature-sensitive mutations in *Drosophila melanogaster*. VII. A mutation (para-ts) causing reversible adult paralysis. *Proc Natl Acad Sci U S A*. 1971; 68:890–893. [PubMed: 5280526]
- Tang B, Dutt K, Papale L, Rusconi R, Shankar A, Hunter J, Tufik S, Yu FH, Catterall WA, Mantegazza M, Goldin AL, Escayg A. A BAC transgenic mouse model reveals neuron subtype-specific effects of a Generalized Epilepsy with Febrile Seizures Plus (GEFS+) mutation. *Neurobiol Dis*. 2009; 35:91–102. [PubMed: 19409490]
- Thomas EA, Hawkins RJ, Richards KL, Xu R, Gazina EV, Petrou S. Heat opens axon initial segment sodium channels: a febrile seizure mechanism? *Ann Neurol*. 2009; 66:219–226. [PubMed: 19743470]
- Wallace RH, Wang DW, Singh R, Scheffer IE, George ALJ, Phillips HA, Saar K, Reis A, Johnson EW, Sutherland GR, Berkovic SF, Mulley JC. Febrile seizures and generalized epilepsy associated with a mutation in the Na<sup>+</sup>-channel beta1 subunit gene *SCN1B*. *Nat Genet*. 1998; 19:366–370. [PubMed: 9697698]
- Wimmer VC, Reid CA, Mitchell S, Richards KL, Scaf BB, Leaw BT, Hill EL, Royeck M, Horstmann MT, Cromer BA, Davies PJ, Xu R, Lerche H, Berkovic SF, Beck H, Petrou S. Axon initial segment dysfunction in a mouse model of genetic epilepsy with febrile seizures plus. *J Clin Invest*. 2010; 120:2661–2671. [PubMed: 20628201]
- Zhang H, Tan J, Reynolds E, Kuebler D, Faulhaber S, Tanouye M. The *Drosophila* slamdance gene: a mutation in an aminopeptidase can cause seizure, paralysis and neuronal failure. *Genetics*. 2002; 162:1283–1299. [PubMed: 12454073]

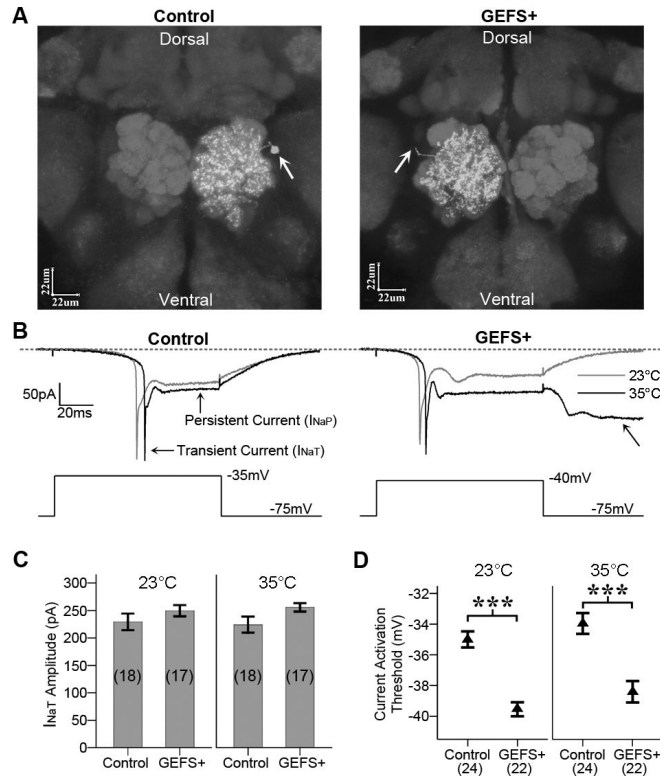


**Figure 1.** Generation of GEFS+ and Control flies by targeted knock-in. A) Schematic diagram of a sodium channel alpha-subunit. Lysine residue altered in the human K1720T GEFS+ mutation is located in the second transmembrane segment in homology domain III (indicated by \*). Comparison of the amino acid sequence in this region reveals a high degree of homology between species. Identical amino acids are shaded gray. Location of lysine residue altered in mutants is indicated by the \*. B) Diagram of the wild-type *para* sodium channel locus and the targeting vectors. The GEFS+ targeting vector contained the K to T substitution and the Control targeting vector contained the control substitution K to K. Location of the substitution indicated by \*. Homologous recombination events between incoming linear recombinogenic DNA and endogenous *para* locus are indicated by crossed lines.



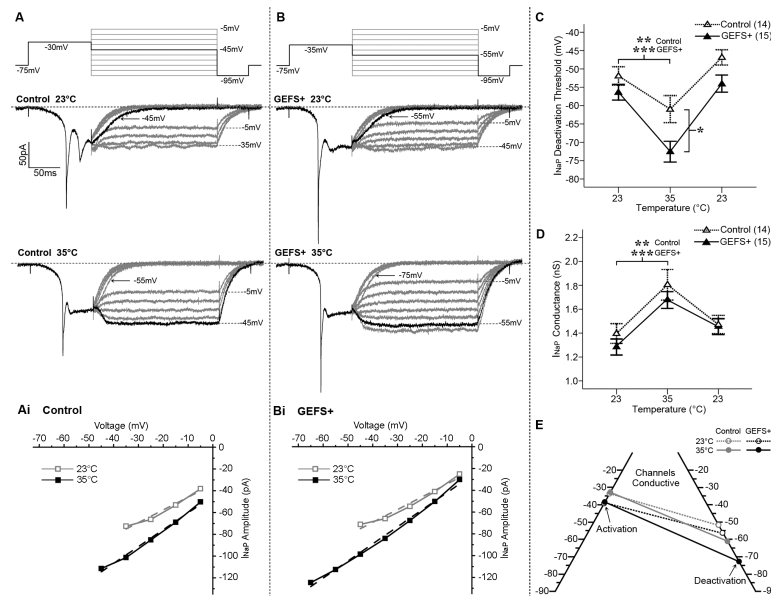
**Figure 2.** GEFS+ flies exhibit a temperature-induced seizure phenotype. Seizures are defined as a brief period of leg twitches, followed by inability to maintain standing posture, with wing flapping, leg twitching, and sometimes abdomen curling. Individual 2-day old flies were put into vials that were immersed in a water bath (40°C, 2 min). The status of each fly (seizing or not seizing) was determined at 5 second intervals and the probability of seizing at each time point was calculated for the population of flies examined in each genotype. The probability of seizing after 2 minutes at 40°C is significantly different between the mutants (GEFS+/Y and GEFS+/GEFS+), heterozygotes (GEFS+/Control) and Control (Control/Y and Control/Control). ( $p < 0.001$ , ANOVA Bonferroni post hoc test). Symbols/bars represent mean  $\pm$  SEM from number of flies indicated (n) for all subsequent figures.





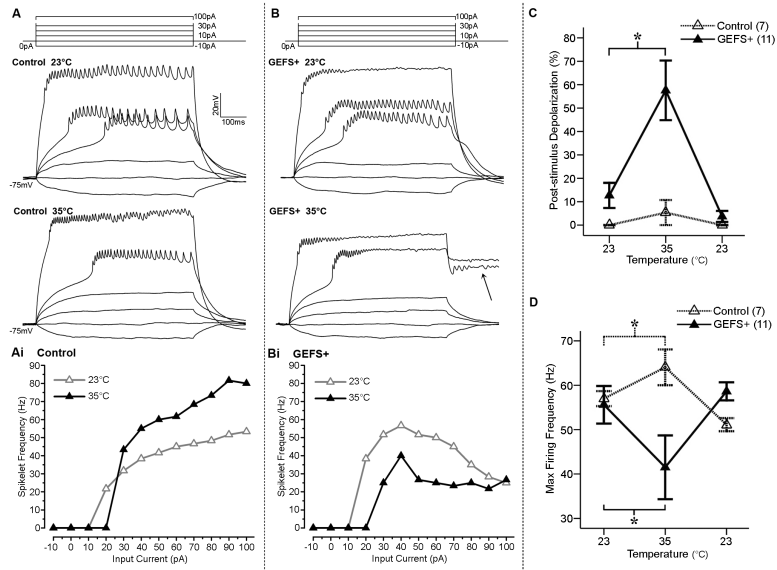
**Figure 3.**

Sodium currents in GEFS+ and Control LNs. A) A LN in the dorsal lateral cluster in the antennal lobe, filled with biocytin during recording, in a Control and GEFS+ brain. Confocal images of the brains fixed and double stained with a fluorescently labeled secondary antibody to biocytin and Nc82 (anti-bruchtpilot antibody). Arrows indicate LN cell body (Control) or axon initial segment (GEFS+). The soma of the GEFS+ cell was lost during pipette removal. B) Depolarizing voltage-step elicited sodium currents at room temperature (23°C) and following heating of the recording solution to high temperature (35°C).  $I_{NaP}$  in Control LN decayed to baseline after the pipet potential returned to -75 mV but it remained activated in the GEFS+ LN at 35°C (arrow). Sodium currents could not be clamped in either genotype. C)  $I_{NaT}$  amplitudes are no different in GEFS+ and Control LNs at 23°C or 35°C (independent *t*-test, 23°C  $p=0.28$ , 35°C  $p=0.07$ ) and the amplitude did not change with temperature in either genotypes (paired *t*-test, Control  $p=0.08$ , GEFS+  $p=0.20$ ). D) The voltage step required to elicit the first inward sodium current is significantly more hyperpolarized in GEFS+ than in Control at both 23°C and 35°C (independent *t*-test, \*\*\* $p<0.001$ ). The current activation threshold did not change significantly with temperature in either genotype (paired *t*-test, Control  $p=0.06$ , GEFS+  $p=0.14$ ). Symbols/bars represent mean  $\pm$  SEM.

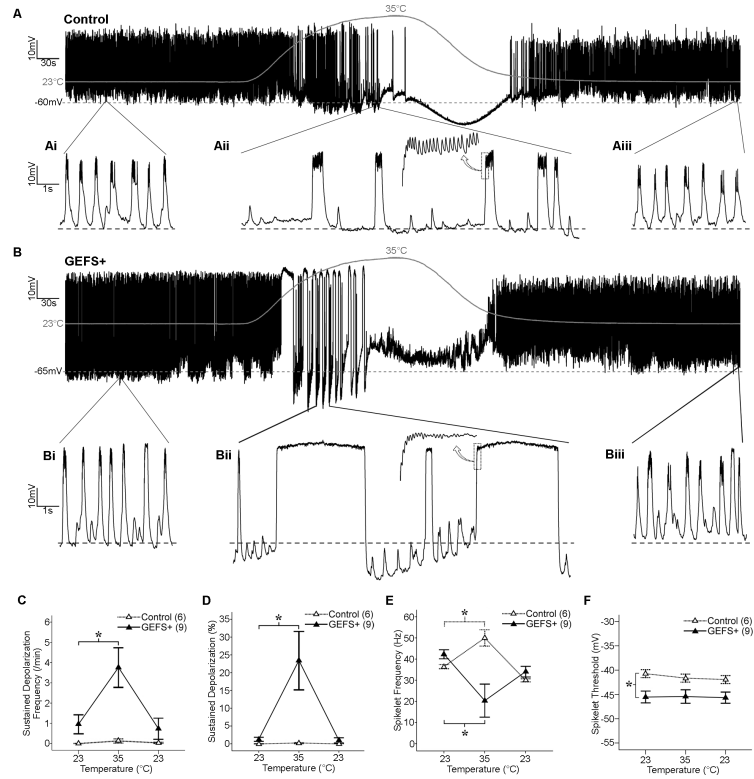


**Figure 4.**

Temperature-induced hyperpolarizing shift in  $I_{NaP}$  deactivation threshold is significantly larger in GEFS+ LNs. A, B) Families of  $I_{NaP}$  associated with the variable test step during the three-step voltage protocol illustrated in a typical Control and GEFS+ LN at 23°C and 35°C. Only one trace during the pre-pulse is shown for clarity. The first test potential that results in decay of the current back to baseline is defined as the current deactivation threshold voltage and is indicated by the arrow in each set of currents. When the temperature is raised from 23 to 35°C, current deactivation voltage shifts from -45 to -55 mV in Control and -55 to -75 mV in GEFS+ LN. Ai, Bi) I-V curves representing  $I_{NaP}$  amplitude measured during last 10 ms of the test pulse for each test potential from the traces shown above. Dashed lines are linear fits used to calculate the conductance of the  $I_{NaP}$ . C) The deactivation voltage is more hyperpolarized at 35°C compared to 23°C in both Control and GEFS+ (paired *t*-test, \*\* $p < 0.01$ , \*\*\* $p < 0.001$ ). However, the deactivation voltage is significantly more hyperpolarized in GEFS+ than in Control at 35°C (independent *t*-test, \* $p < 0.05$ ). D) Mean  $I_{NaP}$  conductance reversibly increase at 35°C in both genotypes but was not different between GEFS+ and Control at 23°C (independent *t*-test,  $p = 0.29$ ) or 35°C ( $p = 0.38$ ). E) Average activation and deactivation threshold voltage of sodium currents in Control and GEFS+ at room temperature and elevated temperature. GEFS+ LNs have a wider voltage range over which sodium channels are conductive.

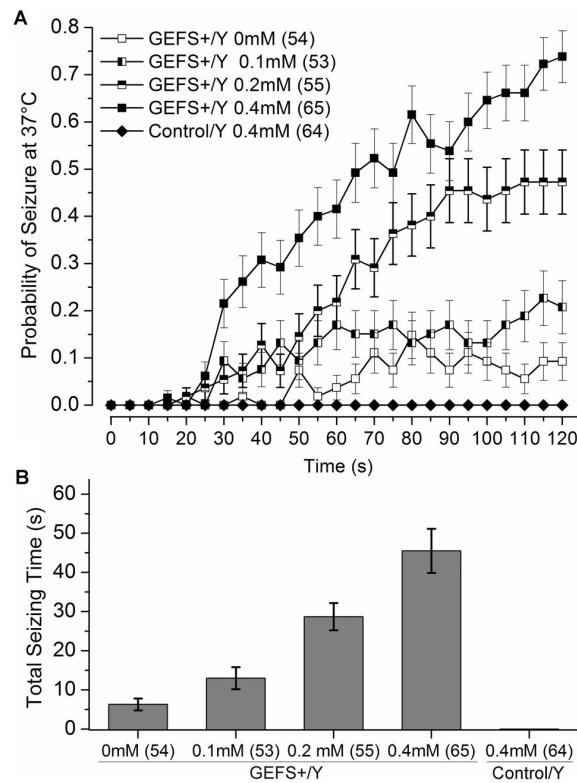


**Figure 5.** Alterations in evoked firing properties of GEFS+ LNs at elevated temperature. A, B) Representative trains of spikelets recorded from Control and GEFS+ LNs at 23 and 35°C evoked by the stimulus protocol illustrated. Ai, Bi) Spikelet frequency plotted as a function of injected current for LNs shown above. C) The incidence of post-stimulus depolarization is defined as the percentage of traces in which there was a post-stimulus depolarization that lasted for at least 50 msec in each LN. The incidence of GEFS+ LNs showing post-stimulus depolarizations increased significantly at 35°C compared to 23°C (paired *t*-test, \**p*<0.05). In contrast, the incidence of post-stimulus depolarization was low in Control LNs and did not increase significantly at elevated temperature (*p*=0.36). D) Raising the temperature from 23 to 35°C resulted in a significant increase in the maximal firing frequency in Control LNs (paired *t*-test, \**p*<0.05) and a significant decrease in GEFS+ LNs (\**p*<0.05).



**Figure 6.**

Appearance of sustained depolarizations without spikelets in GEFS+ LNs at high temperature. A, B) Continuous recordings of spontaneous activity in Control and GEFS+ LNs as the temperature is raised and lowered as indicated by the overlay of the temperature probe recording. Ai-Biii are traces on expanded time scales from regions indicated. In both genotypes the regular burst firing frequency gradually decreases as the temperature increases. Prior to cessation of firing, activity in GEFS+ LNs at high temperature is characterized by the appearance of sustained depolarizations without spikelets that are not observed in Control LNs. Normal burst firing resumes in both genotypes when the bath is returned to room temperature. C) The frequency of sustained membrane depolarizations in GEFS+ LNs increased at high temperature (paired  $t$ -test,  $*p < 0.05$ ). These events were counted at 23°C (5 min prior to heating), at high temperature (30–35°C) and following return to room temperature (0–5 min after return to room temperature). D) The percentage of membrane depolarizations that were sustained increased at 35°C in GEFS+ (paired  $t$ -test,  $*p < 0.05$ ). E) Spikelet frequency increased in Control LNs ( $*p < 0.05$ ), but decreased in GEFS+ LNs ( $*p < 0.05$ ) at 35°C compared to 23°C. F) The spikelet threshold is more hyperpolarized in GEFS+ than in Control LNs at both 23 and 35°C (independent  $t$ -test,  $p < 0.05$ ). The spikelet threshold did not change as a function of temperature in either GEFS+ (paired  $t$ -test,  $p = 0.95$ ) or Control LNs ( $p = 0.23$ ).

**Figure 7.**

PTX increases GEFS+ sensitivity to heat-induced seizures. A) Flies were fed sucrose with indicated concentration of PTX and tested for seizure susceptibility within 30 min. The probability of seizing in GEFS+ flies after 2 minutes at 37°C increases with PTX concentration ( $p < 0.001$ , one-way ANOVA). Control flies fed the maximal dose of PTX (0.4 mM) did not show seizure behavior at 37°C. B) In GEFS+ flies, the time spent seizing during the 2 minute heat exposure increases with PTX concentration ( $p < 0.001$ , one-way ANOVA).