

UCLA

UCLA Electronic Theses and Dissertations

Title

The Combinatorics of Poset Associahedra

Permalink

<https://escholarship.org/uc/item/3h64q6kv>

Author

Sack, Andrew Ian

Publication Date

2024

Peer reviewed|Thesis/dissertation

UNIVERSITY OF CALIFORNIA
Los Angeles

The Combinatorics of Poset Associahedra

A dissertation submitted in partial satisfaction
of the requirements for the degree
Doctor of Philosophy in Mathematics

by

Andrew Ian Sack

2024

© Copyright by
Andrew Ian Sack
2024

ABSTRACT OF THE DISSERTATION

The Combinatorics of Poset Associahedra

by

Andrew Ian Sack

Doctor of Philosophy in Mathematics

University of California, Los Angeles, 2024

Professor Pavel Galashin, Chair

In this dissertation, we study poset associahedra and the combinatorics surrounding them. We provide a simple realization of poset associahedra and affine poset cyclohedra. Furthermore, we show that the f -vector of a poset associahedron depends only on the comparability graph of the poset. We investigate a connection between certain poset associahedra and the theory of stack-sorting. Finally, we show that when the poset is a rooted tree, the 1-skeleton of the poset associahedron orients to a lattice. These lattices generalize both the weak Bruhat order and the Tamari lattice.

The dissertation of Andrew Ian Sack is approved.

Bruce L. Rothschild

Artem Chernikov

Igor Pak

Pavel Galashin, Committee Chair

University of California, Los Angeles

2024

TABLE OF CONTENTS

1	Introduction	1
1.1	Notation	2
1.2	Posets	2
1.2.1	Lattices	4
1.3	Polytopes	6
1.4	Poset Associahedra	9
1.4.1	An interpretation of tubings	11
2	A Realization of Poset Associahedra	14
2.1	Introduction	14
2.1.1	Affine Poset Cyclohedra	15
2.2	Configuration spaces and compactifications	17
2.3	Realizing poset associahedra	20
2.4	Realizing affine poset cyclohedra	24
2.5	Remarks and Questions	27
3	The Poset Associahedron f-vector is a Comparability Invariant.	30
3.1	Introduction	30
3.2	Background	31
3.2.1	Flips of autonomous subsets	31
3.3	Proof of Theorem 3.1.1	33
3.3.1	Proof Sketch	33

3.3.2	Proof details	34
3.4	Proof of Theorem 3.1.4	39
3.5	Open questions	40
4	Operahedron Lattices	42
4.1	Introduction	43
4.2	Preliminaries	49
4.3	The Lattice Property	51
4.4	Intervals	61
4.5	Semidistributivity	62
4.6	Trimness	74
4.7	Stacks and Brooms	76
4.8	Future Directions	81
	References	83

LIST OF FIGURES

1.1	A Hasse diagram of a poset with $1, 2 \preceq 3, 4, 5$	3
1.2	The Boolean lattice B_3	5
1.3	On the left is the Hasse diagram of $\text{Weak}(\mathfrak{S}_3)$ and on the right is the Hasse diagram of Tam_3	6
1.4	The Hasse diagram seen in Figure 1.1 and the corresponding poset associahedron.	9
1.5	Examples and non-examples of proper tubings.	10
1.6	On the left is the poset associahedron of the chain C_4 . On the right is the poset associahedron of the 3-claw.	11
1.7	Multiplication of a word and of a generalized word	12
2.1	An affine poset of order 4 and a maximal tubing	16
2.2	A vertex in $\mathcal{O}(P)$ vs. $\mathcal{A}(P)$	18
2.3	An example illustrating the proof of Lemma 2.3.3.	23
2.4	If $\text{diam}_A(p)$ and $\text{diam}_B(p)$ are small and $\text{diam}_\sigma(p)$ is large, then $\text{diam}_\tau(p)$ is large.	23
2.5	$\mathcal{O}(P)$ as a limit of $\mathcal{A}(P)$	27
3.1	An autonomous subset of a poset and a flip of the autonomous subset	32
3.2	A proper tubing and its image under $\Phi_{P,S}$	33
3.3	T_{bad} (left), T_{good} (middle), and T_{good} on P' (right).	34
3.4	The decomposition of T_{bad}	36
3.5	T'_{bad} and its decomposition.	37
3.6	$\mathcal{A}(P_{(1,2,2)})$ has an octagonal face, but $\mathcal{A}(P_{(2,1,2)})$ does not.	40

4.1	On the left is the chain in PT_4 . In the middle is the claw in PT_4 . On the right is the broom $\text{Broom}_{3,7} \in \text{PT}_7$. We have identified the vertex set of each tree in PT_n with $\{0, 1, \dots, n\}$ in a manner such that $0, 1, \dots, n$ is the preorder traversal of the tree.	44
4.2	On the left is the operahedron lattice of the chain in PT_3 , which is isomorphic to the third Tamari lattice. On the right is the operahedron lattice of the claw in PT_3 , which is isomorphic to the weak order on \mathfrak{S}_3 . Each tube is circled in blue.	45
4.3	The operahedron lattice of the tree  . We have identified the vertex set of the tree with the set $\{0, 1, 2, 3, 4\}$ so that $0, 1, 2, 3, 4$ is the preorder traversal. Each tube is circled in blue. Edges of the lattice corresponding to permutohedron moves are purple, while edges corresponding to associahedron moves are orange.	46
4.4	Three maximal nestings of a tree in PT_9 . The top two maximal nestings cover the bottom maximal nesting. The cover relation on the left corresponds to an associahedron move, while the cover relation on the right corresponds to a permutohedron move.	53
4.5	Applying Ψ to the maximal nestings in Figure 4.4 yields these three pairs, each of which consists of an ornamentation (which we represent by circling the ornaments in red) and a linear extension.	54
4.6	A cover relation $(\lambda_1, \varrho_1) \triangleleft (\lambda_2, \varrho_2)$ corresponding to an associahedron move. . . .	67
4.7	The pairs (λ^*, ϱ^*) (left) and (λ_*, ϱ_*) (right) constructed in the proofs of Theorems 4.5.2 and 4.5.3, where $(\lambda_1, \varrho_1) \triangleleft (\lambda_2, \varrho_2)$ is the cover relation shown in Figure 4.6.	68
4.8	An ornamentation of a forest poset \mathbb{T}^\times . Every vertex of \mathbb{T} that is not in the rightmost branch of \mathbb{T} is covered by at most 1 element.	72

4.9	The pairs (λ^*, ϱ^*) (top) and $(\lambda_*, \varrho_{\min})$ (bottom) constructed in the proofs of Theorems 4.5.5 and 4.5.6, where $(\lambda_1, \varrho_1) \triangleleft (\lambda_2, \varrho_2)$ is the cover relation defined in Theorem 4.5.7 (with $\varrho_1 = \varrho_2$ appearing in Figure 4.8). In the top image, the elements of X are colored green, while the elements of Y are colored purple. . .	73
4.10	An ornamentation of $\mathbf{Broom}_{4,9}^\times$	78

ACKNOWLEDGMENTS

I would like to thank my advisor Pavel Galashin for his endless encouragement and support and for introducing me to so much wonderful mathematics. The mathematical objects of study in this dissertation, poset associahedra, were introduced by him and it could quite literally not exist without him.

Two chapters of this dissertation are based on joint papers with Colin Defant and Son Nguyen, and I am grateful to them for letting me reproduce that work here. I am also grateful to Colin and Son for the excellent mathematical conversations we have had.

For stimulating mathematical conversations, I would like to thank Vincent Pilaud, Arnau Padrol, Chiara Mantovani, Igor Pak, Greta Panova, Swee Hong Chan, Vic Reiner, Pasha Pylyavskyy, Guillaume Laplante-Anfossi, Kurt Stoeckl, Fu Liu, Theo Douvropoulos, Federico Castillo, Lauren Williams, Alex Postnikov, Deanna Needell, Stefan Forcey, Nathan Reading, Hugh Thomas, Daria Poliakova, Erin George, Yotam Yaniv, Clark Lyons, Bar Roytman, Ben Spitz, and many others from whom my mathematical landscape has been broadened.

For the invaluable instruction that helped me pass my qualifying exams I would like to thank Austin Christian, Joe Breen, Ben Szczesny, David Hemminger, Alexander Merkurjev, Ko Honda, Sucharit Sarkar, and Sylvester Eriksson-Bique. I would especially like to thank Bon-Soon Lin who spent countless hours helping me prepare.

I could not have completed my time at UCLA without the support of my friends. I would like to thank Érico Silva, Yotam Yaniv, Erin George, Wes Wise, Paul Burns, Shaaz Feldman, Matt Blum, Michael Rowland, Amanda Snavely, Ezra Thompson, James Chapman, Cecelia Higgins, Jason Schuchardt, Grace Li, Jason Brown, Kate Anderson, Clark Lyons, Nikita Gladkov, Jennifer Wai, Arianna Schmid, Teagan Murphy, David Soukup, Ben Spitz, Adam Lott, Dominic Yang, Jacob Swenberg, Olha Shevchenko, Ariana Chin, Jerry Luo, Isaac Bernstein, Daniel Poirier, Benjamin Knode, Nick Geiser, and everybody else who lent me their support and friendship over the years.

I would like to thank my family. My parents encouraged my interest in mathematics since I was two years old. Some of my earliest memories are when my mom gave me a pocket calculator which quickly became my favorite toy and when my dad taught me what a factorial was. My brother Mitchell and his fiancée Emily have been a constant source of support and our calls always bring a smile to my face. Finally, I'd like to thank my incredible partner Eugene for their kindness, patience, and for always looking out for me. They have helped me more than they could ever know.

My work in this dissertation was supported by the National Science Foundation Graduate Research Fellowship Program under Grant No. DGE-2034835 and National Science Foundation Grants No. DMS-1954121 and DMS-2046915. Colin Defant was supported by the National Science Foundation under Award No. 2201907 and by a Benjamin Peirce Fellowship at Harvard University. Any opinions, findings, and conclusions or recommendations expressed in this material are those of the authors and do not necessarily reflect the views of the National Science Foundation.

VITA

- 2019 B.S. (Mathematics), University of Florida
- 2019 Kermit Sigmon Scholarship
- 2019-2024 NSF Graduate Research Fellowship Program
- 2022 M.A. (Mathematics), University of California, Los Angeles

PUBLICATIONS

- C. Defant, A. Sack. “Operahedron Lattices.” (*submitted*)
- S. Nguyen, A. Sack. “Poset Associahedra and Stack-sorting.” (*submitted*)
- S. Nguyen, A. Sack. “The poset associahedron f -vector is a comparability invariant.” (*submitted*)
- A. Sack. “A realization of poset associahedra.” (*submitted*)
- A. Sack, W. Jiang, M. Perlmutter, P. Salanevich, D. Needell. “On audio enhancement via online non-negative matrix factorization.” In *2022 56th Annual Conference on Information Sciences and Systems (CISS)*, pp. 287-291. *IEEE*, 2022.

L. Heller, A. Sack. “Unexpected failure of a Greedy choice Algorithm Proposed by Hoffman.”
Int. J. Math. Comput. Sci 12, no. 2 (2017): 117-126.

CHAPTER 1

Introduction

Convex polytopes related to combinatorial objects have been the subject of significant research in the past few decades [AS94, BT94, CD06, Hai84, Sta86]. In this dissertation, we study *poset associahedra* which are polytopes introduced by Galashin in [Gal23]. Poset associahedra arise as a natural generalization of Stasheff’s associahedra [Hai84, Pet15, Sta97, Tam54], and were originally discovered by considering compactifications of the configuration space of order-preserving maps $P \rightarrow \mathbb{R}$. These compactifications are generalizations of the Axelrod–Singer compactification of the configuration space of points on a line [AS94, LTV10, Sin04]. Galashin constructed poset associahedra by performing stellar subdivisions on the polar dual of Stanley’s *order polytope* [Sta86], but did not provide an explicit realization. Various poset associahedra and cyclohedra have already been studied including *permutohedra*, *associahedra*, *operahedra* [Lap22], *type B permutohedra* [FR05], and *cyclohedra* [BT94].

Poset associahedra bear resemblance to graph associahedra, where the face lattice of each is described by a *tubing criterion*. However, neither class is a subset of the other. When Carr and Devadoss introduced graph associahedra in [CD06], they distinguish between *bracketings* and *tubings* of a path, where the idea of bracketings does not naturally extend to any simple graph. In the case of poset associahedra, the idea of bracketings *does* extend to every connected poset.

In Chapter 1, we provide background on polytopes, posets, poset associahedra, and other combinatorics relevant to the remainder of the dissertation. In the subsequent chapters,

background is provided when it is only relevant to that chapter. In Chapter 2, we provide a simple geometric realization of poset associahedra as a convex polytope. Chapter 3 is based on joint work with Son Nguyen in which we show that the poset associahedron f -vector is a comparability invariant. Chapter 4 is based on joint work with Colin Defant in which we show that in the special case that the poset is a rooted tree, the 1-skeleton of the poset associahedron orients to a lattice.

1.1 Notation

Throughout this dissertation, we use the following conventions:

1. $[n] := \{1, \dots, n\}$.
2. \mathfrak{S}_n is the symmetric group of order $n!$.
3. \sqcup denotes disjoint union.
4. \simeq denotes isomorphism.

1.2 Posets

“The biggest lesson I learned from Richard Stanley’s work is, combinatorial objects want to be partially ordered!”

Jim Propp [Pro16]

Posets are a major topic of study within combinatorics. For a comprehensive study of the topic, see [Tro92, Sta12]. A *poset* is a pair $P = (X, \preceq)$ where X is a set and \preceq is a relation on X such that the following three conditions hold:

- If $a, b, c \in X$ such that $a \preceq b$ and $b \preceq c$ then $a \preceq c$.
- If $a, b \in X$ such that $a \preceq b$ and $b \preceq a$ then $a = b$.
- For all $a \in X, a \preceq a$.

We call such \preceq a *partial order* on X . Throughout this dissertation, we will frequently abuse notation and identify X with P and for example, write $x \in P$ instead of $x \in X$. We will use \preceq to refer to a partial order and if it is not clear from context which partial order we are using, we will write \preceq_P . If $a \preceq b$ and $a \neq b$ then we write $a \prec b$. We say that c *covers* a if $a \prec c$ and there does not exist b such that $a \prec b \prec c$. We denote that c covers a by writing $a \prec c$.

It is convenient to represent P pictorially via its *Hasse diagram*. The Hasse diagram is the directed graph with vertex set X and edge set

$$\{(a, b) \in X \times X \mid a \prec b\}.$$

We will draw Hasse diagrams with undirected edges, but where if $a \preceq b$ then a will be below b . See Figure 1.1 for an example of a Hasse diagram.

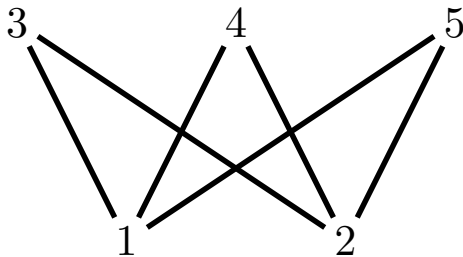

Figure 1.1: A Hasse diagram of a poset with $1, 2 \preceq 3, 4, 5$

Definition 1.2.1. Let $P = (X, \preceq)$ be a poset and let $n = |X|$. A *linear extension* of P is a bijection $f : X \rightarrow [n]$ such that if $i, j \in X$ with $i \preceq j$ then $f(i) \leq f(j)$.

Definition 1.2.2. Let P and Q be posets. A function $f : P \rightarrow Q$ is called *order-preserving* if for all $x, y \in P, x \preceq_P y$ implies $f(x) \preceq_Q f(y)$. An *isomorphism* is an order-preserving bijection whose inverse is also order preserving.

Definition 1.2.3. Let $P = (X, \preceq_P)$ and $Q = (Y, \preceq_Q)$ be posets with $X \cap Y = \emptyset$. The *ordinal sum* of P and Q is the poset

$$P \oplus Q := (X \sqcup Y, \preceq_{P \oplus Q})$$

where $a \preceq_{P \oplus Q} b$ if and only if

- $a, b \in X$ and $a \preceq_P b$ or
- $a, b \in Y$ and $a \preceq_Q b$ or
- $a \in X$ and $b \in Y$.

Example 1.2.4. We define three important posets relevant to this dissertation.

- The *chain* is the poset $C_n := ([n], \preceq_{\mathbb{Z}})$. Observe that $C_n \simeq C_{n-1} \oplus C_1$.
- The *anti-chain* A_n is the poset on n elements with no relations.
- The *n -claw* is $A_1 \oplus A_n$.

Definition 1.2.5. A *lower set* of a poset P is a subset $S \subseteq P$ such that if $x \in P, y \in S$ such that $x \preceq y$ then $x \in S$. For $x \in P$, the *lower set generated by x* is the set

$$\downarrow x := \{y \in P \mid y \preceq x\}.$$

Dually, an *upper set* is a subset $S \subseteq P$ such that if $x \in P, y \in S$ such that $y \preceq x$ then $x \in S$ and the *upper set generated by x* is the set

$$\uparrow x := \{y \in P \mid x \preceq y\}.$$

1.2.1 Lattices

Definition 1.2.6. Let P be a poset and let $x, y \in P$. If the set $(\downarrow x) \cap (\downarrow y)$ has a unique maximal element, we denote this element $x \wedge y$ and call it the *meet* of x and y . If the set $(\uparrow x) \cap (\uparrow y)$ has a unique minimal element, we denote this element $x \vee y$ and call it the *join* of x and y . If $x \wedge y$ and $x \vee y$ exist for all $x, y \in P$ then we call P a *lattice*.

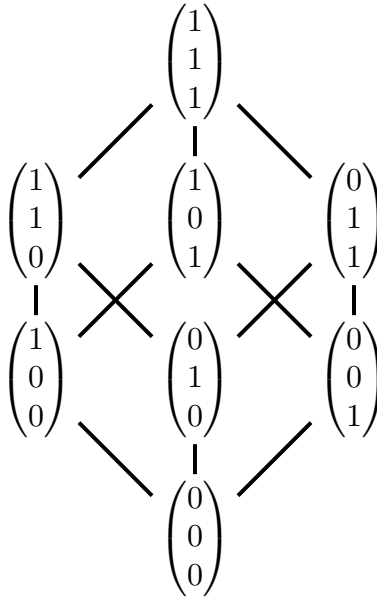

Figure 1.2: The Boolean lattice B_3

Two lattices relevant to this dissertation are the *weak Bruhat order* on permutations and the *Tamari lattice*.

We represent a permutation w in the symmetric group \mathfrak{S}_n via its *one-line notation* $w(1) \cdots w(n)$.

Definition 1.2.7. An *inversion* of w is a pair (i, j) such that $1 \leq i < j \leq n$ and $w^{-1}(j) < w^{-1}(i)$. Let $\text{Inv}(w)$ denote the set of inversions of w . The (*right*) *weak Bruhat order* on \mathfrak{S}_n is the poset $\text{Weak}(\mathfrak{S}_n) = (\mathfrak{S}_n, \leq)$, where for $w, w' \in \mathfrak{S}_n$, we have $w \leq w'$ if and only if $\text{Inv}(w) \subseteq \text{Inv}(w')$.

For a proof that $\text{Weak}(\mathfrak{S}_n)$ is a lattice, see [BB05]. See Figure 1.3 for the Hasse diagram of $\text{Weak}(\mathfrak{S}_3)$.

Definition 1.2.8. Fix $n \geq 1$. The *Tamari lattice* Tam_n is a partial order defined on all binary bracketings on a fixed word with $(n + 1)$ symbols. We define a partial order on Tam_n via the covering relations $(AB)C \prec A(BC)$ where A, B , and C can themselves be binary bracketed expressions.

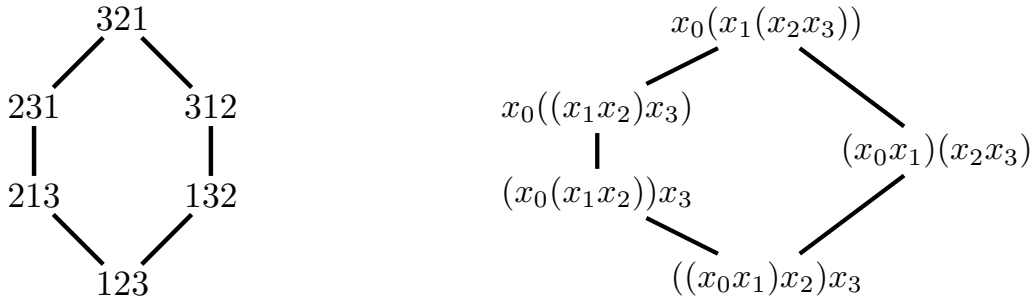

Figure 1.3: On the left is the Hasse diagram of $\text{Weak}(\mathfrak{S}_3)$ and on the right is the Hasse diagram of Tam_3 .

For a proof that Tam_n is a lattice, see [HT72]. See Figure 1.3 for the Hasse diagram of Tam_3 .

1.3 Polytopes

“A related lesson that Stanley has taught me is, combinatorial objects want to belong to polytopes!”

Jim Propp [Pro16]

This chapter covers the basics of polytopes necessary for understanding the remainder of this dissertation, and many results will be stated without proof. All results in this section may be found in [Zie12], which one may consult for a more thorough exposition.

Definition 1.3.1. Let $p \in \mathbb{R}^n$ and let $a \in \mathbb{R}$. The *half-space* $h_{p,a}$ is the set of points

$$h_{p,a} := \{x \in \mathbb{R}^n \mid \langle p, x \rangle \geq a\}.$$

The *hyperplane* $H_{p,a}$ is the set

$$H_{p,a} := \{x \in \mathbb{R}^n \mid \langle p, x \rangle = a\}.$$

Definition 1.3.2. An \mathcal{H} -polytope is a compact intersection of half-spaces.

Definition 1.3.3. A \mathcal{V} -polytope is the convex hull of a finite number of points in \mathbb{R}^n .

It is well-known that these two definitions are equivalent, see [Zie12, §1].

Definition 1.3.4. The *dimension* of a polytope P is the dimension of the affine span of P .

Definition 1.3.5. A *face* F of a polytope $P \subseteq \mathbb{R}^d$ is a subset $F \subseteq P$ such that $F = P \cap H_{p,a}$ for some $p \in \mathbb{R}^n, a \in \mathbb{R}$ such that $P \subseteq h_{p,a}$. The set of all faces of P ordered by inclusion is called the *face lattice* of P and is denoted $L(P)$.

Two polytopes are said to be *combinatorially equivalent* if they have isomorphic face lattices. Let P be a d -dimensional polytope. The 0, 1, and $(d - 1)$ -dimensional faces of P are called *vertices*, *edges*, and *facets* respectively. The *graph* or *1-skeleton* of P whose vertices are equal to the vertices of P and whose edges are equal to the edges of P . We denote this graph $G(P)$.

It is frequently interesting to orient the edges of $G(P)$. In particular, let $p \in \mathbb{R}^n$ be *generic* with respect to P , i.e. for all edges $\{u, v\}$ in the graph of P , $\langle p, u - v \rangle \neq 0$. Then the orientation of $G(P)$ with respect to p has edge set

$$\{(u, v) \mid \{u, v\} \in E(G(P)) \text{ and } \langle p, u - v \rangle > 0\}.$$

Definition 1.3.6. A d -dimensional polytope is called *simple* if for all vertices v in the graph of P , the degree of v is d .

Definition 1.3.7. The *f-vector* of a d -dimensional polytope P is the tuple (f_0, \dots, f_d) where f_i is the number of faces of dimension i and the *f-polynomial* is

$$f(z) = \sum_{i=0}^d f_i z^i.$$

When P is simple, we additionally define the *h-polynomial*

$$h(z) = \sum_{i=0}^n h_i z^i = f(z - 1).$$

Theorem 1.3.8. *Let P be a simple d -dimensional polytope and let $p \in \mathbb{R}^n$ be generic with respect to P . Orient $G(P)$ with respect to p . Then for all $0 \leq i \leq d$,*

$$h_i = \#\{v \in V(G(P)) \mid \text{outdegree}(v) = i\}.$$

Corollary 1.3.9. *Let P be a simple polytope and let $h(z) = \sum_{i=0}^d$ be its h -polynomial. Then for all $0 \leq i \leq d$ we have $h_i \geq 0$ and $h_i = h_{d-i}$.*

As $h(z)$ is palindromic, one can further define the γ -vector $(\gamma_0, \dots, \gamma_{\lfloor d/2 \rfloor})$ via

$$\sum_{i=0}^d h_i t^i = \sum_{i=0}^{\lfloor d/2 \rfloor} \gamma_i t^i (1+t)^{d-2i}.$$

Example 1.3.10. The d -cube $[0, 1]^d$ is a simple polytope with

$$f(z) = (z+2)^d \text{ and } h(z) = (z+1)^d \text{ and } \gamma(z) = z^{\lfloor d/2 \rfloor}.$$

Theorem 1.3.11 ([Kal88]). *Let P be a simple polytope. Then $L(P)$ is determined by $G(P)$.*

Two important simple polytopes that have been studied extensively are permutohedra and associahedra [Pos09, PRW08]. Permutohedra and associahedra are important special cases of poset associahedra.

Definition 1.3.12. The n -th permutohedron Π_n is the convex hull of all permutations of the vector $(1, 2, \dots, n)$.

Theorem 1.3.13. *Orient Π_n with respect to $(1, 2, \dots, n)$. Then $G(\Pi_n)$ is isomorphic to the Hasse diagram of $\text{Weak}(\mathfrak{S}_n)$.*

The associahedron was originally defined as a cell complex by Stasheff [Sta63] and has since been given many polytopal realizations [CSZ15].

Definition 1.3.14. The n -th associahedron Ass_n is any polytope whose face lattice is isomorphic to the set of partial binary bracketings of a fixed word with $(n+1)$ symbols ordered by reverse inclusion.

One can obtain the Hasse diagram of Tam_n as the oriented graph of the realization of Ass_n given in [Lod04].

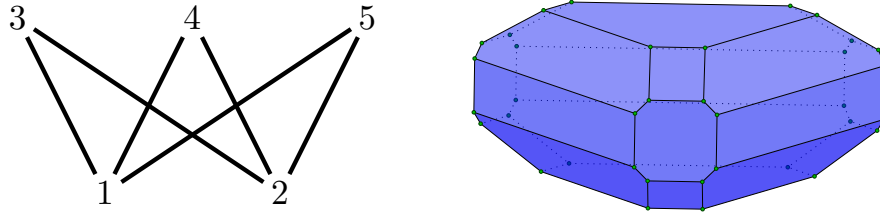

Figure 1.4: The Hasse diagram seen in Figure 1.1 and the corresponding poset associahedron.

1.4 Poset Associahedra

We are now prepared to define *poset associahedra*, the central objects of study in this dissertation. Poset associahedra were introduced in [Gal23]. We recall several definitions.

Definition 1.4.1. Let (P, \preceq) be a finite poset. We make the following definitions:

- A subset $\tau \subseteq P$ is *connected* if it is connected as an induced subgraph of the undirected Hasse diagram of P .
- $\tau \subseteq P$ is *convex* if whenever $a, c \in \tau$ and $b \in P$ such that $a \preceq b \preceq c$, then $b \in \tau$.
- A *tube* of P is a connected, convex subset $\tau \subseteq P$ such that $2 \leq |\tau|$.
- A tube τ is *proper* if $|\tau| \leq |P| - 1$.
- Two tubes $\sigma, \tau \subseteq P$ are *nested* if $\sigma \subseteq \tau$ or $\tau \subseteq \sigma$. Tubes σ and τ are *disjoint* if $\tau \cap \sigma = \emptyset$.
- For disjoint tubes σ, τ we say $\sigma \prec \tau$ if there exists $a \in \sigma, b \in \tau$ such that $a \prec b$.
- A *proper tubing* T of P is a set of proper tubes of P such that any pair of tubes is nested or disjoint and the relation \prec extends to a partial order on T . That is, whenever $\tau_1, \dots, \tau_k \in T$ with $\tau_1 \prec \dots \prec \tau_k$ then $\tau_k \not\prec \tau_1$. This is referred to as the *acyclic tubing condition*.

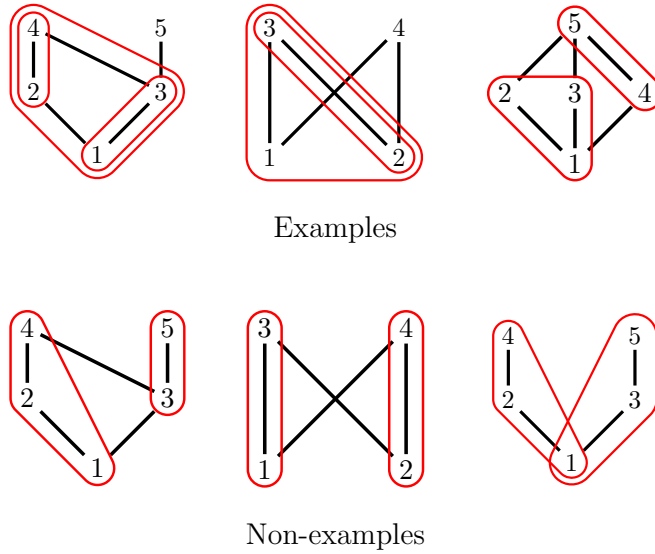

Figure 1.5: Examples and non-examples of proper tubings.

- A proper tubing T is *maximal* if it is maximal by inclusion on the set of all proper tubings.

Figure 1.5 shows examples and non-examples of proper tubings.

Definition 1.4.2. For a finite poset P , the *poset associahedron* $\mathcal{A}(P)$ is a simple, convex polytope of dimension $|P| - 2$ whose face lattice is isomorphic to the set of proper tubings ordered by reverse inclusion. That is, if F_T is the face corresponding to T , then $F_S \subset F_T$ if one can make S from T by adding tubes. Vertices of $\mathcal{A}(P)$ correspond to maximal tubings of P .

When P is a chain on $n + 1$ elements, $\mathcal{A}(P)$ recovers the associahedron Ass_n . When P is the n -claw, $\mathcal{A}(P)$ recovers the permutohedron Π_n . See Figure 1.6 for the 2 dimensional examples.

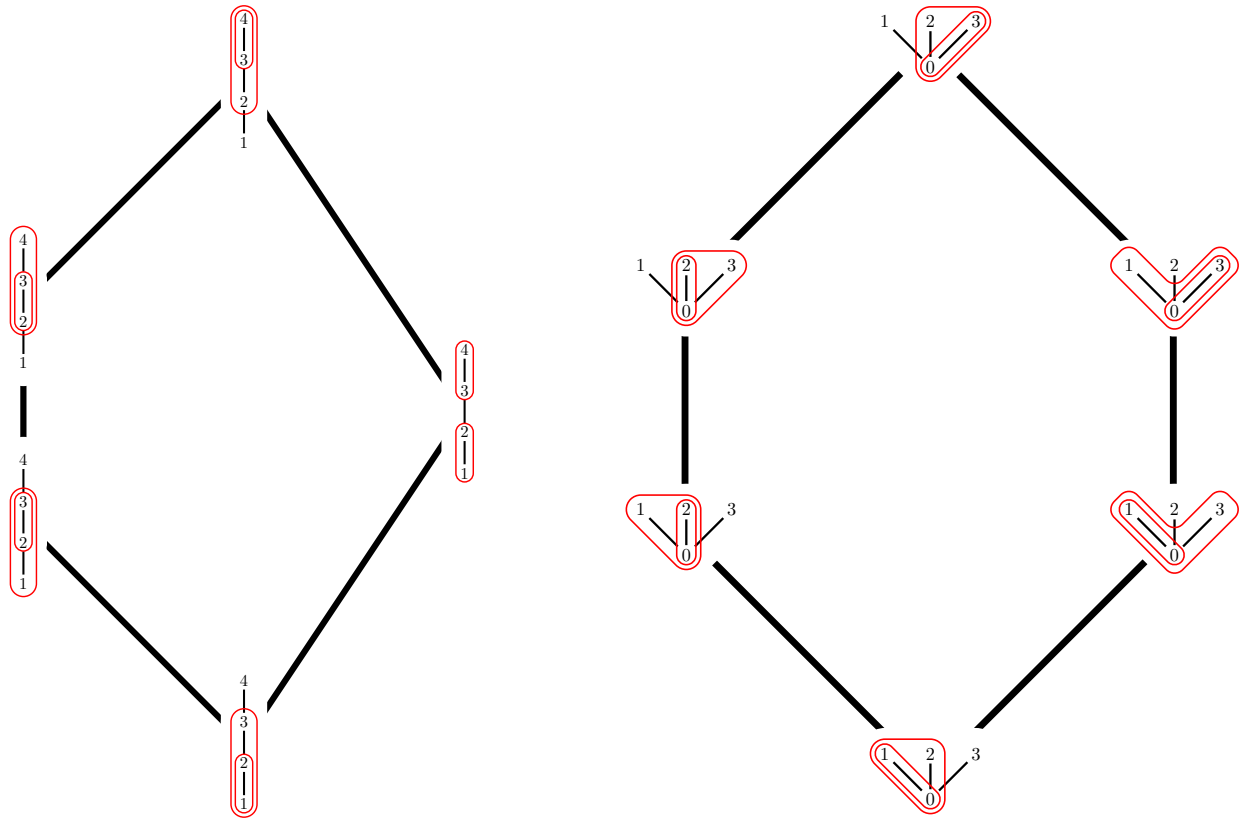

Figure 1.6: On the left is the poset associahedron of the chain C_4 . On the right is the poset associahedron of the 3-claw.

1.4.1 An interpretation of tubings

There is a simple interpretation of maximal proper tubings that explains all of the definitions above in terms of *generalized words*.

We can understand the classical associahedron as follows: Let $P = (\{1, \dots, n\}, \leq)$ be a chain. We can think of the chain as a word we want to multiply together with the rule that two elements can be multiplied if they are connected by an edge in the Hasse diagram. A maximal tubing of P is a way of disambiguating the order in which one performs the multiplication. If a pair of adjacent elements x and y have a pair of brackets around them, they contract along the edge connecting them and replace x and y by their product.

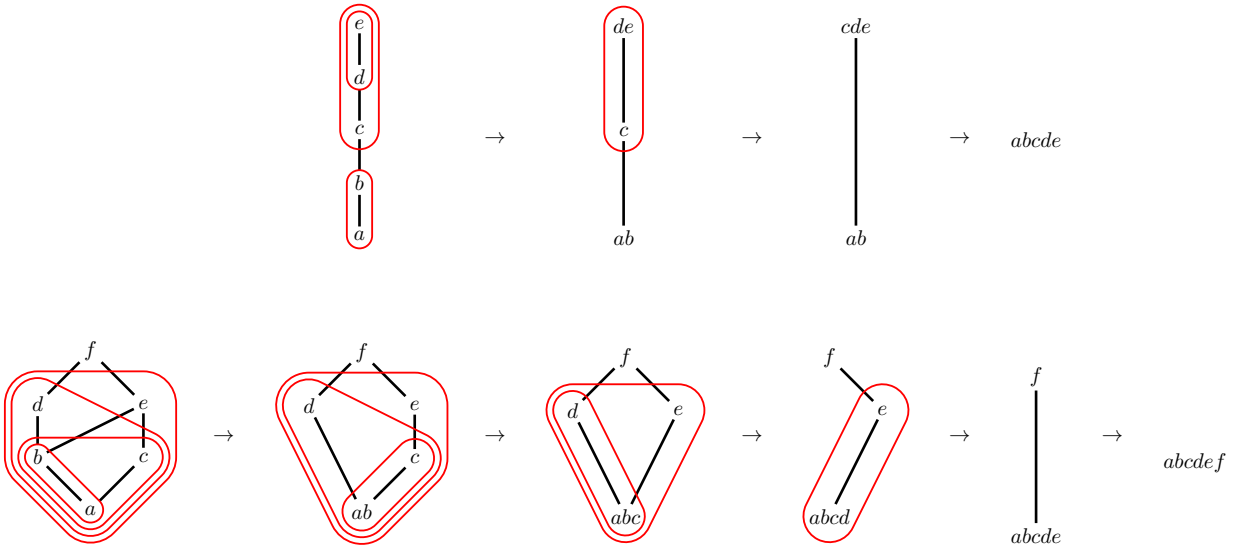

Figure 1.7: Multiplication of a word and of a generalized word

Similarly, we can understand the Hasse diagram of an arbitrary poset P as a *generalized word* we would like to multiply together. Again, we are allowed to multiply two elements if they are connected by an edge, but when multiplying elements, we contract along the edge connecting them and then take the transitive reduction of the resulting directed graph. That is, we identify the two elements and take the resulting quotient poset. A maximal tubing is again a way of disambiguating the order of the multiplication. See Figure 1.7 for an illustration of this multiplication. It is not hard to see that if one keeps track of which sets have been identified during this process, then one recovers the definition of tubes and tubings.

The perspective has seen some application in algebraic topology. In particular, one may view the elements of a poset as operations with multiple inputs and multiple outputs where the edges below an element in the Hasse diagram are its inputs and the edges above an element are its outputs. Maximal tubings then correspond to disambiguating the order of composition of these higher operations. This is discussed in [Sto23, Remark 7.1.3] where it is shown that tubings form an operad governing properads and in [Lap22, Section 2.1] in the

case that the Hasse diagram of P is a rooted tree.

CHAPTER 2

A Realization of Poset Associahedra

This chapter is based on [Sac23]. In this chapter, we give a simple realization of $\mathcal{A}(P)$ as a convex polytope in \mathbb{R}^P . The realization is inspired by the description of $\mathcal{A}(P)$ as a compactification of the configuration space of order-preserving maps $P \rightarrow \mathbb{R}$. In addition, we give an analogous realization for Galashin's affine poset cyclohedra.

2.1 Introduction

In addition to poset associahedra, Galashin [Gal23] also introduces *affine posets*, *affine order polytopes*, and *affine poset cyclohedra*. In this chapter, we provide a simple realization of poset associahedra and affine poset cyclohedra as an intersection of half spaces, inspired by the compactification description and by a similar realization of graph associahedra due to Devadoss [Dev09]. In independent work [MPPep], Mantovani, Padrol, and Pilaud found a realization of poset associahedra as sections of graph associahedra. The authors of [MPPep] also generalize from posets to oriented building sets (which combine a building set with an oriented matroid).

We realize poset associahedra as an intersection of half-spaces. Let P be a finite poset and let $n = |P|$. We work in the ambient space $\mathbb{R}_{\Sigma=0}^P$, the space of real-valued functions on P that sum to 0. For a subset $\tau \subseteq P$, define a linear function α_τ on $\mathbb{R}_{\Sigma=0}^P$ by

$$\alpha_\tau(p) := \sum_{\substack{i \prec j \\ i, j \in \tau}} p_j - p_i.$$

Here the sum is taken over all covering relations contained in τ . We define the half-space h_τ and the hyperplane H_τ by

$$h_\tau := \{p \in \mathbb{R}_{\Sigma=0}^P \mid \alpha_\tau(p) \geq n^{2|\tau|}\} \quad \text{and}$$

$$H_\tau := \{p \in \mathbb{R}_{\Sigma=0}^P \mid \alpha_\tau(p) = n^{2|\tau|}\}.$$

The following is our main result in the finite case:

Theorem 2.1.1. *If P is a finite, connected poset, the intersection of H_P with h_τ for all proper tubes τ gives a realization of $\mathcal{A}(P)$.*

2.1.1 Affine Poset Cyclohedra

Now we describe affine poset cyclohedra.

Definition 2.1.2. An *affine poset* of order $n \geq 1$ is a poset $\tilde{P} = (\mathbb{Z}, \preceq)$ such that:

1. For all $i \in \mathbb{Z}, i \preceq i + n$;
2. \tilde{P} is n -periodic: For all $i, j \in \mathbb{Z}, i \preceq j \Leftrightarrow i + n \preceq j + n$;
3. \tilde{P} is *strongly connected*: for all $i, j \in \mathbb{Z}$, there exists $k \in \mathbb{Z}$ such that $i \preceq j + kn$.

The *order* of \tilde{P} is denoted $|\tilde{P}| := n$.

Following Galashin [Gal23], we give analogous versions of Definition 1.4.1. We give them only where they differ from the finite case.

Definition 2.1.3. Let $\tilde{P} = (\mathbb{Z}, \preceq)$ be an affine poset.

- A *tube* of \tilde{P} is a connected, convex subset $\tau \subseteq \tilde{P}$ such that $2 \leq |\tau|$ and either $\tau = \tilde{P}$ or τ has at most one element in each residue class modulo n .
- A collection of tubes T is n -periodic if for all $\tau \in T, k \in \mathbb{Z}, \tau + kn \in T$.

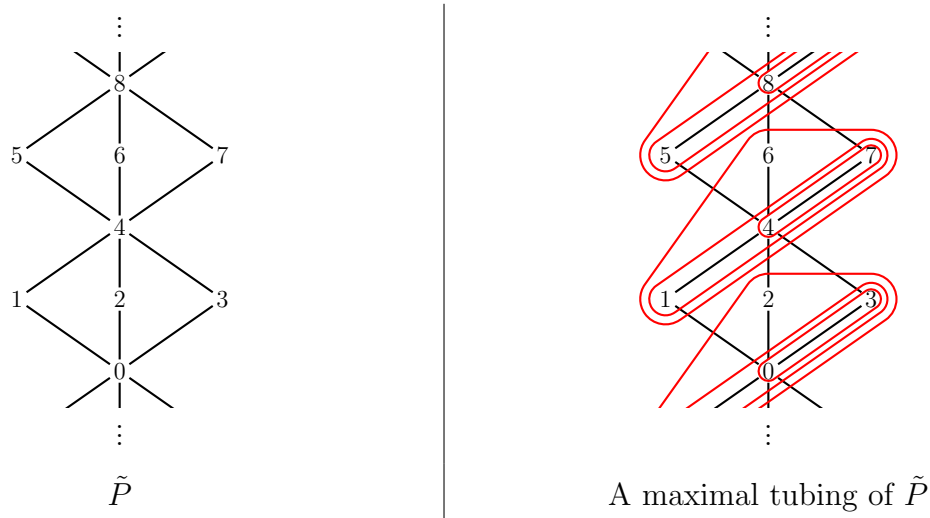

Figure 2.1: An affine poset of order 4 and a maximal tubing

- A *proper tubing* T of \tilde{P} is an n -periodic set of proper tubes of \tilde{P} that satisfies the acyclic tubing condition and such that any pair of tubes is nested or disjoint.

Figure 2.1 gives an example of an affine poset of order 4 and a maximal tubing of that poset.

Definition 2.1.4. For an affine poset \tilde{P} , the *affine poset cyclohedron* $\mathcal{C}(\tilde{P})$ is a simple, convex polytope of dimension $|\tilde{P}| - 1$ whose face lattice is isomorphic to the set of proper tubings ordered by reverse inclusion. Vertices of $\mathcal{C}(\tilde{P})$ correspond to maximal tubings of \tilde{P} .

We also realize affine poset cyclohedra as an intersection of half-spaces. Let \tilde{P} be an affine poset and let $n = |\tilde{P}|$. Fix some constant $c \in \mathbb{R}^+$. We define the space of *affine maps* $\mathbb{R}^{\tilde{P}}$ as the set of bi-infinite sequences $\tilde{\mathbf{x}} = (\tilde{x}_i)_{i \in \mathbb{Z}}$ such that $\tilde{x}_i = \tilde{x}_{i+n} + c$ for all $i \in \mathbb{Z}$. Let $\mathcal{C} \subset \mathbb{R}^{\tilde{P}}$ be the subspace consisting of all constant maps. We work in the ambient space $\mathbb{R}^{\tilde{P}}/\mathcal{C}$ where the constant c in the definition of affine maps is given by $c = n^{2(n+1)}$.

For a finite subset $\tau \subseteq P$, define a linear function α_τ on $\mathbb{R}^{\tilde{P}}/\mathcal{C}$ by

$$\alpha_\tau(\tilde{\mathbf{x}}) := \sum_{\substack{i \leftarrow j \\ i, j \in \tau}} \tilde{x}_j - \tilde{x}_i.$$

Again, the sum is taken over all covering relations contained in τ . We define the half-space h_τ and the hyperplane H_τ by

$$h_\tau := \{p \in \mathbb{R}^{\tilde{P}}/\mathcal{C} \mid \alpha_\tau(p) \geq n^{2|\tau|}\} \quad \text{and}$$

$$H_\tau := \{p \in \mathbb{R}^{\tilde{P}}/\mathcal{C} \mid \alpha_\tau(p) = n^{2|\tau|}\}.$$

Remark 2.1.5. Observe that for any tube τ and $k \in \mathbb{Z}$, $h_\tau = h_{\tau+kn}$.

The following is our main result in the affine case:

Theorem 2.1.6. *If \tilde{P} is an affine poset, the intersection of h_τ for all proper tubes τ gives a realization of $\mathcal{C}(\tilde{P})$.*

2.2 Configuration spaces and compactifications

We turn our attention to the relationship between poset associahedra and configuration spaces. For a poset P , the *order cone*

$$\mathcal{L}(P) := \{p \in \mathbb{R}_{\Sigma=0}^P \mid p_i \leq p_j \text{ for all } i \preceq j\}$$

is the set of order preserving maps $P \rightarrow \mathbb{R}$ whose values sum to 0.

Fix a constant $c \in \mathbb{R}^+$. The *order polytope*, first defined by Stanley [Sta86] and extended by Galashin [Gal23], is the $(|P| - 2)$ -dimensional polytope

$$\mathcal{O}(P) := \{p \in \mathcal{L}(P) \mid \alpha_P(p) = c\}.$$

Remark 2.2.1. When P is *bounded*, that is, has a unique maximum $\hat{1}$ and minimum $\hat{0}$, this construction is projectively equivalent to Stanley's order polytope where we replace the conditions of the coordinates summing to 0 and $\alpha_P(p) = c$ with the conditions $p_{\hat{0}} = 0$ and $p_{\hat{1}} = 1$, see [Gal23, Remark 2.5].

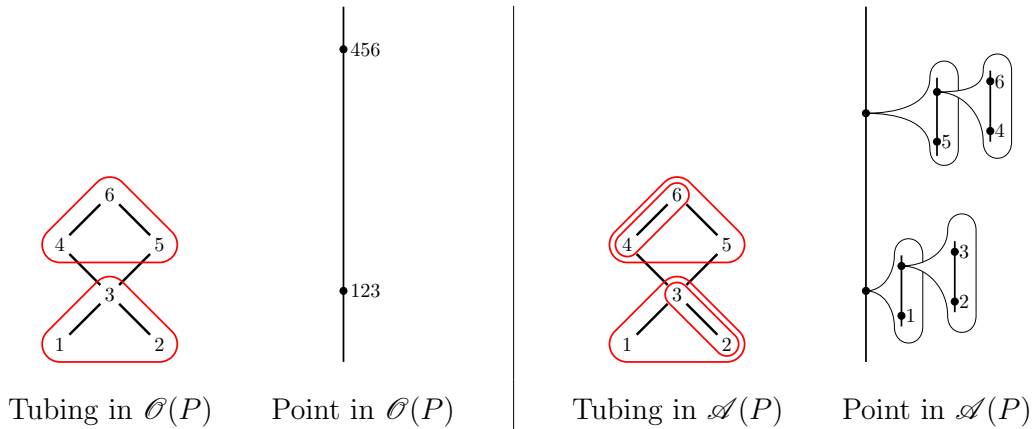

Figure 2.2: A vertex in $\mathcal{O}(P)$ vs. $\mathcal{A}(P)$.

Galashin [Gal23] obtains the poset associahedra by an alternative compactification of $\mathcal{O}^\circ(P)$, the interior of $\mathcal{O}(P)$. We describe this compactification informally, as it serves as motivation for the realization in Theorem 2.1.1.

A point is on the boundary of $\mathcal{O}(P)$ when any of the inequalities in the order cone achieve equality. The faces of $\mathcal{O}(P)$ are in bijection with proper tubings of P such that all tubes are disjoint. Let T be such a tubing. If p is in the face corresponding to T and $\tau \in T$ then $p_i = p_j$ for $i, j \in \tau$.

We can think of the point p in the face corresponding to T as being “what happens in $\mathcal{O}(P)$ ” when for each $\tau \in T$, the coordinates are infinitesimally close. However, by taking all coordinates in τ to be equal, we lose information about their relative ordering. In $\mathcal{A}(P)$, we still think of the coordinates in τ as being infinitesimally close, but we are still interested in their configuration. Upon zooming in, this is parameterized by the order polytope of the subposet (τ, \preceq) . We iterate this process, allowing points in τ to be infinitesimally closer, and so on. We illustrate this in Figure 2.2. This idea is a common explanation of the Axelrod–Singer compactification of $\mathcal{O}^\circ(P)$ when P is a chain, see [AS94, LTV10, Sin04].

The idea of the realization in Theorem 2.1.1 is to replace the notions of *infinitesimally close* and *infinitesimally closer* with being *exponentially close* and *exponentially closer*. For

$p \in \mathcal{L}(P)$, α_τ acts a measure of how close the coordinates of $p|_\tau$ are. We can make this precise with the following definition and lemma.

Definition 2.2.2. For $S \subseteq P$ and $p \in \mathbb{R}^P$, define the *diameter* of p relative to S by

$$\text{diam}_S(p) = \max_{i,j \in S} |p_i - p_j|.$$

That is, $\text{diam}_S(p)$ is the diameter of $\{p_i : i \in S\}$ as a subset of \mathbb{R} .

Lemma 2.2.3. Let $\tau \subseteq P$ be a tube and let $p \in \mathcal{L}(P)$. Then

$$\text{diam}_\tau(p) \leq \alpha_\tau(p) \leq \frac{n^2}{4} \text{diam}_\tau(p).$$

Proof. By the triangle inequality and as τ is connected, $\text{diam}_\tau(p) \leq \alpha_\tau(p)$. For the other inequality,

$$\begin{aligned} \alpha_\tau(p) &= \sum_{\substack{i \prec j \\ i,j \in \tau}} p_j - p_i \\ &\leq \sum_{\substack{i \prec j \\ i,j \in \tau}} \text{diam}_\tau(p) \\ &\leq \frac{1}{4} n^2 \text{diam}_\tau(p) \end{aligned}$$

The inequality in the last line comes from the fact that there are at most $\frac{n^2}{4}$ covering relations in P , which follows from Mantel's Theorem and the fact that Hasse diagrams are triangle-free.

□

In particular, for $p \in \mathcal{L}(P)$, if $p \in H_\tau$, then $\{p_i \mid i \in \tau\}$ is clustered tightly together compared to any tube containing τ . If $p \in h_\tau$, then $\{p_i \mid i \in \tau\}$ is spread far apart compared to any tube contained in τ .

2.3 Realizing poset associahedra

We are now prepared to prove Theorem 2.1.1. Define

$$\mathcal{A}(P) := \bigcap_{\sigma \subset P} h_\sigma \cap H_P$$

where the intersection is over all tubes of P . Note that $\mathcal{A}(P) \subseteq \mathcal{L}(P)$ as if $i \prec j$ is a covering relation, then for $p \in h_{\{i,j\}}$, $p_i \leq p_j$.

Theorem 2.1.1 follows as a result of three lemmas:

Lemma 2.3.1. *If T is a maximal tubing, then*

$$v^T := \bigcap_{\tau \in T \cup \{P\}} H_\tau$$

is a point.

Lemma 2.3.2. *If T is a collection of tubes that do not form a proper tubing, then*

$$\bigcap_{\tau \in T} H_\tau \cap \mathcal{A}(P) = \emptyset.$$

Lemma 2.3.3. *If T is a maximal tubing and $\tau \notin T$ is a proper tube, then $\alpha_\tau(v^T) > n^{2|\tau|}$. That is, v^T lies in the interior of h_τ .*

Lemma 2.3.1 follows from a standard induction argument.

Proof of Lemma 2.3.2. If T is not a collection of tubes that do proper tubing, then at least one of the following two cases holds:

- (1) There is a pair of non-nested and non-disjoint tubes τ_1, τ_2 in T .
- (2) There is a sequence of disjoint tubes τ_1, \dots, τ_k such that $\tau_1 \prec \dots \prec \tau_k \prec \tau_1$.

The idea of the proof is as follows: For $S \subseteq P$, define the *convex hull* of S as

$$\text{conv}(\sigma) := \{b \in P \mid \exists a, c \in S : a \leq b \leq c\}.$$

Observe that if $p \in \mathcal{L}(P)$, then $\text{diam}_S(p) \leq \text{diam}_{\text{conv}(S)}(p)$. Take $\sigma = \text{conv}(\tau_1 \cup \dots \cup \tau_k)$. One can show that σ is a tube, so Lemma 2.2.3 tells us that for each τ_i , $\text{diam}_{\tau_i}(p)$ is very small compared to $n^{2|\sigma|}$. As the tubes either intersect or are cyclic, one can show this forces $\text{diam}_\sigma(p)$ to also be small, so $\alpha_\sigma(p) < n^{2|\sigma|}$.

More concretely, suppose that

$$p \in \bigcap H_{\tau_i} \cap \mathcal{L}(P).$$

Note that for all i , $|\sigma| > |\tau_i| + 1$ and $\text{diam}_{\tau_i}(p) \leq n^{2(|\sigma|-1)}$. In case (1), let $a, b \in \sigma$. There exists some $x \in \tau_1 \cap \tau_2$, so

$$\begin{aligned} |p_a - p_b| &\leq |p_a - p_x| + |p_x - p_b| \\ &\leq \text{diam}_{\tau_1}(p) + \text{diam}_{\tau_2}(p) \\ &\leq 2n^{2(|\sigma|-1)} \\ &< n^{2(|\sigma|)}. \end{aligned}$$

Hence $\text{diam}_\sigma(p) < n^{2|\sigma|}$, so by Lemma 2.2.3, $p \notin h_\sigma$.

Now we move to case (2). Suppose there is a sequence of disjoint tubes τ_1, \dots, τ_k such that for each i there exists $x_i, y_i \in \tau_i$ where $x_i \prec y_{i+1}$ where we take the indices mod k . Then:

$$\begin{aligned} p_{y_i} - \text{diam}_{\tau_i}(p) &\leq p_{x_i} \\ p_{x_i} &\leq p_{y_{i+1}} \\ p_{y_{i+1}} &\leq p_{x_{i+1}} + \text{diam}_{\tau_{i+1}} \end{aligned}$$

Furthermore, since τ_i and τ_{i+1} are disjoint, $|\tau_i| \leq |\sigma| - 2$ and $\text{diam}_{\tau_i} \leq n^{2(|\sigma|-2)}$. Combining these we get

$$p_{y_i} \leq p_{y_{i+1}} + 2n^{2(|\sigma|-2)}.$$

Then we have:

$$\begin{aligned} p_{y_1} &\leq p_{y_i} + 2in^{2(|\sigma|-2)} && \text{and} \\ p_{y_i} + 2in^{2(|\sigma|-2)} &\leq p_{y_1} + 2(k+1)n^{2(|\sigma|-2)}. \end{aligned}$$

These yield

$$p_{y_1} - p_{y_i} \leq 2in^{2(|\sigma|-2)} \quad \text{and}$$

$$p_{y_i} - p_{y_1} \leq 2(k-i+1)n^{2(|\sigma|-2)}.$$

As $i, k-i+1 \leq k \leq \frac{n}{2}$, we have $|p_{y_1} - p_{y_i}| \leq n^{2(|\sigma|-1)}$. Finally, if $z_i \in \tau_i, z_j \in \tau_j$, then

$$\begin{aligned} |p_{z_i} - p_{z_j}| &\leq |p_{z_i} - p_{y_i}| + |p_{y_i} - p_{y_1}| + |p_{y_1} - p_{y_j}| + |p_{y_j} - p_{z_j}| \\ &\leq 4n^{2(|\sigma|-1)} \\ &< n^{2|\sigma|}. \end{aligned}$$

Hence $\text{diam}_\sigma(p) < n^{2|\sigma|}$, and by Lemma 2.2.3, $p \notin h_\sigma$.

□

Proof of Lemma 2.3.3. Let T be a maximal tubing of P and let $\tau \notin T$ be a tube. Define the *convex hull* of τ relative to T by

$$\text{conv}_T(\tau) := \min\{\sigma \in T \mid \tau \subset \sigma\}.$$

Let $\sigma = \text{conv}_T(\tau)$. T partitions σ into a lower set A and an upper set B where A and B are either tubes or singletons. Furthermore, A and B both intersect τ . See Figure 2.3 for an example illustrating this.

The idea of the proof is as follows: Let $p = v^T$. By Lemma 2.2.3, $\text{diam}_A(p)$ and $\text{diam}_B(p)$ are both very small compared to $\text{diam}_\sigma(p)$. Then for any $a \in A, b \in B$, $|p_a - p_b|$ must be large. As τ intersects both A and B , $\text{diam}_\tau(p)$ must be large and hence $p \in h_\tau$. See Figure 2.4 for an illustration of this. More precisely, we show that for any $i \in A, j \in B$, $p_j - p_i > (n^2)^{|\tau|}$, which implies that p lies in the interior of h_τ .

Observe that:

$$\sum_{x \prec y} p_y - p_x = \underbrace{\sum_{\substack{x \prec y \\ x, y \in A}} (p_y - p_x)}_{\substack{\leq (n^2)^{|\sigma|-1} \\ < \frac{1}{8}(n^2)^{|\sigma|}}} + \underbrace{\sum_{\substack{x \prec y \\ x, y \in B}} (p_y - p_x)}_{\substack{\leq (n^2)^{|\sigma|-1} \\ < \frac{1}{8}(n^2)^{|\sigma|}}} + \sum_{\substack{x \prec y \\ x \in A, y \in B}} (p_y - p_x).$$

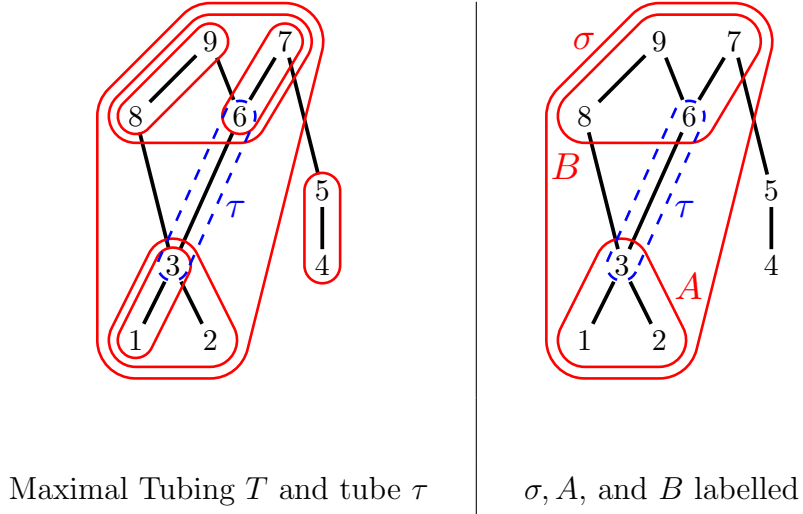

Figure 2.3: An example illustrating the proof of Lemma 2.3.3.

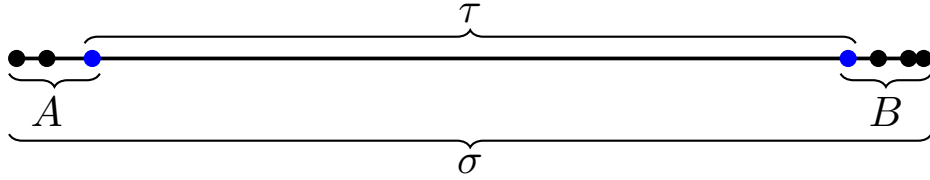

Figure 2.4: If $\text{diam}_A(p)$ and $\text{diam}_B(p)$ are small and $\text{diam}_\sigma(p)$ is large, then $\text{diam}_\tau(p)$ is large.

Fix $i \in A$ and $j \in B$. By Lemma 2.2.3, for any $x \in A, y \in B$,

$$\begin{aligned} p_y - p_x &\leq p_j - p_i + \text{diam}_A(p) + \text{diam}_B(p) \\ &\leq p_j + p_i + 2n^{2(|\sigma|-1)}. \end{aligned}$$

Again, noting that the number of covering relations in σ is at most $\frac{n^2}{4}$ we obtain:

$$\begin{aligned} \sum_{\substack{x \prec_\sigma y \\ x \in A, y \in B}} (p_y - p_x) &\leq \sum_{\substack{x \prec_\sigma y \\ x \in A, y \in B}} (p_j - p_i + 2(n^2)^{|\sigma|-1}) \\ &\leq \frac{n^2}{4} (p_j - p_i + 2(n^2)^{|\sigma|-1}) \\ &= \frac{n^2}{4} (p_j - p_i) + \frac{1}{2} (n^2)^{|\sigma|}. \end{aligned}$$

Combining all of this we get:

$$\begin{aligned}
\sum_{x \prec_{\sigma} y} p_y - p_x &= (n^2)^{|\sigma|} \\
&< \frac{1}{8}(n^2)^{|\sigma|} + \frac{1}{8}(n^2)^{|\sigma|} + \frac{1}{2}(n^2)^{|\sigma|} + \frac{n^2}{4}(p_j - p_i) \\
&\leq \frac{3}{4}(n^2)^{|\sigma|} + \frac{n^2}{4}(p_j - p_i)
\end{aligned}$$

Then $(n^2)^{|\sigma|-1} < (p_j - p_i)$ and as $|\tau| \leq |\sigma| - 1$, p is in the interior of h_{τ} .

□

Remark 2.3.4. A similar approach for realizing graph associahedra is taken by Devadoss [Dev09]. For a graph $G = (V, E)$, Devadoss realizes the graph associahedron of G by taking the supporting hyperplane for a graph tube τ to be

$$\left\{ p \in \mathbb{R}^V \mid \sum_{i \in \tau} p_i = 3^{|\tau|} \right\}.$$

One difference is that Devadoss realizes graph associahedra by cutting off slices of a simplex whereas we cut off slices of an order polytope. When the Hasse diagram of P is a tree, the poset associahedron is combinatorially equivalent to the graph associahedron of the line graph of the Hasse diagram. In this case, the two realizations have linearly equivalent normal fans. If the Hasse diagram of P is a path graph, then both realizations have linearly equivalent normal fans to the realization of the associahedron due to Shnider and Sternberg [Sta97].

2.4 Realizing affine poset cyclohedra

The proofs in the affine case are nearly identical to the finite case with some additional technical components. The similarity comes from the fact that Lemma 2.2.3 still applies. We highlight where the proofs are different. Let \tilde{P} be an affine poset of order n .

Define

$$\mathcal{C}(\tilde{P}) := \bigcap_{\sigma \subset P} h_\sigma \quad \text{and}$$

$$\mathcal{L}(\tilde{P}) := \{p \in \mathbb{R}^{\tilde{P}}/\mathcal{C} \mid p_i \leq p_j \text{ for all } i \preceq j\}.$$

where the intersection is over all tubes of \tilde{P} . Note that $\mathcal{C}(\tilde{P}) \subseteq \mathcal{L}(\tilde{P})$ as if $i \prec j$ is a covering relation, then for $p \in h_{\{i,j\}}$, $p_i \leq p_j$. Theorem 2.1.6 follows as a result of 3 lemmas:

Lemma 2.4.1. *If T is a maximal tubing, then*

$$v^T := \bigcap_{\tau \in T} H_\tau$$

is a point.

Lemma 2.4.2. *If T is a collection of tubes that do not form a proper tubing, then*

$$\bigcap_{\tau \in T} H_\tau \cap \mathcal{C}(\tilde{P}) = \emptyset.$$

Lemma 2.4.3. *If T is a maximal tubing and $\tau \notin T$ is a proper tube, then $\alpha_\tau(v^T) > n^{2|\tau|}$.*

That is, v^T lies in the interior of h_τ .

Proof of Lemma 2.4.1. Let T be a maximal tubing and take any $\sigma \in T$ such that $|\tau| = n$. Then restricting to $\tilde{P}|_\sigma$, Lemma 2.3.1 implies that

$$\bigcap_{\substack{\tau \in T \\ \tau \subseteq \sigma}} H_\tau$$

is a point. However, as T is n -periodic,

$$\bigcap_{\substack{\tau \in T \\ \tau \subseteq \sigma}} H_\tau = \bigcap_{\tau \in T} H_\tau.$$

□

Proof of Lemma 2.4.2. By Remark 2.1.5, we can assume T is n -periodic. The proof is almost identical to the proof of Lemma 2.3.2. Define

$$\mathcal{L}(\tilde{P}) := \{p \in \mathbb{R}^{\tilde{P}}/\mathcal{C} \mid p_i \leq p_j \text{ for all } i \preceq j\}.$$

and note that

$$\mathcal{L}(\tilde{P}) \subseteq R^{\tilde{P}}/\mathcal{C} \bigcap_{\substack{i,j \in \tilde{P} \\ i \prec j}} h_{\{i,j\}}.$$

Let

$$p \in \bigcap H_{\tau_i} \cap \mathcal{L}(\tilde{P}).$$

We again break into two cases:

- (1) There is a pair of non-nested and non-disjoint tubes τ_1, τ_2 in T .
- (2) All tubes in T are pairwise nested or disjoint and there is a sequence of disjoint tubes τ_1, \dots, τ_k such that $\tau_1 \prec \dots \prec \tau_k \prec \tau_1$.

The only difference in the proof occurs in case (1). Here, it is possible that there exists $x \in \tau_1 \cup \tau_2$ such that $x + n \in \tau_1 \cup \tau_2$ as well. In this case, the proof of Lemma 2.3.2 still implies that $\text{diam}_{\tau_1 \cup \tau_2}(p) \leq \text{diam}_{\tau_1}(p) + \text{diam}_{\tau_2}(p) \leq 2n^{2n}$. However, $|p_{x+n} - p_x| = n^{2(n+1)}$.

□

Proof of Lemma 2.4.3. Let T be a maximal tubing and $\tau \notin T$ be a proper tube. Let $p = v^T$. We claim that $\alpha_\tau(p) > n^{2|\tau|}$.

The only difference from the proof of Lemma 2.3.3 is that τ may not be contained by any tube in T so $\text{conv}_T(\tau)$ may not be well-defined. In this case, there exists $A \in T$ such that $|A| = n$, $A \cap \tau \neq \emptyset$, and $(A+n) \cap \tau \neq \emptyset$. Here, $(A+n)$ acts the same as B in the finite case, except the argument is much simpler.

Let $i \in A \cap \tau, j \in (A+n) \cap \tau$. Observe that $\text{diam}_A(p), \text{diam}_{(A+n)}(p) \leq n^{2n}$ and that $i+n \in (A+n)$. Then

$$\begin{aligned} |p_j - p_i| &\geq (p_j - n^{2n}) - p_i \\ &\geq p_{i+n} - p_i \\ &= n^{2(n+1)}. \end{aligned}$$

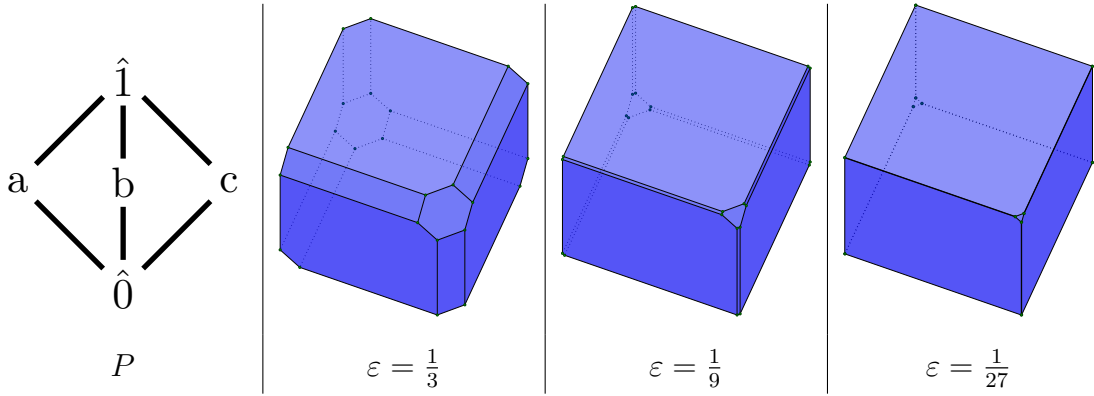

Figure 2.5: $\mathcal{O}(P)$ as a limit of $\mathcal{A}(P)$

Hence $\text{diam}_\tau(p) > n^{2|\tau|}$ and by Lemma 2.2.3, $\alpha_\tau(p) > n^{2|\tau|}$.

□

2.5 Remarks and Questions

Remark 2.5.1. Let (P, \preceq) be a bounded poset. In Remark 2.2.1, we discuss how $\mathcal{O}(P)$ can be realized as the set of all $p \in \mathbb{R}^P$ such that $p_{\hat{0}} = 0$, $p_{\hat{1}} = 1$, and $p_i \leq p_j$ whenever $i \preceq j$. We can similarly realize $\mathcal{A}(P)$ as follows: Fix $0 < \varepsilon < \frac{1}{n^2}$.

For a proper tube $\tau \subset P$, let

$$h'_\tau = \{p \in \mathbb{R}^P \mid \alpha_\tau(p) < \varepsilon^{n-|\tau|}\}.$$

Then $\mathcal{A}(P)$ is realized as the intersection over all h'_τ with the hyperplanes

$$\{p_{\hat{0}} = 0\} \text{ and } \{p_{\hat{1}} = 1\}.$$

Letting $\varepsilon \rightarrow 0$, we obtain $\mathcal{O}(P)$ as a limit of $\mathcal{A}(P)$ as shown in Figure 2.5.

Remark 2.5.2. The key piece to the realizations in Theorems 2.1.1 and 2.1.6 is the linear form α_τ , where α_τ acts as an approximation of diam_τ . In particular, let τ be a tube and let $p \in \mathcal{L}(P)$. Then:

- $\alpha_\tau(p) \geq 0$.
- $\alpha_\tau(p) = 0 \Leftrightarrow p|_\tau$ is constant.
- If $\sigma \subseteq \tau$ is a tube, then $\alpha_\sigma(p) \leq \alpha_\tau(p)$.

However, there are many other options for choice of α_τ that could fill this role. Some other options include:

1. Sum over all pairs $i \prec j$ in τ .

$$\alpha_\tau(p) = \sum_{\substack{i \prec j \\ i, j \in \tau}} p_j - p_i.$$

2. Let A and B be the set of minima and maxima of the restriction $P|_\tau$ respectively.

$$\alpha_\tau(p) = \sum_{\substack{i \prec j \\ i \in A, j \in B}} p_j - p_i.$$

3. Fix a spanning tree T in the Hasse diagram of τ . Let $E = \{(i, j) \mid i \prec_T j\}$ be the set of edges in T .

$$\alpha_\tau(p) = \sum_{(i, j) \in E} p_j - p_i.$$

An advantage of this option is that we would have

$$\text{diam}_\tau(p) \leq \alpha_\tau(p) \leq (n - 1) \text{diam}_\tau(p).$$

A similar realization can be obtained for each choice of α_τ .

Question 2.5.3. Postnikov, Reiner, and Williams [PRW08] found a statistic on maximal tubings of graph associahedra of chordal graphs where

$$\sum_T t^{\text{stat}(T)} = \sum h_i t^i.$$

In particular, they define a map $T \mapsto w_T$ from maximal tubings of a graph on n vertices to the set of permutations \mathfrak{S}_n such that $\text{stat}(T) = \text{des}(w_T)$, the number of descents of w_T . It

would be interesting to find a similar statistic on maximal tubings of poset associahedra and affine poset cyclohedra. In light of Theorem 1.3.8, it may be possible to use our realization to derive such a statistic.

Question 2.5.4. Is $h_{\mathcal{A}(P)}(z)$ always real-rooted? Are the entries of the γ -vector always all non-negative? If so, do they have a combinatorial interpretation?

CHAPTER 3

The Poset Associahedron f -vector is a Comparability Invariant.

This chapter is based on [NS23b] which was joint work with Son Nguyen. In this chapter, we show that the f -vector of $\mathcal{A}(P)$ only depends on the comparability graph of P . In particular, this allows us to produce a family of polytopes with the same f -vectors as permutohedra, but that are not combinatorially equivalent to permutohedra.

3.1 Introduction

Recall that the *comparability graph* of a poset P is a graph $C(P)$ whose vertices are the elements of P and where i and j are connected by an edge if i and j are comparable. A property of P is said to be *comparability invariant* if it only depends on $C(P)$. Properties of finite posets known to be comparability invariant include the order polynomial and number of linear extensions [Sta86], the fixed point property [DPW85], and the Dushnik–Miller dimension [TMS76].

The following is our main result:

Theorem 3.1.1. *The f -vector of $\mathcal{A}(P)$ is a comparability invariant.*

Theorem 3.1.1 may lead one to ask if $C(P) \simeq C(P')$ implies that $\mathcal{A}(P)$ and $\mathcal{A}(P')$ are necessarily combinatorially equivalent.

Definition 3.1.2. Let $\mathbf{a} = (a_1, \dots, a_n) \in \mathbb{Z}^n$ with $a_i \geq 1$ for each i . Define the *complete*

graded poset of type \mathbf{a} to be the poset

$$P_{\mathbf{a}} := \{x_{11}, \dots, x_{1a_1}, x_{21}, \dots, x_{2a_2}, \dots\},$$

where $x_{ij} \prec x_{i'j'}$ if and only if $i < i'$. That is, $P_{\mathbf{a}}$ is the ordinal sum of antichains.

Observe that $C(P_{\mathbf{a}})$ is invariant under permutation of \mathbf{a} . This observation, together with Theorem 3.1.1, yields an immediate corollary.

Corollary 3.1.3. *For any \mathbf{a} , $f_{\mathcal{A}(P_{\mathbf{a}})}(z)$ is invariant under permutation of \mathbf{a} .*

This class of examples is sufficiently rich to answer our question in the negative.

Theorem 3.1.4. *Let $m, n \geq 2$. Then $\mathcal{A}(P_{(m,1,n)})$ is combinatorially equivalent to the permutohedron, but $\mathcal{A}(P_{(1,m,n)})$ is not.*

3.2 Background

3.2.1 Flips of autonomous subsets

Definition 3.2.1. Let P and S be posets and let $a \in P$. The *substitution* of a for S is the poset $P(a \rightarrow S)$ on the set $(P - \{a\}) \sqcup S$ formed by replacing a with S .

More formally, $x \preceq_{P(a \rightarrow S)} y$ if and only if one of the following holds:

- $x, y \in P - \{a\}$ and $x \preceq_P y$
- $x, y \in S$ and $x \preceq_S y$
- $x \in S, y \in P - \{a\}$ and $a \preceq_P y$
- $y \in S, x \in P - \{a\}$ and $y \preceq_P a$.

Definition 3.2.2. Let P be a poset and let $S \subseteq P$. S is called *autonomous* if there exists a poset Q and $a \in Q$ such that $P = Q(a \rightarrow S)$.

Equivalently, S is autonomous if for all $x, y \in S$ and $z \in P - S$, we have

$$(x \preceq z \Leftrightarrow y \preceq z) \text{ and } (z \preceq x \Leftrightarrow z \preceq y).$$

Definition 3.2.3. For a poset S , the *dual poset* S^{op} is defined on the same ground set where $x \preceq_S y$ if and only if $y \preceq_{S^{\text{op}}} x$. A *flip* of S in $P = Q(a \rightarrow S)$ is the replacement of P by $Q(a \rightarrow S^{\text{op}})$.

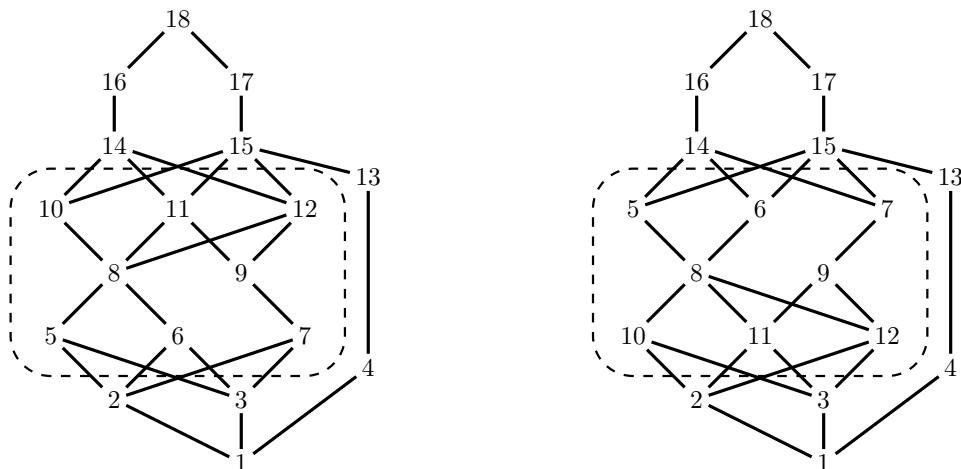

(a) An autonomous subset S of a poset P .

(b) A flip of S .

Figure 3.1: An autonomous subset of a poset and a flip of the autonomous subset

See Figure 3.1a for an example of an autonomous subset and Figure 3.1b for an example of a flip.

Lemma 3.2.4 ([DPW85, Theorem 1]). *If P and P' are finite posets such that $C(P) = C(P')$ then P and P' are connected by a sequence of flips of autonomous subsets.*

In particular, a property is comparability invariant if and only if it is preserved under flips.

Lemma 3.2.5 ([Gal23, Corollary 2.7]). *The codimension of $T \in \mathcal{A}(P)$ is equal to $|T|$.*

By an abuse of notation, we also use $\mathcal{A}(P)$ to refer to the set of proper tubings of P . Our strategy for proving Theorem 3.1.1 is to give a bijection between the tubings of $Q(a \rightarrow S)$

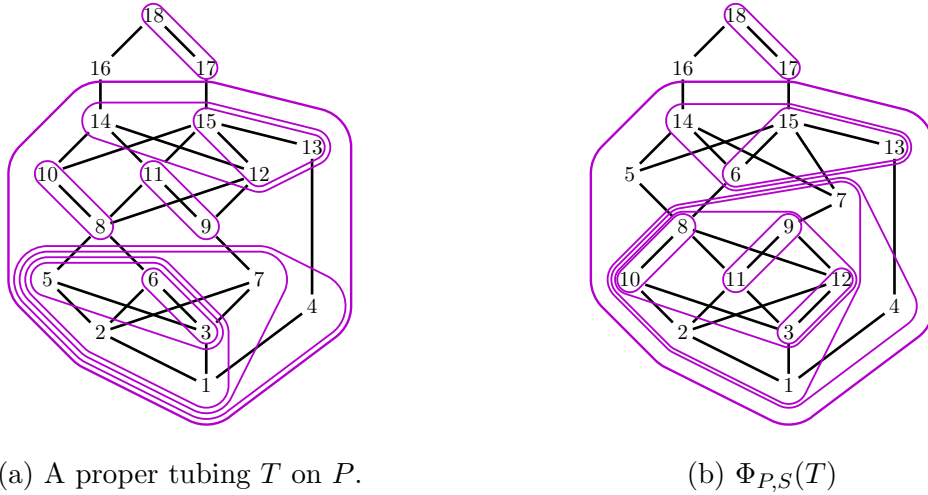

Figure 3.2: A proper tubing and its image under $\Phi_{P,S}$

and of $Q(a \rightarrow S^{\text{op}})$ that preserves the number of tubes in a tubing. See Figure 3.2 for an example of the map.

3.3 Proof of Theorem 3.1.1

3.3.1 Proof Sketch

Let $P = Q(a \rightarrow S)$ and $P' = Q(a \rightarrow S^{\text{op}})$. Our goal is to build a bijection $\Phi_{P,S} : \mathcal{A}(P) \rightarrow \mathcal{A}(P')$ such that for any $T \in \mathcal{A}(P)$, $|T| = |\Phi_{P,S}(T)|$. Let $T \in \mathcal{A}(P)$. We will describe how to construct $T' := \Phi_{P,S}(T)$.

Definition 3.3.1. A tube $\tau \in T$ is *good* if $\tau \subseteq P - S$, $\tau \subseteq S$, or $S \subseteq \tau$ and is *bad* otherwise. We denote the set of good tubes by T_{good} and the set of bad tubes by T_{bad} .

All good tubes are also good tubes in P' , and we add all good tubes to T' . See Figure 3.3 for an example of T_{good} and T_{bad} . It remains to handle the bad tubes.

Definition 3.3.2. A sequence of sets (A_1, \dots, A_r) is called *nested* if $A_i \subseteq A_j$ for all $i \leq j$.

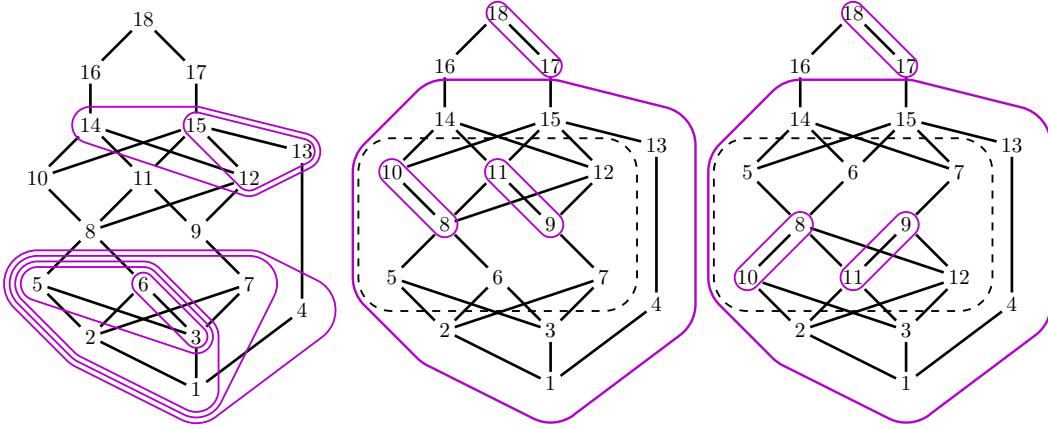

Figure 3.3: T_{bad} (left), T_{good} (middle), and T_{good} on P' (right).

A *decorated* nested sequence is a nested sequence (A_1, \dots, A_r) paired with a function

$$f : \{1, \dots, r\} \rightarrow \{0, 1\}.$$

For brevity, instead of specifying f , we will instead mark A_i with a star if and only if $f(i) = 1$.

The key idea of defining $\Phi_{P,S}$ is to decompose T_{bad} into a triple $(\mathcal{L}, \mathcal{M}, \mathcal{U})$ where \mathcal{L} and \mathcal{U} are decorated nested sequences of sets contained in $P - S$ and \mathcal{M} is an ordered set partition of S . We build the decomposition in such a way so that we can recover T_{bad} from $(\mathcal{L}, \mathcal{M}, \mathcal{U})$ and Figure 3.4 for an example of the decomposition.

We build T'_{bad} by applying the recovery algorithm to the triple $(\mathcal{L}, \overline{\mathcal{M}}, \mathcal{U})$ where $\overline{\mathcal{M}}$ is the reverse of \mathcal{M} . We then add T'_{bad} to T' . See Figure 3.5 for an example of the recovery algorithm applied to $(\mathcal{L}, \overline{\mathcal{M}}, \mathcal{U})$. See Figure 3.2b for the image of T under $\Phi_{P,S}$ (including T_{good}).

3.3.2 Proof details

Definition 3.3.3. A tube $\tau \in T_{\text{bad}}$ is called *lower* (resp. *upper*) if there exist $x \in \tau - S$ and $y \in \tau \cap S$ such that $x \preceq y$ (resp. $y \preceq x$). We denote the set of lower tubes by T_L and the set of upper tubes by T_U .

Lemma 3.3.4 (Structure Lemma). T_{bad} is the disjoint union of T_L and T_U . Furthermore, T_L and T_U each form a nested sequence.

Proof. We first show that T_{bad} is the disjoint union of T_L and T_U . Suppose that $\tau \in T_L \cap T_U$, i.e. there exist $x_1, x_2 \in \tau - S$ and $y_1, y_2 \in \tau \cap S$ such that

$$x_1 \preceq y_1 \text{ and } y_2 \preceq x_2.$$

Then as S is autonomous, for all $y \in S, x_1 \preceq y \preceq x_2$. As τ is convex, this implies $S \subseteq \tau$ and hence that τ is good. Therefore T_L and T_U are disjoint. Next observe that if $\tau \in T_{\text{bad}}$, by connectivity there exist $x \in \tau \cap S$ and $y \in \tau - S$ such that x and y are comparable. Hence $\tau \in T_L \cup T_U$ so $T_{\text{bad}} = T_L \sqcup T_U$.

Finally, we show that T_L is nested. The result on T_U follows analogously. It suffices to show that T_L is pairwise nested. Let $\sigma, \tau \in T_L$. As T is a tubing, if σ and τ are not nested, then they are disjoint. Suppose, for the sake of contradiction, that $\sigma \cap \tau = \emptyset$, and let $x_1 \in \tau - S, x_2 \in \sigma - S, y_1 \in \tau \cap S$, and $y_2 \in \sigma \cap S$ such that $x_1 \preceq y_1$ and $x_2 \preceq y_2$. Then as S is autonomous, $x_1, x_2 \preceq y_1, y_2$. Thus (σ, τ) and (τ, σ) are both edges in D_T , so D_T is not acyclic, a contradiction. \square

We decompose T_L (resp. T_U) into a sequence of nested sets contained in $P - S$ and a sequence of disjoint sets contained in S as follows.

Definition 3.3.5 (Tubing decomposition). Let $T_L = \{\tau_1, \dots\}$ where $\tau_i \subset \tau_{i+1}$ for all i . For convenience, we define $\tau_0 = \emptyset$. We define a decorated nested sequence $\mathcal{L} = (L_1, \dots)$ and a sequence of disjoint sets $\mathcal{M}_L = (M_L^1, \dots)$ as follows.

- For each $i \geq 1$, let $L_i = \tau_i - S$, and mark L_i with a star if $(\tau_i - \tau_{i-1}) \cap S \neq \emptyset$.
- If L_i is the j -th starred set, let $M_L^j = (\tau_i - \tau_{i-1}) \cap S$.

We define the sequences \mathcal{U} and \mathcal{M}_U analogously. We make the following definitions.

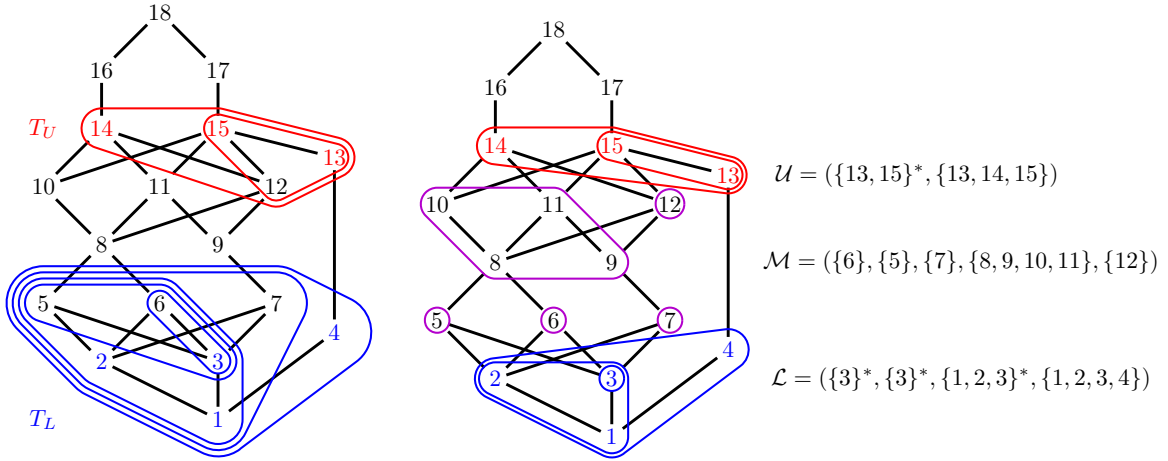

(a) T_L is blue and T_U is red.

(b) \mathcal{L} is blue, \mathcal{M} is purple, and \mathcal{U} is red.

Figure 3.4: The decomposition of T_{bad} .

- Let $\hat{M} := S - \bigcup_{\tau \in T_{\text{bad}}} \tau$.
- For sequences \mathbf{a} and \mathbf{b} , let the sequence $\mathbf{a} \cdot \mathbf{b}$ be \mathbf{b} appended to \mathbf{a} .
- For a sequence \mathbf{a} , let $\bar{\mathbf{a}}$ be the reverse of \mathbf{a} .
- We define

$$\mathcal{M} := \begin{cases} \mathcal{M}_L \cdot \bar{\mathcal{M}}_U & \text{if } \hat{M} = \emptyset \\ \mathcal{M}_L \cdot (\hat{M}) \cdot \bar{\mathcal{M}}_U & \text{if } \hat{M} \neq \emptyset \end{cases}$$

where (\hat{M}) is the sequence containing \hat{M} .

- The *decomposition* of T_{bad} is the triple $(\mathcal{L}, \mathcal{M}, \mathcal{U})$.

See Figure 3.4 for an example a decomposition.

Lemma 3.3.6 (Reconstruction algorithm). T_{bad} can be reconstructed from its decomposition.

Proof. Let $\mathcal{M} = (M_1, \dots, M_n)$. To reconstruct T_L , we set $\tau_1 = L_1 \cup M_1$ and take

$$\tau_i = \begin{cases} \tau_{i-1} \cup L_i & \text{if } L_i \text{ is not starred} \\ \tau_{i-1} \cup L_i \cup M_j & \text{if } L_i \text{ is marked with the } j\text{-th star.} \end{cases}$$

For T_U , we set $\tau_1 = U_1 \cup M_n$ and

$$\tau_i = \begin{cases} \tau_{i-1} \cup U_i & \text{if } U_i \text{ is not starred} \\ \tau_{i-1} \cup U_i \cup M_{n-j+1} & \text{if } U_i \text{ is marked with the } j\text{-th star.} \end{cases}$$

In each case, the efficacy of the algorithm follows easily from induction on i . □

Definition 3.3.7 (Flip map for tubings). Let $T = T_{\text{good}} \sqcup T_{\text{bad}}$. The *flip map*

$$\Phi_{P,S} : \mathcal{A}(P) \rightarrow \mathcal{A}(P')$$

sends T to a tubing $T' = T'_{\text{good}} \sqcup T'_{\text{bad}}$ on P' where $T_{\text{good}} = T'_{\text{good}}$ and T'_{bad} has the decomposition $(\mathcal{L}, \overline{\mathcal{M}}, \mathcal{U})$.

In Lemma 3.3.11, we show that applying the reconstruction algorithm to $(\mathcal{L}, \overline{\mathcal{M}}, \mathcal{U})$ indeed yields a proper tubing T'_{bad} of P' . In Lemma 3.3.12, we show that $T_{\text{good}} \sqcup T'_{\text{bad}}$ is a proper tubing on P' and hence that $\Phi_{P,S}$ is well-defined.

Observation 3.3.8. By construction, the decomposition of T'_{bad} is $(\mathcal{L}, \overline{\mathcal{M}}, \mathcal{U})$, so applying $\Phi_{P',S}$ returns T . In particular, $\Phi_{P,S}$ is a bijection.

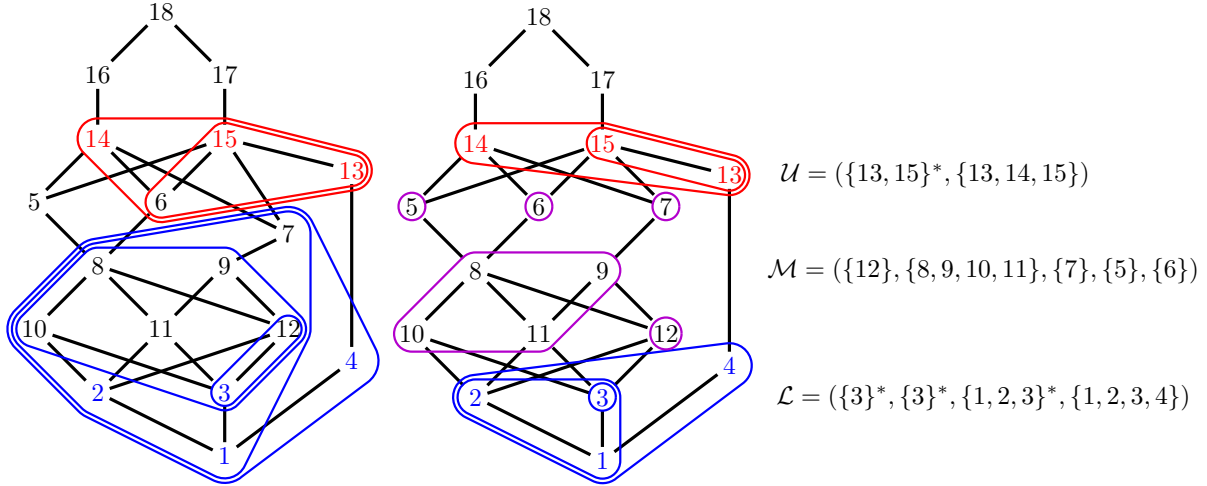

Figure 3.5: T'_{bad} and its decomposition.

Definition 3.3.9. Let $\mathbf{A} = (A_1, \dots, A_n)$ be a sequence of disjoint subsets of P . We say \mathbf{A} is *weakly increasing* if for all $i < j$ we have $(x \in A_i \text{ and } y \in A_j) \Rightarrow y \not\prec x$.

Lemma 3.3.10. \mathcal{M} is weakly increasing.

Proof. First we show that \mathcal{M}_L is weakly increasing. Indeed, suppose to the contrary that $1 \leq i < j \leq |\mathcal{M}_L|$ but that there exist $x \in M_i$ and $y \in M_j$ such that $y \prec x$. As $i < j$, there exists a tube $\tau \in T_L$ such that $x \in \tau$ but $y \notin \tau$. Furthermore, as τ is a lower tube, there exists $z \in \tau - S$ such that $z \preceq y$. Then since τ is convex, $y \in \tau$, a contradiction.

Next, we show that $\mathcal{M}_L \cdot \hat{M}$ is weakly increasing. Let $x \in M_i$ and $y \in \hat{M}$ such that $1 \leq i \leq |\mathcal{M}_L|$. Then there exists a tube $\tau \in T_L$ such that $x \in \tau$. Again, there exists $z \in \tau - S$ such that $z \preceq y$. Then by the same convexity argument, if $y \prec x$ we have $y \in \tau$, contradicting the definition of \hat{M} . Hence $\mathcal{M}_L \cdot \hat{M}$ is weakly increasing.

By symmetry, we have that $\hat{M} \cdot \overline{\mathcal{M}_U}$ is weakly increasing. It remains to show that for all $x \in \bigcup_{A \in \mathcal{M}_L} A$ and $y \in \bigcup_{A \in \mathcal{M}_U} A$ we have $y \not\prec x$.

Suppose to the contrary that there are such x and y . Then there exist $\sigma \in T_L$ and $\tau \in T_U$ with $x \in \sigma$ and $y \in \tau$. Furthermore, there exist $a \in \sigma$ and $b \in \tau$ such that $a \preceq x$ and $y \preceq b$. But then we have a cycle in D_T , a contradiction. □

Lemma 3.3.11. T'_{bad} is a proper tubing on P' such that $|T'_{bad}| = |T_{bad}|$.

Proof. By construction, for all $\sigma, \tau \in T'_{bad}$, σ and τ are nested or disjoint. Furthermore, observe that in the construction of $T'_L = (\tau'_1, \dots)$, if L_i is empty then it is necessarily starred. Thus for all i , we have $\tau'_i \subsetneq \tau'_{i+1}$. Then $|T'_L| = |\mathcal{L}| = |T_L|$. Similarly, $|T'_U| = |T_U|$. Hence

$$|T'_{bad}| = |T_L| + |T_U| = |T_{bad}|.$$

It remains to show that $D_{T'_{bad}}$ is acyclic. It suffices to show that $A := \bigcup_{\tau' \in T'_L} \tau'$ and that $B := \bigcup_{\tau' \in T'_U} \tau'$ do not form a directed cycle. Observe that as \mathcal{M} is weakly increasing in P ,

$\overline{\mathcal{M}}$ is weakly increasing in P' . Hence (A, B) is weakly increasing, so A and B do not form a directed cycle. \square

Lemma 3.3.12. $T_{\text{good}} \sqcup T'_{\text{bad}}$ is a proper tubing on P' .

Proof. This is most easily seen by observing how $\Phi_{P,S}$ interacts with quotients of good tubes. Galashin [Gal23, Corollary 2.7] observes that faces of poset associahedra are products of poset associahedra. In particular, given $T \in \mathcal{A}(P)$ and $\tau \in T \cup \{P\}$, we define an equivalence relation \sim_τ on τ by $i \sim_\tau j$ if there exists $\sigma \in T$ such that $i, j \in \sigma$ and $\sigma \subsetneq \tau$. Then the facet corresponding to T is combinatorially equivalent to the product $\prod_{\tau \in T \cup \{P\}} \mathcal{A}(\tau / \sim_\tau)$.

Let $\tau \in T_{\text{good}} \cup \{P\}$ be minimal such that $S \subseteq \tau$. One may verify that $\Phi_{P,S}$ on any tubing containing T_{good} is equivalent to applying $\Phi_{T/\sim_\tau, S/\sim_\tau}$ on the factor of T/\sim_τ in the product decomposition. Then either $T_{\text{good}} = \emptyset$ and $\Phi_{P,S}$ is well-defined by Lemma 3.3.11 or $\Phi_{P,S}$ is well-defined by induction on the size of P . \square

We can finally prove Theorem 3.1.1.

Proof of Theorem 3.1.1. By Observation 3.3.8, $\Phi_{P,S} : \mathcal{A}(P) \rightarrow \mathcal{A}(P')$ is a bijection. Furthermore, for any tubing $T \in \mathcal{A}(P)$, we have

$$|\Phi_{P,S}(T)| = |T_{\text{bad}}| + |T_{\text{good}}| = |T|.$$

Hence the f -vectors of $\mathcal{A}(P)$ and $\mathcal{A}(P')$ are equal. By Lemma 3.2.4, the f -vector of $\mathcal{A}(P)$ is a comparability invariant. \square

3.4 Proof of Theorem 3.1.4

Observation 3.4.1 ([Lap22, MPPep]). If the Hasse diagram of P is a tree, then $\mathcal{A}(P)$ is combinatorially equivalent to the graph associahedron [PRW08] of the line graph of the Hasse diagram of P .

Proof of Theorem 3.1.4. By Observation 3.4.1, for any $m, n \geq 1$, $\mathcal{A}(P_{m,1,n})$ is combinatorially equivalent to the permutohedron Π_{m+n} .

However, for $m, n \geq 2$, $\mathcal{A}(P_{1,m,n})$ has an octagon for a 2-dimensional face which permutohedra never do. In particular, an octagon is a factor of the facet given by any tube isomorphic to $P_{2,2}$. □

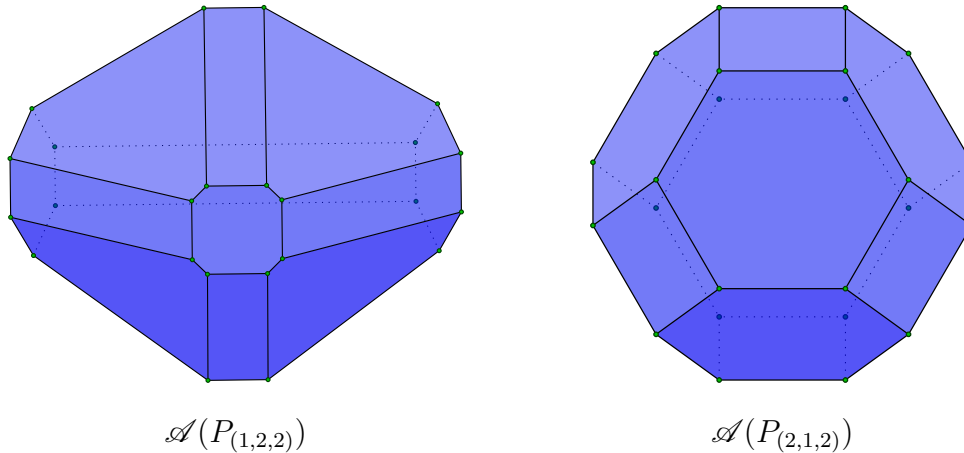

Figure 3.6: $\mathcal{A}(P_{1,2,2})$ has an octagonal face, but $\mathcal{A}(P_{2,1,2})$ does not.

3.5 Open questions

Question 3.5.1. In [Sta86], Stanley defines the *order polytope* and the *chain polytope*, with the latter defined purely in terms of the comparability graph. He constructs a piecewise linear volume preserving map between the two polytopes which sends vertices to vertices.

In particular, this shows that the number of vertices of the order polytope is a comparability invariant. Can a similar geometric map be defined on the realization of poset associahedra in [Sac23]?

Question 3.5.2. More generally, can we define $f_{\mathcal{A}(P)}(z)$ purely in terms of $C(P)$? It would also be interesting to answer this question even for f_0 . Similarly, can

Question 3.5.3. The flip map can be analogously defined for *affine poset cyclohedra* [Gal23], where an autonomous subset S has at most one representative from each residue class. Again, it preserves the f -vector of the affine poset cyclohedron. Does Lemma 3.2.4 (and hence Theorem 3.1.1) hold for affine posets?

CHAPTER 4

Operahedron Lattices

This chapter is based on [DS24] which was joint work with Colin Defant. In this chapter, we study the special case of poset associahedra when the poset is a rooted plane tree.

This case was originally studied by Laplante-Anfossi in [Lap22], who called the poset associahedron in this case an *operahedron*. He also defined a partial order on the vertex set of an operahedron and asked if the resulting poset is a lattice. We answer this question in the affirmative, motivating us to name Laplante-Anfossi’s posets *operahedron lattices*. In this chapter, we use the terminology “maximal nesting” instead of “maximal tubing” to maintain consistency with [Lap22]. Furthermore, for convenience, we make a slight change in definition so that a maximal nesting includes the entire tree as an element.

The operahedron lattice of a chain with $n + 1$ vertices is isomorphic to the n -th Tamari lattice, while the operahedron lattice of a claw with $n + 1$ vertices is isomorphic to $\text{Weak}(\mathfrak{S}_n)$, the weak order on the symmetric group \mathfrak{S}_n . We characterize semidistributive operahedron lattices and trim operahedron lattices.

Finally we consider a special case of posets called *broom posets*. Let $\Delta_{\text{Weak}(\mathfrak{S}_n)}(w_\circ(k, n))$ be the lower set of $\text{Weak}(\mathfrak{S}_n)$ generated by the permutation

$$w_\circ(k, n) = k(k - 1) \cdots 1(k + 1)(k + 2) \cdots n.$$

Our final result states that the operahedron lattice of a broom with $n + 1$ vertices and k leaves is isomorphic to the subposet of $\text{Weak}(\mathfrak{S}_n)$ consisting of the preimages of $\Delta_{\text{Weak}(\mathfrak{S}_n)}(w_\circ(k, n))$ under West’s stack-sorting map; as a consequence, we deduce that this subposet is a semidistributive lattice.

4.1 Introduction

In a recent breakthrough, Masuda, Thomas, Tonks, and Vallette [MTT21] found coherent cellular approximations of the diagonals of associahedra. This allowed them to define a topological cellular operad structure on the Loday realizations of associahedra. Motivated by these results and independently of Galashin, Laplante-Anfossi [Lap22] defined an *operahedron* of a rooted plane tree \mathbb{T} in a nearly identical manner to $\mathcal{A}(\mathbb{T})$. Hence, operahedra are special examples of *poset associahedra*. As the chain and claw are both rooted trees, operahedra also generalize associahedra and permutohedra. Laplante-Anfossi constructed Loday realizations of operahedra and found coherent cellular approximations of their diagonals. He then defined a topological cellular operad structure on these Loday realizations.

Let PT_n denote the set of rooted plane trees with $n + 1$ vertices. We view a tree $\mathbb{T} \in \text{PT}_n$ with vertex set \mathbb{V} as a poset $(\mathbb{V}, \leq_{\mathbb{T}})$, where the partial order $\leq_{\mathbb{T}}$ is defined so that every non-root vertex covers exactly one element. Thus, the root vertex is the unique minimal element of \mathbb{T} . In this context, a *tube* of \mathbb{T} is a set of vertices that induces a connected subgraph of \mathbb{T} . Every tube τ has a unique minimal element under $\leq_{\mathbb{T}}$ that we call the *root* of τ .

Let $\mathbf{Broom}_{k,n} \in \text{PT}_n$ denote the rooted plane tree obtained by identifying the unique maximal element of the chain in PT_{n-k+1} with the root of the claw in PT_{k+1} ; we call $\mathbf{Broom}_{k,n}$ a *broom*. Alternatively, one way view $\mathbf{Broom}_{k,n}$ as the ordinal sum of a chain on $n - k + 1$ elements with an antichain on k elements. See Figure 4.1.

The *preorder traversal* of a rooted plane tree \mathbb{T} is the ordering of the vertices of \mathbb{T} obtained by reading the root first and then reading the subtrees of the root, each in preorder, from left to right. For example, every tree appearing in Figures 4.1 to 4.3 has its vertex set identified with $\{0, 1, \dots, n\}$ (for the appropriate n) so that the preorder traversal is $0, 1, \dots, n$.

Let $\mathbb{T} \in \text{PT}_n$, and let us identify the vertex set of \mathbb{T} with $\{0, 1, \dots, n\}$ so that $0, 1, \dots, n$ is the preorder traversal of \mathbb{T} . A *maximal nesting* of \mathbb{T} is a tubing of \mathbb{T} that has n tubes. Note that we allow the tubes to have size $n + 1$ and in particular, we will always have T

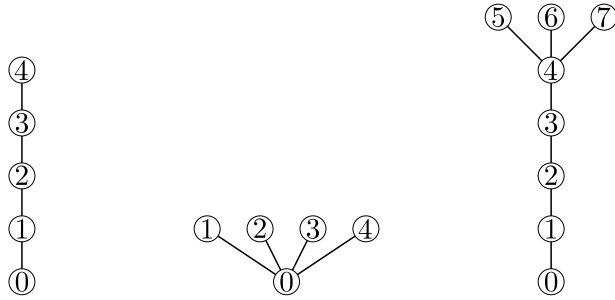

Figure 4.1: On the left is the chain in PT_4 . In the middle is the claw in PT_4 . On the right is the broom $\text{Broom}_{3,7} \in \text{PT}_7$. We have identified the vertex set of each tree in PT_n with $\{0, 1, \dots, n\}$ in a manner such that $0, 1, \dots, n$ is the preorder traversal of the tree.

an an element of a maximal nesting. Maximal nestings are clearly still in bijection with the vertices of the operahedron of \mathbb{T} . Let $\text{MN}(\mathbb{T})$ denote the set of maximal nestings of \mathbb{T} . Say two maximal nestings of \mathbb{T} are *adjacent* if they correspond to vertices that are adjacent in the 1-skeleton of the operahedron of \mathbb{T} . Suppose \mathcal{N} and \mathcal{N}' are adjacent maximal nestings of \mathbb{T} . Then there exist $\tau \in \mathcal{N} \setminus \mathcal{N}'$ and $\tau' \in \mathcal{N}' \setminus \mathcal{N}$ such that $\mathcal{N} \setminus \{\tau\} = \mathcal{N}' \setminus \{\tau'\}$. Moreover, the following are equivalent:

- (1) Every element of $\tau \setminus \tau'$ is less than every element of $\tau' \setminus \tau$ in \mathbb{Z} .
- (2) Some element of $\tau \setminus \tau'$ is less than some element of $\tau' \setminus \tau$ in \mathbb{Z} .

If these equivalent conditions hold, then we write $\mathcal{N} \triangleleft \mathcal{N}'$. This defines the cover relations of a partial order \leq on $\text{MN}(\mathbb{T})$, which allows us to view $\text{MN}(\mathbb{T})$ as a poset. If \mathbb{T} is a chain, then $\text{MN}(\mathbb{T})$ is isomorphic to the n -th Tamari lattice; if \mathbb{T} is a claw, then $\text{MN}(\mathbb{T})$ is isomorphic to the weak order on the symmetric group \mathfrak{S}_n (see Figures 4.2 and 4.3).

Laplante-Anfossi introduced the posets $\text{MN}(\mathbb{T})$ and posed the problem of determining whether they are always lattices. Our first main result answers this question in the affirmative.

Theorem 4.1.1. *For every rooted plane tree \mathbb{T} , the poset $\text{MN}(\mathbb{T})$ is a lattice.*

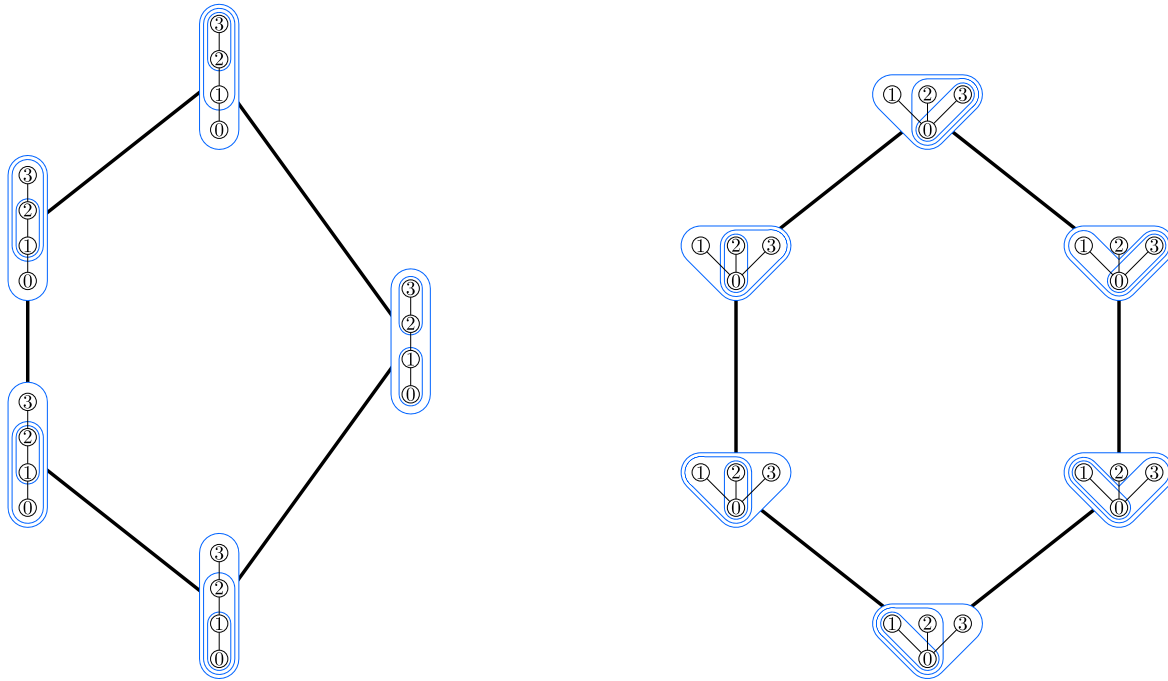

Figure 4.2: On the left is the operahedron lattice of the chain in PT_3 , which is isomorphic to the third Tamari lattice. On the right is the operahedron lattice of the claw in PT_3 , which is isomorphic to the weak order on \mathfrak{S}_3 . Each tube is circled in blue.

In light of Theorem 4.1.1, we call $MN(\mathbb{T})$ an *operahedron lattice*.

Let us say a rooted plane tree \mathbb{T} *contains* a rooted plane tree \mathbb{T}' if \mathbb{T}' can be obtained from \mathbb{T} by contracting edges. The following result is a useful tool for understanding the more refined structural properties of operahedron lattices.

Proposition 4.1.2. *Let \mathbb{T} and \mathbb{T}' be rooted plane trees. If \mathbb{T} contains \mathbb{T}' , then $MN(\mathbb{T}')$ is isomorphic to an interval of $MN(\mathbb{T})$.*

Using Theorem 4.1.2 and the fact that intervals of distributive lattices are distributive, it is not difficult to check by hand that $MN(\mathbb{T})$ is distributive if and only if $n \leq 2$. This characterization of distributivity is not too interesting, so we are naturally led to consider the family of *semidistributive* lattices, which contains a more eclectic array of examples. Upon

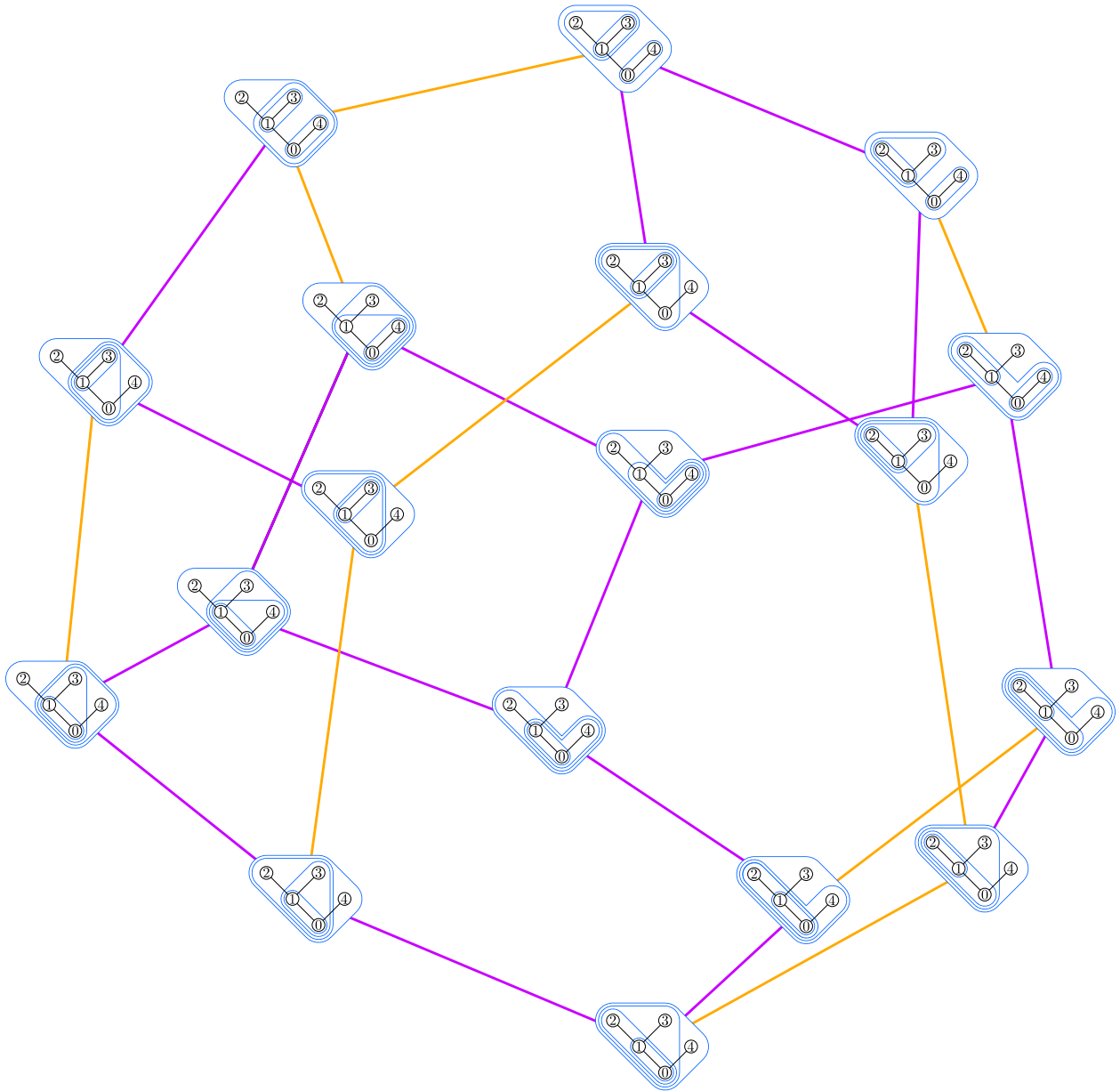





Figure 4.3: The operahedron lattice of the tree $\begin{array}{c} \bullet \\ \diagup \quad \diagdown \\ \bullet \quad \bullet \end{array}$. We have identified the vertex set of the tree with the set $\{0, 1, 2, 3, 4\}$ so that $0, 1, 2, 3, 4$ is the preorder traversal. Each tube is circled in blue. Edges of the lattice corresponding to permutahedron moves are purple, while edges corresponding to associahedron moves are orange.

inspecting Figure 4.3, one can check directly that the operahedron lattice of the tree  is not semidistributive. Because intervals of semidistributive lattices are semidistributive, it follows from Theorem 4.1.2 that the operahedron lattice of a tree that contains  cannot be semidistributive; we will prove that this is actually the only obstruction to semidistributivity.

Theorem 4.1.3. *Let T be a rooted plane tree. The following are equivalent.*

- (I) *The operahedron lattice $\text{MN}(\mathsf{T})$ is semidistributive.*
- (II) *The operahedron lattice $\text{MN}(\mathsf{T})$ is meet-semidistributive.*
- (III) *The operahedron lattice $\text{MN}(\mathsf{T})$ is join-semidistributive.*
- (IV) *The tree T does not contain the tree .*
- (V) *Every vertex of T that is not in the rightmost branch of T is covered by at most 1 element of T .*

When $\text{MN}(\mathsf{T})$ is semidistributive, our proof of Theorem 4.1.3 provides a description of its join-irreducible elements and its meet-irreducible elements (see Theorem 4.5.8).

Another generalization of the family of distributive lattices is the family of *trim* lattices, which was introduced by Thomas [Tho06] (see also [DL23, DW23, TW19] for several notable examples and remarkable properties of trim lattices). Our next result characterizes the rooted plane trees whose operahedron lattices are trim.

Theorem 4.1.4. *Let T be a rooted plane tree. The operahedron lattice $\text{MN}(\mathsf{T})$ is trim if and only if the root of T is covered by at most 2 elements of T and every non-root vertex in T is covered by at most 1 element of T .*

Remark 4.1.5. Defant and Williams [DW23] introduced the family of *semidistributive* lattices and proved that semidistributive lattices and trim lattices are semidistributive. We have checked

that the operahedron lattice of the tree  (shown in Figure 4.3) is not semidistributive. Since intervals of semidistributive lattices are semidistributive [DW23]*Theorem 7.8, it follows that the operahedron lattice $\text{MN}(\mathbb{T})$ of a tree \mathbb{T} is semidistributive if and only if the five equivalent conditions in Theorem 4.1.3 hold.

We denote by \mathfrak{S}_n the n -th symmetric group, which consists of the permutations of $[n]$. Let $\mathbf{s}: \mathfrak{S}_n \rightarrow \mathfrak{S}_n$ denote West's *stack-sorting map* (see Section 4.7 for the definition of this map). West [Wes90] introduced this function as a deterministic analogue of Knuth's stack-sorting machine [Knu73]. It has now been studied vigorously in combinatorics and computer science [Bon19, Bra06, Def20a, Def20b, Def22b, DEM20] and has found striking connections with free probability theory [Def22c] and polyhedral geometry [Def23, NS23a, LMV23].

Let $\text{Weak}(\mathfrak{S}_n)$ denote the (right) weak order on \mathfrak{S}_n . For $w \in \mathfrak{S}_n$, let $\Delta_{\text{Weak}(\mathfrak{S}_n)}(w)$ be the order ideal of $\text{Weak}(\mathfrak{S}_n)$ generated by w , viewed as a subset of $\text{Weak}(\mathfrak{S}_n)$. Let

$$w_{\circ}(k, n) = k(k-1) \cdots 1(k+1)(k+2) \cdots n \in \mathfrak{S}_n.$$

Note that $\Delta_{\text{Weak}(\mathfrak{S}_n)}(w_{\circ}(k, n)) = \{u \in \mathfrak{S}_n : u(i) = i \text{ for all } k+1 \leq i \leq n\}$.

The final direction that we will explore connects West's stack-sorting map with operahedron lattices of brooms. This line of investigation was initiated by Nguyen and Sack [NS23a], who found that the h -vector of the operahedron of $\text{Broom}_{k,n}$ counts permutations in $\mathbf{s}^{-1}(\Delta_{\text{Weak}(\mathfrak{S}_n)}(w_{\circ}(k, n)))$ according to the descent statistic.

Theorem 4.1.6. *Fix positive integers $k \leq n$. The operahedron lattice $\text{MN}(\text{Broom}_{k,n})$ is isomorphic to the subset $\mathbf{s}^{-1}(\Delta_{\text{Weak}(\mathfrak{S}_n)}(w_{\circ}(k, n)))$ of $\text{Weak}(\mathfrak{S}_n)$.*

Our proof of Theorem 4.1.6 constructs an explicit isomorphism.

It is not obvious *a priori* that the subset $\mathbf{s}^{-1}(\Delta_{\text{Weak}(\mathfrak{S}_n)}(w_{\circ}(k, n)))$ of $\text{Weak}(\mathfrak{S}_n)$ is a lattice, yet combining Theorems 4.1.3 and 4.1.6 yields the following even stronger corollary.

Corollary 4.1.7. *Fix positive integers $k \leq n$. The subset $\mathbf{s}^{-1}(\Delta_{\text{Weak}(\mathfrak{S}_n)}(w_{\circ}(k, n)))$ of $\text{Weak}(\mathfrak{S}_n)$ is a semidistributive lattice.*

The remainder of the paper is organized as follows. In Section 4.2, we collect necessary notation and terminology pertaining to posets, lattices, permutations, and rooted plane trees. In Section 4.3, we prove that $\text{MN}(\mathbb{T})$ is isomorphic to a different poset $\Theta(\mathbb{T}^\times)$, and we prove that this latter poset is a lattice, thereby establishing Theorem 4.1.1. Sections 4.4 to 4.6 are devoted to proving Theorem 4.1.2, Theorem 4.1.3, and Theorem 4.1.4, respectively. In Section 4.7, we discuss the stack-sorting map and prove Theorem 4.1.6. We conclude the paper with suggestions for future work in Section 4.8.

4.2 Preliminaries

We assume basic familiarity with the theory of posets (partially ordered sets); a standard reference for this topic is [Sta12]*Chapter 3. All posets in this article are assumed to be finite.

Let P be a poset with partial order \leq . For $x, y \in P$ with $x \leq y$, the *interval* from x to y is the set $[x, y] = \{z \in P : x \leq z \leq y\}$, which we view as a subposet of P . If $x < y$ and $[x, y] = \{x, y\}$, then we say y *covers* x and write $x \triangleleft y$. For $x \in P$, let

$$\Delta_P(x) = \{z \in P : z \leq x\} \quad \text{and} \quad \nabla_P(x) = \{z \in P : x \leq z\}.$$

A *chain* of P is a totally ordered subset of P . We often represent a chain of P as a sequence $x_0 < x_1 < \cdots < x_\ell$; the *length* of this chain is the number ℓ . The *height* of P , which we denote by $\text{height}(P)$, is the maximum length of a chain of P .

Suppose P_1 and P_2 are posets with partial orders \leq_1 and \leq_2 , respectively. A map $\varphi: P_1 \rightarrow P_2$ is said to be *order-preserving* if $\varphi(x) \leq_2 \varphi(y)$ for all $x, y \in P_1$ satisfying $x \leq_1 y$. The *product* of P_1 and P_2 is the poset $P_1 \times P_2$ whose underlying set is the cartesian product of P_1 and P_2 and whose order relation \leq is such that $(x_1, x_2) \leq (y_1, y_2)$ if and only if $x_1 \leq_1 y_1$ and $x_2 \leq_2 y_2$.

Let P be a poset with N elements. A *linear extension* of P is a word $\sigma = \sigma(1) \cdots \sigma(N)$

such that $P = \{\sigma(1), \dots, \sigma(N)\}$ and such that $\sigma(i) \leq \sigma(j)$ whenever $i \leq j$ in \mathbb{Z} . Let $\mathcal{L}(P)$ denote the set of linear extensions of P . For $\sigma \in \mathcal{L}(P)$, we consider the strict total order \prec_σ on P defined so that $x \prec_\sigma y$ if and only if x precedes y in σ . We also write $x \preceq_\sigma y$ to mean $x \prec_\sigma y$ or $x = y$. It will be helpful to extend this notation to subsets of P as well. For $X, Y \subseteq P$, we write $X \prec_\sigma Y$ if $x \prec_\sigma y$ for all $x \in X$ and $y \in Y$. (Note that if $X \prec_\sigma Y$, then $X \cap Y = \emptyset$.) A *consecutive factor* of σ is a word of the form $\sigma(a)\sigma(a+1)\cdots\sigma(b)$ for $1 \leq a \leq b \leq N$. Given a set X , we write $\sigma|_X$ for the word obtained from σ by deleting the entries from $P \setminus X$.

We say a poset L is a *lattice* if any two elements $x, y \in L$ have a greatest lower bound, which is called their *meet* and denoted by $x \wedge y$, and a least upper bound, which is called their *join* and denoted by $x \vee y$. Let L be a lattice. An element of L is *join-irreducible* if it covers exactly 1 element of L . Dually, an element of L is *meet-irreducible* if it is covered by exactly 1 element of L . Let \mathcal{J}_L and \mathcal{M}_L be the set of join-irreducible elements of L and the set of meet-irreducible elements of L , respectively. It is a basic fact that $\text{height}(L) \leq |\mathcal{J}_L|$ and $\text{height}(L) \leq |\mathcal{M}_L|$. We say L is *extremal* if $\text{height}(L) = |\mathcal{J}_L| = |\mathcal{M}_L|$. An element $u \in L$ is *left-modular* if for all $v, w \in L$ satisfying $v < w$, we have $(v \vee u) \wedge w = v \vee (u \wedge w)$. The lattice L is called *left-modular* if it has a maximal chain whose elements are all left-modular. We say L is *trim* if it is both extremal and left-modular. We say L is *meet-semidistributive* if for all elements $x, y, z \in L$ satisfying $x \wedge y = x \wedge z$, we have $x \wedge y = x \wedge (y \vee z)$. We say L is *join-semidistributive* if for all $x, y, z \in L$ satisfying $x \vee y = x \vee z$, we have $x \vee y = x \vee (y \wedge z)$. We say L is *semidistributive* if it is both meet-semidistributive and join-semidistributive.

If L_1 and L_2 are lattices, then their product $L_1 \times L_2$ is a lattice, and

$$\mathcal{J}_{L_1 \times L_2} = (\mathcal{J}_{L_1} \times \{\hat{0}_2\}) \sqcup (\{\hat{0}_1\} \times \mathcal{J}_{L_2}), \quad (4.1)$$

where $\hat{0}_1$ and $\hat{0}_2$ are the unique minimal elements of L_1 and L_2 , respectively.

We represent a permutation w in the symmetric group \mathfrak{S}_n via its *one-line notation* $w(1)\cdots w(n)$. An *inversion* of w is a pair (i, j) such that $1 \leq i < j \leq n$ and $w^{-1}(j) < w^{-1}(i)$.

Let $\text{Inv}(w)$ denote the set of inversions of w . The (*right*) *weak order* on \mathfrak{S}_n is the poset $\text{Weak}(\mathfrak{S}_n) = (\mathfrak{S}_n, \leq)$, where for $w, w' \in \mathfrak{S}_n$, we have $w \leq w'$ if and only if $\text{Inv}(w) \subseteq \text{Inv}(w')$. It is known [BB05] that $\text{Weak}(\mathfrak{S}_n)$ is a lattice.

A *rooted plane tree* is a rooted tree in which the subtrees of each vertex are linearly ordered from left to right. As before, we let PT_n denote the set of rooted plane trees with $n + 1$ vertices. We draw a rooted plane tree \mathbb{T} with vertex set \mathbf{V} as the Hasse diagram of the poset $(\mathbf{V}, \leq_{\mathbb{T}})$ (so the root is at the bottom). Recall that for $v \in \mathbf{V}^\times$, we write $\nabla_{\mathbb{T}}(v) = \{v' \in \mathbf{V}^\times : v \leq_{\mathbb{T}} v'\}$.

Let \mathbb{T} be a rooted plane tree with vertex set \mathbf{V} and root vertex \mathbf{r} . We write \mathbb{T}^\times for the poset obtained from \mathbb{T} by deleting \mathbf{r} . We can also view \mathbb{T}^\times as a forest graph (via its Hasse diagram). We let $\mathbf{V}^\times = \mathbf{V} \setminus \{\mathbf{r}\}$ denote the vertex set of \mathbb{T}^\times . Define the *rightmost branch* of \mathbb{T} as follows. If \mathbb{T} has only 1 vertex, then the rightmost branch of \mathbb{T} is $\{\mathbf{r}\}$. Now suppose \mathbb{T} has at least 2 vertices, and let \mathbf{r}' be the rightmost vertex that covers \mathbf{r} . Let $\mathbb{T}_{\mathbf{r}'}$ be the subtree of \mathbb{T} with vertex set $\nabla_{\mathbb{T}}(\mathbf{r}')$. Then the rightmost branch of \mathbb{T} is $\{\mathbf{r}\} \cup \mathbf{B}_{\mathbf{r}'}$, where $\mathbf{B}_{\mathbf{r}'}$ is the rightmost branch of $\mathbb{T}_{\mathbf{r}'}$.

4.3 The Lattice Property

Let \mathbb{T} be a rooted plane tree with vertex set \mathbf{V} and root vertex \mathbf{r} . As above, let \mathbb{T}^\times be the forest poset with vertex set $\mathbf{V}^\times = \mathbf{V} \setminus \{\mathbf{r}\}$.

It will be useful to distinguish two different types of cover relations in $\text{MN}(\mathbb{T})$. Suppose $\mathcal{N} \triangleleft \mathcal{N}'$ is a cover relation in $\text{MN}(\mathbb{T})$, and let $\tau \in \mathcal{N} \setminus \mathcal{N}'$ and $\tau' \in \mathcal{N}' \setminus \mathcal{N}$ be such that $\mathcal{N} \setminus \{\tau\} = \mathcal{N}' \setminus \{\tau'\}$. If τ and τ' have the same root, then we say \mathcal{N} and \mathcal{N}' are related by a *permutohedron move*. If τ and τ' have different roots, then we say \mathcal{N} and \mathcal{N}' are related by an *associahedron move*.

An *ornament* of \mathbb{T}^\times is a subset of \mathbf{V}^\times that induces a connected subgraph of \mathbb{T}^\times . Every ornament \mathfrak{o} has a unique minimal element $v_{\mathfrak{o}}$; we say \mathfrak{o} is *hung* at $v_{\mathfrak{o}}$. Let $\text{Orn}(\mathbb{T}^\times)$ denote

the set of ornaments of \mathbb{T}^\times . An *ornamentation* of \mathbb{T}^\times is a function $\varrho: \mathbb{V}^\times \rightarrow \text{Orn}(\mathbb{T}^\times)$ such that

- for all $v \in \mathbb{V}^\times$, the ornament $\varrho(v)$ is hung at v ;
- for all $v, v' \in \mathbb{V}^\times$, the ornaments $\varrho(v)$ and $\varrho(v')$ are either nested or disjoint.

An ornament $\varrho(v)$ of an ornamentation ϱ is *maximal* if there does not exist $v' \in \mathbb{V}^\times \setminus \{v\}$ such that $\varrho(v) \subseteq \varrho(v')$. Let $\mathcal{O}(\mathbb{T}^\times)$ denote the set of ornamentations of \mathbb{T}^\times . There is a natural partial order \leq on $\mathcal{O}(\mathbb{T}^\times)$ defined so that $\varrho \leq \varrho'$ if and only if $\varrho(v) \subseteq \varrho'(v)$ for all $v \in \mathbb{V}^\times$.

The poset $\mathcal{O}(\mathbb{T}^\times)$ has a unique minimal element ϱ_{\min} and a unique maximal element ϱ_{\max} ; they are defined so that

$$\varrho_{\min}(v) = \{v\} \quad \text{and} \quad \varrho_{\max}(v) = \nabla_{\mathbb{T}}(v)$$

for all $v \in \mathbb{V}^\times$.

Proposition 4.3.1. *Let \mathbb{T} be a rooted plane tree. The poset $\mathcal{O}(\mathbb{T}^\times)$ is a lattice.*

Proof. The meet operation on $\mathcal{O}(\mathbb{T}^\times)$ is given by

$$(\varrho \wedge \varrho')(v) = \varrho(v) \cap \varrho'(v)$$

for all $v, v' \in \mathbb{V}^\times$. The join $\varrho \vee \varrho'$ is simply the meet of the set of upper bounds of ϱ and ϱ' (this set is nonempty because $\mathcal{O}(\mathbb{T}^\times)$ has a unique maximal element ϱ_{\max}). \square

In light of Theorem 4.3.1, we call $\mathcal{O}(\mathbb{T}^\times)$ an *ornamentation lattice*.

Let us identify \mathbb{V} with $\{0, 1, \dots, n\}$ so that $0, 1, \dots, n$ is the preorder traversal of \mathbb{T} . Then the vertex set of \mathbb{T}^\times is $[n]$, so the set $\mathcal{L}(\mathbb{T}^\times)$ of linear extensions of \mathbb{T}^\times can be viewed as a subset of \mathfrak{S}_n (a linear extension is just the one-line notation of a permutation). It follows from [BW91]*Theorem 6.8 that $\mathcal{L}(\mathbb{T}^\times)$ is an interval in $\text{Weak}(\mathfrak{S}_n)$. In particular, $\mathcal{L}(\mathbb{T}^\times)$ is a lattice.

In order to prove that $MN(\mathbb{T})$ is a lattice, we will first embed it as a subposet of the product lattice $\mathcal{L}(\mathbb{T}^\times) \times \mathcal{O}(\mathbb{T}^\times)$. Suppose $\mathcal{N} \in MN(\mathbb{T})$ is a maximal nesting of \mathbb{T} . For each $v \in \mathbb{V}^\times$, let $\varrho_{\mathcal{N}}(v)$ be the largest tube in \mathcal{N} whose root is v ; if no such tube exists, let $\varrho_{\mathcal{N}}(v) = \{v\}$. This defines an ornamentation $\varrho_{\mathcal{N}} \in \mathcal{O}(\mathbb{T}^\times)$. There is a unique linear extension $\tilde{\lambda}_{\mathcal{N}} \in \mathcal{L}(\mathbb{T})$ such that for every $\tau \in \mathcal{N}$, the elements of τ form a consecutive factor of $\tilde{\lambda}_{\mathcal{N}}$. The first entry in the word $\tilde{\lambda}_{\mathcal{N}}$ is the root vertex \mathbf{r} . Let $\lambda_{\mathcal{N}} \in \mathcal{L}(\mathbb{T}^\times)$ be the linear extension of \mathbb{T}^\times obtained from $\tilde{\lambda}_{\mathcal{N}}$ by deleting \mathbf{r} .

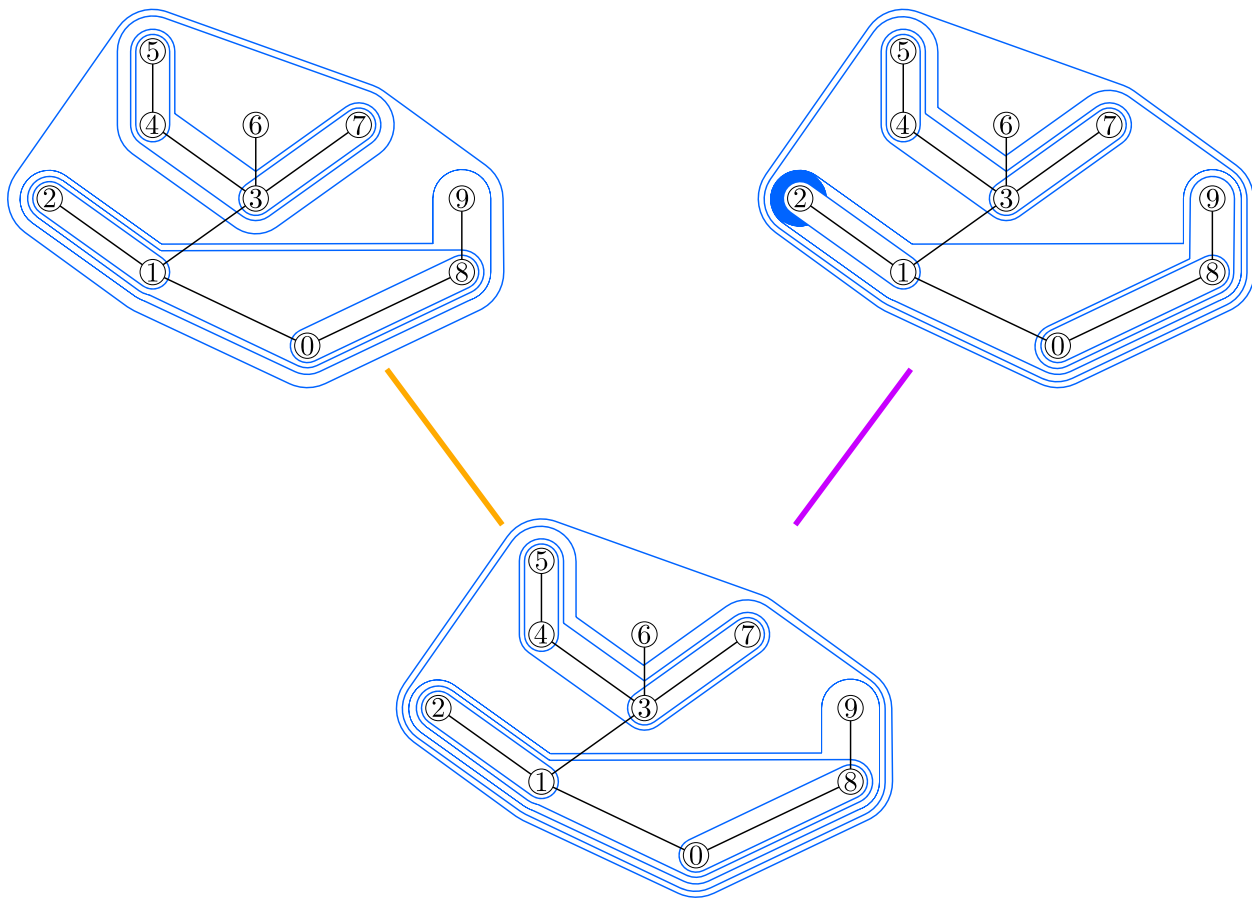

Figure 4.4: Three maximal nestings of a tree in PT_9 . The top two maximal nestings cover the bottom maximal nesting. The cover relation on the left corresponds to an associahedron move, while the cover relation on the right corresponds to a permutohedron move.

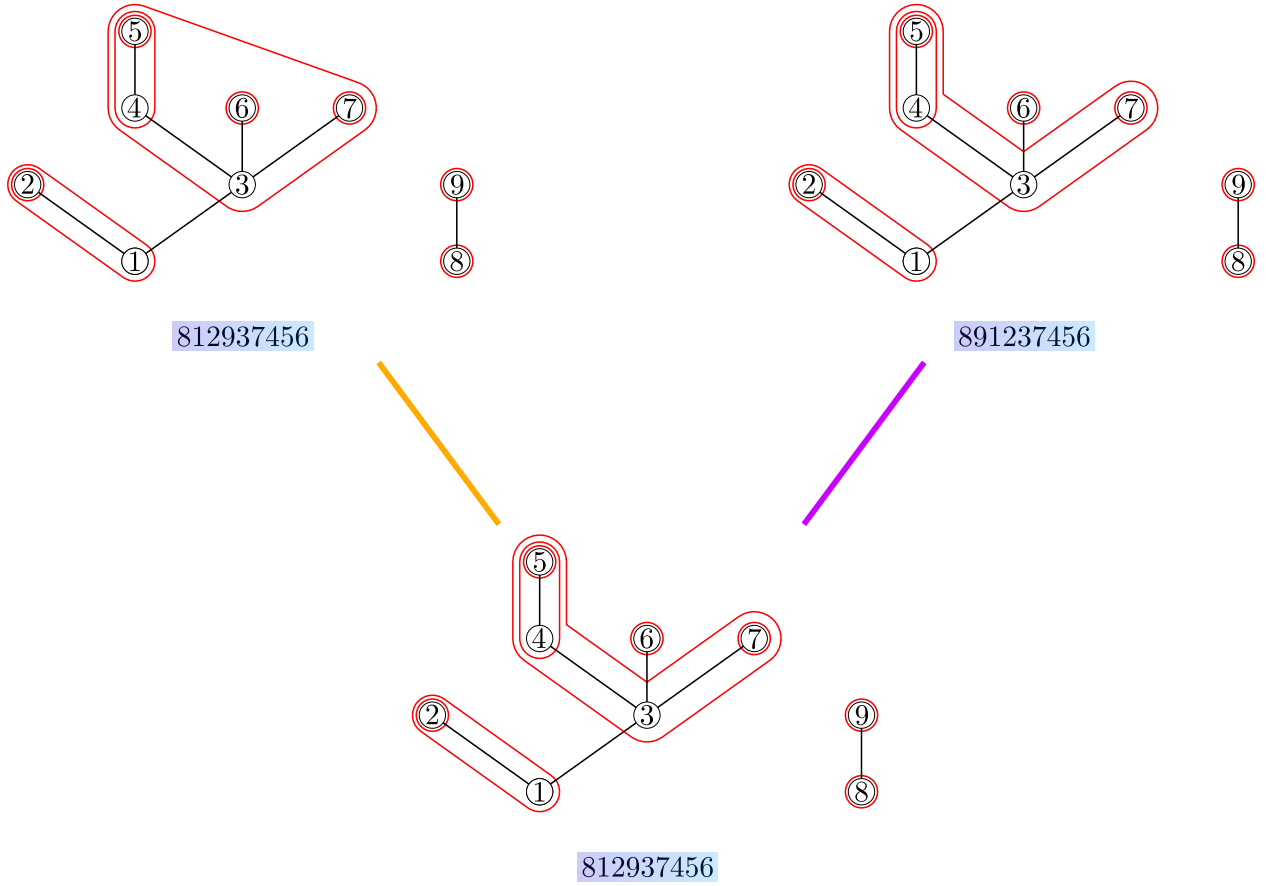

Figure 4.5: Applying Ψ to the maximal nestings in Figure 4.4 yields these three pairs, each of which consists of an ornamentation (which we represent by circling the ornaments in red) and a linear extension.

Remark 4.3.2. Suppose $\mathcal{N} \triangleleft \mathcal{N}'$ is a cover relation in $\text{MN}(\mathbb{T})$. Let $\tau \in \mathcal{N} \setminus \mathcal{N}'$ and $\tau' \in \mathcal{N}' \setminus \mathcal{N}$ be such that $\mathcal{N} \setminus \{\tau\} = \mathcal{N}' \setminus \{\tau'\}$. Let v and v' be the roots of τ and τ' , respectively. If \mathcal{N} and \mathcal{N}' are related by a permutohedron move (meaning $v = v'$), then

- $\varrho_{\mathcal{N}} = \varrho_{\mathcal{N}'}$;
- $\lambda_{\mathcal{N}}|_{\tau \cap \tau'} \lambda_{\mathcal{N}}|_{\tau \setminus \tau'} \lambda_{\mathcal{N}}|_{\tau' \setminus \tau}$ is a consecutive factor of $\lambda_{\mathcal{N}}$;
- $\lambda_{\mathcal{N}'}$ is obtained from $\lambda_{\mathcal{N}}$ by swapping $\lambda_{\mathcal{N}}|_{\tau \setminus \tau'}$ and $\lambda_{\mathcal{N}}|_{\tau' \setminus \tau}$.

On the other hand, if \mathcal{N} and \mathcal{N}' are related by an associahedron move (meaning $v \neq v'$), then

- $\varrho_{\mathcal{N}}(u) = \varrho_{\mathcal{N}'}(u)$ for all $u \in \mathbf{V}^\times \setminus \{v'\}$;
- $\varrho_{\mathcal{N}}(v') = \tau \cap \tau'$;
- $\varrho_{\mathcal{N}'}(v') = \tau'$;
- $\lambda_{\mathcal{N}}$ and $\lambda_{\mathcal{N}'}$ are equal and have $\lambda_{\mathcal{N}}|_{\tau \setminus \tau'} \lambda_{\mathcal{N}}|_{\tau \cap \tau'} \lambda_{\mathcal{N}}|_{\tau' \setminus \tau}$ as a consecutive factor.

See Figures 4.4 and 4.5.

Let $\Theta(\mathbb{T}^\times)$ be the set of pairs $(\lambda, \varrho) \in \mathcal{L}(\mathbb{T}^\times) \times \mathcal{O}(\mathbb{T}^\times)$ such that for every $v \in \mathbf{V}^\times$, the elements of $\varrho(v)$ form a consecutive factor of λ . We will view $\Theta(\mathbb{T}^\times)$ as a subposet of $\mathcal{L}(\mathbb{T}^\times) \times \mathcal{O}(\mathbb{T}^\times)$. Note that $(\lambda_{\mathcal{N}}, \varrho_{\mathcal{N}}) \in \Theta(\mathbb{T}^\times)$ for all $\mathcal{N} \in \text{MN}(\mathbb{T})$. Thus, we can define a map $\Psi: \text{MN}(\mathbb{T}) \rightarrow \Theta(\mathbb{T}^\times)$ by

$$\Psi(\mathcal{N}) = (\lambda_{\mathcal{N}}, \varrho_{\mathcal{N}}).$$

For example, if we apply Ψ to the maximal nestings in Figure 4.4, we obtain the pairs shown in Figure 4.5.

Lemma 4.3.3. *For $\mathbb{T} \in \text{PT}_n$, the map $\Psi: \text{MN}(\mathbb{T}) \rightarrow \Theta(\mathbb{T}^\times)$ is a bijection.*

Proof. Let $(\lambda, \varrho) \in \Theta(\mathbb{T}^\times)$. We will show that there is a unique $\mathcal{N} \in \text{MN}(\mathbb{T})$ such that $\lambda_{\mathcal{N}} = \lambda$ and $\varrho_{\mathcal{N}} = \varrho$. This is trivial if $n \leq 1$, so we may assume $n \geq 2$ and proceed by induction on n .

Let M be the set of vertices $v \in \mathbf{V}^\times$ such that $\varrho(v)$ is a maximal ornament of ϱ . Let v_1, \dots, v_m be the elements of M , listed in the order they appear in λ . For $i \in [m]$, let \mathbb{T}_i be the subtree of \mathbb{T} with vertex set $\varrho(v_i)$.

Fix $i \in [m]$. Let \mathbb{T}_i^\times be the forest poset obtained from \mathbb{T}_i by deleting its root vertex v_i . Let $\mathbf{V}_i^\times = \varrho(v_i) \setminus \{v_i\}$ be the vertex set of \mathbb{T}_i^\times . Consider the ornamentation $\varrho_i \in \mathcal{O}(\mathbb{T}_i^\times)$

obtained by restricting ϱ to V_i^\times . Let $\lambda_i = \lambda|_{V_i^\times}$. Note that $(\lambda_i, \varrho_i) \in \Theta(\mathbb{T}_i^\times)$. By induction, we know that there is a unique $\mathcal{N}_i \in \text{MN}(\mathbb{T}_i)$ such that $\lambda_{\mathcal{N}_i} = \lambda_i$ and $\varrho_{\mathcal{N}_i} = \varrho_i$. For each $1 \leq j \leq m$, it follows from the definition of $\Theta(\mathbb{T}^\times)$ that the set $\tau_j = \{0\} \cup \varrho(v_1) \cup \dots \cup \varrho(v_j)$ is a tube of \mathbb{T} . Let

$$\mathcal{N} = \{\tau_1, \dots, \tau_m\} \cup \mathcal{N}_1 \cup \dots \cup \mathcal{N}_m.$$

Then $\Psi(\mathcal{N}) = (\lambda, \varrho)$, and \mathcal{N} is the unique maximal nesting of \mathbb{T} with this property. \square

Consider a cover relation $(\lambda, \varrho) \triangleleft (\lambda', \varrho')$ in $\Theta(\mathbb{T}^\times)$. We say (λ, ϱ) and (λ', ϱ') are related by a *permutohedron move* if $\varrho = \varrho'$ and there exist vertices $p, q \in V^\times$ such that

- p and q are incomparable in \mathbb{T} ;
- every number in $\varrho(p)$ is less than every number in $\varrho(q)$ in \mathbb{Z} ;
- $\lambda|_{\varrho(p)}\lambda|_{\varrho(q)}$ is a consecutive factor of λ ;
- λ' is obtained from λ by swapping $\lambda|_{\varrho(p)}$ and $\lambda|_{\varrho(q)}$.

For example, if (λ, ϱ) and (λ', ϱ') are the pairs on the bottom and the top right of Figure 4.5, then (λ, ϱ) and (λ', ϱ') are related by a permutohedron move. In this example, the linear extension $\lambda' = 891237456$ is obtained from the linear extension $\lambda = 812937456$ by swapping the consecutive factors $\lambda|_{\varrho(1)} = 12$ and $\lambda|_{\varrho(9)} = 9$. On the other hand, we say (λ, ϱ) and (λ', ϱ') are related by an *associahedron move* if $\lambda = \lambda'$ and there exists $t \in V^\times$ such that $\varrho(v) = \varrho'(v)$ for all $v \in V^\times \setminus \{t\}$ and $\varrho'(t) = \varrho(t) \cup \varrho(t^\rightarrow)$, where t^\rightarrow is the vertex in V^\times appearing immediately after $\lambda|_{\varrho(v)}$ in λ . For example, if (λ, ϱ) and (λ', ϱ') are the pairs on the bottom and the top left of Figure 4.5, then (λ, ϱ) and (λ', ϱ') are related by an associahedron move. In this example, we have $\varrho'(3) = \varrho(3) \cup \varrho(6)$ because 6 is the vertex appearing immediately after the consecutive factor $\lambda|_{\varrho(3)} = 3745$ in λ .

Lemma 4.3.4. *Let $(\lambda, \varrho) \triangleleft (\lambda', \varrho')$ be a cover relation in $\Theta(\mathbb{T}^\times)$. Either (λ, ϱ) and (λ', ϱ') are related by a permutohedron move, or they are related by an associahedron move.*

Proof. It suffices to show that $\varrho = \varrho'$ or $\lambda = \lambda'$. Indeed, if $\varrho = \varrho'$, then it is straightforward to show that (λ, ϱ) and (λ', ϱ') are related by a permutohedron move, and if $\lambda = \lambda'$, then it is straightforward to show that (λ, ϱ) and (λ', ϱ') are related by an associahedron move. Assume by way of contradiction that $\varrho < \varrho'$ and $\lambda < \lambda'$.

Let M be the set of vertices $v \in \mathbf{V}^\times$ such that $\varrho(v)$ is a maximal ornament of ϱ . Let v_1, \dots, v_m be the elements of M , listed in the order they appear in λ . Then $\lambda = \lambda|_{\varrho(v_1)} \cdots \lambda|_{\varrho(v_m)}$. Suppose by way of contradiction that there is an index $i \in \{2, \dots, m\}$ such that $\varrho(v_i) \prec_{\lambda'} \varrho(v_{i-1})$. Then there is a linear extension $\lambda'' \in \mathcal{L}(\mathbf{T}^\times)$ obtained from λ by swapping the factors $\lambda|_{\varrho(v_{i-1})}$ and $\lambda|_{\varrho(v_i)}$. We have $(\lambda'', \varrho) \in \Theta(\mathbf{T}^\times)$ and $(\lambda, \varrho) < (\lambda'', \varrho) < (\lambda', \varrho')$, which contradicts the assumption that (λ, ϱ) is covered by (λ', ϱ') in $\Theta(\mathbf{T}^\times)$. From this contradiction, we deduce that for each $i \in \{2, \dots, m\}$, there exist $\ell_{i-1} \in \varrho(v_{i-1})$ and $r_i \in \varrho(v_i)$ such that $\ell_{i-1} \prec_{\lambda'} r_i$.

Assume for the moment that $\varrho(v_1), \dots, \varrho(v_m)$ are also the maximal ornaments of ϱ' . It follows from the preceding paragraph that the elements of M appear in the order v_1, \dots, v_m in λ' . For $i \in [m]$, let \mathbf{T}_i be the subtree of \mathbf{T} with vertex set $\varrho(v_i)$. Let $\mathbf{V}_i^\times = \varrho(v_i) \setminus \{v_i\}$ be the vertex set of the forest \mathbf{T}_i^\times . Let $\lambda_i = \lambda|_{\mathbf{V}_i^\times}$ and $\lambda'_i = \lambda'|_{\mathbf{V}_i^\times}$, and note that $\lambda_i, \lambda'_i \in \mathcal{L}(\mathbf{T}_i^\times)$. Let ϱ_i and ϱ'_i be the ornamentations in $\mathcal{O}(\mathbf{T}^\times)$ obtained by restricting ϱ and ϱ' , respectively, to \mathbf{V}_i^\times . If there exists $i \in [m]$ such that $\varrho_i < \varrho'_i$ and $\lambda_i < \lambda'_i$, then we can use induction to find that (λ_i, ϱ_i) is not covered by (λ'_i, ϱ'_i) in $\Theta(\mathbf{T}_i^\times)$; this then contradicts the assumption that (λ, ϱ) is covered by (λ', ϱ') in $\Theta(\mathbf{T}^\times)$. Otherwise, there exist distinct indices $i, i' \in [m]$ such that $\lambda_i < \lambda'_{i'}$, $\varrho_i = \varrho'_{i'}$, $\lambda_{i'} = \lambda'_i$, and $\varrho_{i'} < \varrho'_i$. In this case, we can consider the linear extension $\lambda''' \in \mathcal{L}(\mathbf{T}^\times)$ obtained from λ by reordering the elements of $\varrho(v_i)$ into the order they appear in λ' ; we have $(\lambda''', \varrho) \in \Theta(\mathbf{T}^\times)$ and $(\lambda, \varrho) < (\lambda''', \varrho) < (\lambda', \varrho')$, which is again a contradiction.

We may now assume that $\{\varrho(v_1), \dots, \varrho(v_m)\}$ is not the set of maximal ornaments of ϱ' . Thus, there exists $j \in [m]$ such that $\varrho'(v_j)$ is a maximal ornament of ϱ' and such that $\varrho(v_j) \subsetneq \varrho'(v_j)$. Let k be the smallest index in $[m] \setminus \{j\}$ such that $\varrho(v_k) \subseteq \varrho'(v_j)$. Because λ

is a linear extension, every number in $\varrho'(v_j) \setminus \{v_j\}$ appears to the right of v_j in λ . Therefore, $j < k$.

Suppose $k = j + 1$. Let ϱ'' be the ornamentation of \mathbb{T}^\times such that $\varrho''(v_j) = \varrho(v_j) \cup \varrho(v_k)$ and $\varrho''(v) = \varrho(v)$ for all $v \in \mathbb{V}^\times \setminus \{v_j\}$. Then $(\lambda, \varrho'') \in \Theta(\mathbb{T}^\times)$, and $\varrho < \varrho'' \leq \varrho'$. This implies that $(\lambda, \varrho) < (\lambda, \varrho'') < (\lambda', \varrho')$, which is a contradiction. From this, we deduce that $k > j + 1$.

For each $i \in \{j + 1, \dots, k\}$, the set $\varrho(v_i)$ is contained in a maximal ornament of ϱ' , so the assumption that $\varrho'(v_j)$ is a maximal ornament of ϱ' guarantees that either $\varrho(v_i) \prec_{\lambda'} \{v_j\}$ or $\{v_j\} \prec_{\lambda'} \varrho(v_i)$. If there exists $i \in \{j + 1, \dots, k\}$ such that $\varrho(v_i) \prec_{\lambda'} \{v_j\}$, then we can choose this index i minimally to find that $r_i \prec_{\lambda'} \ell_{i-1}$, which is impossible. Therefore, $\{v_j\} \prec_{\lambda'} (\varrho(v_{j+1}) \cup \dots \cup \varrho(v_k))$. This implies that $v_j \prec_{\lambda'} \ell_{k-1} \prec_{\lambda'} r_k$. Because $v_j, r_k \in \varrho(v_j) \subseteq \varrho'(v_j)$ and the numbers in $\varrho'(v_j)$ form a consecutive factor of λ' , this implies that $\ell_{k-1} \in \varrho'(v_j)$. It follows that $\varrho(v_{k-1}) \subseteq \varrho'(v_j)$, which contradicts the minimality in the definition of k . \square

It follows from Theorems 4.3.2 and 4.3.4 that $\mathcal{N} \triangleleft \mathcal{N}'$ is a cover relation in $\text{MN}(\mathbb{T})$ corresponding to a permutohedron (respectively, associahedron) move if and only if $\Psi(\mathcal{N}) \triangleleft \Psi(\mathcal{N}')$ is a cover relation in $\Theta(\mathbb{T}^\times)$ corresponding to a permutohedron (respectively, associahedron) move. This proves the following proposition.

Proposition 4.3.5. *For $\mathbb{T} \in \text{PT}_n$, the map $\Psi: \text{MN}(\mathbb{T}) \rightarrow \Theta(\mathbb{T}^\times)$ is a poset isomorphism.*

The remainder of this section is devoted to proving that $\Theta(\mathbb{T}^\times)$ is a lattice; our proof relies on the following result due to Björner, Edelman, and Ziegler.

Proposition 4.3.6 ([BEZ90]). *Let P be a finite poset with a unique minimal element and a unique maximal element. Suppose that for all distinct $x_0, x_1, x_2 \in P$ satisfying $x_0 \triangleleft x_1$ and $x_0 \triangleleft x_2$, the elements x_1 and x_2 have a least upper bound in P . Then P is a lattice.*

Proof of Theorem 4.1.1. By Theorem 4.3.5, it suffices to prove that $\Theta(\mathbb{T}^\times)$ is a lattice. Let $(\lambda_0, \varrho_0), (\lambda_1, \varrho_1), (\lambda_2, \varrho_2)$ be distinct elements of $\Theta(\mathbb{T}^\times)$ such that $(\lambda_0, \varrho_0) \triangleleft (\lambda_1, \varrho_1)$ and $(\lambda_0, \varrho_0) \triangleleft (\lambda_2, \varrho_2)$. We will prove that (λ_1, ϱ_1) and (λ_2, ϱ_2) have a least upper bound in

$\Theta(\mathbb{T}^\times)$; in light of Theorem 4.3.6, this will complete the proof. We consider three cases based on whether the cover relations under consideration correspond to permutohedron or associahedron moves. By swapping the roles of (λ_1, ϱ_1) and (λ_2, ϱ_2) if necessary, we may assume that either the cover relation $(\lambda_0, \varrho_0) \triangleleft (\lambda_1, \varrho_1)$ corresponds to a permutohedron move or both $(\lambda_0, \varrho_0) \triangleleft (\lambda_1, \varrho_1)$ and $(\lambda_0, \varrho_0) \triangleleft (\lambda_2, \varrho_2)$ correspond to associahedron moves.

Case 1. Assume that both of the cover relations $(\lambda_0, \varrho_0) \triangleleft (\lambda_1, \varrho_1)$ and $(\lambda_0, \varrho_0) \triangleleft (\lambda_2, \varrho_2)$ correspond to permutohedron moves. Then $\varrho_0 = \varrho_1 = \varrho_2$, and there are vertices $p_1, q_1, p_2, q_2 \in \mathbb{V}^\times$ such that for each $i \in \{1, 2\}$,

- p_i and q_i are incomparable in \mathbb{T} ;
- every number in $\varrho_0(p_i)$ is less than every number in $\varrho_0(q_i)$ in \mathbb{Z} ;
- $\lambda_0|_{\varrho_0(p_i)}\lambda_0|_{\varrho_0(q_i)}$ is a consecutive factor of λ_0 ;
- λ_i is obtained from λ_0 by swapping $\lambda_0|_{\varrho_0(p_i)}$ and $\lambda_0|_{\varrho_0(q_i)}$.

We will show that $(\lambda_1 \vee \lambda_2, \varrho_0) \in \Theta(\mathbb{T}^\times)$, from which it will follow that $(\lambda_1 \vee \lambda_2, \varrho_0)$ is the least upper bound of (λ_1, ϱ_1) and (λ_2, ϱ_2) . If p_1, q_1, p_2, q_2 are pairwise distinct, then $\lambda_1 \vee \lambda_2$ is obtained from λ_0 by swapping $\lambda_0|_{\varrho_0(p_1)}$ and $\lambda_0|_{\varrho_0(q_1)}$ and also swapping $\lambda_0|_{\varrho_0(p_2)}$ and $\lambda_0|_{\varrho_0(q_2)}$ (these two swaps commute with each other). In this case, it is straightforward to see that $(\lambda_1 \vee \lambda_2, \varrho_0) \in \Theta(\mathbb{T}^\times)$. Now suppose p_1, q_1, p_2, q_2 are not pairwise distinct. Then either $p_2 = q_1$ or $p_1 = q_2$; we may assume without loss of generality that $p_2 = q_1$. The linear extension λ_0 has $\lambda_0|_{\varrho_0(p_1)}\lambda_0|_{\varrho_0(q_1)}\lambda_0|_{\varrho_0(q_2)}$ as a consecutive factor, and $\lambda_1 \vee \lambda_2$ is obtained from λ_0 by replacing this consecutive factor with $\lambda_0|_{\varrho_0(q_2)}\lambda_0|_{\varrho_0(q_1)}\lambda_0|_{\varrho_0(p_1)}$. In this case, we once again see that $(\lambda_1 \vee \lambda_2, \varrho_0) \in \Theta(\mathbb{T}^\times)$.

Case 2. Assume that both of the cover relations $(\lambda_0, \varrho_0) \triangleleft (\lambda_1, \varrho_1)$ and $(\lambda_0, \varrho_0) \triangleleft (\lambda_2, \varrho_2)$ correspond to associahedron moves. Then $\lambda_0 = \lambda_1 = \lambda_2$, and for each $i \in \{1, 2\}$, there is a vertex $t_i \in \mathbb{V}^\times$ such that $\varrho_0(v) = \varrho_i(v)$ for all $v \in \mathbb{V}^\times \setminus \{t_i\}$ and $\varrho_i(t_i) = \varrho_0(t_i) \cup \varrho_0(t_i^{\rightarrow})$, where t_i^{\rightarrow} is the vertex in \mathbb{V}^\times appearing immediately after $\lambda_0|_{\varrho_0(t_i)}$ in λ_0 . We will show that

$(\lambda_0, \varrho_1 \vee \varrho_2) \in \Theta(\mathbb{T}^\times)$, from which it will follow that $(\lambda_0, \varrho_1 \vee \varrho_2)$ is the least upper bound of (λ_1, ϱ_1) and (λ_2, ϱ_2) . If $t_1, t_1^\rightarrow, t_2, t_2^\rightarrow$ are pairwise distinct, then the ornamentation $\varrho_1 \vee \varrho_2$ sends t_1 to $\varrho_0(t_1) \cup \varrho_0(t_1^\rightarrow)$, sends t_2 to $\varrho_0(t_2) \cup \varrho_0(t_2^\rightarrow)$, and sends each vertex $v \in \mathbb{V}^\times \setminus \{t_1, t_2\}$ to $\varrho_0(v)$. In this case, it is straightforward to see that $(\lambda_0, \varrho_1 \vee \varrho_2) \in \Theta(\mathbb{T}^\times)$. Now suppose $t_1, t_1^\rightarrow, t_2, t_2^\rightarrow$ are not pairwise distinct. Then either $t_2 = t_1^\rightarrow$ or $t_1 = t_2^\rightarrow$; we may assume without loss of generality that $t_2 = t_1^\rightarrow$. The ornamentation $\varrho_1 \vee \varrho_2$ sends t_1 to $\varrho_0(t_1) \cup \varrho_0(t_2) \cup \varrho_0(t_2^\rightarrow)$, sends t_2 to $\varrho_0(t_2) \cup \varrho_0(t_2^\rightarrow)$, and sends each vertex $v \in \mathbb{V}^\times \setminus \{t_1, t_2\}$ to $\varrho_0(v)$. In this case, we once again see that $(\lambda_0, \varrho_1 \vee \varrho_2) \in \Theta(\mathbb{T}^\times)$.

Case 3. Assume that the cover relation $(\lambda_0, \varrho_0) \triangleleft (\lambda_1, \varrho_1)$ corresponds to a permutohedron move while $(\lambda_0, \varrho_0) \triangleleft (\lambda_2, \varrho_2)$ corresponds to an associahedron move. Then $\varrho_0 = \varrho_1$, and there are vertices $p_1, q_1 \in \mathbb{V}^\times$ such that

- p_1 and q_1 are incomparable in \mathbb{T} ;
- every number in $\varrho_0(p_1)$ is less than every number in $\varrho_0(q_1)$ in \mathbb{Z} ;
- $\lambda_0|_{\varrho_0(p_1)}\lambda_0|_{\varrho_0(q_1)}$ is a consecutive factor of λ_0 ;
- λ_1 is obtained from λ_0 by swapping $\lambda_0|_{\varrho_0(p_1)}$ and $\lambda_0|_{\varrho_0(q_1)}$.

Furthermore, $\lambda_0 = \lambda_2$, and there is a vertex t_2 such that $\varrho_0(v) = \varrho_2(v)$ for all $v \in \mathbb{V}^\times \setminus \{t_2\}$ and $\varrho_2(t_2) = \varrho_0(t_2) \cup \varrho_0(t_2^\rightarrow)$, where t_2^\rightarrow is the vertex in \mathbb{V}^\times appearing immediately after $\lambda_0|_{\varrho_0(t_2)}$ in λ_0 . If $p_1, q_1, t_2, t_2^\rightarrow$ are pairwise distinct, then (λ_1, ϱ_2) is the least upper bound of (λ_1, ϱ_1) and (λ_2, ϱ_2) . Now assume $p_1, q_1, t_2, t_2^\rightarrow$ are not pairwise distinct. Then either $q_1 = t_2$ or $p_1 = t_2^\rightarrow$.

Suppose first that $q_1 = t_2$. We have $p_1 < q_2$, and p_1 and q_2 are incomparable in \mathbb{T} . It follows that p_1 is less than every number in $\varrho_2(t_2)$ in \mathbb{Z} . Note that $\lambda_0|_{\varrho_0(p_1)}\lambda_0|_{\varrho_2(t_2)}$ is a consecutive factor of λ_0 . Let λ' be the linear extension of \mathbb{T}^\times obtained from λ_0 by swapping $\lambda_0|_{\varrho_0(p_1)}$ and $\lambda_0|_{\varrho_2(t_2)}$. Noting that $\lambda_1 \leq \lambda'$, we find that (λ', ϱ_2) is in $\Theta(\mathbb{T}^\times)$ and is an upper bound of (λ_1, ϱ_1) and (λ_2, ϱ_2) . We claim that (λ', ϱ_2) is actually the least upper bound of

(λ_1, ϱ_1) and (λ_2, ϱ_2) . To see this, suppose $(\widehat{\lambda}, \widehat{\varrho}) \in \Theta(\mathbb{T}^\times)$ is an upper bound of (λ_1, ϱ_1) and (λ_2, ϱ_2) ; we will show that $\lambda' \leq \widehat{\lambda}$ so that $(\lambda', \varrho_2) \leq (\widehat{\lambda}, \widehat{\varrho})$. Because $\lambda_1 \leq \widehat{\lambda}$, we must have $\varrho_0(t_2) \prec_{\widehat{\lambda}} \varrho_0(p_1)$. Because p_1 and t_2 are incomparable in \mathbb{T} , none of the elements of $\varrho_0(p_1)$ can belong to $\widehat{\varrho}(t_2)$. On the other hand, since $\varrho_2(t_2) \subseteq \widehat{\varrho}(t_2)$ and $(\widehat{\lambda}, \widehat{\varrho}) \in \Theta(\mathbb{T}^\times)$, we must have $\varrho_2(t_2) \prec_{\widehat{\lambda}} \varrho_0(p_1)$. It follows that $\lambda' \leq \widehat{\lambda}$, as desired.

Now suppose $p_1 = t_2^\rightarrow$ and $t_2 \not\leq_{\mathbb{T}} q_1$. Because $t_2^\rightarrow \in \varrho_2(t_2)$, we have $t_2 < t_2^\rightarrow = p_1 < q_1$. Note that $\lambda_0|_{\varrho_2(t_2)}\lambda_0|_{\varrho_0(q_1)}$ is a consecutive factor of λ_0 . All of the elements of $\varrho_0(t_2)$ are incomparable to all of the elements of $\varrho_0(q_1)$ in \mathbb{T} , and an argument similar to the one used in the preceding paragraph shows that (λ', ϱ_2) is the least upper bound of (λ_1, ϱ_1) and (λ_2, ϱ_2) , where λ' is the linear extension of \mathbb{T}^\times obtained from λ_0 by swapping $\lambda_0|_{\varrho_2(t_2)}$ and $\lambda_0|_{\varrho_0(q_1)}$.

Finally, suppose $p_1 = t_2^\rightarrow$ and $t_2 \leq_{\mathbb{T}} q_1$. Let ϱ' be the ornamentation of \mathbb{T}^\times such that $\varrho'(v) = \varrho_0(v)$ for all $v \in \mathbb{V}^\times \setminus \{t_2\}$ and $\varrho'(t_2) = \varrho_0(t_2) \cup \varrho_0(p_1) \cup \varrho_0(q_1)$. Noting that $\varrho_2 \leq \varrho'$, we find that (λ_1, ϱ') is in $\Theta(\mathbb{T}^\times)$ and is an upper bound of (λ_1, ϱ_1) and (λ_2, ϱ_2) . We claim that (λ_1, ϱ') is actually the least upper bound of (λ_1, ϱ_1) and (λ_2, ϱ_2) . To see this, suppose $(\widehat{\lambda}, \widehat{\varrho}) \in \Theta(\mathbb{T}^\times)$ is an upper bound of (λ_1, ϱ_1) and (λ_2, ϱ_2) ; we will show that $\varrho' \leq \widehat{\varrho}$ so that $(\lambda_1, \varrho') \leq (\widehat{\lambda}, \widehat{\varrho})$. To prove that $\varrho' \leq \widehat{\varrho}$, we just need to demonstrate that $\varrho'(t_2) \subseteq \widehat{\varrho}(t_2)$. The assumption that $\varrho_2 \leq \widehat{\varrho}$ already tells us that $\varrho_0(t_2) \cup \varrho_0(p_1) = \varrho_2(t_2) \subseteq \widehat{\varrho}(t_2)$. Hence, we just need to show that $\varrho_0(q_1) \subseteq \widehat{\varrho}(t_2)$. Because $t_2 \leq_{\mathbb{T}} q_1$, we have $\{t_2\} \prec_{\widehat{\lambda}} \varrho_0(q_1)$. Since $\lambda_1 \leq \widehat{\lambda}$, we also know that $\varrho_0(q_1) \prec_{\widehat{\lambda}} \{p_1\}$. The elements of $\widehat{\varrho}(t_2)$ form a consecutive factor of $\widehat{\lambda}$, and $t_2, p_1 \in \widehat{\varrho}(t_2)$. This shows that $\varrho_0(q_1) \subseteq \widehat{\varrho}(t_2)$, as desired. \square

4.4 Intervals

The purpose of this brief section is to prove Theorem 4.1.2, which states that if \mathbb{T} contains \mathbb{T}' , then $\text{MN}(\mathbb{T}')$ is isomorphic to an interval of $\text{MN}(\mathbb{T})$.

Proof of Theorem 4.1.2. It suffices to prove that $\text{MN}(\mathbb{T}')$ is isomorphic to an interval of $\text{MN}(\mathbb{T})$ when \mathbb{T}' is obtained from \mathbb{T} by contracting a single edge e . Let u and u' be the bottom and top vertices of e , respectively. Let Q be the subposet of $\text{MN}(\mathbb{T})$ consisting of the maximal nestings of \mathbb{T} that contain the tube $\tau^* = \{u, u'\}$. The map $\mathcal{N} \mapsto \mathcal{N} \cup \{\tau^*\}$ is a poset isomorphism from $\text{MN}(\mathbb{T}')$ to Q , so Q has a unique minimal element \mathcal{N}_{\min} and a unique maximal element \mathcal{N}_{\max} . Suppose $\mathcal{N} \in \text{MN}(\mathbb{T})$ is such that $\mathcal{N}_{\min} < \mathcal{N} < \mathcal{N}_{\max}$; we will prove that $\mathcal{N} \in Q$.

Let \mathbb{T}^\times be the forest poset obtained by deleting the root from \mathbb{T} , and recall the poset isomorphism $\Psi: \text{MN}(\mathbb{T}) \rightarrow \Theta(\mathbb{T}^\times)$ from Theorem 4.3.5. Note that u appears immediately before u' in both $\lambda_{\mathcal{N}_{\min}}$ and $\lambda_{\mathcal{N}_{\max}}$. Note also that u' belongs to both $\varrho_{\mathcal{N}_{\min}}(u)$ and $\varrho_{\mathcal{N}_{\max}}(u)$ and that $\varrho_{\mathcal{N}_{\min}}(u') = \varrho_{\mathcal{N}_{\max}}(u') = \{u'\}$. Because

$$\Psi(\mathcal{N}_{\min}) < \Psi(\mathcal{N}) < \Psi(\mathcal{N}_{\max}),$$

we have

$$\lambda_{\mathcal{N}_{\min}} < \lambda_{\mathcal{N}} < \lambda_{\mathcal{N}_{\max}} \quad \text{and} \quad \varrho_{\mathcal{N}_{\min}} < \varrho_{\mathcal{N}} < \varrho_{\mathcal{N}_{\max}}.$$

This implies that u appears immediately before u' in $\lambda_{\mathcal{N}}$, that $u' \in \varrho_{\mathcal{N}}(u)$, and that $\varrho_{\mathcal{N}}(u') = \{u'\}$. It follows from the recursive description of Ψ^{-1} in the proof of Theorem 4.3.3 that $\tau^* \in \mathcal{N}$; that is, $\mathcal{N} \in Q$. □

4.5 Semidistributivity

We now proceed to characterize the rooted plane trees \mathbb{T} such that $\text{MN}(\mathbb{T})$ is semidistributive. Our proof will make use of the following result due to Barnard.

Proposition 4.5.1 ([Bar19]*Proposition 22).

- *A finite lattice L is meet-semidistributive if and only if for every cover relation $x < y$ in L , the set $\nabla_L(x) \setminus \nabla_L(y)$ has a unique maximal element.*

- A finite lattice L is join-semidistributive if and only if for every cover relation $x \lessdot y$ in L , the set $\Delta_L(y) \setminus \Delta_L(x)$ has a unique minimal element.

Throughout this section, we will aim to apply Theorem 4.5.1 with $L = \Theta(\mathbb{T}^\times)$, where $\mathbb{T} \in \text{PT}_n$. We identify the vertex set \mathbf{V} of \mathbb{T} with $\{0, 1, \dots, n\}$ so that $0, 1, \dots, n$ is the preorder traversal of \mathbb{T} . Recall that we write \mathbf{V}^\times for the vertex set of \mathbb{T}^\times (so $\mathbf{V}^\times = [n]$). For $(\lambda, \varrho) \in \Theta(\mathbb{T}^\times)$, we will ease notation by writing $\Delta(\lambda, \varrho)$ and $\nabla(\lambda, \varrho)$ instead of $\Delta_{\Theta(\mathbb{T}^\times)}(\lambda, \varrho)$ and $\nabla_{\Theta(\mathbb{T}^\times)}(\lambda, \varrho)$. We will separate the main pieces of our argument into four lemmas. The reader may find it helpful to consult Theorem 4.5.4 while reading the proofs of Theorems 4.5.2 and 4.5.3 and to consult Theorem 4.5.7 while reading the proofs of Theorems 4.5.5 and 4.5.6.

Lemma 4.5.2. *Let $(\lambda_1, \varrho_1) \lessdot (\lambda_2, \varrho_2)$ be a cover relation in $\Theta(\mathbb{T}^\times)$. If (λ_1, ϱ_1) and (λ_2, ϱ_2) are related by an associahedron move, then the set $\nabla(\lambda_1, \varrho_1) \setminus \nabla(\lambda_2, \varrho_2)$ has a unique maximal element.*

Proof. Because (λ_1, ϱ_1) and (λ_2, ϱ_2) are related by an associahedron move, we have $\lambda_1 = \lambda_2$, and there is a vertex $t \in \mathbf{V}^\times$ such that $\varrho_1(v) = \varrho_2(v)$ for all $v \in \mathbf{V}^\times \setminus \{t\}$ and $\varrho_2(t) = \varrho_1(t) \cup \varrho_1(t^\rightarrow)$, where t^\rightarrow is the vertex in \mathbf{V}^\times appearing immediately after the elements of $\varrho_1(t)$ in λ_1 . Let

$$A = \{a \in \nabla_{\mathbb{T}}(t) \setminus \nabla_{\mathbb{T}}(t^\rightarrow) : (a, t^\rightarrow) \notin \text{Inv}(\lambda_1)\}.$$

Define an ornamentation $\varrho^* \in \mathcal{O}(\mathbb{T}^\times)$ by letting $\varrho^*(a) = \nabla_{\mathbb{T}}(a) \cap A$ for all $a \in A$ and letting $\varrho^*(v) = \nabla_{\mathbb{T}}(v)$ for all $v \in \mathbf{V}^\times \setminus A$.

Let K be the set of pairs (i, j) with $1 \leq i < j \leq n$ such that either $i \in A$ and $j \in \nabla_{\mathbb{T}}(t^\rightarrow)$ or $i \leq_{\mathbb{T}} j$. There is a unique linear extension $\lambda^* \in \mathcal{L}(\mathbb{T}^\times)$ whose inversions are the pairs (i, j) such that $1 \leq i < j \leq n$ and $(i, j) \notin K$. Note that λ^* is the unique maximal element (in the weak order) of the set $\{\sigma \in \mathcal{L}(\mathbb{T}^\times) : (\sigma, \varrho^*) \in \Theta(\mathbb{T}^\times)\}$. We will prove that (λ^*, ϱ^*) is the unique maximal element of $\nabla(\lambda_1, \varrho_1) \setminus \nabla(\lambda_2, \varrho_2)$. Choose an arbitrary element $(\widehat{\lambda}, \widehat{\varrho}) \in \nabla(\lambda_1, \varrho_1) \setminus \nabla(\lambda_2, \varrho_2)$; we will prove that $\widehat{\lambda} \leq \lambda^*$ and $\widehat{\varrho} \leq \varrho^*$.

Let us start by proving that $\widehat{\varrho} \leq \varrho^*$; to do so, it suffices to show that $\widehat{\varrho}(a) \subseteq A$ for all $a \in A$. Thus, fix $a \in A$. By the definitions of t^\rightarrow and A , we must have either $a < t^\rightarrow$ and $a \in \varrho_1(t)$ or $a > t^\rightarrow$ and $t^\rightarrow \prec_{\lambda_1} a$. If $a > t^\rightarrow$ and $t^\rightarrow \prec_{\lambda_1} a$, then we must have $b > t^\rightarrow$ and $t^\rightarrow \prec_{\lambda_1} b$ for all $b \in \nabla_{\mathbb{T}}(a)$, so $\nabla_{\mathbb{T}}(a) \subseteq A$. In this case, we certainly have $\widehat{\varrho}(a) \subseteq \nabla_{\mathbb{T}}(a) \subseteq A$, as desired. Thus, we may assume that $a < t^\rightarrow$ and $a \in \varrho_1(t)$. Since $\varrho_1 \leq \widehat{\varrho}$, we have $a \in \varrho_1(t) \subseteq \widehat{\varrho}(t)$, so $\widehat{\varrho}(a) \subseteq \widehat{\varrho}(t)$. Thus, in order to show that $\widehat{\varrho}(a) \subseteq A$, it suffices to prove that $\widehat{\varrho}(t) \subseteq A$. As $\lambda_2 = \lambda_1 \leq \widehat{\lambda}$ and $(\widehat{\lambda}, \widehat{\varrho}) \notin \nabla(\lambda_2, \varrho_2)$, we know that $\varrho_2 \not\leq \widehat{\varrho}$. We also know that $\varrho_2(v) = \varrho_1(v) \subseteq \widehat{\varrho}(v)$ for all $v \in \mathbf{V}^\times \setminus \{t\}$, so we must have $\varrho_1(t) \cup \varrho_1(t^\rightarrow) = \varrho_2(t) \not\subseteq \widehat{\varrho}(t)$. Since $\varrho_1(t) \subseteq \widehat{\varrho}(t)$, we deduce that $\varrho_1(t^\rightarrow) \not\subseteq \widehat{\varrho}(t)$, so $\widehat{\varrho}(t^\rightarrow) \not\subseteq \widehat{\varrho}(t)$. This implies that $\widehat{\varrho}(t^\rightarrow)$ and $\widehat{\varrho}(t)$ are disjoint (since they cannot be nested), so $t^\rightarrow \notin \widehat{\varrho}(t)$. Hence, $\widehat{\varrho}(t) \subseteq \nabla_{\mathbb{T}}(t) \setminus \nabla_{\mathbb{T}}(t^\rightarrow)$. Consider an arbitrary vertex $x \in \widehat{\varrho}(t)$; we will show that $x \in A$. We already know that $x \in \nabla_{\mathbb{T}}(t) \setminus \nabla_{\mathbb{T}}(t^\rightarrow)$, so we just need to prove that $(x, t^\rightarrow) \notin \text{Inv}(\lambda_1)$. Because the elements of $\widehat{\varrho}(t)$ form a consecutive factor of $\widehat{\lambda}$ (since $(\widehat{\lambda}, \widehat{\varrho}) \in \Theta(\mathbb{T}^\times)$), we cannot have $t \prec_{\widehat{\lambda}} t^\rightarrow \prec_{\widehat{\lambda}} x$. Therefore, (x, t^\rightarrow) cannot be an inversion of $\widehat{\lambda}$. Since $\lambda_1 \leq \widehat{\lambda}$, this implies that $(x, t^\rightarrow) \notin \text{Inv}(\lambda_1)$, as desired.

We now show that $\widehat{\lambda} \leq \lambda^*$. Suppose instead that $(i, j) \in \text{Inv}(\widehat{\lambda}) \setminus \text{Inv}(\lambda^*)$. Then $(i, j) \in K$, and we cannot have $i \leq_{\mathbb{T}} j$ (since $\widehat{\lambda} \in \mathcal{L}(\mathbb{T}^\times)$), so we must have $i \in A$ and $j \in \nabla_{\mathbb{T}}(t^\rightarrow)$. This implies that $i < t^\rightarrow$ and $(i, t^\rightarrow) \notin \text{Inv}(\lambda_1)$. Since $t <_{\mathbb{T}} i$, we deduce that $t \prec_{\lambda_1} i \prec_{\lambda_1} t^\rightarrow$. Because t^\rightarrow is the vertex appearing immediately after the elements of $\varrho_1(t)$ in λ_1 , this implies that $i \in \varrho_1(t) \subseteq \widehat{\varrho}(t)$. Because $(i, j) \in \text{Inv}(\widehat{\lambda})$ and $t <_{\mathbb{T}} j$, we must have $t \prec_{\widehat{\lambda}} j \prec_{\widehat{\lambda}} i$. Because $(\widehat{\lambda}, \widehat{\varrho}) \in \Theta(\mathbb{T}^\times)$, the elements of $\widehat{\varrho}(t)$ form a consecutive factor of $\widehat{\lambda}$; this consecutive factor includes t and i , so $j \in \widehat{\varrho}(t)$. We saw in the preceding paragraph that $\widehat{\varrho}(t) \subseteq A$, so $j \in A$. This is a contradiction because $A \subseteq \nabla_{\mathbb{T}}(t) \setminus \nabla_{\mathbb{T}}(t^\rightarrow)$ and $j \in \nabla_{\mathbb{T}}(t^\rightarrow)$. \square

Lemma 4.5.3. *Let $(\lambda_1, \varrho_1) \prec (\lambda_2, \varrho_2)$ be a cover relation in $\Theta(\mathbb{T}^\times)$. If (λ_1, ϱ_1) and (λ_2, ϱ_2) are related by an associahedron move, then the set $\Delta(\lambda_2, \varrho_2) \setminus \Delta(\lambda_1, \varrho_1)$ has a unique minimal element.*

Proof. Because (λ_1, ϱ_1) and (λ_2, ϱ_2) are related by an associahedron move, we have $\lambda_1 = \lambda_2$, and there is a vertex $t \in V^\times$ such that $\varrho_1(v) = \varrho_2(v)$ for all $v \in V^\times \setminus \{t\}$ and $\varrho_2(t) = \varrho_1(t) \cup \varrho_1(t^\rightarrow)$, where t^\rightarrow is the vertex in V^\times appearing immediately after the elements of $\varrho_1(t)$ in λ_1 . Define an ornamentation ϱ_* of T^\times by letting $\varrho_*(t) = \{t^\rightarrow\} \cup \{x \in \varrho_1(t) : x < t^\rightarrow\}$ and letting $\varrho_*(v) = \{v\}$ for all $v \in V^\times \setminus \{t\}$.

Let λ_* be the linear extension $12 \cdots (t-1)\mu\nu$ of T^\times , where μ is the word obtained by reading the elements of $\varrho_*(t)$ in increasing order and ν is the word obtained by reading the elements of $\{t, t+1, \dots, n\} \setminus \varrho_*(t)$ in increasing order. It is straightforward to see that λ_* is the unique minimal element (in the weak order) of the set $\{\sigma \in \mathcal{L}(T^\times) : (\sigma, \varrho^*) \in \Theta(T^\times)\}$. We will prove that (λ_*, ϱ_*) is the unique minimal element of $\Delta(\lambda_2, \varrho_2) \setminus \Delta(\lambda_1, \varrho_1)$. Choose an arbitrary element $(\widehat{\lambda}, \widehat{\varrho}) \in \Delta(\lambda_2, \varrho_2) \setminus \Delta(\lambda_1, \varrho_1)$; we will prove that $\lambda_* \leq \widehat{\lambda}$ and $\varrho_* \leq \widehat{\varrho}$.

Let us start by proving that $\varrho_* \leq \widehat{\varrho}$; to do so, it suffices to show that $\varrho_*(t) \subseteq \widehat{\varrho}(t)$. Thus, let $a \in \varrho_*(t)$. Because $\widehat{\lambda} \leq \lambda_2 = \lambda_1$, we must have $\widehat{\varrho} \not\leq \varrho_1$. We have $\widehat{\varrho}(v) \subseteq \varrho_2(v) = \varrho_1(v)$ for every $v \in V^\times \setminus \{t\}$, so $\widehat{\varrho}(t) \not\subseteq \varrho_1(t)$. But $\widehat{\varrho}(t) \subseteq \varrho_2(t) = \varrho_1(t) \cup \varrho_1(t^\rightarrow)$, so there exists an element $b \in \widehat{\varrho}(t) \cap \varrho_1(t^\rightarrow)$. Since $t <_{\top} t^\rightarrow \leq_{\top} b$ and $\widehat{\varrho}(t)$ induces a connected subgraph of T^\times , we must have $t^\rightarrow \in \widehat{\varrho}(t)$. If $a = t^\rightarrow$, then we have shown that $a \in \widehat{\varrho}(t)$, as desired. Now suppose $a \neq t^\rightarrow$. By the definition of $\varrho_*(t)$, we know that $a < t^\rightarrow$ and that $a \in \varrho_1(t)$. It follows that (a, t^\rightarrow) is not an inversion of the linear extension $\lambda_1 = \lambda_2$, so (since $\widehat{\lambda} \leq \lambda_2$) it is also not an inversion of $\widehat{\lambda}$. This means that $t \preceq_{\widehat{\lambda}} a \prec_{\widehat{\lambda}} t^\rightarrow$. We know that $t, t^\rightarrow \in \widehat{\varrho}(t)$ and that the elements of $\widehat{\varrho}(t)$ form a consecutive factor of $\widehat{\lambda}$, so a must also be in $\widehat{\varrho}(t)$.

Let us now prove that $\lambda_* \leq \widehat{\lambda}$. Suppose (i, j) is an inversion of λ_* . Then j must be in the word μ , while i must be in the word ν . In other words, we have $j \in \varrho_*(t)$ and $i \in \{t, t+1, \dots, n\} \setminus \varrho_*(t)$. We saw in the preceding paragraph that $\varrho_*(t) \subseteq \widehat{\varrho}(t)$, so $j \in \widehat{\varrho}(t)$. We have $i < j \leq t^\rightarrow$, so it follows from the fact that $i \notin \varrho_*(t)$ that $i \notin \varrho_1(t)$. Moreover, the fact that $i < t^\rightarrow$ implies that $i \notin \varrho_1(t^\rightarrow)$. Therefore, $i \notin \varrho_2(t)$. As $\widehat{\varrho}(t) \subseteq \varrho_2(t)$, we find that $i \notin \widehat{\varrho}(t)$. Thus, we have shown that $\widehat{\varrho}(t)$ contains t and j but not i . We also know that $t < i < j$ and that $t <_{\top} j$, so it follows from the definition of the preorder traversal that

$t <_{\mathbb{T}} i$. This implies that $t \prec_{\widehat{\lambda}} i$. However, $\widehat{\varrho}(t)$ is a consecutive factor of $\widehat{\lambda}$ that contains t and j but not i , so $j \prec_{\widehat{\lambda}} i$. This shows that (i, j) is an inversion of $\widehat{\lambda}$. As (i, j) was an arbitrary inversion of λ_* , we deduce that $\lambda_* \leq \widehat{\lambda}$.

The preceding paragraphs show that every element of $\Delta(\lambda_2, \varrho_2) \setminus \Delta(\lambda_1, \varrho_1)$ is greater than or equal to (λ_*, ϱ_*) . In particular, $(\lambda_*, \varrho_*) \in \Delta(\lambda_2, \varrho_2)$. Because $t^{\rightarrow} \in \varrho_*(t) \setminus \varrho_1(t)$, we have $\varrho_* \not\leq \varrho_1$. It follows that $(\lambda_*, \varrho_*) \notin \Delta(\lambda_1, \varrho_1)$. This shows that (λ_*, ϱ_*) is actually in the set $\Delta(\lambda_2, \varrho_2) \setminus \Delta(\lambda_1, \varrho_1)$, so it must be the unique minimal element of this set. \square

Example 4.5.4. Figure 4.6 portrays a cover relation $(\lambda_1, \varrho_1) \triangleleft (\lambda_2, \varrho_2)$ in $\Theta(\mathbb{T}^\times)$, where \mathbb{T}^\times is as depicted. This cover relation corresponds to an associahedron move. In the notation of the proofs of Theorems 4.5.2 and 4.5.3, we have $t = 4$ and $t^{\rightarrow} = 7$. The pairs (λ^*, ϱ^*) and (λ_*, ϱ_*) constructed in the proofs of Theorems 4.5.2 and 4.5.3 are shown on the left and right, respectively, in Figure 4.7.

Lemma 4.5.5. *Suppose that every vertex of \mathbb{T} that is not in the rightmost branch of \mathbb{T} is covered by at most 1 element of \mathbb{T} . Let $(\lambda_1, \varrho_1) \triangleleft (\lambda_2, \varrho_2)$ be a cover relation in $\Theta(\mathbb{T}^\times)$. If (λ_1, ϱ_1) and (λ_2, ϱ_2) are related by a permutohedron move, then the set $\nabla(\lambda_1, \varrho_1) \setminus \nabla(\lambda_2, \varrho_2)$ has a unique maximal element.*

Proof. Let \mathbf{B} be the rightmost branch of \mathbb{T} . Because (λ_1, ϱ_1) and (λ_2, ϱ_2) are related by a permutohedron move, we have $\varrho_1 = \varrho_2$, and there exist vertices $p, q \in \mathbf{V}^\times$ such that

- p and q are incomparable in \mathbb{T} ;
- every number in $\varrho_1(p)$ is less than every number in $\varrho_1(q)$ in \mathbb{Z} ;
- $\lambda_1|_{\varrho_1(p)}\lambda_1|_{\varrho_1(q)}$ is a consecutive factor of λ_1 ;
- λ_2 is obtained from λ_1 by swapping $\lambda_1|_{\varrho_1(p)}$ and $\lambda_1|_{\varrho_1(q)}$.

The vertex p cannot be in \mathbf{B} , so the sets $\varrho_1(p)$ and $C = \{v \in \mathbf{V}^\times \setminus \mathbf{B} : v \leq_{\mathbb{T}} p\}$ are both chains in \mathbb{T} . Let u be the maximum element of $\varrho_1(p)$, and let z be the minimum element of

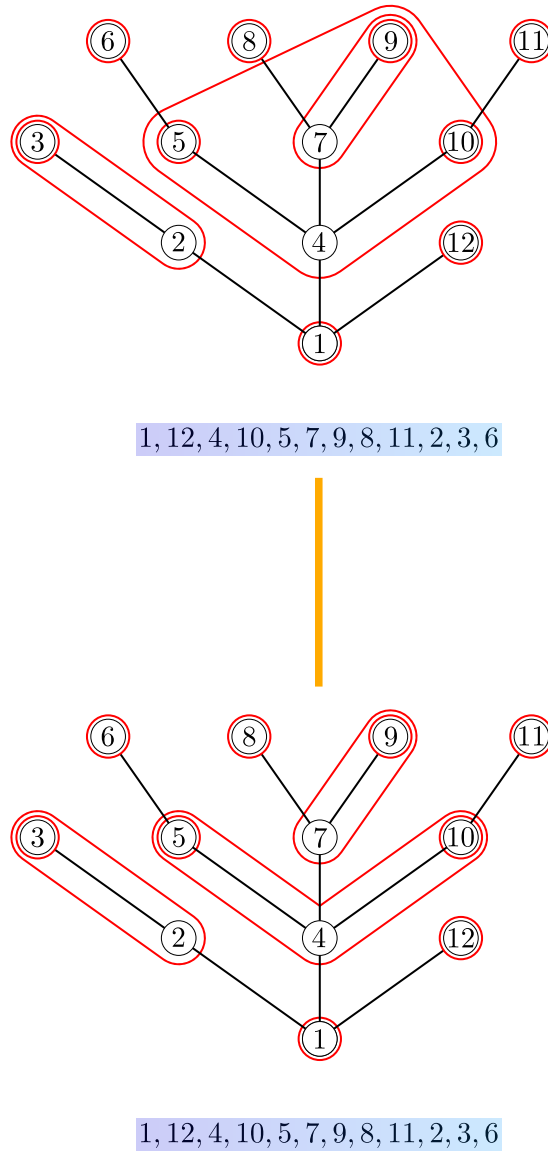

Figure 4.6: A cover relation $(\lambda_1, \varrho_1) \triangleleft (\lambda_2, \varrho_2)$ corresponding to an associahedron move.

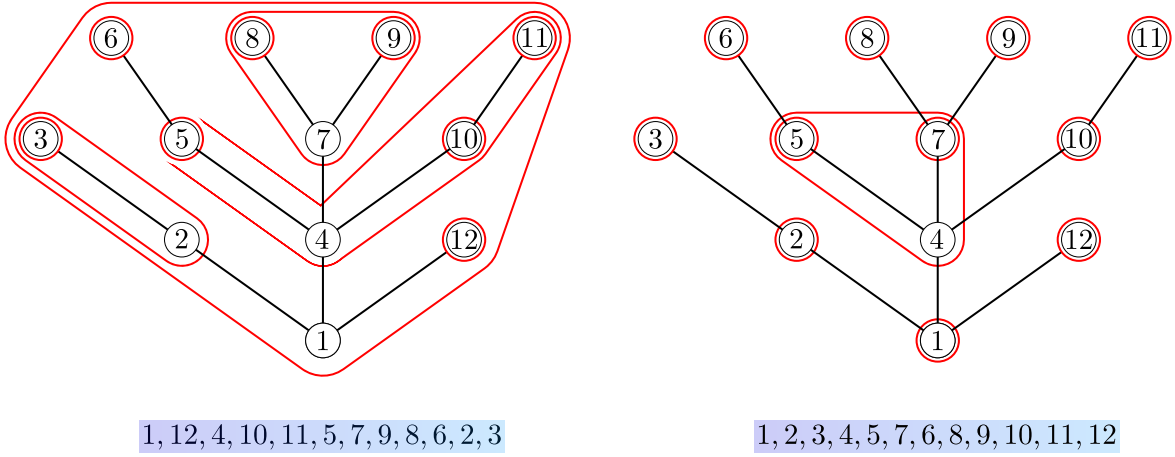

Figure 4.7: The pairs (λ^*, ϱ^*) (left) and (λ_*, ϱ_*) (right) constructed in the proofs of Theorems 4.5.2 and 4.5.3, where $(\lambda_1, \varrho_1) \prec (\lambda_2, \varrho_2)$ is the cover relation shown in Figure 4.6.

C. Let

$$X = \{x \in V^\times : z \leq x < q \text{ and } (x, q) \notin \text{Inv}(\lambda_1)\}$$

and

$$Y = \{y \in V^\times : z \leq y < q \text{ and } (y, q) \in \text{Inv}(\lambda_1)\}.$$

Because the elements of $\varrho_1(p)$ occur immediately before the elements of $\varrho_1(q)$ in λ_1 , we have

$$\nabla_{\mathbb{T}}(u) \setminus \{u\} \subseteq Y. \tag{4.2}$$

Let $\varrho^* \in \mathcal{O}(\mathbb{T}^\times)$ be the ornamentation such that $\varrho^*(x) = \nabla_{\mathbb{T}}(x) \setminus (\nabla_{\mathbb{T}}(q) \cup Y)$ for all $x \in X$ and $\varrho^*(w) = \nabla_{\mathbb{T}}(w)$ for all $w \in V^\times \setminus X$. Let

$$\Xi = \{\sigma \in \mathcal{L}(\mathbb{T}^\times) : X \prec_\sigma \varrho_1(q) \prec_\sigma Y\}.$$

In the weak order, the set Ξ has a unique maximal element λ^* . Moreover, $(\lambda^*, \varrho^*) \in \Theta(\mathbb{T}^\times)$. We will prove that (λ^*, ϱ^*) is the unique maximal element of $\nabla(\lambda_1, \varrho_1) \setminus \nabla(\lambda_2, \varrho_2)$. Choose an arbitrary element $(\widehat{\lambda}, \widehat{\varrho}) \in \nabla(\lambda_1, \varrho_1) \setminus \nabla(\lambda_2, \varrho_2)$; we will prove that $\widehat{\lambda} \leq \lambda^*$ and $\widehat{\varrho} \leq \varrho^*$.

Let us start by proving that $\widehat{\lambda} \leq \lambda^*$; to do so, it suffices to show that $\widehat{\lambda} \in \Xi$. Because $\varrho_1 = \varrho_2$, we have $\lambda_1 \leq \widehat{\lambda}$ and $\lambda_2 \not\leq \widehat{\lambda}$, so there must be an element of $\varrho_1(p)$ that precedes an

element of $\varrho_1(q)$ in $\widehat{\lambda}$. We have $\varrho_1(p) \subseteq \widehat{\varrho}(p)$ and $\varrho_1(q) \subseteq \widehat{\varrho}(q)$, and the sets $\widehat{\varrho}(p)$ and $\widehat{\varrho}(q)$ are disjoint because p and q are incomparable in \mathbb{T} . The fact that $(\widehat{\lambda}, \widehat{\varrho}) \in \Theta(\mathbb{T}^\times)$ implies that $\widehat{\varrho}(p) \prec_{\widehat{\lambda}} \widehat{\varrho}(q)$, so $\varrho_1(p) \prec_{\widehat{\lambda}} \varrho_1(q)$. Consequently, $\{u\} \prec_{\widehat{\lambda}} \varrho_1(q)$. Let $x \in X$. If $z \leq_{\mathbb{T}} x$, then it follows from (4.2) that $x \leq_{\mathbb{T}} u$, so $\{x\} \prec_{\widehat{\lambda}} \varrho_1(q)$. If $z \not\leq_{\mathbb{T}} x$, then (u, x) is an inversion of λ_1 , so it is also an inversion of $\widehat{\lambda}$, and again $\{x\} \prec_{\widehat{\lambda}} \varrho_1(q)$. This shows that $X \prec_{\widehat{\lambda}} \varrho_1(q)$. Now let $y \in Y$. Since (y, q) is an inversion of λ_1 , it is also an inversion of $\widehat{\lambda}$. Because the elements of $\widehat{\varrho}(q)$ form a consecutive factor of $\widehat{\lambda}$, we find that $\widehat{\varrho}(q) \prec_{\widehat{\lambda}} \{y\}$. As $\varrho_1(q) \subseteq \widehat{\varrho}(q)$ and y was an arbitrary element of Y , this proves that $\varrho_1(q) \prec_{\widehat{\lambda}} Y$. Hence, $\widehat{\lambda} \in \Xi$.

Let us now prove that $\widehat{\varrho} \leq \varrho^*$. We have $\widehat{\varrho}(w) \subseteq \nabla_{\mathbb{T}}(w) = \varrho^*(w)$ for all $w \in \mathbb{V}^\times \setminus X$. Now consider $x \in X$; we will prove that $\widehat{\varrho}(x) \subseteq \nabla_{\mathbb{T}}(x) \setminus (\nabla_{\mathbb{T}}(q) \cup Y) = \varrho^*(x)$. The elements of $\widehat{\varrho}(x)$ form a consecutive factor of $\widehat{\lambda}$, and we know from the preceding paragraph that $\{x\} \prec_{\widehat{\lambda}} \varrho_1(q) \prec_{\widehat{\lambda}} Y$, so it suffices to show that $q \notin \widehat{\varrho}(x)$. This is immediate if $x \not\leq_{\mathbb{T}} q$, so assume $x \leq_{\mathbb{T}} q$. Then $x \prec_{\lambda_1} q$. By the definition of X , we must have $x \not\leq_{\mathbb{T}} p$, so $p \notin \widehat{\varrho}(x)$. Since $\lambda_1|_{\varrho_1(p)}\lambda_1|_{\varrho_1(q)}$ is a consecutive factor of λ_1 and $x \notin \varrho_1(p)$, we must have $(p, x) \in \text{Inv}(\lambda_1) \subseteq \text{Inv}(\widehat{\lambda})$. This implies that $\widehat{\varrho}(x) \prec_{\widehat{\lambda}} \{p\} \prec_{\widehat{\lambda}} \{q\}$, so $q \notin \widehat{\varrho}(x)$. \square

Lemma 4.5.6. *Suppose that every vertex of \mathbb{T} that is not in the rightmost branch of \mathbb{T} is covered by at most 1 element of \mathbb{T} . Let $(\lambda_1, \varrho_1) \triangleleft (\lambda_2, \varrho_2)$ be a cover relation in $\Theta(\mathbb{T}^\times)$. If (λ_1, ϱ_1) and (λ_2, ϱ_2) are related by a permutohedron move, then the set $\Delta(\lambda_2, \varrho_2) \setminus \Delta(\lambda_1, \varrho_1)$ has a unique minimal element.*

Proof. Because (λ_1, ϱ_1) and (λ_2, ϱ_2) are related by a permutohedron move, we have $\varrho_1 = \varrho_2$, and there exist vertices $p, q \in \mathbb{V}^\times$ such that

- p and q are incomparable in \mathbb{T} ;
- every number in $\varrho_1(p)$ is less than every number in $\varrho_1(q)$ in \mathbb{Z} ;
- $\lambda_1|_{\varrho_1(p)}\lambda_1|_{\varrho_1(q)}$ is a consecutive factor of λ_1 ;
- λ_2 is obtained from λ_1 by swapping $\lambda_1|_{\varrho_1(p)}$ and $\lambda_1|_{\varrho_1(q)}$.

The vertex p cannot belong to the rightmost branch of \mathbb{T} , so $\varrho_1(p)$ (viewed as a subposet of \mathbb{T}) is a chain. Let u be the maximum element of $\varrho_1(p)$. Let

$$Z_L = \{i \in V^\times : u \leq i \leq q \text{ and } i \preceq_{\lambda_2} q\} \quad \text{and} \quad Z_R = \{i \in V^\times : u \leq i \leq q \text{ and } u \preceq_{\lambda_2} i\}.$$

Let ζ_L (respectively, ζ_R) be the word obtained by writing the elements of Z_L (respectively, Z_R) in increasing order. Let λ_* be the permutation

$$12 \cdots (u-1) \zeta_L \zeta_R (q+1) \cdots (n-1)n.$$

It is straightforward to check that $\lambda_* \leq \lambda_2$. Because $\mathcal{L}(\mathbb{T}^\times)$ is an interval in the weak order whose minimum element is the identity permutation, it must contain λ_* . Recall that the unique minimal element ϱ_{\min} of $\mathcal{O}(\mathbb{T}^\times)$ is defined so that $\varrho_{\min}(v) = \{v\}$ for all $v \in V^\times$. Note that $(\lambda_*, \varrho_{\min}) \in \Theta(\mathbb{T}^\times)$ and that $(\lambda_*, \varrho_{\min}) \in \Delta(\lambda_2, \varrho_2)$. Because $(u, q) \in \text{Inv}(\lambda_*) \setminus \text{Inv}(\lambda_1)$, we have $(\lambda_*, \varrho_{\min}) \in \Delta(\lambda_2, \varrho_2) \setminus \Delta(\lambda_1, \varrho_1)$. We will prove that $(\lambda_*, \varrho_{\min})$ is the unique minimal element of $\Delta(\lambda_2, \varrho_2) \setminus \Delta(\lambda_1, \varrho_1)$. Choose an arbitrary element $(\widehat{\lambda}, \widehat{\varrho}) \in \Delta(\lambda_2, \varrho_2) \setminus \Delta(\lambda_1, \varrho_1)$; we know already that $\varrho_{\min} \leq \widehat{\varrho}$, so we just need to prove that $\lambda_* \leq \widehat{\lambda}$.

Let (i, j) be an inversion of λ_* ; our goal is to show that (i, j) is also an inversion of $\widehat{\lambda}$. Because $\varrho_1 = \varrho_2$, we must have $\widehat{\lambda} \leq \lambda_2$ and $\widehat{\lambda} \not\leq \lambda_1$. This means that there is an inversion (a, b) of $\widehat{\lambda}$ that is also an inversion of λ_2 but not of λ_1 . We must have $a \in \varrho_1(p)$ and $b \in \varrho_1(q)$. Then $a \leq_{\mathbb{T}} u$ and $q \leq_{\mathbb{T}} b$, so $a \preceq_{\widehat{\lambda}} u$ and $q \preceq_{\widehat{\lambda}} b$. Because $(i, j) \in \text{Inv}(\lambda_*)$, we must have $i \in Z_R$ and $j \in Z_L$. This implies that (u, i) and (j, q) are not inversions of λ_2 , so they are also not inversions of $\widehat{\lambda}$. Hence, $j \preceq_{\widehat{\lambda}} q \preceq_{\widehat{\lambda}} b \prec_{\widehat{\lambda}} a \preceq_{\widehat{\lambda}} u \preceq_{\widehat{\lambda}} i$. This shows that (i, j) is an inversion of $\widehat{\lambda}$, as desired. \square

Example 4.5.7. Let $\varrho_1 = \varrho_2 \in \mathcal{O}(\mathbb{T}^\times)$ be the ornamentation shown in Figure 4.8, where \mathbb{T}^\times is as depicted. In the tree \mathbb{T} (which is obtained by adding a new root vertex to \mathbb{T}^\times), every vertex that is not in the rightmost branch is covered by at most 1 element. Let

$$\lambda_1 = 1, 2, 4, 8, 9, 12, 13, 18, 22, 23, 25, 24, 16, 14, 5, 6, 19, 20, 17, 21, 3, 7, 15, 10, 11$$

and

$$\lambda_2 = 1, 2, 4, 8, 9, 12, 13, 18, 22, 23, 25, 24, 16, 14, 19, 20, 5, 6, 17, 21, 3, 7, 15, 10, 11.$$

Then $(\lambda_1, \varrho_1) \prec (\lambda_2, \varrho_2)$ is a cover relation in $\Theta(\mathbb{T}^\times)$ that corresponds to a permutohedron move. In the notation of the proofs of Theorems 4.5.5 and 4.5.6, we have $p = 5$, $q = 19$, $u = 6$, and $z = 4$. The sets X and Y defined in the proof of Theorem 4.5.5 are

$$X = \{4, 5, 6, 8, 9, 12, 13, 14, 16, 18\} \quad \text{and} \quad Y = \{7, 10, 11, 15, 17\}.$$



The sets Z_L and Z_R defined in the proof of Theorem 4.5.6 are

$$Z_L = \{8, 9, 12, 13, 14, 16, 18, 19\} \quad \text{and} \quad Z_R = \{6, 7, 10, 11, 15, 17\}.$$

The pairs (λ^*, ϱ^*) and $(\lambda_*, \varrho_{\min})$ constructed in the proofs of Theorems 4.5.5 and 4.5.6 are shown on the top and bottom, respectively, in Figure 4.9. In the top image in Figure 4.9, the sets X and Y are represented in green and purple, respectively.

We can now tie together all of the pieces established so far in this section to prove Theorem 4.1.3.

Proof of Theorem 4.1.3. Recall that our goal is to prove the equivalence of the five items (I), (II), (III), (IV), (V) listed in the statement of the theorem. By the definition of semidistributivity, item (I) holds if and only if items (II) and (III) both hold. It is also straightforward to see that items (IV) and (V) are equivalent.

The Hasse diagram of the operahedron lattice of  is shown in Figure 4.3. Upon inspecting this figure, we find that the set of maximal nestings \mathcal{N} of  satisfying

$$\begin{array}{c} \text{②} \quad \text{③} \\ \diagdown \quad \diagup \\ \text{①} \\ \diagdown \quad \diagup \\ \text{④} \\ \text{①} \end{array} \leq \mathcal{N} \quad \text{and} \quad \begin{array}{c} \text{②} \quad \text{③} \\ \diagdown \quad \diagup \\ \text{①} \\ \diagdown \quad \diagup \\ \text{④} \\ \text{①} \end{array} \not\leq \mathcal{N}$$

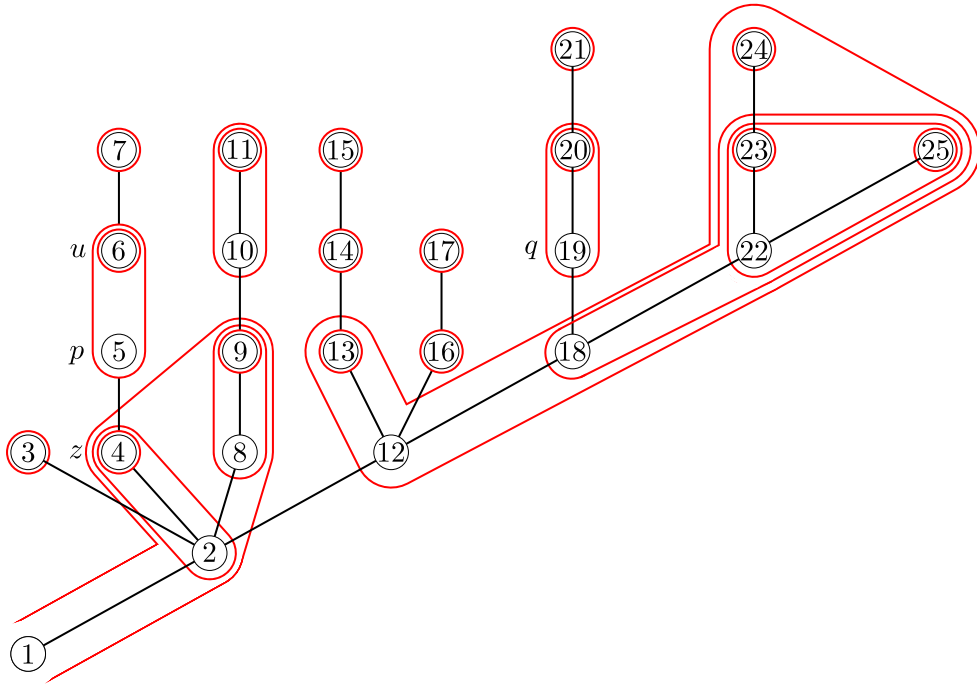





Figure 4.8: An ornamentation of a forest poset T^\times . Every vertex of T that is not in the rightmost branch of T is covered by at most 1 element.

does not have a unique maximal element. Therefore, it follows from Theorem 4.5.1 that the operahedron lattice of  is not meet-semidistributive. Similarly, the set of maximal nestings \mathcal{N} of  satisfying

$$\mathcal{N} \leq \begin{array}{c} \textcircled{2} \quad \textcircled{3} \\ \diagdown \quad \diagup \\ \textcircled{1} \\ \diagup \quad \diagdown \\ \textcircled{0} \end{array} \quad \text{and} \quad \mathcal{N} \not\leq \begin{array}{c} \textcircled{2} \quad \textcircled{3} \\ \diagdown \quad \diagup \\ \textcircled{1} \\ \diagup \quad \diagdown \\ \textcircled{0} \end{array}$$

does not have a unique minimal element, so it follows from Theorem 4.5.1 that the operahedron lattice of  is not join-semidistributive. Intervals of meet-semidistributive lattices are meet-semidistributive, so we can appeal to Theorem 4.1.2 to see that item (II) implies item (IV). Likewise, intervals of join-semidistributive lattices are join-semidistributive, so item (III) implies item (IV).

Finally, it follows from Theorems 4.3.5, 4.5.1 to 4.5.3, 4.5.5 and 4.5.6 that item (V)

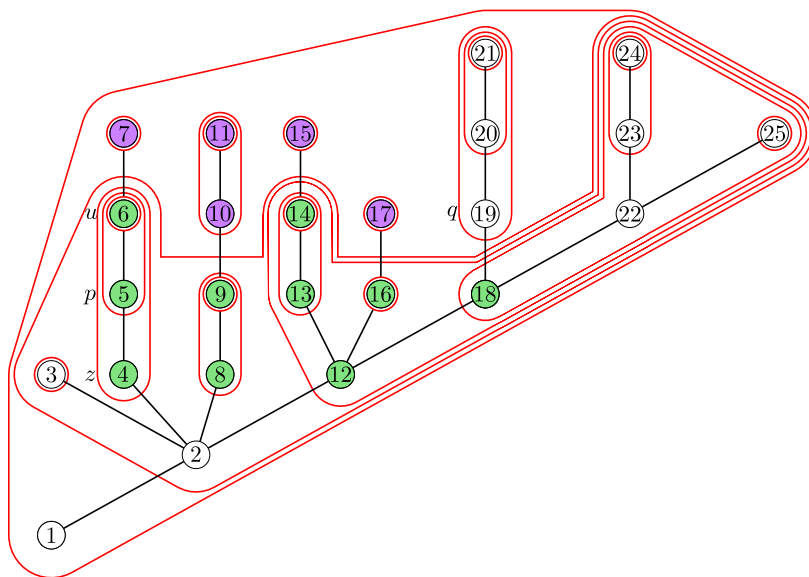

1, 2, 12, 18, 22, 25, 23, 24, 16, 13, 14, 8, 9, 4, 5, 6, 19, 20, 21, 17, 15, 10, 11, 7, 3

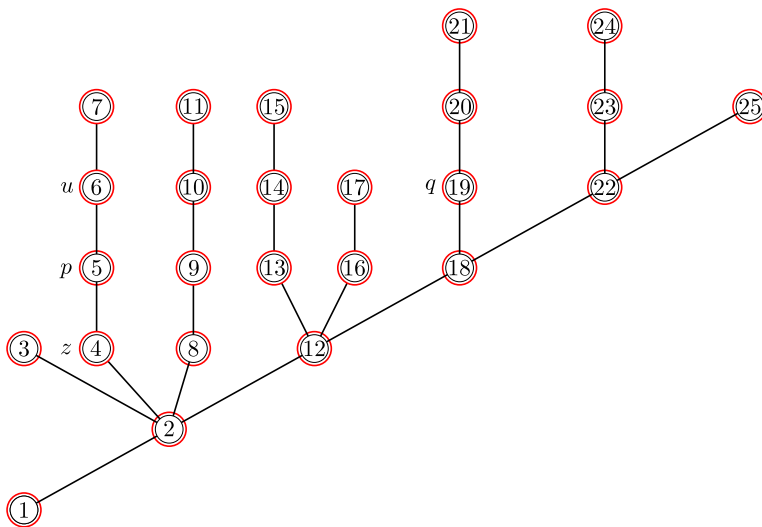

1, 2, 3, 4, 5, 8, 9, 12, 13, 14, 16, 18, 19, 6, 7, 10, 11, 15, 17, 20, 21, 22, 23, 24, 25





Figure 4.9: The pairs (λ^*, ϱ^*) (top) and $(\lambda_*, \varrho_{\min})$ (bottom) constructed in the proofs of Theorems 4.5.5 and 4.5.6, where $(\lambda_1, \varrho_1) \triangleleft (\lambda_2, \varrho_2)$ is the cover relation defined in Theorem 4.5.7 (with $\varrho_1 = \varrho_2$ appearing in Figure 4.8). In the top image, the elements of X are colored green, while the elements of Y are colored purple.

implies both items (II) and (III). □

Remark 4.5.8. Suppose L is a semidistributive lattice. One can show that an element $j \in L$ is join-irreducible if and only if there exists a cover relation $x \lessdot y$ such that j is the unique minimal element of $\Delta_L(y) \setminus \Delta_L(x)$. Likewise, an element $m \in L$ is meet-irreducible if and only if there exists a cover relation $x \lessdot y$ such that m is the unique maximal element of $\nabla_L(x) \setminus \nabla_L(y)$. Therefore, if \mathbb{T} is a rooted plane tree such that $\text{MN}(\mathbb{T})$ (equivalently, $\Theta(\mathbb{T}^\times)$) is semidistributive, then our proofs of Theorems 4.5.2, 4.5.3, 4.5.5 and 4.5.6 provide explicit descriptions of the join-irreducible elements and the meet-irreducible elements of $\Theta(\mathbb{T}^\times)$ (and, hence, also of $\text{MN}(\mathbb{T})$).

4.6 Trimness

We now prove Theorem 4.1.4, which characterizes the rooted plane trees whose operahedron lattices are trim.

Proof of Theorem 4.1.4. The operahedron lattice of the claw  (see the right side of Figure 4.2) is not trim because its height is 3 and it has 4 join-irreducible elements. One can check by hand that the operahedron lattices of the trees  and  are isomorphic to each other. It is known [Tho06]*Theorem 1 that intervals of trim lattices are trim. Therefore, it follows from Theorem 4.1.2 that if $\text{MN}(\mathbb{T})$ is trim, then \mathbb{T} does not contain  or . Consequently, if $\text{MN}(\mathbb{T})$ is trim, then the root of \mathbb{T} is covered by at most 2 elements of \mathbb{T} and every non-root vertex in \mathbb{T} is covered by at most 1 element of \mathbb{T} .

Now assume that the root of \mathbb{T} is covered by at most 2 elements of \mathbb{T} and that every non-root vertex in \mathbb{T} is covered by at most 1 element of \mathbb{T} ; we will prove that $\text{MN}(\mathbb{T})$ is trim. Let us identify the vertex set of \mathbb{T} with $\{0, 1, \dots, n\}$ so that $0, 1, \dots, n$ is the preorder traversal of \mathbb{T} . Let d be the largest element of $[n]$ such that $1 \leq_{\mathbb{T}} d$. If $d = n$, then \mathbb{T} is a chain, so $\text{MN}(\mathbb{T})$ is a Tamari lattice, which is known to be trim. Therefore, we may assume

$d \leq n-1$. Then the root of \mathbb{T} is covered by 1 and $d+1$. Let \mathbb{T}_1 and \mathbb{T}_{d+1} be the subtrees of \mathbb{T} with roots 1 and $d+1$, respectively. Then \mathbb{T}_1 is a chain with d vertices, while \mathbb{T}_{d+1} is a chain with $n-d$ vertices. It is known [TW19]*Theorem 1.4 that every semidistributive extremal lattice is trim. Since we already know by Theorem 4.1.3 that $\text{MN}(\mathbb{T})$ is semidistributive, we just need to prove that $\text{MN}(\mathbb{T})$ is extremal. It is also known [FJN95]*Corollary 2.55 that a semidistributive lattice has the same number of join-irreducible elements as meet-irreducible elements. Therefore, appealing to Theorem 4.3.5, we see that it suffices to prove that $\text{height}(\Theta(\mathbb{T}^\times)) = |\mathcal{J}_{\Theta(\mathbb{T}^\times)}|$, where $\mathcal{J}_{\Theta(\mathbb{T}^\times)}$ is the set of join-irreducible elements of $\Theta(\mathbb{T}^\times)$.

As mentioned in Theorem 4.5.8, an element $(\lambda_*, \varrho_*) \in \Theta(\mathbb{T}^\times)$ is join-irreducible if and only if it is one of the elements constructed in the proof of Theorem 4.5.3 or the proof of 4.5.6. Upon inspecting those proofs, we find that (λ_*, ϱ_*) is join-irreducible if and only if one of the following (mutually exclusive) conditions holds:

- (i) ϱ_* is a join-irreducible element of $\mathcal{O}(\mathbb{T}^\times)$, and λ_* is the unique minimal element (in the weak order) of the set $\{\sigma \in \mathcal{L}(\mathbb{T}^\times) : (\sigma, \varrho_*) \in \Theta(\mathbb{T}^\times)\}$;
- (ii) $\varrho_* = \varrho_{\min}$, and λ_* is a join-irreducible element of $\mathcal{L}(\mathbb{T}^\times)$.

Note that $\mathcal{O}(\mathbb{T}^\times)$ is isomorphic to $\mathcal{O}(\mathbb{T}_1) \times \mathcal{O}(\mathbb{T}_{d+1})$. Moreover, $\mathcal{O}(\mathbb{T}_1)$ (respectively, $\mathcal{O}(\mathbb{T}_{d+1})$) is isomorphic to the d -th (respectively, $(n-d)$ -th) Tamari lattice. It is well known [Gey94, Proposition 2.3] that the m -th Tamari lattice has $\binom{m}{2}$ join-irreducible elements. Hence, it follows from (4.1) that the number of pairs (λ_*, ϱ_*) satisfying the condition (i) is $\binom{d}{2} + \binom{n-d}{2}$. The join-irreducible elements of $\mathcal{L}(\mathbb{T}^\times)$ are the permutations of the form

$$12 \cdots a(d+1)(d+2) \cdots b(a+1)(a+2) \cdots d(b+1)(b+2) \cdots n,$$

where $0 \leq a \leq d-1$ and $d+1 \leq b \leq n$. The number of such permutations, which is also the number of pairs (λ_*, ϱ_*) satisfying condition (ii), is $d(n-d)$. Therefore,

$$|\mathcal{J}_{\Theta(\mathbb{T}^\times)}| = \binom{d}{2} + \binom{n-d}{2} + d(n-d) = \binom{n}{2}.$$

We are left to show that $\text{height}(\Theta(\mathbb{T}^\times)) = \binom{n}{2}$. Since the height of a lattice is always at most the number of join-irreducible elements of the lattice, it suffices to construct a chain in $\Theta(\mathbb{T}^\times)$ of length $\binom{n}{2}$. The maximal element of $\mathcal{L}(\mathbb{T}^\times)$ is the permutation $\lambda_{\max} = (d+1)(d+2)\cdots n 12\cdots d$, which has $d(n-d)$ inversions. Therefore, $\mathcal{L}(\mathbb{T}^\times)$ has a maximal chain $\lambda_0 \triangleleft \lambda_1 \triangleleft \cdots \triangleleft \lambda_{d(n-d)}$ of length $d(n-d)$, where $\lambda_0 = 12\cdots n$ and $\lambda_{d(n-d)} = \lambda_{\max}$. Note that

$$(\lambda_0, \varrho_{\min}) < (\lambda_1, \varrho_{\min}) < \cdots < (\lambda_{d(n-d)}, \varrho_{\min}) \quad (4.3)$$

is a chain in $\Theta(\mathbb{T}^\times)$. We have

$$\text{height}(\mathcal{O}(\mathbb{T}^\times)) = \text{height}(\mathcal{O}(\mathbb{T}_1) \times \mathcal{O}(\mathbb{T}_{d+1})) = \text{height}(\mathcal{O}(\mathbb{T}_1)) + \text{height}(\mathcal{O}(\mathbb{T}_{d+1})) = \binom{d}{2} + \binom{n-d}{2},$$

where the last equality follows from the fact that the m -th Tamari lattice has height $\binom{m}{2}$. Hence, $\mathcal{O}(\mathbb{T}^\times)$ has a maximal chain $\varrho_0 \triangleleft \varrho_1 \triangleleft \cdots \triangleleft \varrho_M$, where $\varrho_0 = \varrho_{\min}$ and $M = \binom{d}{2} + \binom{n-d}{2} = \binom{n}{2} - d(n-d)$. For every $\varrho \in \mathcal{O}(\mathbb{T}^\times)$, the pair $(\lambda_{\max}, \varrho)$ is in $\Theta(\mathbb{T}^\times)$. Therefore,

$$(\lambda_{\max}, \varrho_0) < (\lambda_{\max}, \varrho_1) < \cdots < (\lambda_{\max}, \varrho_M) \quad (4.4)$$

is a chain in $\Theta(\mathbb{T}^\times)$. By concatenating the chains in (4.3) and (4.4), we obtain a chain in $\Theta(\mathbb{T}^\times)$ of length $\binom{n}{2}$. \square

4.7 Stacks and Brooms

Let \mathcal{W} denote the set of finite words over the alphabet of positive integers in which no letter appears more than once. West's *stack-sorting map* is the function $\mathbf{s}: \mathcal{W} \rightarrow \mathcal{W}$ defined recursively as follows.¹ As a base case, we define $\mathbf{s}(\epsilon) = \epsilon$, where ϵ is the empty word. Now, if $\sigma \in \mathcal{W}$ is nonempty, then we can write $\sigma = \mathbf{L}n\mathbf{R}$, where n is the largest letter in σ . With this notation, we define $\mathbf{s}(\sigma) = \mathbf{s}(\mathbf{L})\mathbf{s}(\mathbf{R})n$. For example,

$$\mathbf{s}(316452) = \mathbf{s}(31)\mathbf{s}(452)6 = \mathbf{s}(1)3\mathbf{s}(4)\mathbf{s}(2)56 = 134256.$$

¹The stack-sorting map can also be defined via a procedure that sends a word through a *stack* in a right-greedy manner. Alternatively, it can be defined using postorder and in-order traversals of decreasing binary plane trees. See, e.g., [Bon19, Def22b].

We usually restrict the stack-sorting map to the symmetric group \mathfrak{S}_n and view it as a function $\mathfrak{s}: \mathfrak{S}_n \rightarrow \mathfrak{S}_n$.

The following lemma is well known and follows readily from the definition of \mathfrak{s} .

Lemma 4.7.1. *Let $1 \leq a < b \leq n$. For $\sigma \in \mathfrak{S}_n$, we have $(a, b) \in \text{Inv}(\mathfrak{s}(\sigma))$ if and only if there exists $c \in [n]$ such that $b < c$ and $b \prec_\sigma c \prec_\sigma a$.*

Recall the definition of the broom $\mathbf{Broom}_{k,n}$ from Section 4.1. Let

$$w_\circ(k, n) = k(k-1) \cdots 1(k+1)(k+2) \cdots n \in \mathfrak{S}_n.$$

Note that

$$\Delta_{\text{Weak}(\mathfrak{S}_n)}(w_\circ(k, n)) = \{w \in \mathfrak{S}_n : j \leq k \text{ for all } (i, j) \in \text{Inv}(w)\}. \quad (4.5)$$

Our goal in this section is to prove Theorem 4.1.6, which states that $\text{MN}(\mathbf{Broom}_{k,n})$ is isomorphic to the subposet $\mathfrak{s}^{-1}(\Delta_{\text{Weak}(\mathfrak{S}_n)}(w_\circ(k, n)))$ of $\text{Weak}(\mathfrak{S}_n)$.

As usual, let us identify the vertex set of $\mathbf{Broom}_{k,n}$ with $\{0, 1, \dots, n\}$ so that $0, 1, \dots, n$ is the preorder traversal. Consider a pair $(\lambda, \varrho) \in \Theta(\mathbf{Broom}_{k,n}^\times)$. Let us write $\lambda = w_1 \cdots w_n$. For each $u \in [n]$, let $A_\varrho(u) = \{j \in [n] : u \in \varrho(n+1-j)\}$. Let $B_{(\lambda, \varrho)}(w_\ell) = A_\varrho(w_\ell) \setminus \bigcup_{i=\ell+1}^n A_\varrho(w_i)$. Let us write $\mu_{(\lambda, \varrho)}(w_\ell)$ for the word obtained by reading the elements of $B_{(\lambda, \varrho)}(w_\ell)$ in decreasing order. Finally, let

$$\Omega(\lambda, \varrho) = \mu_{(\lambda, \varrho)}(w_n) \mu_{(\lambda, \varrho)}(w_{n-1}) \cdots \mu_{(\lambda, \varrho)}(w_1) \in \mathfrak{S}_n.$$

Example 4.7.2. Let $k = 4$ and $n = 9$. Let $\lambda = 123459867$, and let ϱ be the ornamentation of $\mathbf{Broom}_{4,9}^\times$ depicted in Figure 4.10. Note that $(\lambda, \varrho) \in \Theta(\mathbf{Broom}_{4,9}^\times)$. We have

$$\begin{aligned} A_\varrho(1) &= \{9\}, & A_\varrho(2) &= \{8, 9\}, & A_\varrho(3) &= \{7\}, \\ A_\varrho(4) &= \{6, 7\}, & A_\varrho(5) &= \{5, 6, 7\}, & A_\varrho(6) &= \{4, 7\}, \\ A_\varrho(7) &= \{3\}, & A_\varrho(8) &= \{2, 6, 7\}, & A_\varrho(9) &= \{1, 6, 7\}, \end{aligned}$$

so

$$\begin{aligned}
B_{(\lambda, \varrho)}(w_9) &= \{3\}, & B_{(\lambda, \varrho)}(w_8) &= \{4, 7\}, & B_{(\lambda, \varrho)}(w_7) &= \{2, 6\}, \\
B_{(\lambda, \varrho)}(w_6) &= \{1\}, & B_{(\lambda, \varrho)}(w_5) &= \{5\}, & B_{(\lambda, \varrho)}(w_4) &= \emptyset, \\
B_{(\lambda, \varrho)}(w_3) &= \emptyset, & B_{(\lambda, \varrho)}(w_2) &= \{8, 9\}, & B_{(\lambda, \varrho)}(w_1) &= \emptyset.
\end{aligned}$$

Therefore, $\Omega(\lambda, \varrho) = 374621598$.

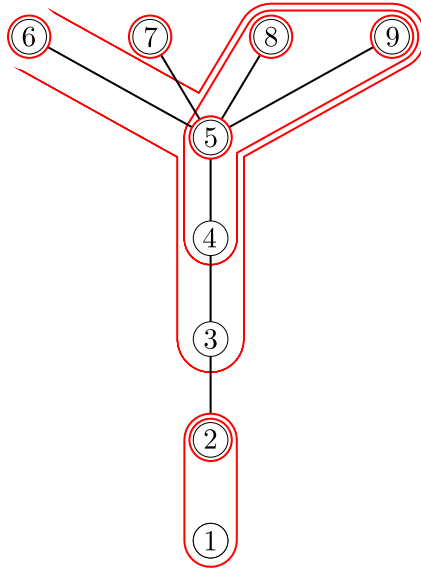

Figure 4.10: An ornamentation of $\text{Broom}_{4,9}^\times$.

Lemma 4.7.3. *Fix positive integers $k \leq n$, and let (i, j) be a pair such that $1 \leq i < j \leq n$. Let $(\lambda, \varrho) \in \Theta(\text{Broom}_{k,n}^\times)$. If $j \leq k$, then $(i, j) \in \text{Inv}(\Omega(\lambda, \varrho))$ if and only if $(n+1-j, n+1-i) \in \text{Inv}(\lambda)$. If $j \geq k+1$, then $(i, j) \in \text{Inv}(\Omega(\lambda, \varrho))$ if and only if $n+1-i \in \varrho(n+1-j)$.*

Proof. Let us write $\lambda = w_1 \cdots w_n$. Note that $w_r = r$ for $1 \leq r \leq n-k$ and that

$$\{w_{n-k+1}, \dots, w_n\} = \{n-k+1, \dots, n\}.$$

For $m \in [n]$, let

$$\ell(m) = \max\{s \in [n] : w_s \in \varrho(n+1-m)\}.$$

Then $\ell(m)$ is the unique element of $[n]$ such that $m \in B_{(\lambda, \varrho)}(w_{\ell(m)})$. It follows that (i, j) is an inversion of $\Omega(\lambda, \varrho)$ if and only if $\ell(i) \leq \ell(j)$.

If $j \leq k$, then $\varrho(n+1-i) = \{n+1-i\}$ and $\varrho(n+1-j) = \{n+1-j\}$, so $w_{\ell(i)} = n+1-i$ and $w_{\ell(j)} = n+1-j$. In this case, $\ell(i) \leq \ell(j)$ if and only if $(n+1-j, n+1-i) \in \text{Inv}(\lambda)$.

Now suppose that $j \geq k+1$. Then $n+1-j \leq_{\text{Broom}_{k,n}} n+1-i$, so either $n+1-i \in \varrho(n+1-j)$ or $\varrho(n+1-j) \prec_{\lambda} \varrho(n+1-i)$. Hence, $\ell(i) \leq \ell(j)$ if and only if $n+1-i \in \varrho(n+1-j)$. \square

Lemma 4.7.4. *Fix positive integers $k \leq n$. If $(\lambda, \varrho) \in \Theta(\text{Broom}_{k,n}^{\times})$, then*

$$\mathbf{s}(\Omega(\lambda, \varrho)) \in \Delta_{\text{Weak}(\mathfrak{S}_n)}(w_{\circ}(k, n)).$$

Proof. In light of (4.5), we must show that every inversion (a, b) of $\mathbf{s}(\Omega(\lambda, \varrho))$ satisfies $b \leq k$. Thus, assume by way of contradiction that there exists $(a, b) \in \text{Inv}(\mathbf{s}(\Omega(\lambda, \varrho)))$ with $b \geq k+1$. According to Theorem 4.7.1, there exists $c \in [n]$ such that $b < c$ and $b \prec_{\Omega(\lambda, \varrho)} c \prec_{\Omega(\lambda, \varrho)} a$. Let $\ell(b)$ and $\ell(c)$ be the unique indices such that $b \in B_{(\lambda, \varrho)}(w_{\ell(b)})$ and $c \in B_{(\lambda, \varrho)}(w_{\ell(c)})$. The pairs (a, b) and (a, c) are both inversions of $\Omega(\lambda, \varrho)$, so we can appeal to Theorem 4.7.3 to find that $n+1-a \in \varrho(n+1-b)$ and $n+1-a \in \varrho(n+1-c)$. This implies that the ornaments $\varrho(n+1-b)$ and $\varrho(n+1-c)$ are nested; since $n+1-c \leq_{\text{Broom}_{k,n}} n+1-b$, we must have $\varrho(n+1-b) \subseteq \varrho(n+1-c)$. It follows that

$$\{u \in [n] : b \in A_{\varrho}(u)\} \subseteq \{u \in [n] : c \in A_{\varrho}(u)\}.$$

Consequently, $\ell(b) \leq \ell(c)$. This implies that $c \prec_{\Omega(\lambda, \varrho)} b$, which is our desired contradiction. \square

Theorem 4.7.4 tells us that we actually have a map

$$\Omega: \Theta(\text{Broom}_{k,n}^{\times}) \rightarrow \mathbf{s}^{-1}(\Delta_{\text{Weak}(\mathfrak{S}_n)}(w_{\circ}(k, n))).$$

In light of Theorem 4.3.5, the following proposition implies Theorem 4.1.6.

Proposition 4.7.5. *Fix positive integers $k \leq n$. The map*

$$\Omega: \Theta(\mathbf{Broom}_{k,n}^\times) \rightarrow \mathbf{s}^{-1}(\Delta_{\text{Weak}(\mathfrak{S}_n)}(w_o(k, n)))$$

is a poset isomorphism.

Proof. Let us first argue that Ω is a bijection. It is immediate from Theorem 4.7.3 that Ω is injective. To prove surjectivity, let us choose an arbitrary

$$\sigma = \sigma(1) \cdots \sigma(n) \in \mathbf{s}^{-1}(\Delta_{\text{Weak}(\mathfrak{S}_n)}(w_o(k, n))).$$

Let v_1, \dots, v_k be the elements of $\{n - k + 1, \dots, n\}$, listed so that

$$n + 1 - v_k \prec_\sigma \cdots \prec_\sigma n + 1 - v_1. \quad (4.6)$$

Let $\lambda = 12 \cdots (n - k)v_1 \cdots v_k$. Define an ornamentation ϱ of $\mathbf{Broom}_{k,n}^\times$ as follows. For $1 \leq j \leq k$, we must define $\varrho(n + 1 - j) = \{n + 1 - j\}$. For $k + 1 \leq j \leq n$, let

$$\varrho(n + 1 - j) = \{n + 1 - j\} \cup \{n + 1 - i : (i, j) \in \text{Inv}(\sigma)\}.$$

Let us first show that the map ϱ is indeed an ornamentation. Let $j \in [n]$; we will prove that $\varrho(n + 1 - j)$ induces a connected subgraph of $\mathbf{Broom}_{k,n}$. If $1 \leq j \leq k$, then this is obvious because $\varrho(n + 1 - j) = \{n + 1 - j\}$. Now assume $k + 1 \leq j \leq n$. Suppose i and i' are vertices satisfying

$$n + 1 - j <_{\mathbf{Broom}_{k,n}} n + 1 - i <_{\mathbf{Broom}_{k,n}} n + 1 - i' \quad (4.7)$$

and $n + 1 - i' \in \varrho(n + 1 - j)$; we must show that $n + 1 - i \in \varrho(n + 1 - j)$. The fact that $n + 1 - i' \in \varrho(n + 1 - j)$ implies that $(i', j) \in \text{Inv}(\sigma)$. It follows from (4.7) that $i' < i < j$ and that $i \geq k + 1$. Since $\mathbf{s}(\sigma) \in \Delta_{\text{Weak}(\mathfrak{S}_n)}(w_o(k, n))$, we know that $(i', i) \notin \text{Inv}(\mathbf{s}(\sigma))$. According to Theorem 4.7.1, we cannot have $i \prec_\sigma j \prec_\sigma i'$. But we know that $j \prec_\sigma i'$, so we must have $j \prec_\sigma i$. This shows that $(i, j) \in \text{Inv}(\sigma)$, so $n + 1 - i \in \varrho(n + 1 - j)$, as desired.

We now must show that for all vertices $j, j' \in [n]$, the sets $\varrho(j)$ and $\varrho(j')$ are either nested or disjoint. Suppose $j, j' \in [n]$ are such that $j \leq j'$ and $\varrho(n+1-j) \cap \varrho(n+1-j') \neq \emptyset$; we will show that $\varrho(n+1-j) \subseteq \varrho(n+1-j')$. If $1 \leq j \leq k$, then this is immediate since $\varrho(n+1-j)$ is a singleton set. Now suppose $j \geq k+1$. Then $n+1-j \in \varrho(n+1-j')$, so $(j, j') \in \text{Inv}(\sigma)$. It follows that if $i \in [n]$ is such that $(i, j) \in \text{Inv}(\sigma)$, then $(i, j') \in \text{Inv}(\sigma)$. Hence, $\varrho(n+1-j) \subseteq \varrho(n+1-j')$. This completes the proof that ϱ is an ornamentation.

If we can show that $(\lambda, \varrho) \in \Theta(\mathbf{Broom}_{k,n}^\times)$, then it will follow from Theorem 4.7.3 that $\Omega(\lambda, \varrho) = \sigma$, which will prove that Ω is surjective. Thus, we must show that for every $j \in [n]$, the elements of $\varrho(n+1-j)$ form a consecutive factor of λ . If $1 \leq j \leq k$, then this is trivial since $\varrho(n+1-j)$ is a singleton set, so assume $k+1 \leq j \leq n$. Referring to the definition of λ , we see that we must demonstrate that the elements of the set $\Gamma = \{n+1-i : 1 \leq i \leq k \text{ and } (i, j) \in \text{Inv}(\sigma)\}$ form a prefix of the word $v_1 \cdots v_k$. Thus, suppose $1 \leq i < i' \leq k$ and $v_{i'} \in \Gamma$. Then $(n+1-v_{i'}, j) \in \text{Inv}(\sigma)$, so $j \prec_\sigma n+1-v_{i'} \prec_\sigma n+1-v_i$ (by (4.6)). It follows that $(n+1-v_i, j) \in \text{Inv}(\sigma)$, so $v_i \in \Gamma$.

We have shown that Ω is bijective. It is a straightforward consequence of Theorem 4.7.3 that Ω and Ω^{-1} are order-preserving. □

4.8 Future Directions

In Theorems 4.1.3 and 4.1.4, we characterized the operahedron lattices that are semidistributive and the operahedron lattices that are trim. We also mentioned in Theorem 4.1.5 that an operahedron lattice is semidistributive if and only if it is semidistributive. It is natural to investigate other structural properties of operahedron lattices.

As mentioned in Section 4.1, operahedra are special examples of poset associahedra. Laplante-Anfossi [Lap22] also noted that they are the *graph associahedra* of the line graphs of trees. Graph associahedra were introduced by Carr and Devadoss [CD06] and further popularized by Postnikov [Pos09] as examples of *generalized permutohedra*. It would be interesting

to further investigate which poset associahedra or graph associahedra have 1-skeletons that can be oriented in some natural way to produce lattices (say, using the realizations in [Sac23] or [Dev09]). Barnard and McConville already have work along these lines [BM21], but there are further avenues worth pursuing. For example, one could consider graph associahedra of particular families of graphs such as block graphs or chordal graphs.

In order to understand the operahedron lattice of a tree T , we first had to introduce the ornamentation lattice $\mathcal{O}(T^\times)$. While ornamentation lattices are generally less complicated than operahedron lattices, it could still be interesting to consider ornamentation lattices in their own right by asking more refined questions than those asked here about operahedron lattices. For example, ornamentation lattices could provide a fruitful landscape for generalizing results about Tamari lattices—which are ornamentation lattices of chains—such as those in [Bar20, BCP23, Che22, CC23, CP15, Def22a, FN14, Hon22].

It is natural to ask if there are even stronger connections between operahedron lattices and stack-sorting. In Theorem 4.1.6, we found an isomorphism between the operahedron lattice of a broom and the subposet of $\text{Weak}(\mathfrak{S}_n)$ consisting of the stack-sorting preimages of a certain set of permutations. Are there families of trees more general than brooms for which similar isomorphisms exist?

REFERENCES

- [AS94] Scott Axelrod and Isadore M Singer. “Chern-Simons perturbation theory. II.” *Journal of Differential Geometry*, **39**(1):173–213, 1994.
- [Bar19] Emily Barnard. “The canonical join complex.” *Electron. J. Combin.*, **26**, 2019.
- [Bar20] Emily Barnard. “The canonical join complex of the Tamari lattice.” *J. Combin. Theory Ser. A*, **174**, 2020.
- [BB05] Anders Björner and Francesco Brenti. *Combinatorics of Coxeter Groups*, volume 231 of Graduate Texts in Mathematics. Springer, 2005.
- [BCP23] Alin Bostan, Frédéric Chyzak, and Vincent Pilaud. “Refined product formulas for Tamari intervals.” *Preprint arXiv:2303.10986(v2)*, 2023.
- [BEZ90] Anders Björner, Paul H. Edelman, and Günter M. Ziegler. “Hyperplane arrangements with a lattice of regions.” *Discrete Comput. Geom.*, **5**:263–288, 1990.
- [BM21] Emily Barnard and Thomas McConville. “Lattices from graph associahedra and subalgebras of the Malvenuto–Reutenauer algebra.” *Algebra Universalis*, **82**, 2021.
- [Bon19] Miklós Bóna. “A survey of stack sortable permutations.” In *50 Years of Combinatorics, Graph Theory, and Computing*, pp. 55–72. Chapman and Hall/CRC, 2019.
- [Bra06] Petter Brändén. “On linear transformations preserving the Pólya frequency property.” *Trans. Amer. Math. Soc.*, **358**:3697–3716, 2006.
- [BT94] Raoul Bott and Clifford Taubes. “On the self-linking of knots.” *Journal of Mathematical Physics*, **35**(10):5247–5287, 1994.
- [BW91] Anders Björner and Michelle L. Wachs. “Permutation statistics and linear extensions of posets.” *J. Combin. Theory Ser. A*, **58**:85–114, 1991.
- [CC23] Clément Chenevière and Cesar Ceballos. “On linear intervals in the alt ν -Tamari lattices.” *Preprint arXiv:2305.02250(v1)*, 2023.
- [CD06] Michael Carr and Satyan L Devadoss. “Coxeter complexes and graph-associahedra.” *Topology and its Applications*, **153**(12):2155–2168, 2006.
- [Che22] Clément Chenevière. “Linear intervals in the Tamari and the Dyck lattices and in the alt-Tamari posets.” *Preprint arXiv:2209.00418(v2)*, 2022.
- [CP15] Grégory Châtel and Viviane Pons. “Counting smaller elements in the Tamari and m -Tamari lattices.” *J. Combin. Theory Ser. A*, **134**:58–97, 2015.

- [CSZ15] Cesar Ceballos, Francisco Santos, and Günter M Ziegler. “Many non-equivalent realizations of the associahedron.” *Combinatorica*, **35**(5):513–551, 2015.
- [Def20a] Colin Defant. “Catalan intervals and uniquely sorted permutations.” *J. Combin. Theory Ser. A*, **174**, 2020.
- [Def20b] Colin Defant. “Counting 3-stack-sortable permutations.” *J. Combin. Theory Ser. A*, **172**, 2020.
- [Def22a] Colin Defant. “Meeting covered elements in ν -Tamari lattices.” *Adv. Appl. Math.*, **134**, 2022.
- [Def22b] Colin Defant. *Stack-sorting and Beyond*. PhD thesis, Princeton University, 2022.
- [Def22c] Colin Defant. “Troupes, cumulants, and stack-sorting.” *Adv. Math.*, **399**, 2022.
- [Def23] Colin Defant. “Fertilitopes.” *Discrete Comput. Geom.*, **70**:713–752, 2023.
- [DEM20] Colin Defant, Michael Engen, and Jordan A. Miller. “Stack-sorting, set partitions, and Lassalle’s sequence.” *J. Combin. Theory Ser. A*, **175**, 2020.
- [Dev09] Satyan L. Devadoss. “A realization of graph associahedra.” *Discrete Math.*, **309**:271–276, 2009.
- [DL23] Colin Defant and Rupert Li. “Ungarian Markov chains.” *Electron. J. Probab.*, **28**:1–39, 2023.
- [DPW85] Bernhardine Dreesen, Werner Poguntke, and Peter Winkler. “Comparability invariance of the fixed point property.” *Order*, **2**:269–274, 1985.
- [DS24] Colin Defant and Andrew Sack. “Operahedron Lattices.” *arXiv preprint arXiv:2402.12717*, 2024.
- [DW23] Colin Defant and Nathan Williams. “Semidistributive lattices.” *Forum Math. Sigma*, **11**, 2023.
- [FJN95] Ralph Freese, Jaroslav Ježek, and J. B. Nation. *Free Lattices*, volume 42 of Mathematical Surveys and Monographs. American Mathematical Society, 1995.
- [FN14] Susanna Fishel and Luke Nelson. “Chains of maximum length in the Tamari lattice.” *Proc. Amer. Math. Soc.*, **142**:3343–3353, 2014.
- [FR05] Sergey Fomin and Nathan Reading. “Root systems and generalized associahedra.” *arXiv preprint math/0505518*, 2005.
- [Gal23] Pavel Galashin. “ P -associahedra.” *Selecta Math.*, **30**, 2023.
- [Gey94] Winfried Geyer. “On Tamari lattices.” *Discrete Math.*, **133**:99–122, 1994.

- [Hai84] Mark Haiman. “Constructing the associahedron.” *Unpublished manuscript, MIT*, 1984.
- [Hon22] Letong Hong. “The pop-stack-sorting operator on Tamari lattices.” *Adv. Appl. Math.*, **139**, 2022.
- [HT72] Samuel Huang and Dov Tamari. “Problems of associativity: A simple proof for the lattice property of systems ordered by a semi-associative law.” *Journal of Combinatorial Theory, Series A*, **13**(1):7–13, 1972.
- [Kal88] Gil Kalai. “A simple way to tell a simple polytope from its graph.” *J. Comb. Theory, Ser. A*, **49**(2):381–383, 1988.
- [Knu73] Donald Knuth. *The Art of Computer Programming, Vol. 1: Fundamental Algorithms*. Addison-Wesley, 1973.
- [Lap22] Guillaume Laplante-Anfossi. “The diagonal of the operahedra.” *Adv. Math.*, **405**, 2022.
- [LMV23] Eon Lee, Carson Mitchell, and Andrés R. Vindas-Meléndez. “Stack-sorting simplices: geometry and lattice-point enumeration.” *Preprint arXiv:2308.16457(v1)*, 2023.
- [Lod04] Jean-Louis Loday. “Realization of the Stasheff polytope.” *Archiv der Mathematik*, **3**(889X/04):030267–12, 2004.
- [LTV10] Pascal Lambrechts, Victor Turchin, and Ismar Volić. “Associahedron, cyclohedron and permutohedron as compactifications of configuration spaces.” *Bulletin of the Belgian Mathematical Society-Simon Stevin*, **17**(2):303–332, 2010.
- [MPPep] Chiara Mantovani, Arnau Padrol, and Vincent Pilaud. “Acyclonestohedra: when oriented matroids meet nestohedra.” in prep.
- [MTT21] Naruki Masuda, Hugh Thomas, Andy Tonks, and Bruno Vallette. “The diagonal of the associahedra.” *J. Éc. polytech. Math.*, **8**:121–146, 2021.
- [NS23a] Son Nguyen and Andrew Sack. “Poset associahedra and stack-sorting.” *Preprint arXiv:2310.02512(v1)*, 2023.
- [NS23b] Son Nguyen and Andrew Sack. “The poset associahedron f -vector is a comparability invariant.” *arXiv preprint arXiv:2310.00157*, 2023.
- [Pet15] Kyle Petersen. *Eulerian Numbers*. Springer, 2015.
- [Pos09] Alexander Postnikov. “Permutohedra, associahedra, and beyond.” *Int. Math. Res. Not. IMRN*, **2009**:1026–1106, 2009.

- [Pro16] James Propp. “Lessons I learned from Richard Stanley.” *The Mathematical Legacy of Richard P. Stanley*, **100**:279, 2016.
- [PRW08] Alex Postnikov, Victor Reiner, and Lauren Williams. “Faces of Generalized Permutohedra.” *Documenta Mathematica*, **13**:207–273, 2008.
- [Sac23] Andrew Sack. “A realization of poset associahedra.” *Preprint arXiv:2301.11449(v2)*, 2023.
- [Sin04] Dev P Sinha. “Manifold-theoretic compactifications of configuration spaces.” *Selecta Mathematica*, **10**(3):391–428, 2004.
- [Sta63] James Dillon Stasheff. “Homotopy associativity of H-spaces. II.” *Transactions of the American Mathematical Society*, **108**(2):293–312, 1963.
- [Sta86] Richard P Stanley. “Two poset polytopes.” *Discrete & Computational Geometry*, **1**(1):9–23, 1986.
- [Sta97] Jim Stasheff. “From operads to “physically” inspired theories.” In *Operads: Proceedings of Renaissance Conferences (Hartfort, CT/Luminy, 1995)*, volume 202 of *Contemporary Mathematics*, pp. 53–81, Cambridge, MA, 1997. American Mathematical Society.
- [Sta12] Richard P. Stanley. *Enumerative Combinatorics, Vol. 1, Second Edition*. Addison-Wesley, 2012.
- [Sto23] Kurt Stoeckl. “Koszul Operads Governing Props and Wheeled Props.” *arXiv preprint arXiv:2308.08718*, 2023.
- [Tam54] Dov Tamari. “Monoïdes préordonnés et chaînes de Malcev.” *Bulletin de la Société mathématique de France*, **82**:53–96, 1954.
- [Tho06] Hugh Thomas. “An analogue of distributivity for ungraded lattices.” *Order*, **23**:249–269, 2006.
- [TMS76] William T Trotter, John I Moore, and David P Sumner. “The dimension of a comparability graph.” *Proceedings of the American Mathematical Society*, **60**(1):35–38, 1976.
- [Tro92] William T Trotter. *Combinatorics and partially ordered sets*. Johns Hopkins University Press, 1992.
- [TW19] Hugh Thomas and Nathan Williams. “Rowmotion in slow motion.” *Proc. Lond. Math. Soc.*, **119**:1149–1178, 2019.
- [Wes90] Julian West. *Permutations with restricted subsequences and stack-sortable permutations*. PhD thesis, MIT, 1990.

[Zie12] Günter M Ziegler. *Lectures on polytopes*, volume 152. Springer Science & Business Media, 2012.