

# UC Berkeley

## Research Reports

### Title

Evaluation of Cost-Effective Planning and Design Options for Bus Rapid Transit in Dedicated Bus Lanes

### Permalink

<https://escholarship.org/uc/item/3q62m787>

### Authors

Li, Jing-Quan  
Song, Myoung Kyun  
Li, Meng  
et al.

### Publication Date

2009-02-01

CALIFORNIA PATH PROGRAM  
INSTITUTE OF TRANSPORTATION STUDIES  
UNIVERSITY OF CALIFORNIA, BERKELEY

## **Evaluation of Cost-Effective Planning and Design Options for Bus Rapid Transit in Dedicated Bus Lanes**

**Jing-Quan Li, Myoung Kyun Song, Meng Li,  
Wei-Bin Zhang, and Mark Miller**

**California PATH Research Report  
UCB-ITS-PRR-2009-14**

This work was performed as part of the California PATH Program of the University of California, in cooperation with the State of California Business, Transportation, and Housing Agency, Department of Transportation, and the United States Department of Transportation, Federal Highway Administration.

The contents of this report reflect the views of the authors who are responsible for the facts and the accuracy of the data presented herein. The contents do not necessarily reflect the official views or policies of the State of California. This report does not constitute a standard, specification, or regulation.

Final Report for Task Order 6404

February 2009

ISSN 1055-1425



# **Evaluation of Cost-Effective Planning and Design Options for Bus Rapid Transit in Dedicated Bus Lanes**

*PATH Research Report on*

*Task Order 6404*

Jing-Quan Li, Myoung Kyun Song, Meng Li, Wei-Bin Zhang, and Mark Miller

California PATH, University of California, Berkeley, Richmond, CA



## Acknowledgements

This work was performed by the California PATH Program at the University of California at Berkeley in cooperation with the State of California Business, Transportation and Housing Agency, Department of Transportation (Caltrans). The contents of this report reflect the views of the authors, who are responsible for the facts and the accuracy of the data presented herein. The contents do not necessarily reflect the official views or policies of the State of California.

The authors thank Bradley Mizuno and Don Dean of Caltrans' Division of Research and Innovation and Graham Carey of Lane County Transit District for their support and advice during the project. They would also like to thank Steven Shladover for his technical input.

## Author List

### University of California, Berkeley:

Jing-Quan Li  
Myong Kyun Song  
Meng Li  
Wei-Bin Zhang  
Mark Miller



## **Abstract**

Bus Rapid Transit (BRT) systems with dedicated lanes have shown advantages over traditional bus systems and have attracted more transit riders. However, it is not always possible to build BRT systems with two dedicated lanes due to physical and cost constraints. A BRT system with a single dedicated lane is more practical and desirable in such situations. In a single lane configuration, buses approaching from opposite directions share the same road section and can overtake or pass each other only at the bus stops. We propose an optimization model to describe the synchronization requirements of the BRT buses with the objective to minimize the total travel and dwell time. The computational results show that a BRT system with a single dedicated lane yields similar total travel time to a BRT system with double dedicated lanes when the headway is not very short (e.g., more than 20 minutes). In addition, in order to manage the possible delay at intersections, a simple speed control algorithm is implemented to adjust the bus speed in real-time if the bus is delayed considerably. A microscopic simulation based on the simulation tool VISSIM is conducted to examine the impact of the BRT bus on other traffic and the performance of the speed control. The simulation result shows that the speed control effectively handles the delay at the intersection and that other traffic is rarely impacted by the speed control.

**Keywords:** Bus Rapid Transit, dedicated lanes; optimization model; synchronization, ITS





## **Executive Summary**

Even though a Bus Rapid Transit (BRT) system with double-dedicated lanes may have to stop in intersections, these systems can generally achieve "rail-like" performance because the buses are separated from other traffic. However, because of physical and financial constraints, it is not always possible to construct double dedicated lanes for a BRT system since it often requires replacing two existing mixed traffic lanes. Alternatively, the BRT system can be built using single dedicated lanes but the performance of a single dedicated lane system will likely be lower than one using double dedicated lanes. The objective of this project is to evaluate the option of operating BRT systems on single dedicated lanes.

In a single lane configuration, the buses approaching from opposite directions have to share the same road section and can pass by each other only at suitably equipped bus stop zones or passing zones if they are constructed. Thus, the synchronization between buses is crucial. To evaluate this, we applied an optimization model to the problem and used a commercial optimization package, CPLEX, to resolve it. The case study is based on a potential BRT with eight bus stops and 13 miles line in the San Francisco Bay Area, California. A comparative analysis examined the travel time for both a single dedicated lane and double-lane BRT system on the same stretch of road under similar operational conditions.

Our findings are as follows: (i) when the headway is long (e.g., more than 20 minutes), the travel time is almost the same for the one-lane and two-lane systems; and (ii) if the headway is smaller and the service is more frequent (e.g., less than 15 minutes), the system with the single dedicated lane leads to higher travel time due to intersection delays and the lack of synchronization. While headways may be different in different instances, the optimization model and analysis program are general, requiring only valid data for the model to function properly.

To deal with the delay at intersections, a simple speed control algorithm is implemented to adjust the bus speed in real-time when necessary. A microscopic simulation, based on a commercial traffic simulation package, VISSIM, was conducted to examine the impact of the BRT system on other traffic and to assess the performance of the speed control. The simulation showed that the speed control effectively handled the bus delay, while minimally impacting other traffic.



# Table of Contents

<b>1.0 INTRODUCTION AND PROBLEM STATEMENT</b>	<b>1</b>
1.1 REVIEW OF THE LITERATURE	2
1.1.1 RAIL-BASED TRANSIT SYSTEMS	2
1.1.2 BLOCK SIGNALING CONTROL STRATEGY: BUS TRANSIT CASE STUDY	2
<b>2.0 MODELING THE BRT SYSTEM WITH A DEDICATED LANE</b>	<b>19</b>
2.1 OPERATIONS WITH THE SINGLE DEDICATED LANE AND TWO-WAY TRAFFIC	19
2.2 OPERATIONAL CONSTRAINTS	20
2.3 UNCERTAINTIES IN THE TRAVEL TIME	21
2.4 FEASIBILITY ANALYSIS	21
<b>3.0 MODELING AND SOLVING THE BRT SYSTEM</b>	<b>22</b>
3.1 MATHEMATICAL MODELING	22
3.2 ELASTIC MODELING	25
<b>4.0 COMPUTATIONAL EXPERIMENTS</b>	<b>27</b>
<b>5.0 SPEED CONTROL</b>	<b>35</b>
<b>6.0 TRAFFIC SIMULATION</b>	<b>36</b>
6.1 SIMULATION SCENARIO	36
6.2 NETWORK CONSTRUCTION	37
6.3 PROGRAMMING IN VISSIM COM	38
6.4 SIMULATION RESULTS	38
<b>7.0 COST AND DEPLOYMENT ANALYSIS</b>	<b>42</b>
7.1 SINGLE LANE MILE COST	42
7.2 COST SAVINGS FOR SINGLE LANE BRT	44
<b>8.0 CONCLUSION AND FUTURE RESEARCH</b>	<b>45</b>
<b>REFERENCES</b>	<b>46</b>
<b>APPENDIX --- SIMULATION TESTING RESULTS</b>	<b>48</b>



## 1.0 Introduction and Problem Statement

Bus Rapid Transit (BRT) systems have demonstrated their effectiveness in both international and U.S. deployments as an alternative public transportation mode designed to attract non-traditional transit riders (12, 16). Features of BRT systems include exclusive transit lanes, fewer stations than traditional transit service, at-grade boarding, easy access and low-floor buses. If BRT buses are operated in dedicated lanes, where the buses are separated from other traffic, the BRT buses can achieve "rail-like" performance. With dedicated lanes, the buses can generally avoid the congestion in the mixed traffic lanes, thereby significantly reducing their nominal travel time and its variability. Therefore, the BRT system can produce a more desirable travel experience for passengers, making it more attractive relative to the automobile and potentially stimulating some modal shifts to BRT by choice riders.

Many transit agencies interested in BRT systems plan to explore the possibility of dedicated BRT lanes. However, the option of BRT with two dedicated lanes sometimes becomes difficult to implement due to physical constraints, institutional issues, cost constraints and other problems. A single lane, bi-directional BRT system has great potential to achieve the benefits of rail-like service with half of the right of way required for double lane BRT. Even if a BRT system with two dedicated lanes is not completely infeasible, a single dedicated lane alternative is likely to require significantly less right of way and have lower facility construction costs. The single lane system may also create less neighborhood disruption during construction and thereby reduce political opposition. A BRT system with the single dedicated lane has been operated in Eugene-Springfield, Oregon by the Lane Transit Agency, even though the system is not very efficient and bus drivers often need to wait for a long time at passing zones to avoid potential accidents (5).

Since opposing BRT buses with a single dedicated lane need to share the same road segment, a bus must 'meet' another bus in the opposite direction only at the bus stop or at a passing zone if it exists. Therefore, it is crucial to determine feasible and reliable schedules at the stops for each BRT bus to avoid two opposing buses entering into the same road segment. Furthermore, the operations efficiency and passenger carrying capacity of single-lane BRTs are limited when the system is entirely operated manually. Automated speed control or speed advisory make it possible for a driver to adjust the bus speed based on the travel conditions of the opposing bus for maximum efficiency. In this paper, we study a BRT system with the single dedicated lane and propose an optimization model to determine the schedules for such a system with the objective to minimize the total travel and dwell time using a speed control option. Then, we compare the performance of the BRT system with a single dedicated lane to a BRT system with double dedicated lanes.

## 1.1 Review of the Literature

The case of a single bi-directional lane is similar to the block signaling method as used extensively in rail-based transit systems, but this has not been explored until recently with respect to bus transit systems. We thus begin the literature review with a discussion of the rail case for single track activity.

### 1.1.1 Rail-based Transit Systems

Although a single lane bi-directional BRT system is relatively new, single track rail operations, having very similar characteristics to the proposed single-lane bi-directional BRT systems, have been in operation for many years. The timetable problems for single-track train operations have been studied extensively. Early attempts of modeling the single track train scheduling problem started with an integer programming model to optimize overtaking and crossing positions, given a set of departure times and train speeds (21). A more comprehensive formulation that included the minimum headway between trains was proposed (20). A line-delay model was presented to consider the uncertainty in the actual train departure time (10). Higgins et al. (17) proposed an optimization model to determine the train schedules on a single line track and found the solution through a branch and bound algorithm. In order for the trains to cross or overtake each other on a single line railway, special stations, called *sidings*, may be constructed. Higgins et al. (18) presented a mixed integer programming model and applied a commercial modeling package, GAMS, to solve it. Carey (6, 7) and Carey and Lockwood (9) applied a decomposition approach to solve train timetable problems for both single track and double tracks. Cai et al. (3) implemented a greedy heuristic to schedule the trains on a single line track. Recently, Zhou and Zhong (23) proposed a branch and bound algorithm with the lower bounds from a Lagrangian relaxation to determine the timing tables for the trains on a single track. Carey and Crawford (8) developed heuristics to schedule trains on a network with multiple one-way tracks. It is described in Caprara et al. (4) that the train timetabling problem is a hard optimization problem. The survey papers of the train timetabling are referred to in Bussieck and Winter (1) and Cordeau et al. (11).

### 1.1.2 Block Signaling Control Strategy: Bus Transit Case Study

Literature on operating transit buses in a single dedicated lane is scarce. In the U.S., a single dedicated lane BRT system has been used by Lane County Transit in Eugene, Oregon (5, 14). This BRT system, the EmX, connects downtown Eugene with downtown Springfield. While most of the EmX route is equipped with dual tracks, there are sections of the Eugene-Springfield corridor where EmX vehicles must use the same roadway as other EmX vehicles traveling in the opposite direction because of restricted right-of-way. The length of these sections totals to approximately 1.7 miles of the 4 mile long corridor. The technical solution of avoiding the conflicts is to use a particular control strategy, called *block signaling* (19, 14, and 5).

The current schedule allows 16 minutes of travel time and the headway varies depending on the time of the day. The most recent operational data shows that during peak hours on weekdays, the bus trip time is between 13.4 minutes and 23 minutes, with a standard deviation of 1.4 minutes. The maximum trip time error is about 40% of the planned trip time. The analysis of the data shows that the bus delay at the intersections and the lack of real-time coordination among buses are the primary causes of the delays.

Block signaling consists of controlling the movements of EmX vehicles upon entering the section of the corridor – the block – with the shared right-of-way. Similar to single track railway system, entry points to the single-track blocks are controlled by BRT signals that allow only one bus the right-of-way to enter the block at any given time. The BRT signals are coordinated with street traffic signals. A separate Type 170 block controller controls each set of block-entry signals and intercepts calls from the EmX vehicle to be given priority. If there is not already an active request for priority for travel by a bus in the opposite direction, the block controller transmits the priority request to the intersection for activation. Once the EmX bus is permitted by a block controller to enter the block, the controller does not allow calls for EmX buses wanting to travel in the opposite direction until after the first bus has checked out of the last intersection in the block. Figure 1 shows a schematic drawing of this BRT control system in which there are two intersections in the example block.

The system is generally designed to have BRT stations at the ends of each block section. EmX vehicles waiting for other EmX vehicles traveling in the opposite direction stay in the station until the block has cleared. The block controller is configured to operate with two exclusive phases, one for each direction in the block. Detectors are used to insure that one bus passes through the block before another bus is permitted to enter the block. When the block is open in one direction, the block controller sends a call for the appropriate BRT phase to each of the two local controllers. At each intersection the local controller responds to the call detectors at the intersection approaches only when a call also exists from the block controller on a matching BRT phase (Figure 1-1).



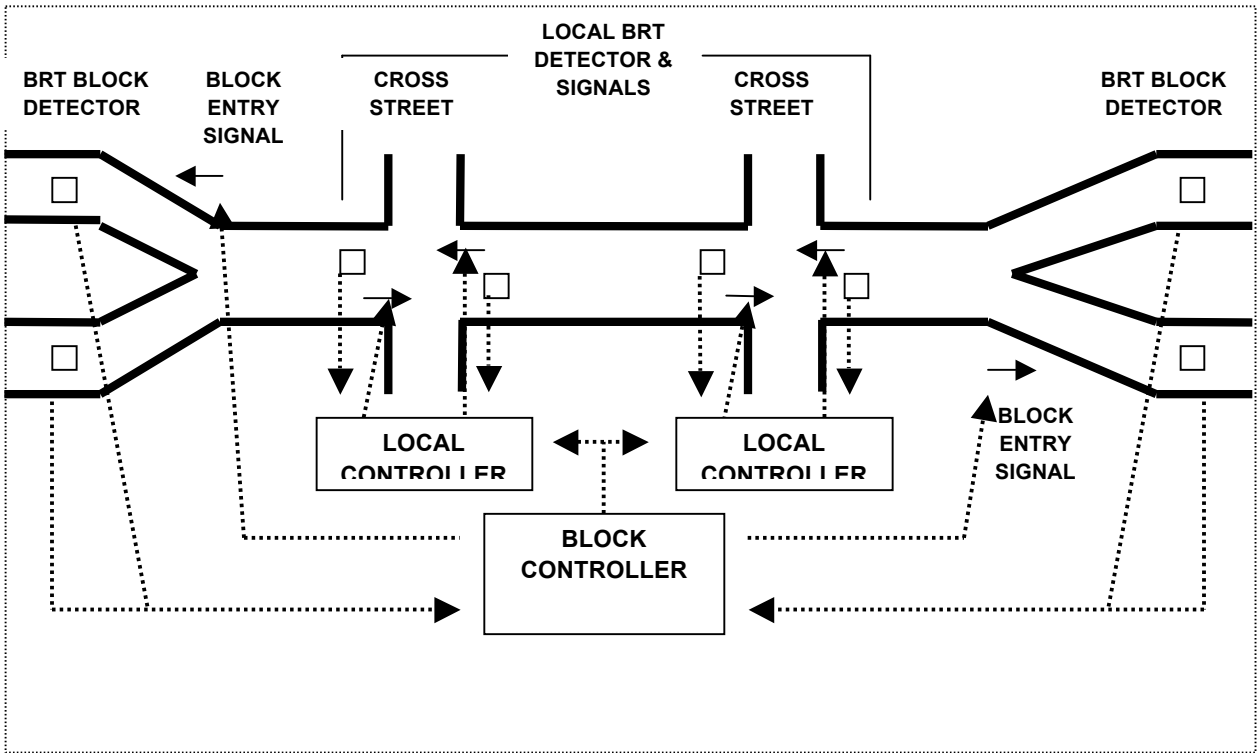

Sources: (19 and 14)

- = Detector
- ← = Signal
- .....▶ = Indicates connection between controller and signal or connection between controller and detector

**Figure 1-1 Single Track Bus Rapid Transit Block Control**

### 1.2 Design Issues for Bus Rapid Transit Systems

There are currently many BRT systems throughout the world including more than 135 systems in over 28 countries and 90 cities in North and South America, Europe, Asia, and Africa. In the United States alone there are nearly 60 existing BRT systems with more

than 20 in the State of California<sup>1</sup> alone. Additional systems are in various stages of development, planning, and construction.

In the operational planning of bus rapid transit systems, there are many design decisions that impact the following three basic parameters that set BRT apart from conventional bus services:

- Sufficient system **capacity** to handle expected passenger demand
- Service **speeds** that minimize travel times
- **Frequency** of service to minimize waiting times

Capacity refers to the maximum number of people or transit vehicles that can be moved past a point by a BRT line or system (14). There are three key issues for BRT system capacity assessment:

- BRT system capacity is limited by its lowest capacity element, that is, the bottleneck, within the BRT system. There are three key elements that determine BRT system capacity: 1) BRT vehicle capacity; 2) BRT station capacity; and 3) BRT running way capacity. The most constraining of these on throughput will be the controlling factor for the entire BRT corridor.
- There is a difference between capacity of a BRT system and the demand placed upon a BRT system. Capacity is a measure of the estimated maximum number of passengers that could be served by a particular BRT line, while demand is the actual number of passengers utilizing the line.
- Capacity is a function of the desired level of service (LOS).

It is important to realize that high-capacity and high travel speeds may be competing issues. As the number of vehicles and passengers increases, the opportunities for congestion and operational problems also increase. Identifying all of the essential elements that may inhibit high-capacity and high-speed service is a significant step toward the effective design of a BRT system. Similarly, identifying the design features that can enable a bus rapid transit system to achieve both high capacity and high speed is just as significant.

After a BRT corridor, route, and basic service options have been selected, the next priority is to determine the conditions that best meet the expected passenger demand while maximizing speed. As is stated in *Bus Rapid Transit Planning Guide* (22), system designers should aim to satisfy three general objectives:

1. Meet current and projected passenger demand
2. Achieve average vehicle speeds of 25 kph or higher
3. Minimize door-to-door travel times for customers

Achieving a high-capacity BRT system must be coupled with satisfying passenger demand and not be a standalone objective. Obviously, in locations with lower levels of demand on primary corridors, high capacity is not needed and designing a high-capacity

---

<sup>1</sup> This counts the Los Angeles Metro Rapid system as a single BRT system, even though there are currently nearly 20 individual Metro Rapid corridors in Los Angeles County.

system may require unnecessary operating and capital costs for the city. For example, with a lower demand, large vehicles would not always be needed and could have negative impacts on system performance since such vehicles would tend to operate with fewer onboard passengers or result in less frequent service. Smaller vehicles could help enhance revenues and meet customer preferences, such as short headways.

Capacity and speed are system attributes that are recognized by and are of importance to transit operators and the transit administrative agency. They are generally not of interest to passengers, who think only of getting from the origin to the destination in the shortest period of time. Unfortunately, designing a high-capacity and high-speed BRT system does not insure that the origin-to-destination travel times for transit passengers are minimized. Thus, a BRTs system design should be optimized in terms of minimizing door-to-door travel times for most passengers in addition to achieving high-capacity and high-speed objectives.

Achieving high-capacity and high-speed operations requires consideration of several inter-dependent design components, examples of which are listed below together with brief descriptions (22).

- **Saturation level:** The percentage of time that a BRT vehicle stopping bay is occupied; as the saturation level increases, the travel time increases and the speed decreases.
- **Stopping bay:** The designated area in a BRT station where a bus will stop and align itself to the boarding platform.
- **Service frequency (headway):** The number of BRT vehicles per hour (waiting time between vehicles).
- **Load factor:** The percentage of a vehicle's total capacity that is actually occupied.
- **Dwell time:** The amount of total stop time per vehicle. Dwell time is composed of boarding time, alighting time, and dead time.
- **Renovation factor:** The average number of passengers that are on a vehicle at any given time going from point A to point B divided by the total boardings along a given route between points A and B. The lower the renovation factor, the greater is the usage rate for the BRT vehicle. This is because lower renovation factors mean that there are a high number of alightings associated with a large number of boardings, which increases the effective capacity of the vehicle.

These factors have precise inter-relationships, such as between vehicle size, dwell times, and renovation factors. Determining the actual capacity of a BRT system requires an understanding of such relationships. For example, as the number of boardings and alightings increases, dwell times will increase, and capacity and the overall average speed will be reduced. Another example involving dwell times deals with whether BRT vehicles have at-level entry or stepped-passenger entry for boarding. The latter contributes to longer dwell times and, again, reduced capacity. Another factor influencing dwell times is the fare payment method, specifically, whether it is on- or off-line with the former contributing to longer dwell times.

Thus a natural question comes to mind: Which combination(s) of all these different attributes contributes to a high-speed and high-capacity system? We quote directly from what is stated in (22):

*“Achieving a high-speed and high-capacity system depends on a range of operational design characteristics, including multiple stopping bays at stations, express and limited-stop services, articulated vehicles with multiple wide doorways, off-board fare collection and fare verification, platform level boarding, and optimum station spacing. In general, the bottleneck point for most BRT systems will be vehicle congestion at the stations. Mechanisms that help to decongest the station area and lead to rapid boarding and alighting of passengers will likely return the greatest dividends in terms of speed and capacity.”*

Corridor capacity can be expressed in different ways, either very simply in terms of only the main factors that affect the capacity of a BRT system or in a more detailed manner that includes the precise inter-relationships between design factors. For example, in simple terms, corridor capacity (passengers per hour per direction) may be expressed by the following equation:

$$\text{Corridor Capacity} = \text{Vehicle capacity (passengers/vehicle)} * \text{Load factor} * \\ \text{Service frequency (vehicles/hour)} * \text{Number of stopping bays}$$

Examples of using this basic – if somewhat coarse – formula for calculating corridor capacity for a range of common scenarios are depicted in Table 1-1. Performing a sensitivity analysis on values for each of the four variables shows the influence that each variable has on the value of the corridor capacity. It must be noted, however, that the values in this table are only examples and are based on findings from a survey of existing BRT systems (reference). Table 1- 2 shows sample values for various factors resulting from the findings of this survey. For example, for vehicle capacity, the three values, 70, 160, and 270, represent sample values for a standard-size bus, an articulated bus, and a bi-articulated bus, respectively (see Table 1-2). Also, the values shown in Table 1-1 are based on the assumptions that the BRT vehicles operate on a segregated, median-aligned busway with at-level boarding. Corridor capacity values will be smaller for curbside busways because in this setting there will be substantially more turning conflicts with other vehicles that will decrease the overall average speed for the BRT vehicle. If the BRT vehicle does not have at-level boarding, then boarding time and hence total dwell time will be larger. Again, this will result in smaller values for the corridor capacity and overall average speed. It is essential to recognize that the actual capacity for a specific corridor in a given city will vary depending on numerous local conditions. Tables 1-3 and 1-4 show the capacity flow numbers together with the average speed and the service frequency for actual bus rapid transit systems (14, 22, and 15). Capacity flow numbers are expressed in terms of the number of passengers per hour per direction (pphpd) in Table 1-3. Where such hourly data was not available, daily estimates were obtained and these are shown in Table 1-4.

**Table 1-1 Sensitivity Analysis: Bus Rapid Transit Corridor Capacity Scenarios**

<b>Vehicle Capacity (Number of passengers)</b>	<b>Load Factor (Peak Period)</b>	<b>Service Frequency (Number of vehicles per hour per stopping bay)</b>	<b>Number of stopping bays per station</b>	<b>Capacity Flow (Number of passengers per hour per direction)</b>
70	0.85	20	1	1,190
160	0.85	20	1	2,720
270	0.85	20	1	4,590
70	0.85	30	1	1,785
160	0.85	30	1	4,080
270	0.85	30	1	6,885
70	0.85	60	1	3,570
160	0.85	60	1	8,160
270	0.85	60	1	13,770
70	0.85	20	2	2,380
160	0.85	20	2	5,440
270	0.85	20	2	9,180
70	0.85	30	2	3,570
160	0.85	30	2	8,160
270	0.85	30	2	13,770
70	0.85	60	2	7,140
160	0.85	60	2	16,320
270	0.85	60	2	27,540
70	0.85	20	4	4,760
160	0.85	20	4	10,880
270	0.85	20	4	18,360
70	0.85	30	4	7,140
160	0.85	30	4	16,320
270	0.85	30	4	27,540
70	0.85	60	4	28,560
160	0.85	60	4	32,640
270	0.85	60	4	55,080

Source: (22)

**Table 1-2 Sample Values from Existing Bus Rapid Transit Systems**

<b>Factor</b>	<b>Typical Range</b>
Vehicle capacity for standard-size buses	60-75 passengers
Vehicle capacity for articulated buses	140-170 passengers
Vehicle capacity for bi-articulated buses	240-270 passengers
Load factor for peak period	0.80 – 0.90
Load factor for off-peak period	0.65 – 0.80
Service frequency per stopping bay for peak period	20 – 60 buses per hour
Service frequency per stopping bay for off-peak period	7 – 15 buses per hour
Dwell time for peak period	20 – 40 seconds
Dwell time for off-peak period	17 – 30 seconds
Number of stopping bays	1 – 5 stopping bays

Source: (22)

Bogota’s Transmilenio BRT system currently transports an average actual peak period capacity of 45,000 pphpd – the largest BRT system capacity known to exist. Many BRT and busway systems in Brazil such as in Sao Paolo, Porto Alegre, Belo Horizonte, and Curitiba – are capable of achieving peak period capacities ranging between 20,000 pphpd and 35,000 pphpd. In the case of Bogota, its capacity is attained mainly through the following factors:

- Use of articulated buses with a capacity of 160 passengers
- Stations with multiple stopping bays that can accommodate up to five buses per direction simultaneously
- Passing lanes at BRT stations to permit express and limited-stop vehicles to pass local bus services
- Multiple combinations of routing options that include local, limited-stop, and express services
- Average service frequency per route of 20 buses per hour and a service frequency as high as 60 buses per hour during peak periods
- Station dwell times of approximately 20 seconds that are achieved by means of the following attributes:
  - At-level boarding and alighting
  - Pre-board or off-line fare collection and fare verification
  - Multiple sets of large double doors on each side of the BRT vehicle

Systems such as in Quito (Ecuador) have only a single lane in each direction and can reach hourly capacities per direction of approximately 14,000 (Table 1-3). However, while the Porto Alegre Assis Busway in Brazil has only one lane in each direction, it has achieved an hourly capacity of 28,000 per direction because it utilizes multiple stopping bays and convoys BRT vehicle movements.

**Table 1-3 Actual Bus Rapid Transit Corridor Capacities: Number of Passengers per Hour per Direction**

<b>BRT Corridor Location</b>	<b>Achievable Capacity or Actual Measured Peak Flow (passengers per hour per direction)</b>	<b>Average Speed (km/h)</b>	<b>Average Peak Service Frequency (number of buses per hour)</b>
<b>SOUTH AMERICA</b>			
Bogota Transmilenio	45,000	27	20
Santiago Transantiago	37,000	20	20
Sao Paulo – 9 de Julho Busway	34,910	22	120
Porto Alegre Assis Brazil Busway	28,000	15	120
Belo Horizonte Christiano Machado	21,100	27.4	314
Curitiba	20,000	19	30
Goiania (Brazil)	11,500	18	90
Quito Trolebus	9,600	15	60
Pereira (Columbia) Megabus	6,900	20	12-20
Quito Ecovia	6,400	18	30
Quito Central Norte	6,400	23	30
Guayaquil (Ecuador)	5,400	22	24
<b>CENTRAL AMERICA</b>			
Guatemala City – TransMetro	5,000	25	N/A
<b>NORTH AMERICA</b>			
Ottawa – Transitway	10,000	38.7	30
Mexico City Metrobus	8,500	19	57
Pittsburgh East Busway	5,000	40.1	15
Leon (Mexico) Optibus	2,900	18	9-24
Pittsburgh South Busway	1,650	34.5	30
Vancouver 99 B-Line	1,700	23	15
Pittsburgh West Busway	1,365	40.5	12
Boston Silver Line	1,260	12.8	12-20

<b>BRT Corridor Location</b>	<b>Achievable Capacity or Actual Measured Peak Flow (passengers per hour per direction)</b>	<b>Average Speed (km/h)</b>	<b>Average Peak Service Frequency (number of buses per hour)</b>
Washington Street			
Vancouver 98 B-Line	1,100	22	10-15
Las Vegas MAX	600	26.3	5
Eugene, Oregon (EmX)	500	24	6
Honolulu Route A	400	22.6	3-8
Honolulu Route C	400	31.2	3-8
Honolulu Route B	260	15.4	3-8
<b>AUSTRALIA</b>			
Brisbane SE Busway	10,000	55-58	156
Adelaide O-Bahn	4,500	80	72
Sydney	N/A	29-34	6
<b>ASIA</b>			
Seoul	12,000	17	240
Taipei	9,500	17	120-240
Beijing	8,000	22	60
Kunming (China)	6,300	18	90
Jakarta – TransJakarta	3,600	17	40
Hangzhou (China)	1,500	24	30
Nagoya (Japan)	N/A	30	15-20
<b>AFRICA</b>			
Johannesburg – Dobsonville	15,000	N/A	20
Johannesburg – Regina Mundi CBD	8,000	N/A	20
Johannesburg – Lenasia-Highgate-Summinghill	6,500	N/A	20
Cape Town Klipfontein Corridor	6,000	N/A	N/A
Johannesburg – Sandton-Alexandra	5,000	N/A	20
Johannesburg – CBD-Sandton	4,000	N/A	20
Johannesburg – Randburg-CBD	2,500	N/A	20
<b>EUROPE</b>			



<b>BRT Corridor Location</b>	<b>Achievable Capacity or Actual Measured Peak Flow (passengers per hour per direction)</b>	<b>Average Speed (km/h)</b>	<b>Average Peak Service Frequency (number of buses per hour)</b>
Dublin	1,750	20	60
Rouen	1,770	17	20
Caen	N/A	20	10
Lyon	N/A	17	6
Nantes	N/A	20	12-15
Paris Val de Marne	N/A	23	15
Amsterdam	N/A	38	8
Eindhoven	N/A	21	8
Crawley (England)	N/A	20	6

Source: (22)

Corridor capacities are greatest in South America, which is understandable given that those BRT systems have been in existence for the longest time periods and have been able to mature and grow. In addition, there are very high passenger demand levels in these denser developing-nation cities. Corridor capacities have their lowest values in North America, which is also understandable based on bus rapid transit systems' relatively short experience in these locations and lower levels of passenger demand in the United States..

**Table 1-4 Actual Bus Rapid Transit Corridor Capacities: Number of Passengers per Day**

<b>BRT Corridor Location</b>	<b>Achievable Capacity or Actual Measured Peak Flow (passengers per day)</b>	<b>Average Speed (km/h)</b>	<b>Average Peak Service Frequency (Number of buses per hour)</b>
<b>IN OPERATION</b>			
Los Angeles Wilshire Boulevard Metro Rapid	45,000	22.6	12
Los Angeles Orange Line	35,000	34	12
New Britain – Hartford	18,000	44.4	12-30
Hartford E. Busway	15,000	N/A	N/A
South Miami – Dade Busway	9,400	21	10

<b>BRT Corridor Location</b>	<b>Achievable Capacity or Actual Measured Peak Flow (passengers per day)</b>	<b>Average Speed (km/h)</b>	<b>Average Peak Service Frequency (Number of buses per hour)</b>
Los Angeles Ventura Metro Rapid	8,777	30.6	12
Albany	8,000	N/A	5
Chicago Neighborhood Express Bus	7,780	N/A	N/A
AC Transit San Pablo Avenue – Rapid Bus	6,000	26.1	5
Colorado Springs	6,000	32.4	2-4
Santa Clara VTA Line 522 El Camino Real	5,200	26.5	4
Orlando Lynx Lymmo	5,000	N/A	12
Provo, Utah	4,000	N/A	12
Sacramento Ebus	1,750	22.1	4
<b>IN PLANNING OR CONSTRUCTION STAGE</b>			
San Francisco Geary Boulevard	62,500	N/A	N/A
San Bernardino sbX	9,100	N/A	N/A

Source: (15)

## 2.0 Modeling the BRT System with a Dedicated Lane

In a dedicated BRT system, only BRT buses are assigned to the dedicated lanes. Other vehicles are not allowed to operate in these lanes. Thus, delays of the BRT buses due to traffic congestion are reduced. The speed of bus operation may be increased even more by constructing fewer stops than exist for the traditional bus service. Similar to traditional bus services, the single lane BRT system is operated based on schedules with a fixed starting time. The headway between consecutive bus trips is determined by the passenger flow demand. During the peak periods, headways are smaller and bus service frequencies range between 10 to 15 minutes. In order to reduce the total travel time, some buses may service only major stops and skip less important ones. The bus that only services the major stops is referred to as the *express bus*, while the bus serving all of the stops is referred to as the *regular bus*.

### 2.1 Operations with the Single Dedicated Lane and Two-way Traffic

Due to physical and institutional constraints, it is not always feasible to build double dedicated lanes for a BRT system. For instance, in many crowded downtown areas, it is extremely difficult to allocate two separate lanes. With a single dedicated lane, physical space is saved and it is more feasible to deploy a BRT system in a crowded area. Equally important is that a single lane BRT system takes less right-of-way from existing traffic lanes and therefore will have a smaller impact on conventional traffic. However, the operational efficiency in this design becomes more demanding. What makes single lane, bi-directional BRT challenging is the coordination between buses traveling in opposite directions. The BRT buses traveling in opposite directions need to share the same lane and buses can overtake each other only at the bus stops. A locking system comparable to a rail interlocking system can be implemented to ensure that only one bus can travel on a segment between the 'meet' areas at the bus stops. Additionally, the possibility of a head-on collision is small because drivers have line-of-sight capability on all sections of the corridor (5 and 6).

An example of a bus stop in a BRT system with a single dedicated lane is shown in Figure 2-1. Two BRT buses traveling in opposite directions are not allowed in the same section of the dedicated lane. If the total travel time is substantially larger than a system with the double dedicated lanes, the viability of single bi-directional BRT is questionable. Figure 2-2 presents an example of a dedicated bus lane.



**Figure 2-1 An Example of a Bus Stop in the BRT System with a Single Dedicated Lane**



**Figure 2-2 An Example of the Single Dedicated Bus Lane**

## **2.2 Operational Constraints**

In the single-track train system, the capacity of the system is constrained by the number of sections in the system, where a section is defined as the railway segment between two stations. Two BRT buses can meet at the bus stop. In general, a constraint on the minimum dwell time (e.g., 10 seconds) at a bus stop is imposed to ensure that it is sufficient to service the passengers. In addition, in the BRT system with the single dedicated lane, a BRT bus may have to stay longer at the bus stop until another bus in the opposite direction exits the upcoming segment. However, passengers may get impatient if a BRT bus stays at a bus stop too long, thus extending its dwell time beyond tolerable levels. Hence, a maximum dwell time at the bus stop is imposed. It is worthy to note that, in a traditional bus system, the dwell time is referred to as the time serving passengers, while in the BRT system with single dedicated lanes, the dwell time also includes the additional time of waiting at the bus stops that is the result of the need for synchronization.

The national average speed of transit buses is 12 miles/hour. The BRT bus can operate faster than 12 miles/hour due to its separation from other traffic. However, if the speed of the BRT is increased too much, accidents become increasingly likely. Hence, an upper limit on the travel speed of the BRT buses needs to be imposed.

### **2.3 Uncertainties in the Travel Time**

Although the BRT buses with dedicated lanes do not share the road with other vehicles, the buses may still encounter traffic signals, right hand turns, and loading/unloading requirements in the case of curb lanes. Hence, uncertainties in the travel time are still in existence and stochastic process-based methods may be used to handle these uncertainties. Nevertheless, the probability distribution of delays due to red traffic lights is difficult to obtain. Our strategy is to use a higher upper limit on the travel speed to manage the uncertain travel time when the optimization model is constructed. A speed control algorithm is then implemented, to adjust the speed in real-time to maintain the scheduled arrival time. If a BRT bus is significantly delayed at an intersection, the speed control algorithm increases the segment speed. Otherwise, the speed control algorithm reduces the speed if a BRT bus is running ahead of schedule.

### **2.4 Feasibility Analysis**

The feasibility of a single dedicated BRT system is related to the length of each section, the number of sections, the headway, the maximum speed, and the minimum and maximum dwell times. If the lengths of all roadway sections are very long, the BRT bus spends increased driving time before reaching the next bus stop. Other buses traveling in the opposite direction may have to spend time waiting at the bus stop before entering and traveling along the roadway section. Similarly, it is more difficult to synchronize the buses in the opposite directions if the headway is smaller, since the smaller frequency leads to more buses simultaneously in the system. It is possible to propose analytical approaches to feasibility analyses. For instance, the headway should not be higher than some value in order to maintain the feasibility of the BRT system. However, because feasibility is related to many issues, we decided to apply our optimization model to these studies.

### 3.0 Modeling and Solving the BRT System

First, we present the mathematical formulation for the bi-directional BRT system with a single dedicated bus lane. Let  $R_1$  be the set including *regular trips* on which the inbound BRT buses serve any stop, and let  $F_1$  be the set including *express trips* on which the inbound BRT buses serve only some stops. Let  $R_2$  and  $F_2$  be of the corresponding sets for trips where the outbound buses run. Let  $S$  be the set of all bus stops. Let  $S(i)$  be the set of bus stops that the bus serving trip  $i$  needs to serve. For regular trips,  $S(i)$  is equivalent to  $S$ , while for the express trips,  $S(i)$  is only a subset of  $S$ . Let  $L(i)$  be the last bus stop of trip  $i$  and  $I(i)$  be the first bus stop of trip  $i$ . Let  $N(i,s)$  be the next stop of stop  $s$ , based on the direction of trip  $i$ . It should be noted that  $N(i,s)$  is different for different directions.

The decision variables are as follows:  $a_i^s$  and  $d_i^s$  are the arrival time and departure time at bus stop  $s$  of trip  $i$ , respectively;  $x_{ij}^s$  is 1 if the bus on trip  $i$  departs from bus stop  $s$  before the bus on trip  $j$  and 0 otherwise;  $y_{ij}^s$  is 1 if the bus on trip  $i$  arrives at bus stop  $N(i,s)$  before the bus on trip  $j$  departs from bus stop  $N(i,s)$  and 0 otherwise.

The main purpose of this study is to examine the impact of bus trip headway on the BRT system with a single dedicated lane. Hence, a fixed headway was used to generate the bus trips occurring in one day. For example, if the time horizon is from 5:00 AM to 24:00 PM and the headway is 20 minutes, the starting times of the bus trips are 5:00 AM, 5:20 AM, 5:40 AM, 6:00 AM, etc. However, in order to increase flexibility, the offset, which is the time difference between the first trip in each direction, is set as a decision variable. Let  $T_i$  be the designated starting time of trip  $i$  and let  $f$  be the offset. Without loss of generality, the starting time of inbound buses is fixed, while the starting time of outbound buses is the designated starting time plus  $f$ . In the above example, the starting times of inbound buses are 5:00 AM, 5:20 AM, 5:40 AM, 6:00 AM, etc, while the starting times of outbound buses are  $(5:00 + f)$  AM,  $(5:20 + f)$  AM,  $(5:40 + f)$  AM,  $(6:00 + f)$  AM, etc. Let  $H$  be the headway, then  $f$  is between 0 and  $H$ .

#### 3.1 Mathematical Modeling

The objective is to minimize the weighted sum of the dwell time and travel time for all BRT trips: 
$$\min \sum_{i \in R_1 \cup F_1 \cup R_2 \cup F_2} \sum_{s \in S} W_i (d_i^s - a_i^s) + \sum_{i \in R_1 \cup F_1 \cup R_2 \cup F_2} \sum_{s \in S \setminus \{L(i)\}, t = N(i,s)} \bar{W}_i (a_i^t - d_i^s) \quad (1a),$$

where  $W_i$  equals the weight for the dwell time of trip  $i$ , and  $\bar{W}_i$  is the weight for the travel time of trip  $i$ . The different weights provide the ability to prioritize the trade-off between minimizing travel time and minimizing dwell time. For example, if reducing the dwell time is more important in a BRT system, a larger  $W_i$  can be applied.

*Constraints on the travel speed:*

The travel speed needs to be between the given range for the inbound and outbound buses.

$$D_s/V_{\max} \leq a_i^t - d_i^s \leq D_s/V_{\min}, \quad \forall i \in R_1 \cup F_1 \cup R_2 \cup F_2, \quad s \in S \setminus \{L(i)\}, \quad t = N(i,s) \quad (1b)$$

*Constraints on the dwell time:*

The dwell time at a bus stop needs to be between the minimum and maximum allowed dwell times:  $T_{\min} \leq d_i^s - a_i^s \leq T_{\max}, \quad \forall i \in R_1 \cup F_1 \cup R_2 \cup F_2, \quad \forall s \in S(i) \quad (1c)$ .

For express BRT buses, the departure time equals the arrival time if a bus stop is not scheduled to service the stop:  $d_i^s = a_i^s, \quad \forall i \in F_1 \cup F_2, \quad \forall s \notin S(i) \quad (1d)$ .

*Constraints on the synchronization between the buses running in the same direction*

In the single-track train problem, more than one train traveling in the same direction can remain in the station. The capacity of a station is generally not a restriction. Nevertheless, the capacity of a bus stop is limited. In general, only one bus can dwell at the bus stop in the BRT system unless infrastructural improvements are made to accommodate more than one bus at a time. Another bus has to wait until the bus currently at the bus stop departs. The capacity of the BRT stop is an important issue in modeling the BRT system.

During operations, an express bus may pass a regular bus that departs earlier, although the express bus cannot pass another express bus that starts earlier. A regular bus cannot pass any other regular or express bus. Let  $FC(i)$  be the set of trips that have a potential conflict with trip  $i$  in the same direction. For the regular trip,  $FC(i)$  includes only the trip that departs just earlier than trip  $i$ . For the express trip,  $FC(i)$  includes all regular trips and the express trip that departs earlier than trip  $i$ .

$$d_j^s - a_i^s \leq 0, \quad \forall i \in R_1 \cup R_2, \quad \forall j \in FC(i), \quad \forall s \in S \quad (1e)$$

$$d_j^s - a_i^s \leq 0, \quad \forall i \in F_1 \cup F_2, \quad \forall j \in FC(i) \cap (F_1 \cup F_2), \quad \forall s \in S \quad (1f)$$

$$d_j^s - d_i^s \leq Mx_{ij}^s, \quad \forall i \in F_1 \cup F_2, \quad \forall j \in FC(i), \quad \forall s \in S \quad (1g)$$

$$a_j^t - a_i^t \leq Mx_{ij}^s, \quad \forall i \in F_1 \cup F_2, \quad \forall j \in FC(i), \quad \forall t = N(i,s), \quad t \notin S(i) \quad (1h)$$

$$d_j^t - a_i^t \leq Mx_{ij}^s, \quad \forall i \in F_1 \cup F_2, \quad \forall j \in FC(i), \quad \forall t = N(i,s), \quad \forall t \in S(i) \quad (1i)$$

$$d_i^s - d_j^s \leq M(1 - x_{ij}^s), \quad \forall i \in F_1 \cup F_2, \quad \forall j \in FC(i), \quad \forall s \in S \quad (1j)$$

$$a_i^t - a_j^t \leq M(1 - x_{ij}^s), \quad \forall i \in F_1 \cup F_2, \quad \forall j \in FC(i), \quad \forall t = N(i,s), \quad t \notin S(i) \quad (1k)$$

$$d_i^t - a_j^t \leq M(1 - x_{ij}^s), \quad \forall i \in F_1 \cup F_2, \quad \forall j \in FC(i), \quad \forall t = N(i,s), \quad \forall t \in S(i) \quad (1l)$$

Constraints (1e) ensure that a regular bus cannot enter a bus stop before earlier buses leave that bus stop. Constraints (1f) guarantee that an express bus cannot enter a bus stop before other express buses that started earlier leave that same bus stop. Constraints (1g) through (1l) ensure that if an express bus overtakes a regular bus, it occurs in a bus stop that the express bus does not need to service.

*Constraints on the synchronization between the buses in different directions*

These constraints are essential for the BRT system with the single dedicated bus lane, since they ensure that only one bus running in the opposite direction can operate on the road segment.

$$a_i^t - d_j^t \leq M(1 - y_{ij}^s), \quad \forall i \in R_1 \cup F_1, \forall j \in R_2 \cup F_2, \forall s \in S, \forall t = N(i,s) \quad (1m)$$

$$a_j^s - d_i^s \leq My_{ij}^s, \quad \forall i \in R_1 \cup F_1, \forall j \in R_2 \cup F_2, \forall s \in S \quad (1n)$$

These synchronization requirements can yield a large number of constraints since every trip pair in opposite directions imposes a constraint at a bus stop. If there are 5 bus stops and 100 trips in each direction, 100,000 constraints are generated. Nevertheless, the number of such constraints can be significantly reduced by preprocessing. The longest travel times of each bus trip can be determined by considering the minimum speed and maximum dwell time. The time when a bus is operated in the BRT lane is determined by the longest possible trip time to the two starting times of each bus trip. If the potential times of two bus trips do not overlap, the synchronization between trips is not considered.

*Constraints on the bus starting time*

As discussed previously, the following constraints hold for the bus starting time.

$$a_i^s = T_i, \quad \forall i \in R_1 \cup F_1, \quad \forall s = I(i) \quad (1o)$$

$$a_i^s = T_i + f, \quad \forall i \in R_2 \cup F_2, \quad \forall s = I(i) \quad (1p)$$

The overall formulation is as follows:



$$\min \sum_{i \in R_1 \cup F_1 \cup R_2 \cup F_2} \sum_{s \in S} W_i (d_i^s - a_i^s) + \sum_{i \in R_1 \cup F_1 \cup R_2 \cup F_2} \sum_{s \in S \setminus \{L(i)\}, t = N(i,s)} \bar{W}_i (a_i^t - d_i^s)$$

st:

$$D_s / V_{\max} \leq a_i^t - d_i^s \leq D_s / V_{\min}, \quad \forall i \in R_1 \cup F_1 \cup R_2 \cup F_2, \quad s \in S \setminus \{L(i)\}, \quad t = N(i,s)$$

$$T_{\min} \leq d_i^s - a_i^s \leq T_{\max}, \quad \forall i \in R_1 \cup F_1 \cup R_2 \cup F_2, \quad \forall s \in S(i)$$

$$d_i^s = a_i^s, \quad \forall i \in F_1 \cup F_2, \quad \forall s \notin S(i)$$

$$d_j^s - a_i^s \leq 0, \quad \forall i \in R_1 \cup R_2, \quad \forall j \in FC(i), \quad \forall s \in S$$

$$d_j^s - a_i^s \leq 0, \quad \forall i \in F_1 \cup F_2, \quad \forall j \in FC(i) \cap (F_1 \cup F_2), \quad \forall s \in S$$

$$d_j^s - d_i^s \leq Mx_{ij}^s, \quad \forall i \in F_1 \cup F_2, \quad \forall j \in FC(i), \quad \forall s \in S$$

$$a_j^t - a_i^t \leq Mx_{ij}^s, \quad \forall i \in F_1 \cup F_2, \quad \forall j \in FC(i), \quad \forall t = N(i,s), \quad t \notin S(i)$$

$$d_j^t - a_i^t \leq Mx_{ij}^s, \quad \forall i \in F_1 \cup F_2, \quad \forall j \in FC(i), \quad \forall t = N(i,s), \quad \forall t \in S(i)$$

$$d_i^s - d_j^s \leq M(1 - x_{ij}^s), \quad \forall i \in F_1 \cup F_2, \quad \forall j \in FC(i), \quad \forall s \in S$$

$$a_i^t - a_j^t \leq M(1 - x_{ij}^s), \quad \forall i \in F_1 \cup F_2, \quad \forall j \in FC(i), \quad \forall t = N(i,s), \quad t \notin S(i)$$

$$d_i^t - a_j^t \leq M(1 - x_{ij}^s), \quad \forall i \in F_1 \cup F_2, \quad \forall j \in FC(i), \quad \forall t = N(i,s), \quad \forall t \in S(i)$$

$$a_i^{s+1} - d_j^{s+1} \leq M(1 - y_{ij}^s), \quad \forall i \in R_1 \cup F_1, \quad \forall j \in R_2 \cup F_2, \quad \forall s \in S$$

$$a_j^s - d_i^s \leq My_{ij}^s, \quad \forall i \in R_1 \cup F_1, \quad \forall j \in R_2 \cup F_2, \quad \forall s \in S$$

$$a_i^s = T_i, \quad \forall i \in R_1 \cup F_1, \quad \forall s = I(i)$$

$$a_i^s = T_i + f, \quad \forall i \in R_2 \cup F_2, \quad \forall s = I(i)$$

$$a_j^s, d_i^s \geq 0, \quad 0 \leq f \leq H$$

$x_{ij}^s, y_{ij}^s$  are binary variables.

### 3.2 Elastic Modeling

Our primary objective is to evaluate the impact of the headway on system performance. However, using the mathematical model presented, it is not always possible to meet all constraints if the headway is very small, considering the constraints of the minimum speed and maximum dwell time (see constraints (1b) and (1c)). An alternative formulation technique is to allow violation of some constraints and incur penalty costs when constraints are violated (2). Constraints (1b) and (1c) can be relaxed by imposing penalty values as follows:

$$D_s/V_{\max} \leq a_i^t - d_i^s \leq D_s/V_{\min} + \hat{p}_i^s, \\ \forall i \in R_1 \cup F_1 \cup R_2 \cup F_2, s \in S \setminus \{L(i)\}, t = N(i,s) \quad (2b)$$

$$T_{\min} \leq d_i^s - a_i^s \leq T_{\max} + p_i^s, \quad \forall i \in R_1 \cup F_1 \cup R_2 \cup F_2, \forall s \in S(i) \quad (2c),$$

where  $\hat{p}_i^s$  is the penalty value due to violation of the minimum speed, and  $p_i^s$  is the penalty value for violation of the maximum dwell time.

The penalty due to these violations is included in the objective function as follows:

$$\min \sum_{i \in R_1 \cup F_1 \cup R_2 \cup F_2} \sum_{s \in S} W_i (d_i^s - a_i^s) + \sum_{i \in R_1 \cup F_1 \cup R_2 \cup F_2} \sum_{s \in S \setminus \{L(i)\}, t = N(i,s)} \bar{W}_i (a_i^t - d_i^s) \\ + \sum_{i \in R_1 \cup F_1 \cup R_2 \cup F_2} \sum_{s \in S \setminus \{L(i)\}} P p_i^s + \hat{P} \hat{p}_i^s \quad (2a)$$

where P is the penalty value for each unit violation. Hence, the alternative formulation is composed of the objective function (2a), and constraints (2b) , (2c), and (1d) through (1n).

The BRT scheduling problem with double dedicated lanes can be obtained by removing constraints (1m) and (1n), which are for the buses in different directions..

In order to solve the optimization problem, we chose the mixed integer solver in CPLEX 11, in which a branch-and-bound algorithm is used.

The overall formulation is as follows:

$$\begin{aligned} \min \quad & \sum_{i \in R_1 \cup F_1 \cup R_2 \cup F_2} \sum_{s \in S} W_i (d_i^s - a_i^s) + \sum_{i \in R_1 \cup F_1 \cup R_2 \cup F_2, s \in S \setminus \{L(i)\}, t = N(i,s)} \sum \bar{W}_i (a_i^t - d_i^s) \\ & + \sum_{i \in R_1 \cup F_1 \cup R_2 \cup F_2, s \in S \setminus \{L(i)\}} P p_i^s + \hat{P} \hat{p}_i^s \end{aligned}$$

st:

$$D_s / V_{\max} \leq a_i^t - d_i^s \leq D_s / V_{\min} + \hat{p}_i^s, \quad \forall i \in R_1 \cup F_1 \cup R_2 \cup F_2, s \in S \setminus \{L(i)\}, t = N(i,s)$$

$$T_{\min} \leq d_i^s - a_i^s \leq T_{\max} + p_i^s, \quad \forall i \in R_1 \cup F_1 \cup R_2 \cup F_2, \forall s \in S(i)$$

$$d_i^s = a_i^s, \quad \forall i \in F_1 \cup F_2, \forall s \notin S(i)$$

$$d_j^s - a_i^s \leq 0, \quad \forall i \in R_1 \cup R_2, \forall j \in FC(i), \forall s \in S$$

$$d_j^s - a_i^s \leq 0, \quad \forall i \in F_1 \cup F_2, \forall j \in FC(i) \cap (F_1 \cup F_2), \forall s \in S$$

$$d_j^s - d_i^s \leq M x_{ij}^s, \quad \forall i \in F_1 \cup F_2, \forall j \in FC(i), \forall s \in S$$

$$a_j^t - a_i^t \leq M x_{ij}^s, \quad \forall i \in F_1 \cup F_2, \forall j \in FC(i), \forall t = N(i,s), t \notin S(i)$$

$$d_j^t - a_i^t \leq M x_{ij}^s, \quad \forall i \in F_1 \cup F_2, \forall j \in FC(i), \forall t = N(i,s), \forall t \in S(i)$$

$$d_i^s - d_j^s \leq M(1 - x_{ij}^s), \quad \forall i \in F_1 \cup F_2, \forall j \in FC(i), \forall s \in S$$

$$a_i^t - a_j^t \leq M(1 - x_{ij}^s), \quad \forall i \in F_1 \cup F_2, \forall j \in FC(i), \forall t = N(i,s), t \notin S(i)$$

$$d_i^t - a_j^t \leq M(1 - x_{ij}^s), \quad \forall i \in F_1 \cup F_2, \forall j \in FC(i), \forall t = N(i,s), \forall t \in S(i)$$

$$a_i^{s+1} - d_j^{s+1} \leq M(1 - y_{ij}^s), \quad \forall i \in R_1 \cup F_1, \forall j \in R_2 \cup F_2, \forall s \in S$$

$$a_j^s - d_i^s \leq M y_{ij}^s, \quad \forall i \in R_1 \cup F_1, \forall j \in R_2 \cup F_2, \forall s \in S$$

$$a_i^s = T_i, \quad \forall i \in R_1 \cup F_1, \forall s = I(i)$$

$$a_i^s = T_i + f, \quad \forall i \in R_2 \cup F_2, \forall s = I(i)$$

$$a_i^s, d_i^s \geq 0, 0 \leq f \leq H$$

$x_{ij}^s, y_{ij}^s$  are binary variables.

## 4.0 Computational Experiments

The objective of the computational experiments is to examine the performance of the BRT system with a single dedicated lane, compared with double dedicated BRT lanes. Based on a potential BRT line in the Bay Area, California, eight bus stops are generated. The distance between the bus stops is calculated using Google Maps. The total length of the route is 13 miles. We then generate the bus trips using a specific headway from 5:00 AM to 24:00 PM. In one direction, the starting time is fixed, whereas in the other direction, a flexible offset is used as a decision variable. The minimum dwell time is set as 10 seconds, while the maximum dwell time is set as 120 seconds. The travel speed is set between 12 miles/hour to 30 miles/hour. The weights for both the traveling and dwell times are set to 1.

The developed algorithms were implemented in C++ on Sun-Fire-880 Workstations, each of which had 2 Ultra-SPARCIII processors at 750MHz, 4GB of RAM and a Solaris 9 operating system. The time limit was set as 4 hours, and if no optimal solution was found, the program was stopped.

Tables 4-1 and 4-2 present the results for the BRT system with double dedicated lanes and with a single dedicated lane, respectively. Column 1 gives the headway (minutes); columns 2 and 3 present minimum and average speeds (miles/hour) for all buses in all road sections, respectively; columns 4 and 5 give maximum and average dwell times (seconds) for all buses, respectively; column 6 presents the average travel time (seconds); and columns 7 and 8 give CPU time (seconds) and the optimality gap, defined as (best solution – lower bound)/lower bound. For example, when the headway is 20 minutes in the single dedicated lane, the minimum speed is 22.07 miles/hour, the maximum dwell time is 120 seconds, the average travel time is 1556.44 seconds, the average speed is 29.78 miles/hour, CPU seconds are 14405.59, and the optimality gap is 2.75% (see row 7 in Table 4-2).

**Table 4-1 Results of the BRT System with the Double Dedicated Lanes**

Headway (minute)	Min Speed (MPH)	Avg. Speed (MPH)	Max Dwell (second)	Avg. Dwell (second)	Avg. Trip Time (second)	CPU time (second)	Opt. Gap (%)
60	30.00	30.09	10.00	10.00	1498.00	0.05	0.00
50	30.00	30.09	10.00	10.00	1498.00	0.06	0.00
40	30.00	30.09	10.00	10.00	1498.00	0.08	0.00
30	30.00	30.09	10.00	10.00	1498.00	0.11	0.00
25	30.00	30.09	10.00	10.00	1498.00	0.13	0.00
20	30.00	30.09	10.00	10.00	1498.00	0.16	0.00
15	30.00	30.09	10.00	10.00	1498.00	0.23	0.00
12	30.00	30.09	10.00	10.00	1498.00	0.31	0.00

**Table 4-2 Results of the BRT System with Single Dedicated Lanes**

Headway (minute)	Min Speed (MPH)	Avg. Speed (MPH)	Max Dwell (second)	Avg. Dwell (second)	Avg. Trip Time (second)	CPU time (second)	Opt. Gap (%)
60	30.00	30.09	10.00	10.00	1498.00	0.36	0.00
50	30.00	30.09	10.00	10.00	1498.00	0.45	0.00
40	30.00	30.09	10.00	10.00	1498.00	0.51	0.00
30	30.00	30.09	10.00	10.00	1498.00	0.77	0.00
25	12.00	30.06	120.00	10.39	1504.24	0.75	0.41
20	22.07	29.78	120.00	17.58	1556.44	14405.59	2.75
15	12.00	28.05	120.00	25.63	1758.29	14405.23	13.95
12	9.98	28.50	238.00	47.38	1810.86	14403.23	82.21

All instances of the BRT system with double dedicated lanes were solved to optimality, even with very high service frequencies. Additionally, computational time was less than 1 second (see column 6 in Table 4-1). The minimum speed is 30 miles/hour (column 2 in Table 1). The maximum dwell time is 10 seconds (column 3 in Table 5), which is the lower limit of the dwell time. The BRT system with the double dedicated lanes runs as fast as possible since it is not necessary to consider the synchronization between the buses in opposite directions. We can also see that the quickest travel time for each bus is 1498 seconds (around 25 minutes).

When the headway is longer than 25 minutes for the BRT system with single dedicated lanes, the computation time is very small and all instances were solved to optimality or near optimality. However, when the headway is smaller, the BRT system with a single dedicated lane is much more complicated, due to the needs of synchronization between the buses traveling in opposite directions. For example, when the headway is less than 15 minutes, the computational time is more than 4 hours. Additionally, the solution may not be guaranteed to be mathematically optimal since an optimality gap exists.

When the headway for the single-lane BRT system is longer than 25 minutes, the average total travel time increases slightly. For example, when the headway is 30 minutes, the bus takes 1498 seconds to finish the entire route in the system with the double dedicated lanes, while the single-lane bus takes 1504.24 seconds to finish the route. This is an increase of only about 6 seconds. When the headway gets shorter, the average total travel time in the BRT system with the single dedicated lane increases. For example, when the headway is 12 minutes, the total travel time with the single dedicated lane is 1758.29 seconds, which is about 4 minutes longer than the time with the double dedicated lanes. However, the total travel time, 1758.29 seconds, may not be the optimal solution since the optimality gap is 13.95%, which indicates that the total travel time can be further reduced if the optimality gap can be improved using improved algorithms. Meanwhile, the minimum speed with the single dedicated lane is generally slower than the speed with double dedicated lanes if the headway is smaller. The maximum dwell time is also longer. Nevertheless, the suboptimum results may still provide a reasonable schedule to address operational needs.

When the headway is sufficiently small, the optimality gap may be very large for the single-lane BRT system. For example, if the headway is 12 minutes, the optimality is 82.21% after 4 hours of computation. This large gap is not surprising since the corresponding minimum speed is 9.98 miles/hour, and the maximum dwell time is 238.00 seconds (see row 9 in Table 4-2). Note that the given minimum speed is 10 miles/hour, while the given maximum dwell time is 120 seconds. Therefore, in our elastic modeling, the constraints (2b) and (2c) are violated and large penalty values are included in the objective function, resulting in a large optimality gap. When the headway is 15 minutes, the optimality gap is still large, 13.95%; however, both the minimum speed (10 miles/hour) and maximum dwell times (120 seconds) are within the given range (see row 8 in Table 4-2). Therefore, we can conclude that if the headway is smaller than 12 minutes for the single-lane BRT system, we must decrease the minimum speed and increase the maximum dwell time.

Figures 4-1, 4-2, 4-3, 4-4, and 4-5 show graphical presentations comparing the single-lane and double-lane BRT systems, including the minimum speed, average speed, maximum dwell, average dwell time and average trip time.

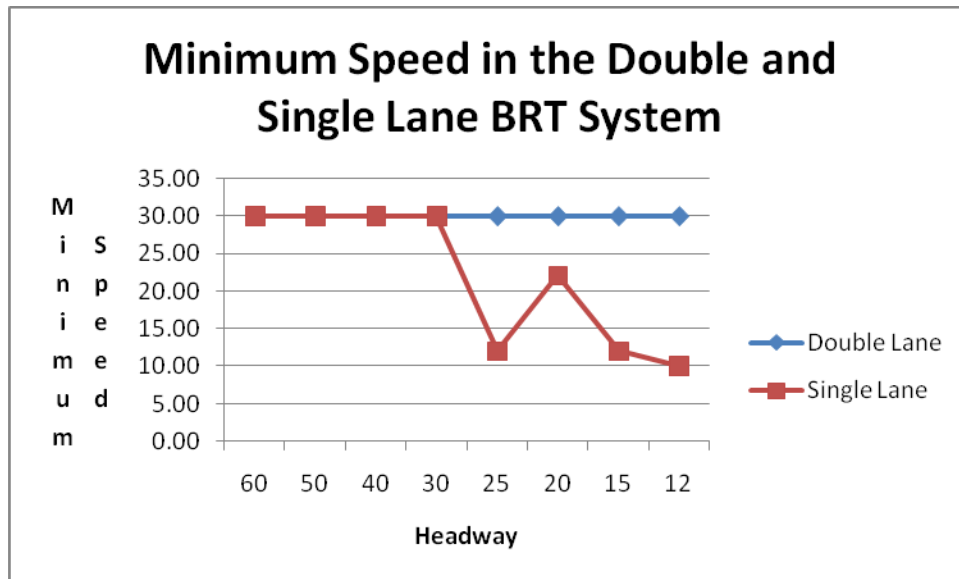

Figure 4-1 Minimum Speed in the Double and Single-lane BRT Systems

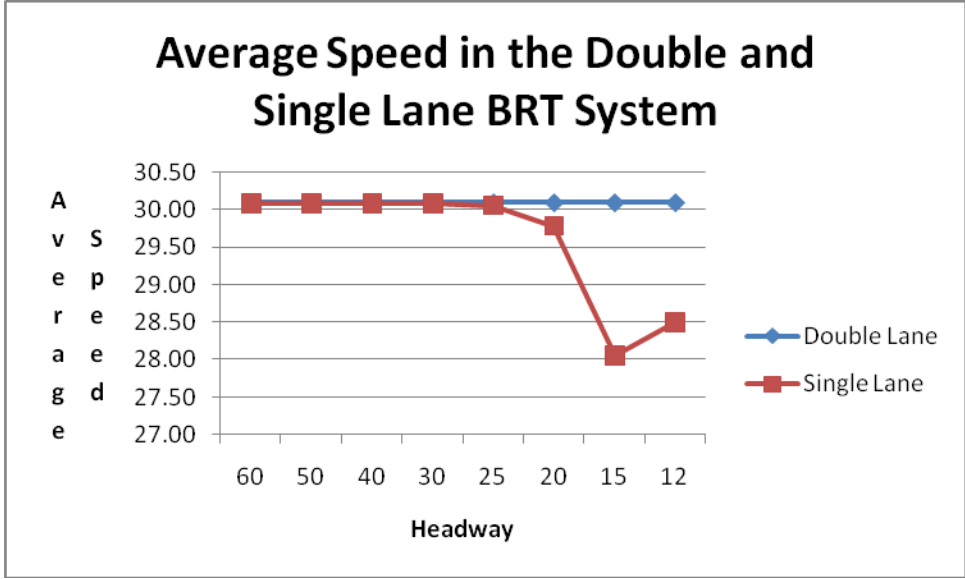

Figure 4-2 Average Speed in the Double and Single-lane BRT Systems

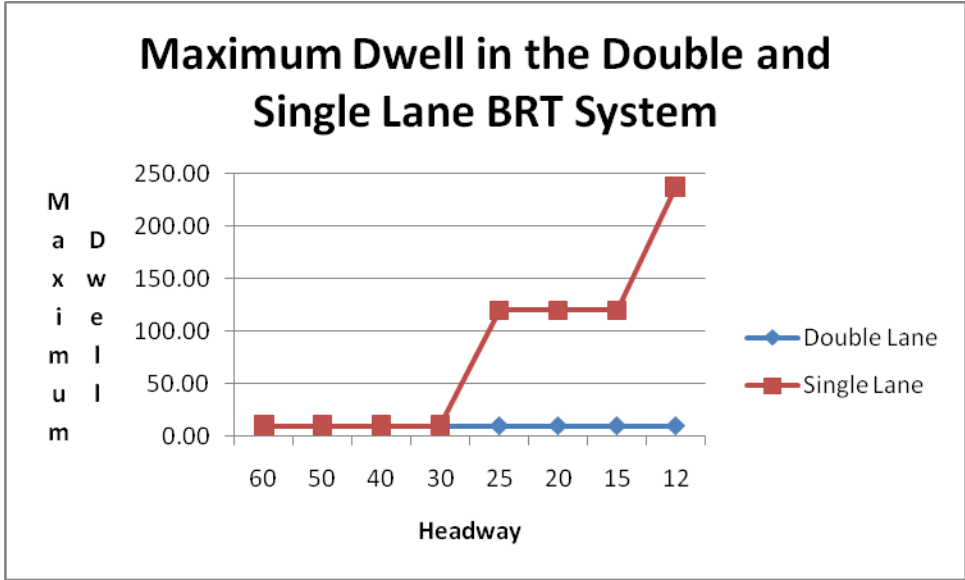

Figure 4-3 Maximum Dwell in the Double and Single-lane BRT Systems

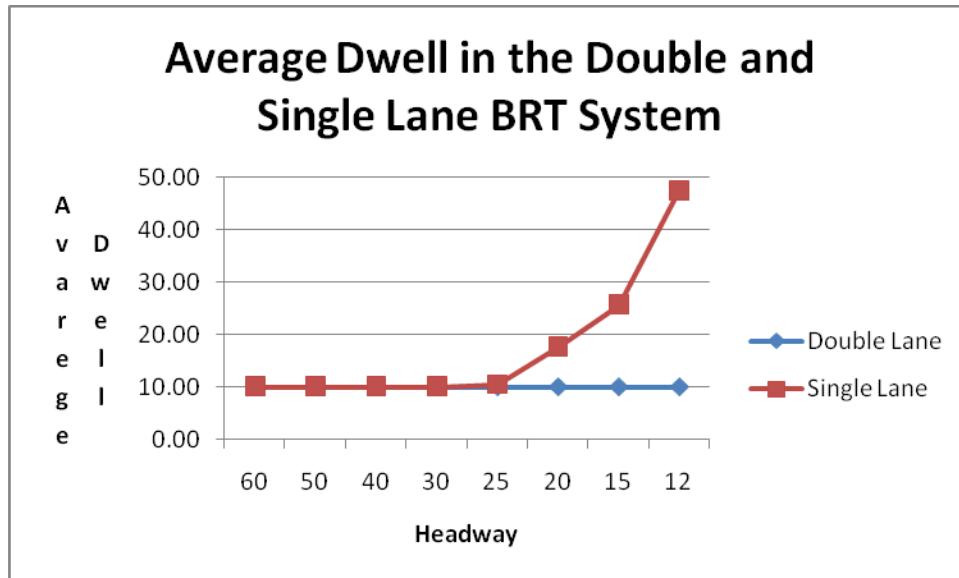

Figure 4-4 Average Dwell Time in the Double and Single-lane BRT Systems

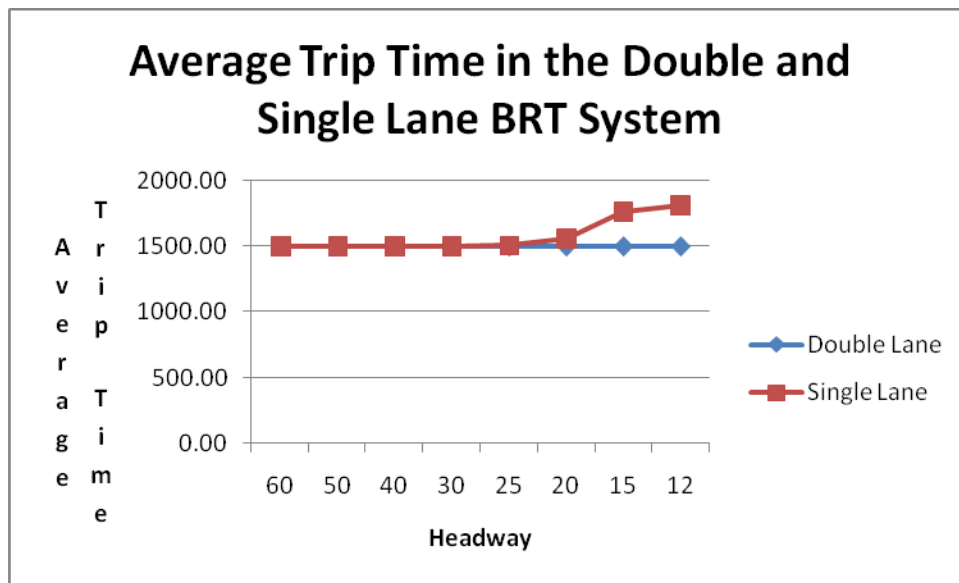

Figure 4-5 Average Trip Time in the Double and Single-lane BRT Systems

From the simulation results, we observe that higher service frequency does not imply a longer travel time. When the headway is sufficiently similar, the number of buses that simultaneously exist in the system is almost the same. The synchronization between buses is strongly related to the number of buses simultaneously existing in the system. When the number of buses in the system remains the same, other issues such as the specific starting time are also relevant. This can answer the question of why smaller headways may have shorter travel times in some situations.

Tables 4-3 and 4-4 present the computational results when 25% of bus trips are express trips, in which the bus only serves 50% of the bus stops. Figures 9 and 10 give graphical



representations of the BRT system with and without express buses. We can see that express buses slightly reduce the average trip time for the double-lane BRT system. The small improvement is expected since the dwell time (10 seconds for each bus stop) is relatively small in comparison with the total trip time in the double-lane BRT system. For the single-lane BRT system, the express buses also slightly reduce the average trip time. However, when the headway is 12 minutes, the BRT system without the express buses has an average trip time of 1810.86 seconds, while that for the BRT system with the express buses is 1871.31 seconds. The slightly longer travel time with express buses may be caused by the synchronization between the buses in the opposite direction.

**Table 4-3 Results of the BRT System with Double Dedicated Lanes and Express Buses**

Headway (minute)	Min Speed (MPH)	Avg. Speed (MPH)	Max Dwell (second)	Avg. Dwell (second)	Avg. Trip Time (second)	CPU time (second)	Opt. Gap (%)
60	30.00	30.09	10.00	8.42	1490.11	0.23	0.00
50	30.00	30.09	10.00	8.43	1490.17	0.28	0.00
40	30.00	30.09	10.00	8.45	1490.24	0.39	0.00
30	30.00	30.09	10.00	8.50	1490.50	0.52	0.00
25	30.00	30.09	10.00	8.50	1490.50	0.69	0.00
20	30.00	30.09	10.00	8.47	1490.37	0.97	0.00
15	30.00	30.09	10.00	8.50	1490.50	1.47	0.00
12	30.00	30.09	10.00	8.50	1490.50	1.88	0.00

**Table 4-4 Results of the BRT System with Single Dedicated Lanes and Express Buses**

Headway (minute)	Min Speed (MPH)	Avg. Speed (MPH)	Max Dwell (second)	Avg. Dwell (second)	Avg. Trip Time (second)	CPU time (second)	Opt. Gap (%)
60	28.28	30.05	10.00	8.42	1492.74	0.37	0.00
50	28.28	30.05	10.00	8.43	1492.78	0.44	0.00
40	28.28	30.05	10.00	8.45	1492.66	0.58	0.00
30	28.28	30.05	10.00	8.50	1492.87	1.05	0.00
25	12.00	30.02	120.00	8.89	1499.13	0.97	0.00
20	12.02	29.40	120.00	11.82	1564.04	14405.94	3.23
15	12.89	28.62	120.00	15.64	1627.51	14404.81	5.99
12	11.87	27.62	120.00	41.89	1871.31	14403.83	23.65

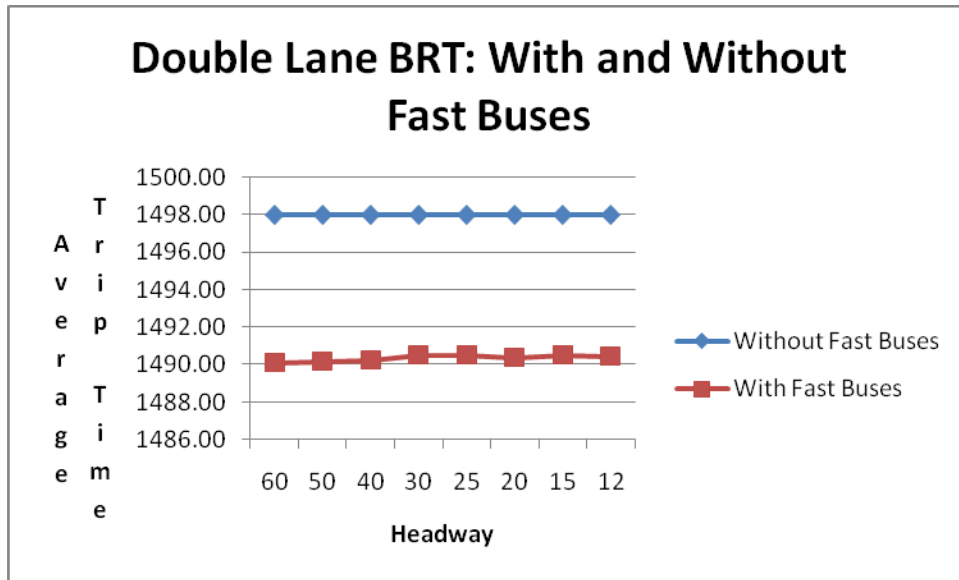

**Figure 4-6 Average Trip Time in the Double-lane BRT System with and without Express Buses**

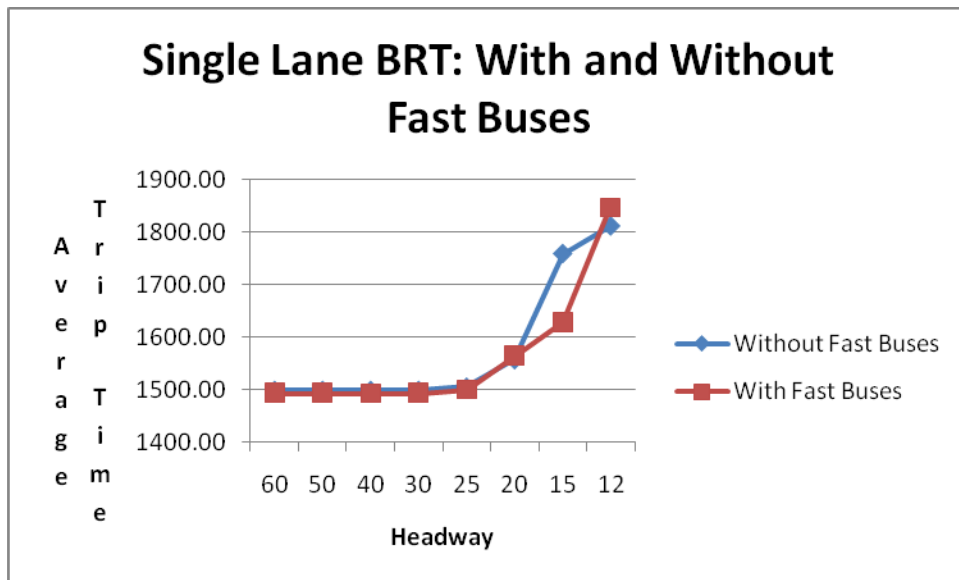

**Figure 4-7 Average Trip Time in the Single-lane BRT System with and without Express Buses**

In summary, when the headway is at least 15 minutes, the BRT system with a single dedicated lane has a similar travel time to the system with double dedicated lanes. In this situation, it is recommended that the BRT system with the single dedicated lane be used if it is difficult to build the system with two lanes. When the headway is small (less than 12 minutes), the travel time in the BRT system with single dedicated lanes increases by about 20% in our case study. However, the schedules obtained for the single-lane system

are not assured to be optimal. When a better algorithm is designed, it is expected to further reduce the travel time in the BRT system with the single dedicated lane.

## 5.0 Speed Control

One of the key features of a single-lane BRT system is that the buses traveling in opposite directions must meet at stations in specially designed bypass lanes. As mentioned previously, uncertainty issues exist in the BRT system with the dedicated lane, caused by possible delays due to red traffic lights, uncertain dwell times at bus stops, etc. Significant delays may result in loss of synchronization between the buses. Additionally, the loss of synchronization between buses can be caused if a BRT bus runs ahead of schedule. Because the buses are operated by drivers who are not aware of the operational status of the traffic signals and vehicles approaching from the opposite direction until they are in visual range, it is difficult to coordinate buses in opposite directions to precisely maintain the planned schedule. Consequently, one bus often needs to wait for another bus for an extended time, lowering the schedule reliability of the system as well as its efficiency (in terms of utilization of operating resources and passenger travel times).

Intelligent Transportation System (ITS) technologies can substantially improve the BRT operational efficiency. GPS and proven wireless communication systems can be used on the BRT buses to monitor and share information, such as their location and speed, with each other and the transit operations center. An advanced speed control algorithm can dynamically adjust the speed of buses based on estimation of arrival times of buses in the opposite direction, factoring in the distance to the station of each bus and the traffic signal status. Real-time speed control allows buses to coordinate their speed adaptively to reduce the possibility of conflicts, reduce dwell time and improve the performance reliability of the system.

We designed a simple speed-control strategy to adjust bus speeds in order to keep up with the original schedule when buses are delayed considerably at an intersection. The cycle lengths of the intersection traffic controllers along the BRT route were obtained from Caltrans. Based on historical data, the probability that a bus passes an intersection without stopping is obtained. The speed-control strategy attempts to increase or decrease the current speed based on the current bus location, the scheduled arrival time, the number of intersections from the current location to the approaching bus stop, the cycle length and the corresponding passing probability. If real-time information regarding the controller is available, the speed-control algorithm can be improved. Meanwhile, the maximum acceleration and deceleration are also considered so that the bus cannot change its speed too abruptly.

## 6.0 Traffic Simulation

We used the VISSIM microscopic simulation tool to evaluate impacts of the proposed BRT systems on signalized intersections, particularly traffic delays. Figure 6-1 shows the informational flow of the simulation testing system. The testing system is composed of VISSIM and C++ programs. Each process is elaborated in the following sections.

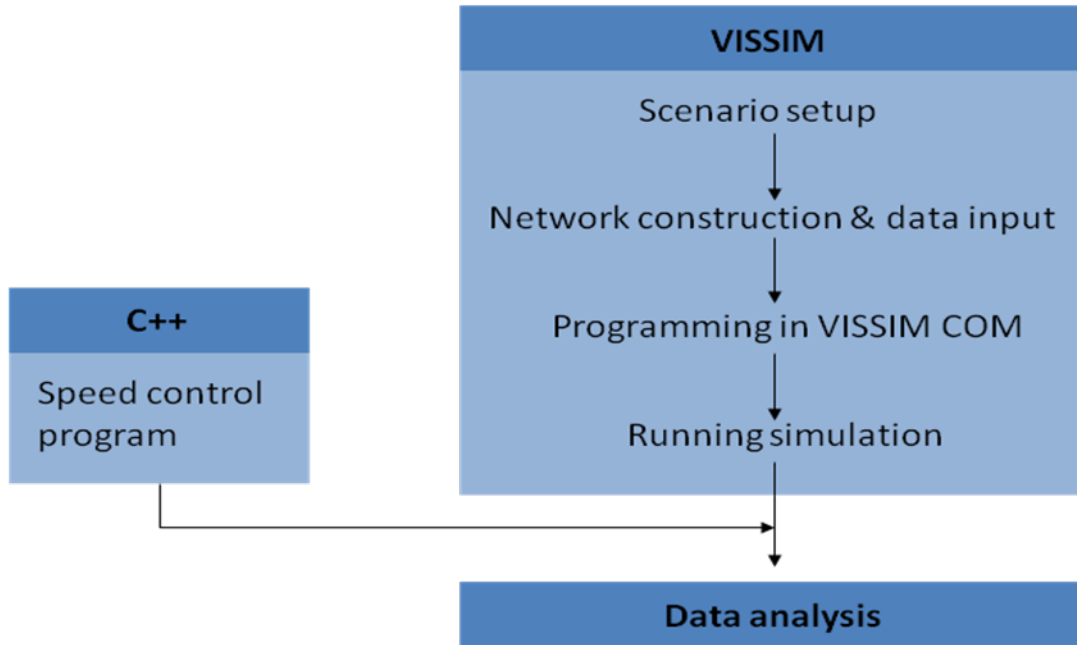

**Figure 6-1 Flow of simulation work**

### 6.1 Simulation scenario

The simulation scenarios are carefully defined. Although there are some detailed scenarios, we can roughly divide this simulation into four cases: the original case, double-lane BRT, single-lane BRT without speed control and single-lane BRT with speed control, as illustrated in Table 6-1.

**Table 6-1 Flow of simulation work**

Case	Description
Original case	<ul style="list-style-type: none"> <li>Simulation for current traffic status</li> </ul>
Double-lane BRT	<ul style="list-style-type: none"> <li>Simulation for the case of double BRT installation</li> </ul>
Single-lane BRT without speed control	<ul style="list-style-type: none"> <li>Simulation for the case of single BRT installation</li> <li>No bus control for schedule adherence</li> </ul>

Single-lane BRT with speed control	<ul style="list-style-type: none"> <li>• Simulation for the case of single BRT installation</li> <li>• Use of speed control algorithm for schedule adherence</li> </ul>
------------------------------------	---

## 6.2 Network construction

There are three networks for this simulation. First, a base network is constructed which is identical to the real network. This network is about 5.1 kilometers in length and extends from High Street to 98th Avenue along International Boulevard in Alameda County, California. This base network is used in the original case. According to a proposed reconstruction plan for the double-lane BRT system from Alameda-Contra Costa Transit District (AC Transit), one traffic lane in each direction will be converted to a dedicated bus lane. Our second simulation network is built upon these changes. Finally, our third simulation network utilizes the road median as the single dedicated bus lane. For all of the three networks, we have installed three BRT bus stops in each direction at High St., 56<sup>th</sup> Ave. and 98<sup>th</sup> Ave.. The constructed network is shown in Figure 6-2.

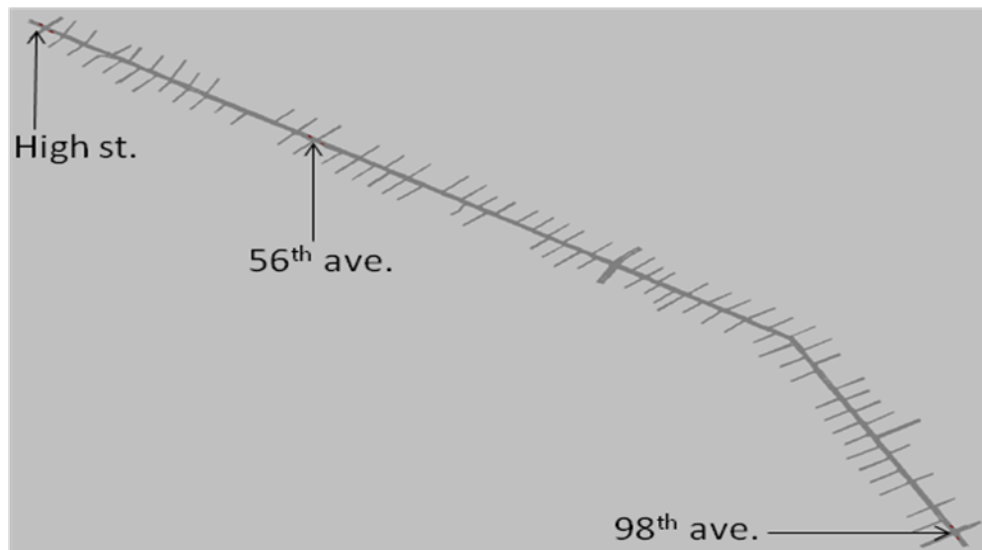

**Figure 6-2 VISSIM simulation network**

The origin-destination (OD) matrix and signal timing parameters were then prepared. A heuristic approach was developed to estimate the OD-matrix for the arterial. Because of the scarcity of historical traffic volumes and turning ratios for International Blvd, we derived the OD matrix based on a reasonable saturation degree and the signal timings. The signal timing parameters were obtained from Caltrans District 4. However, VISSIM does not support the timing parameters for Caltrans C8 software. Thus, we converted all of the C8 parameters into the NEMA-standard format and coded them into VISSIM.

For the transit service, the optimal bus schedules, which are calculated by the aforementioned scheduling model, are input to VISSIM. For simplification, the passenger boarding/alighting times are set to constants.

### 6.3 Programming in VISSIM COM

VISSIM provides a COM-programming interface, a simplified programming interface which supports script language to control objects in simulations and log status data. Figure 6-3 illustrates the processes developed in VISSIM COM. One process scans all vehicles in the VISSIM network and determines if the vehicles are passenger cars or buses, at every simulation time step. In the case that the vehicle is identified as a bus, the process collects the vehicle's speed and location information at that instant. Such information, together with the bus's schedule and current timestamp, is fed to the external speed-control program. After running an iteration of the speed control program with the inputs, the optimal bus speed is derived and fed back from the speed-control program. Finally, the optimal bus speed is set on the target bus through the COM interface.

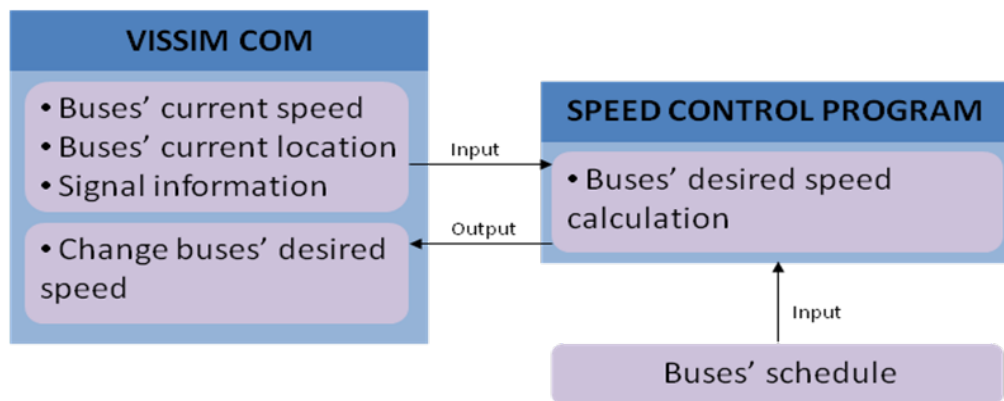
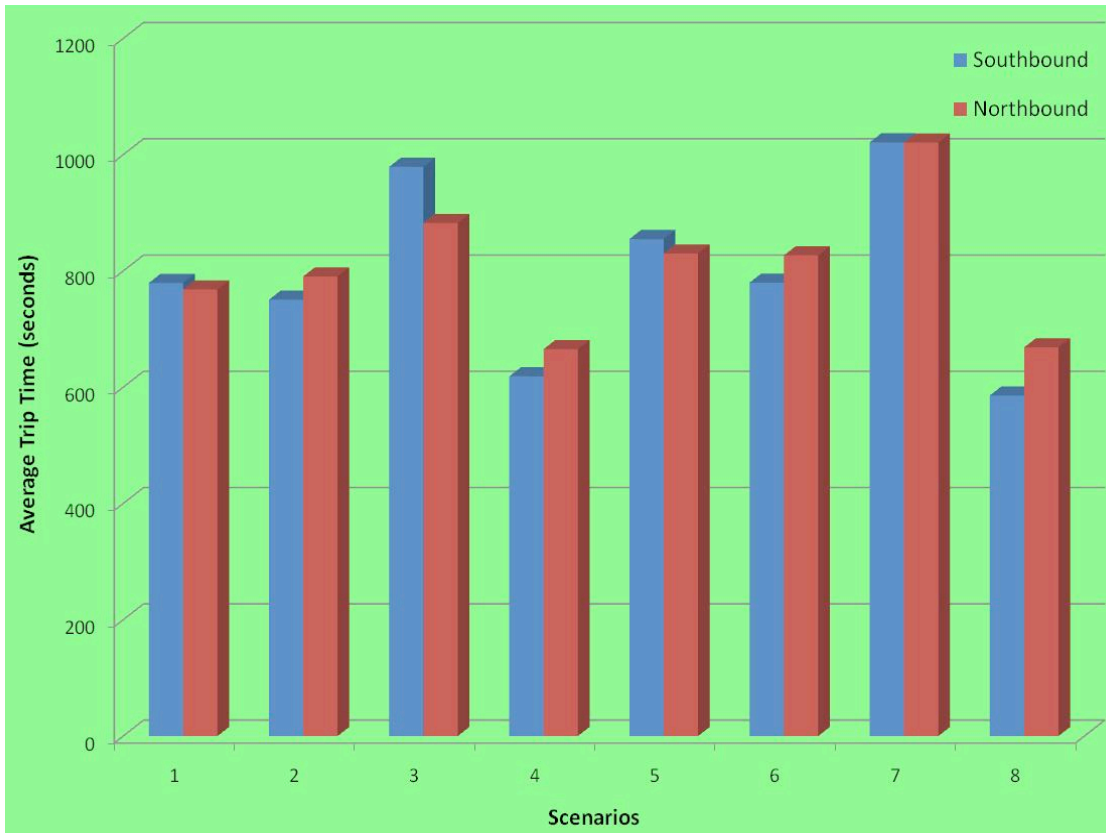

Figure 6-3 Programming process in VISSIM COM

### 6.4 Simulation results

The summary of simulation results consists of transit performance and traffic impacts. Measurements of effectiveness (MOEs) for transit performance include trip travel time, average trip speed, bus delays, maximum speed, standard deviation of speeds, average schedule deviations, average dwell time and standard deviation of dwell times. Figure 6-4 and Table 6-2 illustrate the average bus trip times and average dwelling times for all scenarios. For the traffic impacts, the MOEs are vehicle travel times, average speed and average delays at signalized intersections. Table 6-3 shows the average traffic intersection delay at all signalized intersections. Due to the page limit here, the detailed simulation results are not presented here but are included in the APPENDIX.



**Figure 6-4 Average Bus Trip Time**

Scenarios. 1: Original; 2: Double-lane BRT; 3: Single-lane BRT; 4: Single-lane BRT with speed control; 5~8: Scenario 1~4 with increased traffic demands

**Table 6-2 Average Bus Dwelling Time**

Scenarios (Dwelling time in seconds)	Southbound			Northbound			
	First bus stop	Second bus stop	Third bus stop	First bus stop	Second bus stop	Third bus stop	
<b>Original Traffic Demand</b>	Original	88.6	15.0	15.0	57.5	15.0	15.6
	Double-lane	102.6	15	15.0	102.1	15.0	13.1
	Single-lane	331.2	38.2	15.0	102.6	242.4	15.0
	Single-lane with speed control	139.6	79.4	15.0	139.6	79.4	15.0
<b>Increased Traffic Demand</b>	Original	74.6	15.4	15.3	17.9	15.0	15.3
	Double-lane	102.6	15	15	102.1	15.0	15.0
	Single-lane	102.6	245.3	15	274.9	45.6	15.0
	Single-lane with speed control	102.6	22.25	26.25	134.0	92.0	15.0



**Table 6-3 Average Traffic Intersection Delays**

Scenarios (Intersection delay in seconds/veh)		Intersections											
		High St.	46 <sup>th</sup>	53 <sup>rd</sup>	Seminary	62 <sup>nd</sup>	66 <sup>th</sup>	69 <sup>th</sup>	73 <sup>rd</sup>	85 <sup>th</sup>	90 <sup>th</sup>	94 <sup>th</sup>	98 <sup>th</sup>
<b>Original Traffic Demand</b>	Original	16	9	11	11	18	24	21	22	15	18	16	22
	Double-lane	17	7	10	11	18	25	9	23	9	14	12	30
	Single-lane	18	7	7	9	15	24	7	17	8	13	11	20
	Single-lane with speed control	18	7	7	9	15	24	8	18	8	13	11	20
<b>Increased Traffic Demand</b>	Original	42	14	14	17	47	29	22	50	11	17	43	47
	Double-lane	30	22	13	15	45	39	20	52	63	81	84	97
	Single-lane	45	14	11	17	31	31	12	39	11	17	18	47
	Single-lane with speed control	45	14	11	17	31	31	12	39	11	17	18	47

The dedicated bus lane is capable of increasing buses' cruising speeds and reducing intersection delays due to the queue jumper effects. However, the bus lane cannot reduce the passenger boarding/alighting time and might even increase the station dwelling time because some buses might have to wait until the buses travelling in the opposite direction are cleared from the bus lane in the single-lane BRT system.

In the double-lane BRT system, the bus performance, including the average trip time, intersection delays, and schedule adherence, is improved with respect to the original case. For example, the average bus trip time is been reduced by about 52 seconds/trip (6% of that in the original case). Under the original traffic condition, the traffic intersection delays were not significantly increased because the original traffic demands along International Blvd are not heavy, particularly from 46<sup>th</sup> Ave. to Seminary St. However, in the scenario with high traffic demands, the double-lane BRT system significantly increased the traffic intersection delays by about 17 seconds per vehicle (90% of that in the original case).

In the single-lane BRT system without speed-control programs, the average bus trip time is increased about 180 seconds/trip (22% of that in the original case). However, by adding the speed control process, the average bus trip time can be reduced by 215 seconds/trip (26% of that in the original case). Obviously, the speed-control process is very important for the single-lane BRT system. For the traffic impacts, the single-lane BRT system does not increase the average intersection delays because it does not change the intersection geometries.

In summary, the double-lane BRT system might significantly jeopardize the existing traffic condition, i.e., increasing the intersection delays by 90%, and provide only limited performance improvement on the currently existing transit service, i.e., 6% trip time reduction. The single-lane BRT system with the designed optimal schedules and adaptive speed control can improve the existing transit performance without incurring any significant traffic delays.

## **7.0 Cost and Deployment Analysis**

A single dedicated lane BRT will offer significant cost savings. However, the value of the cost savings is specific to the given project and will need to be determined based on project location and design. It is intuitive that a single-lane BRT will use at least 30-40% less lane-miles. Because typical cost estimation methods for highway construction are based on single-lane miles, savings in lane-miles will represent significant cost savings.

### **7.1 Single-lane Mile Cost**

A comprehensive study was conducted by the Washington State Department of Transportation (WSDOT) in 2002 [24]. In this study, WSDOT surveyed 25 states. The survey form was sent to members of the AASHTO Subcommittee on Design. Participants were asked to provide the unit costs in their states for the bid items included in the survey, and the percentage of the project cost devoted to mobilization, preliminary engineering, and construction engineering. The information gathered provides detail for calculation of the construction cost of the interchange and the construction cost of one lane-mile of highway. Survey participants were asked to identify the range of project costs in their state for right of way, environmental documentation (SEPA, NEPA, permitting), and environmental compliance and mitigation associated with construction.

The survey showed that the cost to construct a typical single-lane mile of highway ranges from \$1 million to \$8.5 million, with an average cost of \$2.3 million. The lane-mile costs for each state are shown in Table 7.1. The cost to construct a single-lane mile in California was about \$2.2M in 2002. Note that construction costs were limited to contract bid items to ensure valid comparison. Costs for engineering, shown as a percentage of the total construction dollars, ranged from 4 to 20 percent for both preliminary engineering (PE) and construction engineering (CE). The average for PE is 10.3 percent and for CE is 11.2 percent.

In addition to construction costs, additional costs include right of way, pre-construction environmental compliance, and construction environmental compliance and mitigation, which were not included in the WSDOT study because of the price variability that occurs based on project location. Right of way and environmental costs can vary significantly from project to project. The participating states of the WSDOT study were asked to identify the range of variability of project costs associated with right of way, pre-construction environmental compliance, and construction environmental compliance and mitigation. The variability rates for right of way ranged from 10 percent or less to over 30 percent of project costs. The rates for environmental documentation (SEPA, NEPA,

permitting) ranged from 10 percent or less to as much as 20 percent in three of the reporting states. The rates for construction environmental compliance and mitigation ranged from 10 percent or less to nearly 20 percent in four states.

**Construction Cost for a Single Lane Mile**

State Name	Construction Cost	Right Of Way Variability	Environmental Documentation Variability	Environmental Mitigation Variability	State Prevailing Wage Law	PE %	CE %	Mob %
Mississippi	\$1,033,576	11 - 20%	0 - 10%	0 - 10%	No	No Data	5%	5%
Montana	\$1,118,827	0 - 10%	0 - 10%	0 - 10%	Yes	<10%	10%	8%
Wyoming	\$1,261,046	11 - 20%	0 - 10%	0 - 10%	Yes	10%	12%	8%
Arizona	\$1,295,908	>30%	11 - 20%	11 - 20%	No	8%	15%	10%
Ohio	\$1,330,176	11 - 20%	0 - 10%	0 - 10%	Yes	10%	8%	3%
Washington	\$1,445,662	0 - 10%	0 - 10%	11 - 20%	Yes	15%	15%	10%
Illinois	\$1,398,314	0 - 10%	0 - 10%	0 - 10%	Yes	10%	12%	3%
Michigan	\$1,454,462	>30%	11 - 20%	11 - 20%	Yes	8%	0 - 15%	5%
New Mexico	\$1,526,631	> 30%	0 - 10%	0 - 10%	Yes	8 - 10%	15 - 20%	10%
Oklahoma	\$1,510,910	11 - 20%	0 - 10%	0 - 10%	No	5%	9%	3%
South Dakota	\$1,616,581	0 - 10%	0 - 10%	0 - 10%	Yes	4%	10%	10%
North Carolina	\$1,590,182	> 30%	0 - 10%	0 - 10%	Yes	10%	10%	5%
West Virginia	\$1,572,946	11 - 20%	0 - 10%	0 - 10%	Yes	15%	18%	1%
Kansas	\$1,914,917	11 - 20%	0 - 10%	0 - 10%	No	7%	10%	6%
Louisiana	\$2,015,042	ROW costly item in urban areas	0 - 10%	0 - 10%	No	15%	4%	5%
Oregon	\$2,112,486	11 - 20%	0 - 10%	0 - 10%	Yes	12%	No Data	10%
Idaho	\$2,178,689	> 30%	0 - 10%	0 - 10%	No	10%	10%	10%
California	\$2,213,519	0 - 10%	0 - 10%	0 - 10%	Yes	20%	15%	10%
Arkansas	\$2,257,449	11 - 20%	0 - 10%	0 - 10%	Yes	10%	10%	10%
Massachusetts	\$3,069,336	Varies Widely	0 - 10%	0 - 10%	Yes	10%	10%	0%
Maine	\$3,594,823	0 - 10%	0 - 10%	0 - 10%	No	9%	10%	8%
New Jersey	\$4,787,268	11 - 20%	0 - 10%	0 - 10%	Yes	15%	10%	10%
Hawaii	\$5,942,278	11 - 20%	11 - 20%	0 - 10%	Yes	10%	15%	10%
New York	\$8,461,268	No Data	No Data	No Data	Yes	5%	10%	4%
Colorado	\$1,602,251	No Data	0-10%	11-20%	No	11%	11%	5%
Total Const. Cost	\$58,304,586							
Average Const. Cost	\$2,332,183							

**Table 7.1 Lane Mile Construction Costs**



Figure 7.1 VTA Alum Rock BRT Plan

## **7.2 Cost Savings for a Single-lane BRT**

As a case example, the cost savings for the Santa Clara/Alum Rock BRT lane was estimated. The Santa Clara Valley Transportation Authority is in the planning stage for a dedicated BRT system between HP Pavilion and Capital Light rail station at Alum Rock Ave. (see figure 7-1 for illustration of this planned BRT system).

The VTA's Alum Rock BRT is 4.5 miles long, with dedicated BRT lanes and 13 stations. The estimated construction costs are \$47.5M, averaging about \$5.3M per lane mile, including stations. Assuming that the station length is 120 ft long, the accumulate length of the stations is about 8% of the total length of the BRT lane. Because construction of the stations involves elevated platforms and amenities, we assumed that the construction cost for the 13 stations was 20% of the total project construction costs. Given these assumptions, should a single-lane BRT be implemented, the total cost of the system can be reduced to \$28.5M, a 40% cost reduction. When designed properly, this BRT system can achieve similar passenger carrying capacity as the double-lane BRT.

Additional cost savings include costs for right of way, pre-construction environmental compliance, and construction environmental compliance and mitigation. Furthermore, the single-lane BRT will impact the conventional traffic far less than the double-lane BRT. Though these benefits need further quantitative assessment, we can determine that the cost savings of these factors will be significant for the Silicon Valley region.

## 8.0 Conclusion and Future Research

Dedicated BRT systems have been proven to be effective as an alternative to urban rail transit in some urban areas. However, due to physical and institutional constraints, it is not always possible to build double dedicated lanes for a BRT system in crowded downtown areas. BRT systems with a single dedicated lane have fewer requirements for physical facilities and are thus more attractive to transit agencies when passenger demand is moderate. For a single dedicated bi-directional BRT, however, the synchronization between buses traveling in opposite directions is crucial since only one bus can travel on a road section at a time. In a single lane design, overtaking and crossing can only occur at bus stops or passing zones if constructed. We applied a mixed integer programming model to formulate the problem and used the integer solver in CPLEX to solve it. A comparative analysis was conducted to examine the travel time for dedicated signal-lane and double-lane BRT systems on the same stretch of road under similar operational conditions. The case study shows that travel time is almost the same between the single dedicated and double dedicated lane systems when the headway is rather long (e.g., more than 20 minutes). If the headway is smaller and the service is more frequent (e.g., less than 15 minutes), the BRT system with the single dedicated lane leads to higher travel time due to intersection delays and the need of synchronization in maintaining schedules. In order to handle the potential delay at intersections, a simple speed control algorithm is designed to adjust the bus speed in real-time to catch up with the original schedule.

Future research can go in several directions. Currently, we are conducting an evaluation of the impact of single or double dedicated BRT systems on traffic. Additionally, we plan to design optimization algorithms to exploit the physical design of the single dedicated BRT system, including consideration of bypasses between stations if a road segment is very long. A more sophisticated speed control algorithm can also be investigated.

## References

1. Bussieck, M. R., T. Winter, and U. T. Zimmermann. Discrete Optimization in Public Rail Transport. *Mathematical Programming*, Vol. 79, 1997, pp. 415-444.
2. Brown, G. G., Goodman, C. E., and Wood, R. K. Annual Scheduling of Atlantic Fleet Naval Combatants. *Operations Research*, Vol. 38, 1990, pp. 249–259.
3. Cai, X., C. J. Goh, and A. I. Mees. Greedy Heuristic for Rapid Scheduling of Trains on a Single Track. *IIE Transactions*, Vol. 30, 1998, pp. 481-493.
4. Caprara, A., M. Fischetti, and P. Toth. 2002. Modeling and Solving the Train Timetabling Problem. *Operations Research* Vol. 50, 2002, pp. 851-861.
5. Carey, G. Bus Rapid Transit - The Eugene-Springfield, OR, USA, Experience. *ITE Journal-Institute of Transportation Engineers*, Vol. 76, 2006, pp. 20-23.
6. Carey, M. Extending a Train Pathing Model from One-way to Two-way Track. *Transportation Research Part B-Methodological*, Vol. 28, 1994, pp. 395-400.
7. Carey, M. A Model and Strategy for Train Pathing with Choice of Lines, Platforms, and Routes. *Transportation Research Part B-Methodological*, Vol. 28, 1994, pp. 333-353.
8. Carey, M., and I. Crawford. Scheduling Trains on a Network of Busy Complex Stations. *Transportation Research Part B-Methodological*, Vol. 41, 2007, pp. 159-178.
9. Carey, M., and D. Lockwood. A Model, Algorithms and Strategy for Train Pathing. *Journal of the Operational Research Society*, Vol. 46, 1995, pp. 988-1005.
10. Chen, B. and P. Harker. Two Moments Estimation of Delay on a Single-Track Rail Lines with Scheduled Traffic. *Transportation Science*, Vol. 24, 1990, pp. 261-275.
11. Cordeau, J.-F., P. Toth, and D. Vigo. A Survey of Optimization Models for Train Routing and Scheduling. *Transportation Science*, Vol. 32, 1998, pp. 380-404.
12. Darido, G., and A. Cain. Report on South American Bus Rapid Transit Field Visits: Tracking the Evolution of the TransMilenio model. Technical Report No. 0704-0188, Federal Transit Administration, U.S. Department of Transportation, December, 2007.
13. Diaz, R.B. et al, Characteristics of Bus Rapid Transit for Decision-Making, Federal Transit Administration, FTA-VA-26-7222-2004.1, August 2004.
14. Hanks, J.R., G. McKenney, and G. Carey, G. Block Signal Control for Bus Rapid Transit, *Compendium of Papers* Institute of Transportation Engineers 2000 District 6 Annual Meeting.
15. GoBRT Website: <http://www.gobrt.org/>
16. Hensher, D. A., and T. F. Golob. Bus Rapid Transit Systems: a Comparative Assessment. *Transportation*, Vol. 35, 2008, pp. 501-518.
17. Higgins, A., E. Kozan, and L. Ferreira. Optimal Scheduling of Trains on a Single Line Track. *Transportation Research Part B-Methodological*, Vol. 30, 1996, pp. 147-161.
18. Higgins, A., E. Kozan, and L. Ferreir. Modeling the Number and Location of Sidings on a Single Line Railway. *Computers and Operations Research*, Vol. 24, 1997, pp. 209-220.
19. JRH Transportation Engineering, (2002) Traffic Design Study – Part 1 Downtown Eugene to Franklin Boulevard DRAFT.
20. Petersen, E. R. and Taylor, A. J. A Structured Model for Rail Line Simulation and Optimization. *Transportation Science*, Vol. 16, 1982, pp. 192-205.
21. Szpigel, B. 1973. “Optimal Train Scheduling on a Single Line Railway”, *Operation Research*, Vol. 72, 1973, pp. 344-351.

22. Wright, L. and W. Hook, Institute for Transportation & Development Policy, *Bus Rapid Transit Planning Guide*, June 2007.
23. Zhou, X., and M. Zhong. Single-track Train Timetabling with Guaranteed Optimality: Branch-and-bound algorithms with Enhanced Lower Bounds. *Transportation Research Part B-Methodological*, Vol. 41, 2007, pp. 320-341
24. Washington State Department of Transportation, "Highway Construction Cost Comparison Survey", April 2002



APPENDIX --- Simulation Testing Results

1. Current OD

1.1 Original case

- MOE for Bus
  - Trip time & average trip speed

Elapsed time	Southbound						Northbound					
	From High st. to 56th ave. (1349 m)			From 56th ave to 98th ave. (3757 m)			From 98th ave. to 56th ave. (3753 m)			From 56th ave. to High st. (1342 m)		
	A	B	C	A	B	C	A	B	C	A	B	C
600	255.5	1	19.0	0	0	0.0	0	0	0.0	0	0	0.0
1200	260.9	1	18.6	580.3	1	23.3	579.6	1	23.3	184	1	26.3
1800	0	0	0.0	491.4	1	27.5	561.8	1	24.0	196.8	1	24.5
2400	262.7	1	18.5	0	0	0.0	0	0	0.0	0	0	0.0
3000	252.1	1	19.3	492.6	1	27.5	676.6	1	20.0	184.9	1	26.1
3600	0	0	0.0	585.6	1	23.1	556	1	24.3	191.5	1	25.2
4200	257.9	1	18.8	0	0	0.0	0	0	0.0	0	0	0.0
4800	263.1	1	18.5	487.6	1	27.7	597.9	1	22.6	189.4	1	25.5
5400	0	0	0.0	505.4	1	26.8	499.1	1	27.1	192	1	25.2
6000	257.6	1	18.9	0	0	0.0	0	0	0.0	0	0	0.0
6600	256.8	1	18.9	545.7	1	24.8	605.5	1	22.3	183.8	1	26.3
7200	0	0	0.0	481.5	1	28.1	579.7	1	23.3	167.4	1	28.9

\*\*A: Trip time (second), B: Number of buses, C: Average trip speed (km/h)

- Delay

	Southbound	Northbound
	From High st. to 98th ave.	From 98th ave. to High st.
Delay (sec/veh)	99.9	121

- Maximum speed and standard deviation of speed

	Southbound	Northbound
Maximum speed (km/h)	37.1	37.1
Std. dev. of speed	13.5	13.4

- Average time difference between scheduled time and actual time

	Southbound			Northbound		
	First bus stop	Second bus stop	Third bus stop	First bus stop	Second bus stop	Third bus stop
Ave. difference (sec)	19.4	176.4	386.1	50.5	242.3	317.4

- Average dwell time & standard deviation of dwell time

	Southbound			Northbound		
	First bus stop	Second bus stop	Third bus stop	First bus stop	Second bus stop	Third bus stop
Ave. dwell time (sec)	88.6	15	15	57.5	15.0	15.6
Std. deviation	0.52	0	0	17.69	0	1.187735

- Traffic
  - Trip time & average trip speed

Elapsed time	Southbound		Northbound	
	Trip time (second)	Average trip speed (km/h)	Trip time (second)	Average trip speed (km/h)
600	437	42.0	432.8	42.4
1200	458	40.1	432.2	42.4
1800	434.7	42.3	439.2	41.7
2400	465.4	39.5	441.1	41.6
3000	456.2	40.3	458	40.0
3600	444	41.4	433.2	42.3
4200	485.6	37.8	425.1	43.1
4800	462.1	39.8	416	44.1
5400	445.7	41.2	451.5	40.6
6000	452.7	40.6	427.3	42.9
6600	459.7	40.0	442.1	41.5
7200	468.8	39.2	514.4	35.6

- Intersection delay

Elapsed time	Intersection													
	High st.		46th		53rd		seminary		62nd		66th		69th	
	A	B	A	B	A	B	A	B	A	B	A	B	A	B
1-600	28	376	9	309	11	247	12	289	16	275	19	276	20	280
601-1200	16	351	7	281	11	228	9	266	20	276	26	263	22	271
1201-1800	16	346	8	290	11	245	9	266	17	260	28	267	17	281
1801-2400	14	348	8	294	13	243	11	262	17	264	25	267	22	307

2401-3000	12	362	6	337	8	261	11	304	20	294	25	278	23	305
3001-3600	13	381	9	301	13	241	12	273	18	252	24	251	20	257
3601-4200	19	399	9	355	12	284	11	303	18	306	22	281	20	293
4201-4800	15	330	11	299	12	241	10	287	19	278	26	286	20	290
4801-5400	17	338	7	262	10	222	12	256	19	273	21	261	24	287
5401-6000	15	351	11	310	10	228	10	269	18	257	22	243	22	272
6001-6600	14	371	10	326	10	258	12	294	19	274	26	250	18	258
6601-7200	14	364	10	311	10	250	9	269	17	266	25	278	21	291
Total	16	4317	9	3675	11	2948	11	3338	18	3275	24	3201	21	3392

\*\*A: Delay (second), B: Number of vehicles

Elapsed time	Intersection											
	73rd		82nd		85th		90th		94th		98th	
	A	B	A	B	A	B	A	B	A	B	A	B
1-600	19	336	59	86	13	91	21	161	16	212	23	439
601-1200	21	315	73	90	17	87	18	144	15	224	19	419
1201-1800	17	354	70	83	15	111	17	170	17	194	25	417
1801-2400	22	353	63	89	18	110	16	153	17	210	18	406
2401-3000	17	322	43	83	16	83	16	147	15	193	21	415
3001-3600	15	305	63	105	11	102	19	162	16	210	25	447
3601-4200	17	379	72	96	14	100	15	169	14	209	23	401
4201-4800	25	348	57	87	15	89	18	156	14	221	23	429
4801-5400	29	319	68	102	15	101	17	177	15	196	21	417
5401-6000	17	318	64	77	13	72	21	142	17	218	22	435
6001-6600	15	298	69	94	18	79	16	139	14	197	18	414
6601-7200	44	328	69	93	18	103	18	176	16	207	22	422
Total	22	3975	65	1085	15	1128	18	1896	16	2491	22	5061

\*\*A: Delay (second), B: Number of vehicles

## 1.2 Double lane case

- Bus
  - Trip time & average trip speed

Elapsed time	Southbound						Northbound					
	From High st. to 56th ave. (1349 m)			From 56th ave to 98th ave. (3757 m)			From 98th ave. to 56th ave. (3753 m)			From 56th ave. to High st. (1342 m)		
	A	B	C	A	B	C	A	B	C	A	B	C
600	264	1	18.4	0	0	0.0	0	0	0.0	0	0	0.0
1200	269.4	1	18.0	487.2	1	27.8	584.2	1	23.1	0	0	0.0
1800	0	0	0.0	529.5	1	25.5	0	0	0.0	183.3	1	26.4
2400	264.7	1	18.3	0	0	0.0	609.3	1	22.2	181.7	1	26.6
3000	259.7	1	18.7	488.1	1	27.7	0	0	0.0	0	0	0.0
3600	0	0	0.0	488.7	1	27.7	612.3	1	22.1	165.5	1	29.2
4200	258.2	1	18.8	0	0	0.0	624.5	1	21.6	184.8	1	26.1
4800	262.7	1	18.5	449.6	1	30.1	567.8	1	23.8	0	0	0.0
5400	0	0	0.0	535	1	25.3	0	0	0.0	199.8	1	24.2
6000	267.6	1	18.1	0	0	0.0	585.1	1	23.1	177.4	1	27.2
6600	256	1	19.0	498.2	1	27.1	0	0	0.0	0	0	0.0
7200	0	0	0.0	427.1	1	31.7	667.4	1	20.2	193.1	1	25.0

\*\*A: Trip time (second), B: Number of buses, C: Average trip speed (km/h)

- Delay

	Southbound	Northbound
		From High st. to 98th ave.
Delay (sec/veh)	29.4	47.4

- Maximum speed and standard deviation of speed

	Southbound	Northbound
Maximum speed (km/h)	37.11	36.80
Std. dev. of speed	13.60	14.08

- Average difference between scheduled time and actual time

	Southbound	Northbound

	First bus stop	Second bus stop	Third bus stop	First bus stop	Second bus stop	Third bus stop
Ave. difference (sec)	5.4	167.4	343.9	5.9	222.3	294.9

- Average dwell time & standard deviation of dwell time

	Southbound			Northbound		
	First bus stop	Second bus stop	Third bus stop	First bus stop	Second bus stop	Third bus stop
Ave. dwell time (sec)	102.6	15	15	102.1	15.0	13.1
Std. deviation	1.30	0	0	0.99	0	0

- Traffic
  - Trip time & average trip speed

Elapsed time	Southbound		Northbound	
	Trip time (second)	Average trip speed (km/h)	Trip time (second)	Average trip speed (km/h)
600	438.5	41.9	428.5	42.8
1200	481.6	38.1	461.6	39.7
1800	412.6	44.5	452.7	40.5
2400	413.2	44.5	432.1	42.4
3000	448.8	40.9	453.8	40.4
3600	484.4	37.9	432.5	42.4
4200	444.4	41.3	490	37.4
4800	425.8	43.1	464.2	39.5
5400	442.6	41.5	471.1	38.9
6000	430.2	42.7	434.4	42.2
6600	417.8	44.0	428.5	42.8
7200	476.1	38.6	455.8	40.2

- Intersection delay

Elapsed time	Intersection													
	High st.		46th		53rd		seminary		62nd		66th		69th	
	A	B	A	B	A	B	A	B	A	B	A	B	A	B
1-600	24	363	8	362	10	224	12	258	17	230	20	225	7	284
601-1200	16	330	5	324	8	198	10	222	19	230	25	226	7	286
1201-1800	15	316	5	311	9	154	11	196	18	200	30	211	7	261
1801-2400	16	310	5	297	13	181	12	218	18	209	37	224	10	288
2401-3000	13	339	7	372	7	186	12	225	20	236	24	228	11	294

3001-3600	16	352	8	345	11	203	12	250	15	229	22	217	10	276
3601-4200	18	375	7	393	12	229	10	238	19	232	28	234	10	303
4201-4800	19	307	9	340	11	213	9	256	18	271	27	273	8	325
4801-5400	17	326	5	311	10	177	12	205	19	208	18	202	10	279
5401-6000	17	308	9	313	9	162	12	196	18	196	27	193	9	274
6001-6600	17	340	8	334	9	192	13	244	19	227	25	224	7	278
6601-7200	15	337	7	353	12	199	11	222	15	210	23	218	10	300
Total	17	4003	7	4055	10	2318	11	2730	18	2678	25	2675	9	3448

\*\*A: Delay (second), B: Number of vehicles

Elapsed time	Intersection											
	73rd		82nd		85th		90th		94th		98th	
	A	B	A	B	A	B	A	B	A	B	A	B
1-600	21	520	14	245	7	223	16	280	14	286	30	476
601-1200	24	508	17	260	9	239	14	242	12	280	31	481
1201-1800	22	524	13	252	9	246	14	263	13	284	30	490
1801-2400	22	554	11	269	11	261	12	259	14	303	28	503
2401-3000	21	502	16	240	10	213	13	236	12	257	29	474
3001-3600	24	480	18	271	7	256	14	278	12	301	35	531
3601-4200	26	560	13	266	8	238	15	252	12	279	31	478
4201-4800	26	555	12	262	8	245	15	275	12	283	30	483
4801-5400	22	508	23	270	9	241	15	266	12	280	30	513
5401-6000	21	499	15	251	6	234	15	262	13	296	28	501
6001-6600	23	499	16	257	8	235	12	249	11	284	29	491
6601-7200	23	515	15	275	11	258	15	280	11	291	30	526
Total	23	6224	15	3118	9	2889	14	3142	12	3424	30	5947

\*\*A: Delay (second), B: Number of vehicles

### 1.3 Single lane without speed control case

- Bus
  - Trip time & average trip speed

Elapsed time	Southbound						Northbound					
	From High st. to 56th ave. (1349 m)			From 56th ave to 98th ave. (3757 m)			From 98th ave. to 56th ave. (3753 m)			From 56th ave. to High st. (1342 m)		
	A	B	C	A	B	C	A	B	C	A	B	C
600	264	1	18.4	0	0	0.0	0	0	0.0	0	0	0.0
1200	265.1	1	18.3	512.8	1	26.4	0	0	0.0	0	0	0.0
1800	0	0	0.0	0	0	0.0	774.7	1	17.4	201.8	1	23.9

2400	265.9	1	18.3	693.4	1	19.5	0	0	0.0	0	0	0.0
3000	265.1	1	18.3	839.1	1	16.1	914.1	1	14.8	200.4	1	24.1
3600	0	0	0.0	592.8	1	22.8	604.4	1	22.4	202.9	1	23.8
4200	264.8	1	18.3	0	0	0.0	868.6	1	15.6	0	0	0.0
4800	265	1	18.3	789.8	1	17.1	0	0	0.0	203.3	1	23.8
5400	0	0	0.0	0	0	0.0	887.6	1	15.2	185	1	26.1
6000	265	1	18.3	868.8	1	15.6	0	0	0.0	0	0	0.0
6600	264.8	1	18.3	895.8	1	15.1	743.7	2	18.2	188.8	1	25.6
7200	0	0	0.0	522.1	1	25.9	0	0	0.0	202.5	1	23.9

\*\*A: Trip time (second), B: Number of buses, C: Average trip speed (km/h)

- Delay

	Southbound	Northbound
	From High st. to 98th ave.	From 98th ave. to High st.
Delay (sec/veh)	192.3	186.8

- Maximum speed and standard deviation of speed

	Southbound	Northbound
Maximum speed (km/h)	34.99	34.99
Std. dev. of speed	15.03	15.18

- Average difference between scheduled time and actual time

	Southbound			Northbound		
	First bus stop	Second bus stop	Third bus stop	First bus stop	Second bus stop	Third bus stop
Ave. difference (sec)	3.2	440.5	529.8	5.4	167.1	574.2

- Average dwell time & standard deviation of dwell time

	Southbound			Northbound		
	First bus stop	Second bus stop	Third bus stop	First bus stop	Second bus stop	Third bus stop
Ave. dwell time (sec)	331.2	38.2	15.0	102.6	242.4	15.0
Std. deviation	121.4	8.0	0.0	1.4	147.1	0.0

- Traffic
  - Trip time & average trip speed

Elapsed time	Southbound		Northbound	
	Trip time (second)	Average trip speed (km/h)	Trip time (second)	Average trip speed (km/h)
600	475.6	38.6	469.2	39.1
1200	445.9	41.2	443.2	41.4
1800	453.3	40.5	459	39.9
2400	475	38.7	462.9	39.6
3000	469	39.2	444	41.3
3600	468.9	39.2	459.5	39.9
4200	466.7	39.4	492.6	37.2
4800	479.8	38.3	471	38.9
5400	492.9	37.3	463.1	39.6
6000	413.8	44.4	461.7	39.7
6600	450.5	40.8	469.4	39.1
7200	492	37.3	441.9	41.5

- Intersection delay

Elapsed time	Intersection													
	High st.		46th		53rd		seminary		62nd		66th		69th	
	A	B	A	B	A	B	A	B	A	B	A	B	A	B
1-600	28	369	7	364	8	342	10	384	14	355	19	350	5	334
601-1200	22	341	6	310	7	288	9	334	14	319	21	333	6	326
1201-1800	15	335	7	339	6	327	9	365	13	356	28	338	6	328
1801-2400	15	314	5	315	9	308	10	344	15	329	31	337	9	331
2401-3000	13	328	7	340	5	312	9	386	15	350	28	333	9	328
3001-3600	16	362	8	344	8	331	10	379	14	343	23	350	8	325
3601-4200	20	381	8	391	9	356	8	399	13	389	24	371	8	359
4201-4800	16	313	9	362	8	349	8	399	17	382	29	396	7	355
4801-5400	17	320	6	329	6	306	9	357	16	343	20	313	9	320
5401-6000	15	321	9	327	8	313	9	356	15	330	20	317	8	315
6001-6600	17	342	8	350	7	342	11	407	17	374	26	360	6	337
6601-7200	15	333	8	351	8	320	8	354	15	332	24	327	8	338
Total	18	4059	7	4122	7	3894	9	4464	15	4202	24	4125	7	3996

\*\*A: Delay (second), B: Number of vehicles



Elapsed time	Intersection											
	73rd		82nd		85th		90th		94th		98th	
	A	B	A	B	A	B	A	B	A	B	A	B
1-600	16	581	21	271	6	237	15	267	13	283	21	493
601-1200	18	554	24	298	8	256	13	271	12	285	20	487
1201-1800	17	577	24	263	9	245	14	261	11	278	20	502
1801-2400	18	586	23	290	10	268	11	283	13	300	20	505
2401-3000	15	549	28	273	8	234	13	246	12	278	20	468
3001-3600	17	538	23	299	7	268	14	277	12	319	24	534
3601-4200	20	609	23	277	8	246	14	277	11	300	18	501
4201-4800	18	572	22	284	9	252	14	269	10	290	20	483
4801-5400	18	564	27	290	9	245	15	280	11	277	20	496
5401-6000	15	525	24	257	8	232	16	259	13	300	18	494
6001-6600	17	556	22	309	8	262	12	263	10	300	19	490
6601-7200	17	567	25	298	9	273	13	293	11	301	21	513
Total	17	6778	24	3409	8	3018	13	3246	11	3511	20	5966

\*\*A: Delay (second), B: Number of vehicles

#### 1.4 Single lane with speed control case

- Bus
  - Trip time & average trip speed

Elapsed time	Southbound						Northbound					
	From High st. to 56th ave. (1349 m)			From 56th ave to 98th ave. (3757 m)			From 98th ave. to 56th ave. (3753 m)			From 56th ave. to High st. (1342 m)		
	A	B	C	A	B	C	A	B	C	A	B	C
600	239.6	1	20.3	347.8	1	38.9	0	0	0.0	0	0	0.0
1200	225.7	1	21.5	0	0	0.0	468.9	1	28.8	0	0	0.0
1800	0	0	0.0	421.3	1	32.1	0	0	0.0	198.5	1	24.3
2400	249.2	1	19.5	0	0	0.0	497.6	1	27.2	179.8	1	26.9
3000	240.3	1	20.2	372.3	1	36.3	447.3	1	30.2	0	0	0.0
3600	0	0	0.0	438	1	30.9	0	0	0.0	224.1	1	21.6
4200	226	1	21.5	0	0	0.0	534.9	1	25.3	151.9	1	31.8
4800	247.1	1	19.7	431.7	1	31.3	523.6	1	25.8	0	0	0.0
5400	0	0	0.0	351.3	1	38.5	0	0	0.0	155.6	1	31.0
6000	219	1	22.2	0	0	0.0	437.3	1	30.9	213.5	1	22.6
6600	242.4	1	20.0	406.3	1	33.3	378.2	1	35.7	0	0	0.0
7200	0	0	0.0	293.5	1	46.1	0	0	0.0	248.7	1	19.4

\*\*A: Trip time (second), B: Number of buses, C: Average trip speed (km/h)

- Delay

	Southbound	Northbound
--	------------	------------

	From High st. to 98th ave.	From 98th ave. to High st.
Delay (sec/veh)	100.2	128.3

- Maximum speed and standard deviation of speed

	Southbound	Northbound
Maximum speed (km/h)	52.4	53.6
Std. dev. of speed	21.35	23.85

- Average difference between scheduled time and actual time

	Southbound			Northbound		
	First bus stop	Second bus stop	Third bus stop	First bus stop	Second bus stop	Third bus stop
Ave. difference (sec)	5.4	138.8	215.8	3.9	84.9	170.1

- Average dwell time & standard deviation of dwell time

	Southbound			Northbound		
	First bus stop	Second bus stop	Third bus stop	First bus stop	Second bus stop	Third bus stop
Ave. dwell time (sec)	139.6	79.4	15.0	139.6	79.4	15.0
Std. deviation	1.51	7.07	0.00	34.69	39.93	0.00

- Traffic

- Trip time & average trip speed

Elapsed time	Southbound		Northbound	
	Trip time (second)	Average trip speed (km/h)	Trip time (second)	Average trip speed (km/h)
600	425.7	43.2	471.6	38.9
1200	443.8	41.4	477.6	38.4
1800	461.4	39.8	460.7	39.8
2400	472.4	38.9	471.7	38.9
3000	443.7	41.4	479.9	38.2
3600	483.5	38.0	479.1	38.3
4200	470.6	39.0	480.1	38.2
4800	467.9	39.3	472.4	38.8
5400	462.5	39.7	467.1	39.2

6000	470.4	39.1	445	41.2
6600	456.3	40.3	465.8	39.4
7200	472.7	38.9	474.9	38.6

• Intersection delay

Elapsed time	Intersection													
	High st.		46th		53rd		seminary		62nd		66th		69th	
	A	B	A	B	A	B	A	B	A	B	A	B	A	B
1-600	28	370	7	370	8	342	9	384	13	346	20	346	5	337
601-1200	22	338	6	309	7	294	8	348	15	336	20	337	7	324
1201-1800	15	335	7	339	7	325	8	358	14	355	25	329	7	325
1801-2400	15	317	5	316	9	309	10	347	15	341	27	343	8	330
2401-3000	13	333	7	342	5	316	9	391	14	342	26	358	9	340
3001-3600	16	359	7	349	8	332	11	382	14	359	23	335	9	326
3601-4200	20	377	8	386	9	366	10	401	14	382	26	359	8	369
4201-4800	16	315	9	364	8	347	8	407	15	394	27	397	8	357
4801-5400	17	325	6	330	6	313	9	350	14	340	20	321	9	324
5401-6000	16	318	9	324	8	302	8	343	14	318	24	310	8	310
6001-6600	17	339	9	346	7	325	12	386	18	363	25	354	6	334
6601-7200	16	330	8	341	8	324	7	361	14	336	22	324	9	331
Total	18	4056	7	4116	7	3895	9	4458	15	4212	24	4113	8	4007

\*\*A: Delay (second), B: Number of vehicles

Elapsed time	Intersection											
	73rd		82nd		85th		90th		94th		98th	
	A	B	A	B	A	B	A	B	A	B	A	B
1-600	17	572	21	269	8	236	16	262	12	268	22	492
601-1200	18	558	24	297	9	255	13	274	12	293	21	495
1201-1800	20	583	22	273	10	248	15	268	13	269	21	491
1801-2400	17	575	22	278	10	255	12	268	12	302	19	502
2401-3000	17	561	27	279	9	248	12	251	11	275	21	478
3001-3600	16	535	28	295	7	258	14	277	12	323	22	542
3601-4200	20	617	26	284	7	263	12	283	10	294	19	480
4201-4800	19	594	21	292	8	253	13	274	10	297	20	497
4801-5400	16	543	30	283	9	243	15	276	11	281	21	507
5401-6000	16	533	27	259	7	229	14	261	13	295	20	503
6001-6600	19	550	23	320	7	275	10	280	9	322	19	490

6601-7200	18	557	26	287	10	271	13	278	12	280	21	501
Total	18	6778	25	3416	8	3034	13	3252	11	3499	20	5978
**A: Delay (second), B: Number of vehicles												

## 2. Increased OD

### 2.1 Original case

- Bus
  - Trip time & average trip speed

Elapsed time	Southbound						Northbound					
	From High st. to 56th ave. (1349 m)			From 56th ave to 98th ave. (3757 m)			From 98th ave. to 56th ave. (3753 m)			From 56th ave. to High st. (1342 m)		
	A	B	C	A	B	C	A	B	C	A	B	C
600	315.9	1	15.4	0	0	0.0	0	0	0.0	0	0	0.0
1200	0	0	0.0	689.5	1	19.6	643.2	1	21.0	240.8	1	20.1
1800	306.3	1	15.9	0	0	0.0	629.9	1	21.4	0	0	0.0
2400	248.1	1	19.6	607.2	1	22.3	0	0	0.0	193.1	1	25.0
3000	253.7	1	19.1	604.1	1	22.4	497.2	1	27.2	198	1	24.4
3600	0	0	0.0	549.7	1	24.6	598.2	1	22.6	0	0	0.0
4200	264.8	1	18.3	0	0	0.0	0	0	0.0	194.3	1	24.9
4800	270.1	1	18.0	519.2	1	26.1	643	1	21.0	193.5	1	25.0
5400	0	0	0.0	526.7	1	25.7	0	0	0.0	0	0	0.0
6000	256.7	1	18.9	0	0	0.0	842.3	1	16.0	194	1	24.9
6600	267.6	1	18.1	579.2	1	23.4	596.2	1	22.7	210.7	1	22.9
7200	0	0	0.0	0	0	0.0	563.4	1	24.0	0	0	0.0
**A: Trip time (second), B: Number of buses, C: Average trip speed (km/h)												

- Delay

	Southbound	Northbound
	From High st. to 98th ave.	From 98th ave. to High st.
Delay (sec/veh)	182.5	216.9

- Maximum speed and standard deviation of speed

	Southbound	Northbound
Maximum speed (km/h)	37.11	37.16
Std. dev. of speed	13.94	13.82

- Average difference between scheduled time and actual time

	Southbound			Northbound		
	First bus stop	Second bus stop	Third bus stop	First bus stop	Second bus stop	Third bus stop
Ave. difference (sec)	33.4	205.4	476.3	96.1	341.0	433.7

- Average dwell time & standard deviation of dwell time

	Southbound			Northbound		
	First bus stop	Second bus stop	Third bus stop	First bus stop	Second bus stop	Third bus stop
Ave. dwell time (sec)	74.6	15.4	15.3	17.9	15.0	15.3
Std. deviation	35.25	5.55	5.45	7.84	0.00	0.76

○ Traffic

- Trip time & average trip speed

Elapsed time	Southbound		Northbound	
	Trip time (second)	Average trip speed (km/h)	Trip time (second)	Average trip speed (km/h)
600	492.7	37.3	535.5	34.2
1200	526.6	34.9	583.2	31.4
1800	500.3	36.7	574.5	31.9
2400	548.8	33.5	522.7	35.1
3000	574.5	32.0	472.9	38.8
3600	516.3	35.6	596.4	30.7
4200	507.4	36.2	521.3	35.2
4800	521.4	35.2	480.1	38.2
5400	527.2	34.9	867.1	21.1
6000	520.5	35.3	661.3	27.7
6600	510.4	36.0	654.6	28.0
7200	515.5	35.6	842.3	21.8

- Intersection delay

Elapsed time	Intersection													
	High st.		46th		53rd		seminary		62nd		66th		69th	
	A	B	A	B	A	B	A	B	A	B	A	B	A	B
1-600	38	586	12	558	15	448	16	533	35	521	30	489	20	487
601-1200	50	640	12	529	14	426	19	475	45	478	26	505	22	535
1201-1800	43	636	9	564	14	458	16	534	47	485	36	447	26	454

1801-2400	43	678	10	601	15	482	15	527	48	525	38	509	26	512
2401-3000	41	612	12	548	12	415	17	497	54	466	30	463	23	505
3001-3600	44	632	13	598	15	460	21	542	47	530	26	530	20	521
3601-4200	42	653	16	582	17	479	18	547	47	530	21	497	24	514
4201-4800	36	615	17	555	14	417	13	451	53	456	30	427	23	442
4801-5400	37	618	16	536	14	425	20	515	45	508	24	513	20	528
5401-6000	47	669	15	583	12	438	16	513	46	535	25	511	22	542
6001-6600	44	568	17	557	13	433	19	507	54	489	26	461	22	464
6601-7200	42	503	15	456	15	348	16	424	43	415	29	407	21	410
Total	42	7410	14	6667	14	5229	17	6065	47	5938	29	5759	22	5914

\*\*A: Delay (second), B: Number of vehicles

Elapsed time	Intersection											
	73rd		82nd		85th		90th		94th		98th	
	A	B	A	B	A	B	A	B	A	B	A	B
1-600	39	878	47	409	10	377	17	411	37	414	45	695
601-1200	39	816	58	423	11	423	16	442	40	438	52	678
1201-1800	43	777	51	425	11	374	16	412	40	426	47	744
1801-2400	40	792	49	435	17	388	17	420	46	424	48	688
2401-3000	45	753	52	422	8	360	14	399	45	397	48	686
3001-3600	41	784	51	428	9	390	16	412	45	418	49	700
3601-4200	32	618	53	426	10	377	16	400	44	407	47	695
4201-4800	91	718	54	412	13	398	23	428	43	405	46	718
4801-5400	63	852	66	431	13	369	17	419	41	441	46	717
5401-6000	67	791	74	400	10	376	17	413	47	396	47	721
6001-6600	51	818	66	458	11	396	15	423	40	447	47	756
6601-7200	46	623	59	271	15	278	16	300	44	314	45	508
Total	50	9220	57	4940	11	4506	17	4879	43	4927	47	8306

\*\*A: Delay (second), B: Number of vehicles

## 2.2 Double lane case

- Bus
  - Trip time & average trip speed

Elapsed time	Southbound						Northbound							
	From High st. to 56th ave. (1349 m)			From 56th ave to 98th ave. (3757 m)			From 98th ave. to 56th ave. (3753 m)			From 56th ave. to High st. (1342 m)				
	A	B	C	A	B	C	A	B	C	A	B	C		

600	268.5	1	18.1	0	0	0.0	0	0	0.0	0	0	0.0
1200	277.6	1	17.5	534.2	1	25.3	0	0	0.0	0	0	0.0
1800	0	0	0.0	484.7	1	27.9	623.7	1	21.7	196.6	1	24.6
2400	274.7	1	17.7	0	0	0.0	629.3	1	21.5	186.8	1	25.9
3000	259.5	1	18.7	532.1	1	25.4	585.7	1	23.1	0	0	0.0
3600	0	0	0.0	550.3	1	24.6	0	0	0.0	184.9	1	26.1
4200	281.7	1	17.2	0	0	0.0	624.6	1	21.6	246	1	19.6
4800	282.6	1	17.2	519.1	1	26.1	586.8	1	23.0	0	0	0.0
5400	0	0	0.0	490.1	1	27.6	0	0	0.0	183.8	1	26.3
6000	285	1	17.0	0	0	0.0	623.5	1	21.7	247.1	1	19.6
6600	279.5	1	17.4	491.7	1	27.5	0	0	0.0	0	0	0.0
7200	0	0	0.0	429.2	1	31.5	623	1	21.7	247.5	1	19.5
**A: Trip time (second), B: Number of buses, C: Average trip speed (km/h)												

- Delay

	Southbound	Northbound
	From High st. to 98th ave.	From 98th ave. to High st.
Delay (sec/veh)	44.0	65.3

- Maximum speed and standard deviation of speed

	Southbound	Northbound
Maximum speed (km/h)	37.11	37.11
Std. dev. of speed	14.03	14.40

- Average difference between scheduled time and actual time

	Southbound			Northbound		
	First bus stop	Second bus stop	Third bus stop	First bus stop	Second bus stop	Third bus stop
Ave. difference (sec)	5.4	180.5	373.4	5.9	229.1	331.4

- Average dwell time & standard deviation of dwell time

	Southbound			Northbound		
	First bus stop	Second bus stop	Third bus stop	First bus stop	Second bus stop	Third bus stop

Ave. dwell time (sec)	102.6	15	15	102.1	15.0	15.0
Std. deviation	1.30	0	0	0.99	0	0

- Traffic
  - Trip time & average trip speed

Elapsed time	Southbound		Northbound	
	Trip time (second)	Average trip speed (km/h)	Trip time (second)	Average trip speed (km/h)
600	678.0	27.1	753.6	24.3
1200	755.4	24.3	900.9	20.4
1800	998.9	18.4	1258.9	14.6
2400	987.3	18.6	1148.3	16.0
3000	993.1	18.5	1234.2	14.9
3600	990.2	18.5	1191.2	15.4
4200	991.7	18.5	1212.7	15.1
4800	990.9	18.5	1201.9	15.3
5400	893.2	20.6	1207.3	15.2
6000	942.1	19.5	1156.3	15.9
6600	917.6	20.0	1181.8	15.5
7200	929.8	19.8	1169.0	15.7

- Intersection delay

Elapsed time	Intersection														
	High st.		46th		53rd		seminary		62nd		66th		69th		
	A	B	A	B	A	B	A	B	A	B	A	B	A	B	
1-600	30	447	21	531	13	333	16	384	42	356	38	325	9	390	
601-1200	35	497	13	498	13	275	16	352	41	319	38	343	12	412	
1201-1800	17	447	20	489	12	268	15	327	50	313	38	308	14	395	
1801-2400	19	464	15	530	13	314	14	345	42	317	37	314	16	368	
2401-3000	15	440	14	471	12	240	16	304	54	248	68	155	27	165	
3001-3600	19	465	16	464	15	191	15	109	35	81	40	29	33	98	
3601-4200	18	408	15	311	16	28	5	30	51	66	10	17	37	130	
4201-4800	65	69	63	34	10	26	5	30	40	62	11	11	35	112	
4801-5400	20	27	18	1	19	12	11	5	11	42	55	8	14	35	112
5401-6000	18	1	37	77	6	0	8	0	8	42	55	5	24	27	138
6001-	47	13	60	8	0	7	0	8	35	1	6	18	32	119	



6600	5		5												
6601-7200	36	24	76	3	5	0	5	0	5	0	2	14	14	31	125
Total	30	3338	22	3366	13	1686	15	1892	45	1873	39	1572	20	2564	

\*\*A: Delay (second), B: Number of vehicles

Elapsed time	Intersection											
	73rd		82nd		85th		90th		94th		98th	
	A	B	A	B	A	B	A	B	A	B	A	B
1-600	40	733	50	323	40	295	30	357	36	386	43	753
601-1200	42	751	58	359	64	277	72	270	139	271	59	548
1201-1800	43	676	95	276	97	202	63	232	130	269	135	394
1801-2400	45	594	91	35	99	155	134	31	129	113	109	270
2401-3000	52	267	129	29	82	29	363	4	115	81	140	108
3001-3600	88	141	115	17	63	17	650	5	78	81	111	101
3601-4200	99	153	78	11	68	11	645	5	50	71	139	74
4201-4800	82	125	50	14	99	14	434	16	37	84	156	108
4801-5400	63	161	37	24	82	24	316	8	64	79	102	104
5401-6000	68	200	45	18	63	18	522	8	59	72	168	94
6001-6600	68	164	43	11	54	14	481	5	32	57	228	94
6601-7200	55	179	11	7	53	2	658	6	44	68	194	89
Total	52	4144	67	993	63	774	81	947	84	1632	97	2737

\*\*A: Delay (second), B: Number of vehicles

### 2.3 Single lane without speed control case

- Bus
  - Trip time & average trip speed

Elapsed time	Southbound						Northbound					
	From High st. to 56th ave. (1349 m)			From 56th ave to 98th ave. (3757 m)			From 98th ave. to 56th ave. (3753 m)			From 56th ave. to High st. (1342 m)		
	A	B	C	A	B	C	A	B	C	A	B	C
600	271.3	1	17.9	0	0	0.0	0	0	0.0	0	0	0.0
1200	275.1	1	17.7	496.8	1	27.2	0	0	0.0	0	0	0.0
1800	0	0	0.0	0	0	0.0	808.3	1	16.7	262.2	1	18.4
2400	278.1	1	17.5	835.6	1	16.2	0	0	0.0	0	0	0.0
3000	265.1	1	18.3	834.2	1	16.2	919.5	1	14.7	203.9	1	23.7
3600	0	0	0.0	613.7	1	22.0	624.5	1	21.6	246.1	1	19.6
4200	273.1	1	17.8	0	0	0.0	876.5	1	15.4	0	0	0.0
4800	271.1	1	17.9	839.8	1	16.1	0	0	0.0	204.4	1	23.6
5400	0	0	0.0	0	0	0.0	924.4	1	14.6	0	0	0.0
6000	270	1	18.0	984.1	1	13.7	678.4	1	19.9	275.2	2	17.6
6600	272.1	1	17.8	641.5	1	21.1	0	0	0.0	0	0	0.0

7200	0	0	0.0	0	0	0.0	925.6	1	14.6	0	0	0.0
**A: Trip time (second), B: Number of buses, C: Average trip speed (km/h)												

- Delay

	Southbound	Northbound
	From High st. to 98th ave.	From 98th ave. to High st.
Delay (sec/veh)	205.5	242.3

- Maximum speed and standard deviation of speed

	Southbound	Northbound
Maximum speed (km/h)	34.99	34.99
Std. dev. of speed	15.18	15.20

- Average difference between scheduled time and actual time

	Southbound			Northbound		
	First bus stop	Second bus stop	Third bus stop	First bus stop	Second bus stop	Third bus stop
Ave. difference (sec)	5.4	174.3	614.9	4.1	435.0	554.2

- Average dwell time & standard deviation of dwell time

	Southbound			Northbound		
	First bus stop	Second bus stop	Third bus stop	First bus stop	Second bus stop	Third bus stop
Ave. dwell time (sec)	102.6	245.3	15	274.9	45.6	15.0
Std. deviation	1.3	154.2	5.3	149.6	30.7	5.7

- Traffic

- Trip time & average trip speed

Elapsed time	Southbound		Northbound	
	Trip time (second)	Average trip speed (km/h)	Trip time (second)	Average trip speed (km/h)
600	541	34.0	597.7	30.7
1200	540.1	34.0	590	31.1
1800	523.4	35.1	606.8	30.2

2400	540.8	34.0	748.8	24.5
3000	540.6	34.0	637.9	28.8
3600	565.7	32.5	606.4	30.2
4200	573.5	32.0	569	32.2
4800	589.9	31.1	575	31.9
5400	579.5	31.7	601.8	30.5
6000	534.9	34.3	651.6	28.1
6600	555.5	33.1	733.1	25.0
7200	575.1	31.9	647.1	28.3

• Intersection delay

Elapsed time	Intersection													
	High st.		46th		53rd		seminary		62nd		66th		69th	
	A	B	A	B	A	B	A	B	A	B	A	B	A	B
1-600	39	573	11	628	14	605	15	676	28	631	28	585	7	557
601-1200	51	573	13	569	11	545	18	640	34	553	39	523	10	547
1201-1800	42	556	11	588	9	545	17	631	33	575	40	539	15	558
1801-2400	49	599	13	640	11	608	15	676	23	631	32	663	21	607
2401-3000	44	619	12	665	9	620	16	728	35	649	29	605	12	632
3001-3600	42	608	13	661	11	624	21	719	27	675	27	623	9	573
3601-4200	44	643	15	691	18	655	18	699	36	630	31	613	10	615
4201-4800	45	549	16	599	11	548	15	636	35	624	32	614	10	580
4801-5400	48	577	14	627	9	609	18	690	28	626	27	586	9	618
5401-6000	48	634	14	627	9	590	16	685	33	630	32	581	17	593
6001-6600	40	618	15	638	11	586	21	684	31	605	30	647	16	608
6601-7200	49	485	14	559	10	516	17	568	25	564	29	491	8	490
Total	45	7034	14	7492	11	7051	17	8032	31	7393	31	7070	12	6978

\*\*A: Delay (second), B: Number of vehicles

Elapsed time	Intersection											
	73rd		82nd		85th		90th		94th		98th	
	A	B	A	B	A	B	A	B	A	B	A	B
1-600	35	889	20	445	10	406	18	445	18	438	45	753
601-1200	37	908	31	512	12	471	17	473	13	511	45	776
1201-1800	38	853	25	450	10	405	13	468	15	478	51	736
1801-2400	42	882	29	457	17	419	17	443	23	498	54	773
2401-3000	36	903	28	497	8	450	17	467	15	506	42	780
3001-3600	40	898	28	516	8	457	16	494	17	499	53	780

3601-4200	40	908	26	466	9	432	18	478	15	522	45	798
4201-4800	35	898	26	493	10	441	17	465	17	527	46	810
4801-5400	39	913	30	511	13	467	18	501	22	529	49	766
5401-6000	42	908	26	523	9	462	17	490	21	523	47	765
6001-6600	41	869	31	484	12	432	17	466	17	479	46	792
6601-7200	39	656	30	395	13	351	16	351	18	365	47	602
Total	39	10485	28	5749	11	5193	17	5541	18	5875	47	9131

\*\*A: Delay (second), B: Number of vehicles

## 2.4 Single lane with speed control case

- Bus
  - Trip time & average trip speed

Elapsed time	Southbound						Northbound					
	From High st. to 56th ave. (1349 m)			From 56th ave to 98th ave. (3757 m)			From 98th ave. to 56th ave. (3753 m)			From 56th ave. to High st. (1342 m)		
	A	B	C	A	B	C	A	B	C	A	B	C
600	251.8	1	19.3	0	0	0.0	0	0	0.0	0	0	0.0
1200	225.7	1	21.5	419.2	1	32.3	575.3	1	23.5	0	0	0.0
1800	0	0	0.0	408.3	1	33.1	0	0	0.0	125.5	1	38.5
2400	259.2	1	18.7	0	0	0.0	454	1	29.8	234.3	1	20.6
3000	240.3	1	20.2	374.4	1	36.1	473.7	1	28.5	0	0	0.0
3600	0	0	0.0	289.7	1	46.7	0	0	0.0	195	1	24.8
4200	226	1	21.5	0	0	0.0	456.3	1	29.6	200.4	1	24.1
4800	252.1	1	19.3	442.7	1	30.6	525.3	1	25.7	0	0	0.0
5400	0	0	0.0	309.4	1	43.7	0	0	0.0	157.9	1	30.6
6000	219.2	1	22.2	193.2	1	70.0	393.4	1	34.3	258.5	1	18.7
6600	253.4	1	19.2	0	0	0.0	378	1	35.7	0	0	0.0
7200	0	0	0.0	323.6	1	41.8	0	0	0.0	253.9	1	19.0

\*\*A: Trip time (second), B: Number of buses, C: Average trip speed (km/h)

- Delay

	Southbound	Northbound
		From High st. to 98th ave.
Delay (sec/veh)	97,2	131.7

- Maximum speed and standard deviation of speed

	Southbound	Northbound
Maximum speed (km/h)	51.2	53.7
Std. dev. of speed	22.4	23.8

- Average difference between scheduled time and actual time

	Southbound			Northbound		
	First bus stop	Second bus stop	Third bus stop	First bus stop	Second bus stop	Third bus stop
Ave. difference (sec)	5.4	144.0	182.4	4.5	80.4	171.3

- Average dwell time & standard deviation of dwell time

	Southbound			Northbound		
	First bus stop	Second bus stop	Third bus stop	First bus stop	Second bus stop	Third bus stop
Ave. dwell time (sec)	102.6	22.25	26.25	134.0	92.0	15.0
Std. deviation	1.5	20.5	31.8	38.2	48.0	0.0

○ Traffic

- Trip time & average trip speed

Elapsed time	Southbound		Northbound	
	Trip time (second)	Average trip speed (km/h)	Trip time (second)	Average trip speed (km/h)
600	541	34.0	597.7	30.7
1200	540.1	34.0	590	31.1
1800	523.4	35.1	606.8	30.2
2400	540.8	34.0	748.8	24.5
3000	540.6	34.0	637.9	28.8
3600	565.7	32.5	606.4	30.2
4200	573.5	32.0	569	32.2
4800	589.9	31.1	575	31.9
5400	579.5	31.7	601.8	30.5
6000	534.9	34.3	651.6	28.1
6600	555.5	33.1	733.1	25.0
7200	575.1	31.9	647.1	28.3

- Intersection delay

Elapsed time	Intersection													
	High st.		46th		53rd		seminary		62nd		66th		69th	
	A	B	A	B	A	B	A	B	A	B	A	B	A	B
1-600	39	573	11	628	14	605	15	676	28	631	28	585	7	557
601-1200	51	573	13	569	11	545	18	640	34	553	39	523	10	547

1201-1800	42	556	11	588	9	545	17	631	33	575	40	539	15	558
1801-2400	49	599	13	640	11	608	15	676	23	631	32	663	21	607
2401-3000	44	619	12	665	9	620	16	728	35	649	29	605	12	632
3001-3600	42	608	13	661	11	624	21	719	27	675	27	623	9	573
3601-4200	44	643	15	691	18	655	18	699	36	630	31	613	10	615
4201-4800	45	549	16	599	11	548	15	636	35	624	32	614	10	580
4801-5400	48	577	14	627	9	609	18	690	28	626	27	586	9	618
5401-6000	48	634	14	627	9	590	16	685	33	630	32	581	17	593
6001-6600	40	618	15	638	11	586	21	684	31	605	30	647	16	608
6601-7200	49	485	14	559	10	516	17	568	25	564	29	491	8	490
Total	45	7034	14	7492	11	7051	17	8032	31	7393	31	7070	12	6978

\*\*A: Delay (second), B: Number of vehicles

Elapsed time	Intersection											
	73rd		82nd		85th		90th		94th		98th	
	A	B	A	B	A	B	A	B	A	B	A	B
1-600	35	889	20	445	10	406	18	445	18	438	45	753
601-1200	37	908	31	512	12	471	17	473	13	511	45	776
1201-1800	38	853	25	450	10	405	13	468	15	478	51	736
1801-2400	42	882	29	457	17	419	17	443	23	498	54	773
2401-3000	36	903	28	497	8	450	17	467	15	506	42	780
3001-3600	40	898	28	516	8	457	16	494	17	499	53	780
3601-4200	40	908	26	466	9	432	18	478	15	522	45	798
4201-4800	35	898	26	493	10	441	17	465	17	527	46	810
4801-5400	39	913	30	511	13	467	18	501	22	529	49	766
5401-6000	42	908	26	523	9	462	17	490	21	523	47	765
6001-6600	41	869	31	484	12	432	17	466	17	479	46	792
6601-7200	39	656	30	395	13	351	16	351	18	365	47	602
Total	39	10485	28	5749	11	5193	17	5541	18	5875	47	9131

\*\*A: Delay (second), B: Number of vehicles