

# Lawrence Berkeley National Laboratory

## LBL Publications

### Title

Impact of Information and Communications Technologies on Residential Customer Energy Services

### Permalink

<https://escholarship.org/uc/item/3c9226vg>

### Authors

Goldman, C

Kempton, W

Eide, A

et al.

### Publication Date

1996-10-01

# ERNEST ORLANDO LAWRENCE BERKELEY NATIONAL LABORATORY



## Impact of Information and Communications Technologies on Residential Customer Energy Services

C. Goldman, W. Kempton, A. Eide,  
M. Iyer, M. Farber, and R. Scheer  
**Energy and Environment Division**

October 1996

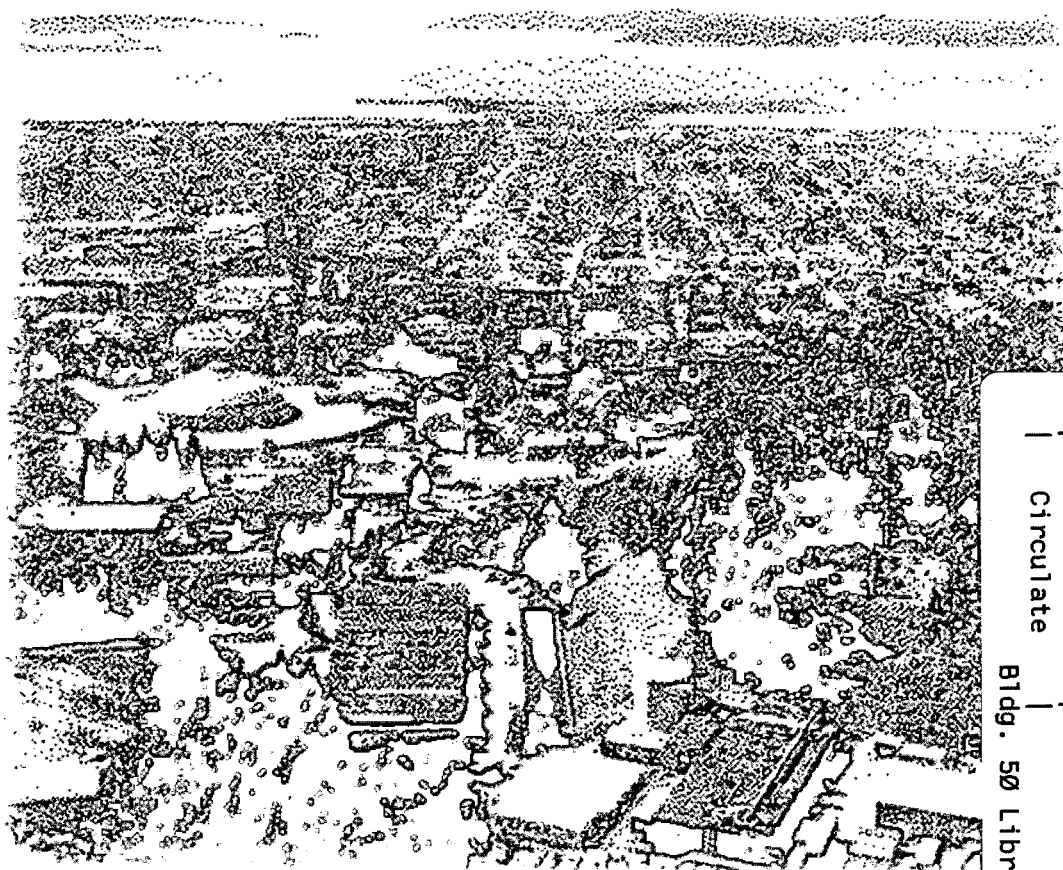

REFERENCE COPY |  
Does Not |  
Circulate |  
Bldg. 50 Library.

LBNL-39015

## **DISCLAIMER**

This document was prepared as an account of work sponsored by the United States Government. While this document is believed to contain correct information, neither the United States Government nor any agency thereof, nor the Regents of the University of California, nor any of their employees, makes any warranty, express or implied, or assumes any legal responsibility for the accuracy, completeness, or usefulness of any information, apparatus, product, or process disclosed, or represents that its use would not infringe privately owned rights. Reference herein to any specific commercial product, process, or service by its trade name, trademark, manufacturer, or otherwise, does not necessarily constitute or imply its endorsement, recommendation, or favoring by the United States Government or any agency thereof, or the Regents of the University of California. The views and opinions of authors expressed herein do not necessarily state or reflect those of the United States Government or any agency thereof or the Regents of the University of California.

# Impact of Information and Communications Technologies on Residential Customer Energy Services

*Charles Goldman, Lawrence Berkeley National Laboratory  
Willett Kempton, Anita Eide and Maithili Iyer, University of Delaware  
Mindi Farber and Richard Scheer, Energetics, Inc.*

Energy & Environment Division  
Lawrence Berkeley National Laboratory  
University of California  
Berkeley, California 94720

October 1996

---

# Contents

Tables .....	iii
Figures .....	v
Acknowledgments .....	vii
Acronyms and Abbreviations .....	ix
Executive Summary .....	xi
Chapter 1: Introduction .....	1
Chapter 2: Survey of Electric Utility Projects .....	9
Chapter 3: Market Trends .....	25
Chapter 4: Exploratory Market Research on Energy-Related and Non-Energy Services .....	39
Chapter 5: Exploratory Market Research: Summary and Key Findings .....	59
References .....	65
Appendix A: Selected Vendor Telecommunications Products .....	A-1
Appendix B: Descriptions of Selected Utility Projects .....	A-21
Appendix C: Interview Protocol: Focus Group and Individual Surveys .....	A-63
Appendix D: Customer Survey on Willingness to Pay .....	A-81



---

# Tables

Table ES-1. Overview of Utility-Customer Telecommunications Projects .....	xii
Table ES-2. Market Features: Project Costs and Savings .....	xvi
Table 1-1. Overview of Electric Utility Services Using Communications Systems .....	4
Table 1-2. Retail Electricity Market Opportunities Enabled by Technology Choices ...	5
Table 1-3. Demand-Side Management Programs and Communications Systems .....	6
Table 2-1. Electric Sales/Revenues and DSM Program Impacts for Sample Utilities ..	12
Table 2-2. Overview of Utility-Customer Telecommunications Projects .....	13
Table 2-3. Hybrid Fiber-Coax Cable Projects .....	15
Table 2-4. Potential Benefits of Fixed Radio Network Communications Systems .....	18
Table 2-5. Services Offered in Utility Telecommunications Projects .....	20
Table 3-1. Market Entry Strategy .....	27
Table 3-2. Link Between Utility's Strategic Vision and Project Objectives .....	31
Table 3-3. Team Members and Roles in Utility Telecommunications Projects .....	32
Table 3-4. Market Features: Project Costs and Savings .....	35
Table 4-1. American Home Energy Management Survey Results .....	40
Table 4-2. Profiles of Respondents .....	41
Table 4-3. Summary of Proposed Services .....	45
Table 4-4. Customer Interest in Energy and Non-Energy Services .....	46





---

# Figures

Figure 2-1. Selected Utility Telecommunications Projects .....	10
Figure 2-2. Sample Itemized Bill .....	23
Figure 4-1. Example of a Graphic Display for Neighborhood Comparison of Energy Use .....	48
Figure 4-2. Information on Energy-Efficient Products .....	52
Figure 4-3. Energy Information Videos .....	53
Figure 4-4. Interactive Service Center for Customer Queries .....	54



---

## Acknowledgments

Focus groups and interviews reported here were conducted by Anita Eide, Maithili Iyer, and Pablo Espinoza (working with W. Kempton). Helpful comments were provided on review drafts by: Andy Colman (FPN), Joe Eto (LBNL), Chris King (Cellnet), Frank Magnotti (Lucent Technologies), Steve Pickle (LBNL), Dennis Ragone (PSE&G), Steve Rivkin, and Bill White (C&SW). We would especially like to thank Diane Pirkey (U.S. DOE) for her support in bringing the research team together and for her vision and understanding of the importance of the topic for the future of residential energy services.

The work described in this study was funded by the Assistant Secretary of Energy Efficiency and Renewable Energy, Office of Utility Technologies, Office of Energy Management Division of the U.S. Department of Energy under Contract No. DE-AC03-76SF00098.



---

# Acronyms and Abbreviations

AEP	American Electric Power
AMR	Automated meter reading
BECO	Boston Edison
BG&E	Baltimore Gas & Electric
CSW	Central & South West
CCLM	Customer-controlled load management
CCU	Cell control unit
C/I	Commercial/industrial
DISCO	Distribution company
DLC	Direct Load control
DSM	Demand-side management
EIA	Energy Information Administration
EIS	Energy information services
ESCO	Energy service company
FERC	Federal Energy Regulatory Commission
Fiber-coax cable	Fiber-optic and coaxial cable network
FPN	First Pacific Network
HVAC	Heating, ventilation, and air-conditioning
IBUS	Integrated Broadband Utility Solution
ICS	Integrated Communications Systems
LAN	Local-area network
LEOS	Low-Earth Orbiting Satellites
KCP&L	Kansas City Power & Light
NII	National Information Infrastructure
PBR	Performance-based regulation
PCS	Personal Communications Services
PG&E	Pacific Gas & Electric
PLC	Power line carrier
PSC	Public Service of Colorado
PSE&G	Public Service Gas & Electric
PUC	Public utilities commission
RF	Wireless radio frequency
RTP	Real-time pricing
SDIG	Southern Development Investment Group
TECO	Tampa Electric
TOU	Time-of-use pricing
TVA	Tennessee Valley Authority
UBI	Universal Bi-directional Integration



---

# Executive Summary

This study analyzes the potential impact of information and communications technologies on utility delivery of residential customer energy services. Scores of U.S. utilities are conducting trials which test energy-related and non-energy services using advanced communications systems (e.g., hybrid fiber-coax cable or wireless radio networks). The cumulative investment by utility ratepayers and shareholders (and other equity partners) may soon approach recent funding levels for ratepayer-funded demand-side management (DSM) activities targeted at residential customers. Key drivers for these initiatives include the rapid innovation in and declining costs of information and communication technologies and utilities' desire to reduce operating costs and to provide enhanced services in order to retain and attract customers in emerging retail services markets.

## *Survey of Electric Utility Projects*

We identified about 40 projects initially based on a literature review of recent publications and the trade press and interviews with vendors. Projects were eliminated that were outside of the study's scope (e.g., focused on commercial/industrial customers) or because utility staff were unwilling to provide the minimum information requested in our survey. Telephone interviews were conducted with utility staff and equipment vendors involved in 21 projects between August and October 1995. Table ES-1 provides an overview of each project including the primary communications system, the project's status and stage of development, the number of participating households, and location.

## *Market Entry Strategies*

Electric utility-sponsored projects that offer communications-enabled services to residential customers can be distinguished along three important dimensions: (1) types of services provided, (2) the communications system used to deliver services (e.g., cable, twisted pair telephone wires, wireless radio), and (3) the utility's strategic approach to accessing telecommunications networks (e.g., own vs. lease) and partnering with telecommunications providers and product vendors.

- The diversity of market entry strategies reflects the early stage of market development. Today, no single communications system is capable of serving all residential market niches economically, in part because choosing the most attractive system (i.e., superior economics and technical features) depends to some extent on the characteristics of the utility (e.g., density, geographical terrain), the utility's exist-

**Table ES-1. Overview of Utility-Customer Telecommunications Projects**

Communications System	Utility	Project Name	Status	Location	Number of Customers
Cable	Central & South West	Customer Choice & Control	Pilot	Laredo, TX	600
	Entergy	Customer-Controlled Load Management	Pilot	Chenal Valley, AR	50
	Glasgow Electric Board	TVA Water Heater Project	Pilot	Glasgow, KY	100
	Hydro Quebec	Universal Bidirectional Integration	Pilot (P)	Chicotimi, QU	440
	Pacific Gas & Electric	Energy Information Services	Pilot	Walnut Creek & Sunnyvale, CA	100
	Public Service Electric & Gas	Integrated Broadband Utility Solution	Pilot	Moorestown, NJ	1,000
	Southern Dev. Inv. Group	Dominion Project	Pilot	Duluth, GA	303
	Virginia Power	Cable-Based Energy Management System	Pilot	Norfolk & Virginia Beach, VA	< 48
Telephone	American Electric Power	TranstexT	Pilot (C)	Dublin, OH; Muncie, IN; Roanoke, VA	460
	Gulf Power	Advanced Energy Management System	Pilot	Gulf Breeze, FL	240
	Wisconsin Energy	Energy Oasys	Concept	Milwaukee, WI	15
	Wright-Hennepin Cooperative	Meter Minder	Roll-out	MN, OK	5,000
Fixed Wireless Radio	Baltimore Gas & Electric	IRIS Fixed Network	Pilot	Timonium, MD	100
	Boston Edison	UtiliNet Automatic On/Off	Pilot (C)	Brighton, MA	15,000
	Kansas City Power & Light	CellNet Pilot	Pilot	Johnson Cty, KS	5,000
	PacifiCorp	UtiliNet	Pilot	Canon Beach, OR	100
	Pacific Gas & Electric	CellNet	Pilot (C)	North Bay, CA	1,700
	TECO Energy	TeCom Inc.	Pilot	Tampa, FL	140
Mobile Wireless Radio	Baltimore Gas & Electric	Itron AMR	Roll-out	MD	<500,000
	Boston Edison	Itron AMR	Roll-out	Boston, MA	40,000
	Public Service of Colorado	Itron AMR	Roll-out	Denver, CO	300,000

Note: C = Completed, P = Planned



ing communications infrastructure, and the desired applications and services. Ultimately, we expect that a small number of big “winners” -- probably four to seven leading firms that act as system integrators for teams of product vendors, meter companies, communications and software firms -- will emerge from the many utility-sponsored trials that are currently underway.

- Wireless radio technologies are farther along in terms of large-scale deployment compared to competing communications systems. Several utilities (Kansas City Power & Light, Public Service of Colorado, Baltimore Gas & Electric) are deploying wireless radio systems, either mobile or fixed network systems, on a systemwide basis. These projects typically involve less complex partnering arrangements than broadband projects.
- Electric utilities involved in hybrid-fiber coax cable (or broadband) projects appear eager to get involved in the burgeoning home-based information, entertainment, and communications market. A few utilities (e.g., Entergy and Central & South West) have decided to build and own their communications infrastructure between utility and customer, while most others have decided to partner with cable and/or telecommunications companies by arranging to lease capacity on the provider’s network. These projects involve complex teaming arrangements. The success of these partnering arrangements is one key factor that distinguishes broadband projects that are moving forward to the next stage of development from those that appear to be floundering.
- A utility’s long-term strategic vision and/or near-term corporate objectives influence and help explain its choices with respect to communications-enabled services. For example, utilities involved in wireless projects focus on near-term improvements in utility operations to reduce rates. In some cases, these utilities are relatively low-cost providers in their region and believe that competitive advantage can be maintained by reducing costs in their traditional core business (e.g., widespread application of automatic meter reading). In contrast, many utilities involved in broadband projects seek to become full-service retail providers of energy and non-energy services and view both as potential sources of new revenue. In some cases, their approach appears driven by a strategic assessment that industry restructuring is proceeding relatively quickly and that utilities should focus on marketing value-added services because electricity is becoming a commodity. These utilities are betting that residential customers will ultimately want “one-stop shopping” (e.g., a critical mass of compelling applications that can hopefully be provided at reasonable cost) and that customers will want interactive services provided over familiar and easy-to-use interfaces (e.g., computer or TV).

*Range of Services Offered or Planned*

- The range and type of services varies among utilities, driven in part by communication system capabilities. Utilities that are utilizing broadband cable networks offer a broader array of energy and non-energy services compared to wireless radio and telephone-based projects. A few utilities package services, which include automated meter reading, time-differentiated pricing, customer-controlled load management, energy information, various types of billing options, long-distance telephone and cable service, home security and alarm services, and personal communication services, together in novel ways. Wireless radio projects currently focus on improving operational efficiency of utility distribution services (e.g., automating meter reading functions). Wireless radio technologies that utilize a fixed network with in-home display units also enable the utility to offer energy information services and pricing options.
- In many cases, we found that utility's current service offerings are much more limited than the capabilities claimed for their system or services that may or could be offered in the future. For example, while many utilities report that they are considering offering a variety of non-energy services, at the time of our survey, only three utilities (Glasgow, Wright-Hennepin, and Entergy) are currently incorporating non-energy services in their pilots.
- Our sample of projects highlights the recent surge in interest among electric utilities in automated meter reading (AMR): every utility offered AMR. Because utilities typically spend only about \$0.50 to \$0.80/month on the direct costs for manual reads, the cost of an AMR system must be fairly low (<\$75 per meter installed) in order to pay for itself in a reasonable time frame. On a stand-alone basis, AMR systems may be cost-justified only in certain niche markets (e.g., difficult-to-read meters, high-density urban areas). However, vendors of fixed network radio systems claim that, in addition to AMR, their systems provide other quantifiable benefits and a gateway for offering innovative, new energy services. These benefits include reduced losses from tampering and theft, reduced service turn-on and turn-off costs, outage monitoring, improvements in billing reliability (e.g., fewer errors than manual reads leading to fewer customer complaints). Moreover, these systems enable utilities to offer innovative pricing and billing services.
- About half of the utilities in our sample offer time-of-use pricing for residential customers, which typically includes posted prices for up to four periods (e.g., low, medium, high, and critical) that were signaled to customers through an interactive, "smart" thermostat or an in-home display device. Only one utility (Public Service Electric & Gas) is testing real-time pricing with a small subset of residential customers participating in its 1,000-home Integrated Broadband Utility Solution trial.

- About half of the utilities in our sample offer various energy information services to residential customers, although a rather limited set of options were being tested compared to services that potentially could be offered (see Chapter 4). For example, a few utilities (e.g., PG&E and Central & South West) plan to offer itemized bills that show usage for major appliances or end uses under each price tier. Several utilities display information on price currently in effect, temperature in the home, electric bill to date (in dollars and kWh), comparisons of current usage with historical energy use, programmed response of appliances to price signals, and scheduling options.

### *Market Trends: Project Costs*

For this study, utilities were asked to provide information on estimated project costs and savings. This information is reported in Table ES-2, with projects grouped into six categories based on communications system and ownership. We present cost ranges for each group as well as the utility's cost target. Project costs are self-reported and typically include the costs of communications link between utility distribution network and customer's home network (the so-called "last mile"), customer premise equipment, program administration, and marketing expenses. Because of the inherent difficulty in estimating per unit costs in small-scale R&D projects, we regard project costs as order of magnitude estimates for the "last mile" connection to the customer premise, while cost targets are indicative of utility goals for system roll-out.

- Utilities testing one-way, *mobile* wireless radio systems report the lowest installation costs (\$100-150/house). Mobile wireless systems typically involve radio-equipped vans that drive by and collect meter readings from electric meters that have been retrofitted with radio modules. These systems have more limited functionality and service offerings compared to other types of communications networks. Project costs for wireless radio systems using *fixed* networks ranged between \$180-\$600 per house. These systems typically have two-way networks from the local poletop collector back to the utility's central location, rather than all the way to the customer premise. In the projects that reported lower costs, a limited number of services are currently being offered. However, vendors claim that additional services can be provided at low incremental costs on a systemwide basis, particularly if these services are not made available or desired by all customers. Projects at the high end of this range either included additional customer premise equipment (e.g., in-home display equipment) or had low customer density levels, which meant that fewer customers were served by each radio transformer. The installed costs of hybrid fiber-coax cable (i.e., broadband) projects is currently quite expensive in residential markets (e.g., \$1,000-3,000/house). Factors that may explain the large range in reported costs include:

**Table ES-2. Market Features: Project Costs and Savings**

Strategy	Utility	Key Partners/ Vendors	Installed Cost (Current) <sup>a</sup>	Installed Cost (Target) <sup>b</sup>	Peak Demand and/or Energy Savings
Cable, Utility-Owned	Central & South West	FPN	1,000-3,000	1,000	Avg. bill savings of 7-10%; 2 kW peak demand reduction
	Entergy Southern Dev. Invest. Group Glasgow Electric Board	FPN formerly FPN CableBus	240 <sup>c</sup>	NA	
Cable, Leased	Hydro Quebec Pacific Gas & Electric Public Service Electric & Gas Virginia Power	Domosys TCI, Microsoft AT&T Cox, Nortel	2,000-3,000	300-500	\$60-80/yr
Telephone, Leased	American Electric Power Gulf Power Wisconsin Energy	ICS ICS Ameritech	1,000- 1,500	750	Avg. bill savings of 12-15% (~\$175/yr) 2-4 kW peak demand reduction
	Wright-Hennepin Cooperative	ITI	240 <sup>d</sup>		
Fixed Wireless, Utility-Owned	Baltimore Gas & Electric Boston Edison PacifiCorp TECO Energy Mgmt Services	IRIS Metricom Metricom IBM	240-600	NA	
Fixed Wireless, Leased	Kansas City Power & Light Pacific Gas & Electric	CellNet CellNet	180-240	NA	
Mobile Wireless, Utility-Owned	Baltimore Gas & Electric Boston Edison Public Service of Colorado	Itron Itron Itron	100-200	NA	

Note: First Pacific Networks (FPN), Integrated Communications Systems (ICS), Interactive Technologies Inc. (IT); NA = Not Available  
a, b: Costs and savings in \$ per residence; cost ranges for pilot projects in each group; excludes costs of installing backbone network  
c: Cost estimates are for incremental costs of pilot (i.e., CableBus switch, AMR meter, and water heating wiring); and do not reflect total cost of linking Glasgow's cable network to the residence  
d: Costs are lower because Wright Hennepin project does not include in-home display unit and cost of CPU is excluded from installation cost.

(1) extent to which an existing backbone network can be utilized vs. the costs of constructing a new backbone network, (2) differences in customer premise equipment costs which depend on the range of services offered (e.g., telephony, cable TV) and their saturation (e.g., every house vs. sub-group among total population), and (3) differences in system design (e.g., coax cable to the customer premise vs. coax cable to secondary transformer and powerline carrier or wireless radio to the customer premise).

- Large-scale deployment of cable systems to residential customers may well hinge on the ability of utilities to meet aggressive cost targets quickly (\$300-500/house) and develop attractive applications for which customers are willing to pay. Developers of broadband projects face a formidable competitive challenge if fixed wireless radio networks are deployed on a large-scale and capture most of the potential energy-related benefits (e.g., reduce costs of utility operations, provide energy information services). These investments in a competing communications network infrastructure may foreclose or seriously limit deployment of broadband networks by electric utilities because project economics may hinge on realizing benefits to the utility system (i.e., cost reductions and peak demand savings) as well as revenues derived from a broad array of energy and non-energy applications.

#### *Benefits to Utilities and Customers*

- With respect to benefits to utilities, several utilities located in the South (Gulf Power and CS&W) report summer peak demand reductions of about 2 to 2.2 kW per home as customers shifted or reduced loads in response to time-of-use prices. A few utilities provided anecdotal information on savings in system operation, productivity impacts, or customer satisfaction. Only a few utilities (e.g., Glasgow Electric Board, Wright-Hennepin) have achieved reasonably high market penetration rates in promoting non-energy services that generate substantial revenue streams from residential customers. Most other utility projects are either still at the proof-of-concept stage, pilot market research, or large-scale technical trial.

## *EXECUTIVE SUMMARY*

---

- With respect to benefits to customers, several utilities reported annual bill savings from TOU prices and customer-controlled load management that ranged from 7 to 15% of current bills. These savings were worth between \$60 and \$175 per year to residential customers at current rates. With one exception (Gulf Power), these savings estimates are self-reported. In the future, some utilities envision that participating customers may pay a portion of the costs of pricing and load management programs if they are offered as energy services. However, several utilities reported that, based on their market research, participating customers were only willing to pay a small monthly fee (\$5-10 per month or less), which translates into less than 25% of the bill savings achieved in most houses. Thus, overall, the amount of savings, customer's willingness to pay a portion of the value of these savings to the utility for these services (e.g., 10-25%), and customer's payback criterion (e.g., 2-3 years) establish an upper limit on the annual contribution that could be expected from customers for these energy-related services.

### *Participation Rates and Market Response*

Some utilities report high participation rates in their pilot projects (20-70% of eligible customers), although customers were typically not asked to pay for services. Not surprisingly, market response is lower in those few projects where customers actually pay for services. Several small publicly-owned and rural electric cooperatives (Glasgow Electric Board and Wright-Hennepin Cooperative Electric Association) have the most experience in providing communications-enabled services that are paid for by customers. However, significant uncertainties still exist regarding services desired by residential customers and their willingness to pay for them—a situation which motivated our exploratory market research effort.

### *Exploratory Market Research*

We also conducted a small market research effort that assessed services which might be of interest to residential customers. Utilities routinely conduct market research, although typically results are not publicly available. To begin to address this information gap, we conducted a focus group and individual interviews with ten residential customers in Newark, Delaware between December 1995 and January 1996. These interviews explored customer reactions to a set of fourteen proposed services. Respondents were also asked to fill out a short questionnaire at the end of the focus group discussion or interview in order to gauge customers' perceived economic value of the services.

Key findings from our exploratory market research include:

- Many respondents were interested in specific energy information services, although most wanted the service only if it were free or were only willing to pay a small amount (\$0.50-1.00 per month or \$1-2 per use). Compared to previous studies, participants were asked for their reactions to a more extensive set of energy information services—neighborhood comparisons of energy use, energy use breakdowns by individual appliances or major end uses, time-of-day pricing, information on energy efficiency products, and on-line “do-it-yourself” or informational videos on home energy use.
- About 10 to 40% of the respondents did not want specific energy information services even if offered free of charge. They regarded the proposed services as unnecessary either because they could access the information with greater ease using existing media (e.g., their utility bill) or questioned the validity of the information. Given these responses, utilities may wish to bundle a set of energy information services as part of a more comprehensive package of communications-enabled services that could command a reasonable monthly fee.
- Not surprisingly, our focus group and interviews revealed several well-known barriers to marketing energy-efficiency services. Some respondents had limited interest in energy efficiency and reducing their bill, partly due to their perception that potential energy savings were low or would negatively impact their lifestyle. To overcome consumer information barriers, effective consumer education will be a necessary component of any large-scale utility effort to deploy communications-enabled energy services.
- We also found that customers’ receptiveness to new, communications-enabled services was affected by concerns regarding privacy, intrusive marketing, and network security. Some respondents were wary that utilities would provide disaggregated data on their household energy use or a customers’ specific product and equipment needs to other private firms. In their view, this unauthorized disclosure could result in an increase in unwanted marketing pitches. Those customers that had previous negative experiences with telecommunications services providers (e.g., intrusive marketing) tended to be more dubious and suspicious of new service offerings.
- Customers viewed customer-controlled load management and time-of-day pricing as particularly useful energy information services; these services had the most favorable responses overall.

## *EXECUTIVE SUMMARY*

---

- A majority of participants were willing to pay for security services and entertainment videos on demand, respectively. The average amounts offered by those customers willing to pay (\$11/month for security services and \$3 per view for entertainment videos on demand) provide a calibration that these measures are at or below market value, thus lending some credence to responses for energy-related services that are not currently offered in the market. Based on reactions of some respondents, we believe that customer concerns about unfair competition and utility entry into new business areas may represent a barrier among some segments of the residential customer base.

### *Future Directions*

We are convinced that the utility pilot projects described in this study foreshadow the future direction of residential customer energy services. Today, the market is in the early stages of development. Only a handful of utilities have demonstrated significant operational savings or generated significant revenue streams through successful marketing of energy and non-energy services to residential customers. Given market and regulatory uncertainties and the technological risks, utilities and their partners must overcome significant hurdles before large-scale deployment of a comprehensive set of communications-enabled services in the residential sector becomes a robust business activity.

We plan to continue monitoring emerging trends in communications-enabled services for residential customers, focusing on developments in the following areas.

**Market experience** - Over the next year or two, we will be better able to assess “winners” and “losers” based on actual field performance from utility trials. System integrators that can successfully target and sell bundles of energy and non-energy services in various residential market niches utilizing a reliable, low-cost, two-way communication connection between service provider and home are more likely to thrive. Important indicators to evaluate include whether early, and in many cases, successful, entry by companies and teams utilizing wireless radio networks creates a sustainable competitive advantage and whether broadband projects in the proof-of-concept or pilot phase successfully are rolled-out on system-wide basis.

**Customer response** - Customer willingness to pay for these services is still unproven and it will be important to analyze utilities’ success in moving from technical trials to market-based programs. The search for the “killer” customer service application will be an important indicator to monitor. We believe that, overall, the industry would benefit if additional market research and field evaluations on customer response to these services were publicly available. We expect that utilities and others will devote increasing efforts towards home security, alarm, monitoring and notification services, and personal communication services (e.g., Internet access). A growing number of utilities may offer both general and interactive energy



information services (EIS) over the Internet in addition to specific EIS services enabled by communications networks to the customer premise (e.g., real-time pricing, customer-controlled load management, customized bills). It is unclear to what extent there will be convergence on communication medium (e.g., computer, TV, or “smart” thermostat).

**Technical innovation & risk** - We expect the rapid pace of innovation in information and communication technologies to continue, and thus it will be important to keep abreast of these developments, particularly as they affect the relative economics of competing systems. It will also be important to monitor progress towards development of “open” standards and protocols and the trend towards “hybrid” communications networks (e.g., fiber backbone networks plus fixed wireless radio systems).

**Regulatory** - Unless there is federal legislation that mandates retail competition, we believe that the pace of electric industry restructuring will vary significantly by state and region. Decisions of state regulators in three key areas could have a major impact on the deployment of communications-enabled residential customer services: (1) performance-based regulation (PBR), (2) policies that require distribution utilities to unbundle metering & billing services, and (3) regulatory oversight and monitoring of the activities of unregulated subsidiaries. Adoption of PBR for distribution utilities that allows shareholders to increase earnings if the utility achieves significant operational cost savings may spur deployment of AMR systems. However, limitations on the scope of services to be provided by distribution utilities may adversely affect the deployment of certain types of communications networks. For example, if billing and metering services are unbundled and provided by competitive suppliers rather than DISCOs, it may be more difficult to justify system-wide deployment of fixed wireless radio networks because low per unit costs of these systems are achieved by including all homes within a defined geographic area (e.g., portion of utility service territory). Regulatory policies in such areas as potential cross-subsidies between regulated and unregulated services or constraints on the activities of unregulated retail energy service affiliates or subsidiaries that take equity positions in product vendors who supply regulated DISCOs may also impact the deployment of communications-enabled services by utilities.



# Introduction

Many U.S. electric utilities are currently testing innovative energy-related and non-energy services for residential customers that are delivered via modern telecommunications systems (e.g., fiber-optic and coaxial cable networks, fixed and mobile wireless radio equipment, dedicated telephone lines). Key drivers for these initiatives include rapid innovation and declining costs in information and communication technologies and utilities' desire to enhance customer service in an increasingly competitive environment and develop business strategies that enable utilities to thrive in emerging retail services markets.

This study explores several important questions which are of interest to electric and gas utilities and their regulators, service providers, and the U.S. Department of Energy. These questions include:

**What are the potential impacts of information and advanced communications technologies on utility delivery of energy services to residential customers?**

Utilities have relied on communications technologies to support load management programs since the 1970s. For example, in direct load control programs, utilities utilized powerline carrier or wireline radio technologies to remotely control the on-off duty cycles of home appliances. However, in designing these programs, utilities often regarded residential load management and innovative rates as mutually exclusive. Moreover, communications were typically one-way, from the utility to the customer, and required relatively little telecommunications system capability (Hanser et al. 1993). By contrast, a number of the utility projects surveyed for this report bundle load management, pricing, distribution automation, and energy information services. Utilities are packaging a variety of services together in novel ways including automated meter reading, time-differentiated pricing, customer-controlled load management, smart thermostats, energy information, various billing options, home security, video, long-distance telephone, and personal communication services (e.g., Internet access). As part of this study, we requested that utilities (and vendors) estimate project costs, savings, and capabilities of their systems. This information is used to assess the relative merits of alternative communications delivery systems and costs of providing various services.

**What role will electric utilities play in the delivery of energy services, particularly energy efficiency services and load management, as the electric power industry moves into a more competitive era?**

In response to increasing competition and the prospect of industry restructuring, many utilities have reduced the size and scope of their demand-side management programs, particularly in the residential sector (EIA 1995). Increasingly, the emphasis of remaining utility DSM programs focuses on retaining large customers and their loads. Utilities have adopted varying strategies with regard to providing services to smaller commercial and residential customers.

Some utilities appear ready to compete primarily on the basis of price with limited service offerings, while other utilities attempt to build loyalty and satisfaction by improving existing services in anticipation of retail choice or providing new value-added services that differentiate them from potential competitors (Rufo 1996). Utilities in this latter group are forming strategic alliances and/or joint ventures with telecommunications companies, product vendors, and information technology vendors.

In order to gain regulatory and political support for these projects, utilities have cited the reduction in electrical system peak demand, reduction in market barriers to energy efficiency through provision of accurate, real-time prices and energy information, and operational cost savings in the distribution utility business. These benefits potentially distinguish electric utilities from other providers that propose to offer communications-enabled non-energy services to residential customers. Some utilities are conducting their projects as a traditional regulated activity, especially those that focus on load management or reduced operating costs through automated meter reading (AMR). Over time, we expect that these activities, particularly if they include energy efficiency services as part of a broader package of non-energy services, will increasingly be developed by unregulated utility affiliates. We are also likely to see “convergence” among fuel forms and energy suppliers as customers are offered comprehensive services, including electricity, gas and fuel oil commodity purchases along with other value-added services. As utilities and other new entrants move to horizontally re-integrate retail energy services, regulators will have to decide to what extent to unbundle various retail services (e.g., merchant, marketing, billing, and metering functions) which are potentially competitive from those portions of the electricity distribution or “wires” business that should be subject to economic regulation because of their natural monopoly characteristics.

**What types of energy-related and non-energy services are of most interest to residential customers, and how much would they be willing to pay for them?**

Ultimately, utilities (and other providers) hope to recoup their investment in information and advanced communications networks through revenues derived from customers’ willingness to pay for energy and non-energy services as well as savings in system operation. Many utilities have conducted market research exploring customers’ interest in these services, although with one or two exceptions, the results of those studies have not been released into the public domain. Thus, to partially address this information gap, we conducted a focus group and a small number of customer interviews in order to explore customer reactions to these new service packages.

## 1.1 Scope

This study focuses on the impact of information and communications technologies on residential customer energy services. Projects and technologies aimed at commercial and industrial customers are not included. Our focus on small customers derives in part from a public policy perspective that, even in a competitive electricity industry, the market barriers to the use of energy efficient products and services may be most significant among these consumers. Moreover, the current Administration, through the U.S. Department of Energy, in their National Information Infrastructure initiative, have expressed concerns that residential customers, particularly low-income and rural customers, are the ones most likely to need governmental assistance in gaining access to the broad array of services envisioned through the deployment of information resources and modern telecommunications networks (NIST 1994).

**Table 1-1. Overview of Electric Utility Services Using Communications Systems**

Category	Service/Program	Primary Business Objective
I. Corporate Activities	<ul style="list-style-type: none"> <li>- Power system monitoring and control</li> <li>- Control center operations</li> <li>- Internal communications and message handling</li> <li>- Supervisory control and data acquisition</li> </ul>	Improving system operations and increasing administrative efficiencies
II. Wholesale Power Market Activities	<ul style="list-style-type: none"> <li>- Reliability exchanges and bulk power transfers</li> <li>- Brokering and spot market transactions</li> <li>- Wholesale pricing</li> </ul>	Improving the efficiency and reducing the cost of wholesale market transactions
III. Retail Electricity Market Activities	<ul style="list-style-type: none"> <li>- Automated meter reading</li> <li>- Automated billing</li> <li>- Remote connect/disconnect</li> <li>- Theft/tamper detection</li> <li>- Outage detection and handling</li> </ul>	Reducing utility cost of service to customers
	<ul style="list-style-type: none"> <li>- Energy information and education</li> <li>- Bill feedback</li> <li>- Energy and demand management</li> <li>- Energy and customer monitoring</li> <li>- Power quality monitoring</li> <li>- Real-time pricing</li> </ul>	Increasing the value of service to customers
IV. Non-Energy Retail Activities	<ul style="list-style-type: none"> <li>- Telephone</li> <li>- Data and information services (e.g., Internet access)</li> <li>- Educational programming</li> <li>- Home and business security and fire protection</li> <li>- Entertainment</li> </ul>	Improving financial performance and expanding business base through diversification

Source: Adapted from EPRI 1994; Andersen 1994.

Potential utility services that can be enhanced by the use of information and telecommunications systems can be grouped into four general categories (EPRI 1994; Andersen Consulting 1994):

- **Corporate Activities** are those aimed at improving utility system operations or internal administrative efficiencies and in most cases rely on phone, radio, or fiber-optic cable networks that are currently in place.
- **Bulk Power Market Activities** are those aimed at enhancing communications between utilities bilaterally, facilitating pooling arrangements, and enabling access by new market entrants such as marketers, brokers, and independent generators. This category also includes growing interest in the use of electronic bulletin boards for broadcasting information on transmission access and pricing policies to market participants on a non-discriminatory basis as outlined in the recent Federal Energy Regulatory Commission Order 889 (FERC 1996).<sup>1</sup>
- **Retail Electricity Market Activities** are aimed at strengthening the business relationship between utilities and their customers not only for providing new energy-related products and services but also to build loyalty and enhance service value.
- **Non-Energy Retail Activities** involve products and services that some utilities wish to provide on a competitive basis with other vendors such as cable, wireless, and telephone companies.

The focus of our study is limited to retail electricity market and non-energy retail activities. Retail electricity market activities involving residential customers are the primary focus of this report. In Table 1-2, we classify these retail market activities in terms of their communications system functionality requirements: system capacity (e.g., narrowband vs broadband) and necessity for customer feedback and interactivity (i.e., one-way vs. two-way).<sup>2</sup> Understanding functionality requirements is important because it impacts the selection of communications systems, which affects costs and profitability of providing certain services. In general, the greater the functionality, the greater the bandwidth and cost. Hybrid fiber-optic and coaxial cable (i.e., broadband) networks offer the greatest capability for two-way

---

<sup>1</sup> FERC required utilities to establish an open access information system (OASIS) to encourage the development of more competitive bulk power markets.

<sup>2</sup> There are not universally accepted definitions of the break points between narrowband, wideband, and broadband systems. According to EPRI (1994), narrowband systems operate at rates of up to 64,000 bits per second, wideband systems operate at rates between 64,000 and several million bits per second, and broadband systems operate at rates of about 10 million bits per second. However, many practitioners prefer not to differentiate between wideband and broadband and label systems as broadband if they operate at greater than 1 million bits/second.

exchange of large volumes of information between utilities and customers and hence greater functionality. However, these systems are the most expensive to install at this time.<sup>3</sup>

**Table 1-2. Retail Electricity Market Opportunities Enabled by Technology Choices**

Communications Technology/ Customer Requirements	Broadband	Narrowband
One-Way	<ul style="list-style-type: none"> <li>- Energy information and education (energy broadcasts on television)</li> </ul>	<ul style="list-style-type: none"> <li>- Demand management (direct load control)</li> </ul>
Two-Way	<ul style="list-style-type: none"> <li>- Power quality monitoring</li> <li>- Energy information and education (interactive)</li> <li>- Bill feedback</li> <li>- Energy management (interactive)</li> </ul>	<ul style="list-style-type: none"> <li>- Remote connect/disconnect</li> <li>- Outage detection and handling</li> <li>- Remote/automated meter reading</li> <li>- Automated billing</li> <li>- Energy and customer monitoring</li> <li>- Real-time pricing</li> </ul>

Table 1-3 provides an overview of telecommunications systems currently used by utilities to support various types of DSM programs. One hallmark of the traditional use of telecommunications in DSM programs is that the majority of communications were one-way, from the utility to the customer and required little telecommunications system bandwidth capacity (i.e., narrowband). As noted earlier, residential direct load control programs have targeted air conditioning and water heating loads of residential customers since the 1970s. Utilities have also experimented with time-of-use pricing and various types of energy information programs (e.g., innovative customer bills, energy education, audits) to elicit response from residential customers. Real-time pricing and interruptible rates are often directed at larger commercial and industrial customers.

<sup>3</sup> Broadband includes hybrid fiber-coax cable systems while standard twisted-pair telephone line, radio, and powerline carrier systems are narrowband.

**Table 1-3. Demand-Side Management Programs and Communications Systems**

Program Type	Load-Shape Objective	Telecommunications System	Target Market (Activity Level in U.S.)
Direct Load Control	Peak Clipping	Radio, Powerline Carrier	Residential and small commercial air conditioning and water heating (over 450 programs)
Real-Time Pricing	Peak Clipping, Valley Filling	Telephone Lines	Large commercial/industrial customers (small number of pilot programs)
Interruptible Rates	Peak Clipping, Valley Filling	Telephone Lines	Large C/I customers (hundreds of programs)
End-Use Metering	Not applicable (used to measure DSM program performance)	Telephone Lines	Residential and commercial customers (over 90 utilities have conducted 500 programs)
Energy Management Cooperatives	Peak Clipping, Valley Filling	Telephone Lines	Large C/I (small number of pilot programs)

## 1.2 Approach

In this study, we collected and analyzed market data from three primary sources: (1) vendors of telecommunications equipment, software, and metering technologies, (2) utilities conducting pilot projects, and (3) focus group and interviews conducted directly with a small number of residential customers.

We reviewed product literature from vendors and conducted a series of telephone interviews with technical representatives. Descriptions of various products were compiled and are summarized in Appendix A. We also conducted telephone interviews with project managers at utilities, using an interview protocol and data collection instrument to gather consistent information on the size, scope, team members, equipment, services, status, and stage of development of projects. Project summaries were prepared (see Appendix B) and as a quality control check were sent to utility project managers to verify and validate their responses. A caution to the reader: while every effort was made to collect accurate information, the rapid pace of developments in these projects means that some of the reported information could be out-of-date.



We also conducted a focus group and interviews with a small number of customers that explored their interest in and willingness to pay for a set of fourteen proposed services. While the results obtained from the focus group and customer interviews provide are evocative and insightful, the sample size is too small for statistical analyses, thus limiting the extent that generalizations can be made.

### 1.3 Organization of the Report

In Chapter 2, we report on results from our survey of 21 utility projects, including services offered. In Chapter 3, we identify and analyze key market trends, including market entry strategies employed by utilities, strategic alliances and teaming arrangements, and a preliminary assessment of costs and benefits. In Chapter 4, we present results from our customer interviews and focus group and discuss reactions to specific energy information and other services. Key findings from our exploratory market research are summarized in Chapter 5.



# Survey of Electric Utility Projects

## 2.1 Overview

This chapter presents results from our survey of 21 utility-customer telecommunications projects at 18 utilities. We provide summary descriptions of pilot projects, which are classified based on their primary communications modes (e.g., telephone lines, wireless radio networks, and hybrid fiber-coax cable). We discuss the types of services offered in these pilots as well as utility experiences implementing specific services.

Every utility in our sample offered automated meter reading (AMR). Projects that use wireless radio communications systems are farthest along in terms of large-scale system deployment compared to fiber-coax cable projects. However, wireless radio projects typically offer only energy-related services. We found that there is a significant gap between services that utilities currently offer and their planned offerings in the future, particularly with respect to non-energy services. Cable-based projects currently include or plan to offer a broader array of energy and non-energy services, although almost all projects are still in the pilot or proof-of-concept stage.

## 2.2 Approach

We identified about 40 projects initially based on interviews with 11 telecommunications equipment and software vendors and a literature review of the trade press, conference proceedings, and recent publications (Chartwell 1995; Andersen Consulting 1995). We focused on projects that targeted residential customers and offered energy information services in conjunction with other services. Projects were eliminated either because they were outside of the study's scope or because utility representatives were unwilling to provide the minimum information requested in our survey. We conducted telephone interviews with utility staff involved in 21 projects between August-October 1995. Written summaries of the interviews were then sent to utility contacts and vendors who had an opportunity to verify the accuracy of the information. Appendix A provides detailed description of vendor products, including technology characterization and current projects with utilities. Appendix B provides a detailed summary of each utility project, including key team members, target market, services offered, and status.

Figure 2-1. Selected Utility Telecommunications Projects

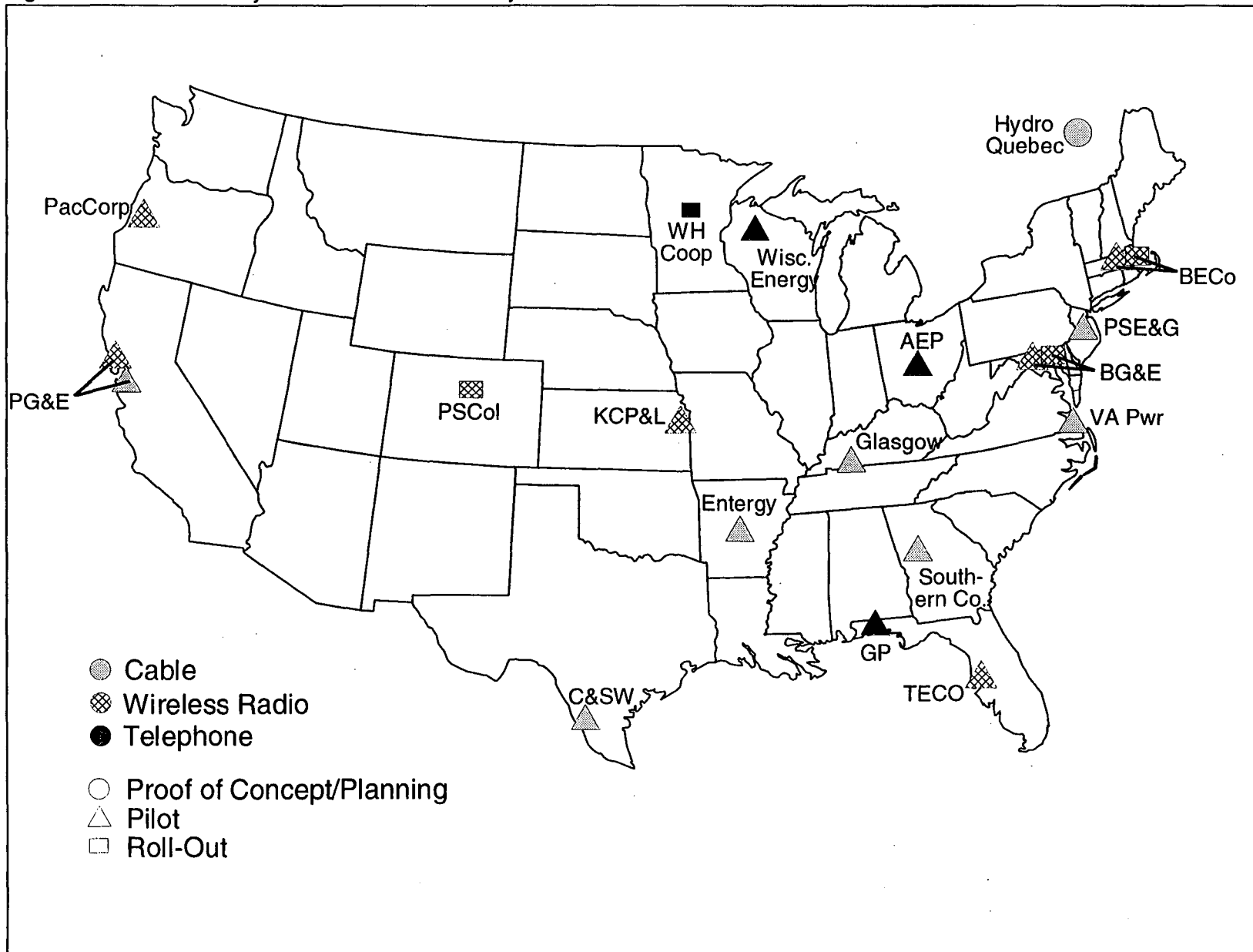

## 2.3 Project Descriptions

Table 2-1 provides background information on the utilities in our survey. With two exceptions (Glasgow Electric Board and Wright-Hennepin Cooperative), utilities in our sample are investor-owned and cumulatively account for about 15% of U.S. residential electricity sales. The sample is geographically diverse and includes utilities of varying sizes (see Figure 2-1). A number of these utilities (e.g., Boston Edison, Pacific Gas & Electric, Baltimore Gas & Electric, and Public Service Electric & Gas) are currently implementing relatively large residential DSM programs. However, previous experience with large-scale residential DSM programs does not appear to be a decisive factor in explaining utility interest in communications-based energy services.

Table 2-2 provides background information on each project including the primary communications media between the utility and customer (e.g., hybrid fiber-coax cable, telephone, fixed or mobile wireless radio frequency), the project's status and stage of development (e.g., proof-of-concept, pilot, market roll-out), the number of participating households and location of the project. For discussion purposes, we describe the projects in terms of primary data communications mode or network.<sup>4</sup>

### 2.3.1 Hybrid Fiber-Coax Cable Network Projects

Eight projects utilize hybrid fiber-coax cable networks to establish the communication link between the electric utility and customers; projects are typically in the pilot or proof-of-concept stage and are limited in scope to a few hundred customers. Several projects that utilize First Pacific Network (FPN) products have substantial field experience. In 1989, Glasgow Electric Board constructed a 120-mile coaxial cable network and was a beta test site for FPN's first generation product (FPN 1000), which features non-energy services (cable TV to over 3,000 subscribers and telephone and LAN services to several hundred customers). Currently, Glasgow Electric Board is involved in a pilot project that focuses on the customer's willingness to heat water off-peak in response to a favorable tariff offered by Tennessee Valley Authority (2.7 ¢/kWh after midnight for water heating). As of December 1995, Central & South West's Customer Choice and Control has completed installations in over 600 homes in Laredo, Texas. This project focuses on energy management, testing customer's interest in and ability to shift load, given their control over scheduling and usage of major appliances. Participants can control use of their air conditioner, water heater, and clothes dryer in response to pre-specified time-of-use rates that range between 5.5 and 50 ¢/kWh.

---

<sup>4</sup> Other technical alternatives that are currently available or under development, which are not represented in our sample of utilities, include: power-line carrier technology, Low-Earth Orbiting Satellites (LEOS), and Personal Communications Services (PCS) and Cellular networks. There are numerous ways to combine technologies in a system (e.g., power line carrier technology within customer premises or from meter to local collector combined with radio or broadband from local collector to utility head-end).

**Table 2-1. Electric Sales/Revenues and DSM Program Impacts for Sample Utilities**

Utility	Class	Total Sales (GWh)	Residential Sales (GWh)	DSM Savings (GWh)	Electric Revenues (\$Million)	DSM Program Costs (\$Million)
American Electric Power	Parent	93,534	28,876	100	4,524	9
Baltimore Gas & Electric	IOU	26,772	10,614	190	2,001	66
Boston Edison	IOU	12,516	3,487	382	1,287	57
Central & South West	Parent	41,363	13,426	270	2,431	9
Entergy	Parent	59,144	18,945	NA	4,005	NA
Glasgow Electric Board	Municipal	274	54	NA	15	NA
Gulf Power	Subsidiary	8,193	3,713	418	472	52
Hydro Quebec	Gov't.	NA	NA	NA	NA	NA
Kansas City Power & Light	IOU	11,303	3,582	NA	784	2
Pacific Gas & Electric	IOU	75,807	24,111	1,610	7,542	147
PacifiCorp	Parent	57,362	12,054	678	1,968	41
Public Service of Colorado	IOU	19,523	5,776	97	1,169	8
Public Service Electric & Gas	IOU	38,154	10,631	56	3,628	50
Southern Development Invest. Group	Subsidiary	NA	NA	NA	NA	NA
TECO Energy	Subsidiary	13,446	5,706	162	942	16
Virginia Power	IOU	68,184	21,846	160	3,784	36
Wisconsin Energy	Subsidiary	20,291	6,405	1,286	1,153	58
Wright-Hennepin Cooperative	Cooperative	398	274	NA	28	NA
Utilities in Our Sample		546,264	169,500	5,409	35,733	551
All U.S. Electric Utilities		2,763,365	935,939	44,349	198,220	2,769

Source: Energy Information Administration (EIA). Form 861 and Annual Electric Utility Report 1993.

**Table 2-2. Overview of Utility-Customer Telecommunications Projects**

Communications System	Utility	Project Name	Status	Location	Number of Customers
Cable	Central & South West	Customer Choice & Control	Pilot	Laredo, TX	600
	Entergy	Customer-Controlled Load Management	Pilot	Chenal Valley, AR	50
	Glasgow Electric Board	TVA Water Heater Project	Pilot	Glasgow, KY	100
	Hydro Quebec	Universal Bidirectional Integration	Pilot (P)	Chicotimi, QU	440
	Pacific Gas & Electric	Energy Information Services	Pilot	Walnut Creek & Sunnyvale, CA	100
	Public Service Electric & Gas	Integrated Broadband Utility Solution	Pilot	Moorestown, NJ	1,000
	Southern Dev. Inv. Group	Dominion Project	Pilot	Duluth, GA	303
	Virginia Power	Cable-Based Energy Management System	Pilot	Norfolk & Virginia Beach, VA	< 48
	Telephone	American Electric Power	TranstexT	Pilot (C)	Dublin, OH; Muncie, IN; Roanoke, VA
Gulf Power		Advanced Energy Management System	Pilot	Gulf Breeze, FL	240
Wisconsin Energy		Energy Oasys	Concept	Milwaukee, WI	15
Wright-Hennepin Cooperative		Meter Minder	Roll-out	MN, OK	5,000
Fixed Wireless Radio	Baltimore Gas & Electric	IRIS Fixed Network	Pilot	Timonium, MD	100
	Boston Edison	UtiliNet Automatic On/Off	Pilot (C)	Brighton, MA	15,000
	Kansas City Power & Light	CellNet Pilot	Pilot	Johnson Cty, KS	5,000
	PacifiCorp	UtiliNet	Pilot	Canon Beach, OR	100
	Pacific Gas & Electric	CellNet	Pilot (C)	North Bay, CA	1,700
	TECO Energy	TeCom Inc.	Pilot	Tampa, FL	140
Mobile Wireless Radio	Baltimore Gas & Electric	Itron AMR	Roll-out	MD	<500,000
	Boston Edison	Itron AMR	Roll-out	Boston, MA	40,000
	Public Service of Colorado	Itron AMR	Roll-out	Denver, CO	300,000

Note: C = Completed, P = Planned

Entergy has substantially downsized its highly-publicized Customer-Controlled Load Management pilot compared to its initial pronouncements. The company has completed installations in about 40-50 homes in the Chenal Valley of Arkansas compared to its original goal of several thousand homes.<sup>5</sup> Entergy is testing a broad set of energy and non-energy services including customer-controlled load management of up to four major appliances (e.g., HVAC, hot water, and two additional appliances), automated meter reading, 22 cable TV stations, and long-distance telephone service. The project was initially co-developed by Entergy and FPN, although FPN is no longer actively involved in the project. Entergy now plans to continue the program, testing a new time-of-use tariff through January 1997, but does not expect a roll-out after the pilot.

Several other cable-based projects are being developed jointly by electric utilities, software companies, and telecommunications or cable TV service providers. Examples include the Energy Information Services trial in which TCI, Microsoft, and Pacific Gas & Electric are taking leading roles. In New Jersey, Public Service Electric & Gas (PSE&G) and Lucent Technologies (formerly AT&T) completed a ten-home proof-of concept in 1995 and have completed equipment installation in a 1,000 customer technical trial of their Integrated Broadband Utility Solution (IBUS) project. PSE&G/Lucent are currently field testing various devices and services among sub-groups of customers. One sub-group of customers is receiving real-time prices over the utility's communication system via a "smart" thermostat, which can be programmed to control HVAC system in response to these time-varying prices. Virginia Power has teamed with Cox Cable to conduct a small pilot program (~50 homes) in two neighborhoods (Virginia Beach and Norfolk) where the backbone hybrid coax cable network is already in place.

Projects sponsored by two utilities, Hydro Quebec and Southern Company, have not yet begun installations. Hydro Quebec's project, called Universal Bi-directional Integration (UBI), is still in the planning stages, with testing slated to begin in September 1996. The energy services portion of this project is limited to a town in northern Quebec, Chicotimi, that is noteworthy because of its relatively high saturation and use of electric appliances and equipment. As a result, the town is a target for Hydro Quebec's load management and efficiency programs. Southern Development Investment Group (SDIG), an unregulated subsidiary of the Southern Company, is testing an extensive set of energy and non-energy services (e.g., home security, cable TV, video on demand) in a new, all-electric apartment complex in Georgia Power's service territory. Dominion, the developer of the complex, has aggregated the load under a master metering contract with Georgia Power.

Electric utilities offered various reasons for their participation in these projects including a desire to develop new products and services (3), reduce summer peak demand (2), and test

---

<sup>5</sup> In January 1994, Entergy announced its intent to deploy a 10,000-home pilot throughout the Entergy system at shareholder expense to demonstrate functionality and potential of its Customer-Controlled Load Management pilot, with the option to request cost recovery later for the program (Vince et al. 1994).



innovative rates (1) (see Table 2-3). Among the eight projects, there is substantial diversity in the types of customers and residential market segments targeted by utilities.

**Table 2-3. Hybrid Fiber-Coax Cable Projects**

Utility	Test Start	Test End	Homes	Reason	Target Market
Central & South West	Mar. 1994	Dec. 1995	500	Reduce summer peak in Laredo	Single family homes
Entergy	Jan. 1996	Jan. 1997	40	High electricity prices	Wealthy, sophisticated substation
Glasgow Electric Board	Dec. 1995	June 1997	50	Test variable rate	Electric water heaters
Hydro Quebec	Sept. 1996	Mar. 1997	330**	Join information highway	Wealthy, all-electric homes
Pacific Gas & Electric	June 1995	Mid-1996	100	Sell product to other utilities	Temperate/coastal climates
Public Service Electric & Gas	Dec. 1995	Dec. 1996	1000	Develop new product	Demographic mix
Southern Development Invest. Group	Apr. 1996	June 1998	303	Reduce summer peak in Atlanta	All-electric wealthy apartments
Virginia Power	May 1995	May 1997	48	Develop new product	VEPCO/Cox employees' homes

\*\* In addition, 110 homes were metered as control group.

For example, several utilities (Public Service Electric & Gas and Central & South West) are consciously seeking a broad demographic mix among residential customers. Several pilots target wealthy owners of single-family houses (e.g., Entergy, Hydro Quebec) or upscale tenants in multi-family complexes (Southern Company) because there may be greater interest in and ability to pay for non-energy services (e.g., home security, video on demand). Customers that live in all-electric homes are often targeted, especially residences with electric heating and air-conditioning, because there may be greater opportunities to either shift or reduce electricity demand. One utility is targeting knowledgeable customers who have already participated in other DSM programs because they may be more receptive to and familiar with customer-controlled load management. In some cases, the utility's choice of location for its pilot is heavily influenced by its desire to make use of an existing hybrid fiber/coax cable network (e.g., Virginia Power).

### 2.3.2 Telephone-Based Projects

Projects sponsored by four utilities employ telephone communications between utility and the home and powerline carrier within the home. The most novel is the Energy Oasys project, co-developed by Wisconsin Energy Corp. and Ameritech, which combines wireless paging to the customer with telephone from the customer. A large suite of energy and non-energy services is envisioned after proof-of-concept testing is completed. Energy Oasys participants use a plug-in device to receive energy information and control appliances in response to time-of-use rates.

American Electric Power (AEP) and Gulf Power (a subsidiary of Southern Company) are using TranstexT products in their pilots. In fact, both holding companies are investors in Integrated Communications Systems (ICS), developer of the TranstexT product line. Customers have the ability to choose automatic settings for heating and air conditioning at four price tiers; electricity price data is received from the utility via telephone line modem. An interesting aspect of the AEP project is their ability to monitor the performance of 460 participating residences in three distinct geographic areas (and operating subsidiaries) from a single computer in the holding company's headquarters in Columbus, Ohio. AEP recently requested that the Public Utilities Commission of Ohio approve a permanent "variable spot price rate" which would enable AEP to roll-out the project in Ohio by 1997. Ultimately, AEP plans to roll out the project to 25,000 homes across six states by the end of 1998. Gulf Power's project, called Advanced Energy Management System targeted large electricity-intensive single-family homes in Gulf Breeze, Florida and was completed in 1994. Gulf Power equipped 240 homes with a smart thermostat and meter for time-of-use rates, and a control group of 200 homes with meters only. Gulf Power is not convinced that telephone is the appropriate technology to communicate TOU prices and plans to test fixed wireless radios to broadcast price information.

Wright Hennepin Cooperative Electric Association offers a telephone-based home security system, known as Meter Minder, with automated meter reading and power outage reporting, discounted cellular phones and long-distance telephone service, and an appliance warranty program. The utility has achieved relatively high market penetration as 3,000 of its 29,000 members have installed the Meter Minder; customers pay a \$17.50 monthly fee for the home security add-on.

### 2.3.3 Wireless Radio Network Projects

Projects sponsored by seven utilities involve wireless radio communications in a *fixed* network. These radio networks typically consist of transmitter modules in residential electric meters, a local neighborhood collection unit (e.g., poletop communications node) with an integral radio that reads meters within its range, and a wide area radio infrastructure that brings meter reading and other information back to a central location. These systems typically

have two-way networks from the local poletop collector back to the utility's central location, rather than all the way to the customer premise. (CPUC DAWG 1996).

A number of vendors have developed or are developing products using this technology including CellNet Data Systems, Itron, Metricom, IRIS and Schlumberger.<sup>6</sup> With one exception (TECO Energy), these projects offer only energy-related services. Fixed radio networks are most cost-effective when deployed in areas of medium to high density in relatively flat terrain because the cost per household depends to some extent on the number of meters that are within the range of the neighborhood collection unit.

Most projects are still in the pilot stages, although several utilities have recently signed contracts for system-wide roll-out. For example, Kansas City Power & Light, Union Electric, and Northern States Power have signed long-term contracts with CellNet, who will deploy an extensive wireless radio network in each utility's service territory that will ultimately provide over 2.5 million urban customers with various service options (Energy Services and Telecom Report 1996d).<sup>7</sup> CellNet basically offers a turnkey approach: utilities sign a long-term performance contract with the company for installation, operation, and maintenance of the system, paying a fee of about \$1.00 per meter per month for the basic service of a daily meter read.

PacifiCorp and Boston Edison are deploying fixed network radio systems developed by Metricom; in these projects, the utility owns and operates the system outright. Baltimore Gas & Electric and TECO are testing load control options under time-of-use pricing while PacifiCorp is testing time-of-use pricing by providing customers with energy information through an in-home display unit. Some vendors of these systems claim that they can provide additional enhanced services beyond meter reading and other operational benefits once the communications system has been deployed over a significant portion of the utilities distribution network (see Table 2-4).<sup>8</sup>

---

<sup>6</sup> Recently, Itron has purchased Iris and it appears that Metricom is focusing on utility applications rather than large-scale deployments to customers.

<sup>7</sup> As of June 1996, CellNet reports that 250,000 meters have been installed for Kansas City Power & Light and 30,000 meters are in place at Union Electric (Energy Services & Telecom Report 1996c).

<sup>8</sup> Fixed radio networks are especially suited for handling short bursts of information (like meter reads) and are currently unable to handle long, large information streams (e.g., voice and video). (CPUC DAWG 1996).

Table 2-4. Potential Benefits of Fixed Radio Network Communications Systems

<b>Meter Reading</b> <i>Direct Benefits</i>	<ul style="list-style-type: none"> <li>• Reduced manual meter reading costs</li> <li>• Reduced service turn-on and turn-off costs</li> <li>• Reduced accident and injury costs associated with meter reading activities</li> <li>• Fewer missed and inaccurate reads (and customer complaints) because of automated data collection</li> </ul>
<b>Meter Reading</b> <i>Indirect Benefits</i>	<ul style="list-style-type: none"> <li>• Reduced interest expenses associated with accounts receivable because meter read to collection time is shortened</li> <li>• More flexible billing options (e.g., summary billing and selectable bill date)</li> <li>• Ability to continuously monitor customers with recurring payment problems</li> </ul>
<b>Other Benefits</b>	<ul style="list-style-type: none"> <li>• Alarms for meter tampering</li> <li>• Deliver real-time outage alarms and restoration notification</li> </ul>
<b>Up-Side Revenue Opportunities</b>	<ul style="list-style-type: none"> <li>• Gas &amp; Water Meter reading</li> <li>• Vending data and security alarm</li> </ul>

Source: "Vendor Carries Investment in AMR." 1995. *Electrical World*. April; "Design and Implementation of Direct Access Programs." 1996. CPUC Direct Access Working Group (DAWG). August 30.

We surveyed three utilities (Baltimore Gas & Electric, Boston Edison, Public Service of Colorado) that are currently involved in large scale system roll-outs of *mobile* wireless radio projects to several hundred thousand customers. In these systems, utilities have installed radio modules in electric meters, both new and existing, and then use radio-equipped vans that drive by slowly to collect meter readings. As currently configured at most utilities, these systems typically utilize only one-way communication.<sup>9</sup> This technology is attractive to utilities with many difficult- or dangerous-to-read meters.

## 2.4 Customer Energy Services

In this section, we discuss overall trends in the types of services offered and describe utility experiences implementing specific services.

<sup>9</sup> Itron is currently developing a fixed radio network system with local controllers (cell control units or CCUs) on power poles called Genesis, which will allow for two-way communication (see Appendix A).

### 2.4.1 Range of Service Offerings

Table 2-5 shows the energy and non-energy services that utilities are currently offering in their project or planning to offer in the future. The range and type of services varies somewhat by communications system. For example, utilities involved in hybrid fiber-coax cable projects offer a broader array of energy and non-energy services compared to radio and telephone-based projects. Non-energy services include home security, telephone service, medical alert, cable television, video-on-demand, and internet access. In contrast, wireless radio projects currently offer only energy information services. Mobile radio projects focus on energy-related services that provide operational savings to the utility (e.g., AMR, remote connect/disconnect, outage detection), while fixed network radio projects have also utilized in-home display devices to facilitate load control, TOU pricing, and energy information services.

There is also a significant gap between services that utilities currently offer and their planned offerings in the future, particularly with respect to non-energy services (see Table 2-5). For cable projects where utilities have not completed installations or have not yet implemented a particular service, we indicate energy services that are planned (shown as P in Table 2-5). In some wireless projects, utilities are planning to expand their current services to customers to include load control and TOU pricing. Only three utilities (Glasgow, Wright-Hennepin, and Entergy) currently offer non-energy services in their pilots; other utilities are planning to offer these services in the near future.

### 2.4.2 Automated Meter Reading

Every utility in our sample offered automated meter reading (AMR) in their project. The potential market for AMR is huge as a relatively small fraction (2-3%) of the nation's 150 million electric, and 75 to 100 million gas and water meters are automated thus far. Industry analysts are predicting rapid growth in the AMR market for electric meters: a seven-fold increase by 2000 from current levels (~1.1 million). Over 30 vendors offer AMR systems, although a few companies are quite dominant in terms of market share (Electrical World 1996).

It appears that utilities use AMR to "test the water" for more extensive telecommunications-based services. Currently, utilities typically spend only about 0.50-\$0.80/month on the direct costs for manual and appointment meter reads. This means that the overall cost of an AMR system must be fairly low (<\$75 per meter installed) to pay for itself in a reasonable time. On a stand-alone basis, AMR may be cost-justified only in certain niche markets (e.g., difficult-to-read meters, high-density urban areas). However, vendors claim that these systems also reduce losses from tampering and theft, and costs associated with disconnections (Jennings

**Table 2-5. Services Offered in Utility Telecommunications Projects**

Communications System	Utility	Automated Meter Reading	Outage Detection	Remote On/Off	Load Control	TOU Pricing	Energy Information	Planned Non-Energy Services <sup>a</sup>
Cable	Central & South West	x	P		x	x	x	
	Entergy	x			x	P	x	C, T*
	Glasgow Electric Board	P				x		H, C, I, O*
	Hydro Quebec	P			P	P	P	C, V, I, O
	Pacific Gas & Electric	x			P	x	x	H, O
	Public Service Electric & Gas	x	x	x	x	x	x	H, M, O
	Southern Dev. Invest. Group	P	P			P	P	H, M, C, V, I, O
	Virginia Power	x	x		x	P	P	C, V, T, I
Telephone	American Electric Power	x				x	x	
	Gulf Power	x	P			x		
	Wisconsin Energy	x	x	x	x	x	x	H, M, O
	Wright-Hennepin Cooperative	x	x				x	H, T, O*
Fixed Wireless Radio	Baltimore Gas & Electric	x	x		P	P		
	Boston Edison	x		x				
	Kansas City Power & Light	x	x			P		
	PacifiCorp	x				x	x	
	Pacific Gas & Electric	x						
	TECO Energy	x			x	x	x	H, M, I, O
Mobile Wireless Radio	Baltimore Gas & Electric	x		x				
	Boston Edison	x		x				
	Public Service of Colorado	x	P			P		M, O

Notes: X= energy service is currently offered; P = planning to offer service in the future

<sup>a</sup> Non-energy services are currently offered in only Entergy, Glasgow, and Wright Hennepin pilots; other utilities are planning to offer these services in future; H = Home Security, M = Medical Alert, C = Cable TV, V = Video on Demand, T = Telephone Services, I = Internet Access, O = Other

1996).<sup>10</sup> In addition, these systems may improve billing reliability (e.g., usage on inactive accounts) and customer service (e.g., fewer errors than manual reads leading to fewer customer complaints), which may reduce the utility's exposure to bad debt or uncollectibles. Finally, the information collected by an AMR service (e.g., hourly data stored for 40 days of usage) provides increased functionality to the utility which can be used to create new energy information services and products.

One utility in our sample reported that meter reading costs had dropped from about \$1.00/month (fully loaded with benefits) to about \$0.20 per meter per month. Another utility reported that its mobile wireless system paid for itself in less than seven years. In contrast, another utility thought that the project economics for its wireless radio pilot were relatively poor because the customer to transformer ratio was low throughout its service territory; thus system costs were high (because radio was installed on transformers). In evaluating the economics of a network-based AMR system for an individual utility, a number of factors affect the benefits, including (1) current costs for meter reading and related customer services, (2) age and type of existing meters (e.g., number of meters that can not be retrofitted; number of indoor vs. outdoor meters), and (3) population density, geographic distribution, and customer mix of the utility.

### 2.4.3 Outage Detection

We received divergent opinions on the usefulness of automatic reporting to utilities of unscheduled outages by relays on customer meters. Product vendors touted the benefits of outage reporting. Based on their experiences, some utility representatives thought that it was more effective to have a distribution substation or transformer report its outage status to headquarters rather than customer meters served by that station calling in outage reports.

### 2.4.4 Remote Connect/Disconnect

Several utilities (Boston Edison and Baltimore Gas & Electric) indicated that inaccessible meters or problems and costs associated with high turnover among customers was a major contributing factor in their decision to test automated services. For example, BG&E indicated that the utility has about 15,000 physical turn-ons/turn-offs each month due to high turnover among students and apartment dwellers. Because of the large number of universities in the Boston area, Boston Edison's residential customer base includes a disproportionately high number of relatively transient students. The utility incurs additional costs to serve this

---

<sup>10</sup> Vendors claim average savings of about \$0.25 per meter per month from reduced energy theft and tampering. Utilities can also set threshold alarms for unauthorized usage which can eliminate about 75% of the disconnection visits, which cost about \$7.80. Connects and disconnects affect about 30% of customers annually; thus vendors claim average savings of about \$0.20 per month per meter (Jennings 1996).

population (e.g., students move without closing out their bill or notifying the utility, utility staff must verify status of use and payment). Thus, these utilities installed a meter that can be triggered by the utility to shut off when payment is not received or reactivated when payments begin anew. These meters can also disconnect when tampering or theft is detected.

#### 2.4.5 Load Management

As discussed in Chapter 1, many utilities have traditionally offered direct load control programs in which they controlled specific appliances, such as air conditioners or water heaters, during peak demand periods to reduce system loads. Typically, in exchange for allowing the utility to control certain appliances, customers receive a bill credit in the range of \$5 to \$10 per month, during the load control season.<sup>11</sup> Based on our sample, we found that utility control of customer appliances is giving way to customer-controlled load management (CCLM) in which customers can preprogram response of individual appliances to time or price signals.

#### 2.4.6 Time-of-Use Pricing

About half of the projects in our sample included time-of-use prices. Some utilities obtained approval for their tariff from the local city government (e.g., Central & South West) or state regulatory authority. Other utilities (e.g., TEMS and Virginia Power) indicated that the TOU pricing schemes were experimental and would not be formally filed with the state PUC.<sup>12</sup> Utilities typically post prices for up to four periods (i.e., low, medium, high, and critical), which are signaled to customers through an interactive thermostat or an in-home display device. Prices in the four tiers ranged between about 5 and 50 ¢/kWh in CS&W's Laredo pilot. TOU rates ranged between 1 and 28 ¢/kWh in AEP's pilot project with its TranstexT system. The customer may chose to reduce heating and cooling equipment, pool heaters, water heaters, dishwashers, or other appliances during a high or critical price period or shift use to a lower price period. In our sample of projects, no more than eight appliances could be controlled, although one utility (TECO Energy) claims that it plans to control up to 17 devices through CEBus-adapted plugs and thermostats.

---

<sup>11</sup> For example, PSE&G has a direct control program in which customers are paid \$8 for four months of permitting the utility to control central air conditioners no more than 15 times a year.

<sup>12</sup> In TECO Energy's project, participation is limited to TECO employees. In the event that participating customers do not succeed in saving energy and reducing expenses in response to the TOU rate, employees are permitted to submit expense reports to cover the difference between the old billing and the experimental billing.



## 2.4.7 Energy Information

About half of the utilities in our sample offer various energy information services. We found that utilities in our sample are currently testing a rather limited set of energy information services compared to those that potentially could be offered to residential customers (see Chapter 4).

For example, in its Customer Choice and Control pilot, Central & South West presents the following information to customers in its in-home display unit: temperature in the home, time and date, price currently in effect, programmed response of appliance to price signals, vacation schedule programming, and electric bill to date (in dollars and kWh). In Pacificorp's pilot, the in-home display provides energy information through a sequenced menu display which includes four functions: energy usage in kWh and \$ (i.e., last week, last month), historical energy usage in kWh and \$ to compare this month with last year, a pre-set energy budget for customer based on recent and historical usage, and rate structure in effect. The customer is alerted by an LED on the front of the in-home device if actual usage exceeds budgeted consumption.

CSW and PG&E plan to offer itemized bills, with usage quantities under each price tier (see Figure 2-2). TECO Energy plans to track energy use by appliance load with sub-metered information available on four to eight appliances. PSE&G plans to offer customer messaging through one-liners on in-home displays, e.g., notifying customers when gas pressure gets low and request that gas heat use be restricted voluntarily until notified otherwise. PSE&G is also interested in customer load shape information: the utility will be able to generate customer load profiles for electric and gas consumption, graphing out use in five- to 15-minute intervals.

Figure 2-2. Sample Itemized Bill

ELECTRIC BILL					
Customer Name and Address			Total Due:		
			\$99.61		
Account Number 000-001					
Billing Summary from 6/15/96 to 7/14/96					
APPLIANCES	Total	Low Tier 1	Medium Tier 2	High Tier 3	Average Daily Rate
Air Conditioning	\$44.38	\$7.76	\$15.64	\$9.23	\$1.53
Water Heater	\$23.92	\$12.43	\$15.38	\$0	\$0.82
Dryer	\$8.54	\$2.87	\$5.67	\$0	\$0.29
Other	\$22.77	\$3.62	\$12.23	\$4.58	\$0.79
<b>MONTHLY TOTAL</b>	<b>\$99.61</b>	<b>\$26.68</b>	<b>\$48.92</b>	<b>\$13.81</b>	<b>\$3.43</b>
Source: CSW, Customer Choice and Control.					

#### 2.4.8 Other Energy Services

One of the more unique services is the Energy Saver Module offered by Wright-Hennepin Cooperative. Customers with weekend cabins can remotely turn on the heating system and selected appliances and lights from a touch-tone telephone which accesses a setback thermostat.

#### 2.4.9 Home Security

Wright-Hennepin is the first electric utility to offer home security monitoring through its Meter Minder project and its program extends into three service territories in Minnesota and Oklahoma. Customers pay a monthly charge of \$17.50 for the security monitoring service, which generates annual revenues of about one million dollars for the utility. The window and door sensors are wireless and are controlled by a touch pad device or a touch-tone telephone. The alarm system communicates with central monitoring through the Meter Minder's telephone connection.

About one-third of the utilities in our sample are considering offering home security services in the future. For example, SDIG has wired the common areas (e.g., pool, garage, lobby) of the large apartment complex, which is the site for its pilot; apartment dwellers will be able to access and view activity in common spaces through their cable television sets.

#### 2.4.10 Medical Alert

Several utilities indicated that they are planning to offer some type of medical alert feature. For example, TeCom Inc., an unregulated subsidiary of TECO Energy, is considering offering in-home medical monitoring through relationships with hospital in South Florida, although implementation details have yet to be worked out.

#### 2.4.11 Cable Television

Cable-based projects with set-top box controllers plan to offer cable television services.<sup>13</sup> A few utilities already compete with cable providers, most notably Glasgow Electric Board serving 3,000 subscribers. Entergy offers 22 stations and Virginia Power plans to offer cable TV through its Cox Communications partner.

---

<sup>13</sup> Several utilities testing hybrid fiber-coax cable systems, but not the TV as the device, do not plan to compete with existing cable providers in their service territory.

---

# Market Trends

## 3.1 Overview

In this chapter, we draw upon our survey of utility projects, discussions with product vendors, and review of the literature to summarize major market trends. We describe alternative strategies used by utilities to enter the market to provide communications-based services, strategic alliances and teaming arrangements between utilities and telecommunications providers, and the characteristics and costs of competing communications systems.

The battle for competitive advantage involves choice of communications technologies, vendor products, and service offerings as utilities have formed strategic alliances with telecommunications providers and product vendors. Scores of utilities are conducting technical and market trials, although, thus far, only a handful of utilities appear to have either demonstrated significant operational savings or successfully marketed energy and non-energy services that generate significant revenue streams from residential customers. Given differences in population density and existing utility systems infrastructure, no single communications delivery system is capable of serving all residential market niches economically. At present, the installed costs per household for wireless radio projects are substantially lower than for hybrid fiber-coax cable projects (\$100-300 vs. \$1,000-3,000); several utilities have opted for full-scale, system-wide deployment of wireless radio systems. Broadband cable projects offer increased functionality and upside revenue potential from non-energy services, but face a formidable competitive challenge if wireless radio projects foreclose or limit their deployment by capturing most of the potential energy-related benefits (e.g., operational savings, energy information services). Large-scale deployment of cable systems to residential customers may well hinge on the abilities of utilities to meet aggressive cost targets (\$300-500/house) and develop attractive applications that customers are willing to pay for.

We are convinced that these utility pilot projects for communications-enabled services foreshadow the future of residential customer energy services and DSM. This is one of the few growth areas in utility DSM: in aggregate, the cumulative financial investment of utility shareholders and

---

*Scores of utilities are conducting trials—only a handful have demonstrated significant operational savings or successfully marketed energy and non-energy services to residential customers that generate significant revenue streams.*

---

other equity partners may soon approach recent funding levels for ratepayer-funded DSM activities targeted at residential customers (\$700-900 million/year in 1994). However, given the market and regulatory uncertainties and technological risks, utilities and their partners must overcome significant hurdles before large-scale deployment of a comprehensive set of communications-enabled services in the residential sector becomes a robust and profitable business activity.

## 3.2 Market Entry Strategies

Utilities must consider several key parameters in providing energy information services to residential customers: communications delivery system ownership issues (e.g., utility-owned or lease from telecommunications service provider), and communications capability (e.g., one- or two-way). Until recently, utilities have traditionally owned and utilized one-way, wireless or

---

*The diversity of market entry strategies reflects the early stage of market development and the fact that the choice of communications system (i.e., superior economics and technical features) depends on density, geography, existing communications infrastructure, and desired services.*

---

powerline carrier communications systems to provide direct load control and energy information services. Projects in our sample highlight five other emerging market entry strategies that utilities are pursuing: (1) utility owns cable network, (2) utility leases capacity on cable network from telecommunications services provider, (3) utility owns wireless radio system, (4) utility leases wireless system from vendor, and (5) utility leases telephone-based communications system (see Table 3-1).<sup>14</sup>

The diversity of approaches reflects the early stages of market development for communications-enabled services as well as the likelihood that no single communications delivery system will be capable of serving all residential market niches economically, given differences in population density, building stock, and existing utility system communications infrastructure. Some utilities are conducting multiple pilots that test alternative communications delivery systems. For example, both Boston Edison and Baltimore Gas & Electric are trying two different types of wireless radio technologies, while PG&E is conducting pilot projects using cable and wireless radio systems.

---

<sup>14</sup> Within the home, powerline carrier (PLC) technology is typically used to integrate smart thermostats or energy management systems with these communications systems that connect the utility to the residence.

Table 3-1. Market Entry Strategy

Strategy	Utilities Interviewed	Vendors Interviewed
Utility-owned, two-way cable network	Central & South West (CSW) Entergy Glasgow Electric Board Southern Development Invest. Group	First Pacific Networks
Leased, two-way cable network	Hydro Quebec Pacific Gas & Electric (PG&E) Public Service Electric & Gas (PSE&G) Virginia Power	Cox Communications Intellon Lucent Technology TeleCommunications Inc.
Leased, two-way telephone network	American Electric Power Gulf Power Wright-Hennepin Cooperative	Integrated Communications Systems Interactive Technologies Inc.
Utility-owned, two-way wireless network	Baltimore Gas & Electric Boston Edison PacifiCorp TECO Energy	CIC Systems IBM Metricom
Leased, two-way wireless network	Kansas City Power & Light Pacific Gas & Electric	CellNet Data Systems
Utility-owned, one-way wireless network	Baltimore Gas & Electric Boston Edison Public Service of Colorado	Integrated Systems Solutions Corp.

### 3.2.1 Virtues of "Early" Entry

Utilities and product vendors believe that early, successful entry, defined as significant market share, will create a sustainable competitive advantage in this emerging business area. This view follows the "conventional wisdom" in marketing literature on new product and service development. We also believe that a case can be made that significant investments in a particular type of technology infrastructure may foreclose, or seriously limit, competing alternatives. For example, assume that utilities deploy fixed wireless radio networks in system roll-outs and that this enables them to capture most of the potential energy-related benefits (e.g., operations-related savings, energy information services). If this occurs, will utilities be less likely to develop and deploy competing communications systems, such as broadband cable networks. The economics of a broadband network to the customer premise may hinge on realizing benefits to the electric utility system (i.e., cost reductions and peak demand savings) as well as revenues derived from a broad array of energy and non-energy applications.

Knowledge-based products such as computers, telecommunications equipment, and fiber optics are largely subject to increasing returns to scale. Although these products (or systems) require large initial R&D investments, unit costs fall as more systems are built. Moreover,

the benefits of using these systems increase as the technology gains market share, particularly if they operate in networks that require compatibility. Economists describe this phenomenon as “path dependence:” a situation in which a technology or system’s edge quickly snowballs into clear economic advantage because production costs fall as volumes and manufacturing experience increases and because consumer acceptance (or development of supporting products by suppliers) grows with greater familiarity (Arthur 1994; Passell 1996).<sup>15</sup>

### 3.2.2 Wireless vs. Broadband Projects

Thus far, wireless radio projects are farther along than competing communications delivery systems in terms of large-scale deployment. Recent contracts signed between utilities and various vendors for system-wide rollouts of fixed or mobile radio networks highlight this trend (e.g., Kansas City Power & Light, Union Electric). Wireless radio projects typically involve less complex teaming arrangements and fewer partners than broadband projects. Utility staff often are more familiar with wireless radio systems and have more experience integrating these systems into business operations (e.g., metering) or customer services (e.g., direct load control programs).

A fixed network radio system is most attractive in metropolitan areas with medium to high population density levels. Key factors that affect the large-scale deployment of these systems include: (1) demonstrating that a fixed radio network reduces operational and administrative costs of the utility or facilitates additional customer service offerings besides automated meter reading, and (2) maintaining their current cost advantage over competing technologies as they add functionality and services (e.g., security, home alarm). The economics of fixed network radio systems currently depend on widespread deployment over a geographic area and long-term contracts assuring recovery of the capital investment in infrastructure. Thus, a supportive regulatory environment and/or favorable regulatory treatment may also facilitate large-scale deployment. Examples include performance-based regulation, high probability of cost recovery under traditional cost-of-service regulation, or little pressure to unbundle the utility’s distribution “wires” business from provision of various retail services (e.g., billing, information).

Over the last three to four years, a number of electric utilities have launched broadband projects with significant fanfare in the trade press. A few of the utilities, such as Entergy and Central & South West, have decided to build and own their communications infrastructure between utility and customer. However, most other utilities (e.g., PG&E, PSE&G, Virginia

---

<sup>15</sup> A societal implication of the “path dependence” phenomenon is that “a technology that improves slowly at first but has enormous long-term potential could easily be shut out, locking an economy (industry) into a path that is both inferior and difficult to escape.” Standards that are established early can be hard for later ones to dislodge, no matter how superior would-be successors may be (Arthur 1994). This argument has been raised by some broadband proponents (Rivkin 1996).

Power, and Hydro Quebec) have decided to partner with cable and/or telecommunications companies and lease capacity on the provider's network. Electric utilities involved in broadband projects appear eager to get involved in the burgeoning home-based information, entertainment, and communications market. These utilities expect that residential customers will ultimately want a critical mass of compelling applications ("one-stop shopping") and that customers will want interactive services provided over familiar and easy-to-use interfaces (e.g., computer or TV). These utilities are also betting that, in the long run, they can improve the efficiency of utility operations by selecting a base communications system (i.e., two-way broadband) that can handle the greatest number of utility applications (Andersen Consulting 1995).

### 3.2.3 Corporate Strategy: Near-Term Cost Reduction vs. Long-Term Positioning

The approach taken by electric utilities to providing communications-enabled services is often linked to their near-term strategic response to increasing competition or long-term "vision" of their role in evolving residential electricity markets. We sketch out two scenarios, describe the utility's strategic response, and its possible relationship to different types of utility-telecommunications projects. In the first situation, the utility faces minor threats to its market share or core business either because it is a low-cost provider or because restructuring and retail competition do not appear imminent. The utility's strategy is to focus on near-term cost reductions and develop enhanced services in its core utility business. This strategy appears to underlie many wireless radio projects, which often focus on near-term improvements in utility operations to reduce rates and provision of energy information services to a small number of selected customers (e.g., real-time pricing or innovative billing to large commercial customers). In some cases, these utilities are relatively low-cost providers in their region and believe that competitive advantage can be maintained by reducing costs in their core distribution (wires) business. Kansas City Power & Light and Baltimore Gas & Electric are two examples of utilities in our sample who are aggressively moving forward with large-scale wireless projects focused on cost reduction, automation of customer service and distribution, and testing of value-added energy information services.

In contrast, other utilities seek to become full-service providers of energy and other retail services in order to maintain their competitive position. These utilities regard energy and non-energy services as an important new source of potential revenues. In some instances, the utility's strategy may be driven by their current position as a high-cost producer or their desire to focus on value-added services in an industry that is becoming more commoditized. In our sample, a number of the utilities that are testing a broad array of energy and non-energy services in cable projects tend to be located in states where industry restructuring is proceeding relatively quickly (e.g., California) or are higher-cost providers in their region. It appears that these utilities are hoping that communications-enabled services will provide a competitive weapon to retain existing customers and/or offer important new sources of future revenue growth to offset potential revenue losses in commodity sales.

Project objectives and design are often linked to the utility's assessment of the pace of industry restructuring or the future regulatory regime under which it will operate (see Table 3-2). For example:

- Public Service Electric & Gas and Lucent Technologies (formed as a result of the AT&T divestiture) are conducting a technical trial of 1,000 residences and businesses. The project focuses on demonstrating the operational savings from AMR and outage detection and peak demand reductions from load control and energy information services. System-wide rollout is contingent on operational and peak load savings because PSE&G believes that state regulation will move towards performance-based ratemaking (e.g., price cap), which would mean that shareholders would be able to capture these benefits in increased earnings. Based on its assessment of the unbundling of services that were likely to occur as a result of industry restructuring, PSE&G also concluded that its system must have the capability to provide real-time pricing and usage information (i.e., 30-minute intervals) which influenced its choice of a fiber-coax cable system.
- Central & South West's (CSW) strategy is quite explicit: expertise in fiber-optic energy management is key to gaining a competitive advantage in the future. Thus, they have followed an aggressive "learn-by-doing" approach: a large-scale, fast-track, market demonstration (~2,500 homes). CSW concluded that only a large-scale demonstration would provide sufficient experience to assess customer interest in energy information services, develop alliances with strategic partners, reap economies of scale to reduce costs, and demonstrate their capability compared to other potential competitors.
- PG&E, in conjunction with TCI and Microsoft, is currently undertaking a much smaller (~50 homes) market research-oriented pilot with the following objectives: (1) assess customer willingness to pay, (2) assess different ways to bundle services, and (3) develop business plan for PG&E Enterprises (PG&E's unregulated subsidiary). PG&E's cautious approach is driven by their assessment that the consumer services market is highly-demanding, that market demand for the proposed services has not been demonstrated, and, we believe, by the regulatory and market uncertainties created by the electricity industry restructuring process in California.



**Table 3-2. Link Between Utility's Strategic Vision and Project Objectives**

Utility	Project Objectives	Industry Future/Market Strategy
PSE&G	<ul style="list-style-type: none"> <li>• 1,000-home "technical" trial underway</li> </ul>	<ul style="list-style-type: none"> <li>• Utility roll-out contingent on operational &amp; peak load savings</li> <li>• Link to performance-based regulation (PBR); requirements of real-time pricing</li> </ul>
Central & South West (CSW)	<ul style="list-style-type: none"> <li>• Large-scale pilot required to assess customer interest and demonstrate technical and market capability</li> </ul>	<ul style="list-style-type: none"> <li>• Fiber-optic energy management key to competitive advantage</li> </ul>
PG&E	<ul style="list-style-type: none"> <li>• Market research-oriented pilot</li> </ul>	<ul style="list-style-type: none"> <li>• Demands of consumer market &amp; CA regulatory uncertainty shape pilot</li> </ul>

### 3.3 Strategic Alliances and Teaming Arrangements

Utilities have typically forged strategic alliances and teaming arrangements in order to manage the technical and financial risks associated with developing communications-based services. Table 3-3 shows the team members and their roles in each utility project; projects are grouped by communications system (e.g., cable, telephone, and wireless radio). In many wireless radio projects, arrangements are less complex because one key vendor is often responsible for obtaining all necessary equipment (e.g., Cellnet, Itron). In some cases, as more services are offered, additional team members are added to wireless projects. For example, in PacifiCorp wireless radio pilot which uses Metricom's UtiliNet product, CIC Systems developed an in-home energy management system that displays current usage, a 12-month usage history, rate schedules, and budget settings, and Landis & Gyr supplied electronic meters for remote disconnect applications.

It is also common for utilities to make an equity investment in companies that are key technology partners. For example, both AEP and Southern Company are investors in Integrated Communications Systems (ICS), the developer of TranstexT and Advanced Energy Management Systems products. Entergy invested about \$15 million when it purchased its 10% share of First Pacific Network.

**Table 3-3. Team Members and Roles in Utility Telecommunications Projects**

Communi- cations System	Utility	Lead	Thermostat	Display	Controller	Meter	Engineering
Cable	Central & South West	Utility		Raytheon	FPN	American Innovation	FPN, Raytheon
	Entergy	Utility	Honeywell		Echelon	American Innovation	Honeywell, Utility
	Glasgow Electric Board	Utility		CableBus	CableBus		CableBus
	Hydro Quebec	Utility	C-Mac	Zenith	Domosys		Domosys
	Pacific Gas & Electric	Utility, TCI, Microsoft		TCI	Utility	Landis & Gyr	Microsoft, Utility
	Public Service Electric & Gas	Utility, AT&T	Honeywell		Honeywell, Intellon	General Electric	AT&T, Utility
	Southern Development Invest. Group	Utility		Raytheon	FPN	Landis & Gyr	FPN, Raytheon
Telephone	Virginia Power	Cox		Nortel	Nortel		Utility, Cox
	American Electric Power	Utility	Johnson Controls		Southern	ABB	Southern, ICS
	Gulf Power	Utility	Johnson Controls		Southern	ABB	Southern, ICS
	Wisconsin Energy	Utility, Ameritech	Johnson Controls	Pensar			
	Wright-Hennepin Cooperative	Utility				ITI	ITI, Utility
Fixed Wireless Radio	Baltimore Gas & Electric	Utility	TBD		IRIS		IRIS
	Boston Edison	Utility	CIC Systems		Metricom	Landis & Gyr	Metricom
	Kansas City Power & Light	CellNet			CellNet		CellNet
	PacifiCorp	Utility	CIC Systems		Metricom		Metricom
	Pacific Gas & Electric	Utility			CellNet		CellNet
	TECO Energy	Utility		IBM	M-TEL		Utility
Mobile Wireless Radio	Baltimore Gas & Electric	Utility			Itron	Various	Itron
	Boston Edison	Utility			Itron		
	Public Service of Colorado	Utility			Itron	Various	

Fiber-coax projects typically involve more complex teaming arrangements: the utility, along with a telecommunications service provider, often assumes the project integrator or lead role while other companies provide various types of equipment (HVAC controls, thermostat, in-home display), software, or specialized expertise. The success of these partnering arrangements (e.g., successful integration of disparate corporate cultures and balancing of expertise) is one key factor that distinguishes projects that are moving forward to the next stage of development from pilots that appear to be floundering.<sup>16</sup> These strategic alliances are critical in part because the project team leaders (e.g., utility and telecommunications provider) often hope to profit from their venture by marketing their product to other utilities. For example, CSW Communications was recently awarded a large contract to deploy a cable-based system to serve several hundred thousand customers in Austin, Texas, which builds on its Customer Choice and Control pilot in Laredo, Texas (Energy Services & Telecom 1996a). Similarly, PG&E/TCI/Microsoft recently announced that seven utilities agreed to pay an up-front fee for use of the energy information services technology, with access to PG&E's market research for its pilot and assistance to conduct their own market research trials (Energy Services & Telecom 1996b). Finally, Lucent Technologies announced that Consolidated Edison and Louisville Gas & Electric have agreed to participate in its Integrated Broadband Utility Solution.

### 3.4 Participation Rates and Market Response

Some utilities report relatively high participation rates in pilot projects, although customers were typically not asked to pay for services. For example, one utility was able to get 50% of the customers on a feeder line to participate in a wireless R&D project without offering incentives. Gulf Power reports that >20% of targeted single-family customers responded favorably to participating in its pilot program which offered TOU pricing with its TranstexT system. CSW reports that they have signed up about 70% of the customers in neighborhoods that were physically able to participate in their 2,500-home cable pilot in Laredo, Texas. In discussions with utility staff, it appears that they regard these high participation rates as proxies for customer interest in innovative services. Not surprisingly, market response is lower in those few projects where customers actually pay for services. Several small publicly-owned utilities and rural electric cooperatives appear to have the most experience in terms of customers' actual willingness to pay. For example, about 10% of the 29,000 residential

---

*Some utilities have achieved high participation rates in their market trials and aroused customer interest in innovative, new services, although willingness to pay is unclear.*

---

<sup>16</sup> Projects that are "floundering" include those that have been dramatically scaled back in size (e.g., number of households), experienced significant delays due to technical problems, or decided to not proceed to next stage of development (e.g., discontinue after small-scale pilot).

customers of Wright-Hennepin Cooperative Electric Association have installed Meter Minders; many customers lease the security equipment, paying monthly charges of \$17.50. Over 50% of Glasgow's 5,500 residential customers subscribe to cable TV, while 5 to 10% subscribe to telephone and local area network services.

### 3.5 Project Costs and Savings

For this study, utilities were asked to provide information on project costs, estimated savings to the utility and customer, and other benefits or revenues that derived from their projects. This information is reported in Table 3-4, with projects grouped into six general categories based on communications system and ownership. We present cost ranges for each group as well as utility cost targets. Several caveats are worth noting: (1) project costs are self-reported, and (2) it is inherently difficult to estimate per-unit costs in small-scale R&D projects.<sup>17</sup> Project costs typically include the costs of communications link between utility distribution network and customer's home network (the so-called "last mile"), customer premise equipment, program administration, and marketing expenses. The cost of the communications backbone network is typically not included; in some cases, utilities rely heavily on existing cable networks in their pilot programs.<sup>18</sup> Given these caveats, we regard reported costs as order-of-magnitude estimates for the "last-mile" connection, while cost targets are indicative of utility goals for large-scale pilots or system roll-out.

Utilities testing one-way *mobile* wireless networks report the lowest installation costs per household (\$100-150/house). These systems have more limited functionality and service offerings compared to other communication systems. Project costs for wireless radio systems using *fixed* networks typically ranged between \$180-\$600 per house. In the projects that reported lower costs, a limited number of services are currently being offered. However, vendors claim that additional services can be provided at low incremental costs on a systemwide basis, particularly if these services are not made available or desired by all customers. Projects at the high end of this range either included additional customer premise

---

<sup>17</sup> Some utilities were quite reluctant to divulge or include start-up or development costs in their estimates. For example, one utility indicated that the start-up and development costs for its small pilot (<100 homes) would exceed its estimated costs for the "last mile" connection to the household, while others indicated that start-up costs were "substantial."

<sup>18</sup> One utility indicated that the cost of the fiber backbone network in its pilot was "very expensive," but would not divulge costs. Anderson Consulting (1994) estimates that utilities have spent between \$50,000-\$65,000 per mile to build a backbone fiber network. In several cases, utilities noted that estimated costs excluded the sunk costs of software development

**Table 3-4. Market Features: Project Costs and Savings**

Strategy	Utility	Key Partners/ Vendors	Installed Cost (Current) <sup>a</sup>	Installed Cost (Target) <sup>b</sup>	Peak Demand and/or Energy Savings
Cable, Utility-Owned	Central & South West	FPN	1,000-3,000	1,000	Avg. bill savings of 7-10%; 2 kW peak demand reduction
	Entergy Southern Dev. Invest. Group Glasgow Electric Board	FPN formerly FPN CableBus	240 <sup>c</sup>	NA	
Cable, Leased	Hydro Quebec Pacific Gas & Electric Public Service Electric & Gas Virginia Power	Domosys TCl, Microsoft AT&T Cox, Nortel	2,000-3,000	300-500	\$60-80/yr
Telephone, Leased	American Electric Power Gulf Power Wisconsin Energy	ICS ICS Ameritech	1,000- 1,500	750	Avg. bill savings of 12-15% (~\$175/yr) 2-4 kW peak demand reduction
	Wright-Hennepin Cooperative	ITI	240 <sup>d</sup>		
Fixed Wireless, Utility-Owned	Baltimore Gas & Electric	IRIS	240-600	NA	
	Boston Edison	Metricom			
	PacifiCorp	Metricom			
	TECO Energy Mgmt Services	IBM			
Fixed Wireless, Leased	Kansas City Power & Light Pacific Gas & Electric	CellNet CellNet	180-240	NA	
	Baltimore Gas & Electric Boston Edison Public Service of Colorado	Itron Itron Itron	100-200	NA	

Note: First Pacific Networks (FPN), Integrated Communications Systems (ICS), Interactive Technologies Inc. (IT); NA = Not Available

<sup>a, b</sup> Costs and savings in \$ per residence; cost ranges for pilot projects in each group; excludes costs of installing backbone network

<sup>c</sup> Cost estimates are for incremental costs of pilot (i.e., CableBus switch, AMR meter, and water heating wiring); and do not reflect total cost of linking Glasgow's cable network to the residence

<sup>d</sup> Costs are lower because Wright Hennepin project does not include in-home display unit and cost of CPU is excluded from installation cost.

equipment (e.g., in-home display equipment) or had low customer density levels, which meant that fewer customers were served by each radio transformer (e.g., ratio of customers to transformer was 3:1 vs. 20 or 35:1 in dense urban areas).

Installed costs of cable-based projects in residential markets is currently quite expensive (e.g., \$1,000-3,000/house). Factors that may explain the large range in reported costs include: (1) extent to which an existing backbone network can be utilized vs. the costs of constructing a new backbone network, (2) differences in customer premise equipment costs, which depend on the range of services offered (e.g., telephony, cable TV) and their saturation (e.g., every house vs. sub-group among total population), and (3) differences in system design (e.g., coax cable to the customer premise vs. coax to secondary transformer and powerline carrier to customer premise). Some utilities report that installed costs per household have declined significantly as they have ramped up their pilot programs and it appears likely that some utilities will be able to reach their near-term cost targets (e.g., \$500-1,000/house).

We also collected information on utility estimates of either peak demand savings or customer bill reductions (see Table 3-4). Savings estimates are also self-reported with one exception (Gulf Power) where there is an evaluation of the project by a third-party consultant. Gulf Power reported summer peak demand reductions of about 2.25 kW/home from TOU prices in its Advanced Energy Management System pilot. American Electric Power reported that it was able to obtain a significant load shift of 4 kW per house among its all-electric customers when it posted a critical price during an extremely cold winter day (-30° F). Bill savings for customers averaged about 12 to 15% (Energy Services and Telecom Report 1996c). CSW claims that customers in its Customer Control and Choice pilot are reducing their energy bills by about 7 to 10% on average with a summer peak demand reduction of 2 kW per household. Annual bill savings for residential customers reported by several utilities ranged between \$60-\$175 per year.

Peak demand reductions reported by these utilities for customer-controlled load management (CCLM) are in the same range (i.e., ~2 kW/house) as that reported by utilities in their evaluations of traditional direct load control programs. However, given the limited experience with residential CCLM, utilities will need to conduct independent evaluations with large samples in order to establish reasonable forecasts of aggregate peak demand reductions that can be used for system planning purposes.

### 3.6 Technological Risks and Market Uncertainties

These pilot programs allow utilities to assess some of the technological risks associated with providing communications-enabled services. For example, utilities have experienced first-hand the challenges of system integration (e.g., integrating home network and customer premise equipment with the utility distribution network) and problems that arise because of the lack of standardized communications protocols. More fundamentally, utilities are

increasingly aware that large-scale investments in communications infrastructure may become obsolete quickly, a concern driven in part by the rapid pace of technical innovation in information, computing, and communications technologies. Thus, in addition to evaluating the field performance of specific systems, utilities are also assessing technology risk in terms of flexibility and obsolescence. Issues here include: (1) reliance on “open” vs. proprietary standards or protocols, (2) ease with which technology or the system can migrate to new or next generation technologies, and (3) integration with other products and strategic alliance opportunities.

Proponents of broadband (Arthur Anderson 1994) argue that fiber-coax cable communications infrastructure offer significant advantages to electric utilities because of their flexibility and functionality to meet current and future needs (e.g., two-way communications with easy customer interface, ability to

---

*Utilities continue to search for the “killer application”-- Internet access, home security & alarm services - that will open up the residential market for large-scale deployment of two-way, communications-enabled services.*

---

deliver voice, video and data). These capabilities mean that a cable communications infrastructure potentially has “strategic value” to electric utilities because it enhances their ability to address competitive threats or provides flexibility to take advantage of opportunities in the future. In contrast, Komor (1996) argues that the low-risk strategy for utilities is to pilot new services, relying where possible on existing or low-cost narrowband communications networks, which can handle most energy services.<sup>19</sup> Given the lack of demonstrated market demand, it is riskier to rely on higher capacity (and higher cost) links such as fiber-coax cable, which cannot be justified for energy services alone.

Ultimately, utilities hope to recoup their investment in communications systems and service applications from savings in the cost of utility operation and from revenues from customers that are willing to pay for energy-related and non-energy services. At present, utilities typically receive cost recovery from all ratepayers for load management programs based on a determination that these activities provide overall net benefits to the system. However, in the future, some utilities envision that participating customers may pay a portion of the costs of pricing and load management programs if they are offered as energy services. Most utilities either refused to divulge results of their market research or were in the midst of large-scale trials. However, we did uncover one or two studies of utility-sponsored market research that asks customers whether they would be willing to pay for these types of services. For example, Gulf Power found that most customers would be willing to pay \$5 to \$10 per month or less for the TranstexT system, which translates into less than 25% of the bill savings in most houses. Thus, the amount of savings, customers’ willingness to pay a portion of the

---

<sup>19</sup> Komor includes several examples of services that can be offered to commercial customers using existing networks: use phone lines to test remote equipment monitoring, simulating real-time pricing through electronic bulletin board that can be accessed via modem, and send daily faxes that summarize real-time consumption using phone lines.

value of these savings to the utility (e.g., 10-20%), and customers' payback criterion (e.g., 2-3 years) establish an upper limit on the annual contribution that could be expected from customers for these energy-related services.

Other potential benefits include savings in operating costs and improved productivity (e.g., fewer meter readers), increased revenues from non-energy services, and increased customer satisfaction leading to customer retention or growth. Few utility contacts provided data or studies quantifying these benefits, although some managers offered anecdotal information on productivity impacts or customer satisfaction. Based on our survey, only a few utilities (e.g., Glasgow Electric Board, Wright-Hennepin) have achieved reasonably high market penetration rates in promoting non-energy services that generate substantial revenue streams from residential customers. Most other utility projects are either still at the technical proof-of-concept stage, pilot market research, or large-scale technical trial. Utilities and others continue to search for the "killer application" such as Internet access, video-on-demand, or home security services that will open up the residential market for large-scale deployment of two-way, communications-enabled services. However, at this time, significant uncertainties exist regarding services desired by residential customers and their willingness to pay for them. This situation motivated our exploratory market research effort, which we discuss in Chapter 4.



# Exploratory Market Research on Energy-Related and Non-Energy Services

## 4.1 Overview

In this chapter, we discuss results from a focus group and ten individual interviews which sought customer reactions to 14 energy and non-energy services. These customers' local utility is not currently conducting a DSM pilot program that uses advanced telecommunications technologies. Our main objective was to understand consumer perceptions of and explore their interest in and willingness to pay for communications-enabled energy services. A secondary objective was to develop a survey protocol for an extensive set of energy information services that could be used by other groups. To provide a context for our work, we describe briefly the publicly available research on this topic. We then present an overview of our research and sampling methodology and discuss customer reactions to specific services. A summary of key findings from our exploratory market research is presented in Chapter 5.

## 4.2 Market Research on Communications-Enabled Services

Many utilities have conducted market research exploring customers' interest in communications-enabled services, although, with one or two exceptions, results of such studies are proprietary (Frauenheim 1995). The American Information Users Survey involved eight focus groups and structured telephone surveys with 2,000 households. Frauenheim reports that a fairly high proportion of the population is interested in various energy information and other services (see Table 4-1). However, the publicly-available summaries of Frauenheim's proprietary studies are not very detailed, although we assume that more in-depth results are available to clients. Find/SVP and Texas Systems have undertaken another survey, The American Home Energy Management Survey: Consumer Energy Management and Use, to assess how consumers perceive, value, and will use home energy management products and services. As best we could determine, summary results of this second survey are not yet publicly available.

**Table 4-1. American Home Energy Management Survey Results**

Service	Very Interested	Interested	Not Interested
Dial up to switch light or thermostat	38%	41%	21%
Monitor/Control energy usage	33%	45%	22%
Educational programs	47%	41%	12%
Movies and TV on demand	69%	25%	6%
Electronic shopping	25%	50%	25%

Source: Frauenheim (1995)

### 4.3 Research Methodology and Sampling

We utilized qualitative techniques (e.g., focus group and personal, semi-structured interviews) to elicit in-depth responses of perceptions and opinions from a diverse sample of utility bill payers (Bernard 1994). To preserve anonymity, when quoting individual statements by focus group participants or interviewees, only the first name of the participants is used. Individuals were drawn from Newark, Delaware. The focus group was conducted on December 12, 1995 and the ten in-person interviews were conducted during January 1996. Because of Newark's particular demographic profile, our sample did not adequately represent minority or low-income populations. Because both the focus group and interview solicitations yielded high refusal rates, some sampling bias may have been introduced.

For the focus group, we employed a systematic random sample. Individuals were selected from the Newark telephone directory, using a random number table to select page numbers as well as a name from every column from the selected page numbers. We developed screening questions to select the bill payer of the household and to minimize inclusion of University of Delaware faculty and students.<sup>20</sup> A total of 235 calls were placed, of which 125 yielded answers and 110 yielded answering machines or no answer. Seven of the 12 who agreed to participate when first solicited actually attended the focus group. The group included three women and four men; participant profiles are included in Table 4-2.

<sup>20</sup> Newark is a college town, and we thought university students and faculty might be more receptive to new technologies, so our sampling method and screening questions excluded most faculty and students.

**Table 4-2. Profiles of Respondents**

Name	Age	Sex	Occupation
<b>Focus Group:</b>			
Colin	30s	F	Office Manager, construction company
Chuck	30s	M	Carpenter, self-employed
Wayne	30s	M	Engineer
Susan	20s	F	University Administrative Assistant
Pat	40s	M	Chemical Technician
Shirley	50s	F	Not known
Bruce	60s	M	Retired, formerly utility employee
<b>Face-to-Face Interviews:</b>			
Aaron	30s	M	Buyer (self-employed)
Mike	40s	M	Stock Broker
Carl	60s	M	Professor
Becky	30s	F	Graduate Student
Gilles	50s	M	Businessman
Patchy	50s	F	Schoolteacher
Neel	50s	M	Engineer
Paul	50s	M	Professor, Business School
Dave	30s	M	Fitness Instructor
Sherry	30s	F	Collection Officer, major credit card company

Several participants had home computers which they used to access on-line services or indicated that they used software packages, such as Quicken, for personal financial management and record keeping purposes. One group participant (Shirley) had previously participated in a time-of-day pricing program and made regular use of bank-by-phone services.

We also conducted ten personal interviews in order to complement the focus group results, specifically to capture elements that could be clouded by group dynamics. Due to a very low

response rate, six interviewees were recruited through colleagues' and friends' contacts.<sup>21</sup> The interviews typically lasted 30 to 40 minutes. In order to gauge the perceived economic value of the services, respondents were asked to fill out a short questionnaire at the end of the focus group discussion and individual interviews (see Appendix D).

## 4.4 Overall Reactions to Communications-Enabled Services

In this section, we highlight several themes that emerged from the focus group and individual interviews that are not specifically related to the proposed services, but rather to respondents' views on advanced information, computing, and telecommunications technologies, concerns as consumers, or the appropriate role for utilities.

### 4.4.1 Necessity and Usefulness of Services and Information

The predominant direction of the focus group discussion was that many of the services described were viewed as not required or particularly useful because the information either was already available or would not be used. The fact that these services were offered via advanced telecommunications technologies made them even less desirable. In contrast, the personal interviews brought out a fairly positive overall response to the services described. Most of the services were viewed as information—"the more the better"—and considered essential in order to track and become aware of consumption changes.

### 4.4.2 Medium

The appropriate choice of communication medium also emerged as an issue in both the focus group discussions and individual interviews. Among vocal focus group participants, there was a general perception that establishing a separate "high tech" system to provide energy information was unnecessary. For example, participants commented that various energy information services could easily be included in paper-bills, could be offered through telephone services and various printed media, or otherwise be made available on public domain web pages on the Internet.

Participants' views on the relative merits of different communications mediums (e.g., television or computer) also emerged during the discussion of individual services, although

---

<sup>21</sup> We believe the poor response rate may be attributable in part to the timing of our surveys (i.e., Christmas holiday season) and the severe winter weather. Relying on colleagues' and friends' contacts was expected to minimize a bias based on interviewees' interest since they agreed to participate (at nearly 100 percent acceptance) in order to do a favor, not because they had any interest in the topic.

we did not ask participants to indicate their preferences on this issue. For example, some focus group members raised concerns that the television was not the ‘best’ medium for distribution of these services. Several people questioned the ease of use of the TV set and “smart box” or commented that the TV would likely be in use at the time when bill-related activities occurred or was not located near where they processed their bills. In response, other focus group members suggested the computer as an alternative medium of display. To computer users, computers seemed a more logical and easier medium than a separate system on the TV, as one said, “Why not just put all this on the Internet?” During the discussion, several participants voiced concerns that if computers were the preferred medium, sections of the population, particularly the poor, would be excluded from taking advantage of these services, which would tend to further widen the gap between the haves and the have-nots. Although less convenient to use, the television set was seen as a more equitable medium that would reach a broader section of society.

In the individual interviews, most people seemed to be neutral regarding medium, although several commented that television might facilitate broader access to these services because “everybody has televisions” Three participants indicated a strong preference that they did not want the information on a computer, mainly because they did not like high technology devices (they ranged in age from 40s to early 60s).

#### 4.4.3 Control and Choice

Comments of many participants indicate a strong preference for them to be in charge of controlling and monitoring their own energy consumption and make personal choices about the need to engage in energy conservation through the implementation of specific measures, both technical and behavioral. Load management and building automation controlled by the occupants of the house, as opposed to the utility, was the preferred solution for all except one of the respondents.

#### 4.4.4 Privacy

Privacy issues were raised as a significant concern by participants in discussions of several services, particularly ‘Appliance Energy Consumption Breakdown’, ‘Energy Efficiency and Conservation Programs’, ‘Energy Efficiency Product Information’, and ‘Load Management and Automation.’ For example, several participants questioned whether the utility should have access to information on the energy usage patterns associated with different household activities. In some cases, it appears that their objections stem from concerns that the utility would pass this information on to third parties, which would lead to an increase in unwanted marketing calls and letters. Several participants commented that marketing of long distance telephone services was very annoying and that they did not want the type of service offerings described in our materials to become an occasion, and a vehicle, for more marketing calls and

letters. In contrast, the individual interviews yielded very different reactions: most people did not have problems with utilities keeping this type of information. Several focus group members also felt that computer network security issues have not been adequately addressed, specifically that they did not trust that the information could be adequately protected. Overall, our sense is that for focus group participants, privacy and security concerns, coupled with general distrust in the utility, detracted from the perceived desirability of communications-enabled services.

#### 4.4.5 Interest in Energy Efficiency and Bill Reductions

Based on the discussion of various energy information services, we believe that the lack of interest in energy services that could reduce bills may be due in part to participants' perception of low potential for energy conservation, relative to the efforts required to achieve the savings. This finding is consistent with previous studies (Kempton and Montgomery 1982). For example, Aaron said "time consumption does not compensate for the possible savings", and Carl asked, "how much would it save him as opposed to the cost that he would have to incur in order to use the services". Another major issue was the perception that load management or time-of-day pricing would imply significant lifestyle changes.

### 4.5 Reactions to Specific Services

In this section, we discuss customers' reactions to fourteen proposed services, which are described briefly in Table 4-3. The services can be grouped into five general areas: (1) billing-related services, (2) pricing, (3) other energy information services, (4) energy management, and (5) non-energy services. Readers who want a complete description of the text describing the services and accompanying visual illustration should refer to Appendix C. Table 4-4 summarizes the questionnaire responses of the seven focus group participants and ten interviewees regarding interest level and willingness to pay for our 14 proposed services. Appendix D includes the survey questionnaire form and customer's individual responses on willingness-to pay for services. Because our sample is small, we interpret the quantitative results as providing a consistency check on the qualitative discussion and possibly an indication of some customers' willingness to pay for various services.

**Table 4-3. Summary of Proposed Services**

No.	Name of Service	Description
1	Historic Consumption	Gives customers a graphical display of monthly energy usage for an entire year.
2	Neighborhood Comparison of Energy Use	Allows customers to compare their electric or gas bills with households in their neighborhood.
3	Appliance Energy Consumption Breakdown	Gives information on how much energy is consumed by each major appliance in the house.
4	Billing and Payment Plans	Allows customer to review and pay the bill directly via an interactive system.
5	Instantaneous Consumption and Time-of-Day Pricing	Provides the amount of energy being used and the price at which it is being sold, allowing the customer to decide how to reduce energy bills by shifting energy demanding activities.
6	Energy Services Agreements and Rate Options	Offers detailed descriptions of energy services, agreements, and rate options aimed to increase customers awareness of these utility offerings.
7	Energy Efficiency and Conservation Programs	Information about the energy savings programs that could be offered via the system.
8	Energy Efficiency Product Information	Up-to-date energy efficient appliance information offered as a service to customers as part of overall energy efficiency goals.
9	"Do-it-yourself" Videos and Booklets on Energy Information	Enables orders for "Do-it-yourself" Videos and Energy Information booklets.
10	Scheduling of Installation, Field Services and Repairs.	An interactive scheduling service that would allow customers to plan ahead and suggest preferred time for service installation or repair.
11	Specific Customer Queries	An interactive customer service center that would work almost like an electronic mail-box.
12	Load Management and Automation	Services to reduce utility peak load demand, and customer control and operation of appliances based on customized time schedule.
13	Entertainment Videos on Demand	Allows customers to order movies of their choice on a pay-per-view basis.
14	Security Services	Security services that would allow remote monitoring and control of residences through light switches or locks, when home is unoccupied.

Table 4-4. Customer Interest in Energy and Non-Energy Services

No.	Service	Does Not Want	Want If Free	Want and Will Pay <sup>b</sup>	Pay-per-Month <sup>c</sup> (\$)	Pay-per-Month <sup>d</sup> (\$)	Pay-per-Use <sup>e</sup> (\$)
1	Historic Consumption	2	8	5	0.16	0.62	
2	Neighborhood Comparison	6	3	7	0.34	0.91	
3	Appliance Energy Breakdown	4	7	6	0.16	0.50	
4	Billing and Payment Plans	6	7	3	0.06	0.50	
5	Instantaneous Consumption and Time-of-day Pricing	1	10	4	0.13	0.50	
6	Automated Sign-up for Rate Options and Utility Services	2	11	3	0.13	2.0	
7	Conservation Pgm. Information	3	9	4	0.28	1.50	
8	Energy Efficient Product Information	4	5	8	0.13	2.0	1.17
9	Do-it-Yourself Videos and Booklets on Energy Efficiency	3	10	4			2.17
10	Scheduling Repairs and Services	5	10	1	0.12	2.0	
11	Customer Queries	4	11	2	0.12	2.0	2.0
12	Load Management and Automation <sup>e</sup>	0	12	3	0.63	5.0	
13	Entertainment Videos on Demand	3	3	11	3.53	8.57	3.13
14	Security Services	6	4	6	3.82	10.83	

<sup>a</sup> One interviewee was willing to pay \$2 per month to have all the services available plus a \$5 for Pay-per-Use of each service.

<sup>b</sup> One interviewee would prefer an annual maintenance fee of not more than \$60 for Services 1 through 8.

<sup>c</sup> Average over all respondents

<sup>d</sup> Average of those who would pay

<sup>e</sup> One respondent was willing to pay a "one-time" set-up fee of \$15, subsequent willingness to pay depending on cost/savings ratio

**Note:** Number of responses may not add up to 17 since not all respondents answered the question for each service.



---

*Billing-Related Services*

## 4.5.1 Historic Monthly Energy Consumption

Initially, most focus group participants felt that providing information on historic energy usage using advanced communications technologies was redundant and non-essential, because the information was already available from old utility bills. Several respondents said they would not want to go to the effort of a separate 'log-on' for an energy-specific services link to access this type of information. Then, Neel mentioned a situation where a high utility bill caused him to go through several files looking for old bills. He said this was very painstaking and, thus, would find it useful if such a service was available at the push of several buttons. He indicated that such information would also be useful in educating his family members about their "wasteful" habits. Several participants said that this type of information would be easier to keep track of it using a financial software package, such as Quicken.

Focus-group participant, Chuck, expressed doubts about the usefulness of this information in the context of energy management. He felt that more detailed, disaggregated information would be necessary to help utility customers fine tune their energy usage because only dramatic changes in consumption would alert a customer to a problem. Other participants seemed to agree that because of changes in individual behavior and/or weather, historic consumption data would not enable customers to determine whether conservation measures which were implemented during a previous billing period actually had a significant impact. In response, several people indicated that it would be useful to give the average temperatures along with monthly consumption figures.

When considering this service as part of a whole package, five of seven participants in the focus group said they would like it, although they would not want to pay for it.

## 4.5.2 Neighborhood Comparison of Energy Use

Validity of neighborhood comparisons of energy use was the main concern that arose during the discussion of this service (see Figure 4-1). There were two rather distinct schools of thought among focus group participants. One group maintained that this information was useless due to problems inherent in the data used for comparison: "Unless you know how many kids and how many people live in the household, [it] is useless information." Differences in values, lifestyles and habits were other factors thought to complicate and render the comparisons meaningless. The second group commented that this information could be used as a diagnostic tool and would generate some additional inquiries. Pat said that "If you're scrimping and saving, or conserving and you look on the graph and see you're the second highest consumer, you know you have a problem." These participants considered the data less problematic because they perceived

---

*Value of neighborhood comparisons of energy use depends on customer perceptions of validity.*

---

houses in their neighborhood to be approximately the same. For example, Pat stated: “Even with a range of houses in your neighborhood, you would have an idea of where in the range you fall.”

Figure 4-1. Example of a Graphic Display for Neighborhood Comparison of Energy Use

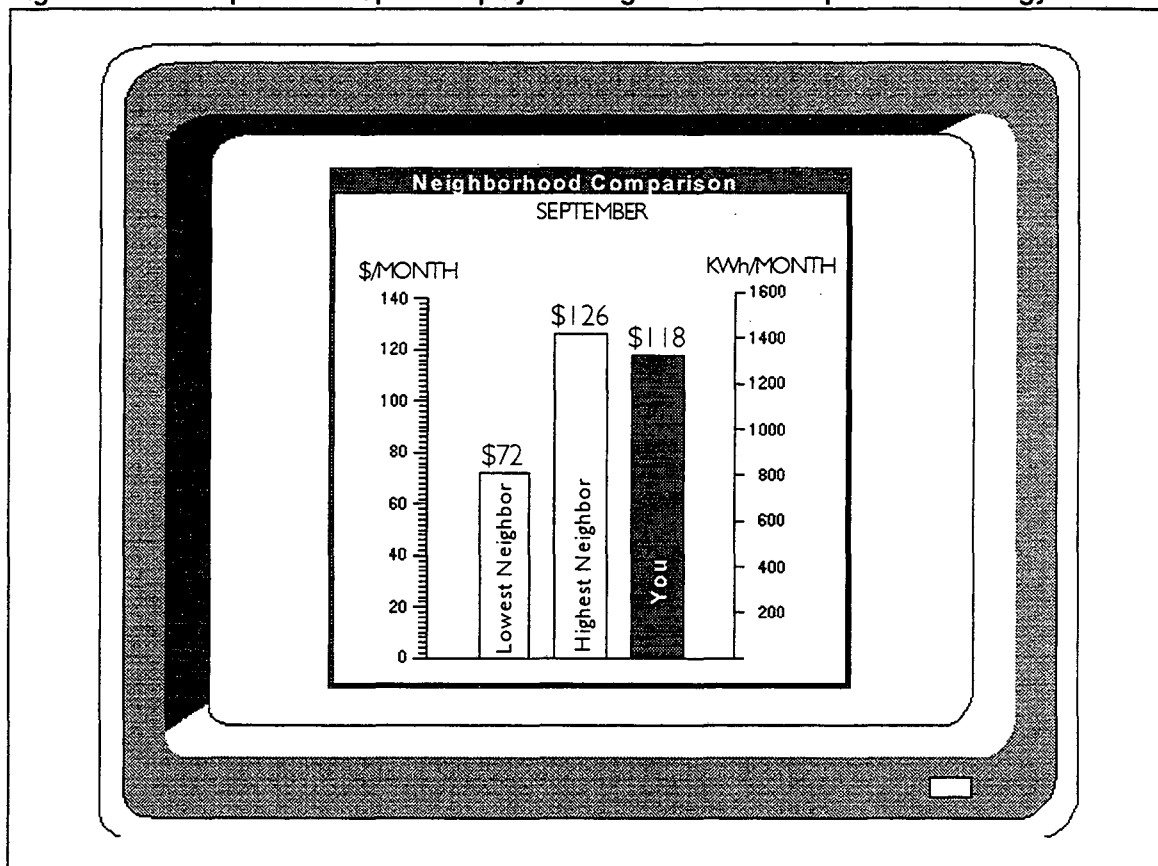

In the personal interviews, the majority of respondents reacted more favorably to this service: first, because they would become aware of their own consumption relative to others; and, second, they could initiate changes. Paul mentioned that such a comparison made a lot of sense and was easy to do since most neighborhoods in Delaware were similar in type and were identifiable. Gilles said he would be interested in knowing “whether it’s my sloppy habits that is causing higher consumption, or if there is a problem.”

It appears that several respondents tend to correlate the level of comfort with the amount of energy that they consume. This partially explains their reluctance to make use of information which compares their usage with that of others. For example, Mike seemed to think that maintaining a certain quality of life required him to maintain his current consumption level (“If I can afford to pay for a certain level of comfort, then why not ... I work hard, and would like

to enjoy the things that I work for” ... “I’d much rather wear a T-shirt and a pair of shorts rather than turn the heat down”).

The ‘willingness-to-pay’ questionnaire indicates a split between the focus group and the interviewees. Among focus group participants, six out of seven participants said they would not be interested in this service even if it was free. Eight of ten interviewees liked the service; five were willing to pay a monthly fee ranging from \$0.50 to \$2.00, while three others preferred an annual fee (see Appendix D, Table D-1).

#### 4.5.3 Appliance Energy Consumption Breakdown

A service that provided energy usage information on each major appliance evoked strong negative responses from several focus group participants because of its potential threat to privacy. Two aspects of privacy seemed to be of concern:

- the potential consequences of allowing the utility to collect and make use of disaggregated energy data; and
- the potentially invasive nature of setting up and installing the disaggregated metering technology, or ‘smart box’ system, which meant that it also would be expensive.

We did not dispel these false assumptions underlying the latter aspect, due to the exploratory nature of the study. The underlying assumption among most focus group participants seemed to be that someone would have to come into the house and the installation would result in additional wiring, possibly going through ceiling and walls, which would be quite expensive.

The focus group moderator asked the group to reconsider the service disregarding the issue of cost, whether low or high, and to disregard issues concerning the nature of the technology itself, whether physically invasive or not. The respondents stated that this would not change the way they felt about the service, because it still did not address the issue of privacy. For example, there was general concern about utilities making this information available to other companies, which would result in unwanted marketing pitches. In the focus group, the general mood was suspicion about the utility’s use of information on individual appliance use.

In contrast, in the personal interviews, this service was viewed quite positively. For example, Gilles said that he had already tried to get this type of information by observing the meter every

---

*Breakdowns of appliance energy usage may be attractive to customers; but privacy concerns must be addressed.*

---

time he turned on or off a particular appliance, but it did not help since it gave him only a rough idea. He indicated a preference for better information, if possible. Becky noted that this service would help her take preventative action, instead of waiting for an appliance to die

before replacing it or repairing it, and avoid wasted energy caused by a malfunctioning appliance. She also suggested that if the display had a comparison showing consumption of a similar efficient model, it would make more sense.

Nine of ten interviewees were interested in and six were willing to pay a monthly fee for the services ranging from \$0.50 to \$1.00, indicative of the positive response to this service. In contrast, in the focus group, four of seven focus group participants indicated that they liked this service but would not want to pay for it, whereas three would not want it even if it was free. The discussion of privacy issues, which was dominated by a few individuals, may have affected the questionnaire responses of other focus group members.

#### 4.5.4 Billing and Payment Plans

The focus group was generally not very enthusiastic about a service in which they could review and automatically pay their bill using an interactive TV or computer system. They perceived that electronic payment and transactions involved some security risks along with a loss of customer control. "Making my checking account open to the utility makes me feel very uncomfortable," Colin said. The group indicated that they like to have control over payment, and wanted a "hard" copy of the bill for record-keeping purposes, which was perceived as impossible given the way this service was described. In their questionnaire, six of seven focus group participants indicated that they would not want this service, even if it were free.

Most respondents in the individual interviews, however, liked the idea of making payments in this way. Several people indicated that this was how transactions were going to take place in the future. Nevertheless, most people did not want to pay for such a service. To them it was more a matter of convenience, than a service to be paid for (see Table 4-4).

#### *Pricing*

#### 4.5.5 Instantaneous Consumption and Time-of-Day Pricing

Overall, focus group participants reacted quite positively to a service in which they were provided with feedback on their hourly energy consumption in conjunction with time-of-use prices that would be posted one day in advance. Participants indicated that it would give them an idea of how to change or shift consumption to take advantage of the bill saving potential embedded in the low rate periods and that it puts the consumer more in control of the bill. One focus group participant, Shirley, recounted her positive experiences with an experimental time-of-day pricing program that her family participated in 12 years ago: "You feel more in charge of your bill, you had more control over how the bill was going to be like when it came in the mail, but you gave up some convenience." The group expressed

considerable astonishment when they learned that Shirley had been able to reduce her monthly household energy bills by at least 30% by implementing behavioral changes under time-of-use pricing. Shirley noted that her utility had provided helpful information during the first several months on appliance energy consumption and tips on how best to take advantage of the program by shifting certain activities to low peak periods. Several participants thought that it was unnecessary to provide time-of-day pricing information on a daily basis and suggested that it would be easier, cheaper and more convenient to include the time-of-day prices on the bill once a month.

In contrast to the focus group, most respondents in the personal interviews were less interested in this service. Most people indicated that they were reluctant to make any changes in lifestyle, which included using certain appliances at specific times of the day or week. However, several people were willing to make changes if it resulted in reduced bills. Gilles, for instance, remarked, "if it is costing me money, yes, I would change my habits".

Fourteen of 15 respondents liked this service to be offered by the utility, although only four participants indicated some willingness to pay (see Table 4-4).

#### 4.5.6 Automated Sign-up for Rate Options and Utility Services

Five of the seven focus group participants said they liked the idea of a service in which they could sign up for utility services or rate options through an interactive computer interface, although they would not want to pay for it. However, several vocal focus group participants looked at this service simply as an attempt by the utility to position itself in the event of deregulation and increased competition in the utility industry. They viewed the utility as trying to sell services rather than improve consumer choice, which negatively influenced their perception of the desirability of the service (e.g., they would not want this service even if it were free). This service did not seem to evoke the same suspicion among interviewees regarding the utilities' intentions for offering such services. Most interviewees said they liked this service if it were provided free of charge, and four people were willing to pay a monthly fee ranging from \$0.50 to \$3.00.

#### *Other Energy Information Services*

#### 4.5.7 Energy-Efficiency Programs and Energy-Efficiency Product Information

We discuss services in which the utility would provide information on energy-efficiency programs and products together because participants viewed them as very similar (Items 7 and 8 in Table 4-3). Neither service was viewed as particularly useful by focus group participants. They indicated that it would provide yet another channel for marketing messages to come into the house. The group also felt that this type of information was

available elsewhere or could be provided more easily in other ways: consumer reports, retailers and energy guide labels were viewed as good alternative information sources. Some focus group members and interviewees were skeptical about the quality and reliability of product information provided by the utility (see Figure 4-2).

Four of seven focus group participants liked the 'Efficiency and Conservation Programs' but would not want to pay for them, whereas three out of seven liked the Product Information service and two of them would be willing to pay for it on a per-use basis, with fees ranging from \$1 to \$1.50. Most interviewees suggested that a pay-per-use option was preferred, since this type of information would be needed very infrequently.

*Utilities may be able to provide information on energy-efficiency products, possibly on a fee-per-use basis.*

Figure 4-2. Information on Energy-Efficient Products

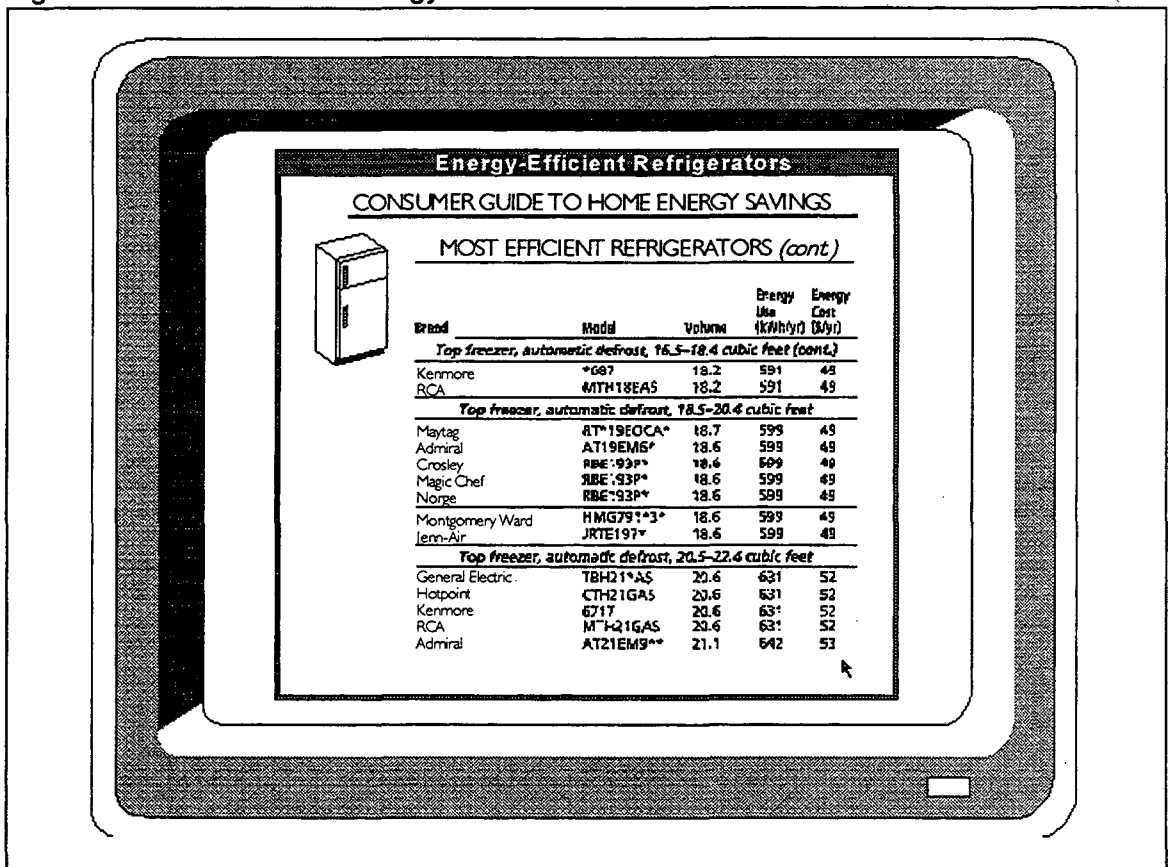

#### 4.5.8 “Do-It-Yourself” Videos and Ordering Energy Information Booklets

A service in which the utility provided “do-it-yourself” videos that provided information on how customers could improve the comfort in their home and save money was perceived as useful by all members of the focus group (see Figure 4-3).

Participants commented that this service was unique among the set of proposed services in that it filled a need that was not already being met. The cost of providing this service would influence whether some would prefer receiving this information using advanced telecommunications technologies or opt for other lower technology options for service delivery. Calling the utility to order was suggested as an alternative, equally convenient method.

In contrast, respondents in individual interviews did not express much interest in this type of service. Some suggested that the service should be ‘pay-per-use’ because it was not something you would require frequently. Five of seven focus group participants said they liked this service but would not want to pay for it (Table 4-4). The convenience of access to videos at all times was seen as a plus by several people.

Figure 4-3. Energy Information Videos

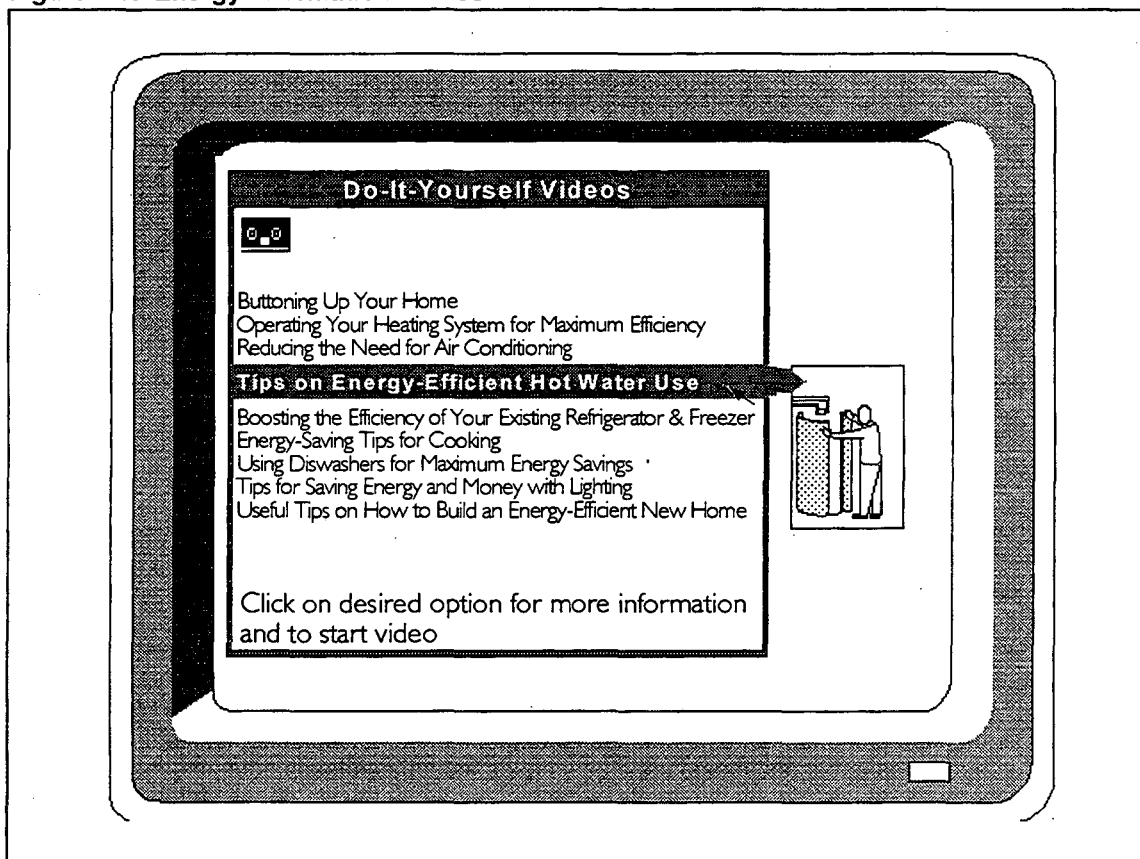

4.5.9 Scheduling of Installation, Field Services and Repairs

Several focus group participants initially thought this service would be useful, in part because it is currently not offered. It seemed to be viewed favorable mainly because it would enable the customer to pin the utility down to a more precise time schedule (e.g., two-hour time block), which in turn would give more time flexibility to customers awaiting service personnel. Colin remarked that “It would be a real advantage to get the service scheduled within a two-hour window.”<sup>22</sup> If this service were to be offered using an advanced information/communications system, most focus group members wanted some confirmation of the appointment time. Most interviewees also found this service useful. However, several respondents stated that an emergency service option was necessary as well, in which case, they would not want to go through a regular appointment scheduling service.

Ten respondents liked this service but were unwilling to pay for it. Five focus group participants did not want the service even if it was free.

4.5.10 Specific Customer Queries

Focus group participants and interviewees generally thought that an interactive customer service center where they could report service problems, make requests, or obtain answers for common questions would be a useful service. However, some respondents had misgivings about the service being too inflexible and impersonal. For example, one person commented that one problem with, “the point and click method is that your question may not

Figure 4-4. Interactive Service Center for Customer Queries

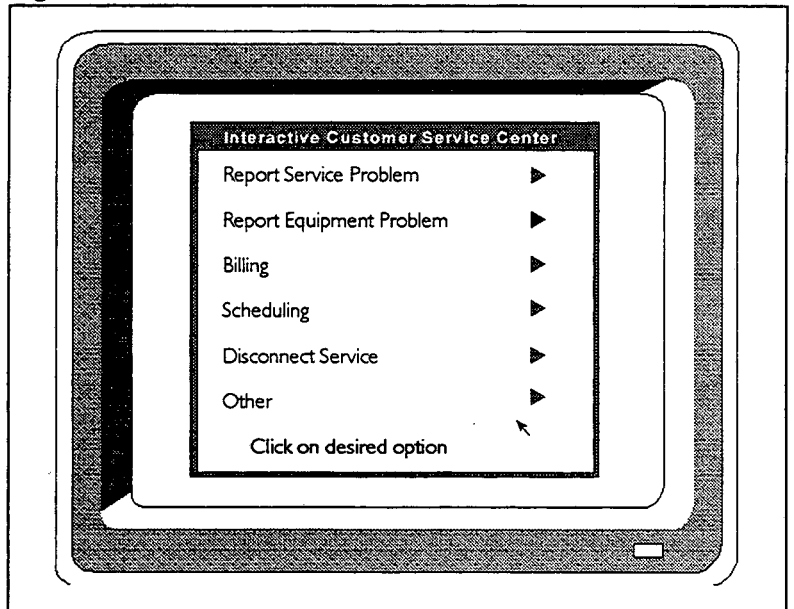

always fall within the parameters defined by the utility.” Accountability was another issue. One participant commented that when you phone the utility you can obtain the person’s name

<sup>22</sup> We think this view was expressed because the ‘screen’ in the display for this service shows the time slots in one-hour intervals, whereas phone and energy utilities often limit themselves to time frames stretching four to five hours.



---

and hold this individual responsible if a problem should occur at a later stage. Personalized service was seen as an additional advantage of the phone over this system.

Eleven of 17 respondents were interested in this service, provided it was offered at no charge, while two others were willing to pay a nominal monthly fee (\$2.00). Three respondents indicated that they would not want this service even if it were free (see Table 4-4).

### *Energy Management*

#### 4.5.11 Direct Load Control and Customer-Controlled Load Management

These two services were combined in our interview materials because of the technical similarity between utility-controlled load management and customer-controlled building automation. However, we found that the distinction in control was critical to both focus group participants and interviewees. Specifically, participants indicated that it was very important for them to determine control over energy use by having the ability to switch appliances on and off at will. With this proviso, focus group members saw these services as very useful, particularly in conjunction with time-of-day pricing as a means of programming and fine tuning household energy management activities.

Respondents stated that the direct load control program should be voluntary and, if controlled by the utility, the consumer should have the ability to override utility peak load settings. In part, objections seemed to be raised based on lack of familiarity with the concept of direct load control (DLC). Thus, in promoting DLC programs, utilities typically would have to respond to these concerns in their marketing materials (e.g., customer ability to override settings and minimal change in comfort levels).<sup>23</sup>

If offered free of charge, more respondents wanted this service (12) than any other of our proposed services. Only three respondents were willing to pay for this service (about \$5 per month). One person indicated that they would be willing to pay a \$15 one-time set-up fee for building automation (see Table 4-4).

---

<sup>23</sup> We did not offer any explanations that would reduce or counter the objections that were raised, since our objective was to establish how the respondents perceived and understood each service as we presented it, and not to explain it to receive more favorable responses.

*Non-Energy Services*

4.5.12 Entertainment Videos on Demand

Reactions of focus group participants to a service offering entertainment videos on demand were somewhat mixed, with differing views on the usefulness of this service as well as whether the utility should get involved in the entertainment business. A few participants commented on problems that are perceived to be a negative by-product of an increasingly technological society (e.g., social alienation and isolation, excessive consumerism). For example, several participants noted that this service would “keep people in front of the TV sets” where they would just have to “point and click,” and “buy, buy, buy.” However, Susan liked the simplicity of having one company providing all utilities, even including entertainment; other participants were more concerned about this concentration of control. This may explain why three focus group participants indicated that they would not want this service even if it was free.

Interviewee reactions to this service were somewhat more positive. Most interviewees liked the flexibility and possibly the lower cost. Patchy believed that such a service could lower the cost of providing entertainment because it would eliminate the intermediate business link from the system, although she was concerned that this would “put somebody (small businesses) out of business.”

More customers were willing to pay for this service than any other (see Table 4-4). Two focus group participants said they would be willing to pay a \$10 monthly fee, while four others would be willing to pay on a per-use basis, with fees ranging from \$2 to \$3 per use. Nine of ten interviewees were willing to pay for a service offering entertainment videos on demand ranging from \$1 to \$25 per month or \$2 to \$5 per use (see Appendix D, Table D-1).

4.5.13 Security Services

Focus group members reacted more negatively to the utility offering security services than interviewees. Six of seven focus group participants did not like this service. Participants did not perceive security services as falling within the ‘core’ business of electric utilities and could not see any advantage to getting this service from the electric utility.

In contrast, most interviewees reacted positively to this service. Five of ten interviewees were willing to pay monthly fees ranging from \$1 to \$30 for the service, assuming cost and quality were competitive with other security firms. One respondent, Neel thought that utility involvement might improve service quality in the home security field. According to him, commonly available home security systems are useful “only to keep school kids away, when it comes to professional robberies, these are no good.”

#### 4.5.14 Additional Service Suggestions

We also asked respondents for their suggestions on other services that would be useful and they offered the following ideas:

- weather reports;
- educational videos for children;
- a bulletin of cultural program offerings in the area;
- food ordering services;
- screening of incoming commercial calls;
- catalog shopping, as a means of saving paper; and
- health monitoring for elderly residents.



# Exploratory Market Research: Summary and Key Findings

## 5.1 Overview

In this chapter, we summarize results and key findings from our focus group and individual interviews with ten residential customers. We found that between 25 and 60% of the 17 respondents had some interest in new billing-related or other energy information services. However, some respondents commented that these services could also be provided quite satisfactorily by current information mechanisms (e.g., utility bills, libraries) and that they were concerned about “technological overkill” and “information overload” because these services would be used on an infrequent basis. Based on survey responses, most customers only wanted billing-related and energy information services if they were free or were only willing to pay a small amount. Our analysis suggests that utilities will need to bundle billing-related and energy information services as part of a comprehensive service package. Customer-controlled load management (CCLM) and time-of-day pricing yielded the most favorable overall responses among energy-related services. We also found that privacy and network security issues and concerns regarding potential for intrusive marketing were a significant issue for many respondents. With respect to utilities offering non-energy services (e.g., security services, entertainment videos on demand), some respondents had concerns regarding the appropriateness of this new business role for electric utilities.

## 5.2 Communications Display Medium: TV, Computer or ‘Smart’ Thermostat

Many respondents viewed the computer as a more convenient medium for display of energy information and other services than TV. However, respondents also commented that TV was universally available and therefore allowed services to be provided to all customers, not just those who owned computers (see Section 4.4.2). Some respondents said they prefer current information mechanisms, such as paper bills, the telephone, consumer reports, and libraries. Our small sample suggests significant differences among residential customers in their attitude toward and familiarity with various media (e.g., TV vs. computer) which when combined with differing availability and usage patterns, affects their receptivity to more sophisticated communications systems.

### 5.3 Bill-Related and Energy Information Services

Compared to previous studies, we developed a more extensive set of bill-related and energy information services which included historic data on monthly consumption, neighborhood comparisons of energy use, breakdown of individual appliance and end use consumption, information on energy efficiency programs and products, and “do-it-yourself” videos. Some respondents

indicated that these services may have some practical value and application (e.g., increase awareness of their own energy consumption and alert them to energy savings opportunities and potentials). However, depending on the proposed service, about 10-40% did not want the service even if it was offered free of charge. Some people regarded the services as unnecessary either because they could access the information with greater ease using other media (e.g., paper bills) or because they would not use the information or questioned its validity.<sup>24</sup> Overall, most respondents wanted the service only if it was free or were only willing to pay a nominal amount (\$0.50-\$1.00 per month or \$1-2 per use).

---

*Most respondents were interested in specific energy information services, although average willingness to pay was quite low; thus we recommend bundling of these services as part of a comprehensive package.*

---

These initial results suggest several possible strategies: (1) bundle a set of energy information services as part of a more comprehensive package of communications-enabled services that could command a reasonable monthly fee; (2) offer energy information services which can easily be unbundled and marketed on a per-use basis (e.g., “do-it-yourself videos, product information), and (3) conduct additional market segmentation analysis in order to determine if some energy information services can be offered profitably on a stand-alone basis to certain targeted customer groups. Based on our small sample, we are not overly optimistic that the third strategy— providing individual stand-alone energy information services— would prove successful. Our focus group discussion also provides utilities with some insights on customer concerns (e.g., privacy, technological overkill, relevancy) that must be addressed so that energy information services add value to their product offering (see Section 4.4).

---

<sup>24</sup> For example, several respondents questioned the validity of neighborhood comparisons of energy use because of the difficulty in normalizing for differences in lifestyle, demographics, and building type.

## 5.4 Barriers to Marketing Energy-Efficiency Services

Some respondents limited interest in energy information services arises in part because they do not consider the potential for energy savings worth pursuing.<sup>25</sup> The basis for this conclusion often rests on two significant discrepancies: (1) the perceived potential for energy savings vs. the actual potential, and (2) the perceived impacts on lifestyle which are thought to be significant vs. minimal lifestyle changes that are typically required to reduce bills. The willingness to engage in behavior to save energy seems to be correlated with knowledge about technical and behavioral potential for energy efficiency and conservation as well as the size of the economic reward relative to changes that have to be made. Thus, in order to overcome consumer information barriers, effective consumer education will be a necessary component of any large-scale utility effort to deploy communications-enabled services. For example, utility marketing materials could highlight the fact that high-efficiency products do not necessarily compromise lifestyle or provide realistic estimates of energy and dollar savings potential that homeowners could expect from various activities.

---

*Respondents' limited interest in energy efficiency and bill reduction is partly due to their perception that energy savings potential is low or would negatively impact their lifestyle.*

---

## 5.5 Customer-Controlled Load Management and Time-of-Day Pricing

Customers viewed customer-controlled load management (CCLM) and time-of-day pricing as particularly useful services; these services had the fewest negative responses. During the focus group discussion, several participants made the connection that CCLM could work particularly well in conjunction with time-of-day pricing. This may be another indication of the benefit of service bundling: a more accurate price signal on electricity service costs may be perceived more favorably in tandem with a service that puts the customer in a position to improve their home energy management and reduce bills. We believe these service options were popular because customers clearly saw that they would enable them take control of and responsibility for their energy management.

---

*Customer-controlled load management and time-of-day pricing were the two energy-related services that yielded the most favorable overall responses*

---



---

<sup>25</sup> One focus group member stated that the savings potential was not perceived as high enough to care. Despite Shirley's earlier testimonial to her significant DSM savings, this comment did not generate remarks or corrections of any kind.

## 5.6 Non-Energy Services

More respondents indicated some willingness to pay for security services and entertainment videos on demand compared to other services which were offered by an electric utility as part of an advanced communications system. The average amounts offered by those customers willing to pay (e.g., \$11 per month for security services and \$3 per view for entertainment videos on demand) appear to be reasonable compared to similar services that are well-established in the market. Again, while we do not expect precise values from this small sample, security services and video-on-demand do provide a calibration that our measures are close to market value, thus lending some credence to the responses for energy-related services that are not currently offered in the market.

---

*Some customers appear willing to pay for non-energy services such as entertainment videos on demand and security services, although customer concerns about unfair competition and utilities entering new business areas may represent a barrier among some segments of the residential customer base*

---

Focus group participants and several interviewees raised concerns regarding the appropriateness of utility entry into these new businesses or the advantages of purchasing these services from a utility vs. a firm that specialized in this business. The utilities current status as a regulated monopoly entity is both a curse and a blessing in the residential market. Some respondents indicated that they tend to trust utilities or value their technical capabilities more than other types of businesses (e.g., security firms) and thus may be receptive to utilities offering non-energy services. On the other hand, because they are often perceived as a large monopoly, utilities are vulnerable to arguments that their entry into new markets will negatively impact small businesses, that they may be unfair competitors, or that they could become too powerful. These sentiments were expressed in one form or another by some respondents.

## 5.7 Intrusive Marketing and Privacy Concerns

Based on the focus group discussion, we found a direct link between customers' receptiveness to new services, their attitude towards electric utilities, and their experiences with telephone utilities and cable companies. For example, several focus group participants appeared to distrust their

---

*Customer reactions to energy information and other services are influenced by their perception of electric utilities, marketing experiences with providers in other recently deregulated industries, and privacy and network security concerns.*

---



investor-owned utility. This distrust appeared to amplify their concerns regarding privacy issues for some services (e.g., services that involved the utility collecting disaggregated data on personal energy use or customers' product and equipment needs), specifically whether the utility would provide information on their usage patterns or energy services needs to other private firms. In their view, this could result in an increase in unwanted marketing pitches from other commercial product and service providers.

Privacy issues and the annoyance factor associated with unwanted marketing pitches were a significant concern for several focus group participants because of their prior experiences with deregulation in the telecommunications industry and the prospect of increased competition in the electricity industry. Not surprisingly, those customers that had negative experiences with providers of telecommunications services tended to be more dubious and suspicious of new service offerings. These concerns were reinforced when the framework for discussion was a deregulated competitive environment in which utilities also offered a range of non-energy services. Several focus group participants' misgivings about a single entity providing bundling of energy and other services (e.g., telecommunications, cable network, security services) were less pronounced if the utility was a locally-controlled, publicly-owned municipal entity. If our small sample is reflective of the population of residential customers, then it is clear that utility marketing and advertising materials will have to address the image of the electric utility as well as differentiate these service offerings from customers' negative perceptions of telecommunications providers' marketing of services.



---

# References

- Andersen Consulting 1995. *The Role of Broadband Communications in the Utility of the Future*.
- Arthur, W. B. 1994. *Increasing Returns and Path Dependence in the Economy*. University of Michigan Press.
- Bernard, R. H. 1994. *Research Methods in Anthropology: qualitative and quantitative approaches*. 2nd ed. Walnut Creek, London, New Delhi: Sage Publications, Inc.
- Chartwell 1995. *Utility Applications on the Information Superhighway*. Atlanta, GA: Chartwell Publications.
- Direct Access Working Group 1996. "Report to the California Public Utilities Commission on Design and Implementation of Direct Access Programs." August.
- Electrical World 1996. "AMR: Much More than Automated Meter Reading" April.
- Electric Power Research Institute (EPRI) 1994. "Business Opportunities and Risks for Electric Utilities in the National Information Infrastructure." EPRI TR-104539, October.
- Energy Information Administration (EIA) 1995. "Electric Power Annual: 1994." DOE/EIA-0348(94)/2. November.
- Energy Services & Telecom Report 1996a. "CSW Communications Named First 'ETC'; Firm Also Wins Big Austin, Texas Job." April 11.
- Energy Services & Telecom Report 1996b. "PG&E Recruits Affiliates to Test Market Interactive Energy Management System." April 25.
- Energy Services & Telecom Report 1996c. "AEP Poised to Begin Installing 25,000 'TranstexT' Energy Management Systems." August 15.
- Energy Services & Telecom Report 1996d. "CellNet Inks Deal with Northern States Power for Wireless Information Network." September 12.
- FIND/SVP and Texas Systems 1995. "The American Home Energy Management Survey: A Multi-Client Study of Consumer Energy Management and Use." Emerging Technologies Research Group.
- Frauenheim J. 1995. "Consumer Energy Management: Future Shock or Future Stock?" Presented at the DA/DSM 1995 Conference. San Jose, CA.
- Frauenheim J. 1996. "If You Build It, Will They Really Come?" Presented at the DA/DSM 1996, DistribuTech Conference. Tampa, FL.
- Hanser, P., W. Malcolm, and R. Levy 1993. "Re-engineering DSM: Opportunities Through Information and Integration." *The Electricity Journal*. November.
- Jennings, J. 1996. "Giving AMR the Nod: Analyzing the Costs and Benefits." *Utility Automation*. March/April.
- Kempton, W. and L. Montgomery 1982. "Folk Quantification of Energy." *Energy: The International Journal*. 7(10) 817-827.

## REFERENCES

---

- Komor, P. 1996. "Online Energy Services for Commercial Energy Users." E-Source Strategic Memo. May.
- NIST Committee on Applications and Technology of the Information Infrastructure Task Force 1994. *The Information Infrastructure: Reaching Society's Goals*. NIST Special Publication 868. September.
- Passell, P. 1996. "Why the Best Doesn't Always Win." *New York Times Magazine*. May 5.
- Rivkin, S. 1996. "If Competition Won't Build the NII, Partnerships Will." *New Telecom Quarterly*.
- Rufo, M 1996. "Energy Information Services and DSM: Merging Lanes on the Information Superhighway." 1996 *Proc. of ACEEE Summer Study on Energy Efficiency in Buildings*. Washington DC.
- Vince, C. A., C. Fogel, and P. Nordstrom 1994. "Fiber Optics, Electric Utilities, and the Information Superhighway - The Community's Role." *The Electricity Journal*. February.

## **Selected Vendor Telecommunications Products**

This appendix provides descriptions of selected vendor products based on telephone interviews conducted during August-October 1995. Reports, technical material, and press releases were used to supplement the interviews. Vendor products are described separately in order to avoid redundancy in the summaries of utility projects that use the same product.

Product: CellNet

Developers: CellNet Data Systems

Investors: AT&T Ventures  
Bank of Boston  
Toronto Dominion Investments  
Barclay's Bank  
Providence Ventures  
Hambrecht & Quist  
Kleiner, Perkins, Caufield & Byers

Background: CellNet was founded in 1984. Much of its beta testing was performed in Pacific Gas & Electric's service territory. CellNet offers an improvement over mobile wireless radio networks which use "virtual" two-way communications to wake up transmitters that send meter readings to hand-held or other mobile receivers. CellNet's fixed wireless radio system consists of a two-way network from the local poletop collector back to the utility's central location. Most of CellNet's utility clients use the distribution automation applications exclusively.

Description: The CellNet product permits wireless, fixed-network data gathering for automated meter reading and distribution automation, as well as other commercial applications. CellNet offers utilities a complete turnkey approach to wireless communications services. The utility signs a long-term performance contract with CellNet for installation, operation, and maintenance of the system, paying a fee of roughly \$1.00 per meter per month for the basic service of a daily meter read. Cellnet has signed two long-term services contracts with utilities (Kansas City Power and Union Electric), which will ultimately enable the utilities to provide over one million urban customers with service options such as power outage reporting and time-of-use rates. Many of CellNet's applications are in capacitor bank control and distribution automation, where efficiency gains from automation will accrue immediately to the utility.

Features: ● The wireless data network employs two integrated radio technologies, direct-sequence spread spectrum (licence-free) and narrowband (licenced), which make the system less resistant to interference and more efficient.

● The Microcell Controller, a small pole-mounted data collection device, communicates with up to 700 meters within a 1/4-mile radius (see Figure A-11). The actual number of meters varies depending on population density and topography. Data from the Microcell Controllers is then passed along to a

Cellmaster with a communications radius of 7-9 miles, and then via leased-line to the utility.

- Utilities can use the data provided by CellNet to offer customers innovative rate programs and other enhanced services.

- Projects:
- Pacific Gas & Electric's pilot with 350 residential customers in the North Bay extended from 1990 to 1993.
  - Kansas City Power & Light signed a long-term contract in September 1994. The first 5,000 meters were deployed by October 1994. To date, more than 80,000 meters are installed, and the remaining meters to complete the roll-out of 420,000 meters will be installed by the end of 1996.
  - Union Electric Company in St. Louis signed a contract in September 1995. The first 5,000 meters were installed within 14 days of contract signing, and full-scale roll-out of 650,000 meters will commence in March 1996.

Figure A-1. CellNet's Network Architecture

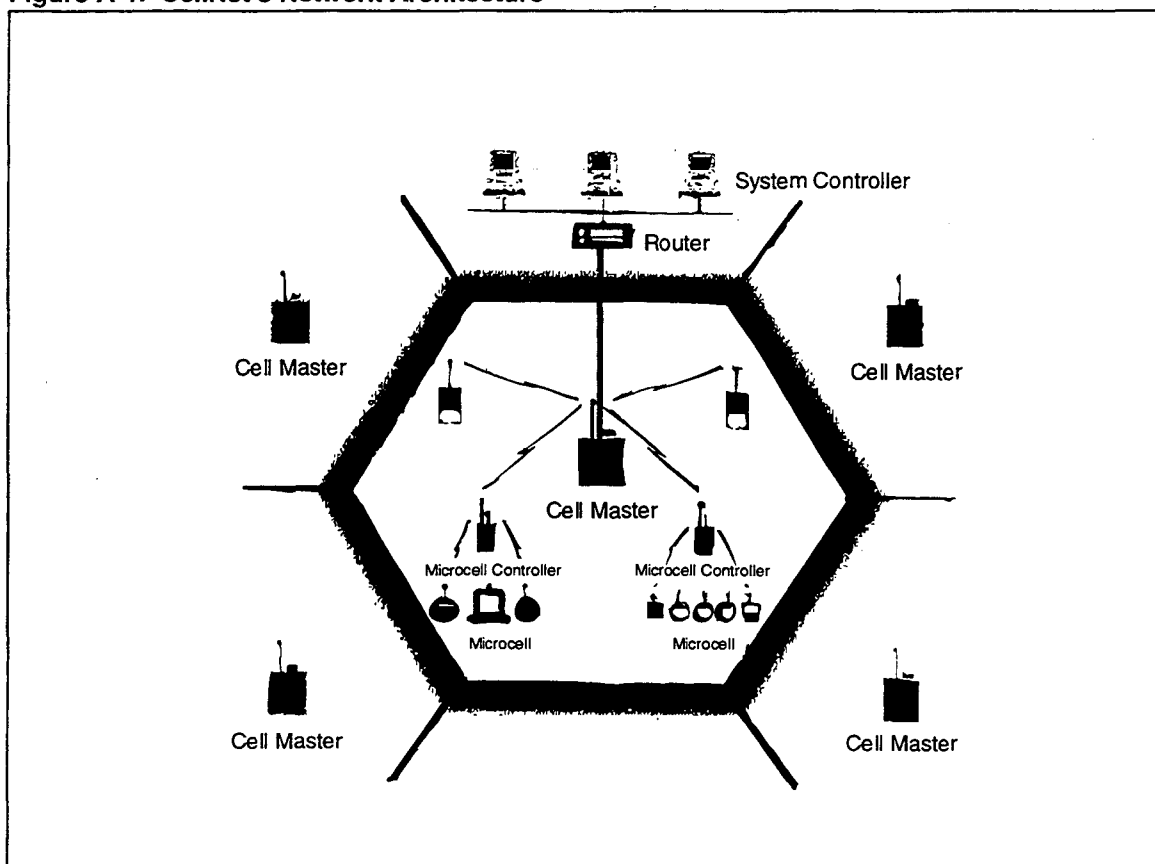

## APPENDIX A

---

- Product: Cox
- Developers: Cox Communications  
Northern Telecom (Nortel)  
Virginia Electric Power (VEPCO)
- Investors:
- Background: Nortel and Cox are collaborating to test an integrated box offering four services -- telephone, high-speed data, energy management, and switched cable. Switched cable is essentially video on demand with special channels personalized for each customer. If all customers wanted to view movies simultaneously, Cox would not have enough channels; switching permits many more viewers. The integrated box will contain cards for each of the four services that can be plugged in to provide the desired level of service. Nortel, Cox, and VEPCO are each responsible for testing and covering the costs of their own services.
- Description: The pilot involves the installation of an integrated box in the homes of eight VEPCO and 36-40 Cox employees. Nortel and Cox are testing the homes for ingress noise and signals that could interfere with the communications platform. VEPCO is the project integrator and is currently selecting equipment vendors. The installations were scheduled to begin in September and be completed by December. Initially, the pilot will offer one of the four services to customers and will add services as the program continues. Automated meter reading, outage detection, and electronic billing will be tested first, followed by CEBus-adapted devices, which will be tested in 10 homes.
- Features:
- The in-home display may use the television, personal computer, thermostat, or hand-held devices. VEPCO expects customers with computers to use them to handle energy management.
  - The bench tests and technical trials will identify protocol limitations with CEBus-based equipment
- Projects:
- VEPCO's multi-phased trial in Virginia Beach and Norfolk began in May 1995.
  - Southern California Edison's trial of Cox cable products in Irvine began in mid-1995.



- 
- Product: Energy Information Services
- Developers: Pacific Gas & Electric (PG&E)  
TeleCommunications Inc. (TCI)  
Microsoft  
Diablo Research  
Energy Line
- Investors: TeleCommunications Inc. (TCI)  
Microsoft  
Landis & Gyr
- Background: This project has three executive team members: PG&E, TCI, and Microsoft. TCI provides the set-top box, coax cable, and hook-ups. Microsoft developed the operating system software compatible with the CEBus chip in the set-top box; Intellon provided the CEBus chip. PG&E is the project integrator, providing the plug controllers and power-line carrier interface and contracting for all equipment and services. A series of second-tier participants are also involved: Landis & Gyr provides the customer meter and HVAC controller, which will eventually be handled via the set-top box; Ademco, the largest manufacturer of security systems, has signed on to provide home security in the third phase of the project; and Andersen Consulting administers an affiliate program and provides systems engineering and market research.
- Description: The project began in 1994 and will continue until July 1996. Currently, 10 homes in Walnut Grove and Sunnyvale are participating in the "market research" trial. TCI plans to begin hooking up two participants per day to reach 100 participants in this phase and to expand to 1000 homes in 1996. TCI purposefully selected non-cable subscribers for the trial in order to determine the full costs to all team members. The team is assessing alternative energy and non-energy services to offer and prices that customers would be willing to pay for these services. PG&E is evaluating home automation, home security, customized billing, access to the information superhighway, and telemetry. TCI is evaluating video-on-demand and a dedicated energy channel, but this service will not be offered in this trial.
- Features:
- Participants can monitor energy use by appliance/equipment, program appliance/equipment to respond to four price signals, and receive automatic meter reading and outage detection.
  - Proprietary market research has been performed since the beginning of product development. Focus groups were conducted but most customers had difficulty conceiving what they were being offered.

*APPENDIX A*

---

- Projects:
- Pacific Gas & Electric's three-phase pilot began in October 1994.
  - Andersen Consulting administers an affiliate program. Andersen recently sent out invitations to all utilities in the U.S. and Europe to participate in the PG&E trial by joining an executive board overseeing the project, paying a \$75,000 fee, sharing in all market research (which PG&E plans to keep private), and ultimately agreeing to deploy a similar program in their service area.

Product: ERT (Encoder, Receiver, Transmitter)

Developers: Itron

Investors:

Background: Itron was formed in 1977 to develop a technology to assist utility customers with onsite meter reading. Itron began public trading of its stock in late 1993, when it had sales of approximately \$100 million. Itron has deployed ERTs in the meters of over 70 utilities. Their technology has gone through several generations: meter readers using hand-held calculators that took readings from meters equipped with an ERT to mobile vans that were driven by meter readers (no faster than 25 mph) which allowed up to 25,000 meters a day to be read.

Description: Itron's utility clients typically use the mobile meter reading product, having implemented a mobile automated meter reading system for all customers in sufficiently densely populated neighborhoods to make the one-way communications service cost effective. Itron manufactures and sells the meter switches, radios, and receivers to utilities, who install the equipment with their own staff or contractors. The next generation Itron system is a fixed network, with two-way communications to accommodate energy services offered by telephone and cable systems, such as time-of-use pricing, outage detection, and energy information (see Figure A-2). The controller, located on top of a pole in a neighborhood, rather than in a van, will send a signal to wake up the meter and the meter will send in its reading. The pole-top collector is equipped with a CPU, wireless radio, and the equivalent of the hand-held device used by meter readers.

Features:

- Utilities benefit because of the productivity gains from automatic meter reading, particularly in densely populated services areas or areas with a large number of meters in difficult or dangerous-to-read locations.
- Utilities also receive fewer customer inquiries regarding estimated bills or high or low bills that occur because the meter was located inside or the meter reader made an error.

Projects:

- Baltimore Gas & Electric is retrofitting 500,000 meters for mobile Itron meter reading by the end of 1997.
- Boston Edison will have 60,000 meters retrofitted for mobile Itron by the end of 1995.
- Public Service Company of Colorado has retrofit 300,000 electric and gas meters for mobile Itron radios; pilot fixed network Itron for 1,500 inaccessible meters began in June 1995.

- Georgia Power reads 52,000 dangerous and hard-to-read meters with mobile Itron radios.
- Pacific Gas & Electric reads 75 inaccessible meters with mobile Itron radios.

Figure A-2. Genesis AMR/DA/DSM Network

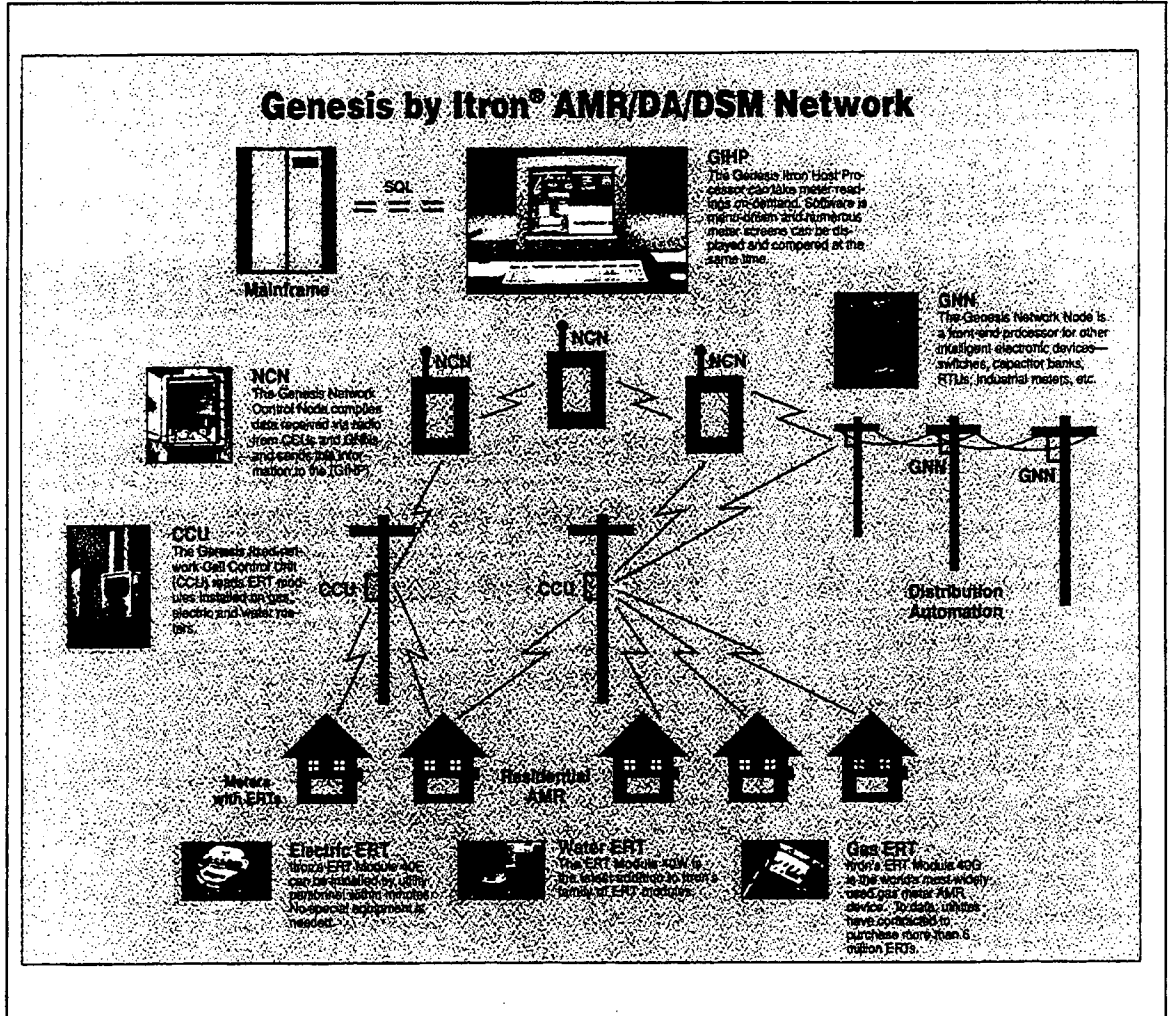

- 
- Product:** Integrated Broadband Utility Solution (IBUS)
- Developers:** Lucent Technologies  
Public Service Electric & Gas (PSE&G)  
Intellon  
Honeywell  
General Electric  
American Meter  
Andersen Consulting
- Investors:** Lucent Technologies  
PSE&G
- Background:** Lucent Technologies (formerly part of AT&T) and PSE&G are codeveloping IBUS to offer a two-way, interactive customer communication system that is tailored to the operational needs of electric and gas utilities and allows the utility to develop new value-added services (e.g., security, medical alert, and alarm services). Lucent is packaging IBUS as a fully integrated turnkey system which can provide various products and services to meet the diverse needs of different types of customers (e.g., residential, commercial/industrial). Lucent has been responsible for system specifications, software & hardware design, system integration of supporting products, and prototype testing, while PSE&G has been responsible for conducting field trials and system-wide deployment and describing the functional requirements of the utility.
- Description:** In April 1995, Lucent & PSE&G completed a proof-of-concept trial in 10 "friendly" homes (employees of Lucent, PSE&G, or Garden State Cable) and installations have been completed in the 1000-home customer pilot. Features to be deployed and tested in 1996 in some or all of the 1000 homes participating in the technical trial include automated meter reading for electric and gas, detailed customer load profiles at 30 minute intervals, remote connection and disconnections, sending real-time prices to customers, power outage reporting, theft-of-service detection, utility-controlled load management, emergency gas curtailment, customer information messaging, and automatic control of thermostats by customers that have been programmed to respond to price fluctuations.
- Features:** ● Figure A-3 provides an overview of the IBUS network architecture in the PSE&G project: hybrid fiber coax cable network from the utility headquarters over a Wide Area Network (WAN) through a Fault Tolerant Signal Processor (FTSP) to a Local Area Network optical node. This node connects to an utility interface unit (UIU) via coax cable at 64 kb/second. The UIU is

Figure A-3. IBUS Network Architecture

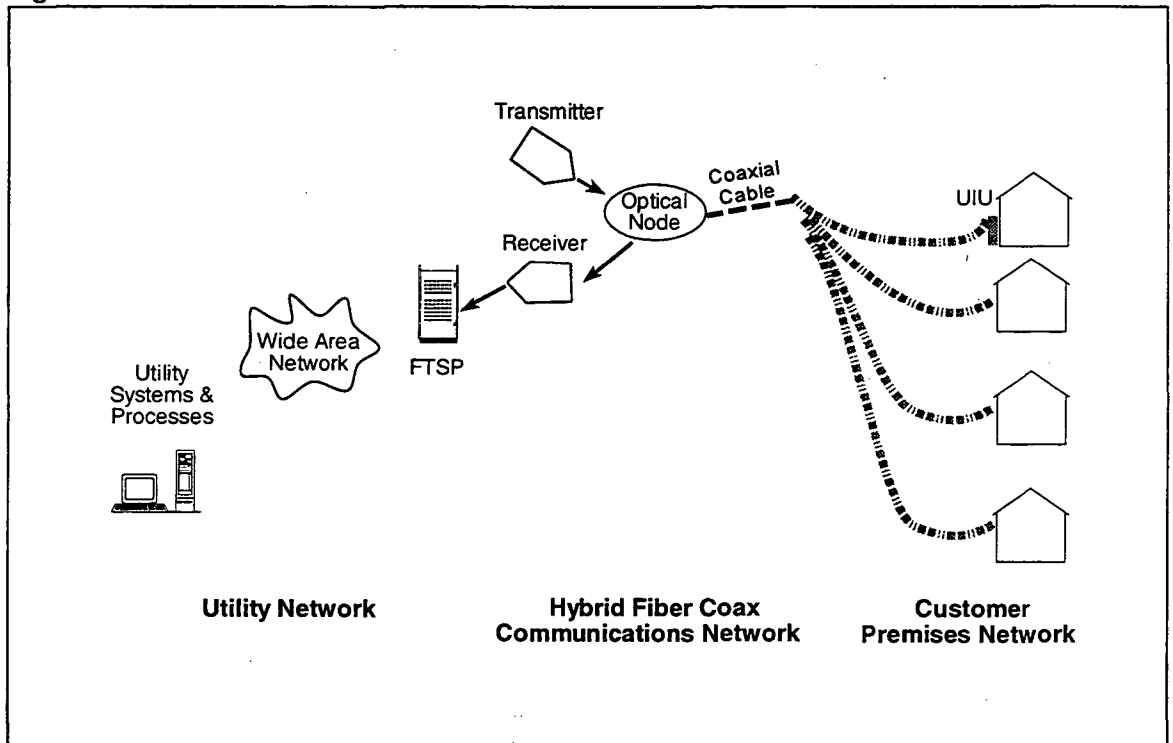

typically connected to 4-6 homes via power line carrier and wireless RF at 9.6 kb/second.

- Within the Customer Premises Network, various customer premise equipment will be installed depending on services required: CEBus-compatible, 3-phase, electric meters (GE), gas meter modules (American Meter), "smart thermostats and home automation applications (Honeywell), and chips and components to facilitate CEBus-based, in-home communication (Intellon).
- The IBUS system is based on "open" standards (e.g., CEBus) and communication protocols, which are shown in Table A-1. Because the specifications will be "open," Lucent envisions that other manufacturers can supply various parts of the system or add additional equipment.
- Because of the limited bandwidth (PLC or RF) between the UIU and homes, IBUS is optimized for electric utility applications and is not designed to provide cable, telephony, or video services over its network.

Table A-1. Integrated Broadband Utilities Solution (IBUS)

	Within Home	Home to UIU	UIU to Node	Node to FTSP	FTSP to Utility
Open	Yes	Yes	Yes	Yes	Yes
One or Two Way	Two Way	Two Way	Two Way	Two Way	Two Way
Standard	CEBus	CEBus	MMS/HDLC	MMS/HDLC	MMS/TCP/IP
Media	CEBus powerline carrier or radio-frequency	CEBus powerline carrier or radio-frequency	COAX, (alternate PCS or CDPD)	Fiber, (alternate PCS or CDPD)	WAN
Where	Premises	Collar Count, Pole Top	Neighborhood Node, Base Station	Head End, Central office, Mobile Switching Center	Utility
Data Rate	9.6 kb/s	9.6 kb/s	64 kb/s	64 kb/s X # fibers	Varies
No. of Customers	1	1-20	500 - 1500	10,000 - 20,000	> 5 million

Note: FTSP = Fault-Tolerant Signaling Processor, UIU = Utility Intelligent Unit

Source: Lucent Technologies

- Projects:
- PSE&G's multi-phase development and deployment began in early 1995.
  - Consolidated Edison and Louisville Gas & Electric have also signed agreements with IBUS; Consolidated Edison's application will target commercial customers.

## APPENDIX A

---

Product: IRIS Fixed Network

Developers: IRIS Systems

Investors:

Background: IRIS is a Canadian firm that entered the U.S. market for wireless radio network systems. IRIS was recently bought out by Itron.

Description: IRIS technology consists of wireless radios (two-way, 900 MHZ) licensed on both sides, to the home and the utility (unlike CellNet which is licensed only on one side). Each meter is retrofitted with a radio. One controller can handle 25 repeaters which each handle up to 1,000 meters. The signal is decoding by the IRIS Sun Workstation at utility headquarters.

Features:

- The modular PBX software can be turned on as needed to gain functionality for Baltimore Gas & Electric customers.
- IRIS can be interfaced with thermostat and CEBus adapters programmed to control appliances.

Projects:

- Baltimore Gas & Electric's pilot for 100 homes in Timonium, Maryland, began in late 1994.
- British Columbia Hydro's trial began in May 1994.
- Winnipeg Hydro's trial began in March 1994.



Product: Meter Minder

Developers: Interactive Technologies Inc. (ITI)

Investors: Wright-Hennepin Cooperative Electric Association  
ITI  
National Rural Electricity Cooperative Association (NRECA)

Background: Meter Minder was introduced four years ago. The product was co-developed by ITI and Wright-Hennepin with a research and development grant from NRECA for \$300,000. Wright-Hennepin was already in the security business before joining forces with ITI. As a result, the product has always been geared towards electric cooperatives.

Description: Meter Minder integrates automated meter reading with home security and safety services. It is a two-way communications device, using the telephone network outside the home and wireless within the home (see Figure A-4). The provision of services is not limited to a utility's territory. For example, Wright-Hennepin performs central monitoring for two cooperatives that cannot afford such service. Home security services generate the most income for this product. A standard package, including a CPU, two door sensors, a smoke or motion detector, and an interior siren, is offered by Wright Hennepin at no initial cost to its customers; customers may add on equipment as needed.

Features:

- Thermostat setback on time schedules (not price signals);
- Outage detection;
- Automated energy billing and rolling usage history of customer (60 days) for utility in case it needs to explain unusual usage/billing, upon customer request;
- Automated meter reading;
- Remote on/off (although not all utilities request this option);
- An energy saver module, which customers can add permitting them to access remotely an ITI setback thermostat via touch tone phone and allowing them to turn on lights and turn up the heat in weekend cabins (from car or home);
- Wireless home security with monitoring.

Projects:

- Wright-Hennepin's pilot began in 1991; the roll-out has involved 3,000 customers.
- About a dozen utilities, mainly rural cooperatives, have enough units installed to be considered a project. A number of these utilities are aggressively marketing safety and security services to residential customers.

Figure A-4. Meter Minder

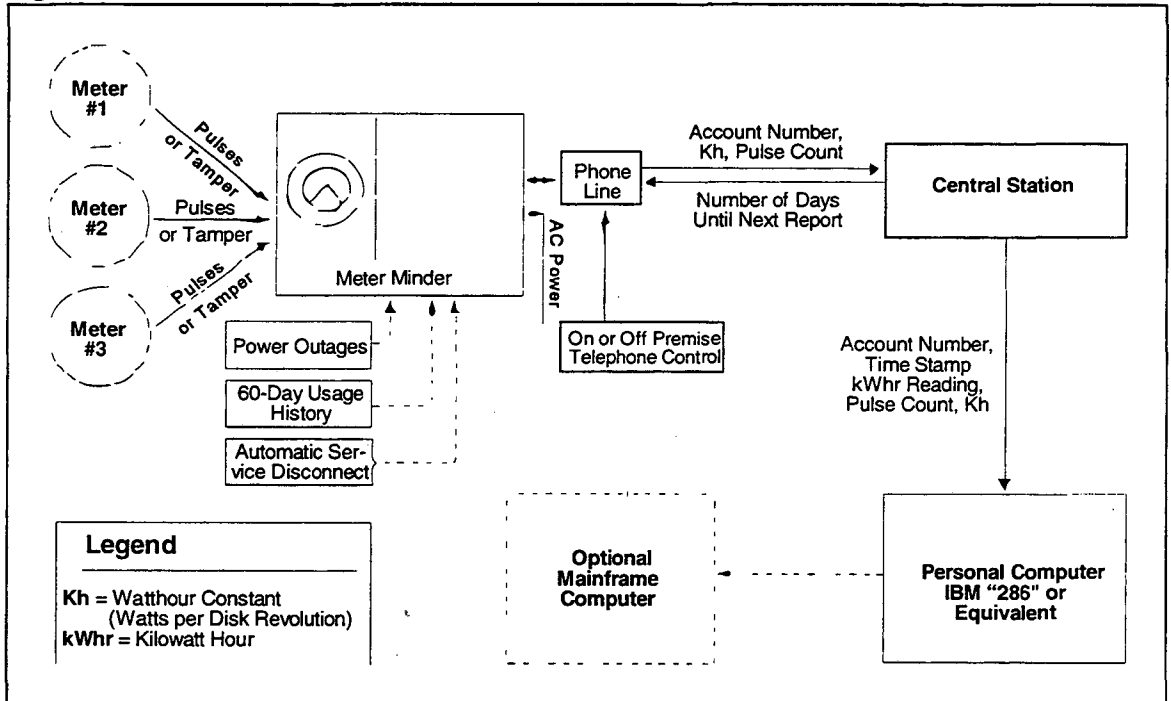

Product: PowerView

Developers: First Pacific Networks (FPN)

Investors: Central & South West (CSW)  
Entergy  
Sprint (also involved with TeleCommunications Inc.)

Background: FPN was founded in 1988 and went public in 1992. In 1989, Glasgow (Kentucky) Electric Plant Board was a beta test site for FPN 1000, the predecessor to PowerView. FPN 1000 offers telephone service over a cable TV (CATV) network. FPN provided the software for free and Glasgow's line crews strung all of the cable (160 miles of coax). The system currently accommodates 44 CATV channels and a two to three megabit data WAN. FPN frequently brought utility representatives to Glasgow to see its product. PowerView is a commercially deployable product, although FPN customizes the name for each utility, e.g., Customer Choice and Control, Customer Choice 2000, etc.

Description: PowerView consists of four networks (see Figure A-5):

- Host Network -- PNP workstation that handles customer information and billing, facilities control, dispatch;
- Backbone Network -- Ethernet high-speed (T-1 or higher) fiber data line (LAN) connecting the Gateway to the utility;
- Distribution Network -- coax or fiber-coax cable connecting FPN's Intelligent Utility Unit (IUU) which handles four homes and FPN's Gateway which serves up to 500 homes in a 25-mile radius; and
- Home Network -- thermostat, user interface, HVAC controller, appliance relays, Powerlon meter, Echelon PLT-20 chip, and powerline carrier.

PowerView is a customer-controlled load management (CCLM) system provided through a CATV network. FPN does not produce all the components:

- Sun makes the PowerView Network Processor (PNP), a SPARCstation 5 system manager;
- American Innovation makes the electronic meters used at the homes for automated readings;
- Raytheon manufactures the thermostat, monitor, HVAC controller, and appliance relays; and
- Echelon produces the LONworks interface (chip), a "proprietary" closed standard chip that competes with the EIA-approved open standard CEBus chip.

Projects undertaken to date use the utilities' own fiber networks or leased lines.

- Features:
- Customers can preprogram operation of HVAC, water heater, and clothes dryer based on four real-time price periods--low medium, high, and critical.
  - Automated meter reading
  - Raytheon's Customer Energy Monitor is a hand-held calculator that can be plugged into any outlet in the home and displays one line of energy information; choices include temperature inside or outside, time and date, price in effect, vacation schedule, electric bill to date, and programmed response of each appliance.
  - Outages are reported automatically to utility through CATV, although not all utilities request this feature.
- Projects:
- Entergy began working with FPN on its pilot, but FPN is no longer working on the project.
  - Central and South West's pilot in 2,500 homes began in December 1994.
  - A pilot conducted by an affiliate of Southern Company (SDIG) in 303 multi-family units is expected to begin in early 1996.

Figure A-5. PowerView System

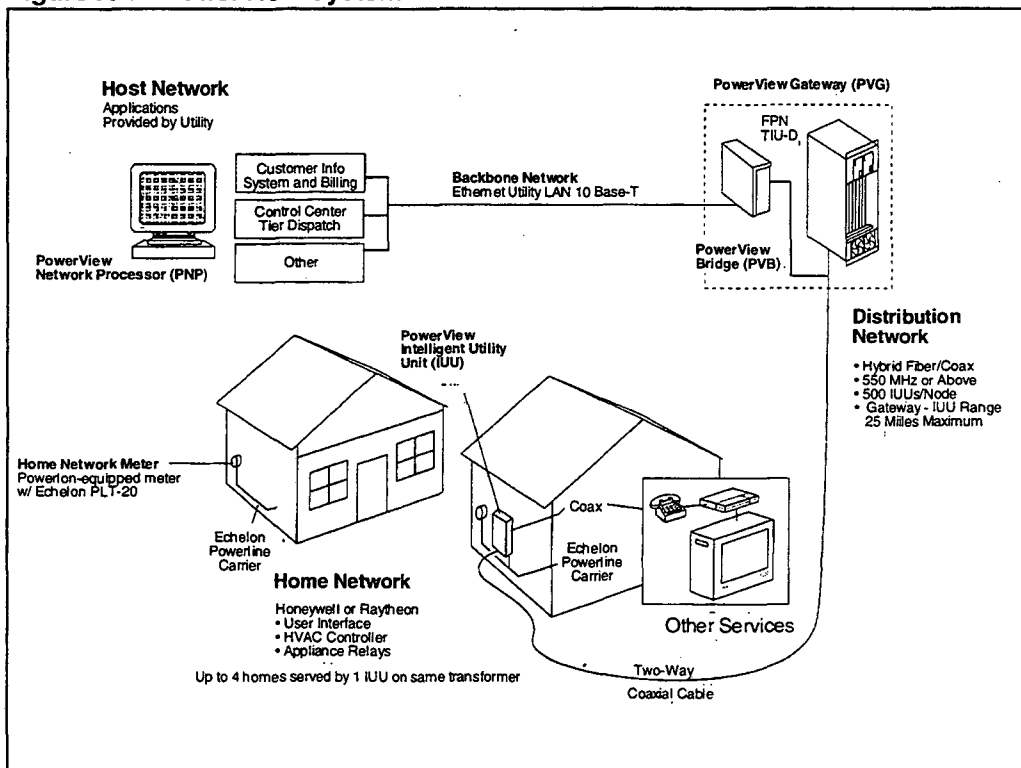

- 
- Product: TranstexT  
Advanced Energy Management System (AEMS)
- Developers: Integrated Communications Systems (ICS)  
Southern Company  
Johnson Controls
- Investors: Southern Company  
American Electric Power (AEP)  
Johnson Controls  
ABB  
American District Telegraph  
Bell South
- Background: When TranstexT was originally tested in 1985 in Risewell, GA, it offered a variety of non-energy services via telephone--home banking, home shopping, classified ads, stock portfolio management, and cable TV--as well as energy information services. The costs of this service were prohibitive--\$5,000/home. During evaluation of the trial, customers responded that the most important feature of TranstexT was the energy management service. TranstexT was then reworked to focus on energy management, with plans to add on non-energy services in the future. AEMS is the demand-side management product ICS offers. AEMS was developed as a stand-alone product (i.e., no interface with distribution automation systems) with research and development assistance from Bell South and Southern Company, particularly for billing information and software.
- Description: TranstexT and AEMS are energy management systems offered through the telephone and powerline carrier. ICS is the integrator, with ABB and Johnson Controls as key manufacturers of meters and thermostat components. Johnson's thermostat controller has low voltage wiring interface with major loads (HVAC, water heater, pool) and can handle frequent billing reports. ICS uses its own TranstexT major appliance relay (a two-way carrier programmed to be compatible with CEBus technology) and acts much like the X-10 plug adapters commercially available. The controller can handle up to eight addresses, and if each outlet has two plugs, then a total of 16 appliances can be controlled. At present ICS can handle only residential and small commercial customers with less than five-ton cooling loads. Automatic meter reading is provided. Other energy services can be offered, such as outage detection, if the utility sees an economic justification. Non-energy services have been considered by ICS but were disregarded because they could not compete cost effectively with existing providers of security and other services. For example, the thermostat site is not the best location for an alarm

“arm/disarm” pad. ICS could offer telephone service, but so far is not doing so.

- Features:
- Variable prices are programmed at one of four price designations -- low, medium, high, or critical. The customer responds with preprogrammed changes in appliance use. ICS has found that customers respond well to time of use pricing for HVAC, water heating, and pool heaters/pumps and have achieved real energy savings.
  - Alpha Meter is a fully electronic meter designed by ABB with three CEBus circuit boards inside to handle central processing, assign the appropriate tariff to blocks of electricity consumed, and report consumption and costs to the utility. This is not an electromechanical meter, and as such is less susceptible to electromagnetic pulse effects (Gulf Power is particularly susceptible to lightning).
  - TranstexT System Manager is a 486 computer controller that can handle up to 10,000 customers.
  - TranstexT Diagnostic Software is under development to permit a utility representative with a laptop computer to plug into an outside outlet at the home and access all appliance usage and billing data for a 40-day period.
- Projects:
- AEP's pilot in 460 homes began in October 1990; the roll-out to 25,000 homes is expected to begin at the end of 1995.
  - Gulf Power's pilot in 250 homes began in 1991; the roll-out to 30,000 homes is awaiting Public Utility Commission approval.
  - The developers are currently investigating opportunities at three other utilities, examining average and incremental production and delivery costs in a six-month screening process.

Product: UtiliNet

Developers: Metricom  
CIC Systems  
Landis & Gyr

Investors:

Background: Founded in 1985, Metricom manufactures profile meters that provide frequent readings for load control. In the early 1990s, Metricom developed its UtiliNet product line to provide high-performance, license-free, two-way wireless networks for electric utility applications in demand-side management and distribution automation. UtiliNet uses spread-spectrum radio in the 902-928 MHz range. Based on Boston Edison's needs, Metricom forged a partnership with Landis & Gyr, whose meters could handle remote on/off functions but required a network to communicate. Based on PacifiCorp's needs, Metricom forged a partnership with CIC Systems, whose in-home energy management system can control HVAC and appliance use according to time or tariff. Metricom's UtiliNet product is installed in 17 electric and gas utilities to handle a variety of SCADA and automated meter reading (AMR) applications.

Description: Metricom's profile meters provide load control readings at intervals set by utility staff that are communicated to headquarters. Metricom's radios can work with Metricom or Landis & Gyr meters, depending on customer needs, as well as CIC in-home displays to permit customer-controlled load management. Metricom notes that it is difficult to justify the cost-effectiveness of AMR on a stand-alone basis; the value of the UtiliNet system is the combination of SCADA and AMR.

Features:

- Metricom's radios are intelligent devices that can execute a number of functions simultaneously: (1) interact with end-use devices to exercise data collection and control, (2) interact with the wider area network to facilitate network access, and (3) act as a repeater for all other radios in the network.
- Installation involves hanging a radio on a utility pole in a central location that permits communication via powerline to up to 100 customers. Utility linemen can hang the radio in eight minutes.
- Savings can accrue to customers by varying residential energy use through CIC displays or to utilities by capacitor bank switching through the UtiliNet radio network.

- CIC displays present one line of energy information: current use in \$ or kWh, \$ or kWh used yesterday, month to date \$ or kWh used, last bill \$ or kWh, and usage history.
- There are three light emitting diodes on the front of the CIC display to alert customers: (1) budget lights if actual usage exceeds budgeted consumption, although there are still bugs in this software, (2) time-of-use (TOU) peak lights 8 am to 5 pm, if the customer is a TOU participant, and (3) load control lights if the utility is directly cycling off water heaters.

- Projects:
- Pacific Gas & Electric reads a few hundred inaccessible Metricom meters in Vacaville, California.
  - Mid-American Energy's energy efficiency pilot with Metricom radios and profile meters extended from 1990 to 1994.
  - Boston Edison's pilot permitting remote on/off for 15,000 inaccessible meters began in 1991.
  - PacifiCorp's 100-meter pilot with Metricom radios and meters and CIC displays began in 1994.
  - Southern California Edison's has a project with 4,000 Metricom meters and 10,000 radios on capacitor banks.



## **Descriptions of Selected Utility Projects**

This appendix includes summaries of 21 utility projects based mainly on interviews with program managers conducted during August-October 1995. In several cases, we describe multiple projects that utilities are conducting if they met our criteria for this study. For each utility we include information on project team members and their roles, project description, target market, current status, energy and non-energy services offered or planned (indicated by an X or P), and regulatory issues. Staff at each utility had an opportunity to review and comment on our summaries during December 1995.

**APPENDIX B**

---

Utility: American Electric Power (AEP)  
Holding company for Appalachian Power, Columbus Southern Power, Indiana Michigan Power, Kentucky Power, Kingsport Power, Michigan Power, Ohio Power, and Wheeling Power.

Project: TranstexT Project  
For description of vendor product, see page A-17.

Team Members	Role	Responsibilities
AEP	Lead	Project direction, funding
Integrated Communications Systems (ICS)	Integrator	Equipment integration
Johnson Controls	Supplier	Engineering, thermostat, HVAC/appliance controls
ABB	Supplier	Engineering, Comset hardware, meter (standard & Alpha)
Southern Company	Software	Systems Manager software development

Description: The TranstexT project employs telephone communications between the utility and home and powerline carrier within the home. The pilot began in October 1990 and was scheduled to run for one year. AEP has continued the pilot, with 94% of original participants still involved. AEP has conducted several evaluations of customer satisfaction with the project. AEP and ICS partners are modifying equipment, upgrading the systems controller at utility headquarters, and installing enhanced Alpha meters at the pilot homes.

Market: The TranstexT project was originally a load shifting program, selecting all-electric residential customers with electric water heaters and heat pumps in both summer and winter peaking areas to participate in the pilot. At first, all participants had to be on the same telephone switch to facilitate communications with the utility. Three neighborhoods (460 homes) were selected, based on different weather and price tiers: Dublin, OH, Muncie, IN, and Roanoke, VA.

Status: As of September 1995, AEP is modifying the equipment in the pilot homes and at the utility. AEP plans to roll-out the project to 25,000 homes across the six states it serves by the end of 1998. In the roll-out, AEP will select areas where customers are expected to benefit most from participation. Not all areas have been selected; once selected, AEP will directly market customers by mail.

## Energy Services Offered

Automated Meter Reading	Outage Detection	Remote On/Off	Load Control	TOU Pricing	Energy Information	Other
X			X	X	X	

Customers scroll through menu-driven screens on thermostats to see time, temperature, 40 days of billing history, bill to date in \$ and kWh comparing variable and standard tariffs so customers can estimate savings, predicted bill for month based on first 7-10 days, and kWh consumption by price tier. Prices range between 1-28 ¢/kWh in the various price tiers. Customers can control HVAC usage on weekday and weekend schedules by programming up to four time periods. Customers can also program up to eight appliances to respond to price or time signals using X-10 plug adapters and the Johnson Controls thermostat.

Non-Energy: No non-energy services are currently offered, but such services may be considered in the next generation of TranstexT (i.e., beyond the AEP roll-out).

Issues:

- AEP has kept respective public utility commissions informed throughout the pilot and does not expect problems during the roll-out or changes in funding sources for the project.
- AEP is also developing other in-house telecommunications technologies aimed at large commercial customers. The focus has been on handling large energy loads regardless of the telecommunications mode.

**APPENDIX B**

---

Utility: Baltimore Gas & Electric (BGE)

Project: Itron AMR  
For description of vendor product, see page A-7.

Team Members	Role	Responsibilities
BGE	Lead	Project direction, funding
Itron	Supplier	ERT meter modules, van radio
Various manufacturers	Supplier	Retrofit/recondition electric meters

Description: The Itron project will provide AMR and related services to 80% of the residential customers located within the Baltimore beltway (i.e., the densely populated areas) at substantial cost savings to the utility. The technology is currently configured for mobile radio readings. The meter retrofits have been simplified and 15,000 residential customers can join the program every month. BGE has 25,000 seed meters (from Landis & Gyr, Schlumberger, GE and a fourth manufacturer) that it has taken from homes and sent to the manufacturers for retrofitting with Itron ERTs and reconditioning. When BGE representatives come to homes, they break the circuit by lifting up the old meter, replace it with a retrofit meter, and plug the replacement meter back into the four-prong circuit. The installation takes less than 10 minutes. As meters are removed from homes, they are sent for reconditioning. If any meters are too old, they are replaced with new meters.

Market: The target market is all residential customers located in densely populated neighborhoods within the Baltimore beltway (695). Mobile Itron does not work well in rural areas where homes are set back from the road. If the van must drive up the driveway to read the meter, it may not be cost-effective to equip the home with a retrofit meter. BGE plans to retrofit 500,000 of the 700,000 gas and electric meters located within the beltway. In total, BGE has 1.3 million electric and 500,000 gas meters. Baltimore has high residential customer turnover because of the students and apartment dwellers, requiring 14,000-15,000 physical turn-on/off's each month.

Status: As of October 1995, BGE had installed 200,000 Itron ERTs. BGE plans to install Itron ERTs on all gas and electric meters within the beltway with 500,000 installed by the end of 1997.

**Energy Services Offered**

Automated Meter Reading	Outage Detection	Remote On/Off	Load Control	TOU Pricing	Energy Information
X					

Non-Energy: No non-energy services offered.

- Issues:
- BGE does not face any regulatory barriers with this project.
  - BGE staff believe that a variety of narrowband and one-way communication systems can meet most customer needs.

**APPENDIX B**

Utility: Baltimore Gas & Electric (BGE)

Project: IRIS Fixed Network  
 For description of vendor product, see page A-12.

Team Members	Role	Responsibilities
BGE	Lead	Project direction, funding
IRIS	Supplier	Meter modules (wireless radios), repeaters
Not Yet Determined	Supplier	Thermostat to control heat pump, A/C

Description: The IRIS pilot is testing a fixed wireless radio network for two-way communications with 100 residential meters in Timonium, Maryland. BGE is testing the viability of fixed wireless networks for automated meter reading and related services. Timonium has very hilly terrain, which provides a "worst case" scenario for testing a radio frequency network. Relatively low population density (2,700 meters per square mile in Timonium versus 20,000 meters per square mile in Baltimore) affects pole-top collector capacity and thus, the cost per meter ratio. BGE is collecting detailed load survey data on participants as needed by remotely activating the function. BGE is considering adding interactive thermostats to the pilot. Once real-time pricing is examined, commercial customers may be invited to participate.

Market: BGE deliberately chose a not-too densely populated residential neighborhood with uneven terrain to test the effectiveness and functionality of pole-top collectors (repeaters).

Status: BGE issued a Request for Proposals in Spring 1994 for a radio propagation, multiple application pilot. BGE was not interested in co-developing a product. IRIS/Motorola won the award and started the 100-meter pilot in Timonium in late 1994; the pilot was expected to continue for 15 months. If roll-out occurs, BGE may consider the area four miles outside the Baltimore beltway (i.e., the bedroom communities), including Laurel, Bowie, and Annapolis, for IRIS applications.

**Energy Services Offered**

Automated Meter Reading	Outage Detection	Remote On/Off	Load Control	TOU Pricing	Energy Information
X	X		P	P	

BGE can change meter reading parameters remotely, choosing standard meter readings (once a month) or load survey readings for total usage (not disaggregated by end use) at 15 minute intervals. BGE does not yet use the IRIS system to bill these customers, but continues to

require on-site verification of readings. The load survey readings give BGE an idea how to structure a real-time pricing mechanism desired by commercial and industrial customers. BGE would like to add on a smart thermostat to control heat pumps and air conditioners.

Non-Energy: No non-energy services considered in this pilot.

**APPENDIX B**

Utility: Boston Edison

Project: Itron AMR  
 For description of vendor product, see page A-7.

Team Members	Role	Responsibilities
Boston Edison	Lead	Project direction, funding
Itron	Supplier	ERT meter modules, van radio
Nscan	Supplier	Electronic board adapter on meter

Description: Boston Edison decided to automate meter reading because it has many inaccessible and hard-to-read meters in its service territory. Boston Edison also has a large student population with billing and shut-off problems. Itron equipment currently provides one-way AMR for 40,000 residential customers. Itron offers "virtual" remote on/off: the meter can be read at shut-off and start-up of power without having a staff person access the building to turn off the meter. Boston Edison uses two meter types: (1) Itron-adapted meters with a switch added that increases the height of the meter from 5.5" to 7", and (2) Nscan meters, which are the old meters with either an electronic board behind the nameplate or a flywheel on the shaft.

Market: Boston Edison does not have high sales volume per residential customer, which is one of the key criteria for automation projects. The Itron roll-out, underway for the past four years, will automate meter reading for residential customers in densely populated area.

Status: Approximately 40,000 customers had been connected to Itron wireless transmitters by the beginning of 1995 and 60,000 customers were expected by the end of 1995. Boston Edison issued a Request for Proposals (RFP) in May 1995 for telecommunications systems to provide multiple functions--AMR, service disconnect, load control, outage detection, and mode to communicate with customer (video, thermostat, etc.). Boston Edison is currently evaluating the proposals and is expected to issue an award for the pilot in the near future.

**Energy Services Offered**

Automated Meter Reading	Outage Detection	Remote On/Off	Load Control	TOU Pricing	Energy Information
X		X			

Non-Energy: No non-energy services offered.



- Issues:
- The Massachusetts Public Utility Commission is very supportive of automation efforts. The gas utilities are three to four years ahead of Boston Edison (95% automated readings), and the water company also has off-site meter reading. At the beginning of 1995, 55,000 Boston Edison customer meters were automated and this was expected to increase to 75,000 by year end (both Itron and UtiliNet). This represents only 10% of the 600,000 residential customers in Boston Edison's service area. The need for proper billing, on a daily, weekly, or monthly interval, will probably drive automation.
  - Within two years, Boston Edison would like to interconnect the various automation projects that are underway, integrating Itron and Metricom services on the spare channels in the Motorola-Schlumberger wireless radio distribution automation network, thereby connecting distributed SCADA and billing functions.

**APPENDIX B**

Utility: Boston Edison

Project: UtiliNet Automatic On/Off  
 For description of vendor product, see page A-19.

Team Members	Role	Responsibilities
Boston Edison	Lead	Project direction, funding
Metricom	Supplier	Pole-top collectors, older meters, software, installation
Landis & Gyr	Supplier	New Meters, installation

Description: Boston Edison coordinated this project with assistance from Metricom and Landis & Gyr for installation, operation, diagnosis phases, and training of utility staff. Metricom hired one representative locally to provide service to Boston Edison on-site. The manufacturers still provide trouble-shooting assistance. The 15,000 meters communicate with 400 pole-top collectors. The ratio of homes to collector is 34:1 for Boston Edison, far below the 100:1 ratio specified by Metricom, because of distance, density, resistance, voltage, and LAN limitations. In suburban locations, the ratio is closer to 8-12:1. Boston Edison can read all of the hooked meters from a PC at its corporate headquarters. Boston Edison still faces one technical barrier--unexplained noise, which occurs around dinner time and causes the equipment to operate poorly. Boston Edison has relocated a few pole-top transmitters to eliminate this noise, but it may emanate from the homes.

Market: Boston Edison picked the Brighton neighborhood of Boston, where the concentration of college and university students is the highest. Problems with billing caused Boston Edison to consider automatic on/off and read-on-demand services for 15,000 meters.

Status: The pilot test is completed. Boston Edison is evaluating the project, compiling data and calculating on/off rates and operational savings.

**Energy Services Offered**

Automated Meter Reading	Outage Detection	Remote On/Off	Load Control	TOU Pricing	Energy Information
X		X			

Boston Edison is not offering outage detection, due to its cost and redundancy. Most power outages are at the transformer, so receiving messages from 800 homes that power is down is not as important as knowing which transformer is down via SCADA. UtiliNet can identify sophisticated tampering by meter jumpers, which is significant for Boston Edison.

Non-Energy: No non-energy services offered.

Issues: ● If Boston Edison rolls-out the project, it may chose to do so through an unregulated affiliate. The Public Utility Commission expects Boston Edison to assume all risks.

**APPENDIX B**

---

Utility: Central & South West (CSW) Corporation  
Holding company for Central Power & Light, Public Service Company of Oklahoma, Southwestern Electric Power, and West Texas Utilities

Project: Customer Choice and Control  
For description of vendor product, PowerView, see page A-15.

Team Members	Role	Responsibilities
CSW Communications, Inc.	Lead	Project direction, cable installation, software, funding
First Pacific Networks (FPN)	Supplier	Intelligent Utility Unit, Eshelon chip, Networks
Raytheon	Supplier	Engineering, Customer Energy Monitor, installation
American Innovation	Supplier	Electronic meter

Description: In February 1994, CSW announced a \$9 million joint research project among its four retail electric operating companies for fiber-optic energy management. Customer Choice and Control is a product co-developed by CSW and FPN (CSW is an equity owner of FPN). CSW installed hybrid fiber cable in 10 neighborhoods in Laredo, Texas that passes roughly 2500 homes. As of December 1995, CSW has signed agreements with to participate with about 1700 households, about 70% of the customers that the fiber cable passes. CSW is not offering CATV or other non-energy services, but is focusing on energy management (i.e., testing customers ability to shift load given control over their electricity usage). Equipment installation did not begin until December 1994. Participants can control use of air conditioners, water heaters, and clothes dryers in response to an experimental time-of-use rate tariff with four periods that was approved by the City of Laredo. Rates range between 5.5 and 50 ¢/kWh. CSW is using an in-home display unit developed by Raytheon in the pilot (rather than set-top box). CSW is very active in customer outreach, maintaining an 800 number for inquiries, preparing a video, and publishing a regular newsletter.

Market: The residential market in Laredo, Texas, was targeted because of its (1) fast growing economy, (2) severe peaks due to hot weather, and (3) isolation from nearby generation plants. CSW would like to avoid building new generation and transmission and distribution facilities near Laredo and is hoping that this project will shift a sufficient load to avoid such investments. CSW marketed Laredo by telephone and by speaking at neighborhood and school meetings; a variety of single and multi-family homes were selected. CSW keeps participants updated with a newsletter. Focus groups are held to assess customer interest in participation.

Status: As of December 1995, all necessary equipment has been installed in about 625 homes. Based on initial experience in the pilot, CSW has initiated a number of improvements to vendor products and plans to roll-out the technology beyond Laredo. For example, FPN's Intelligent Utility Unit (IUU) will be able to serve up to four homes in the updated version of PowerView technology. Pilot participants will continue to use their equipment after December 1995. CSW reports that customers, on average, are saving about 7-10% on their electric bills and claims that the utility is reducing peak demand by about 2 kW in participating homes. Currently, system costs are roughly \$1800/home in the latter phases of the pilot and CSW believes that a cost target of \$1000/house is achievable in the near future.

## Energy Services Offered

Automated Meter Reading	Outage Detection	Remote On/Off	Load Control	TOU Pricing	Energy Information
X	P		X	X	X

Customers are provided with in-home bill-to-date queries. CSW has identified outage detection and itemized bills for major appliances showing costs for usage in the various time-of-use price tiers as features for later inclusion.

Non-Energy: No non-energy services offered in this pilot.

Issues: • The Texas Public Utility Commission has been very supportive of this project. CSW expects no problems obtaining approval for a territory-wide time-of-use rate.

**APPENDIX B**

---

Utility: Entergy  
Holding company for Arkansas Power & Light (AP&L), Louisiana Power & Light, Mississippi Power & Light, and New Orleans Public Service

Project: Customer-Controlled Load Management (CCLM)  
For description of vendor product, PowerView, see page A-15.

Team Members	Role	Responsibilities
Entergy	Lead	Project direction, cable/equipment purchases/installation
Echelon	Supplier	Eshelon chip
Honeywell	Supplier	Engineering, Thermostat in-home display
American Innovation	Supplier	Turnkey retrofit meters
Sprint	Supplier	Long-distance telephone service

Description: Customer Choice 2000 was co-developed by Entergy and First Pacific Networks (FPN) in 1990. Entergy held equity interest in FPN and Entergy Enterprises, the unregulated subsidiary that was responsible for the project. Entergy recently spun this project off to the regulated subsidiary's Marketing Department. FPN is no longer working on the project, in part because of problems and delays that arose during implementation. Entergy has renamed the project Customer-Controlled Load Management (CCLM) and is implementing a pilot in 50 homes in Chenal Valley, Arkansas, working directly with vendors. A Dell 486 CPU (no monitor) is installed in the attic or garage of each home to communicate with the thermostat, meter, repeater, and ultimately a controller at AP&L's headquarters.

Market: Entergy's electricity prices are among the highest in the South. Originally, Entergy wanted real-time access to customers in areas with severe weather where electrical equipment needed to be shut down. Entergy initially chose New Orleans for participation in the project in 1990, but encountered significant regulatory problems. Entergy then selected Chenal Valley, Arkansas, as its trial neighborhood due to high disposable income and a sophisticated substation.

Status: As of September 1995, equipment had been installed in over 40 homes. Entergy plans to complete equipment installation by January 1996 and to continue the pilot with a new variable tariff through January 1997. Entergy does not expect a roll-out after the pilot.

Energy Services Offered

Automated Meter Reading	Outage Detection	Remote On/Off	Load Control	TOU Pricing	Energy Information
X			X	P	X

Customers can control HVAC, water heater, and two additional appliances with a sophisticated set-back thermostat. Time-of-use pricing awaits regulatory approval of a variable tariff.

Non-Energy Services Offered

Home Security	Medical Alert	Cable Television	Video on Demand	Telephone Service	Internet Access	Other
		X		X		

Entergy offers 22 CATV stations and may start a channel focusing on energy efficient products and home improvement. Participants have an A/B switch atop the TV to select Comcast or Entergy CATV channels. Sprint currently provides long-distance telephone service.

Issues: • The Arkansas PUC has been slow to approve time-of-use tariffs and unwilling to let ratepayers finance this project.

**APPENDIX B**

---

Utility: Glasgow (Kentucky) Electric Plant Board  
Municipal utility wholly dependent on Tennessee Valley Authority (TVA)

Project: TVA Water Heater Project

Team Members	Role	Responsibilities
Glasgow Electric Plant Board	Lead	Project direction, cable/equipment purchases/installation
TVA		Funding
CableBus	Supplier	Engineering, CTD terminal, meter retrofit relay/counter

Description: In 1988, Glasgow began constructing broadband fiber network to provide SCADA and telecommunications services (e.g., cable TV service). Currently, Glasgow is the lead on a water heating project, setting product specifications for manufacturers and coordinating this project with the web of non-energy telecommunications services implemented since 1989. Initially, Glasgow did not offer energy management services through its cable network because TVA would not authorize a time-differentiated wholesale rate that would make participation in such a project cost-effective for Glasgow customers. This situation changed when TVA created a 2.7¢/kWh tariff in effect after midnight for water heating. The TVA water heater project will test if residential customers are willing to heat water at night and coast with what is in the tank for the rest of the day. Under this tariff, Glasgow can compete with gas-heated water charges, and possibly gain new electric water heater customers. The TVA water heater project involves hooking up a cable drop to the electric meter outside the home, which is retrofit with a revolution counter, a switch to read water heating use, and a CTD terminal (6" x 8" box).

Market: Glasgow sought 100 residential customers with electric water heaters through advertising on its cable TV network. The utility had trouble finding 100 homes with electric water heaters and ended up with only 50 homes to participate in the pilot.

Status: As of October 1995, Glasgow is evaluating the performance of equipment which has been installed in several homes with electric water heaters. If successful, the equipment will then be installed in the remaining homes that are participating in the pilot. The off-peak TVA discount tariff is in effect and testing is expected to continue for 18 months.



## Energy Services Offered

Automated Meter Reading	Outage Detection	Remote On/Off	Load Control	TOU Pricing	Energy Information
P				X	

Glasgow would like the automated meter reading system to be interconnected with the cable network and to report meter readings to the workstation.

## Non-Energy Services Offered

Home Security	Medical Alert	Cable Television	Video on Demand	Telephone Service	Internet Access	Home Security
X		X		X	X	P

Glasgow provides cable TV to 3,000 subscribers, offering 49 channel basic service option for \$13.50 per month. In 1994, Glasgow began offering local telephone service in direct competition with the local exchange provider (GTE). Glasgow also offers access to a local area network (2 MB/second), called HomeLan, which allows users to access the Internet access, email, and access educational information kept at local schools and libraries. Several hundred customers take advantage of local telephone and LAN services. Glasgow plans to add security services via CableBus, with signals for home break-ins transmitted over the cable network to a monitoring station.

Issues: • As a municipal utility, Glasgow is unregulated at state level and not subject to restrictions by the Public Utility Holding Company Act of 1935. Thus, Glasgow has been able to expand its service offerings to compete against cable and telephone providers.

**APPENDIX B**

---

Utility: Gulf Power  
One of five subsidiaries of Southern Company.

Project: Advanced Energy Management System (AEMS)  
For description of vendor product, see page A-17.

Team Members	Role	Responsibilities
Gulf Power	Lead	Project direction, funding
Integrated Communications Systems (ICS)	Integrator	Hardware/software integration
Johnson Controls	Supplier	Engineering, thermostat, HVAC/appliance controls
ABB	Supplier	Engineering, Comset hardware, meter (standard)
Southern Company	Software	Systems Manager software development

Description: AEMS employs telephone communications between the utility and home and powerline carrier within the home. Gulf Power's pilot project has been underway since 1991, with two full years of testing (1992-1994) under a variable TOU pricing schedule. The project succeeded in shifting customer load and enhancing the customers' perception of the value of controlling their own energy use and bills. Gulf Power is capacity constrained during summer peak periods. Time-of-use pricing provides customers with a way to modify their electricity use considering both cost and comfort and avoiding further utility investment. Based on an independent evaluation, Gulf Power reports that customers reduced their average bills by about 2% during summer and 13% during winter and the utility realized a load reduction of about 2.25 kW/home during its summer peak period (Gulf Power Company 1994).

Market: Gulf Power targeted large electricity-intensive single-family homes (18,000-24,000 kWh/year) with one telephone switch. Gulf Power mailed out an invitation to customers in Gulf Breeze, Florida (a suburb of Pensacola) to participate in the pilot and received a 20% response rate. Gulf Power randomly sampled from the responses, selecting 240 homes, plus 200 for a control group. The control group homes received an ABB meter that could store up to 40 days of data on energy usage; no other equipment was installed on the premises. The test group homes received all equipment.

Status: As of September 1995, Gulf Power was awaiting Florida Public Utility Commission (PUC) approval for full program roll-out to 30,000 customers. In support of its filing, Gulf Power prepared a report documenting the pilot during 1992-1994, complete with select findings from focus groups of participants held in 1994. ICS may not be the provider of the roll-out system;

Gulf Power is about to issue a Request for Proposals specifying its functional requirements (e.g., tiered variable pricing and types of equipment on premises) to see if another vendor offers a superior package.

Energy Services Offered

Automated Meter Reading	Outage Detection	Remote On/Off	Load Control	TOU Pricing	Energy Information
X	P			X	

Automated billing is offered. Energy information is limited to 40 days of billing data available at the meter.

Non-Energy: No non-energy services were offered during the pilot; Gulf Power may consider such services for the roll-out.

- Issues:
- Because the utility is capacity constrained, the PUC established certain peak demand reduction goals for Gulf Power during its 1994-1995 filing.
  - Gulf Power plans to test fixed-point wireless radios during the roll-out in order to broadcast a critical price to more than 10,000 customers simultaneously.

Utility: Hydro Quebec

Project: Universal Bidirection Integration (UBI)

Team Members	Role	Responsibilities
Hydro Quebec	Lead	Project direction, funding
Zenith Corp.	Supplier	Cable set-top box
C-Mac	Supplier	Electronic thermostat
Domosys Lab	Supplier	CEBus chip, programming

Description: UBI is a comprehensive information highway project that will offer energy management, home automation, and other new services to residential customers. Key team members in the joint venture include Hydro Quebec, the Canadian postal service, Lotto Quebec, National Bank, and Videoway. There have been many technical problems and team members (approximately 100 service providers, from Sears to Pizza Hut). UBI will test electronic offering of mail, lottery tickets, video games, banking, energy billing, general information, and service purchasing.<sup>1</sup> As part of the larger UBI project, Hydro Quebec will test the magnitude and timing of load shifts and energy savings realized by customers in a well-to-do neighborhood almost completely dependent on electricity. Hydro Quebec is setting up a telephone-based automated meter reading project for 440 homes in Chicotimi. All 440 homes will receive an electric meter that collects data on hourly usage and automatically dials Hydro Quebec each day to report 24 hours of data; 330 homes will receive CEBus chips to monitor two wall switches and two plug loads in addition to the baseboard electric heaters. The thermostats and CEBus devices will respond to time (not price) triggers.

Market: A statistical sample was drawn from 3,000 Chicotimi homes, identifying customers with no plans to move within the next two to three years and with considerable electric loads--baseboard heaters, water heaters, air conditioners, pool heaters, and block heaters for cars (which draw 700 watts per hour and are plugged in all night to carport or driveway outlets). Hydro Quebec selected 440 homes; 330 homes will be hooked up with all equipment and 110 homes will be metered as a control group.

Status: UBI has been in the planning stages for more than one year. The 110 homes will receive meter hookup in October 1995 so that the winter of 1995-1996 can serve as a baseline reference. Beginning in September 1996, the 330

---

<sup>1</sup> For example, Canada Post will test electronic mail services, the National Bank of Canada will offer home banking services, while Lotto Quebec will provide electronic purchasing of lottery tickets.

homes will be hooked up with meters, thermostats, and CEBus chips, and monitoring will begin in the winter of 1996-1997.

#### Energy Services Offered

Automated Meter Reading	Outage Detection	Remote On/Off	Load Control	TOU Pricing	Energy Information
P			P	P	P

Hydro Quebec plans to offer time-responsive customer-load control, automated meter reading, and billing. If the larger UBI project moves forward, services offered will include electronic billing and payments (through the set-top box with a card reader and small ribbon printer), appliance control via CEBus chips, general energy information, and ordering from Hydro Quebec's publications catalog (e.g., pamphlet Before You Dig, etc.).

#### Non-Energy Services Offered

Home Security	Medical Alert	Cable Television	Video on Demand	Telephone Service	Internet Access
		P	P		P

Hydro Quebec is not offering non-energy services in this phase of pilot. If the larger UBI project moves forward, participants will be able to send electronic mail, purchase lottery tickets, perform banking transactions, and receive two-way communications through a cable box.

Issues: • No regulatory barriers are anticipated as principal UBI team members include government-owned entities.

**APPENDIX B**

Utility: Kansas City Power & Light (KCPL)

Project: CellNet Pilot  
 For description of vendor product, see page A-2.

Team Members	Role	Responsibilities
KCPL		Project direction, funding
CellNet	Lead	Meter modules, CellMasters, installation, operation

Description: KCPL is in the midst of a phased-in, system-wide roll-out of automated meter reading and distribution automation using the CellNet system. The entire roll-out is scheduled to be completed in early 1997. Current objectives are to (1) automate many customer and distribution functions without laying off any of the < 60 meter readers (KCPL intends to offer retraining to move meter readers into other positions), (2) guarantee system operation regardless of power outages, (3) design rate structures to accommodate customer usage, and (4) ultimately automate outage restoration functions with a voice response unit alerting homes and businesses when power will be restored.

Market: KCPL started geographically in Johnson County, Kansas, with 5,000 meters and 60 capacitor banks in early 1995. Currently, system is being deployed throughout the service territory to residential and C/I customers. CellNet established a retrofit center in Kansas City, employing 12 people, who install the meter devices.

Status: In August 1994, KCPL signed a 20-year agreement with CellNet to install and operate the metering system. In Phase 1, 5,000 meters were installed between January-March 1995; in Phase 2, 75,000 meters will be installed by December 1995; and in Phase 3, 340,000 meters are planned to be installed by December 1996. All CellMasters (pole-top data collectors/transmitters) have been installed and the new billing system is being tested in parallel with the existing system for 17,000 customers in one district.

**Energy Services Offered**

Automated Meter Reading	Outage Detection	Remote On/Off	Load Control	TOU Pricing	Energy Information
X	X			P	

KCPL is currently deploying time-of-use pricing on a test basis. Smart bill, a concept for computer- and modem-equipped customers, is also being examined.

Non-Energy: KCPL is investigating home security and other non-energy offerings because only 25% of the CellNet capacity will be used by automated meter and related energy services when the system is fully deployed. CellNet recently announced that it will test home security services at the end of 1996 through an alliance with Interactive Technologies Inc. (ITI) (Energy Services & Telecom Report 1996c).

- Issues:
- KCPL does not expect any regulatory barriers, even though the utility never had a variable tariff approved, nor does it anticipate union problems since all displaced meter readers will be retained in other capacities.
  - KCPL expects that some customers in sparsely-populated areas will need a different automated meter reading system without a central pole-top collector. A number of systems are under study for eventual linkage with CellNet.

**APPENDIX B**

---

Utility: Pacific Gas & Electric (PG&E)

Project: CellNet Pilot  
 For description of vendor product, see page A-2.

Team Members	Role	Responsibilities
PG&E	Lead	Project direction
CellNet	Supplier	Meter modules, installation

Description: PG&E assisted CellNet with development of its meter module, permitting early demonstration of CellNet equipment on 1,700 meters and 100 distribution feeder points. The meter module is an electronic switch installed behind the nameplate inside the meter's protective glass.

Market: PG&E selected residential customers in two locations in California.

Status: The pilot began in 1990 as a research and development project and was completed in 1993, with PG&E's Operations Department absorbing responsibility for all automated meter reading locations.

**Energy Services Offered**

Automated Meter Reading	Outage Detection	Remote On/Off	Load Control	TOU Pricing	Energy Information
X					

Non-Energy: No non-energy services were offered.

- Issues:
- The California Public Utility Commission is supportive of PG&E's telecommunications pilots.
  - In September 1995, PG&E issued a Request for Proposals (RFP) for automation of the utility's 8.2 million gas and electric meters (all customer classes). The RFP was sent to 25 different vendors. PG&E is particularly interested in automating hard-to-read meters (e.g., inside buildings, in locked rooms, or located in geographically challenging areas), dangerous-to-read meters (e.g., in housing projects or other areas where PG&E meter readers always go accompanied), and time-of-use meters. The utilities have not announced final award, in part because of regulatory uncertainties associated with their future role and obligations in this area in a restructured electricity industry.



Utility: Pacific Gas & Electric (PG&E)

Project: Energy Information Services (EIS) Trial  
For description of vendor product, see page A-15.

Team Members	Role	Responsibilities
PG&E	Co-lead	Project direction, CEBus chip programming, funding,
TeleCommunications Inc. (TCI)	Co-lead	Cable installation/hook-ups, set-top box, funding
Microsoft	Co-lead	Operating system, funding
Landis & Gyr	Supplier	Meter, HVAC controller
Ademco	Supplier	Home security
Andersen Consulting	Consultant	Affiliate program administrator

Description: This project incorporates automated meter reading, demand-side management (DSM), and energy information services with home automation and home security via broadband communications. The objectives of the project include: (1) testing customer reactions, (2) determining customer value for services, and (3) documenting internal PG&E costs and DSM savings. PG&E shareholders committed about \$6.2 million for the project.

Market: PG&E and TCI wanted a variety of customers involved in this trial. Phase 1 consisted of laboratory, alpha testing, and "friendly" installations. In Phase 2, 50 Walnut Creek and 50 Sunnyvale homes will participate. An invitation was mailed out to all customers in Walnut Creek and Sunnyvale offering the EIS services. The response was good; a screening process was used to select the 100 participants. Walnut Creek was selected for its upper middle class customers, many pools and air conditioners, and temperate climate. Sunnyvale was selected because of its coastal climate and the variety of single and multi-family homes. No prior cable hook-up was required although most homes were already wired. Participation in the trial is free to customers, as shareholders are bearing all costs. When the trial enters Phase 3, 1,000 homes will be linked in these two neighborhoods as well as selected other neighborhoods offering different demographics.

Status: This is a three-phase project: (1) Phase 1 began in October 1994 with a trial agreement among all parties, access to PG&E employees homes to test out technologies, software development via CEBus, and integration, (2) Phase 2 began in June 1995 and will continue through mid-1996 with 50 Walnut Creek and 50 Sunnyvale residences, and (3) Phase 3 will begin in mid-1996 with an expansion of tested and improved services to 1,000 homes.

**APPENDIX B**

**Energy Services Offered**

Automated Meter Reading	Outage Detection	Remote On/Off	Load Control	TOU Pricing	Energy Information
X			P	X	X

Phase 2 offers customers customer-controlled load management of five electric appliances (pre-programmed response of HVAC, refrigerator, dishwasher, range, and dryer to price signals), real time usage updated every 20 seconds (allows customers to see how much it costs to run each appliance), bill segregation (allows customers to see bill by appliance and price tier), and other energy information. In Phase 3, the customer-controlled load management will handle up to four price signals and electronic billing and payment may be offered (with credit card pin code via a set-top box).

**Non-Energy Services Offered**

Home Security	Medical Alert	Cable Television	Video on Demand	Telephone Service	Internet Access	Other
P						P

PG&E plans to test home automation applications (lighting control - program timers on up to two lights) and home security (working with Ademco Corp. to link an alarm control panel, HVAC controls, and the cable set-top box).

Issues: • PG&E hopes that regulatory restructuring issues will be resolved by 1997 to permit the packaging of energy information systems for implementation by PG&E and other utilities.

Utility: PacifiCorp  
Mega-Utility operating in California, Idaho, Oregon, Utah, and Wyoming

Project: UtiliNet  
For description of vendor product, see page A-19.

Team Members	Role	Responsibilities
PacifiCorp	Lead	Project direction, funding
Metricom	Supplier	UtiliNet, radios, engineering, installation
CIC Systems	Supplier	In-Home energy management system

Description: In response to Oregon Public Utility Commission (PUC) requests, PacifiCorp has undertaken a pilot to examine residential customer response to variable pricing and energy information provision. The pilot program will begin data gathering before the end of 1995 with over 100 customers and 12 utility substations that are connected in a wide area network (WAN) in Portland, OR. This pilot involves automated meter reading, outage detection and restoration through SCADA, and personalized billing and real-time energy usage from the CIC in-home display. PacifiCorp worked closely with vendors to develop equipment and software to meet its needs. PacifiCorp put out a competitive bid, limiting the communications interface to wireless radio technology, which was won by Metricom. As the project evolved, the PUC made a second request that the utility test consumer responses to time-of-use pricing and receipt of energy information. To address these requests, an in-home display unit was required and CIC Systems was brought on board.

Market: The project originally targeted 800 customers, but has since been revised downward to 200 customers. These customers are in older homes located at the end of one feeder in one corner of the Oregon service territory, which allows the utility to easily track energy usage. PacifiCorp mailed out a letter to interest potential participants, and received 65 responses. PacifiCorp then went door-to-door and the response was excellent, even without offering incentives.

Status: Since July 1994, five prototype Metricom systems are under beta testing; four remain operational. As of September 1995, installation of the remaining units remains incomplete. Fifty CIC in-home displays have been installed (100 were purchased). The Metricom meters have been installed for all participants, but communications with PacifiCorp has not been finalized for five participants due to transformer confusion. The time-of-use rate participants are not yet set and may not be until the end of 1995. PacifiCorp would like to see the project expanded, but their budget was deferred.

**APPENDIX B**

---

Energy Services Offered

Automated Meter Reading	Outage Detection	Remote On/Off	Load Control	TOU Pricing	Energy Information
X				X	X

PacifiCorp could perform direct load control and appliance monitoring through CIC displays, but is not doing so. Remote disconnect is available through Landis & Gyr meters; PacifiCorp has 100 Landis & Gyr meters for a different project at a high-rise apartment complex with turnover problems. PacifiCorp is considering broadcasting ASCII text messages to customers to notify them of outages, demand-side management equipment sales, etc.

Non-Energy: No non-energy services offered.

- Issues:
- PacifiCorp is examining a range of technologies, from one-way Itron meter switches to satellite solutions.
  - The economics for this project are relatively poor because the customer-to-transformer ratio is low throughout the service territory, typically 2:1. In dense areas like Portland and Ogden, the ratios are higher, permitting wireless radio options.

Utility: Public Service Company of Colorado (PSC)

Project: AMR Project  
 For description of vendor product, see page A-7.

Team Members	Role	Responsibilities
PSC	Lead	Project direction, funding
Itron	Supplier	ERT meter modules, installation, van radio, collectors
Various manufacturers	Supplier	New electric meters

Description: PSC signed a \$23-million contract with Itron to install transmitters on gas and electric meters in the Denver area. This project is an AMR roll-out to all customers. As currently configured, the AMR permits one-way drive-by reading only. In June 1995, PSC installed 10 Itron pole-top collectors in a pilot to test a fixed AMR network in Denver. Ultimately, PSC would like to install 11,000 pole-top collectors in a roll-out to read all meters in Denver. By March 1996, PSC will decide whether to go with a fixed wireless network, permitting outage detection, time-of-use pricing, medical alert, and other energy and non-energy services to be offered. The billing system was already upgraded two years ago.

Market: The pilot for 1,500 inaccessible meters ran in 1993. PSC issued a Request for Proposals and Itron won the award for a phased roll-out to all PSC electric and gas customers.

Status: As of October 1995, 300,000 meters had been retrofitted with plans to complete installation for all 1.35 million electric and gas customers by December 1997. Simultaneously, PSC is upgrading customers' electric meters, with plans to install up to 500,000 new electric meters by December 1997.

Energy Services Offered

Automated Meter Reading	Outage Detection	Remote On/Off	Load Control	TOU Pricing	Energy Information
X	P			P	

Actual provision of services beyond AMR will not be detailed until the fixed network pilot is underway in early 1996.

**APPENDIX B**

---

Non-Energy Services Offered

Home Security	Medical Alert	Cable Television	Video on Demand	Telephone Service	Internet Access	Other
	P					P

Issues: With respect to other information/communication services, PSC made headlines when it awarded a 10-year contract for its data and communications systems to Integrated Systems Solution Corp. (ISSC), an outsourcing unit of IBM. ISSC controls the customer information system and could provide its own protocol to facilitate data capture/processing from PSC projects.

Utility: Public Service Electric & Gas (PSE&G)

Project: Integrated Broadband Utility Solution (IBUS)  
For description of vendor product, see page A-9.

Team Members	Role	Responsibilities
Public Service Electric & Gas (PSE&G)	Co-Lead	Project direction, funding, Legacy system
Lucent Technologies (formerly AT&T)	Co-lead	Program integrator, funding, software development
Intellon	Supplier	CEBus chips, engineering
Honeywell	Supplier	Total Home EMS 2000 thermostat and load controllers
General Electric	Supplier	New Meter (CM21P single-phase), CEBus compatible
American Meter	Supplier	Gas and water meter wireless AMR modules
Andersen Consulting	Consultant	Market research, business development

Description: Lucent Technologies, formed as a result of the trivesture of AT&T, and PSE&G co-developed IBUS. The IBUS project features an interactive, bi-directional communications system which, in New Jersey, utilizes a hybrid fiber-coax cable connection between the utility and the network node and power line carrier technology between the home and a utility intelligent unit (UIU). The IBUS project features two-way communications all the way to the premises as well as "open" communication standard protocols. Garden State Cable provided cable access during the 10-home proof-of-concept and will provide cable access for the 1,000-home customer pilot. PSE&G is leasing the bandwidth for the 1,000-home customer trial. In the 1,000-home technical trial, Honeywell thermostats will be used as well as a mix of meters provided by General Electric and American Meters.

Market: The proof-of-concept tests took place in Moorestown, NJ, because Garden State Cable had two-way hybrid fiber-coax cable laid there. The 1,000-customer pilot is planned for Evesham township (Marlton, NJ) in Burlington county. Evesham was selected because it has a mix of facilities--condos, apartments, single-family homes, and small commercial facilities. A few industrial customers in Bellmawr, NJ and Moorestown, NJ will also be included in the 1,000-customer pilot.

Status: PSE&G and Lucent Technologies signed a contract to co-develop the IBUS technology in January 1995. Phase 1 involves a three-year development to test proof-of-concept; installations were completed between January-March 1995. Phase 2 involves technical tests and the installation of 20 units

**APPENDIX B**

---

beginning in December 1995, followed by installation of 980 units which should be completed by the end of May 1996. Phase 3 involves a 5,000-point early roll-out beginning in the first quarter of 1997. The roll-out is expected to reach 105,000 customers by the end of 1997; 100,000 customers will be added for the next four years until PSE&G has completed 505,000 installations.

**Energy Services Offered**

Automated Meter Reading	Outage Detection	Remote On/Off	Load Control	TOU Pricing	Energy Information
X	X	X	X	X	X

In the proof-of-concept test, PSE&G demonstrated wireless automated meter reading for electric meters through powerline carrier and direct load control. In the 1,000-customer pilot, PSE&G will add real-time pricing in approximately 40 homes, load reduction evaluation, utility-controlled load management, remote on/off, customer information messaging, theft-of-service detection, TOU metering, customer load profile for electric and gas use, emergency gas curtailment, and distribution automation.

**Non-Energy Services Offered**

Home Security	Medical Alert	Cable Television	Video on Demand	Telephone Service	Internet Access
P	P				

In the third phase of the project, PSE&G is considering testing several non-energy services (home security, medical alert, home automation).

Issues: • PSE&G already has a TOU rate and does not expect regulatory problems.



Utility: Southern Development Investment Group (SDIG)  
Unregulated subsidiary of Southern Company, the holding company for Georgia Power, Alabama Power, Gulf Power, Mississippi Power, and Savannah Electric & Power

Project: Dominion Project  
For description of vendor product, PowerView, see page A-15.

Team Members	Role	Responsibilities
SDIG	Lead	Project direction, cable/equipment installation, funding
Georgia Power	Contractor	Master metering
Dominion (real estate developer)	Owner	Builder of new apartment rentals, funding
First Pacific Networks (FPN)	Supplier	Intelligent Utility Unit, Eshelon chip, Networks
Raytheon	Supplier	Engineering, Customer Energy Monitor
American Innovation	Supplier	Turnkey retrofit meters
Landis & Gyr	Supplier	New electronic meters

Description: SDIG has contracted for trial deployment in an upscale apartment complex with FPN for its PowerView product. SDIG does not have an equity interest in FPN. The Public Utility Commission recently approved SDIG's application (filed two years ago) to operate as an unregulated subsidiary with its authority expanded beyond research and development. SDIG undertook this project to reduce Georgia Power's summer peak, which breaks records every year. In partnership with a cable provider, Southern is wiring the apartments participating in the pilot with coaxial cable as they are built. Energy usage and savings will be monitored from Georgia Power's headquarters.

Market: All-electric, new construction, multi-family homes were targeted. A 14-building, 303-unit complex under construction by Dominion in Duluth, Georgia (a suburb of Atlanta), was selected. Georgia Power is not capacity-constrained, but is interested in reducing its 13-GW swing between peak and off-peak summer loads.

Status: As of October 1995, SDIG has not yet issued an official press release and would not identify all partners. The first apartment building is under construction, with occupancy slated for January 1996. Subsequent buildings will be ready in April 1996 and the pilot will continue through June 1998.

**APPENDIX B**

---

**Energy Services Offered**

Automated Meter Reading	Outage Detection	Remote On/Off	Load Control	TOU Pricing	Energy Information
P	P			P	P

This residential project is the first to offer real-time pricing to control HVAC and water heating use. Dominion pays one monthly bill to Georgia Power, which has a special master metering contract to read and prorate electricity use by apartment.

**Non-Energy Services Offered**

Home Security	Medical Alert	Cable Television	Video on Demand	Telephone Service	Internet Access	Other
P	P	P	P		P	P

SDIG will provide video monitoring of all public spaces in the apartment complex and home security from project inception; other services will be available during the course of the pilot. SDIG is investigating long-distance telephone service provision.

Issues: • This project is being conducted by an unregulated subsidiary, in part to avoid potential regulatory problems.

Utility: TeCom Inc.  
 Unregulated subsidiary of TECO Energy, the holding company for Tampa Electric (TECO)

Project: TEMS

Team Members	Role	Responsibilities
TeCom Inc.	Lead	Project direction, funding, software development
M-TEL	Supplier	Wireless radios

Description: The objectives of this R&D pilot are to (1) design an open architecture system that can run on any customer's personal computer (PC), (2) use over-the-counter equipment (e.g., X-10 adapters), and (3) provide fully functional value-added services to customers and the utility alike. TeCom's primary focus is with residential customers, although it plans to expand the project to commercial and industrial customers. A variety of energy and non-energy services will be offered. TeCom is designing a touch screen device to perform both the thermostat and terminal functions for those who do not have personal computers.

Market: The initial phase of the pilot is being conducted in the homes of "friendly" participants: TeCom selected 150 employees in Tampa Electric's service territory. Selected employees reflect various demographic groups. TeCom is particularly interested in testing creative tariffs. TeCom has designed software to run on any PC platform and, as the pilot rolls out, expects that early adopters will use their own PCs.

Status: Development work began in 1991, with planning and testing of prototype equipment and protocols taking place in a few homes. The pilot began in earnest in June 1995. As of December 1995, about 140 homes had received installations. During the second phase, which is scheduled to begin in the first quarter of 1996, additional services will be added, such as a smart thermostat, Internet access, two-way wireless paging, and entertainment. TeCom regularly mails out a newsletter, TEMStalk, to all participants, informing them of all developments.

Energy Services Offered

Automated Meter Reading	Outage Detection	Remote On/Off	Load Control	TOU Pricing	Energy Information	Other
X			X	X	X	X

**APPENDIX B**

---

TeCom offers (1) customer-controlled load management of up to 17 devices (HVAC, pool pumps, heat pumps, A/C, water heaters, stoves, dryers, and other appliances, whether switches or plugs), (2) submetering of four or eight appliance loads, (3) detailed energy information obtained at 30-second intervals that is used to forecast actual month's bill and test which creative tariff would save the customer the most money, and to monitor appliance use, etc., (4) AMR at 15-minute intervals, and (5) TOU creative rate testing.

**Non-Energy Services Offered**

Home Security	Medical Alert	Cable Television	Video on Demand	Telephone Service	Internet Access	Other
P	P				P	P

TEMS plans to offer Internet access and entertainment services during the second phase. Ultimately, TEMS will offer two-way paging, home security, and in-house medical monitoring, among other services.

- Issues:
- TECO received approval of its time-of-use residential rate from the Florida PSC and expects no regulatory problems.
  - TEMS is providing some innovative telecommunications services, and the company has been approached by other utilities about these services.

Utility: Virginia Electric Power (VEPCO)

Project: Cable-based Energy Management System  
For description of vendor product, see page A-4.

Team Members	Role	Responsibilities
VEPCO	Co-developer	Engineering, installation, funding
Cox Communications	Lead	Project direction, cable installation, software development
Northern Telecom (Nortel)	Co-developer	Software/CEBus programming, box development

Description: Cox coordinates the project and provides the cable infrastructure. Nortel is developing and supplying the integrated box for voice, data, and video communications. VEPCO is negotiating with suppliers of meters, home display devices, and integration software.

Market: Participants in the trial include VEPCO and Cox employees in Virginia Beach and Norfolk, VA, where Cox already has hybrid fiber/coax cable in place. It was difficult finding employee participants because Virginia Beach is an exclusive neighborhood and Norfolk is relatively poor, while most of the utility and telecom employees are middle class. All participants will be equipped with some energy monitoring; there will be no control group to test savings. Originally, 48 homes were desired, but only eight VEPCO employees and 36-40 Cox employees will participate.

Status: The project officially started in May 1995. As of October 1995, bench tests with communication systems were completed; technical details have not yet been fully resolved. Phase 1 will be underway once all equipment is installed in the pilot residences in December 1995. An initial set of energy services will be offered, with additional services added over time. The trial is expected to continue for one and one-half to two years from May 1995.

#### Energy Services Offered

Automated Meter Reading	Outage Detection	Remote On/Off	Load Control	TOU Pricing	Energy Information
X	X		X	P	P

Energy services are being phased in by VEPCO: automated meter reading, outage detection, and electronic billing in Phase 1, followed by testing CEBus-adapted devices in the home; TOU pricing and energy information in Phase 2; and power quality with additional meters per home in Phase 3.

**APPENDIX B**

---

Non-Energy Services Offered

Home Security	Medical Alert	Cable Television	Video on Demand	Telephone Service	Internet Access	Other
		P	P	P	P	

Cox plans to offer video on demand (switched cable) and Nortel plans to offer Internet access and telephone via CATV. These services may not be offered until late 1997.

- Issues:
- The Virginia Public Utility Commission (PUC) has been very cooperative; thus far, the project has been viewed as an R&D activity.
  - VEPCO does not want to petition PUC for rate clearance until the technology trial is successful. VEPCO has an experimental residential peak rate available, but will probably not use it in this pilot.

Utility: Wisconsin Energy Corp.  
 Holding company for Wisconsin Electric Power

Project: Energy Oasys

Team Members	Role	Responsibilities
Wisconsin Energy	Co-Lead	Project direction, development, funding
Ameritech Corp	Co-Lead	Project direction, development, funding
Various manufacturers (Pensar, Johnson Controls)	Supplier	Plug-in display, thermostat, or other in-home device

Description: Energy Oasys utilizes two telecommunications modes--wireless paging to the customer and telephone lines from the customer--in addition to powerline carrier in the home. They want to offer a large suite of energy and non-energy services in the most flexible manner possible. Flexibility is built into the choice of in-home device, meter, and telecommunications mode. Their testing began with Pensar's Basic Customer Interface, a plug-in device; Johnson Controls' smart thermostat is to be tested in the pilot. An Information Gateway is retrofit to any standard meter. Energy Oasys focuses on responding to (1) the operating efficiency needs of utilities today with traditional DSM, AMR, tamper detection, etc. and (2) customer needs with load control, indoor air quality, security, and enhanced two-way communications.

Market: Wisconsin Electric Power started with employee homes in Milwaukee. They hope to target hard-to-read meters, areas with power surges or other service difficulties, and ultimately customers willing to pay for services in the pilot and roll-out. Neighborhoods not selected yet.

Status: As of January 1996, proof-of-concept testing was completed in 15 homes. A pilot with installation complete by end-March 1996 will expand participation to 200 homes. Roll-out to 5,000 customers is planned after April 1996.

Energy Services Offered

Automated Meter Reading	Outage Detection	Remote On/Off	Load Control	TOU Pricing	Energy Information	Other
X	X	X	X	X	X	

AMR for electric, gas, and water is offered today. Wisconsin Gas has signed on with Wisconsin Electric Power; the water utility is negotiating. Up to 48 price signals every half-hour can be offered for TOU pricing. The wireless receiver can handle up to 124 inputs, meaning unlimited control of major loads.

**APPENDIX B**

---

Non-Energy Services Offered

Home Security	Medical Alert	Cable Television	Video on Demand	Telephone Service	Internet Access	Other
P	P					P

All non-energy services are planned offerings. Other services identified are indoor air quality monitoring (noxious gas control) and latch-key child monitoring.



Utility: Wright-Hennepin Cooperative Electric Association

Project: MeterMinder  
For description of vendor product, see page A-13.

Team Members	Role	Responsibilities
Wright-Hennepin	Lead	Project direction, funding, software development
Interactive Technologies Inc. (ITI)	Supplier	Meter Minder, ITI CS-4000 Central Station Receiver, software development

Description: The objectives of this project were (1) to make automated meter reading affordable, (2) to create a system to handle high bill complaints (Meter Minder identifies the day and time of high electricity usage), (3) to automate power outage reporting, and (4) to offer a home security system. Wright-Hennepin has achieved economies of scale using the same modem for both security and Meter Minder functions. The CPU or main panel is a 16" x 12" x 2" box, usually installed in the house, connected to a phone line and the meter. The CPU dials out to four different numbers at Wright-Hennepin to report security, monthly meter readings, usage history, and power outages. Wright-Hennepin prices the Meter Minder with a basic security package at no initial cost to consumers, who may add on door/window sensors and other components for a fee of \$300-500 on average. The customer, however, agrees to pay a \$17.50 monthly monitor fee for the home security add-on. These revenues essentially pay for automatic meter reading and other utility services (e.g., power outage reporting).

Market: The pilot targeted rural residential accounts. (Most of the coop's 29,000 members are residential). Approximately 3,000 Meter Minders have been installed in Wright-Hennepin's area. Wright-Hennepin also provides home security monitoring for several other utilities. At present, Wright-Hennepin provides monitoring services for about 2,000 accounts for Cimarron Electric Cooperative, South Central Indiana Electric Cooperative, NIPSCO, and Bangor Hydro.

Status: The 1991 pilot tested 100 Meter Minders for six months. Wright-Hennepin then started offering Meter Minders to all members (customers), adding on features as the technology evolved.

**APPENDIX B**

**Energy Services Offered**

Automated Meter Reading	Outage Detection	Remote On/Off	Load Control	TOU Pricing	Energy Information	Other
X	X				X	X

Billing is automated and 60 days of usage data are maintained at the meter which the utility can access, examine, and graph out for customers upon request. Customers can add on the energy saver module, which permits remote access to an ITI setback thermostat via touch tone phone so customers can turn on lights and turn up the heat in homes or cabins (from car or home).

**Non-Energy Services Offered**

Home Security	Medical Alert	Cable Television	Video on Demand	Telephone Service	Internet Access	Other
X				X		X

In addition to the services offered in the Meter Minder project, Wright-Hennepin Cooperative also offers cellphones, discounted AT&T wireless phone service (\$14.95/month for members; \$6.95/month for affiliated organization or large electricity consumers), discounted telephone long-distance service, a Service Gold appliance warranty program (for any manufacturer), and electric dispatching and security monitoring services to other utilities.

- Issues: • Wright-Hennepin is a cooperative and is not subject to regulatory oversight by a state PUC.

## Interview Protocol: Focus Group and Individual Surveys

This Appendix includes the interview protocol that was used by LBNL subcontractors to conduct personal interviews with customers.

### C.1 Interview Protocol

We are affiliated with the Center for Energy and Environmental Policy at the University of Delaware. We are conducting a Department of Energy sponsored research project aimed at exploring the possibilities of utilities offering customer services through the National Information Infrastructure, or the 'Information Superhighway' as it is most commonly referred to. The goal of this study is to see how electric and gas utilities could enable the customer to instantaneously access energy information, and allow the utility to remotely read your meter.

One of several options would be to use the equivalent of cable TV, and install a 'Smart Box' hooked up to your television, and monitoring devices hooked up to each of the major appliances, to allow you to monitor, and possibly control, your energy use. It would also be connected to your utility meter, allowing the utility to read your consumption without sending a meter reader to your house or possibly to read consumption of individual appliances.

To give you a better idea of the type of services that may be offered, we have described each of them and designed graphic displays as they may appear on your television screen. We have one sheet for each possible service.

Would you be willing to read the short descriptions and give us your reactions?

[If yes: Do you mind if I tape your comments, so I don't have to write everything down?]

### C.2 Questions

1.
  - A. If the utility were to offer these type of services in your area, do you think that you would take advantage of this offer?
  - B. Which ones would you consider useful to you? (Read from list)
  - C. Why? (Ask for each)
  - D. How would you use this information? (Ask for each)

**APPENDIX C**

---

[After through with all the services listed]

2.    A.    Do you see any problems in the utility providing services to you via the Information Superhighway using the 'Smart Box' and the television as a display?  
      B.    If yes, what type of problems?
3.    Do you have any suggestions as to other services that could be offered, or other ways in which the utility could improve its information to customers?

[For all the services listed]

4.    What would you be willing to pay to receive this service?  
      (See form; "Individual Valuation of Potential Services")

## 1. Historic Monthly Energy Consumption

This option enables the customer to compare energy usage per month over an entire year, or a longer period. If a customer wants to do this now, he or she needs to look through our old bills. Through the proposed system, this information would be obtained right on your television screen whenever you needed it. Energy bills for past months would be made available in graphical format. The same information could be made available for several years to compare annual consumption.

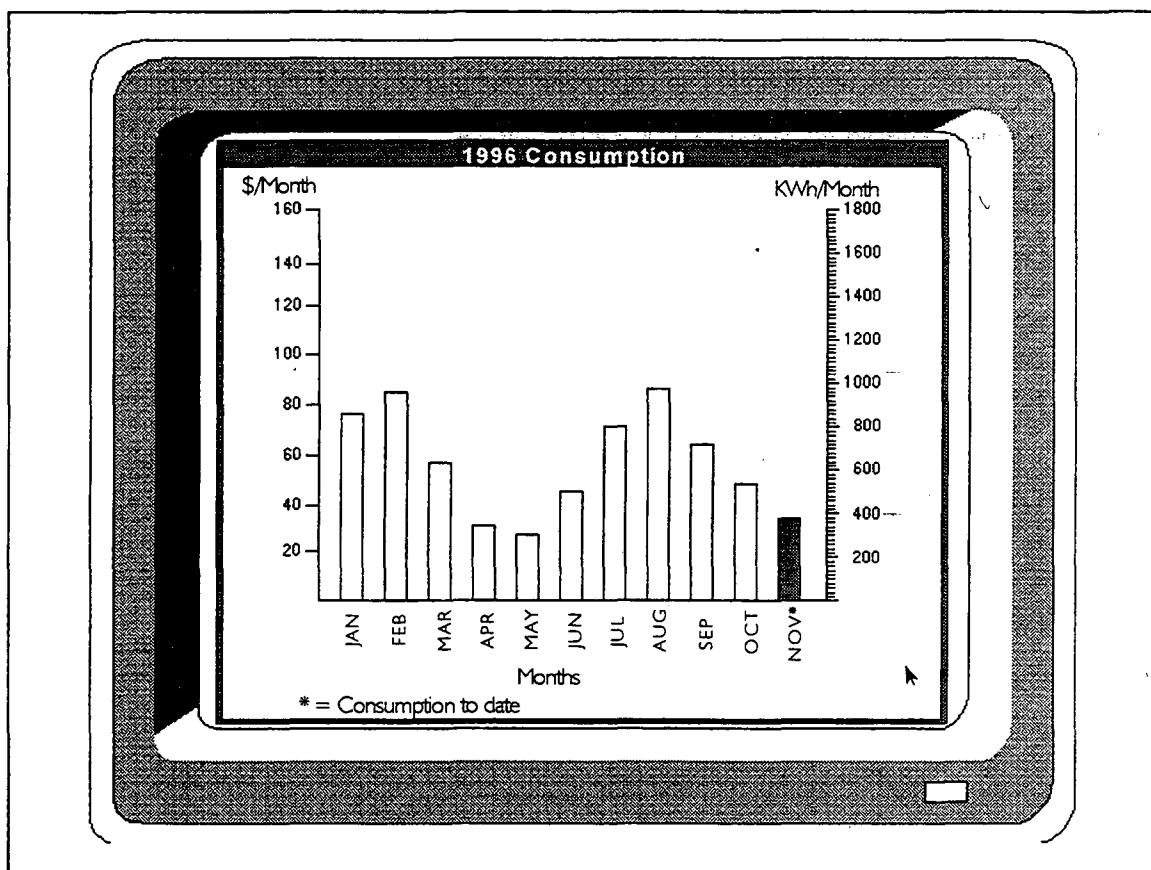

2. Neighborhood Comparison of Energy Use

People often ask their neighbors or friends about electric and gas bills, as a way of gauging whether their own use is high or low. Below is an example of a graph of household energy consumption for an entire neighborhood. Your household energy consumption is illustrated by the shaded bar graph. This allows you to compare your electric or gas bills with households in your neighborhood. Your neighbors cannot access data about your individual household energy consumption.

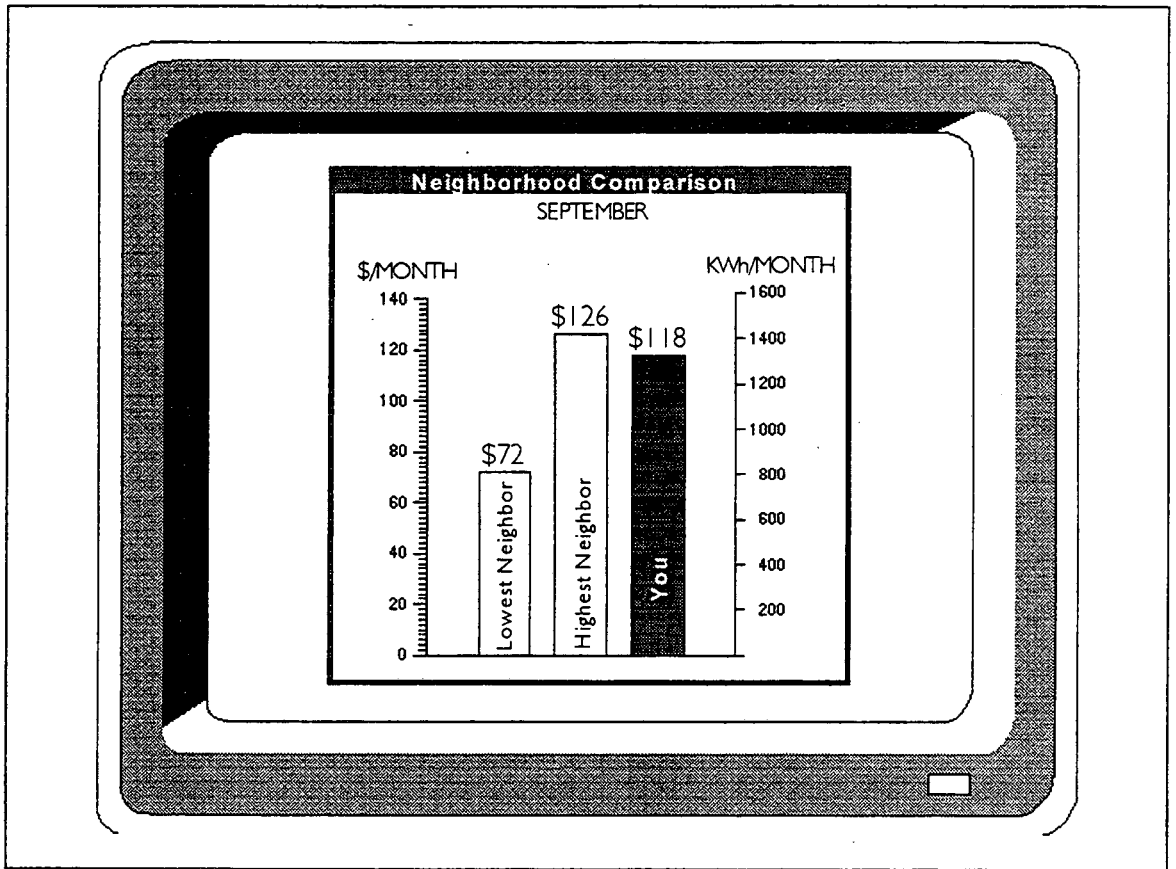

### 3. Appliance Energy Consumption Breakdown

This shows how much energy is consumed by each major appliance in the house. The consumer would be able to determine which appliances use the most electricity, hence making it easier to adjust energy use and reduce utility bills.

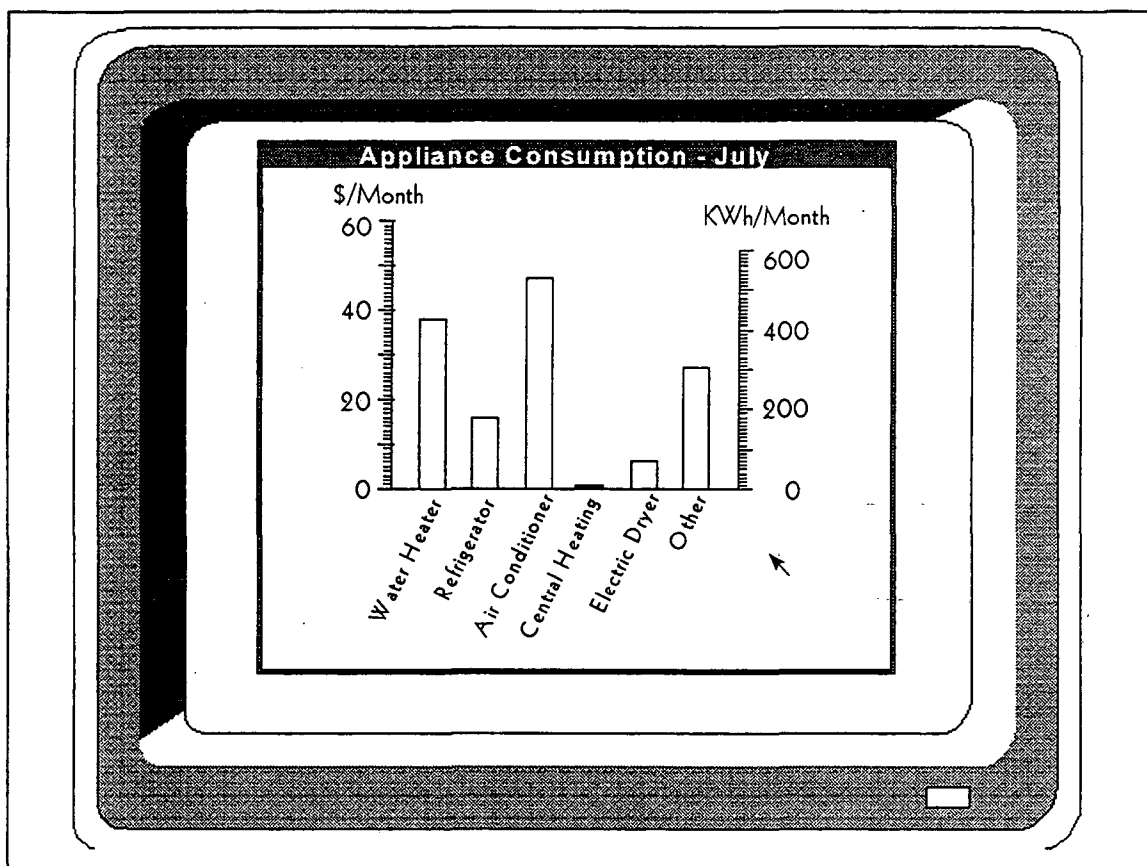

4. Billing and Payment Plans

At a date each month set according to a utility billing schedule, your monthly bill would be calculated. It would be possible to review your bill and pay it directly via the television interactive system.

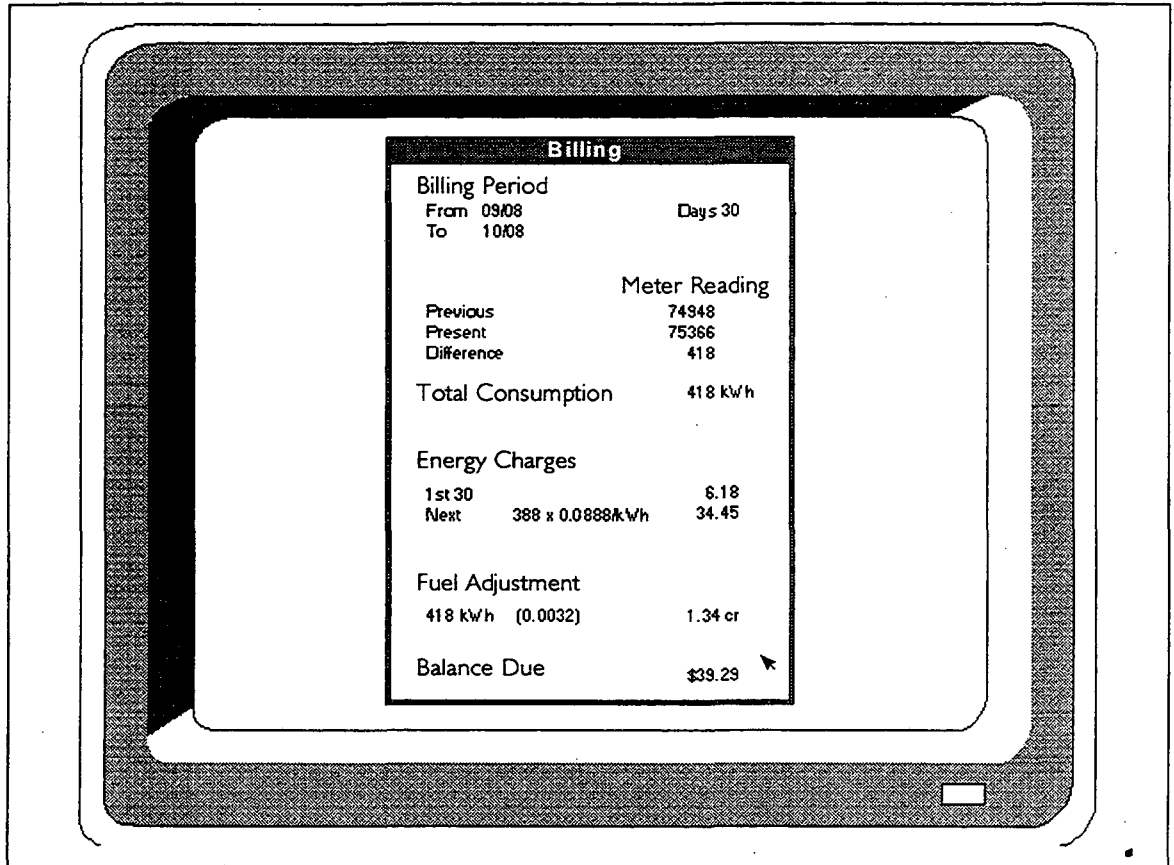



## 5. Instantaneous Consumption and Time-of-Day Pricing

Instantaneous Consumption and time-of-day pricing provide the amount of energy being used and the price at which the energy is sold. With access to this type of information, the customer can see how energy usage changes during the course of the day allowing the customer to decide how to save money on the energy bill by shifting energy demanding activities to periods of the day when the price is lower, or curtailing them at times of high prices. The time-of-day rates would normally be determined and posted a day in advance.

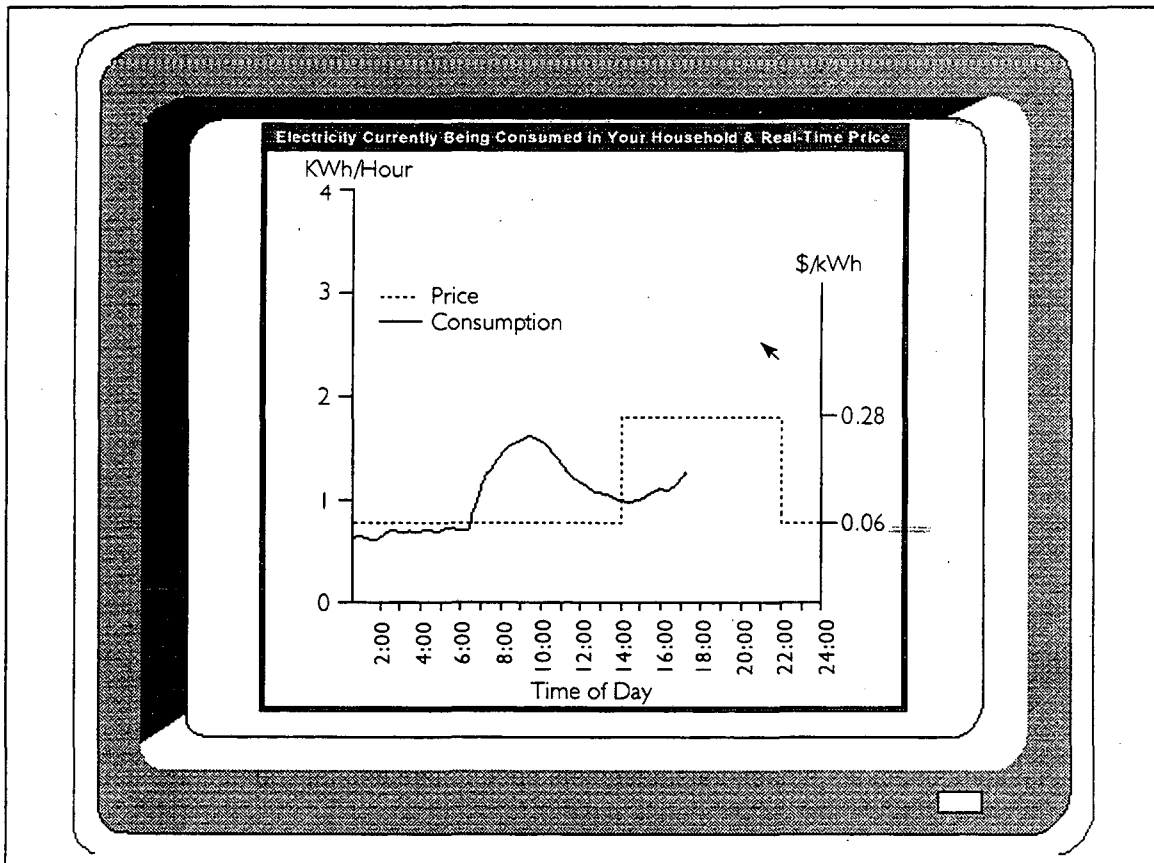

6. Energy Services Agreements and Rate Options

A number of energy service agreements and rate options could be offered by the utility. A description of each of the services, agreements and rate options would be available in a menu that would allow you to read about utility business offerings such as: peak load shedding, time-of-day pricing, power quality agreements, etc.

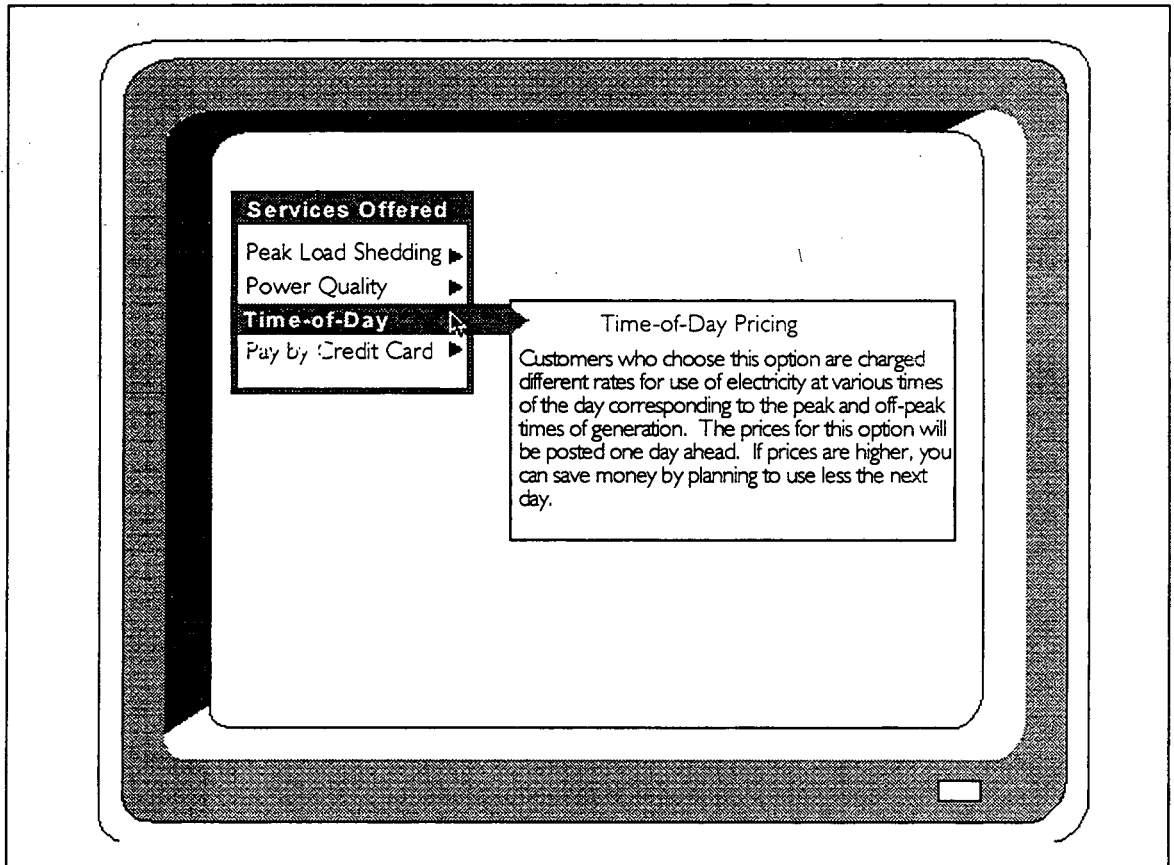

## 7. Energy Efficiency and Conservation Programs

The utility can provide information about the energy savings programs that they currently offer via this system. Customers could select any one of the program options from the menu to get a short description of the program and information on how to sign up.

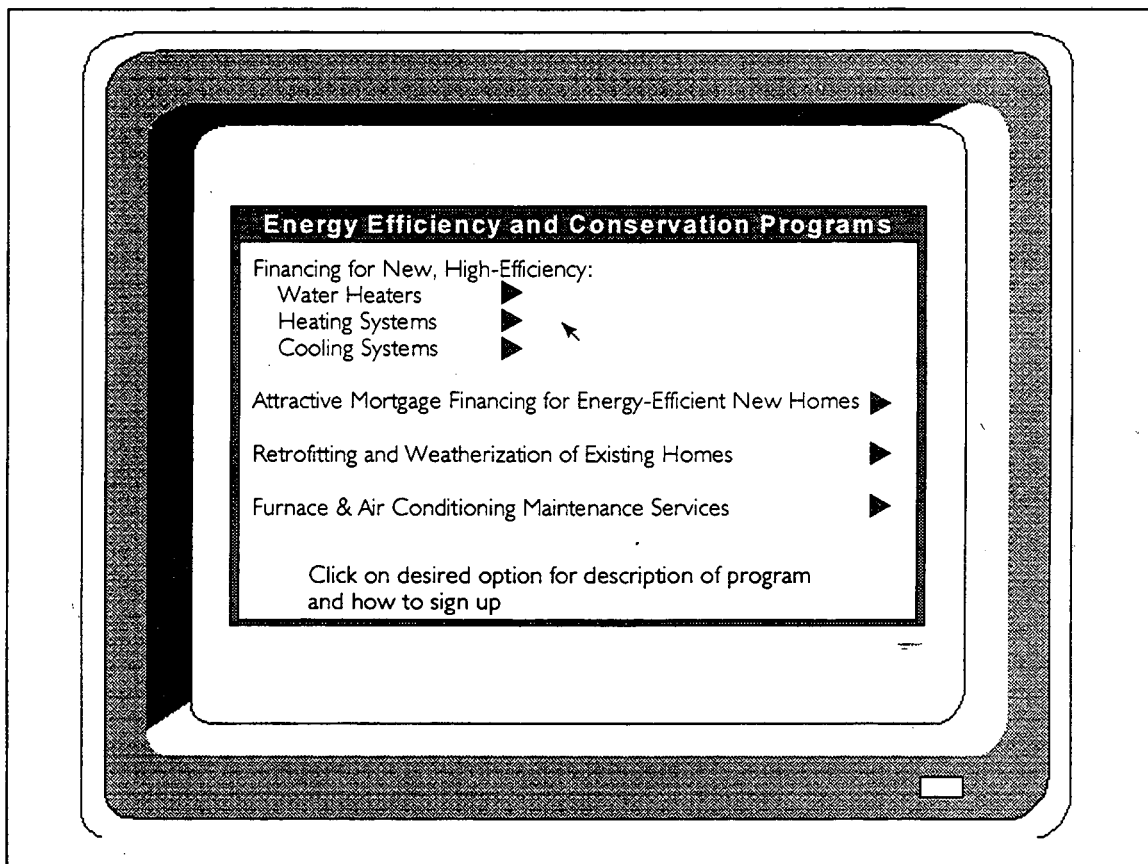

8. Energy-Efficiency Product Information

Information about the most energy-efficient appliances on the market could be made available by the utility in table format.

**Energy-Efficient Refrigerators**

**CONSUMER GUIDE TO HOME ENERGY SAVINGS**

**MOST EFFICIENT REFRIGERATORS (cont.)**

Brand	Model	Volume	Energy Use (kWh/yr)	Energy Cost (\$/yr)
<i>Top freezer, automatic defrost, 16.5-18.4 cubic feet (cont.)</i>				
Kenmore	*067	18.2	591	48
RCA	MTH18EAS	18.2	591	48
<i>Top freezer, automatic defrost, 18.5-20.6 cubic feet</i>				
Maytag	RT*19EOCA*	18.7	599	49
Admiral	AT19EM6*	18.6	599	49
Crosley	RBE*93P*	18.6	599	49
Magic Chef	RBE*93P*	18.6	599	49
Norge	RBE*93P*	18.6	599	49
Montgomery Ward	HMG79**3*	18.6	599	49
Jenn-Air	JRTE197*	18.6	599	49
<i>Top freezer, automatic defrost, 20.5-22.6 cubic feet</i>				
General Electric	T8H21*AS	20.6	631	52
Hotpoint	CTH21GAS	20.6	631	52
Kenmore	6717	20.6	631	52
RCA	M*1-21GAS	20.6	631	52
Admiral	ATZ1EM9**	21.1	642	53

## 9. "Do-It-Yourself" Videos and Ordering Energy Information Booklets

"Do-it-yourself" videos and energy information booklets could be offered via this system. All videos and booklets available from the utility could be listed in menus as shown below and customers could select any one to get a short description of the video or booklet and instructions on how to start a video or order a booklet. Making use of the "do-it-yourself" videos and the energy information booklets would put the customer in a better position to save money, improve the comfort in their homes and help the environment.

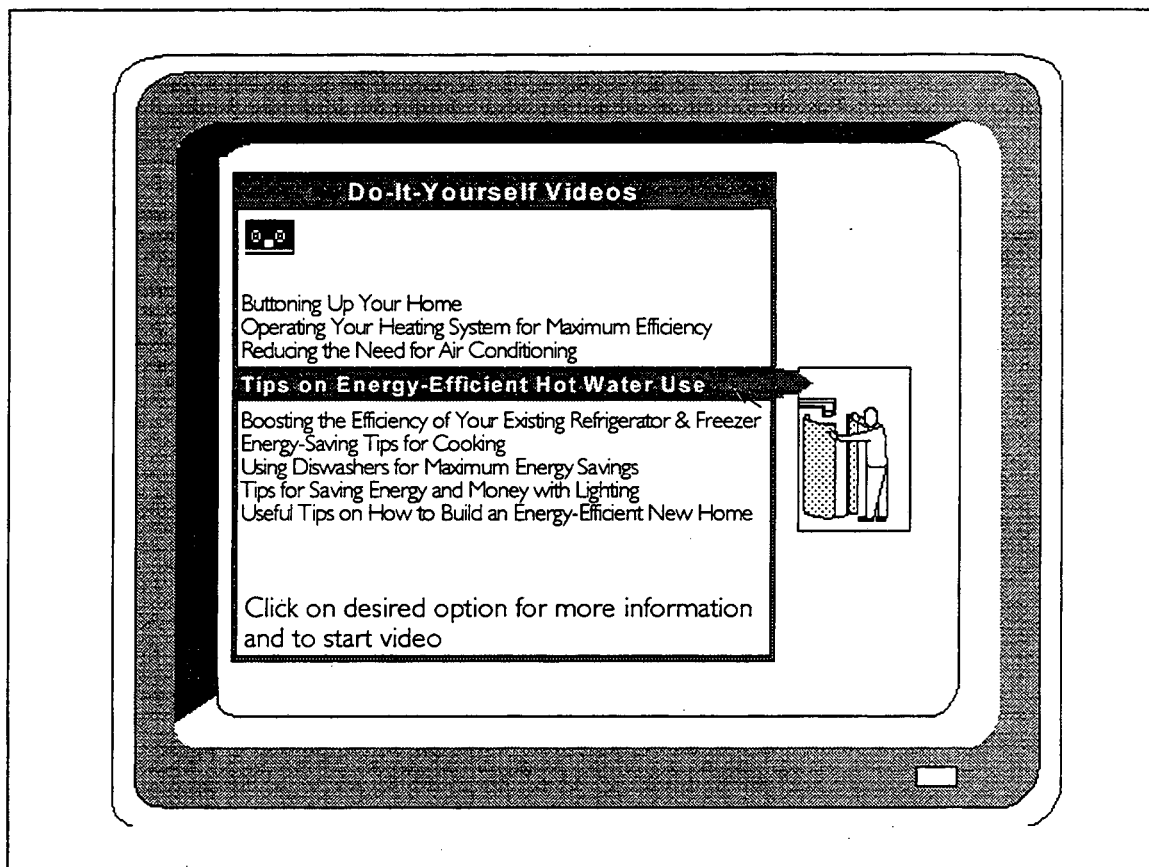

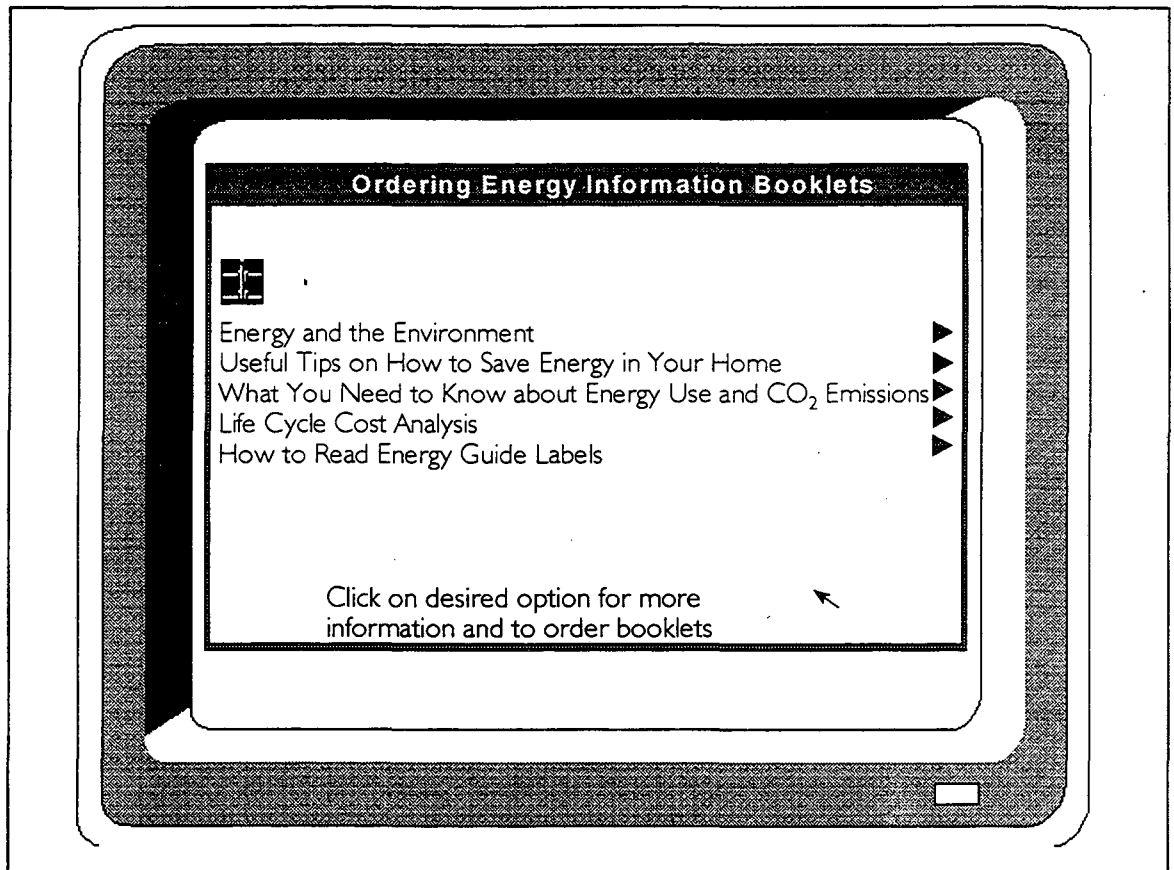

10. Scheduling of Installation, Field Services, and Repairs

The utility could offer an interactive scheduling service that would allow customers to plan ahead and suggest suitable times when service personnel from the utility could come to their residence to perform energy services and install or repair equipment. By the use of a timetable, the customer could inform the utility directly when would be the best time to find someone available at the residence. A sub-menu with all the programs and common repair services available through this direct scheduling service would appear. Below we have given an example of a 'Schedule for Electric Meter Repairs'

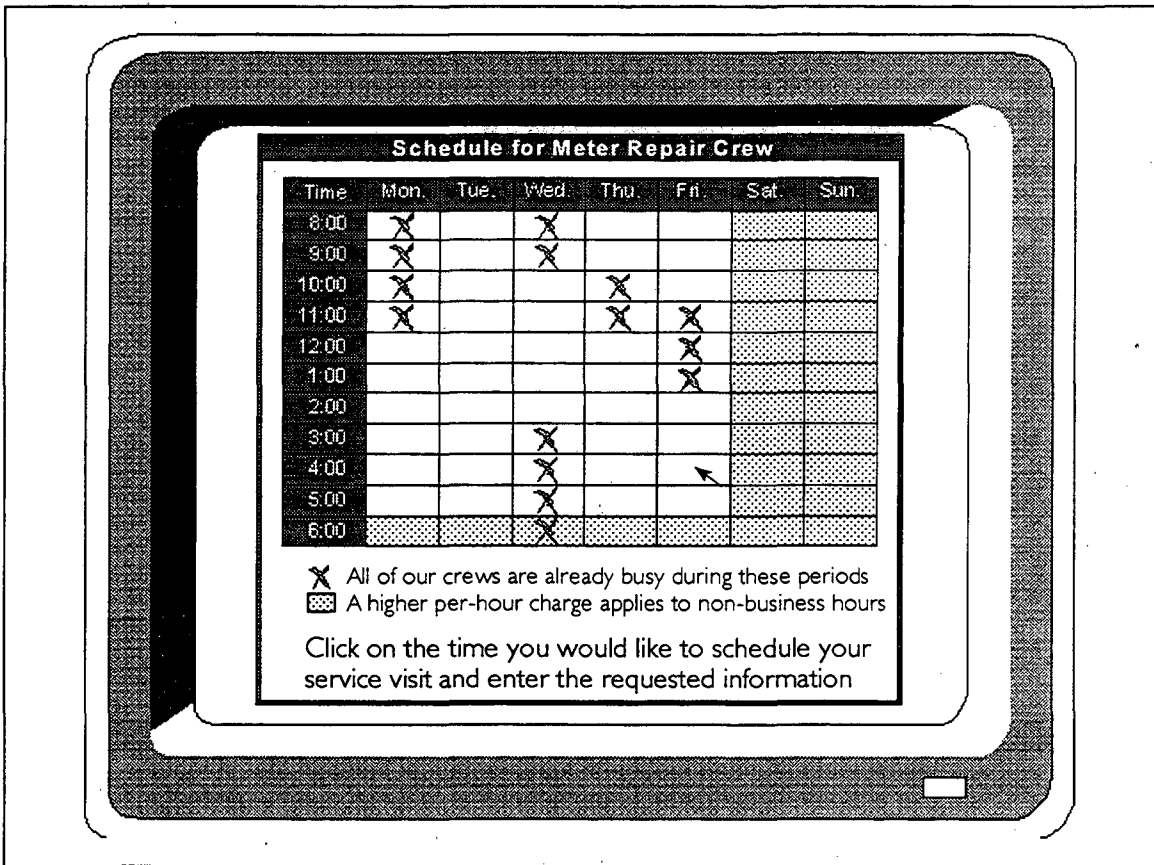

## 11. Specific Customer Queries

This service can be described as an interactive customer service center and could work almost like an electronic mail-box. Customers can report service problems, make requests, acquire information about their account, or obtain answers to common customer queries made to the utility via their utility service display module. Customers could pose questions or place requests by typing them in at any convenient time of the day or night and later receive answers from the utility. The following menu lists some basic options, but does not represent the limit of the information that could be offered via this type of service.

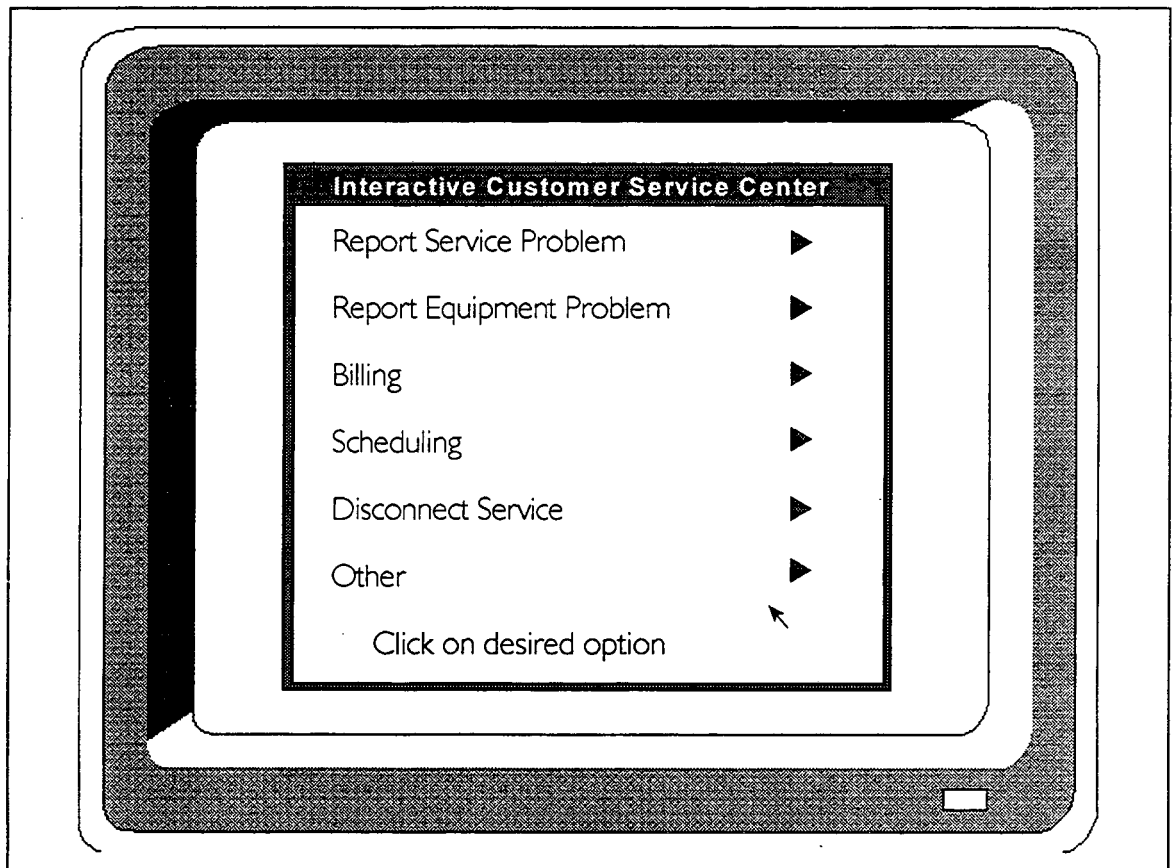



## 12. Load Management and Building Automation

The utility could provide services to reduce the use of energy during peak hours of demand, and customers could make use of the same system to control time and operation of appliances based on their own time-schedule. This could be used to avoid costly peak hours or to match appliance use, for example heating, to your individual time schedule.

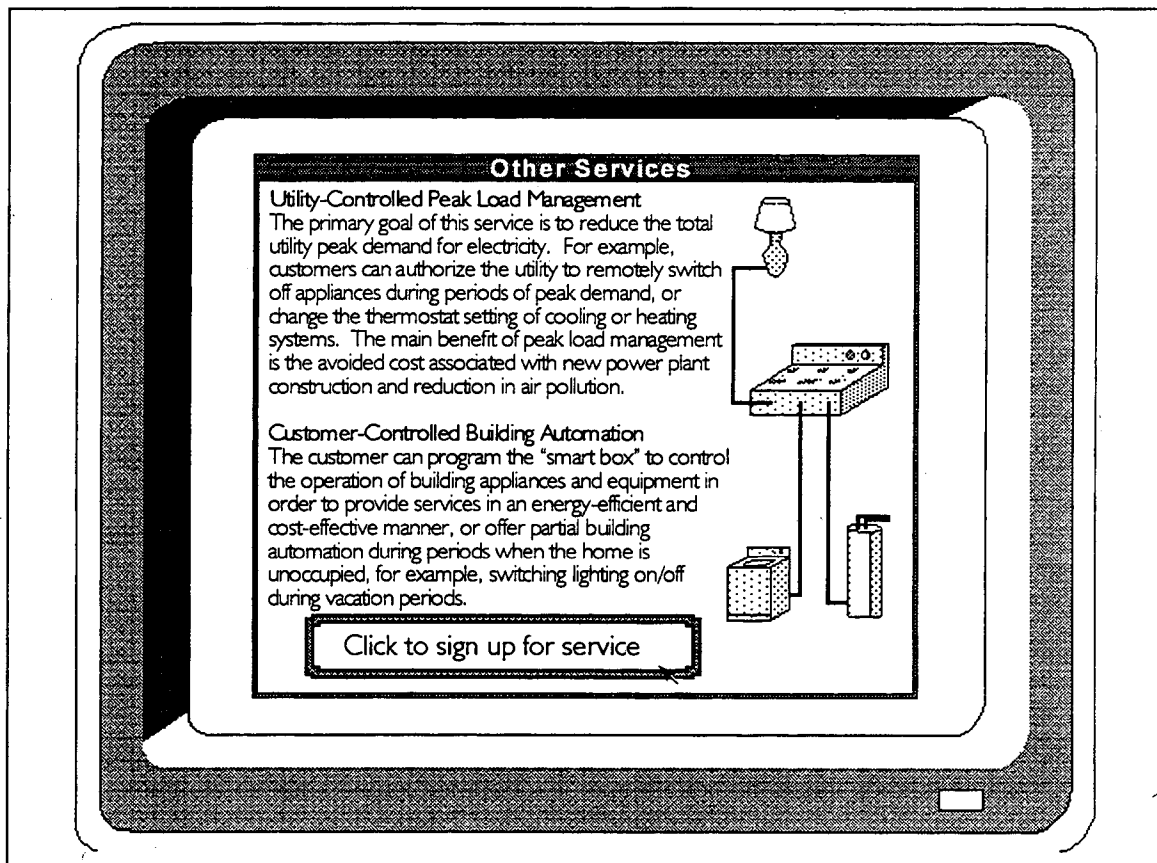

13. Entertainment Video on Demand

You can pick from a set of recent movie releases to see in your home. This service would operate much as a pay-per-view service and you could view the movie of your choice at any time you want.

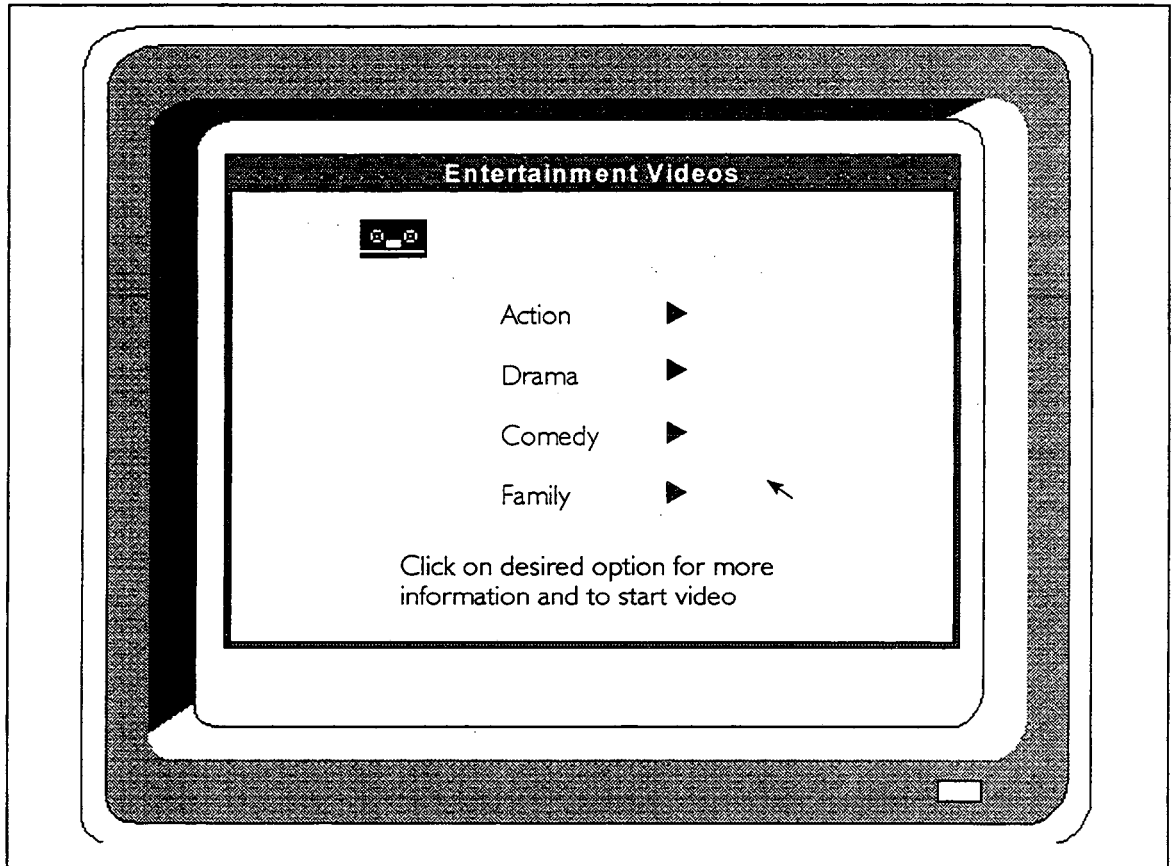

## 14. Security Services

The utility could provide security services that will allow the remote monitoring and control of residences. Devices could be used to control lights or locks when home is unoccupied to deter and detect events such as burglary.

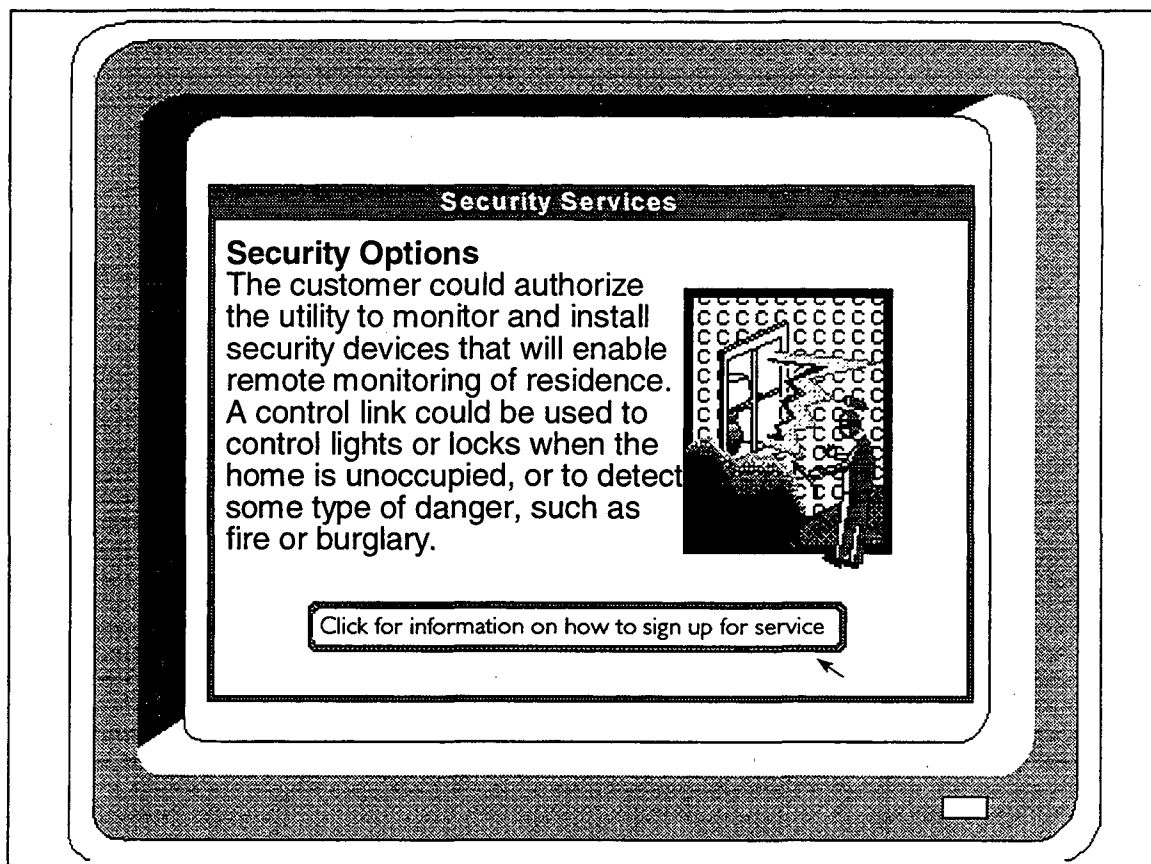



## Customer Survey on Willingness to Pay

This Appendix includes our survey questionnaire on customer willingness to pay for various services which participants filled out at the end of the focus group or personal interview.

### Instructions:

- a. Enter the amount you would pay per month to receive service in cents or dollars;
- b. Put 0 if you like the service, but wouldn't want to pay for it;
- c. Put X if you wouldn't want the service, even if it was free;
- d. For service options 8, 9 and 10, please enter amount per use of service also.

Service Option	\$ per month	\$ per use
1. Historic Monthly Energy Consumption	_____	
2. Neighborhood Comparison of Energy Use	_____	
3. Appliance Energy Consumption Breakdown	_____	
4. Billing and Payment Plans	_____	
5. Instantaneous Consumption and Time-of-Day Pricing	_____	
6. Energy Services Agreements and Rate Options	_____	
7. Energy Efficiency and Conservation Programs	_____	
8. Energy Efficiency Product Information	_____	_____
9. "Do-it-yourself" Videos and Ordering Energy Information Booklets	_____	_____
10. Scheduling of Energy Savings Program Installation, Field Services and Repairs	_____	
11. Specific Customer Queries	_____	
12. Load Management and Automation	_____	
13. Entertainment Videos on Demand	_____	_____
14. Security Services	_____	

**APPENDIX D**

Table D-1 summarizes survey questionnaire results on focus group (FG) participants and interviewees (INT) interest in and willingness-to-pay for individual services.

**Table D-1. Customer Reactions to Energy and Non-Energy Services**

No.	Service	Like the Service But Would Not Want to Pay for It	Would Not Want the Service Even If Free	Willingness-to-Pay per Month (\$)	Pay-per-Use (\$)
1	Monthly Consumption				
	FG	5	2		
	INT	2		\$0.50, 0.50, 1, *, 5	
2	Neighborhood Comparison				
	FG		6		\$1
	INT	3		0.50, 0.50, 1, *, 0.50, 2	
3	Appliance Breakdown				
	FG	4	3		
	INT	3	1	\$0.50, 1, *, 0.50, 0.50	
4	Billing and payment plans				
	FG	1	6		0
	INT	6		\$0.50, *, 0.50	
5	Time-of-Use Pricing				
	FG	5			\$1
	INT	5	1	0.50, 0.50, *	
6	Energy Services & Rate Options				
	FG	5			
	INT	6	2	*, \$2, **	
7	Energy-Efficiency Program Info				
	FG	4			
	INT	5	3	*, \$1, 3, 0.50	
8	Energy-Efficient Product Info				
	FG	2	4		\$1.50, 1, X, X
	INT	3		*, 2	1.50, 1, 1, 1

No.	Service	Like the Service But Would Not Want to Pay for It	Would Not Want the Service Even If Free	Willingness-to-Pay per Month (\$)	Pay-per-Use (\$)
9	Do-it-yourself Videos & Booklets				
	FG	4	2		\$1, 3, 0, 0
	INT	6	1		2.50
10	Scheduling Repairs & Services				
	FG	2	5		
	INT	8		\$2	
11	Customer Queries				
	FG	4	3		
	INT	7	1	\$2	\$2
12	Load Mgmt. & Automation				
	FG	5			
	INT	7			
13	Entertainment Video on Demand				
	FG		3	\$10, 10	\$3, 2.50, 3, 2, X
	INT	3		1, 2, 10, 2, 25	2.50, 2, 5, 5
14	Security Services				
	FG			\$10	
	INT	4		10, 30, 2, 1, 12	

\* One interviewee would prefer an annual maintenance fee of not more than \$60 for Services 1 through 8.

\*\* One of the respondents was willing to pay a "one-time" set-up fee of \$15, subsequent willingness to pay would depend on cost/savings ratio

**Notes:** The number of responses may not add up to 10 for individual interviews since not all respondents answered the question for each service. One interviewee was willing to pay \$2 per month to have all the services available plus a \$5 for Pay-per-Use fee for each service.

**ERNEST ORLANDO LAWRENCE BERKELEY NATIONAL LABORATORY  
ONE CYCLOTRON ROAD | BERKELEY, CALIFORNIA 94720**