

UC Berkeley

Planning & Evaluation

Title

Cool Colored Cars to Reduce Air-Conditioning Energy Use and reduce CO2 Emission

Permalink

<https://escholarship.org/uc/item/2zd3m0kr>

Authors

Levinson, Ronnen
Akbari, Hashem
Ban-Weiss, George
[et al.](#)

Publication Date

2011

**Public Interest Energy Research (PIER) Program
FINAL PROJECT REPORT**

**Cool-Colored Cars to Reduce Air-
Conditioning Energy Use and Reduce
CO₂ Emission**

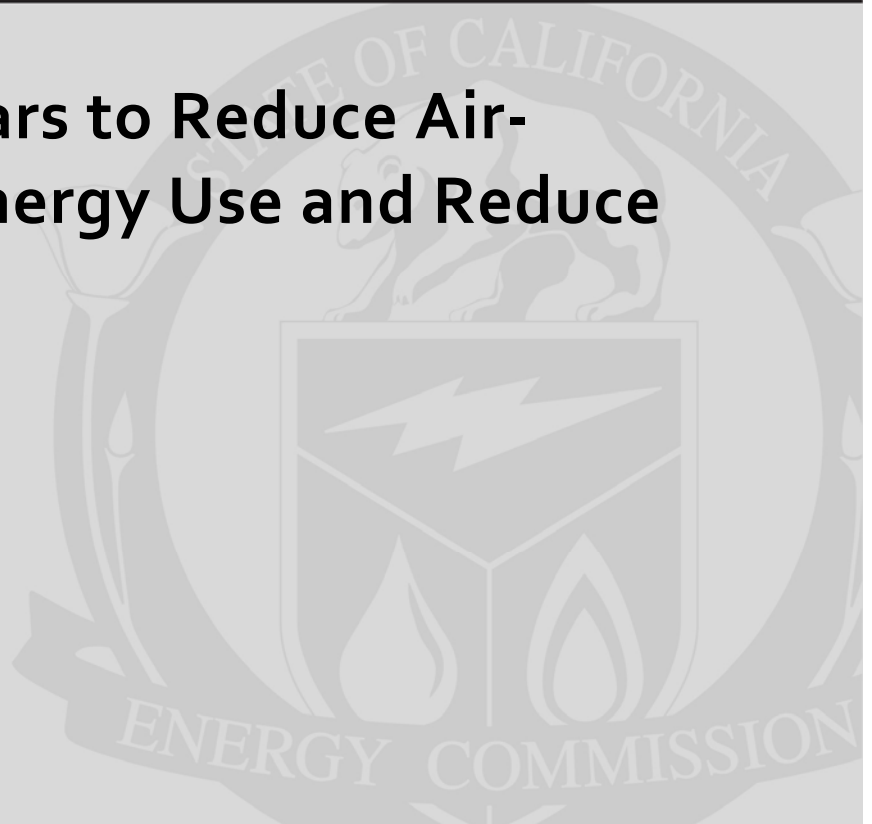

Prepared for: California Energy Commission
Prepared by: Lawrence Berkeley National Laboratory
Concordia University

JANUARY 2011
CEC-500-99-013



Lawrence Berkeley
National Laboratory



Prepared by:

Lawrence Berkeley National Laboratory, Berkeley, CA
Concordia University, Montreal, Quebec, Canada

Primary Author(s):

Ronnen Levinson
Hashem Akbari
George Ban-Weiss
Heng Pan
Riccardo Paolini
Pablo Rosado
Michael Spears
Joyce Tam



Lawrence Berkeley National Laboratory
One Cyclotron Road
Berkeley, CA 94720

Contract Number: 500-99-013

Prepared for:

California Energy Commission

XXXX XXXXXX

Contract Manager

Philip Misemer

Project Manager

XXXX XXXXXX

Office Manager

Name of Office Goes Here

XXXX XXXXXX

Deputy Director

Division Name Goes Here

Melissa Jones

Executive Director

DISCLAIMER

This report was prepared as the result of work sponsored by the California Energy Commission. It does not necessarily represent the views of the Energy Commission, its employees or the State of California. The Energy Commission, the State of California, its employees, contractors and subcontractors make no warrant, express or implied, and assume no legal liability for the information in this report; nor does any party represent that the uses of this information will not infringe upon privately owned rights. This report has not been approved or disapproved by the California Energy Commission nor has the California Energy Commission passed upon the accuracy or adequacy of the information in this report.

Acknowledgments

We wish to thank the California Department of General Services for use of their vehicles and facility, with special appreciation to Kimberly Harbison for her assistance; John Rugh of the National Renewable Energy Laboratory, for technical advice; and Philip Misemer of the California Energy Commission, for guiding our project. We would also like to thank the members of our collaborative research team including Steve Douglas, Alliance of Automobile Manufacturers; Richard Doyle, BASF Automotive Coatings; Marijke Bekken, California Air Resources Board; John Lund and Ken Loye, Ferro; Bill Kittler, JDSU; Dave Darling, National Paint and Coatings Association; Robert Cassidy, Nissan; Jim Ohlinger and Kurt Olson, PPG; and Glenn Kleppinger, Hai Lin, and Parfait Likibi, Silberline.

PREFACE

The California Energy Commission Public Interest Energy Research (PIER) Program supports public interest energy research and development that will help improve the quality of life in California by bringing environmentally safe, affordable, and reliable energy services and products to the marketplace.

The PIER Program conducts public interest research, development, and demonstration (RD&D) projects to benefit California.

The PIER Program strives to conduct the most promising public interest energy research by partnering with RD&D entities, including individuals, businesses, utilities, and public or private research institutions.

PIER funding efforts are focused on the following RD&D program areas:

- Buildings End-Use Energy Efficiency
- Energy Innovations Small Grants
- Energy-Related Environmental Research
- Energy Systems Integration
- Environmentally Preferred Advanced Generation
- Industrial/Agricultural/Water End-Use Energy Efficiency
- Renewable Energy Technologies
- Transportation

Cool-Colored Cars to Reduce Air-Conditioning Energy Use and Reduce CO₂ Emission is the final report for the project of the same name (contract number 500-99-013, work authorization number BOA-99-XXX-P) conducted by Lawrence Berkeley National Laboratory. The information from this project contributes to PIER's Transportation Program.

For more information about the PIER Program, please visit the Energy Commission's website at www.energy.ca.gov/research/ or contact the Energy Commission at 916-654-4878.

ABSTRACT

Air-conditioning in cars and small trucks lowers fuel economy by an estimated 22% and significantly increases tailpipe emissions. The design of vehicle air conditioners is based on the maximum cabin (soak) temperature attained when the vehicle is parked on a hot, sunny summer day. Cool colored paints reflect most of the sun's energy in the near-infrared band (0.7 – 2.5 microns) while offering choice of color in the visible band (0.4 – 0.7 microns). Painting vehicle shells with these cool colors can reduce the soak temperature and thus increase fuel economy by decreasing the vehicle's ancillary load and permitting the use of smaller air conditioners. In this report we investigate cool colored paints (a.k.a. "cool coatings") for cars. This was carried out by (1) establishing a 21-member collaborative research team representing 13 organizations including government, industry and other research institutions; (2) estimating fuel savings and emission reductions attainable with cool coatings; (3) developing an energy RD&D framework (roadmap) addressing energy efficiency measures that have potential for improving the air conditioning performance of cars; (4) initiating development of a database of cool colored coatings for cars with measurements of solar spectral reflectance and thermal emittance of over 180 car coatings. An experimental comparison of otherwise identical black and silver compact sedans indicated that increasing the solar reflectance (ρ) of the car's shell by about 0.5 lowered soak temperature by about 5-6°C. Thermal analysis predicts that the air conditioning capacity required to cool the cabin air in the silver car to 25°C within 30 minutes is 13% less than that required in the black car. Assuming that potential reductions in AC capacity and engine ancillary load scale linearly with increase in shell solar reflectance, ADVISOR simulations of the SC03 urban/highway driving cycle indicate that substituting a typical cool-colored shell ($\rho = 0.35$) for a black shell ($\rho = 0.05$) would reduce fuel consumption by 0.12 L per 100 km (1.1%), increasing fuel economy by 0.10 km L⁻¹ [0.24 mpg] (1.1%). It would also decrease CO₂ emissions by 2.7 g km⁻¹ (1.1%), NO_x emissions by 0.0054 g km⁻¹ (0.44%), CO emissions by 0.017 g km⁻¹ (0.43%), and HC emissions by 0.0041 g km⁻¹ (0.37%). Selecting a typical white or silver shell ($\rho = 0.60$) instead of a black shell would lower fuel consumption by 0.21 L per 100 km (1.9%), raising fuel economy by 0.19 km L⁻¹ [0.44 mpg] (2.0%). It would also decrease CO₂ emissions by 4.9 g km⁻¹ (1.9%), NO_x emissions by 0.0099 g km⁻¹ (0.80%), CO emissions by 0.31 g km⁻¹ (0.79%), and HC emissions by 0.0074 g km⁻¹ (0.67%).

Keywords: Cool colored cars, air conditioning, fuel economy, fuel efficiency, CO₂ emissions, NO_x emissions, CO emissions, HC emissions, ADVISOR, thermal model, solar reflectance

Please use the following citation for this report:

Levinson, Ronnen, Hashem Akbari, George Ban-Weiss, Heng Pan, Ricardo Paolini, Pablo Rosado, Michael Spears, Joyce Tam. (Lawrence Berkeley National Laboratory). 2010. *Cool Colored Cars to Reduce Air Conditioning Energy Use and Reduce CO₂ Emission*. California Energy Commission. Publication number: CEC-500-99-013.

TABLE OF CONTENTS

Acknowledgments	i
PREFACE	ii
ABSTRACT	iii
TABLE OF CONTENTS	iv
Executive Summary	2
Project Objectives	2
Project Outcomes and Recommendations	2
Task 1: Establish a collaborative research team	2
Task 2: Estimate improvement in car fuel economy and reduction in emissions.....	2
Task 3: Developing an energy RD&D framework (roadmap) addressing energy efficiency measures that have the potential for improving the air conditioning performance of vehicles.	3
Task 4: Development of a database of cool colored coatings for cars.....	4
CHAPTER 1: Introduction	6
Background	6
Purpose	6
Project Objectives	7
Report Organization	7
CHAPTER 2: Outcomes and Recommendations	8
2.1 Establish a collaborative research team (Task 1)	8
2.2 Estimate improvement in car fuel economy and reduction in emissions (Task 2).....	8
Recommendations.....	9
2.3 Develop an energy RD&D framework (roadmap) addressing energy efficiency measures that have potential for improving the air conditioning performance of cars (Task 3) 13	13
A 2020 vision.....	13
Strategy: Technology and tool development	13
Technology status	14
Recommendations.....	15
2.4 Development of a database of cool colored coatings for cars (Task 4).....	17

Recommendations.....	18
List of Attachments.....	20

List of Tables

Table 1. Members of the collaborative research team.....	8
Table 2. Summary list and a qualitative assessment of technology status for cool cars	14

List of Figures

Figure 1. Comparisons of (a) roof and (b) cabin air temperatures measured during soaking and cooling trials of the black and silver cars.....	10
Figure 2. Fractional reductions in rates of (a) fuel consumption, (b) NO _x emission, (c) CO emission and (d) HC emission versus solar reflectance of the cool car shell. Reference values of solar reflectance for a typical cool colored car, a typical white or silver car, and a hypothetical super-white car are shown as dashed vertical lines.....	12
Figure 3. Distribution of solar reflectance in each sample set.	19

Executive Summary

Air-conditioning in cars and small trucks lowers fuel economy by an estimated 22% and significantly increases tailpipe emissions. The design of vehicle air conditioners is based on the maximum cabin (soak) temperature attained when the vehicle is parked on a hot, sunny summer day. Cool colored paints reflect most of the sun's energy in the near-infrared band (0.7 – 2.5 microns) while offering choice of color in the visible band (0.4 – 0.7 microns). Painting vehicle shells with these cool colors can reduce the soak temperature and thus increase fuel economy by decreasing the vehicle's ancillary load and permitting the use of smaller air conditioners. In this report we investigate cool colored paints (a.k.a. "cool coatings") for cars.

Project Objectives

The highest priority objectives for this project include:

- Establishing a collaborative research team including government, industry and other research institutions.
- Estimating potential improvements in vehicle fuel economy and reductions in vehicle emissions from cool coatings using a combination of experiments and modeling.
- Developing an energy RD&D framework (roadmap) addressing energy efficiency measures that have the potential for improving the air conditioning performance of vehicles.
- Initiating the development of a database of cool colored coatings for cars through measuring and documenting the solar reflectance, spectral reflectance and thermal emittance of current car finishes.

Project Outcomes and Recommendations

Task 1: Establish a collaborative research team

Our 21-member research collaborative team representing 13 organizations met by teleconference on 14 August 2009, 13 November 2009, 1 March 2010 and 13 July 2010 to discuss and guide the project. Meeting presentations and notes are available from the project website, <http://CoolCars.LBL.gov>.

Task 2: Estimate improvement in car fuel economy and reduction in emissions

In this task we estimated the decrease in soak temperature, potential reduction in AC capacity, and potential fuel savings and emission reductions attainable through the use of solar reflective shells. First, we experimentally characterized component temperatures and cooling demands in a pair of otherwise identical dark and light colored vehicles, the former with a low solar reflectance (ρ) of 0.05 and the latter with high solar reflectance ($\rho = 0.58$). Second, we developed a thermal model that predicted the AC capacity required to cool each vehicle to a comfortable final temperature of 25°C within 30 minutes. Third, we used the ADVISOR vehicle simulation tool to estimate the fuel consumption and pollutant emissions of each vehicle in various standard drive cycles (SC03, UDDS, and HWFET). Finally, we calculated the fuel savings and emission reductions attainable by using a cool shell to reduce ancillary load.

The air conditioners in the experimental vehicles were in most trials too small to lower cabin air temperature to 25°C within 30 minutes. We estimate that if the vehicle ACs were resized to meet this target, the AC cooling capacity would be 3.83 kW for the car with low solar reflectance and 3.34 kW for the car with high solar reflectance.

Assuming that potential reductions in AC capacity and engine ancillary load scale linearly with increase in shell solar reflectance, ADVISOR simulations of the SC03 urban/highway driving cycle indicate that substituting a typical cool-colored shell ($\rho = 0.35$) for a black shell ($\rho = 0.05$) would reduce fuel consumption by 0.12 L per 100 km (1.1%), increasing fuel economy by 0.10 km L⁻¹ [0.24 mpg] (1.1%). It would also decrease CO₂ emissions by 2.7 g km⁻¹ (1.1%), NO_x emissions by 0.0054 g km⁻¹ (0.44%), CO emissions by 0.017 g km⁻¹ (0.43%), and HC emissions by 0.0041 g km⁻¹ (0.37%). Selecting a typical white or silver shell ($\rho = 0.60$) instead of a black shell would lower fuel consumption by 0.21 L per 100 km (1.9%), raising fuel economy by 0.19 km L⁻¹ [0.44 mpg] (2.0%). It would also decrease CO₂ emissions by 4.9 g km⁻¹ (1.9%), NO_x emissions by 0.0099 g km⁻¹ (0.80%), CO emissions by 0.31 g km⁻¹ (0.79%), and HC emissions by 0.0074 g km⁻¹ (0.67%).

Recommendations. We have developed a satisfactory protocol for analyzing the effect of vehicle shell solar reflectance on cabin air soak temperatures, air conditioning capacity, fuel consumption, and emissions. In this task the model was applied only to two compact sedans. Future work could repeat experiments for a wider range of vehicle classes such as mid-sized sedans, sport utility vehicles, light-duty trucks, hybrid vehicles, and electric vehicles.

Task 3: Developing an energy RD&D framework (roadmap) addressing energy efficiency measures that have the potential for improving the air conditioning performance of vehicles.

The objective of this task was to document research and implementation pathways for an all-inclusive effort joining major car manufacturers (the U.S. Big Three and several Japanese and European firms), research institutions (e.g., the National Renewable Energy Laboratory [NREL]), private research companies (such as Clean Air Vehicle Technology Center), manufacturers of color pigments and automotive coatings (e.g., BASF, PPG), the California Air Resource Board, and the California and Federal Departments of Transportation to investigate approaches to minimize the fuel energy use related to operation of air conditioning in passenger cars and small trucks.

In close collaboration with the industry, national laboratories, and governmental agencies, we prepared an R&D plan for development of cool color cars. The R&D plan was developed in three stages:

- An initial list of ideas, topics, and issues were compiled and shared with the partners and stakeholders.
- In June 2010, an initial plan was developed and reviewed by all stakeholders. Subsequently, a revised version of the plan was distributed in September 2010 for review and commentary.
- We convened a 1-day workshop on October 25, 2010 to review and finalize the research topics and implementation pathways document. All partners' comments and input are incorporated in this plan.

Recommendations. The objectives of this program can be achieved by developing research and implementation plans that focus on the following areas:

1. Technology development (A/C components, systems, shell coatings, interior coatings,...)
2. Performance metrics
3. Test methods
4. Process and system modification
5. Design and analysis tools
6. Market transformation (industry and public participation)
7. Milestones

All efforts should be closely coordinated with other stakeholders to (1) perform research based on the current status of the technologies, modeling, performance metrics, and test methods, and (2) take advantage of cost-sharing of many activities planned and underway by various partners.

In designing cool color cars the following critical engineering, environmental, and market issues need to be addressed:

1. Pigments and coatings must be appropriate for automotive and truck OEM applications; the cool coatings must pass the minimum performance criteria for both manufacturing and aftermarket coatings applications
2. The cool pigment coatings need to be studied for their toxicity (do they contain toxics Cr 3+, cadmium, nickel, cobalt, manganese, and antimony); appropriateness (durability, capability, compatibility, color matching etc.); and availability. This should include a complete definition of toxicity by various regulators.
3. In application of bi-layer coating techniques, issues related to consumer satisfaction in regards to scratches and chipping needs to be examined.
4. Consumer choice of color is very important. Cool colors may limit the color choices for the consumers. Will the consumer have a strong interest in dark vs. light colors? How much improvement can be made within the guideline of not significantly altering the palette and using production feasible techniques?
5. In carrying out cost-benefit analysis of cool color cars, careful attention should be given to both factors that may affect the cost (toxicity, waste, emissions, ...) and the benefits. Critical assumptions need to be carefully examined in reference to soak temperature reduction, the effect of cool coatings in tandem with the other load reduction measures (advanced glazing), quantifying fuel and emission savings, and measurement protocols. In addition, the choice of fuel and emission savings protocols must be directly related to the actual pattern of A/C use in cars in different parts of the country.

Initial key activities are detailed in the roadmap task report (Attachment 2).

Task 4: Development of a database of cool colored coatings for cars

We measured the solar spectral reflectance and thermal emittance of over 180 car coating samples obtained from two automotive coating manufacturers. Solar reflectance, visible reflectance, near-infrared reflectance, and color coordinates (CIELAB L^* , a^* and b^*) were

computed from solar spectral reflectance. Solar reflectance index (SRI) was computed from solar reflectance and thermal emittance. A Microsoft Access database containing all measurements and an image of each sample has been posted to the project website, <http://CoolCars.LBL.gov> .

Our measurements verified that the prototype cool colors did generally exhibit solar reflectance exceeding visible reflectance. Solar reflectance ranged from 0.04 (conventional black) to 0.70 (conventional white), with many cool colors ranging in solar reflectance from about 0.20 to 0.50. All coated samples exhibited high thermal emittance (0.82 - 0.95).

Recommendations. Our measurements verified that the prototype cool colors did generally exhibit solar reflectance exceeding visible reflectance. Our online database can be used to explore the palette and performance of cool colored coating options for car shells. In future work, the database could be expanded to characterize more samples, and to detail the non-radiative properties of car shell coatings, such as cost, durability, and toxicity.

CHAPTER 1: Introduction

Background

Over 95% of cars and small trucks sold in California have air conditioning. Air conditioning is used in both hot and cold weather to regulate cabin temperature and humidity, providing “climate control.” We estimate that the contribution of vehicle air conditioner energy use to annual California transportation fuel consumption is about 700 million gallons per year. In addition to lowering fuel efficiency, air conditioning in cars and small trucks significantly increases tailpipe emissions.

Use of cool nonwhite paints can reduce the soak temperature (the maximum cabin temperature attained when the car is parked on a hot, sunny summer day) by 3-5°F. Researchers estimate that each degree Fahrenheit reduction in the soak temperature yields a 2.3% reduction in compressor power, a 0.07 miles per gallon (MPG) increase in fuel efficiency, and a 0.9% reduction in nitrogen oxide (NO_x) emission. Thus, a 3-5°F reduction in soak temperature from the application of cool nonwhite paints would permit a 7-11% reduction in air conditioner capacity. The corresponding increase in fuel efficiency would be 0.21-0.35 MPG (1.0-1.8%), at \$3.8 per gallon of fuel, savings of about \$200 million to \$320 million per year in California. The estimated reduction in CO₂ emissions would be about 2.4 metric tons.

Studies by the California Air Resources Board and the Coordinated Research Council have shown that the use of air conditioning in cars increases CO emissions by 1.6 grams/mile (71%), increases NO_x emissions by 0.19 g/mi (81%), and reduces fuel efficiency by 4.6 mpg (22%). Assuming that air conditioning reduces fuel efficiency by 15 to 20%, and that vehicles run air conditioning 30% of the time, at \$3.80 per gallon of fuel, the contribution of vehicle air conditioner energy use to California transportation fuel expenditure is about \$2.6 billion per year.

The design of a car air conditioner is based on the maximum cabin (soak) temperature attained when the car is parked on a hot, sunny summer day. The soak temperature of the car is strongly influenced by solar gain through its windows and opaque shell. In the past decade, researchers and car manufacturers have used near-infrared reflective windows to reduce fenestration solar gain, lowering the soak temperature by several degrees. Using exterior paints with high solar reflectance can further reduce soak temperature.

Cool colored paints reflect most of the sun’s energy in the near-infrared band (0.7 – 2.5 microns) while offering choice of color in the visible band (0.4 – 0.7 microns). Since about 50% of the sun’s energy lies in the near-infrared band, a surface coated with a cool cooled paint achieves a lower temperature than one coated with a standard paint of the same color. Use of cool-colored paint can reduce the soak temperature by a few degrees (3-5°F). Over the last decade, LBNL has worked with the manufacturers to develop and characterize many cool-colored pigments used in coatings.

Purpose

Perform basic research and provide technical assistance to car manufacturers, car coating manufacturers, and California policy makers for development of cool cars that save energy, reduce emission of greenhouse gases, and improve the urban environment.

Project Objectives

The highest priority objectives for this project include:

- Establishing a collaborative research team including government, industry and other research institutions.
- Estimating potential improvements in vehicle fuel efficiency and reductions in vehicle emissions from cool coatings using a combination of experiments and modeling.
- Developing an energy RD&D framework (roadmap) addressing energy efficiency measures that have the potential for improving the air conditioning performance of vehicles.
- Initiating the development of a database of cool colored coatings for cars through measuring and documenting the solar reflectance, spectral reflectance and thermal emittance of current car finishes.

Report Organization

This report will summarize the activities within each of the project tasks, listed below

Task 1: Establish a collaborative research team

Task 2: Estimate improvement in car fuel economy and reduction in emissions

Task 3: Develop an energy RD&D framework (roadmap) addressing energy efficiency measures that have potential for improving the air conditioning performance of cars

Task 4: Development of a database of cool colored coatings for cars

Attachments to this report provide additional details on the tasks listed above.

CHAPTER 2: Outcomes and Recommendations

2.1 Establish a collaborative research team (Task 1)

Our 21-member research collaborative team representing 13 organizations met by teleconference on 14 August 2009, 13 November 2009, 1 March 2010 and 13 July 2010 to discuss and guide the project. Meeting presentations and notes are available from the project website, <http://CoolCars.LBL.gov> (Table 1).

Table 1. Members of the collaborative research team.

person	organization
Steve Douglas	Alliance of Automobile Manufacturers
Richard Doyle	BASF Automotive Coatings
Heng Pan	Berkeley Lab
Pablo Rosado	Berkeley Lab
Michael Spears	Berkeley Lab
Paul Berdahl	Berkeley Lab
Ronnen Levinson	Berkeley Lab
Marijke Bekken	California Air Resources Board
Philip Misemer	California Energy Commission
Hashem Akbari	Concordia University / Berkeley Lab
John Lund	Ferro
Ken Loye	Ferro
Bill Kittler	JDSU
Dave Darling	National Paint and Coatings Association
Robert Cassidy	Nissan
Riccardo Paolini	Politecnico di Milano / Berkeley Lab
Jim Ohlinger	PPG
Kurt Olson	PPG
Glenn Kleppinger	Silberline
Hai Lin	Silberline
Parfait Likibi	Silberline

2.2 Estimate improvement in car fuel economy and reduction in emissions (Task 2)

In this task we estimated the decrease in soak temperature, potential reduction in AC capacity, and potential fuel savings and emission reductions attainable through the use of solar reflective shells.

First, we experimentally characterized component temperatures and cooling demands in a pair of otherwise identical dark and light colored vehicles, the former with low solar reflectance ($\rho = 0.05$) and the latter with high solar reflectance ($\rho = 0.58$). Figure 1 compares the roof and cabin air temperatures in the low solar reflectance (black) car to those in the high solar reflectance (silver) car. (This represents a small subset of the measured car component temperatures presented in the task report; see Attachment 1 for more detail). The roof of the black car was up

to 25°C warmer than the silver surface. While soaking the cabin air temperature differences peaked around 5-6°C.

Second, we developed a thermal model that predicted the AC capacity required to cool each vehicle to a comfortable final temperature of 25°C within 30 minutes. The air conditioners in the experimental vehicles were in most trials too small to lower cabin air temperature to 25°C within 30 minutes. We estimate using our model that if the vehicle ACs were resized to meet this target, the AC cooling capacity would be 3.83 kW for the car with low solar reflectance and 3.34 kW for the car with high solar reflectance.

Third, we used the ADVISOR vehicle simulation tool to estimate the fuel consumption and pollutant emissions of each vehicle in various standard drive cycles (SC03, UDDS, and HWFET). Finally, we calculated the fuel savings and emission reductions attainable by using a cool shell to reduce ancillary load.

Assuming that potential reductions in AC capacity and engine ancillary load scale linearly with increase in shell solar reflectance, ADVISOR simulations of the SC03 urban/highway driving cycle indicate that substituting a typical cool-colored shell ($\rho = 0.35$) for a black shell ($\rho = 0.05$) would reduce fuel consumption by 0.12 L per 100 km (1.1%), increasing fuel economy by 0.10 km L⁻¹ [0.24 mpg] (1.1%). It would also decrease NO_x emissions by 0.0054 g km⁻¹ (0.44%), CO emissions by 0.017 g km⁻¹ (0.43%), and HC emissions by 0.0041 g km⁻¹ (0.37%). Selecting a typical white or silver shell ($\rho = 0.60$) instead of a black shell would lower fuel consumption by 0.21 L per 100 km (1.9%), raising fuel economy by 0.19 km L⁻¹ [0.44 mpg] (2.0%). It would also decrease NO_x emissions by 0.0099 g km⁻¹ (0.80%), CO emissions by 0.31 g km⁻¹ (0.79%), and HC emissions by 0.0074 g km⁻¹ (0.67%). A hypothetical super-white car shell ($\rho = 0.80$) could save 0.29 L per 100 km (2.6%), increasing fuel economy by 0.25 km L⁻¹ [0.59 mpg] (2.7%) and decreasing NO_x, CO and HC emissions by 0.013 g km⁻¹ (1.1%), 0.043 g km⁻¹ (1.1%), and 0.010 g km⁻¹ (0.91%), respectively.

Recommendations

We have developed a satisfactory protocol for analyzing the effect of vehicle shell solar reflectance on cabin air soak temperatures, air conditioning capacity, fuel consumption, and emissions. In this task the model was applied only to two compact sedans. Future work could repeat experiments for a wider range of vehicle classes such as midsized sedans, sport utility vehicles, light-duty trucks, hybrid vehicles, and electric vehicles.

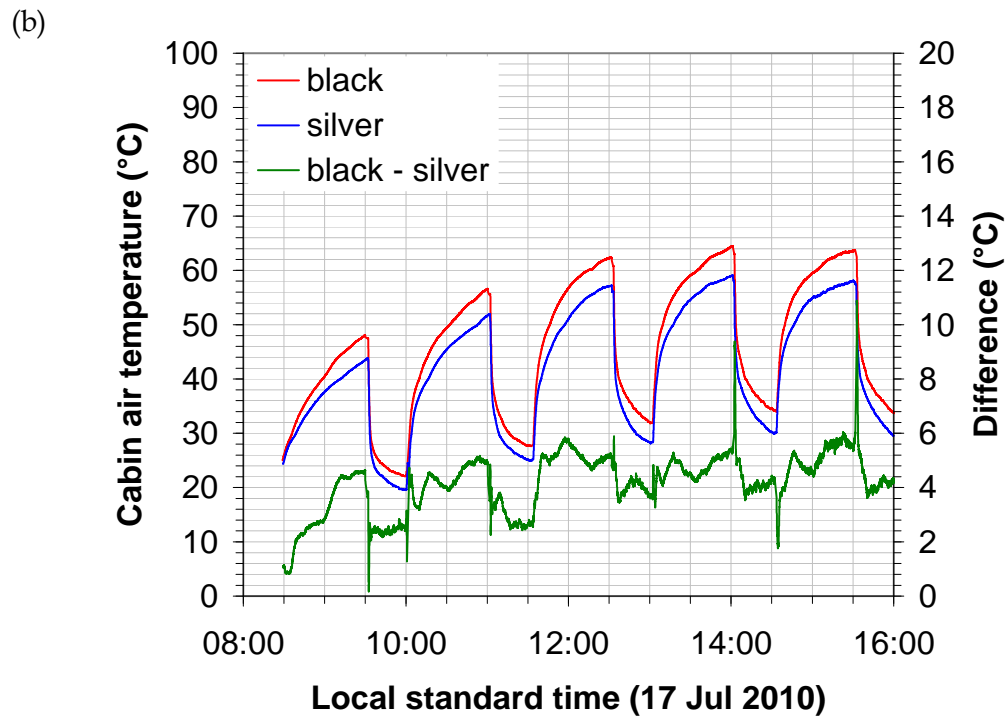
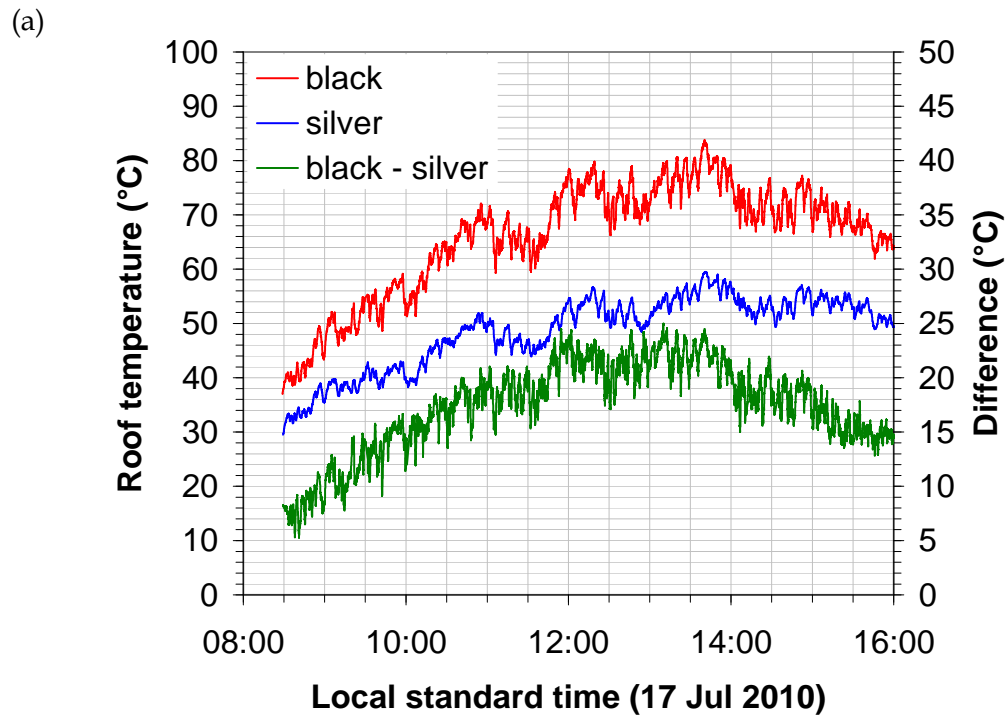
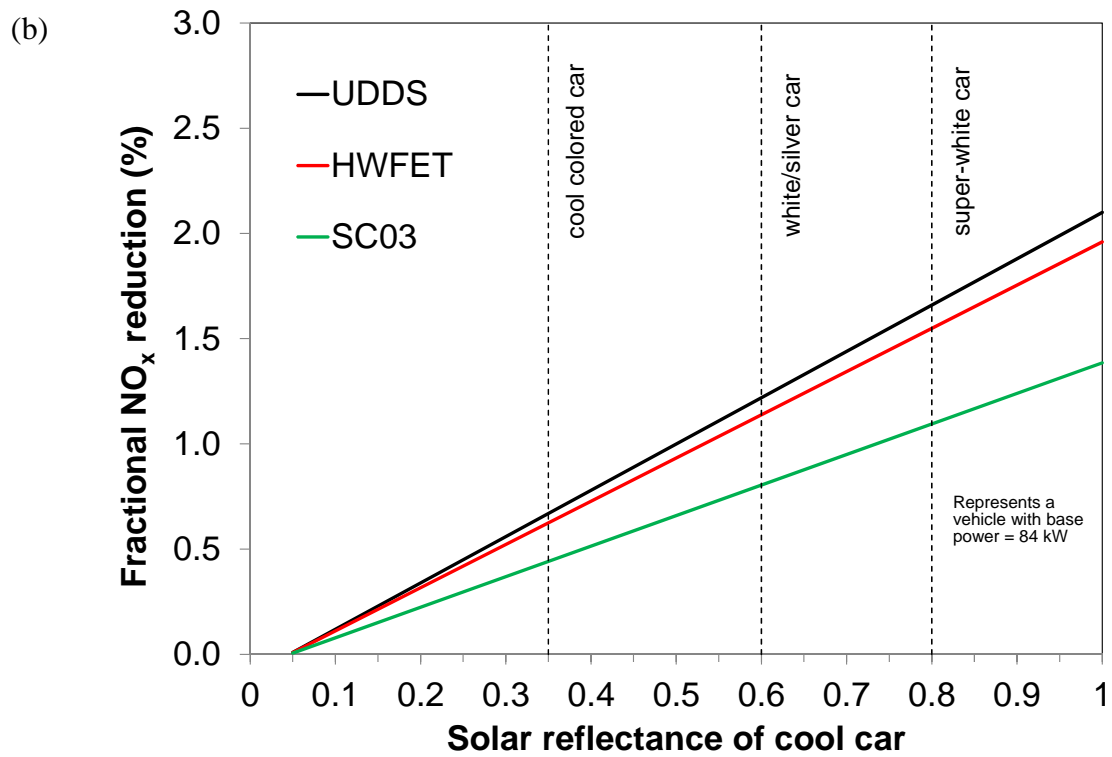
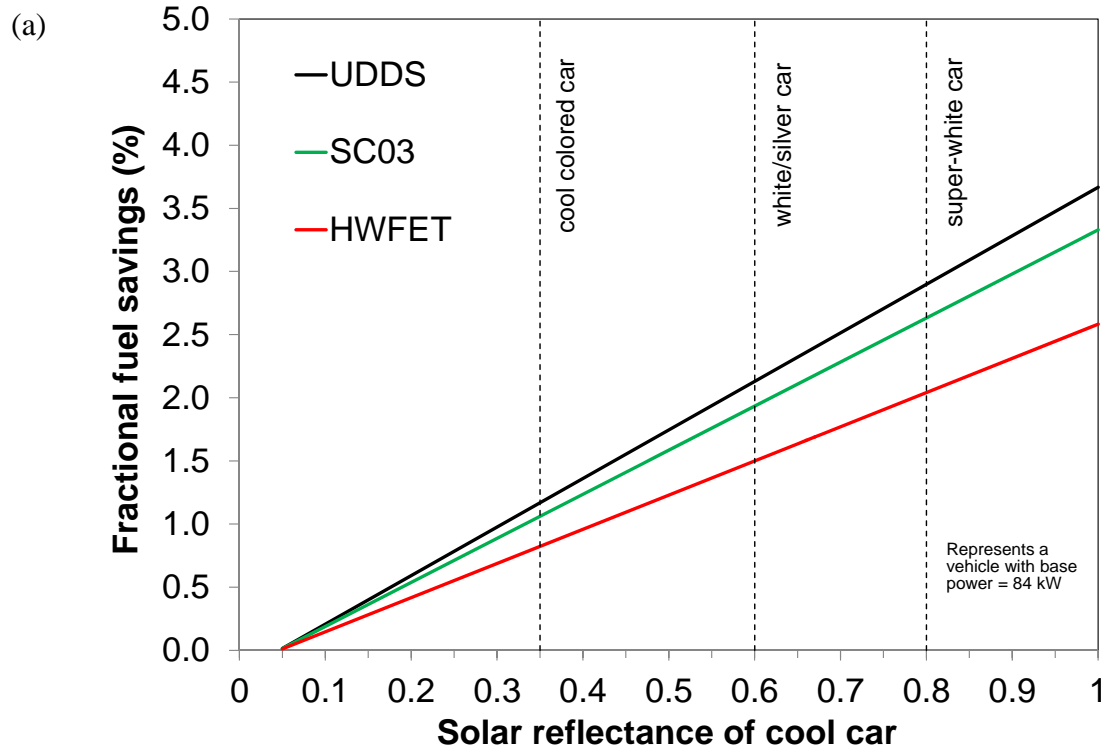

Figure 1. Comparisons of (a) roof and (b) cabin air temperatures measured during soaking and cooling trials of the black and silver cars.



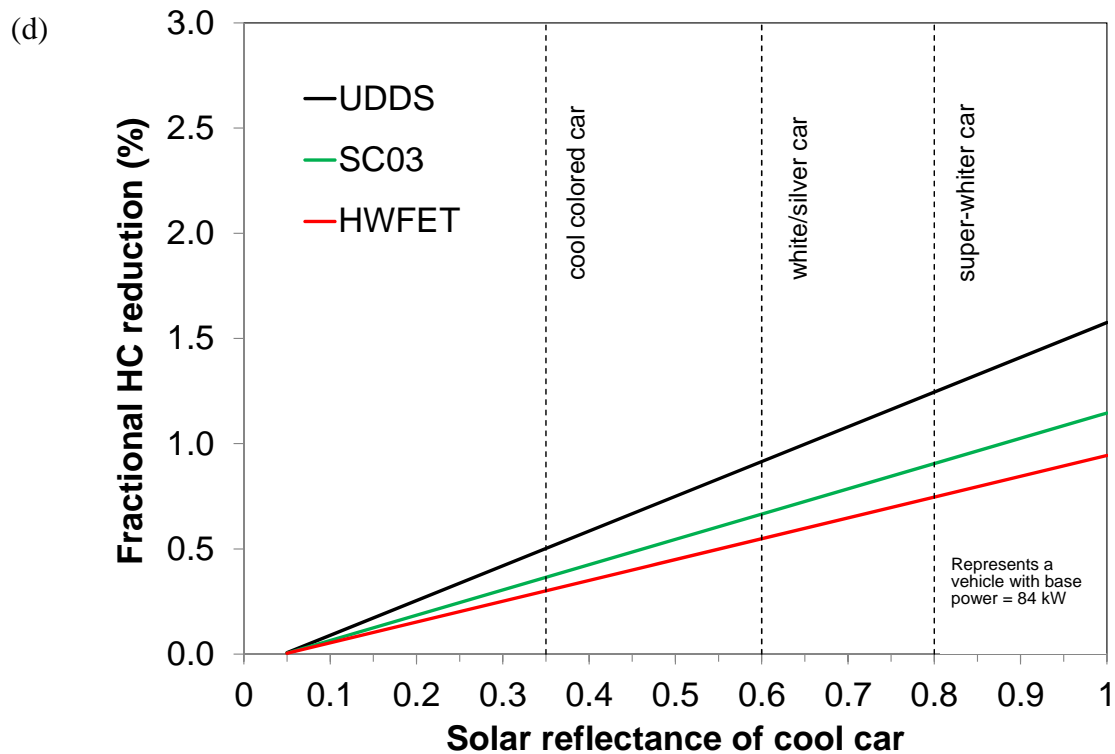
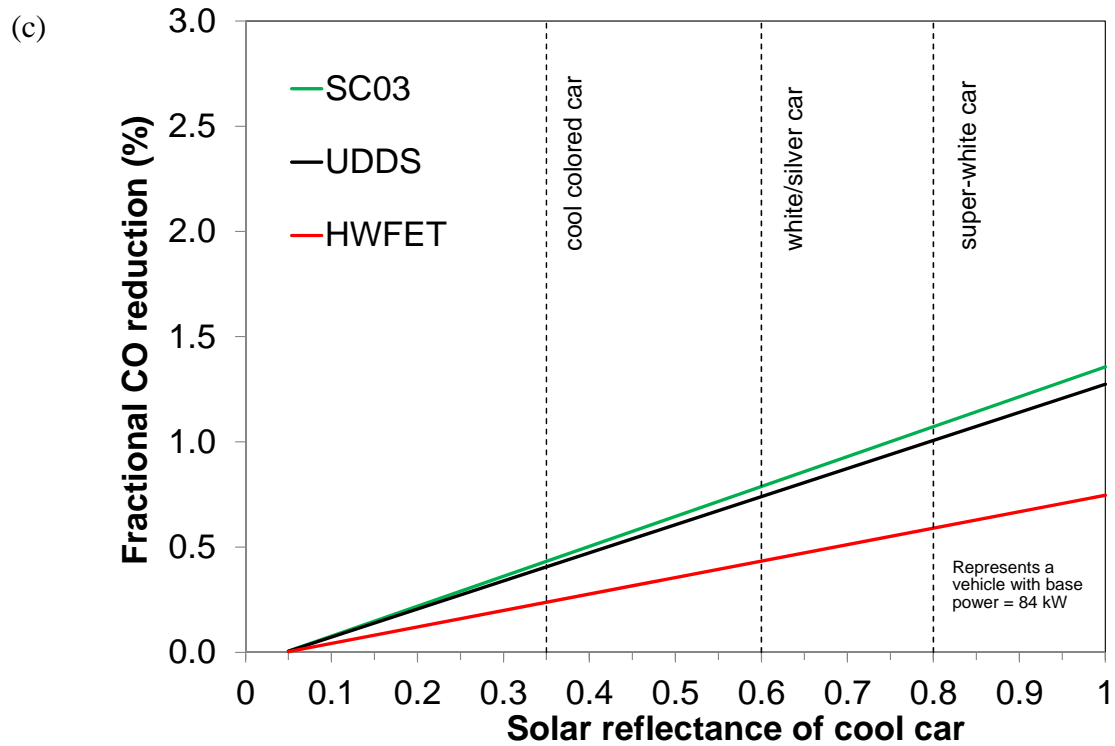

Figure 2. Fractional reductions in rates of (a) fuel consumption, (b) NO_x emission, (c) CO emission and (d) HC emission versus solar reflectance of the cool car shell. Reference values of solar reflectance for a typical cool colored car, a typical white or silver car, and a hypothetical super-white car are shown as dashed vertical lines.

2.3 Develop an energy RD&D framework (roadmap) addressing energy efficiency measures that have potential for improving the air conditioning performance of cars (Task 3)

The objective of this task was to document and research the implementation pathways for an all-inclusive effort joining major car manufacturers (the U.S. Big Three and several Japanese and European firms), research institutions (e.g., the National Renewable Energy Laboratory [NREL]), private research companies (such as Clean Air Vehicle Technology Center), manufacturers of color pigments and automotive coatings (e.g., BASF, PPG), the California Air Resource Board, and the California and Federal Departments of Transportation to investigate approaches to minimize the fuel energy use related to operation of air conditioning in passenger cars and small trucks.

In close collaboration with industry, national laboratories, and governmental agencies, we prepared an R&D plan for development of cool color cars. The R&D plan was developed in three stages:

- An initial list of ideas, topics, and issues were compiled and shared with the partners and stakeholders.
- In June 2010, an initial plan was developed and reviewed by all stakeholders. Subsequently, a revised version of the plan was distributed in September 2010 for review and commentary.
- We convened a 1-day workshop on October 25, 2010 to review and finalize the research topics and implementation pathways document. All partners' comments and input are incorporated in this plan.

A 2020 vision

Our vision for the year 2020 is that most cars sold in the U.S. market use solar reflective coatings, the vehicle AC is designed optimally, and significant fuel consumption and emission reductions are made.

Strategy: Technology and tool development

The objectives of this program can be achieved by developing research and implementation plans that focus on the following areas:

1. Technology development (A/C components, systems, shell coatings, interior coatings,...)
2. Performance metrics
3. Test methods
4. Process and system modification
5. Design and analysis tools
6. Market transformation (industry and public participation)
7. Milestones

All efforts should be closely coordinated with other stakeholders to (1) perform research based on the current status of the technologies, modeling, performance metrics, and test methods, and (2) take advantage of cost-sharing of many activities planned and underway by various partners.

Technology status

Technologies to be considered in this plan are at various stages of development. Table 2 shows a summary list and a qualitative assessment of technology status.

Table 2. Summary list and a qualitative assessment of technology status for cool cars

Technology	Remarks
Solar reflective glazing (advanced windshields)	This technology is fairly mature. Most new effort is to make the technology more affordable
Solar reflective paints (dark cool-colored coatings)	Cool colored pigments and coatings have been developed for other applications (e.g., roofing materials). The application of cool coatings on cars is a new development.
Window shades during parking, advanced window technologies (electrochromics, thermochromics, photochromics)	Window shades are low-tech application and are used by many people. Advanced windows are costly; research is underway to develop economical solutions for advanced glazing.
Optimized insulation (engine insulation)	Insulation is used regularly in design of cars; more modeling can lead to optimal design of car insulation
Ventilation during parking	Venting of the car (either powered by battery or PV) can effectively reduce the soak load; advanced models can help with better design of the ventilation system.
Cool color interiors	Cool colored pigments and coating have been developed for other applications (e.g., roofing materials). The application of cool coatings in cars is a new development.
Low thermal mass seats	Design of low-thermal mass seats has been underway during the last decade. More research in engineering design and material development will lead to optimal design of car seats for both heating and cooling of the car.
Optimal design of the AC system	The air conditioning system design is fairly mature in buildings; the technology can be adopted for optimal design of car air-conditioning systems.
Optimal design of AC system operation	Over the last two decades, significant advances have been made in optimally operating air conditioning in buildings; the technology can be adopted for optimal design of air-conditioning systems in cars. This would require advanced models and measurement sensors.
Air-to-air heat exchanger	Cost-effective heat exchangers need to be designed for AC applications.
Advanced air-conditioning and	Over the last two decades, significant advances have been

control design (adjustable speed drive)	made to design advanced control systems (e.g., adjustable speed drive) for air-conditioners; the technology can be adopted for optimal control of air-conditioning systems in cars. This would require advanced models and measurement sensors.
---	---

Recommendations

The objectives of this program can be achieved by developing research and implementation plans that focus on the following areas:

1. Technology development (A/C components, systems, shell coatings, interior coatings,...)
2. Performance metrics
3. Test methods
4. Process and system modification
5. Design and analysis tools
6. Market transformation (industry and public participation)
7. Milestones

All efforts should be closely coordinated with other stakeholders to (1) perform research based on the current status of the technologies, modeling, performance metrics, and test methods, and (2) take advantage of cost-sharing of many activities planned and underway by various partners.

In designing cool color cars the following critical engineering, environmental, and market issues need to be addressed:

1. Pigments and coatings must be appropriate for automotive and truck OEM applications; the cool coatings must pass the minimum performance criteria for both manufacturing and aftermarket coatings applications
2. The cool pigment coatings need to be studied for their toxicity (do they contain toxics Cr 3+, cadmium, nickel, cobalt, manganese, and antimony); appropriateness (durability, capability, compatibility, color matching etc.); and availability. This should include a complete definition of toxicity by various regulators.
3. In application of bi-layer coating techniques, issues related to consumer satisfaction in regards to scratches and chipping needs to be examined.
4. Consumer choice of color is very important. Cool colors may limit the color choices for the consumers. Will the consumer have a strong interest in dark vs. light colors? How much improvement can be made within the guideline of not significantly altering the palette and using production feasible techniques?
5. In carrying out cost-benefit analysis of cool color cars, careful attention should be given to both factors that may affect the cost (toxicity, waste, emissions, ...) and the benefits. Critical assumptions need to be carefully examined in reference to soak temperature reduction, the effect of cool coatings in tandem with the other load reduction measures (advanced glazing), quantifying fuel and emission savings, and measurement protocols.

In addition, the choice of fuel and emission savings protocols must be directly related to the actual pattern of A/C use in cars in different parts of the country.

Initial key activities:

1. Establish an advisory board from the existing collaborative research team (or expand the existing research team) including government, industrial, and other research institutions
2. Use existing models, perform energy simulations to estimate the impact of cool coatings on fuel efficiency and tailpipe emissions. Improve existing models, if any
3. Expand the existing database of cool colored materials by measuring and documenting the solar reflectance, spectral reflectance and thermal emittance of current car finishes
4. Expand the review and classification of novel cool pigments to those applied to cars
5. Review current car coating techniques and assess the possibility of increasing the solar reflectance of car coatings through novel engineering applications
6. Expand the coating-design software currently being developed at LBNL to include applications for optimal design of cool coatings on cars
7. Analyze the consumer adoptability of cool-color coating palette
8. Review existing protocols for measuring fuel consumption and emissions from cars and adopt one for this program
9. Measure the A/C part-load performance for several cars in the laboratory
10. With leadership from car manufacturers, manufacture several prototype cool cars with optimized air-conditioning systems
11. Measure the field and laboratory performance of the prototype cool cars (both energy efficiency and emission reductions)
12. Perform a detailed cost/benefit and research analysis for application of cool cars. The analysis includes quantifying:
 - a. the energy benefits of cool cars
 - b. the air quality benefits of cool cars
 - c. the potential to downsize the A/C system
 - d. other cost savings potentials (such as emission control hardware) yielded by tailpipe emission reduction
 - e. other environmental benefits
 - f. the costs associated with cool cars
 - g. other detriments to cool cars
13. Analyze the environmental aspects of cool color coatings for their toxicity (do they contain toxics Cr 3+, cadmium, nickel, cobalt, manganese, and antimony);

appropriateness (durability, capability, compatibility, color matching etc.); and availability

14. Perform measurements and analyses to determine whether the shell and interior components of cool cars last longer
15. Perform measurement and analysis to quantify the benefits of applying cool color technology to the car interior components (particularly for dark seats and dashboard)
16. Perform an analysis of the market barriers to cool cars. Focus on why the car manufacturers are not currently designing and marketing cool cars
17. Assess the regional, state, and national impacts on energy use and air quality. This should account for the effects of new and upcoming advances and improvements in cars and their systems (e.g., AC system) performance. In addition, the stock of existing and new cars should be characterized.

Many of these activities need to be cost shared with various governmental institutions and industry. The activities undertaken in this research plan should be closely coordinated with other national and international stakeholders. A modest portion of the effort should be devoted to materials design to continue to improve pigments and application methods for cool colored paints. Demonstration and exhibition of the performance of cool colored cars can accelerate their market penetration.

Other ways to reduce soak temperature such as ventilating the cabin when the interior temperature reaches a certain threshold (e.g., 110°F) should be investigated.

2.4 Development of a database of cool colored coatings for cars (Task 4)

Berkeley Lab invited car coating and vehicle manufacturers to submit samples of car coatings for characterization and inclusion in a database. Samples were received from two coating manufacturers: BASF Automotive, and PPG. Each company provided two sets of coated metal panels.

Set BASF1 explored the effects of primer and basecoat on reflectance, while set BASF2 included both production colors and cool colored prototypes. Set PPG1 contained production colors, and set PPG2 contained cool colored prototypes.

We measured the solar spectral reflectance and thermal emittance of over 180 car coating samples obtained from the two automotive coating manufacturers. Solar reflectance, visible reflectance, near-infrared reflectance, and color coordinates (CIELAB L^* , a^* and b^*) were computed from solar spectral reflectance. Solar reflectance index (SRI) was computed from solar reflectance and thermal emittance. A Microsoft Access database containing all measurements and an image of each sample has been posted to the project website, <http://CoolCars.LBL.gov>.

We charted for each sample set its distributions of solar reflectance (Figure 3), thermal emittance (see Task report), and solar reflectance index (see Task report). Solar reflectance ranged from 0.04 (conventional black) to 0.70 (conventional white), with many cool colors ranging in solar reflectance from about 0.20 to 0.50. All coated samples exhibited high thermal emittance (0.82 - 0.95).

Recommendations

Our measurements verified that the prototype cool colors did generally exhibit solar reflectance exceeding visible reflectance. Our online database can be used to explore the palette and performance of cool colored coating options for car shells. In future work, the database could be expanded to characterize more samples, and to detail the non-radiative properties of car shell coatings, such as cost, durability, and toxicity.

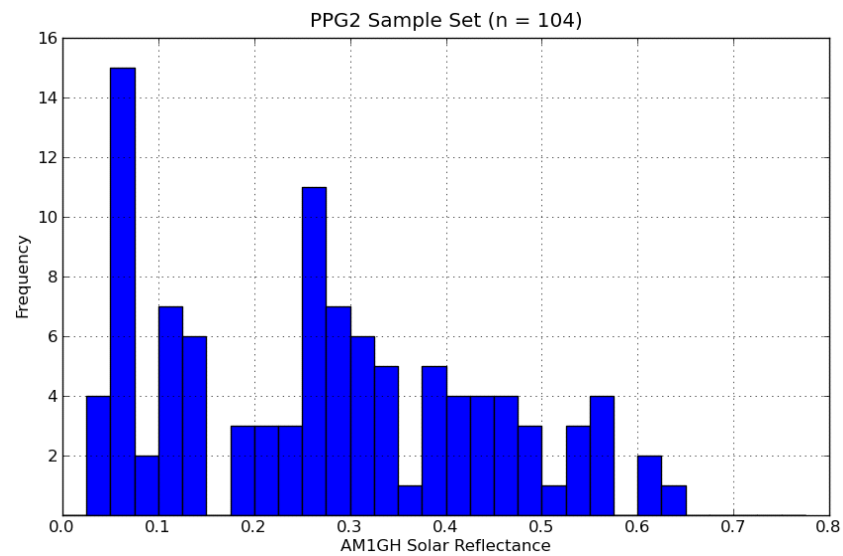
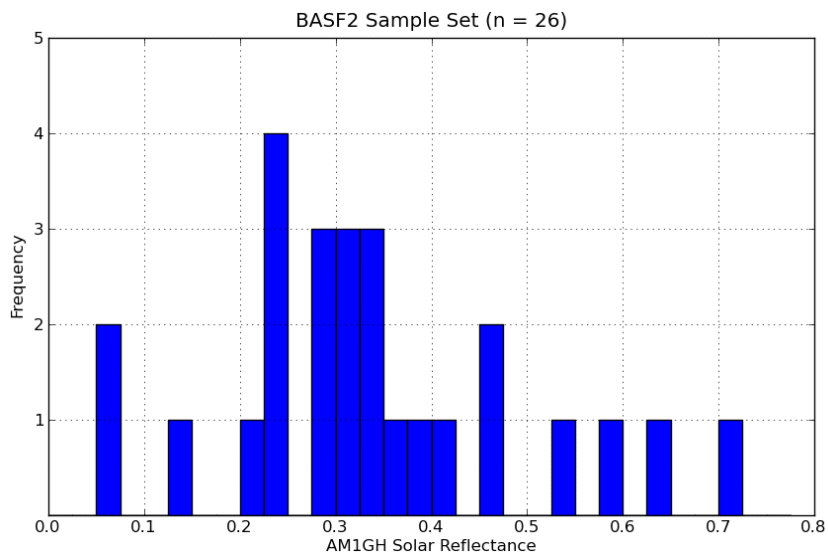
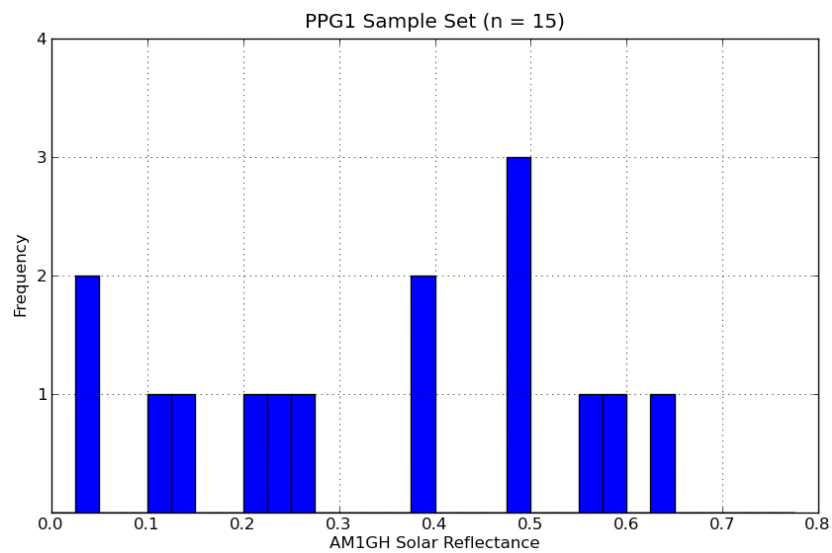
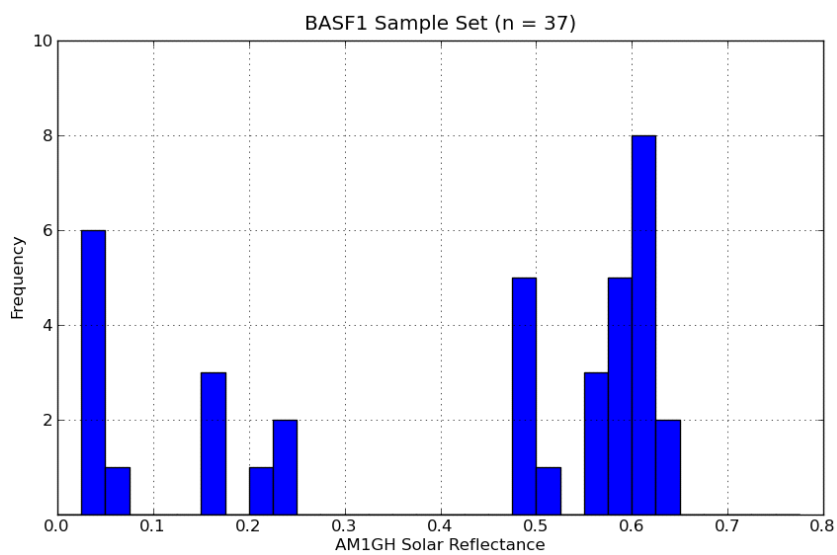

Figure 3. Distribution of solar reflectance in each sample set.

List of Attachments

Attachment 1: Task 2 report (Estimate improvement in car fuel economy and reduction in emissions)

Attachment 2: Task 3 report (Developing an energy RD&D framework [roadmap] addressing energy efficiency measures that have the potential for improving the air conditioning performance of vehicles)

Attachment 3: Task 4 report (Development of a database of cool colored coatings for cars)

ATTACHMENT 1:

Report for Task 2 (Estimate improvement in car fuel economy and reduction in emissions)

Contents

- A. Pan, H., Levinson, R., Paolini, R., Rosado, P., Ban-Weiss, G., Akbari, H. 2011. Potential benefits of solar reflective car shells: cooler cabins, fuel savings, and emission reductions.

Potential benefits of solar reflective car shells: cooler cabins, fuel savings and emission reductions

Heng Pan, Ronnen Levinson, Riccardo Paolini, Pablo Rosado,
George Ban-Weiss and Hashem Akbari

Abstract

Vehicle thermal loads and air conditioning ancillary loads are strongly influenced by the absorption of solar energy. The adoption of solar reflective coatings for opaque surfaces of the vehicle shell can decrease the "soak" temperature of the air in the cabin of a vehicle parked in the sun, potentially reducing the vehicle's ancillary load and improving its fuel economy by permitting the use of a smaller air conditioner. An experimental comparison of otherwise identical black and silver compact sedans indicated that increasing the solar reflectance (ρ) of the car's shell by about 0.5 lowered soak temperature by about 5-6°C. Thermal analysis predicts that the air conditioning capacity required to cool the cabin air in the silver car to 25°C within 30 minutes is 13% less than that required in the black car. Assuming that potential reductions in AC capacity and engine ancillary load scale linearly with increase in shell solar reflectance, ADVISOR simulations of the SC03 urban/highway driving cycle indicate that substituting a typical cool-colored shell ($\rho = 0.35$) for a black shell ($\rho = 0.05$) would reduce fuel consumption by 0.12 L per 100 km (1.1%), increasing fuel economy by 0.10 km L⁻¹ [0.24 mpg] (1.1%). It would also decrease carbon dioxide (CO₂) emissions by 2.7 g km⁻¹ (1.1%), nitrogen oxide (NO_x) emissions by 0.0054 g km⁻¹ (0.44%), carbon monoxide (CO) emissions by 0.017 g km⁻¹ (0.43%), and hydrocarbon (HC) emissions by 0.0041 g km⁻¹ (0.37%). Selecting a typical white or silver shell ($\rho = 0.60$) instead of a black shell would lower fuel consumption by 0.21 L per 100 km (1.9%), raising fuel economy by 0.19 km L⁻¹ [0.44 mpg] (2.0%). It would also decrease CO₂ emissions by 4.9 g km⁻¹ (1.9%), NO_x emissions by 0.0099 g km⁻¹ (0.80%), CO emissions by 0.31 g km⁻¹ (0.79%), and HC emissions by 0.0074 g km⁻¹ (0.67%). A hypothetical super-white car shell ($\rho = 0.80$) could save 0.29 L per 100 km (2.6%), increasing fuel economy by 0.25 km L⁻¹ [0.59 mpg] (2.7%) and decreasing CO₂, NO_x, CO and HC emissions by 6.7 g km⁻¹ (2.6%), 0.013 g km⁻¹ (1.1%), 0.043 g km⁻¹ (1.1%), and 0.010 g km⁻¹ (0.91%), respectively.

Introduction

Over 95% of the cars and small trucks sold in California have air conditioning (Daly 2006; EPA 2009). Use of air conditioning (AC) in cars has been estimated to increase carbon monoxide (CO) emissions by 1.6 grams/mile (71%), increase nitrogen oxide (NO_x) emissions by 0.19 grams/mile (81%), and reduce fuel economy by 4.6 mpg (Bevilacqua 1999). Air conditioning is the major ancillary load for a light-duty vehicle. (Other ancillary loads include lights and fans.) The AC is sized to cool the cabin air from its "hot soak" condition (i.e., vehicle parked in the sun, facing the equator, on a summer afternoon) to a comfortable quasi-steady temperature, such as 25°C. Reducing the peak cooling load lowers the required cooling capacity, reducing ancillary load, improving fuel economy, and decreasing tailpipe emissions.

The current study focuses on the decrease in soak temperature, reduction in AC capacity, and improvement in fuel economy attainable through the use of solar reflective shells. Here "shell" refers to the opaque elements of the car's envelope, such as its roof and doors. First, we experimentally characterize component temperatures and cooling demands in a pair of otherwise identical dark and light colored vehicles, the former with low solar reflectance and the latter with high solar reflectance. Second, we employ a thermal model to predict the AC capacity required to cool each vehicle to a comfortable final cabin air temperature. Third, we use the ADVISOR vehicle simulation tool to estimate the dependence on ancillary load of the fuel consumption and pollutant emissions of a comparable prototype vehicle in various standard drive cycles. Finally, we calculate the fuel savings and emission reductions attainable by using a cool shell to reduce ancillary load.

Literature review

Extensive research over the past two decades has focused on reducing air conditioner ancillary loads. Most studies consider cabin air temperature, AC cooling load, and/or occupant comfort.

Technology performance

Technologies to reduce AC load include solar reflective glazing, solar reflective shells, ventilation, insulation and window shading (Rugh et al. 2001; Turler et al. 2003; Hoke and Greiner 2005; Rugh and Farrington 2008; Han and Chen 2009). Past research has identified the use of solar reflective glazing as an especially effective strategy for reducing cooling loads since sunlight transmitted through glazing accounts for 70% of cabin heat gain in hot soak conditions (Sullivan and Selkowitz 1990). For example, Rugh et al. (2001) measured that solar reflective glazing in a Ford Explorer decreased cabin air ("breath") temperature by 2.7°C, lowered instrument panel temperatures by 7.6°C, and reduced windshield temperatures by 10.5°C. They also reported that this decrease in cabin air soak temperature would permit an 11% reduction in

AC compressor power. More generally, they estimated that AC compressor power could be decreased by about 4.1% per 1°C reduction in cabin soak temperature.

Akabane et al. (1989) experimentally determined that in a vehicle traveling 40 km/h (25 mph) on a hot day (outdoor air temperature 38°C, horizontal solar irradiance 0.81 kW/m²), about 42% of the vehicle heat load resulted from transmission through the glazing, with about 48% from conduction through the shell and about 10% from engine heat and air leaks.

Rugh and Farrington (2008) found that ventilation and window shading during soak can be effective in reducing AC loads. They concluded that natural ventilation (achieved using appropriately placed inlets to allow for natural convection) can be almost as effective as forced ventilation.

Solar reflective shells have also been reported to reduce cooling loads. Hoke and Greiner (2005) used the RadTherm and UH3D modeling tools to simulate soak conditions for a sport utility vehicle (SUV) parked on a hot summer day in Phoenix, AZ. They concluded that each 0.1 increase in the solar reflectance ρ of the shell reduces the cabin air soak temperature by about 1°C. For example, cabin air soak temperature in a vehicle with a white shell ($\rho=0.50$) was predicted to be 4.6°C lower than that in a comparable vehicle with a black shell ($\rho=0.05$). Rugh and Farrington (2008) measured for several vehicles the reduction in cabin air (breath) soak temperature versus increase in shell solar reflectance. Increasing the shell solar reflectance of a Ford Explorer mid-size SUV by 0.44 lowered cabin air soak temperature by 2.1°C (0.47°C reduction per 0.1 gain in shell solar reflectance), while increasing that of a Lincoln Navigator full-size SUV by 0.45 lowered cabin air soak temperature by 5.6°C (1.2°C reduction per 0.1 gain in shell solar reflectance). Increasing the solar reflectance of only the roof of a Cadillac STS full-size sedan by 0.76 lowered cabin air temperature by 1.2°C (0.15°C reduction per 0.1 gain in roof solar reflectance).

A 3-D computational fluid dynamics (CFD) simulation by Han and Chen (2009) estimated that increasing body insulation reduces steady state thermal load, but raises air cabin temperature during soaking and cooling.

Modeling tools

Simulations of thermal load and thermal comfort in vehicles typically use either lumped-parameter models (Heydari and Jani 2001; Turler et al. 2003; Huang et al. 2007; Junior et al. 2009) or transient CFD models (Henry et al. 2001; Taxis-Reischl et al. 2001; Wolfahrt et al. 2005; Zhang et al. 2009a,b). A study by the National Renewable Energy Laboratory (NREL) concluded that transient CFD tools are best suited for this task (Cullimore and Hendricks 2001).

Bharatan et al. (2007) provide a definitive overview of the models that have been adopted or developed by NREL to simulate environmental loads, thermal comfort, and AC fuel use. We summarize some findings below.

Environmental forcing. The GUI-driven MATLAB application Vehicle Solar Load Estimator (VSOLE), developed by NREL (Rugh 2002), calculates the solar radiation transmitted, absorbed, and reflected by glazing as a function of glazing properties and location, vehicle geometry, vehicle orientation, time, and radiation source.

Thermal modeling. The commercial CFD tool RadTherm can be used to simulate solar heat load, interior and exterior convection, and conduction through the envelope, while the commercial CFD tool Fluent can be used to simulate convective heat transfer and fluid flow in the cabin.

AC performance. An NREL model uses transient analysis to optimize vehicle AC performance (Hendricks 2001).

Fuel economy. The ADVISOR vehicle simulator developed by NREL (Wipke et al. 1999a,b) can simulate the effect of vehicle ancillary load on fuel consumption and pollutant emissions.

Thermal comfort. NREL has applied two models from the University of California at Berkeley—the Human Thermal Physiological Model and the Human Thermal Comfort Empirical Model—to evaluate thermal comfort in vehicles.

Theory

Cabin air temperature model

The cabin air heating rate, or rate at which the internal energy of the cabin air $U(t)$ increases with time t , is

$$\frac{dU}{dt} = m_a c_v \frac{dT_a}{dt}, \quad (1)$$

where m_a is the cabin air mass, c_v is the specific heat of air at constant volume, and $T_a(t)$ is the cabin air temperature. The cabin air is transparent to both sunlight and thermal radiation, but exchanges heat with the air conditioner and the cabin surface. If the air is well mixed, a simple model for the variation of cabin air temperature with time is

$$\frac{dT_a}{dt} = \alpha [T_v(t) - T_a(t)] + \beta [T_s(t) - T_a(t)], \quad (2)$$

where $T_v(t)$ is the temperature of the air flowing into the cabin from the AC vent, $T_s(t)$ is the mean temperature of the cabin's surface, and α and β are fitted constants.

As the cabin air is mechanically cooled, it may reach a quasi-steady state in which $T_a(t)$ asymptotically approaches a final value. In this condition, denoted by the superscript $*$, $(dT_a/dt)^* \approx 0$ and thus

$$T_a^* \approx T_v^* + \frac{\beta}{\alpha}(T_s - T_a)^* . \quad (3)$$

We may need to lower the vent air temperature if the final cabin air temperature T_a^* exceeds some design target $T_a'^*$, such as 25°C. If the difference between the cabin surface temperature and the cabin air temperature $(T_s - T_a)$ is insensitive to the vent air temperature T_v , then

$$\frac{dT_a^*}{dT_v^*} \approx 1 . \quad (4)$$

That is, reducing T_v^* by ΔT will lower T_a^* by approximately ΔT . Resizing the AC to yield a new vent air temperature $T_v'(t) \equiv T_v(t) - \Delta T$ results in a new cabin air temperature $T_a'(t)$ that can be computed by numerically integrating

$$\frac{dT_a'}{dt} = \alpha [T_v'(t) - T_a'(t)] + \beta [T_s(t) - T_a(t)] \quad (5)$$

subject to the initial condition $T_a'(0) = T_a(0)$. Note that the second term on the right hand side of Eq. (5) is the same as that in Eq. (2) because we've assumed that $T_s'(t) - T_a'(t) = T_s(t) - T_a(t)$.

AC capacity model

In recirculation mode, the rates at which the original and resized air conditioners remove heat from the cabin air are

$$q_{AC}(t) = \dot{m} c_p [T_a(t) - T_v(t)] \quad (6)$$

and

$$q'_{AC}(t) = \dot{m} c_p [T_a'(t) - T_v'(t)] , \quad (7)$$

respectively, where \dot{m} is the AC air mass flow rate and c_p is the specific heat of air at constant pressure. To meet peak cooling load, the capacity of the resized AC must be at least

$$Q \equiv \max[q'_{AC}(t)] = \dot{m} c_p \max[T'_a(t) - T'_v(t)]. \quad (8)$$

Fuel saving and emission reduction model

Consider two vehicles that differ only in shell solar reflectance ρ and required AC capacity Q . The reduction in AC capacity attainable by substituting the high-reflectance shell (subscript "H") for the low-reflectance shell (subscript "L") is

$$\Delta Q_H \equiv Q_L - Q_H \quad (9)$$

and the reduction in vehicle ancillary power load P is

$$\Delta P_H = \Delta Q_H / COP \quad (10)$$

where COP is coefficient of performance.

Let F denote fuel consumption rate (volume of fuel per unit distance traveled) and E represent pollutant emission rate (mass of pollutant per unit distance traveled). If reductions in F and E are each linearly proportional to reduction in P , then

$$\Delta F_H = \gamma_F \Delta Q_H / COP \quad (11)$$

and

$$\Delta E_H = \gamma_E \Delta Q_H / COP \quad (12)$$

where $\gamma_F \equiv dF/dP$ and $\gamma_E \equiv dE/dP$ are constant coefficients. (We will show that for the drive cycles simulated in this study, γ_F and γ_E are indeed nearly constant within the ancillary power load ranges considered.)

Finally, consider a cool colored vehicle (subscript "C") that differs from the first two vehicles only in shell solar reflectance and required AC capacity. Based on experience with cooling energy use in buildings (Konopacki et al. 1997), we assume that reduction in required AC capacity scales with increase in solar reflectance, such that

$$\Delta Q_C \equiv Q_L - Q_C = \frac{\rho_C - \rho_L}{\rho_H - \rho_L} \times \Delta Q_H. \quad (13)$$

It then follows that the rates of fuel savings and emission reduction for attainable by substituting the cool colored shell for the low-reflectance shell are

$$\Delta F_C = \gamma_F \Delta Q_C / COP \quad (14)$$

and

$$\Delta E_c = \gamma_E \Delta Q_c / COP \quad (15)$$

respectively.

Experiment (thermal study)

Overview

A pair of otherwise identical light duty vehicles, one with a black shell and the other with a silver shell, were instrumented with surface and air temperature sensors. AC performance was calibrated with an indoor heating and cooling trial. The vehicles were then parked outdoors on a sunny summer day and subjected to a series of five soaking and cooling trials.

Vehicles

Two 2009 Honda Civic 4DR GX compact sedans, one black and one silver, were loaned by California's Department of General Services (Figure 1). Apart from shell color, the vehicles were essentially identical, with only minor differences in odometer distance and AC line pressures (Table 1).

The air mass one global horizontal solar reflectance (Levinson et al. 2010a,b) of each exterior surface (roof) and interior surface (ceiling, dashboard, windshield, seat and door) was measured with a solar spectrum reflectometer (Devices & Services SSR-ER, version 6; Dallas, TX). The hemispherical thermal emittance of each roof and windshield was measured with an emissometer (Devices & Services AE1; Dallas, TX). The solar reflectances of the black and silver roofs were 0.05 and 0.58, respectively, while their thermal emittances were 0.83 and 0.79 (Table 2).

Instrumentation

The roof, ceiling, dashboard, windshield, seat, door, vent air and cabin air temperatures in each car were measured with thermistors (Omega SA1-TH-44006-40-T [surfaces], Omega SA1-TH-44006-120-T [air]; Stamford, CT) and recorded at 1 Hz with a portable data logger (Omega OM-DAQPRO-5300; Stamford, CT). The vent air thermistor was suspended in front of a central HVAC outlet, while the cabin air thermistor was suspended at breath level midway between the front seat headrests. Top and side views of the eight temperature measurement points in each vehicle are shown in Figure 2.

Each vent air and cabin air thermistor was wrapped in aluminum foil (high solar reflectance; low thermal emittance) to minimize both solar absorptance and radiative coupling to the cabin. Interior surface thermistors (ceiling, dashboard, windshield, seat, and door) were wrapped in foil and secured with clear adhesive tape. Clear tape over foil yields high solar reflectance and high

thermal emittance, minimizing solar absorptance while retaining radiative coupling to the cabin. Roof thermistors were affixed with reflectance-matched opaque adhesive tape. Black tape of solar reflectance 0.05 was used on the black roof ($\rho=0.05$), and a light-colored tape of solar reflectance 0.62 was used on the silver roof ($\rho=0.58$).

A weather station (Davis Instruments VantagePro2; Hayward, CA) mounted between the vehicles at a height of 2 m recorded 1 min averages of outside air temperature, relative humidity, global horizontal solar irradiance, and wind speed (Figure 1). Solar irradiance was also measured with a first-class pyranometer (Eppley Laboratory Precision Spectral Pyranometer; Newport, RI) to check the solar irradiance reported by the weather station's silicon radiometer. The first class pyranometer shared a datalogger channel with the black car's vent air thermistor. During daytime trials, the shared channel recorded vent air temperature while the vehicle was being cooled, and solar irradiance at other times.

AC calibration (16 Jul 2010)

On the evening of 16 Jul 2010, each vehicle was parked under a carport to shield it from sunlight. All windows were closed. At 18:38 LST, maximum heating (highest HVAC temperature setting, top fan speed, recirculation mode) was used to raise the cabin air temperature in each vehicle to about 60°C in 16 min. Each cabin's air temperature was then reduced to about 20°C after 20 min of maximum cooling (lowest HVAC temperature setting, top fan speed, recirculation mode). The cabin air and vent air temperatures during the cooling cycle in the black car were compared to those in the silver car to verify that the AC systems performed similarly.

Soaking and cooling (17 Jul 2010)

At 08:00 LST on the following day (17 Jul 2010), the vehicles were removed from the carport and parked outdoors, side by side, facing due south (Figure 1). All windows were closed.

The weather was warm and sunny, with the outside air temperature rising steadily from 21°C at 08:00 LST to 38°C at 16:00 LST. Global horizontal solar irradiance reached about 1.0 kW shortly after noon, and wind speed ranged from about 0.5 to 1.3 m/s (Figure 3). Solar irradiances measured with the silicon radiometer closely matched those measured with the first class pyranometer.

From 08:30 to 16:00 LST, each parked car was run through five rounds of soaking and cooling in which an approximately 60 min soak (HVAC off) was followed by about 30 min of maximum cooling. The soaking and cooling intervals were closely synchronized car-to-car.

Simulations (fuel savings and emission reductions)

We used the vehicle simulation tool ADVISOR to relate rates of fuel consumption, nitrogen oxide (NO_x) emission, carbon monoxide (CO) emission, and hydrocarbon (HC) emission to ancillary power load. ADVISOR was first developed in November 1994. It was designed as an analysis tool to assist the U.S. Department of Energy (DOE) in quantifying the potential for fuel use and emissions reductions of hybrid electric vehicles. ADVISOR simulates vehicle powertrains and power flows among its components (Wipke et al., 1999a,b). Fuel use and tailpipe emissions can be simulated following various standardized driving cycles. In ADVISOR, AC power load is added as an accessory mechanical load.

In this study we focus on ADVISOR simulations of the EPA Speed Correction (SC03) driving cycle, which represents a mix of urban and highway driving with an average speed of 34.8 km/h (21.6 mph). We also show results for the EPA Urban Dynamometer Driving Schedule (UDDS) (average speed = 31.5 km/h = 19.6 mph), and the EPA Highway Fuel Economy Test (HWFET) driving cycle (average speed = 77.7 km/h = 48.3 mph) (EPA 2007). Simulations were performed with ancillary power load ranging from 0 to 4 kW at a resolution of 0.2 kW. Since we did not have access to an ADVISOR vehicle prototype for the Honda Civic, each ADVISOR simulation was run for two available prototypes: one with a 63 kW engine, and the other with a 102 kW engine. Results were then interpolated to match the engine power rating of the Honda Civic (84 kW).

We estimate CO₂ emission reduction from fuel savings at the rate of 2321 g CO₂ per L of gasoline (EPA 2005).

Results

AC calibration (16 Jul 2010)

The heater in the silver car was slightly more powerful than that in the black car, yielding 2-3°C higher peak values of vent air temperature and cabin air temperature. However, the AC systems performed comparably: after just 2 min of cooling, the vent air temperatures matched to within 1°C, and the cabin air temperatures agreed to within 0.5°C (Figure 4).

Soaking and cooling (17 Jul 2010)

Temperatures profiles within each car

Figure 5 shows the evolution of the exterior surface, interior surface, and cabin air temperatures in each car over the course of its five soaking and cooling cycles. The following remarks will

focus on the middle three soaking and cooling cycles, which span 10:00 - 14:30 LST and are centered about solar noon (~12:15 LST).

While soaking, the warmest surfaces of the black car is usually its black roof (solar absorptance $A = 1 - \rho = 0.95$) and black dashboard (also $A = 0.95$), both of which are directly heated by the sun. Its next warmest surfaces are the ceiling (conductively heated by the roof and radiatively heated by the dashboard and windshield), followed very closely by the windshield (radiatively and convectively heated by the dashboard). The seat, which is heated primarily by radiative exchange with the ceiling, is markedly cooler. The coolest interior surface in the black car is the door, which from geometric considerations can be expected to receive less than half its thermal radiation from the ceiling.

The warmest surfaces of the silver car while soaking are its black dashboard ($A = 0.95$), which is directly heated by the sun, and its windshield, which is radiatively and convectively heated by the dashboard. The next warmest surfaces are its silver roof (directly heated by the sun, but absorbing only 42% of sunlight) and its ceiling (conductively heated by the roof and radiatively heated by the dashboard and windshield). As in the black car, the seat is marked cooler, and the door is coolest.

We note that in each car, abnormally high door temperatures are observed during the first and last soaking cycles, and abnormally high seat temperatures are seen in the last soaking cycle. This is simply due to direct solar illumination of door exterior and seat surface, which does not occur at other times.

Air conditioning rapidly cools both the cabin air and all interior surfaces in each vehicle. Dashboard and windshield temperatures remain well above the cabin air temperature because the dashboard is still heated by the sun and the windshield is radiatively coupled to the dashboard. Air conditioning has little effect on roof surface temperature, indicating that the conductive heat flow through the lined ceiling is small compared to the roof's solar heat gain.

We approximate each car's cabin surface temperature T_s as the area-weighted average of its ceiling, dashboard, windshield, seat and door surface temperatures. This estimate of mean interior surface temperature neglects unmonitored surfaces, including the floor, rear window and side windows. Figure 6 show the evolutions of T_s , T_a and T_v in each car, as well as those of $T_a - T_v$ and $T_s - T_a$. (Since the vent air temperature is relevant only when the AC is on, zero values drawn for T_v and $T_a - T_v$ during the soak cycles should be ignored.)

Black car versus silver car

Figure 7 compares the roof, ceiling, dashboard, windshield, seat, door, vent air and cabin air temperatures in the black car to those in the silver car. As expected, the greatest temperature

difference is observed at the roof, where the black car was up to 25°C warmer than the silver surface. While soaking, the ceiling temperature difference (black - silver) peaked at 11°C, while the dashboard temperature difference was less than 5°C and the windshield temperature difference was less than 2°C. The seat and door temperature differences reached 7°C and 5°C, respectively. The vent air and cabin air temperature differences each peaked around 5-6°C.

Figure 8 compares the cabin air heating rate dU/dt and AC cooling rate q_{AC} in the black car to those in the silver car. While cooling, the difference in dU/dt is roughly centered about zero and less than 0.03 in magnitude. The difference in q_{AC} is much larger, peaking around 0.3 kW. During the cooling cycle, q_{AC} is one to two orders of magnitude larger than dU/dt , suggesting that most of the heat removed by the AC comes from the cabin surface, rather than the cabin air.

Cooldown temperature versus soak temperature

The five cooling cycles are denoted “cool1” through “cool5”. Table 3 summarizes the properties of each cooling cycle, including its start and end time, duration, primary weather conditions, cabin air and surfaces temperatures after soaking and after cooling, and vent air temperatures after cooling. Each temperature is reported first for the black car, then for the silver car, followed by the black - silver temperature difference.

The cabin air and vent air temperatures attained after ~30 min of cooling each strongly and linearly correlate to the cabin air temperature reached after ~60 min of soaking, with coefficient of determination $R^2 > 0.99$ for the former and $R^2 = 0.95$ for the latter (Figure 9a). The (area weighted mean) cabin surface temperatures attained after soaking and after cooling also linearly correlate to the cabin air soak temperature, with $R^2 = 0.87$ and $R^2 = 0.93$, respectively (Figure 9b). The same linear relationships work equally well for both cars. This indicates that under the strictly controlled conditions of these trials, cabin air soak temperature captures the thermal history of the soaking interval sufficiently well to predict cabin air and cabin surface temperatures after cooling.

Applicability of cabin air temperature model

The validity of the cabin air temperature model in Eq. (2) was tested by regressing the rate of change of the cabin air temperature, dT_a/dt , to the temperature differences $T_v - T_a$ and $T_s - T_a$. Fit coefficients α and β for each car and cooling cycle are presented in Table 4, along with each fit's coefficient of determination R^2 . Values of R^2 were fairly high, ranging from 0.86 to 0.93 for the black car and 0.86 to 0.95 for the silver car. Figure 10 shows the measured and fitted values of dT_a/dt for the fourth cooling cycle in each car.

Figure 11 shows the variation with cooling time of the cabin air temperature reduction $T_a(0) - T_a(t)$ in each vehicle. Cooling is rapid at the start of each 30 min cycle and slow near its end. For example, during the fourth cooling cycle, the cabin air temperature in the black car falls 16°C in the first two minutes (8°C/min), another 11°C in the next 18 minutes (0.6°C/min), and just 2°C in the final 10 minutes (0.2°C/min). This indicates that T_a asymptotically approaches a quasi-steady value T_a^* toward the end of the cooling cycle.

Figure 12 shows the variation with cooling time of $T_s - T_a$ in each car. In the three middle cooling cycles (cool2, cool3 and cool4), this temperature difference varies little after the first two minutes of cooling. For example, during the final 28 minutes of the fourth cooling cycle, $T_s - T_a$ decreases by 1.2°C in the black car and 0.5°C in the silver car, while the vent air temperatures each fall by about 7°C. This indicates that $T_s - T_a$ depends only weakly on T_v .

Resizing AC to attain 25°C final cabin air temperature

The black car attained a final cabin air temperature below 25°C in the first cooling cycle, and the silver car did so in the first and second cooling cycles. Otherwise, neither vehicle's cabin air temperature was reduced to 25°C or lower after approximately 30 min of maximum cooling. For example, at the end of the fourth cooling cycle, the cabin air temperatures in the black and silver cars were 34.3°C and 29.9°C, respectively (Table 4).

To attain a lower final cabin air temperature $T_a'^*$, Eq. (4) indicates that the vent air temperature $T_v(t)$ must be decreased by the difference ΔT between the cabin air final temperature T_a^* (approximated by the cabin air temperature measured at the end of the cooling cycle) and $T_a'^*$. For example, in the fourth cooling cycle ΔT would be 9.3°C for the black car and 4.9°C for the silver car if $T_a'^* = 25^\circ\text{C}$.

New vent air temperature profiles $T_v'(t) \equiv T_v(t) - \Delta T$ were computed for each car and cooling cycle based on the value of ΔT required to cool the cabin air to 25°C. Eq. (5) was then numerically integrated to compute the new cabin air temperature profile $T_a'(t)$. Figure 13 compares the measured and fitted values of $T_a(t)$ in the fourth cooling cycle to the values of $T_a'(t)$ computed after decreasing the black and silver cars' vent air temperatures by $\Delta T = 9.3^\circ\text{C}$ and $\Delta T = 4.9^\circ\text{C}$, respectively. Also drawn for reference is the cooldown target temperature (25°C).

AC cooling rates before and after vent temperature reduction were computed from Eqs. (6) and (7). Figure 14 shows for the fourth cooling cycle in each car the measured AC cooling rate and

the AC cooling rate after lowering the vent air temperature to attain a final cabin air temperature of 25°C.

The AC cooling capacity Q (peak AC cooling rate) required to attain $T_a^* = 25^\circ\text{C}$ was computed from Eq. (8) for each car and cooling cycle (Table 4). For example, in the fourth cooling cycle Q was 3.83 kW in the black car, and 3.34 kW in the silver car. The ratio of Q_{silver} to Q_{black} ranged from 0.83 to 0.87 over the three middle cooling cycles.

Fuel savings and emission reductions

Fuel consumption and pollutant emission versus ancillary power load

Table 5 shows values of γ obtained by linearly regressing ADVISOR simulations of fuel consumption, NO_x emission, CO emission and HC emission rates to ancillary power load. The variations of fuel consumption and emissions with ancillary load were highly linear within the simulated range (0-4 kW) and the minimum coefficient of determination (R^2) was 0.96. Figure 15 relates reductions in fuel consumption and emission to the ancillary loads of the standard (black) and cool (nonblack) cars. Each curve represents a different value for ancillary load of the standard car. For brevity, we present charts only for the SC03 driving cycle, which represents a mix of urban and highway driving.

Fuel savings and emission reductions versus cool car solar reflectance

Since roof and cabin air soak temperatures peaked in the fourth cycle (Table 3), AC capacity requirements Q_L (black car) and Q_H (silver car) were based on values computed for the fourth cooling cycle. The following analysis assumes AC capacities $Q_L = 3.83$ kW and $Q_H = 3.34$ kW and shell solar reflectances $\rho_L = 0.05$ and $\rho_H = 0.58$, for a capacity reduction of 92.5 W per 0.1 increase in shell solar reflectance. We also assume a COP of 2.

Table 6, Figure 16, and Figure 17 present fuel savings and emissions reductions attained when a cool (solar reflective) car shell is substituted for a standard (black) car shell ($\rho = 0.05$). Dashed vertical lines in Figure 16 and Figure 17 mark the shell solar reflectances of a typical cool colored car ($\rho = 0.35$), a typical white or silver car ($\rho = 0.60$), and a hypothetical super-white car ($\rho = 0.80$). Figure 16 shows fractional fuel savings and emissions reductions and Figure 17 shows absolute fuel savings and emissions reductions.

Results from our model with γ values from the SC03 drive cycle indicate selecting a typical cool colored shell ($\rho = 0.35$) would reduce fuel consumption by 0.12 L per 100 km (1.1%), increasing fuel economy by 0.10 km L⁻¹ [0.24 mpg] (1.1%). It would also decrease CO₂ emissions by 2.7 g km⁻¹ (1.1%), NO_x emissions by 0.0054 g km⁻¹ (0.44%), CO emissions by

0.017 g km⁻¹ (0.43%), and HC emissions by 0.0041 g km⁻¹ (0.37%). Selecting a typical white or silver shell ($\rho = 0.60$) instead of a black shell would lower fuel consumption by 0.21 L per 100 km (1.9%), raising fuel economy by 0.19 km L⁻¹ [0.44 mpg] (2.0%). It would also decrease CO₂ emissions by 4.9 g km⁻¹ (1.9%), NO_x emissions by 0.0099 g km⁻¹ (0.80%), CO emissions by 0.31 g km⁻¹ (0.79%), and HC emissions by 0.0074 g km⁻¹ (0.67%). A hypothetical super-white car shell ($\rho = 0.80$) could save 0.29 L per 100 km (2.6%), increasing fuel economy by 0.25 km L⁻¹ [0.59 mpg] (2.7%) and decreasing CO₂, NO_x, CO and HC emissions by 6.7 g km⁻¹ (2.6%), 0.013 g km⁻¹ (1.1%), 0.043 g km⁻¹ (1.1%), and 0.010 g km⁻¹ (0.91%), respectively.

We can compare fuel and emissions reductions of urban versus highway driving by observing results for the UDDS and HWFET driving cycles (Figure 16). Relative to the SC03 drive cycle, fuel savings are larger for the UDDS cycle (highway driving) and smaller for the HWFET cycle (urban driving). Further, relative to the SC03 cycle, emissions reductions for NO_x, CO, and HC are smaller for both the UDDS cycle and HWFET cycle. Emissions reductions are larger for UDDS than HWFET for NO_x, CO, and HC. This may be due to the fact that emissions are more sensitive to transients (e.g., simulated vehicle accelerations) in driving cycles (Samuel et al. 2002).

Summary

In this study we estimate the decrease in soak temperature, potential reduction in AC capacity, and potential fuel savings and emission reductions attainable through the use of solar reflective shells. First, we experimentally characterized component temperatures and cooling demands in a pair of otherwise identical dark and light colored vehicles, the former with low solar reflectance ($\rho = 0.05$) and the latter with high solar reflectance ($\rho = 0.58$). Second, we developed a thermal model that predicted the AC capacity required to cool each vehicle to a comfortable final temperature of 25°C within 30 minutes. Third, we use the ADVISOR vehicle simulation tool to estimate the fuel consumption and pollutant emissions of each vehicle in various standard drive cycles (SC03, UDDS, and HWFET). Finally, we calculated the fuel savings and emission reductions attainable by using a cool shell to reduce ancillary load.

The air conditioners in the experimental vehicles were in most trials too small to lower cabin air temperature to 25°C within 30 minutes. We estimate that if the vehicle ACs were resized to meet this target, the AC cooling capacity would be 3.83 kW for the car with low solar reflectance and 3.34 kW for the car with high solar reflectance (Table 4).

Assuming that potential reductions in AC capacity and engine ancillary load scale linearly with increase in shell solar reflectance, ADVISOR simulations of the SC03 urban/highway driving cycle (SC03) indicate that substituting a typical cool-colored shell ($\rho = 0.35$) for a black shell ($\rho = 0.05$) would reduce fuel consumption by 0.12 L per 100 km (1.1%), increasing fuel economy by 0.10 km L⁻¹ [0.24 mpg] (1.1%). It would also decrease CO₂ emissions by 2.7 g km⁻¹

(1.1%), NO_x emissions by 0.0054 g km⁻¹ (0.44%), CO emissions by 0.017 g km⁻¹ (0.43%), and HC emissions by 0.0041 g km⁻¹ (0.37%). Selecting a typical white or silver shell ($\rho = 0.60$) instead of a black shell would lower fuel consumption by 0.21 L per 100 km (1.9%), raising fuel economy by 0.19 km L⁻¹ [0.44 mpg] (2.0%). It would also decrease CO₂ emissions by 4.9 g km⁻¹ (1.9%), NO_x emissions by 0.0099 g km⁻¹ (0.80%), CO emissions by 0.31 g km⁻¹ (0.79%), and HC emissions by 0.0074 g km⁻¹ (0.67%). A hypothetical super-white car shell ($\rho = 0.80$) could save 0.29 L per 100 km (2.6%), increasing fuel economy by 0.25 km L⁻¹ [0.59 mpg] (2.7%) and decreasing CO₂, NO_x, CO and HC emissions by 6.7 g km⁻¹ (2.6%), 0.013 g km⁻¹ (1.1%), 0.043 g km⁻¹ (1.1%), and 0.010 g km⁻¹ (0.91%), respectively.

Acknowledgments

We wish to thank the California Department of General Services for use of their vehicles and facility, with special appreciation to Kimberly Harbison for her assistance; John Rugh of the National Renewable Energy Laboratory, for technical advice; and Philip Misemer of the California Energy Commission, for guiding our project.

References

- Akabane, T., S. Ikeda, K. Kikuchi, Y. Tamura, R. Sakano, W. Bessler, and H. Harms. 1989. Evaluation of an electrically driven automotive air conditioning system using a scroll hermetic compressor with a brushless DC Motor, SAE Technical Paper 890308, DOI: 10.4271/890308.
- Bevilacqua, O. M. 1999. Effect of air conditioning on regulated emissions for in-use vehicles. A report prepared by Clean Air Vehicle Technology Center for Coordinated Research Council, Inc.
- Bharathan, D., L. Chaney, R.B. Farrington, J. Lustbader, M. Keyser and J. Rugh. 2007. An overview of vehicle test and analysis from NREL's A/C fuel use reduction research. Paper presented at Vehicle Thermal Management Systems Conference & Exhibition (VTMS-8), May 20-24, Nottingham, UK.
- Carslaw, H.S., and J.C. Jeager. 1959. *Conduction of Heat in Solids*, 2nd ed. Clarendon Press, Oxford.
- Clear, R.D, L. Gartland and F.C. Winkelmann. 2003. An empirical correlation for the outside convective air-film coefficient for horizontal roofs, *Energy & Buildings* 35, 797-811
- Cullimore, B.A., and T.J. Hendricks. 2001. Design and transient simulation of vehicle air conditioning systems. Paper presented at Vehicle Thermal Management Systems Conference & Exhibition, May, Nashville, TN, USA.
- Daly, S. 2006. *Automotive air-conditioning and climate control systems*. Butterworth-Heinemann, Lincare House, Jordan Hill, Oxford OX2 8DP, 30 Corporate Drive, Suite 400 Burlington, MA 01803.

EPA. 2005. Emission facts: average carbon dioxide emissions resulting from gasoline and diesel fuel. Office of Transportation and Air Quality, U.S. Environmental Protection Agency. EPA-420-F-05-001, February.

EPA. 2007. Federal Test Procedure Revisions: Driving Cycles. Office of Transportation and Air Quality, U.S. Environmental Protection Agency. Online Resource. <http://www.epa.gov/oms/sftp.htm#cycles>. Accessed December, 2010.

EPA. 2009. Draft Regulatory Impact Analysis: Proposed Rulemaking to Establish Light-Duty Vehicle Greenhouse Gas Emission Standards and Corporate Average Fuel Economy Standards. Assessment and Standards Division, Office of Transportation and Air Quality, U.S. Environmental Protection Agency. EPA-420-D-09-003, September.

Han, T., and K.H. Chen. 2009. Assessment of various environmental thermal loads on passenger compartment soak and cool-down analyses. Paper presented at SAE World Congress & Exhibition, April, Detroit, MI, USA

Hassan, K., and S.A. Mohamed. 1970. Natural convection from isothermal flat surfaces. *International Journal of Heat and Mass Transfer* 13 (12), 1873-1886

Hendricks, T. J. 2001. Optimization of vehicle air conditioning systems using transient air conditioning performance analysis. Paper presented at Vehicle Thermal Management Systems Conference & Exposition, May, Nashville, TN, USA.

Hendricks, T. J. 2001. Vehicle transient air conditioning analysis: Model development & system optimization investigations. Golden, Colorado, USA: NREL/TP-540-30715.

Henry, R. R., J. Koo and C. Richter. 2001. Model development, simulation and validation, of powertrain cooling system for a truck application. Paper presented at Vehicle Thermal Management Systems Conference & Exposition, Nashville, TN, USA.

Heydari, A., and S. Jani. 2001. Entropy-minimized optimization of an automotive air conditioning and HVAC system. Paper presented at SAE World Congress, March, Detroit, MI, USA.

Hoke, P.B., and C. Greiner. 2005. Vehicle paint radiation properties and affect on vehicle soak temperature, climate control system load, and fuel economy. Paper presented at SAE World Congress & Exhibition, April, Detroit, MI, USA.

Huang, D., M.S. Wallis, E. Oker and S. Lepper. 2007. Design of vehicle air conditioning systems using heat load analysis. Paper presented at SAE World Congress & Exhibition, April, Detroit, MI, USA.

Junior, C. S., N.C. Strupp, N. C. Lemke and J. Koehler. 2009. Modeling a thermoelectric HVAC system for automobiles. *Journal of Electronic Materials* 38 (7), 1093-1097.

Konopacki, S., H. Akbari, M. Pomerantz, S. Gabersek and L. Gartland. 1997. Cooling energy savings potential of light-colored roofs for residential and commercial buildings in 11 US metropolitan areas. Technical Report LBNL-39433, Lawrence Berkeley National Laboratory, Berkeley, CA.

Kyle, D.M., V.C. Mei and F.C. Chen. 1993. An automobile air conditioning design model. Paper presented at Vehicle Thermal Management System Conference, March, Columbus, OH, USA.

Levinson, R., H. Akbari and P. Berdahl. 2010a. Measuring solar reflectance—Part I: defining a metric that accurately predicts solar heat gain. *Solar Energy* 84, 1717-1744.

Levinson, R., H. Akbari and P. Berdahl. 2010b. Measuring solar reflectance—Part II: review of practical methods. *Solar Energy* 84, 1745-1759.

Rugh, J. P., T.J. Hendricks and K. Koram. 2001. Effect of solar reflective glazing on Ford Explorer climate control, fuel economy, and emissions. Paper presented at International Body Engineering Conference & Exposition, October 2001, Detroit, MI, USA.

Rugh, J. 2002. Integrated numerical modeling process for evaluating automobile climate control systems. Paper presented at Future Car Congress, June, Crystal City, VA, USA.

Rugh, J.P., and V.S. Malaney. 2004. Comparison of indoor vehicle thermal soak tests to outdoor tests. Paper presented at Future Car Congress, April 2004, Crystal City, VA, USA.

Rugh, J., and R. Farrington. 2008. Vehicle ancillary load reduction project close-out report: An overview of the task and a compilation of the research results. Golden, CO: National Renewable Energy Laboratory (NREL), NREL/TP-540-42454.

Samuel, S., L. Austin, and D. Morrey. 2002. Automotive test drive cycles for emission measurement and real-world emission levels – a review. *Proceedings Institution of Mechanical Engineers*. 216, 555-564.

Sullivan, R., and S. Selkowitz. 1990. Effects of Glazing and Ventilation Options on Automobile Air Conditioner Size and Performance. Paper presented at SAE International Congress and Exposition. February, Detroit, MI, USA.

Taxis-Reischl, B., S. Morgenstern, T. Mersch and F. Brotz. 2001. Progress in the optimized application of simulation tools in vehicle air conditioning. Paper presented at Vehicle Thermal Management Systems Conference & Exposition, May, Nashville, TN, USA.

Turler, D., D. Hopkins and H. Goudey. 2003. Reducing vehicle ancillary loads using advanced thermal insulation and window technologies. Paper presented at SAE World Congress & Exhibition, Detroit, MI, USA.

Wipke, K.; M. Cuddy, D. Bharathan, S. Burch, V. Johnson, A. Markel and S. Sprik. 1999a. ADVISOR 2.0: A Second-Generation Advanced Vehicle Simulatory for Systems Analysis. 14 pp. NREL Report No. TP-540-25928, Golden, CO: NREL.

Wipke, K., M. Cuddy and S. Burch. 1999b. ADVISOR 2.1: A user-friendly advanced powertrain simulation using a combined backward/forward approach. 14 pp. NREL Report No. JA-540 26839, Golden, CO: NREL.

Wolfahrt, J., W. Baier, B. Wiesler, A. Raulot, J. Rugh, D. Bharathan and C. Kussman. 2005. Aspects of cabin fluid dynamics, heat transfer, and thermal comfort in vehicle thermal management simulations. Paper presented at Vehicle Thermal Management Systems Conference & Exposition, May, Toronto, ON, Canada.

Zhang, H., L. Dai, G. Xu, Y. Li, W. Chen and W. Tao. 2009a. Studies of air-flow and temperature fields inside a passenger compartment for improving thermal comfort and saving energy. Part I: Test/numerical model and validation. *Applied Thermal Engineering* 29 (7), 2022-2027.

Zhang, H., L. Dai, G. Xu, Y. Li, W. Chen and W. Tao. 2009b. Studies of air-flow and temperature fields inside a passenger compartment for improving thermal comfort and saving energy. Part II: Simulation results and discussion. *Applied Thermal Engineering* 29 (7), 2028-2036.

Table 1. General properties of test vehicles.

make and model	2009 Honda Civic 4DR GX	
cabin volume (m ³)	2.57	
engine idle speed (RPM)	700	
AC air flow rate (m ³ /s)	0.1	
	<i>black</i>	<i>silver</i>
odometer distance (mi) [km]	4300 [6900]	6200 [10000]
AC line high pressure (psi) [MPa]	165 [1.13]	175 [1.20]
AC line low pressure (psi) [MPa]	35 [0.24]	40 [0.28]

Table 2. Vehicle surface properties.

surface	area (m²)	solar reflectance	thermal emittance
roof	2.0	0.05 (black) 0.58 (silver)	0.83 (black) 0.79 (silver)
ceiling	2.0	0.41	n/a
dashboard	0.6	0.06	n/a
windshield	0.9	0.06	0.88
seat	2.4	0.38	n/a
door	3.0	0.11	n/a

Table 3. Cooling trial measurements. Temperature differences are black car - silver car.

cycle	cool1	cool2	cool3	cool4	cool5
start (LST)	09:32	11:02	12:33	14:02	15:32
end (LST)	09:59	11:32	13:01	14:32	16:00
duration (min)	28	30	28	30	28
mean outdoor air temperature (°C)	25.0	28.8	32.9	35.8	37.5
mean solar irradiance (kW/m ²)	0.83	0.98	1.00	0.86	0.64
black cabin air temperature after soaking (°C)	47.7	55.9	61.8	64.4	63.6
silver cabin air temperature after soaking (°C)	43.3	50.7	56.1	58.0	57.3
cabin air temperature difference after soaking (°C)	4.4	5.2	5.7	6.4	6.4
black cabin air temperature after cooling (°C)	22.1	27.7	32.0	34.3	33.7
silver cabin air temperature after cooling (°C)	19.6	24.9	28.2	29.9	29.5
cabin air temperature difference after cooling (°C)	2.5	2.8	3.8	4.4	4.2
black cabin surface temperature after soaking (°C)	48.5	53.3	58.0	62.2	66.0
silver cabin surface temperature after soaking (°C)	45.3	48.4	52.5	56.4	59.9
cabin surface temperature difference after soaking (°C)	3.2	4.9	5.5	5.8	6.1
black cabin surface temperature after cooling (°C)	28.7	33.7	38.3	40.9	42.7
silver cabin surface temperature after cooling (°C)	27.4	30.5	34.2	36.5	38.3
cabin surface temperature difference after cooling (°C)	1.3	3.2	4.1	4.4	4.4
black vent air temperature after cooling (°C)	9.6	14.2	17.4	20.5	20.2
silver vent air temperature after cooling (°C)	9.1	13.0	15.4	16.8	17.0
vent air temperature difference after cooling (°C)	0.5	1.2	2.0	3.7	3.2

Table 4. Characteristics of each cooling trial, including fit parameters α and β ; coefficient of determination R^2 ; measured final cabin air temperature T_a^* ; and AC cooling capacity Q needed to attain a final cabin air temperature of 25°C.

trial	α [s ⁻¹]	β [s ⁻¹]	R^2	T_a^* [°C]	Q [kW]
black_cool1	0.017	0.030	0.86	22.1	2.60
black_cool2	0.012	0.024	0.90	27.7	3.05
black_cool3	0.010	0.023	0.88	32.0	3.66
black_cool4	0.012	0.024	0.93	34.3	3.83
black_cool5	0.015	0.022	0.93	33.7	3.64
silver_cool1	0.018	0.025	0.95	19.6	2.35
silver_cool2	0.012	0.024	0.86	24.9	2.61
silver_cool3	0.011	0.023	0.90	28.2	3.03
silver_cool4	0.011	0.023	0.89	29.9	3.34
silver_cool5	0.015	0.022	0.90	29.5	3.25

Table 5. Coefficients of proportionality γ relating changes in rates of fuel consumption F , NO_x emission E_{NO_x} , CO emission E_{CO} and HC emission E_{HC} in each of three drive cycles to change in ancillary power load.

Coefficient	UDDS	SC03	HWFET
γ_F (L per 100km per kW)	0.884	0.830	0.403
γ_{E,NO_x} ($\text{g km}^{-1} \text{ kW}^{-1}$)	0.033	0.039	0.024
$\gamma_{E,\text{CO}}$ ($\text{g km}^{-1} \text{ kW}^{-1}$)	0.060	0.123	0.029
$\gamma_{E,\text{HC}}$ ($\text{g km}^{-1} \text{ kW}^{-1}$)	0.022	0.029	0.010

Table 6. Variations with shell solar reflectance of rates of fuel consumption, fuel savings, pollutant emission and emission reduction for a compact sedan (engine power 84 kW). Results are presented for three different drive cycles simulated using ADVISOR. Parenthetical results indicate percent reductions in fuel consumption and emissions rates relative to the black car.

	Driving Cycle	Black car ($\rho = 0.05$)	Cool colored car ($\rho = 0.35$)	Silver or white car ($\rho = 0.60$)	Hypothetical super-white car ($\rho = 0.80$)
Fuel consumption (L per 100 km)					
	SC03	10.95	10.84	10.74	10.67
	UDDS	10.59	10.46	10.36	10.28
	HWFET	6.86	6.80	6.76	6.72
Fuel savings (L per 100 km)					
	SC03	NA	0.12 (1.1%)	0.21 (1.9%)	0.29 (2.6%)
	UDDS	NA	0.12 (1.2%)	0.23 (2.1%)	0.31 (2.9%)
	HWFET	NA	0.056 (0.82%)	0.10 (1.5%)	0.14 (2.0%)
CO ₂ emission reduction (g km ⁻¹)*					
	SC03	NA	2.7	4.9	6.7
	UDDS	NA	2.9	5.2	7.1
	HWFET	NA	1.3	2.4	3.3
NO _x emission (g km ⁻¹)					
	SC03	1.22	1.22	1.22	1.21
	UDDS	0.70	0.69	0.69	0.69
	HWFET	0.53	0.53	0.53	0.52
NO _x emission reduction (g km ⁻¹)					
	SC03	NA	0.0054 (0.44%)	0.0099 (0.80%)	0.013 (1.1%)
	UDDS	NA	0.0047 (0.67%)	0.0085 (1.2%)	0.012 (1.7%)
	HWFET	NA	0.0033 (0.62%)	0.0061 (1.1%)	0.0083 (1.6%)
CO emission (g km ⁻¹)					
	SC03	3.99	3.98	3.96	3.95
	UDDS	2.07	2.06	2.06	2.05
	HWFET	1.69	1.69	1.69	1.68
CO emission reduction (g km ⁻¹)					
	SC03	NA	0.017 (0.43%)	0.031 (0.79%)	0.043 (1.07%)
	UDDS	NA	0.0084 (0.41%)	0.015 (0.74%)	0.021 (1.01%)
	HWFET	NA	0.0040 (0.24%)	0.0073 (0.43%)	0.010 (0.59%)
HC emission (g km ⁻¹)					
	SC03	1.12	1.11	1.11	1.11
	UDDS	0.61	0.61	0.61	0.60
	HWFET	0.46	0.46	0.46	0.46

(table continues next page)

	Driving Cycle	Black car ($\rho = 0.05$)	Cool colored car ($\rho = 0.35$)	Silver or white car ($\rho = 0.60$)	Hypothetical super-white car ($\rho = 0.80$)
HC emission reduction (g km ⁻¹)					
	SC03	NA	0.0041 (0.37%)	0.0074 (0.67%)	0.010 (0.91%)
	UDDS	NA	0.0031 (0.50%)	0.0056 (0.92%)	0.0076 (1.3%)
	HWFET	NA	0.0014 (0.30%)	0.0025 (0.55%)	0.0034 (0.75%)

* CO₂ emission reduction calculated at the rate of 2321 g CO₂ per L gasoline (EPA 2005)



Figure 1. Experimental vehicles parked facing south in Sacramento, CA on July 17, 2010. Tower between vehicles (black car, solar reflectance 0.05, left; silver car, solar reflectance 0.58, right) supports a Davis Instruments Vantage Pro weather station (upper mount) and an Eppley Laboratory Precision Spectral Pyranometer (lower mount).

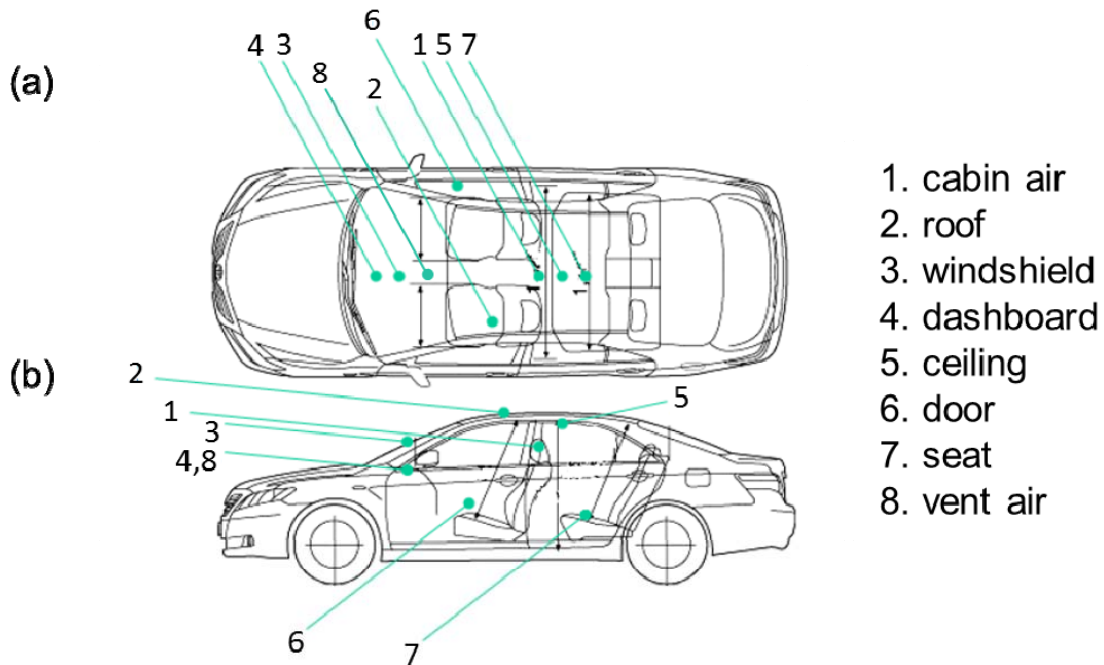

Figure 2. Locations of the eight cabin temperature sensors (thermistors), shown in (a) top view and (b) side view.

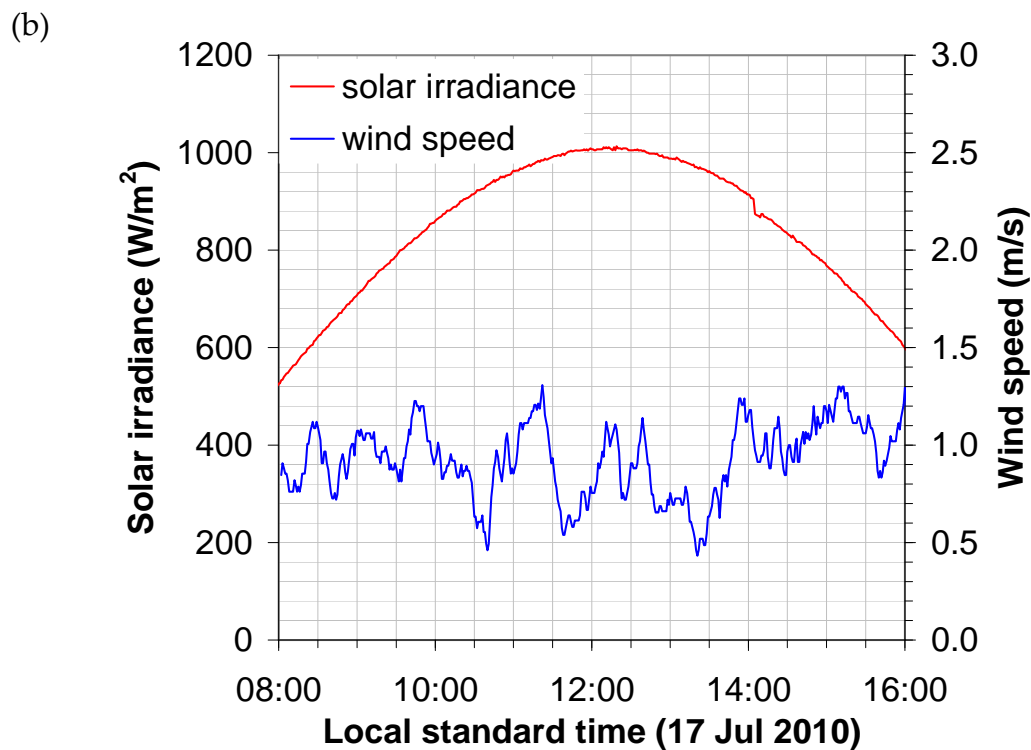
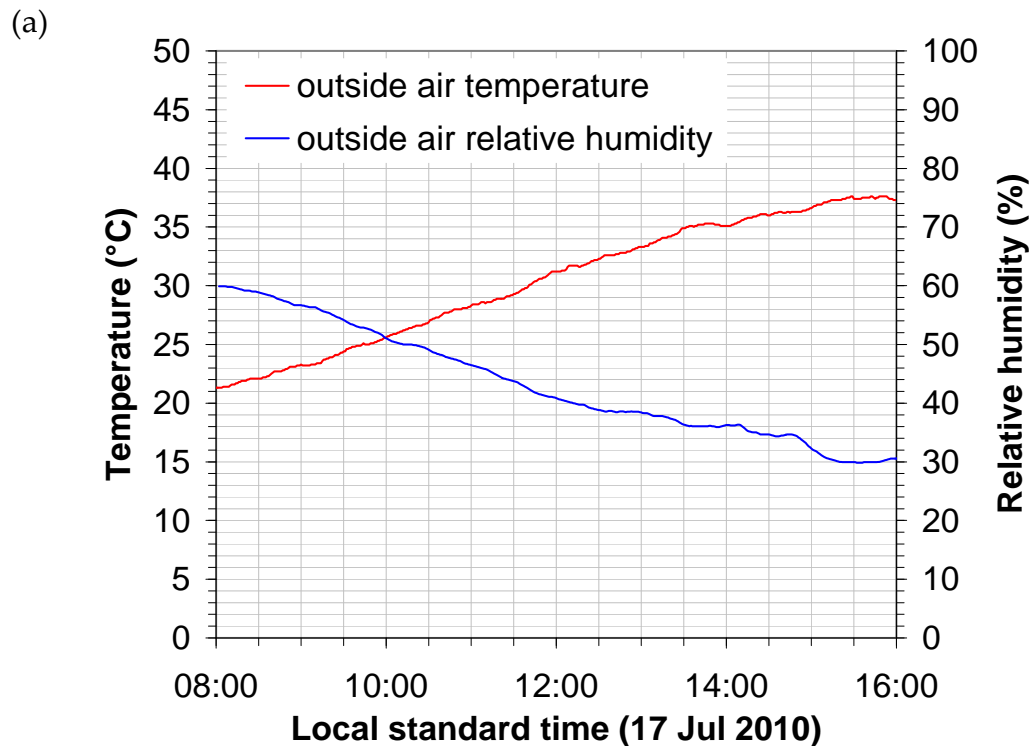

Figure 3. Weather during soaking and cooling trials, including (a) outdoor air temperature and humidity and (b) global horizontal solar irradiance and wind speed.

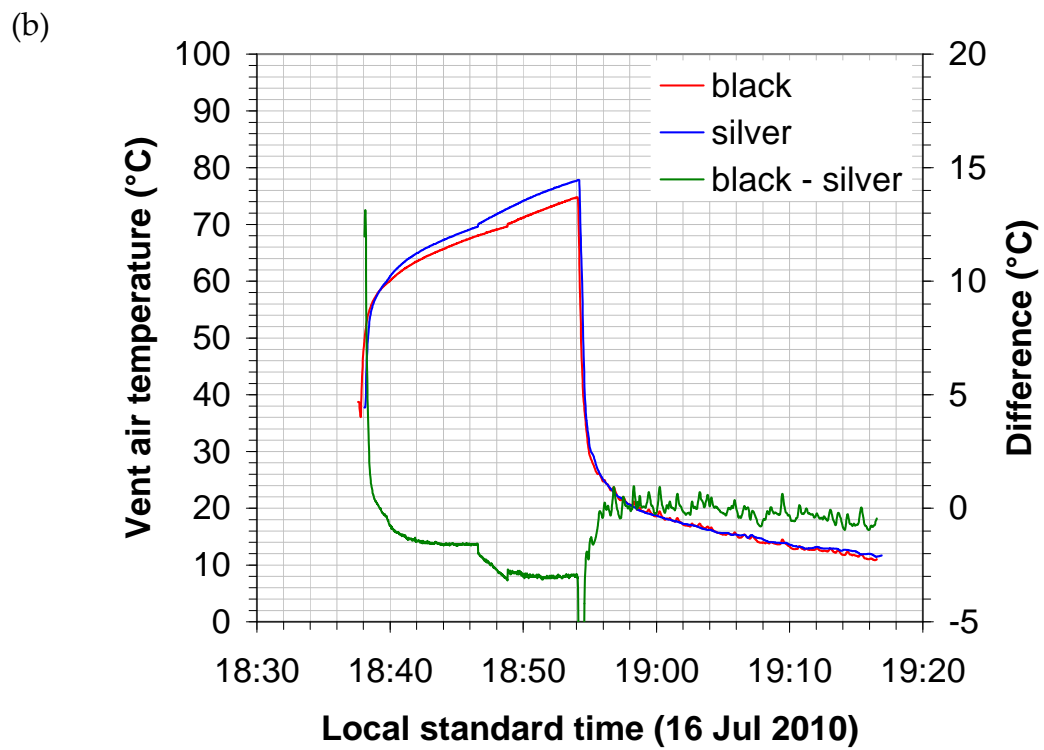
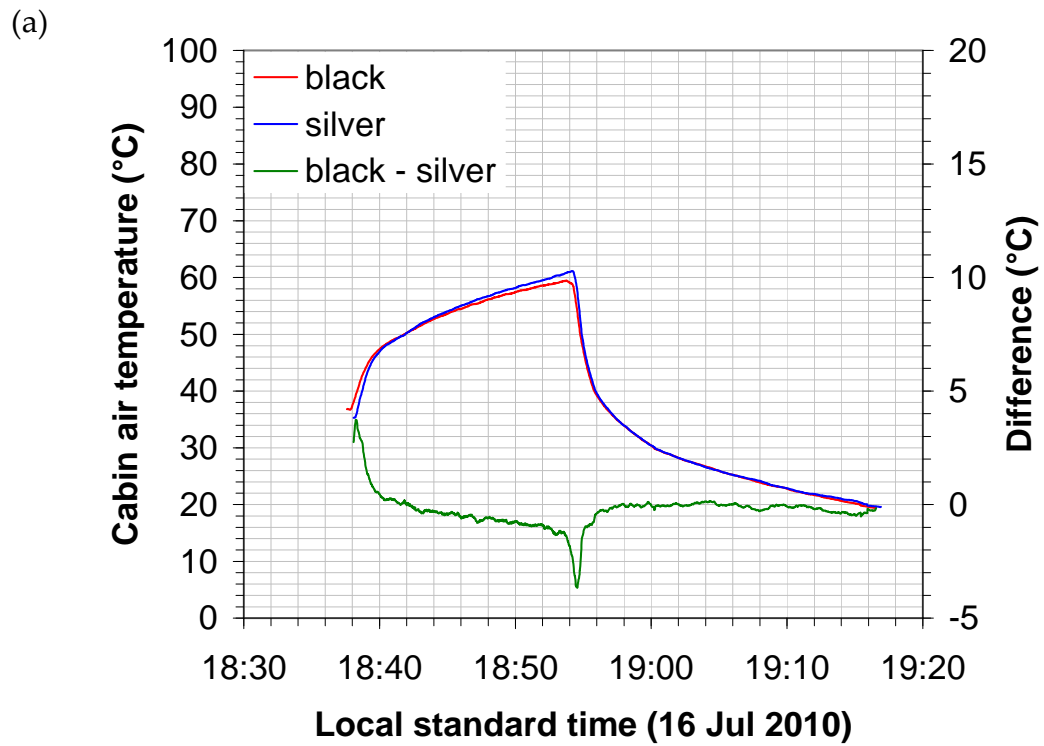

Figure 4. Comparisons of (a) cabin air temperature and (b) vent air temperature in each car during indoor HVAC calibration.

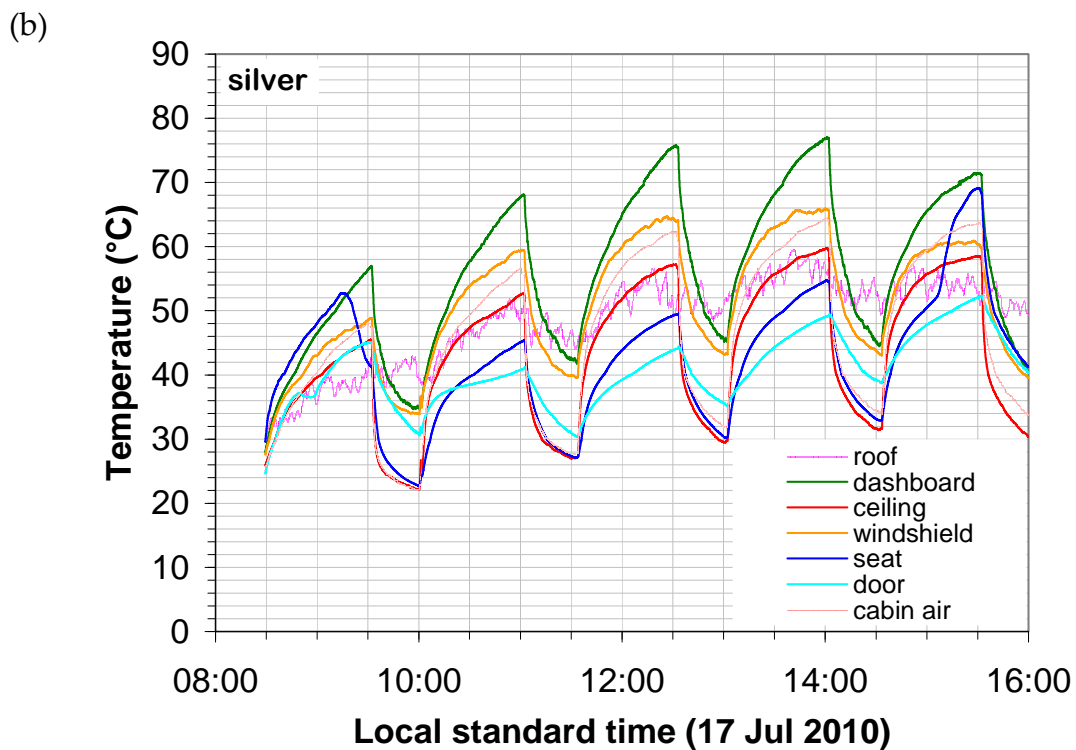
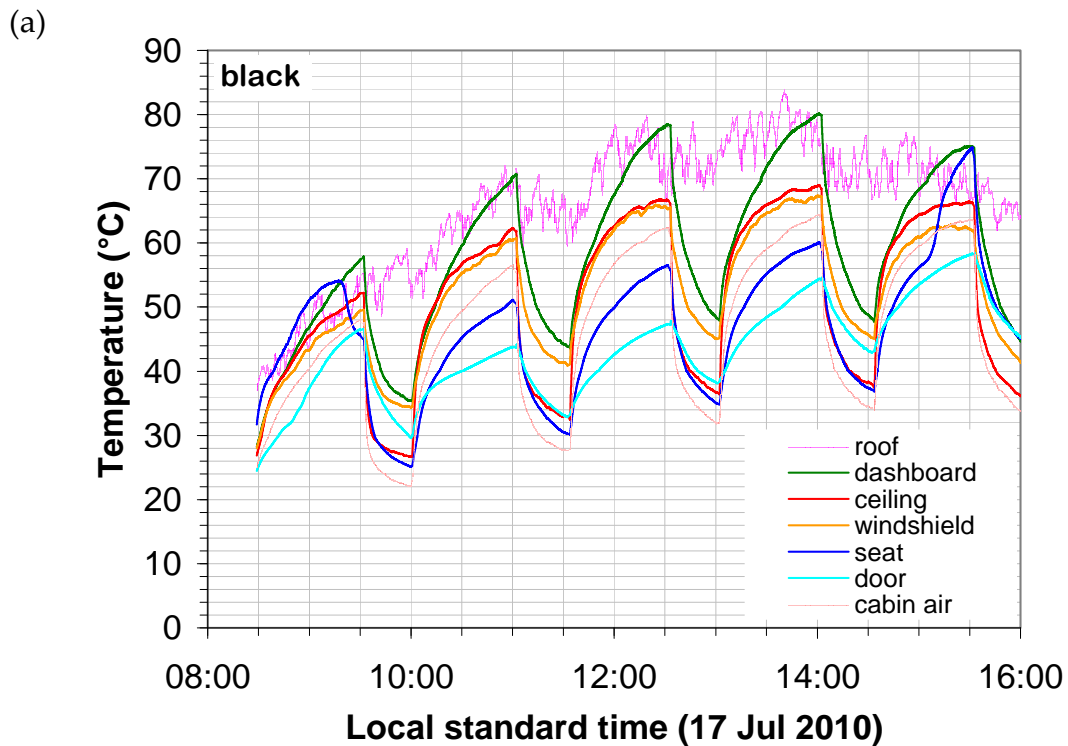

Figure 5. Roof, dashboard, ceiling, windshield, seat, door and cabin air temperatures measured during soaking and cooling trials in (a) the black car and (b) the silver car.

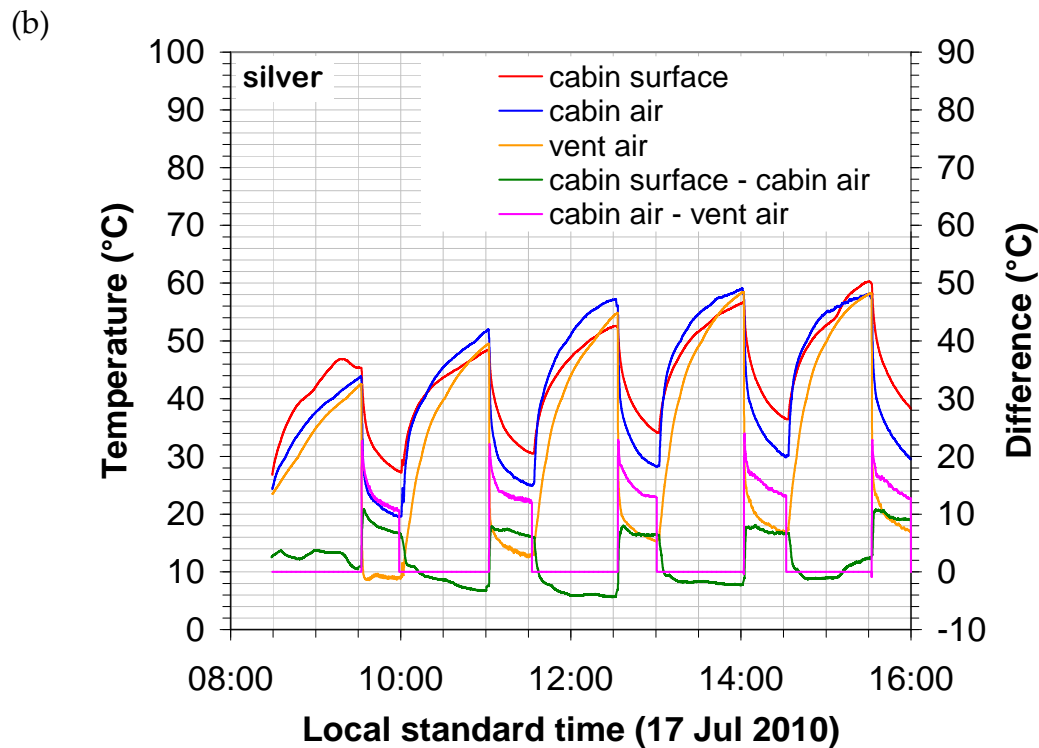
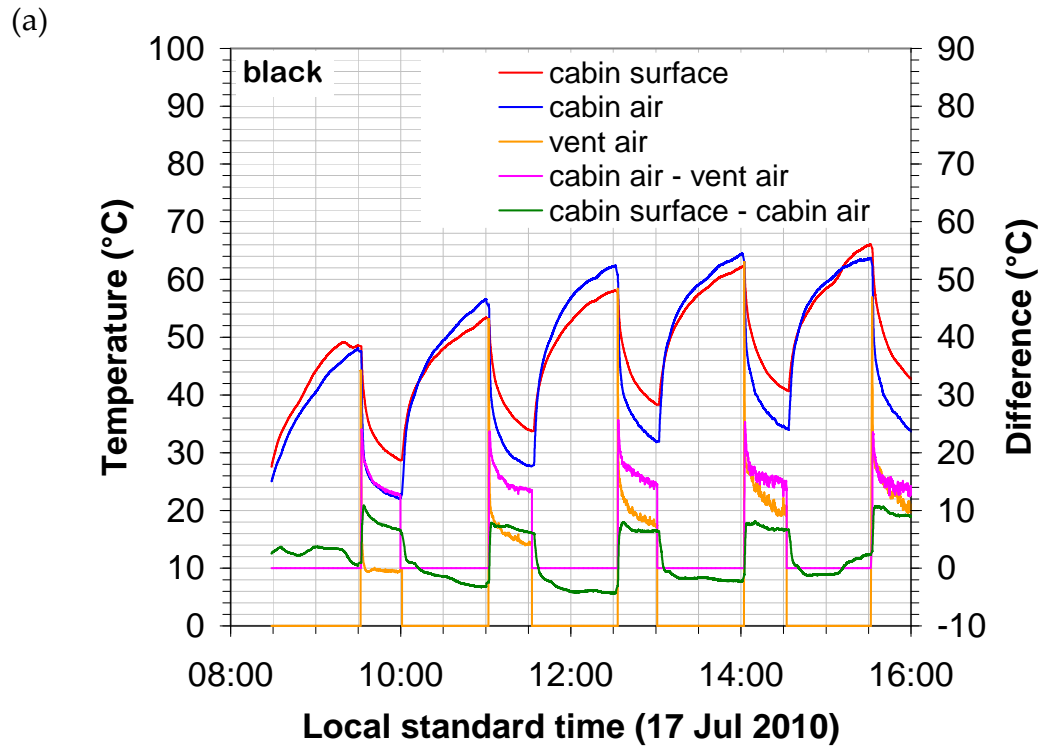
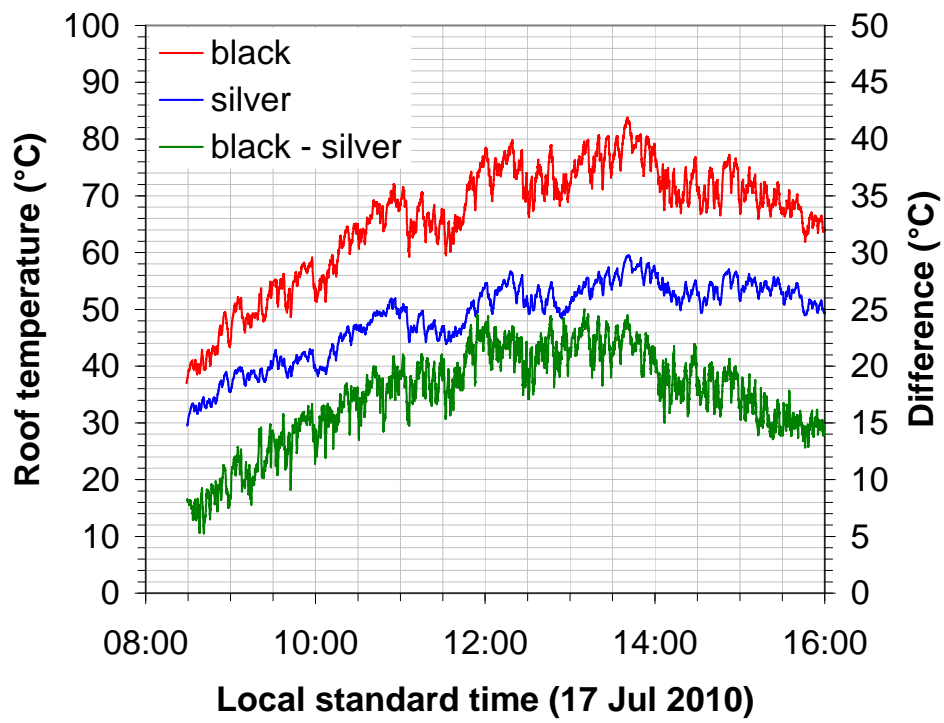
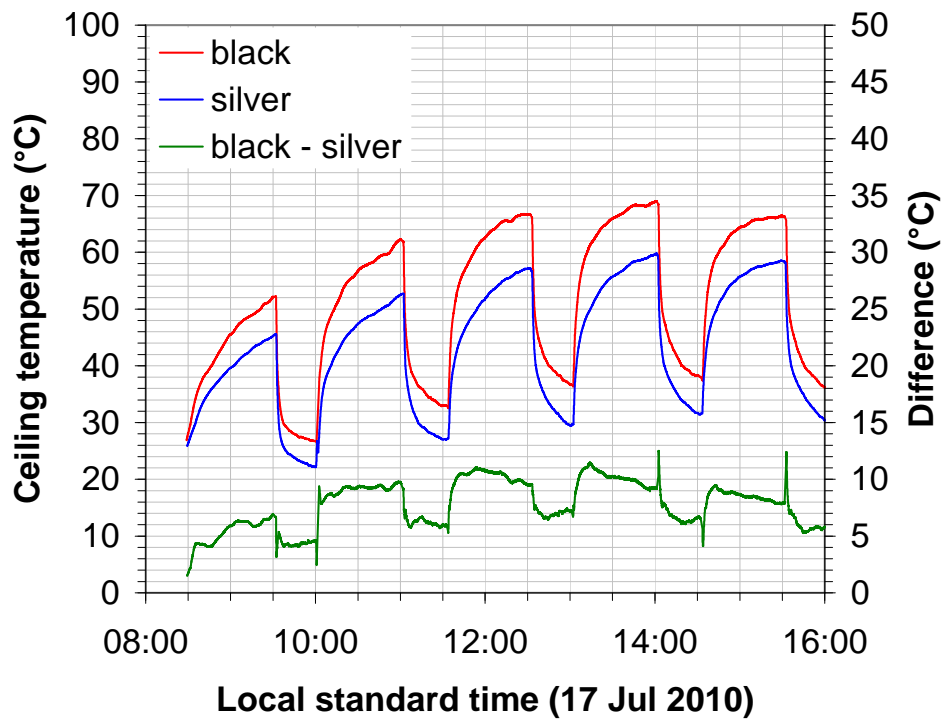

Figure 6. Cabin surface, cabin air and vent air temperatures measured during soaking and cooling trials in (a) the black car and (b) the silver car. Also shown are differences between cabin surface and cabin air temperature and between cabin air and vent air temperature.

(a)



(b)



(c)

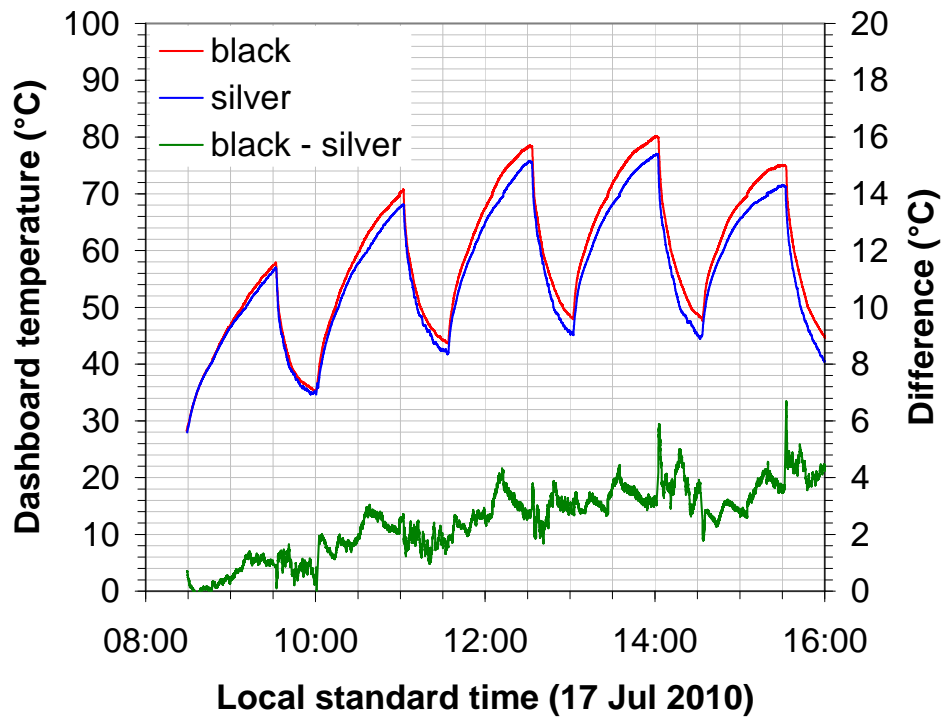

(d)

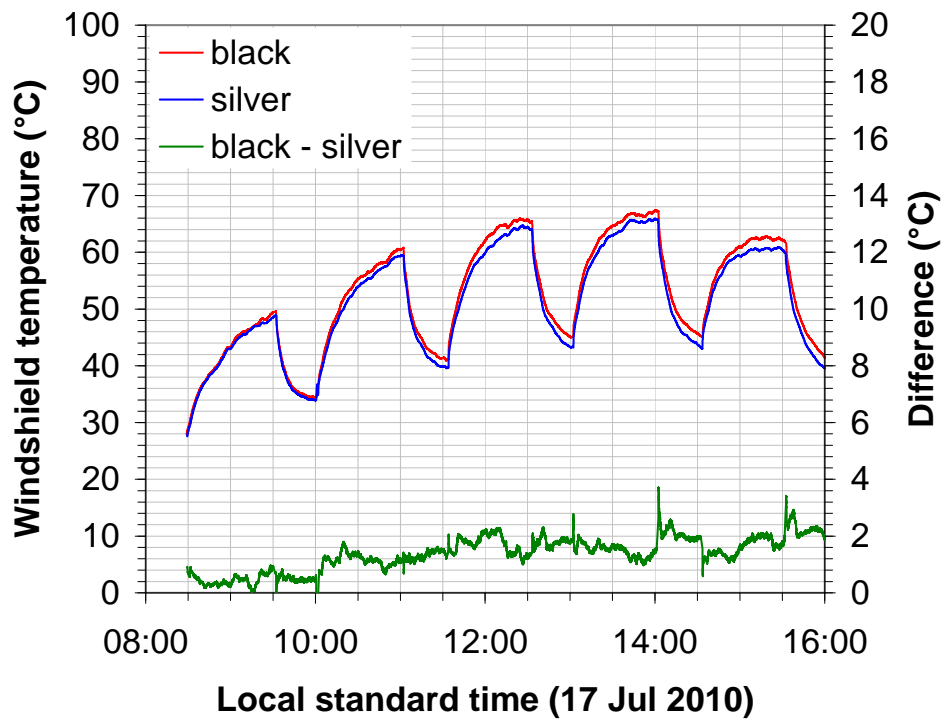

(e)

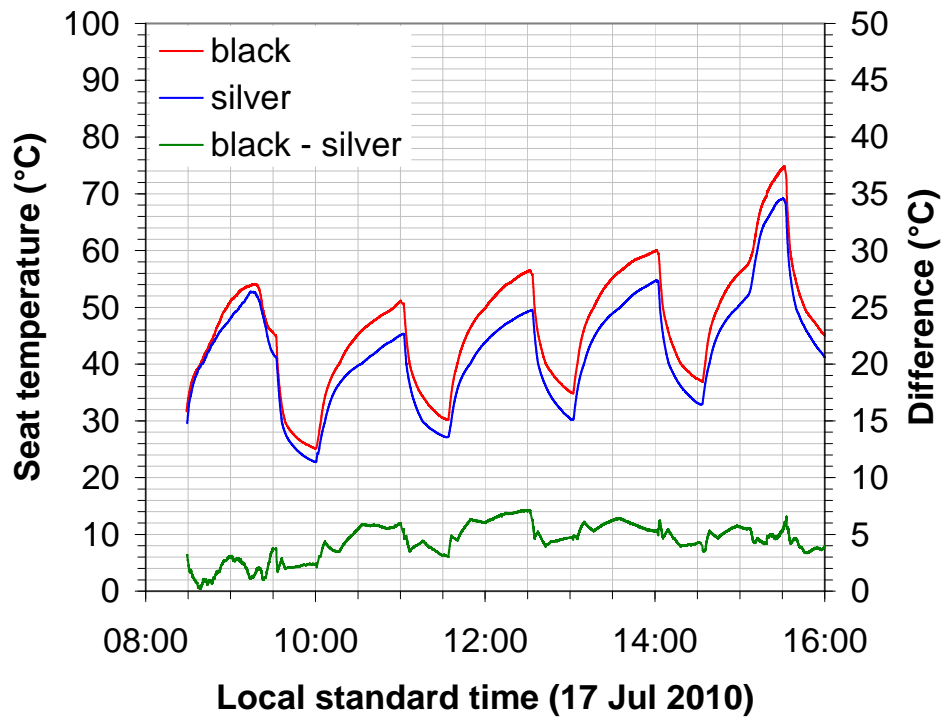

(f)

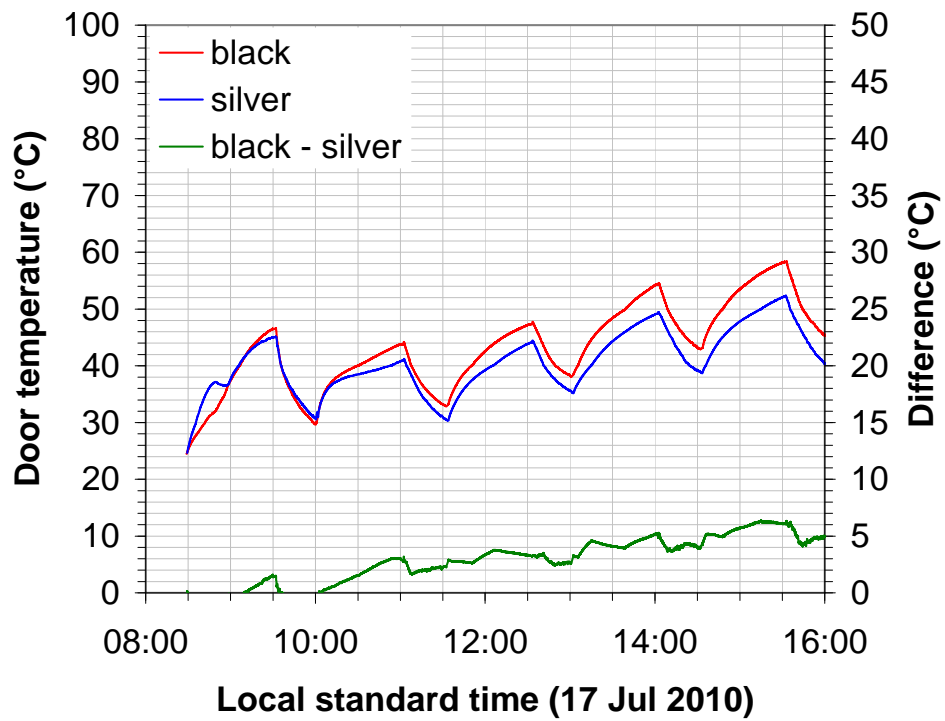

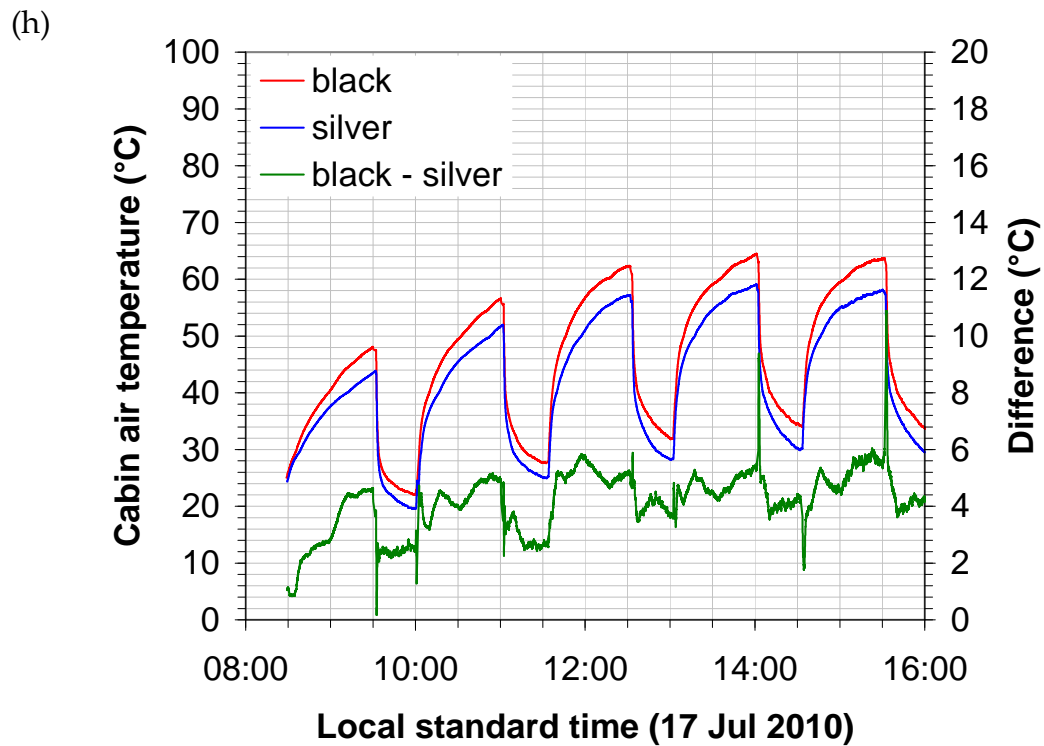
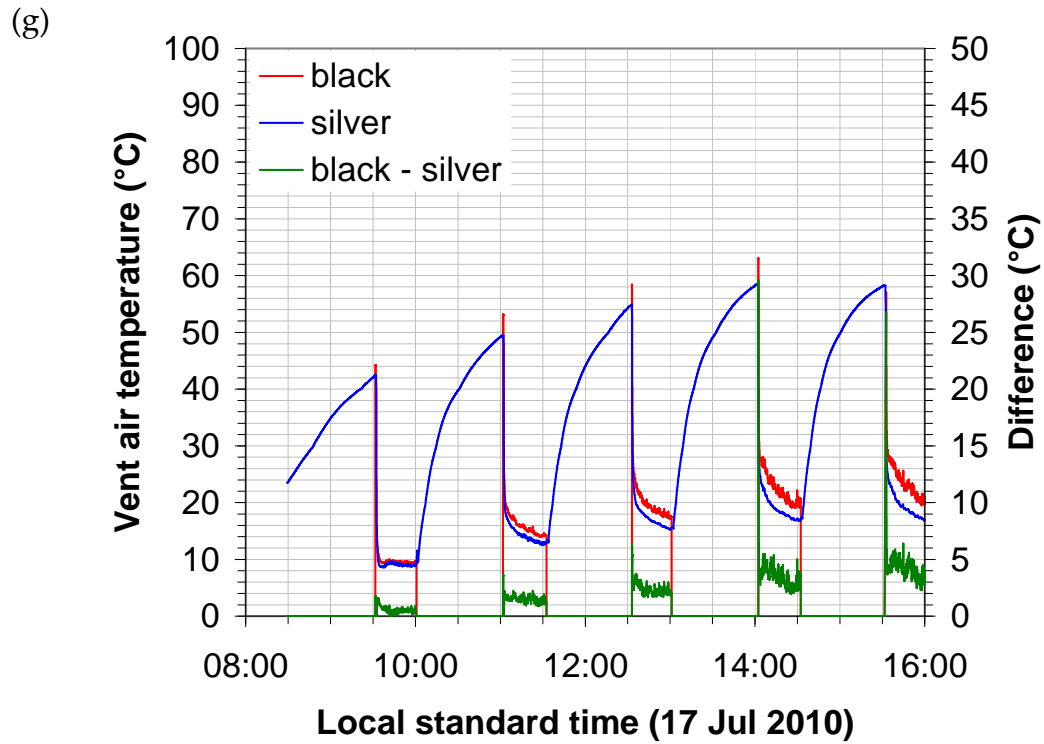

Figure 7. Comparisons of (a) roof, (b) ceiling, (c) dashboard, (d) windshield, (e) seat, (f) door, (g) vent air and (h) cabin air temperatures measured during soaking and cooling trials.

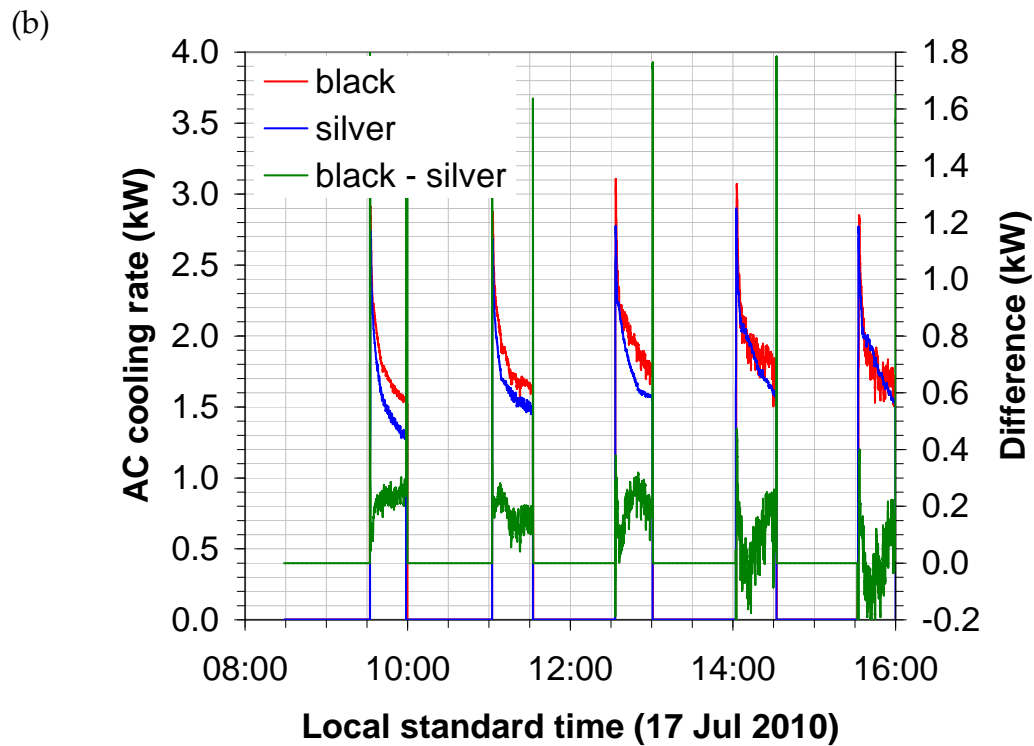
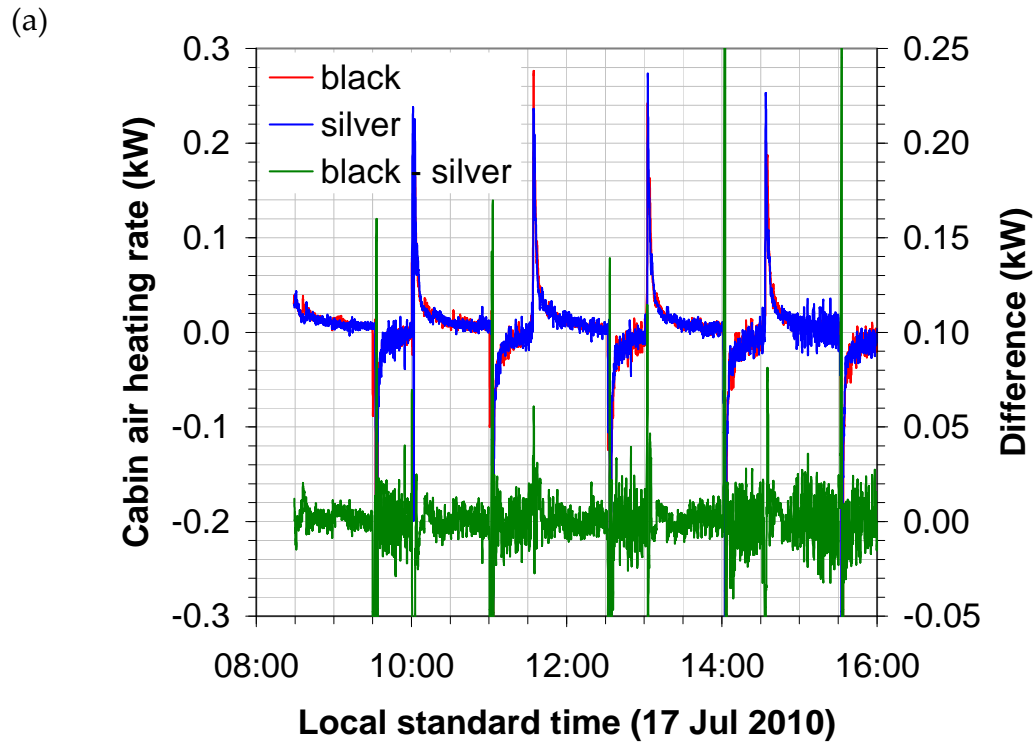
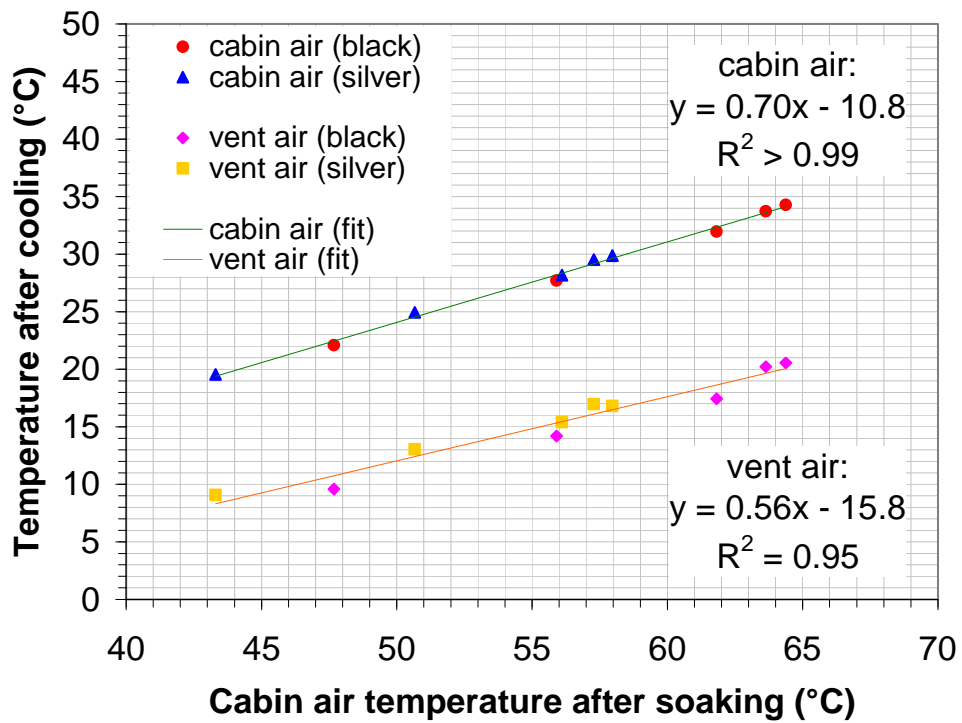

Figure 8. Comparisons of (a) cabin air heating rates measured during soaking and cooling trials and (b) AC cooling rates measured during cooling trials.

(a)



(b)

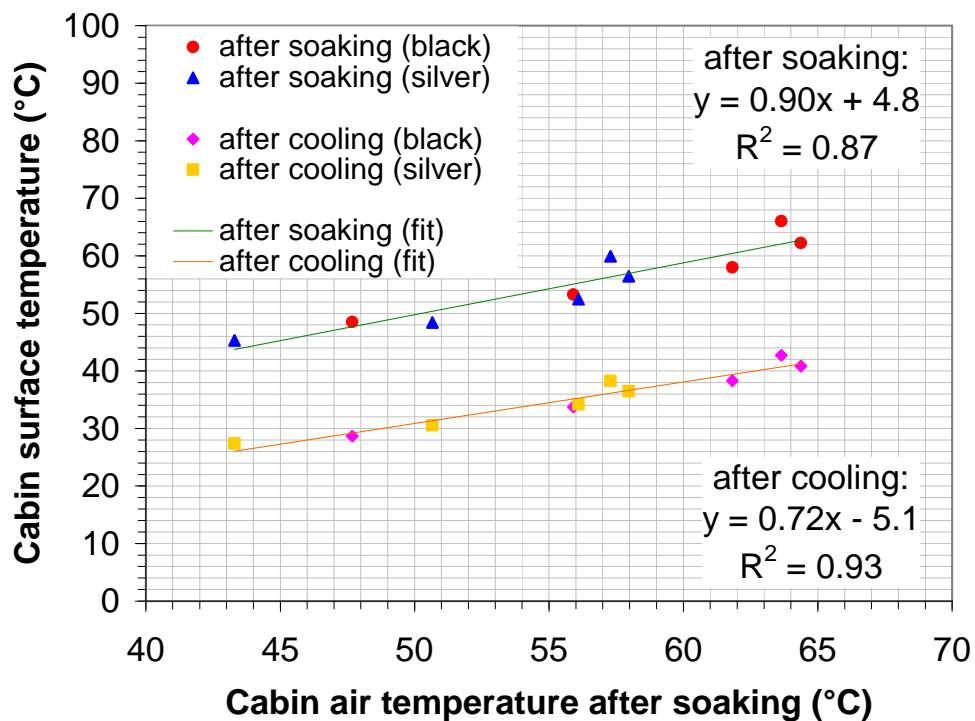

Figure 9. Variations with cabin air final soak temperature of (a) cabin air and vent air final cooldown temperatures and (b) cabin surface final soak and final cooldown temperatures. Soak and cooldown intervals were approximately 60 and 30 min, respectively.

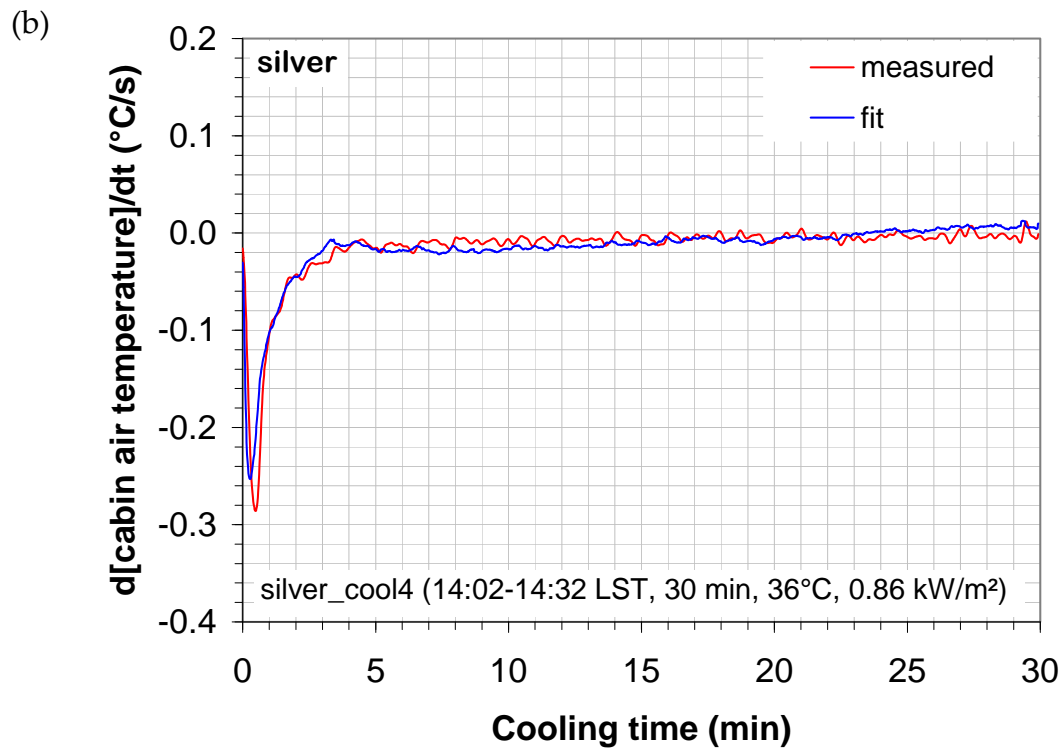
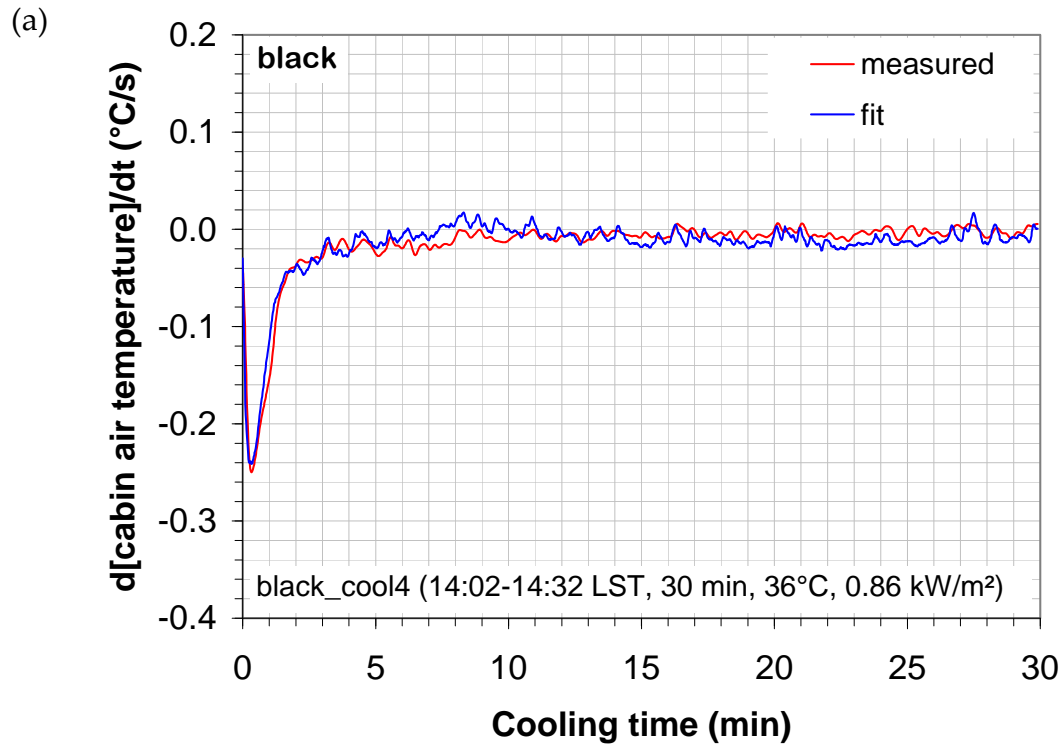

Figure 10. Measured and fitted rates of change of cabin air temperature versus cooling time in Trial 4, shown for (a) the black car and (b) the silver car.

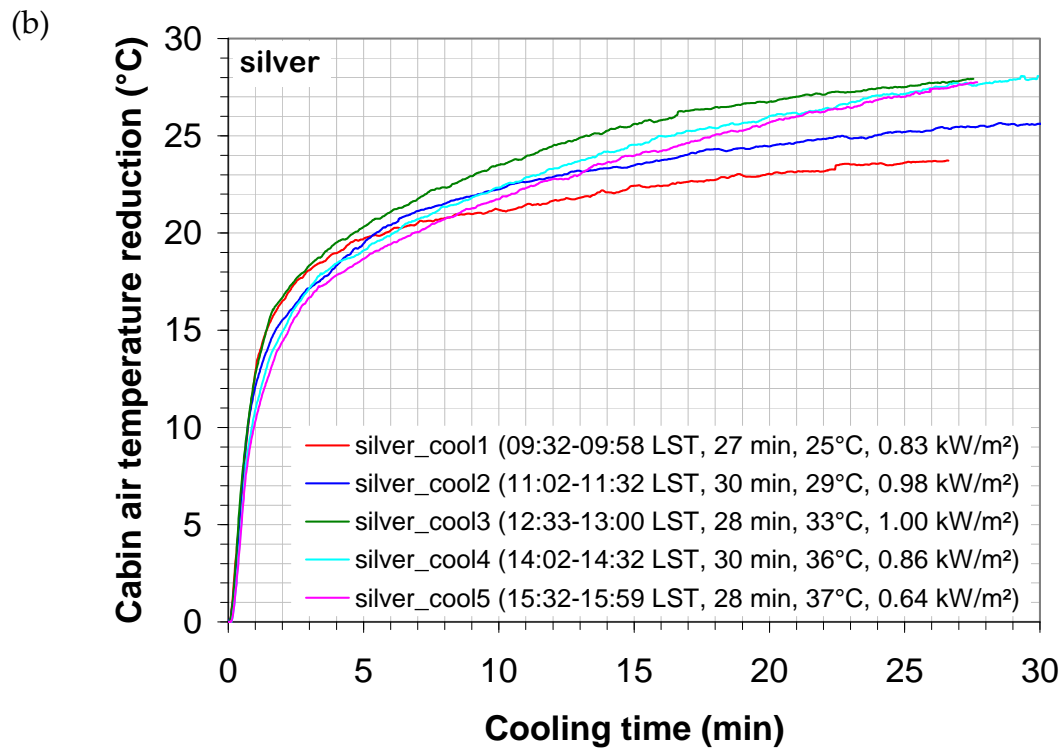
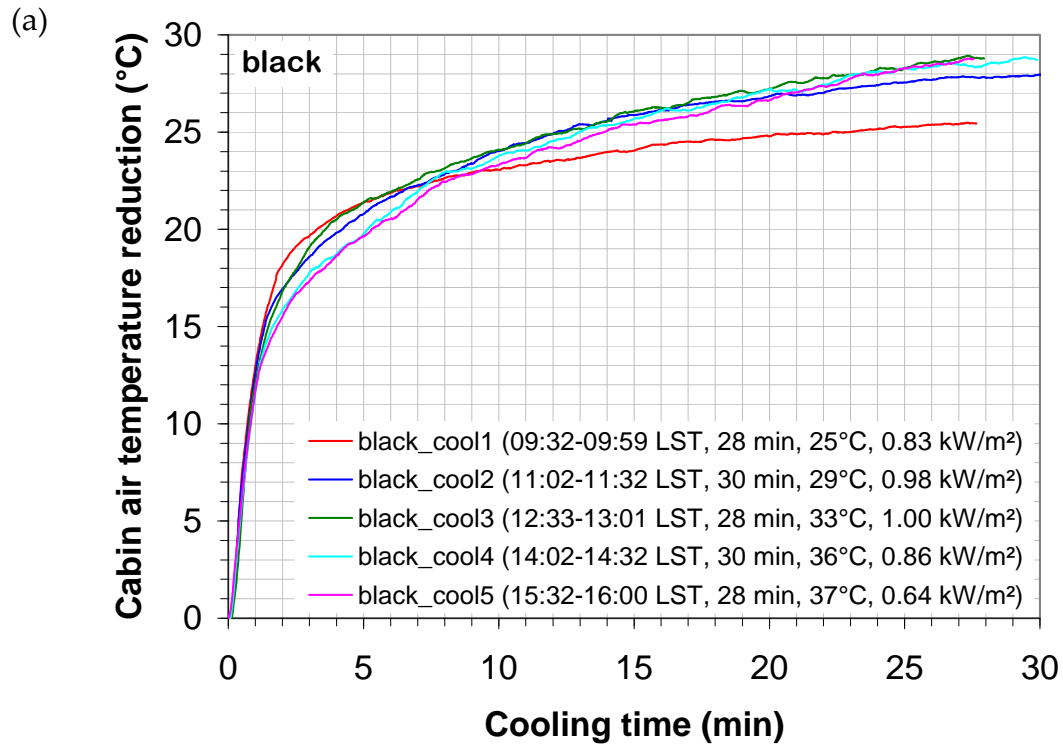

Figure 11. Reduction in cabin air temperature versus cooling time in each of five trials, shown for (a) the black car and (b) the silver car. Cooling trial interval, duration, mean outside air temperature and mean solar irradiance are listed in parentheses.

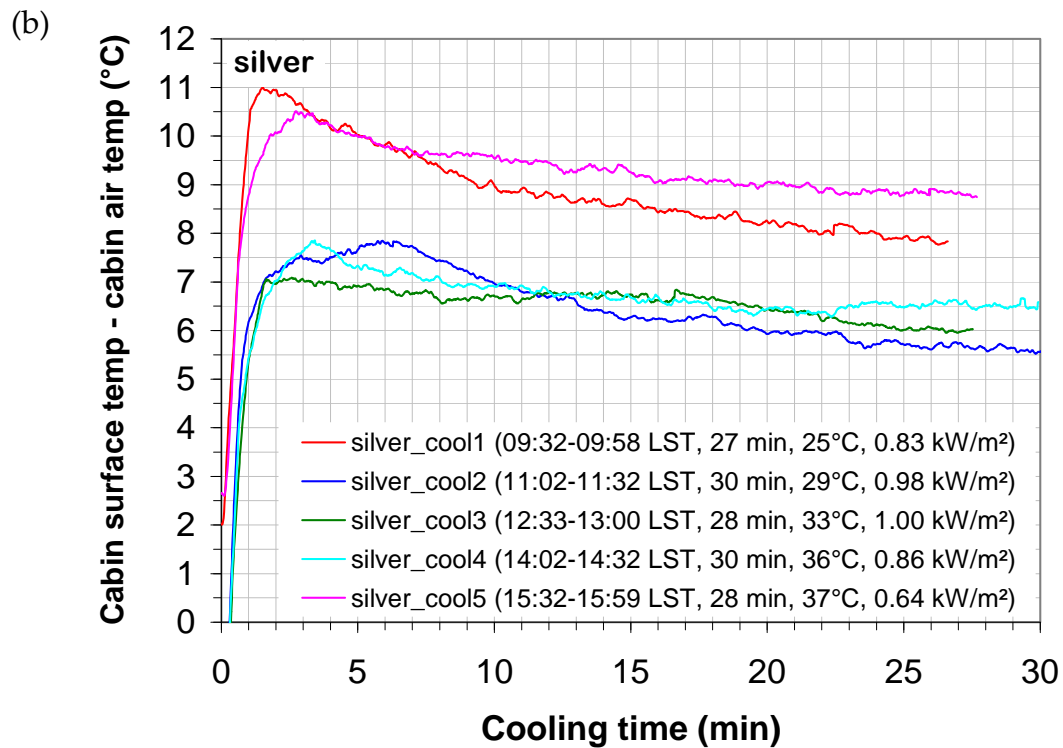
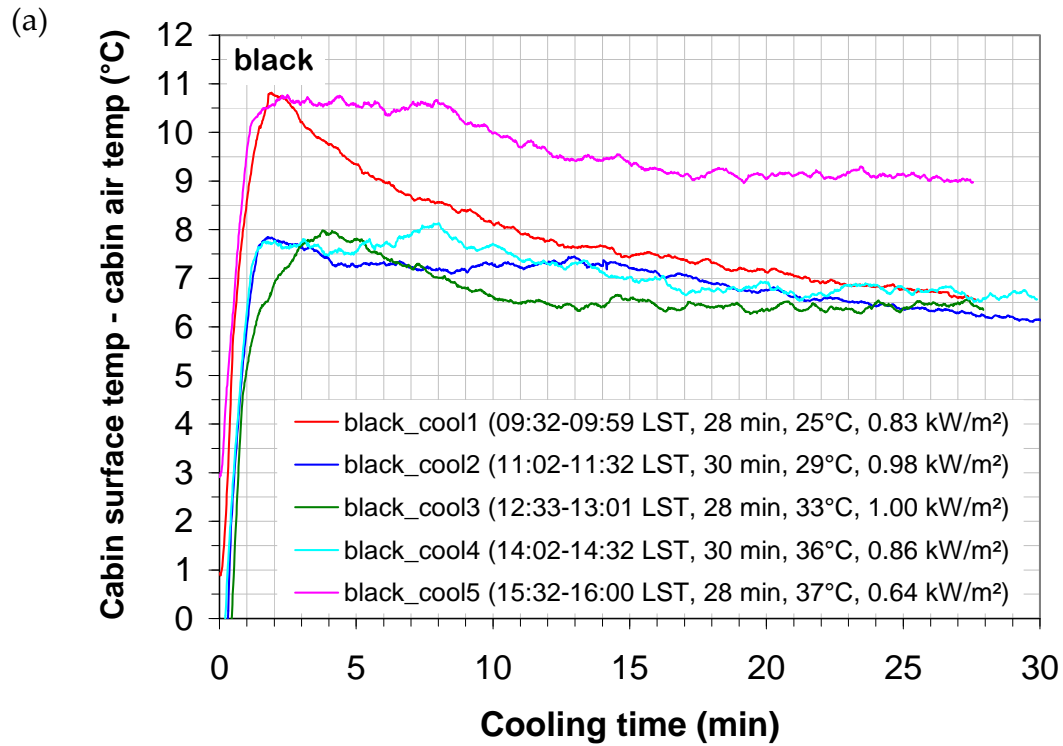

Figure 12. Difference between cabin surface and cabin air temperatures versus cooling time in each of five trials, shown for (a) the black car and (b) the silver car.

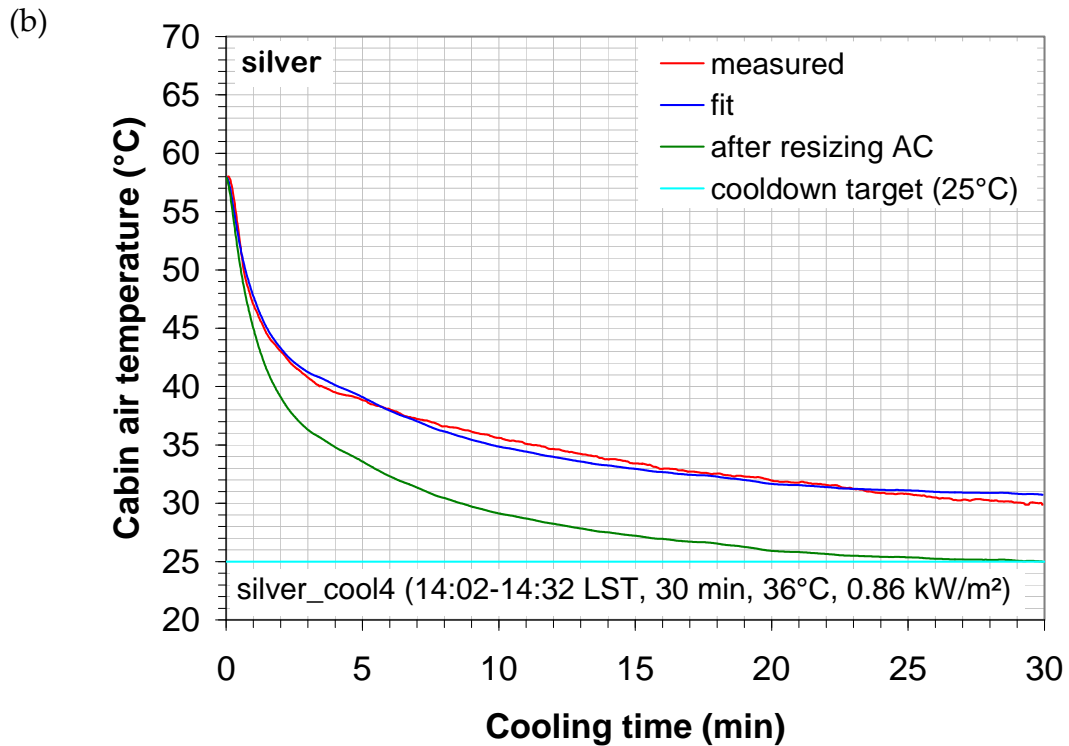
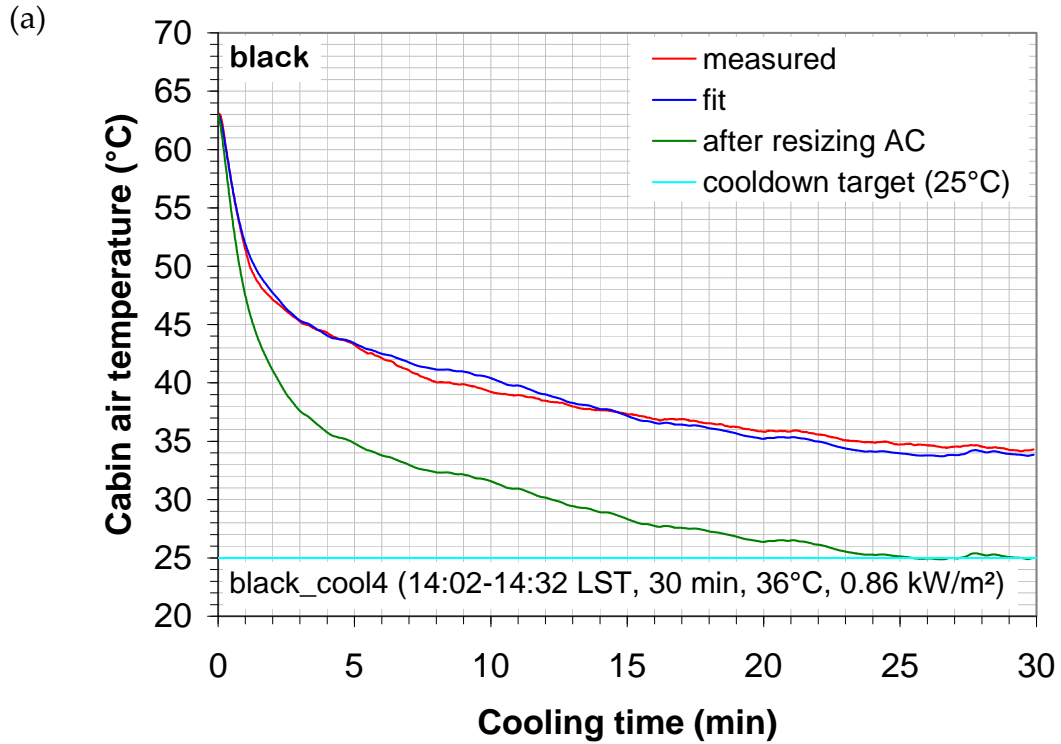

Figure 13. Measured and fitted cabin air temperatures versus cooling time in Trial 4, shown for (a) the black car and (b) the silver car. Each graph also shows the cabin air temperature time series predicted after the AC is resized to attain a target final cabin air temperature of 25°C.

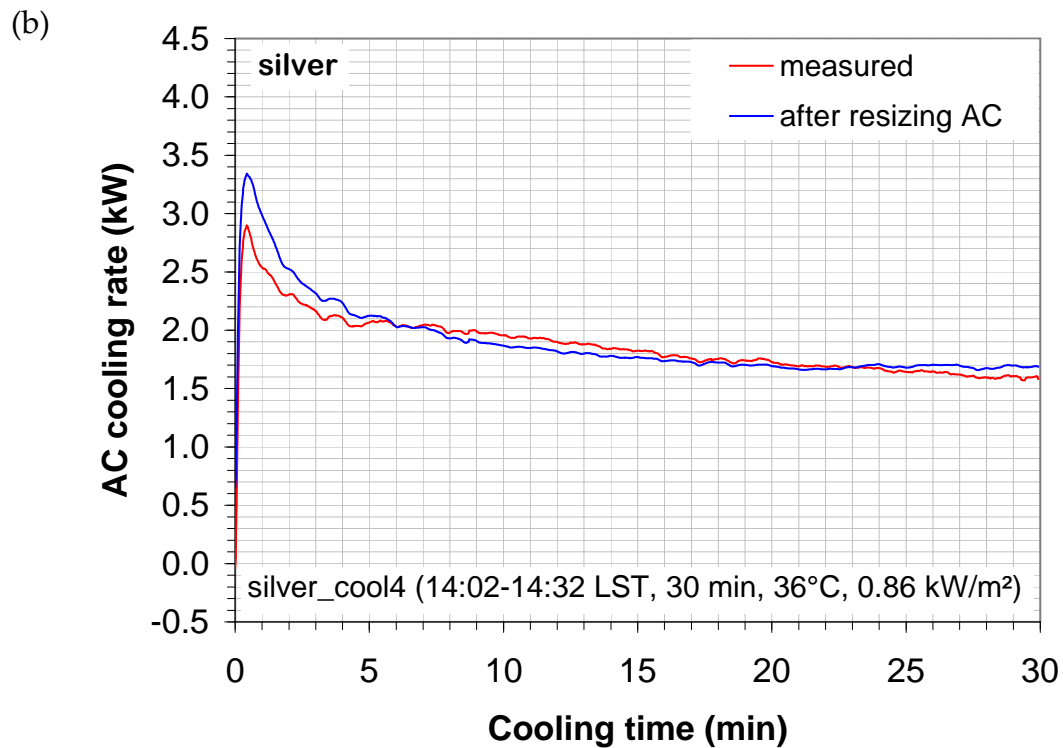
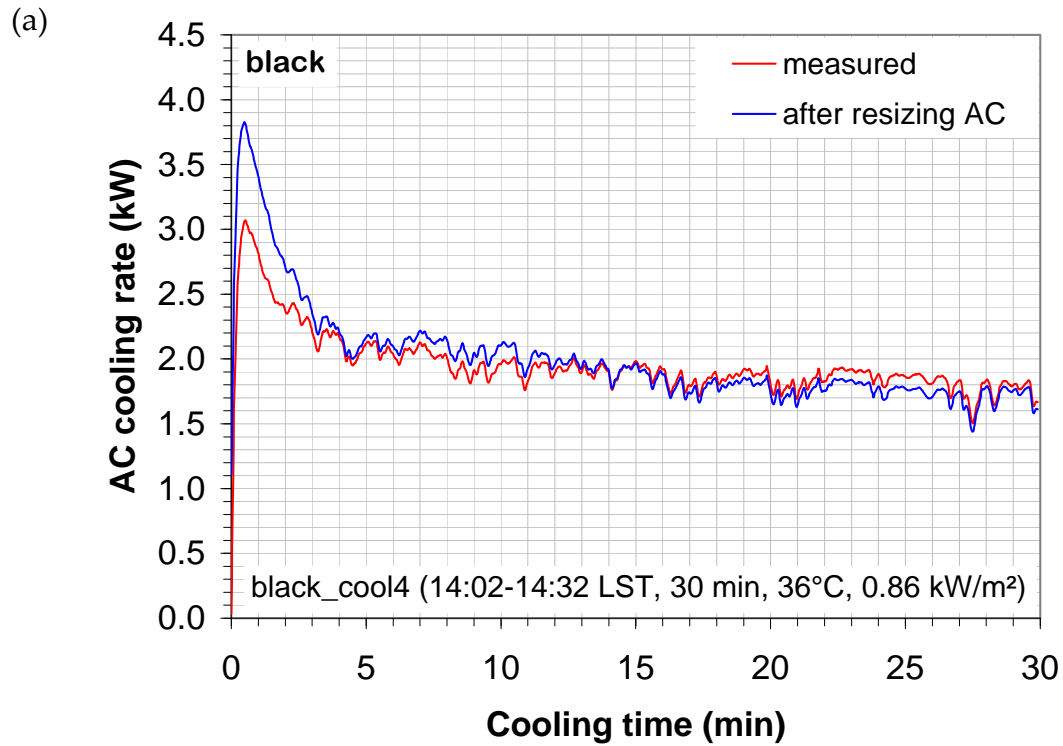
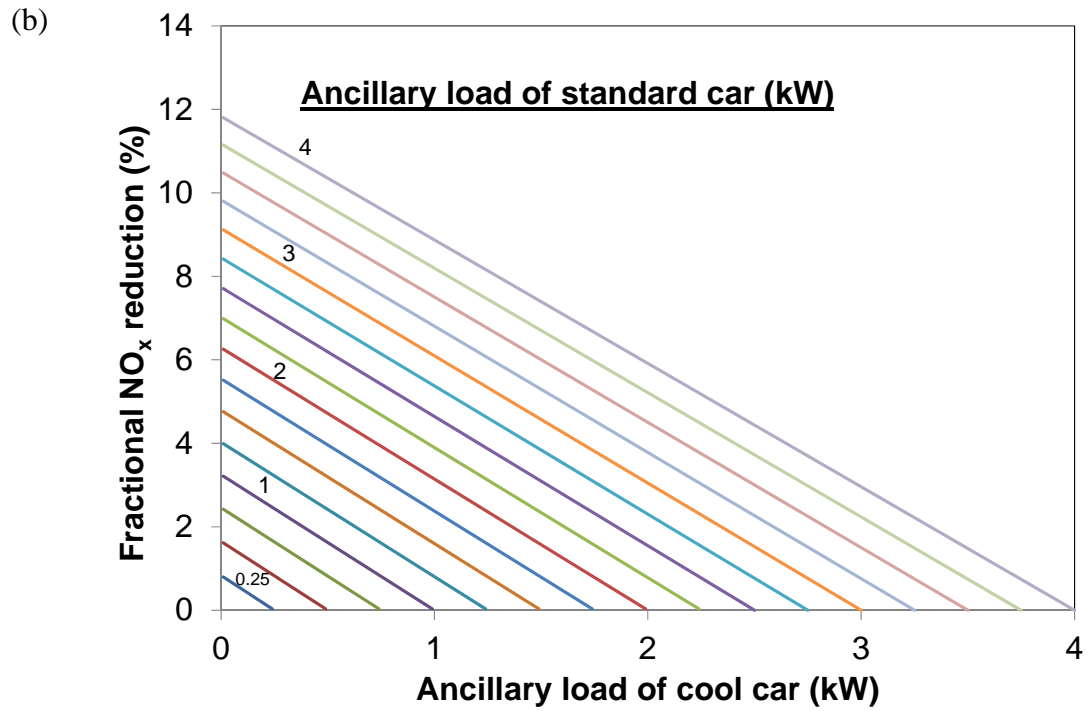
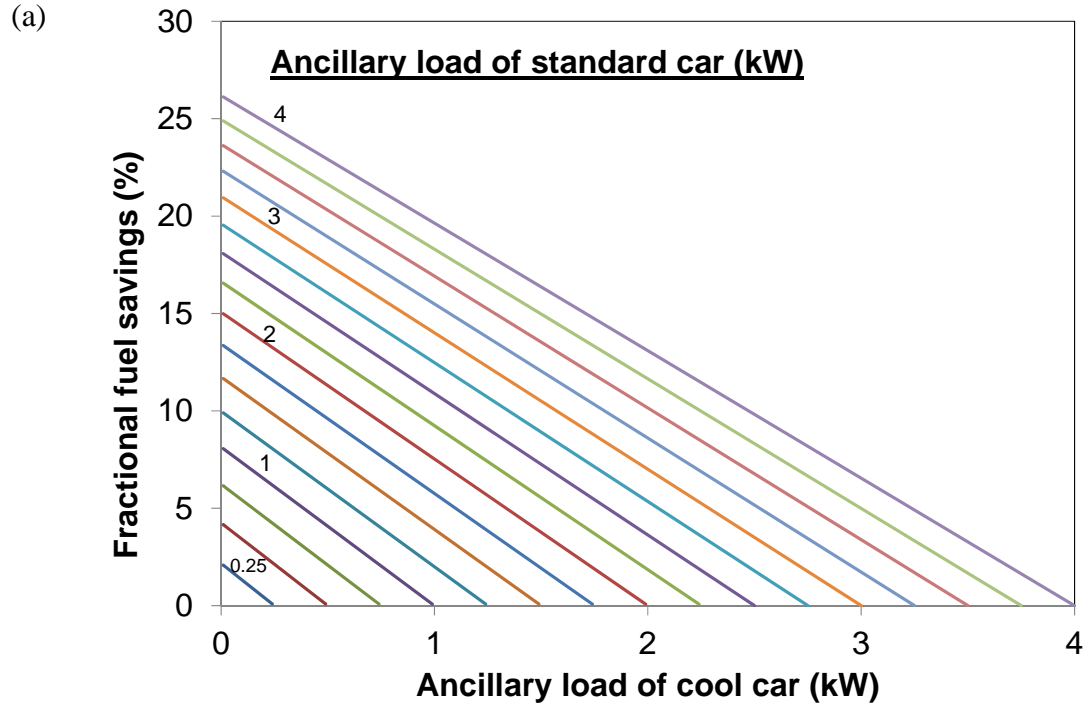

Figure 14. Measured AC cooling rate in Trial 4 shown for (a) the black car and (b) the silver car. Each graph also shows the cooling rate predicted after the AC is resized to attain a target final cabin air temperature of 25°C.



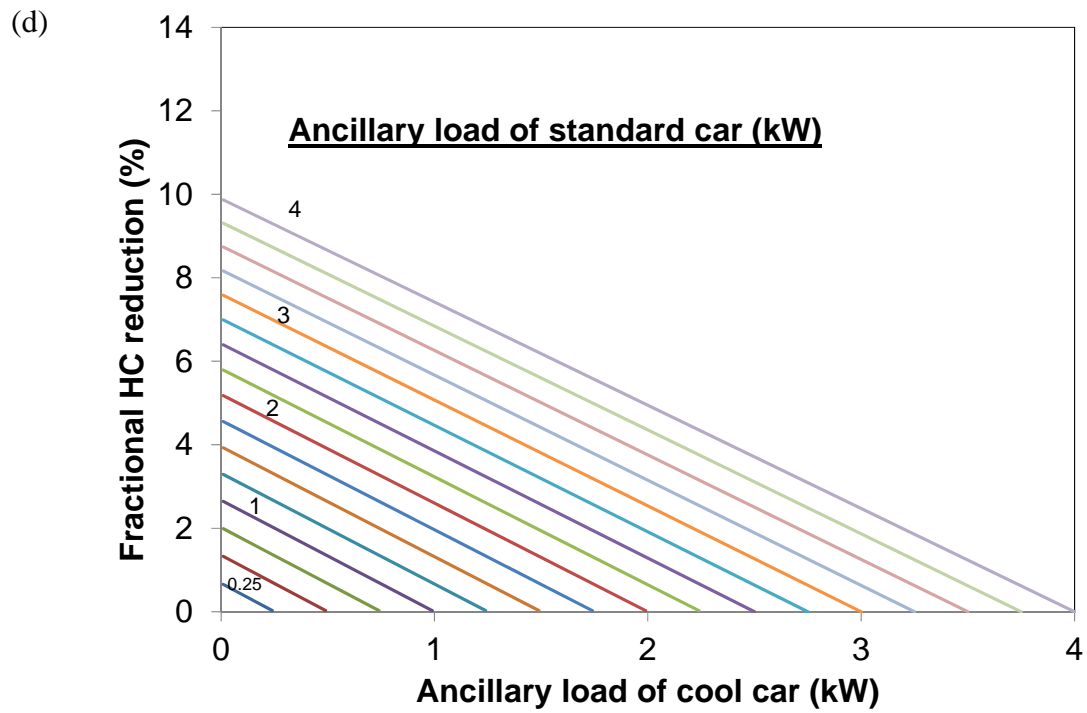
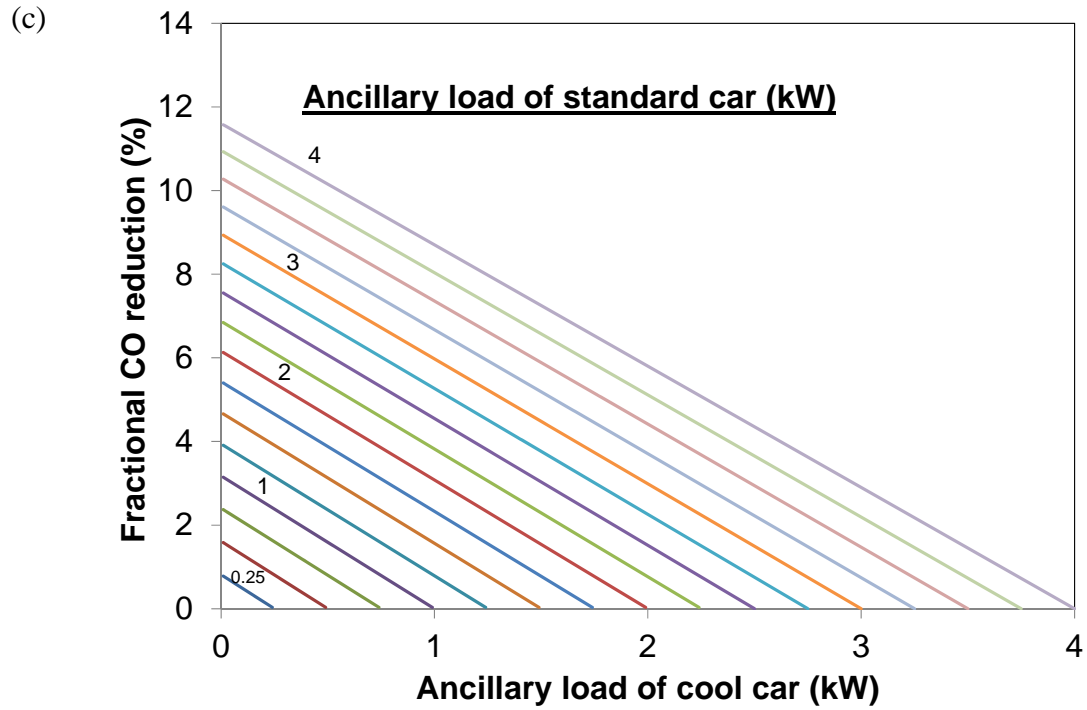
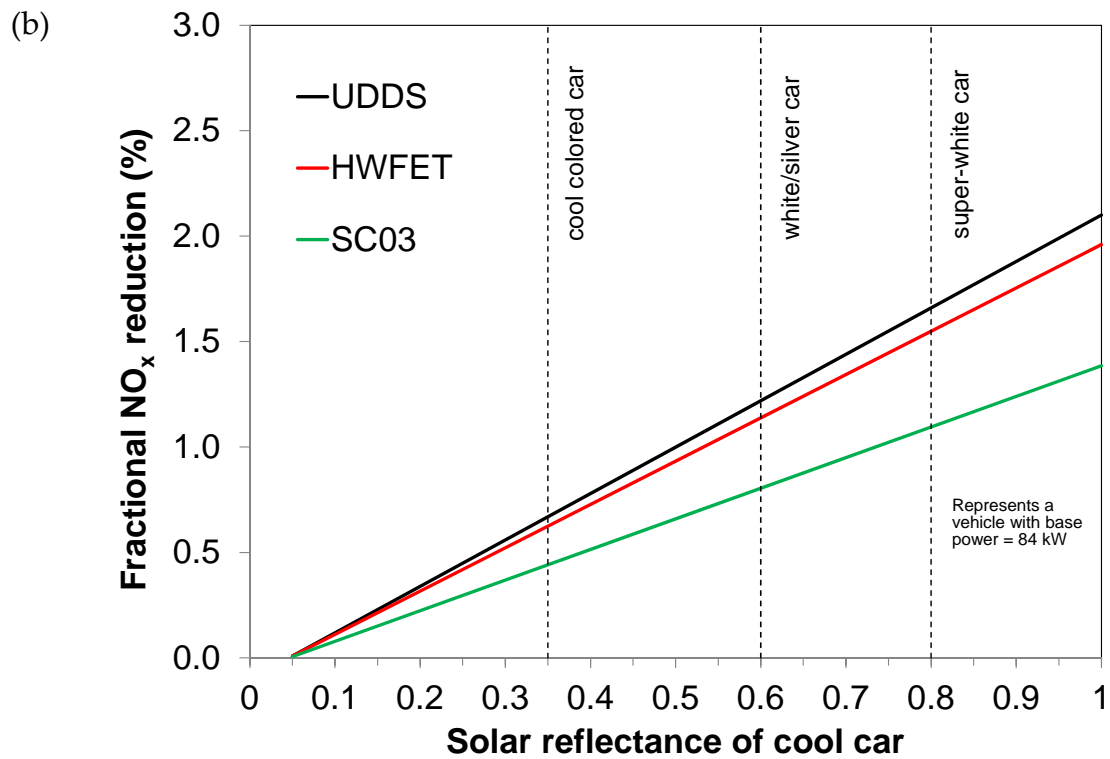
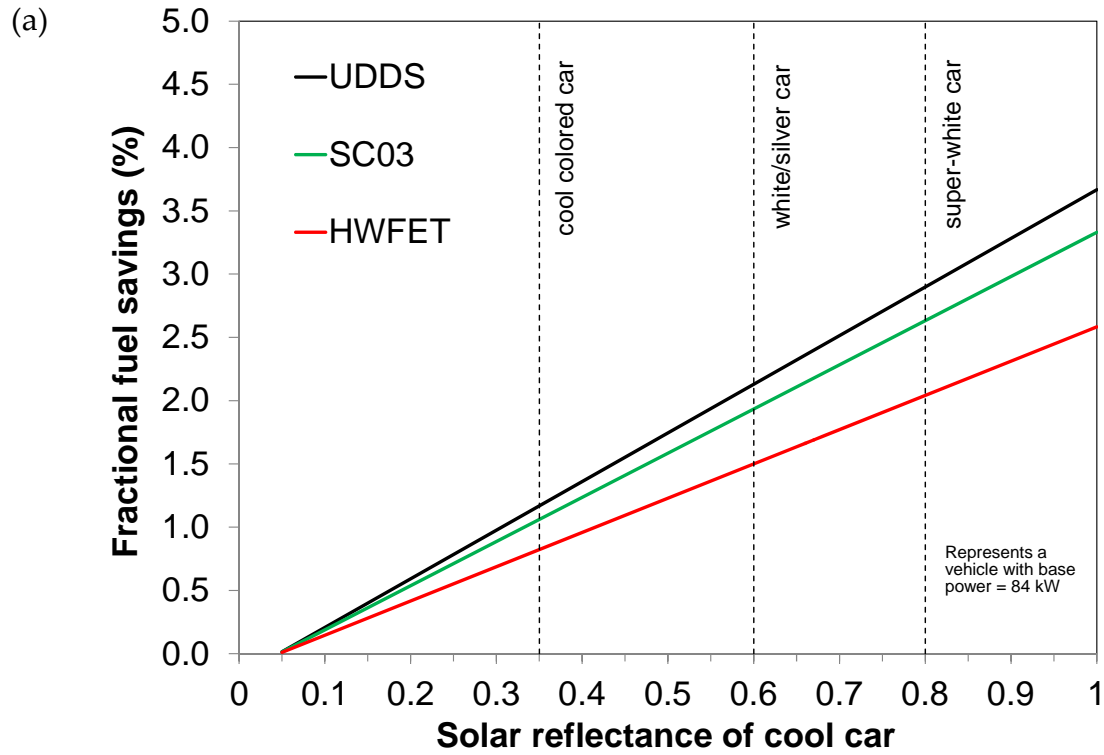

Figure 15. Reductions in fuel consumption and emissions as a function of ancillary loads of the standard (black) and cool (nonblack) cars. Each curve represents a different value for ancillary load of the standard car.



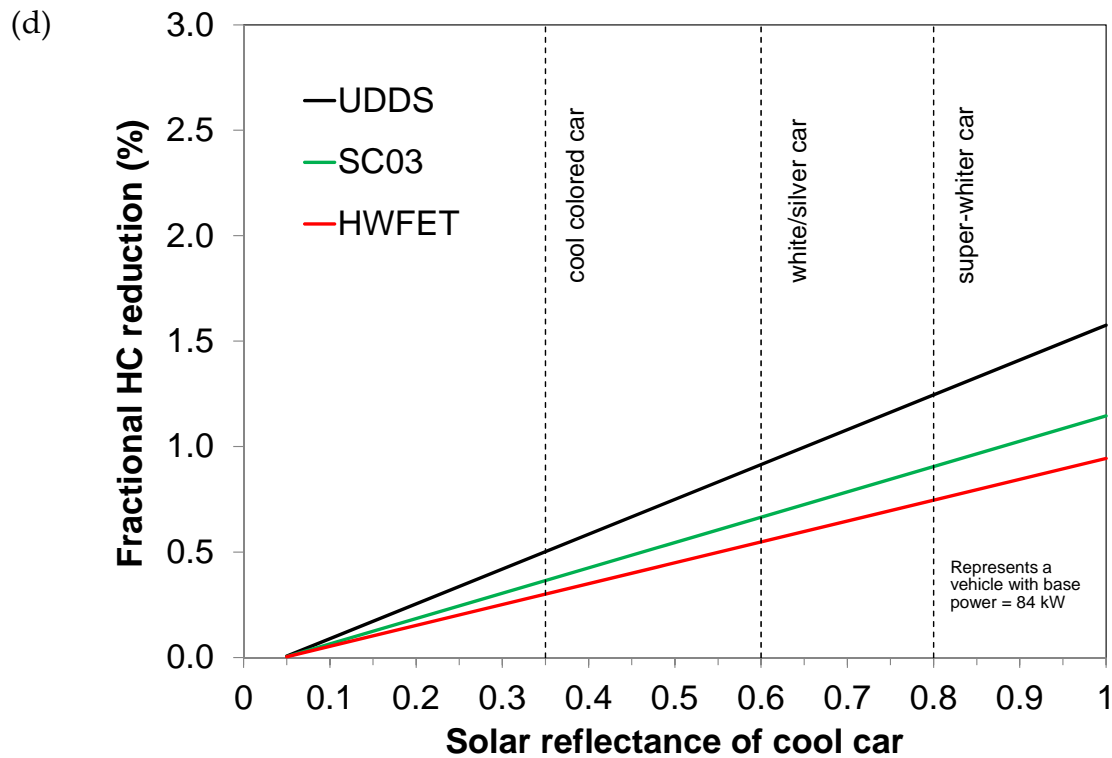
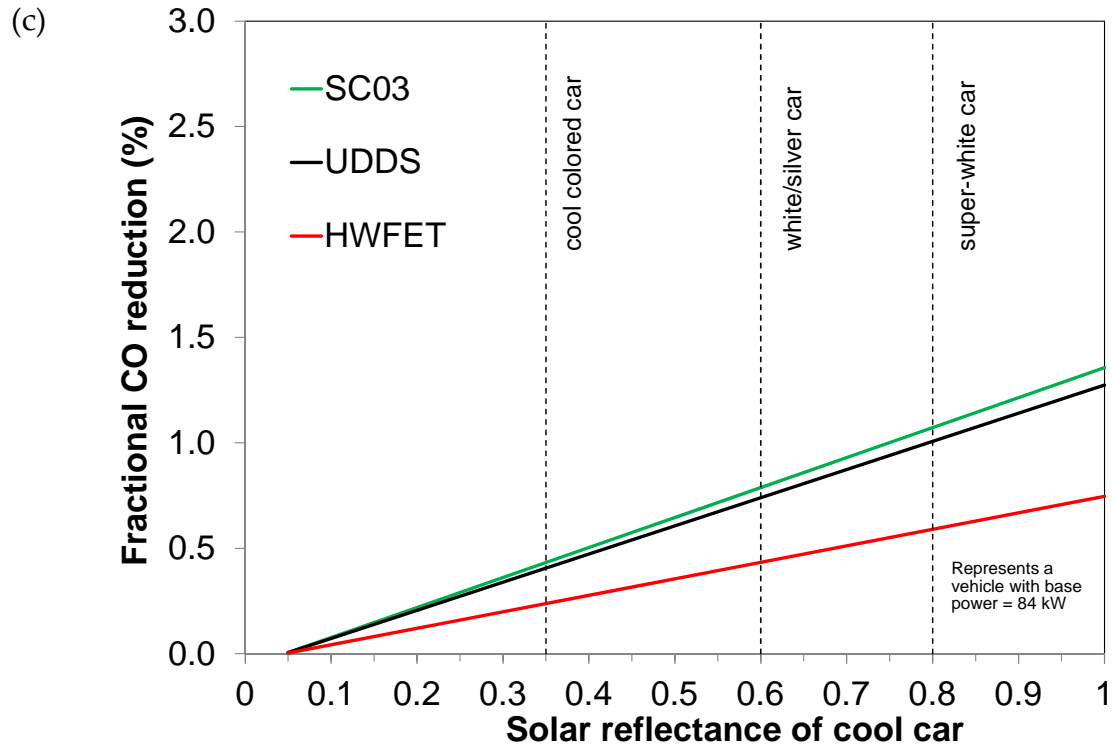
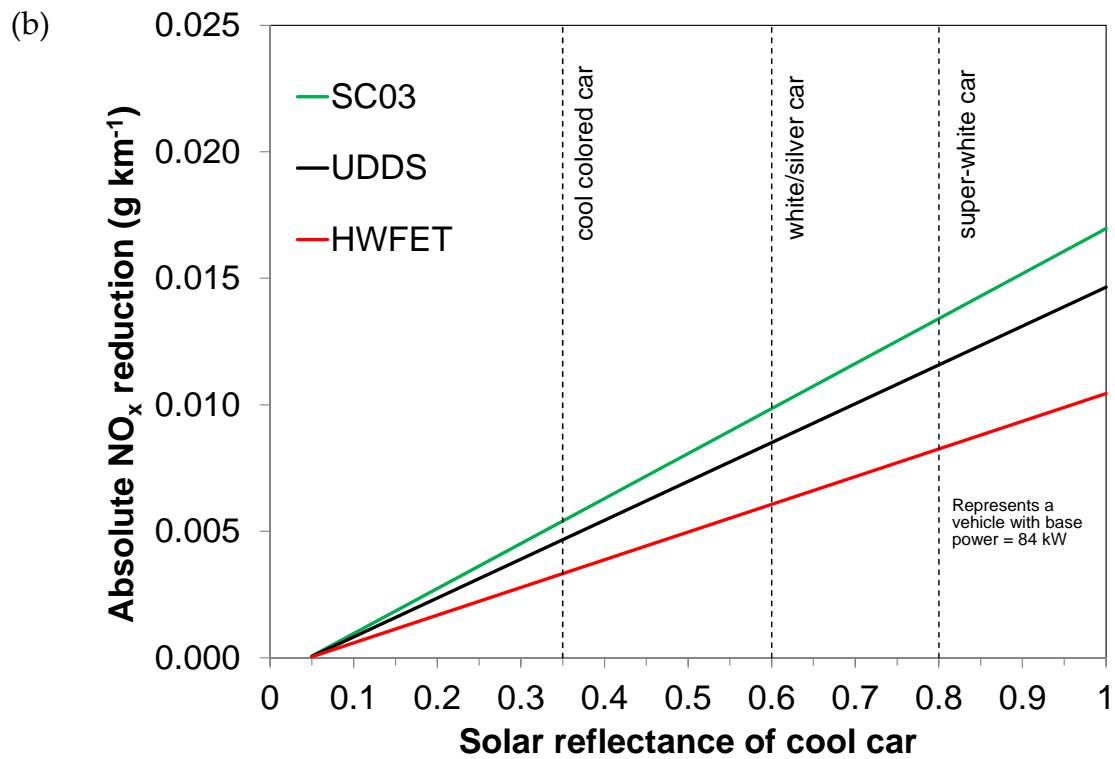
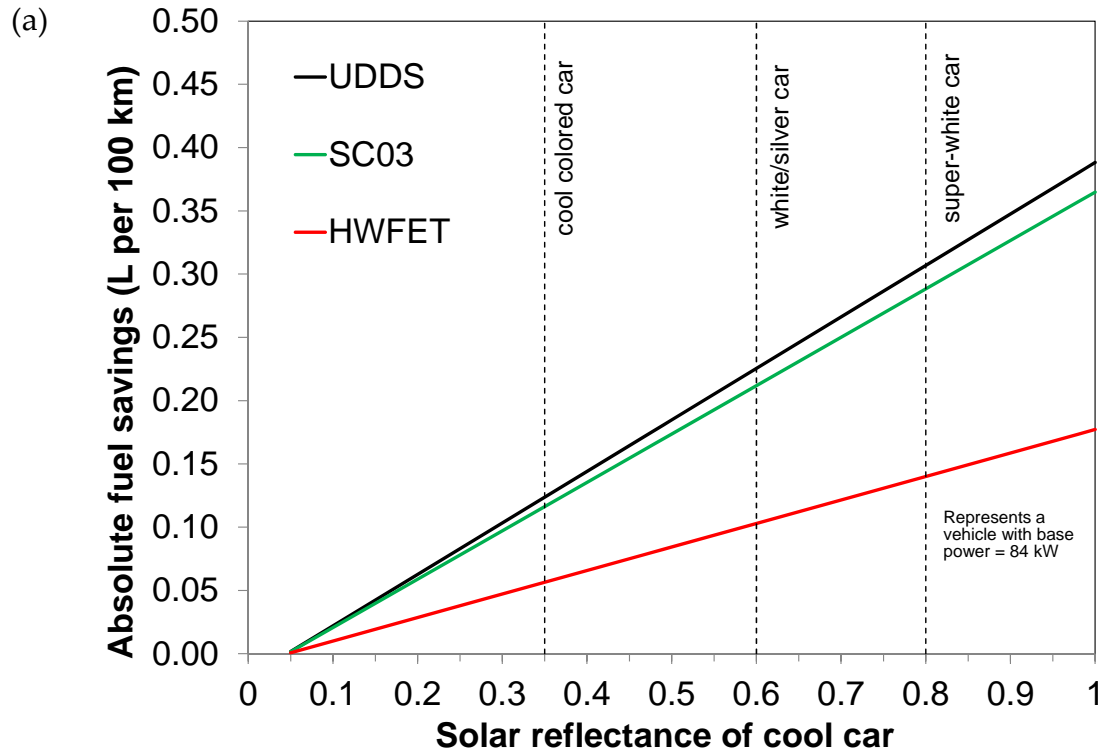

Figure 16. Fractional reductions in rates of (a) fuel consumption, (b) NO_x emission, (c) CO emission and (d) HC emission versus solar reflectance of the cool car shell. Reference values of solar reflectance for a typical cool colored car, a typical white or silver car, and a hypothetical super-white car are shown as dashed vertical lines.



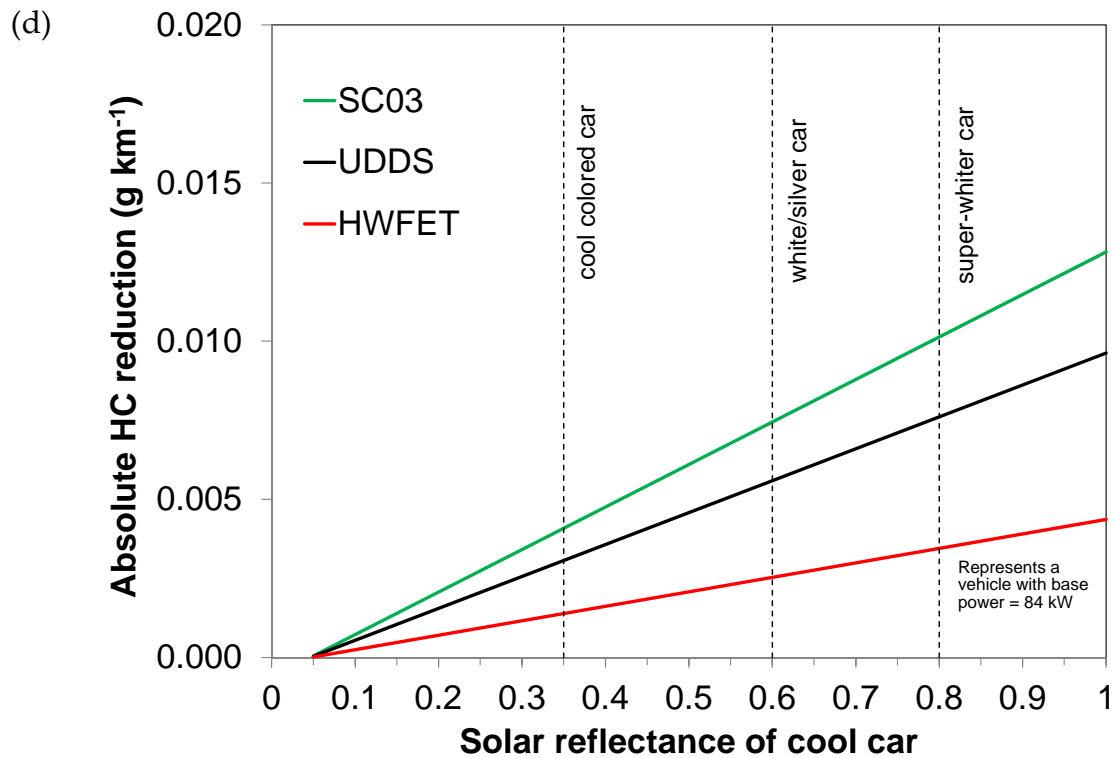
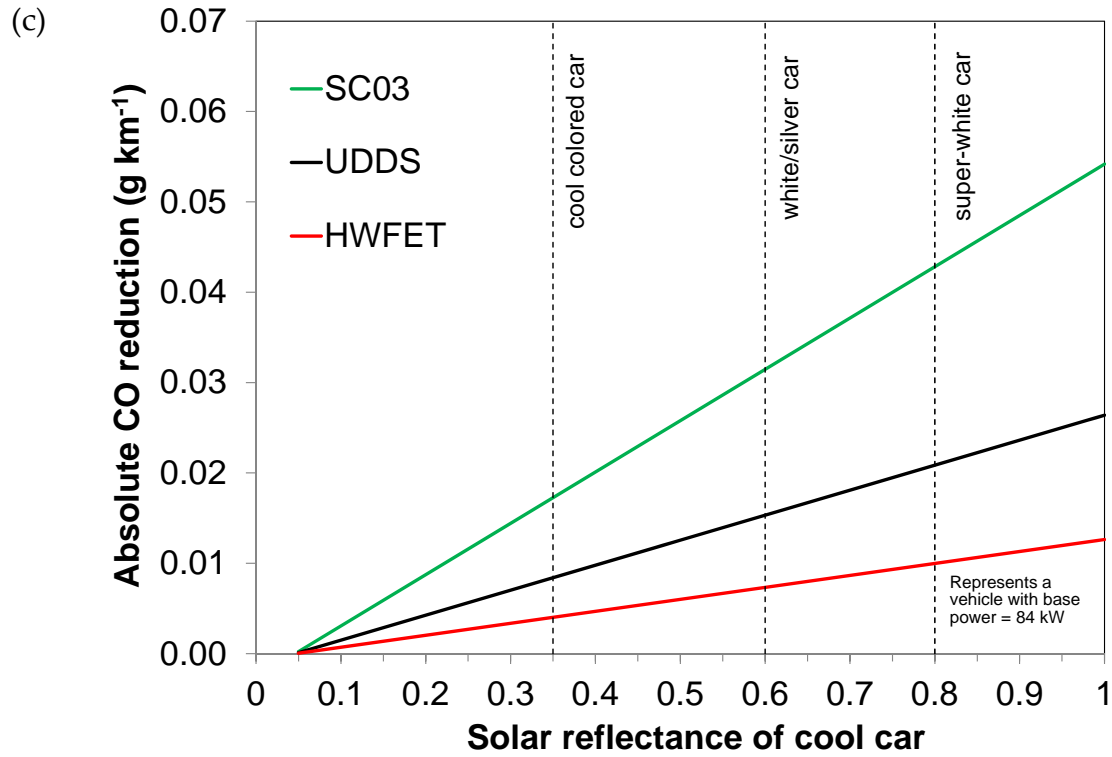

Figure 17. Absolute reductions in rates of (a) fuel consumption, (b) NO_x emission, (c) CO emission and (d) HC emission versus solar reflectance of the cool car shell. Reference values of solar reflectance for a typical cool colored car, a typical white or silver car, and a hypothetical super-white car are shown as dashed vertical lines.

ATTACHMENT 2:

Report for Task 3 (Develop an energy RD&D framework [roadmap] addressing energy efficiency measures that have potential for improving the air conditioning performance of cars)

Contents

- A. Akbari, H. 2011. Advanced shell and component design to reduce air conditioning use: research topics and implementation pathways.

Advanced shell and component design to reduce air conditioning use: research topics and implementation pathways

Hashem Akbari

1.1 Background

Air-conditioning in cars and small trucks lowers fuel efficiency and significantly increases tailpipe emissions. According to a study by the California Air Resources Board and the Coordinated Research Council, the use of air conditioning in cars increases CO emissions by 1.63 grams/mile (71%), increases NO_x emissions by 0.19 g/mi (81%), and reduces fuel efficiency by 4.6 miles/gallon (22%).

Over 95% of cars and small trucks sold in the U.S. in 1997 had air conditioning. Air conditioning is used in both hot and cold weather to regulate cabin temperature and humidity, providing “climate control.” The Bureau of Transportation Statistics (BTS) reported that in the year 2000, the 213 million cars and small trucks in the U.S. (133M cars, 79M trucks) were driven an average of 12 thousand miles (cars 12K mi, trucks 11.7K mi), for a total of 2.5 trillion vehicle miles. With a fleet-average fuel efficiency of 20 MPG (cars 22 MPG, trucks 17.5 MPG), the total annual fuel consumption was about 126 billion gallons (cars 73B gal, trucks 53B gal). Assuming that air conditioning reduces fuel efficiency by 15 to 20%, and that vehicles run air conditioning 50% of the time, the contribution of vehicle air conditioner energy use to annual U.S. transportation fuel expenditure is about 9.5-12.5 B gal per year.

Furthermore, reducing the peak cooling load decreases the required cooling capacity, permitting the installation of a lighter plant that improves fuel economy by (a) running at higher part-load fraction and (b) reducing car mass.

The design of a car air conditioner is based on the maximum cabin temperature attained when the car is parked on a hot, sunny summer day. This maximum interior temperature is commonly referred as the “soak” temperature. Since the cabin must be rapidly cooled for occupant comfort when the car is started, car air conditioners are usually designed with high capacity (about 3-5 tons). After this initial cooling, the air conditioner is typically run at a small fraction of capacity. Reducing the soak temperature permits downsizing of the air conditioner, yielding better part load performance and increased fuel efficiency. ¹

The soak temperature of the car is strongly influenced by solar gain through its windows and opaque shell. In the past decade, researchers and car manufacturers have used near-infrared reflective windows to reduce fenestration solar gain, lowering the soak temperature by several degrees. Using exterior paints with high solar reflectance can further reduce soak temperature. Historically, “high solar reflectance” has been synonymous with white. However, recent

¹ When the car is in motion, its solar heat gain is largely dissipated by convection. Also, the energy used to initially cool the cabin of a hot parked car is small compared to the air conditioning energy consumed over the course of a trip. Hence, the energy savings yielded by cooling the exterior of a car come primarily from installing a smaller, more efficient air conditioner.

advances in pigment technology have yielded non-white paints with relatively high solar reflectance. We refer to these as “cool colored” paints.²

Use of cool-colored paint can reduce the soak temperature by a few degrees (3-5°F). In previous studies, scientists have estimated that each degree F reduction in the soak temperature yields a 2.3% reduction in required compressor power, a 0.07 MPG increase in fuel efficiency, and a 0.9% reduction in NO_x emission. Thus, a 3 to 5 °F reduction in soak temperature from the application of cool paints (for white color up to 7°F) could permit a 7-11% reduction in air conditioner capacity. The corresponding increase in fuel efficiency would be 0.21-0.35 MPG (1.0-1.8%). The estimated reduction in NO_x emissions would be 2.7-4.4%.

Reducing the thermal load of the AC affords the potential option to reduce the size of car air conditioners. Most current air conditioners are designed for the hottest climates of the market. The car air conditioner works initially at maximum capacity to rapidly cool down the cabin. Then the AC operates at non-optimal part load efficiency. Various technologies can be used to improve the part load efficiency of the AC including: use of a double stage compressor, adjustable speed compressors, electric-drive compressors, heat-recovery systems (both on refrigerant cycle and on air supply), desiccant dehumidification systems (using waste heat from the car engine), air filters, and optimal economizer cycle. The technology and the cost effectiveness of all these technologies need to be analyzed.

Many advanced cars have a climate control system that regulates temperature. Most cars achieve the required temperature setting by mixing the cold air from the evaporator with hot ambient air. Using an optimal operation control system that minimizes the energy consumption by the AC system and improves the part-load efficiency of the AC shall be considered.

1.2 A 2020 vision

Our vision for the year 2020 is that most cars sold in the U.S. market use solar reflective coatings, the vehicle AC is designed optimally, and significant fuel consumption and emission reductions are made.

1.3 Trends and drivers in advancement of passenger vehicle technologies

The significant trends of vehicle and fuel technologies over the last 30 years can be summarized as follows:

- Improvement of fuel economy, performance and emissions for both gasoline and diesel fuelled passenger cars
- Increase in the share of diesel fuel cars in many countries
- Increase in the total number of cars in the world; increase in the number of cars on the road has grown faster than improvements in fuel economy

² Cool colored paints, like spectrally selective windows, reflect most of the sun’s energy in the near-infrared band (0.7 - 2.5 microns) while offering choice of color in the visible band (0.4 - 0.7 microns). Since about 50% of the sun’s energy lies in the near-infrared band, a surface coated with a cool cooled paint achieves a lower temperature than one coated with a standard paint of the same color.

- Increase in oil prices have initiated a strong national desire to search for alternative fuels and technologies (fuel cells, electric cars, hybrids, clean diesels, bio fuels)
- Strong local, national, and global interest to reduce emissions have led to major technological development
- There has been a strong correlation between the cost of fuel and customer choices and behavior; For example, relative *low* fuel cost has led to an increase in higher fuel-consuming and polluting cars (e.g. Sport Utility Vehicles) in some countries, and relative *high* fuel cost has led to more efficient cars (smart car) in other countries
- New advances in electronics and their use in passenger vehicles increase the parasitic demand for electricity in cars

In addition, there are major efforts and legislation underway that have the potential to improve the efficiency of cars' AC systems by as much as 50%. These trends are expected to continue at least through the next decade. As the price of fuel increases, there will be a higher demand for efficient cars. And as the engines and drives of cars become more efficient, the contributions of auxiliary loads to fuel consumption of the cars become more significant. The air conditioning constitutes a major factor of the auxiliary loads in a car.

1.4 Objectives

The objective of this document is to develop research and implementation pathways for an all-inclusive effort joining major car manufacturers (the U.S. Big Three and several Japanese and European firms), research institutions (e.g., the National Renewable Energy Laboratory [NREL]), private research companies (such as Clean Air Vehicle Technology Center), manufacturers of color pigments and automotive coatings (e.g., BASF, PPG), the California Air Resource Board, and the California and Federal Departments of Transportation to investigate approaches to minimize the fuel energy use related to operation of air conditioning in passenger cars and small trucks. Previously, the U.S. Department of Energy has sponsored a research effort at NREL to "increase fuel economy and reduce tailpipe emissions by reducing the auxiliary load requirements in vehicles while maintaining the thermal comfort of the passengers." The focus of the NREL research was to downsize vehicle air conditioners by reducing loads using advanced glazing and permitting increased recirculation of air by implementing air-cleaning processes (see <http://www.ott.doe.gov/coolcar/pdfs/vtmsfinalsent.pdf>). NREL has developed a three-pronged approach to reduce the impact of auxiliary systems:

1. Reduce the peak and steady-state cabin thermal heating and cooling load, which reduces the size of the ancillary equipment and minimizes the associated fuel consumption penalty.
2. Increase delivery efficiency with technologies that optimize thermal comfort such as local delivery, zoned systems, and climate control seats.
3. Use efficient equipment to provide cabin cooling including using engine waste heat.

1.5 Methods to reduce A/C load and improve fuel efficiency of cars

Four general methods to reduce A/C load and improve fuel efficiency of passenger vehicles and small trucks include (1) reducing the thermal load of the car when it is parked (lowering soak temperature); (2) reducing the thermal load of the car when it is running; (3) optimal design of the AC system; and (4) optimal design of AC system operation.

Methods and technologies to reduce thermal load of the car when it is parked (lowering soak temperature) include: use of solar reflective glazing, use of solar reflective paints for the car shell, use of window shades during parking, optimized insulation on the car ceiling and body, ventilation of the car during parking, use of cool color interiors, and design of car seats with low thermal mass.

Methods for reducing thermal load of the car when it is running include many of the methods listed above complemented with insulating the cabin from engine heat, use of a fresh air heat exchanger, and use of technologies for improved operation of the economizer.

Technologies and methods to improve the design of the AC system include use of adjustable speed compressors, use of direct current compressors, design of the car AC system with double-stage compressors, use of heat recovery techniques for better operations, and use of desiccant dehumidification.

Car AC can also be optimally designed for an improved part load efficiency (use of adjustable speed controls) and improved humidity and temperature controls.

Past research has identified solar reflective glazing as the most effective strategy for reducing A/C loads. Next ranked are cabin ventilation (natural or forced) and the use of window shades during parking. However, the influence of opaque surfaces on vehicle thermal load in the soak condition is not negligible and has been demonstrated to be an important component of a system solution.

The strategies and techniques to reduce AC peak loads are assessed both through modeling and tests. Modeling activities include simulation of thermal load, assessment of thermal comfort within the cabin, and estimation of fuel consumed by air conditioning. Experimental activities include manikin testing of thermal comfort, laboratory simulation of soak conditions, and outdoor comparisons of the shell temperatures, soak temperatures, and cool down times of side-by-side vehicles. Although the earlier work has identified key characteristics of techniques to reduce A/C energy use, many key issues related to R&D still need to be addressed.

NREL analysis indicated that both solar reflective coatings on car shell and body insulation can reduce vehicle interior temperatures, but are less effective than highly reflective glazing, window shades and parked-car ventilation. Although this is probably true for existing designs, as cars are equipped with advanced glazing systems, the relative effect of other components contributing to A/C load will become more pronounced.

1.6 Strategy: Technology and tool development

The objectives of this program can be achieved by developing research and implementation plans that focus on the following areas:

1. Technology development (A/C components, systems, shell coatings, interior coatings,...)

2. Performance metrics
3. Test methods
4. Process and system modification
5. Design and analysis tools
6. Market transformation (industry and public participation)
7. Milestones

All efforts should be closely coordinated with other stakeholders to (1) perform research based on the current status of the technologies, modeling, performance metrics, and test methods, and (2) take advantage of cost-sharing of many activities planned and underway by various partners.

1.7 Technology status

Technologies to be considered in this plan are at various stages of development. Table 1 shows a summary list and a qualitative assessment of technology status.

1.8 Barriers and challenges

Choice of color (and hence color design) is an important factor in developing and marketing new cars. New colors and coatings are typically developed and tested several years in advance of manufacturing and marketing of the car. The critical issues in development and deployment of cool color cars include: incremental cost, durability, systematic compatibility, after-market coating (technical issues related to painting cars in body shops), availability of a wide palette of colors, and the physical and chemical nature of cool coatings pigments. The stock of existing car coatings includes several cool pigments. This indicates that for at least some existing coatings the industry has some experience in developing cool color coatings for cars. The challenge is to develop cool color coatings for a wider selection of colors at a reasonable incremental cost, without negative environmental effects.

1.9 Environmental impact issues

The environmental benefits relate to reduced greenhouse gas (GHG) emissions, and significant reduction in CO and NO_x during the entire car operation cycle and during the cold start of the car. Potential adverse environmental effects relate to higher emissions of VOCs and other harmful chemicals during application of cool coatings. All potential negative issues should be analyzed and benign processes should be developed before full implementation and deployment of cool color cars. Judging from the fact that cool color coatings are already being used in limited applications in cars and are being fully deployed in some metallic colors (gold and silver), we do not anticipate major environmental issues related to the production and application of cool coatings.

1.10 Cost/Benefit analysis of cool cars

The benefits of cool color coatings for cars include fuel savings by reducing air conditioning load, potential downsizing of A/C leading to further improved fuel efficiency and reduced equipment cost, potential improvement in life expectancy of car interior parts including seats and dashboards, reduction in CO and NO_x emission leading to improved urban air-quality, downsizing emission control hardware leading to a lower cost, and lowering GHG emissions.

Potential increased incremental cost of application of cool color coatings include: incremental cost of pigments and coatings, potential application cost, maintenance, and cost related to production cycle.

1.11 Justification for CEC sponsorship

California is leading the world in developing and implementing state-of-the-art technologies and policies to reduce energy consumption in the state by improving energy utilization efficiency. Efficient utilization of energy yields a better allocation of available resources, saves energy and money, reduces waste, improves ambient air quality, and reduces GHG emissions. California AB32 is a leading legislation to make California GHG emissions in 2020 about 20% lower than those in 2000. Implementation of cool car technologies was one of the early action items initially selected by California Air Resource Board. However, the cool car proposal was postponed pending answers of a few technical questions raised by the manufacturers. This research topical plan is developed in collaboration with industry to address the technical and implementation issues related to the development and deployment of cool color cars. California (the Energy Commission) sponsoring this research program is instrumental to saving significant energy by lowering fuel consumption in California. Of course, the greater prize is when the cool car technologies (all technologies that reduce A/C energy use) are adopted throughout the world and the GHG emissions from the use of air conditioning in cars is significantly reduced.

1.12 Program cost and duration

This five-year plan research and implementation is focusing on research activities for development of cool color cars. The preliminary estimated cost of the program is about \$1.3M per year.

1.13 Partners

LBNL, Concordia University, NREL, CARB, CalTrans, car manufacturers, car-coating manufacturers, pigment manufacturers, A/C OEM.

1.14 Research plan

We have developed an initial list of research activities for developing cool-colored cars (see sections 1.17 and 1.18). This list will be shared with the industry partners for their input.

1.15 Organization

We recommend an integrated program (sponsored and led by a program manager at the Energy Commission) led by the research institutions (LBNL and NREL) with broad participation from car manufacturers and OEMs. The program should establish a Program Advisory Committee constituting from major industry and public stake-holders. The research should be carried out with full participation of the industry.

1.16 Development procedure for the R&D plan

This R&D plan has been developed in close collaboration with the industry, national laboratories, and governmental agencies. In June 2010, an Initial plan was developed and reviewed by all stakeholders. Subsequently, a revised version of the plan was distributed in

September 2010 for review and commentary. We convened a 1-day workshop on October 25, 2010 to review and finalize the research topics and implementation pathways document. The workshop attendees are listed in Table 2.

All partners' comments and input are incorporated in this plan.

1.17 Key issues related to development of cool-colored coatings for cars

The following are some of the key questions that need to be addressed in a research program:

Benefits:

1. What are the energy benefits of cool-colored cars?
2. What are the benefits of applying cool color technology in the cabin, particularly with respect to dark seats and dashboards?
3. What are the air-quality benefits of cool-colored cars?
4. Are there other environmental benefits?
5. To what extent can the air conditioning system of a cool colored car be downsized?
6. Do emission reductions permit cost savings in emission control hardware?
7. What are the regional, statewide, and nation-wide energy and air quality benefits of cool colored cars?

Cost:

1. What are the costs associated with cool colored cars?
 - a. Pigments
 - b. Coatings
 - c. Application
 - d. Maintenance
 - e. Production cycle
2. What are the other detriments of cool cars?
 - a. Emissions in application process
 - b. Production of coatings

Status of technology:

1. What are the capabilities of existing car air conditioner design tools?
2. Do the shell and interior components of cool colored cars last longer?

3. What are the market barriers to cool cars? Why are car manufacturers not currently designing and marketing cool cars? (Perhaps they are designing cool cars to a certain degree!)

Environmental aspects:

1. Toxicity of cool color pigments (this should include a complete definition of toxicity by various regulators)
2. In process emissions of application of cool color coatings
3. Other positive and negative environmental effects

1.18 Methodology for development of cool color cars

In designing cool color cars the following critical engineering, environmental, and market issues need to be addressed:

1. Pigments and coatings must be appropriate for automotive and truck OEM applications; the cool coatings must pass the minimum performance criteria for both manufacturing and aftermarket coatings applications
2. The cool pigment coatings need to be studied for their toxicity (do they contain toxics Cr 3+, cadmium, nickel, cobalt, manganese, and antimony); appropriateness (durability, capability, compatibility, color matching etc.); and availability. This should include a complete definition of toxicity by various regulators.
3. In application of bi-layer coating techniques, issues related to consumer satisfaction in regards to scratches and chipping needs to be examined.
4. Consumer choice of color is very important. Cool colors may limit the color choices for the consumers. Will the consumer have a strong interest in dark vs. light colors? How much improvement can be made within the guideline of not significantly altering the palette and using production feasible techniques?
5. In carrying out cost-benefit analysis of cool color cars, careful attention should be given to both factors that may affect the cost (toxicity, waste, emissions, ...) and the benefits. Critical assumptions need to be carefully examined in reference to soak temperature reduction, the effect of cool coatings in tandem with the other load reduction measures (advanced glazing), quantifying fuel and emission savings, and measurement protocols. In addition, the choice of fuel and emission savings protocols must be directly related to the actual pattern of A/C use in cars in different parts of the country.

Initial key activities:

1. Establish an advisory board from the existing collaborative research team (or expand the existing research team) including government, industrial, and other research institutions
2. Use existing models, perform energy simulations to estimate the impact of cool coatings on fuel efficiency and tailpipe emissions. Improve existing models, if any

3. Expand the existing database of cool colored materials by measuring and documenting the solar reflectance, spectral reflectance and thermal emittance of current car finishes
4. Expand the review and classification of novel cool pigments to those applied to cars
5. Review current car coating techniques and assess the possibility of increasing the solar reflectance of car coatings through novel engineering applications
6. Expand the coating-design software currently being developed at LBNL to include applications for optimal design of cool coatings on cars
7. Analyze the consumer adoptability of cool-color coating palette
8. Review existing protocols for measuring fuel consumption and emissions from cars and adopt one for this program
9. Measure the A/C part-load performance for several cars in the laboratory
10. With leadership from car manufacturers, manufacture several prototype cool cars with optimized air-conditioning systems
11. Measure the field and laboratory performance of the prototype cool cars (both energy efficiency and emission reductions)
12. Perform a detailed cost/benefit and research analysis for application of cool cars. The analysis includes quantifying:
 - a. the energy benefits of cool cars
 - b. the air quality benefits of cool cars
 - c. the potential to downsize the A/C system
 - d. other cost savings potentials (such as emission control hardware) yielded by tailpipe emission reduction
 - e. other environmental benefits
 - f. the costs associated with cool cars
 - g. other detriments to cool cars
13. Analyze the environmental aspects of cool color coatings for their toxicity (do they contain toxics Cr 3+, cadmium, nickel, cobalt, manganese, and antimony); appropriateness (durability, capability, compatibility, color matching etc.); and availability
14. Perform measurements and analyses to determine whether the shell and interior components of cool cars last longer
15. Perform measurement and analysis to quantify the benefits of applying cool color technology to the car interior components (particularly for dark seats and dashboard)
16. Perform an analysis of the market barriers to cool cars. Focus on why the car manufacturers are not currently designing and marketing cool cars

17. Assess the regional, state, and national impacts on energy use and air quality. This should account for the effects of new and upcoming advances and improvements in cars and their systems (e.g., AC system) performance. In addition, the stock of existing and new cars should be characterized.

Many of these activities need to be cost shared with various governmental institutions and industry. The activities undertaken in this research plan should be closely coordinated with other national and international stakeholders. A modest portion of the effort should be devoted to materials design to continue to improve pigments and application methods for cool colored paints. Demonstration and exhibition of the performance of cool colored cars can accelerate their market penetration.

Other ways to reduce soak temperature such as ventilating the cabin when the interior temperature reaches a certain threshold (e.g., 110°F) should be investigated.

Table 1. Summary list and a qualitative assessment of technology status for cool cars

Technology	Remarks
Solar reflective glazing (advanced windshields)	This technology is fairly mature. Most new effort is to make the technology more affordable
Solar reflective paints (dark cool-colored coatings)	Cool colored pigments and coatings have been developed for other applications (e.g., roofing materials). The application of cool coatings on cars is a new development.
Window shades during parking, advanced window technologies (electrochromics, thermochromics, photochromics)	Window shades are low-tech application and are used by many people. Advanced windows are costly; research is underway to develop economical solutions for advanced glazing.
Optimized insulation (engine insulation)	Insulation is used regularly in design of cars; more modeling can lead to optimal design of car insulation
Ventilation during parking	Venting of the car (either powered by battery or PV) can effectively reduce the soak load; advanced models can help with better design of the ventilation system.
Cool color interiors	Cool colored pigments and coating have been developed for other applications (e.g., roofing materials). The application of cool coatings in cars is a new development.
Low thermal mass seats	Design of low-thermal mass seats has been underway during the last decade. More research in engineering design and material development will lead to optimal design of car seats for both heating and cooling of the car.
Optimal design of the AC system	The air conditioning system design is fairly mature in buildings; the technology can be adopted for optimal design of car air-conditioning systems.
Optimal design of AC system operation	Over the last two decades, significant advances have been made in optimally operating air conditioning in buildings; the technology can be adopted for optimal design of air-conditioning systems in cars. This would require advanced models and measurement sensors.
Air-to-air heat exchanger	Cost-effective heat exchangers need to be designed for

	AC applications.
Advanced air-conditioning and control design (adjustable speed drive)	Over the last two decades, significant advances have been made to design advanced control systems (e.g., adjustable speed drive) for air-conditioners; the technology can be adopted for optimal control of air-conditioning systems in cars. This would require advanced models and measurement sensors.

Table 2. Cool Car Workshop Attendee list held on 10/15/2010, 9am – 1pm.

Hashem Akbari	hakbari@encs.concordia.ca
Marijke Bekken	mbekken@arb.ca.gov
Paul Berdahl	phberdahl@lbl.gov
Robert Cassidy	richar.cassidy@nissan-usa.com
Dave Darling	ddarling@paint.org
Steve Douglas	sdouglas@autoalliance.org
Richard Doyle	richard.doyle@basf.com
Haley Elizabeth Gilbert	hegilbert@lbl.gov
Ray Gonzales	
Kevin Iceman	
Bill Kittler	bill.kittler@jdsu.com
Glenn Kleppinger	kleppinger@silberline.com
Parfait Likibi	likibip@silberline.com
Ronnen Levinson	rml27@cornell.edu
Hai Lin	linh@silberline.com
Ken Loye	loyek@ferro.com
John Lund	lundj@ferro.com
Philip Misemer	pmisemer@energy.state.ca.us
Jim Ohlinger	ohlinger@ppg.com
Kurt Olson	kgolson@ppg.com
Heng Pan	hpan@lbl.gov
Riccardo Paolini	rpaolini@lbl.gov
John Rugh	
Michael Spears	mspears@lbl.gov
Tony Tully	
Frank Vrudney	

ATTACHMENT 3:

Report for Task 4 (Development of a database of cool colored coatings for cars)

Contents

- A. Levinson, R., Spears, M., Paolini, R., Tam, J., Pan, H., Akbari, H. 2011. Cool coatings measurement.

Task 4 Report: Cool Coatings Measurement

Ronnen Levinson, Michael Spears, Riccardo Paolini, Joyce Tam,
Heng Pan and Hashem Akbari

Overview

We measured the solar spectral reflectance and thermal emittance of over 180 car coating samples obtained from two automotive coating manufacturers. Solar reflectance, visible reflectance, near-infrared reflectance, and color coordinates (CIELAB L^* , a^* and b^*) were computed from solar spectral reflectance. Solar reflectance index (SRI) was computed from solar reflectance and thermal emittance. A Microsoft Access database containing all measurements and an image of each sample has been posted to the project website, <http://CoolCars.LBL.gov>.

Samples

Berkeley Lab invited car coating and vehicle manufacturers to submit samples of car coatings for characterization and inclusion in a database. Samples were received from two coating manufacturers: BASF Automotive, and PPG. BASF Automotive provided two sets of coated metal panels. The first, denoted "BASF1", included 36 primer/basecoat combinations and one ecoat-only sample (Figure 1); the second, "BASF2", included 26 colors (Figure 2). PPG also provided two sets of coated metal panels. The first, denoted "PPG1", included 15 colors and one bare metal panel (Figure 3); the second, "PPG2", included 104 colors (Figure 4). The tracking codes and descriptions of all 184 samples are shown in Table 1.

Set BASF1 explored the effects of primer and basecoat on reflectance, while set BASF2 included both production colors and cool colored prototypes. Set PPG1 contained production colors, and set PPG2 contained cool colored prototypes.

Measurements and images

Solar spectral reflectance

The solar spectral reflectance of each panel was measured according to ASTM Standard E903-96 (ASTM 1996) using a PerkinElmer LAMBDA 900 UV/Vis/NIR spectrophotometer fitted with a 15 cm diameter Labsphere integrating sphere. Spectral reflectances were recorded at an interval of 5 nm from 300 to 2500 nm, the spectrum containing over 99% of terrestrial solar energy. (In some cases the range of spectral reflectance measurement was extended down to 250 nm; however, these additional values do not influence solar reflectance because virtually no sunlight arrives at wavelengths shorter than 300 nm.)

Thermal emittance

The thermal emittance (TE) of each panel was measured according to ASTM Standard C1371-04a (ASTM 2004) using a Devices & Services Emissometer model AE1. Thermal emittance is a measure of the efficiency with which a surface emits radiation, and is measured on a scale of 0 to 1.

Images

The front of each panel was imaged with a 600 dpi color flatbed scanner. The back of each panel was also scanned if it was labeled with information about the sample.

Calculations

Solar reflectance

The solar reflectance (SR) of each panel was computed by averaging its solar spectral reflectance weighted with clear sky air mass 1 global horizontal (AM1GH) solar spectral irradiance (Levinson 2010). This solar reflectance metric has been found to be a good predictor of the solar heat gain of surfaces exposed to global (both direct and diffuse) sunlight (Levinson et al. 2010a,b). Solar reflectance is the fraction of incident sunlight reflected by a surface, and is measured on a scale of 0 to 1.

Visible and near-infrared reflectances

The visible reflectance (VR) and near-infrared reflectance (NR) of each panel was computed in the same manner as its solar reflectance, but averaging only visible spectral reflectance (400 - 700 nm) or near-infrared spectral reflectance (700 - 2500 nm) weighted with AM1GH solar spectral irradiance. Samples that exhibit solar reflectance greater than visible reflectance may be described as "cool" colors.

Solar reflectance index

The solar reflectance index (SRI) of each sample was computed from its solar reflectance and thermal emittance according to ASTM Standard E1980-01 (ASTM 2001b). The standard medium-wind-speed convection coefficient of $12 \text{ W m}^{-2} \text{ K}^{-1}$ was used in calculation of SRI. Solar reflectance index compares the temperature of a surface on a summer afternoon to that of a clean black surface (SR=0.05, TE=0.90), which is assigned an SRI of 0, and that of a clean white surface (SR=0.80, TE=0.90), which is assigned an SRI of 100. SRI values typically ranges from 0 to 100, but can be lower than 0 for a very hot surface (e.g., a black nickel solar collector) or higher than 100 for a very cool surface (e.g., a very bright white).

Color

CIELAB tristimulus values of L^* , a^* and b^* under CIE Standard Illuminant D65 were calculated for a 10° observer following ASTM Standard E308-01 (ASTM 2001a). Coordinate L^* indicates lightness, where 0=black and 100=diffuse white. Coordinate a^* is a red to green scale in which positive values indicate red and negative values indicate green. Coordinate b^* is a yellow to blue scale in which positive values indicate yellow and negative values indicate blue.

Database

All radiative measurements (solar spectral reflectance, thermal emittance) and images were collected in a Microsoft Access database (Access versions 2003 and later). The database has been posted to the project website, <http://CoolCars.LBL.gov> (Figure 5).

The database splash screen (Figure 6) has a query that lets the operator select one or more samples (Figure 7). The database then generates an Excel workbook with three worksheets

describing the selected samples. The first worksheet contains the samples' solar spectral reflectances. The second worksheet shows a chart that compares the solar spectral reflectances of all samples, and tabulates the thermal emittance, solar reflectance, visible reflectance, near-infrared reflectance, and color coordinates (L^* , a^* and b^*) of each sample. The third worksheet shows for each sample a plot of its solar spectral reflectance, a table of computed values, and its image (Figure 8). An excerpt from the third worksheet is shown in Figure 9.

Analysis

We charted for each sample set its distributions of solar reflectance (Figure 10), thermal emittance (Figure 11), and solar reflectance index (Figure 12). Comparison of solar reflectance to visible reflectance indicates that many samples are, as expected, cool colors (Figure 13). Solar reflectance ranged from 0.04 (conventional black) to 0.70 (conventional white), with many cool colors ranging in solar reflectance from about 0.20 to 0.50. All coated samples exhibited high thermal emittance (0.82 - 0.95).

Summary

We measured the solar spectral reflectance and thermal emittance of over 180 car coating samples obtained from two automotive coating manufacturers: BASF Automotive Coatings, and PPG. These samples included both production colors and prototype color colors.

Solar reflectance, visible reflectance, near-infrared reflectance, and color coordinates (CIELAB L^* , a^* and b^*) were computed from solar spectral reflectance. Solar reflectance index (SRI) was computed from solar reflectance and thermal emittance.

Our measurements verified that the prototype cool colors did generally exhibit solar reflectance exceeding visible reflectance. Solar reflectance ranged from 0.04 (conventional black) to 0.70 (conventional white), with many cool colors ranging in solar reflectance from about 0.20 to 0.50. All coated samples exhibited high thermal emittance (0.82 - 0.95).

A Microsoft Access database containing all measurements and an image of each sample has been posted to the project website, <http://CoolCars.LBL.gov>. The database can be used to explore the palette and performance of cool colored coating options for car shells.

In future work, the database could be expanded to characterize more samples, and to detail the non-radiative properties of car shell coatings, such as cost, durability, and toxicity.

References

ASTM. 1996. ASTM E903-96: Standard test method for solar absorptance, reflectance, and transmittance of materials using integrating spheres. American Society for Testing and Materials, West Conshohocken, PA.

ASTM. 2001a. ASTM E308-01: Standard practice for computing the colors of objects by using the CIE system. American Society for Testing and Materials, West Conshohocken, PA.

ASTM. 2001b. ASTM E1980-01: Standard practice for calculating solar reflectance index of horizontal and low-sloped opaque surfaces. American Society for Testing and Materials, West Conshohocken, PA.

ASTM. 2004. ASTM C1371-04a: Standard test method for determination of emittance of materials near room temperature using portable emissometers. American Society for Testing and Materials, West Conshohocken, PA.

Levinson, Ronnen. 2010. AM1GH Solar Spectral Irradiance.
<<http://coolcolors.lbl.gov/irradiance>>.

Levinson, R., H. Akbari and P. Berdahl. 2010a. Measuring solar reflectance—Part I: defining a metric that accurately predicts solar heat gain. *Solar Energy* 84, 1717-1744.

Levinson, R., H. Akbari and P. Berdahl. 2010b. Measuring solar reflectance—Part II: review of practical methods. *Solar Energy* 84, 1745-1759.

Table 1. Tracking code and description of each car coating sample. The designation "(C)" in the descriptors of samples CBASF047-063 indicates that the manufacturer regards the sample as a cool color.

Code	Description
CBASF000	BASFM000 AUTO Ecoat only %R
CBASF001	BASF-M001_AUTO_stdWprim&stdWcoat %R
CBASF002	BASF-M002_AUTO_stdWprim&stdBcoat %R
CBASF003	BASF-M003_AUTO_stdWHI-prim&stdSILV-coat %R
CBASF004	BASF-M004_AUTO_stdWHI-prim&coolBLACK-coat %R
CBASF005	BASF-M005_AUTO_stdWHI-prim&coolSILV-coat %R
CBASF006	BASF-M006_AUTO_stdWHI-prim&coolWHI-coat %R
CBASF007	BASF-M007_AUTO_stdLtGRAY-prim&stdWHI-coat %R
CBASF008	BASF-M008_AUTO_stdLtGRAY-prim&stdBLACK-coat %R
CBASF009	BASF-M006_AUTO_stdLtGRAY-prim&stdSILV-coat %R
CBASF010	BASF-M010_AUTO_stdLtGRAY-prim&coolBLACK-coat %R
CBASF011	BASF-M011_AUTO_stdLtGRAY-prim&coolSILVER-coat %R
CBASF012	BASF-M012_AUTO_stdLtGRAY-prim&coolWHITE-coat %R
CBASF013	BASF-M013_AUTO_stdDk-prim&stdWHITE-coat %R
CBASF014	BASF-M014_AUTO_stdDk-prim&stdBLACK-coat %R
CBASF015	BASF-M015_AUTO_stdDk-prim&stdSILVcoat %R
CBASF016	BASF-M016_AUTO_stdDk-prim&coolBLACKcoat %R
CBASF017	BASF-M017_AUTO_stdDk-prim&coolSILVcoat %R
CBASF018	BASF-M018_AUTO_stdDk-prim&coolWHITEcoat %R
CBASF019	BASF-M019_AUTO_coolWhite-prim&stdWHITEcoat %R
CBASF020	BASF-M020_AUTO_coolWhite-prim&stdBLACKcoat %R
CBASF021	BASF-M021_AUTO_coolWhite-prim&stdSILVERcoat %R
CBASF022	BASF-M022_AUTO_coolWhite-prim&coolBLACKcoat %R
CBASF023	BASF-M023_AUTO_coolWhite-prim&coolSILVERcoat %R
CBASF024	BASF-M024_AUTO_coolWhite-prim&coolWHITE-coat %R
CBASF025	BASF-M025_AUTO_coolLt-prim&stdWHITE-coat %R
CBASF026	BASF-M026_AUTO_coolLt-prim&stdBLACK-coat %R
CBASF027	BASF-M027_AUTO_coolLt-prim&stdSILV-coat %R
CBASF028	BASF-M028_AUTO_coolLt-prim&coolBLACK-coat %R
CBASF029	BASF-M029_AUTO_coolLt-prim&coolSILVER-coat %R
CBASF030	BASF-M030_AUTO_coolLt-prim&coolWHITE-coat %R
CBASF031	BASF-M031_AUTO_coolDk-prim&stdWHITE-coat %R
CBASF032	BASF-M032_AUTO_coolDk-prim&stdBLACK-coat %R
CBASF033	BASF-M033_AUTO_coolDk-prim&stdSILV-coat %R
CBASF034	BASF-M034_AUTO_coolDk-prim&coolBLACK-coat %R
CBASF035	BASF-M035_AUTO_coolDk-prim&coolSILV-coat %R
CBASF036	BASF-M036_AUTO_coolDk-prim&coolWHITE-coat %R
CBASF038	BASF Japanese Color Trend 97BNC7005-2M
CBASF039	BASF Europe 110.076 Breaking Grey
CBASF040	BASF Europe 110.080 Flavored Gold
CBASF041	BASF Europe 110.020 Monochrome
CBASF042	BASF Europe 110.069 Elastic Fanta
CBASF043	BASF Europe 110.068 Plasmatic Grey
CBASF044	BASF Europe 110.065 Modest Forest
CBASF045	BASF Europe 110.062 Smoking Rose
CBASF046	BASF Europe 110.061 Flash 'n Theory

CBASF047	BASF North America Crystal Frost (C)
CBASF048	BASF North America Chills (C)
CBASF049	BASF North America Chills w Thrills (C)
CBASF050	BASF North America Glacier Ice (C)
CBASF051	BASF North America Boreas (C)
CBASF052	BASF North America Shiver (C)
CBASF053	BASF North America Frostbite (C)
CBASF054	BASF North America Green House (C)
CBASF055	BASF North America Cooler By Degrees (C)
CBASF056	BASF North America Below Zero (C)
CBASF057	BASF North America Degrees (C)
CBASF058	BASF North America Cocoa Cold (C)
CBASF059	BASF North America Fudgesicle (C)
CBASF060	BASF North America Frosted Almond (C)
CBASF061	BASF North America Hawt (C)
CBASF062	BASF North America Polar Cap (C)
CBASF063	BASF North America Brrr (C)
CPPG001	PPG panel DCT7208R - Brilliant Silver
CPPG002	PPG panel MCT7201R - Black Cherry Ice
CPPG003	PPG panel \$MCT7197R - Sangria Red
CPPG004	PPG panel MCT7195R - Vapor Silver
CPPG005	PPG panel MCT7148R - Smokestone
CPPG006	PPG panel MCT7054R - Light Ice Blue
CPPG007	PPG panel *MCT7042R - Colorado Red
CPPG008	PPG panel ODCT6466R - Oxford White
CPPG009	PPG panel MCT6505R - Silver Metallic
CPPG010	PPG panel DCT6373R - Ebony
CPPG011	PPG panel HWB49619 - Green Metallic
CPPG012	PPG panel HWB196221 - Surf Blue
CPPG013	PPG panel HWB196237 - Deep Water Blue
CPPG014	PPG panel HWB204616 - Light Sandstone Metallic
CPPG015	PPG panel HWB700017 - Inferno Red
CPPG016	PPG panel UNCLASSIFIED
CPPG017	uncoated
CPPG018	North America HWB 8-1847-1 Take Notice
CPPG019	Taiwan 20061215 Williamsport
CPPG020	Korea 0783-P12 Mock Black
CPPG021	North America HWB 1-2816-1 Deep Navy
CPPG022	Australia 159-3607-148-3 Abyss
CPPG023	Europe 40-21619 Darkness
CPPG024	North America HWB 9-1078-1 Black Maple
CPPG025	North America HWB 9-1077-1 Scenic
CPPG026	North America HWB 9-1076-1 Aquarius Black
CPPG027	Europe 40-21623 Mirage Brown
CPPG028	Taiwan 20070207 Twinkle Gray
CPPG029	North America HWB 3-1877-1 Vision
CPPG030	Europe 40-21620 Eclipse
CPPG031	North America HWB 2-2315-4 Vista Tricoat
CPPG032	North America HWB 3-1876-1 Carbon Steel
CPPG033	Korea 0784-P-11 Mok Monochrome
CPPG034	Europe 40-21632 Highlight Gold

CPPG035	Europe 40-21630 Shine Gold
CPPG036	Europe 40-21631 Mirror Gold
CPPG037	North America HWB 8-1845-1 Cold Gold
CPPG038	Taiwan 20061215 Meteorite Gray
CPPG039	Europe 40-21622 Solar Brown
CPPG040	Japan HWB 6-1062-1 Autumn
CPPG041	North America HWB 2-2322-2 Bold OptimizM
CPPG042	North America HWB 8-1846-1 Behold Gold
CPPG043	North America HWB 1-2832-2 Out-Of-Sight
CPPG044	Europe 40-21621 Dusk
CPPG045	Europe 40-21603 Chromatic Beige
CPPG046	Europe 40-21601 Spotlight Yellow
CPPG047	Europe 40-21634 Gleam
CPPG048	Europe 40-21639 Shadow White
CPPG049	Europe 40-21615 Glossy Gold
CPPG050	Europe 40-21633 Saturation Beige
CPPG051	Europe 4021604 Sight Yellow
CPPG052	North America HWB 4-2091-1 Quest
CPPG053	Europe 40-21610 Perception Beige
CPPG054	Europe 40-21616 Lightning Beige
CPPG055	Europe 40-21617 Horizon Green
CPPG056	Japan HWB 2-2324-1 Daylight
CPPG057	North America HWB 8-1844-1 Bold Gold
CPPG058	North America HWB 3-1892-1 U-See-It
CPPG059	Europe 40-21606 Hint of Beige
CPPG060	Korea 0734-P-04 Patina Beige
CPPG061	Taiwan 20061215 Spitzweg Beige
CPPG062	Europe 40-21636 Reflection Beige
CPPG063	Taiwan 20061215 Royal Silver
CPPG064	Korea 0784-P-09 Mechanical Silver
CPPG065	North America HWB 9-1079-1 All Steel
CPPG066	North America HWB 3-1873-1 Blade
CPPG067	Korea 0784-P-10 Enigmatic Silver Grey
CPPG068	North America HWB 5-1107-1 Helio Violet
CPPG069	North America HWB 7-2092-2 Look Out
CPPG070	North America HWB 7-2090-2 Idea Red
CPPG071	Europe 40-21628 Sunset Glow
CPPG072	Europe 40-21642 Retention Brown
CPPG073	Europe 40-21608 Viewer Brown
CPPG074	Europe 40-21602 Luminosity Orange
CPPG075	Europe 40-21600 Brightness Red
CPPG076	Europe 40-21643 Violet Dream
CPPG077	Europe 40-21644 Deep Violet
CPPG078	Europe 40-216-9 Eye Catcher Red
CPPG079	Europe 40-21605 Changeable Red
CPPG080	Korea 0713-P-07 Enchanting Red
CPPG081	Japan HWB 7-2106-1 Blossom
CPPG082	Australia 159-3607-148-4 Coral
CPPG083	India IN2007-R1 Dynasty Red
CPPG084	North America HWB 2-2312-3 Bronze
CPPG085	North America HWB 4-2094-1 Double Vision

CPPG086	North America HWB 4-2090-1 Pan-O-Rama
CPPG087	North America HWB 4-2089-1 Sigillum
CPPG088	Europe 40-21629 Luminous Green
CPPG089	Europe 40-21635 Toner Green
CPPG090	Europe 40-21607 Robot Green
CPPG091	Europe 40-21614 Flashlight Green
CPPG092	Europe 40-21613 Flip Flop Green
CPPG093	Japan HWB 4-2099-1 Celadon
CPPG094	Korea 0744-P-06 Mature
CPPG095	Korea 0744-P-05 Botanical Green
CPPG096	Australia 159-3607-148-2 Iceberg
CPPG097	Europe 40-21627 Red Sky
CPPG098	Korea 0734-P-08 Aromatic Orange
CPPG099	North America HWB 1-2832-1 Cold Stare
CPPG100	North America HWB 1-2818-2 Outlook
CPPG101	North America HWB 1-2830-1 Hilite Blue
CPPG102	Europe 40-21637 Index Blue
CPPG103	Europe 40-21638 Blue View
CPPG104	Europe 40-21624 Fatamorgana Teal
CPPG105	Europe 40-21640 Clarity Blue
CPPG106	Europe 40-21611 Strength Blue
CPPG107	Europe 40-21612 Screen Blue
CPPG108	Japan HWB 5-1109-1 Twilight Sky
CPPG109	Australia 159-3607-148-1 Ocean
CPPG110	India IN2007-B1 Deep Pearl Blue
CPPG111	Korea 0753-P-01 Spider Blue
CPPG112	Korea 0754-P-02 Lusterware Blue
CPPG113	India IN2007-S1 Bluish Silver
CPPG114	Europe 40-21641 Tendency Blue
CPPG115	Korea 0754-P-03 Intensional Blue
CPPG116	North America HWB 5-1106-1 Picture Perfect
CPPG117	Europe 40-21625 Contrast Violet
CPPG118	Europe 40-21626 Will-O-Wisp
CPPG119	North America HWB 3-1884-3 Perspective Tricoat
CPPG120	Europe 40-21618 Dawn White



Figure 1. Sample set **BASF1** includes one ecoat-only panel (CBASF000) and 36 primer/basecoat combinations (CBASF001-036). Each sample is labeled with its tracking code (CBASF nnn), solar reflectance (SR) and thermal emittance (TE).



Figure 2. Sample set **BASF2** includes 26 colors (CBASF038-063). Each sample is labeled with its tracking code (CBASF nnn), solar reflectance (SR) and thermal emittance (TE).

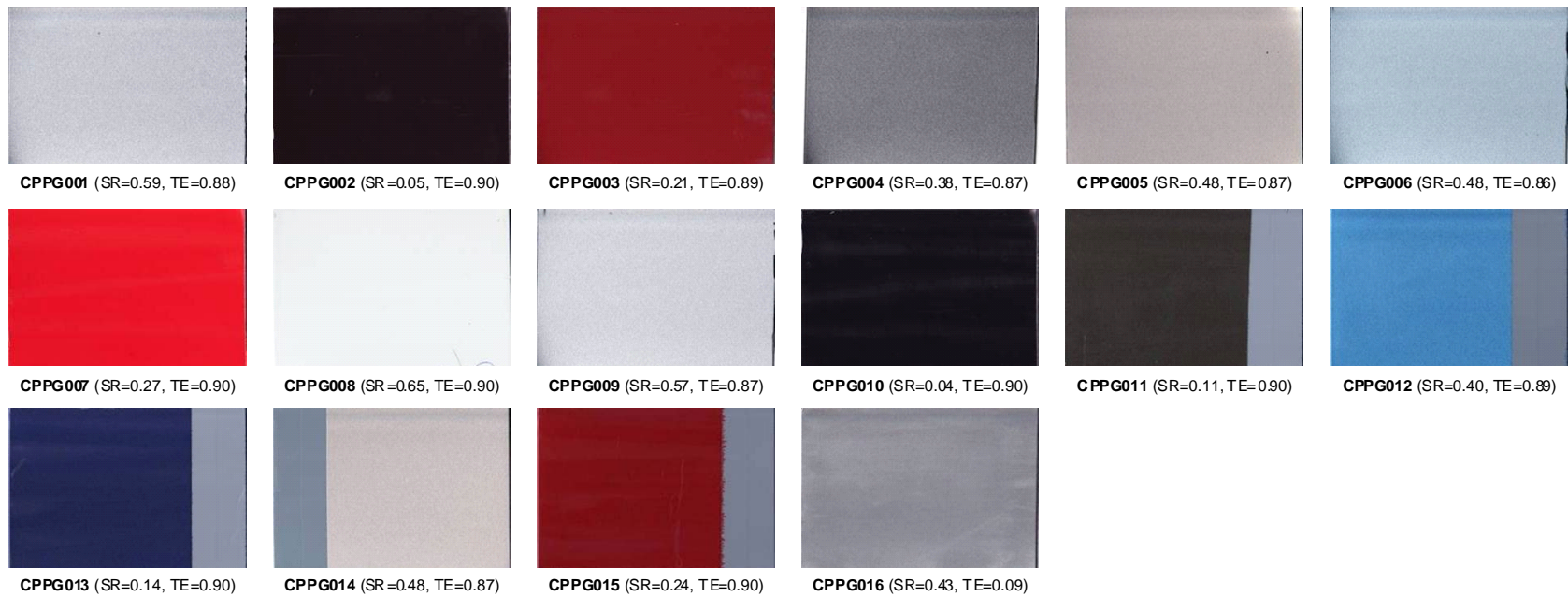
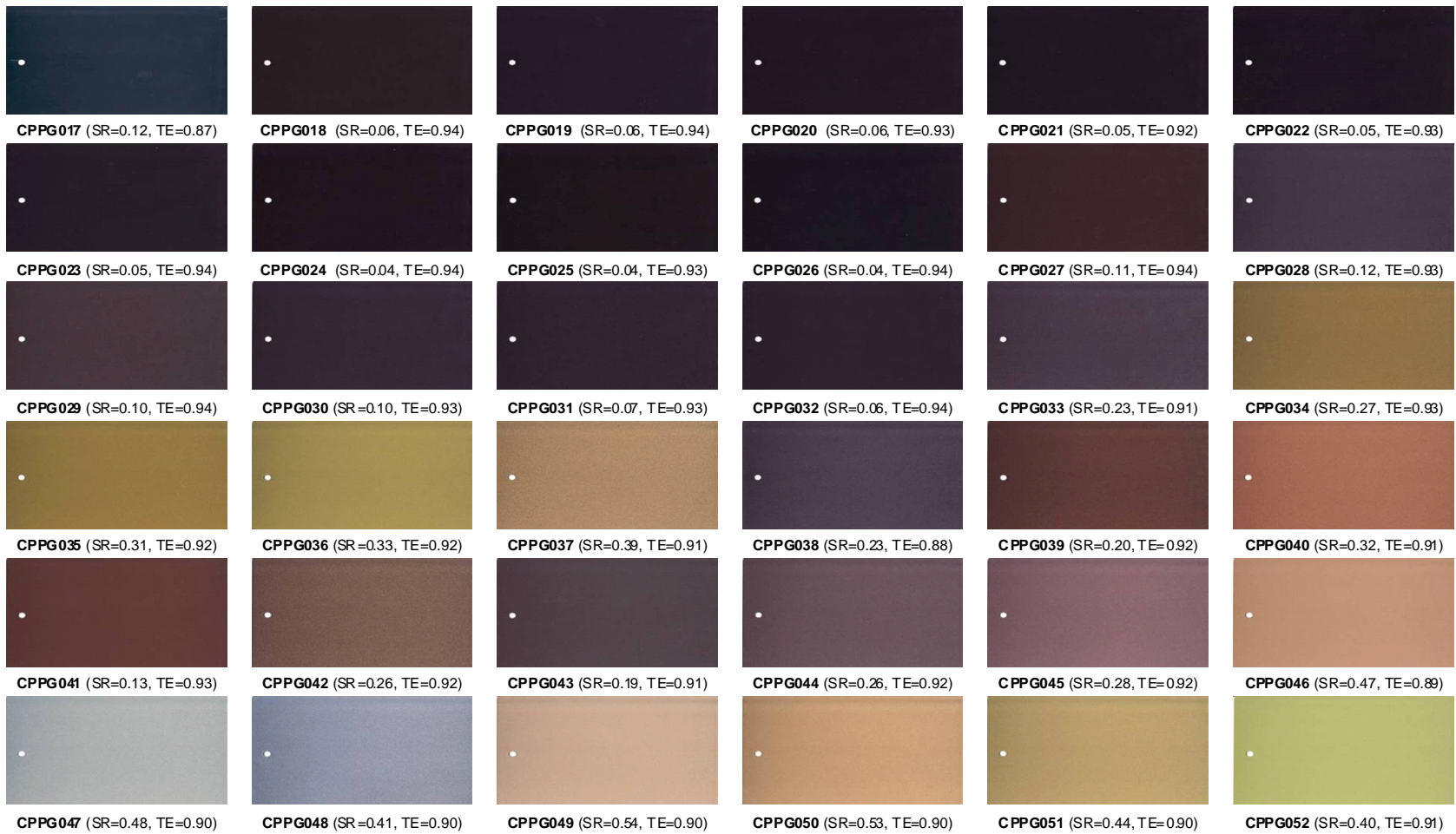
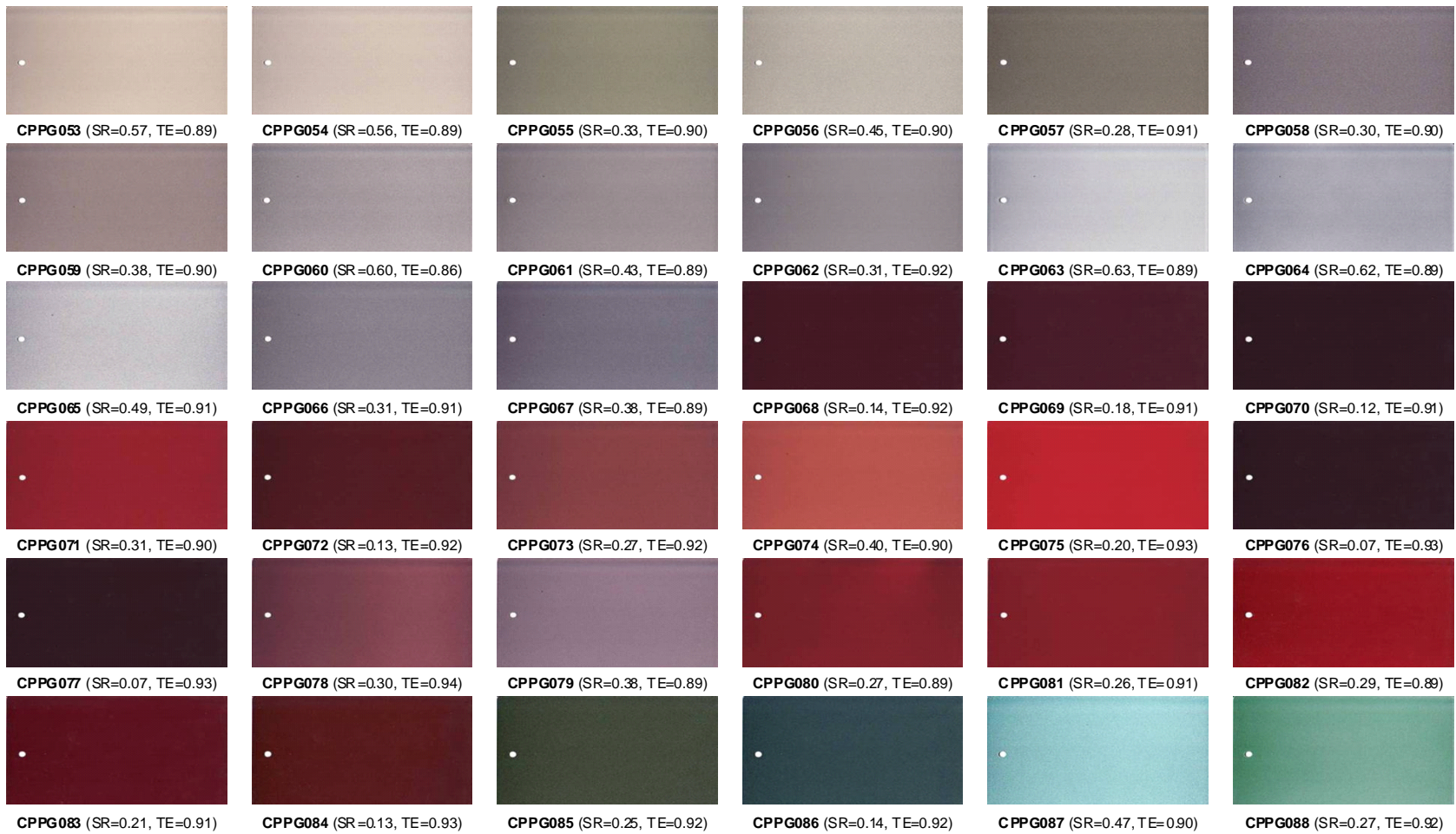

Figure 3. Sample set **PPG1** includes 16 colors (CPPG001-016). Each sample is labeled with its tracking code (CPPG n nn), solar reflectance (SR) and thermal emittance (TE). Narrow vertical bands on samples CPPG011-015 reveal the primer layer.



(i/iii)

Figure 4. Sample set **PPG2** includes 104 colors (CPPG017-120). Each sample is labeled with its tracking code (CPPG nnn), solar reflectance (SR) and thermal emittance (TE).



(ii/iii)

Figure 4 (continued).

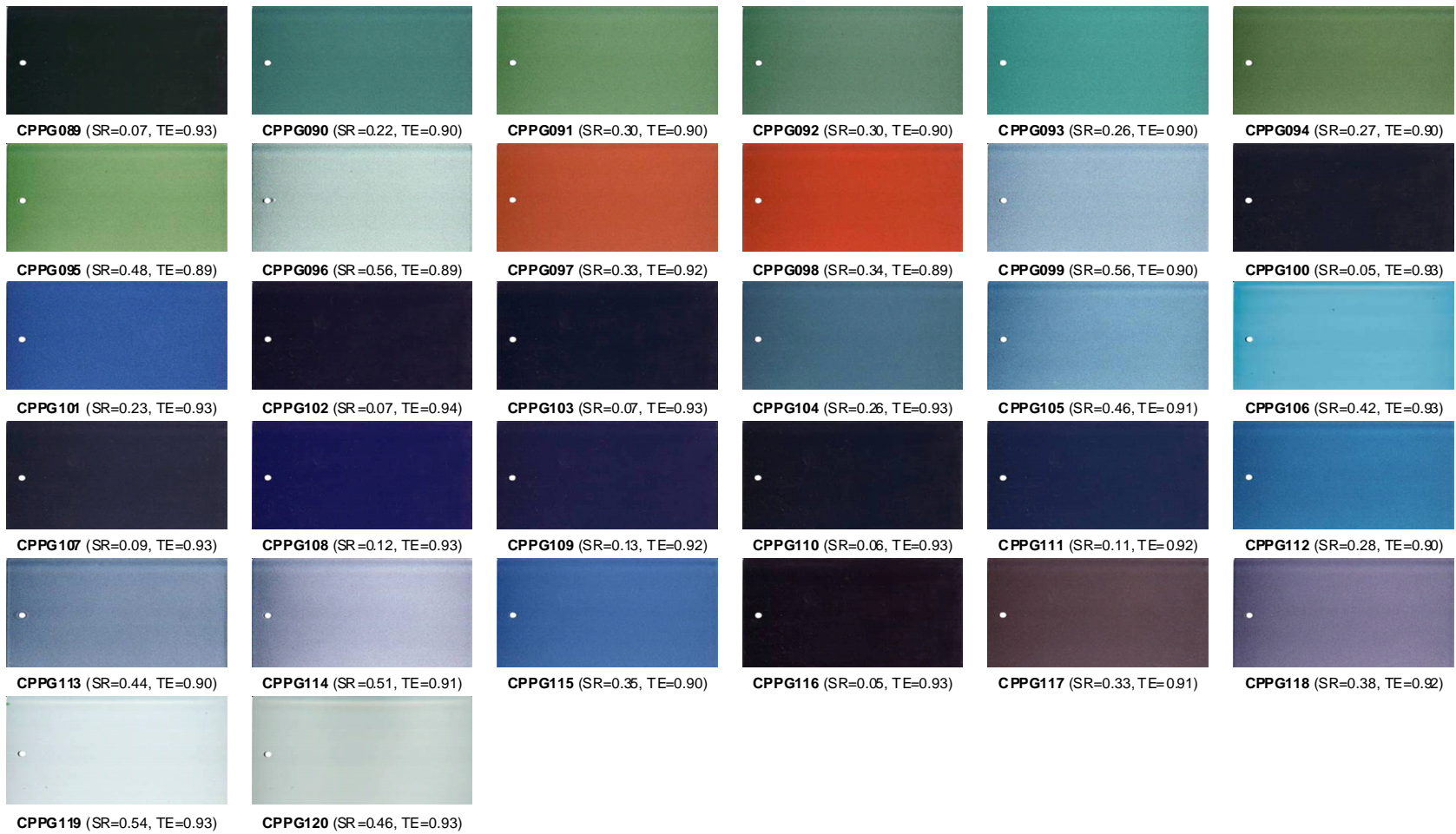

(iii/iii)

Figure 4 (continued).

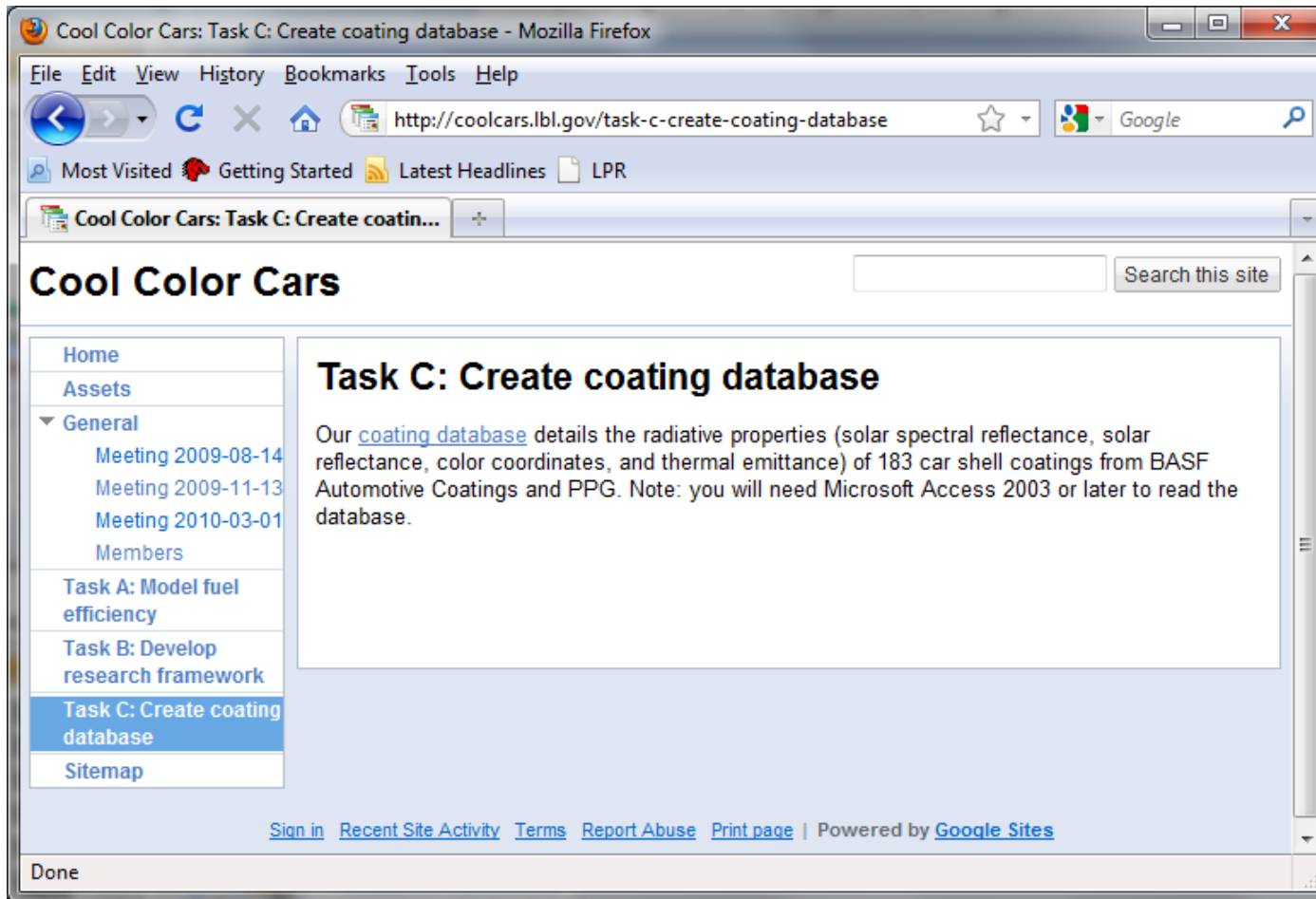

Figure 5. Project website page presenting the coatings database.

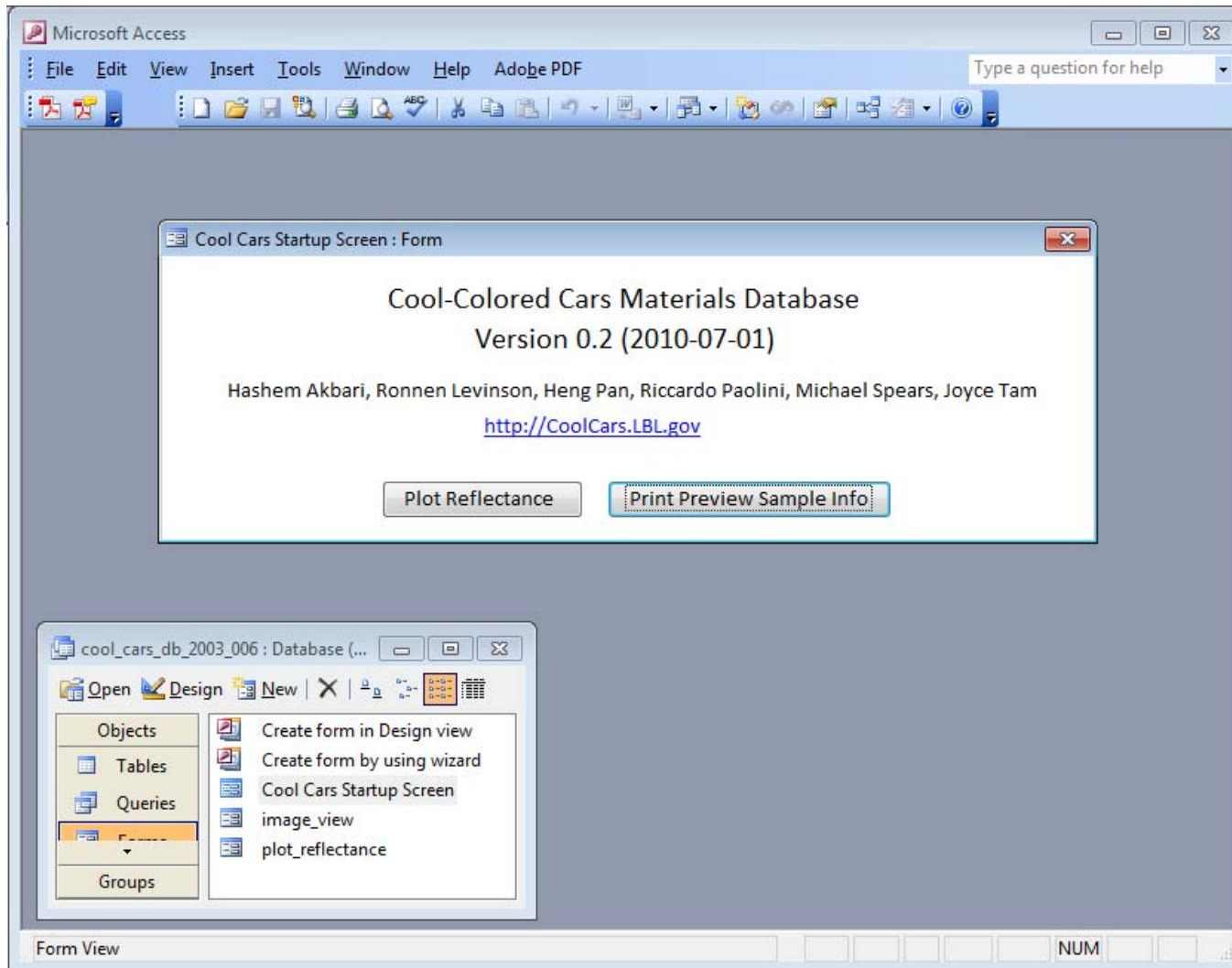

Figure 6. Coatings database splash screen.

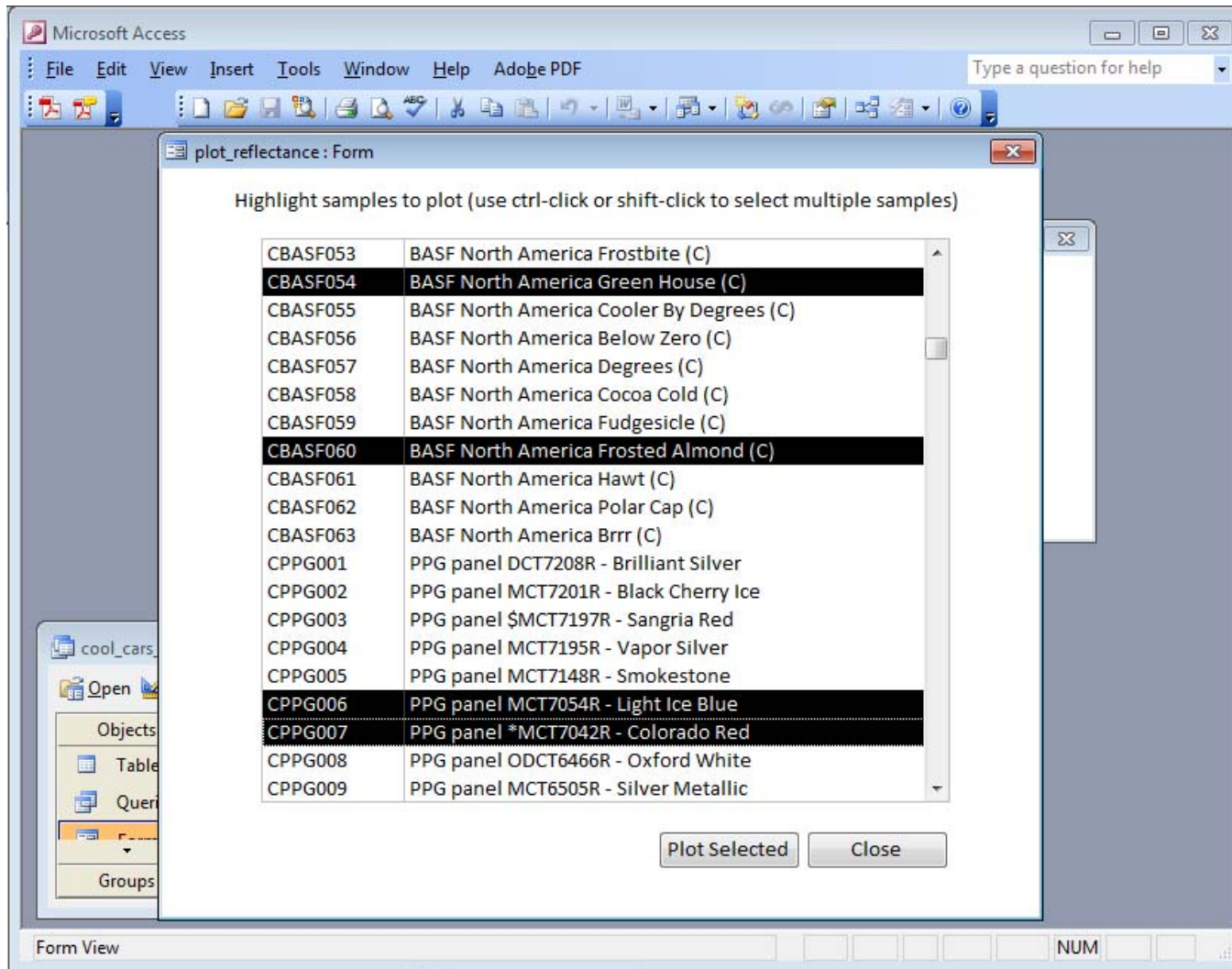

Figure 7. Coatings database sample selection form.

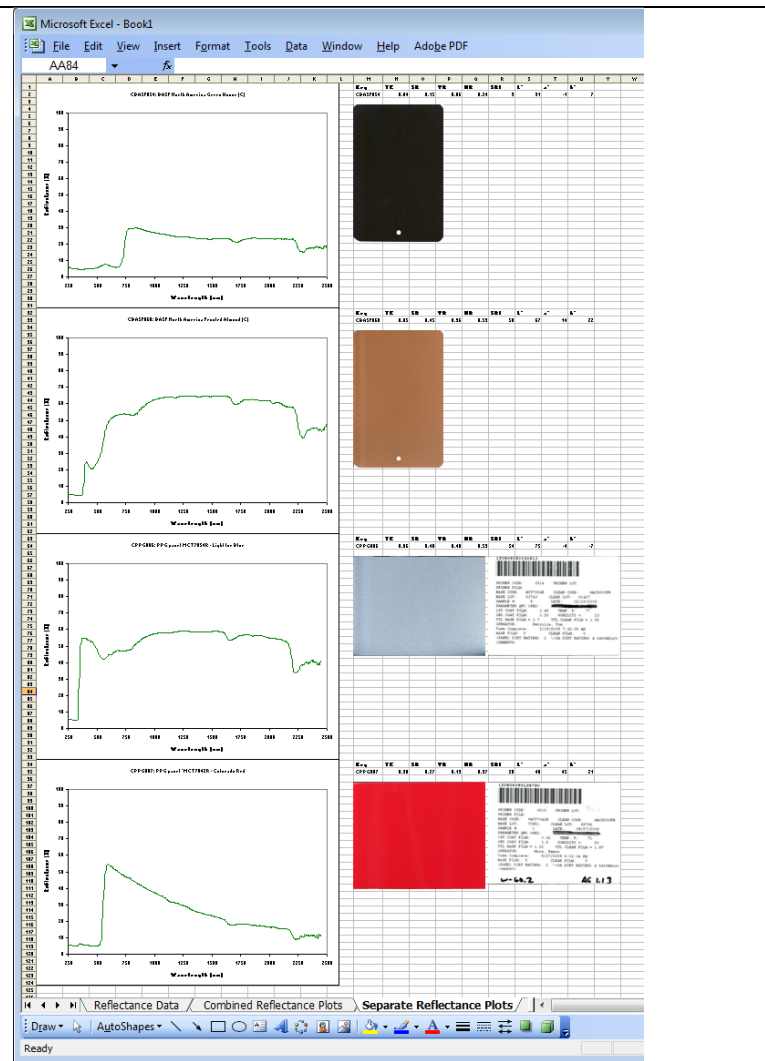
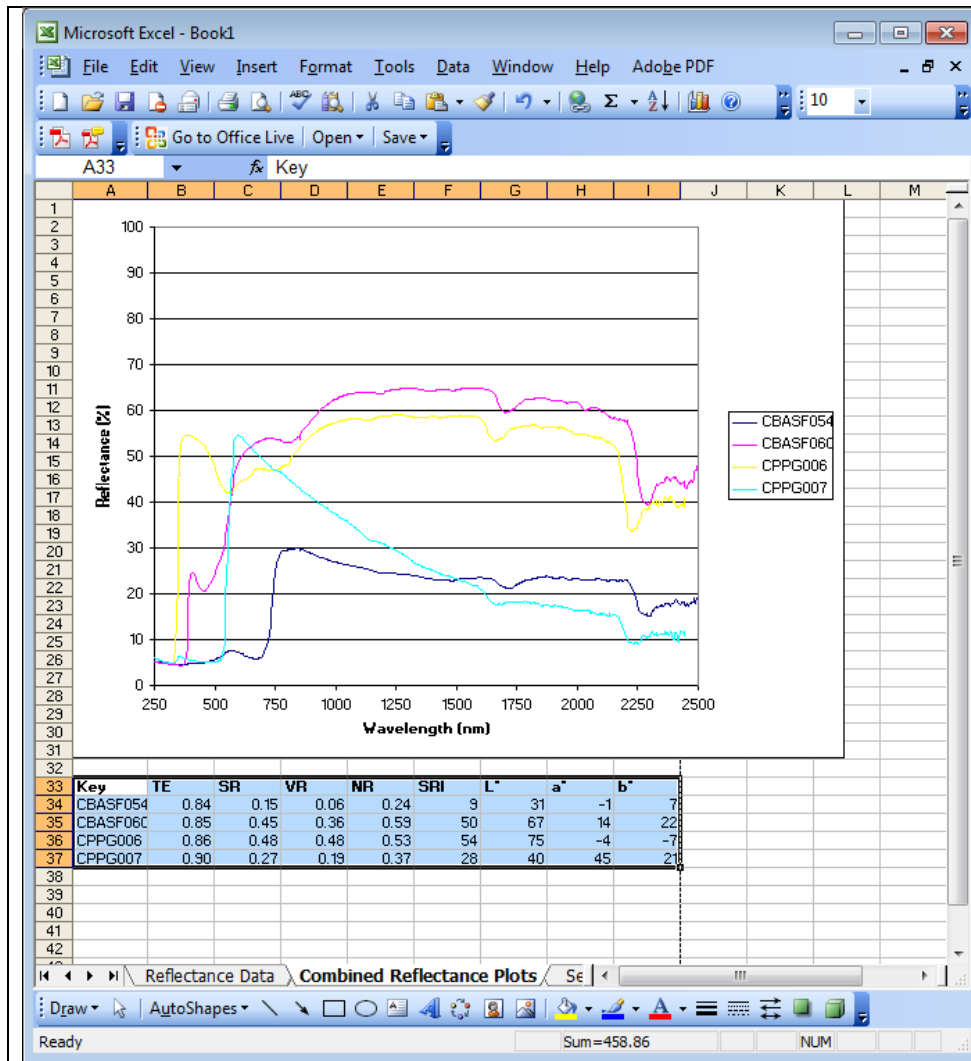

Figure 8. Output from coatings database query. Left image shows combined plot and table of radiative properties of selected samples; right image shows individual plots, tables, and images of selected samples.

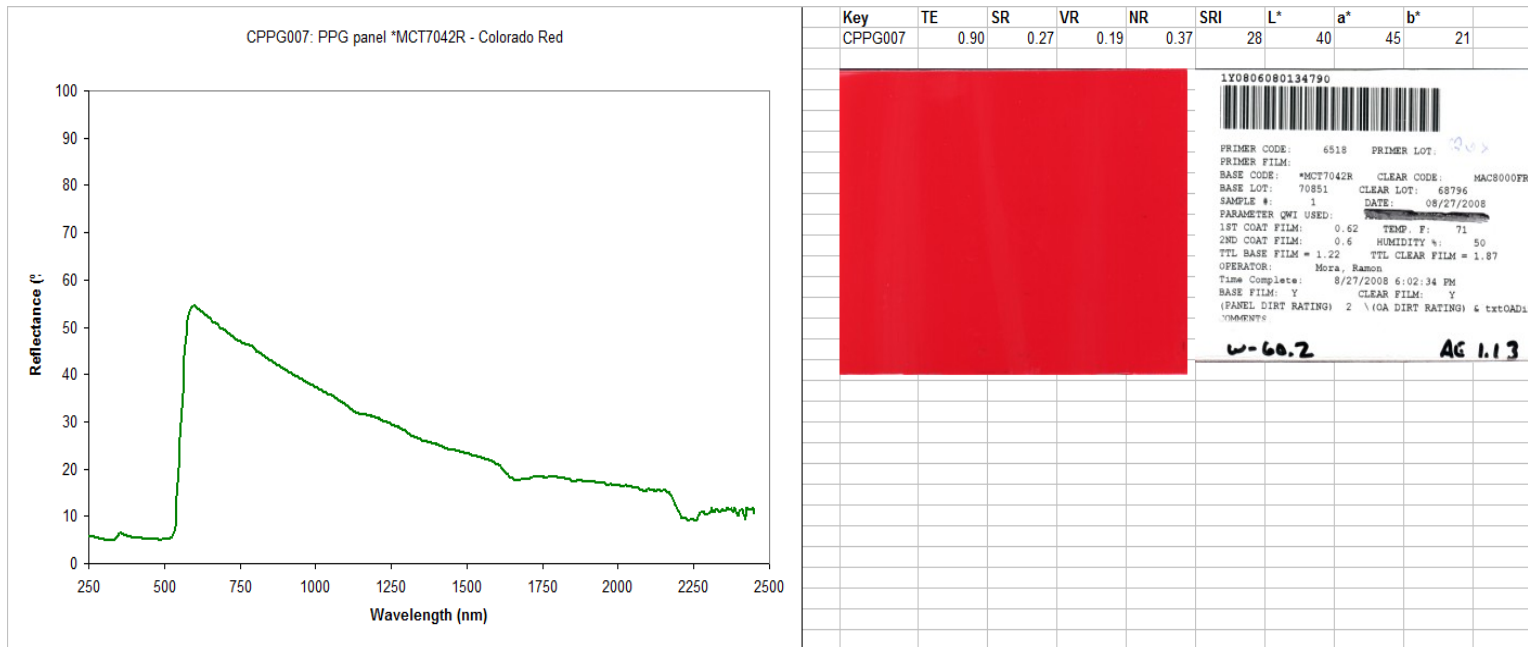

Figure 9. Highlight of spectral reflectance plot, radiative property table and image of one sample. Vertical axis label reads "Reflectance (%)".

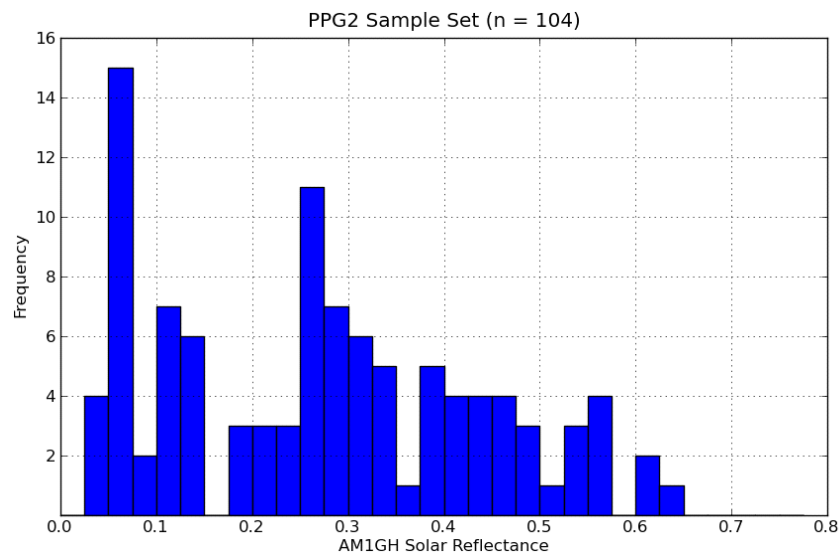
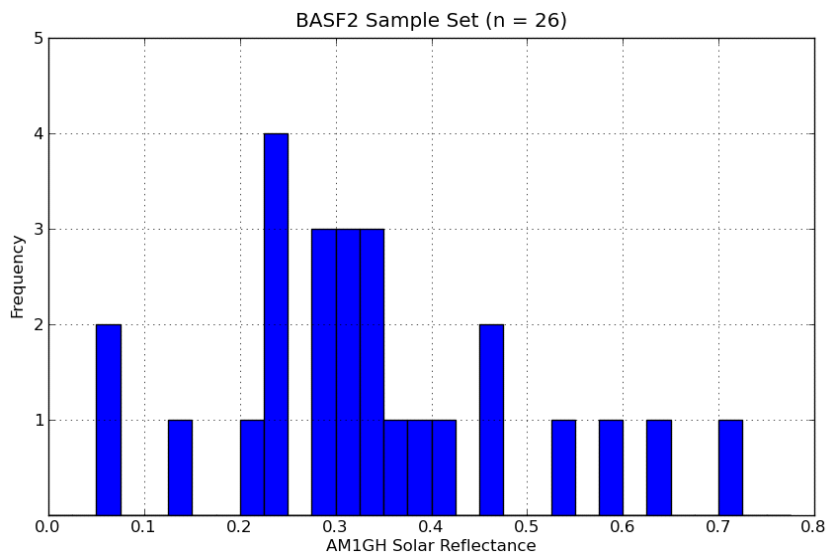
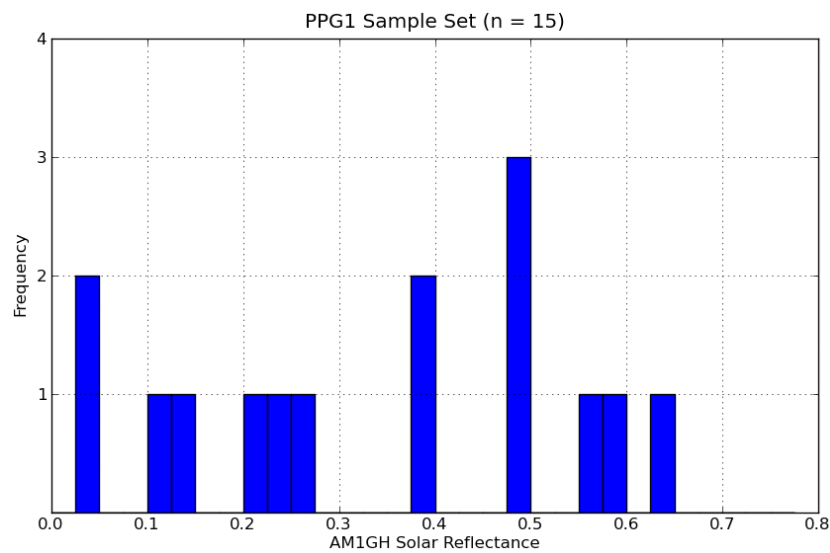
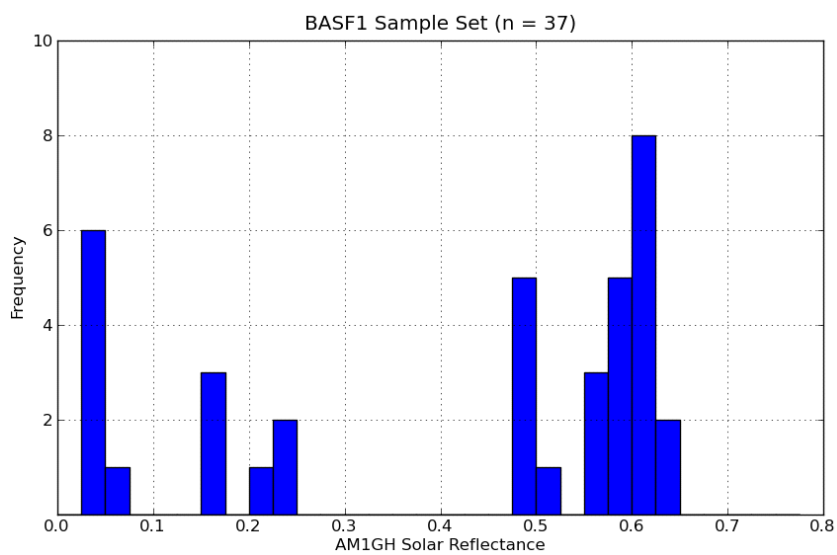

Figure 10. Distribution of solar reflectance in each sample set.

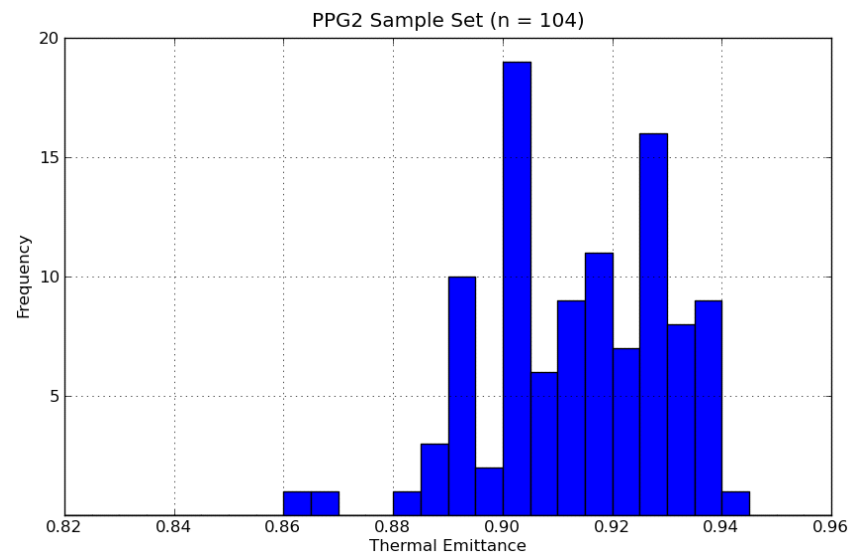
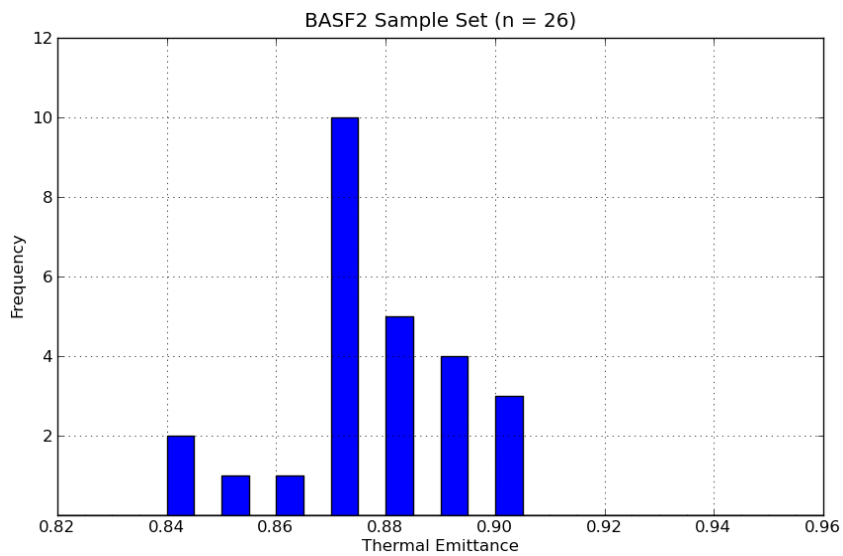
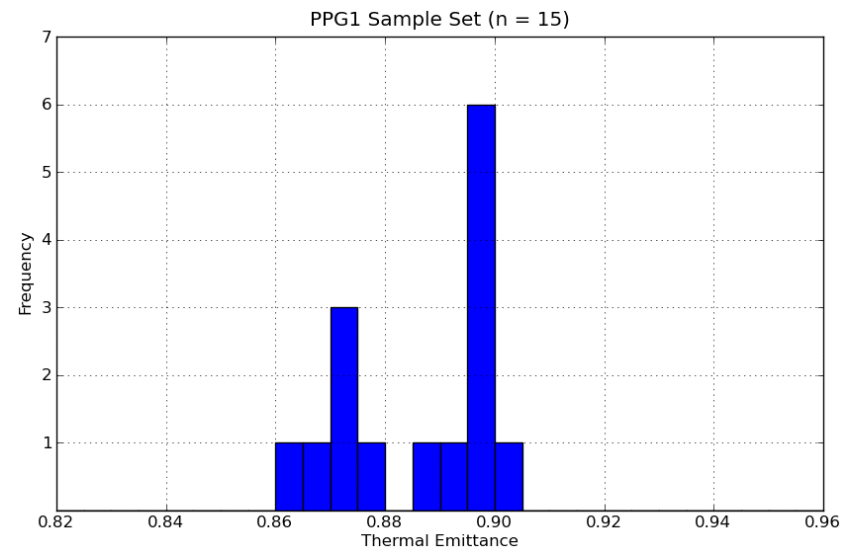
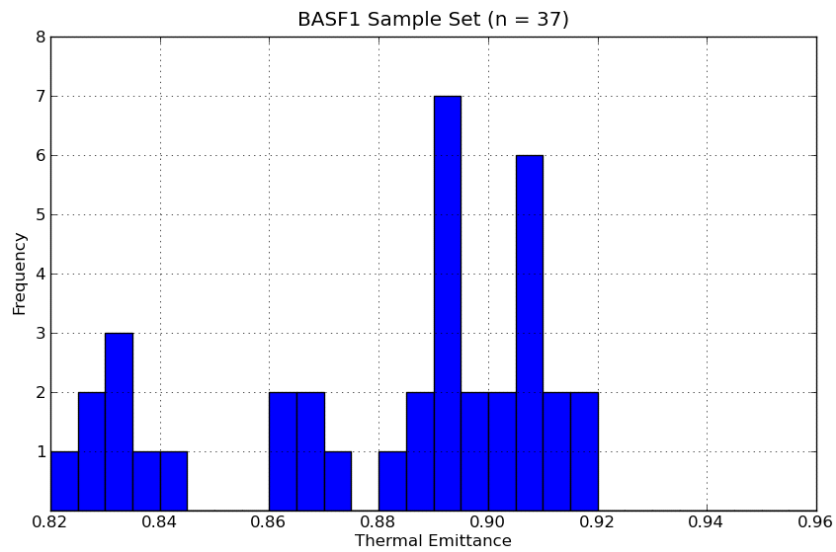

Figure 11. Distribution of thermal emittance in each sample set.

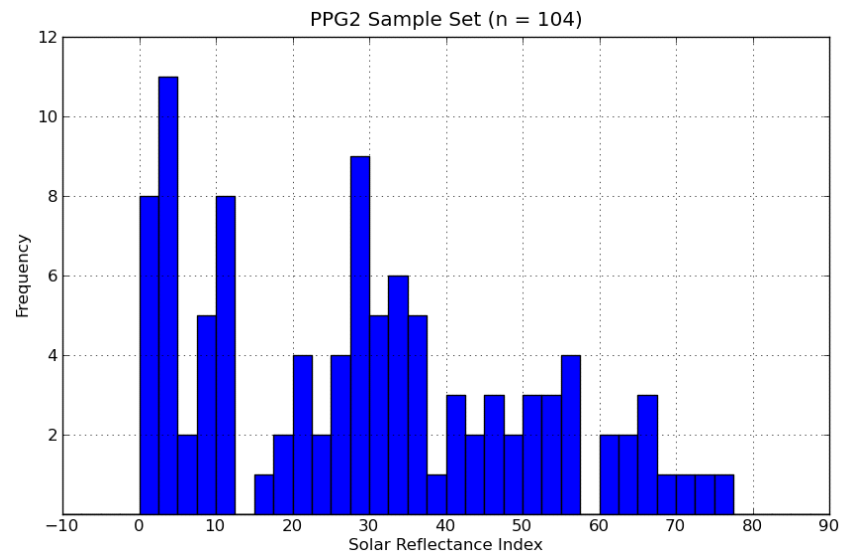
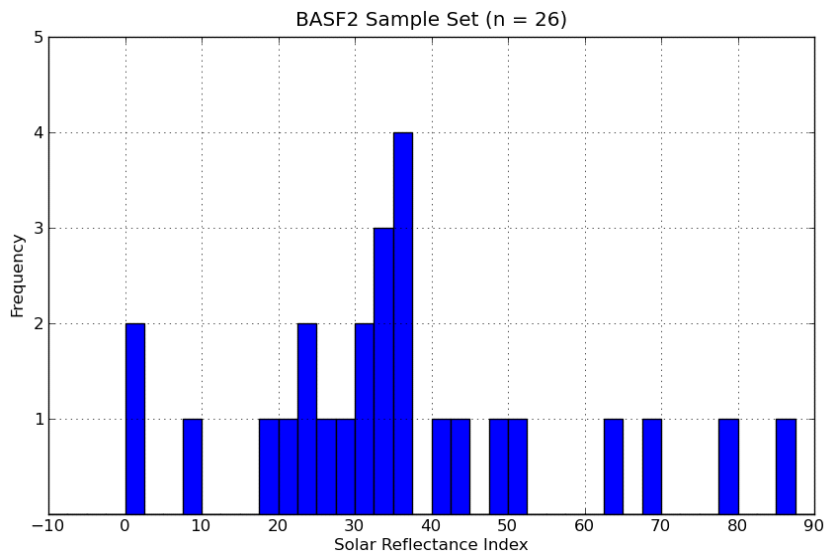
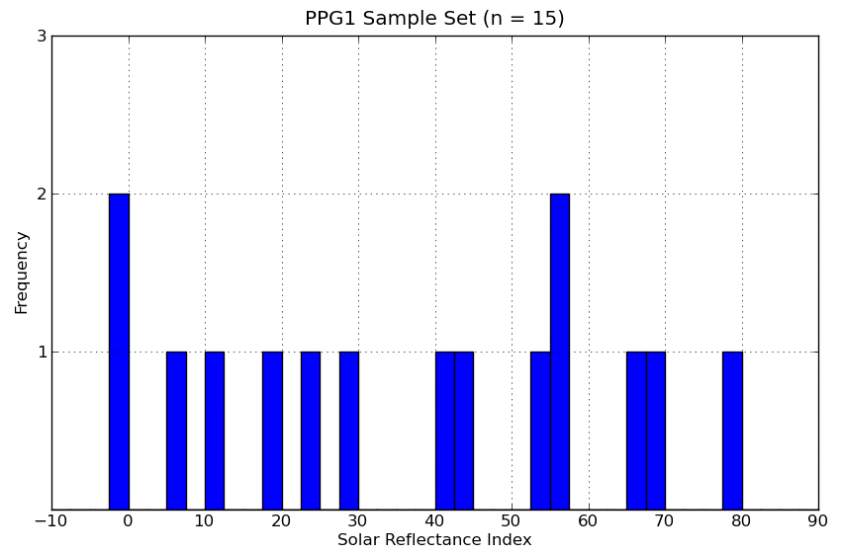
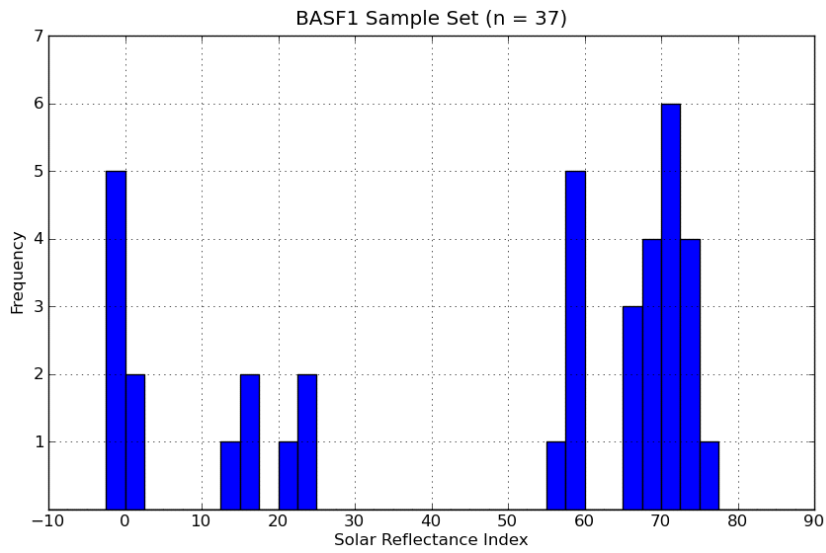

Figure 12. Distribution of solar reflectance index (SRI) in each sample set.

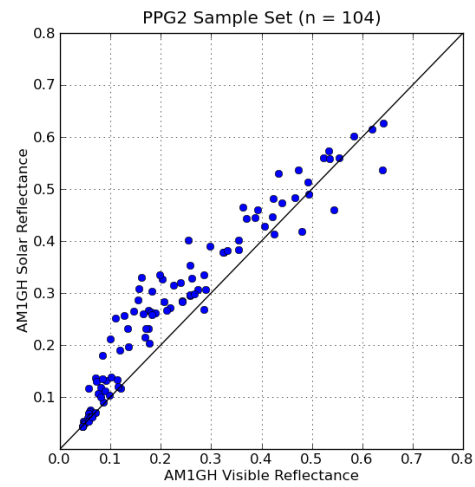
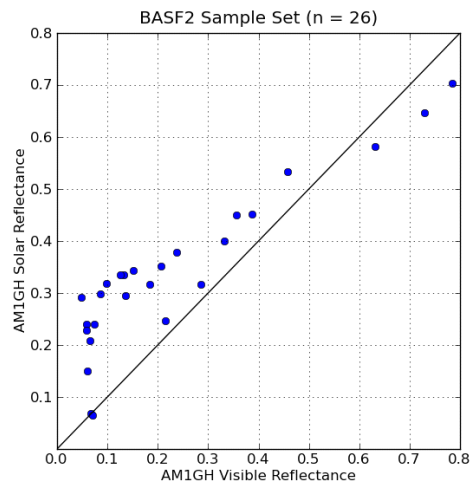
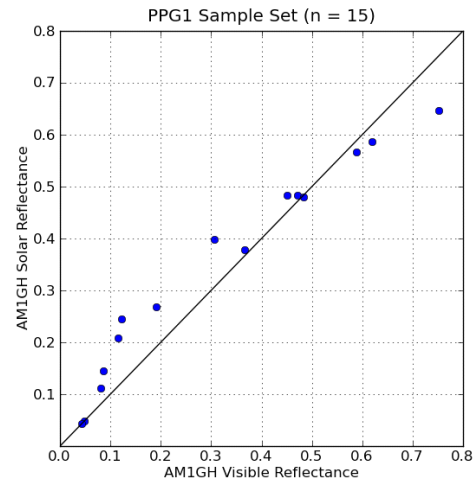
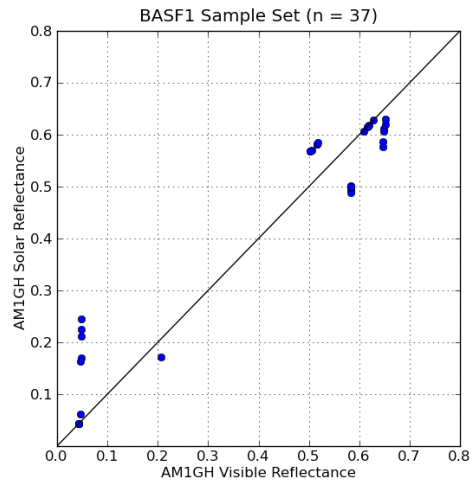

Figure 13. Solar reflectance vs. visible reflectance in each sample set. Samples that exhibit solar reflectance greater than visible reflectance (i.e., that lie above the diagonal equality line) may be described as "cool" colors.