

# Lawrence Berkeley National Laboratory

## LBL Publications

### Title

Laboratory Evaluation of Direct Heating Equipment

### Permalink

<https://escholarship.org/uc/item/2xh4736k>

### Authors

Blum, Helcio

Rapp, Vi H

Chen, Sharon S

et al.

### Publication Date

2024-09-30

### Copyright Information

This work is made available under the terms of a Creative Commons Attribution-NonCommercial-NoDerivatives License, available at

<https://creativecommons.org/licenses/by-nc-nd/4.0/>

Peer reviewed



Energy Efficiency Department  
Energy Analysis and Environmental Impacts Division  
Lawrence Berkeley National Laboratory

# Laboratory Evaluation of Direct Heating Equipment

Helcio Blum, Vi Rapp, Sharon Chen, Jing Ke, Katherine Carlson

September 2024



## **Disclaimer**

This document was prepared as an account of work sponsored by the United States Government. While this document is believed to contain correct information, neither the United States Government nor any agency thereof, nor the Regents of the University of California, nor any of their employees, makes any warranty, express or implied, or assumes any legal responsibility for the accuracy, completeness, or usefulness of any information, apparatus, product, or process disclosed, or represents that its use would not infringe privately owned rights. Reference herein to any specific commercial product, process, or service by its trade name, trademark, manufacturer, or otherwise, does not necessarily constitute or imply its endorsement, recommendation, or favoring by the United States Government or any agency thereof, or the Regents of the University of California. The views and opinions of authors expressed herein do not necessarily state or reflect those of the United States Government or any agency thereof, or the Regents of the University of California.

Lawrence Berkeley National Laboratory is an equal opportunity employer.

## **Copyright Notice**

This manuscript has been authored by an author at Lawrence Berkeley National Laboratory under Contract No. DE-AC02-05CH11231 with the U.S. Department of Energy. The U.S. Government retains, and the publisher, by accepting the article for publication, acknowledges that the U.S. Government retains a non-exclusive, paid-up, irrevocable, world-wide license to publish or reproduce the published form of this manuscript, or allow others to do so, for U.S. Government purposes.

# Laboratory Evaluation of Direct Heating Equipment

Prepared for the  
California Energy Commission  
State of California

Principal Authors  
*Helcio Blum*  
*Vi Rapp*  
*Sharon Chen*  
*Jing Ke*  
*Katherine Carlson*

Lawrence Berkeley National Laboratory  
1 Cyclotron Road, MS 90R4000  
Berkeley CA 94720-8136

September 2024

## Acknowledgements

The work described in this report was conducted at Lawrence Berkeley National Laboratory and supported by the California Energy Commission under Grant Agreement No. PIR-18-006 and the U.S. Department of Energy under Contract No. DE-AC02-05CH11231.

The authors would like to thank the Williams (<https://www.williamscomfort.com>) and Rinnai (<https://www.rinnai.us>) technical support teams for their assistance during the evaluation of the high-efficiency units. We also thank Brett Singer and Mohan Ganeshalingam, Lawrence Berkeley National Laboratory, and Jackson Thach, California Energy Commission, for their comments and feedback on a draft version of this report.

## Legal Notice

The Lawrence Berkeley National Laboratory is a national laboratory of the United States Department of Energy (DOE) managed by The Regents of the University of California for the U.S. Department of Energy under Contract Number DE-AC02-05CH11231. This report was prepared as an account of work sponsored by the California Energy Commission and pursuant to an M&O Contract with the DOE. The Regents of the University of California, nor the DOE, nor the Sponsor, nor any of their employees, contractors, or subcontractors, makes any warranty, express or implied, or assumes any legal liability or responsibility for the accuracy, completeness, or usefulness of any information, apparatus, product, or process disclosed, or represents that its use would not infringe on privately owned rights. Reference herein to any specific commercial product, process, or service by trade name, trademark, manufacturer, or otherwise, does not necessarily constitute or imply its endorsement, recommendation, or favoring by The Regents of the University of California, or the DOE, or the Sponsor. The views and opinions of authors expressed herein do not necessarily state or reflect those of The Regents of the University of California, the DOE, or the Sponsor, or any of their employees, or the United States Government, or any agency thereof, or the State of California. This report has not been approved or disapproved by The Regents of the University of California, the DOE, or the Sponsor, nor has The Regents of the University of California, the DOE, or the Sponsor passed upon the accuracy or adequacy of the information in this report.

# Table of Contents

Acknowledgements.....	i
Legal Notice.....	ii
Table of Contents.....	iii
Table of Figures.....	iv
List of Tables.....	v
Acronyms and Abbreviations.....	vi
Abstract.....	vii
1. Introduction.....	1
2. Methodology.....	3
2.1 Evaluation Protocol Overview.....	3
2.1.1 Measurement Equipment, Calibration, and Data Collection.....	3
2.1.2 Evaluation Procedure.....	6
2.1.3 Additional Protocols.....	9
2.2 Data Reduction and Calculation of Metrics.....	9
2.3 DHE Units Evaluated.....	13
3. Results and Discussion.....	17
4. Conclusions.....	38
References.....	39

# Table of Figures

Figure 1. Examples of DHE .....	1
Figure 2. Generic Measurement Sampling Configuration .....	7
Figure 3. Images of Equipment and DHE Units Installed in the Laboratory .....	7
Figure 4. Images of the Low-Efficiency DHE Units Evaluated .....	15
Figure 5. Images of the High-Efficiency DHE Units Evaluated .....	16
Figure 6. DHE01 Emissions, Exhaust Temperature, and Fuel Consumption .....	21
Figure 7. Images of DHE01 Issues .....	22
Figure 8. DHE05 Emissions, Exhaust Temperature, and Fuel Consumption .....	23
Figure 9. DHE10 Emissions, Exhaust Temperature, and Fuel Consumption .....	24
Figure 10. DHE11 Emissions, Exhaust Temperature, and Fuel Consumption .....	25
Figure 11. DHE14 Emissions, Exhaust Temperature, and Fuel Consumption .....	26
Figure 12. Images of DHE14 Issues .....	27
Figure 13. DHE16 Emissions, Exhaust Temperature, and Fuel Consumption .....	28
Figure 14. Images of DHE16 Issues .....	29
Figure 15. DHE19 Emissions, Exhaust Temperature, and Fuel Consumption .....	30
Figure 16. Images of DHE19 Issues .....	31
Figure 17. DHE22 Emissions, Exhaust Temperature, and Fuel Consumption .....	32
Figure 18. R11 Emissions, Exhaust Temperature, and Fuel Consumption .....	33
Figure 19. R38 Emissions, Exhaust Temperature, and Fuel Consumption .....	34
Figure 20. W2030 Emissions, Exhaust Temperature, and Fuel Consumption .....	35
Figure 21. W3040 Emissions, Exhaust Temperature, and Fuel Consumption .....	36



## List of Tables

Table 1. Instrumentation and Calibration Levels for Gaseous Emissions .....	4
Table 2. Calibration Gases.....	5
Table 3. Natural Gas Parameters .....	5
Table 4. DHE Units Evaluated.....	13
Table 5. Natural Gas Input Rates and Power .....	18
Table 6. NO <sub>x</sub> , CH <sub>4</sub> , and CO Emission Factors During Steady-State Operation .....	19
Table 7. NO <sub>x</sub> , CH <sub>4</sub> , and CO Pilot Burner Emission Factors During Stand-By Periods (per unit of energy and time) .....	20

## Acronyms and Abbreviations

AFUE	Annual Fuel Utilization Efficiency
CEC	California Energy Commission
DHE	Direct Heating Equipment
DOE	United States Department of Energy
DV	Console Wall Furnace
FF	Floor Furnace DHE
GHG	Greenhouse Gases
LBNL	Lawrence Berkeley National Laboratory
NDIR	Non-Dispersive Infrared Analyzer
PG&E	Pacific Gas & Electric
RH	Room Heater DHE
WF	Upright Wall Furnace DHE

## Abstract

Direct Heating Equipment (DHE) is a type of space heating appliance that supplies warm air directly to the space where it is installed. It has been estimated that DHE is the primary and/or secondary source of space heating in 16% of households in California and that one-third of this fleet was installed more than 20 years ago. In addition, DHE is rarely maintained and is repaired only in extreme situations. Old DHE that is still in use has energy and emission implications. We evaluated 12 DHE units in the combustion laboratory at Lawrence Berkeley National Laboratory (LBNL). Of those, eight were low-efficiency units removed from homes in California, and four were new, high-efficiency units. We found that, in most cases, the amount of natural gas used by a unit is consistent with the input rate of the model. We also found that, except for two high-efficiency models with ultra-low NO<sub>x</sub> burners, the NO<sub>x</sub> emissions from both the low- and high-efficiency models were very similar. Emissions of CO and CH<sub>4</sub> are relatively uniform across models, except for two high-efficiency models that exhibit higher emissions of these gases. Additionally, many piloted units produced non-negligible amounts of CO and CH<sub>4</sub> during stand-by periods, when only the pilot was lit. In general, our results are consistent with results from another study with similar scope.<sup>1</sup>

---

<sup>1</sup> Garland et al (2023).

# 1. Introduction

Direct Heating Equipment (DHE) is a type of ductless, space heating appliance that supplies warm air directly to the space where it is installed. There are three types of DHE available on the market: wall furnaces, floor furnaces, and room heaters. Wall furnaces are installed attached to the wall and can be upright (WF) or have a console-like shape (DV). Room heaters (RH) also have a console-like shape, but are installed detached from the wall. Floor furnaces (FF) are installed under the floor, in a basement or a crawl space. Figure 1 shows examples of DHE.<sup>2</sup>



**Figure 1. Examples of DHE**

Source: Blum et al (2024) (Courtesy of Williams Comfort Products, [www.williamscomfortprod.com](http://www.williamscomfortprod.com))

Blum et al. (2024) estimate that DHE is the primary and/or secondary source of space heating in 16.5% of households in California.<sup>3</sup> They further estimate, based on a survey with 1,200 households with DHE in California, that approximately one third of the DHE installed in the state

<sup>2</sup> These images show only a few examples of DHE models available on the market. Reference to this specific brand and models does not constitute or imply their endorsement, recommendation, or favoring by the U.S. Department of Energy, the Regents of the University of California, or the California Energy Commission.

<sup>3</sup> If only natural gas DHE was considered, the percentage would drop to 15%.

was installed more than 20 years ago.<sup>4</sup> Further, they found that DHE is “rarely maintained and repaired only in extreme situations,” and that households are not satisfied with the energy used by the heater. Old units still in use are low-efficiency DHE and contribute to increased household energy use and greenhouse gas (GHG) emissions in the state. The lack of maintenance and appropriate repairs may exacerbate this further.

Previous research evaluated DHE units in a laboratory setting and in the field to measure gas use, pollutant emissions, and consumer sentiments related to DHE in California. Field evaluations in which indoor environmental conditions such as temperature, relative humidity, CO, NO<sub>x</sub>, and NO<sub>2</sub> were monitored in households using old central or wall furnaces found greater spillage of combustion pollutant levels in homes with floor or wall furnaces. Additionally, homes with a pilot burner on their furnace had higher NO<sub>x</sub> and NO<sub>2</sub> levels (Mullen et al., 2015; Singer et al., 2016). A study using both field monitoring and laboratory testing before and after the replacement of old vented gravity wall furnaces with more efficient models found that the advanced wall furnaces were significantly more energy efficient than the standard existing furnaces and that they reduced emissions of CO, NO<sub>x</sub>, and total hydrocarbons by approximately 90% (Gartland et al., 2023). Another study, investigating the energy savings capability of high-efficiency natural gas wall furnace retrofitting, found that although the retrofits yielded a 7.9% reduction in natural gas consumption, the payback time was estimated to be 82.5 years. This indicates that while retrofits can successfully reduce gas use and emissions, they may not provide financial benefits to the consumer, which is where incentive programs may prove most useful (Valmiki et al., 2013).

In this study, we evaluated 12 natural gas DHE units in Lawrence Berkeley National Laboratory’s (LBNL) combustion laboratory. Eight of the units were old models removed from households in California and four were new, high-efficiency models. During the laboratory evaluations, we measured natural gas consumption, pollutant emissions, and electricity use.

This report presents the results of our laboratory evaluations. Section 2 presents the evaluation protocol, including the methods and equipment used for the evaluations, and the approach used to convert pollutant concentration to emission factors. Section 3 presents and discusses our results. Section 4 concludes with the main findings and limitations.

---

<sup>4</sup> In an interview with DHE manufacturers, one manufacturer mentioned that they believe that a significant share of the DHE currently installed in California may be 50-60-year-old units (Blum et al., 2023).

## 2. Methodology

### 2.1 Evaluation Protocol Overview

The laboratory evaluation of each DHE unit assessed in this research study covered both energy use and pollutant emissions. For each DHE unit, the following data was evaluated:

- Natural gas and electricity used by the DHE unit
- Measurements of CO, CO<sub>2</sub>, NO, NO<sub>x</sub> and CH<sub>4</sub> concentrations in the exhaust stream (i.e., vent pipe) after the draft diverter (if present); NO<sub>2</sub> concentration provided by the gas analyzer are calculated as the difference between the averaged value of NO and NO<sub>x</sub>
- Emission factors for air quality pollutants relative to natural gas energy supplied

We designed a protocol for the laboratory evaluations to best capture key components of realistic use patterns using a cycle time that enabled the completion of three to four experiments, including setup and calibration each day of evaluation.<sup>5</sup> The protocol was also designed to ensure easy comparison of units operating under similar conditions. It should be noted that the protocol and evaluation were not designed to measure performance or emissions compliance with standards or codes. We operated each DHE unit through multiple burning cycles with a cooling period between each burning cycle. Before evaluation, we assessed each DHE unit to verify it was operating properly and operated the unit at the highest heat output for at least 20 minutes to burn off potential residue remaining from manufacturing or transportation.

#### 2.1.1 Measurement Equipment, Calibration, and Data Collection

We measured natural gas consumption and volumetric flowrate of each DHE unit using a Singer DTM-115 (1-L dial) dry gas meter with an inline Fox thermal flow meter (model FT2-075P). The gas supply pressure varied between 6 and 8 inches of water. The Fox meter measures gas flowrate in standard cubic feet per hour (*SCFH*). The Singer dry gas meter measures total gas consumption in liters and an average gas flowrate for an evaluation period can be calculated by dividing the measured volume of gas consumed by the evaluation time. Given the Singer meter is more accurate than the Fox meter at lower fuel flowrates, we developed the following linear-curve to correct the Fox meter measurements:

$$SCFH_{corrected} = 1.4031 \times SCFH_{Fox} + 0.507$$

where  $SCFH_{corrected}$  is the corrected gas flowrate and  $SCFH_{Fox}$  is the gas flowrate measured by the Fox meter. The curve-fit was developed by fitting the average Fox flowrate measurements to the average flowrate calculated using the Singer meter for at least 10-minutes of steady operation at different flowrates.

---

<sup>5</sup> The operating procedure of the protocol was designed based on Rapp and Singer (2014).

We used an AC line splitter and a current clamp to measure power consumption and current use. T-type thermocouples were used to measure the following temperatures: combustion air intake, draft diverter (where present), exhaust, and ambient near the unit. Combustion intake relative humidity was measured using an Omega RH-USB (Part THB10,860.86) sensor.

We used a CAI 602P non-dispersive infrared analyzer (NDIR) to measure gaseous CO, CO<sub>2</sub>, and O<sub>2</sub> in the exhaust stream of each DHE unit, and a CAI 600 CLD chemiluminescence analyzer to measure NO and NO<sub>x</sub> (with NO<sub>2</sub> calculated as the difference between the average measured NO and NO<sub>x</sub>). The CAI 602P was also used to measure background CO and CO<sub>2</sub> before and after the experiment. We used a Los Gatos Research (LGR) Ultraportable Greenhouse Gas Analyzer UGGA-ER to measure concentration of exhaust and background CH<sub>4</sub>. Table 1 lists equipment used to measure gaseous emission concentrations.

**Table 1. Instrumentation and Calibration Levels for Gaseous Emissions**

Equipment <sup>a</sup>	Analyte	Method	Operating Range	Accuracy <sup>b</sup>
CAI 602P	CO <sub>2</sub>	Non-dispersive infrared	0-15%	Linearity/Drift <1% of full scale
	O <sub>2</sub>	Paramagnetism	0-25%	
	CO	Non-dispersive infrared	0-200 ppm <sup>c</sup>	
CAI 600 CLD	NO/NO <sub>x</sub>	Chemiluminescence	0-300 ppm	Linearity/Drift <1% of full scale
LGR UGGA-ER	CH <sub>4</sub>	Laser absorption (cavity enhanced absorption technique)	0-10%	Precision <2 ppb (1 sec) <0.6 ppb (10 sec) <0.25 ppb (100 sec)

<sup>a</sup> CAI Envea Group, Orange, CA (<https://www.envea.global/cai/>); ABB (<https://global.abb/>).

<sup>b</sup> Indicators of accuracy and precision provided by the manufacturer.

<sup>c</sup> Parts per million.

At the start of each experimental day, the two CAI gas analyzers were zeroed using ultra-high purity (UHP, 99.999%) nitrogen and then spanned with Certified Standard gas mixtures. The calibration gases used are detailed in Table 2.

We developed a custom Python-based software to monitor and log temperature, relative humidity, gas fuel supply rate, electricity use, and emissions data. Measured values were collected and logged at 1 Hz.

**Table 2. Calibration Gases**

Analyte	Balance	Concentration	Uncertainty	Supplier
Carbon Monoxide	Nitrogen	50.04 ppm	Analytical uncertainty: $\pm 2\%$	Airgas
Oxygen	Nitrogen	10%	Analytical uncertainty: $\pm 2\%$	Airgas
Nitric Oxide	Nitrogen	26.35 ppm	Relative uncertainty: $\pm 1.4\%$	Airgas
Carbon Dioxide	Nitrogen	5.04%	Analytical uncertainty: $\pm 2\%$	Airgas

The natural gas used to operate the DHE units was line-supplied from the local gas utility Pacific Gas & Electric (PG&E). We recorded the energy content of the natural gas (higher heating value, HHV), specific gravity (SG), nitrogen concentration, and carbon dioxide concentration from line J01 of the PG&E website.<sup>6</sup> Table 3 presents the parameters of the natural gas used in the evaluation of the DHE units. Gas supply pressure to all units varied between 6.2 to 6.9 in H<sub>2</sub>O during operation, which is higher than the gas supply in most homes and within the required operating range.

**Table 3. Natural Gas Parameters**

Date	Unit Id	HHV <i>btu/scf</i>	SG	N <sub>2</sub> <i>%mol</i>	CO <sub>2</sub> <i>%mol</i>
Jul 28 2022	R38	1037.54	0.589	0.47	0.89
Sep 02 2022	W2030	1058.86	0.601	0.42	0.86
Sep 07 2022	R11	1059.01	0.602	0.41	0.88
Apr 25 2023	W3040	1059.14	0.605	0.58	0.97
Jun 29 2023	DHE11	1043.39	0.594	0.52	0.92
Jun 30 2023	DHE19	1044.01	0.593	0.44	0.92
Jul 05 2023	DHE22	1043.28	0.592	0.41	0.92
Jul 11 2023	DHE05	1039.57	0.590	0.40	0.92
Aug 01 2023	DHE10	1044.60	0.595	0.46	0.97
Aug 03 2023	DHE16	1046.36	0.595	0.47	0.94
Aug 17 2023	DHE01	1042.66	0.592	0.40	0.95
Oct 13 2023	DHE14	1038.53	0.589	0.44	0.89

<sup>6</sup> [https://www.pge.com/pipeline/operations/gas\\_quality/detail.page?btuld=J01](https://www.pge.com/pipeline/operations/gas_quality/detail.page?btuld=J01).



## 2.1.2 Evaluation Procedure

After preparing and calibrating the laboratory equipment, we installed and prepared each DHE unit for evaluation according to the procedure presented below. Figure 2 shows a schematic of the experimental setup while Figure 3 shows images of DHE installations and equipment in the laboratory. Additional procedures are noted for units with a distinct feature such as a standing pilot, fan or blower, and modulating control.

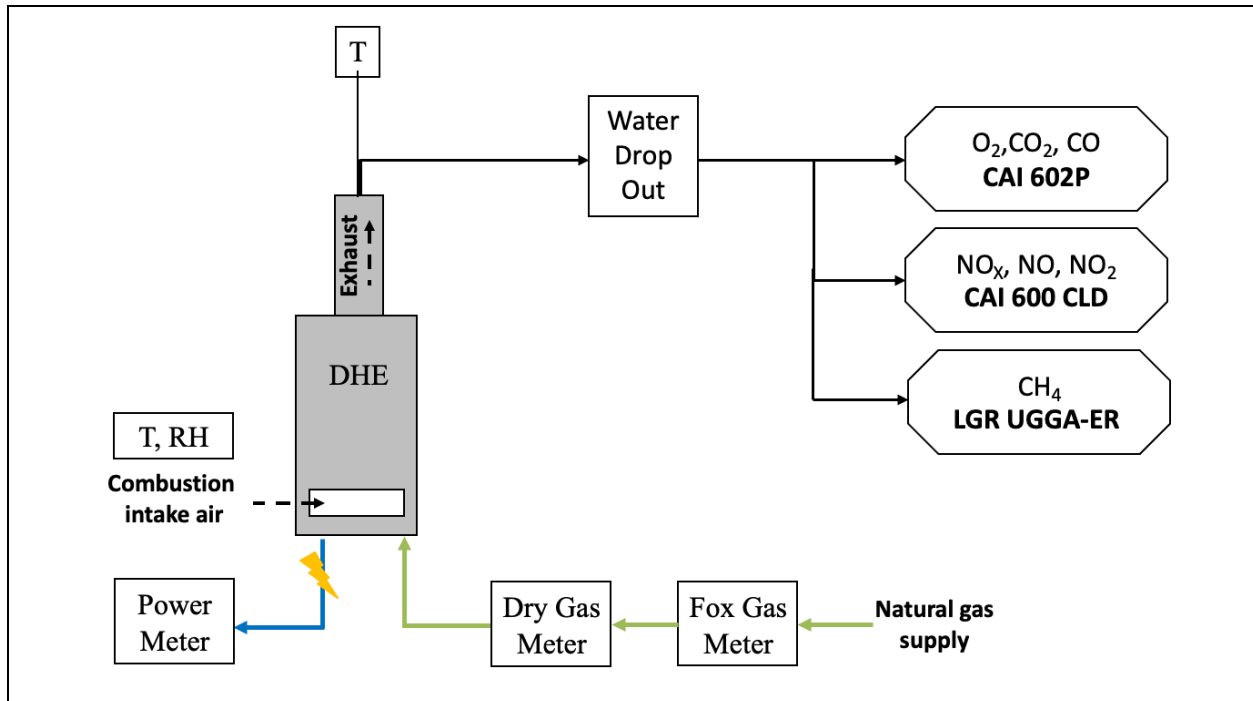
1. Install the unit in accordance with the specifications provided by the manufacturer.
2. Check all connections to ensure no gas leaks using a visual gas leak detector.
3. Install exhaust vent and ensure all exhaust is captured by the laboratory hood to vent emissions outdoors without impacting unit operation (i.e., the laboratory exhaust hood is not inducing draft).
  - a. For direct-vent units, ensure intake combustion air is not pre-heated by the unit as it warms the laboratory air by diverting room heat away from the combustion air intake.
4. Install emission measurement sampling probes in the exhaust vent ensuring probes are centered and sample at least 5.5" before the vent exit for direct vent appliances and at least 10" before the vent exit for B-vent appliances.
5. Install T-type thermocouples to measure combustion air intake, draft diverter (where present), exhaust, and ambient temperature near the unit. The thermocouple used to measure exhaust temperature was at least 2.5" from exit and centered.
6. Mount the relative humidity sensor near the combustion air intake.
7. Connect gas analyzers to the system, as shown in Figure 2.
8. Attach current meters to the main power supply and fan supplies (if available) to log electricity use.<sup>7</sup>
9. Log initial values displayed on the Singer dry gas meter.

After unit and equipment installation, we conducted a pre-evaluation procedure by operating the DHE unit on high heat output for at least 5 minutes and monitoring emissions and exhaust (vent) temperature. This procedure validated proper system operation. The pre-evaluation procedure also included the following steps depending on the unit type:

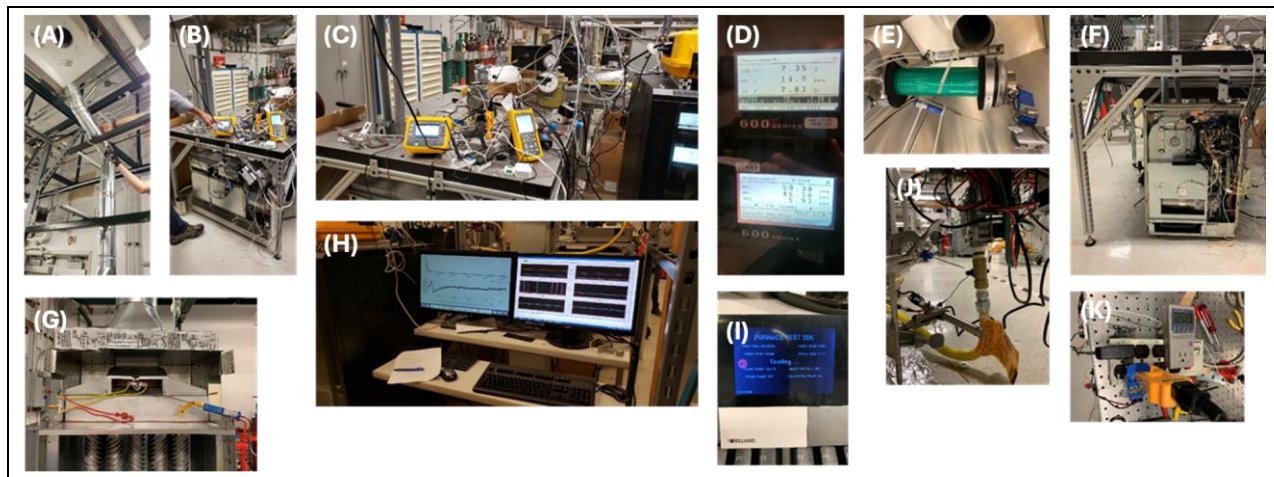
- For the units with a standing pilot, we lit the pilot according to the manufacturer's instructions.
- For units with modulating controls for adjusting heat output, we used the units' pre-programmed diagnostic tests to set and run at different heat outputs.

---

<sup>7</sup> For one of the units (DHE14, see Table 4) we also connected the unit's auxiliary electric components to a stable, surge-protected, power supply that matched the unit's required voltage since the original power supply was missing after removal from household.



**Figure 2. Generic Measurement Sampling Configuration**



**Figure 3. Images of Equipment and DHE Units Installed in the Laboratory**

- |  |  |
|--|--|
| (A) Exhaust termination of b-vent in hood            | (G) Draft diverter and thermocouples on tall DHE unit      |
| (B) Small DHE unit with equipment                    | (H) Python interface                                       |
| (C) Oscilloscopes to measure electricity consumption | (I) Williams digital thermostat                            |
| (D) Gas analyzer output                              | (J) Installation of gas line                               |
| (E) Exhaust termination of direct vent into hood     | (K) Current meter to monitor total electricity consumption |
| (F) Installation of small DHE unit                   |  |

Next, we conducted a burn-in procedure that ensured any residual machine oil (new units) or transportation dust (old units) was removed. This process helped prevent erroneous measurements during the final performance evaluation. To conduct the burn-in procedure, we initiated the data collection program, confirmed readings from the measurement equipment, and confirmed that the background room concentrations of CO<sub>2</sub> were in agreement with those expected (between 400 and 500 ppm). Then, we turned on the unit and operated it for a minimum of thirty minutes, or until we were confident that the unit was not malfunctioning and any residual oil or dust was combusted. We confirmed that all measurement equipment was at the appropriate range settings and logging data. After the burn-in procedure, we let the unit cool for a minimum of 30 minutes before conducting the evaluation performance procedure.

After completing the pre-evaluation and burn-in procedures, we conducted the general performance procedure, using the following steps:

1. Verify operation of the data collection program and the proper recording of the data.
2. Verify that background emission concentrations in the exhaust align with expected values. Record pilot light emissions for at least 1 minute, if applicable.
3. Turn on the burner and operate it until exhaust temperature and emissions reach steady state (minimum of 10 minutes). In the case of units with modulating controls, operate the burner at various heat outputs using the thermostat controls (e.g., maximum, intermediate, and minimum heat outputs). Only operate at setpoints that can be sustained for at least a minute and repeated at least twice.
4. Turn off the burner and allow the unit to cool for a minimum of 10 minutes. For units with a pilot light, the pilot was kept on during this period.
5. Repeat burner operation at least twice.
6. After the last burn is complete, turn off the burner and continue to measure and record exhaust emission concentrations for at least 10 minutes.
7. Turn off the pilot, if applicable, and continue to measure and record exhaust emission concentrations for at least 5 minutes.
8. Measure and record background room concentrations of all gaseous emissions.

After conducting the general performance procedure, we conducted a post-experiment procedure comprised of stopping the data collection program and reviewing all collected data to verify proper collection and alignment with expected values. Once data was confirmed, we closed and depressurized all gas lines by shutting off the main gas valve and operating the unit until the flame extinguished and the gas pressure at the meter read zero.

### **2.1.3 Additional Protocols**

In addition to the procedures described in Section 0 above, we also observed LBNL standard protocols described in the Work Planning and Control Activity BU0111 (Combustion Laboratory) and the following health and safety training:

- EHS0348 Chemical Hygiene and Safety
- EHS0604 Hazardous Waste Generator Training
- EHS0171 Pressure Safety
- EHS0278 Ladder Safety Training
- EHS0059 Ergo Self-Assessment for Computer Users
- EHS0260 General Electrical Safety
- EHS0520 Fire Extinguisher Safety-Part 1
- EHS0522 Fire Extinguisher Safety-Part 2
- EHS0346 Chemical Management System Web Application Training
- EHS0103 Gas Cylinder Safety
- ETA0010 ETA Safety Overview

## **2.2 Data Reduction and Calculation of Metrics**

As described above, the data obtained from an experiment included the following:

- Fuel composition from PG&E
- Fuel supply pressure, fuel volume consumed, and volumetric flow rate
- Ambient/combustion air temperature and relative humidity
- Exhaust temperature at the point of pollutant sampling and draft diverter temperature (if applicable)
- Time-resolved concentrations of exhaust constituents ( $O_2$ ,  $CO_2$ ,  $CO$ ,  $NO$ ,  $NO_x$ , and calculated  $NO_2$ ) measured during periods of burner operation, cool-down periods, and background periods.

Raw data were saved by the custom Python system as comma-delimited text files. For each experiment, individual data files were imported and analyzed using Python and R. In the following, we describe the calculations performed on the raw data to obtain the results presented later in this report.

### *Offsetting Negative Measurement Values*

Due to process and measurement noise, some measurements obtained were very small negative values (e.g., -2 ppm of CO concentration). These values correspond to zero. We used the following approach to shift measurements upward and correct this zero-bias issue for each stage (e.g., combustion, cooling, etc.) of the evaluation process:

$$v'_{n,i} = v_{n,i} - \min(0, m_n), i = 1, 2, \dots, T_n, n = 1, 2, \dots, N$$

where:

- $v_{n,i}$  original value measured at the time step  $i$  of the  $n^{th}$  stage of the evaluation process
- $v'_{n,i}$  corrected value of the measurement taken at the time step  $i$  of the  $n^{th}$  stage of the evaluation process
- $m_n$  minimum value of the measurements from the start of the first evaluation stage to the end of the  $n^{th}$  stage of the evaluation process
- $T_n$  last time step of the  $n^{th}$  stage of the evaluation process
- $N$  total number of stages in the evaluation process

Note that, according to the equation above, no corrections were made to measurements when no negative values were obtained for each stage of the evaluation process and all stages that precede it.

### *Emission Factors Estimation*

Emissions of gases in the exhaust were measured as concentration, in parts-per-million (*ppm*). We converted concentrations of these gases into emissions factors (EF), expressed in pounds per million Btu (*lbm/MMbtu*), using the approach adopted by Gartland et al. (2023a):<sup>8</sup>

$$EF = \frac{PPM \times W \times FF \times 20.9}{(20.9 - O_2) \times MV}$$

where:

---

<sup>8</sup> Based on U.S. EPA (2023).

*PPM* Measured pollutant concentration (*ppm*)

*W* Pollutant's molecular weight (*lbm/lbmol*):

- CO: 28.0097
- NO<sub>x</sub> (as NO<sub>2</sub>): 46.0047
- CH<sub>4</sub>: 16.04206

*FF* Fuel factor (*lbm/MMbtu*), calculated using dry weight percentages of each element in the natural gas used as:

$$0.0765 \times SG \times \frac{10^6 \times (3.64 \times \%H + 1.53 \times \%C + 0.57 \times \%S + 0.14 \times \%N - 0.46 \times \%O)}{HHV}$$

where *SG* is the specific gravity of the natural gas (see Table 3)

*HHV* Higher heating value of the natural gas used (see Table 3)

*O<sub>2</sub>* Measured oxygen percentage in the exhaust stream

*MV* Molar volume (dry) (*ft<sup>3</sup>/lbmol*): 385.3 at 68°F and 1 atmosphere

For the calculation of the fuel factor (FF), we calculated the dry weight mass percentages of each element based on the natural gas composition and the molecule formulas of the natural gas components, assuming that 100% of hydrocarbon content was methane<sup>9</sup> and that no sulfur was included. As an example, considering the composition of the natural gas used for evaluating DHE14, on October 13, 2023, the dry weight mass percentage of each element in one mole of natural gas was calculated as follows:

$$\%C = \frac{M_C}{M_{NG}} = 73.2\%$$

$$\%H = \frac{M_H}{M_{NG}} = 24.3\%$$

$$\%O = \frac{M_O}{M_{NG}} = 1.7\%$$

$$\%N = \frac{M_N}{M_{NG}} = 0.8\%$$

---

<sup>9</sup> Note this does not correspond to the actual composition of the natural gas used during the experiments. Nevertheless, the assumption does not significantly affect the emission factors reported in Section 3.

where:

$M_{NG}$

Molar mass of the natural gas:

$$M_{NG} = M_c + M_H + M_O + M_N = 16.35$$

with the molar mass of each element calculated as:

$$M_C = 12.011 \times (\%mol_{CH_4} + \%mol_{CO_2}) = 11.96$$

$$M_H = 4 \times 1.00784 \times \%mol_{CH_4} = 3.98$$

$$M_O = 2 \times 16 \times \%mol_{CO_2} = 0.28$$

$$M_N = 2 \times 14.0067 \times \%mol_{N_2} = 0.12$$

and:

$\%mol_{CH_4}$

Percentage of methane in one mole of natural gas:

$$\%mol_{CH_4} = 100\% - \%mol_{CO_2} - \%mol_{N_2} = 98.7\%$$

where  $\%mol_{CO_2}$  and  $\%mol_{N_2}$  are, respectively, the percentage of  $CO_2$  and  $N_2$  in one mole of natural gas (see Table 3)

The  $NO_x$  emission factors calculated above correspond to  $NO_x$  emission levels measured at the 0%  $O_2$  reference level. Note that  $NO_x$  emission levels are sometimes expressed referencing a particular oxygen level (e.g., 40 ppm at 3%  $O_2$  level). To convert  $NO_x$  emission levels from one reference level of  $O_2$  to another reference level, one can use the following formula:

$$EL'_{NO_x} = EL_{NO_x} \times \frac{(20.95 - O'_2)}{(20.95 - O_2)}$$

where:

$EL'_{NO_x}$   $NO_x$  emission level at the adjusted level of  $O_2$

$EL_{NO_x}$   $NO_x$  emission level at the base level of  $O_2$

$O'_2$  Adjusted level of  $O_2$  (%)

$O_2$  Base level of  $O_2$  (%)

Using the formula above, the  $NO_x$  emission levels at the 3% reference level of  $O_2$  would be approximately 85.7% of the values at the 0%  $O_2$  reference level presented in this report.

To calculate average emission factors during steady-state operation, we averaged the last five

minutes of steady-state operation from the first combustion evaluation stage of each unit. For modulating units, we averaged the last five minutes of the steady-state operation from the first high-power combustion evaluation stage. All emission factors calculated in pounds per million Btu were also converted to, and are presented in nano-grams per Joule.

## 2.3 DHE Units Evaluated

Twelve DHE units were evaluated using the procedures described in Section 2.1. DHE units included eight low-efficiency units and four high-efficiency units. The low-efficiency units were of varying ages and removed from households in California; the high-efficiency units (bottom four listed in table) were purchased new in 2022. Table 4 presents the main characteristics of the DHE units.<sup>10</sup> Figure 4 shows images of the units evaluated.

**Table 4. DHE Units Evaluated**

Unit Id	Brand and Model	Type <sup>a</sup>	Rated Capacity <sup>b</sup>	AFUE <sup>c</sup>
DHE01	Montgomery Ward SBI 9084	WF	20.0	51.4%
DHE05	Williams 2001622A	RH	20.0	71.0%
DHE10	Perfection Schwank VC235TN-W-1	RH	35.0	64.0%
DHE11	Williams 3509822	WF <sup>d</sup>	35.0	70.0%
DHE14	Sears 600	WF <sup>e</sup>	50.0	75.0%
DHE16	Williams 2509622	WF	25.0	70.0%
DHE19	Williams 14DV-3-NAT	DV	14.0	62.4%
DHE22	Williams 30DV-5	DV	30.0	70.0%
R11	Rinnai EX11	DV	11.0	81.0%
R38	Rinnai EX38	DV	38.4	80.0%
W2030	Williams AC2030	WF	30.0	82.0%
W3040	Williams AC3040	WF <sup>e</sup>	40.0	80.0%

<sup>a</sup> DV: Direct-vent, console wall furnace

WF: Upright, vertically vented wall furnace

RH: Room heater.

<sup>b</sup> Input capacity in kBtu/hr.

<sup>c</sup> Annual Fuel Utilization Efficiency (AFUE) is a metric that expresses furnace energy efficiency.

<sup>d</sup> The unit includes an external circulation fan, mounted on top of the unit.

<sup>e</sup> Double-sided unit.

<sup>10</sup> All units are natural gas DHE.



A variety of brands and types of DHE were represented in the selection of units, including high-efficiency direct-vent Rinnai models, vintage and high-efficiency Williams models, and vintage Montgomery Ward, Perfection Schwank, and Sears models. Four units were direct-vent wall furnaces, six were upright and vertically vented wall furnaces, and two were room heaters. The units ranged in input capacity from 11 to 50 kBtu/hr. Two units had an input capacity of 30 kBtu/hr; half of the remaining units had an input capacity below 30 kBtu/hr and half above that level. The rated AFUE values of the units evaluated ranged from 51.4 to 82 percent. Of the eight vintage units, only five would meet the current federal minimum efficiency standards.<sup>11</sup> The low-efficiency units use single-stage burners; the high-efficiency ones are modulating furnaces. Additionally, two of the units, namely the high-efficiency Williams models AC2030 (W2030) and AC3040 (W3040), are ultra-low NO<sub>x</sub>.<sup>12</sup>

The 12 units were evaluated according to the protocol described in Section 2.1 above. Figure 4 and Figure 5 show images of the units as they were evaluated in the laboratory.

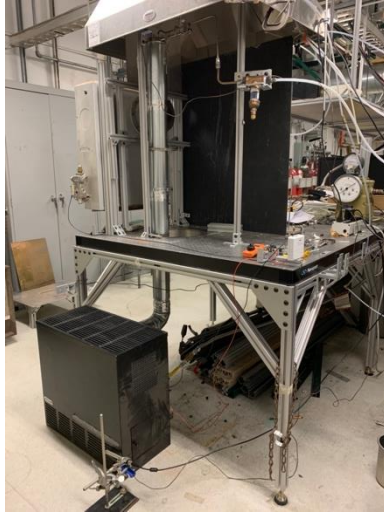
---

<sup>11</sup> The current federal minimum energy efficiency standards for DHE are available in Table VI.66 of the following energy conservation program rule: <https://www.federalregister.gov/documents/2010/04/16/2010-7611/energy-conservation-program-energy-conservation-standards-for-residential-water-heaters-direct>. The standards apply to DHE manufactured for sale in the United States, or imported into the United States, on or after April 16, 2013.

<sup>12</sup> Ultra-low NO<sub>x</sub> furnaces use burners designed to minimize NO<sub>x</sub> emissions during combustion. These burners achieve stable combustion at lower flame temperatures, resulting in reduced NO<sub>x</sub> production. Ultra-low NO<sub>x</sub> furnaces typically emit less than 9 ppm at 3% oxygen concentration when using fuel gas recirculation (FGR). Without FGR, the emissions can often be kept below 25 ppm at 3% oxygen concentration, which is still significantly lower than what conventional burners emit. Ultra-low NO<sub>x</sub> central furnaces are currently required in some counties in California, but the requirement does not currently apply to DHE.



DHE01



DHE05



DHE10



DHE11



DHE14



DHE16

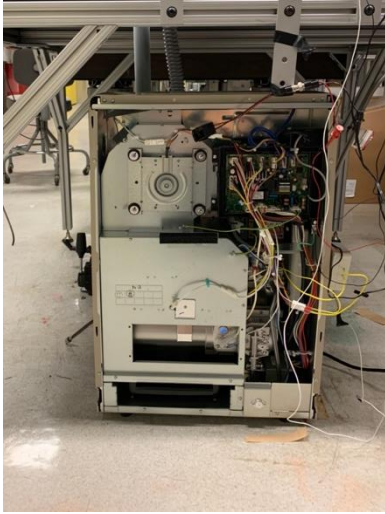


DHE19

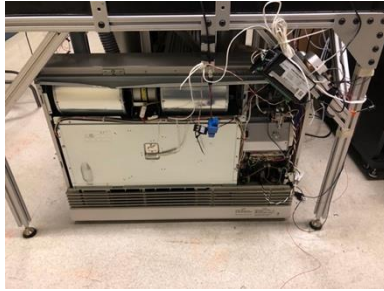


DHE22

**Figure 4. Images of the Low-Efficiency DHE Units Evaluated**



R11



R38



W2030



W3040

**Figure 5. Images of the High-Efficiency DHE Units Evaluated**



### 3. Results and Discussion

Table 5 and Table 6 summarize the results for all DHE units evaluated. The results include natural gas input rates and power consumption; emission factors for NO<sub>x</sub>, CH<sub>4</sub>, and CO (estimated from concentrations in the combustion exhaust); and oxygen and CO<sub>2</sub> concentrations in the combustion exhaust.

Table 5 lists the measured natural gas and electricity used by all DHE units evaluated. For those units with a pilot light or a fan, the inputs associated with these features are listed in addition to the natural gas and electricity use of the whole unit. As noted in Section 2, all measurements reported represent average values during the steady-state periods of the evaluations and do not include startup.

DHE units that used pilot lights to ignite the burner used an average of 0.65 kBtu/hr (ranging from 0.31 to 1.19 kBtu/hr) of natural gas to fuel the pilot. This corresponds, on average, to 3.2% (0.8% - 9.5%) of the natural gas used to operate the main burner (excluding the natural gas used by the pilot light) during the steady-state periods of the evaluations.<sup>13</sup> It is also important to recognize that the pilot remains on during the main burner operation and contributes to heat production. Most of the unit's measured heat input matched the rated heat input except for DHE01 and DHE22 where the measured heat input was about half of the rated value. One possible explanation for DHE01 is that the unit was labeled for use with propane instead of natural gas. Although the homeowner noted the unit was converted to operate with natural gas, it is possible it was not done correctly (e.g., wrong fuel supply orifice or did not adjust supply pressure in unit regulator), resulting in lower natural gas fuel supply rates and lower heat input.

The two units using the most electrical power were the Rinnai EX38 direct-vent wall furnace (R38) and the Sears 600 double-sided wall furnace (DHE14). In both units, the fans used more than half of the total power used by the unit. Across all units with a fan, the fans' power ranges from 15% to 92% of the total power used by the unit. Worth noting, the electricity used by units with a fan is lower than the energy used by a typical pilot burner (except for the two highest electricity consumption units, where the former is greater than the latter). The two units with the highest electricity consumption, along with the Williams AC3040 double-sided wall furnace (W3040), also used the most natural gas, which is to be expected as these three units have the highest input BTU rating (Table 4). The Montgomery Ward SBI 9084 wall furnace (DHE01) used the least natural gas and had the lowest input BTU rating of the non-modulating units.

Table 6 lists the emissions factors for NO<sub>x</sub>, CH<sub>4</sub>, and CO. The concentration of these gases was measured in the flue during steady-state periods of the evaluations and then converted to emission factors based on the methodology described in Section 2.2. Overall, the Rinnai EX11 (R11) direct-vent unit shows the highest methane and CO emission factors, while the Williams

---

<sup>13</sup> Note: when considering how DHE is used in households, assuming that pilot lights are kept on throughout the whole year, the percentage of the annual gas used by the pilot, relative to the annual gas use of the unit, would be higher.

2001622A (DHE05) and Perfection Schwank VC235TN-W-1 (DHE10) show the highest NO<sub>x</sub> emissions emission factors. The lowest NO<sub>x</sub> emission factors were from the Williams AC2030 (W2030) and AC3040 (W3040) wall furnaces.<sup>14</sup> Many of the piloted units produced non-negligible amounts of CO and CH<sub>4</sub> during stand-by periods, when only the pilot was lit. Table 7 presents pilot burner emission factors per unit of fuel energy and time during pilot stand-by periods.

**Table 5. Natural Gas Input Rates and Power**

Unit Id	Brand and Model	Venting Type <sup>e</sup>	Input Rating <sup>a</sup> <i>kBtu/hr</i>		Electric Power <sup>a</sup> <i>W</i>	
			Unit <sup>f</sup>	Pilot <sup>b</sup>	Unit	Fan <sup>c</sup>
DHE01	Montgomery Ward SBI 9084	Direct	11 (20.0)	0.95	-	-
DHE05	Williams 2001622A	B-vent	19 (20.0)	0.44	-	-
DHE10	Perfection Schwank VC235TN-W-1	B-vent	37 (35.0)	0.54	-	-
DHE11	Williams 3509822	B-vent	38 (35.0)	0.31	-	n/a <sup>d</sup>
DHE14	Sears 600	B-vent	44 (50.0)	1.19	129	119
DHE16	Williams 2509622	B-vent	27 (25.0)	1.06	-	-
DHE19	Williams 14DV-3-NAT	Direct	12 (14.0)	0.37	-	-
DHE22	Williams 30DV-5	Direct	19 (30.0)	0.31	-	-
R11	Rinnai EX11	Direct	6-12 (11.0)	-	40-50	15-21
R38	Rinnai EX38	Direct	16-43 (38.4)	-	91-133	50-86
W2030	Williams AC2030	B-vent	22-33 (30.0)	-	19-24	3.2-3.3
W3040	Williams AC3040	B-vent	34-44 (40.0)	-	58-68	19-21

<sup>a</sup> Estimated from measured values. Ranges denote results that vary due to unit modulation, with the first value corresponding to the lowest capacity and the second to the highest capacity.

<sup>b</sup> Standby pilot. Values are calculated based on measurements from the Singer gas meter.

<sup>c</sup> Convection (circulation) fan.

<sup>d</sup> External circulation fan, mounted on top of the unit and not installed for laboratory evaluation.

<sup>e</sup> B-vent is a standard, double wall vent where the appliance has a draft diverter and combustion air is taken from the room; direct venting indicates that combustion air is taken from outside the home near where the appliance is exhausting, but combustion air and exhaust air do not mix. No draft diverter is present in direct vent units.

<sup>f</sup> Values within parenthesis refer to the unit's nameplate input capacity.

<sup>14</sup> This is consistent with the models' technical specifications that show they are both ultra-low-NO<sub>x</sub> furnaces.

**Table 6. NO<sub>x</sub>, CH<sub>4</sub>, and CO Emission Factors During Steady-State Operation**

Unit Id	NO <sub>x</sub>		CH <sub>4</sub>		CO	
	<i>lbm/MMbtu</i>	<i>ng/J</i>	<i>lbm/MMbtu</i>	<i>ng/J</i>	<i>lbm/MMbtu</i>	<i>ng/J</i>
DHE01	0.06	25.8	0.0003	0.1	0.009	3.9
DHE05	0.14	60.2	0.0011	0.5	0.001	0.4
DHE10	0.14	60.2	0.0009	0.4	0.001	0.4
DHE11	0.12	51.6	0.0005	0.2	0.001	0.4
DHE14	0.13	55.9	0.0004	0.2	0.002	0.9
DHE16	0.12	51.6	0.0008	0.3	0.001	0.4
DHE19	0.13	55.9	< 0.0001	< 0.04	0.001	0.4
DHE22	0.09	38.7	< 0.0001	< 0.04	0.002	0.9
R11	0.10 - 0.14	43.0 - 60.2	0.0034 - 0.0122	1.5 - 5.2	0.026 - 0.041	11.2 - 17.6
R38	0.08 - 0.09	34.4 - 38.7	0.000022 - 0.0034	0.009 - 1.5	0.013 - 0.019	5.6 - 8.2
W2030	0.006 - 0.012	2.6 - 5.2	0.0013 - 0.0021	0.6 - 0.9	0.003 - 0.005	1.3 - 2.1
W3040	0.009 - 0.016	3.9 - 6.9	0.0012 - 0.0014	0.5 - 0.6	0.001 - 0.003	0.4 - 1.3

<sup>a</sup> Ranges denote results vary due to unit modulation, with the first value corresponding to the lowest capacity of the model and the second to the highest capacity.

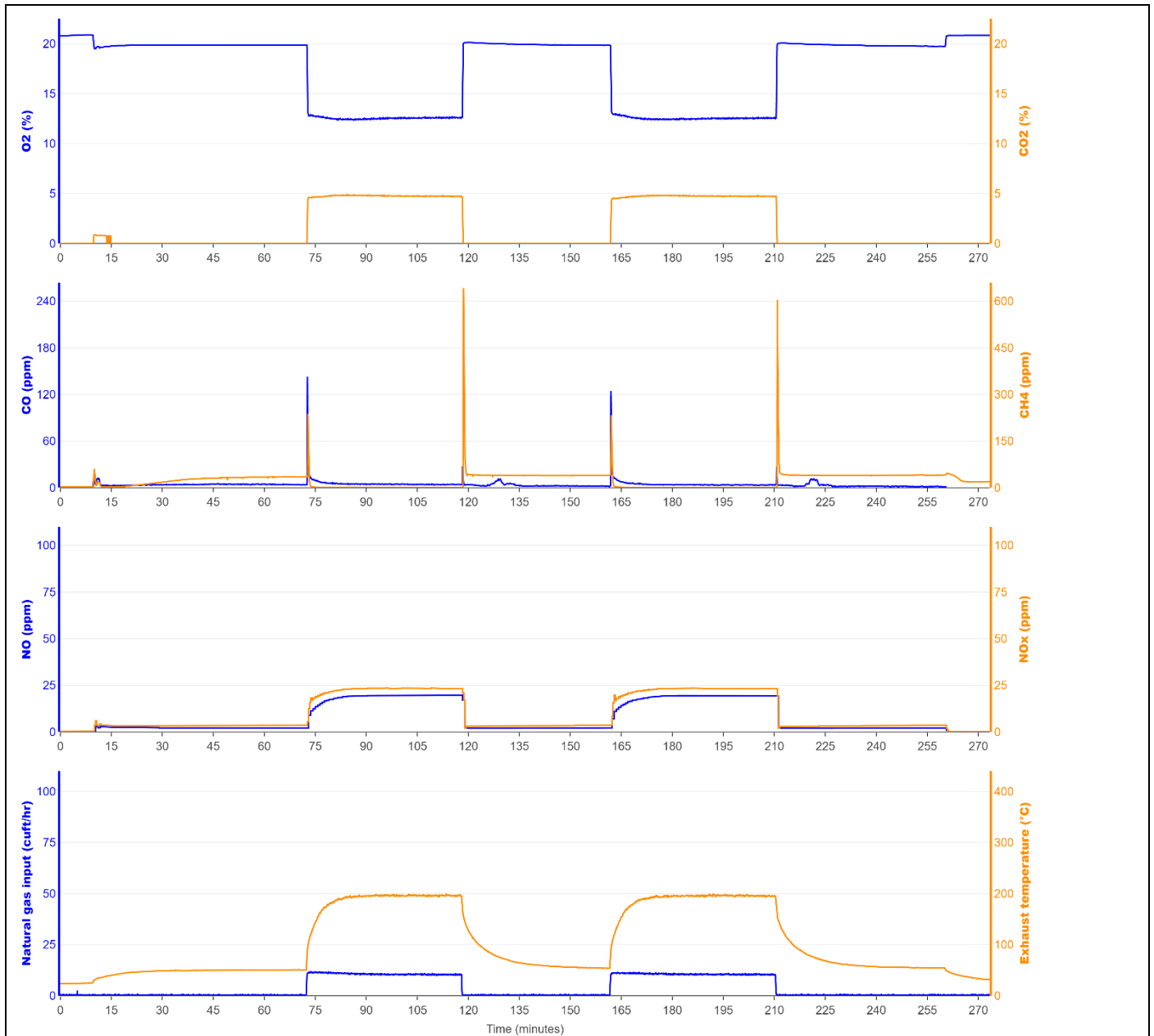
<sup>b</sup> Emissions factors reported as <0.0001 lbm/MMbtu or <0.04 ng/J suggest that the concentrations measured are below the test equipment accuracy.

Figure 6 through Figure 21 present O<sub>2</sub>, CO<sub>2</sub>, CO, CH<sub>4</sub>, NO, and NO<sub>x</sub> concentrations in the flue, as well as natural gas input and exhaust temperature during the evaluations. For all units, NO<sub>x</sub> emissions are primarily (75%–90%, depending on the unit) NO instead of NO<sub>2</sub>. As expected, the ultra-low NO<sub>x</sub> units, W2030 and W3040, had the lowest measured NO<sub>x</sub> concentrations over the course of operation. For the W3040 unit (Figure 20), NO<sub>x</sub> increased sharply before rapidly declining after start-up. NO<sub>x</sub> increased only slightly before rapidly declining for the W2030 unit (Figure 21).

DHE14 (Figure 11), DHE16 (Figure 13), and DHE19 (Figure 15) produced the most CO and CH<sub>4</sub>, with average concentrations ranging from 346 ppm to 643 ppm at the 3% O<sub>2</sub> level for CO and 379 ppm to 1257 ppm at the 3% O<sub>2</sub> level for CH<sub>4</sub>. Methane concentrations also momentarily increased when turning on and off the main burner for all units due to ignition delays and residual unburned fuel after extinction. Additional operating details and experimental notes for the DHE units are provided below each figure.

**Table 7. NO<sub>x</sub>, CH<sub>4</sub>, and CO Pilot Burner Emission Factors During Stand-By Periods (per unit of energy and time)**

Unit Id	NO <sub>x</sub>		CH <sub>4</sub>		CO	
	<i>lbm/MMbtu</i>	<i>ng/J</i>	<i>lbm/MMbtu</i>	<i>ng/J</i>	<i>lbm/MMbtu</i>	<i>ng/J</i>
DHE01	0.066	28	0.263	113	0.022	9
DHE05	0.042	18	0.150	64	0.135	58
DHE10	0.070	30	0.038	16	0.073	31
DHE11	0.069	30	0.069	30	0.082	35
DHE14	0.036	16	0.504	217	0.415	179
DHE16	0.046	20	0.413	177	0.235	101
DHE19	0.047	20	0.181	78	0.273	117
DHE22	0.041	18	0.084	36	0.165	71
	NO <sub>x</sub>		CH <sub>4</sub>		CO	
	<i>lbm/hr</i>	<i>g/hr</i>	<i>lbm/hr</i>	<i>g/hr</i>	<i>lbm/hr</i>	<i>g/hr</i>
DHE01	0.000063	0.0286	0.000250	0.113	0.000021	0.009
DHE05	0.000019	0.0085	0.000066	0.030	0.000060	0.027
DHE10	0.000038	0.0172	0.000020	0.009	0.000039	0.018
DHE11	0.000021	0.0097	0.000021	0.010	0.000025	0.011
DHE14	0.000044	0.0197	0.000602	0.273	0.000496	0.225
DHE16	0.000049	0.0221	0.000438	0.199	0.000250	0.113
DHE19	0.000017	0.0079	0.000067	0.031	0.000101	0.046
DHE22	0.000013	0.0058	0.000026	0.012	0.000051	0.023



Notes: The nameplate on this unit indicated that it was designed for liquid propane, however, the homeowner stated that it was modified to operate with natural gas. Given the low fuel consumption rate (about half of the rating), it seems something in this unit was not operating as expected. Additionally, the unit vent arrived with some damages and modifications. To ensure safe operation in the laboratory, the damaged vent was removed and replaced (see Figure 7). Further, soot was found inside the cover near the top of the unit despite being a direct vent unit. Elevated emissions were not observed in the laboratory space, so it is unclear if the unit leaked in the home or if the soot was caused by another source. Methane concentrations with the pilot operating stabilized around 34 ppm after about an hour of operation.

**Figure 6. DHE01 Emissions, Exhaust Temperature, and Fuel Consumption**





(A)



(B)



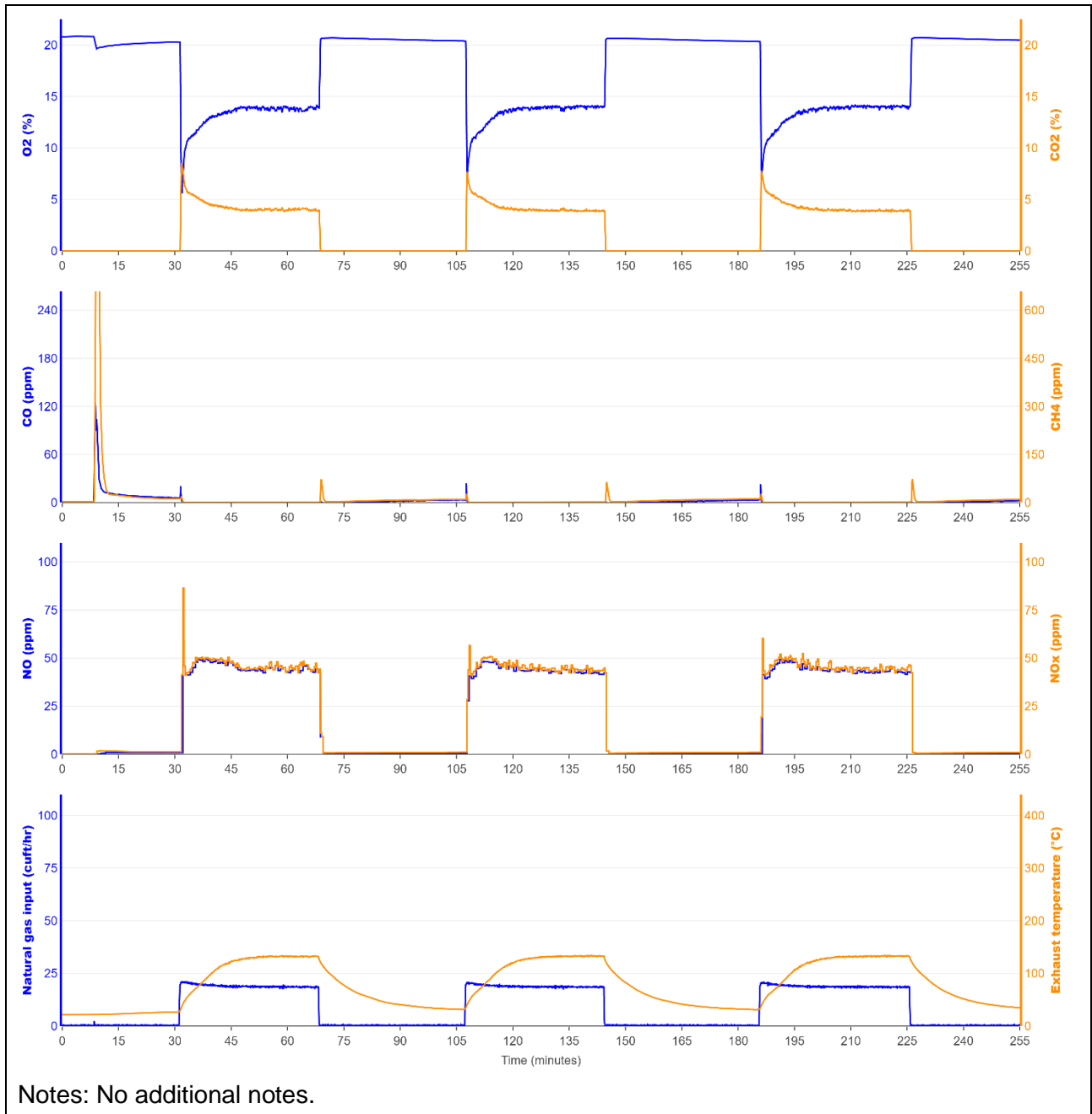
(C)



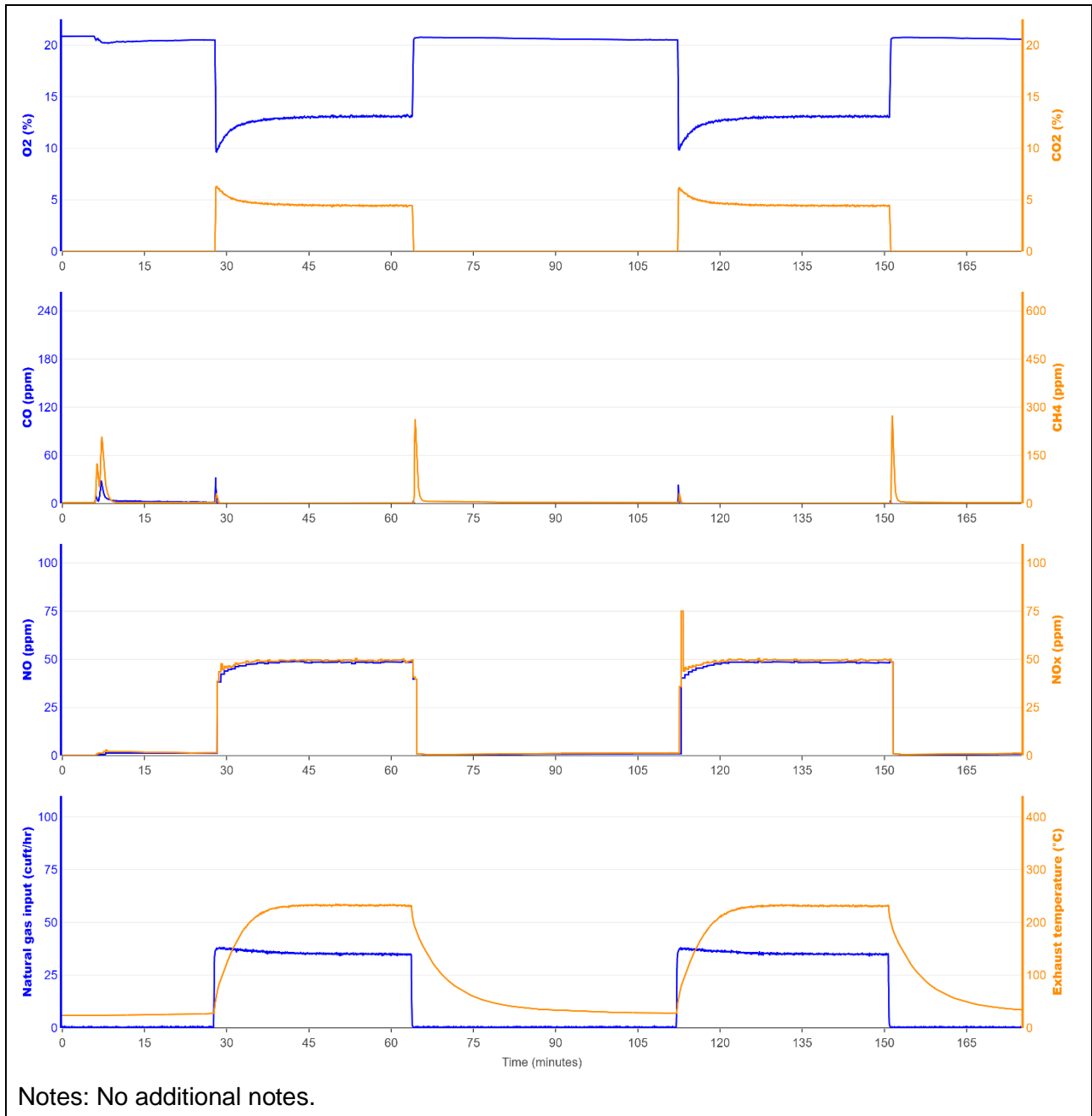
(D)

### Figure 7. Images of DHE01 Issues

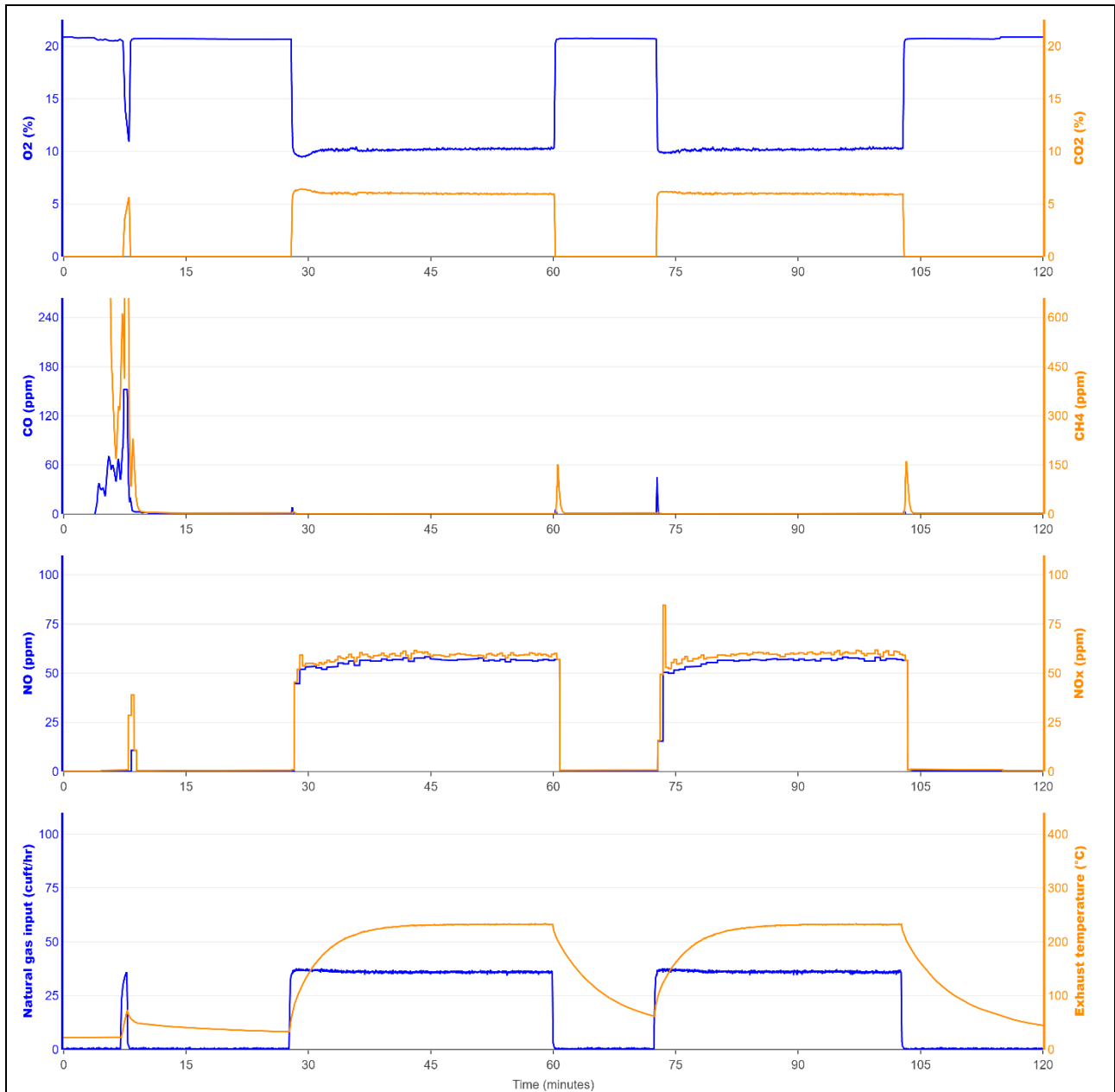
- (A) Exhaust vent on unit
- (B) Close-up of exhaust vent components removed from unit
- (C) Missing screws behind heat exchanger in unit
- (D) Soot on inside of heater cover near the top of the unit



**Figure 8. DHE05 Emissions, Exhaust Temperature, and Fuel Consumption**

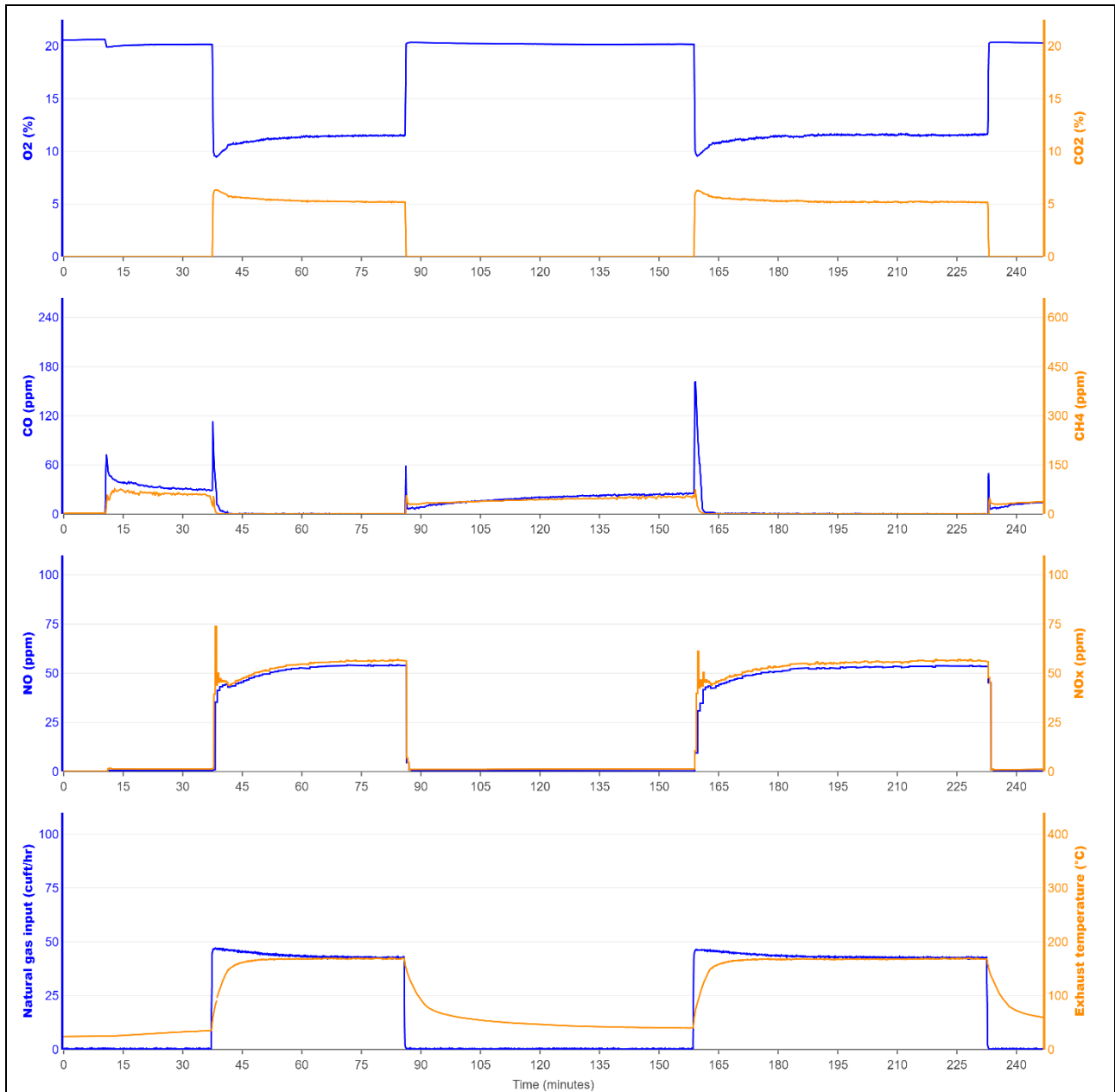


**Figure 9. DHE10 Emissions, Exhaust Temperature, and Fuel Consumption**



Notes: The pilot igniter for this unit failed and had to be lit manually using a lighter and turning on the burner at the beginning of the evaluation (as noted by the increased concentrations of CO and CH<sub>4</sub> at the beginning of the evaluation) and then immediately turning off the burner. This unit came with a blower accessory that was not evaluated with the unit. The unit also had a hole in the back panel to enable the homeowner to heat two rooms.

**Figure 10. DHE11 Emissions, Exhaust Temperature, and Fuel Consumption**



Notes: This unit had an integrated fan that required modifications to the electrical system to safely operate in the laboratory. The fan system had three settings: Automatic, Blower, and Summer. Automatic was the only setting that operated the burner. Further, the unit arrived with a damaged burner and damage to the gas supply line. The crack in the burner and gas supply line leak were repaired. The corrosion to the burner caused by the pilot was left (see Figure 12).

**Figure 11. DHE14 Emissions, Exhaust Temperature, and Fuel Consumption**



(A)



(B)



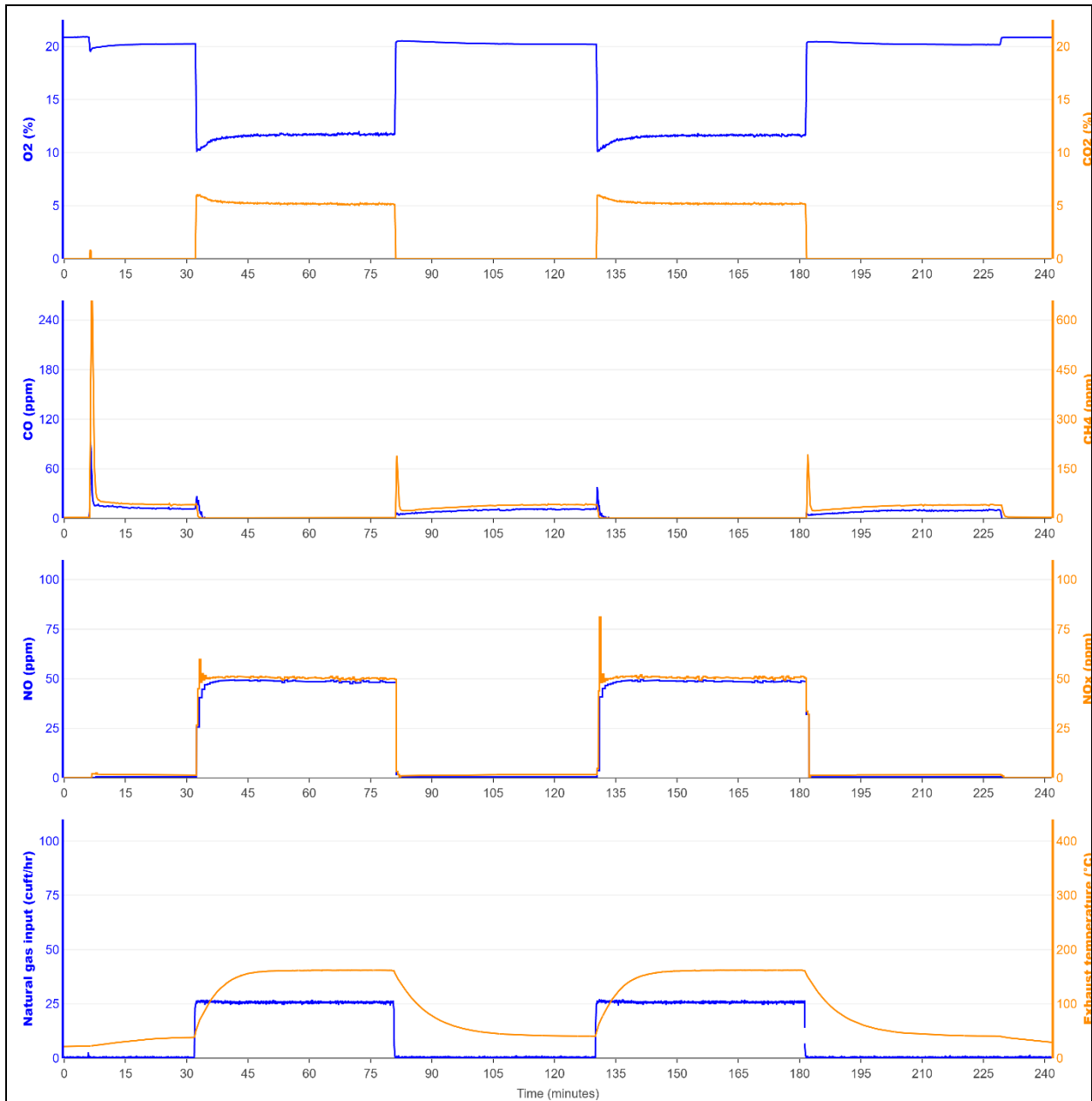
(C)



(D)

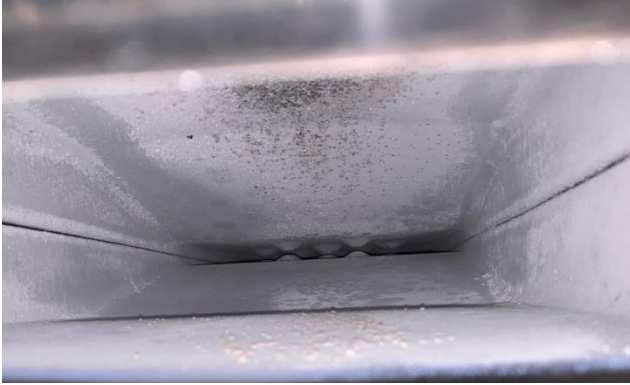
**Figure 12. Images of DHE14 Issues**

- (A) Fan control
- (B) Pilot and pilot damage to burner
- (C) Cracked nut from gas line to burner
- (D) Front profile of burner with gas line.



Notes: A significant amount of white powder leaked out from the heat exchanger of this unit. It is unclear if the powder was ash from combustion or residue from inside the unit. Because the white powder fell onto and into the burner, the flame appeared more orange-colored than blue, even after operating the unit for several hours. After evaluating the unit, we continued to find white powder in the exhaust. Additionally, the pilot flame for this burner was visibly larger than others (see Figure 14).

**Figure 13. DHE16 Emissions, Exhaust Temperature, and Fuel Consumption**



(A)

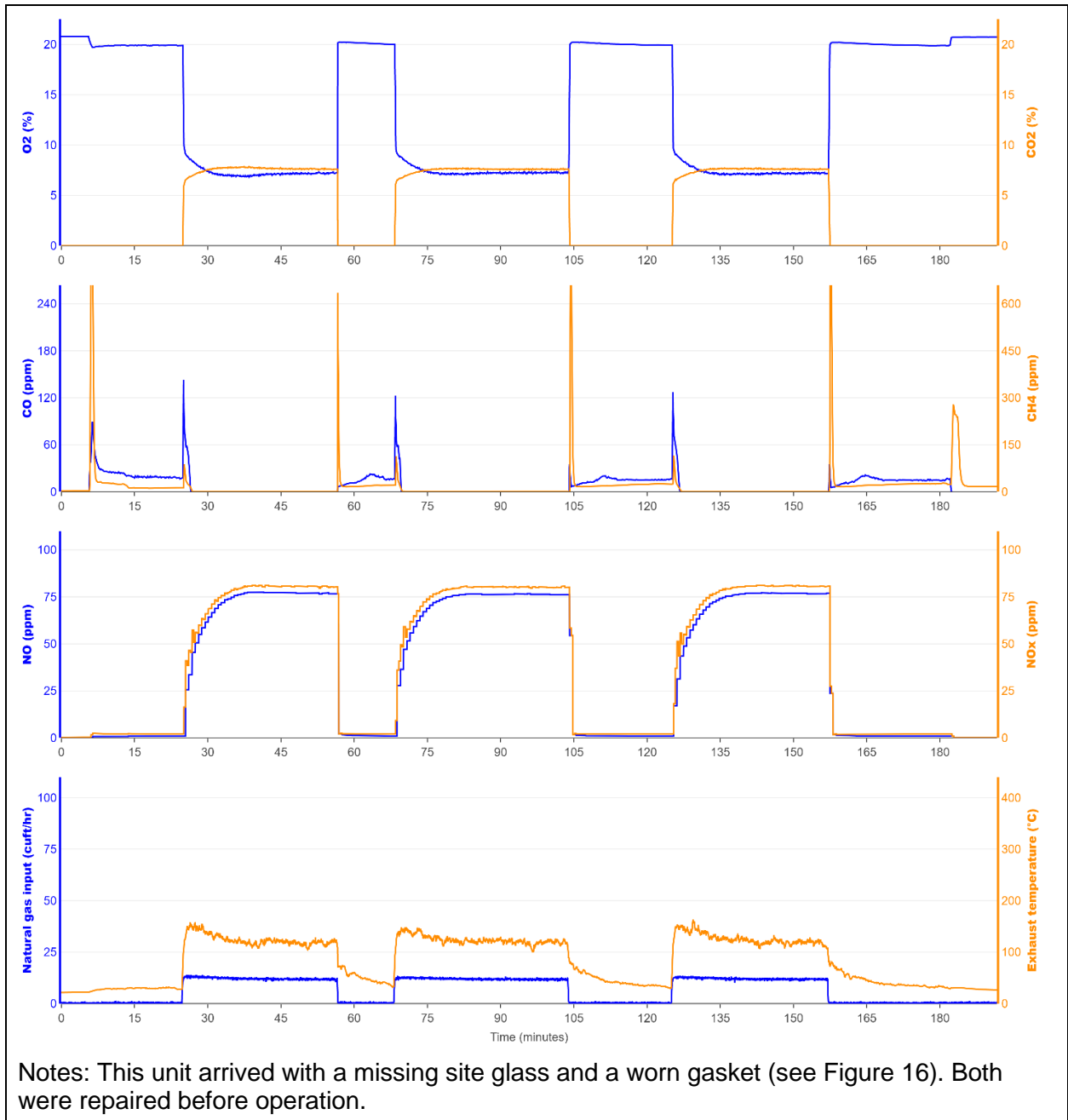


(B)

**Figure 14. Images of DHE16 Issues**

- (A) White powder inside heat exchanger
- (B) Large pilot flame on top of burner





**Figure 15. DHE19 Emissions, Exhaust Temperature, and Fuel Consumption**



(A)



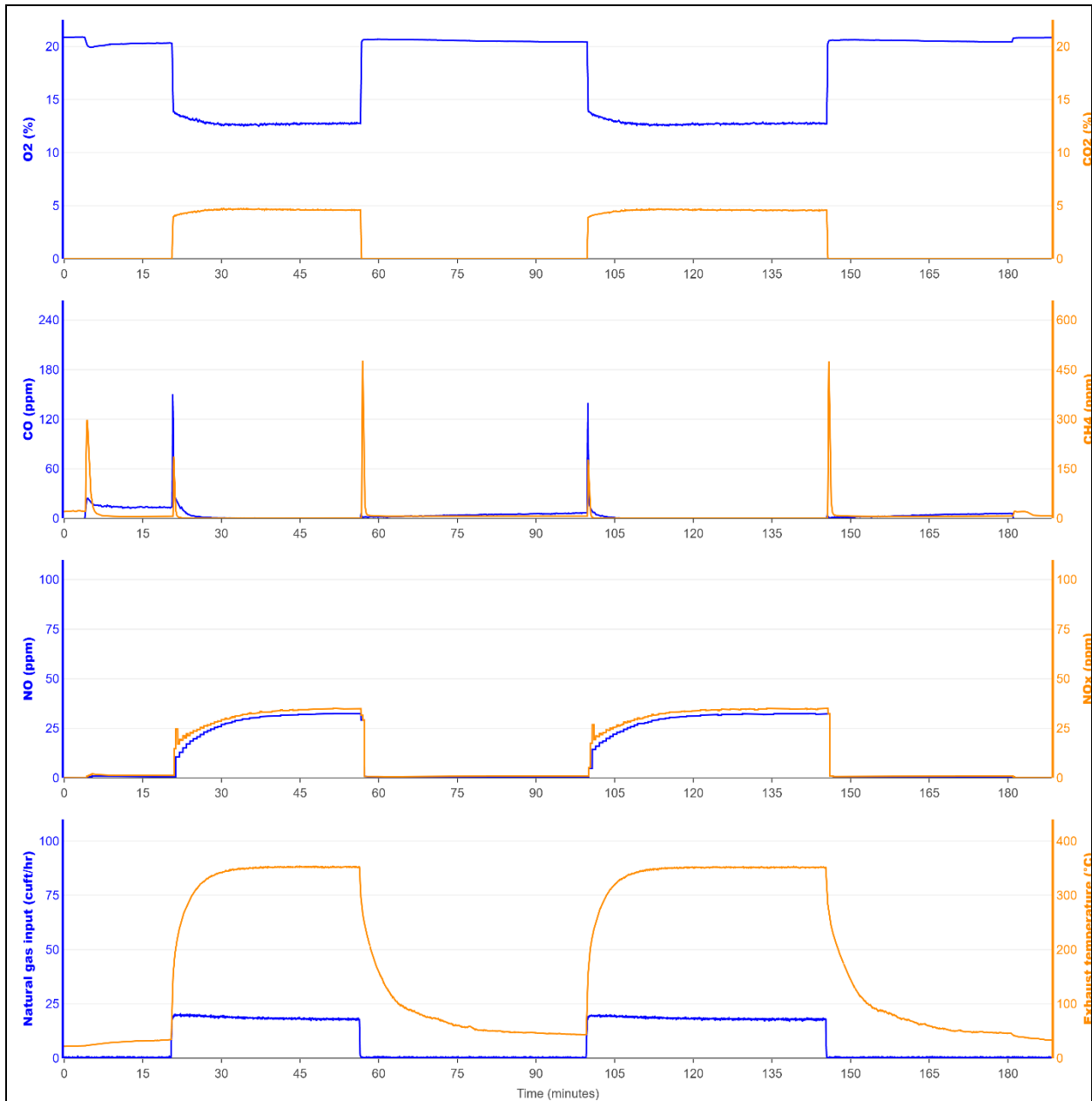
(B)



(C)

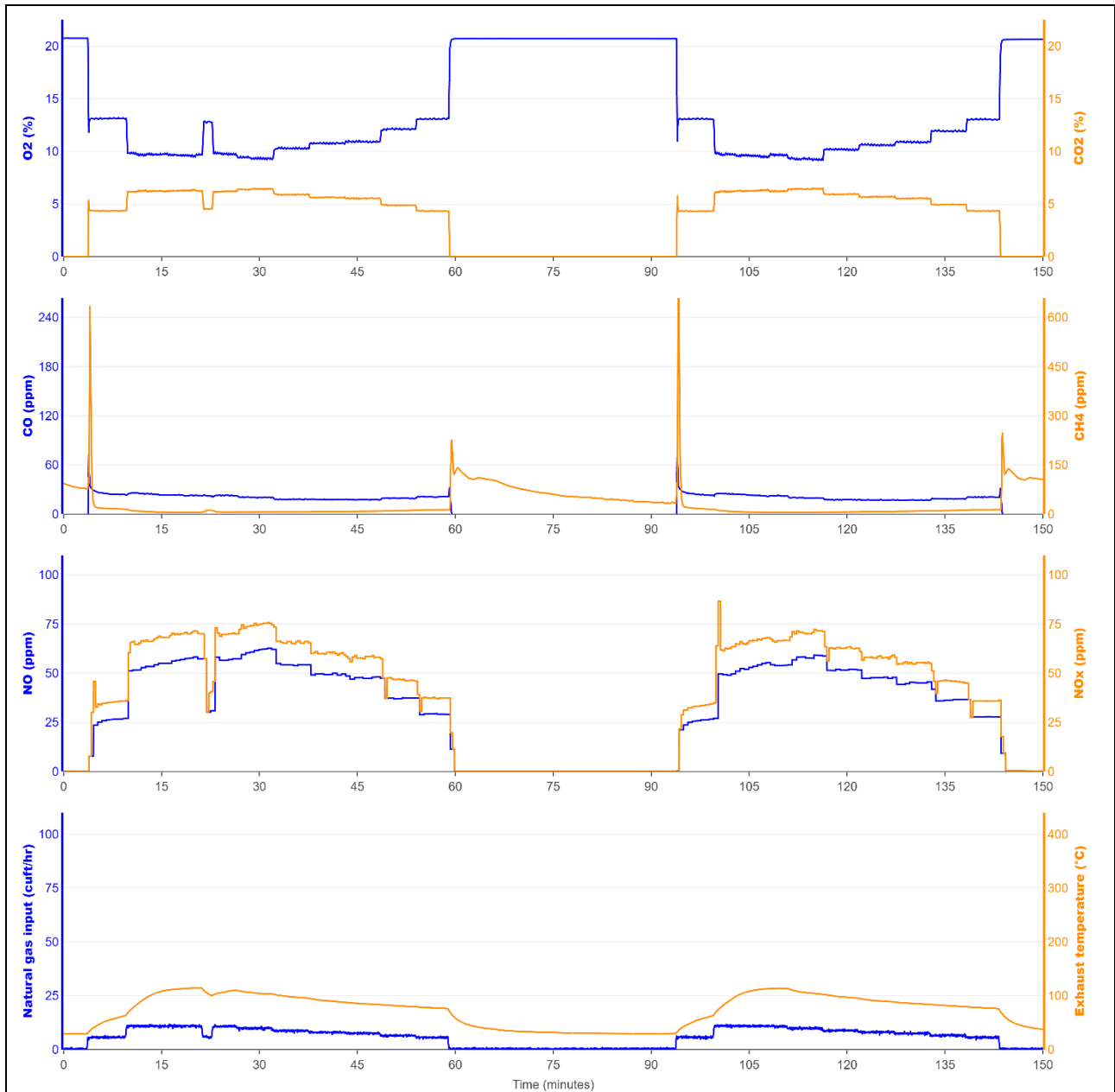
**Figure 16. Images of DHE19 Issues**

- (A) Missing site-glass
- (B) Fabricated site-glass cover
- (C) Repaired leak caused by worn gasket



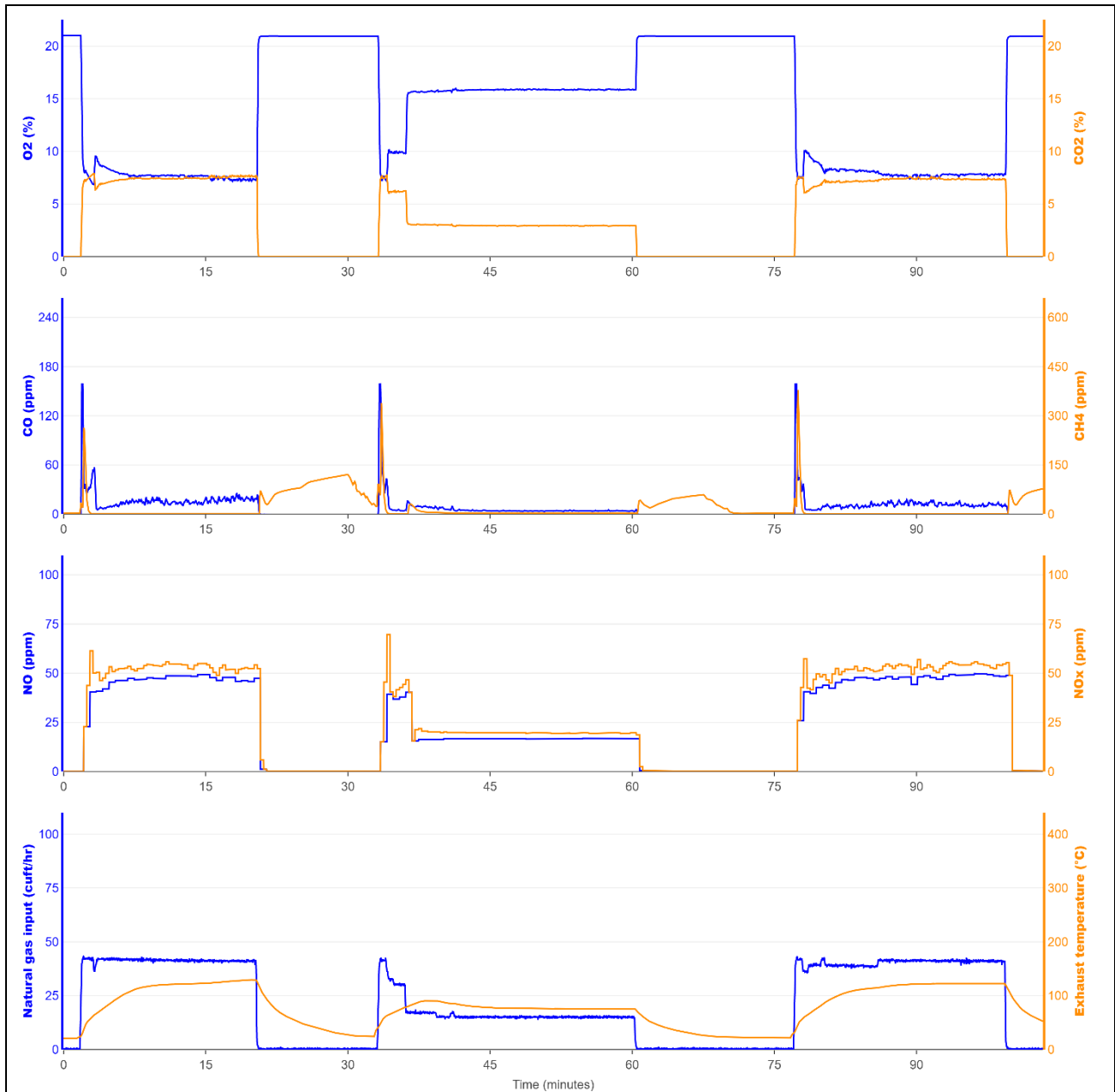
Notes: The heat input rate measured for this unit was about 36% lower than the rated value. Methane emissions were measured near the unit, but the leak was small and did not account for the lower fuel consumption rate. Further, the exhaust temperature of this unit was significantly higher than the others, reaching about 350°C, which could be due to the short distance between the back of the unit and the exhaust vent exit.

**Figure 17. DHE22 Emissions, Exhaust Temperature, and Fuel Consumption**



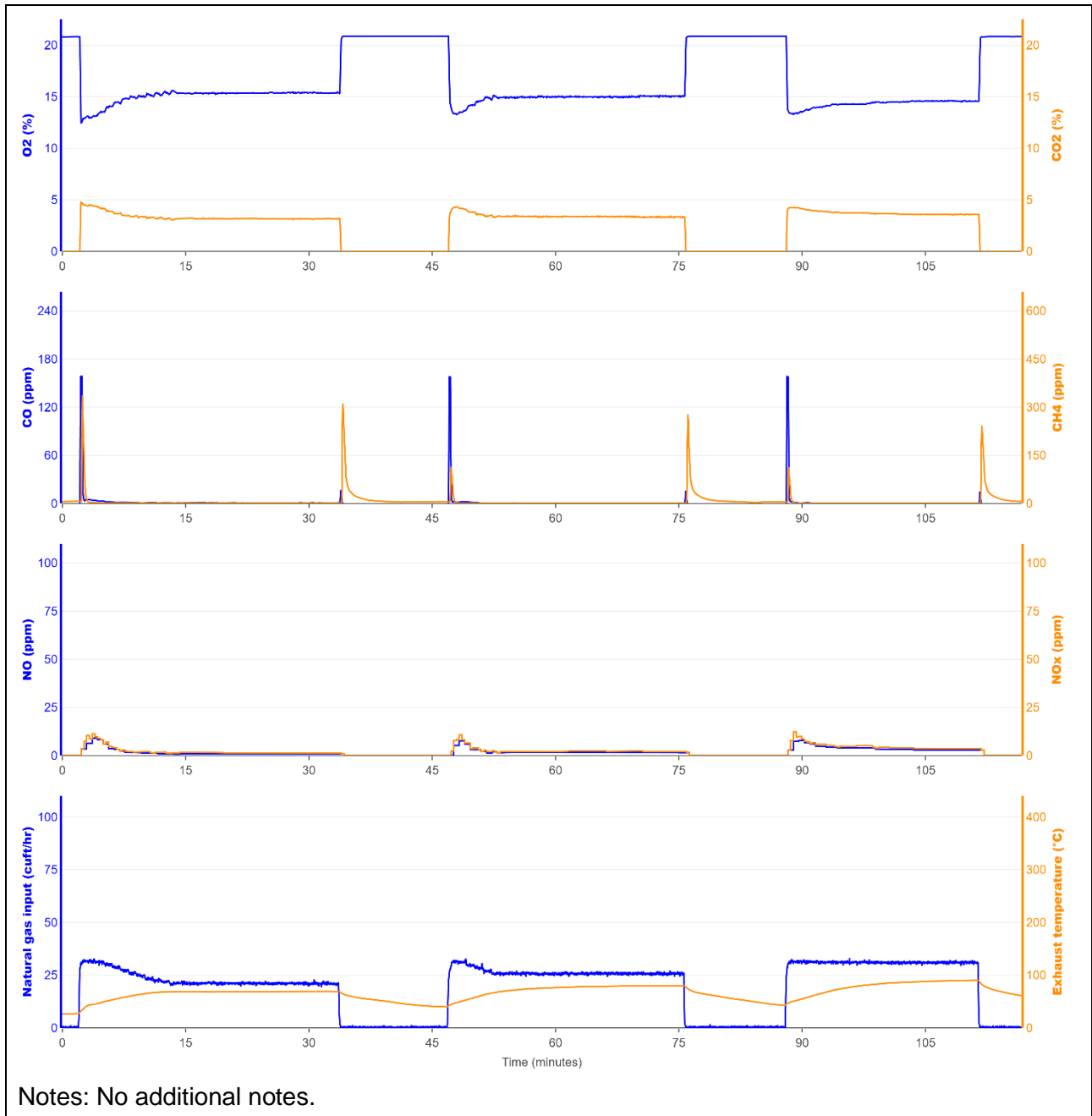
Notes: Operating diagnostics in the thermostat control were used to modulate the heat output. During the first burn, a wrong button was hit and the thermostat needed to be cycled to get back to the setpoint (hence the dip between 15 and 30 min). The burner was operated for at least 5 minutes at each heat output setpoint. Residual methane was observed in the exhaust after the burner was turned off.

**Figure 18. R11 Emissions, Exhaust Temperature, and Fuel Consumption**

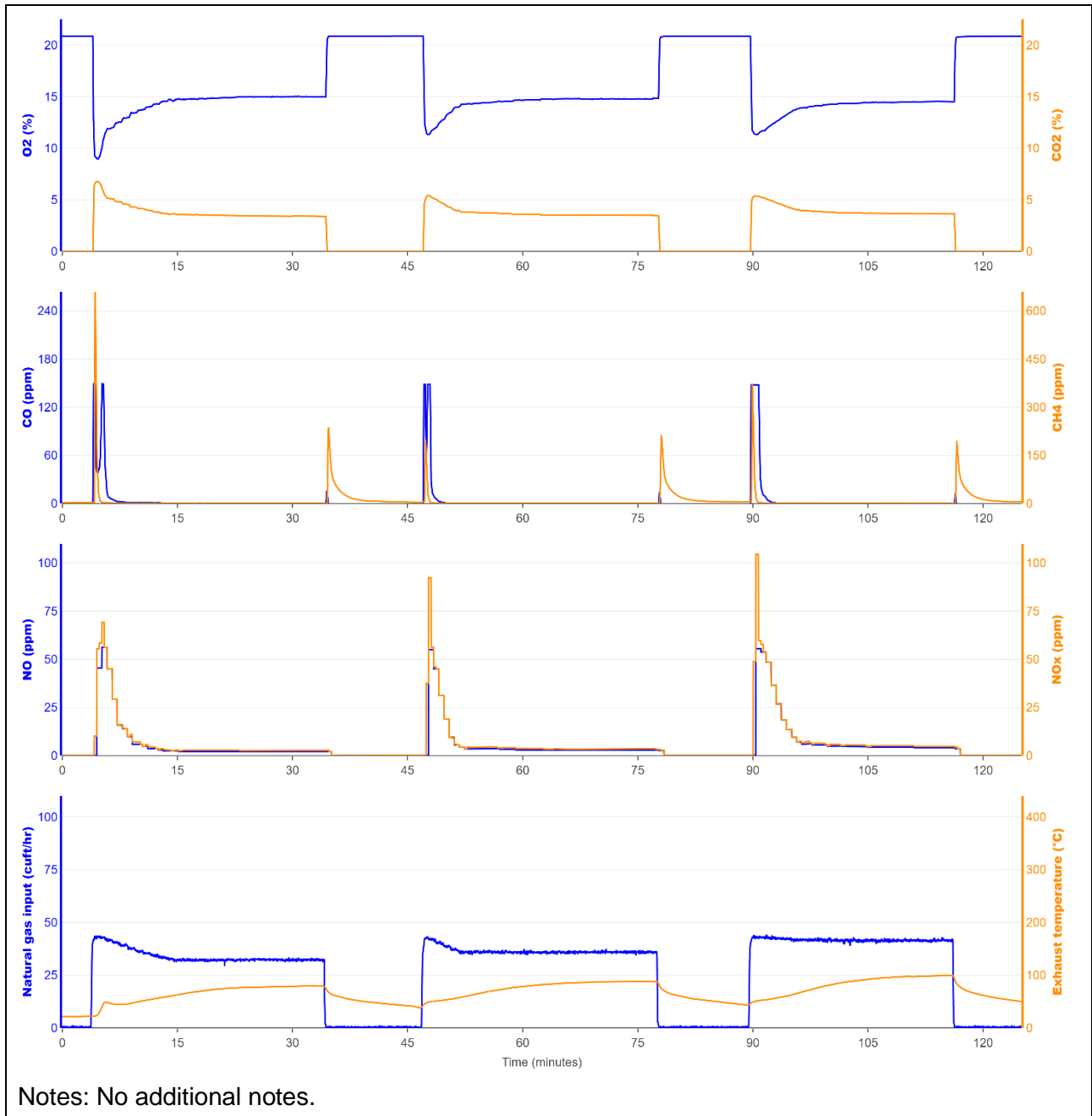


Notes: The thermostat temperature was used to control the heat output for this unit since diagnostic controls were not available. The first burn was on the highest setting and the second burn was an attempt to operate the burner on its lowest setting. The low setting was conducted once because it could not be replicated using the thermostat temperature control. The last burn is the second evaluation on the highest setting.

**Figure 19. R38 Emissions, Exhaust Temperature, and Fuel Consumption**



**Figure 20. W2030 Emissions, Exhaust Temperature, and Fuel Consumption**



**Figure 21. W3040 Emissions, Exhaust Temperature, and Fuel Consumption**

We compared our results with those from other similar studies. For the low-efficiency units, only one DHE model we evaluated (DHE11) was also assessed in another study (Gartland et al., 2023a). NO<sub>x</sub> and CO emission factors are nearly identical across the two studies. As for CH<sub>4</sub> emission factor, we find that the two results are not comparable: While we measured only CH<sub>4</sub> in the flue, Gartland et al. (2023a) list total hydrocarbons in the flue. For the high-efficiency models, two of the models we evaluated (W2030 and W3040) were also assessed in another study (Gartland et al., 2023b). The NO<sub>x</sub> emission factors are similar across the two studies, as are the CO emission factors associated with the W2030 model. The CO emission factor associated with the W3040 model listed by Gartland et al. (2023b) is higher than the emission factor we obtained from our evaluations. Concerning the CH<sub>4</sub> emission factors, similarly to what is commented above, the results are not comparable.



## 4. Conclusions

A non-negligible share of households in California rely on DHE as their primary and/or secondary source of space heating. Yet, until recently, not much was known about their gas and electricity use and their emissions. We evaluated 12 DHE units in the combustion laboratory at LBNL. Of those, eight were low-efficiency units removed from homes in California, and four were new, high-efficiency units.

We found that, when roughly pairing the units based on their input-rated capacity, the gas consumption of six, out of the eight low-efficiency models is mostly comparable to the consumption of the high-efficiency models. This is because they were all evaluated over a specific, fixed time. In real world use, the high-efficiency models would require shorter operation periods to provide the same amount of heat that the low-efficiency models would provide. Further, due to their circulation fans and their ability to modulate, they would keep the indoor temperature more uniform over time and over the heated space than the low-efficiency models would.

We also found that, except for the two models with ultra-low NO<sub>x</sub> burners, the NO<sub>x</sub> emissions from both the low- and high-efficiency models are very similar during steady-state operation. For all units, NO<sub>x</sub> emissions are primarily NO (75%–90%). Emissions of CO and CH<sub>4</sub> associated with the low-efficiency models and the two high-efficiency upright, vertically vented wall furnaces are also very similar. The two high-efficiency direct-vent, console wall furnaces, however, present CO and CH<sub>4</sub> emissions that are higher than the other models during steady-state operation. Additionally, many of the piloted units produced non-negligible amounts of CO and CH<sub>4</sub> during stand-by periods, when only the pilot was lit.

Our results, despite being obtained from a careful evaluation process, have some limitations, which primarily include assumptions about the natural gas composition<sup>15</sup> and assumptions with emission conversion calculations. Although the variability of background gas concentrations, uncertainty in the measurements due to measurement noise and error, and zero-point shifting emissions also contributed to experimental and reporting error, their contribution is not expected to significantly impact the results and conclusions presented in this report.

---

<sup>15</sup> We assumed that, besides N<sub>2</sub> and CO<sub>2</sub>, the input natural gas used was composed only of CH<sub>4</sub>.

## References

- Blum, Helcio, Victor Franco, and Sarah Price (2023): *A Survey of Direct Heating Equipment Market Actors in California*. LBNL Report. Lawrence Berkeley National Laboratory: Berkeley, CA. [https://eta-publications.lbl.gov/sites/default/files/a\\_survey\\_of\\_dhe\\_ma\\_in\\_ca\\_2023.01.05.pdf](https://eta-publications.lbl.gov/sites/default/files/a_survey_of_dhe_ma_in_ca_2023.01.05.pdf)
- Blum, Helcio, Victor Franco, Jing Ke, and Sarah Price (2024): *A Survey of Households with Direct Heating Equipment in California*. LBNL Report. Lawrence Berkeley National Laboratory: Berkeley, CA. [https://eta-publications.lbl.gov/sites/default/files/a\\_survey\\_of\\_households\\_with\\_dhe\\_in\\_california.pdf](https://eta-publications.lbl.gov/sites/default/files/a_survey_of_households_with_dhe_in_california.pdf)
- Gartland, Lisa, Carlos Ortiz, Rohit Jogineedi, Rob Kamisky, Michael Slater, Angelo Karas, and Claudia Pingatore (2023): *Improving the Performance of Wall Furnaces in California*. PIR-18-005 Final Project Report. California Energy Commission, CA. <https://www.gti.energy/california-wall-furnaces/>
- Gartland, Lisa, Brian Sutherland, and Rob Kamisky (2023a): *Baseline Wall Furnace Laboratory Test Report - Improving the Performance of Wall Furnaces in California*. PIR-18-005 Project Report. California Energy Commission, CA. <https://www.gti.energy/california-wall-furnaces/>
- Gartland, Lisa, Brian Sutherland, and Rob Kamisky (2023b): *Retrofit Wall Furnace Laboratory Test Report - Improving the Performance of Wall Furnaces in California*. PIR-18-005 Project Report. California Energy Commission, CA. <https://www.gti.energy/california-wall-furnaces/>
- Mullen, Nasim A., Jina Li, Marion L. Russell, Michael Spears, Brennan D. Less, and Brett C. Singer (2015): *Results of the California Healthy Homes Indoor Air Quality Study of 2011-2013: Impact of Natural Gas Appliances on Air Pollutant Concentrations*. Report LBNL-185629. Lawrence Berkeley National Laboratory: Berkeley, CA. <https://eta-publications.lbl.gov/sites/default/files/lbnl-185629.pdf>
- Rapp, Vi, and Brett C. Singer (2014): *Effect of Fuel Wobbe Number on Pollutant Emissions from Advanced Technology Residential Water Heaters: Results of Controlled Experiments*. Report LBNL-6626E. Lawrence Berkeley National Laboratory: Berkeley, CA. [https://eta-publications.lbl.gov/sites/default/files/lbnl-6626e\\_final.pdf](https://eta-publications.lbl.gov/sites/default/files/lbnl-6626e_final.pdf)
- Singer, Brett C., Brennan D. Less, William W. Delp, Andrew Brooks, Sebastian Cohn, and Brian Finn (2016): *A Field Study of Wall Furnace Venting and Coincident Exhaust Fan Usage in 16 Northern California Apartments*. Report LBNL-1006274. Lawrence Berkeley National Laboratory: Berkeley, CA. [https://eta-publications.lbl.gov/sites/default/files/aptventing\\_lbnl-1006274.pdf](https://eta-publications.lbl.gov/sites/default/files/aptventing_lbnl-1006274.pdf)

U.S. EPA (2023): *Method 19 - Determination of Sulfur Dioxide Removal Efficiency and Particulate Matter, Sulfur Dioxide, and Nitrogen Oxide Emission Rates*.  
[https://www.epa.gov/sites/default/files/2017-08/documents/method\\_19.pdf](https://www.epa.gov/sites/default/files/2017-08/documents/method_19.pdf)

Valmiki, M. M., et al (2013): *High Efficiency Natural Gas Wall Furnace Field Evaluation*. Assessment Report, Project Id E12SCG0018. Emerging Technologies Program, Southern California Gas Company: Los Angeles, CA. [https://www.etcc-ca.com/sites/default/files/reports/e12scg0018\\_wall\\_furnace\\_final\\_report.pdf](https://www.etcc-ca.com/sites/default/files/reports/e12scg0018_wall_furnace_final_report.pdf)